

EAGLE[®] 5 SAS Release 34.3 Commands Manual

Table of Chapters

- Chapter 1. Introduction**
- Chapter 2. Alphabetical List of Commands**
- Chapter 3. Commands Listed by Class**
- Chapter 4. Using Commands**
- Chapter 5. Commands A-C**
- Chapter 6. Commands D-Q**
- Chapter 7. Commands R-Z**
- Chapter 8. Debug Commands**
- Chapter 9. Pass-Through Commands**
- Appendix A. Reference Information**
- Appendix B. Acronyms and Abbreviations**
- Index**

Tekelec EAGLE[®] 5
Signaling Application System

Release 34.3

Commands Manual

910-3251-001 Rev A

March 2006



TEKELEC

**Copyright 2006 Tekelec
All Rights Reserved
Printed in U.S.A.**

Notice

Information in this documentation is subject to change without notice. Unauthorized use or copying of this documentation can result in civil or criminal penalties.

Any export of Tekelec products is subject to the export controls of the United States and the other countries where Tekelec has operations.

No part of this documentation may be reproduced or transmitted in any form or by any means, electronic or mechanical, including photocopying or recording, for any purpose without the express written permission of an authorized representative of Tekelec.

Other product names used herein are for identification purposes only, and may be trademarks of their respective companies.

Trademarks

The Tekelec logo, EAGLE, G-Flex, G-Port, IP⁷, IP⁷Edge, IP⁷ Secure Gateway, and TALI are registered trademarks of Tekelec, Inc. TekServer is a trademark of Tekelec, Inc. All other trademarks are the property of their respective owners.

Patents

This product is covered by one or more of the following U.S. and foreign patents:

U.S. Patent Numbers:

5,008,929, 5,953,404, 6,167,129, 6,324,183, 6,327,350, 6,606,379, 6,639,981, 6,647,113, 6,662,017, 6,735,441, 6,745,041, 6,765,990, 6,795,546, 6,819,932, 6,836,477, 6,839,423, 6,885,872, 6,901,262, 6,914,973, 6,940,866, 6,944,184, 6,954,526, 6,954,794, 6,959,076, 6,965,592, 6,967,956, 6,968,048, 6,970,542

Ordering Information

Additional copies of this document can be ordered from:

Tekelec Network Signaling Group
Attention: Central Logistics
5200 Paramount Parkway
Morrisville, North Carolina, 27560

Or e-mail your request to *CentralLogistics@tekelec.com*

Table of Contents

Chapter 1. Introduction	
Overview	1-2
Where to Find Information in This Manual	1-2
Scope and Audience	1-3
EAGLE 5 SAS Publications	1-3
Customer Assistance	1-8
Documentation Packaging, Delivery, and Updates.....	1-8
Documentation Admonishments	1-9
Chapter 2. Alphabetical List of Commands	
Introduction	2-1
Chapter 3. Commands Listed by Class	
Introduction	3-1
Chapter 4. Using Commands	
Introduction	4-2
Maintenance and Administration Subsystem Processors.....	4-2
Removable Cartridge Disk Drives.....	4-2
Input/Output Devices	4-2
Terminals and Printers	4-3
Terminal and Printer Connections.....	4-5
KSR Function on VT320 Terminal Devices.....	4-5
Telnet Terminals	4-6
Element Management System Alarm Monitor Terminals.....	4-8
About Commands.....	4-9
Entering Commands	4-9
Action Commands.....	4-9
Command Keywords and Parameters	4-9
Keyboard Functions	4-10
Command Output and Messages	4-14
System Security	4-16
Login Procedure	4-18
Login Error Messages	4-22

Table of Contents

Logout Procedure.....	4-23
Chapter 5. Commands A-C	
Chapter 6. Commands D-Q	
Chapter 7. Commands R-Z	
Chapter 8. Debug Commands	
Chapter 9. Pass-Through Commands	
Appendix A. Reference Information	
Summary of Range Values for :link Parameter.....	A-2
Possible Values for PST/SST/AST	A-3
PST.....	A-3
SST.....	A-3
AST.....	A-4
Point Code Formats and Conversion.....	A-6
ANSI Point Codes	A-6
ITU International Point Codes	A-9
ITU National Point Codes.....	A-9
Converting ITU National Point Code Formats.....	A-10
24-bit ITU-National Point Codes	A-12
Spare and Private Point Code Subtype Prefixes.....	A-12
Valid CIC Ranges for SI and MSU Types in Routing Key	
Static Entries.....	A-15
NAIV/NAI Mapping.....	A-15
NPV/NP Mapping	A-16
Summary of Loopback Testing Commands and Functions.....	A-17
Tekelec-defined ISUP Normalization Variants	A-22
Appendix B. Acronyms and Abbreviations	
Index	

List of Figures

Figure 4-1. System Terminal User Display	4-4
Figure 4-2. Telnet Terminal Selection and Login	4-7
Figure 4-3. Output Banner Format	4-15
Figure 5-1. The chg-db:action=backup:dest=fixed command	5-98
Figure 5-2. The chg-db:action=backup:dest=remove command	5-99
Figure 5-3. The chg-db:action=restore:src=fixed command	5-99
Figure 5-4. The chg-db:action=restore:src=remove command	5-100
Figure 5-5. The chg-db:action=repair command	5-100
Figure 5-6. The chg-db:action=import command	5-101
Figure 5-7. The chg-db:action=beginedl/finshedl command	5-102
Figure 5-8. Prefix Table References	5-271
Figure 5-9. EAGLE 5 SAS Input and Internal Clocks with TDM-GTI	5-390
Figure A-1. ATM Loopback Tests	A-21

List of Tables

Table 1-1. Manual Organization	1-2
Table 4-1. Action Commands and Their Associated System Entity	4-9
Table 4-2. Keyboard Functions	4-10
Table 5-1. Parameters That Must Be Provisioned Prior to Updating OAP	5-25
Table 5-2. Other Data Required for Updating the OAP Configuration	5-26
Table 5-3. Performance Impact of act-oap-config parameters	5-28
Table 5-4. TSM and TDM Memory Requirements	5-32
Table 5-5. Commands for which canc-cmd Halts Processing and Output	5-48
Table 5-6. Valid Parameter Combinations for Routing Key Types using the chg-appl-rtkey command.	5-66
Table 5-8. Routing Keys and Supported PSTN Categories and PSTN IDs for PSTN Category 1	5-68
Table 5-7. PSTN Categories and Associated PSTN IDs	5-68
Table 5-9. Maximum IP Connections per Card	5-79
Table 5-10. Valid pvalue Values for chg-dcmps	5-95
Table 5-11. Performance Range for Enhanced Bulk Download Activities	5-105
Table 5-12. Link Alignment Performance	5-128
Table 5-13. EIR Response Type (eirrsptype) Values	5-149
Table 5-14. Valid Parameter Combinations for the chg-gtt Routing Parameters	5-171
Table 5-15. Gateway Screening Stop Action Definitions	5-175
Table 5-16. DRANAIV/DRANAI Mapping	5-182
Table 5-17. DRANPV/DRANP Mapping	5-183
Table 5-18. Examples of parameter combinations for the chg-inpopts command	5-185
Table 5-19. Valid Subnet Mask Values	5-189
Table 5-20. Default Subnet Mask Values	5-189
Table 5-21. Valid chg-isupvar-attrib command parameter combinations	5-192
Table 5-22. SLS Bit Rotation	5-227
Table 5-23. Link Alignment Performance	5-234

Table 5-24. Impacts on Data Collection of Turning On the 15 Minute Measurements Option	5-253
Table 5-25. Valid PVN Subnet Mask Values	5-263
Table 5-26. Acceptable nsfi and si parameter combinations (chg-scr-sio)	5-340
Table 5-27. Valid combinations for the h0/h1 and nh0/nh1 parameters (chg-scr-sio)	5-340
Table 5-28. Additional Valid chg-scr-sio Parameter Combinations	5-341
Table 5-29. Routing Key Quantity Change Examples for DCM Cards	5-358
Table 5-30. Routing Key Quantity Change Examples for SSEDCM Cards	5-359
Table 5-31. NPCFMTI Parameter - ITU National Point Code Values	5-383
Table 5-32. Point Code Format Examples	5-383
Table 5-33. Valid and Default UAPS Parameter Values	5-408
Table 5-34. Performance for the copy-meas command	5-434
Table 6-1. Commands for which dact-cmd Aborts Processing and Output	6-4
Table 6-2. Valid Combinations for the h0/h1 and nh0/nh1 Parameters (chg-scr-sio)	6-121
Table 6-3. Minimum Hardware Required for LNP Quantity Features	6-143
Table 6-4. SE-HSL SLK Capacity Feature Quantities	6-146
Table 6-5. Maximum Sockets/Associations per Card	6-160
Table 6-6. Valid ent-card Applications (appl) and Card Types (type)	6-168
Table 6-7. Valid ent-gtt Routing Parameter Combinations	6-226
Table 6-8. Valid Subnet Mask Values	6-240
Table 6-9. SLS Bit Rotation	6-260
Table 6-10. Link Alignment Performance	6-264
Table 6-11. Valid Combinations for the h0/h1 Parameters (ent-scr-sio)	6-330
Table 6-12. Valid ent-scr-sio nsfi and si Parameter Combinations	6-330
Table 6-13. Additional Valid ent-scr-sio Parameter Combinations	6-331
Table 6-14. Values for the ll Parameter	6-344
Table 6-15. Transmission Rate for the bps Parameter	6-346
Table 6-16. Examples of ent-srvsel Parameter Combinations	6-360
Table 6-17. DMS.CFG File Location for format-disk Command	6-385
Table 6-18. Disk Format Capacity	6-386
Table 6-19. Parameter Combinations for the inh-alm command	6-390
Table 6-20. Route Set Test When LNP is Offline	6-396

List of Tables

Table 6-21. Receiving Messages when LNP is Offline	6-397
Table 6-22. Reason That Card Requires a Full Data Download	6-404
Table 6-23. Reason That Card Requires a Full Data Download	6-420
Table 7-1. rept-ftp-meas Valid and Invalid Parameter Combinations	7-5
Table 7-2. Explanation of rept-imt-info:report=hmuxerr Statistics	7-10
Table 7-3. Explanation of rept-imt-info:report=hiprerr Statistics	7-14
Table 7-4. Hexadecimal/Decimal Values for s and e parameters	7-28
Table 7-5. rept-imt-lvl1 Statistics Explanation	7-36
Table 7-6. Valid Parameter Combinations for the type Parameter	7-49
Table 7-7. Auto-Inhibit Hardware Verification Codes	7-88
Table 7-8. Summary of DPC Parameter Syntaxes	7-126
Table 7-9. IMT Bus States	7-152
Table 7-10. Summary of DPC Parameter Syntaxes	7-187
Table 7-11. Serial Number Formats	7-292
Table 7-12. Summary of DPC Parameter Syntaxes	7-325
Table 7-13. Retrieve Commands for Additional Table Information	7-653
Table 7-14. Time Zones Set by the set-time command	7-703
Table 7-15. Test Disk Execution Times	7-709
Table 7-16. Parameter Combinations for the unhb-alm command	7-728
Table 8-1. Actions with Corresponding Upgrade Phase	8-3
Table 8-2. Dependencies in Card Loading	8-6
Table 8-3. Parameter/Card Type Filters for MSUs	8-41
Table 9-4. M2PA Link States	9-33
Table A-1. Summary of Ranges for link Parameter	A-2
Table A-2. Commands that Support the Spare Point Code Prefix	A-12
Table A-3. Commands that Support the Private Point Code Prefix	A-14
Table A-4. Valid CIC Ranges for SI and MSU Types	A-15
Table A-5. NAIV/NAI Mapping	A-15
Table A-6. NPV/NP Mapping	A-16
Table A-7. Loopback Testing Commands and Functions Per Card Type	A-17
Table A-8. Tekelec- <i>defined</i> ISUP Normalization Variants	A-22

1

Introduction

Overview	1-2
Where to Find Information in This Manual	1-2
Scope and Audience.....	1-3
EAGLE 5 SAS Publications	1-3
Customer Assistance.....	1-8
Documentation Packaging, Delivery, and Updates	1-8
Documentation Admonishments.....	1-9

Overview

The *Commands Manual* provides a description of all commands used in the EAGLE 5 Signaling Application System (SAS) and LNP. The EAGLE 5 SAS includes the IP7 Secure Gateway and the IP7 Front End. The use of the term “the system” indicates that the information is common to all of the functions of the EAGLE 5 SAS. Differences are indicated for the specific product, as appropriate.

NOTE: The IP7 Front End configuration is a stand-alone single-shelf IP7 Secure Gateway. When using this manual, consider IP7 Front End and IP7 Secure Gateway as functional equivalents with the IP7 Front End limited to a single shelf configuration.

Commands are entered at a terminal to perform system operations such as displaying the system status, administering system security, and maintaining the database. Error messages are displayed to provide information about problems encountered when a command is entered.

Where to Find Information in This Manual

Table 1-1 shows how this manual is organized.

NOTE: Throughout this manual, reference to the OAP (Operation System Support Application Processor) applies also to the EOAP (Enhanced Operation System Support Application Process).

Table 1-1. Manual Organization

Chapter Number and Title	Description
Chapter 1, “Introduction”	The organization of this manual The audience References to other Tekelec documentation Customer assistance Documentation packaging, delivery, and updates Safety admonishments
Chapter 2, “Alphabetical List of Commands”	An alphabetical list of the system commands and the corresponding page number for each command description in this manual
Chapter 3, “Commands Listed by Class”	List of the system commands arranged by command class
Chapter 4, “Using Commands”	Descriptions of system terminals, printers, MASP cards, and MDAL cards Keyboard functions Command class administration Definitions of types of command output and messages Procedures for logging into and logging out of the system
Chapter 5, “Commands A-C”	Descriptions of the commands used in the system
Chapter 6, “Commands D-Q”	Descriptions of the commands used in the system
Chapter 7, “Commands R-Z”	Descriptions of the commands used in the system
Chapter 8, “Debug Commands”	Descriptions of debug commands used in troubleshooting and debugging the system

Table 1-1. Manual Organization (Continued)

Chapter Number and Title	Description
Chapter 9, "Pass-Through Commands"	Descriptions of the command strings used within the pass command to gather card- and application-specific information
Appendix A, "Reference Information"	Information that is referred to in more than one command description (including signaling link ports, point code formats and usage rules, device status, loopback testing, and ISUP Normalization Variants) How to convert an ITU national point code from the format specified by the chg-stpopts:npfnti parameter into a single number so that it can be used by gateway screening. Summary of loopback testing functions
Appendix B, "Acronyms and Abbreviations"	List of acronyms and abbreviations used in the document
Index	Alphabetic listing of commands and other information, with page references.

Scope and Audience

This manual is intended for those who maintain and do database administration on the Tekelec Signaling Products and LNP. It is assumed that the user is familiar with the SS7 network and its associated protocols. The manual describes commands used in the system, and it contains a special section on debug commands and their descriptions.

Debug commands are a special group of commands used in troubleshooting and debugging the system. These commands are intended for Tekelec Technical Services personnel and authorized engineering personnel in the operating companies. The use of these commands is restricted to those personnel who have access to the "Debug" command class.

EAGLE 5 SAS Publications

The following manuals are available for the EAGLE 5 SAS. Refer to the Feature Notice of your release to determine the manuals that are included in your documentation set.

- The *Commands Error Recovery Manual* contains the procedures to resolve error message conditions generated by the commands in the *Commands Manual*. These error messages are presented in numerical order.
- The *Commands Pocket Guide* is an abridged version of the *Commands Manual*. It contains all commands and parameters, and it shows the command-parameter syntax.
- The *Commands Quick Reference Guide* contains an alphabetical listing of the commands and parameters. The guide is sized to fit a shirt-pocket.
- The *Database Administration Manual – Features* contains procedural information required to configure the EAGLE 5 SAS to implement these features:
 - X.25 Gateway
 - STP LAN
 - Database Transport Access

- GSM MAP Screening
- EAGLE 5 SAS Support for Integrated Sentinel
- The *Database Administration Manual - Gateway Screening* contains a description of the Gateway Screening (GWS) feature and the procedures necessary to configure the EAGLE 5 SAS to implement this feature.
- The *Database Administration Manual - Global Title Translation* contains procedural information required to configure an EAGLE 5 SAS to implement these features:
 - Global Title Translation
 - Enhanced Global Title Translation
 - Variable Length Global Title Translation
 - Interim Global Title Modification
 - Intermediate GTT Load Sharing
 - ANSI-ITU-China SCCP Conversion
- The *Database Administration Manual - IP7 Secure Gateway* contains procedural information required to configure the EAGLE 5 SAS to implement the SS7-IP Gateway.
- The *Database Administration Manual - SEAS* contains the EAGLE 5 SAS configuration procedures that can be performed from the Signaling Engineering and Administration Center (SEAC) or a Signaling Network Control Center (SNCC). Each procedure includes a brief description of the procedure, a flowchart showing the steps required, a list of any EAGLE 5 SAS commands that may be required for the procedure but that are not supported by SEAS, and a reference to optional procedure-related information, which can be found in one of these manuals:
 - *Database Administration Manual - Gateway Screening*
 - *Database Administration Manual - Global Title Translation*
 - *Database Administration Manual - SS7*
- The *Database Administration Manual - SS7* contains procedural information required to configure an EAGLE 5 SAS to implement the SS7 protocol.
- The *Database Administration Manual - System Management* contains procedural information required to manage the EAGLE 5 SAS database and GPLs, and to configure basic system requirements such as user names and passwords, system-wide security requirements, and terminal configurations.
- The *Dimensioning Guide for EPAP Advanced DB Features* is used to provide EPAP planning and dimensioning information. This manual is used by Tekelec personnel and EAGLE 5 SAS customers to aid in the sale, planning, implementation, deployment, and upgrade of EAGLE 5 SAS systems equipped with one of the EAGLE 5 SAS EPAP Advanced Database (EADB) Features.

- The *ELAP Administration Manual* defines the user interface to the EAGLE 5 SAS LNP Application Processor on the MPS/ELAP platform. The manual defines the methods for accessing the user interface, menus, screens available to the user and describes their impact. It provides the syntax and semantics of user input and defines the output the user receives, including information and error messages, alarms, and status.
- The *EPAP Administration Manual* describes how to administer the EAGLE 5 SAS Provisioning Application Processor on the MPS/EPAP platform. The manual defines the methods for accessing the user interface, menus, and screens available to the user and describes their impact. It provides the syntax and semantics of user input and defines the output the user receives, including messages, alarms, and status.
- The *Feature Manual - EIR* provides instructions and information on how to install, use, and maintain the EIR feature on the Multi-Purpose Server (MPS) platform of the EAGLE 5 SAS. The feature provides network operators with the capability to prevent stolen or disallowed GSM mobile handsets from accessing the network.
- The *Feature Manual - G-Flex C7 Relay* provides an overview of a feature supporting the efficient management of Home Location Registers in various networks. This manual gives the instructions and information on how to install, use, and maintain the G-Flex feature on the Multi-Purpose Server (MPS) platform of the EAGLE 5 SAS.
- The *Feature Manual - G-Port* provides an overview of a feature providing the capability for mobile subscribers to change the GSM subscription network within a portability cluster while retaining their original MSISDNs. This manual gives the instructions and information on how to install, use, and maintain the G-Port feature on the Multi-Purpose Server (MPS) platform of the EAGLE 5 SAS.
- The *Feature Manual - INP* provides the user with information and instructions on how to implement, utilize, and maintain the INAP-based Number Portability (INP) feature on the Multi-Purpose Server (MPS) platform of the EAGLE 5 SAS.
- The *FTP-Based Table Retrieve Application (FTRA) User Guide* describes how to set up and use a PC to serve as the offline application for the EAGLE 5 SAS FTP Retrieve and Replace feature.
- The *Hardware Manual - EAGLE 5 SAS* contains hardware descriptions and specifications of Tekelec's signaling products. These include the EAGLE 5 SAS, OEM-based products such as the ASi 4000 Service Control Point (SCP), the Netra-based Multi-Purpose Server (MPS), and the Integrated Sentinel with Extended Services Platform (ESP) subassembly.

The Hardware Manual provides an overview of each system and its subsystems, details of standard and optional hardware components in each system, and basic site engineering. Refer to this manual to obtain a basic understanding of each type of system and its related hardware, to locate detailed information about hardware components used in a particular release, and to help configure a site for use with the system hardware.

- The *Hardware Manual - Tekelec 1000 Application Server* provides general specifications and a description of the Tekelec 1000 Applications Server (T1000 AS). This manual also includes site preparation, environmental and other requirements, procedures to physically install the T1000 AS, and troubleshooting and repair of Field Replaceable Units (FRUs).
- The *Hardware Manual - Tekelec 1100 Application Server* provides general specifications and a description of the Tekelec 1100 Applications Server (T1100 AS). This manual also includes site preparation, environmental and other requirements, procedures to physically install the T1100 AS, and troubleshooting and repair of Field Replaceable Units (FRUs).
- The *Installation Manual - EAGLE 5 SAS* contains cabling requirements, schematics, and procedures for installing the EAGLE 5 SAS along with LEDs, connectors, cables, and power cords to peripherals. Refer to this manual to install components or the complete systems.
- The *Installation Manual - Integrated Applications* provides the installation information for integrated applications such as EPAP 4.0 or earlier (Netra-based Multi-Purpose Server (MPS) platform) and Sentinel. The manual includes information about frame floors and shelves, LEDs, connectors, cables, and power cords to peripherals. Refer to this manual to install components or the complete systems.
- The *LNP Database Synchronization Manual - LSMS with EAGLE 5 SAS* describes how to keep the LNP databases at the LSMS and at the network element (the EAGLE 5 SAS is a network element) synchronized through the use of resynchronization, audits and reconciles, and bulk loads. This manual is contained in both the LSMS documentation set and in the EAGLE 5 SAS documentation set.
- The *LNP Feature Activation Guide* contains procedural information required to configure the EAGLE 5 SAS for the LNP feature and to implement these parts of the LNP feature on the EAGLE 5 SAS:
 - LNP services
 - LNP options
 - LNP subsystem application
 - Automatic call gapping
 - Triggerless LNP feature
 - Increasing the LRN and NPANXX Quantities on the EAGLE 5 SAS
 - Activating and Deactivating the LNP Short Message Service (SMS) feature
- The *Maintenance Manual* contains procedural information required for maintaining the EAGLE 5 SAS and the card removal and replacement procedures. The *Maintenance Manual* provides preventive and corrective maintenance procedures used in maintaining the different systems.
- The *Maintenance Pocket Guide* is an abridged version of the Maintenance Manual and contains all the corrective maintenance procedures used in maintaining the EAGLE 5 SAS.

- The *Maintenance Emergency Recovery Pocket Guide* is an abridged version of the Maintenance Manual and contains the corrective maintenance procedures for critical and major alarms generated on the EAGLE 5 SAS.
- The *MPS Platform Software and Maintenance Manual - EAGLE 5 SAS with Tekelec 1000 Application Server* describes the platform software for the Multi-Purpose Server (MPS) based on the Tekelec 1000 Application Server (T1000 AS) and describes how to perform preventive and corrective maintenance for the T1000 AS-based MPS. This manual should be used with the EPAP-based applications (EIR, G-Port, G-Flex, and INP).
- The *MPS Platform Software and Maintenance Manual - EAGLE 5 SAS with Tekelec 1100 Application Server* describes the platform software for the Multi-Purpose Server (MPS) based on the Tekelec 1100 Application Server (T1100 AS) and describes how to perform preventive and corrective maintenance for the T1100 AS-based MPS. This manual should be used with the ELAP-based application (LNP).
- The *Provisioning Database Interface Manual* defines the programming interface that populates the Provisioning Database (PDB) for the EAGLE 5 SAS features supported on the MPS/EPAP platform. The manual defines the provisioning messages, usage rules, and informational and error messages of the interface. The customer uses the PDBI interface information to write his own client application to communicate with the MPS/EPAP platform.
- The *Previously Released Features Manual* summarizes the features of previous EAGLE, EAGLE 5 SAS, and IP⁷ Secure Gateway releases, and it identifies the release number of their introduction.
- The *Release Documentation* contains the following documents for a specific release of the system:
 - *Feature Notice* - Describes the features contained in the specified release. The Feature Notice also provides the hardware baseline for the specified release, describes the customer documentation set, provides information about customer training, and explains how to access the Customer Support website.
 - *Master Glossary* - Contains an alphabetical listing of terms, acronyms, and abbreviations relevant to the system.
 - *Master Index* - Lists all index entries used throughout the documentation set.
 - *Release Notice* - Describes the changes made to the system during the lifecycle of a release. The Release Notice includes Generic Program Loads (GPLs), a list of PRs resolved in a build, and all known PRs.
NOTE: The *Release Notice* is maintained solely on Tekelec's Customer Support site to provide you with instant access to the most up-to-date release information.
 - *System Overview* - Provides high-level information on SS7, the IP⁷ Secure Gateway, system architecture, LNP, and EOAP.
- The *System Manual - EOAP* describes the Embedded Operations Support System Application Processor (EOAP) and provides the user with procedures on how to implement the EOAP, replace EOAP-related hardware, device testing, and basic troubleshooting information.

Customer Assistance

The Customer Care Center offers a point of contact through which customers can receive support for problems that may be encountered during the use of Tekelec's products. The Customer Care Center is staffed with highly trained engineers to provide solutions to your technical questions and issues seven days a week, twenty-four hours a day. A variety of service programs are available through the Customer Care Center to maximize the performance of Tekelec products that meet and exceed customer's needs.

To receive technical assistance, call the Customer Care Center at one of the following locations:

- Tekelec, USA
Phone (within the continental US) (888) FOR-TKLC
Phone (outside the continental US) +1 919-460-2150
Fax +1-919-460-0877
Email: support@tekelec.com
- Tekelec, Europe and UK
Phone +44 1784 467 804
Fax +44 1784 477 120
Email: ecsc@tekelec.com

Documentation Packaging, Delivery, and Updates

Customer documentation is provided with each system in accordance with the contract agreements. It is updated whenever significant changes that affect system operation or configuration are made. Updates may be issued as an addendum, or a reissue of the affected documentation.

The document part number appears on the title page along with the current revision of the document and the date of publication. The bottom of each page contains the document part number and date of publication.

Two types of releases are major software releases and maintenance releases. Maintenance releases are issued as addenda with a title page and change bars. On the changed pages, the date and document part number are changed. On any unchanged pages that accompany the changed pages, the date and document part number is unchanged.

When the software release has a minimum effect on documentation, we provide an addendum. The addendum provides an instruction page, a new title page, a change history page, and replacement chapters with the date of publication, the document part number, and change bars.

If a new release has a major impact on documentation, such as a new feature, the entire documentation set is reissued with a new part number and a new release number.

Documentation Admonishments

Admonishments are icons and text that may appear in this and other Tekelec manuals. Admonishments alert the reader to assure personal safety, to minimize possible service interruptions, and to warn of the potential for equipment damage.

The following admonishments, listed in descending order of priority, are used in Tekelec manuals.



TOPPLE: This icon and text indicate the possibility of equipment damage and personal injury from toppling.



DANGER: This icon and text indicate the possibility of *personal injury*.



WARNING: This icon and text indicate the possibility of *equipment damage*.



CAUTION: This icon and text indicate the possibility of *service interruption*.

Alphabetical List of Commands

Introduction.....	2-1
Commands	2-2
Debug Commands	2-9
Pass-Through Commands.....	2-9

Introduction

This chapter contains an alphabetical list of the EAGLE 5 SAS commands (including those used for IP⁷ Secure Gateway and IP⁷ Front End functions), and the page number where each command is described in this manual.

Commands

act-alm-trns	5-2	chg-appl-rtkey	5-60
act-cdl	5-2	chg-appl-sock	5-69
act-dlk	5-4	chg-as	5-73
act-echo	5-5	chg-asp	5-74
act-file-trns	5-6	chg-assoc	5-75
act-flash	5-9	chg-atm-lps	5-80
act-ftp-trns	5-12	chg-attr-seculog	5-83
act-gpl	5-13	chg-cmd	5-84
act-lbp	5-17	chg-cmdclass	5-86
act-lpo	5-23	chg-csl	5-87
act-oap-config	5-24	chg-ctrl-feat	5-92
act-slk	5-28	chg-db	5-96
act-user	5-30	chg-dcmps	5-94
alloc-mem	5-31	chg-dstn	5-106
alw-card	5-32	chg-e1	5-116
alw-imt	5-36	chg-eisopts	5-119
alw-map-ss	5-37	chg-feat	5-120
alw-slk	5-38	chg-ftp-serv	5-130
alw-trm	5-39	chg-gpl	5-132
aud-data	5-40	chg-gsmmap-scrn	5-136
blk-slk	5-45	chg-gsmopts	5-141
canc-alm-trns	5-47	chg-gsms-opcode	5-150
canc-cmd	5-48	chg-gta	5-153
canc-dlk	5-50	chg-gtcnv	5-161
canc-echo	5-51	chg-gtt	5-164
canc-lnp-dpcer	5-51	chg-gttset	5-172
canc-lnp-tnrpt	5-52	chg-gtw-stp	5-174
canc-lpo	5-53	chg-gws-actset	5-175
canc-slk	5-54	chg-gws-redirect	5-179
canc-user	5-56	chg-inpopts	5-181
chg-acg-mic	5-56	chg-ip-card	5-185
chg-acg-noc	5-58	chg-ip-lnk	5-187
		chg-isupvar-attrib	5-190

chg-l2t	5-195	chg-scr-tt	5-342
chg-l3t	5-199	chg-scrset	5-344
chg-lbp	5-204	chg-secu-dflt	5-346
chg-lnp-lrn	5-206	chg-secu-trm	5-351
chg-lnp-npanxx	5-209	chg-sg-opts	5-354
chg-lnp-serv	5-212	chg-sid	5-360
chg-lnp-sub	5-214	chg-slt	5-369
chg-lnp-ttmap	5-217	chg-srvsel	5-371
chg-lnpopts	5-219	chg-ss-appl	5-375
chg-ls	5-222	chg-ss7opts	5-376
chg-m2pa-tset	5-235	chg-stpopts	5-377
chg-map	5-238	chg-t1	5-391
chg-meas	5-244	chg-th-alm	5-393
chg-measopts	5-246	chg-th-sccp	5-395
chg-mrn	5-254	chg-trm	5-396
chg-netopts	5-262	chg-ttmap	5-406
chg-oap-config	5-263	chg-uaps	5-407
chg-pid	5-268	chg-user	5-411
chg-prefix	5-269	chg-x25-dstn	5-415
chg-pstn-pres	5-272	chg-x25-rte	5-417
chg-rte	5-273	chg-x25-slk	5-418
chg-sccp-serv	5-277	chk-unref-ent	5-421
chg-sccpopts	5-283	clr-imt-stats	5-424
chg-scr-aftpc	5-284	conn-imt	5-426
chg-scr-blkdpc	5-289	copy-disk	5-427
chg-scr-blkopc	5-297	copy-fta	5-429
chg-scr-cdpa	5-304	copy-gpl	5-431
chg-scr-cgpa	5-310	copy-isupvar-attrb	5-432
chg-scr-destfld	5-317	copy-meas	5-434
chg-scr-dpc	5-322	copy-seculog	5-435
chg-scr-isup	5-328	dact-alm-trns	6-2
chg-scr-opc	5-331	dact-cdl	6-2
chg-scr-sio	5-337	dact-cmd	6-3

dact-echo	6-5	dlt-ip-host	6-52
dact-lbp	6-6	dlt-ip-node	6-53
dact-rstst	6-8	dlt-ip-rte	6-55
dact-slk	6-9	dlt-lbp	6-56
dact-user	6-10	dlt-lnp-lrn	6-58
disc-imt	6-11	dlt-lnp-npanxx	6-59
disp-fta-dir	6-12	dlt-lnp-serv	6-60
dlt-acg-mic	6-12	dlt-lnp-sp	6-62
dlt-acg-noc	6-13	dlt-lnp-sub	6-62
dlt-appl-rtkey	6-14	dlt-ls	6-64
dlt-appl-sock	6-19	dlt-map	6-65
dlt-as	6-20	dlt-mrn	6-67
dlt-asp	6-21	dlt-na	6-74
dlt-assoc	6-22	dlt-prefix	6-75
dlt-card	6-22	dlt-pstn-pres	6-77
dlt-csl	6-23	dlt-rmt-appl	6-78
dlt-cspc	6-27	dlt-rte	6-80
dlt-dlk	6-29	dlt-sccp-serv	6-84
dlt-dstn	6-30	dlt-scr-aftpc	6-89
dlt-e1	6-35	dlt-scr-blkdpc	6-93
dlt-fta	6-36	dlt-scr-blkopc	6-97
dlt-ftp-serv	6-37	dlt-scr-cdpa	6-101
dlt-gsmmap-scrn	6-38	dlt-scr-cgpa	6-104
dlt-gsms-opcode	6-39	dlt-scr-destfld	6-108
dlt-gsmssn-scrn	6-40	dlt-scr-dpc	6-112
dlt-gta	6-41	dlt-scr-isup	6-115
dlt-gtcnv	6-43	dlt-scr-opc	6-116
dlt-gtt	6-45	dlt-scr-sio	6-120
dlt-gttset	6-47	dlt-scr-tt	6-122
dlt-gttset	6-49	dlt-scrset	6-123
dlt-gws-redirect	6-50	dlt-shlf	6-124
dlt-home-smsc	6-51	dlt-slk	6-125
dlt-homern	6-51	dlt-spc	6-127

dlt-split-npa.....	6-129	ent-gttset.....	6-228
dlt-srvsel.....	6-130	ent-gttset.....	6-230
dlt-ss-appl.....	6-131	ent-gws-redirect.....	6-232
dlt-subnetid.....	6-132	ent-home-smisc.....	6-234
dlt-t1.....	6-133	ent-homern.....	6-235
dlt-tt.....	6-134	ent-ip-host.....	6-236
dlt-ttmap.....	6-136	ent-ip-node.....	6-237
dlt-uim-acthresh.....	6-137	ent-ip-rte.....	6-239
dlt-user.....	6-138	ent-lbp.....	6-241
dlt-vendid.....	6-138	ent-lnp-lrn.....	6-243
dlt-x25-dstn.....	6-139	ent-lnp-npanxx.....	6-246
dlt-x25-rte.....	6-140	ent-lnp-serv.....	6-249
enable-ctrl-feat.....	6-140	ent-lnp-sp.....	6-251
ent-acg-mic.....	6-147	ent-lnp-sub.....	6-252
ent-acg-noc.....	6-149	ent-ls.....	6-255
ent-appl-rtkey.....	6-150	ent-map.....	6-265
ent-appl-sock.....	6-156	ent-mrn.....	6-271
ent-as.....	6-159	ent-na.....	6-279
ent-asp.....	6-160	ent-pstn-pres.....	6-280
ent-assoc.....	6-161	ent-rmt-appl.....	6-282
ent-card.....	6-165	ent-rte.....	6-284
ent-csl.....	6-172	ent-scr-aftpc.....	6-288
ent-cspc.....	6-176	ent-scr-blkdpcc.....	6-293
ent-dlk.....	6-179	ent-scr-blkopc.....	6-298
ent-dstn.....	6-181	ent-scr-cdpa.....	6-304
ent-e1.....	6-193	ent-scr-cgpa.....	6-308
ent-ftp-serv.....	6-197	ent-scr-destfld.....	6-313
ent-gsmmap-scrn.....	6-199	ent-scr-dpc.....	6-316
ent-gsms-opcode.....	6-205	ent-scr-isup.....	6-321
ent-gsmssn-scrn.....	6-209	ent-scr-opc.....	6-323
ent-gta.....	6-210	ent-scr-sio.....	6-328
ent-gtcnv.....	6-217	ent-scr-tt.....	6-332
ent-gtt.....	6-220	ent-scrset.....	6-334

ent-serial-num	6-336	logout	6-424
ent-shlf	6-337	pass	6-425
ent-sid	6-338	rept-ftp-meas	7-2
ent-slk	6-340	rept-imt-info	7-6
ent-spc	6-354	rept-imt-lvl1	7-27
ent-split-npa	6-356	rept-imt-lvl2	7-39
ent-srvsel	6-357	rept-meas	7-43
ent-ss-appl	6-361	rept-stat-alm	7-57
ent-subnetid	6-362	rept-stat-applsock	7-63
ent-t1	6-364	rept-stat-as	7-64
ent-tt	6-367	rept-stat-asp	7-66
ent-ttmap	6-368	rept-stat-assoc	7-67
ent-user	6-370	rept-stat-card	7-69
ent-vendid	6-374	rept-stat-cdl	7-91
ent-x25-dstn	6-375	rept-stat-cdt	7-92
ent-x25-rte	6-377	rept-stat-clk	7-93
flash-card	6-380	rept-stat-cluster	7-98
format-disk	6-383	rept-stat-db	7-105
inh-alm	6-387	rept-stat-dlk	7-122
inh-card	6-393	rept-stat-dstn	7-123
inh-imt	6-394	rept-stat-e1	7-132
inh-map-ss	6-395	rept-stat-eroute	7-135
inh-slk	6-397	rept-stat-gpl	7-140
inh-trm	6-399	rept-stat-iptps	7-152
init-card	6-400	rept-stat-imt	7-150
init-flash	6-406	rept-stat-lfs	7-156
init-imt-gpl	6-411	rept-stat-lnp	7-158
init-mux	6-412	rept-stat-ls	7-164
init-network	6-413	rept-stat-lsms	7-167
init-oap	6-416	rept-stat-meas	7-168
init-sys	6-417	rept-stat-mps	7-170
lock	6-422	rept-stat-mux	7-182
login	6-423	rept-stat-ndc	7-183

rept-stat-rte	7-184	rtrv-bip	7-288
rept-stat-rtkey	7-193	rtrv-card	7-292
rept-stat-sccp	7-194	rtrv-cmd	7-297
rept-stat-seas	7-212	rtrv-cmdclass	7-300
rept-stat-seculog	7-213	rtrv-csl	7-301
rept-stat-slan	7-216	rtrv-cspc	7-308
rept-stat-slk	7-219	rtrv-ctrl-feat	7-310
rept-stat-sys	7-228	rtrv-dcmps	7-314
rept-stat-t1	7-232	rtrv-dlk	7-315
rept-stat-trbl	7-235	rtrv-dstn	7-317
rept-stat-trm	7-239	rtrv-e1	7-345
rept-stat-tstslk	7-241	rtrv-eisopts	7-348
rept-stat-user	7-243	rtrv-feat	7-348
rept-stat-xlist	7-244	rtrv-ftp-serv	7-350
rept-x25-meas	7-245	rtrv-gpl	7-353
rls-alm	7-247	rtrv-gsmmap-scrn	7-361
rmv-card	7-248	rtrv-gsmopts	7-366
rmv-imt	7-249	rtrv-gsms-opcode	7-370
rmv-trm	7-251	rtrv-gsmssn-scrn	7-373
rst-card	7-252	rtrv-gta	7-374
rst-dstn	7-254	rtrv-gtcnv	7-383
rst-imt	7-255	rtrv-gtt	7-385
rst-trm	7-256	rtrv-gttset	7-396
rtrv-acg-mic	7-257	rtrv-gttset	7-400
rtrv-acg-noc	7-259	rtrv-gtw-stp	7-402
rtrv-appl-rtkey	7-260	rtrv-gtwy-acthresh	7-402
rtrv-appl-sock	7-270	rtrv-gtwy-prmtrs	7-404
rtrv-as	7-273	rtrv-gws-actset	7-404
rtrv-asp	7-274	rtrv-gws-redirect	7-406
rtrv-assoc	7-275	rtrv-home-smsc	7-407
rtrv-atm-lps	7-281	rtrv-homern	7-408
rtrv-atm-prm	7-287	rtrv-inpopts	7-409
rtrv-attr-seculog	7-288	rtrv-ip-card	7-410

rtrv-ip-host	7-412	rtrv-rte	7-520
rtrv-ip-lnk	7-413	rtrv-sccp-serv	7-534
rtrv-ip-node	7-415	rtrv-sccpopts	7-537
rtrv-ip-rte	7-417	rtrv-sccpopts	7-537
rtrv-isupvar-attrib	7-419	rtrv-scr-aftpc	7-538
rtrv-l2t	7-421	rtrv-scr-blkdpc	7-543
rtrv-l3t	7-423	rtrv-scr-blkopc	7-549
rtrv-lbp	7-426	rtrv-scr-cdpa	7-555
rtrv-lnp-dbts	7-428	rtrv-scr-cgpa	7-561
rtrv-lnp-dpcer	7-429	rtrv-scr-destfld	7-567
rtrv-lnp-lrn	7-433	rtrv-scr-dpc	7-572
rtrv-lnp-npanxx	7-436	rtrv-scr-isup	7-578
rtrv-lnp-serv	7-439	rtrv-scr-opc	7-581
rtrv-lnp-sp	7-440	rtrv-scr-sio	7-586
rtrv-lnp-sub	7-442	rtrv-scr-tt	7-591
rtrv-lnp-tnrpt	7-447	rtrv-scrset	7-593
rtrv-lnp-ttmap	7-449	rtrv-secu-dflt	7-597
rtrv-lnpopts	7-452	rtrv-secu-trm	7-599
rtrv-log	7-453	rtrv-secu-user	7-602
rtrv-ls	7-463	rtrv-seculog	7-605
rtrv-m2pa-tset	7-483	rtrv-serial-num	7-611
rtrv-map	7-487	rtrv-sg-opts	7-611
rtrv-meas-sched	7-492	rtrv-shlf	7-613
rtrv-measopts	7-494	rtrv-sid	7-614
rtrv-mem	7-497	rtrv-slk	7-620
rtrv-mrn	7-498	rtrv-slt	7-627
rtrv-na	7-502	rtrv-spc	7-629
rtrv-netopts	7-503	rtrv-split-npa	7-633
rtrv-oap-config	7-503	rtrv-srvsel	7-634
rtrv-obit	7-506	rtrv-ss-appl	7-640
rtrv-prefix	7-516	rtrv-ss7opts	7-642
rtrv-pstn-pres	7-518	rtrv-stpopts	7-643
rtrv-rmt-appl	7-519	rtrv-subnetid	7-648

rtrv-t1	7-649
rtrv-tbl-capacity	7-652
rtrv-th-alm	7-654
rtrv-th-sccp	7-655
rtrv-trbl	7-656
rtrv-trbltx	7-658
rtrv-trm	7-664
rtrv-tt	7-679
rtrv-ttmap	7-682
rtrv-uaps	7-684
rtrv-uim-acthresh	7-688
rtrv-user	7-689
rtrv-vendid	7-691
rtrv-x25-dstn	7-693
rtrv-x25-rte	7-694
rtrv-x25-slk	7-698
set-date	7-700
set-gtwy-acthresh	7-700
set-scrrej-prmtrs	7-702
set-time	7-702
set-uim-acthresh	7-704
tst-bip	7-706
tst-disk	7-707
tst-dlk	7-710
tst-e1	7-712
tst-imt	7-714
tst-slk	7-716
tst-t1	7-721
ublk-slk	7-722
unhb-alm	7-724
unhb-slk	7-729
unlock	7-731

Debug Commands

act-upgrade	8-2
cdu	8-8
chg-bip-fld	8-14
chg-bip-rec	8-15
chg-lnp-refnum	8-16
chg-tbl	8-18
clr-disk-stats	8-20
copy-tbl	8-20
disp-bip	8-22
disp-bp	8-23
disp-disk-dir	8-26
disp-disk-stats	8-29
disp-lba	8-30
disp-mem	8-32
dlt-bp	8-34
ent-bp	8-35
ent-trace	8-41
rtrv-data-rtddb	8-48
send-msg	8-53
set-mem	8-56
vfy-lnp-refnum	8-58

Pass-Through Commands

arp	9-2
aslog	9-5
asplog	9-6
assocrtt	9-11
connmgr	9-13
drklog	9-19
ftptest	9-29
linkinfo	9-31

Pass-Through Commands

msucount	9-40
msuroute	9-72
msutrace	9-77
netstat	9-94
nslookup	9-105
ping	9-107
sctp	9-111
sockrtt	9-120
sockstate	9-123
tracert	9-126
ualog	9-133

Alphabetical List of Commands

3

Commands Listed by Class

Introduction.....	3-1
Basic Commands	3-2
Database Administration Commands.....	3-2
System Maintenance Commands.....	3-6
Link Maintenance Commands	3-8
Program Update Commands.....	3-8
Security Administration Commands.....	3-8
LNP Basic Commands	3-9
LNP Database Administration Commands.....	3-9
LNP Subscription Commands.....	3-9
Debug Commands	3-9

Introduction

This chapter provides lists of the available non-configurable command classes and an alphabetical list of the commands allowed in each class. The command class Basic is automatically given to all users and terminals as a default.

Basic Commands

act-echo	5-5
act-user	5-30
canc-cmd	5-48
canc-echo	5-51
canc-user	5-56
chg-pid	5-268
dact-cmd	6-3
dact-echo	6-5
dact-user	6-10
lock	6-422
login	6-423
logout	6-424
rept-stat-user	7-243
rtrv-cmd	7-297
rtrv-cmdclass	7-300
rtrv-user	7-689
unlock	7-731

**Database Administration
Commands**

act-ftp-trns	
act-oap-config	5-24
chg-appl-rtkey	5-60
chg-appl-sock	5-69
chg-as	5-73
chg-asp	5-74
chg-assoc	5-75
chg-atm-lps	5-80
chg-csl	5-87
chg-ctrl-feat	5-92
chg-dcmps	5-94
chg-dstn	5-106

chg-el	5-116
chg-ftp-serv	5-130
chg-gsmmap-scrn	5-136
chg-gsmopts	5-141
chg-gsms-opcode	5-150
chg-gta	5-153
chg-gtcnv	5-161
chg-gtt	5-164
chg-gttset	5-172
chg-gtw-stp	5-174
chg-gws-actset	5-175
chg-gws-redirect	5-179
chg-inpopts	5-181
chg-ip-card	5-185
chg-ip-lnk	5-187
chg-isupvar-attrib	5-190
chg-l2t	5-195
chg-l3t	5-199
chg-lbp	5-204
chg-ls	5-222
chg-m2pa-tset	5-235
chg-map	5-238
chg-mrn	5-254
chg-netopts	5-262
chg-oap-config	5-263
chg-prefix	5-269
chg-pstn-pres	5-272
chg-rte	5-273
chg-sccp-serv	5-277
chg-sccpopts	5-283
chg-scr-aftpc	5-284
chg-scr-blkdpc	5-289
chg-scr-blkopc	5-297

Commands Listed by Class

chg-scr-cdpa	5-304
chg-scr-cgpa	5-310
chg-scr-destfld	5-317
chg-scr-dpc	5-322
chg-scr-isup	5-328
chg-scr-opc	5-331
chg-scr-sio	5-337
chg-scr-tt	5-342
chg-scrset	5-344
chg-sg-opts	5-354
chg-sid	5-360
chg-slt	5-369
chg-srvsel	5-371
chg-ss-appl	5-375
chg-ss7opts	5-376
chg-stpopts	5-377
chg-t1	5-391
chg-th-alm	5-393
chg-th-sccp	5-395
chg-trm	5-396
chg-ttmap	5-406
chg-uaps	5-407
chg-x25-dstn	5-415
chg-x25-rte	5-417
chg-x25-slk	5-418
chk-unref-ent	5-421
dlt-appl-rtkey	6-14
dlt-appl-sock	6-19
dlt-as	6-20
dlt-asp	6-21
dlt-assoc	6-22
dlt-card	6-22
dlt-csl	6-23

Database Administration Commands

dlt-cspc	6-27
dlt-dlk	6-29
dlt-dstn	6-30
dlt-e1	6-35
dlt-ftp-serv	6-37
dlt-gsmmap-scrn	6-38
dlt-gsms-opcode	6-39
dlt-gsmssn-scrn	6-40
dlt-gta	6-41
dlt-gtenv	6-43
dlt-gtt	6-45
dlt-gttset	6-47
dlt-gttset	6-49
dlt-gws-redirect	6-50
dlt-home-smsc	6-51
dlt-homern	6-51
dlt-ip-host	6-52
dlt-ip-node	6-53
dlt-ip-rte	6-55
dlt-lbp	6-56
dlt-ls	6-64
dlt-map	6-65
dlt-mrn	6-67
dlt-na	6-74
dlt-prefix	6-75
dlt-pstn-pres	6-77
dlt-rmt-appl	6-78
dlt-rte	6-80
dlt-sccp-serv	6-84
dlt-scr-aftpc	6-89
dlt-scr-blkdpc	6-93
dlt-scr-blkopc	6-97
dlt-scr-cdpa	6-101

dlt-scr-cgpa	6-104	ent-ftp-serv.	6-197
dlt-scr-destfld	6-108	ent-gsmmap-scrn	6-199
dlt-scr-dpc	6-112	ent-gsms-opcode	6-205
dlt-scr-isup	6-115	ent-gsmssn-scrn	6-209
dlt-scr-opc	6-116	ent-gta	6-210
dlt-scrset	6-123	ent-gtcnv	6-217
dlt-scr-sio	6-120	ent-gtt	6-220
dlt-scr-tt	6-122	ent-gttset	6-228
dlt-shlf	6-124	ent-gttset	6-230
dlt-slk	6-125	ent-gws-redirect	6-232
dlt-spc	6-127	ent-home-smsc	6-234
dlt-srvsel	6-130	ent-homern	6-235
dlt-ss-appl	6-131	ent-ip-host	6-236
dlt-subnetid	6-132	ent-ip-node	6-237
dlt-t1	6-133	ent-ip-rte	6-239
dlt-tt	6-134	ent-lbp	6-241
dlt-ttmap	6-136	ent-ls	6-255
dlt-uim-acthresh	6-137	ent-map	6-265
dlt-vendid	6-138	ent-mrn	6-271
dlt-x25-dstn	6-139	ent-na	6-279
dlt-x25-rte	6-140	ent-pstn-pres	6-280
enable-ctrl-feat	6-140	ent-rmt-appl	6-282
ent-appl-rtkey	6-150	ent-rte	6-284
ent-appl-sock	6-156	ent-scr-aftpc	6-288
ent-as	6-159	ent-scr-blkdpc	6-293
ent-asp	6-160	ent-scr-blkopc	6-298
ent-assoc	6-161	ent-scr-cdpa	6-304
ent-card	6-165	ent-scr-cgpa	6-308
ent-csl	6-172	ent-scr-destfld	6-313
ent-cspc	6-176	ent-scr-dpc	6-316
ent-dlk	6-179	ent-scr-isup	6-321
ent-e1	6-193	ent-scr-opc	6-323
ent-dstn	6-181	ent-scrset	6-334

Commands Listed by Class

ent-scr-sio	6-328
ent-scr-tt	6-332
ent-serial-num	6-336
ent-shlf	6-337
ent-sid	6-338
ent-slk	6-340
ent-spc	6-354
ent-srvsel	6-357
ent-ss-appl	6-361
ent-subnetid	6-362
ent-t1	6-364
ent-tt	6-367
ent-ttmap	6-368
ent-vendid	6-374
ent-x25-dstn	6-375
ent-x25-rte	6-377
rept-stat-db	7-105
rtrv-appl-rtkey	7-260
rtrv-appl-sock	7-270
rtrv-as	7-273
rtrv-asp	7-274
rtrv-assoc	7-275
rtrv-atm-lps	7-281
rtrv-atm-prm	7-287
rtrv-card	7-292
rtrv-ctrl-feat	7-310
rtrv-csl	7-301
rtrv-cspc	7-308
rtrv-data-rtdb	8-48
rtrv-dcmpls	7-314
rtrv-dlk	7-315
rtrv-dstn	7-317
rtrv-e1	7-345

Database Administration Commands

rtrv-ftp-serv	7-350
rtrv-gsmmap-scrn	7-361
rtrv-gsmopts	7-366
rtrv-gsms-opcode	7-370
rtrv-gta	7-374
rtrv-gtcnv	7-383
rtrv-gtt	7-385
rtrv-gttset	7-396
rtrv-gttset	7-400
rtrv-gtw-stp	7-402
rtrv-gtwy-acthresh	7-402
rtrv-gtwy-prmtrs	7-404
rtrv-gws-actset	7-404
rtrv-gws-redirect	7-406
rtrv-home-smsc	7-407
rtrv-homern	7-408
rtrv-inpopts	7-409
rtrv-ip-card	7-410
rtrv-ip-host	7-412
rtrv-ip-lnk	7-413
rtrv-ip-node	7-415
rtrv-ip-rte	7-417
rtrv-isupvar-attrib	7-419
rtrv-l2t	7-421
rtrv-l3t	7-423
rtrv-lbp	7-426
rtrv-ls	7-463
rtrv-m2pa-tset	7-483
rtrv-map	7-487
rtrv-mrn	7-498
rtrv-na	7-502
rtrv-netopts	7-503
rtrv-oap-config	7-503

rtrv-prefix	7-516	rtrv-th-sccp.	7-655
rtrv-pstn-pres	7-518	rtrv-trbltx	7-658
rtrv-rmt-appl	7-519	rtrv-trm.	7-664
rtrv-rte	7-520	rtrv-tt.	7-679
rtrv-sccp-serv	7-534	rtrv-ttmap.	7-682
rtrv-sccpopts.	7-537	rtrv-uaps.	7-684
rtrv-scr-aftpc.	7-538	rtrv-uim-acthresh	7-688
rtrv-scr-blkdpc	7-543	rtrv-vendid.	7-691
rtrv-scr-blkopc	7-549	rtrv-x25-dstn	7-693
rtrv-scr-cdpa	7-555	rtrv-x25-rte.	7-694
rtrv-scr-cgpa	7-561	rtrv-x25-slk.	7-698
rtrv-scr-destfld	7-567	set-gtwy-acthresh	7-700
rtrv-scr-dpc	7-572	set-scrrej-prmtrs	7-702
rtrv-scr-isup	7-578	set-uim-acthresh	7-704
rtrv-scr-opc	7-581		
rtrv-scr-sio.	7-586	System Maintenance	
rtrv-scr-tt.	7-591	Commands	
rtrv-scrset	7-593	act-alm-trns	5-2
rtrv-serial-num.	7-611	act-file-trns.	5-6
rtrv-sg-opts.	7-611	act-flash	5-9
rtrv-shlf	7-613	alloc-mem.	5-31
rtrv-sid.	7-614	alw-card	5-32
rtrv-slk.	7-620	alw-imt	5-36
rtrv-slt	7-627	alw-map-ss.	5-37
rtrv-spc	7-629	alw-trm.	5-39
rtrv-srvsel	7-634	aud-data	5-40
rtrv-ss-appl	7-640	canc-alm-trns.	5-47
rtrv-ss7opts.	7-642	chg-db.	5-96
rtrv-stpopts.	7-643	clr-imt-stats	5-424
rtrv-subnetid.	7-648	conn-imt	5-426
rtrv-t1.	7-649	copy-disk	5-427
rtrv-tbl-capacity	7-652	copy-fta.	5-429
rtrv-th-alm	7-654	copy-gpl	5-431

Commands Listed by Class

copy-isupvar-attrib.....	5-432
copy-meas.....	5-434
dact-alm-trns.....	6-2
dact-rstst.....	6-8
disc-imt.....	6-11
disp-fta-dir.....	6-12
dlt-fta.....	6-36
flash-card.....	6-380
format-disk.....	6-383
inh-alm.....	6-387
inh-card.....	6-393
inh-imt.....	6-394
inh-map-ss.....	6-395
inh-trm.....	6-399
init-card.....	6-400
init-flash.....	6-406
init-imt-gpl.....	6-411
init-mux.....	6-412
init-network.....	6-413
init-oap.....	6-416
init-sys.....	6-417
pass.....	6-425
rept-imt-info.....	7-6
rept-imt-lvl1.....	7-27
rept-imt-lvl2.....	7-39
rept-stat-alm.....	7-57
rept-stat-applsock.....	7-63
rept-stat-as.....	7-64
rept-stat-asp.....	7-66
rept-stat-assoc.....	7-67
rept-stat-card.....	7-69
rept-stat-cdt.....	7-92
rept-stat-clk.....	7-93

System Maintenance Commands

rept-stat-cluster.....	7-98
rept-stat-dlk.....	7-122
rept-stat-dstn.....	7-123
rept-stat-e1.....	7-132
rept-stat-eroute.....	7-135
rept-stat-imt.....	7-150
rept-stat-iptps.....	7-152
rept-stat-lnp.....	7-158
rept-stat-ls.....	7-164
rept-stat-lsms.....	7-167
rept-stat-meas.....	7-168
rept-stat-mps.....	7-170
rept-stat-mux.....	7-182
rept-stat-ndc.....	7-183
rept-stat-rte.....	7-184
rept-stat-rtkey.....	7-193
rept-stat-sccp.....	7-194
rept-stat-seas.....	7-212
rept-stat-slan.....	7-216
rept-stat-slk.....	7-219
rept-stat-sys.....	7-228
rept-stat-t1.....	7-232
rept-stat-trbl.....	7-235
rept-stat-trm.....	7-239
rept-stat-user.....	7-243
rept-stat-xlist.....	7-244
rls-alm.....	7-247
rmv-card.....	7-248
rmv-imt.....	7-249
rmv-trm.....	7-251
rst-card.....	7-252
rst-dstn.....	7-254
rst-imt.....	7-255

rst-trm7-256
 rtrv-bip7-288
 rtrv-log7-453
 rtrv-mem.....7-497
 rtrv-obit.....7-506
 rtrv-trbl7-656
 tst-bip.....7-706
 tst-disk.....7-707
 tst-e1.....7-712
 tst-imt7-714
 tst-t1.....7-721
 unhb-alm.....7-724

**Link Maintenance
 Commands**

act-cdl5-2
 act-dlk5-4
 act-lbp5-17
 act-lpo5-23
 act-slk.....5-28
 alw-slk.....5-38
 blk-slk5-45
 canc-dlk.....5-50
 cancelpo.....5-53
 cancel-slk.....5-54
 chg-meas.....5-244
 chg-measopts5-246
 dact-cdl6-2
 dact-lbp.....6-6
 dact-slk6-9
 inh-slk6-397
 rept-ftp-meas7-2
 rept-meas7-43

rept-stat-cdl7-91
 rept-stat-lfs.....7-156
 rept-stat-tstslk7-241
 rept-x25-meas7-245
 rtrv-meas-sched.....7-492
 rtrv-measopts7-494
 tst-dlk7-710
 tst-slk.....7-716
 ublk-slk.....7-722
 unhb-slk.....7-729

Program Update Commands

act-gpl.....5-13
 chg-feat.....5-120
 chg-gpl5-132
 rept-stat-gpl.....7-140
 rtrv-feat.....7-348
 rtrv-gpl.....7-353

**Security Administration
 Commands**

canc-cmd5-48
 chg-attr-secu-log.....5-83
 chg-cmd5-84
 chg-cmdclass5-86
 chg-eisopts.....5-119
 chg-secu-dflt5-346
 chg-secu-trm5-351
 chg-user5-411
 copy-secu-log5-435
 dact-cmd.....6-3
 dlt-user6-138
 ent-user.....6-370

rept-stat-seculog 7-213
 rtrv-attr-seculog 7-288
 rtrv-eisopts 7-348
 rtrv-secu-dflt 7-597
 rtrv-secu-trm 7-599
 rtrv-secu-user 7-602
 rtrv-seculog 7-605
 set-date 7-700
 set-time 7-702

LNP Basic Commands

canc-lnp-dpcer 5-51
 canc-lnp-tnrpt 5-52
 inh-map-ss 6-395
 rtrv-acg-mic 7-257
 rtrv-acg-noc 7-259
 rtrv-lnp-dbts 7-428
 rtrv-lnp-dpcer 7-429
 rtrv-lnp-lrn 7-433
 rtrv-lnp-npanxx 7-436
 rtrv-lnp-serv 7-439
 rtrv-lnp-sp 7-440
 rtrv-lnp-sub 7-442
 rtrv-lnp-tnrpt 7-447
 rtrv-lnp-ttmap 7-449
 rtrv-lnpopts 7-452
 rtrv-split-npa 7-633

LNP Database

Administration Commands

chg-acg-mic 5-56
 chg-acg-noc 5-58
 chg-lnp-lrn 5-206

chg-lnp-npanxx 5-209
 chg-lnp-serv 5-212
 chg-lnp-sub 5-214
 chg-lnp-ttmap 5-217
 chg-lnpopts 5-219
 dlt-acg-mic 6-12
 dlt-acg-noc 6-13
 dlt-lnp-lrn 6-58
 dlt-lnp-npanxx 6-59
 dlt-lnp-serv 6-60
 dlt-lnp-sp 6-62
 dlt-lnp-sub 6-62
 dlt-split-npa 6-129
 ent-acg-mic 6-147
 ent-acg-noc 6-149
 ent-lnp-lrn 6-243
 ent-lnp-npanxx 6-246
 ent-lnp-serv 6-249
 ent-lnp-sp 6-251
 ent-lnp-sub 6-252
 ent-split-npa 6-356
 rtrv-lnp-dbts 7-428

**LNP Subscription
 Commands**

chg-lnp-sub 5-214
 dlt-lnp-sub 6-62
 ent-lnp-sub 6-252

Debug Commands

act-upgrade 8-2
 cdu 8-8
 chg-bip-fld 8-14

chg-bip-rec	8-15
chg-lnp-refnum	8-16
chg-tbl	8-18
clr-disk-stats	8-20
copy-tbl	8-20
disp-bip	8-22
disp-bp	8-23
disp-disk-dir	8-26
disp-disk-stats	8-29
disp-lba	8-30
disp-mem	8-32
dlt-bp	8-34
ent-bp	8-35
ent-trace	8-41
send-msg	8-53
set-mem	8-56
vfy-lnp-refnum	8-58

4

Using Commands

Introduction.....	4-2
Maintenance and Administration Subsystem Processors	4-2
Removable Cartridge Disk Drives	4-2
Input/Output Devices.....	4-2
Terminal and Printer Connections.....	4-5
Terminals and Printers	4-3
KSR Function on VT320 Terminal Devices.....	4-5
Telnet Terminals	4-6
Element Management System Alarm Monitor Terminals.....	4-8
About Commands	4-9
Entering Commands.....	4-9
Action Commands	4-9
Command Keywords and Parameters.....	4-9
Keyboard Functions.....	4-10
System Security	4-16
Login Procedure	4-18
Login Error Messages	4-22
Logout Procedure.....	4-23

Introduction

This chapter provides the following information:

- A description of the system's Maintenance and Administration Subsystem Processors
- A description of the system's input and output devices
- A description of how to enter commands
- The procedures for logging into and out of the system

This chapter is intended to assist personnel responsible for the system.

Maintenance and Administration Subsystem Processors

The maintenance and administration subsystem contains two Maintenance and administration Subsystem Processors (MASP). The MASP is made up of two cards:

1. A GPSM-II card
2. A Terminal Disk Module (TDM).

The GPSM-II card contains the communications processor and applications processor and provides connections to the IMT bus. This processor controls the maintenance and database administration activity.

Each TDM is equipped with a fixed disk drive, the terminal processor for the 16 I/O ports, and interfaces to the Maintenance Disk and Alarm (MDAL) card. The fixed disk drive is used as either a permanent, temporary, or transient medium for data storage. The data stored on the disk can be used immediately or backed up and stored as permanent archives files.

See the *Installation Manual - EAGLE 5 SAS* for more information.

Removable Cartridge Disk Drives

The system is equipped with a removable cartridge drive located on the Maintenance Disk and Alarm (MDAL) card, located in the control shelf. Refer to the *Installation Manual - EAGLE 5 SAS* for more detailed information about the MDAL card.

The removable cartridge is used for installing new software; backing up the system software, application software, and the database; and downloading measurements data for off-line processing.

Input/Output Devices

There are two types of Input/Output (I/O) devices: terminals and printers. All I/O devices are connected to the system through the control shelf backplane. Each I/O device is described in terms of its function and its connection to the system. Refer to the *Installation Manual - EAGLE 5 SAS* for backplane connection information.

Using Commands

Terminals and Printers

The EAGLE 5 SAS uses VT320 terminals for maintenance and database administration. The EAGLE 5 SAS also can be configured to communicate with the SEAS interface (OAP). The terminals enable you to enter information into or receive information from the system. The system is capable of communicating with terminals at data rates from 2400 to 19,200 baud, using the ASCII character set.

You must configure terminals to operate with the system. You also must set printers (and modems) for hardware flow control. To do this, enable Data Terminal Ready (DTR) through your terminal's configuration menu. A modem also must have DCD set on "high." If your terminal has the auto-wrap feature, ensure that it is disabled before using your terminal on the system.

For information on the setup values for printers and terminals on the system, see the **chg-trm** command.

Terminals provide the following capabilities:

- Command input and output
- Continuous alarm states
- Event/Error messages

You enter commands at the terminal to perform system operations such as displaying the system status, administering system security, and maintaining the database.

An example of a terminal screen is shown in Figure 4-1. Note that the alarm status area is labeled either Total Alarm Status or Active Alarm Status depending on how the VT320 terminal is configured. See the **chg-stpopts** command description for configuration information.

Alarms are displayed in the alarm status area of the terminal screen. The alarm levels are as follows:

- Critical – Indicates a severe, service-affecting condition has occurred and that immediate corrective action is needed, regardless of the time of day or the day of the week.
- Major – Indicates a serious disruption of service or the failure of important circuits is taking place. These troubles require attention and response to restore or maintain system capability.
- Minor – Indicates a trouble, but one that does not have a serious affect on service.
- Inhibited – Indicates a device in the system with an inhibited alarm. A temporarily or permanently inhibited alarm does not generate unsolicited output or cause alarm indicators to be turned on. See the **inh-alm** command description for information on inhibited alarms.

Figure 4-1. System Terminal User Display

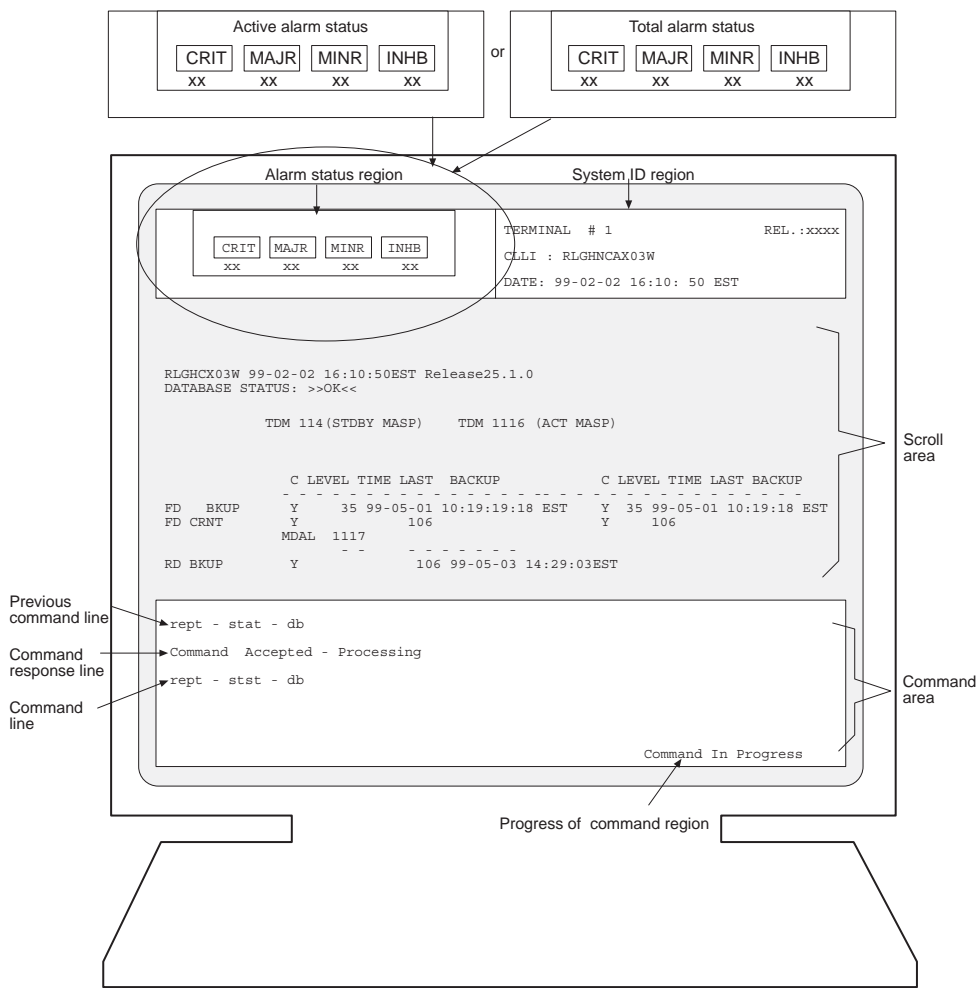

Event/Error messages also are issued to terminals to report system conditions or events. If the condition or event affects service, an alarm is issued along with an Event/Error message. Event/Error messages are displayed in the scroll area of the terminal screen.

Use the command line region of the terminal display (Figure 4-1 on page 4-4) to enter commands. The command line region consists of two lines. Each of these lines can hold up to 80 characters. If you enter a command of more than 80 characters in length, the command appears on both lines. When you press the

Enter key, only the first 80 characters are displayed in the previous command line, followed by a message on the command response line showing the status of the command. The remaining characters have not been rejected; they are not displayed due to line length limitations. If you recall the command by pressing the Up arrow key or Down arrow key, all the characters in the command are displayed. For a description of the arrow key functions, see Table 4-2 on page 4-10.

Using Commands

Terminal and Printer Connections

Terminals and printers are connected to the Terminal Disk Module (TDM), using the control shelf backplane. The TDM also provides Keyboard Send and Receive (KSR) function. See "KSR Function on VT320 Terminal Devices" on page 4-5 for more information on the KSR function. A description of the TDM can be found in the *Installation Manual - EAGLE 5 SAS*.

KSR Function on VT320 Terminal Devices

The terminals can use the keyboard send and receive (KSR) mode of operation. KSR refers to a device or mode of operation that prints or displays all received data. The KSR mode of operation typically supports a teletype printer, but in the system, it also supports a video display unit and keyboard.

The KSR feature enables you to attach a dumb terminal device or teletype printer to the system's I/O ports or emulate KSR mode of operation on a VT320. KSR enhances the system's dial-up administration functions by allowing faster throughput, because the screen formatting characters associated with the VT320 mode of operation need not be transmitted.

KSR Configuration

This feature allows you to configure the operational characteristics of system's I/O serial ports to support KSR terminal devices. See Table 4-2 on page 4-10 for a list of the keyboard functions used by the KSR feature. For information on configuring a serial I/O port for KSR operation, see the *Database Administration Manual - SS7*.

Changing the Mode Of Operation

Before you attempt to change the mode of operation of the terminal, you *must* follow the "Changing the Terminal Characteristics" procedure found in the *Database Administration Manual - SS7*. You must perform this procedure from another terminal.

You can change the mode of operation of the terminal by pressing the **F11** key. The **F11** key instructs the system to mimic a KSR. Command line editing operates exactly like the VT320.

The KSR emulation resembles a printer when in operation. The entire screen is used for output. Before you enter a command, press <Ctrl-A>. The command prompt (>) is displayed. Enter a carriage return to signify the end of command entry.

While in the KSR mode, all output to the video display unit is buffered. When any character is entered from the terminal, a one-minute timer is started and data reception from the system is stopped. The system responds to the command with the appropriate response, then resumes sending data where it left off.

If a carriage return is not received during command entry, a time-out occurs and the system resumes sending data to the terminal.

Requirements

The KSR function operates on any combination of terminal type assignments for the 16 available terminal ports.

Telnet Terminals

Telnet is a user command using the underlying TCP/IP protocol for accessing remote computers. Telnet provides a connection from a remote (client) to a host (server) computer; the client keyboard and monitor (or window) act as if physically attached to the host computer. Remote users log on as if they were local users with whatever privileges may have been granted to the specific applications and data on the remote computer. Remote users, after they log in, can use the same services as a local user.

The IP User Interface feature permits any standard telnet client to act as an EAGLE 5 SAS terminal. This IP-based access provides a standard interface through which EAGLE 5 SAS commands are entered from a telnet session to the EAGLE 5 SAS. The EAGLE 5 SAS then provides command responses back to the remote telnet terminal.

Up to 3 IPSM cards in the EAGLE 5 SAS, with IP connectivity, enable telnet clients to connect from anywhere on the customer's IP LAN. The EAGLE 5 SAS must be on the customer's LAN or WAN. Each IPSM card provides 8 telnet terminal ports (IDs 17-24 for the first card installed, 25-32 for the second card installed, and 33-40 for the third card installed), which are automatically made available when the card is installed and provisioned. See the **chg-trm** command description in this manual for more information about configuring telnet terminals.

From the telnet client, the remote user connect to any one of the equipped IPSM cards available by entering the command **telnet** <IP address>. For example,

```
telnet 192.168.1.100
```

The remote user then selects a terminal number from a list of available terminals. If an incorrect terminal number (one not listed in the prompt) is selected, the prompt appears again. (After three incorrect tries, the session is closed). After the session is accepted, an EAGLE 5 SAS welcome message appears. At this point, broadcast messages (if provisioned) will begin to appear. See Figure 4-2 on page 4-7.

Figure 4-2. Telnet Terminal Selection and Login

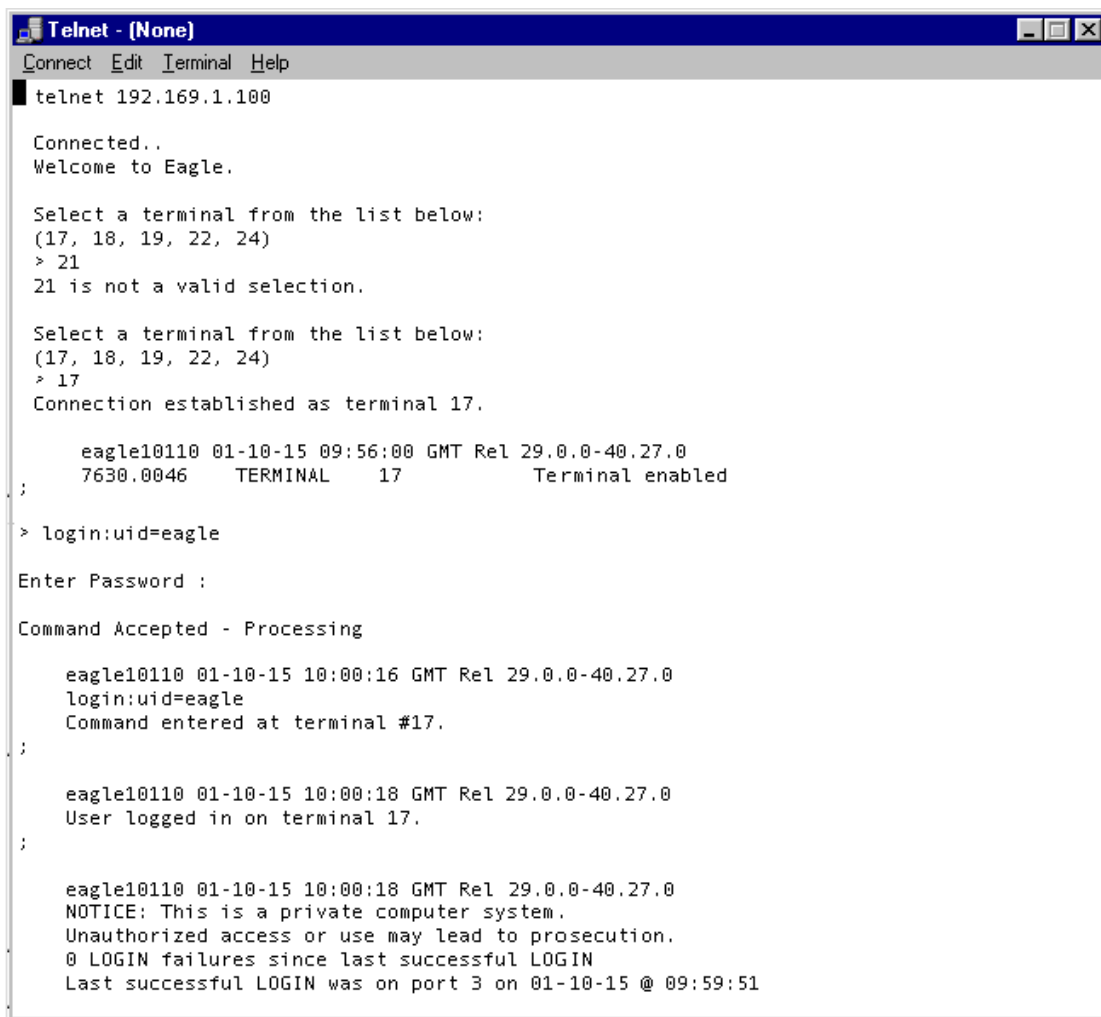

```
Telnet - (None)
Connect Edit Terminal Help
telnet 192.169.1.100

Connected..
Welcome to Eagle.

Select a terminal from the list below:
(17, 18, 19, 22, 24)
> 21
21 is not a valid selection.

Select a terminal from the list below:
(17, 18, 19, 22, 24)
> 17
Connection established as terminal 17.

      eagle10110 01-10-15 09:56:00 GMT Rel 29.0.0-40.27.0
;      7630.0046   TERMINAL   17           Terminal enabled
;

> login:uid=eagle

Enter Password :

Command Accepted - Processing

      eagle10110 01-10-15 10:00:16 GMT Rel 29.0.0-40.27.0
      login:uid=eagle
      Command entered at terminal #17.
;

      eagle10110 01-10-15 10:00:18 GMT Rel 29.0.0-40.27.0
      User logged in on terminal 17.
;

      eagle10110 01-10-15 10:00:18 GMT Rel 29.0.0-40.27.0
      NOTICE: This is a private computer system.
      Unauthorized access or use may lead to prosecution.
      @ LOGIN failures since last successful LOGIN
      Last successful LOGIN was on port 3 on 01-10-15 @ 09:59:51
```

After a connection is made, the remote user can log in using a pre-provisioned user ID and password. (The user ID and password must be provisioned from an existing serial terminal). The **login** command can be typed directly, without typing <Ctrl-A> first.

An EAGLE 5 SAS serial terminal emulating a Keyboard Send/Receive (KSR) device is normally in *display mode* (where outgoing messages are displayed). In order to enter a command, the user must interrupt the display by holding down the Ctrl key and typing an “a” (the ATTENTION or Ctrl-A key sequence). When the terminal controller receives an ATTENTION, it enters a *command entry mode*. The output text is temporarily halted, and the prompt symbol “>” appears.

The telnet terminal enters *command entry mode* when any key is pressed; <Ctrl-A> is not needed.

After the login is accepted and the user presses a key to receive the standard EAGLE 5 SAS command line prompt, all EAGLE 5 SAS commands assigned to that user ID are now accessible.

The display of broadcast messages can be interrupted with any keystroke, and will resume after a command is entered or a set timeout expires. When in command entry mode, the telnet server holds any outgoing messages in a buffer while a command is entered. A command entry is completed by pressing the Enter key.

The telnet server waits up to 60 seconds between keystrokes for the command text to be completed, before timing out and resuming the broadcast display. If the command entry times out, and output resumes, the incomplete command text might scroll off the screen. Even though the incomplete command was not executed, it is saved as an entry in the command buffer. This incomplete command will be displayed again when any key is pressed. The command string can be finished by continuing the typing where it was interrupted. Pressing the Enter key submits this command as usual.

Broadcast messages are held in a buffer from the time a key is pressed, until the command is complete (timed out, aborted, cancelled, or rejected). This is to allow command responses to be completely displayed. After the command completes, broadcast messages (if provisioned) will resume. The IPSM card buffer will hold up to 30 minutes of broadcast output before discarding the oldest messages.

When the user enters the **logout** command to end the telnet session, the user is logged off of the EAGLE 5 SAS, but the port remains assigned to the EAGLE 5 SAS telnet terminal. If the active port connection is lost for a reason such as hardware fault or system interruption, the telnet server resets affected ports, the session is closed, and the user ID is logged off.

Element Management System Alarm Monitor Terminals

Element Management System Alarm Monitor (EMSALM) terminals display UAM alarm set and clear messages and the UIM 1083 "system alive" messages only. No other messages (including reports and other UIMs) are displayed. EMSALM terminals are designed to display alarm messages only. EMSALM terminals are not restricted in any other way. They can accept login, and commands; however these operations may interfere with alarm monitoring and should be performed on an alternate terminal.

Serial port terminal IDs 1-16 can be assigned as EMSALM terminals. These EMSALM terminals are a refinement of the KSR terminal, and contain all the KSR terminal communication parameters.

Telnet terminal IDs 17-40 can be assigned as EMSALM terminals when the IP User Interface feature is enabled and turned on and up to 3 IPSM cards are equipped in the system (see "Telnet Terminals" on page 4-6). These EMSALM terminals have all of the functions of a telnet type terminal.

When the **chg-trm** command is entered to change a terminal to the EMSALM type, all output group parameter values for that terminal default to YES, even if they were set to NO before the change. Even though an output group is set to YES for an EMSALM terminal, no reports or UIMS other than UIM 1083 will appear for that output group. Individual output group values can be changed to NO by entering another **chg-trm** command for an EMSALM terminal (do this only with caution; it can cause loss of UAM alarm messages at the EMSALM terminal).

When the **chg-trm** command is entered to change a terminal from type EMSALM to another type, the output group values remain unchanged. A **chg-trm** command can be entered to change output group settings.

About Commands

Commands allow you to interact with the system to perform specific functions. Commands are available to perform the following functions:

- Obtain system status and operational status
- Modify system configuration
- Obtain measurement reports

The following sections describe how to enter commands through a system terminal. Command correction, keywords, parameters, and syntax are described.

Entering Commands

All commands are entered at the command prompt (>), located in the bottom window of the terminal display. After entering a command, you must press the **Enter** key. When the command has executed (an output message appears in the display to indicate execution), you can enter another command. The **F9** function key allows you to interrupt a running command; however, you cannot enter another command until the running command completes its operation.

Commands are not case sensitive; therefore, either uppercase or lowercase characters can be used. Intermixing (using both upper and lower case) characters does not create an error message, but you must use the correct command syntax.

Action Commands

Throughout this manual, the term “action command” is used in the description of some dependencies, as in the sentence “No other action command can be in progress when this command is entered.”

Action commands are used to effect changes to the state of entities within the system, such as cards and signaling links. For example, you use the **inh-card** command to change the state of the card to Out-of-Service - Maintenance Disabled (OOS-MT-DSBLD).

Table 4-1 lists the action commands and shows which type of system entity they are associated with.

Table 4-1. Action Commands and Their Associated System Entity

Action Commands	System Entity
act-slk, alw-slk, canc-slk, dact-slk, inh-slk, unhb-slk, blk-slk, ublk-slk, tst-slk	Link Commands
act-alm-trns, canc-alm-trns, rls-alm	Alarm Commands
alw-trm, inh-trm	Terminal Commands
alw-card, inh-card, rmv-card, rst-card	Card Commands

Command Keywords and Parameters

Commands consist of two parts: keywords and parameters. Keywords identify the principal action to be performed by the system, and consist of one to three words. Most commands also require parameters to further define the command operation.

Parameters are entered after the keyword. Each parameter must be separated from the keyword or the previous parameter with a colon. If a parameter has multiple values, the values entered are discrete and must be separated with a hyphen or comma. The parameters can be entered in any order.

Some command parameters have built-in default values that are used if a value is not specified. To accept a default value, press **Enter** after the desired keyword and parameters have been entered.

Use the following delimiters when entering commands:

- : —separates parameters
- or , —separates multiple values within a parameter block
- = —use as delimiter between the parameter and input value

The following is an example of a command entry:

```
> dact-slk:loc=1101:port=a
```

The keyword in the above example is **dact-slk** (Deactivate Signaling Link). The first parameter for this command is **loc=1101** (the actual card location in the system for the link being cancelled, based on equipment location). The second parameter is **port=a**. This parameter signifies which signaling link port on the card in the designated location has the link that is to be cancelled.

If an error is made while typing commands, use the **Delete** key to make corrections, one character at a time.

NOTE: If the same parameter is entered more than once in a command, the system accepts the last parameter value that was entered. Any values for the parameter that were entered earlier in the command are ignored.

Keyboard Functions

Some keyboard functions used with commands are described in the previous section. Keyboard functions available for use with commands are listed in Table 4-2. Arrow key functions are further described following the table.

Table 4-2. Keyboard Functions

VT320 Key Sequence	KSR Key Sequence	Description
↑	↑	The Up arrow key recalls the previous commands entered at the prompt, one command at a time. The Up arrow key scrolls backwards through up to 10 commands for a KSR, VT320, or SCCS terminal, and up to 20 commands for an IP UI telnet terminal. See "Up Arrow Key" on page 4-13 for a description of the Up arrow key functions.
←	←	The Left arrow key backspaces the underline cursor without erasing.

Using Commands

Table 4-2. Keyboard Functions (Continued)

VT320 Key Sequence	KSR Key Sequence	Description
↓	↓	The Down arrow key recalls the previous command entered at the prompt, one parameter at a time. If the Up arrow key is pressed and more than one command has been entered in the session, pressing the Down arrow key displays one previously entered command at a time. The Down arrow key scrolls forward through up to 10 commands for KSR, VT320, and SCCS terminals and up to 20 commands for IP UI telnet terminals. See "Down Arrow Key" on page 4-13 for a description of the down arrow key functions.
→	→	The Right arrow key recalls the last command entered at the prompt, one character at a time.
F6	F6	The F6 Function key refreshes the terminal screen, including any characters already input on the command line and the command response line.
F7	F7	The F7 Function key clears the scroll buffer. This enables a user to stop useless information from passing to the scroll region of the system terminal.
F8	F8	The F8 function key enables you to stop and restart the scrolling of information on the terminal screen.
F9	F9	The F9 Function key allows you to interrupt a running command so that you can enter another command. Output and processing of the interrupted command continue. Pressing F9 is the same as issuing the canc-cmd command with no parameters. The commands that can be interrupted by pressing F9 are listed in the description of the canc-cmd command. If the terminal is running one of the listed commands and you press F9 , output and processing are cancelled. This function works only on the same terminal that is running the command you want to cancel. To cancel a command from another terminal, use the canc-cmd:trm= command (see the canc-cmd command description).
F10	F10	The F10 Function key displays help information for the last command that was entered, including parameters, parameter formats, and the command class.
F11	F11	The F11 Function key allows you to toggle the terminal's mode of operation from VT320 to KSR and from KSR to VT320. This function key has no effect on IP UI telnet terminals.
Not Available	Control-A	Control-A allows you to enter a command in the KSR mode.
Control-S	Control-S	Used with the <i>sw</i> or <i>both</i> flow control (see the chg-trm command description for more information), this key sequence sends the XOFF character to temporarily stop sending data.
Control-Q	Control-Q	Used with the <i>sw</i> or <i>both</i> flow control (see the chg-trm command description for more information), this key sequence sends the XON character to resume sending data.
Ins	Ins	When Insert is toggled on, typed characters are inserted into the command line, moving existing characters to the right. When toggled off, typed characters overwrite existing characters.
Del	Del	Deletes one character at a time from the right; the cursor stays in position.
Back Space	Back Space	Deletes a character and moves the cursor one space to the left.

Arrow Key Operation

The arrow keys are used to move the cursor to a different position in a command, and to display part or all of a command that was previously entered.

On KSR, VT320, and SCCS terminals, you can scroll through the last 10 commands that were entered at the terminal during the session. On IP UI telnet terminals, you can scroll through the last 20 commands that were entered at the terminal during the session. Part or all of one command at a time is displayed. When you have scrolled through the complete list of up to 10 or 20 commands, the scrolling wraps back to the beginning of the list.

The list of previously entered commands is cleared when a terminal is inhibited and allowed (**inh-trm:trm=xx** and **alw-trm:trm=xx**) and when a file transfer is initialized with the **act-file-trns** command.

There are two modes of command recall for Up and Down arrow keys:

- Edit Mode

Edit Mode includes any key operation that changes the command at the prompt, such as the Delete key, the Back Space key, or an alphanumeric key. Pressing one of these keys to enter or change a command puts the terminal into Edit Mode. Pressing the Enter key (or carriage return) takes the terminal out of Edit Mode.

- Non-edit Mode

Pressing the Enter key (or carriage return) puts the terminal into Non-edit Mode. A terminal remains in Non-edit Mode when you press an arrow key, a Function key, or the Insert key, which do not change the command at the prompt. When you press a key that changes the command, the terminal goes into Edit Mode until you press the Enter key again.

Using Commands

Up Arrow Key

The Up arrow key is used to recall up to the last 10 commands (KSR, VT320, and SCCS terminals) or the last 20 commands (IP UI telnet terminals) entered at the prompt during the session.

In Edit Mode

- You enter 3 characters of a command at the prompt and press the Up arrow key. If the previous command was 6 characters long, then the last 3 characters of the previous command are recalled and displayed after the 3 characters that you entered at the prompt.
- You enter 10 characters of a command at the prompt and press the Up arrow key. If the previous command was 6 characters long, none of the previous command is displayed. The command that you entered remains as you entered it at the prompt.
- Entering part or all of a command at the prompt puts the terminal into Edit Mode. In Edit Mode, the last (or previous) command is recalled only if the command length of the last command is greater than the command at the prompt.

In Non-edit Mode

- When you have pressed the Enter key and there is no command at the prompt, or you have pressed the Insert key or a Function key, the terminal is in Non-edit Mode.
- When you press the Up arrow key in Non-edit Mode, and you have entered at least one previous command, the last command that you entered is displayed at the prompt. Pressing the Up arrow key again clears the command at the prompt (if any) and displays the next previous command that you entered (if any). By continuing to press the Up arrow key, you can scroll backwards through the last 10 commands (KSR, VT320, and SCCS terminals) or the last 20 commands (IP UI telnet terminals) that you entered at the terminal. The display wraps back to the most recent of the entered commands when all of the available commands have been recalled. The terminal remains in Non-edit Mode until you press a key that changes the displayed command.

Down Arrow Key

In Edit Mode, the Down arrow key recalls the last command that was entered at the terminal, one parameter at a time. The recalled parameter is displayed at the end of the entry that currently appears at the prompt.

In Non-edit Mode:

- If the Up arrow has not been pressed just before pressing the Down arrow key, the Down arrow key recalls the last command that was entered at the terminal, one parameter at a time.
- If the Up arrow key is the last key that was pressed before the Down arrow key is pressed, the Down arrow key scrolls forward through the last 10 commands (KSR, VT320, and SCCS terminals) or last 20 commands (IP UI telnet terminals), displaying one complete command each time the key is pressed. The scrolling wraps to the beginning of the list when all of the available commands have been displayed.

Right Arrow Key

Each time the Right arrow key is pressed, one character of the last command is recalled and the cursor moves one position to the right. When the last command is completely displayed, pressing the Right arrow key does not cause any cursor movement or character display.

Left Arrow Key

The Left arrow key moves the underline cursor one position to the left without erasing the character. The underline cursor can be moved until it reaches the first character at the left of the command. If the Left arrow key is pressed again after the cursor reaches the first character of the command, the bell sounds.

Command Output and Messages

Reports and outputs generated through retrieve or report status commands are followed by a semi-colon (;) to signify the end of the output (this is in compliance with TL1 standards).

The following types of output messages are used on the system:

- **Command Accepted—Processing:** The command has been accepted by the application's command handler as syntactically correct. This message is displayed in the command area of the terminal display.
- **Command Completed—**The command has been entered, and the system has completed processing. This message is displayed in the scroll area of the terminal display.
- **Command Executed—**The command has been entered, and the system has completed processing. This message is displayed in the command area of the terminal display.
- **Command Failed—**The command was executed but failed due to an external reason, such as the link is not equipped or a disk drive is unable to communicate. The reason for the failure is included in this message.
- **Command Rejected—**The command syntax could be incorrect, or a parameter value is incorrect (semantic error). This message is displayed in the command area of the terminal display. The reason for rejecting the command (command syntax or incorrect parameter value) is included in this message.

Using Commands

- **Command Aborted**—The command syntax and the parameter values are ok, but for some reason the command was aborted (for example, a disk drive is inaccessible). This message is displayed in the scroll area of the terminal display.
- **Command Response Messages**—A command is entered at the terminal, and the response to that command is echoed on that same terminal. These messages are displayed in the scroll area of the terminal display.
- **Unsolicited Messages**—An example of unsolicited messages are the messages delivered in response to alarm conditions. These messages are displayed in the scroll area of the terminal display.

The unsolicited messages can be directed to a specific terminal or printer by using the **chg-trm** command to assign one or more of the following groups of unsolicited output messages to the specified terminal or printer.

Application Server	Application Subsystem
Card	Clock
Debug	Global Title Translation
Gateway Screening	Measurements Maintenance
Monitor	MPS
SEAS Maintenance	SLAN Maintenance
System Maintenance	Security Administration
Traffic Measurements	Database Administration
Link Maintenance	Program Update
LNP Database Administration	LNP Subscription

To configure a terminal to receive unsolicited LNP database administration and LNP subscription messages, the LNP feature must be turned on (see the **enable-ctrl-feat** command).

Command Output Banners

When a command is executed in the system, one or more banner lines appear in the output that is displayed for the command.

Figure 4-3 on page 4-15 shows the general format of an output banner.

Figure 4-3. Output Banner Format

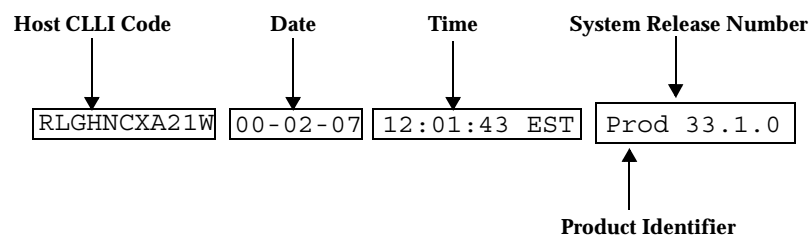

The following fields appear in each output banner:

- **Host CLI code**—a maximum of one alphabetic character and ten alphanumeric characters. The CLI code uniquely identifies the system in terms of its physical location. The CLI code must be unique among all elements in the system.

The CLI code contains the following information:

- City—4 characters
- State— 2 characters
- Building— 2 characters
- Equipment type —3 characters
- Date—year-month-day
- Time—hour: minute: second time zone
- System Release Number— contains a product identifier and the version ID number.

The product identifier, which is shown as 'Prod' in Figure 4-3 and many output examples in this manual, can appear as "EAGLE" or "EAGLE5" depending on the product key that is turned on in the system (see the **rtrv-ctrl-feat** output example). If there are one or more "EAGLE 5" features enabled in the system, the EAGLE5 product key must also be turned on and EAGLE5 will appear in the banner. If there are no "EAGLE 5" features enabled in the system, the EAGLE product key will be turned on and EAGLE will appear in the banner. (If both the EAGLE5 and EAGLE product keys are enabled, the EAGLE5 product key should be turned on and appear in the banner).

The version ID number identifies the GPL set that is specific to the software release that is expected to be installed on the system as approved loads. The format of the version ID number is *maj.min.maint*, defined as follows:

- *maj*—the major release ID
- *min*—the minor release ID
- *maint*—the maintenance release ID

System Security

User IDs and passwords protect the system from unauthorized entry into the system and enhance system security. To enter the system through a terminal, a user must enter a valid user ID and password at the system prompt, and the user ID and password must be authorized for use together. A user ID identifies a user to the system.

To maintain the security of the system, passwords should be changed periodically and user IDs should be deleted whenever there is a personnel change.

When prompted to enter a new password, a different password should be provided. This is the responsibility of the user, and is not enforced by the EAGLE 5 SAS.

Rules for User ID and Password Administration

The rules for administering User IDs and passwords are:

- The maximum number of user ID-password combinations is 100.
- The maximum length of the user ID is 16 characters.
- The maximum length of the password is 12 characters; the minimum length is site provisionable using the **chg-secu-dflt** command, and it can be from 1 – 12 characters long.
- User IDs and passwords may contain any printable characters except the characters used as command delimiters: colon (:), comma (,), hyphen (-), or equal sign (=).
- Each user ID must begin with an alpha character.
- A password must contain:
 - At least as many characters as specified on the **minlen** parameter of the **chg-secu-dflt** command
 - At least as many alphabetic characters as specified on the **alpha** parameter of the **chg-secu-dflt** command
 - At least as many numeric characters as specified on the **num** parameter of the **chg-secu-dflt** command
 - At least as many punctuation characters as specified on the **punc** parameter of the **chg-secu-dflt** command
- A password must not contain the associated user ID.

Command Classes

Each user ID and password combination is assigned to one or more command classes to control the set of commands that a user may enter.

There are 10 unique non-configurable command classes: Basic, Database Administration, Debug, Link Maintenance, Program Update, Security Administration, System Maintenance, LNP Basic, LNP Database Administration, and LNP Subscription. (The Basic command class is assigned to all users as a default).

There are 32 available configurable command classes. See the **chg-cmd** command description and the **chg-cmdclass** command description for information about naming and assigning commands to configurable command classes.

See the **chg-user** command description or the **ent-user** command description for more information on configuring user IDs and passwords and assigning command classes.

Login Security Checks

To aid in system security, the system maintains a record of when a password was last changed and requires a user to change the password when it is older than the site-specified maximum password age. The system also keeps track of the elapsed time between successful logins. If the time between successful logins exceeds the site-specified maximum, a user is not allowed access to the system. The site systems administrator also has the ability to revoke a user ID.

When a user first logs into the system, the default unauthorized user warning is displayed as follows

```
NOTICE: This is a private computer system.  
Unauthorized access or use may lead to prosecution.
```

Additional security is available for the system in that multiple logins using the same user ID are prohibited.

Intrusion Alert

To alert the system administrator to a possible attempt by an unauthorized person trying to log into the system, the system issues a scroll area message. When 5 or more consecutive attempts to log into the system have failed, the following scroll area message is sent to all terminal ports that can receive unsolicited Security Administration messages:

```
Info: xxxxxxxxxx successive LOGIN failures on port pp
```

Where:

`xxxxxxx` is the number of consecutive login failures on the port (1 – 4,294,967,295)

`pp` is the terminal port (1 – 40) on which the login attempts were made

When the attempt to log into the system is successful after a series of failed consecutive login attempts, or if the active MASP reboots, the count of failed consecutive login attempts for that port is reset to 0.

Attempts to log into the system that are not completed normally, are not considered login attempts and are not included in the count of failed consecutive login attempts. For example, while prompting for a password you might use the **F9** key to abort the command, or errors might occur when the system is looking up a user ID or password.

Login Procedure

The commands described in this manual are entered at a terminal connected to the system. Before you can enter most of the commands, you must enter the **login** command to log into the system and open a user session. You must enter the login command with a valid user ID and password combination. When the system accepts your user ID and password as valid, you can enter commands at the terminal in the user session.

The first procedure in this section explains how to log into the system using the **login** command.

The procedures that follow the login procedure explain how to handle common situations that can arise when you log into the system.

- You must change the password the first time that you log in with a new user ID and password.
- The user ID and password that you enter are not accepted as valid.
- Your password has expired and must be changed.
- Someone else has already logged on with your user ID and password; the system does not allow the same ID and password to be used on two terminals at the same time.

NOTE: You can enter the **act-user** command instead of the **login** command.

Procedure - Log into the System for a User Session

- 1 At the system prompt (>), enter the **login** command with your user ID.
-

- 2 Press the **Enter** key.

The following message appears:

```
Enter Password:
```

- 3 At the system prompt, type your password.

For security reasons, the password is not displayed on the terminal screen.

- 4 Press the **Enter** key.

Follow the remaining steps to complete this procedure or to go to another procedure, depending on the system response to validation of your user ID and password.

- 5 If your user ID and password combination are accepted and the following messages appear in the terminal input/command response region, the terminal is available for a user session.

```
Command Accepted-Processing  
Command Executed
```

This procedure is complete.

- 6 If your user ID and password combination are not accepted and the following message appears, go to "Procedure - Your User ID and Password were not Accepted" on page 4-20.

```
E2757 Cmd Rej: Invalid UserID/Password Combination
```

- 7 If you entered a new user ID and password combination for the first time, the following message appears, go to "Procedure - You Must Change Your Password" on page 4-20.

```
Enter new password (password must be changed) :
```

- 8 If you entered your user ID and password combination and your password has expired, the following message appears, go to "Procedure - Your Password has Expired" on page 4-21.

```
Enter new password (password has expired and must be changed) :
```

- 9 If you entered your user ID and password combination and they are already being used at another terminal, the following message appears. Go to "Procedure - Your User ID is Already Being Used" on page 4-22.

```
E2750 Cmd Rej: UserID already logged on (or is logging on) another port
```

Procedure - Your User ID and Password were not Accepted

This procedure outlines the steps to follow when you attempt to log into the system and your user ID and password combination are not accepted.

- 1 When you entered the **login** command with your user ID and entered your password at the system prompt, the following message appeared:

```
E2757 Cmd Rej: Invalid UserID/Password Combination
```

When this message is displayed, the terminal also presents a message describing the login attempt and the time and date the attempt occurred.

- 2 Verify that you have the correct user ID and password.

Return to the login procedure, and log in again with the correct user ID and password.

If the problem occurs again, contact your System Administrator.

Procedure - You Must Change Your Password

This situation can occur when you first log in after the system administrator uses the **ent-user** command to enter a new user ID and password combination, or when you first log in after the **chg-user:pid=yes** command has been entered.

- 1 When you entered the **login** command with your user ID and entered your password at the system prompt, the following message appeared:

```
Enter new password (password must be changed) :
```

Type a new password, following your site guidelines.

For security reasons, the password is not displayed on the terminal screen.

- 2 Press the **Enter** key.

The system checks the password to ensure that it meets your site's password complexity requirements.

- 3 If your password does not meet your site's password complexity requirements, the system displays a message based on the password violation (see "Login Error Messages" on page 4-22 for a list of possible messages).

```
The login process ends.
```

Decide on a new password, and start the login procedure again.

- 4 If your password meets the complexity requirements, the following message appears:

```
Verify Password:
```

Type the exact password again that you entered in Step 1

For security reasons, the password is not displayed on the terminal screen.

Using Commands

5 Press the **Enter** key.

6 If the user ID and password combination are accepted and the following messages appear in the terminal input/command response region, the terminal is available for a user session

```
Command Accepted-Processing  
Command Executed
```

7 Record your new password in a secure location.

Procedure - Your Password has Expired

1 When you entered the **login** command with your user ID and entered your password at the system prompt, the following message appeared:

```
Enter new password (password has expired and must be changed) :
```

Type a new password, following your site guidelines.

For security reasons, the password is not displayed on the terminal screen.

2 Press the **Enter** key.

The system checks the password to ensure that it adheres to your site's password complexity requirements.

3 If your password does not meet your site's password complexity requirements, the system displays a message based on the password violation (see "Login Error Messages" on page 4-22 for a list of possible messages).

The login process ends.

Decide on a new password, and start the login procedure again.

4 If your password meets the complexity requirements, the following message appears:

```
Verify Password:
```

Type the exact password again that you entered in Step 1

For security reasons, the password is not displayed on the terminal screen.

5 Press the **Enter** key.

6 If the user ID and password combination are accepted and the following messages appear in the terminal input/command response region, the terminal is available for a user session

```
Command Accepted-Processing  
Command Executed
```

7 Record your new password in a secure location.

Procedure - Your User ID is Already Being Used

- 1 When you entered the **login** command with your user ID and entered your password at the system prompt, the following message appeared:

E2750 Cmd Rej: UserID already logged on (or is logging on) another port

The following information is displayed in the scroll area:

Info: UID is currently logged on (or is logging on) to port yy.

where yy is in the range of 1 - 40.

- 2 Find the terminal at port yy, and log off your user ID at that workstation.

See "Procedure -Log Out Of the System" on page 4-23

- 3 Return to your terminal and log into the system again.
-

Login Error Messages

E2262 Cmd Rej: Password too long, 12 maximum

E2263 Cmd Rej: Password does not contain enough characters

E2264 Cmd Rej: Password verification failed

E2750 Cmd Rej: UserID already logged on (or is logging on) another port

E2751 Cmd Rej: UserID has been revoked

E2752 Cmd Rej: UserID has become obsolete and cannot be used

E2753 Cmd Rej: Password does not contain enough alphabetic characters

E2754 Cmd Rej: Password does not contain enough numeric characters

E2755 Cmd Rej: Password does not contain enough punctuation characters

E2756 Cmd Rej: Failed reading the password table

E2757 Cmd Rej: Invalid userID/password combination

E2758 Cmd Rej: ALPHA+NUM+PUNC must not be greater than 12

E2759 Cmd Rej: Revocation of security admin userID not allowed

E2760 Cmd Rej: Failed reading the security defaults table

E2761 Cmd Rej: Password cannot contain userID

See the **chg-secu-dflt** command description for information on different options the system administrator has for configuring the system for password requirements.

The following is an example of the information that might be displayed in the scroll area, depending on your site's configuration:

Using Commands

New password must contain

- from 8 to 12 characters
- at least 1 alphabetic character(s) (a – z)
- at least 1 numeric character(s) (0 – 9)
- at least 1 punctuation character(s) (for example, \$%#@#)

Logout Procedure

When a terminal session is completed, you perform the following logout procedure to log out of the system. The terminal returns to an input idle state.

NOTE: You can use the `dact-user` command instead of the `logout` command.

Procedure - Log Out Of the System

1 At the system prompt (>), enter the **logout** command.

2 Press the **Enter** key.

The following messages appear on the terminal screen to confirm command completion:

```
Command Accepted-Processing  
Command Executed
```

5

Commands A-C

This chapter contains commands that start with the letters A through C. The commands are listed in alphabetical order starting on page 5-2.

Introduction

For each command listed in this chapter, the following information is given:

- A description of the command
- The command syntax
- A list of related commands
- The command class to which the command belongs
- A description of the command parameters
- An example of the command usage
- Rules, dependencies, and notes relevant to the command
- Sample command output

act-alm-trns**Activate Alarm Transfer**

Use this command to transfer all alarm indications from the local office to the remote maintenance center.

Keyword: act-alm-trns

Related Commands: dact-alm-trns, rept-stat-clk, rept-stat-trbl, rtrv-obit, rtrv-trbl

Command Class: System Maintenance

Parameters

This command has no parameters.

Example

act-alm-trns

Dependencies

No other action command can be in progress when this command is entered.

Notes

After this command is entered, use the **rept-stat-alm** command to verify the **act-alm-trns** action.

New alarms cause the local maintenance center audible alarms to sound for a short period.

Output

act-alm-trns

```
rlghncxa03w 04-01-09:50:17 EST EAGLE 31.3.0
Alarms transferred to Remote Maintenance Center
Command Completed.
```

;

act-cdl**Activate Command Driven Loopback**

Use this command to initiate a command driven loopback for testing a signaling link.

Command Driven Loopback is the ability to locally drive a signaling link into a manual line loopback. The data received on the signaling link is echoed (transmitted) back. This is effectively the reverse of the **tst-slk:loopback=lxvr**, which loops the transmitted data back to the receive.

Keyword: act-cdl

Related Commands: dact-cdl, rept-stat-cdl, act-lbp, dact-lbp, tst-slk

Command Class: Link Maintenance

Parameters

:loc= (mandatory)

The card location as stenciled on the shelf of the system.

Range: 1101–1108, 1111–1112, 1201–1208, 1211–1218, 1301–1308, 1311–1318, 2101–2108, 2111–2118, 2201–2208, 2211–2218, 2301–2308, 2311–2318, 3101–3108, 3111–3118, 3201–3208, 3211–3218, 3301–3308, 3311–3318, 4101–4108, 4111–4118, 4201–4208, 4211–4218, 4301–4308, 4311–4318, 5101–5108, 5111–5118, 5201–5208, 5211–5218, 5301–5308, 5311–5318, 6101–6108, 6111–6118

:port= or :link= (mandatory)

SS7 signaling links. The SS7 signaling link to be tested.

Range: a, b, a1-a31, b1-b31

Not all card types support all **link** parameter values.

See Table A-1 in Appendix A for valid **link** parameter range values for each type of card that can have assigned signaling links.

:loopback= (optional)

Loopback test type.

Range: line, payload

The **payload** value is valid only on LIM-ATM and E1-ATM cards.

Default: line

Example

```
act-cdl:loc=1205:link=b
```

Dependencies

The card in the location specified in the **loc** parameter must be equipped, in service, and support Command Driven Loopback testing.

The signaling link specified in the **link** parameter must be equipped and not active.

LFS must not be running on the specified signaling link when this command is entered. The LFS processing must be stopped or must be allowed to complete before this command can be entered.

The **loopback=payload** parameter is valid only for LIM-ATM and E1-ATM cards.

Command Driven Loopback testing is not available during upgrade.

A Command Driven Loopback test cannot be in progress on the specified link when this command is entered.

A **tst-slk** command cannot be in progress on the specified link when this command is entered. The **tst-slk** processing must be stopped or must be allowed to complete before this command can be entered.

Notes

None

Output**act-cdl:loc=1205:link=b**

```

tekelecstp 05-01-21 17:00:36 EST EAGLE5 33.0.0
Command Accepted: Command Driven Loopback message is sent.
;

tekelecstp 05-01-21 17:00:36 EST EAGLE5 33.0.0
Command Completed.
;

```

act-dlk**Activate Data Link**

Use this command to activate a TCP/IP data link and put that data link into service. The state of the TCP/IP data link is changed from out of service maintenance disabled (OOS-MT-DSBLD) to in service normal (IS-NR).

Keyword: act-dlk

Related Commands: canc-dlk, dlt-dlk, ent-dlk, rept-stat-dlk, rtrv-dlk, tst-dlk

Command Class: Link Maintenance

Parameters

:loc= (mandatory)

The card location as stenciled on the shelf of the system.

Range: 1101–1108, 1111–1112, 1201–1208, 1211–1218, 1301–1308, 1311–1318, 2101–2108, 2111–2118, 2201–2208, 2211–2218, 2301–2308, 2311–2318, 3101–3108, 3111–3118, 3201–3208, 3211–3218, 3301–3308, 3311–3318, 4101–4108, 4111–4118, 4201–4208, 4211–4218, 4301–4308, 4311–4318, 5101–5108, 5111–5118, 5201–5208, 5211–5218, 5301–5308, 5311–5318, 6101–6108, 6111–6118

Example

act-dlk:loc=1308

Dependencies

No other action command can be in progress when this command is entered.

The shelf and card must be equipped.

The card location must contain an ACM.

Notes

None

Output**act-dlk:loc=1308**

```

rlghncxa03w 04-01-17:00:36 EST EAGLE 31.3.0
Activate Link message sent to card.
Command Completed.
;

```

act-echo**Activate Echo**

Use this command to force responses from the scroll area of a terminal to be printed to a specified terminal or printer. The command supports one terminal echoing to many terminals or many terminals echoing to one terminal.



CAUTION: Exercise restraint in using this command, because excessive echoing can cause a loss of output at the receiving terminal.

Keyword: act-echo

Related Commands: dact-echo, chg-trm, rept-stat-trm, rtrv-trm, rst-trm, rmv-trm

Command Class: Basic

Parameters

:trm= (mandatory)

Serial port number.

Range: 1-16

Example

```
act-echo:trm=3
```

Dependencies

Terminal output cannot be echoed to a terminal that is inhibited or out of service.

If a terminal is already echoing to a specified terminal, the **act-echo** command cannot be entered to echo the terminal's output to that same terminal.

Echo is not allowed to the terminal from which the command is issued.

Echo is not allowed to or from IP User Interface telnet ports (terminals 17-40).

Echo is not allowed to an OAP port.

Notes

This command can be used to echo only command output responses to a terminal. For alarm and network messages to be sent to a terminal, the **chg-trm** command must be used.

To echo output to a destination port, a user must be logged in at the destination port. The following warning message appears in the scroll area of the issuing terminal if echo is attempted to a terminal that has no user logged in:

```
No user logged in at Terminal X. No echo will occur until a user logs in.
```

where X is the **trm** parameter value specified in the **act-echo** command.

Output**act-echo:trm=2**

```
rlghncxa03w 04-01-07 11:11:28 EST EAGLE 31.3.0
act-echo:trm=2
Command entered at terminal #1.
```

```
rlghncxa03w 04-01-07 11:11:28 EST EAGLE 31.3.0
Scroll Area Output is echoed to terminal 2.
```

Caution: Loss of output may occur if too many terminals are echoed.

;

act-echo:trm=3

```
rlghncxa03w 04-01-07 11:11:28 EST EAGLE 31.3.0
act-echo:trm=3
Command entered at terminal #1.
```

```
rlghncxa03w 04-01-07 11:11:28 EST EAGLE 31.3.0
Scroll Area Output is echoed to terminal 2.
Scroll Area Output is echoed to terminal 3.
```

Caution: Loss of output may occur if too many terminals are echoed.

;

act-file-trns**Activate File Transfer**

This command starts a file transfer between the system and a remote computer.

Keyword: act-file-trns

Related Commands: copy-fta, disp-fta-dir, dlt-fta

Command Class: System Maintenance

Parameters

:loc= (optional)

The location of the fixed disk to or from which the file is to be uploaded or downloaded.

Range: 1114, 1116

(TDMs)

Default: The active TDM location

:retries= (optional)

The number of times the system retries a packet before giving up.

Range: 1-20

Default: 10

:timeout= (optional)

The number of seconds the system waits for a packet before sending a negative acknowledgment or retransmitting the previous packet. This parameter also specifies the number of seconds to wait for a transfer initiation message from the remote computer.

Range: 1-120

Default: 30

Example

```
act-file-trns:loc=1113
```

Dependencies

The **loc** parameter must specify a TDM card.

Only one file transfer can be active at a time.

This command cannot be entered on a telnet terminal (IDs 17-40).

Notes

Output messages indicating transfer initiated and transfer terminated (whether successful or not) are sent to the output devices in the Security Administration output group.

Output

Normal session output to non-Security Administration user's terminal.

act-file-trns:loc=1114:timeout=20:retries=2

```
rlghncxa03w 04-01-05 14:37:05 EST  EAGLE 31.3.0
act-file-trns:loc=1114:timeout=20:retries=2
Command entered at terminal #1.
;
rlghncxa03w 04-01-05 14:37:05 EST  EAGLE 31.3.0
Awaiting File Transfer with remote.
Please initiate binary Kermit session on local computer
;
rlghncxa03w 04-01-05 14:38:33 EST  EAGLE 31.3.0
File Transfer : 0 file(s) DOWNLOADED from location 1114 successfully
File Transfer : 1 file(s) UPLOADED to location 1114 successfully
File Transfer : Kermit Session terminated NORMALLY
```

Normal session output to Security Administration group terminals.

act-file-trns:loc=1114:timeout=20:retries=2

```
rlghncxa03w 04-01-05 14:40:42 EST  EAGLE 31.3.0
File Transfer : INITIATED on terminal #1
;
rlghncxa03w 04-01-05 14:41:07 EST  EAGLE 31.3.0
File Transfer: 511_byte.bin UPLOADED to location 1114 successfully.
;
rlghncxa03w 04-01-05 14:41:44 EST  EAGLE 31.3.0
File Transfer : terminated NORMALLY on terminal #1
```

Normal session output to Security Administration user's terminal.

act-file-trns:loc=1114:timeout=20:retries=2

```

rlghncxa03w 04-01-05 14:42:51 EST  EAGLE 31.3.0
act-file-trns:loc=1114:timeout=20:retries=2
Command entered at terminal #1.
;
rlghncxa03w 04-01-05 14:43:29 EST  EAGLE 31.3.0
File Transfer : INITIATED on terminal #1
;
rlghncxa03w 04-01-05 14:43:53 EST  EAGLE 31.3.0
Awaiting File Transfer with remote.
Please initiate binary Kermit session on local computer

rlghncxa03w 04-01-05 14:44:19 EST  EAGLE 31.3.0
File Transfer: 511_byte.bin UPLOADED to location 1114 successfully.
;
rlghncxa03w 04-01-05 14:44:52 EST  EAGLE 31.3.0
File Transfer : 0 file(s) DOWNLOADED from location 1114 successfully
File Transfer : 1 file(s) UPLOADED to location 1114 successfully
File Transfer : Kermit Session terminated NORMALLY
;
rlghncxa03w 04-01-05 14:45:31 EST  EAGLE 31.3.0
File Transfer : terminated NORMALLY on terminal #1
;

```

LNP Measurements

When used to output LNP measurements, the **rept-meas** command sends data to the FTA. Extracting LNP measurements from the FTA requires:

- A computer with a VT320 or KSR connection to the system
- A communication program that both emulates VT terminals and supports Kermit file transfer
- A spreadsheet program that can import Comma Separated Value (CSV) text files

A PC running ProComm® for Windows and Microsoft Excel® can be used.

Use the following procedure to collect LNP measurements.

Procedure - Extracting LNP Measurements from the FTA

- 1** Enter the following command to display the contents of the FTA:

disp-fta-dir:loc=xxxx

Where **xxxx** = the active TDM (**1114** or **1116**)

- 2** Enter the following command to delete any existing files from the FTA:

dlt-fta:loc=xxxx:all=yes

Where **xxxx** = the active TDM (**1114** or **1116**)

- 3 Enter the command to send LNP daily measurements to the FTA. For example:

```
rept-meas:enttype=lnp:type=mtcd
```

- 4 Enter the following command to activate the file transfer:

```
act-file-trns:loc=xxxx
```

Where **xxxx** = the active TDM (**1114** or **1116**)

- 5 Enter the following command to display a list of the files transferred to the FTA in step 4:

```
disp-fts-dir:loc=xxxx
```

Where **xxxx** = the active TDM (**1114** or **1116**)

- 6 Use the **get** command from within the communications program configured to run Kermit in ASCII mode to transfer the desired files (with the .csv suffixes) to the PC. For example:

```
> get mday_lnp.csv
```

```
> get mday_ssp.csv
```

```
> get mday_lrn.csv
```

```
> get mday_npa.csv
```

```
> finish
```

- 7 Run a spreadsheet program and open each of the collected files to view the LNP measurement data.
-

- 8 After all files are successfully transferred and confirmed, enter the following command to remove the files from the FTA:

```
dlt-fts:loc=xxxx:all=yes
```

Where **xxxx** = the active TDM (**1114** or **1116**)

act-flash

Activate Flash

Use this command to activate the trial FLASH GPL that is currently running on one target card or on a range of cards.

Keyword: act-flash

Related Commands: clr-imt-stats, flash-card, init-flash, init-imt-gpl, rept-imt-info, rept-imt-lvl1, rept-imt-lvl2, tst-imt

Command Class: System Maintenance

Parameters

:appl= (obsolete)

This parameter is obsolete; use the **gpl** parameter.

The **appl** parameter has been replaced with the **gpl** parameter to more accurately indicate that a GPL, and not an application, is specified for the parameter value.

:gpl= (optional)

The flash GPL type that is running on the cards in the specified range of cards.

This parameter must be specified for cards that have more than one flash image (GPL).

Range: **blbios, blcpld, bldiag, blvxw, bpdcm, bphcap, bphcapt, bphmux, bpmpl, bpmplt, hipr, imtpci, plde1t1, pldpmc1**

:loc= (optional)

The location of a single target card.

Range: **1101–1113, 1115, 1201–1218, 1301–1318, 2101–2118, 2201–2218, 2301–2318, 3101–3118, 3201–3218, 3301–3318, 4101–4118, 4201–4218, 4301–4318, 5101–5118, 5201–5218, 5301–5318, 6101–6118**

:eloc= (optional)

End location. Location of the last card of a range of cards to be activated.

Range: **1101–1113, 1115, 1201–1218, 1301–1318, 2101–2118, 2201–2218, 2301–2318, 3101–3118, 3201–3218, 3301–3318, 4101–4118, 4201–4218, 4301–4318, 5101–5118, 5201–5218, 5301–5318, 6101–6118**

:sloc= (optional)

Start location. Location of the first card of a range of cards to be activated.

Range: **1101–1113, 1115, 1201–1218, 1301–1318, 2101–2118, 2201–2218, 2301–2318, 3101–3118, 3201–3218, 3301–3318, 4101–4118, 4201–4218, 4301–4318, 5101–5118, 5201–5218, 5301–5318, 6101–6118**

Example

```
act-flash:loc=1105
```

```
act-flash:sloc=1101:eloc=1112:gpl=bpmpl
```

Dependencies

The card, or cards, in the specified location or range of locations for this command must be actively running a FLASH GPL in *trial* mode.

The allowed cards include HCAP, HCAP-T, DCM, DSM, E1/T1 MIM, HC-MIM, GPSM-II, MPL, and MPL-T. Card locations xy09 and xy10 (x is the frame, y is the shelf) can be specified only for HMUX or HIPR cards.

Each specified card does not have to be defined in the database, but it does have to be aligned on the IMT bus.

If the target is HMUX or HIPR, both of the card locations specified in the **sloc** and **eloc** parameters must contain HMUX or HIPR cards on the same IMT bus. For HMUX or HIPR the bus is implicit based on the specified location. Location xy09 specifies HMUX or HIPR IMT-A Bus, and location xy10 specifies HMUX or HIPR IMT-B Bus. For example, **sloc=1109:eloc=6109** specifies all HMUX or HIPR cards on the IMT-A Bus only; **sloc=1110:eloc=6110** specifies all HMUX or HIPR cards on the IMT-B Bus only. HMUX or HIPR cards from both the IMT-A bus and IMT-B bus cannot be flash downloaded simultaneously.

The card must be running an inactive flash GPL when this command is executed.

The provisioning subsystem mode (simple, duplex) must be established prior to executing the command.

The **loc** parameter cannot be specified with the **eloc** and **sloc** parameters.

Either the **loc** parameter or the **eloc** and **sloc** parameters must be specified.

The **eloc** and **sloc** parameters must be specified together in the command; one parameter cannot be specified without the other parameter.

The **sloc** parameter value must be greater than the **eloc** parameter value.

The cards in the specified **sloc** and **eloc** card locations must be present and able to communicate over the IMT. The cards do not have to be provisioned in the database.

The **gpl** parameter must be specified if the **eloc** and **sloc** parameters are specified.

The **gpl** parameter must be specified for cards that have more than one flash image (GPL).

The cards in the locations specified in the **sloc** and **eloc** parameters must be running the specified general program load (**gpl**). Other cards in the range of card locations can be running other GPLs, but will not be activated. Only the cards within the range that are running the specified GPL will be activated.

A card that is the active MASP cannot be specified for the **loc**, **sloc**, or **eloc** parameter.

Notes

None

Output

act-flash:loc=1105

```
rlghncxa03w 04-01-04 13:05:05 EST EAGLE 31.3.0
FLASH Memory Activation for card 1105 Started.
```

```
;
```

```
rlghncxa03w 04-01-04 13:05:05 EST EAGLE 31.3.0
FLASH Memory Activation for card 1105 Completed.
```

```
;
```

```
rlghncxa03w 04-01-04 13:05:05 EST EAGLE 31.3.0
Command Completed.
```

```
;
```

```

act-flash:sloc=1101:eloc=1112:gpl=bpmpl
rlghncxa03w 05-01-04 13:05:05 EST EAGLE 33.0.0
FLASH Memory Activation for cards 1101 - 1112 Started.
;

rlghncxa03w 05-01-04 13:05:05 EST EAGLE 33.0.0
FLASH Activation for cards 1101 - 1112 Completed.
LOC 1101 : PASSED
LOC 1102 : PASSED
LOC 1112 : PASSED

ALL CARD RESULTS PASSED
;

rlghncxa03w 05-01-04 13:05:05 EST EAGLE 33.0.0
Command Completed.
;

```

act-ftp-trns**Activate FTP Transfer**

Use this command to activate an FTP transfer to send database tables from the system to the customer's FTP server.

NOTE: This command is not for customer use. It is for Tekelec use only.

Keyword: act-ftp-trns

Related Commands: None

Command Class: Database Administration

Parameters

:action= (mandatory)

The operation that the command is to perform.

Range: put

:filetype= (mandatory)

EAGLE 5 SAS table type to be transferred.

Range: mtp, gtt, gws, all

mtp—Transfer all Message Transfer Part tables

gtt—Transfer all Global Title Translation tables

gws—Transfer all Gateway Screening tables

all—Transfer all of the types of tables

Example

```
act-ftp-trns:action=put:filetype=gtt
```

Dependencies

An **act-ftp-trns** command cannot be entered if another file transfer is already in progress.

Both the **action** and **filetype** parameters must be specified in the command.

The FTP Server table must contain at least one FTP server entry that specifies the **user** application

Notes

This command communicates with the **user** application, defined in the FTP Server table. The IP address and server details necessary for an FTP transfer are also stored in the FTP Server table. Refer to the User Guide for the **user** application to configure an FTP Server table entry for the **user** application. One such **user** application is the FTP-based Table Retrieve Application (FTRA).

Output

The sections ending in "Copy-table COMPLETE" and "FTP file transfer SUCCESSFUL" appear for each table that is transferred. Each table name is shown as tablexxx.tbl, where xxx indicates the name of the specific table.

act-ftp-trns:action=put:filetype=gtt

```
tekelecstp 04-01-05 08:50:12 EST EAGLE 31.3.0
FTP command sent to IPSM card - Processing
;

tekelecstp 04-01-05 08:50:12 EST EAGLE 31.3.0
Copy-table started - tablexxx.tbl
Copy-table COMPLETE.
;

tekelecstp 04-01-05 08:50:12 EST EAGLE 31.3.0
FTP file transfer started - tablexxx.tbl
FTP file transfer SUCCESSFUL.
;

tekelecstp 04-01-05 08:50:12 EST EAGLE 31.3.0
FTP transfer COMPLETE.
;
```

act-gpl**Activate Generic Program Load**

Use this command to change the status of the trial GPL from "trial" to "approved." The status of the previously approved GPL is changed to "trial."

Keyword: act-gpl

Related Commands: chg-gpl, copy-gpl, rept-stat-gpl, rtrv-gpl

Command Class: Program Update

Parameters

:appl= (obsolete)

This parameter is obsolete; use the **gpl** parameter.

The **appl** parameter has been replaced with the **gpl** parameter to more accurately indicate that a GPL, and not an application, is specified for the parameter value.

:gpl= (mandatory)

The name of the generic program load (GPL) identifier to be moved from "trial" to "approved" status on the disk.

Range: **atmansi, atmitu, blbios, blcpld, bldiag, blvxw, bpdcm, bphcap, bphcapt, bphmux, bpmpl, bpmplt, ccs7itu, cdu, ebdablm, ebdadcm, emdc, eroute, gls, hipr, imt, imtpci, ipgwi, iplim, iplimi, ips, mcp, plde1t1, pldpmc1, sccp, ss7ansi, ss7gx25, ss7hc, ss7ipgw, ss7ml, stplan, vcd, vsccp, vxwslan**

atmansi—The GPL is used by the LIM cards to support the high-speed ATM signaling link feature.

atmitu—The GPL is used by the E1 ATM cards to support the high-speed E1 ATM signaling link feature.

blbios —A flash GPL containing the BIOS ROM image on HC-MIM cards that are used for E1 or T1 signaling links.

blcpld —A flash GPL containing the bit-files for the CPLD on HC-MIM cards that are used for E1 or T1 signaling links.

bldiag —A flash GPL containing the diagnostic code on HC-MIM cards that are used for E1 or T1 signaling links.

blvxw —A flash GPL containing the VxWorks operating system on HC-MIM cards that are used for E1 or T1 signaling links.

bphmux —This GPL is used to support Board PROM for HMUX flash memory.

bphcap —This GPL is used to support Board PROM for HCAP flash memory.

bphcapt —This GPL is used to support Board PROM for HCAP-T flash memory.

bphmux —This GPL is used to support Board PROM for HMUX flash memory.

bpmpl—This GPL is used to support Board PROM for MPL flash memory.

bpmplt—This GPL is used to support Board PROM for E1/T1 flash memory and Board Prom for MPL-T flash memory.

ccs7itu—This GPL is used by the LIM cards for ITU-TSS MTP functionality.

cdu—This GPL is used in the card manufacturing process for testing, and when directed by Tekelec Technical Services.

ebdablm—This GPL is used by the TSM card for enhanced bulk download.

ebdadcm—This GPL is used by the DCM card to transmit the LSMS LNP database to the EAGLE 5 SAS at high speed over an ethernet connection for enhanced bulk download.

emdc—This GPL is used by the DCM card for CMIP/OSI measurement collection interface as defined by Telcordia GR-376.

eroute—This GPL is used by the STC card for EAGLE Support for Integrated Sentinel functions.

hipr —The communication software used on the High Speed IMT Packet Router (HIPR) card.

gls—This GPL is used by the TSM cards for downloading gateway screening to LIM cards.

imt—This GPL is the communication processor on the logical processing element (LPE).

imtpci —The communication software that operates the IMT bus on HC-MIM cards.

ipgwi—This GPL is used by the DCM card for TCP/IP point-to-point connectivity for ITU point codes.

iplim—This GPL is used by the DCM card for TCP/IP point-to-point connectivity for ANSI point codes.

- iplimi**—This GPL is used by the DCM card for TCP/IP point-to-point connectivity for ITU point codes.
- ips**—This GPL is used by the IPSM card for the IP User Interface feature.
- mcp**—This GPL is used by the MCPM card for the Measurements Platform feature.
- plde1t1** —A flash GPL that is used on HC-MIM cards for E1 and T1 signaling links.
- pldpmc1** —A flash GPL that is used on HC-MIM cards for E1 and T1 signaling links.
- sccp**—This GPL is used by the TSM cards for the global title translation application.
- ss7ansi**—This GPL is used by the LIM cards for the MTP functionality.
- ss7gx25**—This GPL is used by the LIM cards to support X.25 functionality.
- ss7ipgw**—This GPL is used by the system to support TCP/IP point-to-multipoint connectivity.
- ss7hc**—This GPL is used to support the functionality for the HC-MIM (High Capacity Multi-Channel Interface Module) card. The HC-MIM card runs either the **ss7ansi** or **ccs7itu** application; the **ss7hc** GPL allows the card to support up to 64 signaling links for E1 and T1 functions.
- ss7ml**—This GPL is used to support the functionality for the multi-port LIM (MPL or MPL-T) card and the E1/T1 MIM (Multi-Channel Interface Module) card. The MPL cards run only the **ss7ansi** application on a LIMDS0 card (as in the command **ent-card:type=limds0:appl=ss7ansi**); the **ss7ml** GPL allows the card to support 8 signaling links rather than the usual 2 links for LIM cards. The MPL cards support only the DS0 interface. The E1/T1 MIM card runs either the **ss7ansi** or **ccs7itu** application; the **ss7ml** GPL allows the card to support 8 signaling links for E1 and T1 functions. The older E1 card supports 2 signaling links for E1 functions).
- stplan**—This GPL is used by the ACM card to support the STP LAN application.
- vcdu**—This GPL is used in the card manufacturing process for testing, and when directed by Tekelec Technical Services.
- vsccp**—This GPL is used by the DSM card to support the G-Flex, G-Port, INP, and LNP ELAP Configuration features. If the G-Flex, G-Port, INP, or LNP ELAP Configuration feature is not turned on, and a DSM card is present, the VSCCP GPL processes normal GTT traffic.

:ver= (mandatory)

The version number of the GPL to be activated, in the form of *major-minor-fix*.

Range: 0–255 for each component of the GPL version number (*major-minor-fix*).

Example

act-gpl:gpl=sccp:ver=101-6-0

act-gpl:gpl=bphcapt:ver=110-25-0

act-gpl:gpl=bpmplt:ver=112-18-0

act-gpl:gpl=mcp:ver=111-17-0

act-gpl:gpl=atmitu:ver=114-1-0

act-gpl:gpl=ips:ver=114-1-0

```

act-gpl:gpl=hipr:ver=118-20-0
act-gpl:gpl=ss7hc:ver=125-1-0
act-gpl:gpl=blvxw:ver=125-1-0
act-gpl:gpl=blcpld=125-1-0
act-gpl:gpl=pldpmc1:ver=125-1-0
act-gpl:gpl=plde1t1:ver=125-1-0
act-gpl:gpl=blbios:ver=125-1-0
act-gpl:gpl=imtpci:ver=125-1-0
act-gpl:gpl=bldiag:ver=125-1-0

```

Dependencies

No other activate, change, copy, or retrieve GPL commands, nor a GPL audit, can be in progress when this command is entered.

Notes

Test the trial GPL by loading to a card before activating the GPL. Activating the GPL changes it from *trial* to *approved*.

The generic program load is committed on the active system and on the standby system.

Trial GPLs are downloaded to cards manually. Only approved GPLs can be downloaded to cards by the system.

Use the **rtrv-gpl** command to determine the version of the GPL.

Output

The output indicates that the specified GPL is activated on each TDM card.

The number of "cards of x complete" represents the total number of cards that can communicate on the IMT at the instant that this information is displayed.

act-gpl:gpl=ss7ansi:ver=101-014-000

```

rlghncxa03w 04-01-07 11:11:28 EST EAGLE 31.3.0
SS7ANSI activate on 1114 completed
SS7ANSI activate on 1116 completed

```

;

act-gpl:gpl=hipr:ver=118-20-0

```

tekelecstp 05-01-03 16:53:23 EST EAGLE5 33.0.0
HIPR activate to 1114 completed
HIPR activate to 1116 completed

```

;

act-gpl:gpl=ss7hc:ver=125-1-0

```

tekelecstp 05-01-03 16:53:23 EST EAGLE5 33.0.0
SS7HC activate to 1114 completed
SS7HC activate to 1116 completed

```

;

act-lbp**Activate Loopback Point Test**

Use this command to activate one or more loopback point tests for testing data signaling link elements in an SS7 transmission path. Use this command to:

- Activate a test for a specified loopback point that is defined in the LFS database table
- Activate a test for one loopback point that is not defined in the LFS database table
- Activate tests for all loopback points that have been defined in the LFS database table

The **ent-lbp** command can be used to define a maximum of 32 loopback points in the LFS database table.

See “Summary of Loopback Testing Commands and Functions” in Appendix A for information about loopback testing commands and functions.

Keyword: act-lbp

Related Commands: chg-lbp, dact-lbp, dlt-lbp, rtrv-lbp, rept-stat-lfs

Command Class: Database Administration

Parameters

To activate a test for a single loopback point that is defined in the LFS database table, specify the loopback point number in the **lbp** parameter and do not specify any of the **lfst**, **rle**, **rep**, and **cli** parameters in the command. Information from the LFS database is used to activate the test for the specified loopback point.

To activate a test for a single loopback point that is not defined in the LFS database table, specify one or more of the **lfst**, **rle**, **rep**, and **cli** parameters in the command. (If the **cli** parameter is not specified, the **cli** value is blank, a null string. If the **rep** parameter is not specified, the default value is 0.)

To activate tests for all loopback points that are defined in the LFS database, do not specify any of the **lbp**, **lfst**, **rle**, **rep**, and **cli** parameters in the command. Information from the LFS database table is used to activate tests for all defined loopback points.

:loc= (mandatory)

Card location. The unique identifier of a the card containing the signaling link to use for loopback point testing.

Range: 1101–1108, 1111–1112, 1201–1208, 1211–1218, 1301–1308, 1311–1318, 2101–2108, 2111–2118, 2201–2208, 2211–2218, 2301–2308, 2311–2318, 3101–3108, 3111–3118, 3201–3208, 3211–3218, 3301–3308, 3311–3318, 4101–4108, 4111–4118, 4201–4208, 4211–4218, 4301–4308, 4311–4318, 5101–5108, 5111–5118, 5201–5208, 5211–5218, 5301–5308, 5311–5318, 6101–6108, 6111–6118

:port= or :link= (mandatory)

SS7 signaling links. The SS7 signaling links to be tested.

Range: a, b, a1, b1, a2, b2, a3, b3

Not all card types support all **link** parameter values.

See Table A-1 in Appendix A for valid **link** parameter range values for each type of card that can have assigned signaling link ports.

:cli= (optional)

The Common Language Location Identifier (CLLI) code, or other mnemonic identifier, used to refer to the given loopback point.

Range: 1 alphabetic character followed by up to 10 alphanumeric characters

Default: If the **rle**, **lfst**, or **rep** parameter is specified—null string (blank)

If the **rle**, **lfst**, or **rep** parameter is not specified—the value in the LFS database table

:data= (optional)

Data used with the *octet* or *alternate* patterns.

Range: 1–255

Default: 255

:force= (optional)

The **force=yes** parameter must be specified to start a test when there are 256 or more tests already running.

Range: yes, no

Default: no

:lbp= (optional)

Loopback point ID. This parameter identifies a far-end loopback point that lies along an SS7 signaling link path between the STP and the target device (up to *and including* the target device).

Range: 1–32

Default: If the **rle**, **cli**, **rep**, and **lfst** parameters are specified, the default is 1.

If the **rle**, **cli**, **rep**, and **lfst** parameters are not specified, the default is all loopback points found in the LFS database table (up to 32 loopback points), as shown in the **rtrv-lbp** command output.

:lfst= (optional; mandatory if the **rle**, **cli**, or **rep** parameter is specified)

Link fault sectionalization test. The type of link fault sectionalization loopback test to be performed.

Range: LLT, MLT, NLT

LLT—latching loopback test; a software latch is set at the test point to reverse everything that is received and return it to the sender until the test is complete

MLT—manual latch loopback test; an external hardware latch has been set to reverse everything that is received and return it to the sender until the test is complete (for equipment that cannot set a software latch for the test)

NLT—nonlatching loopback test; no permanent latch is set. Loopback codes are alternated with test data until the test is complete.

Default: The value in the LFS database, as shown in the **rtrv-lbp** command output

:maxerr= (optional)

The bit error threshold. The actual number of errors allowed for a specific time period during which loopback testing is being performed. If this threshold is exceeded, the *TEST STATUS* field in the output report indicates an error.

Range: 0-4838400

Default: 56

:pattern= (optional)

The type of test pattern used to perform the LFS test.

Range: **b2047, b511, octet, alternate**

The **octet** and **alternate** values are valid only when **lfst=llt** is specified.

b2047—047-bit Bert pattern sent until it is stopped by software

b511—511-bit Bert pattern sent until it is stopped by software

octet—Data (from the **data** parameter) sent continuously until it is stopped by software

alternate—Alternately, a count of 100 octets of the specified data (from the **data** parameter) followed by 100 octets of **0**, sent until it is stopped by the software

Default: **b2047**

:rep= (optional)

Repetition count. The number of link elements of the same type (not including the target device) that lie between the STP and the link element to be tested.

Range: **0–31**

Default: If the **rle**, **cli**, or **lfst** parameter is specified, the default is **0**.

If the **rle**, **cli**, and **lfst** parameters are not specified, the default is the value in the LFS database table, as shown in the **rtrv-lbp** command output.

:rle= (optional; mandatory if the **lfst**, **cli**, or **rep** parameter is specified)

Remote link element. The link element to be looped back for testing.

Range: **ds0, ocu, csu, dsu, nei**

Default: The value from the LFS database table, as shown in the **rtrv-lbp** command output

:time= (optional)

How long the test must be run in order to determine success or failure. If the number of errors that actually occur during this time exceeds the threshold set by the **maxerr** parameter, the loopback test is identified as a failure.

Range: **1–240000**

hhmmss—*hh*=hours (**00–24**), *mm*=minutes (**00–59**), *ss*=seconds (**00–59**)

For example, **time=1** or **time=000001** is one second; **time=240000** is 24 hours; **time=200** or **time=000200** is 2 minutes

Default: 1 second

Example

Activate tests for all loopback points that are defined in the LFS database table:

```
act-lbp:loc=1205:link=b:pattern=alternate:maxerr=10:time=000200
```

Activate a test for a single loopback point that is defined in the LFS database table:

```
act-lbp:loc=1205:link=b:lbp=3:pattern=alternate:maxerr=10:time=000200
```

Activate a test for a single loopback point that is not defined in the LFS database table:

```
act-lbp:loc=1205:link=b:lbp=1:rle=ds0:lfst=llt:cli=rlghncxa05w
```

```
act-lbp:loc=1205:link=b:lbp=1:rle=ds0:lfst=llt:cli=rlghncxa05w:pattern=octet:data=h'ff
```

```
act-lbp:loc=1205:link=b:lbp=1:rle=ds0:lfst=llt:cli=rlghncxa05w:maxerr=40:time=12000
```

Dependencies

The Link Fault Sectionalization (LFS) feature must be on before this command can be entered.

If the **rle=nei** parameter is specified, the **rep=0** parameter must be specified.

The **rep** parameter can be specified only if the **lfst=llt** parameter is specified.

The **rle=ds0** or the **rle=nei** parameter cannot be specified if the **lfst=nl** parameter is specified. The DS0 and Network Element Interface (NEI) link elements do not support non-latching loopbacks.

If one or more of the **rle**, **rep**, **lfst**, or **cli** parameters are specified, the LFS database table is not used to look up their values; therefore, the **lfst** and **rle** parameters must be specified when the **rep** or **cli** parameter is specified.

The **data** parameter can be specified only if the **pattern=octet** parameter or **pattern=alternate** parameter is specified.

The **pattern=octet** and **pattern=alternate** parameters cannot be specified for non-latching tests (**rle=nl**).

The card location (**loc** parameter) must contain a provisioned and equipped **limds0**, **limt1**, or **limch** (associated with a **limt1**) card configured with either an **ss7ansi** or **ccs7itu** application.

The card in the **loc** parameter location must be in the In-Service-Normal state.

The signaling link that is used for LFS testing must be equipped, and must be deactivated before this command is entered.

The loopback points (LBPs) must have been previously defined in the database.

Only one LFS test can be active on a signaling link at a time.

This command cannot be entered for a signaling link LFS test when the maximum number of LFS tests are active for the card. At least one LFS test must complete before this command can be entered again.

On LIM-AINF, LIM-ILA, LIM-EILA, and MPL cards (type LIMDS0 cards), only one LFS test can be active on a card at a time.

On the following cards, up to 8 LFS tests can be active on a card at a time:

- E1/T1 MIM cards or HC-MIM cards used as T1 cards
- E1/T1 MIM cards used as LIMCH cards associated with a T1 card
- MPL-T cards (type LIMDS0)

This command cannot be entered when the maximum combined total number of LFS and link tests (1024) are in progress in the system. At least one test must complete before this command can be entered again.

The **force=yes** parameter must be specified to activate a test when there are 256 or more tests already running in the system.

The specified signaling link must not be running a **tst-slk** test when this command is entered. The **tst-slk** test must be stopped or allowed to complete before this command can be entered for the link.

The specified signaling link must not be in Command Driven Loopback (CDL) when this command is entered. The link must be removed from CDL before this command can be entered for the link.

This command cannot be entered for a link that is already blocked by another link diagnostic test. The test must be canceled or allowed to complete before this command can be entered for the link.

LFS testing is not available during upgrade.

The maximum number of loopback point entries allowed in the LFS table is 32.

Notes

The **act-lbp** command is not supported for **limatm** cards.

If an LFS test is aborted by a card reset, it can leave the remote far-end loopback condition active. Use the **dact-lbp** command to cancel LFS tests.

The E1/T1 MIM card and the HC-MIM card support this command on up to 8 T1 channels at a time; the command is not supported for E1.

The test can terminate with the status "ERROR, bit error exceeded threshold" for two reasons.

- The number of cumulative bit errors exceeds the specified **maxerr** parameter value.
- The number of bit errors for one second reaches or exceeds 255, without considering the **maxerr** parameter value.

Output

The LFS report is displayed when the LFS test completes.

The following example shows how the test failed because the bit error rate exceeded the threshold. Here the **maxerr=10** parameter is used for a test time of 2 minutes. Because more than 10 errors occurred within 2 minutes, the test is considered a failure and the TEST STATUS field displays the cause. The parameter values are applied to each loopback point. The **maxerr** value is per test, not cumulative for all tests.

act-lbp:loc=1205:link=b:pattern=alternate:maxerr=10:time=002000

```
tekelecstp 05-01-21 17:00:36 EST EAGLE5 33.0.0
LOC = 1205 Link = B LSN = ls11345678 Start time = 11:10:34

PATTERN = ALTERNATE DATA= FF MAXERR = 10 TIME = 00:02:00

TEST STATUS = ERROR, bit error exceeded threshold.
```

LBP	CLLI	RLE	REP	LFST	BIT_ERROR	ERRORED_SEC	DURATION
2	rlghncxa05w	DS0	0	LLT	0	0	00:02:00
3	-----	OCU	0	NLT	8	2	00:02:00
5	-----	NEI	0	LLT	15	1	00:01:20

;

In the following example, the test failed because the loopback could not be established.

act-lbp:loc=1205:link=b:pattern=alternate:maxerr=10:time=000200

```
tekelecstp 05-01-21 17:00:36 EST EAGLE5 33.0.0
LOC = 1205 Link = B LSN = ----- Start time = 11:10:34

PATTERN = ALTERNATE DATA= FF MAXERR = 10 TIME = 00:02:00

TEST STATUS = ERROR, loopback was not established.

LBP CLLI          RLE REP LFST BIT_ERROR ERRORED_SEC DURATION
1   rlghncxa05w  DS0  0  LLT   0           0           00:00:00
;
```

Legend

LOC—Card location that contains the signaling being tested.

LINK—Signaling link that is being tested on the card.

LSN—Name of the linkset that contains the link being tested.

START TIME—Time that the test started.

PATTERN—Type of test pattern used to perform the LFS test.

DATA—Data used with the **octet** or **alternate** patterns.

MAXERR—Bit error threshold; actual number of errors allowed for the specific time period during which loopback testing is being performed. If this threshold is exceeded in the specified time period, the *TEST STATUS* field in the output report indicates an error.

TIME—Specified length of time to run the test in order to determine success or failure. If the number of errors that actually occur during this time exceeds the threshold set by the **maxerr** parameter, the loopback test is identified as a failure.

TEST STATUS—Any one of the following *TEST STATUS* values can appear:

- PASS
- ERROR, LFS HARDWARE is not available.
- ERROR, loopback could not be established.
- ERROR, bit error exceeded threshold.
- ERROR, LFS test aborted.
- ERROR, LFS hardware failed.

LBP—Loopback point used to perform the LFS test.

CLLI—Common Language Location Identifier (CLLI) code, or other mnemonic identifier, used to refer to the given loopback point.

RLE—Remote link element to be looped back for testing.

REP—Repetition count. The number of link elements of the same type (not including the target device) that lie between the STP and the link element to be tested.

LFST—Type of link fault sectionalization loopback test to be performed.

BIT_ERROR—The number of bit errors observed during the test.

ERRORED_SEC—The number of seconds that contained bit errors during the test. (Bit errors are sampled once per second; each sample that contains bit errors adds one second to this count).

DURATION—Length of time that the test actually ran for the loopback point. For successful test, the **TIME** and the **DURATION** should be the same. If a test ran for less than the specified amount of time, the **DURATION** will be less than the **TIME**.

act-lpo

Activate Local Processor Outage

Use this command to force a processor outage on the specified link. The system begins sending link status signal units (LSSUs) with a status of SIPO to the adjacent signaling point. Level 2 status remains in service, except when the link is an ATM high-speed signaling link.

NOTE: The signaling link's blocked status is not preserved across a LIM reboot.

Keyword: act-lpo

Related Commands: `canc-lpo`, `blk-slk`, `rept-stat-slk`, `ublk-slk`

Command Class: Link Maintenance

Parameters

:loc= (mandatory)

The card location as stenciled on the shelf of the system.

Range: 1101–1108, 1111–1112, 1201–1208, 1211–1218, 1301–1308, 1311–1318, 2101–2108, 2111–2118, 2201–2208, 2211–2218, 2301–2308, 2311–2318, 3101–3108, 3111–3118, 3201–3208, 3211–3218, 3301–3308, 3311–3318, 4101–4108, 4111–4118, 4201–4208, 4211–4218, 4301–4308, 4311–4318, 5101–5108, 5111–5118, 5201–5208, 5211–5218, 5301–5308, 5311–5318, 6101–6108, 6111–6118

:port= or :link= (mandatory)

The signaling **link** on the card specified in the **loc** parameter. The **links** can be specified in any sequence or pattern.

Range: a, b, a1-a31, b1-b31

Not all card types support all **link** parameter values.

See Table A-1 in Appendix A for valid **link** parameter range values for each type of card that can have assigned signaling **links**.

Example

```
act-lpo:loc=1101:link=a
```

Dependencies

A card location that is valid and defined in the database must be specified.

No other action command can be in progress when this command is entered.

The card must be equipped and must be one of the following cards:

- A LIM card running the **ss7ansi**, **ss7gx25**, **atmansi**, or **ccs7itu** application
- An E1 ATM card running the **atmitu** application

- An SSEDCM card running the **iplim** or **iplimi** application with links having **ipliml2=m2pa**
- An E1/T1 MIM or HC-MIM card running the **ss7ansi** or **ccs7itu** application

This command can be entered for IPLIMx signaling links only when they have an **ipliml2** parameter setting of **m2pa**.

The **act-lpo** command is not valid for DCM cards with **ss7ipgw** or **ipgwi** TCP/IP links.

The card must contain signaling links.

The signaling link must be equipped in the database.

The **link** parameter values **a1**, **b1**, **a2**, **b2**, **a3**, and **b3** can be specified only for the following cards:

- A multi-port LIM
- An E1/T1 MIM
- An HC-MIM

Notes

The function of this command is the same as the **blk-slk** command.

This command generates an alarm.

If the **act-lpo** command is followed by the **init-card** command, the local processor outage is not preserved after the **init-card** command completes.

The *Installation Manual - EAGLE 5 SAS* provides an illustration of card locations.

Output

act-lpo:loc=1101:link=a

```
tekelecstp 05-01-21 17:00:36 EST EAGLE5 33.0.0
Local processor outage being set.

tekelecstp 05-01-21 17:00:36 EST EAGLE5 33.0.0
* 0014.0208 * SLK 1101,A nc00027 slk local blocked
```

act-oap-config

Activate OAP Configuration

Use this command to update the OAPs with the configuration data entered into the EAGLE 5 SAS database with the **chg-oap-config** command.

The **act-oap-config** command also sends the EAGLE 5 SAS Site ID to the OAPs. See the **chg-sid**, **ent-lnp-serv**, and **chg-lnp-serv** commands for more information.



CAUTION: Before the **act-oap-config** command can be entered, the EAGLE 5 SAS database must be provisioned with required data for the SEAS feature, depending on which of those features are turned on. If this information is left blank or incorrectly provisioned and the **act-oap-config** command is entered, the OAP may lose SEAS or LSMS connectivity. The requirements are discussed in the Dependencies section for this command.

Keyword: act-oap-config

Related Commands: chg-lnp-serv, chg-oap-config, chg-sid, dlt-lnp-serv, ent-lnp-serv, rtrv-lnp-serv, rtrv-oap-config, rtrv-sid

Command Class: Database Administration

Parameters

:force= (optional)

Force the EAGLE 5 SAS to provision only one OAP in a dual OAP configuration.

Range: yes, no

Default: no

:oap= (optional)

The OAP being updated.

Range: a, b, all

Default: all

Example

act-oap-config:oap=a:force=yes

Dependencies

Table 5-1 on page 5-25 shows the fields of the **rtrv-oap-config** command output that must be configured depending on which feature is on. Table 5-1 also shows the parameters of the **chg-oap-config** command that are used to configure the OAP configuration data.

If the required information for a feature has already been configured in the EAGLE 5 SAS database, you do not have to re-enter all the parameters for that feature when you make a change. It is mandatory, however, that the configuration data in the EAGLE 5 SAS and the OAP database match.

Table 5-1. Parameters That Must Be Provisioned Prior to Updating OAP

Feature	Fields Displayed	Required Entry before Configuration can be sent to the OAP	chg-oap-config Parameter
SEAS	SEAC CLI	An entry is required if the SEAS feature is on.	seaccli
	X25 Packet Size	An entry is required if the SEAS feature is on.	x25ps
	X25 Mode	An entry is required if the SEAS feature is on.	x25mode

Table 5-1. Parameters That Must Be Provisioned Prior to Updating OAP (Continued)

Feature	Fields Displayed	Required Entry before Configuration can be sent to the OAP	chg-oap-config Parameter
LNP	Active LSMS	An entry is required if the LNP feature is on.	lsms
	Main LSMS NSAP	An entry is required if the lsms=main parameter is specified.	mnsap
	Main LSMS SSEL	An entry is required if the lsms=main parameter is specified.	mpsel
	Main LSMS PSEL	An entry is required if the lsms=main parameter is specified.	mssel
	Shadow LSMS NSAP	An entry is required if the lsms=shadow parameter is specified.	snsap
	Shadow LSMS SSEL	An entry is required if the lsms=shadow parameter is specified.	spsel
	Shadow LSMS PSEL	An entry is required if the lsms=shadow parameter is specified.	sssel
Either SEAS or LNP features	Hostname	An entry is required.	aname and bname
	IP Address	An entry is required if the LNP feature is on.	aipaddr and bipaddr
	IP Netmask	An entry may be required depending on the network configuration.	anmask and bnmask
	Default Router	An entry may be required depending on the network configuration.	arouter and brouter
	Config	An entry is required.	cfg

Table 5-2 shows other data not shown in the **rtrv-oap-config** command output that must be provisioned in the database before the OAP configuration can be updated.

Table 5-2. Other Data Required for Updating the OAP Configuration

Feature	Data Required Before an OAP can be Updated
Either SEAS or LNP features	Eagle CLI - configured with the cli parameter of the chg-sid command
LNP	The LNP services class , lidb , cnam , and isvm configured with the serv parameter of either the ent-lnp-serv or chg-lnp-serv command

To keep OAP parameters in sync with the EAGLE 5 SAS, a checksum is created using all of the OAP configuration data stored on the EAGLE 5 SAS (shown in Table 5-1 and Table 5-2). The OAP also calculates this checksum based on the data it has. The OAP returns this checksum every five seconds. The EAGLE 5 SAS compares the checksums, and generates the following alarm within ten seconds of any mismatch:

```
rlghncxa03w 04-01-07 11:11:28 EST EAGLE 31.3.0
* nnnn.0364 * OAP A Configuration data checksum mismatch
```

The alarm is cleared when a maintenance poll returns a checksum that matches the EAGLE 5 SAS's checksum, indicating that the databases are back in sync. The EAGLE 5 SAS clears the alarm within five seconds. The following UAM clears the alarm:

```
rlghncxa03w 04-01-07 11:11:28 EST EAGLE 31.3.0
nnnn.0365      OAP A      Configuration data checksum alarm cleared
```

If the **oap=a**, **oap=b**, or **oap=all** parameter is specified with the **act-oap-config** command, then the link from the EAGLE 5 SAS to the specified OAP must be in service.

The **force=yes** parameter must be specified with the **oap=a** or **oap=b** parameters.

Notes

To configure the OAP from the EAGLE 5 SAS, the procedure "Configuring the OAP from the EAGLE 5 SAS STP Terminal" in the *Database Administration Manual - System Administration* is recommended.

It is recommended that only one OAP be updated at a time. Although the **act-oap-config** command completes immediately on the EAGLE 5 SAS, processing on the OAP may take over 10 minutes depending on which parameters changed and which OAP hardware is installed. Also, whenever some parameters are changed, the OAP reboots to use the new data. The reboot interrupts the connection between that OAP and the SEAC or LSMS. By updating only one OAP at a time, the EAGLE 5 SAS and the SEAC or LSMS will not be isolated, as one OAP is always connected to the SEAC or LSMS.

Table 5-3 shows the action and approximate completion time that you can expect after updating a group of OAP parameters. You do not need to perform the actions manually; they are all automatic.

The OAP is named and addressed according to the terminal port number on the EAGLE 5 SAS control shelf backplane that the OAP is connected to. The terminal ports are numbered from MMI 0 to MMI 15. OAP A is connected to the lower numbered terminal port and OAP B is connected to the higher numbered terminal port. If the terminal port connections for the OAPs change, the names for OAPs A and B could be reversed. For example, OAP A is connected to MMI 3 and OAP B is connected to MMI 9. At some later time, OAP A is moved from MMI 3 to MMI 12. Because of this move, OAP A is now OAP B, and what was OAP B is now OAP A.

Output

act-oap-config:oap=a:force=yes

```
rlghncxa03w 04-01-07 11:11:28 EST EAGLE 31.3.0
ACT-OAP-CONFIG: MASP A - COMPLTD
;
```

Table 5-3. Performance Impact of **act-oap-config** parameters

Configured Parameter Group	OAP Action					
	Restart Q3 Links	Restart Q3 and SEAS Links	Bring Down, Rebuild, Bring Up Q3 and SEAS Links:	Bring Down Q3 and SEAS Links; Reboot OAP	Bring Down and Rebuild Q3 and SEAS Links; Reboot OAP	Total Time Required (in seconds)
Group A mpsel/spsel mssel/sssel mnsap/snsap serv	X					≤ 65
Group B x25ps, x25mode		X				≤ 260
Group C clli, seaccli			X			≤ 320
Group D aname/bname aipaddr/bipaddr anmask, bnmask arouter/brouter				X		≤ 560
Group A and B		X				≤ 260
Group A and C			X			≤ 320
Group A and D				X		≤ 560
Group A, B, and C			X			≤ 320
Group A, B, and D				X		≤ 560
Group A, C, and D			X	X		≤ 620
Group B and C			X			≤ 320
Group B and D			X	X		≤ 620
Group B, C, and D			X	X		≤ 620
Group C and D					X	≤ 620

act-slk**Activate Signaling Link**

Use this command to change the link from OOS-MT-DSBLD (out of service maintenance disabled) to IS-NR (in service normal).

NOTE: The signaling link's activated status is preserved across a card reboot.

Keyword: act-slk

Related Commands: dlt-slk, ent-slk, inh-slk, rept-stat-slk, rtrv-slk, dact-slk, blk-slk, unhb-slk, ublk-slk, tst-slk

Command Class: Link Maintenance

Parameters

:loc= (mandatory)

The card location as stenciled on the shelf of the system.

Range: 1101–1108, 1111–1112, 1201–1208, 1211–1218, 1301–1308, 1311–1318, 2101–2108, 2111–2118, 2201–2208, 2211–2218, 2301–2308, 2311–2318, 3101–3108, 3111–3118, 3201–3208, 3211–3218, 3301–3308, 3311–3318, 4101–4108, 4111–4118, 4201–4208, 4211–4218, 4301–4308, 4311–4318, 5101–5108, 5111–5118, 5201–5208, 5211–5218, 5301–5308, 5311–5318, 6101–6108, 6111–6118

:port= or **:link=** (mandatory)

The **link** on the card specified in the **loc** parameter. The **links** can be specified in any sequence or pattern.

Range: a, b, a1-a31, b1-b31

Not all card types support all **link** parameter values.

See Table A-1 in Appendix A for valid **link** parameter range values for each type of card that can have a location specified in the **loc** parameter.

Example

```
act-slk:loc=1301:link=a
```

Dependencies

The card must be equipped and must be one of the following cards:

- A LIM card running the **ss7ansi**, **ss7gx25**, **atmsansi**, or **ccs7itu** application
- An E1 ATM card running the **atmitu** application.
- A DCM or SSEDCCM card running the **ss7ipgw**, **ipgwi**, **iplim**, or **iplimi** application.
- An E1/T1 MIM card or an HC-MIM card running the **ss7ansi** or **ccs7itu** application.

This command cannot be entered while the **tst-slk** command is in progress.

A card location that is defined in the database must be specified.

The card must contain signaling links.

No other action command can be in progress when this command is entered.

The specified signaling link must be provisioned in the database.

The **link** parameter values **a1**, **b1**, **a2**, **b2**, **a3**, and **b3** can be specified only for the following cards:

- A multi-port LIM
- An SSEDCCM running the **iplim** or **iplimi** application that supports 8 points.
- An E1/T1 MIM or an HC-MIM.

Notes

The *Installation Manual - EAGLE 5 SAS* provides an illustration of card locations.

Output

```
act-slk:loc=1301:port=a
tekelecstp 05-01-21 17:00:36 EST EAGLE5 33.0.0
Activate Link message sent to card
;
```

act-user**Activate User**

This command is an alternate to the **login** command. Use this command to log into the system. After this command is entered, the system requests a password. For security reasons the password is not echoed to the terminal.

Keyword: act-user

Related Commands: chg-pid, chg-user, dact-user, dlt-user, ent-user, login, logout, rept-stat-user, rtrv-secu-user, rtrv-user

Command Class: Basic

Parameters

:uid= (mandatory)

User ID. The system prompts you for a valid password after this ID is entered.

Range: 1 alphabetic character followed by up to 15 alphanumeric characters.

Example

```
act-user:uid=john
```

Dependencies

The first character of the user ID must be a letter.

Notes

CAUTION: If the OA&P IP Security Enhancements feature is not turned on, a serial terminal (terminals 1-16) must be used to log in with a new Userid and password for the first time or to change an expired password. The OA&M IP Security Enhancements feature must be turned on before you can change the password at the prompt from an IP User Interface telnet terminal (IDs 17-40) when:

- It is the first time the user is logging in with the assigned Userid and password.
- The password has expired because of aging out.

The **login** command can be used instead of **act-user**. The command **act-user** has been provided in accordance with OTGR standards.

When a new system is shipped, the user ID and password are set to the system. Change these immediately to ensure system security.

The OAP is named and addressed according to the terminal port number on the EAGLE 5 SAS control shelf backplane that the OAP is connected to. The terminal ports are numbered from MMI 0 to MMI 15. OAP A is connected to the lower numbered terminal port and OAP B is connected to the higher numbered terminal port. If the terminal port connections for the OAPs change, the names for OAPs A and B could be reversed. For example, OAP A is connected to MMI 3 and OAP B is connected to MMI 9. At some later time, OAP A is moved from MMI 3 to MMI 12. Because of this move, OAP A is now OAP B, and what was OAP B is now OAP A.

alloc-mem

Allocate Memory

NOTE: This command is obsolete.

Use this command to create up to five additional LNP 4DIGIT database objects, each capable of containing up to 2 million ported telephone numbers. (The standard EAGLE 5 SAS contains a single LNP 4DIGIT database object). If all five additional LNP 4DIGIT database objects are configured in the database, the database can contain 12 million ported numbers.

NOTE: The `alloc-mem:num` command cannot be entered to create an LNP 4DIGIT database object that, when added to the number of previously created LNP 4DIGIT database objects, would exceed the maximum number allowed.

Keyword: `alloc-mem`

Related Commands: `rtrv-mem`

Command Class: System Maintenance

Parameters

:obj= (mandatory)

The type of database object to create.

Range: `lnp4digit`

:num= (optional)

The number of database objects to create.

Range: `1-5`

Default: `1`

Example

```
alloc-mem:obj=lnp4digit:num=1
```

Dependencies

An LNP ported TNs feature key of sufficient quantity must be on before the **alloc-mem** command can be executed (see the **enable-ctrl-feat** command and Table 5-4).

LNP 4DIGIT objects can be created with the **alloc-mem** command only if the capacity of the fixed disk drives on the TDMs (Terminal Disk Modules) and the amount of memory on the TSM (Translation Services Modules) memory is sufficient to support the number of ported telephone numbers allowed by the number of LNP 4DIGIT objects configured in the database (one plus the value of the **num** parameter). Table 5-4 on page 5-32 shows the TSM and TDM requirements.

Table 5-4. TSM and TDM Memory Requirements

Number of LNP 4DIGIT Objects	Number of Ported Numbers Supported	TSM Memory Requirements	Fixed Disk Drive Capacity Requirements
1	2 Million	256 Mbytes	4 Gigabytes
2	4 Million	512 Mbytes	4 Gigabytes
3	6 Million	768 Mbytes	4 Gigabytes
4	8 Million	1024 Mbytes	4 Gigabytes
5	10 Million	1024 Mbytes	4 Gigabytes
6	12 Million	1024 Mbytes	4 Gigabytes

Notes

If an in-service TSM does not have sufficient memory to support the number of ported telephone numbers allowed by the number of LNP 4DIGIT objects configured in the database, the EAGLE 5 SAS is considered to be in degraded mode and the **alloc-mem** command is rejected. The **rept-stat-card:loc=<SCCP card location>:mode=full** command can be used to display the status and the amount of memory for the TSMs equipped in the database.

Output

```
alloc-mem:obj=lnp4digit:num=1
rlghncxa03w 04-01-07 11:11:28 EST EAGLE 31.3.0
Memory allocation complete.
;
```

alw-card

Allow Card

Use this command to change the card from *OOS-MT-DSBLD* (out-of-service-maintenance-disabled) to *IS-NR* (in-service-normal) if the loading is successful.

Keyword: alw-card

Related Commands: dlt-card, ent-card, inh-card, init-card, rtrv-card, rept-stat-card, rmv-card, rst-card

Command Class: System Maintenance

Parameters**:loc=** (mandatory)

The card location as stenciled on the shelf of the system.

Range: 1101–1108, 1111–1113, 1115, 1201–1208, 1211–1218, 1301–1308, 1311–1318, 2101–2108, 2111–2118, 2201–2208, 2211–2218, 2301–2308, 2311–2318, 3101–3108, 3111–3118, 3201–3208, 3211–3218, 3301–3308, 3311–3318, 4101–4108, 4111–4118, 4201–4208, 4211–4218, 4301–4308, 4311–4318, 5101–5108, 5111–5118, 5201–5208, 5211–5218, 5301–5308, 5311–5318, 6101–6108, 6111–6118

:code= (optional)

The GPL type to be loaded.

Range: **appr**, **trial**, **utility****appr**—Approved GPL**trial**—Trial GPL**utility**—Utility GPL that downloads the CDU or VCDU GPL based on hardware type; used primarily by the factory for loading special GPLs for testing purposes.**Default:** **appr****:data=** (optional)

High memory refresh. This parameter causes data to be reloaded to the specified card. This parameter is used to reload data if the LNP (see the **enable-ctrl-feat** command), G-Flex, G-Port, or INP feature is on. This parameter is applicable only to network cards containing the LNP database (SCCP, EBDABLM) or the MPS database (VSCCP).

Range: **refresh**, **persist****refresh**—Causes data to be reloaded to the specified card.**persist**—Indicates that the database is not to be reloaded to the card. Used to request that the EAGLE 5 SAS perform a warm restart of the requested cards. The EAGLE 5 SAS performs various checks to ensure that all conditions necessary to initiate the warm restart are in place (for example, that the TSM/BLM card is present and ready and that the downloaded LNP database is coherent. The LNP database audit cannot be performed prior to the card reset). During the card initialization and loading sequence, a warm restart is performed if the card meets the warm restart conditions, as described in the Notes section of this command.**Default:** **refresh**

NOTE: Various conditions in the system may prevent the persistence of the data on the cards.

Example**alw-card:loc=2301:code=trial****alw-card:loc=1101:data=persist****Dependencies**

The following card locations are not valid for this command: **1117**, **1118**, and all **xy09** and **xy10** locations (where *x* is the frame and *y* is the shelf).

The active and standby TDM card locations and the card location that is running the active OAM cannot be specified in the **loc** parameter.

The shelf and card must be equipped.

If the card is a LIM, it must have a signaling link assigned to it before it can be allowed.

No other action command can be in progress when this command is entered.

An SCCP card cannot be reset when the system is in LNP degraded mode.

The LNP (see the **enable-ctrl-feat** command), G-Flex, G-Port, or INP feature must be turned on before the **data** parameter can be specified.

The **data** parameter is valid only for SCCP and EBDABLM card locations or GPLs, or MPS database (VSCCP) card locations or GPLs.

If a location for an E1/T1 MIM card (type **lime1**, **limt1**, or **limch**) or an HC-MIM card (type **lime1** or **limt1**) is specified, at least one signaling link must be provisioned for that card before it can be allowed.

Notes

The function of this command is the same as the **rst-card** command.

The *Installation Manual - EAGLE 5 SAS* provides an illustration of card locations.

The system previously supported the **data** parameter for reloading GTT data. The system does not support persistent GTT data loading, and the **data** parameter is now used in support of the warm restart feature.

A number of reasons exist for not being able to warm restart. If none of these conditions exists, a warm restart is possible and will be attempted following a SCCP/EBDABLM or VSCCP card reset.

- The following conditions require a full data reload:
 - **AUDIT FAILED**—The checksum comparisons of the LNP database failed during card initialization. Data on the card is determined to be corrupted after the reset (was not yet detected by normal auditing).
 - **AUDIT TIMEOUT**—LNP initialization audit timed out (software failure).
 - **DB LEVEL**—Database level not supported or difference exceeds incremental loading capability. This condition is caused by reset of OAMs or if the number of updates exceeds the incremental loading capability.
 - **DB STATUS**—Database status of the card is incoherent at the time of a reset. This condition can be caused by a failed network card update or a reset during a database update to the card.
 - **DB VERSION**—LNP Database version has changed from previous version. Online memory allocation (**alloc-mem**), import or bulk downloads (**chg-db**), or changes from release to release may alter the database version.
 - **HW ERROR**—The hardware error bit checks on the card failed during card initialization.

- **NO AUDIT**—Unable to perform LNP audit. LNP audit not on (for example, LNP options has **audit=off**). If the rate of LNP updates exceeds the ability of the LNP audit to compute checksums (excessive unknown checksums). This condition is more likely on a small database where there are fewer checksums. The percentage of known checksums must be 99% or more. The percentage is based on the number of checksums in use, which is smaller for small databases (such as two million TNs or fewer).
 - **POWER ON**—Power on reset (card is pulled and reinserted).
 - **UNKNOWN/OTHER**—Unknown or other type of software failure.
 - **USER REQUEST**—User initiated **init-card** or **init-sys** command reload type cold. The default restart type for these commands is a cold or full LNP data reload. User must specify **data=persist** for warm restart on command.
 - **XILINX VERSION**—M256 Xilinx program version has changed from previous version.
- The following conditions require an MCPM card cold restart:
 - **DB STATUS**—Database status of the card is incoherent at the time of a reset. This condition can be caused by a failed network card update or a reset during a database update to the card.
 - **MEAS DB**—Measurements database Init failure or corruption.
 - **POWER ON**—Power on reset (card is pulled and reinserted).
 - **UNKNOWN/OTHER**—Unknown or other type of software failure.
 - **XILINX VERSION**—D1G Xilinx program version has changed from previous version.



CAUTION: You can use this command to enable Measurements Platform measurements collection after the collection function has been disabled with the **inh-card** command for ALL MCPM cards in the system. To enable collection, you must allow at least 1 MCPM card in the system. Disabling collection by inhibiting all MCPM cards CAN RESULT IN LOSING ALL PAST MEASUREMENT DATA ON THE CARDS.

When the OA&M IP Security feature is turned on, and an IPSM card is inserted and initialized for the first time or is removed, inserted, and initialized again, the "SSH Host Keys Regenerated" UIM is displayed. The UIM shows the generated SSH Host Key fingerprint that must be provided at the secure client in order for secure information transfer to occur. The SSH Host Key fingerprint is changed whenever power is lost and restored to an IPSM card.

```
rlghncxa03 03-07-11 07:05:00 EST EAGLE 30.2.0
0021.1493 CARD 1111 INFO SSH Host Keys Regenerated
DSA Server Host Key FTRA-formatted Fingerprint=
84 7c 92 8b c 7c ds 19 1c 6 4b de 5c 8f c5 4d
Report Date:03-07-11 Time:22:27:36
```

When the OA&M IP Security feature is turned on, and an IPSM card is restarted with this command, the "SSH Host Keys Loaded" UIM is displayed. The UIM shows the current SSH Host Key fingerprint. The SSH Host Key fingerprint is not changed if the IPSM card does not lose power.

```

rlghncxa03 03-07-11 07:05:00 EST EAGLE 30.2.0
0021.1493 CARD 1111 INFO SSH Host Keys Loaded
DSA Server Host Key FTRA-formatted Fingerprint=
84 7c 92 8b c 7c ds 19 1c 6 4b de 5c 8f c5 4d
Report Date:03-07-11 Time:22:27:36

```

Output

alw-card:loc=2301:code=trial

```

rlghncxa03w 04-01-07 11:11:28 EST EAGLE 31.3.0
Card has been allowed.

```

;

alw-imt

Allow IMT

Use this command to change the state of the specified Interprocessor Message Transport (IMT) bus from OOS-MT-DSBLD (out-of-service maintenance disabled) to IS-NR (in-service normal), if the command is successful. If the command fails, the status is IS-ANR (in-service abnormal). The IMT bus is comprised of two 125 Mbps counter-rotating serial busses. If one bus fails, the other immediately assumes control of all messages.

Keyword: alw-imt

Related Commands: clr-imt-stats, conn-imt, disc-imt, inh-imt, rept-imt-lvl1, rept-imt-lvl2, rept-stat-imt, rst-imt, rmv-imt, tst-imt

Command Class: System Maintenance

Parameters

:bus= (mandatory)

The IMT bus whose status you want to change.

Range: a, b

Example

```
alw-imt:bus=a
```

Dependencies

This command cannot be entered during an IMT Fault Isolation Test.

Notes

This command returns an inhibited IMT bus to service.

The function of this command is the same as the **rst-imt** command.

See the **tst-imt** command to determine the location of faults on a failed or abnormal IMT bus.

Output**alw-imt:bus=a**

```
rlghncxa03w 04-01-07 11:11:28 EST EAGLE 31.3.0
Allow IMT Bus A command issued.
```

```
rlghncxa03w 04-01-07 11:11:28 EST EAGLE 31.3.0
0100.0097 IMT BUS A Imt allowed
;
```

alw-map-ss**Allow Mated Application Subsystem**

Use this command to activate a subsystem and bring it online. Currently, the LNPQS, INPQS, and Equipment Identity Register (EIR) subsystems can be allowed and inhibited.

Keyword: alw-map-ss

Related Commands: chg-map-ss, inh-map-ss, rept-stat-lnp, rept-stat-sccp

Command Class: System Maintenance

Parameters

:ssn= (mandatory)

The LNP, INP, or EIR subsystem number.

Range: 2–255

Example

```
alw-map-ss:ssn=10
```

Dependencies

No other action command can be in progress when this command is entered.

The EAGLE 5 SAS must be configured with at least one TSM card running the **sccp** application or one DSM card running the **vsccp** application.

The LNP feature (see the **enable-ctrl-feat** command) or the INP feature must be turned on, or the EIR feature must be enabled and turned on before this command can be entered.

The specified **ssn** parameter value must represent the LNPQS, INPQS, or EIR subsystem.

The LNPQS, INPQS, or EIR subsystem must be online in the database before this command can be entered.

The LNPQS, INPQS, or EIR subsystem must be out-of-service maintenance disabled (OOS-MT-DSBLD) for command action to occur. Otherwise, the command is accepted and no action occurs.

Notes

None

Output**alw-map-ss:ssn=11**

```

integrat40 00-05-24 10:37:22 EST EAGLE5 31.0.0
Allow map subsystem command sent to all SCCP cards.
Command Completed.

```

;

alw-slk**Allow Signaling Link**

Use this command to return an inhibited signaling link to service. If the link was aligned when it was inhibited, a changeover occurred. This command causes a changeback on the specified link. MSUs are transmitted on the link after the changeback is issued.

NOTE: The signaling link's inhibited status is not preserved across a card reboot.

Keyword: alw-slk

Related Commands: act-slk, blk-slk, canc-slk, dact-slk, dlt-slk, ent-slk, inh-slk, rept-stat-slk, rtrv-slk, tst-slk, ublk-slk, unhb-slk

Command Class: Link Maintenance

Parameters

:loc= (mandatory)

The card location as stenciled on the shelf of the system.

Range: 1101–1108, 1111–1112, 1201–1208, 1211–1218, 1301–1308, 1311–1318, 2101–2108, 2111–2118, 2201–2208, 2211–2218, 2301–2308, 2311–2318, 3101–3108, 3111–3118, 3201–3208, 3211–3218, 3301–3308, 3311–3318, 4101–4108, 4111–4118, 4201–4208, 4211–4218, 4301–4308, 4311–4318, 5101–5108, 5111–5118, 5201–5208, 5211–5218, 5301–5308, 5311–5318, 6101–6108, 6111–6118

:port= or :link= (mandatory)

The signaling link defined on the card specified in the **loc** parameter. The links can be specified in any sequence or pattern.

Range: a, b, a1-a31, b1-b31

Not all card types support all **link** parameter values.

See Table A-1 in Appendix A for valid **link** parameter range values for each type of card that can have a location specified in the **loc** parameter.

Example

```
alw-slk:loc=1301:link=b
```

Dependencies

A card location that is valid and defined in the database must be specified.

No other action command can be in progress when this command is entered.

The card must be equipped and must be one of the following cards:

- A LIM card running the **ss7ansi**, **ss7gx25**, **atmansi**, or **ccs7itu** application
- An E1 ATM card running the **atmitu** application

- A dual-slot DCM or EDCM card running the **iplim** or **iplimi** application with links having **ipliml2=saaltali**
- An SSEDCCM card running the **iplim** or **iplimi** application with links having **ipliml2=m2pa** or **ipliml2=saaltali**
- An E1/T1 MIM card or an HC-MIM card running the **ss7ansi** or **ccs7itu** application

This command is not valid on TCP/IP point-to-multipoint links (DCM cards equipped as SS7IPGW or IPGWI links).

The card must contain signaling links.

The signaling link must be equipped in the database.

The **link** parameter values **a1**, **b1**, **a2**, **b2**, **a3**, and **b3** can be specified only for the following cards:

- A multi-port LIM
- An SSEDCCM running the **iplim** or **iplimi** application that supports 8 points
- An E1/T1 MIM or an HC-MIM

Notes

The function of this command is the same as the **unhb-slk** command.

Not every card location represents a signaling link. Be sure to address a signaling link in this command.

The *Installation Manual - EAGLE 5 SAS* provides an illustration of card locations.

Output

alw-slk:loc=1301:link=b

```
tekelecstp 05-01-21 17:00:36 EST EAGLE5 33.0.0
Allow Link message sent to card
```

;

alw-trm

Allow Terminal

Use this command to return the specified serial port to the state IS-NR (in-service normal) from the state OOS-MT-DSBLD (out-of-service maintenance-disabled) if the command is successful. If the command is not successful, the terminal's state is OOS-MT (out-of-service maintenance).

Keyword: alw-trm

Related Commands: act-echo, canc-echo, chg-trm, dact-echo, inh-trm, rept-stat-trm, rmv-trm, rst-trm, rtrv-trm

Command Class: System Maintenance

Parameters

:trm= (mandatory)

The ID of the serial port to be put into service.

Range: 1-40

Example

```
alw-trm:trm=5
```

```
alw-trm:trm=23
```

Dependencies

No other action command can be in progress when this command is entered.

The IP User Interface feature must be enabled before terminal ports 17 through 40 can be specified in the **trm** parameter.

The terminal specified by the **trm** parameter must be equipped.

Anyone logged in to the terminal specified by this command is logged off when this command is executed. For the user to continue working on the specified terminal, the user must log on to that terminal again.

Notes

The function of this command is the same as the **rst-trm** command.

When you attempt to return to service a terminal that is already in service, a warning message is echoed to the scroll area but no action is taken.

Output

```
alw-trm:trm=12
```

```
rlghncxa03w 04-01-07 11:11:28 EST EAGLE 31.3.0
Allow message sent to terminal
```

```
rlghncxa03w 04-01-07 11:11:28 EST EAGLE 31.3.0
1062.0046     TERMINAL      12          Terminal Enabled
;
```

aud-data**Audit Data**

Use this command to perform a data audit, which is used to determine the integrity of the database. The data audit is separate from the GPL audit, which determines if a specified GPL is at the correct version level.

Keyword: aud-data

Related Commands: rept-stat-db, rtrv-gpl

Command Class: System Maintenance

Parameters

:display= (optional)

Indicates the scope of the display, whether it is a brief display or full display. The output includes the type and location of the card, the data collection being audited, and a message indicating the overall status. This parameter applies only to STP databases.

Range: all, brief, except

all—Contains the actual checksum values (in hexadecimal) and details for each individual GPL and each subset of the current and backup database

brief—Contains data collections for the current database, the backup database on the fixed disk and the approved and trial GPLs

except—Contains the same as **display=all**, except that only the GPLs or database subsets with problems are displayed

Default: **brief**

Example

```
aud-data:display=all
```

Dependencies

Only one **aud-data** command can be in progress at a time.

Notes

The standby OAM must be available when the **aud-data** command commences so that the standby OAM can receive the signal to begin auditing. If the standby OAM is not available when **aud-data** is issued, then the following messages are issued:

```
Extended Processing Time Required  
Standby MASP is (or was) not available at audit start.
```

The above messages may also appear if the standby OAM is not available when the hourly periodic audit, which uses the **aud-data** command, automatically starts. Because the standby OAM is not performing any auditing, no audit results for the standby OAM are displayed in the audit report. Instead, the standby's audit results are as follows:

```
No information currently available
```

If an auditing cycle completes on either the active or standby OAM and does not produce the full set of expected results (i.e., checksums), the following message appears:

```
Audit results may be incomplete
```

The audit results may be missing some of the checksums that would normally be displayed (**:display=all** or **:display=except**). The results may also contain summary status information (**:display=brief**) that might have been calculated differently had some of the missing checksums been available. This condition can be caused if the audit results for the backup database are missing, probably because a backup database has not been created.

If the "Audit results may be incomplete" message appears in the audit report, perform the following procedure:

Procedure - Audit Data

- 1 Ensure that the standby OAM is online and ready.

- 2 Enter the following command to ensure that a backup database has been created:
rept-stat-db
If no backup has ever been created, the output shows the fixed disk backup (FD BKUP) database at level 1. There will be no information under the heading "Time Last Backup".

- 3 If necessary, create a backup on the fixed disk by entering the following command:

```
chg-db:action=backup:dest=fixed
```

- 4 Re-enter the **aud-data** command.
-

If the standby OAM does not run an audit cycle and no audit information is available, the following message appears:

```
Audit results are not available
```

This condition is probably caused by the standby OAM rebooting while an audit cycle is underway. If this message appears, ensure that the standby OAM is available and re-enter the **aud-data** command. Ensure that the standby OAM remains up (is not rebooted) for the duration of the audit cycle.

Output

The following example shows a full display. This example applies only to STP databases.

aud-data:display=all

```
rlghncxa03w 04-01-07 10:39:04 EST EAGLE 31.3.0
DATA AUDIT COMPLETE
CARD      LOC      DATA              STATUS      NEW CS  OLD CS  REF CS
TDM-ACTV  1115  CRNT MTP          SUBSET OK      H'ffaf  H'ffaf  H'ffaf
          CRNT GTT          SUBSET OK      H'5864  H'5864  H'5864
          CRNT GWS          SUBSET OK      H'd089  H'd089  H'd089
          CRNT MISC        SUBSET OK      H'2735  H'2735  H'2735
          CRNT DBMM        SUBSET OK      H'1001  H'1001  H'1001
          BKUP MTP          SUBSET OK      H'2b85  H'2b85  H'2b85
          BKUP GTT          SUBSET OK      H'5864  H'5864  H'5864
          BKUP GWS          SUBSET OK      H'd089  H'd089  H'd089
          BKUP MISC        SUBSET OK      H'5af1  H'5af1  H'5af1
          BKUP DBMM        SUBSET OK      H'1001  H'1001  H'1001
          APPR SS7ANSI    GPL          OK      H'1372  H'1372  H'1372
          APPR SCCP      GPL          OK      H'9251  H'9251  H'9251
          TRI  SCCP      GPL          OK      H'9251  H'9251  H'9251
          APPR GLS       GPL          OK      H'8887  H'8887  H'8887
          TRI  GLS       GPL          OK      H'8887  H'8887  H'8887
          APPR UTILITY  GPL          OK      H'18de  H'18de  H'18de
          TRI  UTILITY  GPL          OK      H'18de  H'18de  H'18de
          APPR SS7GX25  GPL          OK      H'9251  H'9251  H'9251
          TRI  SS7GX25  GPL          OK      H'610c  H'610c  H'610c
          APPR STPLAN   GPL          OK      H'93bf  H'93bf  H'93bf
          TRI  STPLAN   GPL          OK      H'93bf  H'93bf  H'93bf
          APPR              OK      H'b6c6  H'b6c6  H'b6c6
          TRI              OK      H'b6c6  H'b6c6  H'b6c6
```

```
rlghncxa03w 04-01-07 10:39:04 EST EAGLE 31.3.0
DATA AUDIT COMPLETE
CARD      LOC      DATA              STATUS      NEW CS  OLD CS  REF CS
TDM-STDBY 1113  CRNT MTP          SUBSET OK      H'ffaf  H'ffaf  H'ffaf
          CRNT GTT          SUBSET OK      H'5864  H'5864  H'5864
          CRNT GWS          SUBSET OK      H'd089  H'd089  H'd089
          CRNT MISC        SUBSET OK      H'2735  H'2735  H'2735
          CRNT DBMM        SUBSET OK      H'1001  H'1001  H'1001
          BKUP MTP          SUBSET OK      H'2b85  H'2b85  H'2b85
          BKUP GTT          SUBSET OK      H'5864  H'5864  H'5864
          BKUP GWS          SUBSET OK      H'd089  H'd089  H'd089
```

```

BKUP MISC      SUBSET OK          H'5af1 H'5af1 H'5af1
BKUP DBMM      SUBSET OK          H'1001 H'1001 H'1001
APPR SS7ANSI   GPL      OK          H'1372 H'1372 H'1372
APPR SCCP      GPL      OK          H'9251 H'9251 H'9251
TRI  SCCP      GPL      OK          H'9251 H'9251 H'9251
APPR GLS       GPL      OK          H'8887 H'8887 H'8887
TRI  GLS       GPL      OK          H'8887 H'8887 H'8887
APPR UTILITY   GPL      OK          H'18de H'18de H'18de
TRI  UTILITY   GPL      OK          H'18de H'18de H'18de
APPR SS7GX25  GPL      OK          H'9251 H'9251 H'9251
TRI  SS7GX25  GPL      OK          H'610c H'610c H'610c
APPR STPLAN   GPL      OK          H'93bf H'93bf H'93bf
TRI  STPLAN   GPL      OK          H'93bf H'93bf H'93bf
APPR          OK          H'b6c6 H'b6c6 H'b6c6
TRI          OK          H'b6c6 H'b6c6 H'b6c6
;

```

The following example applies only to STP databases.

aud-data:display=except

```

rlghncxa03w 04-01-07 10:39:01 EST  EAGLE 31.3.0
Extended Processing Time Required
Results will be displayed on completion

```

```

rlghncxa03w 04-01-07 10:39:04 EST  EAGLE 31.3.0
DATA AUDIT COMPLETE
CARD      LOC  DATA          STATUS      NEW CS OLD CS REF CS
TDM-ACTV  1116  CRNT MTP      SUBSET  DIFFERENT  H'aaaa H'aaaa H'cccc
          CRNT GTT      SUBSET  CORRUPTED  H'aaaa H'bbbb H'aaaa
          APPR MCM      GPL      CORRUPTED  H'4321 H'3456 H'4321
          APPR GLS      GPL      CORRUPTED  H'4321 H'3456 H'4321
          APPR SCCP     GPL      CORRUPTED  H'4321 H'3456 H'4321

```

```

rlghncxa03w 04-01-07 10:39:01 EST  EAGLE 31.3.0
Extended Processing Time Required
Results will be displayed on completion

```

```

rlghncxa03w 04-01-07 10:39:04 EST  EAGLE 31.3.0
DATA AUDIT COMPLETE
CARD      LOC  DATA          STATUS      NEW CS OLD CS REF CS
TDM-STDBY 1113  CRNT MTP      SUBSET  DIFFERENT  H'aaaa H'aaaa H'cccc
          CRNT GTT      SUBSET  CORRUPTED  H'aaaa H'bbbb H'aaaa
          APPR MCM      GPL      CORRUPTED  H'4321 H'3456 H'4321
          APPR GLS      GPL      CORRUPTED  H'4321 H'3456 H'4321
          APPR SCCP     GPL      CORRUPTED  H'4321 H'3456 H'4321
;

```

The following example shows a brief display. This example applies only to STP databases.

aud-data or aud-data:display=brief

```

rlghncxa03w 04-01-07 10:39:01 EST  EAGLE 31.3.0
CARD      LOC  DATA          STATUS
TDM-ACTV  1115  CRNT DB        OK
          BKUP DB        OK
          GPLS          OK

```

```
rlghncxa03w 04-01-07 10:39:01 EST EAGLE 31.3.0
DATA AUDIT COMPLETE:
```

```
CARD          LOC   DATA          STATUS
TDM-STDBY    1113  CRNT DB      OK
              BKUP DB      OK
              GPLS          OK
```

;

Legend

APPR—The approved GPL

BKUP—The database in the backup partition

CCS7ITU—The CCS7ITU GPL

CRNT—The database in the current partition

DBMM—The database management mechanism database

GLS—The GLS GPL

GTT—The global title translation database

GWS—The gateway screening database

MISC—The miscellaneous system configuration database

MTP—The message transfer part database (links, linksets, routing tables)

OAM—The OAM GPL

SCCP—The SCCP GPL

SS7ANSI—The SS7ANSI GPL

SS7GX25—The SS7GX25 GPL

SUBSET or **GPL**—Indicates whether the data is a part of the database or a generic program load.

TRI—The trial GPL

CARD—The card type

CORRUPTED—The database or GPL has been changed by some abnormal process. The GPL cannot be used

DIFFERENT—The database or GPL contains information that is not consistent with the reference database or GPL

OK—The database or GPL is not corrupted and contains the same information as the reference database or GPL

DATA—The type of data being audited:

LOC—The location of the card

NEW CS—The new checksum value calculated by this command

OLD CS—The checksum value stored in the database or GPL

REF CS—The reference checksum value stored on the active MASP

STATUS—The status of the database or GPL, as one of the following conditions:

blk-slk

Block Signaling Link

Use this command to force a local processor outage (LPO) on the specified link. The system begins sending link status signal units (LSSU) with status of processor outage (SIPO) to the adjacent signaling point. Maintenance personnel should use this command only to block MSUs from being sent to the system. Level 2 status remains in service, except when the link is an ATM high-speed signaling link.

NOTE: The signaling link's blocked status is not preserved across a card reboot.

Keyword: blk-slk

Related Commands: `canc-lpo`, `blk-slk`, `rept-stat-slk`, `ublk-slk`

Command Class: Link Maintenance

Parameters

:loc= (mandatory)

The card location as stenciled on the shelf of the system.

Range: 1101–1108, 1111–1112, 1201–1208, 1211–1218, 1301–1308, 1311–1318, 2101–2108, 2111–2118, 2201–2208, 2211–2218, 2301–2308, 2311–2318, 3101–3108, 3111–3118, 3201–3208, 3211–3218, 3301–3308, 3311–3318, 4101–4108, 4111–4118, 4201–4208, 4211–4218, 4301–4308, 4311–4318, 5101–5108, 5111–5118, 5201–5208, 5211–5218, 5301–5308, 5311–5318, 6101–6108, 6111–6118

:port= or :link= (mandatory)

The signaling link defined on the card specified in the **loc** parameter. The links can be specified in any sequence or pattern.

Range: a, b, a1-a31, b1-b31

Not all card types support all **link** parameter values.

See Table A-1 in Appendix A for valid **link** parameter range values for each type of card that can have a location specified in the **loc** parameter.

Example

```
blk-slk:loc=2311:port=a
```

```
blk-slk:loc=2312:port=a
```

```
blk-slk:loc=2355:port=a
```

Dependencies

A card location that is valid and defined in the database must be specified.

No other action command can be in progress when this command is entered.

The card must be equipped and must be one of the following cards:

- A LIM card running the `ss7ansi`, `ss7gx25`, `atmansi`, or `ccs7itu` application
- An E1 ATM card running the `atmitu` application

- An SSEDCCM card running the **iplim** or **iplimi** application with links having **ipliml2=m2pa** or **ipliml2=saaltali**
- An E1/T1 MIM card or an HC-MIM card running the **ss7ansi** or **ccs7itu** application

The **blk-slk** command is not valid for DCM cards with **ss7ipgw** or **ipgwi** TCP/IP links.

The card must contain signaling links.

The signaling link must be equipped in the database.

The **link** parameter values **a1**, **b1**, **a2**, **b2**, **a3**, and **b3** can be specified only for the following cards:

- A multi-port LIM
- An SSEDCCM card running the **iplim** or **iplimi** application with links having **ipliml2=m2pa** or **ipliml2=saaltali**
- An E1/T1 MIM or an HC-MIM.

Notes

The function of this command is the same as the **act-lpo** command.

This command generates a minor alarm. Refer to the *Maintenance Manual* for information on MRNs 0201 and 0208.

If the **blk-slk** command is followed by the **init-card** command, the signaling link blockage is not preserved after the **init-card** command completes.

The *Installation Manual - EAGLE 5 SAS* provides an illustration of card locations.

Output

blk-slk:loc=2311:link=a

```
tekelecstp 05-01-21 17:00:36 EST EAGLE5 33.0.0
Local processor outage being set.
```

;

In the following example, no signaling link has been defined for link a.

blk-slk:loc=2312:link=a

```
tekelecstp 05-01-21 17:00:36 EST EAGLE5 33.0.0
Link is UNEQUIPPED in the database.
Local processor outage being set.
```

;

In the following example, slot 55 in the card location is not valid.

blk-slk:loc=2355:link=a

```
tekelecstp 05-01-21 17:00:36 EST EAGLE5 33.0.0
Command Rejected: Slot ID out of range
```

;

canc-alm-trns**Cancel Alarm Transfer**

Use this command to return all audible alarm indications to the local office.

Keyword: **canc-alm-trns**

Related Commands: **act-alm-trns**, **dact-alm-trns**, **rept-stat-cdt**, **rept-stat-clk**, **rept-stat-trbl**, **rls-alm**, **rtrv-obit**, **rtrv-trbl**

Command Class: System Maintenance

Parameters

This command has no parameters.

Example

canc-alm-trns

Dependencies

None

Notes

No other action command can be in progress when this command is entered.

The function of this command is the same as the **dact-alm-trns** command.

After the **canc-alm-trns** command is entered, the **rept-stat-alm** command can be entered to verify the status of the alarms.

Output**canc-alm-trns**

```
rlghncxa03w 04-01-07 11:11:28 EST EAGLE 31.3.0  
Alarms returned to Local Maintenance Center  
Command Completed.
```

;

canc-cmd**Cancel Command**

This command halts processing and output of the commands listed in Table 5-5:

Table 5-5. Commands for which **canc-cmd** Halts Processing and Output

Commands		
rept-imt-info	rtrv-appl-rtkey	rtrv-ls
rept-stat-applsock	rtrv-appl-sock	rtrv-map
rept-stat-as	rtrv-as	rtrv-mrn
rept-stat-assoc	rtrv-assoc	rtrv-obit (active OAM)
rept-stat-card	rtrv-cmd	rtrv-rte
rept-stat-clk	rtrv-dcmps	rtrv-seculog
rept-stat-dstn	rtrv-dstn	rtrv-secu-user
rept-stat-ls	rtrv-gta	rtrv-slk
rept-stat-rte	rtrv-gtt	rtrv-tbl-capacity
rept-stat-slk	rtrv-lbp	rtrv-trbltx
rept-stat-trbl	rtrv-log	rtrv-uaps

When using the **canc-cmd** command without the **trm** parameter, enter the command on the same terminal that is currently running the command you want to cancel.

When using the **canc-cmd** command with the **trm** parameter, enter the command on a terminal other than the one that is currently running the command you want to cancel.

Keyword: **canc-cmd**

Related Commands: **rept-imt-info**, **rept-stat-assoc**, **rept-stat-card**, **rept-stat-dstn**, **rept-stat-ls**, **rept-stat-rte**, **rept-stat-slk**, **rtrv-appl-rtkey**, **rtrv-appl-sock**, **rtrv-assoc**, **rtrv-dcmps**, **rtrv-dstn**, **rtrv-gta**, **rtrv-gtt**, **rtrv-log**, **rtrv-ls**, **rtrv-map**, **rtrv-obit** (active OAM), **rtrv-rte**, **rtrv-seculog**, **rtrv-slk**, **rtrv-trbltx**, **rtrv-uaps**

Command Class: Basic for **canc-cmd**; Security Administration for **canc-cmd:trm=x**

Parameters

:trm= (optional)

The terminal on which the command is to be canceled.

Range: 1–40

Example

```
canc-cmd
```

```
canc-cmd:trm=3
```

Dependencies

The **trm** parameter cannot be specified in a **canc-cmd** command that is entered on the same terminal that is running the command that is to be cancelled. The terminal will return an error: system is busy.

The **canc-cmd:trm=** command requires the security administration command class for the terminal and for the user.

Notes

The **canc-cmd** command (without the **trm** parameter) must be entered on the same terminal that is running the command to be cancelled.

If the **canc-cmd** command is entered on a terminal that is not running a command, the **canc-cmd** command completes successfully without returning an error. Likewise, if the **canc-cmd:trm=** command is entered and there is no command running on the specified terminal, the **canc-cmd:trm=** command completes successfully without returning an error.

When the **canc-cmd** with no parameter is entered, a scroll area message appears to indicate that the command has been cancelled. For example:

```
Command aborted on terminal 2.
```

Some output can still appear after the above abort message if output accumulated in the output queue before the **canc-cmd** command was entered. When a command is cancelled, the cancellation should take no longer than 25 seconds to take effect.

The **F9** function key provides the same function as the **canc-cmd** command (without the **trm** parameter). On a terminal in KSR mode, pressing **<CTRL>I** also provides the same function.

The **canc-cmd** and the **F9** function key cannot be used for pure SEAS commands.

If **canc-cmd** is entered to cancel a command other than ones listed in Table 5-5 on page 5-48, the terminal will accept another command but output and processing of the current command continue.

When **canc-cmd** is entered, a command status code of **AB** (command aborted) is logged in the security log as follows:

- When the **canc-cmd** (without the **trm** parameter) is entered, no entry is logged.
- When the **canc-cmd:trm=** command is entered, an entry is logged.
- When the **canc-cmd** command (without the **trm** parameter) is entered as a SEAS flow-thru command, an entry is logged. The **canc-cmd:trm=** command is not allowed as a SEAS flow-thru command because the **canc-cmd:trm=** command belongs to the Security Administration Command Class.

For examples of the security log entries, see the **rtrv-secu** command.

Output

canc-cmd

```
rlghncxa03w 04-07-27 17:00:36 EST      EAGLE 31.6.0
canc-cmd
Command entered at terminal #2.
```

```
rlghncxa03w 04-07-27 17:00:36 EST      EAGLE 31.6.0
Command aborted on terminal 2.
```

```
;
```

canc-cmd:trm=2

```

rlghncxa03w 04-07-27 17:00:36 EST    EAGLE 31.6.0
canc-cmd:trm=2
Command entered at terminal #3.

rlghncxa03w 04-07-27 17:00:36 EST    EAGLE 31.6.0
Command aborted on terminal 2.
;

```

canc-dlk**Cancel Data Link**

Use this command to remove a TCP/IP data link from service. The state of the TCP/IP data link is changed from in service normal (IS-NR) to out of service maintenance disabled (OOS-MT-DSBLD).

Keyword: **canc-dlk**

Related Commands: **act-dlk, dlt-dlk, ent-dlk, rept-stat-dlk, rtrv-dlk, tst-dlk**

Command Class: Link Maintenance

Parameters

:loc= (mandatory)

The card location as stenciled on the shelf of the system.

Range: **1101-1108, 1111-1112, 1201-1208, 1211-1218, 1301-1308, 1311-1318, 2101-2108, 2111-2118, 2201-2208, 2211-2218, 2301-2308, 2311-2318, 3101-3108, 3111-3118, 3201-3208, 3211-3218, 3301-3308, 3311-3318, 4101-4108, 4111-4118, 4201-4208, 4211-4218, 4301-4308, 4311-4318, 5101-5108, 5111-5118, 5201-5208, 5211-5218, 5301-5308, 5311-5318, 6101-6108, 6111-6118**

Example

canc-dlk:loc=1308

Dependencies

No other action command can be in progress when this command is entered.

The shelf and card must be equipped.

The card location must contain an ACM card.

Notes

None

Output**cancel-dlk:loc=1308**

```

rlghncxa03w 04-01-27 17:00:36 EST    EAGLE 31.3.0
Deactivate Link message sent to card.
Command Completed.
;

```

canc-echo**Cancel Echo**

Use this command to halt the echoing of command responses from the user's terminal to other terminals or printers

Keyword: `canc-echo`

Related Commands: `act-echo`, `alw-trm`, `chg-trm`, `dact-echo`, `inh-trm`, `rept-stat-trm`, `rmv-trm`, `rst-trm`, `rtrv-trm`

Command Class: Basic

Parameters

:trm= (optional)

The ID number of the terminal for which the echo is being canceled.

Range: 1–16

Default: Cancels all active echoes

Example

```
canc-echo
```

```
canc-echo:trm=7
```

Dependencies

The echo cannot be cancelled to the same terminal from which the **canc-echo** command is entered.

Notes

Only the echoing of command output responses can be halted by this command. To halt the printing of alarm and network messages, the **chg-trm** command must be used.

Output**canc-echo**

```
rlghncxa03w 04-01-07 11:11:28 EST EAGLE 31.3.0
canc-echo
Command entered at terminal #6.
Scroll Area Output echo disabled to all terminals.
;
```

canc-echo:trm=7

```
rlghncxa03w 04-01-07 11:11:28 EST EAGLE 31.3.0
canc-echo:trm=7
Command entered at terminal #6
Scroll Area Output echo disabled for terminal 7.
;
```

canc-lnp-dpcer**Cancel LNP DPC Transaction Report**

NOTE: This command is obsolete.

Use this command to cancel a report previously invoked with the **rtrv-lnp-dpcer** command.

NOTE: If the LNP ELAP Configuration controlled feature is turned on, this command is no longer available, and all LNP provisioning is performed at the LSMS.

Keyword: `canc-lnp-dpcer`

Related Commands: `rtrv-lnp-dpcer`

Command Class: LNP Basic Administration

Parameters

This command has no parameters.

Example

```
canc-lnp-dpcer
```

Dependencies

The LNP feature must be turned on before this command can be entered (see the `enable-ctrl-feat` and `chg-ctrl-feat` commands).

Notes

If the `canc-lnp-dpcer` command is entered on the same EAGLE 5 SAS terminal at which the currently active `rtrv-lnp-dpcer` command was entered, you must press the *F9* key before the command will be accepted. However, you can cancel the command from a different terminal without pressing the *F9* key.

Output

```
canc-lnp-dpcer
```

```
rlghncxa03w 04-01-07 11:11:28 EST EAGLE 31.3.0
CANC-LNP-DPCER: MASP A - COMPLTD
;
```

canc-lnp-tnrpt

Cancel LNP Subscription Version Report

NOTE: This command is obsolete.

Use this command to cancel a report previously invoked with the `rtrv-lnp-tnrpt` command.

NOTE: If the LNP ELAP Configuration controlled feature is turned on, this command is no longer available, and all LNP provisioning is performed at the LSMS.

Keyword: `canc-lnp-tnrpt`

Related Commands: `rtrv-lnp-tnrpt`

Command Class: LNP Basic Administration

Parameters

This command has no parameters.

Example

```
canc-lnp-tnrpt
```

Dependencies

None

Notes

If the **canc-lnp-tnrpt** command is entered on the same EAGLE 5 SAS terminal at which the currently active **rtrv-lnp-dpcer** command was entered, you must press the **F9** key before the command will be accepted. However, you can cancel the command from a different terminal without pressing the **F9** key.

Output**canc-lnp-tnrpt**

```
rlghncxa03w 04-01-07 11:11:28 EST EAGLE 31.3.0
CANC-LNP-TNRPT: MASP A - COMPLTD
```

```
;
```

canc-lpo**Cancel Local Processor Outage**

Use this command to cancel a processor outage and restore the link to its previous state. LSSUs with status of processor outage are terminated, and the link begins sending MSUs.

NOTE: The signaling link's blocked status is not preserved across a card reboot.

Keyword: **canc-lpo**

Related Commands: **act-lpo**, **blk-slk**, **ublk-slk**

Command Class: Link Maintenance

Parameters

:loc= (mandatory)

The address of the card containing the signaling link to be unblocked.

Range: 1101-1108, 1111-1112, 1201-1208, 1211-1218, 1301-1308, 1311-1318, 2101-2108, 2111-2118, 2201-2208, 2211-2218, 2301-2308, 2311-2318, 3101-3108, 3111-3118, 3201-3208, 3211-3218, 3301-3308, 3311-3318, 4101-4108, 4111-4118, 4201-4208, 4211-4218, 4301-4308, 4311-4318, 5101-5108, 5111-5118, 5201-5208, 5211-5218, 5301-5308, 5311-5318, 6101-6108, 6111-6118

:port= or :link= (mandatory)

The signaling link defined on the card specified in the **loc** parameter. The links can be specified in any sequence or pattern.

Range: **a, b, a1-a31, b1-b31**

Not all card types support all **link** parameter values.

See Table A-1 in Appendix A for valid **link** parameter range values for each type of card that can have a location specified in the **loc** parameter.

Example

```
canc-lpo:loc=2311:link=b
```

Dependencies

A card location must be specified that is valid and defined in the database.

No other action command can be in progress when this command is entered.

The card must be equipped and must be one of the following cards:

- A LIM card running the **ss7ansi**, **ss7gx25**, **atmansi**, or **ccs7itu** application
- An E1 ATM card running the **atmitu** application
- An SSEDCCM card running the **iplim** or **iplimi** application with links having **ipliml2=m2pa**
- An E1/T1 MIM card or an HC-MIM card running the **ss7ansi** or **ccs7itu** application

This command cannot be entered for IPLIMx signaling links that have an **ipliml2** parameter setting that is not **m2pa**.

The **canc-lpo** command is not valid for DCM cards with **ss7ipgw** or **ipgwi** TCP/IP links.

The card must contain signaling links.

The signaling link must be equipped in the database.

The link parameter values **a1**, **b1**, **a2**, **b2**, **a3**, and **b3** can be specified only for the following cards:

- A multi-port LIM
- An E1/T1 MIM or an HC-MIM

Notes

The function of this command is the same as the **ublk-slk** command.

Unblocking a signaling link removes a Level 2 failure resulting from a **blk-slk** of an ATM high-speed signaling link.

The *Installation Manual - EAGLE 5 SAS* provides an illustration of card locations.

Output

canc-lpo:loc=2311:link=a

```
tekelecstp 05-01-21 17:00:36 EST EAGLE5 33.0.0
Local processor outage being cleared.
```

;

In the following example, card location 1113 is not valid:

canc-lpo:loc=1113:link=a

```
tekelecstp 05-01-21 17:00:36 EST EAGLE5 33.0.0
Command Rejected : Location is not valid for command
```

;

canc-slk

Cancel Signaling Link

Use this command to change the state of the specified link to OOS-MT-DSBLD (Out-Of-Service Maintenance Disabled).



CAUTION: This command impacts network performance, and should be used only during periods of low traffic.

Keyword: `canc-slk`

Related Commands: `act-slk`, `alw-slk`, `blk-slk`, `dact-slk`, `dlt-slk`, `ent-slk`, `inh-slk`, `rept-stat-slk`, `rtrv-slk`, `tst-slk`, `ublk-slk`, `unhb-slk`

Command Class: Link Maintenance

Parameters

:loc= (mandatory)

The card location as stenciled on the shelf of the system.

Range: 1101–1108, 1111–1112, 1201–1208, 1211–1218, 1301–1308, 1311–1318, 2101–2108, 2111–2118, 2201–2208, 2211–2218, 2301–2308, 2311–2318, 3101–3108, 3111–3118, 3201–3208, 3211–3218, 3301–3308, 3311–3318, 4101–4108, 4111–4118, 4201–4208, 4211–4218, 4301–4308, 4311–4318, 5101–5108, 5111–5118, 5201–5208, 5211–5218, 5301–5308, 5311–5318, 6101–6108, 6111–6118

:port= or :link= (mandatory)

Signaling link defined on the card specified in the `loc` parameter. The links can be specified in any sequence or pattern.

Range: a, b, a1-a31, b1-b31

Not all card types support all `link` parameter values.

See Table A-1 in Appendix A for valid `link` parameter range values for each type of card that can have a location specified in the `loc` parameter.

Example

```
canc-slk:loc=1301:link=a
```

Dependencies

A card location must be specified that is valid and defined in the database.

No other action command can be in progress when this command is entered.

The card must be equipped and must be one of the following cards:

- A LIM card running the `ss7ansi`, `ss7gx25`, `atmansi`, or `ccs7itu` application
- An E1 ATM card running the `atmitu` application
- A DCM or SSEDCCM card running the `ss7ipgw`, `ipgwi`, `iplim`, or `iplimi` application
- An E1/T1 MIM or HC-MIM card running the `ss7ansi` or `ccs7itu` application

The card must contain signaling links.

The signaling link must be equipped in the database.

The `link` parameter values `a1`, `b1`, `a2`, `b2`, `a3`, and `b3` can be specified only for the following cards:

- A multi-port LIM
- An SSEDCCM running the `iplim` or `iplimi` application that supports 8 points
- An E1/T1 MIM or HC-MIM

The `link` parameter values `a4-a31` and `b4-b31` can be specified only for the HC-MIM card:

Notes

Not every card location represents a signaling link. Be sure to address a signaling link in this command.

The *Installation Manual - EAGLE 5 SAS* provides an illustration of card locations.

After the **canc-slk** command is entered, the **rept-stat-slk** command can be entered to verify the cancellation.

Output

```
canc-slk:loc=1301:link=a
rlghncxa03w 05-02-07 11:11:28 EST EAGLE5 33.0.0
Deactivate Link message sent to card
;
```

canc-user**Cancel User**

Use this command to end a user session. The **dact-echo** or **logout** command has the same affect as the **canc-user** command.

Keyword: **canc-user**

Related Commands: **act-user, chg-pid, chg-user, dact-user, dlt-user, ent-user, login, logout, rept-stat-user, rtrv-secu-user, rtrv-user**

Command Class: Basic

Parameters

This command has no parameters.

Example

```
canc-user
```

Dependencies

None

Notes

The **dact-echo** or **logout** commands can be used in place of **canc-user**.

chg-acg-mic**Change ACG Manually Initiated Control**

Use this command to change the values of ACG controls assigned to certain queries. The control can apply to all queries or to specific query services and called party digits. A particular control is selected to be changed by either specifying that it is the **type=all** control or specifying its service and digits.

Keyword: **chg-acg-mic**

Related Commands: **dlt-acg-mic, ent-acg-mic, rept-stat-lnp, rtrv-acg-mic**

Command Class: LNP Database Administration

Parameters**:aintvl=** (optional)

AIN interval index

Range: 1-15**Default:** The current value**:dgts=** (optional)

Digits

Range: 000-999, 000000-9999999999**:drtn=** (optional)

Duration index. The amount of time that the ACG is in effect. This number is mapped to a time value at the LNP node. Refer to the chapter on Automatic Call Gapping (AGC) configuration in the *LNP Feature Activation Guide* for a description of the use of the duration index.

Range: 1-13**Default:** The current value**:intvl=** (optional)

Interval index. The amount of time between ACGs. This number is mapped to a time value for the LNP node. Refer to the chapter on Automatic Call Gapping configuration in the *LNP Feature Activation Guide* for a description of the use of the gap interval index.

Range: 0-15**Default:** Current value**:nd=** (optional)

New number of digits

Range: 3, 6-10**Default:** The current value**:serv=** (optional)

Query service

Range: ain, in**:type=** (optional)

Type of control

Range: all, sd**Default:** sd**Example**

To change the **type=all** MIC to use 3 digits:

chg-acg-mic:type=all:nd=3

To change the MIC for AIN queries for 919-460-2132 to use an interval index of 15:

chg-acg-mic:serv=ain:dgts=9194602132:aintvl=15

To change the MIC for IN queries for 919-xxx-xxxx to use a duration index of 9 and an interval index of 5:

chg-acg-mic:serv=in:dgts=919:drtn=9:intvl=5

Dependencies

If the **type=all** parameter is specified, at least one optional parameter (**nd**, **drtn**, **intvl**, or **aintv**) must be specified.

If the **type=all** parameter is specified, optional parameters **serv** and **dgts** cannot be specified.

If the **type=sd** parameter is specified, optional parameters **serv** and **dgts** must be specified.

If the **type=sd** parameter is specified, optional parameter **nd** cannot be specified.

If the **serv=ain** parameter is specified, at least one optional parameter (**drtn** or **aintvl**) must be specified.

If the **serv=ain** parameter is specified, optional parameter **intvl** cannot be specified.

If the **serv=in** parameter is specified, at least one optional parameter (**drtn** or **intvl**) must be specified.

If the **serv=in** parameter is specified, optional parameter **aintvl** cannot be specified.

The **dgts** parameter value must be **3** or **6-10** digits.

The **nd** parameter value must be **3** or **6-10**.

The LNP feature must be turned on (see the **enable-ctrl-feat** command) before this command can be entered.

If the **type=all** parameter is specified, a MIC with **type=all** must exist.

If the **type=sd** parameter is specified, a MIC with the same service and digits must exist.

Notes

None

Output

chg-acg-mic:type=all:nd=31

```
rlghncxa03w 04-01-28 08:50:12 EST EAGLE 31.3.0
ACG MIC table is (11 of 256) 4% full of type SD
CHG-ACG-MIC: MASP A - COMPLTD
```

;

chg-acg-noc

Change ACG Node Overload Control

Use this command to change the definition of a node overload level. The definition is comprised of the threshold LNP query rates for node overload levels and the values for the automatic call gappings (ACG) to be sent when at the specified level.

Keyword: **chg-acg-noc**

Related Commands: **dlt-acg-noc**, **ent-acg-noc**, **rept-stat-lnp**, **rtrv-acg-noc**

Command Class: LNP Database Administration

Parameters

:lvl= (mandatory)

Overload level.

Range: 1–10

:and= (optional)

AIN number of digits. The number of digits in the global title address of an AIN query.

Range: 6, 10

Default: The current value

:drtn= (optional)

Duration index. The amount of time that the ACG is in effect. This number is mapped to a time value at the LNP node. Refer to the chapter on Automatic Call Gapping (ACG) configuration in the *LNP Feature Activation Guide* for a description of the use of the duration index.

Range: 1–13

Default: The current value

:ind= (optional)

IN number of digits. The number of digits in the global title address of an IN query.

Range: 6, 10

Default: The current value

:intvl= (optional)

Interval index. The amount of time between ACGs. This number is mapped to a time value for the LNP node. Refer to the chapter on Automatic Call Gapping configuration in the *LNP Feature Activation Guide* for a description of the use of the gap interval index.

Range: 0–15

Default: Current value

:qr= (optional)

Query rate. The number of LNP queries, which define a particular overload level, in a 30-second period.

Range: 1–2147483647

Default: The current value

Example

To change level 10's query rate and AIN number of digits:

```
chg-acg-noc:lvl=10:qr=900000:and=6
```

To change level 3's duration and interval indexes:

```
chg-acg-noc:lvl=3:drtn=7:intvl=3
```

Dependencies

At least one optional parameter must be specified.

Either **6** or **10** must be specified for the **and** and the **ind** parameters.

The ACG NOC table must be accessible.

The LNP feature must be turned on (see the **enable-ctrl-feat** command) before this command can be entered.

Notes

None

Output

```
chg-acg-noc:lvl=10:qr=900000:and=6
rlghncxa03w 03-02-28 08:50:12 EST EAGLE 28.1.0
CHG-ACG-NOC: MASP A - COMPLTD
;
```

chg-appl-rtkey

Change Static Routing Key Table Entries

Use this command to change static entries in the Routing Key table.

Keyword: chg-appl-rtkey

Related Commands: ent-appl-rtkey, dlt-appl-rtkey, rtrv-appl-rtkey

Command Class: Database Administration

Parameters

NOTE: See “Point Code Formats and Conversion” in Appendix A for a detailed description of point code formats, rules for specification, and examples.

:cice= (optional)

The end range of circuit identification codes assigned to the routing key. Specify **cice** along with **cics** to identify the routing key to be changed. Valid only if **si=4, 5, or 13** and required if **si=4, 5, or 13**.

Range: See Table A-4 in Appendix A for valid CIC values for specified SI and MSU types.

:cics= (optional)

The end range of circuit identification codes assigned to the routing key. Specify **cice** along with **cics** to identify the routing key to be changed. Valid only if **si=4, 5, or 13** and required if **si=4, 5, or 13**.

Range: See Table A-4 in Appendix A for valid CIC values for specified SI and MSU types.

:dpc/dpca/dpci/dpcn/dpcn24= (optional)

Destination point code.

:dpc= or **:dpca=** (optional)

ANSI destination point code with subfields *network indicator-network cluster-network cluster member (ni-nc-ncm)*.

Range: **000-255**

Specify a valid value for each subfield of the point code, and separate the subfields with a dash (-).

When **chg-sid:pctype=ansi** is specified, **ni = 000** is not valid.

When **chg-sid:pctype=ansi** is specified, **nc = 000** is not valid if **ni = 001-005**.

When **chg-sid:pctype=ansi** is specified, **nc = 000** is valid if **ni = 006-255**.
The point code **000-000-000** is not a valid point code.

:dpci= (optional)

ITU international destination point code with subfields *zone-area-id*. The *prefix* subfield indicates a spare point code (*prefix-zone-area-id*).

Range: **s-, 0-255**

Specify a valid value for each subfield of the point code, and separate the subfields with a dash (-).

prefix—s-

zone—0-7

area—000-255

id—0-7

The point code **0-000-0** is not a valid point code.

:dpcn= (optional)

ITU national destination point code in the format of a 5-digit number (*nnnnn*); or 2, 3, or 4 numbers (members) separated by dashes (*m1-m2-m3-m4*) as defined by the **chg-stpopts:npcfmti** flexible point code option. A group code must be specified when the ITUDUPPC feature is turned on (*nnnnn-gc*, *m1-m2-m3-m4-gc*). The *prefix* subfield indicates a spare point code (*prefix-nnnnn*, *prefix-nnnnn-gc*, *prefix-m1-m2-m3-m4*, *prefix-m1-m2-m3-m4-gc*).

Range: **s-, 0-16383, aa-zz**

Specify a valid value for each subfield of the point code, and separate the subfields with a dash (-).

prefix—s-

nnnnn—0-16383

gc—aa - zz

m1-m2-m3-m4—0-14 for each member; values must sum to 14

:dpcn24= (optional)

24-bit ITU national destination point code with subfields *main signaling area-sub signaling area-signaling point* (*msa-ssa-sp*).

Range: **000-255**

Specify a valid value for each subfield of the point code, and separate the subfields with a dash (-).

msa—000-255

ssa—000-255

sp—000-255

:nasname= (obsolete)

This parameter is obsolete.

:ncice= (optional)

The new end range of circuit identification codes assigned to the routing key. Specify **ncice** and/or **ncics** to change the range of the circuit identification codes assigned to the routing key. Valid only if **si=4, 5, or 13** and not valid with **split**.

Range: See Table A-4 in Appendix A for valid CIC values for specified SI and MSU types.

:ncics= (optional)

The new start range of circuit identification codes assigned to the routing key. Specify **ncics** and/or **ncice** to change the range of the circuit identification codes assigned to the routing key. Valid only if **si=4, 5, or 13** and not valid with **split**.

Range: See Table A-4 in Appendix A for valid CIC values for specified SI and MSU types.

:norm= (optional)

Normalization Enabled/Disabled. Used to enable/disable the normalization process for MSUs using the routing key. Not valid with **ncics, ncice, split**.

Range: **yes, no**

If **norm=yes, pstncat** and **pstnid** must be set to values supported by the Secure Gateway.

Default: Current value in the database

:nsname= (obsolete)

This parameter is obsolete.

:opc/opca/opci/opcn/opcn24= (optional)

Originating point code. Valid only if **si=4, 5, or 13** and required if **si=4, 5, or 13**.

:opc= or :opca= (optional)

ANSI originating point code with subfields *network indicator-network cluster-network cluster member* (*ni-nc-ncm*).

Range: **000-255**

Specify a valid value for each subfield of the point code, and separate the subfields with a dash (-).

When **chg-sid:pctype=ansi** is specified, *ni = 000* is not valid.

When **chg-sid:pctype=ansi** is specified, *nc = 000* is not valid if *ni = 001-005*.

When **chg-sid:pctype=ansi** is specified, *nc = 000* is valid if *ni = 006-255*.

The point code **000-000-000** is not a valid point code.

:opci= (optional)

ITU international originating point code with subfields *zone-area-id*. The *prefix* subfield indicates a spare point code (*prefix-zone-area-id*).

Range: **s-, 0-255**

Specify a valid value for each subfield of the point code, and separate the subfields with a dash (-).

prefix—s-

zone—0-7

area—000-255

id—0-7

The point code **0-000-0** is not a valid point code.

:opcn= (optional)

ITU national originating point code in the format of a 5-digit number (*nnnnn*); or 2, 3, or 4 numbers (members) separated by dashes (*m1-m2-m3-m4*) as defined by the **chg-stpopts:npcfnti** flexible point code option. A group code must be specified when the ITUDUPPC feature is turned on (*nnnnn-gc, m1-m2-m3-m4-gc*). The *prefix* subfield indicates a spare point code (*prefix-nnnnn, prefix-nnnnn-gc, prefix-m1-m2-m3-m4, prefix-m1-m2-m3-m4-gc*).

Range: **s-**, **0-16383**, **aa-zz**
Specify a valid value for each subfield of the point code, and separate the subfields with a dash (-).

prefix—**s-**

nnnnn—**0-16383**

gc—**aa - zz**

m1-m2-m3-m4—**0-14** for each member; values must sum to 14

:opcn24= (optional)

24-bit ITU national originating point code with subfields *main signaling area-sub signaling area-signaling point* (*msa-ssa-sp*).

Range: **000-255**

Specify a valid value for each subfield of the point code, and separate the subfields with a dash (-).

msa—**000-255**

ssa—**000-255**

sp—**000-255**

:pstncat= (optional)

Public Switched Telephone Network (PSTN) Category assigned to the routing key. Not valid with **ncics**, **ncice**, **split**.

Range: **0-65535**

Default: Current value in the database

:pstnid= (optional)

Public Switched Telephone Network (PSTN) ID assigned to the routing key. Not valid with **ncics**, **ncice**, **split**.

Range: **0-65535**

Default: Current value in the database

:rcontext= (optional)

Routing Context. The routing context parameter can be used to assign a new routing context to the routing key or to change the existing routing context of the routing key. The routing context uniquely identifies the routing key.

- Routing context is mandatory for routing keys associated with SUA Application Servers.
- Routing context is optional for routing keys associated with M3UA Application Servers.
- Routing context is invalid for routing keys associated with TALI connections.

An AS can be associated with only 1 routing key with routing context. An AS can be associated with multiple routing keys that do not contain routing context. An AS cannot be simultaneously assigned to a routing key with routing contexts and to routing keys without routing contexts.

The **pstncat**, **pstnid**, and **norm** parameters cannot be specified when the **rcontext** parameter is specified.

Split and resize operations are invalid for routing keys with routing context. The **split**, **ncics**, and **ncics** parameter cannot be specified with the **rcontext** parameter in this command.

Range: 0-4294967295

:si= (optional)

The service indicator.

Range: 0-15 or equivalent text values:

Number = Text—Description

0 = snm—Signaling network management messages

1 = regtest—Signaling network testing and maintenance regular

2 = spltest—Signaling network testing and maintenance special

3 = sccp—SCCP

4 = tup—Telephone user part

5 = isup—ISDN user part

13 = qbicc

See Table A-4 in Appendix A and Table 5-8 on page 5-68 for valid **si** values in combination with other parameters.

:split= (optional)

The CIC value where the routing key with the specified CICS and CICE range will be split. The specified routing key is split into two entries with adjacent CIC ranges.

The existing routing key retains the range of CICs that is lower than the **split** value. The value of **split -1** is used as the end range for this entry. The range of CICs assigned to the original entry is the values of **cics** to **split -1**.

A new routing key entry is created with the high end of the original range. The **split** value is used as the start of the CIC range for this entry. The range of CICs assigned to the new entry is the values of **split** to **cice**.

This parameter is valid only if **si=4, 5, or 13** and not valid with **ncics** or **ncice**. See Table A-4 in Appendix A and Table 5-8 on page 5-68.

Range: 0-16363

:ssn= (optional)

The subsystem number. Valid only if **si=3** and required if **si=3**.

Range: 0-255

:type= (optional)

The type of routing key.

Range: full, partial, default

Default: full

Example

chg-appl-rtkey:dpc=123-230-245:si=5:opc=123-230-244:cics=1:cice=100:split=50

chg-appl-rtkey:dpc=123-230-245:si=5:opc=123-230-244:cics=1:cice=50:ncice=100

chg-appl-rtkey:dpcn24=10-100-10:si=5:opc=10-100-11:cics=1:cice=100:ncice=200

chg-appl-rtkey:dpc=8-8-8:si=3:ssn=5:rcontext=500

Dependencies

Optional parameters that must be specified with the **chg-appl-rtkey** command depend on the type of routing key being changed. See Table 5-8 on page 5-68 for valid parameter combinations.

The **srkq** parameter value in the **chg-sg-opts** command limits the maximum number of static routing keys that can be provisioned using the **ent-appl-rtkey** command.

- For **ss7ipgw** and **ipgwi** applications running on dual-slot DCM cards (870-1945-xx), there is a limit of 1000 routing keys in the system. The **chg-sg-opts** command will not allow the **srkq** parameter to be set to a value greater than 1000.
- For **ss7ipgw** and **ipgwi** applications running on SSED CM cards (870-2732-xx), there is a limit of 2500 routing keys in the system. See the **chg-sg-opts** command for parameter values that allow 2500 routing keys to be defined in the system.

The subsystem number must be specified, and is valid only when **si** is equal to **3** (or **sccp**); when **si** does not equal **3** (or **sccp**), **ssn** must not be specified.

The **pstnid**, **pstncat**, and **norm** parameters are not valid for 24-bit ITU-N point codes.

The value entered for the starting circuit identification code (**cics**) must be less than or equal to the value entered for the ending circuit identification code (**cice**).

The value entered for the new starting circuit identification code (**ncics**) must be less than or equal to the value entered for the new ending circuit identification code (**ncice**).

A circuit identification code range (**cics** to **cice**) cannot be specified that overlaps an existing routing key.

When **si=4, 5, or 13** (or **tup, isup, or qbicc**), the **opc**, **cics**, and **cice** parameters are required. The **opc**, **cics**, and **cice** parameters can be specified only if **si=4, 5, or 13**.

The value entered for the circuit identification code split range (**split**) must be greater than the value entered for the starting circuit identification code (**cics**) and less than or equal to the value entered for the ending circuit identification code (**cice**).

The value entered for the new starting circuit identification code (**ncics**) must be less than or equal to the value entered for the ending circuit identification code (**cice**) when the new ending circuit identification code (**ncice**) is not specified.

The value entered for the new ending circuit identification code (**ncice**) must be greater than or equal to the value entered for the starting circuit identification code (**cics**) when the new starting circuit identification code (**ncics**) is not specified.

The **split**, **ncics**, and **ncice** parameters are not allowed with the **si** parameter unless **si=4, 5, or 13** (or **tup, isup, or qbicc**).

TALI sockets cannot be specified for IPGWI cards when the Spare Point Code Support Feature is enabled.

The spare point code prefix (**s-**) cannot be specified for TALI connections.

A DPC/SI routing key must be specified when the DPC is ANSI and **si=4** (TUP is used only in an ITU network).

Table A-4 in Appendix A shows valid CIC values for SI types **4, 5, and 13**.

Partial point codes are not allowed; no asterisks can be specified in the point codes in the command.

Mixed point code types are not allowed; **opc** and **dpc** types must match.

When **type=partial** or **type=default**, attributes must be specified.

When **type=partial** or **type=default**, **split** and **resize** are not supported.

When **type=full**, **dpc** and **si** must be specified.

The parameter value **pstncat=0** requires the parameter value **pstnid=0**.

The parameter value **pstncat=1** requires ITU-I or ITU-N point code.

The following types of partial routing keys are supported:

- DPC-SI-OPC (ignore CIC) can be used as a partial match key for CIC- based traffic.
- DPC-SI (ignore all other fields) can be used as a partial match key for CIC- based traffic or SCCP traffic.
- DPC only (ignore all other fields) can be used as a partial match for any type of traffic.
- SI only (ignore all other fields) can be used as a partial match for any type of traffic.

When a default routing key is specified, only the attributes parameters **pstnid**, **pstncat**, and **norm** are allowed.

The **split**, **ncics**, **ncice**, **pstncat**, **pstnid**, **norm** parameters cannot be specified together with the **rcontext** parameter in the command.

The **rcontext** parameter must be specified for routing keys that are associated with SUA Application Servers.

The specified **rcontext** parameter value must already exist in the database.

If specified, the service indicator parameter must be **si=3** for routing keys that are associated with SUA Application Servers.

An AS cannot be simultaneously assigned to a routing key with routing contexts and routing keys without routing context.

To assign an M3UA or SUA association to multiple routing keys with routing context, the M3UA/SUA association must be assigned to multiple AS's, and then each AS must be assigned to a routing key with routing context.

The AS name and parameters specified for a routing key must use an address format that is valid for the adapter type assigned to the AS.

Table 5-6. Valid Parameter Combinations for Routing Key Types using the **chg-appl-rtkey** command.

Action	dpc	si	ssn	opc	cics	cice	ncics	ncice	split	type
Split CIC Range	X	X		X	X	X			X	full
Re-size CIC Range	X	X		X	X	X	X	X		full
Socket Name Override (SI=ISUP or 5)	X	X		X	X	X				full
Socket Name Override (SI = SCCP or 3)	X	X	X							full

Table 5-6. Valid Parameter Combinations for Routing Key Types using the **chg-appl-rtkey** command. (Continued)

Action	dpc	si	ssn	opc	cics	cice	ncics	ncice	split	type
Socket Name Override (SI = not 3, 4, 5, or 13)	X	X								full
Socket Name Override (SI = 4, 5, or 13)	X	X		X						partial
Socket Name Override (SI = 3, 4, 5 or 13)	X	X								partial
Socket Name Override SI-only key		X								partial
Socket Name Override DPC-only key	X									partial
Socket Name Override Default key										default

Notes

A routing key entry associates a routing key with a socket name or Application Server (AS) name.

The parameters **dpc**, **si**, **ssn**, **opc**, **cics**, and **cice** are used to identify the routing key to be changed.

The parameters **split**, **ncics**, and **ncice** are used to specify new values for the routing key.

The **opc**, **cics**, and **cice** parameters are not required for partial routing keys.

The **cics**, **cice**, **ncice**, **ncice**, and **split** parameters are valid and required when **si=4** and ITU DPCs (**dpci**, **dpcn**) are specified. These parameters are not valid when an ANSI DPC (**dpc**, **dpca**) is specified and **si=4**.

The parameters **pstncat**, **pstnid**, and **norm** are routing key attributes. These attributes are not used to uniquely identify routing keys. The **pstncat** and **pstnid** parameter values convey PSTN format information to IP devices and are also used to control the normalization process when **norm=yes**. Table 5-7 describes the PSTN Category and ID combinations.

Table 5-7. PSTN Categories and Associated PSTN IDs

PSTN Category	PSTN Category Description	PSTN ID	PSTN ID Description
0	Unknown	0	Unknown
1	Defines PSTN formats for which the Tekelec EAGLE 5 SAS provides ISUP Normalization function	0	Unknown
		1	ITU Q.767
		2	ETSI V3
		3	UK PNO-ISC7
		4	GERMAN ISUP
2 - 4095	Reserved for future definition by Tekelec	None	None
4096-65535	Available for user definition	0-65535	User-defined PSTN IDs

The values **0** and **4096-65535** are always valid for the **pstncat** parameter when **norm=no**.

Use the **rtvr-pstn-pres** command to display allowed values for the **pstncat** and **pstnid** parameters.

The parameter value **pstncat=1** may be used only with keys that specify ITU-N or ITU-I point codes. PSTN IDs used with **pstncat=1** must meet specific **si** value criteria shown in Table 5-8.

The parameter value **norm=yes** can be entered if **pstncat=1** and the **pstnid** parameter value is indicated by "*" in Table 5-8.

Table 5-8. Routing Keys and Supported PSTN Categories and PSTN IDs for PSTN Category 1

Routing Key Entry Type	SI	PC Type	norm= yes is valid	pstnid for pstncat = 1			
				1=ITU Q.767	2=ETSI V3	3=UK PNO-I SC7	4= GERMAN ISUP
Full-CIC and Partial DPC/OPC/SI	5 4 or 13	ANSI					
		ITU-I/N	*	*	*	*	*
Full-SCCP	3		ALL				
Full-DPC/SI	All valid	ALL					
Partial DPC/SI	5	ANSI					
		ITU-I/N	*	*	*	*	*
	Other than 5						
Partial DPC	N/A	ALL					
Partial SI	ALL	N/A					
Default	N/A	N/A					

The following changes can be made for routing keys. Only one of these changes is allowed per command.

- A routing key can be split into two entries with adjacent CIC ranges. The resulting entries retain the socket associations of the original entry.
- The range of CICs assigned to a routing key can be changed as long as it does not overlap another routing key. The new entry retains the socket associations of the original entry.
- Routing key attributes **pstncat**, **pstnid**, and **norm** can be changed. These values replace the current attribute values for the routing key.

Group codes are required for ITU-N point codes (DPCN/OPCN) when the Duplicate Point Code feature is turned on.

Routing context is a routing key parameter that uniquely identifies routing keys. Routing context is mandatory for routing keys associated with SUA Application Servers, optional for routing keys associated with M3UA Application Servers, and invalid for routing keys associated with TALI connections.

An AS cannot be simultaneously assigned to a routing key with routing contexts and routing keys without routing contexts.

In this command, only ITU-international and ITU national point codes support the spare point code subtype prefix (s-).

Output

```
chg-appl-rtkey:dpc=123-230-245:si=3:ssn=250:nsname=socket5
```

```
r1ghncxa03w 04-01-28 08:50:12 EST EAGLE 31.3.0
CHG-APPL-RTKEY: MASP A - COMPLTD
;
```

chg-appl-sock

Change Application Socket

Use this command for the IPLIM, IPLIMI, SS7IPGW, or IPGWI application to configure the Socket table which is used to associate the local host/local port to a remote host/remote port.

Keyword: **chg-appl-sock**

Related Commands: **rtrv-appl-sock**, **dlt-appl-sock**, **ent-appl-sock**

Command Class: Database Administration

Parameters

:sname= (mandatory)

Name of socket. The routing key table and maintenance commands use these names to reference individual sockets.

Range: Up to 15 alphanumeric characters; the first character must be a letter

:alw= (optional)

Tells the connection manager whether to allow or disallow the socket to carry SS7 traffic.

Range: **yes, no**
yes—The connection manager is allowed to carry SS7 traffic.
no—The connection manager is to prohibit the socket from carrying SS7 traffic.

Default: No change to current value

:dcmps= (optional)
The parameter set that will be used by this socket.

Range: **1-10**

Default: No change to current value

:lhost= (optional)
Local host name. The logical name assigned to the local host device.

Range: **a-z, A-Z, 0-9, -, .** (any string of characters beginning with a letter and comprising up to 60 characters in length).

Default: Current value

:lport= (optional)
The TCP port number for the local host.

Range: **1024-65535**

Default: Current value
System Default: **0**

:open= (optional)
Socket state. Whether this socket should be open/connected to far end.

Range: **yes, no**
yes—The connection manager is to open the socket if the socket is operational
no—The connection manager will not open the socket

:port= or :link= (optional)
The signaling **link** associated with this socket.

Range: **a, b, a1, b1, a2, b2, a3, b3**
Not all card types support all **link** parameter values.
See Table A-1 in Appendix A for valid **link** parameter range values for each type of card that can have assigned signaling links.

Default: Current value.

:remit= (optional)
Retransmission Mode. This parameter tells the connection whether to use the Standard Berkeley Sockets Distribution (BSD) Retransmission Policy, the FIXED Tekelec Aggressive Transmission Policy (a fixed interval between each retransmission), or a combination of the two (MOD—a fixed interval between each retransmission and the fixed interval is doubled after each third retry), if packet loss is detected on the socket.

Range: **bsd, fixed, mod**

Default: No change to current value
System Default: **fixed**

:rhost= (optional)
Remote host name. The logical name assigned to the remote host device.

Range: a–z, A–Z, 0–9, -, . (any string of characters beginning with a letter and comprising up to 60 characters in length).

Default: Current value

:rport= (optional)

The TCP port number of the remote host.

Range: 1024–65535

Default: Current value

System Default: 0

:rtt= (optional)

Round Trip Time. This parameter tells the connection manager the expected time (in milliseconds) in which a message on this socket is sent to the remote host and an acknowledgment is received back at the local host. If the RTT is entered, the Retransmission Mode cannot be set to BSD.

Range: 1–750

Default: No change to current value

System Default: 60

:server= (optional)

Defines the role of the local socket in the client/server relationship.

Range: yes, no

yes—Local side is the server

no—Local side is the client

Default: No change to current value

Example

```
chg-appl-sock:sname=socket1:lhost=gw105.nc.tekelec.com:lport=1030:server=yes
:rhost=gw100.nc.tekelec.com:rport=1030:open=yes:alw=yes:dcmps=10
```

Dependencies

At least one optional parameter must be specified.

The **link** parameter is used to associate a socket with a signaling link.

- Only link **a** is valid on cards that execute the **ss7ipgw** or **ipgwi** application.
- Links **a** and **b** are valid on dual-slot DCM cards or SSEDCCM cards that execute the **iplim** or **iplimi** application and support 2 point-to-point links.
- Links **a**, **b**, **a1**, **b1**, **a2**, **b2**, **a3**, and **b3** are valid only on SSEDCCM cards that execute the **iplim** or **iplimi** application and support 8 point-to-point links.

The allowed maximum is 2 sockets per local host on DCM or SSEDCCM IPLIMx cards that support 2 point-to-point links, and 8 sockets per local host on SSEDCCM IPLIMx cards that support 8 point-to-point links. (IPLIMx refers to cards that execute the **iplim** or **iplimi** application).

To assign a socket on an IPLIMx card for a local host, the linkset associated with the signaling link must contain only links with the **ent-slk** parameter **ipliml2** set to **saaltali**.

The allowed maximum is 1 socket per signaling link on IPLIMx cards.

There is a maximum of 50 connections (association-to-AS assignments + sockets) per Local Host on IPGWx cards.

A maximum of 4000 connections (association-to-AS assignments + sockets) are allowed per system.

IPGWI sockets cannot be defined when the Spare Point Code Support Feature is enabled.

The **sname** parameter value must exist in the IPAPSOCK table.

The specified local host name (**lhost**) must exist in the IP Host table.

The local host name (**lhost**) must be provisioned in the IP Host table as local to this EAGLE 5 SAS.

The **rhost** value must exist in the IP Host table.

The **open** parameter must be set to **no** before the **server**, **lhost**, **lport**, **rhost**, **link**, **rexmit**, **rtt**, and **rport** parameters can be specified.

Socket connection parameters (**lhost**, **lport**, **rhost**, **rport**) must be unique for each socket name (**sname**).

To change the value of the **open=yes** parameter, the values must be specified for all parameters that are required to fully specify the connection (**server**, **lhost**, **lport**, **rhost**, and **rport**).

If the socket is a client and **open=yes** is specified, the socket's **lhost** / **lport** configuration must not match that of any other open socket.

If the socket is a server and **open=yes** is specified, the socket's **lhost** / **lport** configuration must not match that of any other open client socket.

Before **open=yes** can be specified for a socket, the local host must have a signaling link assigned to its associated signaling link port.

When **rexmit=bsd**, **rtt** cannot be specified.

When **rexmit=fixed** or **rexmit=mod**, **rtt** must be specified.

Before the local host IP address can be changed, the new local host must have a signaling link assigned to its associated signaling link port.

Notes

The command input is limited to 150 characters.

The total number of sockets and SCTP associations provisioned for **iplim** and **iplimi** applications is limited to 2 on non-SSEDCM cards, and when any SCTP associations are provisioned for the card.

Output

```
chg-appl-sock:sname=socket1:lhost=gw105.nc.tekelec.com:lport=1030:server=yes
:rhost=gw100.nc.tekelec.com:rport=1030:open=yes:alw=yes:dcmps=10
```

```
rlghncxa03w 04-01-07 15:35:05 EST EAGLE 31.3.0
CHG-APPL-SOCK: MASP A - COMPLTD
```

```
;
```

chg-as**Change Application Server**

Use this command to change the characteristics of an existing Application Server (AS).

Keyword: **chg-as**

Related Commands: **dlt-as, ent-as, rept-stat-as, rtrv-as**

Command Class: Database Administration

Parameters

:asname= (mandatory)

Application Server (AS) name in the AS table.

Range: Up to 15 alphanumeric characters; the first character must be a letter

:mode= (optional)

The traffic mode assigned to this AS.

Range: **loadshare, override**

override is not valid for SUA associations bound to the AS.

Default: No change from current value in AS

System Default: **loadshare**

:tr= (optional)

The recovery timer value for this AS, in milliseconds.

Range: **10 - 2000**

Default: No change from current value in AS

System Default: **200 ms**

Example

```
chg-as:asname=asx:mode=override
```

Dependencies

The AS name (**asname**) must already exist in the AS table.

Association connection parameters must be unique.

The connection state for all associations bound to the AS must be **open=no** to change the **mode** parameter.

The override traffic mode is not supported for SUA associations.

Notes

By default the AS recovery timer value is set to 200 ms when an AS is entered. This value can be changed at any time using the **chg-as** command. The new timer value will be used the next time the AS enters the AS-Pending state.

Output

```
chg-as:asname=asx:mode=override
```

```
rlghncxa03w 04-01-17 15:35:05 EST EAGLE 31.3.0
CHG-AS: MASP A - COMPLTD
```

```
;
```

chg-asp**Change Application Server Process**

NOTE: This command is obsolete.

Use this command to change the UA parameter set that an Application Server Process (ASP) uses for various SNM message and notification response options. UA parameter sets are valid only for M3UA associations.

For additional information, see PR36303, Feature 48571 - M3UA RFC enhancements, and FD005046.doc, rev 1, March 2000

Keyword: chg-asp

Related Commands: dlt-asp, ent-asp, rtrv-asp

Command Class: Database Administration

Parameters

:aspname= (mandatory)

Application Server Process (ASP) name.

Range: Up to 15 alphanumeric characters; the first character must be a letter.

:uaps= (mandatory)

UA parameter set.

Range: 1-10

Default: 10

Example

```
chg-asp:aspname=asp1:uaps=1
```

Dependencies

The ASP must already be defined.

For the associations assigned to the ASP, the association adapter layer type must be **m3ua**.

The associations assigned to the ASP must be set to **open=no** before the UAPS can be changed.

Notes

None

Output

```
chg-asp:aspname=asp1:uaps=1
```

```
rlghncxa03w 03-02-17 15:35:05 EST EAGLE 30.0.0
rlghncxa03w 04-09-17 15:35:05 EST EAGLE 31.10.0
CHG-ASP: MASP A - COMPLTD
```

```
;
```

chg-assoc**Change Association**

Use this command to configure existing SCTP associations in the IPAPSOCK table.

Keyword: **chg-assoc**

Related Commands: **dlt-assoc, ent-assoc, rept-stat-assoc, rtrv-assoc**

Command Class: Database Administration

Parameters

:aname= (mandatory)

Name assigned to this association (in IPAPSOCK table).

Range: Up to 15 alphanumeric characters; the first character must be a letter

:adapter= (optional)

The adapter layer for this association.

Range: **m3ua, sua, m2pa**

Default: Current value

System Default: **m3ua**

:alhost= (optional)

Name of alternate local host. When specified, this parameter configures the SCTP association as a multi-homed endpoint.

Range: **a-z, A-Z, 0-9, -, .**—any string of characters beginning with a letter and comprising up to 60 characters in length

none—the **alhost** is not configured; the SCTP association is configured as a uni-homed endpoint

:alw= (optional)

Indicates to the connection manager whether to allow or disallow the association to carry SS7 traffic.

Range: **yes, no**

yes—The connection manager is to allow the association to carry SS7 traffic.

no—The connection manager is to prohibit the association from carrying SS7 traffic.

Default: No change in current value

System Default: **no**

:cwmn= (optional)

Minimum congestion window. The minimum size in bytes of the association's congestion window and the initial size in bytes of the congestion window.

Range: **1500-196608**

Default: No change in current value

System Default: **3000**

:istrms= (optional)

SCTP Inbound Stream Value. A 16-bit unsigned integer that defines the number of streams the sender allows the peer end to create in this association.

Range: 1, 2

Default: No change in current value

System Default: 2

:lhost= (optional)

The Local Host name as defined in the IP Host table.

Range: a-z, A-Z, 0-9, -, . (any string of characters beginning with a letter and comprising up to 60 characters in length)

Default: No change in current value.

:lport= (optional)

The SCTP port number for the Local Host.

Range: 1024-65535

Default: Current value.

:m2patset= (optional)

The M2PA timer set assigned to this association.

Range: 1-20

Default: 1

:open= (optional)

Connection state (open or closed) that the connection manager is to put the association in when the socket is operational.

Range: yes, no

yes—The connection manager is to open the association if the association is operational.

no—The connection manager will not open the association.

Default: No change in current value

System Default: no

:ostrms= (optional)

SCTP Outbound Stream Value. A 16-bit unsigned integer that defines the number of streams the sender wants to create in this association.

Range: 1, 2

Default: No change in current value

System Default: 2

:port= or :link= (optional)

The signaling link that will be used by this association.

Range: a, b, a1, b1, a2, b2, a3, b3

Not all card types support all **link** parameter values.

See Table A-1 in Appendix A for valid **link** parameter range values for each type of card that can have assigned signaling links.

Default: Current value.

:rhost= (optional)

Name of Remote Host as defined in the IP Host table.

Range: a-z, A-Z, 0-9, -, . (any string of characters beginning with a letter and comprising up to 60 characters in length)

Default: Current value.

:rmax= (optional)

Maximum retransmission timeout. The maximum value of the calculated retransmission timeout in milliseconds.

Range: 10-1000

Default: No change in current value
System Default: **800**

:rmin= (optional)

Minimum retransmission timeout. The minimum value of the calculated retransmission timeout in milliseconds.

Range: 10-1000

Default: No change in current value
System Default: **120**

:rmode= (optional)

Retransmission mode. The retransmission policy used when packet loss is detected.

Range: lin, rfc

lin—The Tekelec Linear Retransmission Policy where each retransmission timeout value is the same as the initial transmission timeout, and only the slow start algorithm is used for congestion control.

rfc—Standard RFC 2960 algorithm in the retransmission delay doubles after each retransmission. The RFC 2960 standard for congestion control is also used.

Default: No change in current value
System Default: **lin**

:rport= (optional)

The SCTP port number for the Remote Host.

Range: 1024-65535

Default: Current value.

:rtimes= (optional)

Maximum retransmission retries The number of times a data retransmission will occur before closing the association.

Range: 3-12

Default: No change in current value.
System Default: **10**

:uaps (optional)

Specifies the User Adapter Parameter Set used by the M3UA or SUA association for various SNM message and notification response options.

Range: 1-10

:ver= (optional)

The M2PA version supported by this association.

Range: d6, rfc

Default: No change in current value.

System Default: rfc

Example

```
chg-assoc:aname=a1:lhost=gw105.nc.tekelec.com:lport=1030
:rhost=gw100.nc.tekelec.com:rport=1030:open=yes:alw=yes:uaps=10
```

Dependencies

At least one optional parameter must be specified.

The association name (:**aname**) must already exist in the IP Socket/Association (IPASOCK) table.

An association's connection parameters (**lhost**, **rhost**, **lport**, **rport**) must be unique.

The connection state must be **open=no** to change **lhost**, **rhost**, **lport**, **rport**, **port**, **alhost**, **adapter**, **m2patset**, **ver**, **istrms**, **ostrms**, **rmode**, **rmin**, **rmax**, **rtime**s, and **cwmin** parameters.

To change the value of the **open** parameter to **yes**, the values must be specified for all parameters that are required to fully specify the connection (**lhost**, **lport**, **rhost**, and **rport**). Changing the value to **open=no** requires only the **aname** parameter and at least one other optional parameter.

The value of the **uaps** parameter can be changed for an association if the value of the **open** parameter is set to **yes**.

The host name specified by the **lhost** parameter must exist in the IP Host table and must be provisioned as local to this EAGLE 5 SAS.

The hostnames specified in the **lhost** and **alhost** parameters must refer to different IP addresses.

The hostnames specified in the **lhost** and **alhost** parameters must refer to IP addresses on the same IP card.

An association with **adapter=sua** or **m3ua** cannot be specified for an **lhost** on a card running the **iplim** or **iplimi** application.

Before **open=yes** can be specified for an association, the local host must have a signaling link assigned to its associated signaling link port.

An association's **lhost** and **alhost** cannot be assigned to a card's Ethernet interface B.

The adapter layer cannot be changed for an association that is already associated with an Application Server (AS).

Before the local host can be changed, the new local host must have a signaling link assigned to its associated signaling link port.

Only **port=a** can be specified if the card is running the **ss7ipgw** or **ipgwi** application.

Only **port=a** or **port=b** can be specified for the **port** parameter value if the card is a dual-slot DCM card running the **iplim** or **iplimi** application.

The **port** parameter values **a**, **b**, **a1**, **b1**, **a2**, **b2**, **a3**, and **b3** can be specified only if the card is an SSEDCCM card running the **iplim** or **iplimi** application.

The card location for the card associated with the **lhost** and **alhost** must exist in the IP Link table.

The allowed maximum is 1 association per signaling link on IPLIMx cards.

There is a maximum of 50 connections (association-to-AS assignments + sockets) per Local Host on IPGWx cards.

A maximum of 4000 connections (association-to-AS assignments + sockets) are allowed per system.

Table 5-9 shows the maximum IP connections per DCM card.

Table 5-9. Maximum IP Connections per Card

Type	Cards Per System	Links Per Card	IP Connections Per Link	Total Connections
IPLIMx	100	8	1	800
IPGWx	64	1	50	3200
System				4000

The **rmin** parameter value must be less than or equal to the **rmax** parameter value.

The **cwmin** parameter value must be less than or equal to 16384 for IPGW associations.

To assign an association on an IPLIMx card for a local host, the association must have an adapter parameter value that is the same as the **ipliml2** setting of its assigned signaling link. An association having an adapter value of **m2pa** must be assigned to an IPLIM signaling link having an **ipliml2** value of **m2pa**.

If the **m2patset** parameter is specified, the **adapter** parameter value must be **m2pa**.

The trade ratio states the quantity of associations to sockets that may be provisioned on a certain card, as follows:

$$\text{Trade Ratio} = a:s$$

Where: a=associations and s=sockets

The M2PA version is only valid for associations with adapter type **m2pa**.

The M2PA version is supported if the application is IPLIMx and the **adapter** parameter value equals **m2pa**. Allowed values are M2PA Draft 6 (**d6**) and M2PA RFC (**rfc**). When changing association adapter type to **m2pa**, if the version is not specified, the default version **rfc** is assigned.

The **open** parameter must be set to **no** before changes can be made to the M2PA version.

Notes

The command that is entered cannot exceed a total of 150 characters in length.

The IPAPSOCK table is used to associate the Local Host/Local Port to a Remote Host/Remote Port. This fully specifies the connection.

If the **open** parameter value is changed to **yes**, the association's **lhost** and **lport** configuration must not match that of any open association.

If the card's application is **iplim** or **iplimi**,

- The **adapter** parameter value must equal **m2pa**.
- The **ipliml2** value for the assigned signaling link must equal **m2pa**.

If the entered **lhost** or **alhost** corresponds to an IP address associated with the card's B Ethernet Interface hosted by a present non-EDCM card, an error will be generated. If the entered **lhost** or **alhost** corresponds to an IP address associated with the card's B Ethernet Interface hosted by a provisioned but not present DCM card, the card will be auto-inhibited upon card insertion.

An association with an **adapter** value of **m2pa** cannot be assigned to an SS7IPGW or IPGWI host.

Output

```
chg-assoc:aname=a1:lhost=gw105.nc.tekelec.com:lport=1030:rport=1030:uaps=10
:rhost=gw100.nc.tekelec.com:open=yes:alw=yes
    rlgncxa03w 04-01-17 15:35:05 EST  EAGLE 31.3.0
    CHG-ASSOC: MASP A - COMPLTD
;
```

chg-atm-lps

Change ATM Link Parameter Set

Use this command to configure a link parameter set with timers and other parameters used by the system to provide level 2 functions for each ATM high-speed signaling link.

Use this command also to copy values from **lpset 20** and **30**, as well as any **lpset** to another. The **action=copy** and **srclpset=x** parameters provide this capability.

Keyword: **chg-atm-lps**

Related Commands: **ent-slk**, **rtrv-atm-lps**

Command Class: Database Administration

Parameters

NOTE: Unless specified, the system default values are meant for both ANSI (T1) and ITU (E1) standards.

:lpset= (mandatory)

The link parameter set being changed. Sets **1** through **19** and **21** through **29** can be configured by the user. Link parameter sets **20** and **30** are not configurable, but are used to contain the recommended default values for a set.

Range: **1-19, 21-29**

Default: **1** for ANSI ATM linksets
21 for ITU ATM linksets

:action= (optional)

Use this parameter to copy a set of ATM signaling link parameters from one set to another.

Range: **copy**

Default: No change to the current value

:maxcc= (optional)

The maximum number of transmissions of BGN, END, ER, or RS PDU.

Range: 1–10 PDUs

Default: 4

:maxnrp= (optional)

The maximum number of retransmitted PDUs during proving.

Range: 0–10 PDUs

Default: 1 PDU for ANSI, 0 for ITU

:maxpd= (optional)

The maximum number of SD PDUs that can be sent before a POLL is sent.

Range: 5–2120 PDUs

Default: 500

:maxstat= (optional)

The maximum number of list elements in a STAT PDU.

Range: 3–67 PDUs

Default: 67

:n1= (optional)

The number of PDUs sent during proving.

Range: 500–64552 PDUs

Default: 64552 PDUs for ANSI
1000 PDUs for ITU

:nblk= (optional)

The number of monitoring intervals per block.

Range: 1–10

Default: 3

:srclpset= (optional)

The source **lpset** for a **copy** action. This parameter can be specified only with the **action=copy** parameter.

Range: 1–30

:tmrcc= (optional)

The timer, in milliseconds, used during the connection phase to guard against unacknowledged BGN, END, ER or RS PDUs.

Range: 100–2000 milliseconds

Default: 200 milliseconds

:tmrerm= (optional)

The error rate monitor interval, in milliseconds.

Range: 25–500 milliseconds

Default: 100 milliseconds

:tmridle= (optional)

The timer, in milliseconds, used during the idle phase when no SD PDUs are being sent to limit time in the idle phase.

Range: 25–1000 milliseconds

Default: 100 milliseconds

:tmrkalive= (optional)

The timer, in milliseconds, used during the transient phase when no SD PDUs are being sent to keep connection up.

Range: 25–500 milliseconds

Default: 100 milliseconds

:tmrnocred= (optional)

The timer, in milliseconds, used when the no credit exists and PDUs are available to be sent.

Range: 1000–6000 milliseconds

Default: 1500 milliseconds

:tmrnorsp= (optional)

The timer, in milliseconds, used to check that STAT PDUs are arriving often enough.

Range: 500–2000 milliseconds

Default: 1500 milliseconds

:tmrpoll= (optional)

The timer, in milliseconds, used to guarantee that POLL PDUs are sent often enough.

Range: 25–500 milliseconds

Default: 100 milliseconds

:tmrprov= (optional)

The timer, in milliseconds, used to monitor the status of a link after it is placed into service.

Range: 60000–120000 milliseconds

Default: 60000 milliseconds

:tmrsrec= (optional)

The timer, in milliseconds, used to prohibit closely spaced SSCOP recoveries from occurring.

Range: 60000–10800000 milliseconds

Default: 3600000 milliseconds

:tmrt1= (optional)

The time, in milliseconds, between link release action and the next link reestablish action during alignment.

Range: 1000–15000 milliseconds

Default: 5000 milliseconds

:tmrt2= (optional)

The total time, in milliseconds, that SSCF will attempt alignment.

Range: 15000–180000 milliseconds

Default: 120000 milliseconds for ANSI
30000 milliseconds for ITU (E1)

:tmrt3= (optional)

The time, in microseconds, between proving PDUs.

Range: 450–23000 microseconds

Default: 925 microseconds

Example

```
chg-atm-lps:lpset=5:tmrprov=1000:tmridle=55
```

```
chg-atm-lps:lpset=3:srclpset=5:action=copy
```

Dependencies

The values in link parameter sets **20** and **30** are the system default values. They cannot be changed but can be copied to another link parameter set.

The values of the **lpset** and **srclpset** parameters cannot be the same.

The **action** and **srclpset** parameters must be specified together.

If **action=copy** is specified, only the **lpset** and **srclpset** parameters can be specified.

At least one optional parameter must be specified.

Notes

The **lpset** values **20** and **30** are non-configurable and contain the default values for ANSI and ITU ATM standards respectively. The **lpset** values **1** through **19** and **21** through **29** are configurable and initialized to the default values for ANSI and ITU standards respectively.

If no parameter value for **lpset** is included when the **ent-slk** command is entered, the system default value of **1** is assigned for ANSI links and the system default value of **21** is assigned for ITU links.

All timer values for link parameter sets are initialized to the system default values.

Output

```
chg-atm-lps:lpset=5:tmrprov=1000:tmridle=55
```

```
rlghncxa03w 04-01-05 16:40:40 EST EAGLE 31.3.0
CHG-ATM-LPS: MASP A - COMPLTD
```

```
;
```

chg-attr-seculog

Change the Security Log Characteristics

Use this command to modify various attributes that affect the operation of the security logging feature. These attributes include:

- Enabling or disabling the raising of alarms when the log needs uploading
- Specifying the log percentage full threshold at which an *upload required* alarm is raised for the active security log.

Keyword: chg-attr-seculog

Related Commands: rtrv-attr-seculog

Command Class: Security Administration

Parameters**:upldalm=** (optional)

Enable or disable log alarms that pertain to uploading of the security log.

Range: **yes, no****yes**—Enables the log alarms pertaining to uploading of the log, as follows:

- Upload required
- Log overflowed
- Standby log contains greater than 0 un-uploaded entries

no—Prevents the log alarms from being raised when these conditions occur. Should the alarm already be raised when **no** is specified, the alarm is lowered.**Default:** No change to the current value**:upslg=** (optional)Percent full threshold. This parameter specifies the percent full threshold for the security logs. If the **upldalm=yes** parameter is configured, an alarm is raised for the security log when the **%full** field (as displayed using the **rept-stat-seculog** command) in the log, on the active OAM, reaches or exceeds the value specified for **upslg**. This alarm indicates that the administrator must upload the log.**Range:** **1-99****Default:** No change to the current value**Example****chg-attr-seculog:upslg=80:upldalm=yes****Dependencies**

At least one optional parameter must be specified.

Notes

None

Output**chg-attr-seculog:upslg=80:upldalm=yes**

```
rlghncxa03w 04-01-05 16:40:40 EST EAGLE 31.3.0
CHG-ATTR-SECULOG: MASP B - COMPLTD
```

;

chg-cmd**Change Command Attributes**

Use this command to change the attributes of a command.

Keyword: **chg-cmd****Related Commands:** **rtrv-cmd****Command Class:** Security Administration**Parameters****:cmd=** (mandatory)

The command whose attributes are to be changed.

Range: One alphabetic character followed by up to 19 additional alphanumeric characters.

:class1= (optional)

Configurable command class name, and indicator to specify whether the command class is allowed.

Range: 1 alphabetic character followed character by 2 alphanumeric characters (ayy), followed by **-no** or **-yes**

Default: No change to current value

:class2= (optional)

Configurable command class name, and indicator to specify whether the command class is allowed.

Range: 1 alphabetic character followed character by 2 alphanumeric characters (ayy), followed by **-no** or **-yes**

Default: No change to current value

:class3= (optional)

Configurable command class name, and indicator to specify whether the command class is allowed.

Range: 1 alphabetic character followed character by 2 alphanumeric characters (ayy), followed by **-no** or **-yes**

Default: No change to current value

:class4= (optional)

Configurable command class name, and indicator to specify whether the command class is allowed.

Range: 1 alphabetic character followed character by 2 alphanumeric characters (ayy), followed by **-no** or **-yes**

Default: No change to current value

:class5= (optional)

Configurable command class name, and indicator to specify whether the command class is allowed.

Range: 1 alphabetic character followed character by 2 alphanumeric characters (ayy), followed by **-no** or **-yes**

Default: No change to current value

:class6= (optional)

Configurable command class name, and indicator to specify whether the command class is allowed.

Range: 1 alphabetic character followed character by 2 alphanumeric characters (ayy), followed by **-no** or **-yes**

Default: No change to current value

:class7= (optional)

Configurable command class name, and indicator to specify whether the command class is allowed.

Range: 1 alphabetic character followed character by 2 alphanumeric characters (ayy), followed by **-no** or **-yes**

Default: No change to current value

:class8= (optional)

Configurable command class name, and indicator to specify whether the command class is allowed.

Range: 1 alphabetic character followed character by 2 alphanumeric characters (ayy), followed by **-no** or **-yes**

Default: No change to current value

Example

```
chg-cmd:cmd=ent-rte:class1=u11=yes
```

```
chg-cmd:cmd=rept-stat-slk:class7=dab-no
```

Dependencies

At least one optional parameter must be specified.

The Command Class Management feature must be enabled before this command can be entered.

The LNP feature must be turned on (see the **enable-ctrl-feat** command) before a command from the classes LNPBAS, LNPDB, and LNPSUB can be specified.

The **cmd** parameter value must be a valid system command.

The **class1** - **class8** parameter values must be valid default or provisioned configurable command class names.

Notes

Up to 8 configurable command class names can be specified in one command. More than 8 command classes can be updated by entering additional commands. To update all 32 available configurable command classes, you could enter four commands with 8 command classes specified in each command.

```
chg-cmd:cmd=ent-rte:class1=u11=yes
```

```
rlghncxa03w 04-01-05 16:40:40 EST EAGLE 31.3.0
CHG-CMD: MASP B - COMPLTD
```

```
;
```

chg-cmdclass

Change Command Class:

Use this command to change the name or description of a configurable command class.

Keyword: **chg-cmdclass**

Related Commands: **rtrv-cmdclass**

Command Class: Security Administration

Parameters

:class= (mandatory)

The configurable command class name.

Range: 1 alphabetic character followed by 2 alphanumeric characters (ayy)

:nclass= (optional)

The new configurable command class name.

Range: 1 alphabetic character followed by 2 alphanumeric characters (*ayy*)

Default: No change to current value

:descr= (optional)

New configurable command class description.

Range: 1 alphabetic character followed by up to 31 alphanumeric characters

Default: No change to current value

Example

```
chg-cmdclass:class=abc:descr="my command class description"
```

```
chg-cmdclass:class=u23:nclass=dab:descr="his command class description"
```

```
chg-cmdclass:class=dab:nclass=krb
```

Dependencies

At least one optional parameter must be specified.

The Command Class Management feature must be enabled and turned on before this command can be entered.

The **class** parameter value must be a valid configurable command class name (one of the default configurable command class names or a user-defined command class name).

The new command class name parameter value (**nclass**) must not be the same as an existing configurable or non-configurable command class name.

Notes

None

Output

```
chg-cmdclass:class=abc:descr="my command class description"
```

```
rlghncxa03w 04-01-05 16:40:40 EST EAGLE 31.3.0
```

```
CHG-CMDCLASS: MASP B - COMPLTD
```

```
;
```

chg-csl

Common Screening List

Use this command to change an existing entry in the Common Screening List (CSL). The Common Screening List commands are used to tailor certain types of general screening information to specific features.

Keyword: **chg-csl**

Related Commands: **ent-csl, dlt-csl, rtrv-csl, rtrv-ctrl-feat**

Command Class: Database Administration

Parameters

NOTE: See "Point Code Formats and Conversion" on page A-6 for a detailed description of point code formats, rules for specification, and examples.

:ds= (Optional)

Digit String. This parameter specifies a unique string of digits that is used by the specified screening feature.

NOTE: Either the ds or the pc parameter must be specified. Both parameters cannot be specified in the same command.

Range: 1 -15 digits

Valid digits are **0-9, a-f, A-F**

1-15 digits—IDP Screening for Prepaid **insl** list

4 digits—IDP Screening for Prepaid **skts** list

1-15 digits—Prepaid IDP Query Relay **ccnc** list

1-15 digits—Prepaid IDP Query Relay **ccnc** list

1-5 digits—Prepaid IDP Query Relay **delpfx** list

1-6 digits—Prepaid IDP Query Relay **gta** list

1-4 digits—Prepaid IDP Query Relay **skbcsm** list

:feature= (Optional)

Feature Name. The name of the enabled screening feature for which the command is entered. Enter the entire feature name as it appears in the **rtrv-ctrl-feat** command description output example.

NOTE: Either the pn parameter or the feature parameter must be specified to identify the feature.

Range: *abcdefghijklmnopqrstuvwxyz*

1 alphabetic character and up to 24 optional alphanumeric characters, including spaces and special characters, enclosed in double quotation marks (" ").

The following feature names are valid for this command:

- IDP Screening for Prepaid
- Prepaid IDP Query Relay

:list= (Optional)

The name of the Common Screening List that is associated with the feature.

NOTE: The list parameter must be specified when the feature uses more than one type of Common Screening List.

Range: **ccnc, delpfx, gt, insl, skbcsm, skts**

ccnc—CC+NC List

delpfx—Delete Prefix List

gt—Global Title List

insl—In Network Subscriber List

skbcsm—SK+BCSM List

skts—Service Key + TeleService List

The following screening lists are valid for the indicated features:

- **skts, insl**—IDP Screening for Prepaid
- **ccnc, delpfx, gt, skbcsm**—Prepaid IDP Query Relay feature

:p1= (Optional)

Parameter value 1. The parameter value is specific to the feature and list name that use this parameter.

Range: 1 digit
Valid digit values are:
0-1—For the Prepaid IDP Query Relay feature **delpfx** list, where **0**=National,
1=International

:p2= (Optional)
Parameter value 2. The parameter value is specific to the feature and list name that use this parameter. No feature currently uses this parameter.

:p3= (Optional)
Parameter value 3. The parameter value is specific to the feature and list name that use this parameter. No feature currently uses this parameter.

:pc= or :pca= (Optional)
ANSI point code with subfields *network indicator-network cluster-network cluster member* (*ni-nc-ncm*).

Range: **000-255**
Specify a valid value for each subfield of the point code, and separate the subfields with a dash (-).
When **chg-sid:pctype=ansi** is specified, *ni* = **000** is not valid.
When **chg-sid:pctype=ansi** is specified, *nc* = **000** is not valid if *ni* = **001-005**.
When **chg-sid:pctype=ansi** is specified, *nc* = **000** is valid if *ni* = **006-255**.
The point code **000-000-000** is not a valid point code.

:pc/pca/pci/pcn/pcn24= (Optional)
Point code. Either the **ds** or **pc** parameter must be specified from this command. Currently, there are no common screening list features that use point codes.

:pci= (Optional)
ITU international point code with subfields *zone-area-id*. The *prefix* subfield indicates a spare point code (*prefix-zone-area-id*).

Range: **s-, 0-255**
Specify a valid value for each subfield of the point code, and separate the subfields with a dash (-).
prefix—**s-**
zone—**0-7**
area—**000-255**
id—**0-7**
The point code **0-000-0** is not a valid point code.

:pcn= (Optional)
ITU national destination point code in the format of a 5-digit number (*nnnnn*); or 2, 3, or 4 numbers (members) separated by dashes (*m1-m2-m3-m4*) as defined by the **chg-stpopts:npcfnti** flexible point code option. A group code must be specified when the ITUDUPPC feature is turned on (*nnnnn-gc, m1-m2-m3-m4-gc*). The *prefix* subfield indicates a spare point code (*prefix-nnn-gc, prefix-m1-m2-m3-m4-gc*).

Range: **s-, 0-16383, aa-zz**
Specify a valid value for each subfield of the point code, and separate the subfields with a dash (-).
prefix—**s-**
nnnnn—**0-16383**

gc—**aa - zz**

m1-m2-m3-m4—**0-14** for each member; values must sum to 14

:pcn24= (Optional)

24-bit ITU national point code with subfields *main signaling area-sub signaling area-signaling point* (*msa-ssa-sp*).

Range: **000-255**

Specify a valid value for each subfield of the point code, and separate the subfields with a dash (-).

msa—**000-255**

ssa—**000-255**

sp—**000-255**

:pn= (Optional)

Part Number. The 9-digit "893xxxxxx" part number of the feature for which the command is entered. The **rtrv-ctrl-feat** command description shows the part number in the command output example.

NOTE: Either the **pn** parameter or the **feature** parameter must be specified to identify the feature.

Range: **893000000-893999999**

The first three digits are **893**. Do not separate the digits with dashes or spaces. The following part numbers are valid for this command:

- 893015501—IDP Screening for Prepaid feature
- 893016001—Prepaid IDP Query Relay feature.

Example

```
chg-csl:feature="IDP Screening for Prepaid":list= insl:ds=123456789bcdEF
```

```
chg-csl:feature="IDP Screening for Prepaid":list= skts:ds=36ab
```

```
chg-csl:feature="Prepaid IDP Query Relay":list=ccnc:ds=123456
```

```
chg-csl:feature="Prepaid IDP Query Relay":list=skbcsm:ds=4321
```

```
chg-csl:feature="Prepaid IDP Query Relay":list=delpfx:ds=54321:p1=0
```

Dependencies

An enabled feature must be specified via either a valid part number (**pn**) or feature name (**feature**). The specified feature must use a Common Screening List.

The specified feature name must be for a feature that uses a Common Screening List.

The feature name must be specified as it appears in the **rtrv-ctrl-feat** command output example. The entire feature name must be specified.

The following features use a Common Screening List:

- IDP Screening for Prepaid
- Prepaid IDP Query Relay

The feature that is specified in the **feature** parameter must be enabled.

The **list** parameter must be specified for features that use more than one type of screening list.

The **list** parameter value must be valid for the specified screening list feature. The following **list** parameter values are valid for the indicated feature:

- **insl, skts**—IDP Screening for Prepaid feature
- **gt, ccnc, delpfx, skbcm**—Prepaid IDP Query Relay feature

The specified screening list entry must exist in the screening list that is used by the feature.

The length of the digit string that is specified for the **ds** parameter must be valid for the screening feature and list type.

A valid **ds** parameter is required for the specified feature and list type.

The following parameters are allowed with the indicated common screening list type:

- **list=gt**—**ds** parameter
- **list=ccnc**—**ds** parameter
- **list=delpfx**—**ds** and **p1** parameters
- **list=skbcm**—**ds** parameter
- **list=insl**—**ds** parameter
- **list=skts**—**ds** parameter

The leading digit pattern in the specified digit string (**ds** parameter) must be unique in the specified screening list for the indicated feature:

- **insl** and **skts** lists—IDP Screening for Prepaid
- **gt** and **ccnc** lists—Prepaid IDP Query Relay

The specified **ds** parameter value must be valid for the specified screening list (**list** parameter).

The value that is specified for a common screening list parameter must be valid for the specified common screening list feature.

Notes

None

Output

chg-csl:feature="IDP Screening for Prepaid":list=insl:ds=123456789bcdEF

```
tekelecstp 05-08-21 15:18:41 EST EAGLE 34.3.0
  INSL List table is (5 of 25) 20% full
  CHG-CSL: MASP A - COMPLTD
```

;

chg-csl:feature="Prepaid IDP Query Relay":list=skbcm:ds=919556

```
tekelecstp 05-08-21 15:18:41 EST EAGLE 34.1.0
  SK+BCSM List table is (5 of 25) 20% full
  CHG-CSL: MASP A - COMPLTD
```

;

chg-ctrl-feat

Change Controlled Feature

Use this command for controlled features that have been purchased and enabled with the **enable-ctrl-feat** command to:

- Turn on or turn off On/Off features
- Turn on Permanently On features (they cannot be turned off after they have been turned on)

Use this command when the **system** station shows an expired temporary key and the administrator wants to clear the CRITICAL system error without purchasing a permanent Feature Access Key.

Keyword: **chg-ctrl-feat**

Related Commands: **enable-ctrl-feat**, **rtrv-ctrl-feat**

Command Class: Database Administration

Parameters

:partnum= (mandatory)

The Part Number for the feature.

Range: **893000000 - 893999999**

Do not include dashes in the 9-digit number.

:alarm= (optional)

Clears alarms when temporary feature keys have expired.

Range: **clear**

:status= (optional)

Changes the operational status of the feature.

Range: **on, off**

Default: No change in current status

Example

```
chg-ctrl-feat:partnum=893xxxxxx:status=on
```

```
chg-ctrl-feat:partnum=893xxxxxx:alarm=clear
```

Dependencies

The controlled feature must be enabled (see the **enable-ctrl-feat** command) before this command can be entered.

One of the optional parameters, but not both, must be specified in the command.

The Part Number specified in the command must be for an On/Off feature, with the following exceptions. The following Permanently On features are turned on with this command; after they have been turned on, they cannot be turned off with this command:

- 120 Million LNP ported TNs
- 15 Minute Measurements feature
- ANSI/ITU/China SCCP Conversion feature
- Enhanced GSM MAP Screening (EGMS) feature

- Equipment Identity Register (EIR) feature
- GSM MAP Screening (GMS) feature
- GSM MAP SRI Redirect for Serving HLR
- IDP Screening for Prepaid
- ISUP NP with EPAP
- Prepaid IDP Query Relay
- Flexible GTT Load Sharing
- LNP ELAP Configuration feature
- Spare Point Code Support

Turning on a feature that is already on or turning off a feature that is already off has no effect.

Before the LNP ELAP Configuration feature can be turned on, all cards that are running the **sccp**, **ebdadcm**, and **ebdablm** applications must be deleted.

Before the Intermediate Global Title Translation Load Sharing (IGTTLS) feature can be turned on,

- The GTT feature must be turned on (see the **chg-feat** command).
- Every SCCP card in the system must have at least a 586 processor.

The G-Port feature must be turned on before the following features can be turned on:

- The Prepaid Short Message Service (PPSMS) Phase 1 feature
- The G-Port MNP Circular Route Prevention feature

All IPSM cards in the system must be inhibited before the IP User Interface (Telnet) feature can be turned on or off.

All IPSM cards in the system must be inhibited before the OA&M IP Security Enhancements feature can be turned on or off.

Enabling of any 192 Million LNP feature quantity key requires all DSM cards to have at least a 4GB daughter board equipped in system.

The default country code (**defcc**) parameter must be provisioned using the **chg-stpopts** command before the IDP RELAY feature can be enabled.

Before the 15 Minute Measurements feature can be turned on,

- The 15 Minute Measurements feature must be enabled (see the **enable-ctrl-feat** command).
- The Measurements Platform feature must be turned on (see the **chg-feat** command).
- The Measurements Platform collection option must be enabled (see the **chg-measopts** command).
- At least one MCPM card must be in the IS-NR state in the system.

- No EMDC cards can be provisioned in the system.
- 30 minute measurements collection cannot be in progress.

Notes

None

Output

```

chg-ctrl-feat:partnum=893xxxxxx:status=on
rlghncxa03w 04-01-05 16:40:40 EST EAGLE 31.3.0
CHG-CTRL-FEAT: MASP A - COMPLTD
;

chg-ctrl-feat:partnum=893xxxxxx:alarm=clear
rlghncxa03w 04-01-05 16:40:40 EST EAGLE 31.3.0
CHG-CTRL-FEAT: MASP A - COMPLTD
;

rlghncxa03w 04-01-05 16:40:40 EST EAGLE 31.3.0
0367.0181 * SYSTEM Temp Key(s) expiration alarm cleared.
;

```

chg-dcmps Change Database Communication Module Parameter Set

Use this command to change the set of generic timers and parameters used by the system application.

Keyword: chg-dcmps

Related Commands: rtrv-dcmps

Command Class: Database Administration

Parameters

:set= (mandatory)

The set number.

Range: 1-9

:parm= (optional)

The parameter number within the timer.

Range: 1-10

parm=1 is used for the Type of Service (TOS) socket option.

parm=2 is used for the Nagle's Algorithm socket option.

parm=3 is used for the Default SORP flags socket option.

The remaining parameter values are unused.

Default: No change to current value

:pvalue= (optional)

The value to be set for this parameter if the **parm** parameter is specified.

Range: As shown in Table 5-10:

Default: No change to current value

Table 5-10. Valid pvalue Values for chg-dcmpps

parm	pvalue bits	Valid Range
1	0-7	0-255
2	0	0=Disabled 1=Enabled
3	0-31	0x0 – 0xFFFFFFFF

:srcset= (optional)

The source set of the copy.

Range: 1-10

Default: Empty

:timer= (optional)

The timer number within the set.

Range: 1-10

timer=1 is the time in milliseconds between sending of TEST messages by NE.

timer=2 is the time in milliseconds to wait for a response to a TEST message.

timer=3 is the time in milliseconds to continue processing received service messages after NE is prohibited.

timer=4 is the time in milliseconds between sending of MONI messages by NE. The remaining timer numbers are unused.

Default: No change to current value

:tvalue= (optional)

The value the timer will be set to, in milliseconds.

Range: 0-4294967275

Default: No change to current value

Example

chg-dcmpps:set=1:srcset=10

Dependencies

At least one of the following optional parameters must be specified: **timer**, **parm**, **srcset**.

If the **srcset** parameter is specified, no other optional parameters can be entered.

If the **timer** parameter is specified, the **tvalue** parameter must be specified.

If the **parm** parameter is specified, the **pvalue** parameter must be specified.

Notes

There are 10 IP parameter sets. Each IP parameter set has 10 timers.

IP parameter set number 10 contains parameter set default values. It cannot be changed.

Output

chg-dcmpps:set=1:srcset=10

```
rlghncxa03w 03-02-05 15:35:05 EST EAGLE 28.1.0
CHG-DCMPS: MASP A - COMPLTD
```

;

chg-db

Change Database

Use this command to manipulate elements of the database.



CAUTION: When this command is entered, all other database operations are locked out while the command executes. The only chg-db actions that are not locked out are the LNP electronic bulk download operations (beginedl and canceledl).



CAUTION: The cards that run both the active and standby OAM reboot whenever the restore, import, or finishedl operations complete successfully. When a database is repaired successfully, the card with the standby OAM reboots. This action purges old database data from memory and reloads the MASPs with the new data. When the card with the active OAM reboots, all terminals reinitialize, automatically logging off all users. Depending on the new database, the terminals may be initialized to a different configuration, and user IDs and passwords may change.

Keyword: chg-db

Related Commands: copy-meas, rept-stat-db

Command Class: System Maintenance

Parameters

:action= (mandatory)

The database management action.

Range: backup, repair, restore, import, beginedl, canceledl, finishedl



CAUTION: These parameter values (except beginedl, canceledl, or finishedl) can cause loss of synchronization of LNP databases unless you inhibit the OAP terminal ports before entering the chg-db command with these parameters. Refer to the *Database Administration Manual - System Management* for procedures using these command parameters.

backup—Makes a copy of the database from the current data partitions to the backup partitions on both fixed disks or from the active fixed disk to the backup partition on the removable cartridge on the MDAL card.

repair—Copies the current and backup databases from the active to the standby fixed disk.



CAUTION: The action=restore parameter initiates an emergency recovery procedure and requires the init-sys command to download the restored database to all the cards in the system.

restore —Copies the backup partitions to the current data partitions on both fixed disks, or copies the database on the removable cartridge on the MDAL card to the current partitions on both fixed disks.



CAUTION: Performing a cartridge bulk download to the system using the chg-db:action=import command, removes the alias translation type (*ALIAS*) values, because they were entered directly into the system.



CAUTION: The imported database must be loaded onto all TSMs in the system. The preferred method is to take each TSM out of service using the rmv-card command then put it back into service using the rst-card command until all the TSMs have been reloaded.

import—Copies the LNP database from a removable cartridge created at the LSMS to current partitions on both fixed disks. The **import** parameter is used to manually load the LNP database from the LSMS when the LNP is first brought into service or when resynchronization of the LNP database with the LSMS database is needed. For more information, refer to Chapter 9 "Manual LSMS to STP Bulk Download" or Chapter 10 "Manual STP to STP Bulk Load" in the *LNP Database Synchronization Manual*.



CAUTION: The following method should be used only in emergency situations: all the TSMs can be initialized at the same time using the **init-card:appl=sccp** command. This method not only loads the imported LNP database onto the TSMs at the same time, but takes all the TSMs out of service and the LNP subsystem offline.

beginedl—Signals that an electronic bulk download of the LNP database from the LSMS can proceed. The LSMS LNP data is downloaded to the RAM memory of the Bulk Load Module (BLM) card. The command performs various checks to ensure that the system is ready to receive the data from the LSMS.

finishedl—Signals that an electronic bulk download of the LNP database from the LSMS is completed; specifically, that the LNP database currently resident in the BLM's memory should be copied to the OAM fixed disks, overwriting the current LNP database. The command performs various checks to ensure the BLM's LNP database is acceptable prior to copying it to fixed disk. During the execution of **finishedl**, LNP database provisioning is blocked.

canceledl—Signals that the LNP database resident in the BLM card should not be copied to the OAM fixed disks, but instead should be discarded. The command causes the BLM card to reboot in order to reload a fresh copy of current LNP database.

:dest= (optional)

Destination drive. This parameter provides the option to back up the database to the fixed or removable drive.

Range: remove, fixed

Default: fixed

:force= (optional)

Force indicator. Specify **force=yes** with the **action=canceledl** parameter. This parameter prevents the inadvertent destruction of the downloaded LSMS LNP database currently resident in the BLM card.

Range: yes, no

Default: no

:src= (optional)

Source drive. This parameter provides the option to restore the database from the fixed or removable drive.

Range: remove, fixed

Default: fixed

Example

```
chg-db:action=backup:dest=fixed
```

```
chg-db:action=backup:dest=remove
```

chg-db:action=restore:src=fixed
chg-db:action=restore:src=remove
chg-db:action=repair
chg-db:action=import
chg-db:action=beginndl
chg-db:action=finishedl
chg-db:action=canceledl:force=yes

Dependencies

The **chg-db** command cannot be entered while the system is in upgrade mode.

When a removable disk is involved in the operation, the removable disk must meet the following criteria:

- Be accessible and ready in the drive.
- Be formatted as a system removable disk, not a measurement removable disk.

The **dest** parameter can be specified only when **action=backup**. If the **dest=fixed** parameter is specified, or the **dest** parameter is not specified, the database on the current partition of the fixed disk is copied to the backup partition of the fixed disk. This action is shown in Figure 5-1 on page 5-98.

Figure 5-1. The **chg-db:action=backup:dest=fixed** command

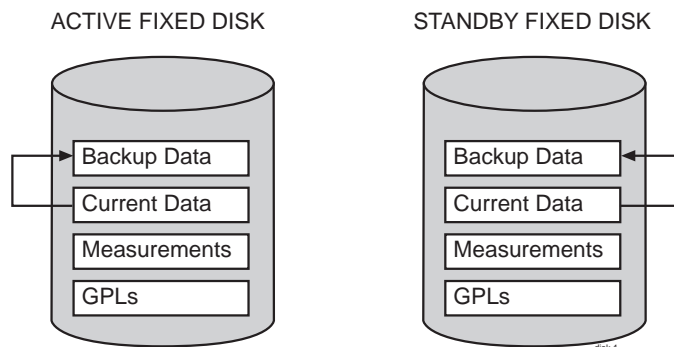

If the **dest=remove** parameter is specified, the database on the current partition of the active TDM fixed disk is copied to the removable cartridge in the MDAL. This action is shown in Figure 5-2.

Figure 5-2. The `chg-db:action=backup:dest=remove` command

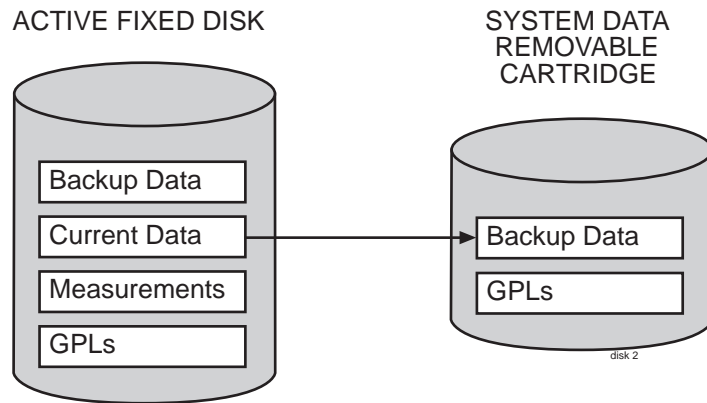

The current database partition of both fixed disks must be free of integrity violations (for example, incoherency, inconsistency, and data corruption) when **action=backup** is specified.

The **src** parameter can be used only when **action=restore**. To restore the database, if the **src=fixed** parameter is specified or the **src** parameter is not specified, the backup partition of each fixed disk is copied to the current partition of the fixed disk. This action is shown in Figure 5-3 on page 5-99.

Figure 5-3. The `chg-db:action=restore:src=fixed` command

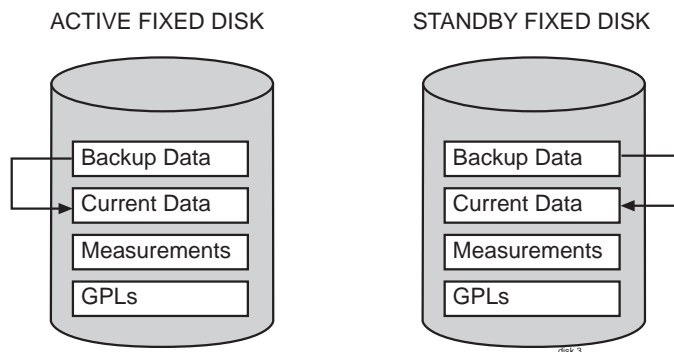

The backup database partition of both fixed disks must be coherent when **chg-db:action=restore:src=fixed** is specified.

If the **src=remove** parameter is specified, the database on the removable cartridge is copied to the current partitions on both the active and standby fixed disks. This action is shown in Figure 5-4.

Figure 5-4. The `chg-db:action=restore:src=remove` command

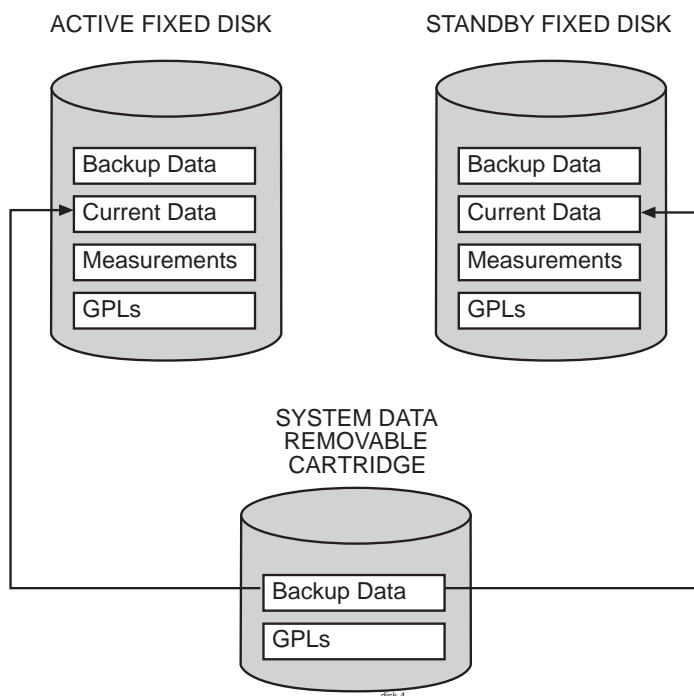

The database on the removable cartridge must be coherent when `action=restore:src=remove` is specified.

If the `action=repair` parameter is specified, the current and backup database partitions are copied from the active fixed disk to the standby fixed disk. Figure 5-5 illustrates this action.

Figure 5-5. The `chg-db:action=repair` command

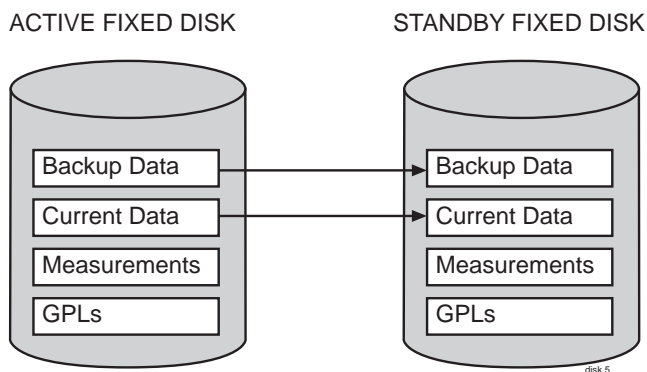

The current and backup database partitions of the active fixed disk must be free of integrity violations (for example, incoherency and data corruption) when `action=repair` is specified.

If the **action=import** parameter is specified, an LNP database is copied from a removable created by the LSMS to the current partition of both fixed disks. Figure 5-6 illustrates this action.

NOTE: Before issuing a **chg-db:action=import** command, be sure to familiarize yourself with the information in Chapter 9 "Manual LSMS to STP Bulk Download" in the *LNP Database Synchronization Manual*.

Figure 5-6. The **chg-db:action=import** command

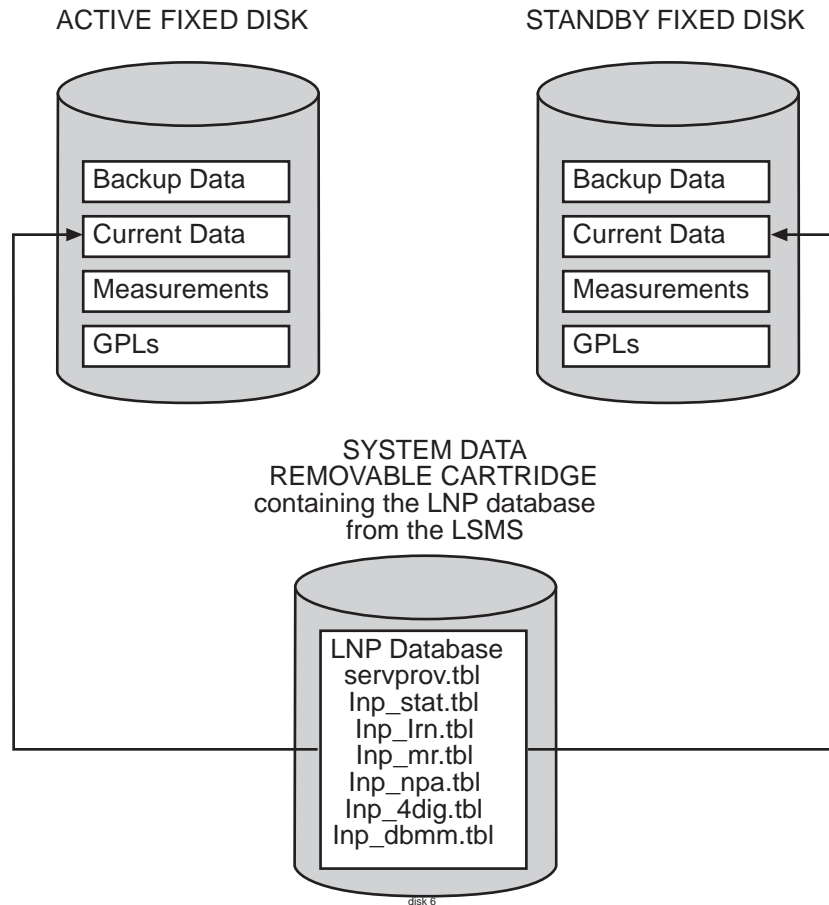

The current database partitions of the active and standby fixed disks must be free of integrity violations (for example, incoherency and data corruption) when the **action=import** parameter is specified.

The LNP feature must be on for use with OAP before the **action=import**, **beginedl**, **finishedl**, or **canceledl** parameter can be specified. Verify that the LNP feature is on by entering the **rtrv-ctrl-feat** command. In the output:

- If the *LNP ported TNs* quantity is not listed, the LNP feature is not on.
- If the LNP ELAP Configuration controlled feature is not listed or is turned off, and the quantity for the *LNP ported TNs* entry is less than or equal to 12,000,000, the LNP feature is turned on for use with OAP.

- If the LNP ELAP Configuration controlled feature is turned on, the LNP feature is turned on for use with ELAP and not with OAP.

Refer to “Activating the LNP Feature” in Chapter 2 of the *Database Administration Manual - LNP*.

If the **chg-db:action=beginedl** command is entered, part or all of the LNP database is transmitted via an ethernet connection from the LSMS to the RAM memory of the system’s Bulk Load Module (BLM) card. After the electronic bulk download of the LNP data from the LSMS is completed and is resident in the BLM’s memory, the **chg-db:action=finishedl** command copies the database to the OAM fixed disks, overwriting the current LNP database. This process is shown in Figure 5-7.

Figure 5-7. The **chg-db:action=beginedl/finishedl** command

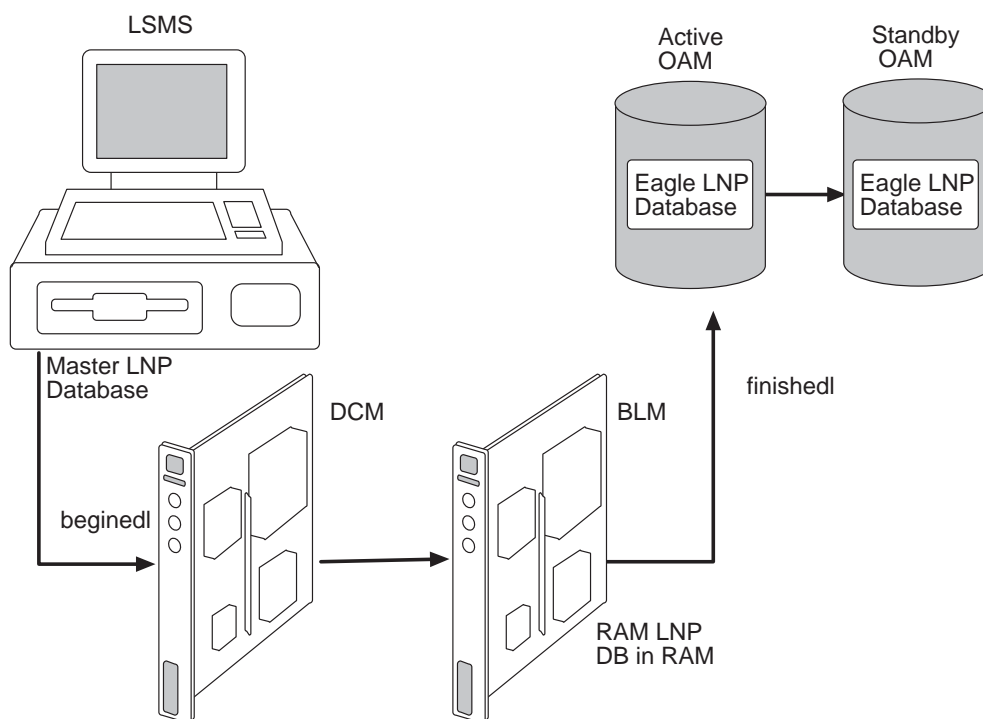

NOTE: Before issuing the **chg-db:action=beginedl/ canceledl/finishedl** commands, be sure to familiarize yourself with the procedures in Chapter 3 "Preparing the EAGLE 5 SAS for High-Speed Operations," in the *LNP Database Synchronization Manual*.

To specify the **chg-db:action=beginedl** command, the following conditions must be met:

- The current database on the active and standby OAM fixed disks must be coherent.
- The BLM and DCM cards must be provisioned and their primary state (PST) must be IS-NR.

- The LNP database currently resident in the BLM card must be at the same level as the current database on the active OAM and must be coherent.
- A **chg-db:action=beginedl/finishedl/canceledl** command must not currently be in effect.

To specify the **chg-db:action=finishedl** command, the following conditions must be met:

- The BLM card must be provisioned and its primary state (PST) must be IS-NR.
- The download from the LSMS to the BLM card must have completed.
- The database in the BLM card must be coherent.
- There cannot be a measurement preparation operation in progress.

To specify the **chg-db:action=canceledl** command, a **chg-db:action=beginedl** command must currently be in effect.

The **force** parameter can be used only with the **chg-db:action=canceledl** command. The **force=yes** parameter must be specified whenever the **action=canceledl** operation is specified.

- If the LNP ELAP Configuration controlled feature is turned on, the **beginedl**, **finishedl**, and **canceledl** parameter values are no longer available. All data from the LSMS is transmitted over an ethernet connection to the active ELAP rather than a BLM. The ELAP automatically distributes the changes to LNP databases or DSM cards in the EAGLE 5 SAS; it is not necessary to identify a beginning and end for high-speed transmissions. For more information, refer to the *LNP Database Synchronization (LSMS with EAGLE 5 SAS)*.

Notes

When the **chg-db** command is entered with the **action=backup** parameter, the following message appears when an audit is in progress:

```
Command In Progress: waiting for database audit to complete
```

The command executes when the audit is finished.

Should the EAGLE 5 SAS's LNP database become severely out of sync with the LSMS's master LNP database (such as, a long-duration communications failure between the EAGLE 5 SAS and LSMS), then you can use one of the following methods to resynchronize the EAGLE 5 SAS from the master LSMS database:

- The **chg-db:action=import** command (cartridge-based method)
- The **chg-db:action=beginedl** and **chg-db:action=finishedl** command (ethernet-based method)
- If the LNP ELAP Configuration controlled feature is turned on, the LSMS can accomplish the resynchronization with no action required at the EAGLE 5 SAS. For more information, refer to the *LNP Database Synchronization (LSMS with EAGLE 5 SAS)*.

After an **action=import** or **action=finishedl** operation completes, the following alarm is raised for all operational SCCP cards:

```
* 5022.0429 * CARD xxxx SCCP LNP database is inconsistent
```

This alarm indicates that all SCCP cards must be reloaded to receive the newly imported LNP database.

The **action=import** or **action=finishedl** operations do not affect the database level. Therefore, these operations do not require that you reinitialize non-SCCP networking cards. Only SCCP cards must be reinitialized.

If the **chg-db:action=finishedl** command is entered, but no modifications have been made to the LNP database in the BLM card (that is, the LSMS did not apply any updates to the database), then the results are as follows:

- The database will not be uploaded from the BLM card to the OAM fixed disks.
- The following output message appears:

```
FINISHEDL : MASP A - LNP DB in BLM card not modified by LSMS.  
No upload will occur.
```

When the LNP ELAP Configuration controlled feature is not turned on, the following components must be in place before the LNP database can be electronically downloaded from the LSMS:

- A single BLM card running the **ebdablm** GPL must be provisioned and must be operational (IS-NR). This card is populated with the current LNP database, and the download must have completed. The card does not go to the IS-NR state until the download is completed.
- A single DCM card running the **ebdadcm** GPL must be provisioned and must be operational (IS-NR).
- An ethernet connection between the LSMS and DCM must exist.
- The DCM card must be provisioned with the necessary TCP/IP configuration information so that the card can establish a data connection with the LSMS.

Performance

For **chg-db** command activities using the **backup**, **restore**, **repair**, and **import** parameter values, the performance time varies depending on the number of records allocated for the database, system activity, and system setup. These operations should typically take no longer than 30 minutes. If one of these operations exceeds one hour, contact Tekelec Technical Services for assistance at (888) FOR-TKLC.

The performance time required for enhanced bulk download activities varies depending on the number of records provisioned in the database and the quality of the transmission and connections. Table 5-11 on page 5-105 lists the performance range for enhanced bulk download activities.

Table 5-11. Performance Range for Enhanced Bulk Download Activities

Activity	Typical Performance per Million Records	Maximum Time* per Million Records
Uploading a database from the BLM to the OAM fixed disks (active and standby).	10 minutes	15-20 minutes
Downloading a database from the LSMS to the BLM (includes extracting and formatting the entries on the LSMS, transmitting the data from the LSMS to the EAGLE 5 SAS and inserting the entries in the database).	75 minutes	90 minutes
*If an activity exceeds the maximum time, contact Tekelec Technical Services for assistance at (888) FOR-TKLC.		

Output

The output of the various actions of the **chg-db** command is shown in the following examples.

chg-db:action=backup

```
BACKUP (FIXED): MASP B - Backup starts on active MASP.
BACKUP (FIXED): MASP B - Backup on active MASP to fixed disk complete.
BACKUP (FIXED): MASP B - Backup starts on standby MASP.
BACKUP (FIXED): Backup on standby MASP to fixed disk complete.
```

chg-db:action=restore

```
RESTORE (FIXED): MASP A - Restore starts on active MASP.
RESTORE (FIXED):MASP A - Restore from fixed disk on active MASP complete.
RESTORE (FIXED): MASP A - Restore starts on standby MASP.
RESTORE (FIXED):MASP A - Restore from fixed disk on standby MASP complete.
RESTORE (FIXED): MASP A - MASP(s) will reboot to load data.
```

chg-db:action=backup:dest=remove

```
BACKUP (REMOVABLE) : MASP A - Backup starts on active MASP.
BACKUP (REMOVABLE) : MASP A - Backup to removable cartridge complete.
```

chg-db:action=backup:dest=fixed

```
BACKUP (FIXED) : MASP A - Backup starts on active MASP.
BACKUP (FIXED) : MASP A - Backup on active MASP to fixed disk complete.
BACKUP (FIXED) : MASP A - Backup starts on standby MASP.
BACKUP (FIXED) : MASP A - Backup on standby MASP to fixed disk complete.
```

chg-db:action=restore:src=remove

```
RESTORE (REMOVABLE) : MASP A - Restore starts on active MASP.
RESTORE (REMOVABLE) : MASP A - Restore starts on standby MASP.
RESTORE (REMOVABLE) : MASP A - MASP(s) will reboot to load data.
RESTORE (REMOVABLE) : MASP A - Restore from removable cartridge complete.
```

chg-db:action=restore:src=fixed

```
RESTORE (FIXED) : MASP A - Restore starts on active MASP.
RESTORE (FIXED) : MASP A - Restore from fixed disk on active MASP complete.
RESTORE (FIXED) : MASP A - Restore starts on standby MASP.
RESTORE (FIXED) : MASP A - MASP(s) will reboot to load data.
RESTORE (FIXED) : MASP A - Restore from fixed disk on stdby MASP complete.
```

chg-db:action=repair

REPAIR: MASP A - Repair starts on standby MASP.
 REPAIR: MASP A - Standby MASP will reboot to load data.
 REPAIR: MASP A - Repair from fixed disk complete.

chg-db:action=import

IMPORT : MASP A - Import (LNP) starts on active MASP.
 IMPORT : MASP A - Import (LNP) on active MASP complete.
 IMPORT : MASP A - Import (LNP) starts on standby MASP.
 IMPORT : MASP A - Import (LNP) on standby MASP complete.
 IMPORT : MASP A - MASP(s) will reboot to reload data.

In addition to the **beginedl** output shown in the following example, messages such as UIMs may appear on your terminal.

chg-db:action=beginedl

BEGINEDL : MASP A - Electronic Bulk Download from LSMS may proceed.
 Note: Issue CHG-DB:ACTION=FINISHEDL or CANCELEDL to resume.

chg-db:action=finishedl

FINISHEDL : MASP A - Upload (LNP) starts on active MASP.
 FINISHEDL : MASP A - Upload (LNP) on active MASP complete.
 FINISHEDL : MASP A - Upload (LNP) starts on standby MASP.
 FINISHEDL : MASP A - Upload (LNP) on standby MASP complete.
 FINISHEDL : MASP A - MASP(s) will reboot to load data.

chg-db:action=finishedl

FINISHEDL : MASP A - LNP DB in BLM card not modified by LSMS.
 No upload will occur.

In addition to the **canceledl** output shown in the following example, messages such as UIMs may appear on your terminal.

chg-db:action=canceledl

CANCELEDL : MASP A - LNP DB upload will not occur.
 Note: BLM will now reboot to reload LNP DB.

chg-dstn**Change Destination**

Use this command to change the characteristics of the point codes that are considered destinations from this signal transfer point (STP). A destination does not have to be an adjacent signaling point, but the system must be able to route traffic to this destination.

Keyword: chg-dstn

Related Commands: chg-rte, dlt-dstn, dlt-rte, ent-dstn, ent-rte, rept-stat-dstn, rtrv-dstn, rtrv-rte

Command Class: Database Administration

Parameters

NOTE: See "Point Code Formats and Conversion" in Appendix A for a detailed description of point code formats, rules for specification, and examples.

:dpc/dpca/dpci/dpcn/dpcn24= (mandatory)

Destination point code.

:dpc= or **:dpca=** (mandatory)

ANSI destination point code with subfields *network indicator-network cluster-network cluster member* (*ni-nc-ncm*). The *prefix* subfield indicates a private point code (*prefix-ni-nc-ncm*).

Range: **p-**, **000-255**, *

Specify a valid value for each subfield of the point code, and separate the subfields with a dash (-).

prefix—**p-**

The asterisk (*) value is not valid for the *ni* subfield.

When **chg-sid:pctype=ansi** is specified, *ni* = **000** is not valid.

When **chg-sid:pctype=ansi** is specified, *nc* = **000** is not valid if *ni* = **001-005**.

When **chg-sid:pctype=ansi** is specified, *nc* = **000** is valid if *ni* = **006-255**.

When **chg-sid:pctype=ansi** is specified, *ni* = **006-255** is valid if *ni* = **006-255**.

The point code **000-000-000** is not a valid point code.

:dpci= (mandatory)

ITU international destination point code with subfields *zone-area-id*. The *prefix* subfield indicates a spare point code, private point code, or private and spare point code (*prefix-zone-area-id*).

Range: **s-**, **p-**, **ps-**, **0-255**

Specify a valid value for each subfield of the point code, and separate the subfields with a dash (-).

The point code **0-000-0** is not a valid point code.

prefix—**s-**, **p-**, **ps-**

zone—**0-7**

area—**000-255**

id—**0-7**

:dpcn= (mandatory)

ITU national destination point code in the format of a 5-digit number (*nnnnn*); or 2, 3, or 4 numbers (members) separated by dashes (*m1-m2-m3-m4*) as defined by the **chg-stpopts:npcfmti** flexible point code option. A group code must be specified when the ITUDUPPC feature is turned on (*nnnnn-gc*, *m1-m2-m3-m4-gc*). The *prefix* subfield indicates a spare point code, private point code, or private and spare point code (*prefix-nnnnn*, *prefix-nnnnn-gc*, *prefix-m1-m2-m3-m4*, *prefix-m1-m2-m3-m4-gc*).

Range: **s-**, **p-**, **ps-**, **0-16383**, **aa-zz**

Specify a valid value for each subfield of the point code, and separate the subfields with a dash (-).

prefix—**s-**, **p-**, **ps-**

nnnnn—**0-16383**

gc—**aa - zz**

m1-m2-m3-m4—**0-14** for each member; values must sum to 14

:dpcn24= (mandatory)

24-bit ITU national destination point code with subfields *main signaling area-sub signaling area-signaling point* (*msa-ssa-sp*). The *prefix* subfield indicates a private point code (*prefix-msa-ssa-sp*).

Range: **p-**, **000-255**
Specify a valid value for each subfield of the point code, and separate the subfields with a dash (-).

prefix—**p-**
msa—**000-255**
ssa—**000-255**
sp—**000-255**

:aliasa/aliasi/aliasn/aliasn24= (optional)

Alias point code.

:aliasa= (optional)

ANSI destination point code with subfields *network indicator-network cluster-network cluster member* (*ni-nc-ncm*).

Range: **000-255, none**

Specify a valid value for each subfield of the point code, and separate the subfields with a dash (-).

When **chg-sid:pctype=ansi** is specified, *ni* = **000** is not valid.

When **chg-sid:pctype=ansi** is specified, *nc* = **000** is not valid if *ni* = **001-005**.

When **chg-sid:pctype=ansi** is specified, *nc* = **000** is valid if *ni* = **006-255**.

Enter **none** to delete the point code.

The point code **000-000-000** is not a valid point code.

:aliasi= (optional)

ITU international alias point code with subfields *zone-area-id*. This parameter is not valid if an ITU international (**dpci**) point code is entered. The *prefix* subfield indicates a spare point code (*prefix-zone-area-id*).

Range: **s-, 0-255, none**

Specify a valid value for each subfield of the point code, and separate the subfields with a dash (-).

prefix—**s-**
zone—**0-7**
area—**000-255**
id—**0-7**

Enter **none** to delete the point code.

The point code **0-000-0** is not a valid point code.

:aliasn= (optional)

ITU national alias point code in the format of a 5-digit number (*nnnnn*); or 2, 3, or 4 numbers (members) separated by dashes (*m1-m2-m3-m4*) as defined by the **chg-stpopts:npcfmti** flexible point code option. A group code must be specified when the ITUDUPPC feature is turned on (*nnnnn-gc*, *m1-m2-m3-m4-gc*). The *prefix* subfield indicates a spare point code (*prefix-nnnnn*, *prefix-nnnnn-gc*, *prefix-m1-m2-m3-m4*, *prefix-m1-m2-m3-m4-gc*).

Range: **s-, 0-16383, aa-zz, none**

Specify a valid value for each subfield of the point code, and separate the subfields with a dash (-).

prefix—**s-**
nnnnn—**0-16383**
gc—**aa - zz**

m1-m2-m3-m4—**0-14** for each member; values must sum to 14
Enter **none** to delete the point code.

:aliasn24= (optional)

24-bit ITU national destination point code with subfields *main signaling area-sub signaling area-signaling point (msa-ssa-sp)*.

Range: **000-255, none**

Specify a valid value for each subfield of the point code, and separate the subfields with a dash (-).

msa—**000-255**

ssa—**000-255**

sp—**000-255**

Enter **none** to delete the point code.

:bei= (optional)

Broadcast exception indicator. This parameter specifies whether the STP broadcasts network management messages to adjacent signaling points. The network management messages contain information about the indicated cluster and any of that cluster's member signaling points that are on its exception list. The messages whose broadcast is determined by this parameter are:

- **TFP**—transfer prohibited
- **TCP**—transfer cluster prohibited

Range: **yes, no**

yes—Network management messages are not broadcast

no—Network management messages are broadcast

Default: No change to the current value

:cli= (optional)

The Common Language Location Identifier assigned to this destination.

Range: 1 alphabetic character followed by 10 alphanumeric characters

Default: No change to the cli value

:lei= (optional)

Exception-list exclusion indicator, for cluster destinations only. This parameter specifies whether the system *excludes* or *includes (maintains)* a dynamic status exception list (x-list) for each cluster route used to reach the member signaling points that make up the cluster.

Range: **yes, no**

yes—Do not maintain a dynamic status x-list

no—Maintain a dynamic status x-list

Default: No change to current value.

:ncai= (optional)

Nested cluster allowed indicator. Specifies whether the route to the cluster point code can be different for provisioned members of the cluster. A point code is a member of a cluster point code if it has the same network identifier (NI) and network cluster (NC) values as the cluster point code. This parameter can only be specified for cluster point codes. Nested cluster routing is allowed if this parameter is set to **yes** and the CRMD and NCR features are turned on.

Range: yes, no

yes—The cluster point code is a nested cluster point code. Point codes that are members of this cluster point code can be assigned to route sets that are different from the route set assigned to the cluster point code.

no—The cluster point code is not a nested cluster point code. Point codes that are members of this cluster point code must be assigned to the same route set assigned to the cluster point code.

Default: Current value.

:spc/spca/spci/spcn/spcn24= (optional)

Secondary point code.

:spc= or :spca= (optional)

ANSI secondary point code with subfields *network indicator-network cluster-network cluster member (ni-nc-ncm)*. The *prefix* subfield indicates a private point code (*prefix-ni-nc-ncm*).

Range: p-, 000-255

Specify a valid value for each subfield of the point code, and separate the subfields with a dash (-).

prefix—p-

When **chg-sid:pctype=ansi** is specified, *ni* = 000 is not valid.

When **chg-sid:pctype=ansi** is specified, *nc* = 000 is not valid if *ni* = 001-005.

When **chg-sid:pctype=ansi** is specified, *nc* = 000 is valid if *ni* = 006-255.

The point code 000-000-000 is not a valid point code.

Default: No change.

:spci= (optional)

ITU international secondary point code with subfields *zone-area-id*. The *prefix* subfield indicates a spare point code, private point code, or private and spare point code (*prefix-zone-area-id*).

Range: s-, p-, ps-, 0-255

Specify a valid value for each subfield of the point code, and separate the subfields with a dash (-).

The point code 0-000-0 is not a valid point code.

prefix—s-, p-, ps-

zone—0-7

area—000-255

id—0-7

Default: No change.

:spcn= (optional)

ITU national secondary point code in the format of a 5-digit number (*nnnnn*); or 2, 3, or 4 numbers (members) separated by dashes (*m1-m2-m3-m4*) as defined by the **chg-stpopts:npcfmti** flexible point code option. A group code must be specified when the ITUDUPPC feature is turned on (*nnnnn-gc*, *m1-m2-m3-m4-gc*). The *prefix* subfield indicates a spare point code, private point code, or private and spare point code (*prefix-nnnnn*, *prefix-nnnnn-gc*, *prefix-m1-m2-m3-m4*, *prefix-m1-m2-m3-m4-gc*).

Range: **s-, p-, ps-, 0-16383, aa-zz**
Specify a valid value for each subfield of the point code, and separate the subfields with a dash (-).

prefix—**s-, p-, ps-**

nnnnn—**0-16383**

gc—**aa - zz**

m1-m2-m3-m4—**0-14** for each member; values must sum to 14

Default: No change.

:spcn24= (optional)

24-bit ITU national secondary point code with subfields *main signaling area-sub signaling area-signaling point (msa-ssa-sp)*. The *prefix* subfield indicates a private point code (*prefix-msa-ssa-sp*).

Range: **p-, 000-255**

Specify a valid value for each subfield of the point code, and separate the subfields with a dash (-).

prefix—**p-**

msa—**000-255**

ssa—**000-255**

sp—**000-255**

Example

To change the **cli** of destination **111-222-111** to **rlghncxa01a**:

chg-dstn:dpc=111-222-111:cli=rlghncxa01a

To change the national alias of ANSI destination **111-222-111** to **321**:

chg-dstn:dpca=111-222-111:aliasn=321

To change the exception-list exclusion indicator for cluster **20-2-*** to **yes**:

chg-dstn:dpca=20-2-*:elei=yes

To change an existing destination to remove the SPC:

chg-dstn:dpc=20-2-2:spc=none

To change an existing destination to contain an SPC:

chg-dstn:dpc=20-2-2:spc=5-5-5

To change Nested Cluster Allowed Indicator for cluster **20-2-*** to **yes**:

chg-dstn:dpc=20-2-*:ncai=yes

To change a network destination:

chg-dstn:dpc=25-*-*:cli=tklc

To change the **bei** parameter value of ITU national destination **8111-aa** to **yes**:

chg-dstn:dpcn=8111-aa:bei=yes

To change the **bei** parameter value of 24-bit ITU-N destination **15-100-10** to **yes**:

chg-dstn:dpcn24=15-100-10:bei=yes

To change the International alias of 24-bit ITN-N destination 12-12-12 to 5-5-5:

chg-dstn:dpcn24=12-12-12:aliasi=5-5-5

To change the 24-bit ITN-N alias of International destination 1-6-1 to 9-9-9:

chg-dstn:dpci=1-6-1:aliasn24=9-9-9

To change an existing 24-bit ITN-N destination to contain a 24-bit ITN-N SPC:

chg-dstn:dpcn24=12-12-12:spcn24=25-25-25

To change ITU-I spare destination point code s-2-100-1:

chg-dstn:dpci=s-2-100-1:spci=s-2-129-9:aliasa=121-120-120:aliasn=s-129

To change ITU-N spare destination point code s-231:

chg-dstn:dpci=s-231:spcn=129:aliasa=120-120-122:aliasi=s-2-123-2

Dependencies

NOTE: A *full point code* contains numerical values for all three segments of the point code.

At least one optional parameter must be specified.

The specified destination point code value must already be defined in the Destination point code table.

The destination address must be a full point code, a network destination, or a cluster point code.

The ANSI self-ID destination point code for the STP must be defined before ANSI destinations can be changed.

The ITU-I self-ID destination point code for the STP must be defined before ITU-I destinations can be changed.

The ITU-N self-ID destination point code for the STP must be defined before ITU-N destinations can be changed.

The Spare Point Code Support feature must be enabled before the spare point code prefix s- can be specified for an ITU-I or ITU-N destination, secondary, or alias point code.

If the **dpcn** or **aliasn** parameter is specified, the format must match the format that was assigned with the **chg-stpopts:npfinti** parameter.

When the 7000 Routesets or 8000 Routesets feature quantity is enabled, the total number of provisioned aliases in the system cannot exceed 8000.

Alias point codes are allowed only for full point code destinations.

Alias point codes for destinations must be full point codes.

A specified alias cannot already be defined as a destination address.

Alias ANSI point codes cannot be members of a cluster or network destination.

The specified alias network type must be different from the destination point code network type.

A 24-bit ITU-N point code cannot have:

- A 14-bit ITU-N alias point code
- An ANSI alias point code

A 24-bit ITU-National point code can have an ITU-I point code alias. This allows conversion of 14-bit ITU-I routing label to 24-bit routing label and vice versa.

An ANSI or ITU-I point code can have either a 14-bit ITU-N alias or a 24-bit ITU-N alias, but not both.

A 14-bit ITU-N point code cannot have a 24-bit ITU-N alias point code.

An ANSI point code cannot have a 24-bit ITU-N alias point code.

If an ITU-I point code is specified, either the **aliasn** or the **aliasn24** parameter can be specified, but not both.

Cluster destinations are allowed only if the CRMD feature is turned on.

The **ncai** parameter can be specified only for cluster destinations.

The **elei** parameter can be specified only for cluster destinations (for example, **dpc=ni-nc-***).

The **bei** parameter can be specified only for cluster destinations.

The NCR (Nested Cluster Routing) feature must be turned on before the **ncai** parameter can be specified.

Network routing is valid only if the Network Routing (NRT) feature is turned on.

When using network routing, if the destination point code has a value of * in the *nc* subfield, the *ncm* subfield must also be * (for example, **dpc=21-*-***).

If a provisioned nested cluster point code is being changed to a non-nested cluster point code (**ncai=no**), previously provisioned members of the cluster must have the same route set.

If a provisioned non-nested cluster point code is being changed to a nested cluster point code (**ncai=yes**), the maximum number of provisioned nested clusters must be no greater than 500.

If specified, the **spc** parameter value must already be configured as a secondary point code in the Secondary Point Code table.

If specified, the **spc** parameter value must be a full point code (except when **spc=none**).

If the **spc** parameter is specified, the **domain=ss7** parameter must be specified.

If the **spc** parameter is specified (except when **spc=none**), the specified destination point code (**dpc**) must be a full point code.

If the **spc** parameter is specified (except when **spc=none**), its network type must match the network type for the destination point code (**dpc**).

If a new **cli** for the destination point code is specified, it cannot match the **cli** of the system.

If the corresponding destination for the specified destination point code is an adjacent signaling point (matched a Far End point code in its linkset entity set), the **cli** of the specified destination point code cannot be assigned to any other destination address.

Alias point codes are supported only for destinations in the SS7 domain (**domain=ss7**).

A reserved word cannot be specified for the destination identifier (**cli**).

If an ITU national destination is being changed and the ITUDUPPC feature is turned on, the following applies depending on whether the destination uses an SPC (secondary point code):

If the destination does *not* use an SPC, the group code of the destination must be the same as the group code of the ITU national true point code.

If the destination uses an SPC, then the group code of the destination must match the group code of the SPC.

For example, if the ITU national true point code has a group code of **ee**, then destinations with group codes of **ee** can be added without using an SPC. Destinations with a group code of **ff**, however, must use an SPC with a group code of **ff**.

Notes

The **domain** parameter of a destination (see the **ent-dstn** command) cannot be changed with this command. To change the **domain** parameter, the destination must be removed with the **dlt-dstn** command and re-entered with the **ent-dstn** command.

In this command, only ITU-international and ITU national point codes and aliases support the spare point code subtype prefix (**s-**). Only ITU-international and ITU national point codes support the private and spare point code subtype prefix (**ps-**). All of the point code types support the private (internal) point code subtype prefix (**p-**). Aliases do not support the private (internal) point code prefix.

Output

The following example shows the display of the destination memory space accounting command completion response with the NCR, NRT, and CRMD features off (disabled) and all Routes and Routesets features off (disabled):

chg-dstn:dpca=111-222-111:aliasn=321

```
rlghncxa03w 04-08-17 15:35:05 EST EAGLE 31.8.0
Destination table is (10 of 2000) 1% full
Alias table is (8 of 12000) 1% full
CHG-DSTN: MASP A - COMPLTD
```

;

The following example shows the display of the destination memory space accounting command completion response with the NCR, NRT, and CRMD features off (disabled) and the 5000 Routes feature on:

chg-dstn:dpca=111-222-111:aliasn=321

```
rlghncxa03w 04-08-18 08:29:15 EST EAGLE 31.8.0
Destination table is (10 of 5000) 1% full
Alias table is (8 of 12000) 1% full
CHG-DSTN: MASP A - COMPLTD
```

;

The following example shows the display of the destination memory space accounting command completion response with one or more of the NCR, NRT, or CRMD features on and the DSTN5000 (5000 Routes) feature on:

chg-dstn:dpca=111-222-111:aliasn=321

```
rlghncxa03w 04-08-18 08:29:15 EST EAGLE 31.8.0
DESTINATION ENTRIES ALLOCATED: 5000
  FULL DPC(s): 9
  NETWORK DPC(s): 0
  CLUSTER DPC(s): 1
  TOTAL DPC(s): 10
  CAPACITY (% FULL): 1%
ALIASES ALLOCATED: 12000
  ALIASES USED: 8
  CAPACITY (% FULL): 1%
X-LIST ENTRIES ALLOCATED: 500
CHG-DSTN: MASP A - COMPLTD
```

;

The following example shows the display of the destination memory space accounting command completion response with the NCR, NRT, and CRMD features off (disabled) and the 6000 Routesets feature on:

chg-dstn:dpca=111-222-111:aliasn=321

```
rlghncxa03w 04-08-18 08:29:15 EST EAGLE 31.8.0
Destination table is (60 of 6000) 1% full
Alias table is (8 of 12000) 1% full
CHG-DSTN: MASP A - COMPLTD
```

;

The following example shows the display of the destination memory space accounting command completion response with one or more of the NCR, NRT, or CRMD features and the 6000 Routesets feature on:

chg-dstn:dpca=111-222-111:aliasn=321

```
rlghncxa03w 04-08-18 08:29:15 EST EAGLE 31.8.0
DESTINATION ENTRIES ALLOCATED: 6000
  FULL DPC(s): 46
  NETWORK DPC(s): 1
  CLUSTER DPC(s): 1
  TOTAL DPC(s): 12
  CAPACITY (% FULL): 1%
ALIASES ALLOCATED: 12000
  ALIASES USED: 8
  CAPACITY (% FULL): 1%
X-LIST ENTRIES ALLOCATED: 500
CHG-DSTN: MASP A - COMPLTD
```

;

The following example shows the display of the destination memory space accounting command completion response with the NCR, NRT, and CRMD features off (disabled). When the 7000 Routesets quantity feature is on, the Destination table line shows "...of 7000" as it appears in the example. When the 8000 Routesets quantity feature is on, the Destination table line shows "...of 8000".

chg-dstn:dpca=111-222-111:aliasn=321

```
rlghncxa03w 04-08-18 08:29:15 EST EAGLE 31.8.0
Destination table is (60 of 7000) 1% full
Alias table is (8 of 8000) 1% full
CHG-DSTN: MASP A - COMPLTD
```

;

The following example shows the display of the destination memory space accounting command completion response with one or more of the NCR, NRT, or CRMD features on: When the 7000 Routesets quantity feature is on, the DESTINATION ENTRIES ALLOCATED line shows "8000" as it appears in the example. When the 7000 Routesets quantity feature is on, the DESTINATION ENTRIES ALLOCATED line shows "7000".

chg-dstn:dpca=111-222-111:aliasn=321

```
rlghncxa03w 04-08-18 08:29:15 EST EAGLE 31.8.0
DESTINATION ENTRIES ALLOCATED: 8000
  FULL DPC(s): 9
  NETWORK DPC(s): 0
  CLUSTER DPC(s): 1
  TOTAL DPC(s): 10
  CAPACITY (% FULL): 1%
ALIASES ALLOCATED: 8000
  ALIASES USED: 8
  CAPACITY (% FULL): 1%
X-LIST ENTRIES ALLOCATED: 500
CHG-DSTN: MASP A - COMPLTD
```

;

chg-e1

Change E1 Interface

Use this command to change an interface for an E1 card (a 2-port E1 card, an E1/T1 MIM card, an HC-MIM card used as an E1 card, or an HC-MIM card used as an SE-HSL card) in the system. The E1 port number on the card and the E1 card location in the EAGLE 5 SAS must be specified.

CRC4, CAS, CCS, encoding, timing source, and NFAS signaling bit options can be set.

On a HC-MIM card, E1 ports 1, 3, 5, and 7 (master ports) can be independently channel bridged with their adjacent even-numbered (slave) E1 ports 2, 4, 6, and 8 to allow non-signaling data pass-through.

Keyword: chg-e1

Related Commands: dlt-e1, ent-e1, rtrv-e1, tst-e1

Command Class: Database Administration

Parameters

:e1port= (mandatory)

E1 port number. The value must be an E1 port that has already been configured with an E1 interface on the specified E1 card.

Range: 1- 8

Ports 3 through 8 can be specified only for HC-MIM cards.

Any 2 of the 8 ports on an HC-MIM card can be specified when the card is used as an SE-HSL card.

:loc= (mandatory)

Card address. The card location as stenciled on the shelf of the system.

Range: 1101-1108, 1111-1112, 1201-1208, 1211-1218, 1301-1308, 1311-1318, 2101-2108, 2111-2118, 2201-2208, 2211-2218, 2301-2308, 2311-2318, 3101-3108, 3111-3118, 3201-3208, 3211-3218, 3301-3308, 3311-3318, 4101-4108, 4111-4118, 4201-4208, 4211-4218, 4301-4308, 4311-4318, 5101-5108, 5111-5118, 5201-5208, 5211-5218, 5301-5308, 5311-5318, 6101-6108, 6111-6118

:cas= (optional)

CAS (**on**) or CCS (**off**) indicator.

Range: on, off

CAS cannot be specified for HC-MIM cards.

Default: No change in current value

:chanbrdg= (optional)

Port bridging status. Indicates whether an HC-MIM card odd-numbered E1 port is channel bridged with its adjacent even-numbered E1 port for non-signaling data pass through.

Range: on, off

Default: off

:crc4= (optional)

CRC4 enable or disable indicator.

Range: on, off

Default: No change in current value

:encode= (optional)

Indicator for use of HDB3 or AMI encoding/decoding.

NOTE: AMI is not supported for the 2-port E1 card; AMI is supported for the E1/T1 MIM card or HC-MIM card used as an E1 card.

Range: hdb3, ami

Default: No change in current value

:e1tsel= (optional)

Timing source. Indicates master (external) or slave (line) timing source, or timing source recovered from the paired master port for channel bridged slave ports.

Range: line, external, recovered

Default: No change in current value

:minsurate= (optional)

Minimum signal unit rate. Indicates the minimum number of SUs present on a link uniformly distributed. This parameter is valid only when the **linkclass=unchan** parameter is specified.

Range: 500-2000

Default: No change in current value

:si= (optional)
Value of two Spare International bits of NFAS data.

Range: One digit, values **0-3**

Default: No change in current value

:sn= (optional)
Value of five Spare International bits of NFAS data.

Range: One or two digits, values **0-31**

Default: No change in current value

Example

chg-e1:loc=1205:e1port=1:crc4=off:cas=on:encode=hdb3:e1tsel=external:si=2:sn=12

chg-e1:loc=1205:e1port=2:cas=off:encode=ami

chg-e1:loc=1205:e1port=3:chanbrdg=on:e1tsel=recovered

chg-e1:loc=1205:e1port=1:minsrate=1000

Dependencies

At least one optional parameter must be specified.

The specified card location (**loc** parameter) must be equipped.

The card specified by the **loc** parameter must be a **lime1** card type.

The port specified by the **e1port** parameter must already be equipped with an E1 interface.

All signaling links serviced by the specified E1 card must be deactivated before the values for the **crc4**, **cas**, **encode**, and **e1tsel** parameters can be changed.

The **cas=on** parameter cannot be specified when timeslot 16 on the E1 card is being used by a signaling link.

The **cas=on** parameter cannot be specified for HC-MIM cards.

The **encode=ami** parameter is supported only for the E1/T1 MIM card or HC-MIM card used as an E1 card, and not for the 2-port E1 card.

The **chanbrdg** parameter can be specified only for HC-MIM cards.

The **chanbrdg=on** parameter cannot be specified for HC-MIM card even-numbered E1 ports.

The **chanbrdg=on** parameter cannot be specified for HC-MIM card even-numbered card locations.

The timing source parameter **e1tsel** must be specified if **chanbrdg=on** is specified.

The **e1tsel=line** parameter cannot be specified if the specified HC-MIM E1 port is in channel bridging mode.

The **e1tsel=recovered** parameter can be specified only if the specified HC-MIM E1 port is in channel bridging mode.

The **e1port** parameter values **3** through **8** cannot be specified for an even-numbered HC-MIM card location.

When provisioning an odd-numbered E1 HC-MIM port to channel bridging mode, **force=yes** must be specified if the adjacent even-numbered port is already provisioned.

The **minsurate** parameter can be specified only when the **linkclass=unchan** parameter is specified.

The **chanbrdg=on** parameter cannot be specified when the **linkclass=unchan** parameter is specified.

The **cas=on** parameter cannot be specified when the **linkclass=unchan** parameter is specified.

Channelized and un-channelized E1 ports (mixed mode) are not allowed on a single HC-MIM card (the card cannot be used as an HC-MIM card and an SE-HSL card at the same time).

Notes

When **eltsel=external** is specified, a user-supplied BITS clock is required.

External timing is derived from the EAGLE 5 SAS High-Speed Master Clock (1.544 MHz for T1 or 2.048 MHz for E1); the Master Timing feature is required. Line timing is derived from its received data stream, if present.

Output

```
chg-e1:loc=1205:e1port=2:cas=off:encode=ami
    rlgncxa03w 04-01-20 09:07:58 EST EAGLE 31.3.0
    CHG-E1: MASP A - COMPLTD
;
```

chg-eisopts

Change Eagle Support for Integrated Sentinel Options

Use this command to enable and disable the copy function associated with the Eagle Support for Integrated Sentinel (EIS) feature.

Keyword: **chg-eisopts**

Related Commands: **rtrv-eisopts**

Command Class: Security Administration

Parameters

:eiscopy= (optional)

System-wide control for MSU, alarm, and event copy to the ESP.

Range: **on, off**

Default: **off**

Example

```
chg-eisopts:eiscopy=on
```

Dependencies

At least one parameter must be specified.

The Eagle Support for Integrated Sentinel (EIS) feature must be turned on before this command can be entered.

Before the EIS copy function can be enabled, at least 2 STC cards must be installed and in the IS-NR state in the system.

Notes

None

Output

chg-eisopts:eiscopy=on

```
rlghncxa03w 04-01-20 09:07:58 EST EAGLE 31.3.0
CHG-EISOPTS: MASP A - COMPLTD
```

;

chg-feat

Change Feature

Use this command to activate the optional features available on the system.

You must purchase a feature before you turn the feature on. If you are not sure whether you have purchased a feature, contact your Tekelec Sales Representative or Account Representative.



CAUTION: The features are off when you install the system. After they are turned on with this command, you cannot turn them off.

Keyword: chg-feat

Related Commands: rtrv-feat

Command Class: Program Update

Parameters

:cncf= (optional)

This parameter turns on the Calling Name Conversion Facility (CNCF) feature.

Range: on

Default: No change in current value.

System Default: **off**

:crmd= (optional)

This parameter turns on the Cluster Routing and Management Diversity (CRMD) feature.

Range: on

Default: No change in current value.

System Default: **off**

:dstn5000= (optional)

This command turns on the 5000 Routes feature.

Range: on

Default: No change in current value.

System Default: **off**

:dynrtk= (optional)

This parameter turns on the Dynamic Routing Key feature.

Range: on

Default: No change in current value.

System Default: **off**

:e5is= (optional)

This parameter turns on the Eagle Support for Integrated Sentinel (EIS) feature. This feature cannot be turned on until the Time Slot Counter Synchronization (TSC) feature used with GSPM-II cards is turned on (**:tscsync=on**). The **e5is** parameter and the **tscsync** parameter can be specified in the same **chg-feat** command to turn both features on at the same time.

Range: on

Default: No change in current value.

System Default: **off**

:egtt= (optional)

This parameter turns on the Enhanced Global Title Translation (EGTT) feature.

Range: on

Default: No change in current value.

System Default: **off**

:fan= (optional)

This parameter turns on the cooling fan feature.

Range: on

Default: No change in current value.

System Default: **off**

:gflex= (optional)

This parameter turns on the GSM flexible numbering (G-Flex) feature.

Range: on

Default: No change in current value.

System Default: **off**

:gport= (optional)

This parameter turns on the GSM mobile number portability (G-Port) feature.

Range: on

Default: No change in current value.

System Default: **off**

:gtt= (optional)

This parameter turns on the Global Title Translation (GTT) feature.

Range: on

Default: No change in current value.

System Default: **off**

:gws= (optional)

This parameter turns on the Gateway Screening (GWS) feature.

Range: on

Default: No change in current value.

System Default: **off**

:inp= (optional)

This parameter turns on the INAP (Intelligent Network Application Part) number portability feature.

Range: on

Default: No change in current value.

System Default: **off**

:ipisup= (optional)

This parameter turns on the ISUP Routing Over IP (IPISUP) feature.

Range: on

Default: No change in current value.

System Default: **off**

:ituduppc= (optional)

This parameter turns on the ITU National Duplicate Point Code (ITUDUPPC) feature.

Range: on

Default: No change in current value.

System Default: **off**

:itumtps= (optional)

This parameter turns on the ITU MTP Restart feature.

Range: on

Default: No change in current value.

System Default: **off**

:lan= (optional)

This parameter turns on the STP LAN feature.

Range: on

Default: No change in current value.

System Default: **off**

:lfs= (optional)

This parameter turns on the Link Fault Sectionalization (LFS) feature.

Range: on

Default: No change in current value.

System Default: **off**

:measplat= (optional)

This parameter turns on the Measurements Platform feature. The

chg-measopts:platformenable=on command must be entered to enable the Measurement Platform collection function (which cannot be disabled after it is enabled in the system).

Range: on

Default: No change in current value.
System Default: **off**

:mgtt= (optional)

This parameter turns on the Modified Global Title Translation (MGTT) feature. The MGTT feature replaces the PRFXDLGT feature.

Range: on

Default: No change in current value.
System Default: **off**

:mpc= (optional)

This parameter turns on the Multiple Point Code (MPC) feature.

Range: on

Default: No change in current value.
System Default: **off**

:mtpsr= (optional)

This parameter turns on the ANSI MTP Restart feature.

Range: on

Default: No change in current value.
System Default: **off**

:ncr= (optional)

This parameter turns on the Nested Cluster Routing (NCR) feature.

Range: on

Default: No change in current value.
System Default: **off**

:nrt= (optional)

This parameter turns on the Network Routing feature.

Range: on

Default: No change in current value.
System Default: **off**



CAUTION: When using the Network Routing feature, limited network management is provided for point codes not covered by full point code routing, Cluster Routing, or Nested Cluster Routing.

:plnp= (optional)

This parameter turns on the PCS (Personal Communication Service) 1900 Number Portability feature.

Range: on

Default: No change in current value.
System Default: **off**

:sccpcnv= (optional)

This parameter turns to the SCCP conversion feature.

Range: on

Default: No change in current value.

System Default: **off**

:seas= (optional)

This parameter turns on the Signaling Engineering Administration System (SEAS) feature.

Range: on

Default: No change in current value.

System Default: **off**

:slsocb= (optional)

This parameter turns on the Other CIC (Circuit Identification Code) Bit Used feature.

Range: on

Default: No change in current value.

System Default: **off**

:tcapcnv= (optional)

This parameter turns on the TCAP conversion feature.

Range: on

Default: No change in current value.

System Default: **off**

:tlnp= (optional)

This parameter turns on the Triggerless Local Number Portability (TLNP) feature.

Range: on

Default: No change in current value.

System Default: **off**

:tcsync= (optional)

This parameter turns on the Time Slot Counter Synchronization (TSC) feature that is used with GSM-II cards. This feature is required, along with use of STC cards, for the Eagle Support for Integrated Sentinel feature (**e5is=on**).

Range: on

Default: No change in current value.

System Default: **off**

:vgtt= (optional)

This parameter turns on the Variable Length GTT (VGTT) feature.

Range: on

Default: No change in current value.

System Default: **off**

:wnp= (optional)

This parameter turns on the Wireless Number Portability (WNP) feature.

Range: on

Default: No change in current value.
System Default: off

:x252000= (optional)

This parameter turns on the 2000 X.25 Routes and Destinations feature.

Range: on

Default: No change in current value.
System Default: off

:x25g= (optional)

This parameter turns on the X.25/SS7 Gateway feature.

Range: on

Default: No change in current value.
System Default: off

Example

chg-feat:gtt=on

chg-feat:gws=on:cncf=on

chg-feat:gtt=on:gws=on:crmd=on:x25g=on:lan=on:lfs=on

chg-feat:sccpcnv=on:tcapcnv=on

chg-feat:tscsync=on:e5is=on

chg-feat:mgtt=on

Dependencies

At least one optional parameter must be specified.

The Gateway Screening feature must be turned on (**gws=on**) before the following features can be turned on:

- The STP LAN feature (**lan=on**)
- The CNCF feature (**cncf=on**)

The SCCP conversion feature must be on (**sccpcnv=on**) before the TCAP conversion feature can be turned on (**tcapcnv=on**).

NOTE: The "LNP feature" is turned on when the LNP ported TNs quantity appears in the **rtrv-ctrl-feat** command output. An LNP quantity feature access key has been enabled and turned on. See the **enable-ctrl-feat** and **chg-ctrl-feat** commands for more information about turning on the LNP feature.

The LNP feature must be turned on before the following features can be turned on:

- The Wireless Number Portability feature (**wnp=on**)
- The PCS 1900 Number Portability feature (**plnp=on**)

The LNP feature must be turned on and the Gateway Screening feature must be turned on (**gws=on**) before the Triggerless LNP feature can be turned on (**tlnp=on**).

If **dstn5000=on**, the values of the **mtpdpcq** (destination point code) and **mtpxlq** (exception list entries) parameters of the **chg-stpopts** command can total **5500**. Otherwise, the sum total for **mtpdpcq** and **mtpxlq** cannot exceed **2500**. Note that the Cluster Routing and Management Diversity (CRMD) feature must be turned on before the **mtpxlq** parameter can be specified.

The X.25/SS7 Gateway feature must be turned on (**x25g=on**) before the 2000 X.25 Routes and Destinations feature can be turned on (**x252000=on**).

The Cluster Routing and Management Diversity (CRMD) feature must be turned on (**crmd=on**) before the Nested Cluster Routing (NCR) feature can be turned on (**ncr=on**).

The Global Title Translation (GTT) feature must be turned on (**gtt=on**) before the Enhanced Global Title Translation (EGTT) feature (**egtt=on**) or the Modified Global Title Translation (MGTT) feature (**mgtt=on**) can be turned on. When the EGTT feature is turned on, three new command sets, the GTT Selector (**ent/chg/dlt/rtrv-gttsel**), GTT Set (**ent/dlt/rtrv-gttset**), and GTA (**ent/chg/dlt/rtrv-gta**) commands, replace the following Translation Type and Global Title Translation commands: **ent/dlt/rtrv-tt**, and **ent/chg/dlt/rtrv-gtt**. All data previously provisioned with these commands is maintained.

The EGTT feature cannot be turned on while there is an SCCP card running on a 486 processor.

The Multiple Point Code (MPC) feature must be turned on (**mpc=on**) before the ITU National Duplicate Point Code (ITUDUPPC) feature can be turned on (**ituduppc=on**).

The Global Title Translation (GTT) feature must be turned on (**gtt=on**) before the INAP (Intelligent Network Application Part) number portability (INP) feature (**inp=on**) can be turned on.

If the LNP feature is turned on, the INP feature cannot be turned on. If the INP feature is turned on, the LNP feature cannot be turned on.

If the LNP feature is turned on, the G-Flex or G-Port feature cannot be turned on. If the G-Flex or G-Port feature is turned on, the LNP feature cannot be turned on.

If the LNP ELAP Configuration feature is turned on, the INP, G-Flex, or G-Port feature cannot be turned on. If the INP, G-Flex, or G-Port feature is turned on, the LNP ELAP Configuration feature cannot be turned on. The LNP ELAP Configuration feature can be displayed by entering the **rtrv-ctrl-feat** command.

The Global Title Translation (GTT) feature must be turned on (**gtt=on**) or Enhanced Global Title Translation (EGTT) feature (**egtt=on**) must be turned on before the G-Flex feature can be turned on (**gflex=on**).

The Global Title Translation (GTT) feature must be turned on (**gtt=on**) before the Variable Length GTT (VGTT) feature (**vgtt=on**), or the GSM Mobile Number Portability (G-Port) feature (**gport=on**) can be turned on.

The G-Port, G-Flex, and INP features require DSM cards in the system.

To turn on both the VGTT and LNP features requires that the system has all DSM cards. To turn on both the VGTT and EGTT features requires that the system has TSM or DSM cards. The VGTT feature requires TSM or DSM cards in the system.

The Global Title Translation (GTT) feature must be turned on (**gtt=on**) before the Modified Global Title Translation (MGTT) feature (**mgtt=on**) can be turned on.

The Modified Global Title Translation (MGTT) feature (**mgtt=on**) cannot be turned on if any SCCP card has less than a 586 processor.

Both cards that run the OAM must be GPSM-II cards before the Time Slot Counter Synchronization (TSC) feature (**tsctsync** parameter) can be turned on.



CAUTION: Never install or initialize MCAP cards in card slots 1113 and 1115 after GPSM-II cards are provisioned in these slots. Attempting to initialize MCAP cards after GPSM-II cards have been provisioned in slots 1113 and 1115 will cause a system outage. Before replacing an existing GPSM-II card in slot 1113 or 1115, contact Tekelec Customer Service.

The Time Slot Counter Synchronization (TSC) feature (**tsctsync** parameter) must be turned on before the Eagle Support for Integrated Sentinel feature (**e5is** parameter) can be turned on. The two parameters can be specified in the same **chg-feat** command to turn them both on at the same time.

The SCCP and TCAP conversion features (SCCPCNV and TCAPCNV) cannot be turned on when the ANSI-ITU-China SCCP Conversion feature is enabled (see the **enable-ctrl-feat** command).

The GPORT and INP features cannot be turned on if the **ansigflex** system option is enabled (see the **chg-stpopts** command).

Notes

This command is not allowed in upgrade mode.

After a feature bit is turned on, it cannot be turned off. Take care in turning on features that are not used in the network configuration.

The Calling Name Conversion Facility (CNCV) feature provides a conversion of ISUP IAM messages. The facility uses the following two versions of calling name identification presentation (CNIP) for calling name information delivery:

- The nonstandard, proprietary ISUP party information (PIP) parameter.
- The ANSI standard ISUP generic name (GN) parameter.

The conversion either replaces the PIP parameter with the GN parameter or the GN parameter with the PIP parameter in the ISUP IAM message. The user can set up GWS screens to apply the CNCV feature on a per-point-code or range-of-point-code basis.

The Cluster Routing and Management Diversity (CRMD) feature allows the system to configure one route set to an entire cluster of destinations, thus enabling the system to manage and switch traffic to more end nodes.

The Global Title Translation (GTT) feature allows the system to provide translation of the global title digits located in the called party address of an SCCP message. The translation consists of a point code and subsystem number. This feature requires TSMs or DSMs loaded with the SCCP application.

The Enhanced Global Title Translation (EGTT) feature provides enhancements to the way the system performs GTT for both ITU and ANSI messages. The feature allows the combination of domain (ANSI or ITU), global title indicator (GTI), translation type (TT), numbering plan (NP), and nature of address indicator (NAI) selectors to be used to select a translation table when the system receives a message requiring EGTT. The feature also allows inclusion of the translated subsystem number (SSN) in the called party address (CDPA) and inclusion of the originating point code (OPC) in the calling party address (CGPA). The feature also provides deletion capability of the GT (global title) in the CDPA.

The Modified Global Title Translation (MGTT) feature allows customizing of the GTT information in the MSU (in addition to the Translation Type) to ensure correct routing. The Global Title information can be modified on outbound MSUs for some networks in order to be compatible with the network the MSU is going to. The MGTT feature replaces the Prefix Deletion of Global Title (PRFXDLGT) feature.

The Gateway Screening (GWS) feature allows the system to screen specific message types with selected parameters from entering the network through this STP. This feature requires TSM cards loaded with the GLS application.

The STP LAN feature allows selected SS7 messages to be copied and sent to a remote host over an ethernet LAN using the TCP/IP protocol. This feature also requires the gateway screening feature and application communication modules (ACMs).

The Triggerless LNP (TLNP) feature gives service providers a method to route calls to ported numbers without having to upgrade their signaling switch (end office or mobile switching center) software. This feature uses the gateway screening stop action TLNP to intercept through-switched ISUP messages on the LIM.

The Link Fault Sectionalization (LFS) feature allows the system to perform a series of far end loopback tests that identify faulty segments of an SS7 transmission path up to and including the remote network element.

The ANSI MTP Restart (MTPRS) feature provides an orderly process for bringing signaling links back into service after the system has been isolated and restarted. A greater preference is given to restoring the STP to network service in an orderly fashion than to the speed of recovery. The time required is system dependent; Table 5-12 provides examples of some approximate times.

Table 5-12. Link Alignment Performance

System Size (No. of LIMs)	Link Alignment Delay (seconds)
Up to 64	62
64 to 127	97
128 to 191	132
More than 191	167

The ITU MTP Restart (ITUMTPRS) feature provides MTP restart support for ITU networks and extends the system's ANSI MTP restart support to mixed ITU and ANSI networks. The performance of ITU MTP Restart is comparable to the performance of ANSI MTP Restart.

SEAS interface support allows the system to interface with the Signaling Engineering and Administration System (SEAS).

The X.25/SS7 Gateway (X25G) feature allows cellular providers to connect their X.25 signaling networks to other providers SS7 network.

The SCCP and TCAP conversion features (SCCPCNV and TCAPCNV) allow the system to convert MTP-routed SCCP and TCAP messages from ANSI to ITU format and to convert ITU formatted messages to ANSI.

The PCS 1900 LNP Query (PLNP) feature provides for LNP query/response in a PCS wireless environment using the LRN method to support Service Provider Number Portability.

The Nested Cluster Routing (NCR) feature allows the system to support full point code entries on different routes within a cluster.

The Other CIC (Circuit Identification Code) Bit Used feature is one of two methods provided as ITU SLS enhancements for distributing the load across links in a combined and single linkset. The Other CIC Bit Used feature lets the system derive the LSB (Least Significant Bit) from bits 2 through 4 of the CIC to serve as the three lower bits of the SLS (Signaling Link Selection) and one other bit of the CIC to serve as the MSB (Most Significant Bit) of the SLS. The SLSOCB feature applies only to ITU-ISUP messages. The other method of distributing the load is rotation of the four bits of the SLS to change the LSB of the SLS. For additional information on bit rotation, see the **ent-ls** command.

The Network Routing (NR) feature allows provisioning of a single routeset to be used for all MSUs destined to members of that network.

The DSTN5000 (5000 Routes) feature provides the ability to administer up to 5000 routes on the system.

The MPC (Multiple Point Code) feature enables the user to use SPCs (secondary point codes) in addition to the true point codes that the EAGLE 5 SAS uses. The SPCs are used for provisioning and routing as if they were the true point code of the EAGLE 5 SAS. SPCs can be provisioned in any of the three domains (ANSI, ITU-N, and ITU-I). SPCs are supported for any type of link.

The ITUDUPPC (ITU National Duplicate Point Code) feature allows an EAGLE 5 SAS STP mated pair to route traffic for two or more countries that may have overlapping point code values.

The INP [INAP (Intelligent Network Application Part) Number Portability] feature supports service-provider number portability, which allows subscribers to change to a new service provider while retaining their phone number.

The G-Flex (GSM Flexible Numbering) feature optimizes the use of subscriber numbers and number ranges by providing a logical link between any MSISDN (Mobile Station ISDN number), MDN (Mobile Dialed Number), or MIN (Mobile Identification Number) and any IMSI (International Mobile Station Identifier), between any IMSI and any HLR, and/or between any MSISDN/MDN/MIN and any HLR. This link allows subscribers to move from one HLR (Home Location Register) to another.

The VGTT (Variable Length GTT) feature provides the ability to provision global title entries of varying lengths to a single translation type or GTT set. Users are able to assign global title entries of up to 10 different lengths to a single translation type or GTT set.

The G-Port (GSM Mobile Number Portability) feature provides the ability for a mobile subscriber to change the GSM subscription network within a portability cluster while retaining the original MSISDNs (Mobile Station ISDN numbers).

The Time Slot Counter Synchronization (TSCSYNC) feature allows the system's A (Active) and B (Standby) internal clocks to be synchronized by the GPSM-II card that is running the standby OAM.

The Eagle Support for Integrated Sentinel feature provides an Ethernet interface between the EAGLE 5 SAS STP and the Sentinel Extended Services Platform (ESP), to eliminate the need for cabling between each SS7 link and the ESP to monitor SS7 traffic.

The Measurements Platform feature provides a dedicated processor for collecting and reporting STP, LNP, INP, G-Flex, and G-Port Measurements data, with support for EAGLE 5 SAS STP growth to more than 700 links.

Output

chg-feat:gtt=on

```
rlghncxa03w 04-01-11 11:34:04 EST EAGLE 31.3.0
CHG-FEAT: MASP A - COMPLD
;
```

chg-ftp-serv

Change FTP Server Entry

Use this command to change an entry for an FTP server in the FTP Server table.

NOTE: Though the user parameter value is available, it is not for customer use unless directed by Tekelec Technical Support. The FTP-based Table Retrieve Application (FTRA) sends the necessary FTP Server information to the system, and the system overwrites any entry that is already in the FTP Server table for that server.

Keyword: chg-ftp-serv

Related Commands: dlt-ftp-serv, ent-ftp-serv, rtrv-ftp-serv

Command Class: Database Administration

Parameters

:app= (mandatory)

The FTP Client application that interfaces with the FTP server.

Range: meas, user

meas—the Measurements Platform application

user—the FTP-based Table Retrieve Application (FTRA)

:ipaddr= (mandatory)

IP Address of the FTP Server.

Range: 4 numbers separated by dots, with each number in the range of 000–255.

:login= (optional)

FTP Server Username (A prompt for entering a password appears on a separate line).

Range: 1 to 15 alphanumeric characters; mixed-case is allowed

:path= (optional)

FTP path used to locate the file that will be sent.

Range: Up to 100 characters; mixed-case string in double quotes with valid FTP path format

Default: User's home directory

:prio= (optional)

Priority of this FTP server when there is more than one FTP Server for this application.

Range: 1 - 10

Example

```
chg-ftp-serv:app=meas:ipaddr=1.255.0.102:login=ftpmeas1:path="~meas":prio=1
```

```
chg-ftp-serv:app=user:ipaddr=1.255.0.102:login=tekperson1:path="~\data":prio=1
```

Dependencies

At least one optional parameter must be specified.

The **app** parameter must specify an application that uses the FTP Support feature.

The **ipaddr** parameter must specify a valid IP address for the FTP server.

The **path** parameter value must be in a valid FTP path format.

The **prio** parameter specifies a priority for use of an FTP server by an application when the application has more than one FTP server defined in the table. Each FTP server defined for use by the application must have a priority from 1 to 10 assigned. The available FTP server with the highest priority (smallest number) will be used first by the application.

If the **login** parameter is specified, a separate prompt appears for entry of the FTP server password. You must enter a password that is at least 1 and not more than 15 characters long. If an invalid password is entered or the Return key is pressed without entering a password, the entire command must be entered again to cause the password prompt to appear again. The password is not displayed as it is entered.

An entry for the specified application ID at the specified priority cannot already exist.

The FTP server entry to be changed with this command must already exist in the FTP Server table for the specified IP address and application.

Notes

The same FTP server can be defined more than once, but the specified application must be different for each entry.

Output

```
chg-ftp-serv:app=meas:ipaddr=1.255.0.102:path="-ftpmeas1"
```

```
rlghncxa03w 04-01-20 09:07:58 EST EAGLE 31.3.0
CHG-FTP-SERV: MASP A - COMPLTD
```

```
;
```

```
chg-ftp-serv:app=meas:ipaddr=1.255.0.102:login=ftpmeas1
```

```
Enter Password:*****
```

```
rlghncxa03w 04-01-20 09:07:58 EST EAGLE 31.3.0
CHG-FTP-SERV: MASP A - COMPLTD
```

```
;
```

```
chg-ftp-serv:app=user:ipaddr=1.22.10.2:prio=3
```

```
rlghncxa03w 04-01-20 09:07:58 EST EAGLE 31.3.0
CHG-FTP-SERV: MASP A - COMPLTD
```

```
;
```

chg-gpl**Change Generic Program Load**

Use this command to copy a generic program load from the system removable cartridge to the destination active and standby system disks as a "trial" version. The system release identification file is uploaded from the system removable cartridge to the active and standby fixed drives along with each GPL. This command also provides a parameter to turn GPL auditing "on" and "off".

Keyword: **chg-gpl**

Related Commands: **act-gpl, alw-card, copy-gpl, init-card, init-sys, rept-stat-gpl, rtrv-gpl**

Command Class: Program Update

Parameters

:appl= (obsolete)

This parameter is obsolete; use the **gpl** parameter.

The **appl** parameter has been replaced with the **gpl** parameter to more accurately indicate that a GPL, and not an application, is specified for the parameter value.

:gpl= (mandatory)

The generic program load (GPL) identifier. The name of the GPL to be uploaded from the system removable cartridge to the system disks.

Range: **atmansi, atmitu, blbios, blcpld, bldiag, blvxw, bpdcm, bphcap, bphcapt, bphmux, bpmpl, bpmplt, ccs7itu, cdu, ebdablm, ebdadcm, emdc, eoam, eroute, gls, hipr, imt, imtpci, ipgwi, iplim, iplimi, ips, mcp, plde1t1, pldpmc1, sccp, ss7ansi, ss7gx25, ss7hc, ss7ipgw, ss7ml, stplan, vcd, vsccp, vxwslan**

atmansi—The GPL is used by the LIM cards to support the high-speed ATM signaling link feature.

atmitu—The GPL is used by the E1 ATM cards to support the high-speed E1 ATM signaling link feature.

blbios —A flash GPL containing the BIOS ROM image on HC-MIM cards that are used for E1 or T1 signaling links.

blcpld —A flash GPL containing the bit-files for the CPLD on HC-MIM cards that are used for E1 or T1 signaling links.

bldiag —A flash GPL containing the diagnostic code on HC-MIM cards that are used for E1 or T1 signaling links.

blvxw —A flash GPL containing the VxWorks operating system on HC-MIM cards that are used for E1 or T1 signaling links.

bphmux —This GPL is used to support Board PROM for HMUX flash memory.

bphcap —This GPL is used to support Board PROM for HCAP flash memory.

bphcapt —This GPL is used to support Board PROM for HCAP-T flash memory.

bphmux —This GPL is used to support Board PROM for HMUX flash memory.

bpmpl—This GPL is used to support Board PROM for MPL flash memory.

bpmplt—This GPL is used to support Board PROM for E1/T1 flash memory and Board Prom for MPL-T flash memory.

ccs7itu—This GPL is used by the LIM cards for ITU-TSS MTP functionality.

cdu—This GPL is used in the card manufacturing process.

ebdablm—This GPL is used by the TSM card for enhanced bulk download.

- ebdadcm**—This GPL is used by the DCM card to transmit the LSMS LNP database to the EAGLE 5 SAS at high speed over an ethernet connection for enhanced bulk download.
- emdc**—This GPL is used by the DCM card for CMIP/OSI measurement collection interface as defined by Telcordia GR-376.
- eoam** —This GPL is used by the GPSM-II card for enhanced OAM functions.
- eroute**—This GPL is used by the STC card for Eagle Support for Integrated Sentinel functions.
- gls**—This GPL is used by the TSM cards for downloading gateway screening to LIM cards.
- hipr** —The communication software used on the High Speed IMT Packet Router (HIPR) card.
- imt**—This GPL is the communication processor on the logical processing element (LPE).
- imtpci** —The communication software that operates the IMT bus on HC-MIM cards.
- ipgwi**—This GPL is used by the DCM card for TCP/IP point-to-point connectivity for ITU point codes.
- iplim**—This GPL is used by the DCM card for TCP/IP point-to-point connectivity for ANSI point codes.
- iplimi**—This GPL is used by the DCM card for TCP/IP point-to-point connectivity for ITU point codes.
- ips**—This GPL is used by the IPSM card for the IP User Interface feature.
- mcp**—This GPL is used by the MCPM card for the Measurements Platform feature.
- pldel1t1** —A flash GPL that is used on HC-MIM cards for E1 and T1 signaling links.
- pldpmc1** —A flash GPL that is used on HC-MIM cards for E1 and T1 signaling links.
- sccp**—This GPL is used by the TSM cards for the global title translation application.
- ss7ansi**—This GPL is used by the LIM cards for the MTP functionality.
- ss7gx25**—This GPL is used by the LIM cards to support X.25 functionality.
- ss7ipgw**—This GPL is used by the system to support TCP/IP point-to-multipoint connectivity.
- ss7hc**—This GPL is used to support the functionality for the HC-MIM (High Capacity Multi-Channel Interface Module) card. The HC-MIM card runs either the **ss7ansi** or **ccs7itu** application; the **ss7hc** GPL allows the card to support up to 64 signaling links for E1 and T1 functions.
- ss7ml**—This GPL is used to support the functionality for the multi-port LIM (MPL or MPL-T) card and the E1/T1 MIM (Multi-Channel Interface Module) card. The MPL cards run only the **ss7ansi** application on a LIMDS0 card (as in the command **ent-card:type=limds0:appl=ss7ansi**); the **ss7ml** GPL allows the card to support 8 signaling links rather than the usual 2 links for LIM cards. The MPL cards support only the DS0 interface. The E1/T1 MIM card runs either the **ss7ansi** or **ccs7itu** application; the **ss7ml** GPL allows the card to support 8 signaling links for E1 and T1 functions. The older E1 card supports 2 signaling links for E1 functions).

stplan—This GPL is used by the ACM card to support the STP LAN application.

utility—This GPL is used by the factory for testing, and when directed by Tekelec Technical Services.

vcdu—This GPL is used in the card manufacturing process.

vsccp—This GPL is used by the DSM card to support the G-Flex, G-Port, INP, and LNP ELAP Configuration features. If the G-Flex, G-Port, INP, or LNP ELAP Configuration feature is not turned on, and a DSM card is present, the VSCCP GPL processes normal GTT traffic.

:ver= (optional)

Version number of the GPL, in the form of *major-minor-fix*.

Range: 0-255 for each component of the GPL version number (*major-minor-fix*).

:audit= (optional)

This parameter specifies whether the active MASP system release running version is to be audited every 90 seconds. The audit state is preserved through a system restart or power up.

NOTE: When audit is turned off, the system release audit process is stopped. The detection, marking, and reporting of corrupt GPLs is continuous and not affected by turning audit off.

Range: on, off

Default: on

Example

chg-gpl:gpl=ss7ansi:ver=101-014-000

chg-gpl:audit=on

chg-gpl:gpl=vsccp:ver=101-014-000

chg-gpl:gpl=iplim:ver=101-014-000

chg-gpl:gpl=bpmpl:ver=108-11-0

chg-gpl:gpl=ss7ml:ver=108-11-0

chg-gpl:gpl=bphmux:ver=105-21-0

chg-gpl:gpl=hipr:ver=105-21-0

chg-gpl:gpl=mcp:ver=111-17-0

chg-gpl:gpl=ipgwi:ver=111-17-0

chg-gpl:gpl=bphcapt:ver=111-17-0

chg-gpl:gpl=eoam:ver=111-17-0

chg-gpl:gpl=bpmplt:ver=112-18-0

chg-gpl:gpl=atmitu:ver=114-1-0

chg-gpl:gpl=ss7hc:ver=125-1-0

chg-gpl:gpl=blvxw:ver=125-1-0

chg-gpl:gpl=blcpld=125-1-0

chg-gpl:gpl=plde1t1:ver=125-1-0

chg-gpl:gpl=pldpmc1:ver=125-1-0

chg-gpl:gpl=blbios:ver=125-1-0

chg-gpl:gpl=imtpci:ver=125-1-0

chg-gpl:gpl=bldiag:ver=125-1-0

Dependencies

No other activate, change, copy, or retrieve GPL command can be in progress when this command is entered.

If either the **ver** or the **gpl** parameter is specified, both parameters must be specified.

The **audit** parameter, or the **ver** and **gpl** parameters together, or the **audit**, **ver**, and **gpl** parameters together must be specified.

Notes

If there is a failure changing the active system, the operation is stopped. If there is a failure changing the standby system, the active system is still updated.

A cartridge must be inserted into the removable disk drive, the cartridge must be initialized, and it must be formatted as a system disk.

Use the **rtrv-gpl** command to determine the version number and audit state of a GPL.

The **ver** and **gpl** parameters are mandatory if a generic program load is being uploaded from a removable cartridge.

The **audit** parameter is required only when turning GPL auditing on or off and the **ver** and **gpl** parameters are optional.

Before the **gpl=oap** parameter can be specified, the OAPs must be provisioned and functional.

When the **audit** parameter is set to **off**, the system release audit process is stopped. The detection, marking, and reporting of corrupt GPLs is continuous and not affected by turning audit off.

Output

chg-gpl:gpl=atmansi:ver=101-014-000

```
rlghncxa03w 05-01-10 11:43:04 EST EAGLE 33.0.0
ATMANSI upload to 1114 completed
ATMANSI upload to 1116 completed
```

;

chg-gpl:gpl=bphcap:ver=101-014-000

```
rlghncxa03w 05-01-10 11:43:04 EST EAGLE 33.0.0
BPHCAP upload to 1114 completed
BPHCAP upload to 1116 completed
```

;

chg-gpl:gpl=bphcap:ver=101-014-000

```
rlghncxa03w 05-01-10 11:43:04 EST EAGLE 33.0.0
BPHCAP corrupted on 1117 removable: mismatched checksums
```

;

chg-gpl:gpl=ss7ml:ver=105-21-0

```
rlghncxa03w 05-01-10 11:43:04 EST EAGLE 33.0.0
SS7ML upload to 1114 completed
SS7ML upload to 1116 completed
```

;

chg-gpl:gpl=bphmux:ver=105-21-0

```
rlghncxa03w 05-01-10 11:43:04 EST EAGLE 33.0.0
BPHMUX upload to 1114 completed
BPHMUX upload to 1116 completed
```

;

chg-gpl:gpl=eoam:ver=111-17-0

```
rlghncxa03w 05-01-10 11:43:04 EST EAGLE 33.0.0
EOAM upload to 1114 completed
EOAM upload to 1116 completed
```

;

chg-gpl:gpl=hipr:ver=125-1-0

```
rlghncxa03w 05-01-10 11:43:04 EST EAGLE 33.0.0
HIPR upload to 1114 completed
HIPR upload to 1116 completed
```

;

chg-gpl:gpl=ss7hc:ver=125-1-0

```
rlghncxa03w 05-01-10 11:43:04 EST EAGLE 33.0.0
SS7HC upload to 1114 completed
SS7HC upload to 1116 completed
```

;

chg-gsmmap-scrn**Change GSM MAP Screening Entry**

Use this command to change the attributes (**nforbid**, **npc/npca/npci/npcn/npcn24**, **nssn**, **ncgsr**, **ncdsr**, and **naction**) of GSM Map Screening CgPA and CdPA entries that are used to filter out or allow SCCP messages containing Map Op-Codes, CgPA GTA+NPV+NAIV, CdPA GTA+NPV+NAIV, and forbidden parameters.

Keyword: chg-gsmmap-scrn

Related Commands: dlt-gsmmap-scrn, ent-gsmmap-scrn, rtrv-gsmmap-scrn

Command Class: Database Administration

Parameters

NOTE: See “Point Code Formats and Conversion” in Appendix A for a detailed description of point code formats, rules for specification, and examples.

:cgsr= (mandatory)

CgPA Screening Reference.

Range: 1 alphabetic character followed by up to 3 optional alphanumeric characters

:opname= (mandatory)

The user-defined name for the operation code. The **opname** value references the operation code (**opcode**) defined with the **ent-gsms-opcode** command. GSM MAP Screening is performed on the specified address or addresses for the referenced operation code.

Range: Up to 8 alphanumeric characters

:cdsr= (optional)

CdPA Screening Reference.

Range: 1 alphabetic character followed by up to 3 optional alphanumeric characters

:force= (optional)

Check Mated Application Override. This parameter must be used to complete command execution if the **npc/npca/npci/npcn** and **nssn** parameter combination specified in the command is not already defined in the SCCP Application entity set (Remote Point Code/Mated Application Table).

Range: **yes, no**

Default: **no**

:naction= (optional)

The new screening action to take if a message is forbidden as defined by the **forbid** parameter.

Range: **pass, discard, atierr, route, forward, duplicate, dupdisc**

pass—Route the message as normal to the destination; a UIM will be issued.

This is intended to be a test mode and is recommended when setting up GSM Map Screening during the initial phase to assure that no MSUs will be inadvertently thrown away.

discard—Do not route the MSU. The MSU is discarded (thrown away and an appropriate UIM is issued).

atierr—Do not route the MSU. An ATI (Any Time Interrogation) reject message is generated to the originator. This value is valid only for ATI MAP operation codes.

route—Route the message as normal to the original destination node; no UIM will be generated. The original destination is the node to which normal GTT would be sent if no GSM MAP actions are taken.

forward—Route the original message to the forward node. The original message will not be sent to the original node. If, however, the forward node is not available for routing, the MSU is routed to the original node.

duplicate—Route the message as normal to the original destination and route a copy of the original message to the duplicate node. If the MSU fails to route to the duplicate node, a UIM is generated indicating the duplicate routing failure.

dupdisc—Route the original message to the duplicate node. The original message will not be sent to the original node. If, however, the duplicate node is not available for routing, the MSU is routed to the original node.

Default: No change to current value

:ncdsr= (optional)

The new CDPA Screening Reference.

Range: 1 alphabetic character followed by up to 3 optional alphanumeric characters

:ncgsr= (optional)

The new CGPA Screening Reference.

Range: 1 alphabetic character followed by up to 3 optional alphanumeric characters

:nforbid= (optional)

The new forbidden parameter value. Indicates a forbidden parameter for the specified entry. If a forbidden parameter is detected, the message is handled with the action defined by the **action/naction** parameter.

Range: **all, none, state, location**

all—All parameters are forbidden. Take the specified screening action defined by the **naction** parameter for messages arriving at the system.

none—None of the parameters are forbidden. Route the message to its destination.

state—Take the specified screening action defined by the **naction** parameter for messages arriving at the system that contain **state** as the forbidden parameter for the entered address/operation code combination. Note: The **state** parameter is valid only for GSM ATI messages.

location—Take the specified screening action defined by the **naction** parameter for messages arriving at the system that contain **location** as the forbidden parameter for the entered address/operation code combination. Note: The **location** parameter is valid only for GSM ATI messages.

Default: No change to current value

:npc/npc/npci/npcn/npcn24= (optional)

New point code. The **npc/npc/npci/npcn/npcn24** and **nssn** parameters are used when the new screening action (**naction**) is **forward**, **duplicate**, or **dupdisc** (duplicate and discard). These parameters allow the technician to change the defined node to which the input message will be routed.

:npc= or :npca= (optional)

New ANSI point code with subfields *network indicator-network cluster-network cluster member* (*ni-nc-ncm*).

Range: **000-255**

Specify a valid value for each subfield of the point code, and separate the subfields with a dash (-).

When **chg-sid:pctype=ansi** is specified, *ni* = **000** is not valid.

When **chg-sid:pctype=ansi** is specified, *nc* = **000** is not valid if *ni* = **001-005**.

When **chg-sid:pctype=ansi** is specified, *nc* = **000** is valid if *ni* = **006-255**.

The point code **000-000-000** is not a valid point code.

:npci= (optional)

New ITU international destination point code with subfields *zone-area-id*. The *prefix* subfield indicates a spare point code (*prefix-zone-area-id*).

Range: **s-, 0-255**

Specify a valid value for each subfield of the point code, and separate the subfields with a dash (-).

The point code **0-000-0** is not a valid point code.

prefix—**s-**

zone—**0-7**

area—**000-255**

id—**0-7**

:npcn= (optional)

New ITU national destination point code in the format of a 5-digit number (*nnnnn*); or 2, 3, or 4 numbers (members) separated by dashes (*m1-m2-m3-m4*) as defined by the **chg-stpopts:npcfnti** flexible point code option. A group code must be specified when the ITUDUPPC feature is turned on (*nnnnn-gc*, *m1-m2-m3-m4-gc*). The *prefix* subfield indicates a spare point code (*prefix-nnnnn*, *prefix-nnnnn-gc*, *prefix-m1-m2-m3-m4*, *prefix-m1-m2-m3-m4-gc*).

Range: s-, 0-16383, aa-zz

Specify a valid value for each subfield of the point code, and separate the subfields with a dash (-).

prefix—s-

nnnnn—0-16383

gc—aa - zz

m1-m2-m3-m4—0-14 for each member; values must sum to 14

:npcn24= (optional)

New 24-bit ITU national point code with subfields main signaling area-sub signaling area-signaling point (*msa-ssa-sp*).

Range: 000-255

Specify a valid value for each subfield of the point code, and separate the subfields with a dash (-).

msa—000-255

ssa—000-255

sp—000-255

:nssn= (optional)

New Subsystem Number. The **npc/npca/npci/npcn/npcn24** and **nssn** parameters are used when the new screening action (**naction**) is **forward**, **duplicate**, or **dupdisc** (duplicate and discard). These parameters allow the technician to change the defined node to which the input message will be routed.

Range: 002 - 255

Example

```
chg-gsmmap-scrn:opname=xyz:cgsr=fela:naction=pass
```

```
chg-gsmmap-scrn:opname=xyz:cgsr=fela:cdsr=fall:naction=discard
```

```
chg-gsmmap-scrn:opname=test2:cgsr=pcn1:npcn=s-333:nssn=254
```

Dependencies

At least one optional parameter must be specified.

If the **cdsr** parameter is specified, at least one additional optional parameter must be specified.

When the **ncdsr** parameter is specified, the **cdsr** parameter must be specified.

When the **cdsr** parameter is specified, the **ncgsr** parameter cannot be specified.

The **ncgsr** parameter and the **ncdsr** parameter cannot be specified together in the same command.

The specified **cgsr** parameter value must exist in the database.

The specified **cdsr** parameter value must exist in the database.

The specified **ncgsr** parameter value cannot already exist in the database.

The specified **ncdsr** parameter value cannot already exist in the database.

The GSM Map Screening feature (see the **enable-ctrl-feat** command) must be turned on before this command can be entered.

The Enhanced GSM Map Screening (EGMS) feature must be turned on before the **cdsr**, **ncdsr**, **pc**, and **pca** parameters can be specified.

The specified **opname** parameter value must exist in the GSM Map Op-Code table.

A value of **state** or **location** cannot be specified for the **nforbid** parameter unless the operation code (**opcode**) referenced by **opname** is **71**. An operation code of **71** signifies an ATI MAP operation code.

A value of **atierr** cannot be specified for the **naction** parameter unless the operation code (**opcode**) referenced by **opname** is **71**. The **atierr** option is valid only for ATI MAP operation codes; **opcode=71** signifies an ATI MAP operation code.

If specified, the **npc/npca/npci/npcn/npcn24** parameter must be a full point code.

The **npc/npca/npci/npcn/npcn24** and **nssn** parameters can be specified only if the **naction** parameter is specified and its value is **forward**, **duplicate**, or **dupdisc**.

If the **naction** parameter is specified and its value is **forward**, **duplicate**, or **dupdisc**, the **npc/npca/npci/npcn/npcn24** parameter and the **nssn** parameter must be specified.

The **force** parameter can be specified only if the **npc/npca/npci/npcn/npcn24** parameter and the **nssn** parameter are specified.

If the **npc/npca/npci/npcn/npcn24** parameter and the **nssn** parameter are specified, and the **force** parameter is not specified as **yes**, the PC-SSN must be populated in the SCCP Application entity set (Remote Point Code / Mated Application Table).

If specified, the **npc/npca/npci/npcn/npcn24** parameter value must exist as a destination in the Ordered Route entity set (ANSI only), or must reside in a cluster that exists as a destination in the Ordered Route entity set (for global title routing).

Notes

Unlike GTT (Global Title Translation) entries, the GSM MAP Screening commands do not support splits of ranges during deletion or changes of entries.

In this command, only ITU-international and ITU national point codes support the spare point code subtype prefix (**s-**).

Output

```
chg-gsmmap-scrn:cgsr=fela:opname=xyz:naction=pass
rlghncxa03w 04-02-20 09:07:58 EST EAGLE 31.4.0
GSM Map Screening table is (2 of 4000) 1% full
CHG-GSM MAP-SCRN: MASP A - COMPLTD
;
```

chg-gsmmap-scrn:cgsr=fela:cdsr=fall:opname=xyz:naction=discard

```
rlghncxa03w 04-02-20 09:07:58 EST EAGLE 31.4.0
GSM Map Screening table is (2 of 4000) 1% full
CHG-GSM MAP-SCRN: MASP A - COMPLTD
```

;

chg-gsmopts**Change GSM System Options**

Use this command to enter GSM (Global System for Mobile Telecommunications) system options in the database. This command updates the GSMOPTS Table.

Keyword: chg-gsmopts

Related Commands: rtrv-gsmopts

Command Class: Database Administration

Parameters

NOTE: See “Point Code Formats and Conversion” in Appendix A for a detailed description of point code formats, rules for specification, and examples.

:ccnc= (mandatory if the **mccmnc** parameter is specified)

E214 country code and network code. The G-Flex feature must be turned on before this parameter can be specified.

Range: 2–8 digits (0–9, A–F, a–f)

Default: No change to current value

:defmapvr= (optional)

The default MAP version. The G-Port feature must be turned on before this parameter can be specified.

Range: 1–3

Default: 1

:defmcc= (optional)

E212 default mobile country code. The G-Flex feature must be turned on before this parameter can be specified.

Range: 3 digits (0–9, A–F, a–f), none

none—Deletes the current value for the **defmcc** parameter.

Default: No change to current value

:defmnc= (optional)

E212 default mobile network code. The G-Flex feature must be turned on before this parameter can be specified.

Range: 1–4 digits (0–9, A–F, a–f), none

none—Deletes the current value for the **defmnc** parameter.

Default: No change to current value

:eirrsp= (optional)

Equipment Identity Register (EIR) Global Response status. The EIR feature must be enabled and turned on before this parameter can be specified. When a value other than **off** is specified, EIR responds according to the specified value.

Range: off, whitelst, graylst, blkst, unknown

off—EIR Global Response is not used.

whitelst—Indicates that the IMEI is “valid” and registration should be allowed for this handset.

graylst—Indicates that the IMEI is “questionable.” Registration should be allowed, but the event is logged in the EIR log and a special measurement peg is incremented.

blkst—Indicates that the IMEI is “invalid” and registration should not be allowed for this handset.

unknown—Indicates that the IMEI is not in the White list, the Gray list, or the Black list and registration should not be allowed for this handset.

Default: off

:eirrsptype= (optional)

Equipment Identity Register (EIR) Response Type. The EIR feature must be turned on before this parameter can be specified.

Range: type1, type2, type3

Table 5-13 on page 5-149 contains information to help you choose the value for this parameter.

Default: type1

:eirimsichk= (optional)

Equipment Identity Register (EIR) IMSI Check status. This parameter is not valid for IMEI ranges.

Range: on, off

Default: off

:is412gsm= (optional)

IS-41 to GSM migration prefix. To specify this parameter, the G-Port feature must be turned on.

Range: 1–15 digits (0–9, A–F, a–f), none

none—Deletes the current value of the **is412gsm** parameter.

Default: No change to current value

:mccmnc= (mandatory if the **ccnc** parameter is specified)

E212 mobile country code and mobile network code. The G-Flex feature must be turned on before this parameter can be specified.

Range: 4–7 digits (0–9, A–F, a–f), none

none—Deletes the current **mccmnc** and **ccnc** parameter combination entry.

Default: No change to current value

:msrndig= (optional)

The routing number to be used as is or to be concatenated with the MSISDN. The G-Port feature must be turned on before this parameter can be specified.

Range: rn, rnidn, ccrndn

rn—Routing number

rnidn—Routing number prefix and the international DN (dialed/directory number)

ccrndn—Country code, routing number, and national directory number

Default: rn

:msrnnai= (mandatory if the **msrnnp** parameter is specified)

The nature of address indicator value for the MSRN. The G-Port feature must be turned on before this parameter can be specified.

Range: 0-7

0—Unknown Nature of Address

1—International Number

2—National Significant Number

3—Network Specific Number

4—Subscriber Number

5—Reserved for national use

6—Abbreviated Number

7—Reserved for extension

Default: No change to current value

:msrnnp= (mandatory if the **msrnnai** parameter is specified)

The numbering plan value for the MSRN. The G-Port feature must be turned on before this parameter can be specified.

Range: 0-15

Default: No change to current value

:multcc= (optional)

Multiple country code. The G-Port feature must be turned on before this parameter can be specified.

Range: 1 to 3 digits (0-9, a-f, A-F)

Default: No change to current value

:nmultcc= (optional)

New multiple country code. The specified **multcc** value is either changed to the specified **nmultcc** value, or deleted if **nmultcc=none** is specified. The G-Port feature must be turned on before this parameter can be specified.

Range: 1 to 3 digits (0-9, a-f, A-F), or **none**

none—Deletes the specified **multcc** value from the multiple country code list.

Default: No change to current value

:msisdntrunc= (optional)

MS ISDN truncation digits. Specifies number of digits to delete from the beginning of the National MSISDN (MSISDN without Country Code) before formulating the MSRN parameter of the SRI-ack response. The G-Port feature must be on before this parameter can be specified.

Range: 1 digit (0-5)

Default: No change to current value

:nppmsgta= (optional)

New entity address of an Intelligent Network (IN) platform for the Prepaid Short Message Service Intercept (PPSMS) Phase 1 feature. The PPSMS Phase 1 feature must be turned on before this parameter can be specified.

Range: 1-15 digits (0-9, A-F, a-f), **none**

none—Deletes the specified **nppmsgta** parameter value.

Default: No change to current value

:ppsmgta= (optional)

Entity address of an IN platform for the Prepaid Short Message Service Intercept (PPSMS) Phase 1 feature. The Prepaid Short Message Service Intercept (PPSMS) Phase 1 feature must be turned on before this parameter can be specified.

Range: 1–15 digits (**0–9, A–F, a–f**)

Default: No change to current value

:ppmspci1= (optional)

ITU international point code (subfields *zone-area-id*) of IN platform 1 for the Prepaid Short Message Service Intercept (PPSMS) Phase 1 feature. The PPSMS Phase 1 feature must be turned on before this parameter can be specified. The *prefix* subfield indicates a spare point code (*prefix-zone-area-id*).

Range: **s-**, **0-255**, **none**

Specify a valid value for each subfield of the point code, and separate the subfields with a dash (-).

prefix—**s-**

zone—**0-7**

area—**000-255**

id—**0-7**

The point code **0-000-0** is not a valid point code.

Enter **none** to delete the IN platform 1 ITU-I point code value.

Default: No change to current value

:ppmspci2= (optional)

ITU international point code (subfields *zone-area-id*) of IN platform 2 for the Prepaid Short Message Service Intercept (PPSMS) Phase 1 feature. The PPSMS Phase 1 feature must be turned on before this parameter can be specified. The *prefix* subfield indicates a spare point code (*prefix-zone-area-id*).

Range: **s-**, **0-255**, **none**

Specify a valid value for each subfield of the point code, and separate the subfields with a dash (-).

prefix—**s-**

zone—**0-7**

area—**000-255**

id—**0-7**

The point code **0-000-0** is not a valid point code.

Enter **none** to delete the IN platform 2 ITU-I point code value.

Default: No change to current value

:ppmspcn1= (optional)

ITU national point code of IN platform 1 for the Prepaid Short Message Service Intercept (PPSMS) Phase 1 feature. The PPSMS Phase 1 feature must be turned on before this parameter can be specified. The *prefix* subfield indicates a spare point code (*prefix-nnnnn*, *prefix-nnnnn-gc*, *prefix-m1-m2-m3-m4*, *prefix-m1-m2-m3-m4-gc*).

Range: **s-**, **0-16383**, **aa-zz**, **none**

Specify a valid value for each subfield of the point code, and separate the subfields with a dash (-).

prefix—**s-**

nnnnn—**0-16383**

gc—**aa - zz**

m1-m2-m3-m4—**0-14** for each member; values must sum to 14

Enter **none** to delete the value for the IN platform 1 ITU-N point code.

Default: No change to current value

:ppsmspcn2= (optional)

ITU national point code of IN platform 2 for the Prepaid Short Message Service Intercept (PPSMS) Phase 1 feature. The PPSMS Phase 1 feature must be turned on before this parameter can be specified. The *prefix* subfield indicates a spare point code (*prefix-nnnnn*, *prefix-nnnnn-gc*, *prefix-m1-m2-m3-m4*, *prefix-m1-m2-m3-m4-gc*).

Range: **s-**, **0-16383**, **aa-zz**, **none**

Specify a valid value for each subfield of the point code, and separate the subfields with a dash (-).

prefix—**s-**

nnnnn—**0-16383**

gc—**aa - zz**

m1-m2-m3-m4—**0-14** for each member; values must sum to 14

Enter **none** to delete the value for the IN platform 2 ITU-N point code.

Default: No change to current value

:ppsmsri1= (optional)

Routing Indicator of IN platform 1 for the Prepaid Short Message Service Intercept (PPSMS) Phase 1 feature. The PPSMS Phase 1 feature must be turned on before this parameter can be specified.

Range: **gt**, **ssn**

Default: No change to current value

:ppsmsri2= (optional)

Routing Indicator of IN platform 2 for the Prepaid Short Message Service Intercept (PPSMS) Phase 1 feature. The PPSMS Phase 1 feature must be turned on before this parameter can be specified.

Range: **gt**, **ssn**

Default: No change to current value

:serverpfx= (optional)

Server SRI prefix.

Range: 1–4 hexadecimal digit string (**0-9**, **A-F**, **a-f**), **none**

none—No Server SRI prefix is provisioned

Default: No change to current value

System Default: **none**

:srfaddr= (mandatory if the **srfnai** and **srfnp** parameters are specified)

Entity address of the MNP_SRF node. The G-Port feature must be turned on before this parameter can be specified.

Range: 1–15 digits (**0-9**, **A-F**, **a-f**), **none**

Default: No change to current value

:srfnai= (mandatory if the **srfaddr** and **srfnp** parameters are specified)

The nature of address indicator value of the MNP_SRF. The G-Port feature must be turned on before this parameter can be specified.

Range: 0-127

Default: No change to current value

:srfnp= (mandatory if the **srfnai** and **srfaddr** parameters are specified)

The numbering plan value of the MNP_SRF. The G-Port feature must be turned on before this parameter can be specified.

Range: 0-15

Default: No change to current value

:sridn= (optional)

The Send Routing Information Dialed Number location.

Range: tcap, sccp

Default: No change to current value

Example

```
chg-gsmopts:dfmcc=214:dfmnc=34
```

```
chg-gsmopts:ccnc=33322123:mccmnc=21434
```

```
chg-gsmopts:ccnc=334:mccmnc=22435
```

```
chg-gsmopts:is412gsm=0123456789abcde
```

```
chg-gsmopts:eirimsichk=on:eirrsptype=type1
```

```
chg-gsmopts:eirimsichk=on:eirrsptype=type2:eirgrsp=blkst
```

```
chg-gsmopts:multcc=011
```

```
chg-gsmopts:multcc=011:nmultcc=11
```

```
chg-gsmopts:msisdntrunc=1
```

The following example deletes a **ccnc/mccmnc** parameter combination. The value of the **ccnc** parameter specifies the **ccnc/mccmnc** parameter combination to delete:

```
chg-gsmopts:ccnc=334:mccmnc=none
```

```
chg-gsmopts:srfaddr=123456789abcdef:srfnai=0:srfnp=0
```

```
chg-gsmopts:msrndig=ccrndn
```

```
chg-gsmopts:msrnnai=1:msrnp=1
```

```
chg-gsmopts:serverpfx=0000
```

The following examples illustrate use of parameters for the IN platforms used in Prepaid Short Message Service Intercept feature:

```
chg-gsmopts:ppsmsgta=123
```

```
chg-gsmopts:ppsmsgta=123:nppsmsgta=234
```

```
chg-gsmopts:ppsmsgta=234:nppsmsgta=none
```

```
chg-gsmopts:ppsmcpc1=2-2-2:ppsmcpc1=gt
```

```
chg-gsmopts:ppsmcpc1=s-2-2-2:ppsmcpc1=gt
```

```
chg-gsmopts:ppsmcpcn1=120:ppsmcpcn1=ssn
```

chg-gsmopts:ppmspci2=s-3-3-3:ppsmsri2=gt

chg-gsmopts:ppmspci2=3-3-3:ppsmsri2=gt

chg-gsmopts:ppmspcn2=234:ppsmsri2=ssn

chg-gsmopts:ppmspci1=none:ppmspcn2=none

The following example shows the **sridn** parameter used with G-Port and the G-Port MNP Circular Route Prevention features.

chg-gsmopts:sridn=sccp

Dependencies

At least one parameter must be specified.

The G-Flex or G-Port feature must be turned on, or the Equipment Identity Register (EIR) feature must be enabled and turned on, before this command can be entered.

The G-Flex feature must be turned on before the following parameters can be specified: **defmcc**, **defmnc**, **ccnc**, **mccmnc**.

The G-Port feature must be turned on before the following parameters can be specified: **defmapvr**, **srfaddr**, **srfnai**, **srfnp**, **mrsndig**, **mrsnnai**, **mrsnnp**, **sridn**, **multcc**, **nmultcc**, **msisdntrunc**.

The G-Port feature must be turned on before the **sridn** parameter can be specified in the command.

The G-Port feature must be turned on before the **is412gsm** parameter can be specified in the command.

The G-Port feature must be turned on before the **serverpfx** parameter can be specified in the command.

An **is412gsm** parameter value must exist in the database before the **serverpfx** parameter can be specified.

The **serverpfx** value must be set to **none** in the database before the **is412gsm** value can be set to **none**.

The EIR feature must be enabled and turned on before the following parameters can be specified: **eigrsp**, **eirsptype**, **eirimsichk**.

The Prepaid Short Message Service Intercept (PPSMS) Phase 1 feature must be turned on before the following parameters can be specified: **ppmsgta**, **nppmsgta**, **ppmspci1**, **ppmspci2**, **ppmspcn1**, **ppmspcn2**, **ppsmsri1**, and **ppsmsri2**.

The **ccnc** and **mccmnc** parameter values must be specified together in sets.

A maximum of 10 **ccnc** records can exist in the database.

The **ccnc** parameter value must not already exist in the database unless the **mccmnc=none** parameter is specified.

The **srfaddr**, **srfnai**, and **srfnp** parameters must be specified together.

The **mrsnnai** and **mrsnnp** parameters must be specified together.

The value **none** cannot be specified for the **ccnc** parameter.

When the **nppssmgta** parameter is specified, the **ppssmgta** parameter must be specified. The **nppssmgta** parameter cannot be specified by itself.

A value of **none** cannot be specified for the **ppssmgta** parameter.

The specified **ppssmgta** parameter value must already exist in the database when the **nppssmgta** parameter is specified.

The specified **nppssmgta** parameter value cannot already exist in the database.

A maximum of 10 entries can be defined in the multiple country code list (in addition to the STP options **defcc** value).

The value **none** cannot be specified for the **multcc** parameter.

A multiple country code cannot be entered when the STP options **defcc** value is none. A **defcc** value must first be defined before the first multiple country code can be entered. See the **chg-stpopts** command.

When the **multcc** parameter is specified to enter a new value in the multiple country list, the specified value cannot already exist in the list.

When the **nmultcc** parameter is specified, the **multcc** parameter must be specified.

When the **multcc** and **nmultcc** parameters are specified to change the specified **multcc** value to the specified **nmultcc** value, the specified **nmultcc** value cannot already exist in the multiple country code list.

When the **multcc** and **nmultcc** parameters are specified to change the specified **multcc** value to the specified **nmultcc** value, the specified **multcc** value must already exist in the multiple country code list.

The specified **multcc** and **nmultcc** values cannot already be defined as the STP options **defcc** parameter value.

The specified or existing **ppsmSpi1**, **ppsmSpi2**, **ppsmSpCn1**, or **ppsmSpCn2** parameter value must be provisioned in the Mated Applications (MAP) table when the specified or existing **ppsmSri1** or **ppsmSri2** parameter value is **ssn**.

A route to a point code must already be entered before the point code can be specified as the **ppsmSpi1**, **ppsmSpi2**, **ppsmSpCn1**, or **ppsmSpCn2** parameter value. when the **ppsmSri1** or **ppsmSri2** parameter value is **gt**.

The **ppsmSpi1**, **ppsmSpi2**, **ppsmSpCn1**, and **ppsmSpCn2** parameter values cannot be the STP True Point Code.

The **ppsmSpi1**, **ppsmSpi2**, **ppsmSpCn1**, and **ppsmSpCn2** parameter values cannot be the STP Capability Point Code.

Notes

The spare point code subtype prefix **s-** is supported only for ITU international and ITU national point codes.

For the Prepaid Short Message Service Intercept (PPSMS) Phase 1 feature:

- The GTA digits (**ppsmgta** and **nppsmgta** parameters) are used to determine whether or not the incoming message should use the PPSMS Phase 1 function.
- A maximum of 3 GTA values (for 3 IN platforms) can be defined in the database at one time.
- Two IN platforms can be configured for load sharing, by using the **ent-map** and **ent-mrn** commands as described in the *Feature Manual - G-Port*.
- The point code and routing indicator values (**ppmspci1**, **ppmspci2**, **ppmspcn1**, **ppmspcn2**, **ppmsri1**, and **ppmsri2** parameters) are used to route messages from prepaid subscribers to the correct IN for credit checking.

The **sridn** parameter can be used with G-Port only or with G-Port and G-Port MNP Circular Route Prevention. Refer to the *Feature Manual - G-Port* for more information.

Table 5-13. EIR Response Type (eirrsptype) Values

Presence in List			EIR Response Type		
White	Gray	Black	Type 1	Type 2	Type 3
X			in white list	in white list	in white list
X	X		in gray list	in gray list	in gray list
X	X	X	in black list	in black list	in black list
X		X	in black list	in black list	in black list
	X		in gray list	in gray list	unknown
	X	X	in black list	in black list	unknown
		X	in black list	in black list	unknown
			in white list*	unknown*	unknown*

* This entry in the table indicates that there has been no match found for the IMEI in an incoming message within the database.

Output

```
chg-gsmopts:dfmcc=214:dfmnc=34
rlghncxa03w 04-01-20 09:04:14 EST EAGLE 31.3.0
CHG-GSMOPTS: MASP A - COMPLTD
;
```

chg-gsms-opcode Change GSM MAP Screening Operation Code

Use this command to change the attributes of the GSM (Global System for Mobile Telecommunication) MAP (mobile application part) screening operation codes. The command allows you to change the default screening action and the operation-code name for a specific operation code.

Keyword: chg-gsms-opcode

Related Commands: dlt-gsms-opcode, ent-gsms-opcode, rtrv-gsms-opcode

Command Class: Database Administration

Parameters

NOTE: See “Point Code Formats and Conversion” in Appendix A for a detailed description of point code formats, rules for specification, and examples.

:opname= (mandatory)

The user-defined name for the operation code. The **opname** value is defined with the **ent-gsms-opcode** command.

Range: Up to 8 alphanumeric characters

:ndfltact= (optional)

The new default screening action.

Range: **pass, discard, atierr, route, forward, duplicate, dupdisc**

pass—Route the message as normal to the destination; a UIM will be issued.

This is intended to be a test mode and is recommended when setting up GSM Map Screening during the initial phase to assure that no MSUs will be inadvertently thrown away.

discard—Do not route the MSU. The MSU is discarded (thrown away) and an appropriate UIM is issued.

atierr—Do not route the MSU. An ATI (Any Time Interrogation) reject message is generated to the originator. This value is valid only for ATI MAP operation codes.

route—Route the message as normal to the original destination node; no UIM will be generated. The original destination is the node to which normal GTT would be sent if no GSM MAP actions are taken.

forward—Route the original message to the forward node. The original message will not be sent to the original node. If, however, the forward node is not available for routing, the MSU is routed to the original node.

duplicate—Route the message as normal to the original destination and route a copy of the original message to the duplicate node. If the MSU fails to route to the duplicate node, a UIM is generated indicating the duplicate routing failure.

dupdisc—Route the original message to the duplicate node. The original message will not be sent to the original node. If, however, the duplicate node is not available for routing, the MSU is routed to the original node.

Default: No change to the existing value

:force= (optional)

Check Mated Application Override. This parameter must be used to complete command execution if the **npc/npca/npci/npcn/npcn24** and **nssn** parameter combination specified

in the command is not already defined in the SCCP Application entity set (Remote Point Code/Mated Application Table).

Range: yes, no

Default: no

:npc/npca/npci/npcn/npcn24= (optional)

New point code. The **npc/npca/npci/npcn/npcn24** and **nssn** parameters are used when the default screening action (**dflfact**) is **forward**, **duplicate**, or **dupdisc** (duplicate and discard). These parameters allow the technician to change the defined node to which the input message will be routed.

:npc= or :npca= (optional)

ANSI point code with subfields *network indicator-network cluster-network cluster member* (*ni-nc-ncm*).

Range: 000-255

Specify a valid value for each subfield of the point code, and separate the subfields with a dash (-).

When **chg-sid:pctype=ansi** is specified, *ni* = 000 is not valid.

When **chg-sid:pctype=ansi** is specified, *nc* = 000 is not valid if *ni* = 001-005.

When **chg-sid:pctype=ansi** is specified, *nc* = 000 is valid if *ni* = 006-255.

The point code 000-000-000 is not a valid point code.

:npci= (optional)

New ITU international point code with subfields *zone-area-id*. The *prefix* subfield indicates a spare point code (*prefix-zone-area-id*).

Range: s-, 0-255

Specify a valid value for each subfield of the point code, and separate the subfields with a dash (-).

prefix—s-

zone—0-7

area—000-255

id—0-7

The point code 0-000-0 is not a valid point code.

:npcn= (optional)

New ITU national destination point code in the format of a 5-digit number (*nnnnn*); or 2, 3, or 4 numbers (members) separated by dashes (*m1-m2-m3-m4*) as defined by the **chg-stpopts:npcfmti** flexible point code option. A group code must be specified when the ITUDUPPC feature is turned on (*nnnnn-gc*, *m1-m2-m3-m4-gc*). The *prefix* subfield indicates a spare point code (*prefix-nnnnn*, *prefix-nnnnn-gc*, *prefix-m1-m2-m3-m4*, *prefix-m1-m2-m3-m4-gc*).

Range: s-, 0-16383, aa-zz

Specify a valid value for each subfield of the point code, and separate the subfields with a dash (-).

prefix—s-

nnnnn—0-16383

gc—aa - zz

m1-m2-m3-m4—0-14 for each member; values must sum to 14

:npcn24= (optional)

New 24-bit ITU national point code with subfields *main signaling area-sub signaling area-signaling point (msa-ssa-sp)*.

Range: 000-255

Specify a valid value for each subfield of the point code, and separate the subfields with a dash (-).

msa—000-255

ssa—000-255

sp—000-255

:nopname= (optional)

The new user-defined name for the operation code.

Range: Up to 8 alphanumeric characters

Default: No change to current value

:nssn= (optional)

New Subsystem Number. The **npc/npca/npci/npcn/npcn24** and **nssn** parameters are used when the new default screening action (**ndflact**) is **forward**, **duplicate**, or **dupdisc** (duplicate and discard). These parameters allow the technician to change the defined node to which the input message will be routed.

Range: 002 - 255

Example

```
chg-gsms-opcode:opname=ati:ndflact=atierr
```

```
chg-gsms-opcode:opname=ati:ndflact=forward:npci=1-1-1:nssn=5:force=yes
```

```
chg-gsms-opcode:opname=xyz:npca=9-9-9:nssn=3
```

```
chg-gsms-opcode:opname=test2:npci=s-1-1-1
```

Dependencies

At least one optional parameter must be specified.

If the **ndflact** parameter is specified, one of the following values must be specified: **pass**, **discard**, **atierr**, **route**, **forward**, **duplicate**, or **dupdisc**.

If the **ndflact** parameter is specified and its value is **forward**, **duplicate**, or **dupdisc**, the **npc/npca/npci/npcn/npcn24** and **nssn** parameters must be specified.

The reserved word **none** cannot be specified as a value for the **opname** parameter or **nopname** parameter.

If the **npc/npca/npci/npcn/npcn24** and **nssn** parameters are specified with the **ndflact** parameter, the **ndflact** parameter value must be **forward**, **duplicate**, or **dupdisc**.

The **force** parameter can be specified only if the **npc/npca/npci/npcn/npcn24** parameter and the **nssn** parameter are specified.

The value specified for the **opname** parameter must already exist in the GSM Map Op-Code table.

The GSM Map Screening feature (see the **enable-ctrl-feat** command) must be turned on before this command can be entered.

The Enhanced GSM Map Screening feature must be enabled and turned on before **npc/npca** can be specified.

A value of **atierr** for the **ndfltact** parameter cannot be specified unless the value of the operation code (**opcode**) referenced by the **opname** parameter is **71**. The **atierr** option is valid only for ATI MAP operation codes; **opcode=71** signifies an ATI MAP operation code.

If specified, the **npc/npca/npci/npcn/npcn24** parameter value must be a full point code.

If the **npc/npca/npci/npcn/npcn24** parameter and the **nssn** parameter are specified, and the **force** parameter is not specified as **yes**, the PC-SSN must be populated in the SCCP Application entity set (Remote Point Code / Mated Application Table).

If specified, the **npc/npca/npci/npcn/npcn24** parameter value must exist as a destination in the Ordered Route entity set or reside in a cluster (ANSI only) that exists as a destination in the Ordered Route entity set (for global title routing).

Notes

In this command, only ITU-international and ITU national point codes support the spare point code subtype prefix (**s-**).

Output

chg-gsms-opcode:opname=ati:ndfltact=atierr

```
rlghncxa03w 04-01-10 11:43:04 EST EAGLE 31.3.0
GSM Map Op-code Table is (1 of 256) 1% full
CHG-GSMS-OPCODE: MASP A - COMPLTD
```

;

chg-gta

Change Global Title Address Information

Use this command to change the global title address information (GTA) for applicable global title selectors required to specify a global title entry.

This command changes the routing objects for messages requiring global title translations. The point code, subsystem number, mnrset id and routing indicator specified overwrite the existing data values.

Keyword: **chg-gta**

Related Commands: **chg-gtt, dlt-gta, ent-gta, rtrv-gta,**

Command Class: Database Administration

Parameters

NOTE: See “Point Code Formats and Conversion” in Appendix A for a detailed description of point code formats, rules for specification, and examples.

:gta= (mandatory)

Start global title address.

Range: Maximum of 21 digits

:gttsn= (mandatory)

GTT set name. A GTT set is an entity to which global title addresses and selectors are assigned.

Range: One leading alphabetic character and up to eight alphanumeric characters

:ccgt= (optional)

New cancel called global title indicator.

Range: **yes, no**

Default: No change to **ccgt** value

:egta= (optional)

End global title address.

Range: Maximum of 21 digits

Default: Same as the specified **gta** value

:force= (optional)

Check mated application override.

Range: **yes, no**

Default: **no**

:mrnset= (optional)

The MRN set ID.

Range: **1-3000, dflt, none**

dflt—The default **mrnset**.

none—The GTA translation does not participate in any load sharing.

:ngti= (optional)

New GTI code. When the ANSI-ITU-China SCCP Conversion and MGTT features are on and the Translated Point Code is of a different network type, the **ngti** parameter specifies whether the new GTI translation format is GTI type 2 or GTI type 4.

Range: **2, 4**

:nnai= (optional)

New Nature of Address Indicator

This parameter identifies Nature of Address Indicator with which to replace the received Nature of Address Indicator.

Range: **0-127**

Default: If **:rmgtt=no** is specified, no change to current value

If **:rmgtt=yes** is specified, resets to default value of **0**.

:nnp= (optional)

New Numbering Plan

This parameter identifies Numbering Plan with which to replace the received Numbering Plan.

Range: **0-15**

Default: If **:rmgtt=no** is specified, no change to current value

If **:rmgtt=yes** is specified, resets to default value of **0xFFFF**.

:npdd= (optional)

New Prefix Digits to be Deleted

This parameter identifies the number of Prefix Digits to be deleted and replaced with the New Prefix Digits String (**npds**).

Range: 0–21

Default: If **:rmgtt=no** is specified, no change to current value
If **:rmgtt=yes** is specified, resets to default value of **0xFFFF**.

:npds= (optional)

New Prefix Digits String

This parameter identifies New Prefix Digits String with which to replace the deleted Prefix Digits.

Range: Maximum of 21 digits

Default: If **:rmgtt=no** is specified, no change to current value
If **:rmgtt=yes** is specified, resets to default value of no digits.

:nsdd= (optional)

New Suffix Digits to be Deleted. This parameter identifies the number of Suffix Digits to be deleted and replaced with the New Suffix Digits String (**nsds**).

Range: 0–21

Default: 0

:nsds= (optional)

New Suffix Digits String

New Suffix Digits String. This parameter identifies the New Suffix Digits String with which to replace the deleted Suffix Digits.

Range: Maximum of 21 digits

Default: No digits

:ntt= (optional)

New translation type.

The point code domain translation types for EGTT are handled by the EAGLE 5 SAS protocol processing as either ANSI or ITU; therefore, ITU applies to ITU-I, ITU-I Spare, ITU-N, and ITU-N Spare. ITU-I includes ITU-I Spare, and ITU-N includes ITU-N Spare.

Range: 000–255

Default: No change in current value unless the value for **xlat** changes from **dpcngt**, in which case **ntt** is removed.

:pc/pca/pci/pcn/pcn24= (optional)

New translated point code defined as **pc** and **pca** (ANSI), **pci** (ITU international), **pcn** (ITU national), and **pcn24** (24-bit ITU national).

:pc= or :pca= (optional)

ANSI point code with subfields *network indicator-network cluster-network cluster member* (*ni-nc-ncm*). The *prefix* subfield indicates a private point code (*prefix-ni-nc-ncm*).

Range: p-, 000–255

Specify a valid value for each subfield of the point code, and separate the subfields with a dash (-).

prefix—p-

When **chg-sid:pctype=ansi** is specified, *ni* = 000 is not valid.

When **chg-sid:pctype=ansi** is specified, *nc* = 000 is not valid if *ni* = 001–005.

When **chg-sid:pctype=ansi** is specified, *nc* = 000 is valid if *ni* = 006–255.

The point code 000-000-000 is not a valid point code.

:pci= (optional)

ITU international point code with subfields *zone-area-id*. The *prefix* subfield indicates a spare point code, private point code, or private and spare point code (*prefix-zone-area-id*).

Range: **s-, p-, ps-, 0-255**

Specify a valid value for each subfield of the point code, and separate the subfields with a dash (-).

prefix—**s-, p-, ps-**

zone—**0-7**

area—**000-255**

id—**0-7**

The point code **0-000-0** is not a valid point code.

:pcn= (optional)

ITU national destination point code in the format of a 5-digit number (*nnnnn*); or 2, 3, or 4 numbers (members) separated by dashes (*m1-m2-m3-m4*) as defined by the **chg-stpopts:npcfnti** flexible point code option. A group code must be specified when the ITUDUPPC feature is turned on (*nnnnn-gc*, *m1-m2-m3-m4-gc*). The *prefix* subfield indicates a spare point code, private point code, or private and spare point code (*prefix-nnnnn*, *prefix-nnnnn-gc*, *prefix-m1-m2-m3-m4*, *prefix-m1-m2-m3-m4-gc*).

Range: **s-, p-, ps-, 0-16383, aa-zz**

Specify a valid value for each subfield of the point code, and separate the subfields with a dash (-).

prefix—**s-, p-, ps-**

nnnnn—**0-16383**

gc—**aa - zz**

m1-m2-m3-m4—**0-14** for each member; values must sum to 14

:pcn24= (optional)

24-bit ITU national point code with subfields *main signaling area-sub signaling area-signaling point* (*msa-ssa-sp*). The *prefix* subfield indicates a private point code (*prefix-msa-ssa-sp*).

Range: **p-, 000-255**

Specify a valid value for each subfield of the point code, and separate the subfields with a dash (-).

prefix—**p-**

msa—**000-255**

ssa—**000-255**

sp—**000-255**

Default: No change to current value.

:ri= (optional)

New routing indicator.

Range: **gt, ssn**

Default: No change to current value.

:rmgtt= (optional)

This parameter resets all MGTT fields to default values before applying values for other parameters in the command.

Range: **yes, no**

Default: **no**

:ssn= (optional)

New translated subsystem number.

Range: 000-255

Default: No change unless **xlat=dpcngt**, in which case **ssn** is removed

:xlat= (optional)

New translate indicator.

Range: dpc, dpcngt, dpcssn

Default: No change to current value.

Example

chg-gta:gttsn=lidb:gta=9195554321:xlat=dpcssn:ri=ssn:pc=001-255-252:ssn=254

**chg-gta:gttsn=test:gta=100000:egta=199999:pca=1-1-1:xlat=dpcngt:ri=gt:rmgtt=yes
:nnp=3:nnai=120**

chg-gta:gttsn=setnat003:gta=987658321198765432102:pcn=s-129

chg-gta:gttsn=itui1:gta=987658321198765432112:pci=s-1-210-1

chg-gta:gttsn=setnat003:gta=987658321198765432122:pcn=s-128-aa

chg-gta:gttsn=setmrn:gta=1234567880:pc=1-1-2:mrnset=dflt

chg-gta:gttsn=setmrn:gta=1234567890:egta=2234567890:pc=1-1-2:mrnset=none

chg-gta:gttsn=setmrn:gta=2345678901:egta=3456789012:pc=1-1-3:mrnset=2

Dependencies

The EGTT feature must be turned on before this command can be entered.

The MGTT feature must be turned on before the **rmgtt**, **nnp**, **nnai**, **ngti**, **nsdd**, **nsds**, **npdd**, and **npds** parameters can be specified.

The ANSI-ITU-China SCCP Conversion feature must be enabled and turned on before the **ngti** parameter can be specified.

The ANSI-ITU-China SCCP Conversion feature must be enabled and turned on before a translated point code that is of a different domain than the **gttsn** can be specified.

The **nsdd**, **nsds**, **npdd**, and **npds** parameters cannot be changed with this command. Use the **rmgtt** parameter to reset all MGTT entry values to their default values, and enter the command again to specify new MGTT parameter values.

At least one optional parameter must be specified.

Asterisks cannot be specified for the **ssn** and **ri** parameters.

The value **dpc** is invalid for the **ri** parameter.

The **gttsn** parameter must be specified, cannot not have a value of **none**, and must match an existing **gttsn**.

The **pc/pca/pci/pcn/pcn24** parameter cannot be out of range and must be a full point code.

If the **egta** parameter is specified, the **gta** and **egta** values must be the same length and the **egta** value must be greater than the **gta** value.

When **ngti=4** is specified, **nnp** and **nnai** must be specified.

When **ngti=4** is specified, the translated point code cannot be ANSI. For ANSI point codes, the GTI value must be **2**.

When **ngti=2** is specified, **nnp** and **nnai** cannot be specified.

The **ccgt** and **ngti** parameters cannot be specified together in the command.

When the ANSI-ITU-China SCCP Conversion feature is not on and the specified GTT set is an ANSI set, the **pc/pca** parameter must be a valid ANSI point code.

When the ANSI-ITU-China SCCP Conversion feature is not on and the specified GTT set is an ITU set, the **pci/pcn/pcn24** parameter must be a valid ITU point code.

The length of the specified **gta** parameter must match the number of digits provisioned for the specified GTT set (**gttsn**). If the VGTT (variable length GTT) feature is turned on, there can be up to 10 GTA lengths per GTT set. When the **ent-gta** command is entered to create entries, the software keeps track of the lengths and allows only 10 different lengths. The global title address specified for the GTT set must have the same number of digits as an existing GTA.

The specified **gta/egta** range must exist for the specified GTT set in the STP active database. While an exact match is not required, an overlap with another range cannot be specified. If the range overlaps, an error is generated that displays a list of overlapped point codes. An example follows that shows what happens when the user attempts to enter a point code range (such as 8005550000 to 8005559999) that overlaps an existing range. The overlapping links must match. If they do not, error message E2401 is generated displaying the list of overlapped point codes:

The following GTA ranges overlap the input GTA range

```
START GTA          END GTA
8005550000         8005551999
8005552000         8005553999
8005554000         8005555999
CHG-GTA: MASP A - Command Aborted
```

When the ANSI-ITU-China SCCP Conversion feature is not on, the **ntt** parameter can be specified only when the **xlat** parameter value is **dpcngt**.

When the ANSI-ITU-China SCCP Conversion feature is on, the **ntt** parameter can be specified only when the **xlat** parameter value is **dpc** or **dpcngt**.

When the ANSI-ITU-China SCCP Conversion feature is on and the **ntt** parameter is specified, the **ri=gt** parameter must be specified.

The **ngti** parameter can be specified only when the translated point code and the translation type are in different domains, or are both in the ITU domain.

If **xlat=dpcngt** is specified, the **ntt** parameter must be specified.

If a new or existing **xlat=dpcngt** is specified, the new or existing **ri** value must be **gt**.

If the **ssn** parameter is specified, the new or existing **xlat** value must be **dpcssn**.

If **xlat=dpcssn** is specified, then the **ssn** parameter must be specified.

The **mrnset** parameter must not be specified if the routing indicator **ri = ssn**.

If the **pc/pca/pci/pcn/pcn24** parameter is specified and the point code is the STP true point code, the new or existing **xlat** value must be **dpcssn** and the new or existing **ri** value must be **ssn**.

If the **pc/pca/pci/pcn/pcn24** parameter is specified and/or the **ssn** parameter is specified and the point code is the STP true point code, the new or existing **ssn** parameter must exist in the SS-APPL table.

If the **pc/pca/pci/pcn** parameter is specified, it must exist as a destination in the Route table or reside in a cluster that exists as a destination in the Route table (for global routing), unless the point code is the STP's true point code.

If a new or existing **ri=ssn** and **xlat=dpc** parameter is specified and the **pc/pca/pci/pcn/pcn24** parameter is not specified, the existing point code must exist in the Remote Point Code/Mated Application table, unless the **force=yes** parameter is specified.

If a new or existing **ri=ssn** and **xlat=dpc** parameter are specified and the **pc/pca/pci/pcn/pcn24** parameter is specified, the new point code must exist in the Remote Point Code/Mated Application table, unless the **force=yes** parameter is specified.

If a new or existing **ccgt=yes** parameter is specified, the new or existing **ri** value must be **ssn**.

If a new or existing **ri=gt** parameter is specified, the new or existing **ccgt** value must be **no**.

If the new or existing **pc/pca/pci/pcn/pcn24** parameter is one of the STP's point codes or capability point codes, the **ccgt** value must be **no**.

The **nnp**, **nnai**, **ngti**, **nsdd**, **nsds**, **npdd**, and **npds** parameters cannot be specified with the **rmggt** parameter in the command.

If a new or existing **ri=ssn** and a new or existing **xlat=dpcssn** are specified, the new or existing point code and subsystem number must exist in the Remote Point Code/Mated Application table, unless the **force=yes** parameter is specified.

The GTT table cannot be full.

The MRN table has a maximum of 6000 point code entries. Each point code group can contain a maximum of 8 point codes.

The specified point code (**pc**) must already exist in the specified MRN set if the Flexible GTT Load Sharing feature is enabled.

The specified MRN set must already exist in the MRN table.

The **mrnset** parameter must be specified if the Flexible GTT Load Sharing feature is enabled and the routing indicator **ri = gt**.

The SEAS command is not allowed to operate on any other MRNSET except the default MRNSET.

Notes

The maximum length of the resulting GTA string must not exceed 21 digits when translation is complete.

When the EGTT feature is turned on, the GTT Selector (**ent/chg/dlt/rtrv-gttset**), GTT Set (**ent/dlt/rtrv-gttset**), and GTA (**ent/chg/dlt/rtrv-gta**) commands replace the Translation Type (**ent/dlt/rtrv-tt**) and Global Title Translation (**ent/chg/dlt/rtrv-gtt**) commands. All data previously provisioned with these commands is maintained.

If a GTT is being deleted or changed and the point code (**dpc** or **rte**) is not found in the route table (unless the point code is the STP's true point code), the following message is displayed in the terminal scroll area:

```
NOTICE: No DPC and/or RTE found for GTT being deleted or changed.
```

The above situation may occur for the following reasons:

- A database was upgraded from a release prior to EAGLE 5 SAS Release 27.1 or IP⁷ Secure Gateway Release 3.0 when GTT entries were not linked to the route table and the deletion of the **dpc** was permitted. The GTT referenced a **dpc/rte** that was deleted, and the enforce reference counts between the GTT and route tables were not updated.
- A serious problem occurred in which the reference count rules were not enforced and a **dpc** and/or **rte** were deleted while being referenced by a GTT entry. This indicates a software error; notify the Customer Care Center at (888) FOR-TKLC.

In this command, only ITU-international and ITU national point codes support the spare point code subtype prefix (**s-**) and the private and spare point code subtype prefix (**ps-**). All of the point code types support the private (internal) point code subtype prefix (**p-**).

The Flexible GTT Load Sharing feature allows multiple relationships to be defined among sets of destination point codes in the Mated Relay Node (MRN) table. The relationship used in a particular translation is based on the GTA digits used for translation.

The MRN set along with the post-translation PC formulates a key that is used for a lookup in the MRN table. The MRN table lookup provides a set of alternate PCs for routing the MSU in the most cost effective way.

The default MRN set consists of multiple load sharing groups of PCs that allow both GTT features and MPS-based features to run in parallel. However, MPS-based features are limited to using ONLY the **dflt** MRN set. GTT features can be provisioned to use the **dflt** MRN set as well. To operate on entries in the default mrnset, specify **dflt** as the value of the **mrnset** parameter.

Output

```
chg-gta:gttsn=lidb:gta=9195554321:xlat=dpccsn:ri=ssn:pc=001-255-252:ssn=254
```

```
rlghncxa03w 04-01-20 09:04:14 EST EAGLE 31.3.0
```

```
CHG-GTA: MASP A - CMPLTD
```

```
;
```

chg-gtcnv**Change Global Title Conversion**

Use this command to change entries in the Default Global Title Conversion table. A table entry is identified by the direction and either the **tta** parameter, the **tti** parameter, or the **tti/np/nai** parameter combination. The Notes section for this command describes rules for changing entry information.

Keyword: **chg-gtcnv**

Related Commands: **ent-gtcnv, dlt-gtcnv, rtrv-gtcnv**

Command Class: Database Administration

Parameters

:dir= (mandatory)

Direction of conversion.

Range: **atoi, itoa, both**

atoi—ANSI to ITU conversion

itoa—ITU to ANSI conversion

both—Conversion in both directions

:np= (optional)

Numbering Plan. This parameter is mandatory when **gtixlat=24** is specified, and cannot be specified when **gtixlat=22** is specified.

Range: **0-15, ***

Default: No change to current value

:nai= (optional)

Nature of Address Indicator. This parameter is mandatory when **gtixlat=24** is specified, and cannot be specified when **gtixlat=22** is specified.

Range: **0-63, ***

Default: No change to current value

:npdd= (optional)

The number of New Prefix Digits to be deleted, which will be replaced with the New Prefix Digits String (**npds**).

Range: **0-21**

Default: No change to current value

:npds= (optional)

The New Prefix Digits String with which to replace the deleted Prefix Digits.

Range: Maximum of 21 digits

Default: No change to current value

:nsdd= (optional)

The number of New Suffix Digits to be deleted, which will be replaced with the New Suffix Digits String (**nsds**).

Range: **0-21**

Default: No change to current value

:nsds= (optional)

The New Suffix Digits String with which to replace the deleted Suffix Digits.

Range: Maximum of 21 digits

Default: No change to current value

:rdmod= (optional)

Reset digit modifiers (**npdd** and **npds** or **nsdd** and **nsds**) values to "no digit modification".

Range: **yes, no**

yes—Reset the **npdd** and **npds** parameter or **nsdd** and **nsds** parameter values.

no—Do not reset the **npdd** and **npds** parameter or **nsdd** and **nsds** parameter values.

Default: No change to current value

:tta= (optional)

ANSI translation type. This parameter is mandatory when **dir=atoi** or **dir=both** is specified.

Range: **0-255, ***

Default: No change to current value

:tti= (optional)

ITU translation type. This parameter is mandatory when **dir=atoi** is specified.

Range: **0-255, ***

Default: No change to current value

Example

The following example changes a **dir=atoi** entry's current **tti** value to 5.

```
chg-gtcnv:dir=atoi:tta=10:tti=5
```

The following example changes a **dir=atoi** entry's current **tti**, **nai**, and **np** values to 7, 8, and 6 respectively, and either changes or adds the **nsdd** and **nsds** values.

```
chg-gtcnv:dir=atoi:tta=11:tti=7:nai=8:np=6:nsdd=3:nsds=123
```

The following example changes a **dir=itoa** entry's current **tta** value to 11, and either changes or adds the **npdd** and **npds** values.

```
chg-gtcnv:dir=itoa:tta=11:tti=7:npdd=3:npds=123
```

The following example changes a **dir=itoa** entry's current **tta** value to 12, and either changes or adds the **nsdd** and **nsds** values.

```
chg-gtcnv:dir=itoa:tta=12:tti=7:nai=8:np=6:nsdd=5:nsds=45667
```

The following example adds or changes a **dir=both** entry's **nsdd** and **nsds** values.

```
chg-gtcnv:dir=both:tta=12:tti=33:nsdd=3:nsds=456
```

The following example changes a default **dir=atoi** entry's current **tti** value to 9, and either changes or adds the **nsdd** and **NSDS** values.

```
chg-gtcnv:dir=atoi:tta=*:tti=9:nsdd=1:nsds=9
```

The following example changes a default **dir=atoi** entry's current **tti**, **nai**, and **np** value to 4, 6, and 5 respectively.

```
chg-gtcnv:dir=atoi:tta=*:tti=4:nai=6:np=5
```

The following example changes a default **dir=itoa** entry's current **tta** value to 17, and either changes or adds the **npdd** and **npds** values.

```
chg-gtcnv:dir=itoa:tta=17:tti=*.nai=*.np=*.npdd=3:npds=123
```

The following example resets existing **npdd/npds** or **nsdd/nsds** values to "no digit modification".

```
chg-gtcnv:dir=both:tta=12:tti=11:rdmod=yes
```

Dependencies

The ANSI-ITU-China SCCP Conversion feature must be turned on before this command can be entered.

When **dir=atoi** is specified, the **tta** parameter must be specified.

When **dir=both** is specified, at least the **tta** and **tti** parameters must be specified.

When **dir=both** is specified, no asterisk (*) parameter values can be specified.

When **dir=atoi** is specified, the asterisk parameter value (*) can be specified only for the **tta** parameter.

When **dir=itoa** is specified, the asterisk parameter value (*) must be specified for the **tti**, **np**, and **nai** parameters.

When **dir=itoa** and **gtixlat=22** are specified, asterisk parameter values (*) cannot be specified; **gtixlat=24** must be specified with asterisk parameter values when **dir=itoa** is specified.

The specified **dir**, **tta**, **tti**, **np**, and **nai** parameter combination cannot already exist in the database.

The **nsdd** and **nsds** parameters cannot be used in the same command with the **npdd** and **npds** parameters.

The Default Global Title Conversion table can contain a maximum of 1000 entries.

Notes

The use of asterisks (wild cards) is allowed only once for each direction of ANSI to ITU and ITU to ANSI. This provides a configurable default.

In the conversion direction of ANSI to ITU, an asterisk can be specified only for the ANSI **tta** parameter.

In the conversion direction of ITU to ANSI, the asterisk value must be specified for the **itu tti**, **np**, and **nai** parameters.

Asterisks are not allowed when conversion is in both directions (**dir=both**).

The suffix digit manipulation parameters **nsdd** and **nsds** cannot be specified in the same command with the prefix digit manipulation parameters **npdd** and **npds** parameters. The **npdd** and **nsdd** parameters specify how many digits to delete, if any, from the beginning or end respectively of the Global Title address digits. The **npds** and **nsds** parameters specify what digits, if any, to append to the beginning or end respectively of the Global Title address digits.

The **gtixlat** parameter is expressed in the form of the ANSI GTI and the ITU GTI. The **gtixlat** parameter is used to indicate the conversion of the Global Title Indicator between the ANSI and ITU standards. For example: A **gtixlat** value of **24** converts an incoming ANSI GTI2 to an outgoing ITU GTI 4 or an incoming ITU GTI 4 to an outgoing ANSI GTI2.

Output

```
ent-gtcnv:dir=atoi:gtixlat=22:tta=10:tti=5
  rlgncxa03w 03-11-07 11:43:07 EST EAGLE 31.3.0
  CHG-GTCNV: MASP A - COMPLTD
;
```

chg-gtt

Change Global Title Translation

Use this command to change the routing objects for messages requiring global title translation. The global title addresses remain unchanged.

NOTE: If the EGTT (Enhanced Global Title Translation) feature is turned on, the system will no longer accept GTT (Global Title Translation) and TT (Translation Type) commands. Refer to the new command sets that replace the GTT and TT commands:

- GTT Selector commands (**ent/chg/dlt/rtrv-gttsel**),
- GTT Set commands (**ent/dlt/rtrv-gttset**), and
- GTA commands (**ent/chg/dlt/rtrv-gta**).

With the ANSI-ITU-China SCCP Conversion feature turned on, the Translated Point Code (**pc**, **pca**, **pci**, **pcn**, and **pcn24** parameters) can be of a different network type than the Translation Type (**type** parameter).

When the ANSI-ITU-China SCCP Conversion and MGTT features are on and the Translated Point Code is of a different network type, the **ngti** parameter specifies whether the new GTI translation format is GTI type 2 or GTI type 4.

When the MGTT feature is off, **ngti** cannot be specified and the Default GT Conversion Table is used for conversion.

When the ANSI-ITU-China SCCP Conversion feature is off, mixed network types are not allowed.

Keyword: **chg-gtt**

Related Commands: **dlt-gtt**, **ent-gtt**, **rtrv-gtt**

Command Class: Database Administration

Parameters

† At least one of these parameters must be specified.

NOTE: See “Point Code Formats and Conversion” in Appendix A for a detailed description of point code formats, rules for specification, and examples.

:gta= (mandatory)

Global title start address is the beginning of a range of global title digits.

Range: 1–21 digits

:egta= (optional)

Global title end address is the end of a range of global title digits.

Range: 1–21 digits

Default: egta same as gta

:mrnset= (optional)

The MRN set ID.

Range: 1–3000, dflt, none

dflt—The default mrnset.

none—The GTT translation does not participate in any load sharing.

:ngt= (optional)

New global title

Range: 000–255

Default: If the value for **xlat** changes from **dpcngt**—the **ngt** is removed.

If the value for **xlat** does not change from **dpcngt**—no change in **ngt** value

:ngti= (optional)

New GTI code. When the ANSI-ITU-China SCCP Conversion and MGTT features are on and the Translated Point Code is of a different network type, the **ngti** parameter specifies whether the new GTI translation format is GTI type 2 or GTI type 4.

Range: 2, 4

:nnai= (optional)

New Nature of Address Indicator. This parameter identifies Nature of Address Indicator with which to replace the received Nature of Address Indicator.

Range: 0–127

Default: If **:rmgtt=no** is specified, current value

If **:rmgtt=yes** is specified, resets to default value of 0.

nnp= (optional)

New Numbering Plan. This parameter identifies Numbering Plan with which to replace the received Numbering Plan.

Range: 0–15

Default: If **:rmgtt=no** is specified, no change to current value

If **:rmgtt=yes** is specified, resets to default value of 0xFFFF.

:npdd= (optional)

New Prefix Digits to be Deleted. This parameter identifies New Prefix Digits to be Deleted with which to replace the received Prefix Digits to be Deleted.

Range: 0–21

Default: If **:rmgtt=no** is specified, no change to current value

If **:rmgtt=yes** is specified, resets to default value of 0xFFFF.

:npds= (optional)

New Prefix Digits String. This parameter identifies New Prefix Digits String with which to replace the received Prefix Digits String.

Range: Maximum of 21 digits

Default: If **:rmgtt=no** is specified, no change to current value

If **:rmgtt=yes** is specified, resets to default value of no digits.

:nsdd= (optional)

New Suffix Digits to be Deleted. This parameter identifies the New Suffix Digits to be Deleted with which to replace the received Suffix Digits to be Deleted.

Range: 0-21

Default: 0

:nsds= (optional)

New Suffix Digits String

New Suffix Digits String. This parameter identifies the New Suffix Digits String with which to replace the received Suffix Digits String.

Range: Maximum of 21 digits

Default: No digits

:pc/pca/pci/pcn/pcn24= (optional)†

Point code.

:pc= or **:pca=** (optional)

ANSI point code with subfields *network indicator-network cluster-network cluster member* (*ni-nc-ncm*). The *prefix* subfield indicates a private point code (*prefix-ni-nc-ncm*).

Range: p-, 000-255

Specify a valid value for each subfield of the point code, and separate the subfields with a dash (-).

prefix—p-

When **chg-sid:pctype=ansi** is specified, *ni* = 000 is not valid.

When **chg-sid:pctype=ansi** is specified, *nc* = 000 is not valid if *ni* = 001-005.

When **chg-sid:pctype=ansi** is specified, *nc* = 000 is valid if *ni* = 006-255.

The point code 000-000-000 is not a valid point code.

:pci= (optional)

ITU international point code with subfields *zone-area-id*. The *prefix* subfield indicates a spare point code, private point code, or private and spare point code (*prefix-zone-area-id*).

Range: s-, p-, ps-, 0-255

Specify a valid value for each subfield of the point code, and separate the subfields with a dash (-).

The point code 0-000-0 is not a valid point code.

prefix—s-, p-, ps-

zone—0-7

area—000-255

id—0-7

:pcn= (optional)

ITU national point code in the format of a 5-digit number (*nnnnn*); or 2, 3, or 4 numbers (members) separated by dashes (*m1-m2-m3-m4*) as defined by the **chg-stpopts:npcfinti** flexible point code option. A group code must be specified when the ITUDUPPC feature is turned on (*nnnnn-gc, m1-m2-m3-m4-gc*). The *prefix* subfield indicates a spare point code, private point code, or private and spare point code (*prefix-nnnnn, prefix-nnnnn-gc, prefix-m1-m2-m3-m4, prefix-m1-m2-m3-m4-gc*).

Range: **s-, p-, ps-, 0-16383, aa-zz**

Specify a valid value for each subfield of the point code, and separate the subfields with a dash (-).

prefix—**s-, p-, ps-**

nnnnn—**0-16383**

gc—**aa - zz**

m1-m2-m3-m4—**0-14** for each member; values must sum to 14

:pcn24= (optional)

24-bit ITU national point code with subfields *main signaling area-sub signaling area-signaling point (msa-ssa-sp)*. The *prefix* subfield indicates a private point code (*prefix-ni-nc-ncm*).

Range: **p-, 000-255**

Specify a valid value for each subfield of the point code, and separate the subfields with a dash (-).

prefix—**p-**

msa—**000-255**

ssa—**000-255**

sp—**000-255**

:ri= (optional)†

The routing indicator provides routing instructions to the receiving signaling point. In gateway screening, messages may be screened based on the value of the routing indicator.

Range: **gt, ssn**

gt—Allow a called party address with a routing indicator value of “global title.”

ssn—Allow a called party address with a routing indicator value of “DPC/SSN.”

Default: No change in current value.

:rmgtt= (optional)

This parameter resets all MGTT fields to default values before applying values for other parameters in the command.

Range: **yes, no**

Default: **no**

:ssn= (optional)†

Subsystem number

Range: **0-255**

Default: If **xlat=dpcngt** is specified, current value.

If **xlat=dpcngt** is not specified, the **ssn** parameter is removed.

:ttn= (optional)†

Translation type name.

Range: 1 alphabetic character followed by up to 7 alphanumeric characters

Default: No translation name is given

:type/typea/typei/typen/typen24= (optional)†

Translation type identifies the translation type and network type. This parameter is the decimal representation of the 1-byte field used in SS7.

The **type** and **typea** parameters specify an ANSI network.

The **typei** parameter specifies an ITU-international network.

The **typen** parameter specifies an ITU-national network.

The **typen24** parameter specifies a 24-bit ITU-national network.

A translation type numeric value may be entered as ANSI type (**type** or **typea**) and also as an ITU type (**typei** or **typen**). However, they are separate entities.

The point code domain translation types for GTT are handled by the EAGLE 5 SAS protocol processing as either ANSI or ITU; therefore, ITU applies to ITU-I, ITU-I Spare, ITU-N, and ITU-N Spare. ITU-I includes ITU-I Spare, and ITU-N includes ITU-N Spare.

Range: 0-255

Default: No translation type is specified

:xlat= (optional)†

Translate indicator is used to determine translation actions and routing actions.

Range: dpc, dpcssn, dpcngt

Default: No change in current value.

Example

```
chg-gtt:type=5:gta=9195551212:egta=9195551999:xlat=dpcssn:ri=ssn:pc=255-002-001
:ssn=255
```

```
chg-gtt:ttn=lidb2:gta=9197771212:egta=9197771999:xlat=dpcngt:ri=gt:pc=255-002-001
:ngt=3
```

```
chg-gtt:ttn=lidb6:gta=910777:pc=255-002-002
```

```
chg-gtt: type=10:gta=8005553232:egta=8005554000:rmgtt=yes:nnp=3:npdd=5
```

```
chg-gtt:type=11:gta=8005553232:egta=8005554000:nnai=4:nnp=4:nsdd=5:nsds=2341
:ngti=4
```

```
chg-gtt:gta=123456:pci=s-1-129-7:typei=41
```

```
chg-gtt:gta=223456:pcn=s-128-aa:typen=3
```

```
chg-gtt:ttn=setmrn:gta=1234567890:egta=2234567890:pc=1-1-2: mnrset=none
```

```
chg-gtt:ttn=setmrn:gta=2234567891:egta=2234567892:pc=1-1-2: mnrset=dflt
```

```
chg-gtt:ttn=setmrn:gta=2345678901:egta=3456789012:pc=1-1-3:mnrset=2
```

Dependencies

This command is not valid when the EGTT feature is turned on.

If the **pcn** parameter is specified, its format must match the format that was assigned with the **chg-stpopts:npcfmti** parameter.

If the **ttn** parameter is specified, that name must correspond to a translation type entry.

If the translation type is specified, the translation type must already exist.

The network type (ANSI, ITU-I, ITU-N, or 24-bit ITU-N) of the Translation Type and the Translated Point Code must be the same.

The ANSI-ITU-China SCCP Conversion feature must be on before a translated point code and a translation type in different network types can be specified.

The range of global title addresses to be changed, as specified by the start and end global title addresses, must match exactly an existing range in the global title translation data for the specified translation type.

If the new or existing value of **xlat** is **dpc** and the new or existing value of **ri** is **ssn**, and **pc/pca/pci/pcn** is specified, the new point code must exist in the Remote Point Code/Mated Application table.

If the new or existing value of **xlat** is **dpc** and the new or existing value of **ri** is **ssn**, and **pc/pca/pci/pcn** is not specified, a point code must exist in the remote point code (mated application) table.

If the current value for **xlat** is **dpcssn** and a different value is entered for **xlat**, an **ssn** value must not be entered, and the current **ssn** value is removed.

If the new value for **xlat** is **dpcssn**, and the current **ssn** value has been removed, an **ssn** value must be specified.

The start **gta** length must equal the number of digits specified by the translation type. If the VGTT (variable length GTT) feature is turned on, up to 10 GTA lengths per translation type are allowed. When the **ent-gtt** command is entered to create entries, the software keeps track of the lengths and allows only ten different lengths. The global title address specified for the translation type must then have the same number of digits as an existing GTA.

The maximum length of the resulting GTA string must not exceed 21 digits when translation is complete.

The **nnp**, **nnai**, **nsdd**, **nsds**, **npdd**, and **npds** parameters cannot be specified with the **rmgtt** parameter in the command.

The MGTT feature must be on before the **rmgtt**, **nnp**, **nnai**, **nsdd**, **nsds**, **npdd**, and **npds** parameters can be specified in the command.

The **nsdd** and **nsds** parameters cannot be specified in the same command with the **npdd** and **npds** parameters.

To change existing **nsdd**, **nsds**, **npdd**, and **npds** parameter values, enter the command with the **rmgtt** parameter to reset the MGTT values, and enter the command with new **nnp** and **nnai** or **npdd** and **npds** parameter values.

The **ngti** parameter can be specified only when the translated point code and the translation type are in different domains, or are both in the ITU domain.

When **ngti=4** is specified, **nnp** and **nnai** must be specified.

When **ngti=4** is specified, the translated point code cannot be ANSI. For ANSI point codes, the GTI value must be 2.

When **ngti=2** is specified, **nnp** and **nnai** cannot be specified.

The **mrnset** parameter must not be specified if the routing indicator **ri** = **ssn**.

If the **egta** parameter is specified, the length must equal the length of the start **gta**.

If the **egta** parameter is specified, the value must be greater than the value specified on the **gta** parameter.

The range of global title addresses to be changed, as specified by the start and end global title addresses, must match exactly or be contained within an existing range in the global title translation data for the specified translation type.

If the range overlaps, an error is generated that displays a list of overlapped point codes. An example follows that shows what happens when the user attempts to enter a point code range (such as 8005550000 to 8005559999) that overlaps an existing range. The overlapping links must match. If they do not, error message E2401 is generated displaying the list of overlapped point codes:

The following GTA ranges overlap the input GTA range

```
START GTA          END GTA
8005550000         8005551999
8005552000         8005553999
8005554000         8005555999
CHG-GTT: MASP A - Command Aborted
```

If the range as specified by the **gta** and **egta** parameters does not exactly match the existing range, the existing range is split. All addresses in the existing range that are outside the range specified by **gta** and **egta**, retain the original **xlat**, **ri**, **pc**, **ssn**, and **ngt** parameters. A new range is created bounded by the **gta** and **egta** containing new values of **xlat**, **ri**, **pc**, **ssn** and **ngt** as present in the command, and retaining parameter values from the previous range that do not have corresponding new values in the command.

When the ANSI-ITU-China SCCP Conversion feature is not on and the current value of **xlat** is **dpcngt** and a different value is specified for **xlat**, an **ngt** value must not be specified and the current **ngt** value is removed.

If the new value for **xlat** is **dpcngt**, and the current **ngt** value has been removed, an **ngt** value must be specified.

When the ANSI-ITU-China SCCP Conversion feature is turned on, the **ngt** parameter can be specified only when **xlat=dpc** or **xlat=dpcngt** is specified.

When the ANSI-ITU-China SCCP Conversion feature is turned on and **ngt** is specified, **ri=gt** must be specified.

A translation type cannot be specified that is already defined as an alias for another translation type.

Either the **type** parameter or the **tn** parameter must be specified.

Point code entries must be full point codes. Partial point codes are not allowed.

Table 5-14 on page 5-171 shows the valid combinations for the **xlat**, **ri**, **ssn**, and **ngt** parameters. All other combinations are rejected.

To enter this command, the Remote Point Code table cannot be full.

To enter this command, the subsystem table for primary remote point codes cannot be full.

The MRN table has a maximum of 6000 point code entries. Each point code group can contain a maximum of 8 point codes.

The specified point code (**pc**) must already exist in the specified MRN set if the Flexible GTT Load Sharing feature is enabled.

The specified MRN set must already exist in the MRN table.

The **mrnset** parameter must be specified if the Flexible GTT Load Sharing feature is enabled and the routing indicator **ri = gt**.

The **seas** command is not allowed to operate on any other MRN set except the default MRN set.

Table 5-14. Valid Parameter Combinations for the **chg-gtt** Routing Parameters

New or Existing XLAT Value	New or Existing RI Value	Routing Action	SSN Value	NGT Value
DPC	GT	Translate DPC only and route on GT	Cannot be specified. The current database entry is removed.	Cannot be specified unless ANSI-ITU-China SCCP Conversion is enabled. The current database entry is removed.
DPC	SSN	Translate DPC only and route on SSN	Cannot be specified. The current database entry is removed.	Cannot be specified. The current database entry is removed.
DPCSSN	GT	Translate DPC and SSN and route on GT	Must be specified.	Cannot be specified. The current database entry is removed.
DPCSSN	SSN	Translate DPC and SSN and route on SSN	Must be specified.	Cannot be specified. The current database entry is removed.
DPCNGT	GT	Translate DPC, new translation type (TT), and route on GT	Cannot be specified. The current database entry is removed.	Must be specified.

Notes

The specified DPC, SSN, relative cost, and routing indicator will overwrite the existing data values in the table.

In this command, only ITU-international and ITU national point codes support the spare point code subtype prefix (**s-**) and the private and spare point code subtype prefix (**ps-**). All of the point code types support the private (internal) point code subtype prefix (**p-**).

The Flexible GTT Load Sharing feature allows multiple relationships to be defined among sets of destination point codes in the Mated Relay Node (MRN) table. The relationship used in a particular translation is based on the GTA digits used for translation.

The **mrnset** along with the post-translation PC formulates a key that is used for a lookup in the MRN table. The MRN table lookup provides a set of alternate PCs for routing the MSU in the most cost effective way.

The default **mrnset** consists of multiple load sharing groups of PCs that allow both GTT features and MPS-based features to run in parallel. However, MPS-based features are limited to using ONLY the **dflt** mrnset. GTT features can be provisioned to use the **dflt** mrnset as well. To operate on entries in the default mrnset, specify **dflt** as the value of the MRN Set.

Output

```
chg-gtt:ttn=lidb6:gta=910777:pc=255-002-002
      rlgncxa03w 04-01-07 11:43:04 EST EAGLE 31.3.0
      CHG-GTT: MASP A - COMPLTD
;
```

chg-gttset

Change GTT Selectors

Use this command to change the global title translation (GTT) set (**gttsn**) linked with an existing **gti**, **tt**, **np/npv**, and **nai/naiv** combination.

Keyword: chg-gttset

Related Commands: dlt-gttset, ent-gttset, rtrv-gttset

Command Class: Database Administration

Parameters

:gti/gtia/gtii/gtin/gtin24= (mandatory)

Global title indicator. For all EGTT selector commands, the domain is defined as **gti** and **gtia** (ANSI), **gtii** (ITU international), **gtin** (ITU national), and **gtin24** (24-bit ITU national). For the selector commands, **gti** and **gtia** are equivalent; **gtii** and **gtin/gtin24** are mutually exclusive because the EGTT database does not distinguish between ITU national and ITU international translations. This means that while ITU-I and ITU-N selectors are stored separately, two separate ITU-I and ITU-N entries with the same selector values cannot exist. For example, if an entry with **gtii=2** and **tt=4** already exists, an entry of **gtin=2** and **tt=4** cannot be entered.

Range: Supported value for ANSI: **gti=2** and **gtia=2**

Supported values for ITU: **gtii=2, 4** and **gtin/gtin24=2, 4**

:gttsn= (mandatory)

GTT set name. A GTT set is an entity to which global title addresses and selectors are assigned.

Range: 1 leading alphabetic character and up to 8 alphanumeric characters.

:tt= (mandatory)

Translation type.

Range: 0-255

:nai= (optional)

Nature of address indicator (see Table A-5 in Appendix A).

Range: sub, rsvd, natl, intl, dflt

:naiv= (optional)

Nature of address indicator value (see Table A-5 in Appendix A).

Range: 0–127

NOTE: The nature of address indicator parameters (**naiv** or **nai**) can be specified by supplying either a mnemonic or an explicit value. At no time may both the mnemonic and the explicit value be specified at the same time for the same parameter. Either the **naiv** or **nai** parameter can be specified. Table A-5 in Appendix A shows the mapping between the **naiv** and the **nai** parameters.

:np= (optional)

Numbering plan (see Table A-6 in Appendix A).

Range: e164, generic, x121, f69, e210, e212, e214, private, dflt

:npv= (optional)

Numbering plan value (see Table A-6 in Appendix A).

Range: 0–15

NOTE: The numbering plan parameters (**npv** or **np**) can be specified by supplying either a mnemonic or an explicit value. At no time may both the mnemonic and the explicit value be specified as the same time for the same parameter. Either the **npv** or **np** parameter can be specified. Table A-6 in Appendix A shows the mapping between the **npv** and the **np** parameters.

Example

```
chg-gttset:gti=2:tt=10:gttsn=t800
```

```
chg-gttset:gtia=2:tt=253:gttsn=newansi
```

```
chg-gttset:gtin=4:tt=0:np=dflt:nai=dflt:gttsn=setint000
```

The following example would change the selectors (**gtii=4**, **tt=5**, **npv=1**, **naiv=2**) linked with GTTSN **ansi1** so that the selectors are linked with **ansi2** (assuming that **ansi2** is an existing GTT set in the database):

```
chg-gttset:gtii=4:tt=5:npv=1:naiv=2:gttsn=ansi2
```

Dependencies

The EGTT feature must be turned on before this command can be entered.

At least one parameter value must be changed in the command.

The **np** and **npv** parameters cannot be specified together in the same command.

The **nai** and **naiv** parameters cannot be specified together in the same command.

The parameter values **gtia=4**, **gti/gtia/gtii/gtin/gtin24=1**, and **gti/gtia/gtii/gtin/gtin24=3** cannot be specified.

When the **gti/gtia/gtii/gtin/gtin24=2** parameter is specified, the **np/npv** and **nai/naiv** parameter combinations cannot be specified.

When the **gtii/gtin/gtin24=4** parameter is specified, an **np(v)** and **nai(v)** parameter combination must be specified. These parameters can be specified in any combination: **np** and **naiv**, **npv** and **nai**, **np** and **nai**, or **npv** and **naiv**.

The **gttsn** parameter must be specified, cannot have a value of **none**, and must match an existing **gttsn**.

An entry must already exist that matches the **gti**, **tt**, and **np(v)** and **nai(v)** combination of parameters.

An entry must already exist that matches the **gtii**, **tt**, and **np(v)** and **nai(v)** combination of parameters.

An entry must already exist that matches the **gtin**, **tt**, and **np(v)** and **nai(v)** combination of parameters.

The specified **gttsn** value must exist for the specified **gtin24**, **tt**, **np/npv/nai/naiv** parameter combination.

The network domain (ANSI or ITU) must match that of the existing GTT Set entry specified by the **gttsn** parameter.

A maximum of 1024 entries is allowed in the GTT Selector table.

Notes

When the EGTT feature is turned on, the GTT Selector (**ent/chg/dlt/rtrv-gttset**), GTT Set (**ent/dlt/rtrv-gttset**), and GTA (**ent/chg/dlt/rtrv-gta**) commands replace the Translation Type (**ent/dlt/rtrv-tt**) and Global Title Translation (**ent/chg/dlt/rtrv-gtt**) commands. All data previously provisioned with these commands is maintained.

The entry that matches the specified parameter combination is assigned to the specified **gttsn**.

Output

chg-gttset:gti=2:tt=10:gttsn=t800

```
rlghncxa03w 04-01-18 08:50:12 EST EAGLE 31.3.0
GTT Selector table is (114 of 1024) 11% full
CHG-GTTSEL: MASP A - CMPLTD
```

;

chg-gtw-stp

Change Gateway Parameters

Use this command to modify the level 3 ANSI transfer control status (TFCSTAT) when converted from ITU to ANSI.

Keyword: **chg-gtw-stp**

Related Commands: **rtrv-gtw-stp**

Command Class: Database Administration

Parameter

:tfcstat= (mandatory)

This parameter identifies the desired level 3 control status on a TFC message received from an ITU node destined for an ANSI node.

Range: 1-3

Example

chg-gtw-stp:tfcstat=1

Dependencies

None

Notes

None

Output

```
chg-gtw-stp:fcstat=1
rlghncxa03w 04-01-11 11:34:04 EST EAGLE 31.3.0
CHG-GTW-STP: MASP A - COMPLTD
;
```

chg-gws-actset

Change Gateway Screening Stop Action Sets

Use this command to configure the gateway screening stop action sets in the system database. Stop action sets are used to define the actions performed on the Message Sending Units (MSUs) that pass the gateway screening process. The gateway screening stop action table contains a maximum of 16 stop action sets, with each stop action set containing a maximum of 10 stop actions. The first three gateway screening stop action sets (**actid=1**, **actid=2**, and **actid=3**) are already defined with the existing gateway screening stop actions shown in Table 5-15 on page 5-175.



CAUTION: Even though gateway screening is in the screen test mode, as defined by the parameters **gwsa=off** and **gws=on** in the **chg-ls** command, the gateway screening action in the stop action set *will* be performed at the end of the screening process.

Table 5-15. Gateway Screening Stop Action Definitions

Gateway Screening Stop Action ID	Gateway Screening Stop Action Set Name	Stop Action 1	Stop Action 2	Action Performed by the system
1	copy	copy	—	Copy the MSU for the STP LAN feature.
2	rdct	rdct	—	Redirect the MSU for the DTA feature.
3	cr	copy	rdct	Copy the MSU for the STP LAN feature and redirect the MSU for the DTA feature.

Keyword: chg-gws-actset

Related Commands: rtrv-gws-actset

Command Class: Database Administration

Parameters

:actid= (mandatory)

The identification number of the gateway screening stop action set.

Range: 4–16

:act1= (optional)

Stop action 1.

Range: cncf, copy, none, rdct, tlnp

Default: No change to the existing value.

:act2= (optional)

Stop action 2.

Range: **cnf, copy, none, rdct, tlnp**

Default: No change to the existing value.

:act3= (optional)

Stop action 3.

Range: **cnf, copy, none, rdct, tlnp**

Default: No change to the existing value.

:act4= (optional)

Stop action 4.

Range: **cnf, copy, none, rdct, tlnp**

Default: No change to the existing value.

:act5= (optional)

Stop action 5.

Range: **cnf, copy, none, rdct, tlnp**

Default: No change to the existing value.

:act6= (optional)

Stop action 6.

Range: **cnf, copy, none, rdct, tlnp**

Default: No change to the existing value.

:act7= (optional)

Stop action 7.

Range: **cnf, copy, none, rdct, tlnp**

Default: No change to the existing value.

:act8= (optional)

Stop action 8.

Range: **cnf, copy, none, rdct, tlnp**

Default: No change to the existing value.

:act9= (optional)

Stop action 9.

Range: **cnf, copy, none, rdct, tlnp**

Default: No change to the existing value.

:act10= (optional)

Stop action 10.

Range: **cnf, copy, none, rdct, tlnp**

Default: No change to the existing value.

:actname= (optional)

The name of the gateway screening stop action set.

This parameter is mandatory when you first enter an action set.

Range: One alphabetic character followed by up to five alphanumeric characters.

Default: No change to the existing value.

:all= (optional)

The **all=none** parameter clears all of the actions in the specified stop action set, and deletes the stop action set.

Range: none

Default: Undefined

:force= (optional)

Use **force=yes** when changing the stop action of an existing stop action set.

Range: yes, no

Default: no

Example

```
chg-gws-actset:actid=4:actname=cncf:act1=cncf
```

Dependencies

At least one optional parameter must be specified.

If **all=none** is specified, no other optional parameters can be specified.

The reserved word *none* cannot be used for the **actname** parameter.

The **force=yes** parameter must be specified to change an existing stop action.

If **cncf** is specified for **act1** through **act10**, the Calling Name Conversion Feature (CNCF) must be on. Use the **rtrv-feat** command to determine whether CNCF is on or off. If off, CNCF can be turned on with the **chg-feat** command. Note also that Gateway Screening (GWS) must be on before CNCF can be turned on

To provision a Gateway Screening TLNP stop action (**tlnp**), either the TLNP feature must be turned on or the ISUP NP with EPAP feature must be enabled.

If **tlnp** is specified for **act1** through **act10** for Triggerless LNP in the system,

- The Triggerless LNP feature (TLNP) must be on. Use the **rtrv-feat** command to determine whether TLNP is on or off. If TLNP is off, TLNP can be turned on with the **chg-feat** command. (Verify that TLNP has been purchased for your system before you turn it on).
- The LNP (Local Number Portability) and GWS (Gateway Screening) features must be on before TLNP can be turned on. See the **enable-ctrl-feat** command and the **chg-feat** command.

If **tlnp** is specified for **act1** through **act10** with the ISUP NP with EPAP feature in the system,

- The ISUP NP with EPAP feature must be enabled. Use the **rtrv-ctrl-feat** command to determine whether the ISUP NP with EPAP feature is enabled. The feature is listed in the output if it is enabled. If the ISUP NP with EPAP feature does not appear in the output, you must purchase it and receive the feature access key before you can enable it with the **enable-ctrl-feat** command.
- The G-Port and GWS (Gateway Screening) features must be on before the ISUP NP with EPAP feature can be enabled. See the **chg-feat** command.

A specific gateway screening stop action (**cncf**, **copy**, **none**, **rdct**, **tlnp**) can be specified for one and only one gateway screening stop action parameter for each gateway screening stop action set.

If a value is entered for the **actname** parameter, the value must be unique. Note that the **actname** parameter is *mandatory* when you first enter a gateway screening stop action set in the database and *optional* thereafter.

If **copy** is specified for an action set, it must be specified in stop action 1 (**act1**). A parameter value of **copy** cannot be specified for **act2** through **act10**.

If the redirect gateway screening action (**rdct**) is specified with other gateway screening stop actions, it must be specified with the last gateway screening stop action parameter specified for the command.

The **tlnp** (Triggerless LNP) gateway screening stop action cannot be specified in the same action set with either the **cncf** (Calling Name Conversion Facility) or **rdct** (Redirect) gateway screening stop actions.

Notes

Gateway screening stop action 1 (**act1**) is the first stop action to be performed and gateway screening stop action 10 (**act10**) is the last stop action to be performed on the MSU. These parameters can have the following values:

- **cncf**—Convert the PIP parameter with the GN parameter or the GN parameter with the PIP parameter in the ISUP IAM message for the Calling Name Conversion Facility feature.
- **copy**—Copy the MSU for the STP LAN feature.
- **none**—No action is performed on the MSU.
- **rdct**—Redirect the MSU for the DTA feature
- **tlnp**—ISUP IAMs that pass gateway screening are intercepted by the Triggerless LNP equipped EAGLE 5 SAS and converted to include the LRN if the call is to a ported number. This gateway screening stop action applies only to the Triggerless LNP feature.

Output

```
chg-gws-actset:actid=4:actname=cncf:act1=cncf
rlghncxa03w 04-01-10 11:43:04 EST EAGLE 31.3.0
CAUTION: GWS action set may be referenced by one or more GWS rules
CHG-GWS-ACTSET: MASP A - COMPLTD
;
```

chg-gws-redirect**Change Gateway Screening Redirect**

Use this command to change the provisioning data for the redirect function. The values that are specified for this command are stored in the Redirect table, and they are used to set the variable fields of the MSUs being redirected. For example, if the **ri=gt** parameter is specified, the value **gt** is set for the routing indicator in the called party address (CDPA) of the MSU being redirected.

Keyword: chg-gws-redirect

Related Commands: dlt-gws-redirect, ent-gws-redirect, rtrv-gws-redirect

Command Class: Database Administration

Parameters

NOTE: See “Point Code Formats and Conversion” in Appendix A for a detailed description of point code formats, rules for specification, and examples.

:dpc/dpca/dpci/dpcn/dpcn24= (optional)

Destination point code.

:dpc= or **dpca=** (optional)

Specifies the value used to set the ANSI destination point code field in the routing label of the MSU that is being redirected. The point code has subfields *network indicator-network cluster-network cluster member* (*ni-nc-ncm*).

Range: 000-255

Specify a valid value for each subfield of the point code, and separate the subfields with a dash (-).

When **chg-sid:pctype=ansi** is specified, *ni* = 000 is not valid.

When **chg-sid:pctype=ansi** is specified, *nc* = 000 is not valid if *ni* = 001-005.

When **chg-sid:pctype=ansi** is specified, *nc* = 000 is valid if *ni* = 006-255.

The point code 000-000-000 is not a valid point code.

Default: Current value.

:dpci= (optional)

Specifies the value used to set the ITU international destination point code field in the routing label of the MSU that is being redirected. The point code has subfields *zone-area-id*.

Range: 0-255

Specify a valid value for each subfield of the point code, and separate the subfields with a dash (-).

zone—0-7

area—000-255

id—0-7

The point code 0-000-0 is not a valid point code.

Default: Current value.

:dpcn= (optional)

Specifies the value used to set the ITU national destination point code field in the routing label of the MSU that is being redirected. The point code is in the format of a 5-digit number (*nnnnn*); or 2, 3, or 4 numbers (members) separated by dashes (*m1-m2-m3-m4*) when the **chg-stpopts:npcfmti** flexible point code option is on. A group code (*gc*) must be specified when the ITUDUPPC feature is on (*nnnnn-gc*, *m1-m2-m3-m4-gc*).

Range: 0-16383, aa-zz
Specify a valid value for each subfield of the point code, and separate the subfields with a dash (-).

nnnnn—0-16383

gc—aa - zz

m1-m2-m3-m4—0-14 for each member; values must sum to 14

Default: Current value.

:dpcn24= (optional)

Specifies the value used to set the 24-bit ITU national destination point code field in the routing label of the MSU that is being redirected. The point code has subfields *main signaling area-sub signaling area-signaling point (msa-ssa-sp)*.

Range: 000-255

Specify a valid value for each subfield of the point code, and separate the subfields with a dash (-).

msa—000-255

ssa—000-255

sp—000-255

Default: Current value.

:enabled= (optional)

Specifies whether MSUs that have passed gateway screening are to be redirected (**enabled=on**) or routed as normal (**enabled=off**).

Range: on, off

Default: Current value.

:gta= (optional)

Specifies the value used to set the global title address (dialed digits) in the SCCP called party address of the MSU being redirected.

Range: 1-21 digits

:ri= (optional)

Specifies the value used to set the routing indicator in the SCCP called party address of the MSU being redirected. Use the **gt** value to route by global title digits or use the **ssn** value to route by subsystem number.

Range: gt, ssn

Default: Current value

:ssn= (optional)

Specifies the value used to set the subsystem number (SSN) in the SCCP called party address of the MSU being redirected. This number is the SSN of the SCP to which all MSUs meeting the redirect criteria are to be redirected.

Range: 0-255

Default: Current value

:tt= (optional)

Identifies the type of the global title translation (GTT). It is the decimal representation of the 1-byte field used in SS7. This value is used to set the type of the GTT in the SCCP called party address of the MSU being redirected.

Range: 0-255

Default: Current value

Example

```
chg-gws-redirect:dpc=111-222-111:ri=gt:ssn=10:tt=1:gta=180833:enabled=on
chg-gws-redirect:dpc=111-222-111:ri=ssn:ssn=10:tt=1:gta=1800833:enabled=off
chg-gws-redirect:enabled=off
```

Dependencies

At least one optional parameter must be specified.

The **dpc/dpca/dpci/dpcn/dpcn24** parameter must be defined in the Destination table or defined as the STP site point code.

If the **dpc/dpca/dpci/dpcn/dpcn24** parameter is defined as a destination, at least one route must be defined.

The redirect function data must exist in the database before it can be changed with this command.

Notes

None

Output

```
chg-gws-redirect:dpc=111-222-111:ri=gt:ssn=10:tt=1:gta=180833:enabled=on
rlghncxa03w 04-07-10 11:43:04 EST EAGLE 31.6.0
CHG-GWS-REDIRECT: MASP A - COMPLTD
;
```

chg-inpopts**Change INP Options Command**

Use this command to provision INP-specific data. This command updates the INPOPTS table.

Keyword: **chg-inpopts**

Related Commands: **rtrv-inpopts**

Command Class: Database Administration

Parameters

:cdnpfx= (optional)

The Called Party Number Prefix.

Range: **1-FFFFFFFFFFFFFF**

1 to 15 characters. Allowed characters are 0-9, a-f, A-F.

Default: Current value

:cdpnai= (optional)

The Called Party Number Nature of Address indicator.

Range: **0-127**

Default: Current value

:dltpfx= (optional)

Delete prefix.

Range: yes, no

Default: no

:dra= (optional)

The destination routing address.

Range: rdn, rn, ccrdn

rdn—Routing number prefix and the dialed number

rn—Routing number

ccrdn—Country code + routing number + dialed number

Default: Current value

:dranai= (optional)

The Nature of Address indicator. (See Table 5-16 on page 5-182).

Range: sub, unknown, natl, intl, ntwk

Default: Current value

:dranaiv= (optional)

The nature of address indicator value. (See Table 5-16 on page 5-182).

Range: 0-127

Default: Current value

NOTE: The nature of address indicator parameters (dranaiv or dranai) can be specified by supplying either a mnemonic or an explicit value. At no time may both the mnemonic and the explicit value be specified at the same time for the same parameter. Either the dranaiv or dranai parameter can be specified. Table 5-16 shows the mapping between the naiv and the nai parameters.

Table 5-16. DRANAIV/DRANAI Mapping

dranaiv	dranai	Description
1	sub	Subscriber Number
2	unknown	Unknown
3	natl	National significant number
4	intl	International number
5	ntwk	Network
The mnemonic's list is different from the list for the Service Selector commands because the INAP destination routing address uses ISUP values instead of SCCP values.		

:dranp= (optional)

The numbering plan. (See Table 5-17).

Range: e164, x121, f69

Default: Current value

:dranpv= (optional)

The numbering plan value. (See Table 5-17).

Range: 1-7

Default: Current value

NOTE: The numbering plan parameters (dranpv or dranp) can be specified by supplying either a mnemonic or an explicit value. At no time may both the mnemonic and the explicit value be specified at the same time for the same parameter. Either the dranpv or dranp parameter can be specified. Table 5-17 shows the mapping between the dranpv and the dranp parameters.

Table 5-17. DRANPV/DRANP Mapping

dranpv	dranp	Description
1	E164	ISDN/telephony numbering plan
3	X121	Data numbering plan
4	F69	Telex numbering plan
Several of the numbering plan mnemonics that apply to the Service Selector commands are not in this list because they do not apply to INAP destination routing addresses.		

:ncdnpnfx= (optional)

The New Called Party Number Prefix.

Range: 1-FFFFFFFFFFFFFF or none

1 to 15 characters. Allowed characters are 0-9, a-f, A-F.

:snai= (optional)

The Service Nature of Address indicator.

Range: sub, natl, intl, none, unknown

Default: Current value

:sprestype= (optional)

INP option

Range: connect, continue

The **connect** parameter tells the EAGLE 5 SAS to send a "Connect" message when an IDP message is received for INP service, the DN digits match, and the HLR ID is present.

The **continue** parameter tells the EAGLE 5 SAS to send a "Continue" message when an IDP message is received for INP service, the DN digits match, and the HLR ID is present.

Default: continue

Example

chg-inopts:dra=rn:dranp=e164:dranai=intl

chg-inopts:dranp=f69:dranai=sub:dra=rndn

chg-inopts:dra=rn:dranp=e164:dranai=intl:cdpnpfx=fac:dltprfx=yes

chg-inopts:dranp=f69:dranai=sub:dra=rndn:cdpnpfx=200

chg-inopts:dranp=f69:dranai=sub:dra=rndn:cdpnpfx=200:ncdnpnfx=3abcdef:dltprfx=yes

chg-inopts:dranp=f69:dranai=sub:dra=rndn:cdpnpfx=3abcdef:ncdnpnfx=none

chg-inopts:dranp=f69:dranai=sub:dra=rndn:cdpnpfx=fed123:dltprfx=no

chg-inopts:dra=rn:dranp=e164:dranai=intl:cdpnpfx=fac:dltprfx=yes:cdpnai=50:snai=intl

```
chg-inpopts:dra=rndn:dranp=x121:dranai=intl:cdpnpx=fac:dltplx=no:cdpnnai=1
:snai=natl
```

```
chg-inpopts:dra=rn:dranp=e164:dranai=intl:cdpnpx=fac:dltplx=yes:cdpnnai=70
:snai=sub
```

```
chg-inpopts:dra=rn:dranp=e164:dranai=intl:cdpnpx=fac:dltplx=no:cdpnnai=1
:snai=none
```

```
chg-inpopts:sprestype=connect
```

```
chg-inpopts:dra=ccrndn:cdpnnai=127:snai=unknown
```

Dependencies

At least one optional parameter must be specified.

The INP feature must be turned on before this command can be entered.

The **dranp** and **dranpv** parameters cannot be specified together in the command.

The **dranai** and **dranaiv** parameters cannot be specified together in the command.

If the **ncdpnpx** or **dltplx** parameter is specified, the **cdpnpx** parameter must be specified.

A value of **none** for the **cdpnpx** parameter cannot be specified.

If **ncdpnpx=none** is specified, the **dltplx** parameter cannot be specified.

The specified Called Party Number Prefix (**cdpnpx**) must exist in the INPOPTS table.

The specified New Called Party Number Prefix (**ncdpnpx**) must not already exist in the INPOPTS table.

A maximum of 5 Called Party Number Prefix values is allowed.

A maximum of 5 Called Party Number Nature of Address values is allowed.

The **cdpnnai** and **snai** parameters must be specified together in the command.

If this command is entered to delete a Called Party Number Nature of Address value from the INPOPTS table (for example, if the command is entered with **:cdpnnai=1:ssnai=none**, the specified **cdpnnai** value must exist in the INPOPTS table.

Notes

Table 5-20 on page 5-189 provides examples of **dranp/dranpv**, **dranai/dranaiv**, **cdpnpx/ncdpnpx/dltplx**, and **cdpnnai/snai** parameter combinations.

Output

```
chg-inpopts:dra=rn:dranp=e164:dranai=intl
  rlgncxa03w 04-01-11 11:34:04 EST  EAGLE 31.3.0
  CHG-INPOPTS: MASP A - COMPLTD
;
```

Table 5-18. Examples of parameter combinations for the **chg-inpopts** command

Command	Comments
chg-inpopts:dranai=sub:dranaiv=1:dra=rn	dranai and dranaiv cannot be specified together.
chg-inpopts:dranp=e164:dranpv=1:dra=rndn	dranp and dranpv cannot be specified together.
chg-inpopts:dranp=e164:dranaiv=4:dranpv=1	dranp and dranpv cannot be specified together.
chg-inpopts:dranai=sub:dranaiv=1:dranpv=5	dranai and dranaiv cannot be specified together
chg-inpopts:dranp:=e164:dranai=sub:dranpv=1	dranp and dranpv cannot be specified together.
chg-inpopts:dranai=natl:dranaiv=3:dranp=e164	dranai and dranaiv cannot be specified together.
chg-inpopts:dranai=sub:dranp=f69:dra=rndn	Okay
chg-inpopts:dranp=e164:dranaiv=10:dra=rn	Okay
chg-inpopts:dranai=sub:dranpv=3	Okay
chg-inpopts:dranpv=4:dranaiv=20	Okay
chg-inpopts:dltprfx=yes	cdpnprfx must be specified.
chg-inpopts:ncdpnprfx=1:dltprfx=yes	cdpnprfx must be specified.
chg-inpopts:cdpnprfx=none:dltprfx=yes	cdpnprfx=none is not valid.
chg-inpopts:cdpnprfx=1:dltprfx=yes	Okay
chg-inpopts:cdpnprfx=1:ncdpnprfx=none:dltprfx=yes	dltprfx must not be specified when ncdpnprfx=none.
chg-inpopts:cdpnprfx=2a3b4c5d6e7f	Okay
chg-inpopts:cdpnprfx=2:ncdpnprfx=3:dltprfx=yes	Okay
chg-inpopts:cdpnnai=1	cdpnnai and snai must be specified together.
chg-inpopts:snai=intl	cdpnnai and snai must be specified together.
chg-inpopts:cdpnnai=1:snai=intl	Okay
chg-inpopts:cdpnnai=1:snai=sub	Okay
chg-inpopts:cdpnnai=70:snai=sub	Okay
chg-inpopts:dra=ccrndn	Okay
chg-inpopts:cdpnnai=5:snai=unknown	Okay

chg-ip-card

Change Internet Protocol Card

Use this command to provision IP networking parameters for a given card.

Keyword: chg-ip-card

Related Commands: rtrv-ip-card

Command Class: Database Administration

Parameters

:loc= (mandatory)

Card location. The unique identifier of a specific application subsystem located in the STP.

Range: 1101–1108, 1111–1112, 1201–1208, 1211–1218, 1301–1308, 1311–1318, 2101–2108, 2111–2118, 2201–2208, 2211–2218, 2301–2308, 2311–2318, 3101–3108, 3111–3118, 3201–3208, 3211–3218, 3301–3308, 3311–3318, 4101–4108, 4111–4118, 4201–4208, 4211–4218, 4301–4308, 4311–4318, 5101–5108, 5111–5118, 5201–5208, 5211–5218, 5301–5308, 5311–5318, 6101–6108, 6111–6118

:defrouter= (optional)

Default router IP address. This is a TCP/IP address expressed in standard dot notation. IP addresses consist of the system's network number and the machine's unique host number. An example IP address is 192.126.100.5, where 192.126.100 is the network number and 5 is the machine's host number.

Range: 4 numbers separated by dots, with each number in the range of **0–255**.
A value of **0.0.0.0** will remove an IP address from this parameter.

Default: No change to the parameter value
System Default: **0.0.0.0**

:domain= (optional)

The Domain Name of the Domain Server.

Range: Any string of characters beginning with a letter and comprising up to 120 characters in length (**a–z, A–Z, 0–9, -, .**).

Default: No change to the parameter value.
System Default: Null

:dnasa= (optional)

The IP address for Domain Name Server A. This is a TCP/IP address expressed in standard dot notation. IP addresses consist of the system's network number and the machine's unique host number. An example IP address is 192.126.100.5, where 192.126.100 is the network number and 5 is the machine's host number.

Range: 4 numbers separated by dots, with each number in the range of **0–255**.
A value of **0.0.0.0** will remove an IP address from this parameter.

Default: No change to the parameter value.
System Default: **0.0.0.0**

:dnspb= (optional)

The IP address for Domain Name Server B. This is a TCP/IP address expressed in standard dot notation. IP addresses consist of the system's network number and the machine's unique host number. An example IP address is 192.126.100.5, where 192.126.100 is the network number and 5 is the machine's host number.

Range: 4 numbers separated by dots, with each number in the range of **0–255**.
A value of **0.0.0.0** will remove an IP address from this parameter.

Default: No change to the parameter value.
System Default: **0.0.0.0**

:rstdomain= (optional)

Reset Domain Name. This parameter is used to reset the Domain Name to a NULL value.

Range: **yes, no**

yes—reset Domain Name to a NULL value

no—Domain Name does not change

Default: **no**

:srchordr= (optional)

Host table search order.

Range: **local, srvr, srvronly**

local—Local host table is searched first.

srvr—Domain Server is searched first.

srvronly—Only the Domain Server is searched.

Default: No change to the parameter value

System Default: No search

Example

```
chg-ip-card:loc=1211:dnsa=150.1.1.1:domain=nc.tekelec.com:defrouter=150.1.1.105
```

Dependencies

At least one optional parameter must be specified.

The **loc** parameter value must correspond to the location of a DCM or SSEDCCM card in the card table.

The DCM or SSEDCCM card associated with the **loc** parameter must be inhibited prior to command execution.

If the **domain** parameter is specified, the **rstdomain** parameter cannot be specified.

The **defrouter** IP address must be local to the Ethernet A network or Ethernet B network for the card. The B network can be used only on SSEDCCM cards.

Notes

The Domain Name has a 120 character limitation.

Output

```
chg-ip-card:loc=1211:dnsa=150.1.1.1:domain=nc.tekelec.com:defrouter=150.1.1.105
```

```
rlghncxa03w 04-01-17 15:35:05 EST EAGLE 31.3.0
```

```
CHG-IP-CARD: MASP A - COMPLTD
```

```
;
```

chg-ip-lnk

Change Internet Protocol Link

Use this command to provision the IP link table.

Keyword: **chg-ip-lnk**

Related Commands: **rtrv-ip-lnk**

Command Class: Database Administration

Parameters

:loc= (mandatory)

Card location. The unique identifier of a specific application subsystem located in the system.

Range: 1101–1108, 1111–1112, 1201–1208, 1211–1218, 1301–1308, 1311–1318, 2101–2108, 2111–2118, 2201–2208, 2211–2218, 2301–2308, 2311–2318, 3101–3108, 3111–3118, 3201–3208, 3211–3218, 3301–3308, 3311–3318, 4101–4108, 4111–4118, 4201–4208, 4211–4218, 4301–4308, 4311–4318, 5101–5108, 5111–5118, 5201–5208, 5211–5218, 5301–5308, 5311–5318, 6101–6108, 6111–6118

:port= (mandatory)

Ethernet interface Port ID.

Range: a, b

Port **b** is not valid for SS7IPGW and IPGWI applications with Application Sockets.

:auto= (optional)

Tells hardware whether to automatically determine duplex and speed.

Range: yes, no

yes—Automatically determines duplex and speed

no—Do not automatically determine duplex and speed

Default: No change to the parameter value

System Default: **yes**

:duplex= (optional)

This is the mode of operation of the interface.

Range: half, full

half—Half duplex

full—Full duplex

Default: No change to the parameter value

System Default: **half**

:ipaddr= (optional)

The IP address for the specified port. This is a TCP/IP address expressed in standard dot notation. IP addresses consist of the system's network number and the machine's unique host number. An example IP address is 192.126.100.5, where 192.126.100 is the network number and 5 is the machine's host number.

Range: 4 numbers separated by dots, with each number in the range of **0–255**.

A value of **0.0.0.0** will remove an IP address from this parameter.

Default: No change to the parameter value.

System Default: **0.0.0.0**

:mactype= (optional)

The Media Access Control Type of the interface.

Range: 802.3, DIX

802.3—The IEEE standard number 802.3

DIX—The Digital/Inter/Xerox *de facto* standard for ethernet

Default: No change to the parameter value

System Default: **802.3**

:mcast= (optional)

Multicast Control. This parameter enables or disables multicast support for the interface. This parameter is necessary for INP, G-Port, and G-Flex to establish the connection from the DSM card to the MPS system.

Range: yes, no

yes—Multicasting is enabled on the interface and the sending and receiving of multicast frames is allowed.

no—All multicast frames are silently dropped.

:speed= (optional)

The bandwidth for the interface in megabits per second

Range: 10, 100

Default: No change to the parameter value

:submask= (optional)

The subnet mask of the IP interface in the form of an IP address with a restricted range of values.

Range: If the **ipaddr** parameter is specified, the **submask** parameter is required and must be valid for the class of the entered IP address as shown in Table 5-19.

Table 5-19. Valid Subnet Mask Values

Valid for Class A Networks	Valid for Class A or B Networks	Valid for Class A, B, or C Networks
255.0.0.0	255.255.0.0	255.255.255.0
255.192.0.0	255.255.192.0	255.255.255.192
255.224.0.0	255.255.224.0	255.255.255.224
255.240.0.0	255.255.240.0	255.255.255.240
255.248.0.0	255.255.248.0	255.255.255.248
255.252.0.0	255.255.252.0	255.255.255.252
255.254.0.0	255.255.254.0	
255.255.128.0	255.255.255.128	

Default: If **ipaddr** is not specified, there is no change to the parameter value.

When a host's IP address is known, the default subnet mask should be chosen according to Table 5-20 on page 5-189.

Table 5-20. Default Subnet Mask Values

Network Class	IP Network Address Range	Default Subnet Mask
A	1.0.0.0 to 127.0.0.0	255.0.0.0
B	128.0.0.0 to 191.255.0.0	255.255.0.0
C	192.0.0.0 to 223.255.255.0	255.255.255.0

Example

chg-ip-lnk:loc=1211:port=A

Dependencies

The IP address must be entered in the IP Host table using the **ent-ip-host** command before it can be entered in the IP Link table using the **chg-ip-lnk** command.

Each IP address entered into the IP Link table must be unique.

At least one optional parameter must be specified.

If the **auto** parameter is entered, then the **duplex** and **speed** parameters are not allowed.

The **loc** parameter value must correspond to a DCM or SSEDCCM card in the card table.

The card associated with the **loc** parameter must be inhibited before executing this command.

For SS7IPGW and IPGWI, Application Sockets on port **b** are not allowed.

The local **ipaddr** and **submask** values of either the A or B network cannot be changed to an address that represents a different network if a default router and/or other gateway routers are assigned to the current local network (display with **rtv-ip-card** and **rtv-ip-rte**).

The local IP address cannot be changed if the current or new local host has open sockets or associations (the **open** parameter set to **yes** with the **ent-assoc** or **chg-assoc** command).

The IP address of an existing IP link entry in the IP Link table cannot be changed if it exists in the IP Host table.

An IP link entry must be provisioned in the IP Link table before an IP host entry can be provisioned with a corresponding IP address in the IP Host table.

The IP host entry must be deleted from the IP Host table before an IP link entry can be deleted from the IP Link table.

An existing IP link entry in the IP Link table cannot be deleted (IPADDR=0.0.0.0) if it exists in the IP Host table.

Notes

None

Output

```
chg-ip-lnk:loc=1211:port=a
  rlgncxa03w 04-01-17 15:35:05 EST EAGLE 31.3.0
  CHG-IP-LNK: MASP A - COMPLTD
;
```

chg-isupvar-attrb

Change ISUP Variant Attribute

Use this command to change the attributes of ISUP Variant table entries.

Keyword: **chg-isupvar-attrb**

Related Commands: **copy-isupvar-attrb**, **rtv-isupvar-attrb**, **rtv-pstn-pres**

Command Class: Database Administration

Parameters

Table 5-21 on page 5-192 lists valid combinations of required and optional parameters.

:attrib= (mandatory)

The attribute being assigned to a message or parameter.

Range: **defined, notdefined, supp, notsupp**

defined—The message or parameter is defined in the Variant.

notdefined—The message or parameter is not defined in the Variant.

supp—the parameter is supported in the specified message in the Variant.

notsupp—The parameter is not supported in the specified message in the Variant.

:pstncat= (mandatory)

The Public Switched Telephone Network (PSTN) category assigned to the Variant.

Range: **0-65535**

:pstnid= (mandatory)

The Public Switched Telephone Network (PSTN) ID assigned to the Variant.

Range: **0-65535**

:action= (optional)

Specifies the message or parameter conversion action the software follows when a message is received with the specified **msgcode** or **msgcode:parmcode** combination.

Range: **none, convert, passthru**

none—The software will follow its normal conversion rules. No special conversions will occur.

convert—The software will invoke a special conversion routine that is available in the SG for the specified **msgcode** or **msgcode:parmcode** combination.

passthru—For **msgcode**, the specified **msgcode** should be passed through unconverted using the raw MTP3 transfer method.

For **msgcode:parmcode** combination, **parmcode**, when encountered in **msgcode**, should be passed through to the Normalized section of the message (ignoring the **defined** and **supp** attributes of the Normalized specification).

Valid only when included with the following combinations:

msgcode:attrib=defined

msgcode:parmcode:attrib=supp

Default: **none**

:force= (optional)

You must set **force=yes** when setting **msgcode:attr0b=notdefined**. This is to ensure the user understands that this action is destructive and will clear all the associated parameter data for that **msgcode**.

Range: **no, yes**

Default: **no**

:msgcode= (optional)

The ISUP message type code entered to identify a specific ISUP message that is going to have its attributes changed.

Range: 0-255 or (h'00-h'ff)

:minlen= (optional)

Specified the minimum parameter length. This command is used for validating the length of the received parameter is at least **minlen** bytes long.

Range: 0-255

:order= (optional)

Specifies the order the mandatory parameters appear in the message.

Range: 1-7

:parmcode= (optional)

The ISUP parameter code entered to identify a specific ISUP parameter that is going to have its attributes changed.

Range: 0-255 or (h'00-h'ff)

:parmtyp= (optional)

Specifies the type of ISUP parameter.

Range: opt, mf, mv

opt—The parameter may appear in the Optional part of the ISUP message.

mf—The parameter must appear in the Mandatory Fixed part of the ISUP message.

mv—The parameter must appear in the Mandatory Variable part of the ISUP message.

Default: opt

Table 5-21. Valid **chg-isupvar-attrib** command parameter combinations

These are the only permitted combinations of required and optional parameters for this command.											
msg code	parm code	attrib				min len	parmtyp		order	action	force
		defined	not defined	supp	not supp		opt	mf/mv			
R		R								O	
R			R								R
	R	R				R					
	R		R								
R	R			R			R			O	
R	R			R				R	R	O	
R	R				R						

R = Required — O = Optional with the required parameter(s)

Example

chg-isupvar-attrb:pstncat=1:pstnid=5:msgcode=4:attrb=defined

chg-isupvar-attrb:pstncat=1:pstnid=5:parmcode=10:attrb=defined:minlen=6

chg-isupvar-attrb:pstncat=1:pstnid=5:msgcode=4:attrb=defined:action=convert

Dependencies

The combination of **pstncat=1** and **pstnid=2** values is invalid.

A controlled feature must exist for the specified **pstncat** and **pstnid** combination.

The **msgcode** and **parmcode** parameters cannot be specified together in the command.

When the **parmtyp** parameter is specified, the **attrb** parameter must be specified.

When the **parmtyp=mf/mv** parameter is specified, the **order** parameter must be specified.

When the **order** parameter is specified, the **parmtyp** parameter must be specified.

When a parameter is being **defined**, the **minlen** parameter must be specified.

The following parameter combinations are invalid:

- **attrb** is not allowed to be **defined** or **notdefined** if both **msgcode** and **parmcode** are specified.
- **attrb** is not allowed to be **supp** or **notsupp** unless both **msgcode** and **parmcode** are specified.
- **parmtyp** and **order** are not allowed unless both **msgcode** and **parmcode** are not specified.
- **order** is not allowed if **parmtyp=opt**.
- **minlen** is not allowed if **msgcode** is specified.
- **action** is not allowed if only **parmcode** is specified.
- **action** is not allowed to be **convert** or **passthru** if **msgcode:parmcode=0** is specified.

Only **parmcode=0** (EOP) can have **minlen=0**.

Required controlled features must be enabled:

- ISUP normalization controlled feature
- On/off controlled feature for *Tekelec-defined* Variant
- Quantity controlled feature for *user-defined* Variant.

The PSTN must have been previously defined with the **ent-pstn-pres** command.

The **mf** or **mv** parameters must be kept in an ordered list starting with 1.

The **force=yes** parameter is required and valid only if the **msgcode:attrbnotdefined** combination is specified.

Notes

An ISUP Variant table entry exists for each Variant defined in the SG. Each entry contains ISUP message and parameter data specific to the ISUP protocol used by that Variant. A Variant is uniquely defined by its PSTN presentation value, consisting of a PSTN category and PSTN ID.

The **pstncat** and **pstnid** parameters identify the ISUP Variant table entry to be changed. Use the **rtrv-pstn-pres** command to display the only allowed values for the PSTN category and ID. This command can be used to change any *Tekelec-defined* or *user-defined* Variants that **rtrv-pstn-pres** displays. The *Tekelec-defined* Variants' associated ON/OFF control feature *must* be ENABLED.

The user can change the following aspects of the ISUP Variant table entries:

- All the ISUP messages for the Variant can be provisioned as **defined** or **notdefined**. All the ISUP messages default to **notdefined** until this command sets them to **defined**.
- All the ISUP parameters for the Variant can be provisioned as **defined** or **notdefined**. All the ISUP parameters default to **notdefined** until this command sets them to **defined**.
- Values **defined** and **notdefined** are valid **only** if either **msgcode** or **parmcode** is specified alone. When a parameter is being **defined**, **minlen** is required.
- Changing a **msgcode** to **notdefined** clears all the associated parameter data. In this case, **force=yes** is required.
- All the ISUP parameters for specified messages in the Variant can be provisioned as **supported** or **notsupported**. All the ISUP parameters default to **notsupported** until this command sets them to *supported*.
- Values **supp** and **notsupp** are valid only if the **msgcode:parmdoce** parameter is specified.
- **parmcode** cannot be set to **notdefined** if it occurs in any message as **supp**.
- The minimum valid parameter length can be specified for each **defined** ISUP parameter.
- All the ISUP messages provisioned as **defined** can also have a message conversion action assigned.
- All the ISUP parameters provisioned as **supported** can also have a parameter conversion action assigned.
- All the ISUP parameters provisioned as **supported** can also be assigned as optional, mandatory-fixed (**mf**), or mandatory-variable (**mv**).
- If assigned as MF or MV, the numerical order the parameter appears in the message must be specified.
- The user cannot change the attributes for **pstncat=1**, **pstnid=2**.
- When specified with **msgcode**, **parmcode** identifies a parameter within the **msgcode** that is going to have its attributes changed. **parmcode** is required if **msgcode** is not specified.

- **minlen** is required and valid only if the **parmcode:attrib=defined** combination is specified.
- The **minlen=0** is valid only if **parmcode=0 (EOP)**. All other parameters have a range of **1-255**.
- **parmtyp** is valid only if the **msgcode:parmcode:attrib=supp** combination is specified.
- When **mf** or **mv** is specified, **order** must also be specified. The **parmtyp** can be changed as long as the change does not violate the **order** rules.
- The MF parameters **must** be specified in an order list starting with 1. The mv parameters **must** be specified in a different ordered list starting with 1. There can be no gaps in order number. A parameter **cannot** be deleted from a list, as when changing **parmtyp** or changing **attrib** to *notsupp*, unless all parameters with a higher **order** number are deleted first.
- **order** is required and valid only if the **msgcode:parmcode:attrib=supp:parmtyp=mf/mv** combination is specified.
- **action** is valid only when included with the **msgcode:attrib=defined** or **msgcode:parmcode:attrib=supp** combinations.
- When **parmcode=0**, **none** is the only valid **action**.
- The user can enter an **action** for *user-defined* Variants; however, the SG will ignore the **convert** value. There will be no supported conversion **action**.
- **force** is required and valid only if the **msgcode:attribnotdefined** combination is specified.

Output

The following example defines a message in a Variant.

```
chg-isupvar-attr:pstncat=1:pstnid=5:msgcode=4:attrib=defined
```

```
CHG-ISUPVAR-ATTRIB: MASP A - COMPLTD
```

```
;
```

chg-l2t

Change Level 2 Timers

Use this command to change the values of the SS7 MTP level 2 timers. The SS7 MTP level 2 timers are organized in 30 timer sets of 8 timer values each. The 30 timer sets have been grouped and system default values have been initialized by specification (ANSI, ITU, High Speed for China, and High Speed for Q.703 Annex A). Each timer set is administered individually by this command. The **ent-slk** command associates links with timer sets. Each assigned link is associated with one of the 30 timer sets.

Keyword: **chg-l2t**

Related Commands: **rtrv-l2t**, **ent-slk**, **rtrv-slk**

Command Class: Database Administration

Parameters**:l2tset=** (mandatory)

Level 2 timer set identifier, or timer set number. Up to 30 different timer sets can be defined. A signaling link may be assigned to any one of the 30 timer sets.

Range: 1–30

1–10 for ANSI links

11–20 for low-speed ITU links

21–25 for China high speed links

26–30 for Q.703 Annex A high speed links

:t1= (optional)

Timer 1—Aligned/ready

Range: 5000–350000

For ANSI timer sets 1–10—5000–20000 milliseconds

For ITU timer sets 11–20—40000–50000 milliseconds

For China timer sets 21–25—25000–350000 milliseconds

For Q.703 Annex A timer sets 26–30—25000–350000 milliseconds

Default: No change to the current value

System Default: For ANSI timer sets 1–10—13000 milliseconds

For ITU timer sets 11–20—40000 milliseconds

For China timer sets 21–25—150000 milliseconds

For Q.703 Annex A timer sets 26–30—300000 milliseconds

:t2= (optional)

Timer 2—Not aligned

Range: 5000–150000

For ANSI timer sets 1–10—5000–30000 milliseconds

For ITU timer sets 11–20—5000–150000 milliseconds

For China timer sets 21–25—5000–150000 milliseconds

For Q.703 Annex A timer sets 26–30—5000–150000 milliseconds

Default: No change to the current value

System Default: For ANSI timer sets 1–10—11500 milliseconds

For ITU timer sets 11–20—30000 milliseconds

For China timer sets 21–25—130000 milliseconds

For Q.703 Annex A timer sets 26–30—130000 milliseconds

:t3= (optional)

Timer 3—Aligned

Range: 5000–20000

For ANSI timer sets 1–10—5000–30000 milliseconds

For ITU timer sets 11–20—1000–2000 milliseconds

For China timer sets 21–25—1000–2000 milliseconds

For Q.703 Annex A timer sets 26–30—1000–2000 milliseconds

Default: No change to the current value

System Default: For ANSI timer sets 1–10—11500 milliseconds

For ITU timer sets 11–20—2000 milliseconds

For China timer sets 21-25—**1000** milliseconds
For Q.703 Annex A timer sets 26-30—**1000** milliseconds

:t4npp= (optional)

Timer 4— Proving period normal

Range: 500-70000

For ANSI timer sets 1-10—**500-5000** milliseconds

For ITU timer sets 11-20—**7500-9500** milliseconds

For China timer sets 21-25—**3000-70000** milliseconds

For Q.703 Annex A timer sets 26-30—**3000-70000** milliseconds

Default: No change to the current value

System Default: For ANSI timer sets 1-10—**2300** milliseconds

For ITU timer sets 11-20—**8200** milliseconds

For China timer sets 21-25—**30000** milliseconds

For Q.703 Annex A timer sets 26-30—**30000** milliseconds

:t4epp= (optional)

Timer 4—Proving period Emergency

Range: 200-1000

For ANSI timer sets 1-10—**200-1000** milliseconds

For ITU timer sets 11-20—**400-600** milliseconds

For China timer sets 21-25—**400-600** milliseconds

For Q.703 Annex A timer sets 26-30—**400-600** milliseconds

Default: No change to the current value

System Default: For ANSI timer sets 1-10—**600** milliseconds

For ITU timer sets 11-20—**500** milliseconds

For China timer sets 21-25—**500** milliseconds

For Q.703 Annex A timer sets 26-30—**500** milliseconds

:t5= (optional)

Timer 5—Sending SIB

Range: 40-500

For ANSI timer sets 1-10—**40-500** milliseconds

For ITU timer sets 11-20—**80-120** milliseconds

For China timer sets 21-25—**80-120** milliseconds

For Q.703 Annex A timer sets 26-30—**80-120** milliseconds

Default: No change to the current value

System Default: For ANSI timer sets 1-10—**100** milliseconds

For ITU timer sets 11-20—**100** milliseconds

For China timer sets 21-25—**100** milliseconds

For Q.703 Annex A timer sets 26-30—**100** milliseconds

:t6= (optional)

Timer 6—Remote congestion

Range: 1000-10000

For ANSI timer sets 1-10—**1000-10000** milliseconds

For ITU timer sets 11-20—**3000-6000** milliseconds

For China timer sets 21-25—**3000-6000** milliseconds

For Q.703 Annex A timer sets 26-30—**3000-6000** milliseconds

Default: No change to the current value

System Default: For ANSI timer sets 1-10—**4500** milliseconds

For ITU timer sets 11-20—**4500** milliseconds

For China timer sets 21-25—**5000** milliseconds

For Q.703 Annex A timer sets 26-30—**5000** milliseconds

:t7= (optional)

Timer 7—Excessive delay of acknowledgment

Range: **200-3000**

For ANSI timer sets 1-10—**200-3000** milliseconds

For ITU timer sets 11-20—**500-2000** milliseconds

For China timer sets 21-25— **500-2000** milliseconds

For Q.703 Annex A timer sets 26-30—**500-2000** milliseconds

Default: No change to the current value

System Default: For ANSI timer sets 1-10—**1500** milliseconds

For ITU timer sets 11-20—**1500** milliseconds

For China timer sets 21-25—**800** milliseconds

For Q.703 Annex A timer sets 26-30—**800** milliseconds

Example

chg-l2t:l2tset=1:t1=5400

chg-l2t:l2tset=21:t4epp=600:t5=90:t6=3500:t7=1900

Dependencies

At least one optional parameter must be specified.

Notes

ANSI timer defaults are within the Telcordia recommended ranges.

ITU timer defaults are within ITU Q.703 white book recommended ranges.

Output

chg-l2t:l2tset=21:t4epp=600:t5=90:t6=3500:t7=1900

rlghncxa03w 05-02-07 11:11:28 EST EAGLES 34.0.0

CHG-L2T: MASP A - COMPLTD

;

chg-13t

Change Level 3 Timers

Use this command to change the SS7 MTP level 3 timers. The SS7 MTP level 3 timers are organized in a timer set of 21 values each. Only one timer set is administered by this command. Each linkset is associated with the SS7 MTP level 3 Timer set. The linkset and timer set association is assigned with the link administration commands.

Keyword: chg-13t

Related Commands: chg-12t, rtrv-12t, rtrv-13t

Command Class: Database Administration

Parameters

:l3tset= (mandatory)

Timer set table. Only one timer set table exists. All SS7 signaling links use the SS7 MTP level 3 timer set table.

Range: 1

:t1= (optional) (For ANSI or ITU networks).

Timer 1—Changeover delay. Also used as isolation timer for ITU MTP Restart.

Range: 0.1–2.0 seconds

Default: No change to the current value
System Default: 0.8 seconds

:t2= (optional) (For ANSI or ITU networks).

Timer 2—Wait for changeover acknowledge (COA).

Range: 0.1–3.0 seconds

Default: No change to the current value
System Default: 1.4 seconds

:t3= (optional) (For ANSI or ITU networks).

Timer 3—Time controlled diversion on changeback.

Range: 0.1–2.0 seconds

Default: No change to the current value
System Default: 0.8 seconds

:t4= (optional) (For ANSI or ITU networks).

Timer 4—Wait for changeback acknowledge (CBA) #1.

Range: 0.1–2.0 seconds

Default: No change to the current value
System Default: 0.8 seconds

:t5= (optional) (For ANSI or ITU networks).

Timer 5—Wait for changeback acknowledge (CBA) #2.

Range: 0.1–2.0 seconds

Default: No change to the current value
System Default: 0.8 seconds

:t6= (optional) (For ANSI or ITU networks).

Timer 6—Controlled reroute.

Range: 0.1–2.0 seconds

Default: No change to the current value

System Default: 0.8 seconds

:t7= (optional) (For ANSI or ITU networks).

Timer 7—Signaling data link connection (SDLC) acknowledge.

Range: 0.1–3.0 seconds

Default: No change to the current value.

System Default: 1.0 seconds

:t8= (optional) (For ANSI or ITU networks).

Timer 8—Transfer prohibited (TFP) inhibit.

Range: .5–2.0 seconds

Default: No change to the current value.

System Default: 0.8 seconds

:t10= (optional) (For ANSI or ITU networks).

Timer 10—Wait to repeat signaling route set test (SRST) message.

Range: 20.0–90.0 seconds

Default: No change to the current value

System Default: 30.0 seconds

:t11= (optional) (For ANSI or ITU networks).

Timer 11—Transfer restricted.

Range: 1.0–90.0 seconds

Default: No change to the current value System

Default: 30.0 seconds

:t12= (optional) (For ANSI or ITU networks).

Timer 12—Wait for uninhibit acknowledgment.

Range: 0.1–2.0 seconds

Default: No change to the current value

System Default: 0.8 seconds

:t13= (optional) (For ANSI or ITU networks).

Timer 13—Wait for force uninhibit.

Range: 0.1–2.0 seconds

Default: No change to the current value.

System Default: 0.8 seconds

:t14= (optional) (For ANSI or ITU networks).

Timer 14—Wait for inhibit acknowledgment.

Range: 0.2–4.0 seconds

Default: No change to the current value

System Default: 2.0 seconds

:t15= (optional) (For ANSI or ITU networks).

timer 15—Wait for repeat route set congestion test (RSCT).

Range: 0.2–4.0 seconds

Default: No change to the current value

System Default: 3.0 seconds

:t16= (optional) (For ANSI or ITU networks).

Timer 16—Wait for route set congestion test (RSCT) update.

Range: 0.2–3.0 seconds

Default: No change to the current value

System Default: 0.8 seconds

:t17= (optional) (For ANSI or ITU networks).

Timer 17—Delay to avoid oscillation of initial alignment failure.

Range: .5–2.0 seconds

Default: No change to the current value

System Default: 0.8 seconds

:t18= (optional) (For ANSI networks).

Timer 18—Repeat transfer restricted (TFR) once by response method.

Range: 2.0–20.0 seconds

Default: No change to the current value

System Default: 10.0 seconds

:it18= (optional) (For ITU networks).

Timer 18—Timer within a signaling point whose MTP restarts to supervise the receipt of routing information and the activation of the link and link set.

Range: 19–50.0 seconds

Default: No change to the current value.

System Default: 50.0 seconds

:t19= (optional) (For ANSI networks).

Timer 19—Failed link craft referral timer.

Range: 30.0–600.0 seconds

Default: No change to the current value.

System Default: 480.0 seconds

:it19= (optional) (For ITU networks).

Timer 19—Supervision timer during MTP restart to avoid ping-pong of TFP, TFR1, and TRA messages.

Range: 67.0–69.0 seconds

Default: No change to the current value

System Default: 67.0 seconds

:t20= (optional) (For ANSI networks).

Timer 20—Repeat local inhibit test.

Range: 90.0–120.0 seconds

Default: No change to the current value

System Default: 90.0 seconds

:it20= (optional) (For ITU networks).

Timer 20—Overall MTP restart timer at the signaling point whose MTP restarts.

Range: 59.0–61.0 seconds

Default: No change to the current value.

System Default: 59.0 seconds

:t21= (optional) (For ANSI networks).

Timer 21—Repeat remote inhibit test.

Range: 90.0–120.0 seconds

Default: No change to the current value

System Default: 90.0 seconds

:it21= (optional) (For ITU networks).

Timer 21—Overall MTP restart timer at a signaling point adjacent to one whose MTP restarts.

Range: 63.0–65.0 seconds

Default: No change to the current value.

System Default: 63.0 seconds

:t22= (optional) (For ANSI networks).

Timer 22—Timer at restarting STP, waiting for signaling links to become available.

Range: 10.0–60.0 seconds

Default: No change to the current value.

System Default: 10.0 seconds

:it22= (optional) (For ITU networks).

Timer 22—Waiting to repeat local inhibit test.

Range: 180.0–360.0 seconds

Default: No change to the current value

System Default: 90.0 seconds

:t23= (optional) (For ANSI networks).

Timer 23—Timer at restarting STP, started after T22, waiting to receive all TRA messages.

Range: 9.0–100.0 seconds

Default: No change to the current value.

System Default: 10.0 seconds

:it23= (optional) (For ITU networks).

Timer 23—Waiting to repeat remote inhibit test.

Range: 180.0–360.0 seconds

Default: No change to the current value

System Default: 90.0 seconds

:t24= (optional) (For ANSI networks).

Timer 24—Timer at restarting STP with transfer function, started after T23, waiting to broadcast all TRA messages.

Range: 9.0–60.0 seconds

Default: No change to the current value.

System Default: 10.0 seconds

:t25= (optional) (For ANSI networks).

Timer 25—Timer at adjacent STP and restarting STP, waiting for TRA message; may be started at level 2.

Range: 30.0–35.0 seconds

Default: No change to the current value
System Default: 30.0 seconds

:t26= (optional) (For ANSI networks).

Timer 26—Timer at restarting STP, waiting to repeat TRW message.

Range: 12.0–15.0 seconds

Default: No change to the current value.
System Default: 12.0 seconds

:t28= (optional) (For ANSI networks).

Timer 28—Timer at STP adjacent to restarting STP, waiting for TRW message.

Range: 3.0–35.0 seconds

Default: No change to the current value
System Default: 3.0 seconds

:t29= (optional) (For ANSI networks).

Timer 29—Timer started when a TRA is sent in response to an unexpected TRA or TRW; also, started when traffic resumed without receipt of TRA.

Range: 60.0–65.0 seconds

Default: No change to the current value
System Default: 60.0 seconds

:t30= (optional) (For ANSI networks).

Timer 30—Timer to limit sending of TFPs/TFRs in response to an unexpected TRA or TRW.

Range: 30.0–35.0 seconds

Default: No change to the current value
System Default: 30.0 seconds

:t31= (optional) (For ANSI networks).

Timer 31—False link congestion detection.

Range: 10.0–120.0 seconds

Default: No change to the current value.
System Default: 60.0

:t32= (optional) (For ANSI networks).

Timer 32—Link oscillation timer – Procedure A.

Range: 60.0–120.0 seconds

Default: No change to the current value.
System Default: 60.0

Example

```
chg-l3t:l3tset=1:t1=800
```

```
chg-l3t:l3tset=1:t5=800:t6=800:t32=70000
```

Dependencies

The minimum parameter requirement is the table number and at least one timer specified.

You can enter seconds or milliseconds for the timer values. If seconds are entered, the timer value must contain at least one decimal place, but it can contain up to three decimal places. If you do not use decimal places, the system accepts the value as milliseconds. Be aware that the **rtrv-l3t** command always displays the output in seconds, not milliseconds.

Do not specify the following pairs of timers together because one value overrides the other:

- T20 and IT22
- T21 and IT23

Notes

The command line allows 157 characters. Some SS7 MTP level 3 timer changes may exceed this limit. Multiple entries of this command may be required in such cases.

Timer 9 is not currently supported in the SS7 protocol, and has been omitted from this manual. The command will support this timer when it has been defined in the protocol.

The default values are within the Telcordia recommended ranges.

Output

chg-l3t:l3tset=1:t1=800

```
rlghncxa03w 04-01-07 08:40:50 EST EAGLE 31.3.0
CHG-L3T: MASP A - COMPLTD
```

;

chg-lbp

Change Loopback Point's Attribute Values

Use this command to change a far-end loopback point's attribute values maintained in the link fault sectionalization table.

Keyword: **chg-lbp**

Related Commands: **act-lbp, dlt-lbp, dact-lbp, ent-lbp, rtrv-lbp**

Command Class: Database Administration

Parameters

:lbp= (mandatory)

Loopback point ID. This parameter identifies a far-end loopback point that lies along an SS7 signaling link path between the STP and the target device (up to *and including* the target device).

Range: 1-32

:loc= (mandatory)

Card location. The unique identifier of a specific application subsystem located in the STP.

Range: 1101–1108, 1111–1112, 1201–1208, 1211–1218, 1301–1308, 1311–1318, 2101–2108, 2111–2118, 2201–2208, 2211–2218, 2301–2308, 2311–2318, 3101–3108, 3111–3118, 3201–3208, 3211–3218, 3301–3308, 3311–3318, 4101–4108, 4111–4118, 4201–4208, 4211–4218, 4301–4308, 4311–4318, 5101–5108, 5111–5118, 5201–5208, 5211–5218, 5301–5308, 5311–5318, 6101–6108, 6111–6118

:port= or :link= (mandatory)

SS7 signaling links. The SS7 signaling link to be tested.

Range: a, b, a1-a31, b1-b31

Not all card types support all **link** parameter values.

See Table A-1 in Appendix A for valid **link** parameter range values for each type of card that can have assigned signaling links.

:cli= (optional)

The Common Language Location Identifier (CLLI) code, or other mnemonic identifier, used to refer to the given loopback point.

Range: 1 alphabetic character followed by up to 23 alphanumeric characters

Default: No change to the cli value

:lfst= (optional)

Link fault sectionalization test. The type of link fault sectionalization loopback test to be performed.

Range: llt, nlt

llt—latching loopback test

nlt—nonlatching loopback test

:rep= (optional)

Repetition count. The number of link elements of the same type (not including the target device) that lie between the STP and the link element to be tested.

Range: 0–31

Default: No change unless:

0—The link element to be looped back for testing is NEI (**rle=nei** is specified)

0—The type of link fault sectionalization test is NLT (**lfst=nlt** is specified)

0—The type of link fault sectionalization test is NLT (**lfst=nlt** is specified)

0—The new remote link element is the first loopback point of the link to be tested

1–30—Next sequential number for subsequent loopback points of the link to be tested

:rle= (optional)

Remote link element. The link element to be looped back for testing.

Range: ds0, ocu, csu, dsu, nei

Default: No change to the rle value

Example

```
chg-lbp:loc=1101:link=a:lbp=1:rle=ds0:lfst=llt
```

Dependencies

The Link Fault Sectionalization (LFS) feature must be on before using this command.

At least one optional parameter must be specified.

The card location cannot be reserved by the system.

The card location (**loc** parameter) must identify a provisioned **limds0**, **limt1**, or **limch** (associated to a **limt1**) card configured with either an **ss7ansi** or **ccs7itu** application.

The CLLI cannot be a reserved word.

The **rep** parameter value that is specified for this loopback point (LBP) must be greater than the **rep** parameter value of any previously defined LBP and *less* than the **rep** parameter value of any subsequently defined LBP.

The **rep** parameter must be specified if the default value is a duplicate of the **rep** parameter value of any previously defined loopback point.

The LBP must have been previously defined.

The card location cannot be reserved by the system.

The **rep** parameter can be specified only if the **lfst=llt** parameter is specified.

If the **rle=nei** parameter is specified, the **rep=0** parameter must be specified.

The **rle=ds0** or the **rle=nei** parameter cannot be specified if the **lfst=nlts** parameter is specified. The DS0 and Network Element Interface (NEI) link elements do not support non-latching loopbacks.

For each SS7 signaling link, you can define only one loopback point with **rle=nei** specified, and that loopback point must be the terminating SS7 signaling link component.

Notes

None

Output

```
chg-lbp:loc=1101:port=a:lbp=1:rle=ds0:lfst=llt
r1ghncxa03w 05-01-17 15:35:05 EST EAGLE5 33.0.0
CHG-LBP: MASP A - COMPLTD
;
```

chg-lnp-lrn

Change LNP Location Routing Number

NOTE: This command is obsolete.

Use this command to change existing location routing number (LRN) specific information in the database. You can change existing message relay override services. This command updates the LNP LRN table. You can change a maximum of two overriding message relay global title translations at a time.

NOTE: If the LNP ELAP Configuration feature is turned on, this command is no longer available. This function can be performed at the LSMS or using the ELAP user interface.

Keyword: chg-lnp-lrn

Related Commands: dlt-lnp-lrn, ent-lnp-lrn, rtrv-lnp-lrn

Command Class: LNP Database Administration

Parameters**:lrn=** (mandatory)

The location routing number.

Range: 10 digits**:nmrgt1=** (optional)

New message relay global title entry 1.

Range: **tt, pc, ssn, xlat, ri, ngt, rgta****Default:** Null or current value**:nmrgt2=** (optional)

New message relay global title entry 2.

Range: **tt, pc, ssn, xlat, ri, ngt, rgta****Default:** Null or current value

The following arguments allow you to incrementally change default global title translations by entering the **nmrgt1** and **nmrgt2** parameters several times. When **nmrgt1** or **nmrgt2** parameters are used, the constituent values must *all* be entered and separated by a comma (,) or a dash (-) in the order **tt-pc-ssn-xlat-ri-ngt-rgta**.

tt-

Translation type

Range: **0-255**

NOTE: See “Point Code Formats and Conversion” in Appendix A for a detailed description of point code formats, rules for specification, and examples.

pc-ANSI destination point code with subfields *network indicator-network cluster-network cluster member (ni-nc-ncm)*.**Range:** **000-255**

Specify a valid value for each subfield of the point code, and separate the subfields with a dash (-).

When **chg-sid:pctype=ansi** is specified, *ni = 000* is not valid.

When **chg-sid:pctype=ansi** is specified, *nc = 000* is not valid if *ni = 001-005*.

When **chg-sid:pctype=ansi** is specified, *nc = 000* is valid if *ni = 006-255*.

The point code **000-000-000** is not a valid point code.

ssn-

Subsystem number

Range: **0-255****xlat-**

Translate.

Range: **dpc, dpcssn, dpcngt****r-**

Routing indicator.

Range: **gt, ssn****ngt-**

New global title translation type.

Range: 0–255

rgta-

Replace global title address (TN) with LRN.

Range: yes, no

Example

```
chg-lnp-lrn:lrn=1234567890
```

```
chg-lnp-lrn:lrn=1234567891:nmrgt1=16-233-233-233-20-dpcssn-ssn-0-yes
```

Dependencies

To enter this command, the LNP feature must be turned on (see the **enable-ctrl-feat** and **chg-ctrl-feat** commands).

When **nmrgt1** or **nmrgt2** parameters are used, the constituent values must be entered in this order: **tt**, **pc**, **ssn**, **xlat**, **ri**, **ngt**, **rgta**

At least one optional parameter must be specified.

Translation type (**tt** parameter) values that are associated with AIN, IN, PCS, LNPQS, or WNP LNP queries cannot be specified.

The same **tt** value cannot be specified more than once.

When the **xlat=dpcssn** parameter is specified, the **ssn** parameter value must be non-zero.

When the **xlat** parameter is specified with a value other than **dpcssn**, a value of **0** must be specified for the **ssn** parameter.

When a value other than **dpcngt** is specified for the **xlat** parameter, a value of **0** must be specified for the **ngt** parameter.

When the **xlat=dpcngt** parameter is specified, the **ri=gt** parameter must be specified.

The point code must be an ANSI point code, and it must be a valid DPC (not **0-0-0**). The point code entry must be a full point code. Partial point codes are not allowed.

The subsystem number (**ssn** parameter) must be in the LNP database.

The service provider (SP) must be specified if an LRN was not assigned previously.

The LRN must exist.

The Site Identification table is corrupt or cannot be found by the system.

The LNP TT SERV table is corrupt or cannot be found by the system.

The LNP SP table is corrupt or cannot be found by the system.

The NMRGT# message relay translation type must be a reserved service for LNP, and it must already be assigned.

Notes

The LNP EAGLE 5 SAS stores the 10-digit override global title NGT (new global title) value on a per service, point code, and subsystem combination basis. This design allows a user to always modify the NGT field for all LRNs assigned the same service, point code, and subsystem combination instantly with one command. Conversely, the LSMS stores the NGT field independently for each 10-digit override (LRN) global title translation entered.

When an NGT field is modified or assigned to a particular LNP 10-digit override global title translation (either via the LSMS interface or directly from an EAGLE 5 SAS terminal), every existing LRN entry in the LNP EAGLE 5 SAS with the same combination of service, point code, and subsystem will reflect that NGT. Because of this difference in how this information is stored on the LSMS versus how it is stored on the EAGLE 5 SAS, a user could get into a situation where the NGT values in the LSMS are not reflective of those stored in the EAGLE 5 SAS. The NGT value must be specified correctly every time a 10-digit override (LRN) global title translation is updated or the LNP service on the EAGLE 5 SAS could be seriously impacted.

Output

chg-lnp-lrn:lrn=1234567890

```
rlghncxa03w 04-01-18 08:50:12 EST EAGLE 31.3.0
CHG-LNP-LRN: MASP A - COMPLTD
```

;

chg-lnp-npanxx**Change LNP NPANXX**

NOTE: This command is obsolete.

Use this command to change an existing LNP NPANXX record, including a message relay default global title translation in the database. This command allows the replacement of a single message relay default global title translation in the database and the replacement of the message relay indicator. It does not add to or delete from the NPANXX a new message relay translation type. This command changes only the existing data. Translation type values associated with WNP, PCS, AIN, LNPQS, or IN LNP queries are not allowed to be administered as NPANXX default message relay global title translations.

NOTE: If the LNP ELAP Configuration feature is turned on, this command is no longer available. This function can be performed at the LSMS or using the ELAP user interface.

Keyword: chg-lnp-npanxx

Related Commands: dlt-lnp-npanxx, ent-lnp-npanxx, rtrv-lnp-npanxx

Command Class: LNP Database Administration

Parameters

:npanxx= (mandatory)

Numbering plan area.

Range: 6 digits

:ngt1= (optional)

New default global title entry 1.

Range: **ngt, pc, ri, ssn, tt, xlat**

Default: The default global title entry is not specified

:ngt2= (optional)

New default global title entry 2.

Range: **ngt, pc, ri, ssn, tt, xlat**

The following arguments allow you to incrementally change default global title translations by entering the **ngt1** and **ngt2** parameters several times. When **ngt1** or **ngt2** parameters are used, the constituent values must *all* be entered and separated by a comma (,) or a dash (-) in the order **tt-pc-ssn-xlat-ri-ngt-ngta**

tt-

Translation type

Range: **0-255**

NOTE: See “Point Code Formats and Conversion” in Appendix A for a detailed description of point code formats, rules for specification, and examples.

pc-

ANSI destination point code with subfields *network indicator-network cluster-network cluster member (ni-nc-ncm)*.

Range: **000-255**

Specify a valid value for each subfield of the point code, and separate the subfields with a dash (-).

When **chg-sid:pctype=ansi** is specified, *ni = 000* is not valid.

When **chg-sid:pctype=ansi** is specified, *nc = 000* is not valid if *ni = 001-005*.

When **chg-sid:pctype=ansi** is specified, *nc = 000* is valid if *ni = 006-255*.

The point code **000-000-000** is not a valid point code.

ssn-

Subsystem number

Range: **0-255**

xlat-

Translate.

Range: **dpc, dpcssn, dpcngt**

ri-

Routing indicator.

Range: **gt, ssn**

ngt-

New global title translation type.

Range: **0-255**

ngta-

New global title address translation type.

Range: **yes, no**

:nmr (optional)

New message relay ported indication

Range: yes, no

Default: The current value

Example

```
chg-lnp-npanxx:npanxx=111111:nmr=no
```

```
chg-lnp-npanxx:npanxx=111111:nmr=yes:ngt1=16-255-255-255-0-dpcngt-gt-20
```

Dependencies

At least one optional parameter must be specified.

To enter the **chg-lnp-npanxx** command, the LNP feature must be turned **on** (see the **enable-ctrl-feat** and **chg-ctrl-feat** commands).

The new message relay global title point code must exist in the route table.

The LNP query default global title point code must exist in the route table, or must be the EAGLE 5 SAS's true point code and LNP subsystem.

The **gt1** and **gt2** parameters translation type must already be assigned, and they must be a reserved service for the LNP.

The NPANXX must already exist.

Translation type (**tt** parameter) values associated with PCS, LNPQS, or WNP LNP queries cannot be specified.

The same translation type value cannot be specified more than once.

When the **xlat=dpcssn** parameter is specified, the **ssn** parameter value must be non-zero.

When the **xlat** parameter is specified with a value other than **dpcssn**, a value of **0** must be specified for the **ssn** parameter.

When a value other than **dpcngt** is specified for the **xlat** parameter, a value of **0** for the **ngt** parameter must be specified.

When the **xlat=dpcngt** parameter is specified, you must specify the **ri=gt** parameter must be specified.

The point code must be an ANSI point code, and it must be a valid DPC (not **0-0-0**). The point code must be a full point code entry.

The subsystem number (**ssn** parameter) must be in the LNP database.

The LNP database, LNP TT SERV table, LNP MR table, and the SID table must all be accessible.

The new GTT value must not match the old GTT value.

Notes

This command can be entered several times for the same NPANXX to change one or more default global title translations.

The LNP EAGLE 5 SAS stores the 6-digit default global title NGT (new global title) value on a per service, point code, and subsystem combination basis, not on an NPA-NXX basis. This design allows a user to always modify the NGT field for all NPA-NXXs assigned the same service, point code, and subsystem combination instantly with one command. Conversely, the LSMS stores the NGT field independently for each 6-digit default (NPA-NXX) global title translation entered.

When an NGT field is modified or assigned to a particular LNP 6-digit global title translation (either via the LSMS interface or directly from an EAGLE 5 SAS terminal), every existing NPA-NXX entry in the LNP EAGLE 5 SAS with the same combination of service, point code, and subsystem will reflect that NGT. Because of this difference in how this information is stored on the LSMS versus how it is stored on the EAGLE 5 SAS, a user could get into a situation where the NGT values in the LSMS are not reflective of those stored in the EAGLE 5 SAS. The NGT value must be specified correctly every time a 6-digit default (NPA-NXX) global title translation is updated or the LNP service on the EAGLE 5 SAS could be seriously impacted.

Output

```
chg-lnp-npanxx:npanxx=111111:nmr=no
rlghncxa03w 04-01-18 08:50:12 EST EAGLE 31.3.0
CHG-LNP-NPANXX: MASP A - COMPLTD
;
```

chg-lnp-serv

Change LNP Service

NOTE: This command is obsolete.

Use this command to change an existing LNP service. You can specify a new translation type, digit validity indicator, and translation type name for the existing service. A new translation type name of **none** defaults the name back to the reserved service type name.

Keyword: chg-lnp-serv

Related Commands: dlt-lnp-serv, ent-lnp-serv, rtrv-lnp-serv

Command Class: LNP Database Administration

Parameters

:ndv= (optional)

New digits valid.

Range: sccp, tcap

Default: The current value

:nserv= (optional)

New reserved service type name.

Range: ain, in, pcs, wnp, class, lidb, cnam, isvm, lnpqs, wsmc, udf1, udf2, udf3, udf4

Default: The current value

:ntt= (optional)

New translation type.

Range: 0-255

Default: The current value

:nttn= (optional)

User defined TT name.

Range: 1 to 8 alphabetic characters, including **none**

Default: The current value, but if **none** is specified, it defaults to the reserved service type name (serv parameter)

:serv= (optional)

Reserved service type name.

Range: ain, in, pcs, wnp, class, lidb, cnam, isvm, lnpqs, wsmc, udf1, udf2, udf3, udf4

Default: The current value

:tt= (optional)

Translation type.

Range: 0-255

Default: The current value

Example

```
chg-lnp-serv:serv=lidb:ntt=22, ndv=tcap:nttn=mlidb
```

```
chg-lnp-serv:tt=11:nserv=lnpqs
```

Dependencies

To enter the **chg-lnp-serv** command, the LNP feature must be turned on (see the **enable-ctrl-feat** and **chg-ctrl-feat** commands).

To specify the **serv=wsmc** parameter, the LNP SMS feature must be turned on.

To specify the **nserv=pcs** parameter, the PCS 1900 LNP (PLNP) feature must be turned on.

To specify the **nserv=wnp** parameter, the WNP feature must be turned on.

At least one optional parameter must be specified.

The new translation type (**ntt** parameter) must not already exist in the LNP database.

The new translation type name (**nttn** parameter) must not already exist in the LNP database.

The service type (**serv** parameter) must already exist in the LNP database.

The **serv** parameter and the **tt** parameter cannot be specified in the same command.

The **ntt** parameter and the **nserv** parameter cannot be specified in the same command.

The new digits valid indication (**dv** parameter) must not match the old digits valid indication.

An LNP alias cannot be specified as the value for the **ntt** parameter.

Before a service (**serv** parameter) can be changed, all LNP aliases for that service must be removed from the LNP database

Translation type names must be unique for LNP services.

A reserved service type name can be specified for the **tn** parameter only if the name matches the existing **service**.

Notes

When the LNP feature is on for up to 12 million TNs (see the **enable-ctrl-feat** command), the LNP services CLASS, CNAM, LIDB, and ISVM must be in the OAP configuration in the EAGLE 5 SAS database. You must update the OAP configuration (with the **act-oap-config** command) whenever you perform the following actions:

- Add LNP services to the database (with the **ent-lnp-serv** command).
- Remove services from the database (with the **dlt-lnp-serv** command).
- Change services (with the **chg-lnp-serv** command).

As a reminder, the following warning message is displayed:

```
CAUTION: LNP service TTs have changed, OAP configuration is required
```

A service cannot be changed if any alias translation type exists for that service. To modify the service based upon translation type, the **tt** parameter with the **nserv** parameter must be specified.

Output

```
chg-lnp-serv:serv=lidb:ntt=22, ndv=tcap:nttn=mrlidb
rlghncxa03w 02-11-18 08:50:12 EST EAGLE 30.0.0
CHG-LNP-SERV: MASP A - COMPLTD
;
```

chg-lnp-sub

Change LNP 10-Digit Subscription

NOTE: This command is obsolete.

Use this command to change an existing LNP 10-digit telephone number (TN) subscription or pooled TN number existing in the database. All the LRN and message relay information must be specified. The messages relay global title point code is validated as a destination in the Route table.

NOTE: If the LNP ELAP Configuration feature is turned on, this command is no longer available. This function can be performed at the LSMS or using the ELAP user interface.

Keyword: chg-lnp-sub

Related Commands: dlt-lnp-sub, ent-lnp-sub, rtrv-lnp-sub

Command Class: LNP Subscription

Parameters

:tn= (mandatory)

The telephone number.

Range: 10 digits—To specify a single TN subscription

7 digits with 3 asterisks (***) appended—To pool a block of 1000 TNs

:nlrn= (optional)

The new location routing number.

Range: 10 digits

:nmrgt1= (optional)

The new message relay global title entry number 1.

Range: **tt, pc, ssn, xlat, ri, ngt, rgta**

:nmrgt2= (optional)

The new message relay global title entry number 2.

Range: **ngt, pc, ri, ssn, tt, xlat**

The following arguments allow you to incrementally change default global title translations by entering the **nmrgt1** and **nmrgt2** parameters several times. When **nmrgt1** or **nmrgt2** parameters are used, the constituent values must *all* (mandatory) be entered and separated by a comma (,) or a dash (-) in the order **tt-pc-ssn-xlat-ri-ngt-rgta**.

tt-

Translation type

Range: **0-255**

NOTE: See “Point Code Formats and Conversion” in Appendix A for a detailed description of point code formats, rules for specification, and examples.

pc-

ANSI destination point code with subfields *network indicator-network cluster-network cluster member (ni-nc-ncm)*.

Range: **000-255**

Specify a valid value for each subfield of the point code, and separate the subfields with a dash (-).

When **chg-sid:pctype=ansi** is specified, *ni = 000* is not valid.

When **chg-sid:pctype=ansi** is specified, *nc = 000* is not valid if *ni = 001-005*.

When **chg-sid:pctype=ansi** is specified, *nc = 000* is valid if *ni = 006-255*.

The point code **000-000-000** is not a valid point code.

ssn-

Subsystem number

Range: **0-255**

xlat-

Translate.

Range: **dpc, dpcssn, dpcngt**

ri-

Routing indicator.

Range: **gt, ssn**

ngt-

New global title translation type.

Range: **0-255**

rgta-

Replace global title address (TN) with LRN.

Range: yes, no

Example

```
chg-lnp-sub:tn=1234567890:nsp=a123:nlrn=1234567890:nmrgt1=16,233-233-233,0,dpc,gt,28,yes
```

```
chg-lnp-sub:tn=1234567***:nsp=a123:nlrn=1234567890:nmrgt1=16,233-233-233,0,dpc,gt,28,yes
```

```
chg-lnp-sub:tn=1234567000:nsp=a123:nlrn=1234567890:nmrgt1=16,233-233-233,0,dpc,gt,28,yes
```

Dependencies

The LNP feature must be turned on (see the **enable-ctrl-feat** command) before this command can be entered.

The LNP database must be accessible.

When the **nmrgt1** or **nmrgt2** parameter is specified, the constituent values must be entered in this order: **tt**, **pc**, **ssn**, **xlat**, **ri**, **ngt**, **rgta**

Ranges across NPANXX boundaries cannot be specified.

Translation type values associated with AIN, IN, LNPQS, PCS, or WNP LNP queries are not allowed as message relay global title translations.

A maximum of two message relay global title translations can be changed at a time.

When the **xlat=dpcssn** parameter is specified, a non-zero value must be specified for the **ssn** parameter.

When a value other than **dpcssn** is specified for the **xlat** parameter, a value of **0** must be specified for the **ssn** parameter.

When the **xlat=dpcngt** parameter is specified, the **ri=gt** parameter must be specified.

When a value other than **dpcngt** is specified for the **xlat** parameter, a value of **0** must be specified for the **ngt** parameter.

When the **rgta=yes** parameter is specified, the **nlrn** parameter must be specified.

Either the **nlrn** parameter or the **ngt** parameter must be specified.

The point code must be a valid ANSI DPC that exists in the routing table. (The point code **0-0-0** is not a valid ANSI point code). The point code entry must be a full point code. Partial point codes are not allowed.

The same **tt** parameter value cannot be specified more than once.

The following tables must be accessible: LNP MR, LNP LRN, LNP SP, LNP TT SERV, NPANXX, PORTED TN, ROUTE.

The **nmrgt# tt** must be already assigned and it must be a reserved service for LNP.

Notes

This command can be entered several times to change an existing LNP service for an existing **tn**.

The LNP EAGLE 5 SAS stores the 10-digit subscription global title NGT (new global title) value on a per service, point code, and subsystem combination basis. This design allows a user to always modify the NGT field for all 10-digit subscriptions assigned the same service, point code, and subsystem combination instantly with one command. Conversely, the LSMS stores the NGT field independently for each 10-digit subscription global title translation entered.

When an NGT field is modified or assigned to a particular LNP 10-digit global title translation (either through the LSMS interface or directly from an EAGLE 5 SAS terminal), every existing subscription entry in the LNP EAGLE 5 SAS with the same combination of service, point code, and subsystem will reflect that NGT. Because of this difference in how this information is stored on the LSMS versus how it is stored on the EAGLE 5 SAS, a user could get into a situation where the NGT values in the LSMS are not reflective of those stored in the EAGLE 5 SAS. The NGT value must be specified correctly every time a 10-digit subscription global title translation is updated or the LNP service on the EAGLE 5 SAS could be seriously impacted.

Pooled TNs are allocated on an even 1000-block boundary and cannot cross an NPANXX's boundary. Specific ported TNs can overlap a pooled block and contain different routing.

Pooled TNs cannot be changed to specific subscriptions, nor can specific subscriptions be changed to pooled TNs.

Output

```
chg-lnp-sub:tn=1234567890:nsp=a123:nlrn=1234567890:nmrgt1=16,233-233-233,0,dpc,gt,28,yes
```

```
rlghncxa03w 04-01-18 08:50:12 EST EAGLE 31.3.0
CHG-LNP-SUB: MASP A - COMPLTD
```

```
;
```

chg-lnp-ttmap

Change LNP Translation Type Mapping

Use this command to create, change, or disable the existing message relay global title (MRGT) LNP GT entry for a group of existing telephone numbers (TN) in the database. This command allows you to specify a translation type and global title address treatment of different service providers according to the DPC configured in the message relay (MR) global title translation (GTT) table.

NOTE: This command does not support 24-bit ITU national point codes.

Keyword: chg-lnp-ttmap

Related Commands: rtrv-lnp-ttmap

Command Class: LNP Database Administration

Parameters

NOTE: See "Point Code Formats and Conversion" in Appendix A for a detailed description of point code formats, rules for specification, and examples.

:pc= or :pca= (mandatory)

ANSI destination point code with subfields *network indicator-network cluster-network cluster member (ni-nc-ncm)*.

Range: 000-255

Specify a valid value for each subfield of the point code, and separate the subfields with a dash (-).

When **chg-sid:pctype=ansi** is specified, *ni = 000* is not valid.

When **chg-sid:pctype=ansi** is specified, *nc = 000* is not valid if *ni = 001-005*.

When **chg-sid:pctype=ansi** is specified, *nc = 000* is valid if *ni = 006-255*.

The point code **000-000-000** is not a valid point code.

:tt= (mandatory)

Translation type.

Range: 0-255

:nngt= (optional)

New new global title translation type.

Range: 0-255

Default: No change to current value

:nrgta= (optional)

New replacement **gta** treatment.

Range: yes, no

Default: No change to current value

Example

```
chg-lnp-ttmap:tt=16:pc=233-233-233:nngt=28
```

Dependencies

The LNP feature must be turned on (see the **enable-ctrl-feat** command) before this command can be entered.

At least one optional parameter must be specified.

The **tt** must be reserved for LNP.

The **tt** cannot be an LNP alias.

The point code (**pc/pca** parameter) must exist in the routing table.

The LNP MR table must not be full.

Notes

Entering this command one time affects all the NPANXXs and TNs that reference the specified DPC in their default MR GTT or MR GTT respectively.

If the **nngt** parameter is specified, the **xlat=dpcnngt** and **ri=gt** parameter values must be specified. If they are not specified, they are changed to those values.

The **nrgta** parameter assumes an associated LRN is specified. If no LRN is specified, the real-time database displays *not found* information.

If the **nrgta** or **ngt** parameter is specified, it performs a global database assignment of **ngt** or **rgta** to the specified translation type and point code combination in the database. Subsequent assignments of non-**ngt** parameters specified by **sub** or **npanxx** commands, for the globally updated translation type and point code combination, retain the globally defined **ngt** or **rgta** value.

The EAGLE 5 SAS terminal-administered **npanxx** or **sub** commands can also globally enable or disable **ngt** or **rgta** values.

Output

```
chg-lnp-ttmap:tt=16:pc=233-233-233:nngt=28
rlghncxa03w 04-01-05 16:40:40 EST EAGLE 31.3.0
CHG-LNP-TTMAP: MASP A - COMPLTD
;
```

chg-lnpopts

Change LNP System Options

Use this command to enter LNP-specific system options in the database. This command updates the LNPOPTS table.

Keyword: **chg-lnpopts**

Related Commands: **rtrv-lnpopts**

Command Class: LNP Database Administration

Parameters

:admhipri= (optional)

Give LNP database administration the highest administrative priority in the system.

Range: **yes, no**

Default: The current value.

:amactype= (optional)

AMA call type.

Range: 3 digits

Default: The current value.

:amafeatid= (optional)

AMA feature ID.

Range: 3 digits

Default: The current value.

:amaslpid= (optional)

AMA slip ID.

Range: Exactly 9 digits

Default: The current value.

:aud= (optional)

Audit indicator.

Range: **on, off**

Default: The current value.

:ccp= (optional)

Copy charge parameters. When this parameter is enabled (**ccp=yes**), the EAGLE 5 SAS copies the Charge Number and Charge Party Station type from an LNP AIN query (if present) to the LNP AIN Response message.

Range: yes, no

Default: The current value.

:cic= (optional)

Carrier identification code.

Range: 3 or 4 digits

Default: The current value.

:frcsmplx= (optional)

Allow simplex database updates.

Range: yes, no

Default: The current value.

:gtwystp= (optional)

Indicates that the LNP system is also configured as a Gateway STP.

Range: yes, no

Default: The current value.

:incslp= (optional)

Include AMA slip ID in the response.

Range: yes, no

Default: The current value.

:jipdigits= (optional)

The Jurisdictional Information Parameter value.

Range: 6 digits

Default: The current value.

:jipprv= (optional)

Determines whether a Jurisdictional Information Parameter value is to be added to the IAM.

Range: yes, no

Default: The current value.

:servport= (optional)

Service portability.

Range: yes, no

yes—This is a protocol setting that allows splitting services between TN and LRN override records. This setting lets the technician update LRN overrides for message relay services that are to be supported in the network. The EAGLE 5 SAS then uses the TN gateway point code (NPAC subscription data) for message relay services the CLEC wants to provide.

no—If no LRN override services are provisioned, then the TN's gateway point codes (NPAC subscription data) are used to route queries out of the network. If one or more LRN override services are provisioned, the TN is considered to be ported into the network. In this case, if an LRN override service is

requested and the LRN has other services administered, but the requested service is not provisioned, then a UDTs response for the service is provided.

Default: The current value

:sp= (optional)

Service provider ID.

Range: 4 alphanumeric characters

Default: The current value.

:wqredrct= (optional)

Wireless queries directed to default GTT.

Range: **on, off**

on—This setting allows the GTT functionality to treat any wireless LNP (WNP and PCS) queries that require GT as a normal GTT.

off—This setting routes all wireless LNP queries (WNP and PCS) that require GT directly to the local subsystem.

Default: the current value

:wsmc10dig= (optional)

SCCP GTA digit length indicator for 10 or 11 digits.

Range: **yes, no**

yes—The system verifies that either 10 or 11 digits are present in the CDPA GTA. If 11 digits are present, the first digit is stripped to derive 10 digits for LNP SMS translation. If 10 digits are present, all 10 digits are used for LNP SMS translation.

no—The system verifies that 11 digits (plus a padded 0 digit) are present in the CDPA GTA. If 11 digits are present, the system strips the first digit and considers only 10 digits for LNP SMS translation.

Default: the current value

Example

chg-lnpopts:amaslpid=123456789

chg-lnpopts:amactype=003

chg-lnpopts:amafeatid=010

chg-lnpopts:incslp=yes

chg-lnpopts:cic=1369

chg-lnpopts:aud=on

chg-lnpopts:sp=1234

chg-lnpopts:jipdigits=919460

chg-lnpopts:jipprv=yes

chg-lnpopts:frcsmplx=yes

chg-lnpopts:admhipri=yes

chg-lnpopts:gtwystp=yes

chg-lnpopts:ccp=yes

chg-lnpopts:servport=yes

```
chg-lnpopts:wqredrct=off
chg-lnpopts:wsmc10dig=yes
```

Dependencies

At least one optional parameter must be specified.

The LNP feature (see the **enable-ctrl-feat** command) and the Triggerless LNP (TLNP) feature must be turned on before this command can be entered.

The **jipprv** and **jipdigits** parameters can be specified only if the Triggerless LNP feature is **on**.

The LNP SMS feature must be turned on before the **wsmc10dig** parameter can be specified.

Notes

The **frcomplex** parameter is used to force the system in a forced simplex mode. In this mode, simplex updates are accepted by the active OAM if the standby OAM is in one of the following states: incoherent, diff level, or unstable.

If the **admhipri** parameter is set to **yes**, LNP database administration can starve out normal STP updates during LNP administration of 2 TNs per second. If the parameter is set to **no**, then STP and LNP updates receive the same priority. Depending on the system activity level, the performance of LNP updates may be reduced.

If the **gtwystp** parameter is set to **yes**, the LNP system is also configured as a gateway STP. The NPAC sends down capability point codes without routes.

Output

```
chg-lnpopts:amaslpid=123456789
rlghncxa03w 04-01-07 00:57:31 EST EAGLE 31.3.0
CHG-LNPOPTS: MASP A - COMPLTD
;
```

chg-ls

Change Linkset

Use this command to change the attributes for a specified linkset in the system database. The new values overwrite the existing values.

Keyword: **chg-ls**

Related Commands: **chg-slt, dlt-ls, rtrv-ls**

Command Class: Database Administration

Parameters

:lsn= (mandatory)

The name of the linkset. The linkset name must be unique.

Range: 1 alphabetic character followed by up to 9 alphanumeric characters

:action= (optional)

Add or delete SAPC or mate IPGWx linkset name.

Range: **add, delete**

Default: **add**

:apc/apca/apci/apcn/apcn24= (optional)
Adjacent point code.

NOTE: See “Point Code Formats and Conversion” in Appendix A for a detailed description of point code formats, rules for specification, and examples.

:apc= or **:apca=** (optional)

ANSI point code with subfields *network indicator-network cluster-network cluster member* (*ni-nc-ncm*). The *prefix* subfield indicates a private point code (*prefix-ni-nc-ncm*).

Range: **p-**, **000-255**

Specify a valid value for each subfield of the point code, and separate the subfields with a dash (-).

prefix—**p-**

The asterisk (*) value is not valid for the *ni* subfield.

When **chg-sid:pctype=ansi** is specified, *ni* = **000** is not valid.

When **chg-sid:pctype=ansi** is specified, *nc* = **000** is not valid if *ni* = **001-005**.

When **chg-sid:pctype=ansi** is specified, *nc* = **000** is valid if *ni* = **006-255**.

When **chg-sid:pctype=ansi** is specified, *ni*-*-*** is valid if *ni* = **006-255**.

The point code **000-000-000** is not a valid point code.

:apci= (optional)

ITU international point code with subfields *zone-area-id*. The *prefix* subfield indicates a spare point code, private point code, or private and spare point code (*prefix-zone-area-id*).

Range: **s-**, **p-**, **ps-**, **0-255**

Specify a valid value for each subfield of the point code, and separate the subfields with a dash (-).

The point code **0-000-0** is not a valid point code.

prefix—**s-**, **p-**, **ps-**

zone—**0-7**

area—**000-255**

id—**0-7**

:apcn= (optional)

ITU national point code in the format of a 5-digit number (*nnnnn*); or 2, 3, or 4 numbers (members) separated by dashes (*m1-m2-m3-m4*) as defined by the **chg-stpopts:npcfinti** flexible point code option. A group code must be specified when the ITUDUPPC feature is turned on (*nnnnn-gc*, *m1-m2-m3-m4-gc*). The *prefix* subfield indicates a spare point code, private point code, or private and spare point code (*prefix-nnnnn*, *prefix-nnnnn-gc*, *prefix-m1-m2-m3-m4*, *prefix-m1-m2-m3-m4-gc*).

Range: **s-**, **p-**, **ps-**, **0-16383**, **aa-zz**

Specify a valid value for each subfield of the point code, and separate the subfields with a dash (-).

prefix—**s-**, **p-**, **ps-**

nnnnn—**0-16383**

gc—**aa - zz**

m1-m2-m3-m4—**0-14** for each member; values must sum to 14

:apcn24= (optional)

24-bit ITU national point code with subfields *main signaling area-sub signaling area-signaling point* (*msa-ssa-sp*). The *prefix* indicates a private point code (*prefix-msa-ssa-sp*).

Range: p-, 000-255
prefix—p-
msa—000-255
ssa—000-255
sp—000-255

:apctype= (optional)

ITU-N Adjacent Point Code Type. The ITU National or ITU National China Adjacent Point Code types indicate the format that will be used for changeover and changeover acknowledgement messages.

Range: itun, itunchina

Default: itun

:asl8= (optional)

Adjacent SLS 8-bit indicator. Specifies whether the adjacent node is sending MSUs with 8-bit SLSs.

Range: yes, no

Default: Current value

:bei= (optional)

The broadcast exception indicator. This parameter indicates whether TFP (transfer prohibited) messages are allowed to be broadcast on the linkset. The **yes** parameter means TFPs are not broadcast, and the **no** parameter means TFPs are broadcast.

Range: yes, no

Default: Current value

:clli= (optional)

The far-end Common Language Location Identifier (CLLI).

Range: 1 alphabetic character followed by up to 10 alphanumeric characters

Default: Current value

:gmscrn= (optional)

GSM MAP screening allowed.

Range: on, off

Default: Current value

:gwsa= (optional)

Gateway screening action. This parameter determines whether gateway screening (GWS) is on or off for the specified linkset.

Range: on, off

Default: Current value

:gwsd= (optional)

Use gateway screening MSU discard to turn on or off the discarding of MSUs that bypass the gateway screening function due to load-shedding. Also use this parameter with the redirect function; MSUs that cannot be screened are discarded if **gwsd=on** is specified.

Range: on, off

Default: off

:gwsn= (optional)

Gateway screening messaging. This parameter determines whether messages are generated for each message screened by gateway screening.

Range: on, off

Default: Current value

:iptps= (optional)

IPGWx Linkset TPS. This value is a user-defined portion of the total enabled system IP Signaling TPS shown in the **rtrv-ctrl-feat** command output. This parameter is allowed and required only for IPGWx linksets (when **ipgwapc=yes** is specified).

Range: 100-112000

The specified value must be divisible by 10.

The sum of the **iptps** values assigned to all linksets in the system cannot exceed the enabled system IPGWs Signaling TPS value (see the **rtrv-ctrl-feat** command).

NOTE: The maximum range value for the **iptps** parameter is 188000 for future expansion. However, the maximum system IPGWx Signaling TPS capacity currently available is 112000.

Default: No change to current value.

:itutfr= (optional)

ITU TFR (Transfer Restricted) procedure indicator. This parameter is used to enable or disable the TFR procedure on a per-linkset basis. This parameter is valid for ITU national linksets only.

Range: on, off

Default: No change to current value

:l3tset= (optional)

Link timer set, defined with the **chg-l3t** command.

Range: 1

Default: No change to current value

:lst= (optional)

The linkset type of the specified linkset. This parameter indicates whether the specified link is an access link, bridge link, cross link, diagonal link, or extended link, as defined in Telcordia GR-246-CORE, T1.111.5.

Range: a, b, c, d, e

a—Access links

b—Bridge links

c—Cross links

d—Diagonal links

e—Extended links

Default: No change to current value

:lsusealm= (optional)

IPTPS linkset alarm threshold percent. The percent of the linkset TPS (**iptps**) at which an alarm is generated to indicate that the actual linkset TPS is approaching the configured **iptps** value for the linkset.

Range: 10-100

Default: No change to current value

:matelsn= (optional)

Mate linkset name.

Range: 1 alphabetic character followed by up to 9 alphanumeric characters

Default: No change to current value

:mtpmse= (optional)

ANSI or ITU MTP Restart equipped. This parameter indicates whether the node adjacent to the linkset is equipped with MTP Restart.

Range: **yes, no**

yes—equipped

no—not equipped

Default: No change to current value

:nis= (optional)

This parameter determines whether the Network Indicator Spare option is on or off for the specified linkset. When this option is enabled, the Network Spare value for network indicator for both ANSI and ITU-National (ITU-N) links is supported by the system.

Range: **on, off**

Default: **off**

:nlsn= (optional)

New linkset name, when the command is entered to change the linkset name specified in the **lsn** parameter.

Range: Up to 8 alphanumeric characters; the first character must be a letter

Default: No change to current value

:scrm= (optional)

The gateway screening screen set assigned to this linkset.

Range: 1 alphabetic character followed by up to 3 alphanumeric characters or none
(deletes screen set association)

Default: No change to current value

:slkusealm= (optional)

IPTPS signaling link alarm threshold percent. The percent of the link "fair share" TPS at which an alarm is generated to indicate that the actual link TPS is approaching the link's "fair share" of its linkset's configured TPS (**iptps**). The "fair share" of the linkset TPS for a link is the configured linkset TPS divided by the number of in-service links in the linkset.

Range: **10-100**

Default: No change to current value

:slsci= (optional)

5-bit to 8-bit SLS conversion indicator. Specifies whether the 5-bit to 8-bit SLS conversion feature is used to select links for outgoing messages direct to the given linkset. When enabled, the system replaces any 5-bit SLS values contained in received messages, with a random 8-bit value before the 5-bit SLS values are used by the STP to select the outgoing link in that linkset.

Range: **yes, no**

yes—enabled

no—disabled

Default: No change to current value.

:slsobit= (optional)

Other CIC (Circuit Identification Code) Bit. If the SLSOCB feature is turned on, this parameter allows you to specify whether the Other CIC Bit option is to be used during link selection. If the option is to be used, you specify which bit (5– 16) of the CIC is to be used as the other CIC bit. During link selection, the specified bit acts as the most significant bit of the new SLS and bits 2 through 4 of the received CIC become the least significant bits of the new SLS. This parameter is used for ITU-ISUP messages. The SLS is not modified in the outgoing message. The following example shows a received CIC where bit 9 is the other CIC bit (**slsobit=9**). The new SLS is 0100:

16	15	14	13	12	11	10	9	8	7	6	5	4	3	2	1
0	0	0	0	1	0	0	0	1	0	0	1	1	0	0	1
New SLS							0					1	0	0	

Range: 5–16, none

Default: No change to current value

:slrsb= (optional)

Rotated SLS (Signaling Link Selection) Bit. This parameter is used for ITU messages on a per-linkset basis to select the bit (1–4) to rotate as the new SLS LSB (Least Significant Bit). The SLS is not modified in the outgoing message. Table 5-22 shows how the rotation affects the four bits of the SLS during linkset selection:

Table 5-22. SLS Bit Rotation

If This Bit Is Selected . . .	Then Bit Locations 4 3 2 1 Are Rotated To . . .	
Bit 4	3 2 1 4	SLS = 0110 becomes Rotated SLS = 1100 SLS = 1011 becomes Rotated SLS = 0111
Bit 3	2 1 4 3	SLS = 0110 becomes Rotated SLS = 1001 SLS = 1011 becomes Rotated SLS = 1110
Bit 2	1 4 3 2	SLS = 0110 becomes Rotated SLS = 0011 SLS = 1011 becomes Rotated SLS = 1101
Bit 1	No rotation is performed because bit 1 is the existing LSB.	

Range: 1–4

Default: No change to current value.

:sltset= (optional)

The SLTM record to be associated with the linkset

Range: 1–20

Default: No change to current value.

:sapci/sapcn/sapcn24= (optional)

Secondary adjacent point code.

:sapci= (optional)

ITU international secondary adjacent point code with subfields *zone-area-id*. The *prefix* subfield indicates a spare point code, private point code, or private and spare point code (*prefix-zone-area-id*).

Range: s-, p-, ps-, 0-255

Specify a valid value for each subfield of the point code, and separate the subfields with a dash (-).

prefix—s-, p-, ps-

zone—0-7

area—000-255

id—0-7

The point code **0-000-0** is not a valid point code.

:sapcn= (optional)

ITU national secondary adjacent point code in the format of a 5-digit number (*nnnnn*); or 2, 3, or 4 numbers (members) separated by dashes (*m1-m2-m3-m4*) as defined by the **chg-stpopts:npcfmti** flexible point code option. A group code must be specified when the ITUDUPPC feature is turned on (*nnnnn-gc*, *m1-m2-m3-m4-gc*). The *prefix* subfield indicates a spare point code, private point code, or private and spare point code (*prefix-nnnnn*, *prefix-nnnnn-gc*, *prefix-m1-m2-m3-m4*, *prefix-m1-m2-m3-m4-gc*).

Range: s-, p-, ps-, 0-16383, aa-zz

Specify a valid value for each subfield of the point code, and separate the subfields with a dash (-).

prefix—s-, p-, ps-

nnnnn—0-16383

gc—aa - zz

m1-m2-m3-m4—0-14 for each member; values must sum to 14

:sapcn24= (optional)

24-bit ITU national secondary adjacent point code with subfields *main signaling area-sub signaling area-signaling point* (*msa-ssa-sp*). The *prefix* indicates a private point code (*prefix-msa-ssa-sp*).

Range: p-, 000-255

Specify a valid value for each subfield of the point code, and separate the subfields with a dash (-).

prefix—p-

msa—000-255

ssa—000-255

sp—000-255

:tfatcabmlq= (optional)

TFA/TCA broadcast minimum link quantity. This parameter specifies the minimum number of links in the given linkset, or in the combined linkset in which the linkset resides, that must be available to user-part messages traffic. This parameter value is used by the STP to consider the first-choice ordered routes using that linkset as Allowed rather than Restricted.

When the **tfatcabmlq** parameter provisioned or default value is **0**, the TFA/TCA broadcast minimum link quantity is calculated by the EAGLE 5 SAS to be either **1** for linksets containing 3 or fewer links, or half of the number of links configured in the linkset for linksets containing more than 3 links.

When the **tfatcabmlq** parameter value is set to a specific value greater than **0**, the EAGLE 5 SAS does not calculate a TFA/TCA broadcast minimum link quantity. The specified value is used.

If the **lsrestrict** option is **off** (see the **chg-ss7opts** command), the **tfatcabmlq** database value for C linksets cannot be changed to a value greater than **0**. If the **lsrestrict** option is **on** (see the **chg-ss7opts** command), the **tfatcabmlq** value for C linksets (**lst=c**) can be set to a value from **1** to **16**. If you change the **tfatcabmlq** value for one or more C linksets in the system, you cannot set the **lsrestrict** option from **on** to **off** until you set all of the changed C linkset **tfatcabmlq** values back to **0**.

NOTE: The **rtrv-ls** command output always shows the calculated value or the provisioned value for the **tfatcabmlq** parameter. See the **rtrv-ls** command description.

Range: 0, 1-16

Default: No change to current value.
System default: 0

Example

Changes link set **wy644368** to use APC **144-202-5**

chg-ls:lsn=wy644368:apc=144-202-005

Changes link set **wy644368** to Link Set Type A

chg-ls:lsn=wy644368:lst=a

Changes link set **wy644370** to use APCN24 **10-100-15**

chg-ls:lsn=wy644370:apcn24=10-100-15

Adds an SAPC to a linkset

chg-ls:lsn=linkset:sapcn=1234-fr:action=add

Deletes an SAPC from a linkset

chg-ls:lsn=linkset:sapcn=1234-fr:action=delete

Modifies an SAPC, **sapc** has to be deleted first and added again

chg-ls:lsn=nc001:apc=144-201-001

chg-ls:lsn=c002:gwsm=on: nis=on

chg-ls:lsn=nc002:gwsm=on

chg-ls:lsn=nc003:sltm=reg:lst=b

Adds a 24-bit ITU-N SAPC to a linkset

chg-ls:lsn=ls1:sapcn24=5-5-5

Deletes a 24-bit ITU-N SAPC from a linkset:

chg-ls:lsn=ls1:sapcn24=5-5-5:action=delete

Assigns a mate linkset to a linkset:

chg-ls:lsn=linkset:matelsn=matelinkset or

chg-ls:lsn=linkset:matelsn=matelinkset:action=add

Removes a mate linkset assignment from a linkset:

chg-ls:lsn=linkset:matelsn=matelinkset:action=delete

Changes an ITUN24 linkset to an **apctype** for China:

chg-ls:lsn=ls2:apctype=itunchina

Changes an ITUN24 linkset to an **apctype** for Q703.A:

chg-ls:lsn=ls2:apctype=itun

Additional examples:

chg-ls:lsn=nc003:slsci=yes:tfatcabmlq=2

chg-ls:lsn=lsitu1:gsmscrn=off

chg-ls:lsn=wy644370:apcn24=10-100-15

chg-ls:lsn=ls1:sapcn24=5-5-5

chg-ls:lsn=ls1:sapcn24=5-5-5:action=delete

chg-ls:apca=p-011-2-3:lsn=lsa1:lst=a

chg-ls:apci=s-1-2-3:lsn=lsn1:lst=c

chg-ls:apcn= ps-1-1-1-2047:lst=a

Dependencies

The **gwsa**, **gwsn**, and **gwsd** parameters can be specified only if the **scrn** parameter is specified.

The **gwsd=on** parameters can be specified only if the **gwsa=on** parameter is specified.

At least one optional parameter must be specified.

If the **lsrestrict** option is **off** (see the **chg-ss7opts** command), the **tfatcabmlq** database value for C linksets cannot be changed from the system default of **0**. If the **lsrestrict** option is **on** (see the **chg-ss7opts** command), the **tfatcabmlq** value for C linksets (**lst=c**) can be set to a value from **1** to **16**. If you change the **tfatcabmlq** value for one or more C linksets in the system, you cannot set the **lsrestrict** option from **on** to **off** until you set all of the changed C linkset **tfatcabmlq** values back to **0**. C linksets are never the primary route (except to reach the STP's mate).

The **tfatcabmlq** parameter value cannot exceed the total number of assigned links in the linkset.

The **tfatcabmlq=0** parameter specifies that the system broadcasts TFAs or TCAs only when half the links in the given linkset, or in the combined linkset in which it resides, become available.

The **slsci** parameter is valid only for ANSI linksets.

The linkset name must be in the database.

The screen set name specified by the **scrn** parameter must be valid and must be in the database.

Adjacent point codes must be full point codes.

The adjacent point code must be defined as a destination point code.

The adjacent point code cannot match the site point code or the capability point code.

If the adjacent point code is in the X.25 domain, **bei=yes** must be specified or the **bei** parameter must be omitted.

The domain of the new adjacent point code must be the same as the previous adjacent point code unless there are no links in the linkset.

The adjacent point code cannot be referenced by an X.25 route with **lc2nm=yes** specified.

Only one linkset can be defined for an adjacent point code.

An SAPC cannot be deleted when routes exist for its SS7 domain.

If the **gwsa=off** and **gwsn=off** parameters are specified, all MSUs are passed. If the **gwsa=off** and **gwsn=off** parameters are specified for all linksets, gateway screening and the GWS redirect function for the DTA feature are disabled.

If the **gwsa=off** and **gwsn=on** parameters are specified, all MSUs pass, but error messages are generated if an MSU matches a screening condition.

If the **gwsa=on** and **gwsn=off** parameters are specified, MSUs are screened but messages are not generated.



CAUTION: Even though gateway screening is in the screen test mode, as defined by the parameters **gwsa=off** and **gwsn=on**, the gateway screening action in the stop action set specified by the **actname** parameter of the screen set *will* be performed at the end of the screening process.

If the **gwsa=on**, **gwsn=on**, and **gwsd=off** parameters are specified, MSUs are screened and error messages are generated if an MSU is passed when it should have been screened. For example, an LIM was configured for gateway screening but was unable to load its screening data.

The **lc2nm** parameter, in the X.25 route commands, allows the system to apply network management procedures to X.25 logical channels. If an X.25 logical channel fails, network management reroutes messages to an alternate route.

The **mtprse** parameter can be specified only if the MTP restart feature, MTPRS (for ANSI), or ITUMTPRS (for ITU), is turned on. The **rtrv-feat** command can be used to verify whether the feature is turned on (MTPRS=YES or ITUMTPRS=YES in the output).

The **mtprse=yes** parameter is not valid for IPGW Adjacent Point Code linksets (**ipgwapc=yes** specified when the linkset was entered in the database).

The **mtprse=yes** parameter is not valid for IPLIMx M3UA signaling links.

A gateway linkset can be configured only from a SEAS terminal and not from a system terminal.

The **cli** parameter and the **apc/apca/apci/apcn/apcn24** parameter must be specified together in the command.

The **nis** parameter can be specified only for ANSI and ITU-N links.

If a DPC matching the far end point code exists, the system compares the far end CLI for the given linkset to the destination identifier (DI) of that matching destination. If they are not identical, the system rejects the command.

If the **asl8=yes** parameter is specified with the **lst=a** parameter (a linkset containing access signaling links), this indicates that the originator of the MSUs is generating 8-bit SLSs. For other linkset types, the **asl8=yes** parameter indicates that the adjacent STP is converting 5-bit SLSs to 8-bit SLSs. The SLS in MSUs received by the system on a linkset that has the **asl8=yes** parameter assigned to it will not be converted. These MSUs are assumed to contain 8-bit SLSs.

The **asl8=yes** parameter can be assigned only to an SS7 linkset (a linkset containing an adjacent point code in the SS7 domain).

If the **apcn** parameter is specified, its format must match the format that was assigned with the **chg-stpopts:npcfmti** parameter.

The **apcntype** parameter can be specified only for ITU-N and ITU-N24 linksets.

The **slsocbit** parameter is valid only for ITU linksets and if the SLSOCB feature is turned on.

The **slrsb** parameter is valid only for ITU linksets.

The GSM Map Screening feature must be turned on before the **gsmscrn** parameter can be specified (see the **enable-ctrl-feat** and **chg-ctrl-feat** commands).

The Enhanced GSM Map Screening feature must be turned on before **gsmscrn=on** can be specified for an ANSI linkset.

The **itutfr** parameter is valid only for ITU national linksets.

The group code of DPC(s) must match the group code of the APC/SAPC when **multgc=no**.

The **multgc** parameter value can be changed to **no** only if there are no routes with group codes different from the adjacent point code's group code.

If the adjacent point code's group code is changed, **multgc** must be **yes** or there must be no routes using the linkset.

Only one ITU-N APC/SAPC is allowed with **multgc=no**.

Only one ITU-I or 24-bit ITU-N APC/SAPC is allowed per linkset

The **apcntype** parameter can be specified only for ITU-N and ITU-N24 linksets.

The SAPC cannot be 24-bit ITU-N if the linkset contains IPLIM SAALTALI or E1 ATM links, which do not support 24-bit ITU-N traffic.

A linkset cannot have both a 14-bit ITU-N and a 24-bit ITU-N APC/SAPC unless it contains only IPGWI links or IPLIM M3UA links. These links support 14-bit ITU-N and 24-bit ITU-N traffic simultaneously.

A linkset with **ipgwapc=no** cannot have both a 14-bit ITU-N and a 24-bit ITU-N APC/SAPC if no links are provisioned.

Private (**p-**) and private and spare (**ps-**) point codes can be assigned only to IPGW linksets (**ipgwapc=yes** is specified).

The **iptps** parameter cannot be specified for linksets that are not IPGWx.

The specified **iptps** parameter value must be divisible by 10.

The total of the **iptps** parameter values for all linksets cannot exceed the IPGWx Signaling TPS feature quantity that is enabled in the system.

The **lsusealm** parameter cannot be specified for linksets that are not IPGWx.

The **slkusealm** parameter cannot be specified for linksets that are not IPGWx.

The specified linkset name (**lsn**) cannot be the same as the specified mate linkset name (**matelsn**).

When **action=add** is specified, the specified mate linkset cannot already be assigned as the mate of the specified linkset.

When **action=add** is specified, the specified mate linkset cannot already be the mate of another linkset.

The specified mate linkset must be an existing linkset in the database.

A mated linkset can have only one assigned link.

Mated linksets can contain only SS7IPGW or IPGWI links.

Mated linksets must have APCs of the same network type.

The card that has the link assigned to the specified linkset must be inhibited before **action=add** can be specified to assign the specified mate linkset to the specified linkset.

The card that has a link in the mate linkset must be inhibited before **action=delete** can be specified to delete the mate linkset assignment.

When **action=delete** is specified to delete a mate linkset assignment, the specified mate linkset must be the mate of the specified linkset in the database.

Either an SAPC or a mate linkset (**matelsn**), but not both, can be specified with **action=delete**.

Notes

Any optional parameter that is not specified is not changed.

The links that directly connect the system with a distant node are grouped into one or more linksets. A linkset can contain up to 8 (international standards) or 16 (national standard) signaling links, depending on how the system attributes were defined when the network was created.

Signaling link test acknowledgments (SLTA) are the same type of maintenance message as the SLTMs received on the link.

MTP restart provides an orderly process for bringing signaling links back into service after the system has been isolated and restarted. A greater preference is given to restoring the STP to network service in an orderly fashion than to the speed of recovery. The time required is system-dependent. Table 5-23 provides examples of some approximate times.

Table 5-23. Link Alignment Performance

System Size (No. of LIMs)	Link Alignment Delay (seconds)
up to 64	62
64 to 127	97
128 to 191	132
more than 191	167

When two linksets are used as a combined linkset, each linkset should have the same **slsci** and **asl8** values. **This is not enforced in the system and there is no warning mechanism if the values of these parameters are not the same for each linkset.**

The **tfacabmlq** parameter is not supported for linkset that terminate in the X.25 domain.

The **slrsrb** parameter alone does not provide an even distribution of ITU-ISUP messages across all links within a linkset. The system uses all four bits of the SLS to determine the actual link to route messages. Because the static bit is simply rotated within the SLS, all possible values of the SLS field will still not be realized. The **slsobit** parameter must also be used to provide an even distribution across all links within the linkset. If both parameters are used for a given linkset, the SLS field is processed in the following order.

1. The SLS is modified using the Other CIC Bit option.
2. The modified SLS is modified again using the Rotated SLS Bit option.
3. The modified SLS is used by the existing linkset and link selection algorithms to select a link.
4. The ISUP message is sent out of the link containing the original, unmodified SLS field.

To modify a secondary adjacent point code, **sapc** has to be first deleted, then added again.

A 24-bit ITU-N point code can be provisioned as an SAPC only if the APC is not already a 24-bit ITU-N point code.

Only one 24-bit ITU-N point code is allowed to be provisioned as an SAPC.

For a linkset containing either low speed CCS7ITU links or IPLIM M2PA links, if the APC is a 14-bit ITU-N point code, then a 24-bit ITU-N point code cannot be provisioned as an SAPC.

For a linkset containing either low speed CCS7ITU links or IPLIM M2PA links, if the APC is a 24-bit ITU-N point code, then a 14-bit ITU-N point code cannot be provisioned as a SAPC.

For a linkset containing either low speed CCS7ITU links or IPLIM M2PA links, if the APC is a ITU-I point code, then either a 24-bit ITU-N point code or a 14-bit ITU-N point code can be provisioned as an SAPC, but not both

In this command, only ITU-international and ITU national point codes support the spare point code subtype prefix (s-) and the private and spare point code subtype prefix (ps-). All of the point code types support the private (internal) point code subtype prefix (p-).

The ITU National and ITU National China Adjacent Point Code types indicate the format that is used for changeover and changeover acknowledgement messages. China specifies a 16-bit field for data in changeover messages. The FSN occupies the first 12 bits. The trailing 4 bits are spare and are coded as 0. ITU uses a 24-bit field for data in the extended changeover/changeover acknowledgement messages. The FSN is encoded in the first 12 bits. The last 12 bits of the field are spare and are coded as zero.

Output

chg-ls:lsn=nc002:gwsn=on

```
rlghncxa03w 04-01-18 08:16:14 EST EAGLE 31.3.0
Link set table is (114 of 1024) 11% full
CHG-LS: MASP A - COMPLTD
```

;

Output if the APC was changed:

chg-ls:lsn=nc002:gwsn=on

```
rlghncxa03w 04-01-18 08:16:14 EST EAGLE 31.3.0
CAUTION: Linkset APC has changed - verify remote node's APC.
Link set table is (114 of 1024) 1% full
CHG-LS: MASP A - COMPLTD
```

;

chg-m2pa-tset

Change M2PA Timer Set

Use this command to change change M2PA timers in a M2PA timer set. The **srctset** and **tset** parameters can be used to copy one timer set to another timer set.

Keyword: chg-m2pa-tset

Related Commands: rtrv-m2pa-tset

Command Class Database Administration

Parameters

:tset= (mandatory)

The M2PA timer set name.

Range: 1-20

:srctset= (optional)

The **srctset** parameter indicates which timer set is to be copied into the timer set specified by the **tset** parameter. If the **srctset** parameter is specified, no other timer values can be specified. The timer set specified by the **srctset** parameter cannot be the same timer set that is specified by the **tset** parameter.

Range: 1-20

:t1= (optional)

The M2PA T1 timer function differs depending on whether the RFC or Draft 6 implementation is used. The M2PA RFC T1 timer is the alignment ready timer in milliseconds and signals the amount of time to wait for a Link Status Ready message after proving. The M2PA Draft 6 T1 timer is the alignment timer in milliseconds and signals the amount of time to wait for a Link Status Alignment message after sending a Link Status Alignment message.

Range: 1000-350000

Default: 300000 RFC, 10000 D6

:t2= (optional)

The M2PA RFC T2 timer is the not aligned timer in milliseconds. This timer marks the amount of time M2PA waits to receive a Link Status RFC Timer T2 value. The t2 timer applies to only the M2PA RFC timer set.

Range: 5000-150000

Default: 20000 RFC

:t3= (optional)

The M2PA T3 timer function differs depending on whether the RFC or Draft 6 implementation is used. The M2PA RFC T3 timer is the alignment timer in milliseconds and marks the amount of time M2PA waits to receive a Link Status Alignment message from the peer. The M2PA Draft 6 T3 timer is the ready timer in milliseconds and marks the amount of time after proving that M2PA waits to receive a Link Status Ready message from the peer.

Range: 1000-60000

Default: 2000 RFC, 10000 D6,

:t4e= (optional)

The M2PA T4E timer is the emergency proving timer in milliseconds. The emergency proving timer marks the amount of time M2PA generates Link Status Proving messages during emergency proving.

Range: 400-600

Default: 500

:t4n= (optional)

The M2PA T4N timer is the normal proving timer in milliseconds. The normal proving timer marks the amount of time M2PA generates Link Status Proving messages during normal proving.

Range: 1000-70000

Default: 15000 RFC, 10000 D6

:t5= (optional)

The M2PA T5 timer is the busy rate timer in milliseconds. The busy rate timer marks the amount of time between sending Link Status Busy messages while the link is in service.

Range: 80-10000

Default: 100 RFC, 1000 D6

:t6= (optional)

The M2PA T6 timer is the remote congestion timer in milliseconds. The remote congestion timer marks the amount of time that a congested link will remain in service.

Range: 1000-6000

Default: 3000

:t7= (optional)

The M2PA T7 timer is the excessive acknowledgement delay timer. The excessive acknowledgement delay timer marks the maximum amount of time that can pass between transmission of a user data message and receipt of an acknowledgement for that message from the peer. If this timer expires, the link is taken out of service.

Range: 200-2000

Default: 1200

:t16= (optional)

The M2PA T16 timer is the proving rate timer in microseconds. The proving rate timer marks the amount of time between sending Link Status Proving messages while T2N or T2E is running.

Range: 100-500000

Default: 200000

:t17= (optional)

The M2PA T17 timer is the ready rate timer in milliseconds. The ready rate timer marks the amount of time between sending Link Status Ready messages while T3 is running.

Range: 100-500

Default: 250

:t18= (optional)

The M2PA T18 timer is the processor outage rate timer. The processor outage rate timer marks the amount of time between sending Link Status Processor Outage messages while the link is in service.

Range: 100-10000

Default: 1000

:ver= (optional)

The **ver** parameter indicates which M2PA timer set to update.

Range: rfc, d6

Default: rfc

Example

```
chg-m2pa-tset:tset=1:t1=20000
```

```
chg-m2pa-tset:tset=1:t1=20000:ver=d6
```

```
chg-m2pa-tset:tset=1:t1=20000:ver=rfc
```

```
chg-m2pa-tset:srctset=1:tset=2:ver=d6
```

```
chg-m2pa-tset:srctset=1:tset=2:ver=rfc
```

Dependencies

At least one optional parameter must be specified.

The **srctset** parameter and the **tset** parameter cannot specify the same timer set name.

Timer **t2** is supported only for the M2PA RFC timer sets.

Notes

None

Output

```

chg-m2pa-tset:tset=1:t1=20000
  r1ghncxa03w 04-01-18 08:16:14 EST EAGLE 31.3.0
  CHG-M2PA-TSET: MASP A - COMPLTD
;

```

chg-map**Change Mate Applications**

Use this command to change the mate point code and subsystem number and its attributes. A mate point code defines an adjacent signaling point, which is considered the mated signal transfer point (STP) to the system.

Keyword: chg-map

Related Commands: dlt-map, ent-map, rtrv-map

Command Class: Database Administration

Parameters

† At least one of these parameters must be specified.

NOTE: See “Point Code Formats and Conversion” in Appendix A for a detailed description of point code formats, rules for specification, and examples.

:pc/pca/pci/pcn/pcn24= (mandatory)

Primary remote point code.

:pc= or **:pca=** (mandatory)

ANSI point code with subfields *network indicator-network cluster-network cluster member* (*ni-nc-ncm*).

Range: 000-255

Specify a valid value for each subfield of the point code, and separate the subfields with a dash (-).

When **chg-sid:pctype=ansi** is specified, *ni = 000* is not valid.

When **chg-sid:pctype=ansi** is specified, *nc = 000* is not valid if *ni = 001-005*.

When **chg-sid:pctype=ansi** is specified, *nc = 000* is valid if *ni = 006-255*.

The point code **000-000-000** is not a valid point code.

:pci= (mandatory)

ITU international point code with subfields *zone-area-id*. The *prefix* subfield indicates a spare point code (*prefix-zone-area-id*).

Range: s-, 0-255

Specify a valid value for each subfield of the point code, and separate the subfields with a dash (-).

The point code **0-000-0** is not a valid point code.

prefix—s-

zone—0-7

area—000-255

id—0-7

:pcn= (mandatory)

ITU national point code in the format of a 5-digit number (*nnnnn*); or 2, 3, or 4 numbers (members) separated by dashes (*m1-m2-m3-m4*) as defined by the **chg-stpopts:npcfinti** flexible point code option. A group code must be specified when the ITUDUPPC feature is turned on (*nnnnn-gc, m1-m2-m3-m4-gc*). The *prefix* subfield indicates a spare point code (*prefix-nnnnn, prefix-nnnnn-gc, prefix-m1-m2-m3-m4, prefix-m1-m2-m3-m4-gc*).

Range: **s-, 0-16383, aa-zz**

Specify a valid value for each subfield of the point code, and separate the subfields with a dash (-).

prefix—s-

nnnnn—0-16383

gc—aa - zz

m1-m2-m3-m4—0-14 for each member; values must sum to 14

:pcn24= (mandatory)

24-bit ITU national point code with subfields *main signaling area-sub signaling area-signaling point* (*msa-ssa-sp*).

Range: **000-255**

Specify a valid value for each subfield of the point code, and separate the subfields with a dash (-).

msa—000-255

ssa—000-255

sp—000-255

:ssn= (mandatory)

The subsystem number to be changed.

Range: **2-255**

:grp= (optional)†

The concerned point code broadcast list (CSPC) group name. This parameter is the name of a group of point codes that should be notified of the subsystem status. A different CSPC group can be assigned to each mated PC/SSN. For ANSI, the EAGLE 5 SAS broadcasts SSP or SSA to the mate subsystem only if you provision the mate's point code as part of the CSPC group to receive an SSP or SSA.

Range: 1 alphabetic character followed by up to 7 alphanumeric characters or **none**
none—Disassociates a concerned point code broadcast list group from the given mate application

Default: Current value.

:materc= (optional)†

Mate relative cost. The EAGLE 5 SAS determines the multiplicity mode based on the relative costs (the **rc** and **materc** parameters) of the subsystem. (See Notes for additional information on multiplicity modes).

Range: **00-99**

Default: Current value.

:mpc/mpca/mpci/mpcn/mpcn24= (optional)†

Mate remote point code.

:mpc= or :mpca= (optional)†

ANSI point code with subfields *network indicator-network cluster-network cluster member* (*ni-nc-ncm*).

Range: 000-255

Specify a valid value for each subfield of the point code, and separate the subfields with a dash (-).

When **chg-sid:pctype=ansi** is specified, *ni* = **000** is not valid.

When **chg-sid:pctype=ansi** is specified, *nc* = **000** is not valid if *ni* = **001-005**.

When **chg-sid:pctype=ansi** is specified, *nc* = **000** is valid if *ni* = **006-255**.

The point code **000-000-000** is not a valid point code.

Default: 000-000-000

:mpci= (optional)†

ITU international point code with subfields *zone-area-id*. The *prefix* subfield indicates a spare point code (*prefix-zone-area-id*).

Range: s-, 0-255

Specify a valid value for each subfield of the point code, and separate the subfields with a dash (-).

prefix—s-

zone—0-7

area—000-255

id—0-7

The point code **0-000-0** is not a valid point code.

Default: 000-000-000

:mpcn= (optional)†

ITU national point code in the format of a 5-digit ITU number (*nnnnn*). The *prefix* subfield indicates a spare point code (*prefix-nnnnn*).

Range: s-, 0-16383

Specify a valid value for each subfield of the point code, and separate the subfields with a dash (-).

prefix—s-

nnnnn—0-16383

Default: 00000

:mpcn24= (optional)†

24-bit ITU national point code with subfields *main signaling area-sub signaling area-signaling point* (*msa-ssa-sp*).

Range: 000-255

Specify a valid value for each subfield of the point code, and separate the subfields with a dash (-).

msa—000-255

ssa—000-255

sp—000-255

Default: 000-000-000

:mrc= (optional)†

Message routing under congestion. This parameter defines whether or not class 0 messages are routed during congestion conditions.

Range: yes, no

Default: Current value.

:mssn= (optional)†

Mated subsystem number identifies the subsystem number, which acts as a backup in the event the subsystem number should fail.

Range: 2–255

Default: Current value.

:rc= (optional)

Relative cost. The EAGLE 5 SAS determines the multiplicity mode based on the relative costs (the **rc** and **materc** parameters) of the subsystem. (See Notes for additional information on multiplicity modes).

Range: 00–99

Default: Current value.

:srm= (optional)†

Subsystem routing messages. This parameter defines whether subsystem routing messages (SBR, SNR) are transmitted between the mated applications.

Range: yes, no

Default: Current value.

:sso= (optional)

Subsystem Status Option. This parameter indicates whether or not the PC/SSN is to initiate a subsystem test when a RESUME is received for the PC.

Range: on, off

on—prohibited

off—allowed

Default: Primary—no change

Mate, if entered—**off**

Example

The following example enters **1-1-3/10** into the MAP table and adds it to the same group as **1-1-0/10**. Because **1-1-0/10** already exists in the MAP table, the **rc** parameter is not used.

chg-map:pc=1-1-0:ssn=10:mpc=1-1-3:mssn=10:materc=40

The following example enters **1-1-2/10** into the MAP table, and adds it to the same group as **1-1-0/10** (see above example). Because **1-1-2/10** has a lower relative cost than **1-1-3/10**, it is placed into the group in relative cost order.

chg-map:pc=1-1-0:ssn=10:mpc=1-1-2:mssn=10:materc=30

The following example changes the relative cost (**rc**) for the specified **pc/ssn** pair:

chg-map:pc=1-1-0:ssn=10:rc=20

The following example changes the concerned PC broadcast list group name (**grp**) for the specified **pc/ssn** pair:

chg-map:pc=1-1-0:ssn=10:grp=abc

This command changes the ITU-I spare point code entry **s-1-12-2** and adds the spare mate point code entry **s-2-23-3** in the map table:

chg-map:pci=s-1-12-2:ssn=10:rc=10:mpci=s-2-23-3:mssn=20:materc=10

The following example turns ON the **sso** option for **pc 1-1-0** and **ssn 10**.

chg-map:pc=1-1-0:ssn=10:sso=on

The following example turns OFF the **sso** option for **pc 1-1-0** and **ssn 10**.

chg-map:pc=1-1-0:ssn=10:sso=off

The following example does not change the current value of the **sso** option for the primary or the mate.

chg-map:pc=1-1-0:ssn=10:rc=10

The following example turns ON the **sso** option for primary and mate.

chg-map:pc=1-1-0:ssn=10:mpc=3-3-3:mssn=2:sso=on

The following example turns OFF the **sso** option for primary and mate.

chg-map:pc=1-1-0:ssn=10:mpc=4-4-4:mssn=2:sso=off

The following example does not change the current value for the **sso** option for the primary. The **sso** option is turned OFF for the mate, because the mate is specified but the **sso** parameter is not specified (the default is OFF for the mate when the mate is specified).

chg-map:pc=1-1-0:ssn=10:mpc=5-5-5:mssn=2

Dependencies

At least one optional parameter must be specified.

The specified remote point code must exist in the Mate Applications (MAP) table.

The Spare Point Code Support feature must be enabled before an ITU-I or ITU-N spare point code can be specified.

The specified **ssn** must exist for the specified remote point code.

ITU-I, ITU-N, ITU-I spare, and ITU-N spare true point codes must be entered with the same subsystem number (**ssn**).

The mate point code/SSN cannot be the same as the primary point code/SSN.

If the point code value is an ITU type (**pci**, **pcn**, or **pcn24**), **srm=yes** cannot be specified.

If the point code value is entered as **pc** or **pca**, the **mpc**, if specified, must be **mpc** or **mpca**.

If the point code value is entered as **pci**, **pcn**, or **pcn24**, the **mpc**, if specified, must be **mpci**, **mpcn**, or **mpcn24**, respectively.

If the ANSI-ITU-China SCCP Conversion feature is turned on, concerned point code broadcast group and PC network types can be mixed.

If the ANSI-ITU-China SCCP Conversion feature is not turned on,

- If point code values are entered as **pc** or **pca**, the point codes in the new concerned point code (CPC) broadcast group, if specified, must be entered as **pc** or **pca**.
- If point code values are entered as **pci**, the point codes in the new CPC broadcast group, if specified, must be entered as **pci**.
- If point code values are entered as **pcn** or **pcn24**, the point codes in the new CPC broadcast group, if specified, must be entered as **pcn** or **pcn24**.

The point code/subsystem number pair must exist in the MAP table. If a concerned point code broadcast list group name is specified, it must already exist, unless **none** is specified.

If a new mate point code or mate subsystem is specified, the pair must not already exist in the MAP table.

The destination point codes of the primary subsystem and the mate subsystem must be full point codes.

The LNP feature must be turned on (see the **enable-ctrl-feat** command) before an EAGLE 5 SAS true point code and the LNP subsystem can be changed.

The following tables must be accessible: the Route table, the SS APPL table, and the Site Identification table.

If the **pcn** parameter or the **mpcn** parameter is specified, the format must match the format that was assigned with the **chg-stpopts:npcfmti** parameter.

The **mpc**, **mssn**, and **materc** parameters must be specified together in the command.

If the **pc** parameter value is an EAGLE 5 SAS true point code, the subsystem must have a lower relative cost than all other mated subsystems in the group.

A maximum of 8 mated applications is allowed.

The **sso** parameter cannot be specified with a point code that is the system true point code.

A true point code can have only one mate.

A true point code cannot be routed to itself.

Notes

When the ANSI-ITU-China SCCP Conversion feature is turned on, the Concerned Point Code (CSPC) Group's network type can be of a different network than the mated application's network type. For example, the mated application's network type could be ANSI and the CSPC Group could be ITU or mixed with ANSI, ITU, and ITUN concerned point codes.

The EAGLE 5 SAS supports four multiplicity modes for nodes/subsystems. A description of each mode follows.

- When a PC/SSN pair is not replicated, the pair is in *solitary* mode. The subsystem acts as the only application, with no backup. If this subsystem fails, messages routed to it are discarded and SCCP management returns "Subsystem Unavailable" messages to the originator.
- A group of replicated PC/SSN pairs are in *dominant* mode if each PC/SSN pair in the group has a unique relative cost. The specified subsystem with the lowest

relative cost acts as the primary subsystem, while the mate subsystem acts as a backup. In the event of congestion, messages route to the mate subsystem. When the congestion subsides, messages are again routed to the primary (dominant) subsystem.

- A group of replicated PC/SSN pairs are in *load sharing* mode if each PC/SSN pair in the group has the same relative cost. All messages are evenly distributed at the SCCP level to all nodes/subsystems in the group. In the event of congestion or failure, the non-affected subsystem assumes the load of its failed or congested mate.
- The *combined load sharing/dominant* mode supports a combination of load sharing and dominant mode and is new for the Weighted SCCP Load Balancing feature. A group of PC/SSN pairs are in combined load sharing/dominant mode when at least two of the PC/SSN pairs have the same relative cost and another node subsystem in the group has a different relative cost. A combination of node accessibility and relative cost determines the preferred PC/SSN.

The **sso** parameter changes the initialization of the subsystem status (“prohibited” or “allowed”) for PC/SSN MAP entries. The EAGLE 5 SAS previously marked the subsystem status “allowed” (OFF) for each PC/SSN entry. The **sso** option marks the subsystem status “prohibited” for each entry that has **sso=on**. This causes the EAGLE 5 SAS to generate an SST to the remote point-code when an MTP-RESUME is received. Upon reception of an SSA, the subsystem status is marked “allowed”.

In this command, only ITU-international and ITU national point codes support the spare point code subtype prefix (s-).

Output

```
chg-map:pc=1-1-0:ssn=10:mpc=1-1-2:mssn=10:materc=30
rlghncxa03w 04-01-07 11:43:04 EST EAGLE 31.3.0
CHG-MAP: MASP A - COMPLTD
;
```

chg-meas

Change Measurements

Use this command to change both the report and collecting status of the measurement subsystem.

NOTE: After the Measurements Platform collection function has been enabled, the **collect=on/off** parameter controls only the output of reports to the UI. The parameter has no effect on enabling and disabling collection and report generation for the Measurements Platform. Measurements Platform collection can, but should not, be enabled and disabled by allowing and inhibiting the MCPM cards. (See the **alw-card** and **inh-card** command descriptions). Report generation for the Measurements Platform is controlled by the **rept-ftp-meas** and **chg-measopts** commands.

Keyword: chg-meas

Related Commands: rtrv-meas-sched, rept-meas, copy-meas, rept-ftp-meas

Command Class: Link Maintenance

Parameters

:collect= (optional)

Activates or deactivates the reporting of scheduled measurements to the UI. This parameter does not affect measurements collection and generation for the Measurements Platform.

Range: on, off

Default: No change to value
System Default: off

:complink= (optional)

Activates or deactivates scheduled measurement report for links.

Range: on, off

Default: Current value

:complinkset= (optional)

Activates or deactivates scheduled measurement report for linksets.

Range: on, off

Default: Current value

:gtwylnkset= (optional)

Activates or deactivates the scheduled GTWY measurement report for the linkset.

Range: on, off

Default: Current value

:gtwylsfltr= (optional)

Filters the linksets included in the GTWY report.

Range: both, stp, seas, none

both—Only gateway linksets are included in the report to the terminal and SEAS.

stp—Only gateway linksets are included in the report to the terminal. All defined linksets are included in the report to SEAS.

seas—All defined linksets are included in the report to the terminal. Only gateway linksets are included in the report to SEAS.

none—All defined linksets are included in the report to the terminal and SEAS.

:gtwystp= (optional)

Activates or deactivates the scheduled GTWY measurement report for the STP.

Range: on, off

Default: Current value

:systotstp= (optional)

Activates or deactivates scheduled measurement report for STP system totals.

Range: on, off

Default: Current value

:systotstplan= (optional)

Activates or deactivates scheduled measurement report for the STPLAN feature system totals.

Range: on, off

Default: Current value

:systott= (optional)

Activates or deactivates scheduled measurement report for translation type system totals.

Range: on, off

Default: Current value

Example

```
chg-meas:collect=on
```

```
chg-meas:complink=on:complnkset=on:systott=off:systotstp=off:collect=on
```

```
chg-meas:gtwylsfltr=both
```

Dependencies

At least one optional parameter must be specified.

If the 15 Minute Measurements collection option is turned on, the **collect=on** parameter cannot be specified in this command.

Notes

Activated scheduled reports print at serial ports configured for traffic-related unsolicited messages (the **traf=yes** parameter of the **chg-trm** command).

When the Measurements Platform is not enabled, the daily maintenance scheduled reports are always allowed and cannot be inhibited.

The *Maintenance Manual* provides detailed information on measurements and measurement reports.

Output

```
chg-meas:complink=on:complnkset=on:systott=off:systotstp=off:collect=on
```

```
rlghncxa03w 04-01-18 17:02:57 EST EAGLE 31.3.0
CHG-MEAS: MASP A - COMPLTD
```

```
;
```

chg-measopts

Change Measurements Options

Use this command for the following functions:

- Enable the Measurements Platform collection function
- Turn on or turn off the 15 Minute Measurements collection function
- Enable or disable the automatic generation and FTP transfer of scheduled measurements reports to the FTP serve
- Turn on or off the CLLI-based file name option for measurements reports files

NOTE: After the Measurements Platform collection function has been enabled with the **platformenable=on** parameter, it cannot be disabled with this command.

Keyword: chg-measopts

Related Commands: rtrv-measopts, rept-stat-meas, rept-ftp-meas, chg-ftp-serv, dlt-ftp-serv, ent-ftp-serv, rtrv-ftp-serv, chg-meas, rept-meas, chg-netopts, rtrv-netopts

Command Class: Link Maintenance

Parameters

:all= (optional)

Activates or deactivates the automatic generation and FTP transfer of all scheduled measurements reports.

NOTE: The all parameter does not change the setting of the platformenable parameter.

Range: on, off

Default: No change to the current value

:avldlink= (optional)

Activates or deactivates the automatic generation and FTP transfer of the scheduled daily availability measurement report for links.

Range: on, off

Default: No change to the current value

:avllink= (optional)

Activates or deactivates the automatic generation and FTP transfer of the scheduled hourly availability measurement report for links.

Range: on, off

Default: No change to the current value

:avlstplan= (optional)

Activates or deactivates the automatic generation and FTP transfer of the scheduled hourly availability measurement report for STPLAN.

Range: on, off

Default: No change to the current value

:cllibasedname= (optional)

Enable or disable CLLI-based measurements report file name option.

Range: on, off

Default: No change to the current value

:collect15min= (optional)

Turns on or off the 15 Minute Measurements collection function.

Range: on, off

Default: No change to the current value

:complink= (optional)

Activates or deactivates the automatic generation and FTP transfer of the scheduled component measurement report for links.

Range: on, off

Default: No change to the current value

:complnkset= (optional)

Activates or deactivates the automatic generation and FTP transfer of the scheduled component measurement report for linksets.

Range: on, off

Default: No change to the current value

:gtwylnkset= (optional)

Activates or deactivates the automatic generation and FTP transfer of scheduled GTWY measurement report for linksets.

Range: on, off

Default: No change to the current value

:gtwylsdestni= (optional)

Activates or deactivates the automatic generation and FTP transfer of scheduled GTWY link set measurement report for destination NI

Range: on, off

Default: No change to the current value

:gtwylsonismt= (optional)

Activates or deactivates the automatic generation and FTP transfer of scheduled GTWY linkset measurement report for ISUP message type per linkset per originating NI

Range: on, off

Default: No change to the current value

:gtwylsorigni= (optional)

Activates or deactivates the automatic generation and FTP transfer of scheduled GTWY link set measurement report for originating NI

Range: on, off

Default: No change to the current value

:gtwyorigni= (optional)

Activates or deactivates the automatic generation and FTP transfer of scheduled GTWY link measurement report for originating NI.

Range: on, off

Default: No change to the current value

:gtwyorigninc= (optional)

Activates or deactivates the automatic generation and FTP transfer of scheduled GTWY link measurement report for originating NI and NC.

Range: on, off

Default: No change to the current value

:gtwystp= (optional)

Activates or deactivates the automatic generation and FTP transfer of scheduled GTWY measurement report for STP.

Range: on, off

Default: No change to the current value

:mtcdeir= (optional)

Activates or deactivates the automatic generation and FTP transfer of the daily maintenance measurement report for Equipment Identity Register (EIR).

Range: on, off

Default: No change to the current value

:mtcdlink= (optional)

Activates or deactivates the automatic generation and FTP transfer of the daily maintenance measurement report for links.

Range: on, off

Default: No change to the current value

:mtcdlnkset= (optional)

Activates or deactivates the automatic generation and FTP transfer of the daily maintenance measurement report for link sets.

Range: on, off

Default: No change to the current value

:mtcdlnp= (optional)

Activates or deactivates the automatic generation and FTP transfer of the scheduled daily maintenance measurement report per LNP.

Range: on, off

Default: No change to the current value

:mtcdmap= (optional)

Activates or deactivates the automatic generation and FTP transfer of the scheduled daily maintenance measurement report per GSM MAP Screening server entry.

Range: on, off

Default: No change to the current value

:mtcdnp= (optional)

Activates or deactivates the automatic generation and FTP transfer of the scheduled daily maintenance measurement report per NP.

Range: on, off

Default: No change to the current value

:mtcdstp= (optional)

Activates or deactivates the automatic generation and FTP transfer of the daily maintenance measurement report for STP.

Range: on, off

Default: No change to the current value

:mtcdstplan= (optional)

Activates or deactivates the automatic generation and FTP transfer of the daily maintenance measurement report for STPLAN.

Range: on, off

Default: No change to the current value

:mtcheir= (optional)

Activates or deactivates the automatic generation and FTP transfer of the scheduled hourly maintenance measurement report for Equipment Identity Register (EIR).

Range: on, off

Default: No change to the current value

:mtchlnp= (optional)

Activates or deactivates the automatic generation and FTP transfer of the scheduled hourly maintenance measurement report per LNP.

Range: on, off

Default: No change to the current value

:mtchmap= (optional)

Activates or deactivates the automatic generation and FTP transfer of scheduled hourly maintenance measurement report per GSM MAP Screening server entry.

Range: on, off

Default: No change to the current value

:mtchnp= (optional)

Activates or deactivates the automatic generation and FTP transfer of the scheduled hourly maintenance measurement report per NP.

Range: on, off

Default: No change to the current value

:nmlink= (optional)

Activates or deactivates automatic generation and FTP transfer of the scheduled network management measurement report for links.

Range: on, off

Default: No change to the current value

:nmlnkset= (optional)

Activates or deactivates automatic generation and FTP transfer of the scheduled network management measurement report for link sets.

Range: on, off

Default: No change to the current value

:nmstp= (optional)

Activates or deactivates automatic generation and FTP transfer of scheduled network management measurement report for STP.

Range: on, off

Default: No change to the current value

:platformenable= (optional)

Enables the Measurements Platform collection function.

Range: on

Default: No change to the current value

:systotstp= (optional)

Activates or deactivates automatic generation and FTP transfer of scheduled measurement report for STP system totals.

Range: on, off

Default: No change to the current value

:systotstplan= (optional)

Activates or deactivates automatic generation and FTP transfer of the scheduled measurement report for the STPLAN feature system totals.

Range: on, off

Default: No change to the current value

:systottt= (optional)

Activates or deactivates automatic generation and FTP transfer of scheduled measurement report for translation type system totals.

Range: on, off

Default: No change to the current value

Example

```
chg-measopts:platformenable=on
```

```
chg-measopts:platformenable=on:complink=on:complinkset=on:systottt=off:systotstp=off
```

Dependencies

The Measurements Platform feature must be on before this command can be entered.

An MCPM card must be in the IS-ANR Restrict state before the Measurements Platform collection option can be enabled.

The 15 Minute Measurements feature must be enabled and turned on before the 15 Minute Measurements collection option can be turned on.

The Measurements Platform collection option must be enabled (**platformenable=on**) before the CLLI-based name option can be turned on (**cllibasedname=on**).

The LNP feature must be turned on (see the **enable-ctrl-feat** command) before the **mtchnp=on** parameter or the **mtcdlnp=on** parameter can be specified.

The GSM Map Screening (GSMSCR) feature must be turned on before the **mtcdmap=on** parameter or the **mtchmap=on** parameter can be specified.

Either the G-Port feature or the INP feature must be turned on before the **mtchnp=on** parameter or the **mtcdnp=on** parameter can be specified.

The Equipment Identity Register (EIR) feature must be turned on before the **mtcheir=on** parameter or the **mtcdeir=on** parameter can be specified.

This command is not allowed while in upgrade mode.

Half-hour collection and report processing cannot be in progress when **collect15min=on** is specified.

Quarter-hour collection and report processing cannot be in progress when **collect15min=off** is specified.

Notes

When **all=on** is specified, the **mtchnp**, **mtchlnp**, **mtchmap**, **mtcheir**, **mtcdnp**, **mtcdlnp**, **mtcdmap**, and **mtcdeir** report will be turned on if the corresponding feature is turned on.

Activated scheduled reports are generated and transferred to the customer's FTP server

The **rept-ftp-meas** command can be used to manually generate and transfer one report at a time as needed.

The primary application of the **set-time** command is for Daylight Savings Time changes, setting the time forward or backward 1 hour. To reduce effects of **set-time** changes on measurements, the time change should be done within the first 15 minutes of any hour.

The *Maintenance Manual* provides detailed information on measurements and measurement reports.

CLLI-Based Measurements Report File Name

When the CLLI-based file name option (**cllibasedname**) is turned on, the CLLI is added to the measurements report file name, and the year is removed from the file name to ensure that the file name is equal to or fewer than 39 characters.

15 Minute Measurements

When the SEAS feature is turned on and 15 Minute Measurements collection is turned from off to on with the **collect15min=on** parameter, the message "Disabling SEAS Measurements..." is displayed at the UI.

When the SEAS feature is turned on and 15 Minute Measurements collection is running (**collect15min=on**), EAGLE 5 SAS measurements output to the SEAS interface is disabled.

When the SEAS feature is turned on and 15 Minute Measurements collection is turned from on to off with the **collect15min=off** parameter, EAGLE 5 SAS measurements output to the SEAS interface is enabled again.

NOTE: If SEAS reporting is turned on, for the 24 hours after the 15 Minute Measurements option is turned from on to off, 30-minute demand SEAS reports for time periods prior to the option status change will contain only 15 minutes of data, and SEAS will not support reporting at the xx15 and xx45 times.

Some quarter-hour measurements data might not be available for 24 hours after turning 15 Minute Measurements collection on. This condition exists for quarter-hour intervals for which 15 Minute Measurements collection has not yet occurred. Data that was collected on a 30-minute basis is available for reporting for up to 24 hours after it is collected. After the 15 Minute Measurements collection option is turned on, this data remains available on a half-hour basis (xx00 and xx30) but is not available on a quarter-hour basis (xx15 and xx45) because no data was collected on the quarter hours. After the 15 Minute Measurements collection option has been turned on for 24 hours, all 15-minute measurements data is available on a quarter-hour basis (xx00, xx15, xx30, and xx45).

In addition, full 30-minute data coverage will not be available until 24 hours after turning off the 15 Minute Measurements collection option. Reports for specific periods will always contain the amount of data collected for that period.

The action of turning 15-minute measurements feature control status on using the **chg-ctrl-feat** command also has an impact on the generation of measurements reports for **period=active**. Specifically, if the feature control status of 15-minute measurements is turned on and a report is requested for the active interval prior to the next scheduled measurements collection (based on the current 15-minute measurements status), the starting time for the period shown in the report will be incorrect. As soon as the next scheduled collection occurs, active reports will show the correct starting time. For example, if 15-minute feature control status is turned on with the **chg-ctrl-feat** command at 13:03, and the 15-minute measurements collection option is turned on using the **chg-measopts** command at 13:05, and a comp-link report for **period=active** is requested at 13:10, that report will contain an incorrect interval start time. If the same report is requested at 13:20, the start time shown in the report will be correct, because a collection occurred at 13:15.

A similar limitation exists for **period=last**. If the feature control status of 15-minute measurements is turned on and a report is requested for the last interval prior to the next scheduled measurements collection (based on the current 15-minute measurements status), the start and end times for the period shown in the report will be incorrect. The data presented in the report will correspond to the start and end times. As soon as the next scheduled collection occurs, then **period=last** reports will show the correct start and end times and the corresponding data for that interval. To generate measurements from the last collected interval before the first collection with feature control status on, a **period=specific** report will need to be entered. In the example given in the previous paragraph, the first report requested at 13:10 would not give the last interval, but the data given would correspond to the interval shown in the report. The second report requested at 13:20 would show correct start and end times and the data would correspond to the interval.

If the 15 Minute Measurements collection option is turned from on to off in the first 15 minutes of a half-hour (xx00-xx15 or xx30-xx45) and a demand report is requested in the second 15 minutes of a half-hour (xx15-xx30 or xx45-xx60) for **period=last** or **period** not specified, the report that is displayed will be the last 15-minute interval (xx00-xx15 or xx30-xx45), not the last collected 15-minute interval (xx45-xx00 or xx15-xx30). Collection did not occur during this 15-minute period, and the message "Measurements data not current" will be displayed. To report the last collected 15-minute interval, **period=specific** must be specified in the command with the correct **qh/hh** value.

The time interval in each measurements report shows which collection option was on when the measurements were collected. (This might not be the option that is currently on if the option was changed in the last 24 hours).

Table 5-24 on page 5-253 summarizes the impacts of turning on the 15 Minute Measurements collection option.

Table 5-24. Impacts on Data Collection of Turning On the 15 Minute Measurements Option

Time Window for Turning On the Option	Impact on Data Collection
xx00-xx15	None. 15 minutes of data will be collected for the quarter-hour xx15.
xx-15-xx30	The xx15 interval will contain no data. The xx30 interval will contain 30 minutes of data
xx30-xx45	None. 15 minutes of data will be collected for the quarter-hour xx15.
xx45-xx00	The xx45 interval will contain no data. The xx00 interval will contain 30 minutes of data

Output

```
chg-measopts:complink=on:complnkset=on:systottt=off:systotstp=off
:platformenable=on
rlghncxa03w 03-10-18 17:02:57 EAGLE EAGLE 31.3.0
CHG-MEASOPTS: MASP A - COMPLTD
;
```

chg-mrn**Change Mated Relay Node**

Use this command to add point codes to a group or an MRN set and change relative cost assignments for point codes in the Mated Relay Node (MRN) table.

Keyword: **chg-mrn**

Related Commands: **dlt-mrn, ent-mrn, rtrv-mrn**

Command Class: Database Administration

Parameters

NOTE: See “Point Code Formats and Conversion” in Appendix A for a detailed description of point code formats, rules for specification, and examples.

:pc/pca/pci/pcn/pcn24= (mandatory)

Post-GTT-translated point code.

:pc= or **:pca=** (mandatory)

ANSI point code with subfields *network indicator-network cluster-network cluster member* (*ni-nc-ncm*).

Range: **000-255**

Specify a valid value for each subfield of the point code, and separate the subfields with a dash (-).

When **chg-sid:pctype=ansi** is specified, *ni* = **000** is not valid.

When **chg-sid:pctype=ansi** is specified, *nc* = **000** is not valid if *ni* = **001-005**.

When **chg-sid:pctype=ansi** is specified, *nc* = **000** is valid if *ni* = **006-255**.

The point code **000-000-000** is not a valid point code.

:pci= (mandatory)

ITU international point code with subfields *zone-area-id*. The *prefix* subfield indicates a spare point code (*prefix-zone-area-id*).

Range: **s-, 0-255**

Specify a valid value for each subfield of the point code, and separate the subfields with a dash (-).

The point code **0-000-0** is not a valid point code.

prefix—**s-**

zone—**0-7**

area—**000-255**

id—**0-7**

:pcn= (mandatory)

ITU national point code in the format of a 5-digit number (*nnnnn*); or 2, 3, or 4 numbers (members) separated by dashes (*m1-m2-m3-m4*) as defined by the **chg-stpopts:npfnti** flexible point code option. A group code must be specified when the ITUDUPPC feature is turned on (*nnnnn-gc, m1-m2-m3-m4-gc*). The *prefix* subfield indicates a spare point code (*prefix-nnnnn, prefix-nnnnn-gc, prefix-m1-m2-m3-m4, prefix-m1-m2-m3-m4-gc*).

Range: **s-, 0-16383, aa-zz**

Specify a valid value for each subfield of the point code, and separate the subfields with a dash (-).

prefix—**s-**

nnnnn—**0-16383**

gc—**aa - zz**

m1-m2-m3-m4—**0-14** for each member; values must sum to 14

:pcn24= (mandatory)

24-bit ITU national point code with subfields *main signaling area-sub signaling area-signaling point (msa-ssa-sp)*.

Range: **000-255**

Specify a valid value for each subfield of the point code, and separate the subfields with a dash (-).

msa—**000-255**

ssa—**000-255**

sp—**000-255**

:mrnset= (optional)

The MRN set ID.

Range: **1-3000, dflt**

dflt—The default **mrnset**.

:pc1/pca1/pci1/pcn1/pcn241= (optional)

Alternate post-GTT-translated point code.

:pc1 or :pca1= (optional)

ANSI point code with subfields *network indicator-network cluster-network cluster member (ni-nc-ncm)*.

Range: **000-255**

Specify a valid value for each subfield of the point code, and separate the subfields with a dash (-).

When **chg-sid:pctype=ansi** is specified, *ni* = **000** is not valid.

When **chg-sid:pctype=ansi** is specified, *nc* = **000** is not valid if *ni* = **001-005**.

When **chg-sid:pctype=ansi** is specified, *nc* = **000** is valid if *ni* = **006-255**.

The point code **000-000-000** is not a valid point code.

:pci1= (optional)

ITU international point code with subfields *zone-area-id*. The *prefix* subfield indicates a spare point code (*prefix-zone-area-id*).

Range: **s-, 0-255**

Specify a valid value for each subfield of the point code, and separate the subfields with a dash (-).

The point code **0-000-0** is not a valid point code.

prefix—**s-**

zone—**0-7**

area—**000-255**

id—**0-7**

:pcn1= (optional)

ITU national point code in the format of a 5-digit number (*nnnnn*); or 2, 3, or 4 numbers (members) separated by dashes (*m1-m2-m3-m4*) as defined by the **chg-stpopts:npcfinti** flexible point code option. A group code must be specified when the ITUDUPPC feature is turned on (*nnnnn-gc, m1-m2-m3-m4-gc*). The *prefix* subfield indicates a spare point code (*prefix-nnnnn, prefix-nnnnn-gc, prefix-m1-m2-m3-m4, prefix-m1-m2-m3-m4-gc*).

Range: **s-**, **0-16383**, **aa-zz**
Specify a valid value for each subfield of the point code, and separate the subfields with a dash (-).

prefix—**s-**

nnnnn—**0-16383**

gc—**aa - zz**

m1-m2-m3-m4—**0-14** for each member; values must sum to 14

:pcn241= (optional)

24-bit ITU national point code with subfields *main signaling area-sub signaling area-signaling point (msa-ssa-sp)*.

Range: **000-255**

Specify a valid value for each subfield of the point code, and separate the subfields with a dash (-).

msa—**000-255**

ssa—**000-255**

sp—**000-255**

:pc2/pca2/pci2/pcn2/pcn242= (optional)

Alternate post-GTT-translated point code.

:pc2 or **:pca2=** (optional)

ANSI point code with subfields *network indicator-network cluster-network cluster member (ni-nc-ncm)*.

Range: **000-255**

Specify a valid value for each subfield of the point code, and separate the subfields with a dash (-).

When **chg-sid:pctype=ansi** is specified, *ni* = **000** is not valid.

When **chg-sid:pctype=ansi** is specified, *nc* = **000** is not valid if *ni* = **001-005**.

When **chg-sid:pctype=ansi** is specified, *nc* = **000** is valid if *ni* = **006-255**.

The point code **000-000-000** is not a valid point code.

:pci2= (optional)

ITU international point code with subfields *zone-area-id*. The *prefix* subfield indicates a spare point code (*prefix-zone-area-id*).

Range: **s-**, **0-255**

Specify a valid value for each subfield of the point code, and separate the subfields with a dash (-).

The point code **0-000-0** is not a valid point code.

prefix—**s-**

zone—**0-7**

area—**000-255**

id—**0-7**

:pcn2= (optional)

ITU national point code in the format of a 5-digit number (*nnnnn*); or 2, 3, or 4 numbers (members) separated by dashes (*m1-m2-m3-m4*) as defined by the **chg-stpopts:npfinti** flexible point code option. A group code must be specified when the ITUDUPPC feature is turned on (*nnnnn-gc*, *m1-m2-m3-m4-gc*). The *prefix* subfield indicates a spare point code (*prefix-nnnnn*, *prefix-nnnnn-gc*, *prefix-m1-m2-m3-m4*, *prefix-m1-m2-m3-m4-gc*).

Range: **s-**, **0-16383**, **aa-zz**
Specify a valid value for each subfield of the point code, and separate the subfields with a dash (-).

prefix—**s-**

nnnnn—**0-16383**

gc—**aa - zz**

m1-m2-m3-m4—**0-14** for each member; values must sum to 14

:pcn242= (optional)

24-bit ITU national point code with subfields *main signaling area-sub signaling area-signaling point (msa-ssa-sp)*.

Range: **000-255**

Specify a valid value for each subfield of the point code, and separate the subfields with a dash (-).

msa—**000-255**

ssa—**000-255**

sp—**000-255**

:pc3/pca3/pci3/pcn3/pcn243= (optional)

Alternate post-GTT-translated point code.

:pc3 or **:pca3=** (optional)

ANSI point code with subfields *network indicator-network cluster-network cluster member (ni-nc-ncm)*.

Range: **000-255**

Specify a valid value for each subfield of the point code, and separate the subfields with a dash (-).

When **chg-sid:pctype=ansi** is specified, *ni* = **000** is not valid.

When **chg-sid:pctype=ansi** is specified, *nc* = **000** is not valid if *ni* = **001-005**.

When **chg-sid:pctype=ansi** is specified, *nc* = **000** is valid if *ni* = **006-255**.

The point code **000-000-000** is not a valid point code.

:pci3= (optional)

ITU international point code with subfields *zone-area-id*. The *prefix* subfield indicates a spare point code (*prefix-zone-area-id*).

Range: **s-**, **0-255**

Specify a valid value for each subfield of the point code, and separate the subfields with a dash (-).

The point code **0-000-0** is not a valid point code.

prefix—**s-**

zone—**0-7**

area—**000-255**

id—**0-7**

:pcn3= (optional)

ITU national point code in the format of a 5-digit number (*nnnnn*); or 2, 3, or 4 numbers (members) separated by dashes (*m1-m2-m3-m4*) as defined by the **chg-stpopts:npcfnti** flexible point code option. A group code must be specified when the ITUDUPPC feature is turned on (*nnnnn-gc*, *m1-m2-m3-m4-gc*). The *prefix* subfield indicates a spare point code (*prefix-nnnnn*, *prefix-nnnnn-gc*, *prefix-m1-m2-m3-m4*, *prefix-m1-m2-m3-m4-gc*).

Range: **s-**, **0-16383**, **aa-zz**
Specify a valid value for each subfield of the point code, and separate the subfields with a dash (-).

prefix—**s**

nnnnn—**0-16383**

gc—**aa - zz**

m1-m2-m3-m4—**0-14** for each member; values must sum to 14

:pcn243= (optional)

24-bit ITU national point code with subfields *main signaling area-sub signaling area-signaling point (msa-ssa-sp)*.

Range: **000-255**

Specify a valid value for each subfield of the point code, and separate the subfields with a dash (-).

msa—**000-255**

ssa—**000-255**

sp—**000-255**

:pc4/pca4/pci4/pcn4/pcn244= (optional)

Alternate post-GTT-translated point code.

:pc4 or **:pca4=** (optional)

ANSI point code with subfields *network indicator-network cluster-network cluster member (ni-nc-ncm)*.

Range: **000-255**

Specify a valid value for each subfield of the point code, and separate the subfields with a dash (-).

When **chg-sid:pctype=ansi** is specified, *ni* = **000** is not valid.

When **chg-sid:pctype=ansi** is specified, *nc* = **000** is not valid if *ni* = **001-005**.

When **chg-sid:pctype=ansi** is specified, *nc* = **000** is valid if *ni* = **006-255**.

The point code **000-000-000** is not a valid point code.

:pci4= (optional)

ITU international point code with subfields *zone-area-id*. The *prefix* subfield indicates a spare point code (*prefix-zone-area-id*).

Range: **s-**, **0-255**

Specify a valid value for each subfield of the point code, and separate the subfields with a dash (-).

prefix—**s-**

zone—**0-7**

area—**000-255**

id—**0-7**

The point code **0-000-0** is not a valid point code.

:pcn4= (optional)

ITU national point code in the format of a 5-digit number (*nnnnn*); or 2, 3, or 4 numbers (members) separated by dashes (*m1-m2-m3-m4*) as defined by the **chg-stpopts:npcfnti** flexible point code option. A group code must be specified when the ITUDUPPC feature is turned on (*nnnnn-gc*, *m1-m2-m3-m4-gc*). The *prefix* subfield indicates a spare point code (*prefix-nnnnn*, *prefix-nnnnn-gc*, *prefix-m1-m2-m3-m4*, *prefix-m1-m2-m3-m4-gc*).

Range: **s-**, **0-16383**, **aa-zz**
Specify a valid value for each subfield of the point code, and separate the subfields with a dash (-).

prefix—**s-**

nnnnn—**0-16383**

gc—**aa - zz**

m1-m2-m3-m4—**0-14** for each member; values must sum to 14

:pcn244= (optional)

24-bit ITU national point code with subfields *main signaling area-sub signaling area-signaling point (msa-ssa-sp)*.

Range: **000-255**

Specify a valid value for each subfield of the point code, and separate the subfields with a dash (-).

msa—**000-255**

ssa—**000-255**

sp—**000-255**

:rc= (optional)

The relative cost of the route for the post-GTT-translated point code.

Range: **0-99**

:rc1= (optional)

The relative cost of the route for alternate post-GTT-translated point code 1.

Range: **0-99**

:rc2= (optional)

The relative cost of the route for alternate post-GTT-translated point code 2.

Range: **0-99**

:rc3= (optional)

The relative cost of the route for alternate post-GTT-translated point code 3.

Range: **0-99**

:rc4= (optional)

The relative cost of the route for alternate post-GTT-translated point code 4.

Range: **0-99**

Example

In the following example, the system searches the MRN table for a point code of 1-1-0. If the point code is found, its relative cost is set to 40.

chg-mrn:pc=1-1-0:rc=40

In the following example, the system searches the MRN table for point code 1-1-0. Having found it, the system then searches the associated group of point codes for 1-1-10. If it finds 1-1-10 it changes the relative cost of 1-1-10 to 30. If 1-1-10 is not in the group of point codes, the command will add point code 1-1-10 to the group and assign it a relative cost of 30.

chg-mrn:pc=1-1-0:pc1=1-1-10:rc1=30

In the following example, the system searches the MRN table for a point code of 1-1-0. Having found it, the system then searches for each of the two specified associated point codes in the group. If the associated point code is found, its relative cost is changed to the value indicated in the command. If the associated point code is not found, the specified point code and its relative cost are inserted into the group in the MRN table.

chg-mrn:pc=1-1-0:pc1=1-1-1:rc1=10:pc2=1-1-10:rc2=20

The following examples include spare point codes.

chg-mrn:pcn=s-1-1-1-123-aa:rc=1:pcn1=s-1-1-1-235-aa:rc1=2:pcn2=s-1-1-1-235-aa:rc2=3

chg-mrn:pci=s-2-2-1:rc=20:pci1=s-2-2-2:rc1=21:pci2=s-2-100-1:rc2=22

The following command changes the relative cost to 30 for an existing point code 1-1-1 in the default load-sharing set.

chg-mrn:pc=1-1-1:rc=30:mrnset=dflt

The following command changes the relative cost to 30 for an existing point code 1-1-1 in an existing MRN set 111.

chg-mrn:pc=1-1-1:rc=30:mrnset=111

The following command inserts a new entry for point code 1-1-2 with relative cost 60 in an existing MRN set 111.

chg-mrn:pc=1-1-1:pc1=1-1-2:rc1=60:mrnset=111

Dependencies

The Intermediate Global Title Translation Load Sharing (IGTTLS) feature must be turned on before this command can be entered.

A point code must have the same network type as existing point codes.

When a new point code is specified, its relative cost (**rc**) must be specified; a new point code and its relative cost must be entered together in the command.

A new point code that is specified in the command must not already exist in the MRN table.

The **rc** parameter must be specified when only the **pc** parameter is specified and no other point code parameters are specified.

Point codes cannot have the same value as the EAGLE 5 SAS SID.

The same point code value cannot be entered more than once in the MRN table unless the Flexible GTT Load Sharing feature is enabled. Then the same point code can be entered once in the default MRN set and once in multiple MRN sets.

Point codes must be the format set by the **npcfmti** parameter of the **chg-stpopts** command. (Use the **rtrv-stpopts** command to display the STP option settings).

Mate remote point codes must already exist as destinations in the Ordered Route entity set or reside in a cluster destination for which ordered routes are specified.

To change the relative cost for a point code, the point code must already exist in the MRN table.

If the command is entered to change the relative cost of more than one point code, all specified point codes must exist in the same group in the MRN table or the same mrnset. (They must exist in the group indicated by the point code specified in the **pc** parameter).

The MRN table has a maximum of 6000 point code entries. Each point code group can contain a maximum of 8 point codes.

The specified point code (**pc**) must already exist in the specified MRN set if the Flexible GTT Load Sharing feature is enabled.

The specified MRN set must already exist in the MRN table.

The **mrnset** parameter must be specified if the Flexible GTT Load Sharing feature is enabled and the routing indicator **ri = gt**.

The **seas** command is not allowed to operate on any other MRN set except the default MRN set.

If the Flexible GTT Load Sharing feature is enabled, a point code can exist in only one group (**mrnset=default** parameter) and in multiple MRN sets.

Notes

To add one or more new point codes to a group or MRN set in the MRN table,

- Specify a point code in the **pc** parameter that already exists in the group or MRN set and *do not* specify the **rc** parameter for that point code.
- Specify the point code and the relative cost parameters (**pc1** and **rc1**, for example) for each new point code that you want to add to that group or MRN set.

To change the relative cost of one point code, enter that point code as the **pc** parameter value and specify its new relative cost in the **rc** parameter value.

To change the relative cost of more than one point code in a group or MRN set,

- Enter one of the point codes as the **pc** parameter value and its new relative cost in the **rc** parameter value.
- Enter the other point codes and their new relative cost values in additional parameters.

All of the point codes that are specified in one command must exist in the same group or MRN set in the MRN table.

In this command, only ITU-international and ITU national point codes support the spare point code subtype prefix (**s-**).

The Flexible GTT Load Sharing feature allows multiple relationships to be defined among sets of destination point codes in the Mated Relay Node (MRN) table. The relationship used in a particular translation is based on the GTA digits used for translation.

The MRN set along with the post-translation PC formulates a key that is used for a lookup in the MRN table. The MRN table lookup provides a set of alternate PCs for routing the MSU in the most cost effective way.

The default MRN set consists of multiple load sharing groups of PCs that allow both GTT features and MPS-based features to run in parallel. However, MPS-based features are limited to using ONLY the default MRN set. GTT features can be provisioned to use the default MRN set as well. To operate on entries in the default mrnset, specify **dflt** as the value of the **mrnset** parameter.

Output

chg-mrn:pc=1-1-0:pc1=1-1-10:rc1=30

```
rlghncxa03w 04-01-20 09:07:58 EST EAGLE 31.3.0
CHG-MRN: MASP A - COMPLTD
```

;

chg-mrn:pc=1-1-1:rc=30:mrnset=dflt

```
tekelecstp 05-05-17 10:19:51 EST EAGLE5 34.2.0
CHG-MRN : MASP A - COMPLTD
```

;

chg-mrn:pc=1-1-1:rc=10:pc1=1-1-2:rc1=10:mrnset=111

```
tekelecstp 05-05-17 10:19:51 EST EAGLE5 34.2.0
CHG-MRN : MASP A - COMPLTD
```

;

chg-mrn:pc=1-1-1:pc1=1-1-2:rc1=10:mrnset=111

```
tekelecstp 05-05-17 10:19:51 EST EAGLE5 34.2.0
CHG-MRN : MASP A - COMPLTD
```

;

chg-netopts

Change Network Options

Use this command to change the Private Virtual Network address and PVN subnet mask values for the IP networks used by the EAGLE 5 SAS.

Keyword: chg-netopts

Related Commands: rtrv-netopts

Command Class: Database Administration

Parameters

:pvn= (optional)

Private Virtual Network (PVN) address for the EAGLE 5 SAS. The value must be valid for a Class B network IP address.

Range: 4 numbers separated by dots in the range **128.0.0.0** to **191.255.0.0**

Default: **172.20.50.0**

:pvnmask= (optional)

Subnet mask for the EAGLE 5 SAS PVN. An IP address with a restricted range of values.

Range: The value must be valid for a Class B network IP address as shown in Table 5-25.

Default: **255.255.252.0**

Table 5-25. Valid PVN Subnet Mask Values

Valid for Class B Networks	
255.255.0.0	255.255.248.0
255.255.192.0	255.255.252.0
255.255.224.0	255.255.254.0
255.255.240.0	255.255.255.128

Example

```
chg-netopts:pvn=172.20.51.0:pvnmask=255.255.255.0
```

Dependencies

Both optional parameters must be specified in the command.

The **pvn** and **pvnmask** IP addresses cannot have the same value.

The **pvn** and **pvnmask** parameters must be specified together in the command.

Notes

None

Output

```
chg-netopts:pvn=172.20.51.0:pvnmask=255.255.255.0
rlghncxa03w 04-01-20 09:07:58 EST EAGLE 31.3.0
CHG-NETOPTS: MASP A - COMPLTD
;
```

chg-oap-config**Change OAP Configuration**

Use this command to configure the EAGLE 5 SAS database with the OAP configuration information. This information is sent to the specified OAP with the **act-oap-config** command.

NOTE: This command enables you to configure the OAP from the EAGLE 5 SAS terminal. You should no longer perform this function from a terminal connected to the OAP.

Keyword: chg-oap-config

Related Commands: chg-lnp-serv, chg-sid, dlt-lnp-serv, ent-lnp-serv, rtrv-lnp-serv, rtrv-oap-config, rtrv-sid

Command Class: Database Administration

Parameters

NOTE: You must provision the EAGLE 5 SAS database with valid information for the SEAS or LNP features if you have those features turned on (as shown by SEAS=on in the output of the rtrv-feat command or by an LNP ported TNs quantity less than or equal to 12000000 in the output of the rtrv-ctrl-feat command). The information must be provisioned to clear the checksum mismatch alarm (UAM 0364).

:aipaddr= (optional)

The IP address of OAP A. This is a TCP/IP address expressed in standard dot notation. IP addresses consist of the system's network number and the machine's unique host number. A sample IP address is **192.126.100.5**, where **192.126.100** is the network number and **5** is the machine's host number. If you are unsure of your IP address, check with your Information Services department. You can configure this parameter even if the LNP feature is turned off.

This parameter is mandatory for LNP.

Range: 4 numbers separated by dots
1-223—first number
1-254—the other three numbers

:aname= (optional)

The name assigned to OAP A.

This parameter is mandatory for LNP and SEAS.

Range: 1 alphabetic character followed by 1 to 13 alphanumeric characters. The value should be enclosed in quotes (" "), for example, **aname="tekelec-10"**.

:anmask= (optional)

The netmask for OAP A. If you are unsure whether your network requires this configuration, check with your Information Services department.

Depending on your network configuration, this parameter may be mandatory for LNP and SEAS.

Range: 4 numbers separated by dots. Each number is in the range of **0-255**.

:arouter= optional)

The IP address of the default router assigned to OAP A. This is a TCP/IP address expressed in standard "dot notation." IP addresses consist of the system's network number and the machine's unique host number. A sample IP address is **192.126.100.5**, where **192.126.100** is the network number and **5** is the machine's host number. If you are unsure whether your network requires this configuration, check with your Information Services department.

Depending on your network configuration, this parameter may be mandatory for LNP and SEAS.

Range: 4 numbers separated by dots (for example, **192.126.100.5**)
1-223—first number
1-254—the other three numbers

:bipaddr= optional)

The IP address of OAP B. This is a TCP/IP address expressed in standard dot notation. IP addresses consist of the system's network number and the machine's unique host number. A sample IP address is **192.126.100.5**, where **192.126.100** is the network number and **5** is the machine's host number. If you are unsure of your IP address, check with your Information Services department. You can configure this parameter even if the LNP feature is turned off.

This parameter is mandatory for LNP.

Range: 4 numbers separated by dots (for example, **192.126.100.5**)
1-223—first number
1-254—the other three numbers

:bname= optional)

The name assigned to OAP B.

This parameter is mandatory for LNP and SEAS.

Range: 1 alphabetic character followed by 1 to 13 alphanumeric characters. The value is enclosed in quotes (" "), for example, **bname="tekelec-10"**.

:bnmask= optional)

The netmask for OAP B. If you are not sure that your network requires this configuration, check with your Information Services department.

Depending on your network configuration, this parameter may be mandatory for LNP and SEAS.

Range: 4 numbers separated by dots. Each number is in the range of **0–255**.

:brouter= optional)

Depending on your network configuration, this parameter may be mandatory for LNP and SEAS.

The IP address of the default router assigned to OAP B. This is a TCP/IP address expressed in standard dot notation. IP addresses consist of the system's network number and the machine's unique host number. A sample IP address is **192.126.100.5**, where **192.126.100** is the network number and **5** is the machine's host number. If you are unsure whether your network requires this configuration, check with your Information Services department.

Range: 4 numbers separated by dots

1–223—first number

1–254—the other three numbers

:cfg= optional)

The number of OAPs being configured.

This parameter is mandatory for LNP and SEAS.

Range: **sngl, dual**

sngl OAP A

dual OAP A and OAP B

:lsms= optional)

The LSMS to be associated with the OAP.

This parameter is mandatory for LNP.

Range: **main, shadow**

:mnsap= optional)

The network service access point of the main LSMS. This is a TCP/IP address expressed in standard dot notation. IP addresses consist of the system's network number and the machine's unique host number. A sample IP address is **192.126.100.5**, where **192.126.100** is the network number and **5** is the machine's host number.

This parameter is mandatory for LNP if **lsms=main**.

Range: 4 numbers separated by dots

1–223—first number

1–254—the other three numbers

:mpsel= optional)

The presentation selector of the main LSMS.

This parameter is mandatory for LNP if **lsms=main**.

Range: 1 to 4 alphanumeric characters. The value is enclosed in quotes (" ").

:mssel= optional)

The session selector of the main LSMS.

This parameter is mandatory for LNP if **lsms=main**.

Range: 1 to 4 alphanumeric characters. The value is enclosed in quotes (" ")

:seaccli= optional)

The common language location identifier (CLLI) of the SEAC the OAP is connecting to.

This parameter is mandatory for SEAS.

Range: 1 alphabetic character followed by 1 to 10 alphanumeric characters.

:snsap= optional)

The network service access point of the shadow LSMS. This is a TCP/IP address expressed in standard dot notation. IP addresses consist of the system's network number and the machine's unique host number. A sample IP address is **192.126.100.5**, where **192.126.100** is the network number and **5** is the machine's host number.

This parameter is mandatory for LNP if **lsms=shadow**.

Range: 4 numbers separated by dots

1-223—first number

1-254—the other three numbers

:spsel= optional)

The presentation selector of the shadow LSMS. The value is enclosed in quotes (" ").

This parameter is mandatory for LNP if **lsms=shadow**.

Range: 1 to 4 alphanumeric characters.

:sssel= optional)

The session selector of the shadow LSMS.

This parameter is mandatory for LNP if **lsms=shadow**.

Range: 1 to 4 alphanumeric characters. The value should be enclosed in quotes (" ").

:x25mode= optional)

The mode of the x.25 link to the SEAC.

This parameter is mandatory for SEAS.

Range: DTE, DCE

:x25ps= (optional)

The x.25 packet size for the link to the SEAC.

This parameter is mandatory for SEAS.

Range: 7, 8

Example

```
chg-oap-config:aname="tekelec-xx":bname="tekelec-xx"
```

```
chg-oap-config:aipaddr=128.132.64.15:bipaddr=128.132.64.16
```

```
chg-oap-config:mnsap=198.89.39.22:mssel="emss":mpsel="emsp":lsms=main
```

Dependencies

At least one parameter must be specified each time the **chg-oap-config** command is entered.

The **chg-oap-config** command allows one or several parameters to be specified at a time. If the required information for a feature has already been provisioned in the EAGLE 5 SAS database, all of the parameters for that feature do not need to be specified when you make a change. It is mandatory, however, that the configuration data in the EAGLE 5 SAS and the OAP database match. The EAGLE 5 SAS generates an alarm (UAM 0364) if the EAGLE 5 SAS database is not provisioned with the same information as the OAP.

To keep OAP parameters in sync with the EAGLE 5 SAS, a checksum is created using all of the OAP configuration data stored on the EAGLE 5 SAS. The OAP also calculates this checksum based on the data it has. The OAP returns this checksum every five seconds. The EAGLE 5 SAS compares the checksums, and generates the following alarm within 10 seconds of any mismatch:

```
rlghncxa03w 04-01-07 11:11:28 EST EAGLE 31.3.0
* nnnn.0364 * OAP A Configuration data checksum mismatch
```

The alarm is cleared when a maintenance poll returns a checksum that matches the EAGLE 5 SAS's checksum, indicating that the databases are back in sync. The EAGLE 5 SAS clears the alarm within five seconds. The following UAM clears the alarm:

```
rlghncxa03w 04-01-07 11:11:28 EST EAGLE 31.3.0
nnnn.0365 OAP A Configuration data checksum alarm cleared
```

All configured parameters are included in the data checksum with the following exceptions:

:mnsap, **:mpsel**, and **:mssel** if **:lsms=shadow**

:snsap, **:spsel**, and **:sssel** if **:lsms=main**

In addition to parameters configured with the **chg-oap-config** command, the EAGLE 5 SAS's Site ID (**:cli**) and LNP service information (**serv=class/lidb/ cnam/ isvm**) are also included in the checksum. See the **chg-sid** and **ent-lnp-serv** or **chg-lnp-serv** commands for more information.

Notes

Before starting disaster recovery operations for the LSMS and before a switchover can occur, the shadow LSMS must be stable. The shadow LSMS should have no active alarms or hardware failures and cannot be in recovery mode with any number portability administration center (NPAC).

Output

chg-oap-config:aipaddr=128.132.64.15:bipaddr=128.132.64.16

```
rlghncxa03w 04-01-07 11:11:28 EST EAGLE 31.3.0
CHG_OAP_CONFIG: MASP A - COMPLTD
;
```

chg-pid

Change Password ID

Use this command to change your password.

Keyword: chg-pid

Related Commands: act-user, chg-secu-dflt, chg-user, dact-user, dlt-user, ent-user, login, logout, rept-stat-user, rtrv-secu-dflt, rtrv-secu-user, rtrv-user

Command Class: Basic

Parameters

None

Example

chg-pid

Dependencies

Passwords cannot be created or modified from a telnet terminal (terminal IDs 17-40) without the OA&M IP Security Enhancements feature turned on.

When this command is executed, you are prompted to enter your current password. This prevents anyone but you from changing your password.

Use the following rules for creating passwords:

- A new password cannot contain more than 12 characters.
- A new password must contain at least the number of characters that is specified on the **minlen** parameter of the **chg-secu-dflt** command.
- A new password must contain at least the number of alphabetic (**alpha** parameter), numeric (**num** parameter), and punctuation (**punc** parameter) characters that is specified on the **chg-secu-dflt** command.
- A new password cannot contain the associated user ID.

Notes

When a new system is shipped, both the user ID and password are set to the system. Change these immediately to ensure system security.

Output

chg-pid

```
rlghncxa03w 04-01-07 09:10:41 EST EAGLE 31.3.0  
CHG-PID: MASP A - COMPLTD
```

;

chg-prefix**Change Prefix**

Use this command to enter the name of a feature, the value of a prefix used by the feature, and a prefix number that is used to refer to the prefix from another table.

Keyword: **chg-prefix**

Related Commands: **dlt-prefix**, **rtrv-prefix**, **rtrv-ctrl-feat**

Command Class: Database Administration

Parameters

:feature= (mandatory)

Feature Name. This parameter specifies the name of an enabled controlled feature that is supported by this command. The parameter value must match the feature name as it is displayed in the **rtrv-ctrl-feat** command output.

Range: 1 alphabetic character and up to 24 optional alphanumeric characters and spaces, enclosed in double quotation marks.

The parameter value is not case-sensitive; upper case or lower case or both can be entered.

Part or all of the feature name can be entered. If part of the feature name is specified, the entry must start with the first letter of the name, and must contain enough of the name to uniquely identify the feature. For example, there are two feature names that begin with "GSM MAP." Enough additional characters to identify which GSM MAP feature is being entered (at least "GSM MAP SR" to identify the "GSM MAP SRI Redirect" feature). This command supports the following controlled features:

- GSM MAP SRI Redirect
- ISUP NP for EPAP

:prefix= (mandatory)

Prefix Value. Prefix table entries for the GSM MAP SRI Redirect and ISUP NP with EPAP features.

Range: 1-15 digits; valid digits are **0-9**, **a-f**, **A-F**

Default: Current value

:prefixnum= (mandatory)

Prefix Number. The prefix number identifies the prefix value to use for the specified feature name.

Range: **1-7**

1-3 for GSM MAP SRI Redirect feature prefix values

1-5 for ISUP NP with EPAP feature prefix values

6 for the ISUP NP with EPAP feature Insertion Country Code

7 for the ISUP NP with EPAP feature Deletion Condition value

1 for the Prepaid IDP Query Relay International Insert Prefix

2 for the Prepaid IDP Query Relay National Insert Prefix

3 for the Prepaid IDP Query Relay Outgoing CDPN NAI

4 for the Prepaid IDP Query Relay CGPA DEF CC Check

Default: Current value

Example

Define a prefix with prefix number 1 for the ISUP NP with EPAP feature.

```
chg-prefix:feature="isup np with epap":prefix=1004:prefixnum=1
```

Define a prefix with prefix number 2 and specify part of the GSM MAP SRI Redirect feature name.

```
chg-prefix:feature="gsm map sri":prefix=104:prefixnum=2
```

Dependencies

The specified feature name value (**feature**) must be enclosed in double quotation marks.

The G-Port feature must be turned on before a prefix can be defined for the GSM MAP SRI Redirect feature.

The GSM MAP SRI Redirect feature must be enabled before a GSM MAP SRI Redirect prefix can be defined.

The ISUP NP with EPAP feature must be enabled before an ISUP NP with EPAP prefix can be defined.

The specified prefix value must contain a number of digits that is equal to or greater than the minimum number of digits required by the specified feature.

The specified prefix value must contain a number of digits that is equal to or less than the maximum number of digits required by the specified feature.

The prefix value **none** is not valid for GSM MAP SRI Redirect prefixes.

The specified prefix number (**prefixnum**) must be valid for the specified feature.

The maximum number of prefixes that can be defined is:

- 3 for the GSM MAP SRI Redirect feature
- 5 values, 1 Insertion Country Code, and 1 Deletion Condition for the ISUP NP with EPAP feature

The specified feature name must be the name of an enabled controlled feature as it is displayed in the **rtrv-ctrl-feat** command output; The specified feature must be one of the following features that are supported by this command:

- GSM MAP SRI Redirect
- ISUP NP for EPAP
- Prepaid IDP Query Relay

The specified feature prefix value cannot already exist in the database.

The Prepaid IDP Query Relay feature must be enabled before a prefix can be provisioned for the feature. At least one feature must be enabled for this command to be used for the enabled feature.

Notes

The Prefix table contains different groups of entries based on the features that are turned on. For the GSM MAP SRI Redirect for Serving HLR feature, the entries are referenced by the VendID table, based on a Vendor Number matching a Prefix Number. For the ISUP NP with EPAP feature, the entries are referenced by the SubnetID table, based on a Subnet Number matching a Prefix Number. The Prefix table for the ISUP NP with EPAP feature also reserves Prefix Number 6 for the Insertion Country Code value, and reserves Prefix Number 7 for the Deletion Condition value. Figure 5-8 illustrates the references to the Prefix table.

Figure 5-8. Prefix Table References

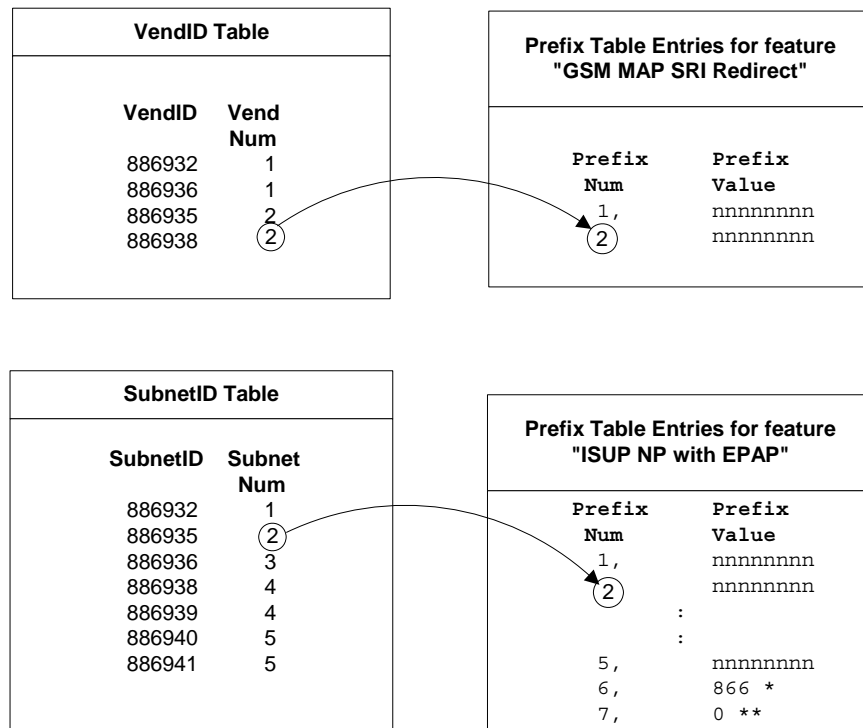

* Reserved for the ISUP NP with EPAP feature Insertion Country Code value

** Reserved for the ISUP NP with EPAP feature Deletion Condition value

For the ISUP NP with EPAP feature:

- When the Insertion Country Code (prefix number 6) is defined, the following information message appears:

`ISUP NP with EPAP, Insertion Country Code value is now defined`

- When the Deletion Condition (prefix number 7) is defined, the following information message appears:

`ISUP NP with EPAP, Deletion Condition value is now defined`

- When the "Prepaid IDP Query Relay" feature (prefix number 1) is defined, the following information message appears:

Intl Insert Prefix

- When the “Prepaid IDP Query Relay,” feature (prefix number 2) is defined, the following information message appears:

Natl Insert Prefix

- When the “Prepaid IDP Query Relay,” feature (prefix number 3, prefix = 0) is defined, the following information message appears:

CDPN NAI Unknown

- When the “Prepaid IDP Query Relay,” feature (prefix number 3, prefix = 1) is defined, the following information message appears:

CDPN NAI Incoming

- When the “Prepaid IDP Query Relay,” feature (prefix number 4, prefix = 0) is defined, the following information message appears:

CDPA CC Check Off

- When the “Prepaid IDP Query Relay,” feature (prefix number 4, prefix = 1) is defined, the following information message appears:

CDPA CC Check On**Output**

```
chg-prefix:feature="isup np with epap":prefix=1004:prefixnum=1
```

```
rlghncxa03w 04-09-20 09:04:14 EST EAGLE 31.11.0
CHG-PREFIX: MASP A - COMPLTD
```

```
;
```

chg-pstn-pres**Change PSTN Presentation**

Use this command to change the description for a previously defined Public Switched Telephone Network (PSTN) presentation value.

Keyword: chg-pstn-pres

Related Commands: ent-pstn-pres, dlt-pstn-pres, rtrv-pstn-pres

Command Class: Database Administration

Parameters

:pstncat= (mandatory)

PSTN category that identifies the new Variant being defined.

Range: 0-65535

:pstnid= (mandatory)

PSTN ID that identifies the new Variant being defined.

Range: 0-65535

:pstndesc= (mandatory)

A test description of the PSTN presentation value.

Range: any alphanumeric string of 0 to 31 characters in length, in double quotes

Example

```
chg-pstn-pres:pstncat=5000:pstndesc="Mexican ISUP v1.8"
```

Dependencies

Required controlled features must be enabled.

- ISUP Normalization controlled feature.
- ON/OFF controlled feature for *Tekelec-defined* Variant.
- The Tekelec-defined Variants are listed in section “Tekelec-defined ISUP Normalization Variants” in Appendix A.
- Quantity controlled feature enabled for *user-defined* Variant.

A valid combination of **pstncat** and **pstnid** values must be specified.

- A controlled feature must exist for the **pstncat**/**pstnid** combination.
- The **pstncat** and **pstnid** values must not already be defined.

The maximum number of Variants that the IP⁷ SG supports cannot be exceeded.

You cannot define more than the maximum number of *user-defined* Variants associated with the quantity controlled feature.

Notes

The IP⁷ Secure Gateway uses the PSTN presentation value, consisting of a PSTN category and a PSTN ID, to uniquely define an ISUP Variant.

Use the **rtrv-pstn-pres** command to display the only allowed values for the PSTN category and ID for which the description is being changed.

The **pstndesc=<pstn description>** parameter should be used to describe the Variant that the PSTN is for. The **rtrv-pstn-pres** command displays this field.

Output

The following command changes the description for a previously assigned PSTN.

```
chg-pstn-pres:pstncat=5000:pstnid=1:pstndesc="new description text"
```

```
rlghncxa03w 04-01-07 09:10:41 EST EAGLE 31.3.0
CHG-PSTN-PRES: MASP A - COMPLTD
```

```
;
```

chg-rte**Change Route**

Use this command to change the “cost,” or priority of a route. The cost is based on whether this route is first choice, second choice, and so on. Prioritize routes in such a way that the most direct route (fewest intermediate signaling points) is highest priority.

Keyword: **chg-rte**

Related Commands: **chg-dstn**, **dlt-dstn**, **dlt-rte**, **ent-dstn**, **ent-rte**, **rtrv-dstn**, **rtrv-rte**

Command Class: Database Administration

Parameters

:dpc/dpca/dpci/dpcn/dpcn24= (mandatory)

Destination point code.

NOTE: See “Point Code Formats and Conversion” in Appendix A for a detailed description of point code formats, rules for specification, and examples.

:dpc= or :dpca= (mandatory)

ANSI destination point code with subfields *network indicator-network cluster-network cluster member (ni-nc-ncm)*. The *prefix* subfield indicates a private point code (*prefix-ni-nc-ncm*).

Range: **p-, 000-255, ***

Specify a valid value for each subfield of the point code, and separate the subfields with a dash (-).

prefix—p-

The asterisk (*) value is not valid for the *ni* subfield.

When **chg-sid:pctype=ansi** is specified, *ni = 000* is not valid.

When **chg-sid:pctype=ansi** is specified, *nc = 000* is not valid if *ni = 001-005*.

When **chg-sid:pctype=ansi** is specified, *nc = 000* is valid if *ni = 006-255*.

When **chg-sid:pctype=ansi** is specified, *ni-*-** is valid if *ni = 006-255*.

The point code **000-000-000** is not a valid point code.

:dpci= (mandatory)

ITU international destination point code with subfields *zone-area-id*. The *prefix* subfield indicates a spare point code, private point code, or private and spare point code (*prefix-zone-area-id*).

Range: **s-, p-, ps-, 0-255**

Specify a valid value for each subfield of the point code, and separate the subfields with a dash (-).

prefix—s-, p-, ps-

zone—0-7

area—000-255

id—0-7

The point code **0-000-0** is not a valid point code.

:dpcn= (mandatory)

ITU national point code in the format of a 5-digit number (*nnnnn*); or 2, 3, or 4 numbers (members) separated by dashes (*m1-m2-m3-m4*) as defined by the **chg-stpopts:npcfinti** flexible point code option. A group code must be specified when the ITUDUPPC feature is turned on (*nnnnn-gc, m1-m2-m3-m4-gc*). The *prefix* subfield indicates a spare point code, private point code, or private and spare point code (*prefix-nnnnn, prefix-nnnnn-gc, prefix-m1-m2-m3-m4, prefix-m1-m2-m3-m4-gc*).

Range: **s-, p-, ps-, 0-16383, aa-zz**

Specify a valid value for each subfield of the point code, and separate the subfields with a dash (-).

prefix—s-, p-, ps-

nnnnn—0-16383

gc—aa - zz

m1-m2-m3-m4—0-14 for each member; values must sum to 14

:dpcn24= (mandatory)

24-bit ITU national destination point code with subfields *main signaling area-sub signaling area-signaling point*. The *prefix* subfield indicates a private point code.

Range: **p-**, **000-255**

Specify a valid value for each subfield of the point code, and separate the subfields with a dash (-).

prefix—**p-**

msa—**000-255**

ssa—**000-255**

sp—**000-255**

:lsn= (mandatory)

The linkset name associated with this route.

Range: 1 alphabetic character followed by 9 alphanumeric characters

:nlsn= (optional)

The new linkset name associated with this route.

Range: 1 alphabetic character followed by 9 alphanumeric characters

Default: The current value

:rc= (optional)

The relative cost (priority) for this route. Zero (**0**) is the highest priority, **99** the lowest.

Range: **0-99**

Default: The current value

Example

chg-rte:lsn=rlgh03:rc=0:dpc=244-003-001

chg-rte:dpc=25-*-*:lsn=myls:rc=10

The following example changes route for **dpcn 4085-aa** using linkset **e1m2itun** to relative cost of **30**:

chg-rte:dpcn=4085-aa:lsn=e1m2itun:rc=30

The following example changes route for **dpcn24 10-100-14** using linkset **we123624** to a relative cost of **25**:

chg-rte:dpcn24=10-100-14:lsn=we123624:rc=25

The following example changes route for private point code **dpc p-1-1-1** using linkset **we123642** to relative cost of **50**:

chg-rte:dpc=p-1-1-1:lsn=we123642:rc=50

The following example changes route for spare point code **dpcn s-4085-aa** using linkset **e1m2itun** to relative cost of **30**:

chg-rte:dpc=s-4085-aa:lsn=e1m2itun:rc=30

The following example changes route for private point code **dpcn24 p-1-100-1** using linkset **we123624** to relative cost of **25**:

chg-rte:dpcn24=p-1-100-1:lsn=we123624:rc=25

The following example changes route for private and spare point code **dpci ps-1-104-1** using linkset **e1m2itui** to relative cost of **30**:

```
chg-rte:dpci=ps-1-104-1:lsn=e1m2itui:rc=30
```

Dependencies

At least one optional parameter must be specified.

The specified DPC must be in the database.

No more than two linksets can be assigned the same cost (**rc**) value.

If the specified destination address is a full point code address (*ni-nc-ncm*) and is a member of a specified cluster (**ni-nc-***), attributes of the ordered routes assigned to it cannot be changed.

If the specified destination address is a network cluster address (**ni-nc-***), the specified ordered route attributes are changed for each signaling point code having the same network identifier (**ni**) and network cluster (**nc**) codes.

Combined linksets are not allowed for X.25 destinations. In other words, routes of equal cost destined for X.25 domains are not allowed.

If you are changing the identity of one route because of a change in the linkset name, the database must not already contain the new linkset name and destination address.

If the **nlsn** parameter, is specified the value must already exist in the database, and at least one link must be assigned to it.

If the new linkset name (**nlsn** parameter) is specified for an existing destination network cluster address (**ni-nc-***), the linkset type used in the route must be consistent with cluster routing; that is, the linkset must be either a B, C, or D linkset.

If the specified destination address is a full point code address (*ni-nc-ncm*) and is a member of a provisioned cluster (**ni-nc-***), whether the attributes of the ordered routes assigned to the cluster can be changed is determined by the destination address's NCAI (nested cluster allowed indicator). The NCAI (**ncai=yes/no**) is set with the **ncai** parameter of the **ent/chg-dstn** commands.

- If the NCAI is set to **no**, the cluster point code is not a nested cluster point code, so the attributes of the ordered routes assigned to the cluster cannot be changed.
- If the NCAI is set to **yes**, then the specified destination address is a member of a provisioned nested cluster where the attributes of the ordered routes assigned to the cluster can be changed.

The route destination's type must match the route's linkset adjacent point code or the route's linkset secondary adjacent point code type.

Only IPGW routes are allowed for private point codes.

If the ITU Duplicate Point Code feature is on, the group code must match for all linksets that are not IPGWx linksets.

If the specified destination address is a network cluster address (**ni-nc***), how the attributes of the specified ordered route are changed is determined by the setting of the destination address's NCAI (nested cluster allowed indicator). The NCAI (**ncai=yes/no**) is set with the **ncai** parameter of the **ent/chg-dstn** commands.

- If the NCAI is set to **no**, the attributes of the specified ordered route are changed for each signaling point code having the same network identifier (**ni**) and network cluster (**nc**) codes.
- If the NCAI is set to **yes**, then the specified destination address is a nested cluster where changing the attributes of the ordered routes for the cluster does not affect the attributes of the ordered routes of the provisioned members.

If the **dpcn** parameter is specified, its format must match the format that was assigned with the **chg-stpopts:npcfnti** parameter.

Network routing is valid only if the NRT feature is on. The NRT feature is turned on with the **chg-feat** command.

When using network routing, if the destination point code has a value of * in the **nc** field, the **ncm** field must also be * (for example, **dpc=21-*-***).

Notes

In this command, only ITU-international and ITU national point codes support the spare point code subtype prefix (**s-**) and the private and spare point code subtype prefix (**ps-**). All of the point code types support the private (internal) point code subtype prefix (**p-**).

Output

```
chg-rte:lsn=rlgh03:rc=0:dpc=244-003-001
      rlgncxa03w 04-01-07 11:43:04 EST EAGLE 31.3.0
      CHG-RTE: MASP A - COMPLTD
;
```

chg-sccp-serv

Change SCCP Service

Use this command to change service state information and to provision service re-route data. This command supports changing service state to OFFLINE and ONLINE. It also supports the assignment of PCs to PC groups used for service re-route assignment.

Keyword: **chg-sccp-serv**

Related Commands: **dlt-sccp-serv**, **rtrv-sccp-serv**

Command Class: Database Administration

Parameters

NOTE: See “Point Code Formats and Conversion” in Appendix A for a detailed description of point code formats, rules for specification, and examples.

:serv= (mandatory)

Name of the service.

Range: **gflex**, **gport**

:state= (optional)

Status of the service.

Range: offline, online

Default: offline

:gtt= (optional)

States whether the gtt option has been defined.

Range: no, yes

Default: yes

:pc1/pca1/pci1/pcn1/pcn241= (optional)

Re-route point code.

:pc1= or **:pca1=** (optional)

ANSI point code with subfields *network indicator-network cluster-network cluster member* (*ni-nc-ncm*).

Range: 000-255

Specify a valid value for each subfield of the point code, and separate the subfields with a dash (-).

When **chg-sid:pctype=ansi** is specified, *ni = 000* is not valid.

When **chg-sid:pctype=ansi** is specified, *nc = 000* is not valid if *ni = 001-005*.

When **chg-sid:pctype=ansi** is specified, *nc = 000* is valid if *ni = 006-255*.

The point code **000-000-000** is not a valid point code.

:pci1= (optional)

ITU international point code with subfields *zone-area-id*. The *prefix* subfield indicates a spare point code (*prefix-zone-area-id*).

Range: s-, 0-255

Specify a valid value for each subfield of the point code, and separate the subfields with a dash (-).

The point code **0-000-0** is not a valid point code.

prefix—s-

zone—0-7

area—000-255

id—0-7

:pcn1= (optional)

ITU national point code in the format of a 5-digit number (*nnnnn*); or 2, 3, or 4 numbers (members) separated by dashes (*m1-m2-m3-m4*) as defined by the **chg-stpopts:npfnti** flexible point code option. A group code must be specified when the ITUDUPPC feature is turned on (*nnnnn-gc*, *m1-m2-m3-m4-gc*). The *prefix* subfield indicates a spare point code (*prefix-nnnnn*, *prefix-nnnnn-gc*, *prefix-m1-m2-m3-m4*, *prefix-m1-m2-m3-m4-gc*).

Range: s-, 0-16383, aa-zz

Specify a valid value for each subfield of the point code, and separate the subfields with a dash (-).

prefix—s-

nnnnn—0-16383

gc—aa - zz

m1-m2-m3-m4—0-14 for each member; values must sum to 14

:pcn241= (optional)

24-bit ITU national point code with subfields *main signaling area-sub signaling area-signaling point* (*msa-ssa-sp*).

Range: 000-255

Specify a valid value for each subfield of the point code, and separate the subfields with a dash (-).

msa—000-255

ssa—000-255

sp—000-255

:pc2/pca2/pci2/pcn2/pcn242= (optional)

Alternate re-route point code.

:pc2 or :pca2= (optional)

ANSI point code with subfields *network indicator-network cluster-network cluster member* (*ni-nc-ncm*).

Range: 000-255

Specify a valid value for each subfield of the point code, and separate the subfields with a dash (-).

When **chg-sid:pctype=ansi** is specified, *ni* = 000 is not valid.

When **chg-sid:pctype=ansi** is specified, *nc* = 000 is not valid if *ni* = 001-005.

When **chg-sid:pctype=ansi** is specified, *nc* = 000 is valid if *ni* = 006-255.

The point code 000-000-000 is not a valid point code.

:pci2= (optional)

ITU international point code with subfields *zone-area-id*. The *prefix* subfield indicates a spare point code (*prefix-zone-area-id*).

Range: s-, 0-255

Specify a valid value for each subfield of the point code, and separate the subfields with a dash (-).

The point code 0-000-0 is not a valid point code.

prefix—s-

zone—0-7

area—000-255

id—0-7

:pcn2= (optional)

ITU national point code in the format of a 5-digit number (*nnnnn*); or 2, 3, or 4 numbers (members) separated by dashes (*m1-m2-m3-m4*) as defined by the **chg-stpopts:npcfinti** flexible point code option. A group code must be specified when the ITUDUPPC feature is turned on (*nnnnn-gc*, *m1-m2-m3-m4-gc*). The *prefix* subfield indicates a spare point code (*prefix-nnnnn*, *prefix-nnnnn-gc*, *prefix-m1-m2-m3-m4*, *prefix-m1-m2-m3-m4-gc*).

Range: s-, 0-16383, aa-zz

Specify a valid value for each subfield of the point code, and separate the subfields with a dash (-).

prefix—s-

nnnnn—0-16383

gc—aa - zz

m1-m2-m3-m4—0-14 for each member; values must sum to 14

:pcn242= (optional)

24-bit ITU national point code with subfields *main signaling area-sub signaling area-signaling point* (*msa-ssa-sp*).

Range: 000-255

Specify a valid value for each subfield of the point code, and separate the subfields with a dash (-).

msa—000-255

ssa—000-255

sp—000-255

:pc3/pca3/pci3/pcn3/pcn243= (optional)

Alternate re-route point code.

:pc3 or :pca3= (optional)

ANSI point code with subfields *network indicator-network cluster-network cluster member* (*ni-nc-ncm*).

Range: 000-255

Specify a valid value for each subfield of the point code, and separate the subfields with a dash (-).

When **chg-sid:pctype=ansi** is specified, *ni* = 000 is not valid.

When **chg-sid:pctype=ansi** is specified, *nc* = 000 is not valid if *ni* = 001-005.

When **chg-sid:pctype=ansi** is specified, *nc* = 000 is valid if *ni* = 006-255.

The point code 000-000-000 is not a valid point code.

:pci3= (optional)

ITU international point code with subfields *zone-area-id*. The *prefix* subfield indicates a spare point code (*prefix-zone-area-id*).

Range: s-, 0-255

Specify a valid value for each subfield of the point code, and separate the subfields with a dash (-).

The point code 0-000-0 is not a valid point code.

prefix—s-

zone—0-7

area—000-255

id—0-7

:pcn3= (optional)

ITU national point code in the format of a 5-digit number (*nnnnn*); or 2, 3, or 4 numbers (members) separated by dashes (*m1-m2-m3-m4*) as defined by the **chg-stpopts:npfinti** flexible point code option. A group code must be specified when the ITUDUPPC feature is turned on (*nnnnn-gc*, *m1-m2-m3-m4-gc*). The *prefix* subfield indicates a spare point code (*prefix-nnnnn*, *prefix-nnnnn-gc*, *prefix-m1-m2-m3-m4*, *prefix-m1-m2-m3-m4-gc*).

Range: s-, 0-16383, aa-zz

Specify a valid value for each subfield of the point code, and separate the subfields with a dash (-).

prefix—s

nnnnn—0-16383

gc—aa - zz

m1-m2-m3-m4—0-14 for each member; values must sum to 14

:pcn243= (optional)

24-bit ITU national point code with subfields *main signaling area-sub signaling area-signaling point (msa-ssa-sp)*.

Range: 000-255

Specify a valid value for each subfield of the point code, and separate the subfields with a dash (-).

msa—000-255

ssa—000-255

sp—000-255

:pc4/pca4/pci4/pcn4/pcn244= (optional)

Alternate re-route point code.

:pc4 or **:pca4=** (optional)

ANSI point code with subfields *network indicator-network cluster-network cluster member (ni-nc-ncm)*.

Range: 000-255

Specify a valid value for each subfield of the point code, and separate the subfields with a dash (-).

When **chg-sid:pctype=ansi** is specified, *ni* = 000 is not valid.

When **chg-sid:pctype=ansi** is specified, *nc* = 000 is not valid if *ni* = 001-005.

When **chg-sid:pctype=ansi** is specified, *nc* = 000 is valid if *ni* = 006-255.

The point code 000-000-000 is not a valid point code.

:pci4= (optional)

ITU international point code with subfields *zone-area-id*. The *prefix* subfield indicates a spare point code (*prefix-zone-area-id*).

Range: s-, 0-255

Specify a valid value for each subfield of the point code, and separate the subfields with a dash (-).

prefix—s-

zone—0-7

area—000-255

id—0-7

The point code 0-000-0 is not a valid point code.

:pcn4= (optional)

ITU national point code in the format of a 5-digit number (*nnnnn*); or 2, 3, or 4 numbers (members) separated by dashes (*m1-m2-m3-m4*) as defined by the **chg-stpopts:npcfmti** flexible point code option. A group code must be specified when the ITUDUPPC feature is turned on (*nnnnn-gc*, *m1-m2-m3-m4-gc*). The *prefix* subfield indicates a spare point code (*prefix-nnnnn*, *prefix-nnnnn-gc*, *prefix-m1-m2-m3-m4*, *prefix-m1-m2-m3-m4-gc*).

Range: s-, 0-16383, aa-zz

Specify a valid value for each subfield of the point code, and separate the subfields with a dash (-).

prefix—s-

nnnnn—0-16383

gc—aa - zz

m1-m2-m3-m4—0-14 for each member; values must sum to 14

:pcn244= (optional)

24-bit ITU national point code with subfields *main signaling area-sub signaling area-signaling point (msa-ssa-sp)*.

Range: 000-255

Specify a valid value for each subfield of the point code, and separate the subfields with a dash (-).

msa—000-255

ssa—000-255

sp—000-255

:rc1= (optional)

The relative cost of the route for alternate post-GTT-translated point code 1.

Range: 0-99

:rc2= (optional)

The relative cost of the route for alternate post-GTT-translated point code 2.

Range: 0-99

:rc3= (optional)

The relative cost of the route for alternate post-GTT-translated point code 3.

Range: 0-99

:rc4= (optional)

The relative cost of the route for alternate post-GTT-translated point code 4.

Range: 0-99

:state= (optional)

Status of the service.

Range offline, online

Default offline

NOTE: Rerouting is performed when state=offline.

Example

```
chg-sccp-serv:serv=gport:state=ONLINE
```

```
chg-sccp-serv:serv=gport:pca1=1-1-1:rc1=10:pca2=2-2-2:rc2=20:pca3=3-3-3:rc3=30:pca4=4-4-4:rc4=40
```

```
chg-sccp-serv:serv=gport:state=ONLINE:gtt=yes
```

Dependencies

The point code network type must match the existing network type.

The **pc** and **rc** parameters must be entered as a pair.

The **pc** parameter cannot match the **sid** parameter.

Mate remote point codes must already exist as a destination in the ORDERED ROUTE entity set or reside in a cluster destination for which ordered routes are specified

A maximum of 7 point codes are allowed per network type.

At least one point code must be specified.

The feature associated with a **serv** parameter must be ON or enabled.

Notes

For each supported service (G-Port and G-Flex), up to 7 point codes may be specified for each network type (ANSI, ITU-I, S-ITU-I, ITU-N, S-ITU-N, and ITU-N24).

Output

```
chg-sccp-serv:serv=gport:pca1=1-1-1:rc1=10:pca2=2-2-2:rc2=20:pca
tekelecstp 05-12-20 08:35:15 EST 34.3
chg-sccp-serv:serv=gport:pca1=1-1-1:rc1=10:pc2=1-1-2:rc2=20
Command entered at terminal #4.
CHG-SCCP-SRV : MASP A - COMPLTD
;
```

chg-sccpopts

Change SCCP Options

Use this command to change the values of one or more of the SCCP option indicators maintained in the STP options table.

Keyword: **chg-sccpopts**

Related Commands: **rtrv-sccpopts**

Command Class: Database Administration

Parameters

:class1seq= (optional)

Enable or disable Class 1 message sequencing.

Range: **on, off**

on—Enabled; Class 1 messages are guaranteed to be sequenced, but the messages are not load shared.

off—Disabled; Class 1 message sequencing is not guaranteed, but the messages might be load shared (if appropriate configuration exists).

Default: Current value

System Default: **off**

Example

```
chg-sccpopts:class1seq=on
```

Dependencies

At least one optional parameter must be specified.

Notes

None.

Output

```
chg-sccpopts:class1seq=on
rlghncxa03w 04-08-29 16:40:40 EST EAGLE 31.6.3
CHG-SCCPOPTS: MASP A - COMPLTD
;
```

chg-scr-aftpc**Change Allowed Affected Point Code**

Use this command to change the attributes of a specific screening reference in the allowed affected point code category. Attributes that can be changed are the point code and the subsystem number.

Keyword: **chg-scr-aftpc**

Related Commands: **dlt-scr-aftpc**, **ent-scr-aftpc**, **rtrv-scr-aftpc**

Command Class: Database Administration

Parameters

NOTE: See “Point Code Formats and Conversion” in Appendix A for a detailed description of point code formats, rules for specification, and examples.

:sr= (mandatory)

Screening reference. This parameter specifies the point code's unique screening reference name.

Range: 1 alphabetic character followed by up to 3 alphanumeric characters

:ssn= (mandatory)

The subsystem number. An asterisk (*) indicates the full range of values from 1-255.

Range: 1-255, *

:actname= (optional)

The name of the gateway screening stop action set. Stop actions must be administered using the **actname** parameter in conjunction with the gateway screening stop action table (see **chg-gws-actset** and **rtrv-gws-actset**).

Range: 1 alphabetic character followed by up to 5 alphanumeric characters.

none—remove an existing gateway screening stop action set from a gateway screening rule.

:area= (optional)

The ITU international area. The area is specified in the point code. The format of the point code is *zone-area-id*. An asterisk (*) indicates the full range of values from 000-255.

Range: 000-255, *

:id= (optional)

The ITU international ID. The parameter specifies the ID in the point code represented by format *zone-area-id*. An asterisk (*) indicates the full range of values from 0-7.

Range: 0-7, *

:msa= (optional)

The 24-bit ITU-national main signaling area (msa) value. It specifies the *msa* of the point code represented by *msa-ssa-spt*. An asterisk (*) indicates the full range of values from 000-255.

Range: 000-255, *

:narea= (optional)

The new ITU-international area value. An asterisk (*) indicates the full range of values from 000-255.

Range: 000-255, *, c

Default: Current value

:nc= (optional)

The network cluster (*nc*) value. This parameter specifies one or more *nc* values for the network indicator (*ni*) and network cluster member (*ncm*) values specified in the **ni** and **ncm** parameters. It specifies the *nc* of the point code represented by *ni-nc-ncm*. A single value or a range of values can be specified. An asterisk (*) indicates the full range of values from **000-255**.

Range: **000-255, ***

:ncm= (optional)

The network cluster member (*ncm*) value. This parameter specifies one or more *ncm* values for the network indicator (*ni*) and network cluster (*nc*) values identified in the **ni** and **nc** parameters. It specifies the *ncm* of the point code represented by *ni-nc-ncm*. A single value or a range of values can be specified. An asterisk (*) indicates the full range of values from **000-255**.

Range: **0-255, ***

:ni= (optional)

The network indicator (*ni*) value. This parameter specifies one or more *ni* values for the network cluster (*nc*) and network cluster member (*ncm*) values identified in the **nc** and **ncm** parameters. It specifies the *ni* of the point code represented by *ni-nc-ncm*. A single value or a range of values can be specified. An asterisk (*) indicates the full range of values from **000-255**.

Range: **0-255, ***

:nid= (optional)

The new ITU-international ID value. An asterisk (*) indicates the full range of values from **0-7**.

Range: **0-7, ***

Default: Current value

:nmsa= (optional)

The new 24-bit ITU-national main signaling area (*nmsa*) value. It specifies the new *msa* of the point code represented by *msa-ssa-sp*. An asterisk (*) indicates the full range of values from **000-255**.

Range: **000-255, ***

:nnc= (optional)

The new network cluster (*nnc*). This parameter specifies one or more *nnc* values for the screening reference specified in the **sr** parameter. It specifies the new network cluster (*nc*) of the point code represented by *ni-nc-ncm*. A single value or a range of values can be specified. An asterisk (*) indicates the full range of values from **000-255**.

Range: **000-255, ***

Default: Current value

:nncm= (optional)

The new network cluster member (*nncm*). This parameter specifies one or more *ncm* values for the screening reference specified in the **sr** parameter. It specifies the new network cluster member (*ncm*) of the point code represented by *ni-nc-ncm*. A single value or a range of values can be specified. An asterisk (*) indicates the full range of values from **0-255**.

Range: **0-255, ***

Default: Current value

:nni= (optional)

The new network identifier (*nni*). This parameter specifies one or more *nni* values for the screening reference specified in the **sr** parameter. It specifies the new network indicator (*ni*) of the point code represented by *ni-nc-ncm*. A single value or a range of values can be specified. An asterisk (*) indicates the full range of values from **000-255**.

Range: 0-255, *

Default: Current value

:nnpc= (optional)

The new ITU-national point code. An asterisk (*) indicates the full range of values from **00000-16383**.

Range: 00000-16383, *

Default: Current value

NOTE: Gateway screening allows the ITU national point code to be displayed and entered in the database only as a single number. If you use multiple-part ITU national point codes, see “Converting ITU National Point Code Formats” in Appendix A for information on converting the point code format.

:npc= (optional)

The ITU national point code. An asterisk (*) indicates the full range of values from **00000-16383**.

Range: 00000-16383, *

:npcst= (optional)

New point code subtype. This parameter indicates whether the specified new ITU international or ITU national point code has no subtype prefix or has the spare point code prefix (s-).

Range: none, s

Default: none

:nsfi= (optional)

This parameter specifies the next screening category that is used in the gateway screening process. If specified, the parameter value must be **stop**.

Range: stop

stop—The gateway screening process ends and the message proceeds through normal routing.

Default: Current value

:nsp= (optional)

The new 24-bit ITU national signaling point (*nsp*). It specifies the new *sp* of the point code represented by *msa-ssa-sp*. An asterisk (*) indicates the full range of values from **000-255**.

Range: 000-255, *

:nsr= (optional)

Next screening reference (*nsr*). The parameter indicates which screening reference in the specified screening category (**nsfi**) is to be used in the screening process. If **nsfi=stop**, the **nsr** parameter cannot be specified.

Range: 1 alphabetic character followed by up to 3 alphanumeric characters

Default: Current value

:nssa= (optional)

The new 24-bit ITU national sub signaling area (*nssa*). It specifies the new sub signaling area (*ssa*) of the point code represented by *msa-ssa-sp*. An asterisk (*) indicates the full range of values from **000-255**.

Range: 000-255, *

:nssn= (optional)

The new subsystem number. An asterisk (*) indicates the full range of values from **000-255**.

Range: 000-255, *

Default: Current value

:nzone= (optional)

The new ITU-international zone. The parameter specifies a new zone for the point code represented by *zone-area-id*. An asterisk (*) indicates the full range of values from **0-7**.

Range: 0-7, *, c

Default: Current value

:pcst= (optional)

Point code subtype. This parameter indicates whether the specified ITU international or ITU national point code has no subtype prefix or has the spare point code prefix (*s*).

Range: none, s

Default: none

:sp= (optional)

The 24-bit ITU national signaling point (*sp*). This parameter specifies the signaling point (*sp*) in the point code represented by *msa-ssa-sp*. An asterisk (*) indicates the full range of values from **000-255**.

Range: 000-255, *

:ssa= (optional)

The 24-bit ITU national sub signaling area (*ssa*). This parameter specifies the sub signaling area (*ssa*) in the point code represented by the format *msa-ssa-sp*. An asterisk (*) indicates the full range of values from **000-255**.

Range: 000-255, *

:zone= (optional)

The ITU international zone. The parameter specifies the zone in the point code represented by format *zone-area-id*. An asterisk (*) indicates the full range of values from **0-7**.

Range: 0-7, *

Example

```
chg-scr-aftpc:sr=iec:ni=240:nc=010:ncm=010:ssn=254:nni=240:nnc=003:nncm=030
:nssn=253
```

```
chg-scr-aftpc:sr=iec:ni=240:nc=008:ncm=203:nssn=253:nsfi=stop:actname=copy
```

```
chg-scr-aftpc:sr=aft1:zone=1:area=2:id=3:nsfi=stop:ssn=1:pcst=s:npcst=none
```

Dependencies



CAUTION: Even though gateway screening is in the screen test mode, as defined by the parameters **gwsa=off** and **gws=on**, the gateway screening action in the stop action set specified by the **actname** parameter of the screen set *will* be performed at the end of the screening process.

A complete point code must be specified, and must be one, and only one of the four point code parameter combinations: **ni-nc-ncm**; **zone-area-id**; **msa-ssa-sp**; or **npc**.

ANSI point code value **000-000-000** and ITU-International point code value **0-000-0** are not allowed.

At least one optional parameter must be specified.

The new affected point code and subsystem number to be changed cannot already exist in the affected point code entity set.

The value of the **actname** parameter must already be defined in the Gateway Screening Stop Action table with the **chg-gws-actset** command. These values are shown in the **ACT NAME** field of the **rtv-gws-actset** command output.

If **zone=*** is specified, **area=*** and **id=*** must be specified.

If **area=*** is specified, **id=*** must be specified.

If **msa=*** is specified, **ssa=*** and **sp=*** must be specified.

If **ssa=*** is specified, **sp=*** must be specified.

If the **nc** parameter is specified as a range, the **ncm** parameter must be specified as an asterisk or as the full range **000-255**

If the **nc** parameter is specified as a single value or a range, a single value must be specified for the **ni** parameter.

If the **nc** parameter is specified as an asterisk (**nc=***), the **ncm** parameter must be specified as an asterisk or as the full range **000-255**.

If the **ncm** parameter is specified as a single value, or a range other than the full range of **000-255**, the **ni** and the **nc** parameters must be specified with a single value.

If the **ni** parameter is specified as an asterisk (**ni=***) or as a range, the **nc** and **ncm** parameters must be specified as an asterisk or as the full range **000-255**.

If the **nsfi** parameter is specified, the parameter value must be **stop**.

If the **nsfi=stop** parameter is specified, the **nsr** parameter cannot be specified.

The character **c** is not a valid value for the **ni**, **nc**, **ncm**, **zone**, **area**, **id**, **msa**, **ssa**, **sp**, and **npc** parameters.

The Gateway Screening Rules table can contain a maximum of 372,600 rules.

The specified screening reference (**sr**) must already exist in the database.

The Spare Point Code Support feature must be enabled before the **pcst** parameter can be specified.

The spare point code subtype prefix (**s-**) is not supported for ANSI point codes (parameters **ni**, **nc**, **ncm**) or for 24-bit ITU national point codes (parameters **msa**, **ssa**, **sp**). The **pcst** and **npcst** parameters cannot be specified for ANSI and ITU-N24 point codes.

Notes

A range of values is specified by separating the values that define the range by two ampersands (**&&**); for example, **:ni=025&&100** specifies all network indicators for ANSI point codes from **25** to **100**.

An asterisk cannot be specified for a parameter value in this command unless an asterisk was specified for the parameter value in the original **ent-scr-aftpc** command.

If the screen set reaches 100% capacity (indicated by the “100% full” message), the system will allow subsequent entries. An error will occur, however, when downloading the screen set to the card. Screen sets should not exceed 100% capacity. Remove screen set entries until the capacity is below 100%.

A screening reference is assigned to screen sets using the **ent-scrset** command. A screening reference can belong to multiple screen sets.

The spare point code subtype prefix **s-** is supported only for ITU international and ITU national point codes. The **pcst** parameter indicates whether the specified point code has no subtype prefix or has the spare point code prefix.

Output

```
chg-scr-aftpc:sr=iec:ni=240:nc=010:ncm=010:ssn=254:nni=240:nnc=003:nncm=030
:nssn=253
```

```
rlghncxa03w 04-01-07 11:43:04 EST EAGLE 31.3.0
CHG-SCR-AFTPC: SCREEN SET AFFECTED - IEC 25% FULL
CHG-SCR-AFTPC: MASP A - COMPLTD
```

```
;
```

Legend

CHG-SCR-AFTPC—The command entered that caused this output. This is echoed to the printer as a reference.

SCREEN SET AFFECTED - IEC—Identifies the screen set that was affected by the command. The screen set name is provided.

25% FULL—Indicates the relative size of the screen set.

chg-scr-blkdpc

Change Blocked DPC

Use this command to change the attributes of a specific screening reference in the blocked DPC category. Attributes that can be changed are the blocked destination point code, next screening function identifier, and the next screening reference.

Keyword: **chg-scr-blkdpc**

Related Commands: **dlt-scr-blkdpc**, **ent-scr-blkdpc**, **rtrv-scr-blkdpc**

Command Class: Database Administration

Parameters

NOTE: See “Point Code Formats and Conversion” in Appendix A for a detailed description of point code formats, rules for specification, and examples.

:sr= (mandatory)

Screening reference. This parameter specifies the point code’s unique screening reference name.

Range: 1 alphabetic character followed by up to 3 alphanumeric characters

:actname= (optional)

The name of the gateway screening stop action set. Stop actions must be administered using the **actname** parameter in conjunction with the gateway screening stop action table (see **chg-gws-actset** and **rtrv-gws-actset**).

Range: 1 alphabetic character followed by up to 5 alphanumeric characters.

none—remove an existing gateway screening stop action set from a gateway screening rule.

:area= (optional)

The ITU international area. The area is specified in the point code. The format of the point code is *zone-area-id*. An asterisk (*) indicates the full range of values from **000–255**.

Range: **000–255, ***

:id= (optional)

The ITU international ID. The parameter specifies the ID in the point code represented by format *zone-area-id*. An asterisk (*) indicates the full range of values from **0–7**.

Range: **0–7, ***

:msa= (optional)

The 24-bit ITU-national main signaling area (*msa*) value. It specifies the main signaling area (*msa*) of the point code represented by *msa-ssa-spt*. An asterisk (*) indicates the full range of values from **000–255**.

Range: **000–255, ***

:narea= (optional)

The new ITU-international area value. An asterisk (*) indicates the full range of values from **000–255**.

Range: **000–255, *, c**

Default: Current value

:nc= (optional)

The network cluster (*nc*) value. This parameter specifies one or more *nc* values for the network indicator (*ni*) and network cluster member (*ncm*) values specified in the **ni** and **ncm** parameters. It specifies the *nc* of the point code represented by *ni-nc-ncm*. A single value or a range of values can be specified. An asterisk (*) indicates the full range of values from **000–255**.

Range: **000–255, ***

:ncm= (optional)

The network cluster member (*ncm*) value. This parameter specifies one or more *ncm* values for the network indicator (*ni*) and network cluster (*nc*) values identified in the **ni** and **nc** parameters. It specifies the *ncm* of the point code represented by *ni-nc-ncm*. A single value or a range of values can be specified. An asterisk (*) indicates the full range of values from **000-255**.

Range: 0-255, *

:ni= (optional)

The network indicator (*ni*) value. This parameter specifies one or more *ni* values for the network cluster (*nc*) and network cluster member (*ncm*) values identified in the **nc** and **ncm** parameters. It specifies the *ni* of the point code represented by *ni-nc-ncm*. A single value or a range of values can be specified. An asterisk (*) indicates the full range of values from **000-255**.

Range: 0-255, *

:nid= (optional)

The new ITU-international ID value. An asterisk (*) indicates the full range of values from **0-7**.

Range: 0-7, *

Default: Current value

:nmsa= (optional)

The new 24-bit ITU-national main signaling area (*nmsa*) value. It specifies the new main signaling area (*msa*) of the point code represented by *msa-ssa-sp*. An asterisk (*) indicates the full range of values from **000-255**.

Range: 000-255, *

:nnc= (optional)

The new network cluster (*nnc*). This parameter specifies one or more *nnc* values for the screening reference specified in the **sr** parameter. It specifies the new network cluster (*nc*) of the point code represented by *ni-nc-ncm*. A single value or a range of values can be specified. An asterisk (*) indicates the full range of values from **000-255**.

Range: 000-255, *

Default: Current value

:nncm= (optional)

The new network cluster member (*nncm*). This parameter specifies one or more *ncm* values for the screening reference specified in the **sr** parameter. It specifies the new network cluster member (*ncm*) of the point code represented by *ni-nc-ncm*. A single value or a range of values can be specified. An asterisk (*) indicates the full range of values from **0-255**.

Range: 0-255, *

Default: Current value

:nni= (optional)

The new network identifier (*nni*). This parameter specifies one or more *nni* values for the screening reference specified in the **sr** parameter. It specifies the new network indicator (*ni*) of the point code represented by *ni-nc-ncm*. A single value or a range of values can be specified. An asterisk (*) indicates the full range of values from **000-255**.

Range: 0-255, *

Default: Current value

:nnp= (optional)

The new ITU-national point code. An asterisk (*) indicates the full range of values from **00000-16383**.

Range: **00000-16383, ***

Default: Current value

NOTE: Gateway screening allows the ITU national point code to be displayed and entered in the database only as a single number. If you use multiple-part ITU national point codes, see “Converting ITU National Point Code Formats” in Appendix A for information on converting the point code format.

:npc= (optional)

The ITU national point code. An asterisk (*) indicates the full range of values from **00000-16383**.

Range: **00000-16383, ***

:npcst= (optional)

New point code subtype. This parameter indicates whether the specified new ITU international or ITU national point code has no subtype prefix or has the spare point code prefix (s-).

Range: **none, s**

Default: **none**

:nsfi= (optional)

This parameter specifies the next screening category that is used in the gateway screening process, or it indicates that the gateway screening process should stop.

Range: **cgpa, destfld, fail, isup, stop**

cgpa—Allowed CGPA is the next screening category.

destfld—Allowed destination field (DESTFLD) is the next screening category.

fail—Discard the received message.

isup—ISUP message type (ISUP) is the next screening category.

stop—The gateway screening process ends and the message proceeds through normal routing.

Default: Current value

:nsp= (optional)

The new 24-bit ITU national signaling point (*nsp*). It specifies the new signaling point (*sp*) of the point code represented by *msa-ssa-sp*. An asterisk (*) indicates the full range of values from **000-255**.

Range: **000-255, ***

:nsr= (optional)

Next screening reference (*nsr*). The parameter indicates which screening reference in the specified screening category (**nsfi**) is to be used in the screening process. If **nsfi=stop**, the **nsr** parameter cannot be specified.

Range: 1 alphabetic character followed by up to 3 alphanumeric characters

Default: Current value

:nssa= (optional)

The new 24-bit ITU national sub signaling area (*nssa*). It specifies the new sub signaling area (*ssa*) of the point code represented by *msa-ssa-sp*. An asterisk (*) indicates the full range of values from **000-255**.

Range: **000-255, ***

:nzone= (optional)

The new ITU-international zone. The parameter specifies a new zone for the point code represented by *zone-area-id*. An asterisk (*) indicates the full range of values from **0-7**.

Range: **0-7, *, c**

Default: Current value

:pcst= (optional)

Point code subtype. This parameter indicates whether the specified ITU international or ITU national point code has no subtype prefix or has the spare point code prefix (**s**).

Range: **none, s**

Default: **none**

:sp= (optional)

The 24-bit ITU national signaling point (*sp*). This parameter specifies the signaling point (*sp*) in the point code represented by *msa-ssa-sp*. An asterisk (*) indicates the full range of values from **000-255**.

Range: **000-255, ***

:ssa= (optional)

The 24-bit ITU national sub signaling area (*ssa*). This parameter specifies the sub signaling area (*ssa*) in the point code represented by the format *msa-ssa-sp*. An asterisk (*) indicates the full range of values from **000-255**.

Range: **000-255, ***

:zone= (optional)

The ITU international zone. The parameter specifies the zone in the point code represented by format *zone-area-id*. An asterisk (*) indicates the full range of values from **0-7**.

Range: **0-7, ***

Example

chg-scr-blkdpc:sr=ie:c:ni=240:nc=010:ncm=010:nni=240:nnc=003:nncm=030

chg-scr-blkdpc:sr=ie:c:ni=c:nc=c:ncm=c:nsfi=cgpa:nsr=wr2

chg-scr-blkdpc:sr=ie:c:ni=240:nc=010:ncm=010:nsfi=stop:actname=cr

chg-scr-blkdpc:sr=bdp1:npc=128:nsfi=fail:pcst=s:npcst=none

Dependencies



CAUTION: Even though gateway screening is in the screen test mode, as defined by the parameters **gwsa=off** and **gws=on**, the gateway screening action in the stop action set specified by the **actname** parameter of the screen set *will* be performed at the end of the screening process.

The Gateway Screening Rules table can contain a maximum of 362, 700 rules.

A complete point code must be specified, and must be one and only one of the four point code parameter combinations: **ni-nc-ncm**; **zone-area-id**; **msa-ssa-sp**; or **npc**, except in the special case of entering **c** for "continue".

A new point code entry must be specified by one, and only one of the four point code parameter combinations: **nni-nnc-ncm**, **nzone-narea-nid**, **nmsa-nssa-nsp**, or **nnpc**. If the new point code entry is a different point code type than the existing point code entry, all subfields of the new point code type must be specified.

ANSI point code value **000-000-000** and ITU-International point code value **0-000-0** are not allowed.

At least one optional parameter must be specified.

The blocked DPC specified by **ni-nc-ncm**; **zone-area-id**; **msa-ssa-sp**; or the **npc** parameter must already exist in the screening reference or within an existing range of DPCs.

The new blocked DPC or DPC range defined by **ni-nc-ncm**; **zone-area-id**, **msa-ssa-sp**, or the **npc** parameter must not already exist in the screening reference or within an existing range of DPCs.

If an asterisk (*) is specified for the new blocked DPC, nothing that matches the specified range of DPCs can already exist in the DPC screening table for the screening reference.

If the **actname** parameter is specified, the **nsfi-stop** parameter must be specified.

If the **actname** parameter is specified, the **nsr** parameter cannot be specified.

The value of the **actname** parameter must already be defined in the Gateway Screening Stop Action table with the **chg-gws-actset** command. These values are shown in the *ACT NAME* field of the **rtrv-gws-actset** command output.

If **area=*** is specified, **id=*** must be specified.

If **msa=*** is specified, **ssa=*** and **sp=*** must be specified.

If **msa=c** is specified, either the character **c** must also be specified for the **ssa** and **sp** parameters or the **ssa** and **sp** parameters must not be specified. If the **ssa** and **sp** parameters are not specified when **msa=c** is specified, the **ssa** and **sp** values default to the character **c** in the database.

If the **nc** parameter is specified as a range, the **ncm** parameter must be specified as an asterisk or as the full range **000-255**.

If the **nc** parameter is specified as a single value or a range, a single value must be specified for the **ni** parameter.

If the **nc** parameter is specified as an asterisk (**nc=***), the **ncm** parameter must be specified as an asterisk or as the full range **000-255**.

If the **ncm** parameter is specified as a single value, or a range other than the full range of **000-255**, the **ni** and the **nc** parameters must be specified with a single value.

If the **ni** parameter is specified as an asterisk (**ni=***) or as a range, the **nc** and **ncm** parameters must be specified as an asterisk or as the full range **000-255**.

If **ni=c** is specified, either the character **c** must also be specified for the **nc** and **ncm** parameters or the **nc** and **ncm** parameters must not be specified. If the **nc** and **ncm** parameters are not specified when **ni=c** is specified, the **nc** and **ncm** values default to the character **c** in the database.

If the specified **ni-nc-ncm** or **zone-area-id** or **msa-ssa-sp** is not equal to **c-c-c** or **npc** is not equal to **c**, **nsfi=fail** must be specified and the **nsr** parameter cannot be specified.

If the **nnc** parameter is specified as a range, the **nncm** parameter must be specified as an asterisk or as the full range **000-255**.

If the **nnc** parameter is specified as a single value or a range, a single value must be specified for the **nni** parameter.

If the **nnc** parameter is specified as an asterisk (**nnc=***), the **nnm** parameter must be specified as an asterisk or as the full range **000-255**.

If the **nncm** parameter is specified as a single value, or a range other than the full range of **000-255**, the **nni** and the **nnc** parameters must be specified with a single value.

If the **nni** parameter is specified as an asterisk (**nni=***) or as a range, the **nnc** and **nncm** parameters must be specified as an asterisk or as the full range **000-255**.

If the **nsfi** parameter has a value other than **stop** or **fail**, the **nsr** parameter must be specified and must exist.

When changing a screening entry that has **nsfi** equal to **fail**, the **nni**, **nnc**, **nncm**, **narea**, **nzone**, **nid**, **nmsa**, **nssa**, **nsp**, and **npc** parameter values cannot equal **c**.

The specified screening reference (**sr**) must already exist in the database.

The Spare Point Code Support feature must be enabled before the **pcst** parameter can be specified.

The **pcst** and **npcst** parameters cannot be specified with **c** for a blocked screen reference (**sr**).

The spare point code subtype prefix (**s-**) is not supported for ANSI point codes (parameters **ni**, **nc**, **ncm**) or for 24-bit ITU national point codes (parameters **msa**, **ssa**, **sp**). The **pcst** and **npcst** parameters cannot be specified for ANSI and ITU-N24 point codes.

If **ssa=*** is specified, **sp=*** must be specified.

If **zone=*** is specified, **area=*** and **id=*** must be specified.

If **zone=c** is specified, either the character **c** must also be specified for the **area** and **id** parameters or the **area** and **id** parameters must not be specified. If the **area** and **id** parameters are not specified when **zone=c** is specified, the **area** and **id** values default to the character **c** in the database.

Notes

When a blocked DPC screening reference is created, the first entry for a point code must be **c-c-c**, or **c** for the **npc** parameter. Subsequent entries must be specific point codes.

The character **c** is used in the blocked DPC screens to allow the screening process to continue for messages with point codes that do not match any point codes in the blocked DPC screens. When screening for a blocked DPC and the point code being screened does not match any of the point codes in the blocked DPC screens, the message is not rejected and the screening process continues.

There must be an entry in the blocked DPC screens to allow the screening process to continue. This entry consists of a screening reference, point code, **nsfi**, and **nsr**. The point code is **npc=c** or subfields equal to **c-c-c**. When the character **c** is specified, the **nsfi** and **nsr** parameters must be specified.

If the character **c** is specified for the parameters **ni-nc-ncm** or **zone-area-id** or **msa-ssa-sp**, the character **c** is the only value that can be specified for all three parameters. No other values can be used. For example, a point code **c-c-255** is not allowed. The point code must be **c-c-c**. The asterisk (*) value cannot be used with the character **c** (for example, a point code **c-c-*** is not allowed).

When the point code does not match any entries in the blocked DPC screens, the screening process is directed to the screening reference with the point code **c-c-c** or **npc=c**. The **nsfi** and **nsr** in this entry are examined to determine the next step in the screening process.

If the current **ni-nc-ncm** or **zone-area-id** or **msa-ssa-sp** is equal to **c-c-c** or **npc=c**, only the **nsfi** and **nsr** can be changed. Otherwise, only the blocked DPC can be changed.

A range of values is specified by separating the values that define the range by two ampersands (&&); for example, **:ni=025&&100** specifies all network indicators for ANSI point codes from **25** to **100**.

An asterisk cannot be specified for a parameter value in this command unless an asterisk was specified for the parameter value in the **ent-scr-blkdpc** command.

If the screen set reaches 100% capacity (indicated by the 100% Full message), the system allows subsequent entries. An error occurs, however, when downloading the screen set to an LIM. Ensure that screen sets do not exceed 100% capacity. Remove screen set entries until the capacity is below 100%.

The spare point code subtype prefix **s-** is supported only for ITU international and ITU national point codes. The **pcst** and **npcst** parameters indicate whether the specified point code has no subtype prefix or has the spare point code prefix.

Output

```
chg-scr-blkdpc:sr=ss01:ni=240:nc=010:ncm=010:nni=240:nnc=003:nncm=030
```

```
rlghncxa03w 04-01-07 11:43:04 EST EAGLE 31.3.0
CHG-SCR-BLKDPC: SCREEN SET AFFECTED - SS01 25% FULL
CHG-SCR-BLKDPC: MASP A - COMPLTD
```

```
;
```

Legend

CHG-SCR-BLKDPC—The command entered that caused this output. This is echoed to the printer as a reference.

SCREEN SET AFFECTED - SS01—Identifies the screen set that was affected by the command. The screen set name is provided.

25% FULL—Indicates the relative size of the screen set.

chg-scr-blkopc**Change Blocked OPC**

Use this command to change the attributes associated with a screening reference in the blocked OPC category. Attributes that can be changed are the point code, next screening function identifier, and next screening reference.

Keyword: **chg-scr-blkopc**

Related Commands: **dlt-scr-blkopc**, **ent-scr-blkopc**, **rtrv-scr-blkopc**

Command Class: Database Administration

Parameters

† At least one of these parameters must be entered.

:sr= (mandatory)

Screening reference. This parameter specifies the point code's unique screening reference name.

Range: 1 alphabetic character followed by up to 3 alphanumeric characters

:actname= (optional)

The name of the gateway screening stop action set. Stop actions must be administered using the **actname** parameter in conjunction with the gateway screening stop action table (see **chg-gws-actset** and **rtrv-gws-actset**).

Range: 1 alphabetic character followed by up to 5 alphanumeric characters.

none—Remove an existing gateway screening stop action set from a gateway screening rule.

:area= (optional)

The ITU international area. The area is specified in the point code. The format of the point code is *zone-area-id*. An asterisk (*) indicates the full range of values from **000–255**.

Range: **000–255, ***

:id= (optional)†

The ITU international ID. The parameter specifies the ID in the point code represented by format *zone-area-id*. An asterisk (*) indicates the full range of values from **0–7**.

Range: **0–7, ***

:msa= (optional)

The 24-bit ITU-national main signaling area (msa) value. It specifies the main signaling area (*msa*) of the point code represented by *msa-ssa-spt*. An asterisk (*) indicates the full range of values from **000–255**.

Range: **000–255, ***

:narea= (optional)†

The new ITU-international area value. An asterisk (*) indicates the full range of values from **000–255**.

Range: **000–255, *, c**

Default: Current value

:nc= (optional)†

The network cluster (*nc*) value. This parameter specifies one or more *nc* values for the network indicator (*ni*) and network cluster member (*ncm*) values specified in the **ni** and **ncm** parameters. It specifies the *nc* of the point code represented by *ni-nc-ncm*. A single value or a range of values can be specified. An asterisk (*) indicates the full range of values from **000-255**.

Range: **000-255, ***

:ncm= (optional)†

The network cluster member (*ncm*) value. This parameter specifies one or more *ncm* values for the network indicator (*ni*) and network cluster (*nc*) values identified in the **ni** and **nc** parameters. It specifies the *ncm* of the point code represented by *ni-nc-ncm*. A single value or a range of values can be specified. An asterisk (*) indicates the full range of values from **000-255**.

Range: **0-255, ***

:ni= (optional)†

The network indicator (*ni*) value. This parameter specifies one or more *ni* values for the network cluster (*nc*) and network cluster member (*ncm*) values identified in the **nc** and **ncm** parameters. It specifies the *ni* of the point code represented by *ni-nc-ncm*. A single value or a range of values can be specified. An asterisk (*) indicates the full range of values from **000-255**.

Range: **0-255, ***

:nid= (optional)†

The new ITU-international ID value. An asterisk (*) indicates the full range of values from **0-7**.

Range: **0-7, ***

Default: Current value

:nmsa= (optional)

The new 24-bit ITU-national main signaling area (*nmsa*) value. It specifies the new main signaling area (*msa*) of the point code represented by *msa-ssa-spt*. An asterisk (*) indicates the full range of values from **000-255**.

Range: **000-255, ***

:nnc= (optional)†

The new network cluster (*nnc*). This parameter specifies one or more *nnc* values for the screening reference specified in the **sr** parameter. It specifies the new network cluster (*nc*) of the point code represented by *ni-nc-ncm*. A single value or a range of values can be specified. An asterisk (*) indicates the full range of values from **000-255**.

Range: **000-255, ***

Default: Current value

:nncm= (optional)†

The new network cluster member (*nncm*). This parameter specifies one or more *ncm* values for the screening reference specified in the **sr** parameter. It specifies the new network cluster member (*ncm*) of the point code represented by *ni-nc-ncm*. A single value or a range of values can be specified. An asterisk (*) indicates the full range of values from **0-255**.

Range: **0-255, ***

Default: Current value

:nni= (optional)†

The new network identifier (*nni*). This parameter specifies one or more *nni* values for the screening reference specified in the **sr** parameter. It specifies the new network indicator (*ni*) of the point code represented by *ni-nc-ncm*. A single value or a range of values can be specified. An asterisk (*) indicates the full range of values from **000–255**.

Range: **0–255, ***

Default: Current value

:nnp= (optional)†

The new ITU-national point code. An asterisk (*) indicates the full range of values from **00000–16383**.

Range: **00000–16383, ***

Default: Current value

NOTE: Gateway screening allows the ITU national point code to be displayed and entered in the database only as a single number. If you use multiple-part ITU national point codes, see “Converting ITU National Point Code Formats” in Appendix A for information on converting the point code format.

:npc= (optional)†

The ITU national point code. An asterisk (*) indicates the full range of values from **00000–16383**.

Range: **00000–16383, ***

:npcst= (optional)

New point code subtype. This parameter indicates whether the specified new ITU international or ITU national point code has no subtype prefix or has the spare point code prefix (**s-**).

Range: **none, s**

Default: **none**

:nsfi= (optional)†

This parameter specifies the next screening category that is used in the gateway screening process, or it indicates that the gateway screening process should stop.

Range: **cgpa, fail, stop**

cgpa—Allowed CGPA is the next screening category.

fail—Discard the received message.

stop—The gateway screening process ends and the message proceeds through normal routing.

Default: Current value

:nsp= (optional)

The new 24-bit ITU national signaling point (*nsp*). It specifies the new signaling point (*sp*) of the point code represented by *msa-ssa-sp*. An asterisk (*) indicates the full range of values from **000–255**.

Range: **000–255, ***

:nsr= (optional)†

Next screening reference (*nsr*). The parameter indicates which screening reference in the specified screening category (**nsfi**) is to be used in the screening process. If **nsfi=stop**, the **nsr** parameter cannot be specified.

Range: 1 alphabetic character followed by up to 3 alphanumeric characters

Default: Current value

:nssa= (optional)

The new 24-bit ITU national sub signaling area (*nssa*). It specifies the new sub signaling area (*ssa*) of the point code represented by *msa-ssa-sp*. An asterisk (*) indicates the full range of values from **000-255**.

Range: **000-255, ***

:nzone= (optional)†

The new ITU-international zone. The parameter specifies a new zone for the point code represented by *zone-area-id*. An asterisk (*) indicates the full range of values from **0-7**.

Range: **0-7, *, c**

Default: Current value

:pcst= (optional)

Point code subtype. This parameter indicates whether the specified ITU international or ITU national point code has no subtype prefix or has the spare point code prefix (s-).

Range: **none, s**

Default: **none**

:sp= (optional)

The 24-bit ITU national signaling point (*sp*). This parameter specifies the signaling point (*sp*) in the point code represented by *msa-ssa-sp*. An asterisk (*) indicates the full range of values from **000-255**.

Range: **000-255, ***

:ssa= (optional)

The 24-bit ITU national sub signaling area (*ssa*). This parameter specifies the sub signaling area (*ssa*) in the point code represented by the format *msa-ssa-sp*. An asterisk (*) indicates the full range of values from **000-255**.

Range: **000-255, ***

:zone= (optional)†

The ITU international zone. The parameter specifies the zone in the point code represented by format *zone-area-id*. An asterisk (*) indicates the full range of values from **0-7**.

Range: **0-7, ***

Example

chg-scr-blkopc:sr=iec:ni=240:nc=010:ncm=010:nni=240:nnc=010:nncm=020

chg-scr-blkopc:sr=iec:ni=c:nc=c:ncm=c:nsfi=dpc:nsr=wrđ1

chg-scr-blkopc:sr=iec:ni=c:nc=c:ncm=c:nsfi=stop:actname=none

chg-scr-blkopc:sr=bop1:npc=128:nsfi=fail:pcst=s:npcst=none

Dependencies



CAUTION: Even though gateway screening is in the screen test mode, as defined by the parameters *gwsa=off* and *gws=on*, the gateway screening action in the stop action set specified by the *actname* parameter of the screen set *will* be performed at the end of the screening process.

A complete point code must be specified, and must be one and only one of the four point code parameter combinations: **ni-nc-ncm**; **zone-area-id**; **msa-ssa-sp**; or **npc**, except in the special case of entering **c** for "continue".

A new point code entry must be specified by one, and only one of the four point code parameter combinations: **nni-nnc-nncm**, **nzone-narea-nid**, **nmsa-nssa-nsp**, or **nnpc**. If the new point code entry is a different point code type than the existing point code entry, all subfields of the new point code type must be specified.

ANSI point code value **000-000-000** and ITU-International point code value **0-000-0** are not allowed.

At least one optional parameter must be specified.

The blocked OPC specified by **ni-nc-ncm**; **zone-area-id**; **msa-ssa-sp**; or the **npc** parameter must already exist in the screening reference or within an existing range of OPCs.

The new blocked OPC or OPC range defined by **ni-nc-ncm**; **zone-area-id**, **msa-ssa-sp**, or the **npc** parameter must not already exist in the screening reference or within an existing range of OPCs.

If the **actname** parameter is specified, the **nsr** parameter cannot be specified.

The value of the **actname** parameter must already be defined in the Gateway Screening Stop Action table with the **chg-gws-actset** command. These values are shown in the **ACT NAME** field of the **rtrv-gws-actset** command output.

If **area=*** is specified, **id=*** must be specified.

If **msa=*** is specified, **ssa=*** and **sp=*** must be specified.

If **msa=c** is specified, either the character **c** must also be specified for the **ssa** and **sp** parameters or the **ssa** and **sp** parameters must not be specified. If the **ssa** and **sp** parameters are not specified when **msa=c** is specified, the **ssa** and **sp** values default to the character **c** in the database.

The next screening function identifier (**nsfi**) and the next screening reference (**nsr**) must point to an existing screen, or the **nsfi** must be equal to **stop** and the **nsr** must not be specified.

If the **nc** parameter is specified as a range, the **ncm** parameter must be specified as an asterisk or as the full range **000-255**.

If the **nc** parameter is specified as a single value or a range, a single value must be specified for the **ni** parameter.

If the **nc** parameter is specified as an asterisk (**nc=***), the **ncm** parameter must be specified as an asterisk or as the full range **000-255**.

If the **ncm** parameter is specified as a single value, or a range other than the full range of **000-255**, the **ni** and the **nc** parameters must be specified with a single value.

If the **ni** parameter is specified as an asterisk (**ni=***) or as a range, the **nc** and **ncm** parameters must be specified as an asterisk or as the full range **000-255**.

If **ni=c** is specified, either the character **c** must also be specified for the **nc** and **ncm** parameters or the **nc** and **ncm** parameters must not be specified. If the **nc** and **ncm** parameters are not specified when **ni=c** is specified, the **nc** and **ncm** values default to the character **c** in the database.

If the **nnc** parameter is specified as a range, the **nncm** parameter must be specified as an asterisk or as the full range **000-255**.

If the **nnc** parameter is specified as a single value or a range, a single value must be specified for the **nni** parameter.

If the **nnc** parameter is specified as an asterisk (**nnc=***), the **nnm** parameter must be specified as an asterisk or as the full range **000-255**.

If the **nncm** parameter is specified as a single value, or a range other than the full range of **000-255**, the **nni** and the **nnc** parameters must be specified with a single value.

If the **nni** parameter is specified as an asterisk (**nni=***) or as a range, the **nnc** and **nncm** parameters must be specified as an asterisk or as the full range **000-255**.

When changing a screening entry that has **nsfi** equal to **fail**, the **nni**, **nnc**, **nncm**, **narea**, **nzone**, **nid**, **nmsa**, **nssa**, **nsp**, and **npc** parameter values cannot equal **c**.

When changing a screening entry that has **nsfi** equal to **fail**, the **nni**, **nnc**, **nncm**, **narea**, **nzone**, **nid**, **nmsa**, **nssa**, **nsp**, and **npc** parameter values cannot equal **c**.

If the specified **ni-nc-ncm** or **zone-area-id** or **msa-ssa-sp** is equal to **c-c-c** or if **npc=c**, **nsfi=fail** cannot be specified, and the **nni**, **nnc**, **nncm**, **nzone**, **narea**, **nid**, **nmsa**, **nssa**, **nsp**, and **npc** parameters cannot be specified. Point code **c-c-c** and **npc=c** cannot be changed to a numbered point code.

If the specified **ni-nc-ncm** or **zone-area-id** or **msa-ssa-sp** is not equal to **c-c-c** or **npc** is not equal to **c**, **nsfi=fail** must be specified and the **nsr** parameter cannot be specified.

If **ssa=*** is specified, **sp=*** must be specified.

The specified screening reference (**sr**) must already exist in the database.

The Spare Point Code Support feature must be enabled before the **pcst** and **npcst** parameters can be specified.

The **pcst** and **npcst** parameters cannot be specified with **c** for a blocked screen reference (**sr**).

The spare point code subtype prefix (**s-**) is not supported for ANSI point codes (parameters **ni**, **nc**, **ncm**) or for 24-bit ITU national point codes (parameters **msa**, **ssa**, **sp**). The **pcst** and **npcst** parameters cannot be specified for ANSI and ITU-N24 point codes.

If **zone=*** is specified, **area=*** and **id=*** must be specified.

If **zone=c** is specified, either the character **c** must also be specified for the **area** and **id** parameters or the **area** and **id** parameters must not be specified. If the **area** and **id** parameters are not specified when **zone=c** is specified, the **area** and **id** values default to the character **c** in the database.

Notes

When a blocked OPC screening reference is created, the first entry for a point code must be **c-c-c**, or **c** for the **npc** parameter. Subsequent entries must be specific point codes.

The character **c** is used in the blocked OPC screens to allow the screening process to continue for messages with point codes that do not match any point codes in the blocked OPC screens. When screening for a blocked OPC and the point code being screened does not match any of the point codes in the blocked OPC screens, the message is not rejected and the screening process continues. There must be an entry in the blocked OPC screens to allow the screening process to continue.

This entry consists of a screening reference, point code, **nsfi**, and **nsr**. The point code is **npc=c** or subfields equal to **c-c-c**. When the character **c** is specified, the **nsfi** and **nsr** parameters must be specified.

If the character **c** is specified for the parameters **ni-nc-ncm** or **zone-area-id** or **msa-ssa-sp**, the character **c** is the only value that can be specified for all three parameters. No other values can be used. For example, a point code **c-c-255** is not allowed. The point code must be **c-c-c**. The asterisk (*) value cannot be used with the character **c** (for example, a point code **c-c-*** is not allowed).

When the point code does not match any entries in the blocked OPC screens, the screening process is directed to the screening reference with the point code **c-c-c** or **npc=c**. The **nsfi** and **nsr** in this entry are examined to determine the next step in the screening process.

If the current **ni-nc-ncm** or **zone-area-id** or **msa-ssa-sp** is equal to **c-c-c** or **npc=c**, only the **nsfi** and **nsr** can be changed. Otherwise, only the blocked OPC can be changed.

A range of values is specified by separating the values that define the range by two ampersands (&&); for example, **:ni=025&&100** specifies all network indicators for ANSI point codes from **25** to **100**.

An asterisk cannot not be specified for a parameter value in this command unless an asterisk was specified for the parameter value in the original **ent-scr-blkopc** command.

If the screen set reaches 100% capacity (indicated by the "100% full" message), the system will allow subsequent entries. An error will occur, however, when downloading the screen set to the card. Screen sets should not exceed 100% capacity. Remove screen set entries until the capacity is below 100%.

The spare point code subtype prefix **s-** is supported only for ITU international and ITU national point codes. The **pcst** and **npcst** parameters indicate whether the specified point code has no subtype prefix or has the spare point code prefix.

Output

```
chg-scr-blkopc:sr=iec:ni=240:nc=010:ncm=010:nni=240:nnc=010:nncm=020
```

```
rlghncxa03w 04-01-07 11:43:04 EST EAGLE 31.3.0
CHG-SCR-BLKOPC: SCREEN SET AFFECTED - IEC 25% FULL
CHG-SCR-BLKOPC: MASP A - COMPLTD
```

```
;
```

Legend

CHG-SCR-BLKOPC—The command entered that caused this output. This is echoed to the printer as a reference.

SCREEN SET AFFECTED - IEC—Identifies the screen set that was affected by the command. The screen set name is provided.

25% FULL—Indicates the relative size of the screen set.

chg-scr-cdpa

Change Allowed Called Party Address

Use this command to change the attributes associated with a specific screening reference in the allowed called party address category. Attributes that can be changed are the point code, subsystem number, next screening function identifier, and next screening reference.

Keyword: chg-scr-cdpa

Related Commands: dlt-scr-cdpa, ent-scr-cdpa, rtrv-scr-cdpa

Command Class: Database Administration

Parameters

:sr= (mandatory)

Screening reference. This parameter specifies the point code's unique screening reference name.

Range: 1 alphabetic character followed by up to 3 alphanumeric characters

:ssn= (mandatory)

The subsystem number. An asterisk (*) indicates the full range of values from **1-255**.

Range: 1-255, *

:actname= (optional)

The name of the gateway screening stop action set. Stop actions must be administered using the **actname** parameter in conjunction with the gateway screening stop action table (see **chg-gws-actset** and **rtrv-gws-actset**).

Range: 1 alphabetic character followed by up to 5 alphanumeric characters.

none—Remove an existing gateway screening stop action set from a gateway screening rule.

:area= (optional)

The ITU international area. The area is specified in the point code. The format of the point code is *zone-area-id*. An asterisk (*) indicates the full range of values from **000-255**.

Range: 000-255, *

:id= (optional)

The ITU international ID. The parameter specifies the ID in the point code represented by format *zone-area-id*. An asterisk (*) indicates the full range of values from **0-7**.

Range: 0-7, *

:msa= (optional)

The 24-bit ITU-national main signaling area (*msa*) value. It specifies the main signaling area (*msa*) of the point code represented by *msa-ssa-spt*. An asterisk (*) indicates the full range of values from **000-255**.

Range: 000-255, *

:narea= (optional)

The new ITU-international area value. An asterisk (*) indicates the full range of values from **000-255**.

Range: **000-255, *, c**

Default: Current value

:nc= (optional)

The network cluster (*nc*) value. This parameter specifies one or more *nc* values for the network indicator (*ni*) and network cluster member (*ncm*) values specified in the **ni** and **ncm** parameters. It specifies the *nc* of the point code represented by *ni-nc-ncm*. A single value or a range of values can be specified. An asterisk (*) indicates the full range of values from **000-255**.

Range: **000-255, ***

:ncm= (optional)

The network cluster member (*ncm*) value. This parameter specifies one or more *ncm* values for the network indicator (*ni*) and network cluster (*nc*) values identified in the **ni** and **nc** parameters. It specifies the *ncm* of the point code represented by *ni-nc-ncm*. A single value or a range of values can be specified. An asterisk (*) indicates the full range of values from **000-255**.

Range: **0-255, ***

:ni= (optional)

The network indicator (*ni*) value. This parameter specifies one or more *ni* values for the network cluster (*nc*) and network cluster member (*ncm*) values identified in the **nc** and **ncm** parameters. It specifies the *ni* of the point code represented by *ni-nc-ncm*. A single value or a range of values can be specified. An asterisk (*) indicates the full range of values from **000-255**.

Range: **0-255, ***

:nid= (optional)

The new ITU-international ID value. An asterisk (*) indicates the full range of values from **0-7**.

Range: **0-7, ***

Default: Current value

:nmsa= (optional)

The new 24-bit ITU-national main signaling area (*nmsa*) value. It specifies the new main signaling area (*msa*) of the point code represented by *msa-ssa-spt*. An asterisk (*) indicates the full range of values from **000-255**.

Range: **000-255, ***

:nnc= (optional)

The new network cluster (*nnc*). This parameter specifies one or more *nnc* values for the screening reference specified in the **sr** parameter. It specifies the new network cluster (*nc*) of the point code represented by *ni-nc-ncm*. A single value or a range of values can be specified. An asterisk (*) indicates the full range of values from **000-255**.

Range: **000-255, ***

Default: Current value

:nncm= (optional)

The new network cluster member (*nncm*). This parameter specifies one or more *nncm* values for the screening reference specified in the **sr** parameter. It specifies the new network cluster member (*nncm*) of the point code represented by *ni-nc-nncm*. A single value or a range of values can be specified. An asterisk (*) indicates the full range of values from **0-255**.

Range: 0-255, *

Default: Current value

:nni= (optional)

The new network identifier (*nni*). This parameter specifies one or more *nni* values for the screening reference specified in the **sr** parameter. It specifies the new network indicator (*ni*) of the point code represented by *ni-nc-nncm*. A single value or a range of values can be specified. An asterisk (*) indicates the full range of values from **000-255**.

Range: 0-255, *

Default: Current value

:nnpc= (optional)

The new ITU-national point code. An asterisk (*) indicates the full range of values from **00000-16383**.

Range: 00000-16383, *

Default: Current value

NOTE: Gateway screening allows the ITU national point code to be displayed and entered in the database only as a single number. If you use multiple-part ITU national point codes, see “Converting ITU National Point Code Formats” in Appendix A for information on converting the point code format.

:npc= (optional)

The ITU national point code. An asterisk (*) indicates the full range of values from **00000-16383**.

Range: 00000-16383, *

:npcst= (optional)

New point code subtype. This parameter indicates whether the specified new ITU international or ITU national point code has no subtype prefix or has the spare point code prefix (s-).

Range: none, s

Default: none

:nscmgfid= (optional)

The new SCMG format ID. A single value or a range of values can be specified. An asterisk (*) indicates the full range of values from **1-255**.

Range: 1-255, *

Default: Current value

:nsfi= (optional)

This parameter specifies the next screening category that is used in the gateway screening process, or it indicates that the gateway screening process should stop.

Range: **aftpc, stop**

aftpc—Allowed affected point code is the next screening category.

stop—The gateway screening process ends and the message proceeds through normal routing.

Default: Current value

:nsp= (optional)

The new 24-bit ITU national signaling point (*nsp*). It specifies the new signaling point (*sp*) of the point code represented by *msa-ssa-sp*. An asterisk (*) indicates the full range of values from **000-255**.

Range: **000-255, ***

:nsr= (optional)

Next screening reference (*nsr*). The parameter indicates which screening reference in the specified screening category (**nsfi**) is to be used in the screening process. If **nsfi=stop**, the **nsr** parameter cannot be specified.

Range: 1 alphabetic character followed by up to 3 alphanumeric characters

Default: Current value

:nssa= (optional)

The new 24-bit ITU national sub signaling area (*nssa*). It specifies the new sub signaling area (*ssa*) of the point code represented by *msa-ssa-sp*. An asterisk (*) indicates the full range of values from **000-255**.

Range: **000-255, ***

:nssn= (optional)

The new subsystem number. An asterisk (*) indicates the full range of values from **000-255**.

Range: **000-255, ***

Default: Current value

:nzone= (optional)

The new ITU-international zone. The parameter specifies a new zone for the point code represented by *zone-area-id*. An asterisk (*) indicates the full range of values from **0-7**.

Range: **0-7, *, c**

Default: Current value

:scmgfid= (optional)

The SCCP management (SCMG) format ID, which consists of a one-octet field and uniquely defines the function and format of each SCMG message. A single value or a range of values can be specified. An asterisk (*) indicates the full range of values from **1-255**. The following SCCP message types are screened against the Allowed CDPA table and all others are passed: UDT, UDTS, XUDT, XUDTS.

Range: **1-255, ***

:pcst= (optional)

Ppoint code subtype. This parameter indicates whether the specified ITU international or ITU national point code has no subtype prefix or has the spare point code prefix (**s**).

Range: **none, s**

Default: **none**

:sp= (optional)

The 24-bit ITU national signaling point (*sp*). This parameter specifies the signaling point (*sp*) in the point code represented by *msa-ssa-sp*. An asterisk (*) indicates the full range of values from **000-255**.

Range: **000-255, ***

:ssa= (optional)

The 24-bit ITU national sub signaling area (*ssa*). This parameter specifies the sub signaling area (*ssa*) in the point code represented by the format *msa-ssa-sp*. An asterisk (*) indicates the full range of values from **000-255**.

Range: **000-255, ***

:zone= (optional)

The ITU international zone. The parameter specifies the zone in the point code represented by format *zone-area-id*. An asterisk (*) indicates the full range of values from **0-7**.

Range: **0-7, ***

Example

```
chg-scr-cdpa:sr=cdp1:ni=5:nc=5:ncm=5:ssn=1:scmgfid=4:nsfi=stop:nni=6:nncm=3
:nssn=*
```

```
chg-scr-cdpa:sr=cdp1:ni=c:nc=c:ncm=c:ssn=1:scmgfid=3:nsfi=stop:actname=copy
```

```
chg-scr-cgpa:sr=cgpa:zone=1:area=2:id=3:ssn=1:sccpmt=9:ri=*:nsfi=stop:pcst=s
:npct=none
```

Dependencies



CAUTION: Even though gateway screening is in the screen test mode, as defined by the parameters **gwsa=off** and **gws=on**, the gateway screening action in the stop action set specified by the **actname** parameter of the screen set *will* be performed at the end of the screening process.

A complete point code must be specified, and must be one and only one of the four point code parameter combinations: **ni-nc-ncm**; **zone-area-id**; **msa-ssa-sp**; or **npc**, except in the special case of entering **c** for "continue".

ANSI point code value **000-000-000** and ITU-International point code value **0-000-0** are not allowed.

At least one optional parameter must be specified.

The CDPA point code, **scmgfid**, and **ssn** to be changed must already exist in the CDPA entity set.

The new CDPA point code, **scmgfid**, and **ssn** cannot already exist in the CDPA entity set.

If the **actname** parameter is specified, the **nsfi-stop** parameter must be specified.

If the **actname** parameter is specified, the **nsr** parameter cannot be specified.

The value of the **actname** parameter must already be defined in the Gateway Screening Stop Action table with the **chg-gws-actset** command. These values are shown in the *ACT NAME* field of the **rtrv-gws-actset** command output.

If the **nc** parameter is specified as a range, the **ncm** parameter must be specified as an asterisk or as the full range **000-255**

If the **nc** parameter is specified as a single value or a range, a single value must be specified for the **ni** parameter.

If the **nc** parameter is specified as an asterisk (**nc=***), the **ncm** parameter must be specified as an asterisk or as the full range **000-255**.

If the **ncm** parameter is specified as a single value, or a range other than the full range of **000-255**, the **ni** and the **nc** parameters must be specified with a single value.

If the **ni** parameter is specified as an asterisk (**ni=***) or as a range, the **nc** and **ncm** parameters must be specified as an asterisk or as the full range **000-255**.

If the **nnc** parameter is specified as a range, the **nncm** parameter must be specified as an asterisk or as the full range **000-255**

If the **nnc** parameter is specified as a single value or a range, a single value must be specified for the **nni** parameter.

If the **nnc** parameter is specified as an asterisk (**nnc=***), the **nnm** parameter must be specified as an asterisk or as the full range **000-255**.

If the **nncm** parameter is specified as a single value, or a range other than the full range of **000-255**, the **nni** and the **nnc** parameters must be specified with a single value.

If the **nni** parameter is specified as an asterisk (**nni=***) or as a range, the **nnc** and **nncm** parameters must be specified as an asterisk or as the full range **000-255**.

If the **nsfi=afpc** parameter is specified, the **ssn=1** parameter must be specified.

If the **nsfi=stop** parameter is specified, the **nsr** parameter cannot be specified.

If the **nsfi** parameter has a value other than **stop**, the **nsr** parameter must be specified.

The next screening function identifier (**nsfi**) and the next screening reference (**nsr**) must point to an existing screen, or the **nsfi** must be equal to **stop** and the **nsr** must not be specified.

The specified screening reference (**sr**) must already exist in the database.

The Spare Point Code Support feature must be enabled before the **pcst** parameter can be specified.

The spare point code subtype prefix (**s-**) is not supported for ANSI point codes (parameters **ni**, **nc**, **ncm**) or for 24-bit ITU national point codes (parameters **msa**, **ssa**, **sp**). The **pcst** and **npcst** parameters cannot be specified for ANSI and ITU-N24 point codes.

If the **ssn** parameter is a value other than **1**, the **scmgfid** parameter cannot be specified.

If the **ssn=1** parameter is specified, the **scmgfid** parameter must be specified.

Notes

A range of values is specified by separating the values that define the range by two ampersands (&&); for example, **:ni=025&&100** specifies all network indicators for ANSI point codes from **25** to **100**.

If the screen set reaches 100% capacity (indicated by the 100% Full message), the system will allow subsequent entries. An error will occur, however, when downloading the screen set to a LIM. Screen sets should not exceed 100% capacity. Remove screen set entries until the capacity is below 100%.

An asterisk can be specified for a parameter value in the **chg-scr-cdpa** and **dlt-scr-cdpa** commands *only* if that parameter value was specified as an asterisk in the **ent-scr-cdpa** command to define the parameter value.

The Spare Point Code Support feature must be enabled before the **pcst** parameter can be specified.

The spare point code subtype prefix **s-** is supported only for ITU international and ITU national point codes. The **pcst** parameter indicates whether the specified point code has no subtype prefix or has the spare point code prefix.

Output

```
chg-scr-cdpa:sr=cdp1:ni=5:nc=5:ncm=5:ssn=1:scmgfid=4:nsfi=stop:nni=6:nncm=3
:nssn=*
```

```
rlghncxa03w 04-01-14 15:35:30 EST EAGLE 31.3.0
CHG-SCR-CDPA: MASP A - COMPLTD
```

```
;
```

chg-scr-cgpa

Change Allowed Calling Party Address

Use this command to change the attributes associated with a specific screening reference in the allowed calling party address category. Attributes that can be changed are the point code, subsystem number, routing indicator, next screening function identifier, and next screening reference.

Keyword: **chg-scr-cgpa**

Related Commands: **dlt-scr-cgpa**, **ent-scr-cgpa**, **rtrv-scr-cgpa**

Command Class: Database Administration

Parameters

† At least one of these parameters must be specified.

:ri= (mandatory)

Routing indicator that provides routing instructions to the receiving signaling point. In gateway screening, messages may be screened based on the value of the routing indicator.

Range: **dpc**, **gt**, *

dpc—Allow a called party address with a routing indicator value of “DPC/SSN.”

gt—Screening stops and gateway screening is bypassed as a forced pass.

*—Allow both routing indicator values.

:sccpmt= (mandatory)

The SCCP message type. A single value or a range of values can be specified. An asterisk (*) indicates the full range of values.

Range: 9, 10, 17, 18, *

9—UDT

10—UDTS

17—XUDT

18—XUDTS

:sr= (mandatory)

Screening reference. This parameter specifies the point code's unique screening reference name.

Range: 1 alphabetic character followed by up to 3 alphanumeric characters

:ssn= (mandatory)

The subsystem number. An asterisk (*) indicates the full range of values from 1-255.

Range: 1-255, *

:actname= (optional)

The name of the gateway screening stop action set. Stop actions must be administered using the **actname** parameter in conjunction with the gateway screening stop action table (see **chg-gws-actset** and **rtrv-gws-actset**).

Range: 1 alphabetic character followed by up to 5 alphanumeric characters.

none—remove an existing gateway screening stop action set from a gateway screening rule.

:area= (optional)

The ITU international area. The area is specified in the point code. The format of the point code is *zone-area-id*. An asterisk (*) indicates the full range of values from 000-255.

Range: 000-255, *

:id= (optional)

The ITU international ID. The parameter specifies the ID in the point code represented by format *zone-area-id*. An asterisk (*) indicates the full range of values from 0-7.

Range: 0-7, *

:msa= (optional)

The 24-bit ITU-national main signaling area (*msa*) value. It specifies the main signaling area (*msa*) of the point code represented by *msa-ssa-spt*. An asterisk (*) indicates the full range of values from 000-255.

Range: 000-255, *

:narea= (optional)

The new ITU-international area value. An asterisk (*) indicates the full range of values from 000-255.

Range: 000-255, *, c

Default: Current value

:nc= (optional)

The network cluster (*nc*) value. This parameter specifies one or more *nc* values for the network indicator (*ni*) and network cluster member (*ncm*) values specified in the **ni** and **ncm** parameters. It specifies the *nc* of the point code represented by *ni-nc-ncm*. A single value or a range of values can be specified. An asterisk (*) indicates the full range of values from **000-255**.

Range: **000-255, ***

:ncm= (optional)

The network cluster member (*ncm*) value. This parameter specifies one or more *ncm* values for the network indicator (*ni*) and network cluster (*nc*) values identified in the **ni** and **nc** parameters. It specifies the *ncm* of the point code represented by *ni-nc-ncm*. A single value or a range of values can be specified. An asterisk (*) indicates the full range of values from **000-255**.

Range: **0-255, ***

:ni= (optional)

The network indicator (*ni*) value. This parameter specifies one or more *ni* values for the network cluster (*nc*) and network cluster member (*ncm*) values identified in the **nc** and **ncm** parameters. It specifies the *ni* of the point code represented by *ni-nc-ncm*. A single value or a range of values can be specified. An asterisk (*) indicates the full range of values from **000-255**.

Range: **0-255, ***

:nid= (optional)

The new ITU-international ID value. An asterisk (*) indicates the full range of values from **0-7**.

Range: **0-7, ***

Default: Current value

:nmsa= (optional)

The new 24-bit ITU-national main signaling area (*nmsa*) value. It specifies the new main signaling area (*msa*) of the point code represented by *msa-ssa-spt*. An asterisk (*) indicates the full range of values from **000-255**.

Range: **000-255, ***

:nnc= (optional)

The new network cluster (*nnc*). This parameter specifies one or more *nnc* values for the screening reference specified in the **sr** parameter. It specifies the new network cluster (*nc*) of the point code represented by *ni-nc-ncm*. A single value or a range of values can be specified. An asterisk (*) indicates the full range of values from **000-255**.

Range: **000-255, ***

Default: Current value

:nncm= (optional)

The new network cluster member (*nncm*). This parameter specifies one or more *ncm* values for the screening reference specified in the **sr** parameter. It specifies the new network cluster member (*ncm*) of the point code represented by *ni-nc-ncm*. A single value or a range of values can be specified. An asterisk (*) indicates the full range of values from **0-255**.

Range: **0-255, ***

Default: Current value

:nni= (optional)

The new network identifier (*nni*). This parameter specifies one or more *nni* values for the screening reference specified in the **sr** parameter. It specifies the new network indicator (*ni*) of the point code represented by *ni-nc-ncm*. A single value or a range of values can be specified. An asterisk (*) indicates the full range of values from **000–255**.

Range: 0–255, *

Default: Current value

:nnpc= (optional)

The new ITU-national point code. An asterisk (*) indicates the full range of values from **00000–16383**.

Range: 00000–16383, *

Default: Current value

NOTE: Gateway screening allows the ITU national point code to be displayed and entered in the database only as a single number. If you use multiple-part ITU national point codes, see “Converting ITU National Point Code Formats” in Appendix A for information on converting the point code format.

:npc= (optional)

The ITU national point code. An asterisk (*) indicates the full range of values from **00000–16383**.

Range: 00000–16383, *

:npcst= (optional)

New point code subtype. This parameter indicates whether the specified new ITU international or ITU national point code has no subtype prefix or has the spare point code prefix (s-).

Range: none, s

Default: none

:nri= (optional)

New routing indicator that provides routing instructions to the receiving signaling point. In gateway screening, messages may be screened based on the value of the routing indicator. An asterisk (*) indicates that both routing indicator values (**gt** and **dpc**) will be accepted in the gateway screening process.

Range: dpc, gt, *

dpc—Allow a called party address with a routing indicator value of “DPC/SSN.”

gt—Screening stops and gateway screening is bypassed as a forced pass.

Default: Current value

:nscpmt= (optional)

New SCCP message type. A single value or a range of values can be specified. An asterisk (*) indicates the full range of values.

Range: 9, 10, 17, 18, *

Default: Current value

:nsfi= (optional)†

This parameter specifies the next screening category that is used in the gateway screening process, or it indicates that the gateway screening process should stop.

Range: **cdpa, stop, tt**

cdpa—Allowed called party address is the next screening category.

stop—The gateway screening process ends and the message proceeds through normal routing.

tt—Allowed translation type is the next screening category.

Default: Current value

:nsp= (optional)

The new 24-bit ITU national signaling point (*nsp*). It specifies the new signaling point *sp* of the point code represented by *msa-ssa-sp*. An asterisk (*) indicates the full range of values from **000-255**.

Range: **000-255, ***

:nsr= (optional)

Next screening reference (*nsr*). The parameter indicates which screening reference in the specified screening category (**nsfi**) is to be used in the screening process. If **nsfi=stop**, the **nsr** parameter cannot be specified.

Range: 1 alphabetic character followed by up to 3 alphanumeric characters

Default: Current value

:nssa= (optional)

The new 24-bit ITU national sub signaling area (*nssa*). It specifies the new sub signaling area (*ssa*) of the point code represented by *msa-ssa-sp*. An asterisk (*) indicates the full range of values from **000-255**.

Range: **000-255, ***

:nssn= (optional)

The new subsystem number. An asterisk (*) indicates the full range of values from **000-255**.

Range: **000-255, ***

Default: Current value

:nzone= (optional)

The new ITU-international zone. The parameter specifies a new zone for the point code represented by *zone-area-id*. An asterisk (*) indicates the full range of values from **0-7**.

Range: **0-7, *, c**

Default: Current value

:pcst= (optional)

Point code subtype. This parameter indicates whether the specified ITU international or ITU national point code has no subtype prefix or has the spare point code prefix (*s-*).

Range: **none, s**

Default: **none**

:sp= (optional)

The 24-bit ITU national signaling point (*sp*). This parameter specifies the signaling point (*sp*) in the point code represented by *msa-ssa-sp*. An asterisk (*) indicates the full range of values from **000-255**.

Range: 000-255, *

:ssa= (optional)

The 24-bit ITU national sub signaling area (*ssa*). This parameter specifies the sub signaling area (*ssa*) in the point code represented by the format *msa-ssa-sp*. An asterisk (*) indicates the full range of values from 000-255.

Range: 000-255, *

:zone= (optional)

The ITU international zone. The parameter specifies the zone in the point code represented by format *zone-area-id*. An asterisk (*) indicates the full range of values from 0-7.

Range: 0-7, *

Example

```
chg-scr-cgpa:sr=iec:ni=240:nc=010:ncm=010:ssn=3:ri=dpc
```

```
chg-scr-cgpa:sr=iec:ni=240:nc=010:ncm=010:ssn=3:ri=dpc:nsfi=stop:actname=copy
```

```
chg-scr-cgpa:sr=cdp1:ni=5:nc=5:ncm=5:ssn=1:ri=dpc:sccpmt=009:nsfi=sdpa:nsr=cdp1
```

```
chg-scr-cgpa:sr=cgpa:zone=1:area=2:id=3:ssn=1:sccpmt=9:ri=*:nsfi=stop:pcst=s
:npct=none
```

Dependencies



CAUTION: Even though gateway screening is in the screen test mode, as defined by the parameters *gwsa=off* and *gws=on*, the gateway screening action in the stop action set specified by the *actname* parameter of the screen set *will* be performed at the end of the screening process.

A complete point code must be specified, and must be one, and only one of the four point code parameter combinations: **ni-nc-ncm**; **zone-area-id**; **msa-ssa-sp**; or **npc**.

ANSI point code value **000-000-000** and ITU-International point code value **0-000-0** are not allowed.

At least one optional parameter must be specified.

The CGPA point code or range of point codes, **ri**, **sccpmt**, and subsystem number or numbers to be changed must exist in the CGPA entity set.

The new CGPA point code and subsystem number cannot already exist in the CGPA entity set.

If the **actname** parameter is specified, the **nsfi-stop** parameter must be specified.

If the **actname** parameter is specified, the **nsr** parameter cannot be specified.

The value of the **actname** parameter must already be defined in the Gateway Screening Stop Action table with the **chg-gws-actset** command. These values are shown in the **ACT NAME** field of the **rtrv-gws-actset** command output.

The next screening function identifier (**nsfi**) and the next screening reference (**nsr**) must point to an existing screen, or the **nsfi** must be equal to **stop** and the **nsr** must not be specified.

If the **nc** parameter is specified as a range, the **ncm** parameter must be specified as an asterisk or as the full range **000-255**

If the **nc** parameter is specified as a single value or a range, a single value must be specified for the **ni** parameter.

If the **nc** parameter is specified as an asterisk (**nc=***), the **ncm** parameter must be specified as an asterisk or as the full range **000-255**.

If the **ncm** parameter is specified as a single value, or a range other than the full range of **000-255**, the **ni** and the **nc** parameters must be specified with a single value.

If the **ni** parameter is specified as an asterisk (**ni=***) or as a range, the **nc** and **ncm** parameters must be specified as an asterisk or as the full range **000-255**.

If the **nnc** parameter is specified as a range, the **nncm** parameter must be specified as an asterisk or as the full range **000-255**.

If the **nnc** parameter is specified as a single value or a range, a single value must be specified for the **nni** parameter.

If the **nnc** parameter is specified as an asterisk (**nnc=***), the **nncm** parameter must be specified as an asterisk or as the full range **000-255**.

If the **nncm** parameter is specified as a single value, or a range other than the full range of **000-255**, the **nni** and the **nnc** parameters must be specified with a single value.

If the **nni** parameter is specified as an asterisk (**nni=***) or as a range, the **nnc** and **nncm** parameters must be specified as an asterisk or as the full range **000-255**.

The **nsfi=cdpa** parameter can be specified only when the **ri=*** or the **ri=dpc** parameter is specified.

The **nsfi=tt** parameter can be specified only when the **ri=*** or the **ri=gt** parameter is specified.

If the **nsfi=stop** parameter is specified, the **nsr** parameter cannot be specified.

If the **nsfi** parameter has a value other than **stop**, the **nsr** parameter must be specified.

The specified screening reference (**sr**) must already exist in the database.

The Spare Point Code Support feature must be enabled before the **pcst** parameter can be specified.

The spare point code subtype prefix (**s-**) is not supported for ANSI point codes (parameters **ni**, **nc**, **ncm**) or for 24-bit ITU national point codes (parameters **msa**, **ssa**, **sp**). The **pcst** and **npcst** parameters cannot be specified for ANSI and ITU-N24 point codes.

Notes

A range of values is specified by separating the values that define the range by two ampersands (**&&**); for example, **:ni=025&&100** specifies all network indicators for ANSI point codes from **25** to **100**.

If the screen set reaches 100% capacity (indicated by the 100% Full message), the system will allow subsequent entries. An error will occur, however, when downloading the screen set to a LIM. Screen sets should not exceed 100% capacity. Remove screen set entries until the capacity is below 100%.

An asterisk can be specified for a parameter value in the **chg-scr-cgpa** and **dlt-scr-cgpa** commands *only* if that parameter value was specified as an asterisk in the **ent-scr-cgpa** command to define the parameter value.

The spare point code subtype prefix **s-** is supported only for ITU international and ITU national point codes. The **pcst** parameter indicates whether the specified point code has no subtype prefix or has the spare point code prefix.

Output

chg-scr-cgpa:sr=iec:ni=240:nc=010:ncm=010:ssn=3:ri=dpc

```
rlghncxa03w 04-01-07 11:43:04 EST EAGLE 31.3.0
CHG-SCR-CGPA: SCREEN SET AFFECTED - IEC 25% FULL
CHG-SCR-CGPA: MASP A - COMPLTD
```

;

Legend

CHG-SCR-CGPA—The command entered that caused this output. This is echoed to the printer as a reference.

SCREEN SET AFFECTED - IEC—Identifies the screen set that was affected by the command. The screen set name is provided.

25% FULL—Indicates the relative size of the screen set.

chg-scr-destfld

Change an Allowed DESTFLD

Use this command to change the attributes of a specific screening reference in the allowed affected destination field (DESTFLD) category. Attributes that can be changed are the allowed affected destination point codes.

Keyword: **chg-scr-destfld**

Related Commands: **dlt-scr-destfld**, **ent-scr-destfld**, **rtrv-scr-destfld**

Command Class: Database Administration

Parameters

:sr= (mandatory)

Screening reference. This parameter specifies the point code's unique screening reference name.

Range: 1 alphabetic character followed by up to 3 alphanumeric characters

:actname= (optional)

The name of the gateway screening stop action set. Stop actions must be administered using the **actname** parameter in conjunction with the gateway screening stop action table (see **chg-gws-actset** and **rtrv-gws-actset**).

Range: 1 alphabetic character followed by up to 5 alphanumeric characters.

none—remove an existing gateway screening stop action set from a gateway screening rule.

:area= (optional)

The ITU international area. The area is specified in the point code. The format of the point code is *zone-area-id*. An asterisk (*) indicates the full range of values from **000-255**.

Range: 000-255, *

:id= (optional)

The ITU international ID. The parameter specifies the ID in the point code represented by format *zone-area-id*. An asterisk (*) indicates the full range of values from 0-7.

Range: 0-7, *

:msa= (optional)

The 24-bit ITU-national main signaling area (*msa*) value. It specifies the main signaling area (*msa*) of the point code represented by *msa-ssa-sp*. An asterisk (*) indicates the full range of values from 000-255.

Range: 000-255, *

:narea= (optional)

The new ITU-international area value. An asterisk (*) indicates the full range of values from 000-255.

Range: 000-255, *, c

Default: Current value

:nc= (optional)

The network cluster (*nc*) value. This parameter specifies one or more *nc* values for the network indicator (*ni*) and network cluster member (*ncm*) values specified in the **ni** and **ncm** parameters. It specifies the *nc* of the point code represented by *ni-nc-ncm*. A single value or a range of values can be specified. An asterisk (*) indicates the full range of values from 000-255.

Range: 000-255, *

:ncm= (optional)

The network cluster member (*ncm*) value. This parameter specifies one or more *ncm* values for the network indicator (*ni*) and network cluster (*nc*) values identified in the **ni** and **nc** parameters. It specifies the *ncm* of the point code represented by *ni-nc-ncm*. A single value or a range of values can be specified. An asterisk (*) indicates the full range of values from 000-255.

Range: 0-255, *

:ni= (optional)

The network indicator (*ni*) value. This parameter specifies one or more *ni* values for the network cluster (*nc*) and network cluster member (*ncm*) values identified in the **nc** and **ncm** parameters. It specifies the *ni* of the point code represented by *ni-nc-ncm*. A single value or a range of values can be specified. An asterisk (*) indicates the full range of values from 000-255.

Range: 0-255, *

:nid= (optional)

The new ITU-international ID value. An asterisk (*) indicates the full range of values from 0-7.

Range: 0-7, *

Default: Current value

:nmsa= (optional)

The new 24-bit ITU-national main signaling area (*nmsa*) value. It specifies the new main signaling area (*msa*) of the point code represented by *msa-ssa-sp*. An asterisk (*) indicates the full range of values from 000-255.

Range: 000–255, *

:nnc= (optional)

The new network cluster (*nnc*). This parameter specifies one or more *nnc* values for the screening reference specified in the **sr** parameter. It specifies the new network cluster (*nc*) of the point code represented by *ni-nc-ncm*. A single value or a range of values can be specified. An asterisk (*) indicates the full range of values from 000–255.

Range: 000–255, *

Default: Current value

:nncm= (optional)

The new network cluster member (*nncm*). This parameter specifies one or more *ncm* values for the screening reference specified in the **sr** parameter. It specifies the new network cluster member (*ncm*) of the point code represented by *ni-nc-ncm*. A single value or a range of values can be specified. An asterisk (*) indicates the full range of values from 0–255.

Range: 0–255, *

Default: Current value

:nni= (optional)

The new network identifier (*nni*). This parameter specifies one or more *nni* values for the screening reference specified in the **sr** parameter. It specifies the new network indicator (*ni*) of the point code represented by *ni-nc-ncm*. A single value or a range of values can be specified. An asterisk (*) indicates the full range of values from 000–255.

Range: 0–255, *

Default: Current value

:npc= (optional)

The new ITU-national point code. An asterisk (*) indicates the full range of values from 00000–16383.

Range: 00000–16383, *

Default: Current value

NOTE: Gateway screening allows the ITU national point code to be displayed and entered in the database only as a single number. If you use multiple-part ITU national point codes, see “Converting ITU National Point Code Formats” in Appendix A for information on converting the point code format.

:npc= (optional)

The ITU national point code. An asterisk (*) indicates the full range of values from 00000–16383.

Range: 00000–16383, *

:npcst= (optional)

New point code subtype. This parameter indicates whether the specified new ITU international or ITU national point code has no subtype prefix or has the spare point code prefix (s-).

Range: none, s

Default: none

:nsfi= (optional)

This parameter specifies the next screening category that is used in the gateway screening process. If specified, the parameter value must be **stop**.

Range: **stop**
stop—The gateway screening process ends and the message proceeds through normal routing.

Default: Current value

:nsp= (optional)

The new 24-bit ITU national signaling point (*nsp*). It specifies the new signaling point (*sp*) of the point code represented by *msa-ssa-sp*. An asterisk (*) indicates the full range of values from **000-255**.

Range: **000-255, ***

:nssa= (optional)

The new 24-bit ITU national sub signaling area (*nssa*). It specifies the new sub signaling area (*ssa*) of the point code represented by *msa-ssa-sp*. An asterisk (*) indicates the full range of values from **000-255**.

Range: **000-255, ***

:nzone= (optional)

The new ITU-international zone. The parameter specifies a new zone for the point code represented by *zone-area-id*. An asterisk (*) indicates the full range of values from **0-7**.

Range: **0-7, *, c**

Default: Current value

:pcst= (optional)

Point code subtype. This parameter indicates whether the specified ITU international or ITU national point code has no subtype prefix or has the spare point code prefix (*s*).

Range: **none, s**

Default: **none**

:sp= (optional)

The 24-bit ITU national signaling point (*sp*). This parameter specifies the signaling point (*sp*) in the point code represented by *msa-ssa-sp*. An asterisk (*) indicates the full range of values from **000-255**.

Range: **000-255, ***

:ssa= (optional)

The 24-bit ITU national sub signaling area (*ssa*). This parameter specifies the sub signaling area (*ssa*) in the point code represented by the format *msa-ssa-sp*. An asterisk (*) indicates the full range of values from **000-255**.

Range: **000-255, ***

:zone= (optional)

The ITU international zone. The parameter specifies the zone in the point code represented by format *zone-area-id*. An asterisk (*) indicates the full range of values from **0-7**.

Range: **0-7, ***

Example

```
chg-scr-destfld:sr=iecc:ni=240:nc=010:ncm=019&&020:nncm=021
```

```
chg-scr-destfld:sr=iecc:ni=240:nc=010:ncm=019&&020:nsfi=stop:actname=none
```

```
chg-scr-destfld:sr=dst1:zone=1:area=2:id=3:nsfi=stop:pcst=s:npct=none
```

Dependencies



CAUTION: Even though gateway screening is in the screen test mode, as defined by the parameters **gwsa=off** and **gws=on**, the gateway screening action in the stop action set specified by the **actname** parameter of the screen set *will* be performed at the end of the screening process.

A complete point code must be specified, and must be one, and only one of the four point code parameter combinations: **ni-nc-ncm**; **zone-area-id**; **msa-ssa-sp**; or **npc**.

A new point code entry must be specified by one, and only one of the four point code parameter combinations: **nni-nnc-nncm**, **nzone-narea-nid**, **nmsa-nssa-nsp**, or **nnpc**. If the new point code entry is a different point code type than the existing point code entry, all subfields of the new point code type must be specified.

ANSI point code value **000-000-000** and ITU-International point code value **0-000-0** are not allowed.

At least one optional parameter must be specified.

The new DESTFLD defined by **ni-nc-ncm**, **zone-area-id**, **msa-ssa-sp**, or the **npc** parameter must not already exist in the screening reference.

If the **actname** parameter is specified, the **nsfi-stop** parameter must be specified.

If the **actname** parameter is specified, the **nsr** parameter cannot be specified.

The value of the **actname** parameter must already be defined in the Gateway Screening Stop Action table with the **chg-gws-actset** command. These values are shown in the *ACT NAME* field of the **rtrv-gws-actset** command output.

If **zone=*** is specified, **area=*** and **id=*** must be specified.

If **area=*** is specified, **id=*** must be specified.

If **msa=*** is specified, **ssa=*** and **sp=*** must be specified.

If **ssa=*** is specified, **sp=*** must be specified.

The **nsr** parameter cannot be specified in this command because **nsfi=stop** must be specified.

If the **nc** parameter is specified as a range, the **ncm** parameter must be specified as an asterisk or as the full range **000-255**.

If the **nc** parameter is specified as a single value or a range, a single value must be specified for the **ni** parameter.

If the **nc** parameter is specified as an asterisk (**nc=***), the **ncm** parameter must be specified as an asterisk or as the full range **000-255**.

If the **ncm** parameter is specified as a single value, or a range other than the full range of **000-255**, the **ni** and the **nc** parameters must be specified with a single value.

If the **ni** parameter is specified as an asterisk (**ni=***) or as a range, the **nc** and **ncm** parameters must be specified as an asterisk or as the full range **000-255**.

If the **nnc** parameter is specified as a range, the **nncm** parameter must be specified as an asterisk or as the full range **000-255**.

If the **nnc** parameter is specified as a single value or a range, a single value must be specified for the **nni** parameter.

If the **nnc** parameter is specified as an asterisk (**nnc=***), the **nnm** parameter must be specified as an asterisk or as the full range **000-255**.

If the **nncm** parameter is specified as a single value, or a range other than the full range of **000-255**, the **nni** and the **nnc** parameters must be specified with a single value.

If the **nni** parameter is specified as an asterisk (**nni=***) or as a range, the **nnc** and **nncm** parameters must be specified as an asterisk or as the full range **000-255**.

The **nsfi=stop** parameter must be specified in the command

The entry specified by **ni-nc-ncm**, **zone-area-id**, **msa-ssa-sp**, or the **npc** parameter must already exist in the screening reference.

The specified screening reference (**sr**) must already exist in the database.

The Spare Point Code Support feature must be enabled before the **pcst** parameter can be specified.

The spare point code subtype prefix (**s-**) is not supported for ANSI point codes (parameters **ni**, **nc**, **ncm**) or for 24-bit ITU national point codes (parameters **msa**, **ssa**, **sp**). The **pcst** and **npcst** parameters cannot be specified for ANSI and ITU-N24 point codes.

Notes

A range of values is specified by separating the values that define the range by two ampersands (&&); for example, **:ni=025&&100** specifies all network indicators for ANSI point codes from **25** to **100**.

An asterisk can be specified for a parameter value in the **chg-scr-destfld** and **dlt-scr-destfld** commands *only* if that parameter value was specified as an asterisk in the **ent-scr-destfld** command to define the parameter value.

The spare point code subtype prefix **s-** is supported only for ITU international and ITU national point codes. The **pcst** and **npcst** parameters indicate whether the specified point code has no subtype prefix or has the spare point code prefix.

Output

```
chg-scr-destfld:sr=iec:ni=240:nc=010:ncm=019&&020:nncm=021
```

```
rlghncxa03w 04-01-13 11:49:47 EST EAGLE 31.3.0
CHG-SCR-DESTFLD: SCREEN SET AFFECTED - SS01 25% FULL
CHG-SCR-DESTFLD: MASP A - COMPLTD
```

```
;
```

chg-scr-dpc

Change Allowed DPC

Use this command to change the attributes of a specific screening reference in the allowed DPC category. Attributes that may be changed are the point code, next screening function identifier, and the next screening reference.

Keyword: **chg-scr-dpc**

Related Commands: **dlt-scr-dpc**, **ent-scr-dpc**, **rtrv-scr-dpc**

Command Class: Database Administration

Parameters

† At least one of these parameters must be specified.

:sr= (mandatory)

Screening reference. This parameter specifies the point code's unique screening reference name.

Range: 1 alphabetic character followed by up to 3 alphanumeric characters

:actname= (optional)

The name of the gateway screening stop action set. Stop actions must be administered using the **actname** parameter in conjunction with the gateway screening stop action table (see **chg-gws-actset** and **rtrv-gws-actset**).

Range: 1 alphabetic character followed by up to 5 alphanumeric characters.

none—remove an existing gateway screening stop action set from a gateway screening rule.

:area= (optional)

The ITU international area. The area is specified in the point code. The format of the point code is *zone-area-id*. An asterisk (*) indicates the full range of values from **000-255**.

Range: **000-255, ***

:id= (optional)

The ITU international ID. The parameter specifies the ID in the point code represented by format *zone-area-id*. An asterisk (*) indicates the full range of values from **0-7**.

Range: **0-7, ***

:msa= (optional)

The 24-bit ITU-national main signaling area (*msa*) value. It specifies the main signaling area (*msa*) of the point code represented by *msa-ssa-spt*. An asterisk (*) indicates the full range of values from **000-255**.

Range: **000-255, ***

:narea= (optional)

The new ITU-international area value. An asterisk (*) indicates the full range of values from **000-255**.

Range: **000-255, *, c**

Default: Current value

:nc= (optional)

The network cluster (*nc*) value. This parameter specifies one or more *nc* values for the network indicator (*ni*) and network cluster member (*ncm*) values specified in the **ni** and **ncm** parameters. It specifies the *nc* of the point code represented by *ni-nc-ncm*. A single value or a range of values can be specified. An asterisk (*) indicates the full range of values from **000-255**.

Range: **000-255, ***

:ncm= (optional)

The network cluster member (*ncm*) value. This parameter specifies one or more *ncm* values for the network indicator (*ni*) and network cluster (*nc*) values identified in the **ni** and **nc** parameters. It specifies the *ncm* of the point code represented by *ni-nc-ncm*. A single value or a range of values can be specified. An asterisk (*) indicates the full range of values from **000-255**.

Range: 0–255, *

.ni= (optional)

The network indicator (*ni*) value. This parameter specifies one or more *ni* values for the network cluster (*nc*) and network cluster member (*ncm*) values identified in the **nc** and **ncm** parameters. It specifies the *ni* of the point code represented by *ni-nc-ncm*. A single value or a range of values can be specified. An asterisk (*) indicates the full range of values from **000–255**.

Range: 0–255, *

.nid= (optional)

The new ITU-international ID value. An asterisk (*) indicates the full range of values from **0–7**.

Range: 0–7, *

Default: Current value

.nmsa= (optional)

The new 24-bit ITU-national main signaling area (*nmsa*) value. It specifies the new main signaling area (*msa*) of the point code represented by *msa-ssa-sp*. An asterisk (*) indicates the full range of values from **000–255**.

Range: 000–255, *

.nnc= (optional)

The new network cluster (*nnc*). This parameter specifies one or more *nnc* values for the screening reference specified in the **sr** parameter. It specifies the new network cluster (*nc*) of the point code represented by *ni-nc-ncm*. A single value or a range of values can be specified. An asterisk (*) indicates the full range of values from **000–255**.

Range: 000–255, *

Default: Current value

.nncm= (optional)

The new network cluster member (*nncm*). This parameter specifies one or more *ncm* values for the screening reference specified in the **sr** parameter. It specifies the new network cluster member (*ncm*) of the point code represented by *ni-nc-ncm*. A single value or a range of values can be specified. An asterisk (*) indicates the full range of values from **0–255**.

Range: 0–255, *

Default: Current value

.nni= (optional)

The new network identifier (*nni*). This parameter specifies one or more *nni* values for the screening reference specified in the **sr** parameter. It specifies the new network indicator (*ni*) of the point code represented by *ni-nc-ncm*. A single value or a range of values can be specified. An asterisk (*) indicates the full range of values from **000–255**.

Range: 0–255, *

Default: Current value

.nnp= (optional)

The new ITU-national point code. An asterisk (*) indicates the full range of values from **00000–16383**.

Range: 00000–16383, *

Default: Current value

NOTE: Gateway screening allows the ITU national point code to be displayed and entered in the database only as a single number. If you use multiple-part ITU national point codes, see “Converting ITU National Point Code Formats” in Appendix A for information on converting the point code format.

:npc= (optional)

The ITU national point code. An asterisk (*) indicates the full range of values from **00000–16383**.

Range: **00000–16383, ***

:npcst= (optional)

New point code subtype. This parameter indicates whether the specified new ITU international or ITU national point code has no subtype prefix or has the spare point code prefix (s-).

Range: **none, s**

Default: **none**

:nsfi= (optional)†

This parameter specifies the next screening category that is used in the gateway screening process, or it indicates that the gateway screening process should stop.

Range: **blkdpc, cgpa, destfld, isup, stop**

blkdpc—Blocked DPC is the next screening category.

cgpa—Allowed CGPA is the next screening category.

destfld—Allowed destination field (DESTFLD) is the next screening category.

isup—ISUP message type (ISUP) is the next screening category.

stop—The gateway screening process ends and the message proceeds through normal routing.

Default: Current value

:nsp= (optional)

The new 24-bit ITU national signaling point (*nsp*). It specifies the new signaling point (*sp*) of the point code represented by *msa-ssa-sp*. An asterisk (*) indicates the full range of values from **000–255**.

Range: **000–255, ***

:nsr= (optional)

Next screening reference (*nsr*). The parameter indicates which screening reference in the specified screening category (*nsfi*) is to be used in the screening process. If **nsfi=stop**, the **nsr** parameter cannot be specified.

Range: 1 alphabetic character followed by up to 3 alphanumeric characters

Default: Current value

:nssa= (optional)

The new 24-bit ITU national sub signaling area (*nssa*). It specifies the new sub signaling area (*ssa*) of the point code represented by *msa-ssa-sp*. An asterisk (*) indicates the full range of values from **000–255**.

Range: **000–255, ***

:nzone= (optional)

The new ITU-international zone. The parameter specifies a new zone for the point code represented by *zone-area-id*. An asterisk (*) indicates the full range of values from **0–7**.

Range: 0-7, *, c

Default: Current value

:pcst= (optional)

Point code subtype. This parameter indicates whether the specified ITU international or ITU national point code has no subtype prefix or has the spare point code prefix (s-).

Range: none, s

Default: none

:sp= (optional)

The 24-bit ITU national signaling point (*sp*). This parameter specifies the signaling point (*sp*) in the point code represented by *msa-ssa-sp*. An asterisk (*) indicates the full range of values from 000-255.

Range: 000-255, *

:ssa= (optional)

The 24-bit ITU national sub signaling area (*ssa*). This parameter specifies the sub signaling area (*ssa*) in the point code represented by the format *msa-ssa-sp*. An asterisk (*) indicates the full range of values from 000-255.

Range: 000-255, *

:zone= (optional)

The ITU international zone. The parameter specifies the zone in the point code represented by format *zone-area-id*. An asterisk (*) indicates the full range of values from 0-7.

Range: 0-7, *

Example

```
chg-scr-dpc:sr=iec:ni=240:nc=010:ncm=010:nni=240:nnc=003:nncm=030
```

```
chg-scr-dpc:sr=iec:ni=240:nc=010:ncm=010:nni=240:nnc=003:nncm=030:nsfi=stop
:actname=none
```

```
chg-scr-dpc:sr=dpc1:npc=128:nsfi=fail:pcst=s:npcst=none
```

Dependencies



CAUTION: Even though gateway screening is in the screen test mode, as defined by the parameters *gwsa=off* and *gwsm=on*, the gateway screening action in the stop action set specified by the *actname* parameter of the screen set *will* be performed at the end of the screening process.

A complete point code must be specified, and must be one, and only one of the four point code parameter combinations: **ni-nc-ncm**; **zone-area-id**; **msa-ssa-sp**; or **npc**.

A new point code entry must be specified by one, and only one of the four point code parameter combinations: **nni-nnc-nncm**, **nzone-narea-nid**, **nmsa-nssa-nsp**, or **nnpc**. If the new point code entry is a different point code type than the existing point code entry, all subfields of the new point code type must be specified.

ANSI point code value **000-000-000** and ITU-International point code value **0-000-0** are not allowed.

At least one optional parameter must be specified.

The DPC specified by **ni-nc-ncm**, **zone-area-id**, **msa-ssa-sp**, or the **npc** parameter must already exist in the screening reference or within an existing range of DPCs.

The new DPC or DPC range defined by **ni-nc-ncm**, **zone-area-id**, **msa-ssa-sp**, or the **npc** parameter must not already exist in the screening reference or within an existing range of DPCs.

If the **actname** parameter is specified, the **nsfi-stop** parameter must be specified.

If the **actname** parameter is specified, the **nsr** parameter cannot be specified.

The value of the **actname** parameter must already be defined in the Gateway Screening Stop Action table with the **chg-gws-actset** command. These values are shown in the *ACT NAME* field of the **rtrv-gws-actset** command output.

If **zone=*** is specified, **area=*** and **id=*** must be specified.

If **area=*** is specified, **id=*** must be specified.

If **msa=*** is specified, **ssa=*** and **sp=*** must be specified.

If **ssa=*** is specified, **sp=*** must be specified.

The next screening function identifier (**nsfi**) and the next screening reference (**nsr**) must point to an existing screen, or the **nsfi** must be equal to **stop** and the **nsr** must not be specified.

If the **nc** parameter is specified as a range, the **ncm** parameter must be specified as an asterisk or as the full range **000-255**.

If the **nc** parameter is specified as a single value or a range, a single value must be specified for the **ni** parameter.

If the **nc** parameter is specified as an asterisk (**nc=***), the **ncm** parameter must be specified as an asterisk or as the full range **000-255**.

If the **ncm** parameter is specified as a single value, or a range other than the full range of **000-255**, the **ni** and the **nc** parameters must be specified with a single value.

If the **ni** parameter is specified as an asterisk (**ni=***) or as a range, the **nc** and **ncm** parameters must be specified as an asterisk or as the full range **000-255**.

If the **nnc** parameter is specified as a range, the **nncm** parameter must be specified as an asterisk or as the full range **000-255**.

If the **nnc** parameter is specified as a single value or a range, a single value must be specified for the **nni** parameter.

If the **nnc** parameter is specified as an asterisk (**nnc=***), the **nncm** parameter must be specified as an asterisk or as the full range **000-255**.

If the **nncm** parameter is specified as a single value, or a range other than the full range of **000-255**, the **nni** and the **nnc** parameters must be specified with a single value.

If the **nni** parameter is specified as an asterisk (**nni=***) or as a range, the **nnc** and **nncm** parameters must be specified as an asterisk or as the full range **000-255**.

If the **nsfi** parameter has a value other than **stop**, the **nsr** parameter must be specified.

The specified screening reference (**sr**) must already exist in the database.

The Spare Point Code Support feature must be enabled before the **pcst** parameter can be specified.

The spare point code subtype prefix (**s-**) is not supported for ANSI point codes (parameters **ni**, **nc**, **ncm**) or for 24-bit ITU national point codes (parameters **msa**, **ssa**, **sp**). The **pcst** and **npcst** parameters cannot be specified for ANSI and ITU-N24 point codes.

Notes

A range of values is specified by separating the values that define the range by two ampersands (&&); for example, **:ni=025&&100** specifies all network indicators for ANSI point codes from **25** to **100**.

An asterisk cannot not be specified for a parameter value in this command unless an asterisk was specified for the parameter value in the original **ent-scr-dpc** command.

If the screen set reaches 100% capacity (indicated by the “100% full” message), the system will allow subsequent entries. An error will occur, however, when downloading the screen set to the card. Screen sets should not exceed 100% capacity. Remove screen set entries until the capacity is below 100%.

The spare point code subtype prefix **s-** is supported only for ITU international and ITU national point codes. The **pcst** and **npcst** parameters indicate whether the specified point code has no subtype prefix or has the spare point code prefix.

Output

chg-scr-dpc:sr=iec:ni=240:nc=010:ncm=010:nni=240:nnc=003:nncm=030

```
r1ghncxa03w 04-01-07 11:43:04 EST EAGLE 31.3.0
CHG-SCR-DPC: SCREEN SET AFFECTED - IEC 25% FULL
CHG-SCR-DPC: MASP A - COMPLTD
;
```

Legend

CHG-SCR-DPC—The command entered that caused this output. This is echoed to the printer as a reference.

SCREEN SET AFFECTED - IEC—Identifies the screen set that was affected by the command. The screen set name is provided.

25% FULL—Indicates the relative size of the screen set.

chg-scr-isup

Change Allowed ISUP Screening Reference

Use this command to change the attributes associated with a specific allowed ISUP screening reference in the Allowed ISUP entity set.

Keyword: **chg-scr-isup**

Related Commands: **dlt-scr-isup**, **ent-scr-isup**, **rtrv-scr-isup**

Command Class: Database Administration

Parameters

:isupmt= or **:tupmt=** (mandatory)

ISUP message type or TUP message type. A single value or a range of values can be specified. An asterisk (*) indicates the full range of values from **000–255**. The **tupmt** parameter is not valid for SEAS.

Range: **000–255**

:nisupmt= or **:ntupmt=** (mandatory)

New ISUP message type or new TUP message type. A single value or a range of values can be specified. An asterisk (*) indicates the full range of values from **000–255**. The **ntupmt** parameter is not valid for SEAS.

Range: **000–255**

:sr= (mandatory)

Screening reference. This parameter specifies the point code's unique screening reference name.

Range: 1 alphabetic character followed by up to 3 alphanumeric characters

:nsfi= (optional)

This parameter specifies the next screening category that is used in the gateway screening process. If specified, the parameter value must be **stop**.

Range: **stop**

stop—The gateway screening process ends and the message proceeds through normal routing.

Default: Current value

:nsr= (optional)

Next screening reference (nsr). The parameter indicates which screening reference in the specified screening category (**nsfi**) is to be used in the screening process. If **nsfi=stop**, the **nsr** parameter cannot be specified.

Range: 1 alphabetic character followed by up to 3 alphanumeric characters

Default: Current value

Example

```
chg-scr-isup:sr=iec:isupmt=1:nisupmt=1&&2
```

```
chg-scr-isup:tupmt=20:ntupmt=1:sr=tu01
```

Dependencies

At least one optional parameter must be specified.

If the **actname** parameter is specified, the **nsfi-stop** parameter must be specified.

The value of the **actname** parameter must already be defined in the Gateway Screening Stop Action table with the **chg-gws-actset** command. These values are shown in the **ACT NAME** field of the **rtrv-gws-actset** command output.

The specified **isupmt** parameter or **tupmt** parameter value must already exist in the specified **sr**.

The specified **nisupmt** parameter or **ntupmt** parameter value must not already exist in the specified **sr**.

If the **nsfi** parameter is specified, the parameter value must be **stop**.

If the **nsfi=stop** parameter is specified, the **nsr** parameter cannot be specified.

Notes

An asterisk can be specified for a parameter value in the **chg-scr-isup** and **dlt-scr-isup** commands *only* if that parameter value was specified as an asterisk in the **ent-scr-isup** command to define the parameter value.

A range of values can be specified for the **isupmt** parameter or **tupmt** parameter, by separating the values that define the range by two ampersands (&&); for example, **:isupmt=025&&100** specifies all ISUP message types from **25** to **100**. The value to the left of the && must be less than the value to the right of the && in the range.

TUP does not apply to SEAS. ISUP Message Type is the default.

To use TUP message type screening, an SIO screening reference with **si=04** (TUP) must exist in the SIO table. The TUP screening reference specifies the SIO screening reference as the next screening reference parameter (**nsr**) value.

To use ISUP message type screening, an SIO screening reference with **si=05** (ISUP) must exist in the SIO table. The ISUP screening reference specifies the ISUP SIO screening reference as the next screening reference parameter (**nsr**) value.

To screen for TUP and ISUP message types using a combined ISUP/TUP screen set, the SIO screening reference with **si=4** and the SIO screening reference with **si=5** must be two different screening references. The TUP screening reference specifies the SIO screening reference as the next screening reference parameter (**nsr**) value, and the ISUP screening reference specifies the SIO ISUP screening reference as the next screening reference parameter (**nsr**) value.

Output

When a screening reference is specified that is not yet associated with a screen set, the following output appears:

```
chg-scr-isup:sr=is01:isupmt=2:nsfi=stop:nisupmt=4
  rlghncxa03w 04-01-14 16:45:50 EST  EAGLE 31.3.0
  CHG-SCR-ISUP: MASP A - COMPLTD
;
```

When a screening reference is specified that is already associated with one or more screen sets, the following output appears:

```
chg-scr-isup:sr=is02:isupmt=9:nsfi=stop:nisupmt=8
  tekelecstp 04-02-17 16:35:56 EST  EAGLE 31.4.0
  Extended Processing Time Required -- Please Wait
  Notice: The number of screensets affected is  2.
  CHG-SCR-ISUP: SCREEN SET AFFECTED - ist1  1% FULL
  CHG-SCR-ISUP: SCREEN SET AFFECTED - ist2  1% FULL
  CHG-SCR-ISUP: MASP A - COMPLTD
;
```

chg-scr-opc**Change Allowed OPC**

Use this command to change the attributes associated with a specific screening reference in the allowed OPC category. Attributes that can be changed are the point code, next screening function identifier and, next screening reference.

Keyword: **chg-scr-opc**

Related Commands: **dlt-scr-opc**, **ent-scr-opc**, **rtrv-scr-opc**

Command Class: Database Administration

Parameters

† At least one of these parameters must be specified.

:sr= (mandatory)

Screening reference. This parameter specifies the point code's unique screening reference name.

Range: 1 alphabetic character followed by up to 3 alphanumeric characters

:actname= (optional)

The name of the gateway screening stop action set. Stop actions must be administered using the **actname** parameter in conjunction with the gateway screening stop action table (see **chg-gws-actset** and **rtrv-gws-actset**).

Range: 1 alphabetic character followed by up to 5 alphanumeric characters.

none—Remove an existing gateway screening stop action set from a gateway screening rule.

:area= (optional)

The ITU international area. The area is specified in the point code. The format of the point code is *zone-area-id*. An asterisk (*) indicates the full range of values from **000–255**.

Range: **000–255, ***

:id= (optional)

The ITU international ID. The parameter specifies the ID in the point code represented by format *zone-area-id*. An asterisk (*) indicates the full range of values from **0–7**.

Range: **0–7, ***

:msa= (optional)

The 24-bit ITU-national main signaling area (*msa*) value. It specifies the main signaling area (*msa*) of the point code represented by *msa-ssa-sp*. An asterisk (*) indicates the full range of values from **000–255**.

Range: **000–255, ***

:narea= (optional)

The new ITU-international area value. An asterisk (*) indicates the full range of values from **000–255**.

Range: **000–255, *, c**

Default: Current value

:nc= (optional)

The network cluster (*nc*) value. This parameter specifies one or more *nc* values for the network indicator (*ni*) and network cluster member (*ncm*) values specified in the **ni** and **ncm** parameters. It specifies the *nc* of the point code represented by *ni-nc-ncm*. A single value or a range of values can be specified. An asterisk (*) indicates the full range of values from **000-255**.

Range: **000-255, ***

:ncm= (optional)

The network cluster member (*ncm*) value. This parameter specifies one or more *ncm* values for the network indicator (*ni*) and network cluster (*nc*) values identified in the **ni** and **nc** parameters. It specifies the *ncm* of the point code represented by *ni-nc-ncm*. A single value or a range of values can be specified. An asterisk (*) indicates the full range of values from **000-255**.

Range: **0-255, ***

:ni= (optional)

The network indicator (*ni*) value. This parameter specifies one or more *ni* values for the network cluster (*nc*) and network cluster member (*ncm*) values identified in the **nc** and **ncm** parameters. It specifies the *ni* of the point code represented by *ni-nc-ncm*. A single value or a range of values can be specified. An asterisk (*) indicates the full range of values from **000-255**.

Range: **0-255, ***

:nid= (optional)

The new ITU-international ID value. An asterisk (*) indicates the full range of values from **0-7**.

Range: **0-7, ***

Default: Current value

:nmsa= (optional)

The new 24-bit ITU-national main signaling area (*nmsa*) value. It specifies the new main signaling area (*msa*) of the point code represented by *msa-ssa-sp*. An asterisk (*) indicates the full range of values from **000-255**.

Range: **000-255, ***

:nnc= (optional)†

The new network cluster (*nnc*). This parameter specifies one or more *nnc* values for the screening reference specified in the **sr** parameter. It specifies the new network cluster (*nc*) of the point code represented by *ni-nc-ncm*. A single value or a range of values can be specified. An asterisk (*) indicates the full range of values from **000-255**.

Range: **000-255, ***

Default: Current value

:nncm= (optional)†

The new network cluster member (*nncm*). This parameter specifies one or more *ncm* values for the screening reference specified in the **sr** parameter. It specifies the new network cluster member (*ncm*) of the point code represented by *ni-nc-ncm*. A single value or a range of values can be specified. An asterisk (*) indicates the full range of values from **0-255**.

Range: **0-255, ***

Default: Current value

:nni= (optional)†

The new network identifier (*nni*). This parameter specifies one or more *nni* values for the screening reference specified in the **sr** parameter. It specifies the new network indicator (*ni*) of the point code represented by *ni-nc-ncm*. A single value or a range of values can be specified. An asterisk (*) indicates the full range of values from **000–255**.

Range: **0–255, ***

Default: Current value

:nnpc= (optional)

The new ITU-national point code. An asterisk (*) indicates the full range of values from **00000–16383**.

Range: **00000–16383, ***

Default: Current value

NOTE: Gateway screening allows the ITU national point code to be displayed and entered in the database only as a single number. If you use multiple-part ITU national point codes, see “Converting ITU National Point Code Formats” in Appendix A for information on converting the point code format.

:npc= (optional)

The ITU national point code. An asterisk (*) indicates the full range of values from **00000–16383**.

Range: **00000–16383, ***

:npcst= (optional)

New point code subtype. This parameter indicates whether the specified new ITU international or ITU national point code has no subtype prefix or has the spare point code prefix (**s-**).

Range: **none, s**

Default: **none**

:nsfi= (optional)†

This parameter specifies the next screening category that is used in the gateway screening process, or it indicates that the gateway screening process should stop.

Range: **blkdpc, blkopc, cgpa, dpc, sio, stop**

blkdpc—Blocked DPC is the next screening category.

blkopc—Blocked OPC is the next screening category.

cgpa—Allowed CGPA is the next screening category.

dpc—Allowed DPC is the next screening category.

sio—Allowed SIO is the next screening category.

stop—The gateway screening process ends and the message proceeds through normal routing.

Default: Current value

:nsp= (optional)

The new 24-bit ITU national signaling point (*nsp*). It specifies the new signaling point (*sp*) of the point code represented by *msa-ssa-sp*. An asterisk (*) indicates the full range of values from **000–255**.

Range: **000–255, ***

:nsr= (optional)†

Next screening reference (*nsr*). The parameter indicates which screening reference in the specified screening category (**nsfi**) is to be used in the screening process. If **nsfi=stop**, the **nsr** parameter cannot be specified.

Range: 1 alphabetic character followed by up to 3 alphanumeric characters

Default: Current value

:nssa= (optional)

The new 24-bit ITU national sub signaling area (*nssa*). It specifies the new sub signaling area (*ssa*) of the point code represented by *msa-ssa-sp*. An asterisk (*) indicates the full range of values from **000-255**.

Range: **000-255, ***

:nzone= (optional)

The new ITU-international zone. The parameter specifies a new zone for the point code represented by *zone-area-id*. An asterisk (*) indicates the full range of values from **0-7**.

Range: **0-7, *, c**

Default: Current value

:pcst= (optional)

Point code subtype. This parameter indicates whether the specified ITU international or ITU national point code has no subtype prefix or has the spare point code prefix (**s-**).

Range: **none, s**

Default: **none**

:sp= (optional)

The 24-bit ITU national signaling point (*sp*). This parameter specifies the signaling point (*sp*) in the point code represented by *msa-ssa-sp*. An asterisk (*) indicates the full range of values from **000-255**.

Range: **000-255, ***

:ssa= (optional)

The 24-bit ITU national sub signaling area (*ssa*). This parameter specifies the sub signaling area (*ssa*) in the point code represented by the format *msa-ssa-sp*. An asterisk (*) indicates the full range of values from **000-255**.

Range: **000-255, ***

:zone= (optional)

The ITU international zone. The parameter specifies the zone in the point code represented by format *zone-area-id*. An asterisk (*) indicates the full range of values from **0-7**.

Range: **0-7, ***

Example

```
chg-scr-opc:sr=iec:ni=240:nc=010:ncm=010:nni=240:nnc=010:nncm=020
```

```
chg-scr-opc:sr=iec:ni=240:nc=010:ncm=010:nni=240:nnc=010:nncm=020:nsfi=stop
:actname=cncf
```

```
chg-scr-opc:sr=iec:nsfi=dpc:nsr=wr2
```

```
chg-scr-opc:sr=opc1:npc=128:nsfi=fail:pcst=s:npcst=none
```

Dependencies



CAUTION: Even though gateway screening is in the screen test mode, as defined by the parameters **gwsa=off** and **gws=on**, the gateway screening action in the stop action set specified by the **actname** parameter of the screen set *will* be performed at the end of the screening process.

A complete point code must be specified, and must be one, and only one of the four point code parameter combinations: **ni-nc-ncm**; **zone-area-id**; **msa-ssa-sp**; or **npc**.

A new point code entry must be specified by one, and only one of the four point code parameter combinations: **nni-nnc-nncm**, **nzone-narea-nid**, **nmsa-nssa-nsp**, or **npc**. If the new point code entry is a different point code type than the existing point code entry, all subfields of the new point code type must be specified.

ANSI point code value **000-000-000** and ITU-International point code value **0-000-0** are not allowed.

At least one optional parameter must be specified.

The OPC specified by **ni-nc-ncm**; **zone-area-id**, **msa-ssa-sp**, or the **npc** parameter must not already exist in the screening reference or within an existing range of OPCs.

The OPC specified by **ni-nc-ncm**; **zone-area-id**, **msa-ssa-sp**, or the **npc** parameter must not already exist in the screening reference or within an existing range of OPCs.

The new OPC or OPC range defined by **ni-nc-ncm**, **zone-area-id**, **msa-ssa-sp**, or the **npc** parameter must not already exist in the screening reference or within an existing range of OPCs.

If the **actname** parameter is specified, the **nsfi-stop** parameter must be specified.

If the **actname** parameter is specified, the **nsr** parameter cannot be specified.

The value of the **actname** parameter must already be defined in the Gateway Screening Stop Action table with the **chg-gws-actset** command. These values are shown in the **ACT NAME** field of the **rtrv-gws-actset** command output.

If **zone=*** is specified, **area=*** and **id=*** must be specified.

If **area=*** is specified, **id=*** must be specified.

If **msa=*** is specified, **ssa=*** and **sp=*** must be specified.

If **ssa=*** is specified, **sp=*** must be specified.

The next screening function identifier (**nsfi**) and the next screening reference (**nsr**) must point to an existing screen, or the **nsfi** must be equal to **stop** and the **nsr** must not be specified.

If the **nc** parameter is specified as a range, the **ncm** parameter must be specified as an asterisk or as the full range **000-255**

If the **nc** parameter is specified as a single value or a range, a single value must be specified for the **ni** parameter.

If the **nc** parameter is specified as an asterisk (**nc=***), the **ncm** parameter must be specified as an asterisk or as the full range **000-255**.

If the **ncm** parameter is specified as a single value, or a range other than the full range of **000-255**, the **ni** and the **nc** parameters must be specified with a single value.

If the **ni** parameter is specified as an asterisk (**ni=***) or as a range, the **nc** and **ncm** parameters must be specified as an asterisk or as the full range **000-255**.

If the **nnc** parameter is specified as a range, the **nncm** parameter must be specified as an asterisk or as the full range **000-255**.

If the **nnc** parameter is specified as a single value or a range, a single value must be specified for the **nni** parameter.

If the **nnc** parameter is specified as an asterisk (**nnc=***), the **nnm** parameter must be specified as an asterisk or as the full range **000-255**.

If the **nncm** parameter is specified as a single value, or a range other than the full range of **000-255**, the **nni** and the **nnc** parameters must be specified with a single value.

If the **nni** parameter is specified as an asterisk (**nni=***) or as a range, the **nnc** and **nncm** parameters must be specified as an asterisk or as the full range **000-255**.

If the **nsfi** parameter has a value other than **stop**, the **nsr** parameter must be specified.

The specified screening reference (**sr**) must already exist in the database.

The Spare Point Code Support feature must be enabled before the **pcst** parameter can be specified.

The spare point code subtype prefix (**s-**) is not supported for ANSI point codes (parameters **ni**, **nc**, **ncm**) or for 24-bit ITU national point codes (parameters **msa**, **ssa**, **sp**). The **pcst** parameter cannot be specified for ANSI and ITU-N24 point codes.

Notes

A range of values is specified by separating the values that define the range by two ampersands (**&&**); for example, **:ni=025&&100** specifies all network indicators for ANSI point codes from **25** to **100**.

An asterisk cannot not be specified for a parameter value in this command unless an asterisk was specified for the parameter value in the original **ent-scr-opc** command.

If the screen set reaches 100% capacity (indicated by the "100% full" message), the system will allow subsequent entries. An error will occur, however, when downloading the screen set to the card. Screen sets should not exceed 100% capacity. Remove screen set entries until the capacity is below 100%.

The spare point code subtype prefix **s-** is supported only for ITU international and ITU national point codes. The **pcst** and **npcst** parameters indicate whether the specified point code has no subtype prefix or has the spare point code prefix.

Output

chg-scr-opc:sr=iec:ni=240:nc=010:ncm=010:nni=240:nnc=010:nncm=020

```
rlghncxa03w 04-01-07 12:05:33 EST EAGLE 31.3.0
CHG-SCR-OPC: SCREEN SET AFFECTED - IEC 25% FULL
CHG-SCR-OPC: MASP A - COMPLTD
```

;

Legend

CHG-SCR-OPC—The command entered that caused this output. This is echoed to the printer as a reference.

SCREEN SET AFFECTED - IEC—Identifies the screen set that was affected by the command. The screen set name is provided.

25% FULL—Indicates the relative size of the screen set.

chg-scr-sio**Change Allowed SIO**

Use this command to change a specific screening reference in the allowed service indicator octet category. Attributes that may be changed are the network indicator, service indicator, message priority, heading codes, next screening function identifier, and next screening reference.

NOTE: To use TUP message type screening, an SIO screening reference with **si=04 (TUP)** must be defined in the SIO table. This SIO screening reference is specified as the next screening reference (nsr) value in an ISUP screening reference for screening TUP message types.

Keyword: chg-scr-sio

Related Commands: dlt-scr-sio, ent-scr-sio, rtrv-scr-sio

Command Class: Database Administration

Parameters

† At least one of these parameters must be specified.

:nic= (mandatory)

The network indicator code identifies whether the message originated from an international (0) or national (2) network. A single value or a range of values can be specified. An asterisk (*) indicates the full range of values from 0-3.

Range: 0-3, *

:pri= (mandatory)

New message priority. This parameter specifies the new message priority in the SIO. A single value or a range of values can be specified. An asterisk (*) indicates the full range of values from 0-3.

Range: 0-3, *

Default: Current value

:si= (mandatory)

Service indicator. The service indicator identifies the type of message. The values are defined in Telcordia TR-NWT-000246.

Range: 00, 01- 15

:sr= (mandatory)

Screening reference. This parameter specifies the point code's unique screening reference name.

Range: 1 alphabetic character followed by up to 3 alphanumeric characters

:actname= (optional)

The name of the gateway screening stop action set. Stop actions must be administered using the **actname** parameter in conjunction with the gateway screening stop action table (see **chg-gws-actset** and **rtrv-gws-actset**).

Range: 1 alphabetic character followed by up to 5 alphanumeric characters.

none—remove an existing gateway screening stop action set from a gateway screening rule.

:h0= (optional)

H0 Heading Code. This parameter specifies an H0 heading code for the screening reference specified in the **sr** parameter. A single value or a range of values can be specified. An asterisk (*) indicates the full range of values from **0-15**.

This parameter is mandatory if the service indicator (**si**) value is **00**, **01**, **02**, or **03**. Otherwise, the **h0** parameter is undefined.

Range: **0-15**, *

Default: Current value or undefined

:h1= (optional)

H1 Heading Code. This parameter specifies an H1 heading code for the screening reference specified in the **sr** parameter. A single value or a range of values can be specified. An asterisk (*) indicates the full range of values from **0-15**.

This parameter is mandatory if the service indicator (**si**) value is **00**, **01**, **02**, or **03**. Otherwise, the **h1** parameter is undefined.

Range: **0-15**, *

Default: Current value or undefined

:nh0= (optional)†

New H0 heading code. This parameter specifies a new H0 heading code for the screening reference specified in the **sr** parameter. A single value or a range of values can be specified. An asterisk (*) indicates the full range of values from **0-15**.

Range: **0-15**, *

Default: Current value

:nh1= (optional)†

New H1 heading code. This parameter specifies a new H1 heading code for the screening reference specified in the **sr** parameter. A single value or a range of values can be specified. An asterisk (*) indicates the full range of values from **0-15**.

Range: **0-15**, *

Default: Current value

:nnic= (optional)†

New network indicator code. This parameter specifies the new **nic** for the screening reference specified. A single value or a range of values can be specified. An asterisk (*) indicates the full range of values from **0-3**.

Range: **0-3**, *

Default: Current value

:npri= (optional)

New message priority. This parameter specifies the new message priority in the SIO. A single value or a range of values can be specified. An asterisk (*) indicates the full range of values from **0-3**.

Range: **0-3, ***

Default: Current value

:nsfi= (optional)†

Next screening function identifier. This parameter specifies the next screening category that is used in the gateway screening process, or it indicates that the gateway screening process should stop.

Range: **blkdpc, cdpa, cgpa, destfld, isup, stop**

blkdpc—Blocked DPC is the next screening category.

cdpa—Allowed CDPA is the next screening category.

cgpa—Allowed CGPA is the next screening category.

destfld—Allowed destination field (DESTFLD) is the next screening category.

isup—ISUP message type (ISUP) is the next screening category.

stop—The gateway screening process ends and the message proceeds through normal routing.

Default: Current value

:nsi= (optional)†

New service indicator. The service indicator identifies the type of message for the specified screening reference. The values are defined in Telcordia TR-NWT-000246.

Range: **0-15**

Default: Current value

:nsr= (optional)†

Next screening reference. The parameter indicates which screening reference in the specified screening category (**nsfi**) is to be used in the screening process. If **nsfi=stop**, the **nsr** parameter cannot be specified.

Range: 1 alphabetic character followed by up to 3 alphanumeric characters

Default: Current value

Example

```
chg-scr-sio:sr=iec:nic=1:si=1:h0=02:h1=03:pri=*.nh0=03&&04
```

```
chg-scr-sio:sr=iec:nic=1:si=3:pri=2:npri=1
```

```
chg-scr-sio:sr=iec:nic=1:si=3:pri=3:nnic=2:nsfi=stop:actname=copy
```

Dependencies



CAUTION: Even though gateway screening is in the screen test mode, as defined by the parameters **gwsa=off** and **gwsn=on**, the gateway screening action in the stop action set specified by the **actname** parameter of the screen set *will* be performed at the end of the screening process.

At least one attribute must be changed.

If asterisk values or ranges are specified for the new heading codes, nothing that matches the entire combination of **nic/nnic**, **si/nsi**, and the specified new heading codes and priorities can already exist in the allowed SIO category for the screening reference.

An asterisk cannot be specified for a parameter value in this command unless an asterisk was specified for the parameter value in the original **ent-scr-sio** command.

If the **actname** parameter is specified, the **nsfi-stop** parameter must be specified.

If the **actname** parameter is specified, the **nsr** parameter cannot be specified.

The value of the **actname** parameter must already be defined in the Gateway Screening Stop Action table with the **chg-gws-actset** command. These values are shown in the **ACT NAME** field of the **rtrv-gws-actset** command output.

The next screening function identifier (**nsfi**) and the next screening reference (**nsr**) must point to an existing screen, or the **nsfi** must be equal to **stop** and the **nsr** must not be specified.

Use Table 5-26 to determine an acceptable combination of the **nsfi** (new entries) and **si** parameters:

Table 5-26. Acceptable **nsfi** and **si** parameter combinations (**chg-scr-sio**)

If the nsfi parameter is...	...the si parameter must be:
destfl	00
cdpa	03
cgpa	03

If a value greater than **2** is specified for the **si** parameter and a value less than **3** is specified for the **nsi** parameter, the **nh0** and **nh1** parameters are used to enter required **h0** and **h1** values.

Table 5-27 shows the valid combinations of the **h0/h1** and **nh0/nh1** parameters

Table 5-27. Valid combinations for the **h0/h1** and **nh0/nh1** parameters (**chg-scr-sio**)

If the h0 (nh0) parameter is specified as:	The h1 (nh1) parameter can be specified as:
A single value	A single value
A single value	A range
A single value	An asterisk (*) entry
A range	An asterisk (*) entry
An asterisk (*) entry	An asterisk (*) entry

The **nh0** and **nh1** parameters cannot be specified if the **nsi** parameter is specified and is not equal to **00**, **01**, or **02**.

Use Table 5-28 to determine additional acceptable combinations of specified parameter values

Table 5-28. Additional Valid **chg-scr-sio** Parameter Combinations

si value:	nic value	pri value	h0 value:	h1 value:
0	s, *	s, *, r	s	s, *, r
0	s, *	s, *, r	*, r	*
1, 2	s, *	s, *, r	s	s, *, r
1, 2	s, *	s, *, r	*, r	*
3-15	s, *	s, *, r	u	u
Legend s = single value r = range * = asterisk u = unspecified				

When the **chg-scr-sio** command is entered and specify the **nh0** or **nh1** parameters, the values is specified must be valid with the **h0** or **h1** values currently in the database.

The **h0**, **h1**, **nh0**, and **nh1** parameters cannot be specified if the **si** parameter is not equal to **00**, **01**, or **02** and the **nsi** parameter is not specified.

The **nnic**, **nsi**, **pri**, and **nh0/nh1** parameters must not already exist in the allowed SIO category.

The **sr**, **nic**, **si**, **pri**, and **h0/h1** parameters for which attributes are to be changed must be in the allowed SIO category.

Notes

If the screen set reaches 100% capacity (indicated by the “100% full” message), the system allows subsequent entries. An error occurs, however, when downloading the screen set to the card. Ensure that screen sets do not exceed 100% capacity. Remove screen set entries until the capacity is below 100%.

To use TUP message type screening, an SIO screening reference with **si=04** (TUP) must be defined in the SIO table. To use ISUP message type screening, a rule with **si=05** (ISUP) must be defined in the SIO table. To use a combined ISUP/TUP screen set for TUP and ISUP message screening, the SIO screening reference with **si=4** and the SIO screening reference with **si=5** must be two different screening references.

A network indicator value of **1** or **3** can be used in private networks.

A network indicator value of **3** can be used in some national networks to broaden the identity of a national network, but is usually spare.

Output

chg-scr-sio:sr=iec:nic=1:si=3:pri=2:npri=1

```
rlghncxa03w 04-01-14 16:45:50 EST EAGLE 31.3.0
CHG-SCR-SIO: SCREEN SET AFFECTED - SS01 25% FULL
CHG-SCR-SIO: SCREEN SET AFFECTED - SS04 35% FULL
CHG-SCR-SIO: MASP A - COMPLTD
```

;

Legend

CHG-SCR-SIO—The command entered that caused this output. This is echoed to the printer as a reference.

SCREEN SET AFFECTED - SS01—Identifies the screen set that was affected by the command. The screen set name is provided.

25% FULL—Indicates the relative size of the screen set.

chg-scr-tt**Change Allowed Translation Type**

Use this command to change the attributes of a specific screening reference in the allowed translation type category. Attributes that can be changed are the translation type, next screening function identifier and next screening reference.

Keyword: **chg-scr-tt**

Related Commands: **dlt-scr-tt, ent-scr-tt, rtrv-scr-tt**

Command Class: Database Administration

Parameters

:sr= (mandatory)

Screening reference. This parameter specifies the point code's unique screening reference name.

Range: 1 alphabetic character followed by up to 3 alphanumeric characters

:type= (mandatory)

Translation type. The translation type identifies the global title translation type value in the called party address. A single value or a range of values can be specified. An asterisk (*) indicates the full range of values from **0-255**.

Range: **000-255, ***

:actname= (optional)

The name of the gateway screening stop action set. Stop actions must be administered using the **actname** parameter in conjunction with the gateway screening stop action table (see **chg-gws-actset** and **rtrv-gws-actset**).

Range: 1 alphabetic character followed by up to 5 alphanumeric characters.

none—remove an existing gateway screening stop action set from a gateway screening rule.

:nsfi= (optional)

This parameter specifies the next screening category that is used in the gateway screening process, or it indicates that the gateway screening process should stop.

Range: **cdpa, stop**

cdpa—Allowed called party address is the next screening category.

stop—The gateway screening process ends and the message proceeds through normal routing.

Default: Current value

:nsr= (optional)

Next screening reference (*nsr*). The parameter indicates which screening reference in the specified screening category (**nsfi**) is to be used in the screening process. If **nsfi=stop**, the **nsr** parameter cannot be specified.

Range: 1 alphabetic character followed by up to 3 alphanumeric characters

Default: Current value

:ntype= (optional)

New translation type. The translation type identifies the global title translation type value in the called party address. A single value or a range of values can be specified. An asterisk (*) indicates the full range of values from **0-255**.

Range: **000-255, ***

Default: Current value

Example

```
chg-scr-tt:sr=iec:type=012:ntype=014
```

```
chg-scr-tt:sr=iec:type=012:ntype=014:nsfi=stop:actname=none
```

Dependencies



CAUTION: Even though gateway screening is in the screen test mode, as defined by the parameters **gwsa=off** and **gws=on**, the gateway screening action in the stop action set specified by the **actname** parameter of the screen set *will* be performed at the end of the screening process.

At least one attribute must be changed.

The new translation type cannot already exist.

If an asterisk is specified for the new allowed **type**, no other translation types can exist in the screening table.

If the **actname** parameter is specified, the **nsfi=stop** parameter must be specified.

If the **actname** parameter is specified, the **nsr** parameter cannot be specified.

The value of the **actname** parameter must already be defined in the Gateway Screening Stop Action table with the **chg-gws-actset** command. These values are shown in the **ACT NAME** field of the **rtrv-gws-actset** command output.

The next screening function identifier and the next screening to be added must point to one or more existing screening references.

If the **nsfi=stop** parameter is specified, the **nsr** parameter cannot be specified.

If the **nsfi** parameter has a value other than **stop**, the **nsr** parameter must be specified.

If the screening reference exists, the single value or range specified for the allowed **type** to be added to the TT screen for the allowed TT screening reference must not already exist in that TT screen.

The screening reference and translation type for which the attributes are to be changed must exist.

Notes

If the screen set reaches 100% capacity (indicated by the “100% full” message), the system allows subsequent entries. An error occurs, however, when downloading the screen set to the card. Ensure that screen sets do not exceed 100% capacity. Remove screen set entries until the capacity is below 100%.

An asterisk can be specified for a parameter value in the **chg-scr-tt** and **dlt-scr-tt** commands *only* if that parameter value was specified as an asterisk in the **ent-scr-tt** command to define the parameter value.

Output

chg-scr-tt:sr=iec:type=012:ntype=014

```
rlghncxa03w 04-01-07 12:05:33 EST EAGLE 31.3.0
CHG-SCR-TT: SCREEN SET AFFECTED - IEC 25% FULL
CHG-SCR-TT: MASP A - COMPLTD
```

;

Legend

CHG-SCR-TT—The command entered that caused this output. This is echoed to the printer.

SCREEN SET AFFECTED - IEC—Identifies the screen set that was affected by the command. The screen set name is provided.

25% FULL—Indicates the relative size of the screen set.

chg-scrset

Change Screen Set

Use this command to change the attributes of a screen set. A screen set is a group of screening references that can be assigned to a linkset. It is defined by a name and a pointer to the first screening reference of a screen set.

Keyword: **chg-scrset**

Related Commands: **dlt-scrset**, **ent-scrset**, **rtrv-scrset**

Command Class: Database Administration

Parameters

† At least one of these parameters must be specified.

:scrn= (mandatory)

Screen set name. Each screening reference must have a unique name.

Range: 1 alphabetic character followed by up to 3 alphanumeric characters

:actname= (optional)

The name of the gateway screening stop action set. Stop actions must be administered using the **actname** parameter in conjunction with the gateway screening stop action table (see **chg-gws-actset** and **rtrv-gws-actset**).

Range: 1 alphabetic character followed by up to 5 alphanumeric characters.

none—remove an existing gateway screening stop action set from a gateway screening rule.

:destfld= (optional)

This parameter turns on and off the automatic allowed affected destination screening for network management messages against the routing table, self point codes, and capability point codes. When this parameter is **on**, the automatic screening is applied at the end of the provisioned screen set.

Range: **yes, no**

Default: Current value

:nscrn= (optional)†

New screen set name.

Range: 1 alphabetic character followed by up to 3 alphanumeric characters

Default: Current value

:nsfi= (optional)†

Next screening function identifier. This parameter specifies the next screening category that is used in the gateway screening process, or it indicates that the gateway screening process should stop.

Range: **blkdpc, blkopc, dpc, opc, sio, stop**

blkdpc—Blocked DPC is the next screening category.

blkopc—Blocked OPC is the next screening category.

dpc—Allowed DPC is the next screening category.

opc—Allowed OPC is the next screening category.

sio—Allowed SIO is the next screening category.

stop—The gateway screening process ends and the message proceeds through normal routing.

Default: Current value

:nsr= (optional)†

Next screening reference. The parameter indicates which screening reference in the specified screening category (**nsfi**) is to be used in the screening process. If **nsfi=stop**, the **nsr** parameter cannot be specified.

Range: 1 alphabetic character followed by up to 3 alphanumeric characters

Default: Current value

Example

```
chg-scrset:scrn=ss01:nsfi=opc:nsr=iec
```

```
chg-scrset:scrn=ss02:nsfi=stop:nscrn=ss03
```

```
chg-scrset:scrn=ss02:nscrn=ss03:nsfi=stop:actname=copy
```

```
chg-scrset:scrn=ss02:nsfi=stop:nscrn=ss03:destfld=no
```

Dependencies

The new screen set name cannot be in use by another screen set.

If the **actname** parameter is specified, the **nsfi-stop** parameter must be specified.

If the **actname** parameter is specified, the **nsr** parameter cannot be specified.

The value of the **actname** parameter must already be defined in the Gateway Screening Stop Action table with the **chg-gws-actset** command. These values are shown in the *ACT NAME* field of the **rtrv-gws-actset** command output.

The next screening function identifier (**nsfi**) and the next screening reference (**nsr**) must point to an existing screen, or the **nsfi** must be equal to **stop** and the **nsr** must not be specified.

If the **nsfi** parameter has a value other than **stop**, the **nsr** parameter must be specified.

An existing screen set must be removed from all linksets before it can be changed.

If a new screen set name (**nscren**) is specified, the screen set name (**scrn**) must not be referenced by a linkset.

Notes

If the screen set reaches 100% capacity (indicated by the “100% full” message), the system allows subsequent entries. An error occurs, however, when downloading the screen set to the card. screen sets should not exceed 100% capacity. Remove screen set entries until the capacity is below 100%.

The system validates the command to verify that the specified screen set name is in use.

Output

```
chg-scrset:scrn=ss01:nsfi=opc:nsr=iec
  rlgncxa03w 04-01-07 09:35:10 EST EAGLE 31.3.0
  CHG-SCRSET: SCREEN SET AFFECTED - SS01 25% FULL
  CHG-SCRSET: MASP A - COMPLTD
;
```

Legend

CHG-SCRSET—The command entered that caused this output. This is echoed to the printer as a reference.

SCREEN SET AFFECTED - SS01—Identifies the screen set that was affected by the command. The screen set name is shown (SS01).

25% FULL—Indicates the relative size of the screen set.

chg-secu-dflt

Change System-Wide Security-Related Defaults

Use this command to change various system-wide, security-related defaults, such as:

- The default password aging interval
- The default user ID aging interval
- Whether to allow or prohibit multiple simultaneous logins with the same user ID
- Control of the password-complexity checking algorithm
- Login warning message text

Keyword: **chg-secu-dflt**

Related Commands: **ent-user, login, rtrv-secu-dflt**

Command Class: Security Administration

Parameters

:alpha= (optional)

The minimum number of alphabetic characters (a-z) required in a new password.

Range: 0-12

Default: Current value

System Default: 1

:minlen= (optional)

The minimum password length. This parameter sets the minimum number of characters that must be in a user password.

Range: 1-12

Default: Current value

System Default: 8

:multlog= (optional)

Use this parameter to allow multiple simultaneous logins with a user ID. If **multlog=yes** is specified, a user ID can be logged in to more than one terminal at the same time. If **multlog=no** is specified, a user ID can be logged in to only one terminal at a time.

Range: yes, no

Default: Current value

System Default: no

:num= (optional)

The minimum number of numeric characters (0-9) required in a new password.

Range: 0-12

Default: Current value

System Default: 1

:page= (optional)

The default password aging interval for newly created user IDs. If the **page** parameter is specified in the **ent-user** command, the system uses that value; otherwise, the system uses the value specified here.

Range: 0-999 (days)

Default: Current value

System Default: 90

:punc= (optional)

The minimum number of punctuation characters required in a new password. A punctuation character is any character that is not an alphabetic or numeric character, including spaces.

Range: 0-12

Default: Current value

System Default: 1

:uout= (optional)

The user ID aging interval; that is, the number of successive days a user ID can go unused (no successful login) before the system denies login. If the **uout** parameter is specified in the **ent-user** command, the system uses that value; otherwise, the system uses the value specified here.

Range: 0-999 (days)
Default: Current value
 System Default: 90

:wrnln= (optional)
 The warning message line number. Use this parameter to specify the line number within the warning message to receive the new text specified by the **wrntx** parameter.

Range: 1-20
Default: Current value

:wrntx= (optional)
 New message text for the warning message. Use this parameter to specify the text that replaces the current text of the warning message line specified by the **wrnln** parameter. Specify a zero-length text string (“”) to prevent the line from displaying when the message is displayed during login.

Range: Any quoted alphanumeric string from 0-70 characters in length; for example, “abc123”.
Default: Current value

Example

chg-secu-dflt:minlen=5

The following example input shows how you can add a blank line to the display after a successful login, and how you can cause lines *not* to display as part of the message after a successful login.

```
chg-secu-dflt:wrnln=1:wrntx="*****" (see note)
chg-secu-dflt:wrnln=2:wrntx="* notice: this is a private computer system.*"
chg-secu-dflt:wrnln=3:wrntx="* unauthorized access or use may lead to*"
chg-secu-dflt:wrnln=4:wrntx="* prosecution.*"
chg-secu-dflt:wrnln=5:wrntx="* 05-07-01 notice!!! eagle will be upgraded between*"
chg-secu-dflt:wrnln=6:wrntx="* the hours of 2am-3am on 05-07-01.*"
chg-secu-dflt:wrnln=7:wrntx="*"
chg-secu-dflt:wrnln=8:wrntx="* today's happy message: go with tekelec!*"
chg-secu-dflt:wrnln=9:wrntx="*****"
chg-secu-dflt:wrnln=10:wrntx=" " (set to 1 space to cause blank line)
chg-secu-dflt:wrnln=11:wrntx=""
chg-secu-dflt:wrnln=12:wrntx=""
chg-secu-dflt:wrnln=13:wrntx=""
chg-secu-dflt:wrnln=14:wrntx="" (remaining lines are provisioned to "" to cause
chg-secu-dflt:wrnln=15:wrntx="" them not to display as part of the message
chg-secu-dflt:wrnln=16:wrntx="" after successful login)
chg-secu-dflt:wrnln=17:wrntx=""
chg-secu-dflt:wrnln=18:wrntx=""
```

```
chg-secu-dflt:wrnln=19:wrntx=""
```

```
chg-secu-dflt:wrnln=20:wrntx=""
```

NOTE: The combined length of the command name, parameter names, and parameter data in this example would cause the command line to wrap to the second line of the command input area. The system allows this action.

Dependencies

At least one optional parameter must be specified.

The sum of the values specified for the **alpha**, **num**, and **punc** parameters must not be greater than 12.

The **wrnln** and **wrntx** parameters must be specified together in this command.

Notes

The warning message lines are displayed in the scroll area in order after a successful login; that is, line 1, line 2, and so on.

Any warning message line provisioned as a zero-length null string (" ") is not displayed in the scroll area during login.

Specify at least one blank (" ") to cause a blank line to be displayed as part of the warning message.

The following message is the default message delivered with every system:

```
NOTICE: This is a private computer system.  
Unauthorized access or use may lead to prosecution.
```

Even though the minimum number of characters allowed in a password is specified using the **minlen** parameter, the password also must satisfy the minimum value requirements specified on the **alpha**, **num**, and **punc** parameters. The actual minimum password length is the greater of either the value specified on the **minlen** parameter or the total number of characters specified on the **alpha**, **num**, and **punc** parameters.

For example, if **chg-secu-dflt:minlen=5:alpha=2:num=2:punc=2** is entered, the minimum number of password characters specified on the **minlen** parameter is 5. But the total number of characters specified in the **alpha**, **num**, and **punc** parameters is 6 (**alpha+num+punc**). The effective minimum number of characters is actually 6 rather than the 5 specified on the **minlen** parameter.

Output

```

chg-secu-dflt:wrnl=1:wrntx="*****
*****" (see note)
chg-secu-dflt:wrnl=2:wrntx="* notice: this is a private computer system.*"
chg-secu-dflt:wrnl=3:wrntx="* unauthorized access or use may lead to*"
chg-secu-dflt:wrnl=4:wrntx="* prosecution.*"
chg-secu-dflt:wrnl=5:wrntx="* 05-07-01 notice!!! eagle will be upgraded between*"
chg-secu-dflt:wrnl=6:wrntx="* the hours of 2am-3am on 05-07-01.*"
chg-secu-dflt:wrnl=7:wrntx="*"
chg-secu-dflt:wrnl=8:wrntx="* today's happy message: go with tekelec!*"
chg-secu-dflt:wrnl=9:wrntx="*****"
chg-secu-dflt:wrnl=10:wrntx=" " (set to 1 space to cause blank line)
chg-secu-dflt:wrnl=11:wrntx=" "
chg-secu-dflt:wrnl=12:wrntx=" "
chg-secu-dflt:wrnl=13:wrntx=" "
chg-secu-dflt:wrnl=14:wrntx=" " (remaining lines are provisioned to " " to cause
chg-secu-dflt:wrnl=15:wrntx=" " them not to display as part of the message
chg-secu-dflt:wrnl=16:wrntx=" " after successful login)
chg-secu-dflt:wrnl=17:wrntx=" "
chg-secu-dflt:wrnl=18:wrntx=" "
chg-secu-dflt:wrnl=19:wrntx=" "
chg-secu-dflt:wrnl=20:wrntx=" "

```

```

rlghncxa03w 04-01-10 11:43:04 EST EAGLE 31.3.0
CHG-SECU-DFLT: MASP A - COMPLTD

```

```

LOGIN:UID=eagle
PASSWORD:<password is not displayed>

```

Warning message is displayed after login



```

*****
* NOTICE: This is a private computer system. *
* Unauthorized Access or use may lead to *
* prosecution. *
* 11/3/00 Notice!!! Eagle will be upgraded between *
* the hours of 2am-3am on 11/11/00. *
* *
* Today's happy message: Go with Tekelec!! *
*****

```

Blank line in warning message



```

0 LOGIN failures since last successful LOGIN
Last successful LOGIN was on port 3 on 04-01-06 @ 12:12:35

```

Login history information displayed here after login warning message



chg-secu-trm**Change Terminal Access Rights**

Use this command to configure the access rights for a terminal. Only a user with system security administration authority can change a terminal's access rights. Access rights determine whether a terminal or port has command access to the system for the different command classes.

Keyword: **chg-secu-trm**

Related Commands: **rtrv-secu-trm**

Command Class: Security Administration

Parameters

:trm= (mandatory)

Terminal ID. Specifies the port to be configured.

Range: 1-16

:all= (optional)

All non-configurable command classes. Specifies whether you want to configure all of the command classes.

Range: **yes, no**

Default: Current value

System Default: **no**

:cc1= (optional)

Configurable command class name, and indicator to specify whether the command class is allowed.

Range: 1 alphabetic character followed by 2 alphanumeric characters (ayy), followed by **-no** or **-yes**

Default: Current value

:cc2= (optional)

Configurable command class name, and indicator to specify whether the command class is allowed.

Range: 1 alphabetic character followed by 2 alphanumeric characters (ayy), followed by **-no** or **-yes**

Default: Current value

:cc3= (optional)

Configurable command class name, and indicator to specify whether the command class is allowed.

Range: 1 alphabetic character followed by 2 alphanumeric characters (ayy), followed by **-no** or **-yes**

Default: Current value

:cc4= (optional)

Configurable command class name, and indicator to specify whether the command class is allowed.

Range: 1 alphabetic character followed by 2 alphanumeric characters (ayy), followed by **-no** or **-yes**

Default: Current value

:cc5= (optional)

Configurable command class name, and indicator to specify whether the command class is allowed.

Range: 1 alphabetic character followed by 2 alphanumeric characters (ayy), followed by **-no** or **-yes**

cc6= (optional)

Configurable command class name, and indicator to specify whether the command class is allowed.

Range: 1 alphabetic character followed by 2 alphanumeric characters (ayy), followed by **-no** or **-yes**

Default: Current value

:cc7= (optional)

Configurable command class name, and indicator to specify whether the command class is allowed.

Range: 1 alphabetic character followed by 2 alphanumeric characters (ayy), followed by **-no** or **-yes**

Default: Current value

:cc8= (optional)

Configurable command class name, and indicator to specify whether the command class is allowed.

Range: 1 alphabetic character followed by 2 alphanumeric characters (ayy), followed by **-no** or **-yes**

Default: Current value

:db= (optional)

Database Administration class. Specifies whether the Database Administration class of commands is allowed.

Range: **yes, no**

Default: Current value

System Default: **no**

:dbg= (optional)

Debug class. Specifies whether the Debug class of commands is allowed.

Range: **yes, no**

Default: Current value

System Default: **no**

:link= (optional)

Link Maintenance class. Specifies whether the Link Maintenance class of commands is allowed.

Range: **yes, no**

Default: Current value

System Default: **no**

:lnpbas= (optional)

LNP Basic class. Specifies whether the LNP Basic class of commands is allowed.

Range: yes, no

Default: Current value
System Default: no

:lnpdb= (optional)

LNP Database class. Specifies whether the LNP Database class of commands is allowed.

Range: yes, no

Default: Current value
System Default: no

:lnpsub= (optional)

LNP Subscription class. Specifies whether the LNP Subscription class of commands is allowed.

Range: yes, no

Default: Current value
System Default: no

:pu= (optional)

Program Update class. Specifies whether the Program Update class of commands is allowed.

Range: yes, no

Default: Current value
System Default: no

:sa= (optional)

Security Administration class. Specifies whether the Security Administration class of commands is allowed.

Range: yes, no

Default: Current value
System Default: no

:sys= (optional)

System Maintenance class. Specifies whether the System Maintenance class of commands is allowed.

Range: yes, no

Default: Current value
System Default: no

Example

```
chg-secu-trm:trm=3:all=yes
```

```
chg-secu-trm:trm=3:sys=yes:lnpbas=yes:lnpdb=no:lnpsub=no
```

```
chg-secu-trm:trm=3:sys=yes:lnpbas=yes:lnpdb=no:lnpsub=no:cc1=u04-no:cc3=u11=yes
```

Dependencies

This command is not supported on telnet terminals (terminal IDs 17-40).

At least one optional parameter must be specified.

Access rights for a terminal cannot be changed while a user is logged on to that terminal.

At least two terminal ports must be configured to have security administration authority.

The Command Class Management feature must be enabled before configurable command class name parameters (**cc1**, **cc2**, **cc3**, **cc4**, **cc5**, **cc6**, **cc7**, **cc8**) can be specified.

The value specified for a configurable command class name must be a default or provisioned command class name in the CCNAMES table.

If the **all** parameter is specified and any of the individual command classes are also specified, the individual command classes take precedence.

If the **lnpbas**, **lnpdb**, and **lnpsub** parameters is specified, the LNP feature must be turned on (see the **enable-ctrl-feat** command).

If the **all=yes** parameter is specified, but the LNP feature is not turned on, the **lnpbas**, **lnpdb**, and **lnpsub** parameters default to a **no** value for the user.

Notes

Up to 8 configurable command class name parameters can be entered in one command. Additional commands can be entered to change access rights for more than 8 names. To change access rights for all 32 available configurable command class names, four commands could be entered with 8 names specified in each command.

Security Administration ports whose terminal port type has been configured with a value of **oap**, **none**, or **printer** do not allow commands to be entered. Because commands cannot be entered from terminals attached to these ports, they are not considered as ports configured for security administration authority.

Output

chg-secu-trm:trm=3:all=yes

```
rlghncxa03w 04-01-15 12:30:04 EST EAGLE 31.3.0
Command entered at terminal #13.
```

```
rlghncxa03w 04-01-15 12:30:07 EST EAGLE 31.3.0
CHG-SECU-TRM: MASP A - COMPLTD
```

;

chg-sg-opts

Change IP⁷ Secure Gateway Options

Use this command to change the IP⁷ Secure Gateway protocol options.

Keyword: **chg-sg-opts**

Related Commands: **rtrv-sg-opts**

Command Class: Database Administration

Parameters

:drkq= (optional)

The dynamic routing key quantity. The maximum number of dynamic routing key entries in the Routing Key table of each SS7IPGW or IPGWI card.

Range: **0-2500**

Default: Current value

System Default: **0**

:getcomm= (optional)

The community name to use for SNMP Get and GetNext request validations. This value applies for each DCM or SSED CM SNMP agent in the system.

Range: Any string up to 32 characters in length

If the string contains characters other than alphanumeric characters, the entire string must be enclosed in single quotes (' ').

The string can be entered in upper and lower case; the system converts upper case alphabetic characters to lower case.

Default: Current value

System Default: **public**

:inhfepalm= (optional)

This parameter specifies whether or not major alarms for TALI sockets whose secondary state is NEA-FEP will be inhibited. This value applies to all IPLIM and SS7IPGW cards in the system.

Range: **yes, no**

yes—All TALI sockets with a secondary status of NEA-FEP are reported as IS-NR and no socket alarm is raised. For IPLIM and IPLIMI cards, where each link consists of a single TALI socket, a link alarm will still be raised when the TALI socket's secondary status is NEA-FEP, regardless of the **inhfepalm** setting.

no—NEA-FEP sockets are reported as OOS-MT and a major alarm is raised for that connection.

Default: Current value

System Default: **no**

:ipgwabate= (optional)

Enable or disable IPGWx SS7 congestion abatement procedures. This parameter controls whether the TFC is forwarded to the system's true point code, to allow MSUs to be discarded as part of abatement procedures on all cards running the IPGWx application. When set to **yes**, the system will maintain and abate congestion on behalf of IPGWx-connected nodes.

Range: **yes, no**

Default: Current value

System Default: **no**

:iplimabate= (optional)

Enable or disable IPLIMx SS7 congestion abatement procedures. This parameter controls whether the TFC is forwarded to the system's true point code, to allow MSUs to be discarded as part of abatement procedures on all cards running the IPLIMx application. When set to **yes**, the system will maintain and abate congestion on behalf of IPLIMx/M3UA signaling links.

Range: **yes, no**

Default: Current value

System Default: **no**

:iptpsalmthresh= (optional)

System IPTPS alarm threshold percentage at which an alarm is raised. The threshold can be set below 100 percent if "early warning" is desired.

Range: **10-100**

Default: Current value.

System Default: **80**

:sctpsum= (optional)

This parameter specifies the configured SCTP checksum algorithm. The configured SCTP checksum algorithm takes effect on the IPLIMx or IPGWx under the following conditions:

- All associations on the card are in the **open=no** state
- No associations are provisioned on the card

If neither condition is true, the card raises a minor alarm indicating that it is not using the configured SCTP checksum algorithm. The minor alarm is cleared and the configured SCTP checksum algorithm takes effect when all associations on the card are set to **open=no** or when the card is reset.

Range: **adler32, crc32c**

Default: Current value

System Default: **crc32c**

:setcomm= (optional)

The community name to use for SNMP set request validations. This value applies for each DCM or SSED CM SNMP agent in the system.

Range: Any string up to 32 characters in length.

If the string contains characters other than alphanumeric characters, the entire string must be enclosed in single quotes (' ').

The string can be entered in upper and lower case; the system converts upper case alphabetic characters to lower case.

Default: Current value

System Default: **private**

:snmpcont= (optional)

The system contact information for each DCM SNMP agent in the Secure Gateway. This value is used to define the sysContact object in the SNMP MIB II System Group (OID 1.3.6.1.2.1.1.4).

Range: Any string of up to 64 characters.

If the string contains characters other than alphanumeric characters, the entire string must be enclosed in single quotes (' ').

The string can be entered in upper and lower case; the system converts upper case alphabetic characters to lower case.

Default: Current value

System Default: **tekelec**

:srkq= (optional)

The static routing key quantity. The maximum number of routing key entries available in the Static Routing Key table of each SS7IPGW or IPGWI card.

Range: **0-2500**

Default: Current value

System Default: **1000**

:sync= (optional)

The sync code used by TALI protocol on messages sent by SS7IPGW/IPGWI cards. This value controls whether SS7IPGW/IPGWI cards use the string "TALI" or "SASI" in the header of messages exchanged by the TALI protocol.

Range: **tali, sassi**

Default: Current value

System Default: **tali**

:trapcomm= (optional)

The value used in the community name field when SNMP traps are generated. This value applies for each DCM or SSEDCCM SNMP agent in the system.

Range: Any string up to 32 characters in length.

If the string contains characters other than alphanumeric characters, the entire string must be enclosed in single quotes (' ').

The string can be entered in upper and lower case; the system converts upper case alphabetic characters to lower case.

Default: Current value

System Default: **public**

Example

chg-sg-opts:sync=tali

chg-sg-opts:srkq=500:drkq=500

chg-sg-opts:snmpcont="John Doe 555-123-4444"

chg-sg-opts:getcomm=public

chg-sg-opts:setcomm=private

chg-sg-opts:sctpcsum=adler32

chg-sg-opts:trapcomm=public

chg-sg-opts:ipgwabate=yes

chg-sg-opts:iplimabate=yes

chg-sg-opts:iptpsalmthresh=90

Dependencies

This command cannot be entered to change the **sync** option on a card that is not in the Out-of-Service Maintenance-Disabled (OOS-MT-DSBLD) state.

At least one optional parameter must be specified.

The Dynamic Routing Key feature must be turned on before parameter values relating to dynamic routing keys can be changed.

The sum of the values specified for the **srkq** and **drkq** parameters must not be greater than:

- 1000 if there are any DCM cards (870-1945-xx) running the **ss7ipgw** or **ipgwi** application.
- 2500 if all cards running the **ss7ipgw** or **ipgwi** application are SSEDCCM cards (870-2732-xx).

Replacing an SSEDCCM card with a dual-slot DCM card when the sum of the values for the **srkq** and **drkq** parameters is greater than 1000 will result in the DCM card being auto-inhibited.

The number of static entries in the Routing Key table cannot exceed the value specified for the **srkq** parameter.

The **srkq** parameter value must be greater than or equal to the current number of static routing key entries. Attempts to decrease the **srkq** value below the actual current number of static routing key entries are not allowed.

If **d** is the current maximum number of actual dynamic routing keys on any card that is running the **ss7ipgw** or **ipgwi** application, then the sum of **d** and the **srkq** value cannot exceed:

1000 for dual-slot DCM cards running the **ss7ipgw** or **ipgwi** application

2500 for SSEDCCM cards running the **ss7ipgw** or **ipgwi** application

The total number of actual routing keys cannot not exceed 2500 per card. Effectively this means that even if the **drkq** parameter value has been decreased to less than **d**, the **srkq** value cannot be increased until **d** has first been decreased.

Notes

For DCM cards:

As shown in Table 5-29 on page 5-358, the following conditions must be satisfied when changing routing key quantity assignments.

1. **drkq** + **srkq** cannot exceed **1000**. The total number of routing keys per card cannot exceed 1000.
2. If **d** is the current maximum number of actual dynamic routing keys on any SS7IPGW card (as reported by the **rept-stat-rtkey** command), then **d** + **srkq** must be ≤ 1000 . The total number of actual routing keys may not exceed 1000 per card. Effectively this means that even if **drkq** has been decreased to less than **d**, **srkq** cannot be increased until **d** has also decreased.
3. If **s** is the current maximum number of actual static routing keys, then **srkq** must be $\geq s$. Attempts to decrease **srkq** below **s** are not allowed.

Table 5-29. Routing Key Quantity Change Examples for DCM Cards

srkq	drkq	d	s	Change	Result
500	500	500	500	drkq to 250	OK
500	500	500	500	srkq to 250	Fails #3 above
250	250	250	250	drkq to 750	OK
250	250	250	250	srkq to 750	OK
250	250	250	250	drkq to 1000	Fails #1 above
250	250	250	250	srkq to 1000	Fails #1 and #2 above
250	250	500	250	srkq to 750	Fails #2 above
250	250	500	250	srkq to 500	OK

Table 5-29. Routing Key Quantity Change Examples for DCM Cards (Continued)

srkq	drkq	d	s	Change	Result
250	250	0	250	drkq to 1000	Fails #1 above
250	250	250	250	srkq to 200	Fails #3 above

For SSEDCCM cards:

As shown in Table 5-30 on page 5-359, the following conditions must be satisfied when changing routing key quantity assignments.

1. **drkq + srkq** cannot exceed 2500. The total number of routing keys per card cannot exceed 2500.
2. If **d** is the current maximum number of actual dynamic routing keys on any SS7IPGW card (as reported by the **rept-stat-rtkey** command), then **d + srkq** must be ≤ 2500 . The total number of actual routing keys may not exceed 2500 per card. Effectively this means that even if **drkq** has been decreased to less than **d**, **srkq** cannot be increased until **d** has also decreased.
3. If **s** is the current maximum number of actual static routing keys, then **srkq** must be $\geq s$. Attempts to decrease **srkq** below **s** are not allowed.

Table 5-30. Routing Key Quantity Change Examples for SSEDCCM Cards

srkq	drkq	d	s	Change	Result
1000	1000	1000	1000	drkq to 500	OK
1000	1000	1000	1000	srkq to 500	Fails #3 above
500	500	500	500	drkq to 1500	OK
500	500	500	500	srkq to 1500	OK
500	500	500	500	drkq to 2000	OK
500	500	500	500	srkq to 2200	Fails #1 and #2 above
500	500	1000	500	srkq to 1600	Fails #2 above
500	500	1000	500	srkq to 1500	OK
500	500	0	500	drkq to 2200	Fails #1 above
500	500	500	500	srkq to 400	Fails #3 above

The **sctpcsum** parameter specifies the configured SCTP checksum algorithm. The configured SCTP checksum algorithm takes effect on the IPLIMx/IPGWx under the following conditions:

- All associations on the card are **open=no**
- No associations are provisioned on the card

If neither condition is true, the card raises a minor alarm indicating that it is not using the configured SCTP checksum algorithm. The minor alarm is cleared and the configured SCTP checksum algorithm takes effect after all associations are set to **open=no** or after the card is reset.

Output

chg-sg-opts:sync=tali

```
rlghncxa03w 04-01-07 09:17:40 EST EAGLE 31.3.0
chg-sg-opts:sync=tali
CHG-SG-OPTS: MASP A - COMPLTD
```

;

chg-sg-opts:sctpcsum=crc32c

```
rlghncxa03w 04-01-07 09:17:40 EST EAGLE 31.3.0
chg-sg-opts:sctpcsum=crc32c
Command entered at terminal #4.
CHG-SG-OPTS: MASP A - COMPLTD
```

;

chg-sg-opts:ipgwabate=yes

```
rlghncxa03w 04-01-07 09:17:40 EST EAGLE 31.3.0
chg-sg-opts:ipgwabate=yes
Command entered at terminal #4.
CHG-SG-OPTS: MASP A - COMPLTD
```

;

chg-sg-opts:iplimabate=yes

```
rlghncxa03w 04-01-07 09:17:40 EST EAGLE 31.3.0
chg-sg-opts:iplimabate=yes
Command entered at terminal #4.
CHG-SG-OPTS: MASP A - COMPLTD
```

;

chg-sid**Change Self Identification**

Use this command to change the self-identification of the system. The self-identification identifies the system to the other signaling points in the network.



CAUTION: Use this command only during periods of low traffic. If you change the point code using the **chg-sid** command, the change does not become enabled until you initialize (**init-sys**) the system.

Keyword: **chg-sid**

Related Commands: **ent-sid, rtrv-sid**

Command Class: Database Administration

Parameters

NOTE: See “Point Code Formats and Conversion” in Appendix A for a detailed description of point code formats, rules for specification, and examples.



CAUTION: If there are STC cards in the system for the Eagle Support for Integrated Sentinel (E5IS) feature, you must turn off the EIS copy function (see the **chg-eisopts** command) before you change the system CLI. When the CLI change is complete, use the **chg-eisopts** command to turn on the EIS copy function again.

:cli= (optional)

Common language location identifier. The CLLI, which must be unique, identifies the system in terms of its physical location:

- The first four characters identify the city, town, or locality.
- The fifth and sixth characters identify state or province.
- The seventh and eighth characters identify the building.
- The last three characters identify the traffic unit.

Range: 1 alphabetic character followed by up to 10 alphanumeric characters
The value **none** is invalid for the CLLI.

Default: Current value.

:cpc/cpca/cpci/cpcn/cpcn24= (optional)

Capability point code. The code used by the SS7 protocol to identify a group of functionally related STPs in the signaling network to which the STP belongs.

:cpc= or **:cpca=** (optional)

ANSI capability point code with subfields *network indicator-network cluster-network cluster member* (*ni-nc-ncm*).

Range: **000-255**

Specify a valid value for each subfield of the point code, and separate the subfields with a dash (-).

When **chg-sid:pctype=ansi** is specified, *ni* = **000** is not valid.

When **chg-sid:pctype=ansi** is specified, *nc* = **000** is not valid if *ni* = **001-005**.

When **chg-sid:pctype=ansi** is specified, *nc* = **000** is valid if *ni* = **006-255**.

The point code **000-000-000** is not a valid point code.

:cpci= (optional)

ITU international point code with subfields *zone-area-id*. The *prefix* subfield indicates a spare point code (*prefix-zone-area-id*).

Range: **s-, 0-255**

Specify a valid value for each subfield of the point code, and separate the subfields with a dash (-).

prefix—**s-**

zone—**0-7**

area—**000-255**

id—**0-7**

The point code **0-000-0** is not a valid point code.

Default: No change to existing point code value.

:cpcn= (optional)

ITU national point code in the format of a 5-digit number (*nnnnn*); or 2, 3, or 4 numbers (members) separated by dashes (*m1-m2-m3-m4*) as defined by the **chg-stpopts:npcfnti** flexible point code option. A group code must be specified when the ITUDUPPC feature is turned on (*nnnnn-gc*, *m1-m2-m3-m4-gc*). The *prefix* subfield indicates a spare point code (*prefix-nnnnn*, *prefix-nnnnn-gc*, *prefix-m1-m2-m3-m4*, *prefix-m1-m2-m3-m4-gc*).

Range: **s-**, **0-16383**, **aa-zz**
Specify a valid value for each subfield of the point code, and separate the subfields with a dash (-).

prefix—**s-**

nnnnn—**0-16383**

gc—**aa - zz**

m1-m2-m3-m4—**0-14** for each member; values must sum to 14

Default: No change to existing point code value.

:cpcn24= (optional)

24-bit ITU national point code with subfields *main signaling area-sub signaling area-signaling point (msa-ssa-sp)*.

Range: **000-255**

Specify a valid value for each subfield of the point code, and separate the subfields with a dash (-).

msa—**000-255**

ssa—**000-255**

sp—**000-255**

Default: No change to existing point code value.

:cpctype= (optional)

Capability point code type. Specify whether the capability point code is for the STP or for LNP, INP, or Equipment Identity Register (EIR).

Range: **lnp, stp, inp, eir**

Default: **stp**

:ncpc/ncpca/ncpci/ncpcn/ncpcn24= (optional)

New capability point code. Use new CPCs to replace or delete existing CPCs.

:ncpc= or **:ncpca=** (optional)

New ANSI capability point code with subfields *network indicator-network cluster-network cluster member (ni-nc-ncm)*.

Range: **000-255, none**

Specify a valid value for each subfield of the point code, and separate the subfields with a dash (-).

When **chg-sid:pctype=ansi** is specified, *ni* = **000** is not valid.

When **chg-sid:pctype=ansi** is specified, *nc* = **000** is not valid if *ni* = **001-005**.

When **chg-sid:pctype=ansi** is specified, *nc* = **000** is valid if *ni* = **006-255**.

The point code **000-000-000** is not a valid point code.

Enter **none** to delete a **cpc** or **cpca** point code.

Default: No change to existing point code value.

:ncpci= (optional)

ITU international point code with subfields *zone-area-id*. The *prefix* subfield indicates a spare point code (*prefix-zone-area-id*).

Range: **s-**, **0-255, none**

Specify a valid value for each subfield of the point code, and separate the subfields with a dash (-).

The point code **0-000-0** is not a valid point code.

prefix—**s-**

zone—0-7
area—000-255
id—0-7

Enter **none** to delete a **cpci** point code.

Default: No change to existing point code value.

:npcn= (optional)

New ITU national point code in the format of a 5-digit number (*nnnnn*); or 2, 3, or 4 numbers (members) separated by dashes (*m1-m2-m3-m4*) as defined by the **chg-stpopts:npcfnti** flexible point code option. A group code must be specified when the ITUDUPPC feature is turned on (*nnnnn-gc*, *m1-m2-m3-m4-gc*). The *prefix* subfield indicates a spare point code (*prefix-nnnnn*, *prefix-nnnnn-gc*, *prefix-m1-m2-m3-m4*, *prefix-m1-m2-m3-m4-gc*).

Range: **s-**, **0-16383**, **aa-zz**, **none**

Specify a valid value for each subfield of the point code, and separate the subfields with a dash (-).

prefix—s-
nnnnn—0-16383
gc—aa - zz

m1-m2-m3-m4—0-14 for each member; values must sum to 14
 Enter **none** to delete **cpcn** point code.

Default: No change to existing point code value.

:npcn24= (optional)

New 24-bit ITU national point code with subfields *main signaling area-sub signaling area-signaling point* (*msa-ssa-sp*).

Range: **000-255**, **none**

Specify a valid value for each subfield of the point code, and separate the subfields with a dash (-).

msa—000-255
ssa—000-255
sp—000-255

Enter **none** to delete **cpcn24** point code.

Default: No change in point code value.

:npci/npcn= (optional)

New STP ITU national or international point code.

:npci= (optional)

New STP ITU international point code with subfields *zone-area-id*. The *prefix* subfield indicates a spare point code (*prefix-zone-area-id*).

Range: **s-**, **0-255**, **none**

Specify a valid value for each subfield of the point code, and separate the subfields with a dash (-).

prefix—s-
zone—0-7
area—000-255
id—0-7

Enter **none** to delete the point code.

The point code **0-000-0** is not a valid point code.

Default: No change to existing point code value.

:npcn= (optional)

New STP ITU national point code in the format of a 5-digit number (*nnnnn*); or 2, 3, or 4 numbers (members) separated by dashes (*m1-m2-m3-m4*) as defined by the **chg-stpopts:npcfmt** flexible point code option. A group code must be specified when the ITUDUPPC feature is turned on (*nnnnn-gc*, *m1-m2-m3-m4-gc*). The *prefix* subfield indicates a spare point code (*prefix-nnnnn*, *prefix-nnnnn-gc*, *prefix-m1-m2-m3-m4*, *prefix-m1-m2-m3-m4-gc*).

Range: **s-**, **0-16383**, **aa-zz**, **none**

Specify a valid value for each subfield of the point code, and separate the subfields with a dash (-).

prefix—**s-**

nnnnn—**0-16383**

gc—**aa - zz**

m1-m2-m3-m4—**0-14** for each member; values must sum to 14

Enter **none** to delete the **pcn** point code.

Default: No change to existing point code value.

:pc/pca/pci/pcn/pcn24= (optional)

STP point code.

:pc= or **:pca=** (optional)

ANSI STP point code with subfields *network indicator-network cluster-network cluster member* (*ni-nc-ncm*).

Range: **000-255**

Specify a valid value for each subfield of the point code, and separate the subfields with a dash (-).

When **chg-sid:pctype=ansi** is specified, *ni* = **000** is not valid.

When **chg-sid:pctype=ansi** is specified, *nc* = **000** is not valid if *ni* = **001-005**.

When **chg-sid:pctype=ansi** is specified, *nc* = **000** is valid if *ni* = **006-255**.

The point code **000-000-000** is not a valid point code.

:pci= (optional)

ITU international point code with subfields *zone-area-id*. The *prefix* subfield indicates a spare point code (*prefix-zone-area-id*).

Range: **s-**, **0-255**

Specify a valid value for each subfield of the point code, and separate the subfields with a dash (-).

prefix—**s-**

zone—**0-7**

area—**000-255**

id—**0-7**

The point code **0-000-0** is not a valid point code.

Default: No change in point code value.

:pcn= (optional)

ITU national point code in the format of a 5-digit number (*nnnnn*); or 2, 3, or 4 numbers (members) separated by dashes (*m1-m2-m3-m4*) as defined by the **chg-stpopts:npfinti** flexible point code option. A group code must be specified when the ITUDUPPC feature is turned on (*nnnnn-gc*, *m1-m2-m3-m4-gc*). The *prefix* subfield indicates a spare point code (*prefix-nnnnn*, *prefix-nnnnn-gc*, *prefix-m1-m2-m3-m4*, *prefix-m1-m2-m3-m4-gc*).

Range: **s-**, **0-16383**, **aa-zz**

Specify a valid value for each subfield of the point code, and separate the subfields with a dash (-).

prefix—s-

nnnnn—0-16383

gc—aa - zz

m1-m2-m3-m4—0-14 for each member; values must sum to 14

Default: No change in point code value.

:pcn24= (optional)

24-bit ITU national point code with subfields *main signaling area-sub signaling area-signaling point* (*msa-ssa-sp*).

Range: **000-255**

Specify a valid value for each subfield of the point code, and separate the subfields with a dash (-).

msa—000-255

ssa—000-255

sp—000-255

Default: No change in point code value.

:pctype= (optional)

The type of point code. The **pctype** parameter does not affect ITU destinations.

Range: **ansi**, **other**

ansi—Supports point codes that meet the ANSI standard

other—Supports point codes that do not meet the ANSI standard.

Default: The point code type is not changed.

Example

To change the ANSI site identification STP point code:

chg-sid:pc=10-20-30

To change the site identification PCTYPE to ANSI:

chg-sid:pctype=ANSI

To change the site identification CLLI to **rlghncxa03w**:

chg-sid:cli=rlghncxa03w

To add a new ANSI capability point code:

chg-sid:cpc=002-002-002

To delete an ITU-I capability point code:

chg-sid:cpci=2-003-4:ncpci=none

To change an existing ITU-N capability point code, **01234**, to **02092**: (The existing CPC is replaced with the new CPC).

chg-sid:cpcn=01234:ncpcn=02092

To add a new ANSI LNP CPC:

chg-sid:cpc=002-002-002:cpctype=lnp

To change an existing ITU-N capability point code with a group code of **01234-aa** to **02092-si**: (The existing CPC is replaced with the new CPC).

chg-sid:cpcn=01234-aa:ncpcn=02092-si:cpctype=stp

To add an ITU national INP CPC:

chg-sid:cpcn=04567:cpctype=inp

To change the ITU-N 24-bit site identification STP Point Code when no previous ITU-N site identification STP point code exists:

chg-sid:pcn24=1-101-1

To change the ITU-N 24-bit site identification STP Point Code when a previous ITU-N site identification STP point code exists:

chg-sid:pcn=none

chg-sid:pcn24=1-101-1

To change the ITU-N site identification STP Point Code when a previous ITU-N 24-bit site identification STP point code exists:

chg-sid:pcn24=none

chg-sid:pcn=2000

To add a new ITU-N 24-bit Capability Point Code:

chg-sid:cpcn24=22-22-22

To change an existing 24-bit ITN-N Capability Point Code **22-22-22** to **33-33-33**.

chg-sid:cpcn24=22-22-22:ncpcn24=33-33-33

To add a new EIR-type Capability Point Code:

chg-sid:cpctype=eir:cpci=2-30-1

chg-sid:cpctype=eir:cpcn=123

To delete an existing ITUI Capability Spare Point Code:

chg-sid:cpci=s-2-003-4:ncpci=none

To change an existing node ITU-I spare true point code from an assigned point code value to **none**:

chg-sid:pci=s-1-234-5:npci=none

To change an existing ITU-N spare capability point code from **s-01234** to **s-02092**. The existing CPC is replaced with the new CPC:

chg-sid:cpcn=s-01234:ncpcn=s-02092:cpctype=stp

To change or add new node true point codes simultaneously, for multiple point code types:

chg-sid:pca=111-111-111:pci=1-234-5:pcn=12345

chg-sid:pca=111-111-111:pci=1-234-5:pcn24=233-255-255

To change or add new node true point codes simultaneously, for ITU-I spare and ITU-N spare point code types.

chg-sid:pci=s-1-234-5:pcn=s-12345

To change an existing node ITU-N spare true point code from an assigned point code value to **none**:

chg-sid:pcn=s-12345:npcn=none

Dependencies

At least one optional parameter must be specified.

The Spare Point Code Support feature must be enabled before a spare point code (prefix **s-**) can be specified in the command.

ANSI point code value **000-000-000** and ITU-International point code value **0-000-0** are not allowed.

The STP destination and capability point codes can be specified only as full point codes or **none**.

If an **npcn**, **npcn24**, **npci**, **npci**, **npci**, **npci**, or **npcn24** parameter is specified, a corresponding existing **cpc**, **cpc**, **cpc**, **cpc**, or **cpcn24** parameter value must be specified in the command.

If an **npci** parameter is specified, a corresponding existing **pci** parameter value must be specified in the command.

If an **npcn** parameter is specified, a corresponding existing **pcn** parameter value must be specified in the command.

If the **cpctype** parameter is specified, a **cpc**, **cpc**, **cpc**, **cpc**, or **cpcn24** parameter must be specified in the command.

If the **cpctype** parameter is specified, an **npcn**, **npcn24**, **npci**, **npci**, or **npcn24** parameter cannot be specified in the command.

If a **pc**, **pc**, **pc**, **pc**, or **pcn24** parameter, a **cpc**, **cpc**, **cpc**, **cpc**, or **cpcn24** parameter, and an **npci**, **npcn**, **npcn**, **npcn**, **npcn**, **npcn**, or **npcn24** parameter are specified, their values must be different.

The STP capability point code type (domain) must match the new STP capability point code type (domain).

When **cpctype** is **lnp**, the **cpc** parameter must have an ANSI point code value.

If the **cpctype=lnp** parameter or the **cpctype=eir** parameter is specified, the **pcn** or **pci** parameter must be specified for the point code. An ANSI point code cannot be specified.

Before the **cpctype=lnp** parameter can be specified, the LNP feature must be on (see the **enable-ctrl-feat** command).

Before the **cpctype=inp** parameter can be specified, the INP feature must be on.

Before the **cpctype=eir** parameter can be specified, the Equipment Identity Register (EIR) feature must be on.

Only the **pcn** parameter or the **pcn24** parameter can be specified in a command; both parameters cannot be specified in the same command.

If a 14-bit ITU-N site ID currently exists, it must be disabled before a 24-bit ITU-N site ID can be assigned.

Only one new point code parameter (**npc**, **npc**, **npc**, **npc**, **npc**, or **npcn24**) can be specified in a command.

If the **pcn**, **npcn**, **cpcn**, or **npcn** parameter is specified, the format must match the format that was assigned with the **chg-stpopts:npcfmti** parameter.

The site CLLI code that is specified in the command cannot be the same as an existing route destination CLLI code.

The STP destination point code that is specified in the command cannot be the same as:

- An existing route destination point code
- An existing STP capability point code

The STP capability point code that is specified in the command cannot be the same as:

- The STP destination point code
- An existing route destination point code
- An existing STP capability point code

The new STP capability point code that is specified in the command cannot be the same as:

- The STP destination point code
- An existing route destination point code.
- An existing STP capability point code

If the system is configured for ANSI format point codes, the specified network indicator value (*ni*) of the **pc**, **cpc**, or **npc** parameter must be **6** or greater when the specified cluster value is **0** (*nc*).

The true point code (**pc**, **pca**) and capability point codes cannot be the same as existing secondary point codes.

The existing true point code cannot be changed if it is in the MAP table.

The maximum number of capability point codes that can be provisioned is 96.

The STP destination point code can be deleted by specifying a value of **none** for the **pc/pca/pci/pcn/pcn24** parameter only if there are no destination point codes in the route table that have the same point code type (**pctype**) as the STP point code to be deleted.

The **cpc/cpca/cpci/cpcncpcn24** parameter cannot be specified with a value of **none**.

Notes

If one of the **pc/pca/pci/pcn/pcn24** parameters is specified to change the point code, the following message is displayed:

```
CAUTION: SYSTEM SITE ID HAS BEEN CHANGED, MANUAL RE-INITIALIZATION IS NEEDED
```

If the redirect function refers to any of the **pc/pca** or **cpc/cpca** parameters, the following message is displayed:

```
CAUTION: SYSTEM SITE ID WAS REFERENCED BY THE REDIRECT FUNCTION'S DPC
```

When the system's CLI has been entered into the database or changed with the **chg-sid** command, the OAP configuration in the system database must be changed to include the new CLI value. The following warning message is displayed to remind the user to update the OAP configuration:

```
CAUTION: System CLI has changed, OAP configuration is required
```

To update the OAP configuration, use the **act-oap-config** command.

In order for the change to be fully implemented, you must enter the **init-sys** command. This initializes the entire system system, and reloads all LIMs with the new self ID.

Only one ITU-N site ID point code can be defined at one time (pcn or pcn24). If you want to change from one to the other, you must disable the current site ID before you define the new one.

When the **cpctype=lnp** parameter is specified, it associates a specific service or capability (for example, local number portability query response and message relay service) with one or more of the capability point codes.

After the **cpctype** is defined, it cannot be changed.

For initial installation of a system, the self point code must be entered before any destination is entered.

In this command, only ITU-international and ITU national point codes support the spare point code subtype prefix (**s-**).

Output

chg-sid:pc=10-20-30

```
rlghncxa03w 04-01-07 09:17:40 EST EAGLE 31.3.0
CHG-SID: MASP A - COMPLTD
```

```
;
```

chg-slt

Change Signaling Link Test Message

Use this command to change the fields of a signaling link test message (SLTM) record in the SLTM table.

Keyword: **chg-slt**

Related Commands: **chg-l3t, ent-ls, rtrv-ls, rtrv-slt**

Command Class: Database Administration

Parameters

:sltset= (mandatory)

The signaling link test message record number in the SLTM table.

Range: 1–20

:enabled= (optional)

Enables the signaling link test message.

Range: on, off

Default: Current value.

:mode= (optional)

The *SLTM* mode to be used when sending test messages.

Range: special, regular

special—All SLTMs generated by the links in the linkset associated with this SLTM record are designated “special” maintenance messages.

regular—All SLTMs generated by the links in the linkset associated with this SLTM record are designated “regular” maintenance messages.

Default: Current value.

:pattern= (optional)

The test pattern to be sent with a signaling link test message.

Range: 2 to 30 alphanumeric characters (0–9 and A–F)

The number of characters used in the pattern must be even. The first two characters of the pattern must be alpha characters.

Default: Current value.

:t1= (optional)

The T1 timer for repeating the SLTM after a failure

Range: 4 to 12 seconds

Default: Current value.

:t2= (optional)

The T2 timer for the SLTM period.

Range: 30 to 90 seconds

Default: Current value.

Example

```
chg-slt:sltset=1:t1=6:t2=60:enabled=off:pattern=aabbcdd
```

Dependencies

The value of **t1** should be greater than the level 3 timer **t6**. The level 3 timer **t6** can be **0** to **6** seconds. Enter the **rtrv-l3t** command to verify the value of the level 3 timer **t6**.

Notes

None

Output

```
chg-slt:sltset=1:t1=6:t2=60:enabled=off:pattern=aabbccdd
r1ghncxa03w 04-01-07 00:21:41 EST EAGLE 31.3.0
CHG-SLT: MASP A - COMPLTD
;
```

chg-srvsel**Change Service Selector**

Use this command to assign the applicable service selectors required to change a service entry for DSM services.

Keyword: chg-srvsel

Related Commands: dlt-srvsel, ent-srvsel, rtrv-srvsel

Command Class: Database Administration

Parameters

:gti/gtia/gtii/gtin/gtin24= (mandatory)

Global title indicator. For all service selector commands, the domain is defined as **gti** and **gtia** (ANSI), **gtii** (ITU international), **gtin** (ITU national) and **gtin24** (24-bit ITU national). For the service selector commands, **gti** and **gtia** are equivalent.

Range: Supported value for ANSI: **gti=2** and **gtia=2**
Supported values for ITU: **gtii=2, 4; gtin=2, 4, gtin24=2, 4**

:ssn= (mandatory)

Subsystem number.

Range: **0-255, ***

:tt= (mandatory)

Translation type.

Range: **0-255**

:nai= (optional)

Nature of address indicator (see Table A-5 in Appendix A).

Range: **sub, rsvd, natl, intl**

Default: Current value

:naiv= (optional)

Nature of address indicator value (see Table A-5 in Appendix A).

Range: **0-127**

Default: Current value

NOTE: The nature of address indicator parameters (**naiv** or **nai**) can be specified by supplying either a mnemonic or an explicit value. At no time may both the mnemonic and the explicit value be specified at the same time for the same parameter. Either the **naiv** or **nai** parameter. can be specified. Table A-5 in Appendix A shows the mapping between the **naiv** and the **nai** parameters.

:np= (optional)

Numbering plan (see Table A-6 in Appendix A).

Range: e164, generic, x121, f69, e210, e212, e214, private

Default: Current value

:npv= (optional)

Numbering plan value (see Table A-6 in Appendix A).

Range: 0-15

Default: Current value

NOTE: The numbering plan parameters (npv or np) can be specified by supplying either a mnemonic or an explicit value. At no time may both the mnemonic and the explicit value be specified at the same time for the same parameter. Either the npv or np parameter can be specified. Table A-6 in Appendix A shows the mapping between the npv and the np parameters.

:nserv= (optional)

The new DSM service.

NOTE: The gport service cannot be used for Prepaid SMS Intercept; use the smsmr service. The gport service cannot be used for Portability Check for Mobile Originated SMS; use the mnpsms service.

Range: eir, gflex, gport, idpr, idps, inpq, inpmr, mnpsms, smsmr

eir—Equipment Identity Register

gflex—GSM flexible numbering

idpr—Prepaid IDP Query Relay

idps—IDP Screening for Prepaid

inpq—INP query

inpmr—INP message relay

gport—GSM number portability

mnpsms—Portability Check for Mobile Originated SMS

smsmr—Prepaid SMS Intercept

Default: No change to existing value.

:nsnai= (optional)

The new service nature of address indicator.

Range: sub, natl, intl, rnidn, rnndn, rnsdn, none, ccrndn

sub—Subscriber number

natl—National significant number

intl—International number

rnidn—Routing number prefix and international dialed/directory number

rnndn—Routing number prefix and national dialed/directory number

rnsdn—Routing number prefix and subscriber dialed/directory number

ccrndn—Country code, routing number, and national directory number

none—The nsnai is not associated with the new DSM service.

Default: No change to existing value.

:nsnp= (optional)

The new service numbering plan.

Range: **e164**, **e212**, **e214**, **none**
e164—E.164 numbering plan
e212—E.212 numbering plan
e214—E.214 numbering plan
none—The **nsnp** is not associated with the new DSM service.

Default: No change to existing value.

Example

```
chg-srvsel:gti=2:tt=10:nserv=gflex
chg-srvsel:gtin=2:tt=253:nserv=inpq
chg-srvsel:gtin=4:tt=0:np=e164:nai=intl:nsnp=e164:nsnai=rmidn
chg-srvsel:gtin=4:tt=0:np=e164:nai=sub:nsnp=e164:nsnai=rnsdn:nserv=inpqr
chg-srvsel:gtin24=4:tt=4:np=e164:nai=intl:nsnai=rmidn
chg-srvsel:gtii=4:tt=4:np=e164:nai=intl:ssn=10:nserv=eir
```

Dependencies

The G-Flex feature must be turned on before the **nserv=gflex** parameter can be specified.

The INP feature must be turned on before the **nserv=inpqr** or **nserv=inpq** parameter can be specified.

The G-Port feature must be turned on before the **nserv=gport** parameter can be specified.

The Prepaid SMS Intercept (PPSMS) Phase 1 feature must be turned on before the **nserv=smsmr** parameter can be specified.

The Portability Check for Mobile Originated SMS feature must be turned on before the **nserv=mnpsms** parameter can be specified.

The Equipment Identity Register (EIR) feature must be turned on before the **nserv=eir** parameter can be specified.

At least one of the following parameters must be specified: **nsnp**, **nsnai**, or **nserv**.

The values **1** and **3** are not valid for the **gti/gtia/gtii/gtin/gtin24** parameters.

The value **4** is not valid for the **gtia** parameter.

When the **gti/gtia/gtii/gtin/gtin24=2** parameter is specified, no **np(v)** and **nai(v)** parameter combinations can be specified.

When the **gtii/gtin/gtin24=4** parameter is specified, an **np(v)** and **nai(v)** parameter combination must be specified. The parameters can be specified in these combinations: **np** and **naiv**, **npv** and **nai**, **np** and **nai**, or **npv** and **naiv**.

The **np** and **npv** parameters cannot be specified together in the command.

The **nai** and **naiv** parameters cannot be specified together in the command.

When the **nserv** parameter value is **inpqr**, **inpq**, **gport**, **eir**, **mnpsms**, or **smsmr**, the **gtia** and **gti** parameters cannot be specified.

When the **nserv=inpqr** parameter is specified, the **nsnp=e164** parameter must be specified.

When **nsnai** parameter value **rmidn**, **rncdn**, or **rnsdn** is specified, an **nserv** parameter value of **inpmr**, **gport**, **smsmr**, or **mnpsms** must be specified.

When **nserv=inpq** is specified, the **gtii** parameter cannot be specified.

When **nserv=gport** is specified, the **gtia** and **gti** parameters cannot be specified.

When the **nserv** parameter value **inpq** or **eir** is specified, the **nsnai** and **nsnp** parameters cannot be specified.

When **nserv=gflex** is specified, **nsnai=none** and **nsnp=none** cannot be specified.

When **nserv=inpmr** is specified, the **nsnai** parameter must be specified.

An entry must already exist that exactly matches the **gti/gtii/gtin/gtin24**, **tt**, **ssn**, **np(v)**, and **nai(v)** combination of parameters.

When **nsnai=ccrncdn** is specified, the **nserv** parameter value **gport**, **mnpsms**, or **smsmr** must be specified.

When the **nserv** parameter value **inpmr**, **smsmr**, **mnpsms**, or **gport** is specified, **nsnp=e164** must be specified.

When the **nserv** parameter value **gflex**, **gport**, **inpmr**, **mnpsms**, or **smsmr** is specified, the **nsnai** and **nsnp** parameters must be specified.

The **nsnai=none** parameter can be specified only when **nserv=inpq** is specified.

An ITU Service Selector cannot be entered when the **ansigflex** STP option is enabled (see the **chg-stpotps** command).

When the **nserv=idpr** parameter is specified, the Prepaid IDP Query Relay feature must be on.

When the **nserv=idpr** parameter is specified, the only valid mandatory service parameters are **tt**, **serv**, **ssn**, **gtii** and **gtin**.

When the **nserv=idpr** parameter is specified, the only valid optional parameters are **np** and **nai**.

When the **nserv=idps** parameter is specified, the IDP Screening for Prepaid feature must be on.

When the **nserv=idps** parameter is specified, the only valid mandatory service parameters are **tt**, **serv**, **ssn**, **gtin**, and **gtii**.

When the **nserv=idps** parameter is specified, the only valid optional service parameters are **np** and **nai**.

Notes

None

Output

chg-srvsel:gti=2:tt=10:nserv=gflex

```
rlghncxa03w 04-01-05 16:40:40 EST EAGLE 31.3.0
Service Selector table is (114 of 1024) 11% full
CHG-SRVSEL: MASP A - COMPLTD
```

;

chg-ss-appl**Change Subsystem Application**

Use this command to change the application status in the database.

Keyword: **chg-ss-appl**

Related Commands: **dlt-ss-appl**, **ent-ss-appl**, **rtv-ss-appl**

Command Class: Database Administration

Parameters

:appl= (mandatory)

Application type.

Range: **lnp, inp, eir**

:nstat= (optional)

Status.

Range: **offline, online**

Example

```
chg-ss-appl:appl=lnp:nstat=offline
```

```
chg-ss-appl:appl=inp:nstat=online
```

```
chg-ss-appl:appl=eir:nstat=online
```

Dependencies

The LNP feature must be turned on (see the **enable-ctrl-feat** command) before the **chg-ss-appl:appl=lnp** command can be entered.

The INP feature must be turned on before the **chg-ss-appl:appl=inp** command can be entered.

The Equipment Identity Register (EIR) feature must be turned on before the **chg-ss-appl:appl=eir** command can be entered.

The application type (**appl** parameter) must already exist in the SS-APPL table.

The subsystem must be in the opposite state of the requested change.

The subsystem must be inhibited before **status=offline** can be specified.

Notes

After the LNP subsystem is inhibited before performing an LNP ELAP bulk download, **chg-ss-appl:appl=lnp:nstat=offline** must be entered to ensure that the subsystem remains down through DSM card replacements and reloads.

Output

```
chg-ss-appl:appl=lnp:nstat=offline
```

```
rlghncxa03w 04-01-05 16:40:40 EST EAGLE 31.3.0
CHG-SS-APPL: MASP A - COMPLTD
```

```
;
```

chg-ss7opts

Change SS7 Options

Use this command to update (change by simple replacement) the values of one or more of the SS7 option indicators maintained in the STP Options table. SS7 options can modify normal handling of SS7 traffic.

Keyword: `chg-ss7opts`

Related Commands: `rtrv-ss7opts`

Command Class: Database Administration

Parameters

:discardtfc= (optional)

This parameter enables and disables the handling of TFC traffic from ITU-I networks. If enabled, TFC traffic from ITU-I networks will be discarded.

Range: `on, off`

`on`—Discard TFC ITU-I traffic

`off`—Do not discard TFC ITU-I traffic

Default: `off`

:discardtfcn= (optional)

This parameter enables and disables the handling of TFC traffic from ITU-N networks. If enabled, TFC traffic from ITU-N networks will be discarded.

Range: `on, off`

`on`—Discard TFC ITU-N traffic

`off`—Do not discard TFC ITU-N traffic

Default: `off`

:lsrestrict= (optional)

NOTE: This parameter is not available for use at this time.

Use the restricted linkset routing determination algorithm. This parameter enables and disables the restricted linkset routing determination algorithm on a system-wide basis.

Range: `on, off`

`on`—Restrictive linkset routing enabled; route traffic on the least restrictive available route with the lowest cost.

`off`—Restrictive linkset routing disabled; route traffic on the lowest cost route.

Default: Current value in the database.

System Default: `off`

Example

```
chg-ss7opts:lsrestrict=on
```

Dependencies

At least one optional parameter must be specified.

When the `lsrestrict` option is `on`, the `tfatcabmlq` parameter value for C linksets can be changed to a non-zero value (see the `chg-ls` command). If the `tfatcabmlq` parameter in any C linkset has been changed to a non-zero value, the `tfatcabmlq` value must be set back to `0` for all C linksets before the `lsrestrict` option can be turned off.

Notes

None

Output

```

chg-ss7opts:lsrestrict=yes
rlghncxa03w 05-06-29 16:40:40 EST EAGLE 31.11.0
CHG-SS7OPTS: MASP A - COMPLTD
;

```

chg-stpopts**Change STP Options**

Use this command to change the values of one or more of the STP node level processing option indicators maintained in the STP's options table. All values are assigned initially to system defaults at STP installation time, and they may be updated subsequently using this command.

NOTE: For those STP option attributes supporting STP event message throttling, the values for the indicated parameters shall become effective in the next event-message output interval following their activation. All other updates shall be effective immediately, as of the time of activation.

Keyword: chg-stpopts

Related Commands: rtrv-stpopts

Command Class: Database Administration

Parameters

:ansigflex= (optional)

Enables ANSI G-Flex to execute at 1700 TPS per DSM card.

Range: yes, no

yes—Enabled

no—Disabled

Default: Current value

System Default: no

:cnvcgda= (optional)

Enables discarding of the CGPA point code in ANSI SCCP messages if the point code or alias point code of the destination network type is not defined.

Range: yes, no

yes—Enabled

no—Disabled

Default: Current value

System Default: no

:cnvcgdi= (optional)

Enables discarding of the CGPA point code in ITU-I SCCP messages if the point code or alias point code of the destination network type is not defined.

Range: yes, no

Default: Current value

System Default: no

:cnvcgdn= (optional)

Enables discarding of the CGPA point code in ITU-N SCCP messages if the point code or alias point code of the destination network type is not defined.

Range: yes, no

Default: Current value

System Default: **no**

:cnvcgdn24= (optional)

Enables discarding of the CGPA point code in ITU-N24 SCCP messages if the point code or alias point code of the destination network type is not defined.

Range: yes, no

Default: Current value

System Default: **no**

:critalminh= (optional)

Allow inhibiting of critical alarms.

Range: yes, no

yes—enabled

no—disabled

Default: Current value

System Default: **no**

:defcc= (optional)

The default country code.

Range: 1–3 digits (0–9, A–F, a–f), none

Default: Current value

:defndc= (optional)

The default network destination code.

Range: 1–5 digits (0–9, A–F, a–f), none

Default: Current value

:dispactalms= (optional)

Display active or total alarms in the alarm status area of the VT320 screen (see Figure 4-1 on page 4-4). The alarm status area comprises four boxes to show counts for critical, major, minor, and inhibited alarms. When total alarms are displayed (**dispactalms=no**), the counts for critical, major, and minor alarms include any temporarily or permanently inhibited alarms. The alarm status area is labeled *Total Alarm Status*. When active alarms are displayed (**dispactalms=yes**), the counts for critical, major, and minor alarms do not include any temporarily or permanently inhibited alarms. The alarm status area is labeled *Active Alarm Status*. This parameter does not affect the count displayed in the inhibited box; the number of inhibited alarms is always displayed.

Range: yes, no

yes—enabled: active alarm status is displayed

no—disabled: total alarm status is displayed

Default: Current value

System Default: **no**

:dsmaud= (optional)

The DSM audit running state. Refer to the *EPAP Administration Manual* for more information about the DSM checksum audit.

Range: **on, off, ccc**

on—Running

off—Not running

ccc—Running with Corruption Cross Correction enabled. EAGLE 5 SAS LNP. G-Flex, G-Port, and INP systems contain $n+1$ DSM cards (maximum 25) running the VSCCP application. Each of the VSCCP DSM cards contains a full image of the RTDB database. If a record within the RTDB database on any card should become corrupted, a mate VSCCP DSM card can supply the corrected data. The **dsmaud=ccc** parameter enables the Corruption Cross Correction function used by the system to obtain the correct data from a mate DSM.

Default: Current value

:force= (optional)

Specify **force=yes** to change the **hsclksrc** parameter value when the TDMs are reporting that the high speed system clocks are currently valid.

Range: **yes**

:gr2878rglbl= (optional)

Select HSL register labels and data for EAGLE 5 SAS supported registers in measurement reports to SEAS.

Range: **yes, no**

yes—Use GR-2878-CORE HSL labels and data in SEAS output

no—HSL labels and data are not supported to SEAS

Default: Current value

System Default: **no**

:gsmdflt= (optional)

GSM MAP screening default action.

Range: **pass, discard**

Default: Current value

System Default: **pass**

:gsmdecerr= (optional)

GSM MAP screening decode error action.

Range: **pass, discard**

Default: Current value

System Default: **pass**

:gtcnvdfilt= (optional)

Enables routing of SCCP messages using system defaults when an appropriate entry is not found in the Default GT Conversion Table

Range: **yes, no**

Default: Current value

System Default: **no**

:hscclkll= (optional)

High speed master clock line length.

Range: **longhaul, shorthaul**
longhaul—Gain is high for long haul
shorthaul—Gain is low for short haul

Default: Current value
 System Default: **longhaul**

:hscclksrc= (optional)

High speed master clock source. The **force=yes** parameter must be specified with this parameter to change the clock source when the TDMs are reporting that the high speed system clocks are currently valid.



CAUTION: Changing the high speed master clock source can result in clock outage and loss of traffic on all links, if the new source type does not match the provisioned source for the E1 or T1 cards (what is actually plugged into the backplane).

Range: **rs422, e1framed, e1unframed, t1framed, t1unframed**
rs422—RS-422 clock source
e1framed—E1 Framed clock source
e1unframed—E1 Unframed clock source
t1framed—T1 Framed clock source
t1unframed—T1 Unframed clock source

Default: Current value
 System Default: **rs422**

:mtpdpcq= (optional)

MTP destination point code quantity. The maximum number of DPCs that can be provisioned from the STP. The value of this parameter is dependent directly on the number of x-list entries that can be provisioned using the **mtpxlq** parameter. If the number of destinations that can be provisioned is increased, the number of x-list entries that can be maintained is decreased.

Range: **500-2000**—if DSTN5000 feature is not turned on
500-5000—if DSTN5000 feature is turned on
500-6000—if 6000 Routesets feature is enabled
500-7000—if 7000 Routesets feature is enabled
500-8000—if 8000 Routesets feature is enabled

Default: Current value
 System Default: **2000**

:mtpלטdpcq= (optional)

MTP loop test congestion trigger DPC quantity. The number of most frequently occurring DPCs to which the MTP loop test messages are to be sent when the MTP loop test is triggered by congestion.

Range: **3-10**

Default: Current value
 System Default: **3**

:mtpлrst= (optional)

MTP low priority route set test. Specifies whether low priority route set polling is enabled or disabled at the STP.

Range: **yes, no**
yes—enabled
no—disabled

Default: Current value
System Default: **yes**

:mptlti= (optional)

MTP loop test indicator. Specifies whether the MTP loop detection procedures are enabled or disabled at the STP.

Range: **yes, no**
yes—enabled
no—disabled

Default: Current value
System Default: **yes**

:mptlst= (optional)

MTP loop test supervision timer. The amount of time, in milliseconds, that the MTP loop test detection procedures run when started.

Range: **10000–20000** (milliseconds)

Default: Current value
System Default: **10000**

:mptrsi= (optional)

MTP Restart indicator. Specifies whether MTP Restart procedures (both ANSI and ITU) are enabled or disabled at the STP.

Range: **yes, no**
yes—enabled
no—disabled

Default: Current value
System Default: **no**

:mptrsit= (optional)

ANSI MTP Restart isolation timer. The minimum duration of node isolation, in milliseconds, before the ANSI MTP Restart procedure is deemed necessary.

Range: **2000–900000** (milliseconds)

Default: Current value
System Default: **5000**

:mpt10alt= (optional)

MTP T10 alternate timer. Specifies the interval at which the STP performs a route set test on low priority routes. The value of the **mpt10alt** parameter must be equal to or greater than the value of the level 3 T10 timer.

Range: **20000–10000000** (milliseconds)

Default: Current value
System Default: **30000**

:mpt31ctl= (optional)

MTP T31 congestion trigger level. The signaling link congestion level at which the system starts the level 3 t31 timer. When the level 3 t31 timer expires, the associated signaling link is removed from service for realignment.

Range: 1, 2

Default: Current value
System Default: 1

:mtpxlet= (optional)

MTP x-list expiration time. The maximum amount of time the system maintains an unreferenced dynamic status exception list (x-list) entry.

Range: 0020–2400

Default: Current value
System Default: 0100

:mtpxlot= (optional)

MTP x-list occupancy threshold. The dynamic status exception list (x-list) occupancy threshold at which the system raises a minor alarm. The threshold is expressed as a percentage of space available.

Range: 0–100

Default: Current value
System Default: 90

:mtpxlq= (optional)

MTP x-list quantity. The number of dynamic status exception list (x-list) entries the system maintains. The value of this parameter is dependent directly on the number of destinations that are provisioned using the **mtpdpcq** parameter.

Range: 500–2000—if DSTN5000 feature is not turned on
500–5000—if DSTN5000 feature is turned on
500–6000—if 6000, 7000, or 8000 Routesets feature is enabled

Default: Current value
System Default: 500

:npcfnti= (optional)

The ITU National Point Code Format Identifier. Defines how the ITU national point code is entered into the database and how it is displayed in any outputs from the system. The ITU national point code is a 14-bit integer. The point codes can be a single number up to five digits, or two, three, or four numbers separated by dashes. This parameter specifies the number of bits to allow in each position of the four members.

Range: *m1-m2-m3-m4*

Four members where each member represents the number of bits allowed in the corresponding position for a flexible ITU national point code. The range of each member (*m1-m4*) is from 0 to 14. Each member must be specified no matter how many numbers the point code format contains, and the sum of *m1+m2+m3+m4* must equal 14 (for example, **npcfnti=7-7-0-0**, or **npcfnti=0-6-8-0**). Table 5-31 defines the values of the parts of the ITU national point code.

Table 5-31. NPCFMTI Parameter - ITU National Point Code Values

Number of Bits in Point Code Section								
Bit	0	1	2	3	4	5	6	7
Range of Values	Not Used	0-1	0-3	0-7	0-15	0-31	0-63	0-127
Bit	8	9	10	11	12	13	14	
Range of Values	0-255	0-511	0-1023	0-2047	0-4095	0-8191	0-16383	

Table 5-32 shows the range of values for some example point code formats.

Table 5-32. Point Code Format Examples

NPCFMTI Value	Range of Point Code Values
7-7-0-0	0-0 to 127-127
0-6-8-0	0-0 to 63-255
0-0-4-10	0-0 to 15-1023
3-8-3-0	0-0-0 to 7-255-7
2-9-2-1	0-0-0-0 to 3-511-3-1
4-4-4-2	0-0-0-0 to 15-15-15-3
14-0-0-0	00000 to 16385

Default: Current value
System Default: **14-0-0-0**

:randsls= (optional)

Random SLS (signaling link selection) feature. The feature lets the EAGLE 5 SAS ignore the incoming SLS value and randomly generate a new SLS value to select an outgoing linkset and a link. If this option is selected, the option only applies to ITU SCCP messages. The feature also lets the user restrict Random SLS generation to Class 0 messages only. The feature is implemented independent of the ITU SLS Enhancement feature settings for individual linksets. These settings are defined by the **slsocbit** (Use of the Other CIC BIT capability) and **slsrsb** (SLS Bit Rotation capability) parameters of the **ent-ls** and **chg-ls** commands. When this feature is turned on with either the **randsls=all** or **randsls=class0** parameters, the SLS Bit Rotation capability (set with the **slsrsb** parameter of the **ent-ls** or **chg-ls** commands) will be overridden, and cannot be used on individual linksets. Note that the **ent-ls** or **chg-ls** commands do not prevent the user from provisioning with the **slsrsb** parameter.

Range: **class0, all, off**

Default: Current value
System Default: **off**

:rptlnpmrss= (optional)

Report LNP MR SS unequipped. This parameter specifies whether to generate UIN 1049 for LNP message relay (MR) messages with missing subsystems. If no MAP entry is found from a GTT done on an LNP MR message, the UIM is either displayed (**rptlnpmrss=yes**) or suppressed (**rptlnpmrss=no**). This setting applies only to LNP MR messages. All other messages display UIM 1049 when no MAP entry is found, regardless of this setting.

Range: **yes, no**

yes—Display UIM 1049 for all messages.

no—Do not display UIM 1049 for LNP MR with missing subsystems.

Default: Current value

System Default: **yes**

:rstrdev= (optional)

Allow restoration of device states when the **init-sys** command is executed and when an OAM role change occurs; maintains the inhibited state of terminals, links, and cards through an **init-sys** execution, OAM role change, and card reload.

Range: **on, off**

Default: Current value

System Default: **off**

:secmtpmate= (optional)

Enables security screening for MTP messages received by an STP on a non-C-Link, with an OPC equal to the SID (True, Adjacent, or Capability) point code of its mate.

Range: **off, notify, silent, test**

off—Screening is disabled; message is processed normally.

notify—Screening is enabled; UIM is generated and message is discarded.

silent—Screening is enabled; message is discarded. No UIM is generated.

test—Screening is enabled; UIM is generated and message is processed normally.

Default: Current value

System Default: **off**

:secmtpsid= (optional)

Enables security screening for MTP messages received at MTP3 containing an OPC equal to its own SID (OPC that is the True, Secondary, or Capability point code entered in the **chg-sid** command) that is not a route-set-congestion-message. The EAGLE 5 SAS should not receive a message with its own OPC unless the message is a result of a circular route test or is an SLTM when the far end is in loopback. (SLTM messages are not checked).

Range: **off, notify, silent, test**

off—Screening is disabled; message is processed normally.

notify—Screening is enabled; UIM is generated and message is discarded.

silent—Screening is enabled; message is discarded. No UIM is generated.

test—Screening is enabled; UIM is generated and message is processed normally.

Default: Current value

System Default: **off**

:secmtpsnm= (optional)

Enables security screening for MTP SNM messages. The EAGLE 5 SAS should not receive an MTP network management message unless:

- The OPC is an adjacent point code. (For all link types, this rule does not apply to UPU, TFC, and RCT messages).
- The EAGLE 5 SAS has a route to the OPC of the MTP network management message on the linkset which the message was received.
- The EAGLE 5 SAS has a route to the destination field in the message (if applicable to the concerned message) on the linkset which the message was received. (For all link types, this rule is not applicable to RST messages).

Range: **off, notify, silent, test**

off—Screening is disabled; message is processed normally.

notify—Screening is enabled; UIM is generated and message is discarded.

silent—Screening is enabled; message is discarded. No UIM is generated.

test—Screening is enabled; UIM is generated and message is processed normally.

Default: Current value

System Default: **off**

:secscpcsmg= (optional)

Enables security screening for SCCP SCMG messages. The EAGLE 5 SAS should not receive an SCCP network management message unless:

- The EAGLE 5 SAS has a route to the OPC of the SCMG message on the linkset on which the message was received.
- The EAGLE 5 SAS has a route to the Affected Point Code (also called the Concerned Point Code in EAGLE 5 SAS) in the message on the linkset on which the message was received.

This parameter applies only to SSP and SOR messages. SSA, SST, SOG, SBR, SNR and SRT messages are not affected.

Range: **off, notify, silent, test**

off—Screening is disabled; message is processed normally.

notify—Screening is enabled; UIM is generated and message is discarded.

silent—Screening is enabled; message is discarded. No UIM is generated.

test—Screening is enabled; UIM is generated and message is processed normally.

Default: Current value

System Default: **off**

:slscnv= (optional)

Per node SLS conversion indicator.

Range: **on, off, perls**

on—SLS conversion is enabled on all linksets.

off—SLS conversion is disabled on all linksets.

perls—SLS conversion is enabled on a per-linkset basis.

Default: Current value

:tfatfrpr= (optional)

TFA/TFR pacing rate. The amount of time, in milliseconds, between partial broadcasts of up to 20 percent increments of the number of TFAs/TCAs or TFRs/TCRs to be broadcast by the STP when an affected destination becomes accessible using its primary route rather than an alternate route. The STP uses this pacing to prevent congestion on the newly recovered linksets.

Range: 0–1000 (in increments of 100 ms)

Default: Current value

System Default: 1000

:uimrd= (optional)

Unsolicited Information Message (UIM) redirect indicator. Specifies whether UIMs are to be routed to this output group.

Range: yes, no

yes—enabled

no—disabled

Default: Current value

System Default: no

Example

```
chg-stpopts:mtpt31ctl=2:uimrd=yes
chg-stpopts:mtpxlq=1000:mtpxlet=0200:mtpxlot=75
chg-stpopts:criticalminh=yes
chg-stpopts:npcfmti=4-4-4-2
chg-stpopts:defcc=49:defndc=177
chg-stpopts:randsls=all
chg-stpopts:rptlnpmrсс=no
chg-stpopts:rstrdev=on
chg-stpopts:hsclksrc=t1framed
chg-stpopts:hsclksrc=e1unframed:force=yes
chg-stpopts:hsckll=shorthaul
chg-stpopts:ansigflex=yes
chg-stpopts:cnvcgda=yes
chg-stpopts:gcnvdfilt=yes
```

Dependencies

At least one optional parameter must be specified.

The ANSI-ITU-China SCCP Conversion feature must be enabled before the **cnvcgda**, **cnvcgdi**, **cnvcgdn**, **cnvcgdn24** or **gcnvdfilt** parameters can be specified.

The G-Port, INP, and EIR features must be off before the **ansigflex** option can be enabled.

The G-Flex feature must be on before the **ansigflex** option can be enabled.

The **ansigflex** option cannot be enabled when Service Selector table contains an ITU entry. (See the **chg-srvsel** command).

The **hsclksrc** parameter values **t1unframed**, **t1framed**, **e1unframed**, and **e1framed** cannot be specified if either TDM is a version that does not support the Global Timing Interface feature (both TDMs must be TDM-15 or later, with the Global Timing Interface **bpcdm** GPL loaded).

If changing the **hsclksrc** parameter value will cause system clocks to fail that are required to keep links active or TSCSYNC available, the **force=yes** parameter must also be specified. The **force=yes** parameter can be specified only with the **hsclksrc** parameter. Clocks are required in the following situations:

- When at least one DS0 card is provisioned, one BITS clocks is required.
- When a high speed link is being master-timed, at least one high speed clock is required.
- When TSCSYNC is turned on, both SYSTEM clocks (A&B) are required.

The **hskll** parameter cannot be specified if either TDM is a version that does not support the Global Timing Interface feature (both TDMs must be TDM-15 or later, with the Global Timing Interface **bpcdm** GPL loaded).

The **mtpxlet** parameter must be specified in the one of the following formats: *mm*, *hmm*, *hhmm*, where *m* is minutes and *h* is hours. For example, **43** is 43 minutes, **138** is 1 hour 38 minutes, and **2400** is 24 hours.

When the **mtpxlet** parameter is specified, the value for minutes (*mm*) must be in the range **00-59**.

The values of the **mtpxlq** and **mtpdpcq** parameters are interdependent; that is, if you want to increase the number of DPCs that can be provisioned, you must decrease the number of x-list entries that the STP is to maintain. Conversely, if you increase the number of x-list entries that the STP maintains, you must decrease the number of DPCs that can be provisioned.

The DSTN5000 (5000 Routes) feature must be on before the **mtpdpcq** parameter value can be increased to more than **2000**.

When the number of x-list entries (**mtpxlq**) is specified, the total number of DPCs (**mtpdpcq**) and x-list entries provisioned cannot exceed the space available in the Route table.

When the number of DPCs (**mtpdpcq**) is specified, the total number of DPCs and x-list entries (**mtpxlq**) provisioned cannot exceed the space available in the Route table.

The number of DPCs provisioned (**mtpdpcq**) cannot be increased if space allocated for maintaining x-list entries becomes full.

The value for the **mtpdpcq** parameter cannot be less than the number of DPCs provisioned.

The **mtpxlq**, **mtpxlet**, and **mtpxlot** parameters can be specified only if the Cluster Routing and Management Diversity (CRMD) feature is turned on.

The maximum allowed number of destination point codes can be changed by the **mtpdpcq** parameter. The maximum value of the **mtpdpcq** parameter is one of the following values:

- **5000** if the DSTN5000 feature is on
- **6000**, **7000**, or **8000** if the respective 6000, 7000, or 8000 Routesets feature is enabled
- **2000** if no Routes or Routesets feature is on

If the Cluster Routing and Management Diversity feature is turned on, the maximum number of destination point codes contained in the exception list can be changed by the **mtpxlq** parameter. The maximum value of the **mtpxlq** parameter is one of the following values:

- **5000** if the DSTN5000 feature is on
- **6000** if the 6000, 7000, or 8000 Routesets feature is enabled
- **2000** if no Routes or Routesets feature is on

The sum of the values of the **mtpdpcq** and **mtpxlq** parameters can be increased beyond **2500** only if one or more of the following features is turned on:

- If the DSTN5000 feature is turned on (**chg-feat:dstn5000=on**), the **mtpdpcq** and **mtpxlq** parameters cannot exceed **5500**.
- If the 6000 Routesets feature is enabled (see the **enable-ctrl-feat** command), the **mtpdpcq** and **mtpxlq** parameters cannot exceed **6500**.
- If the 7000 Routesets feature is enabled (see the **enable-ctrl-feat** command), the **mtpdpcq** and **mtpxlq** parameters cannot exceed **7500**.
- If the 8000 Routesets feature is enabled (see the **enable-ctrl-feat** command), the **mtpdpcq** and **mtpxlq** parameters cannot exceed **8500**.

The **mtprsit** parameter can be specified only if the ANSI MTP restart (MTPRS) feature is turned **on**.

The **mtparsi** parameter can be specified only if the ANSI MTP restart (MTPRS) or ITU MTP restart (ITUMTPRS) feature is turned **on**.

A value for the **tfatfrpr** parameter must be specified in increments of 100 milliseconds (0.1 seconds).

To enter seconds (instead of milliseconds) for the timer values, the timer value must contain at least one decimal place, and can contain up to three decimal places. If no decimal places are entered, the system accepts the value as milliseconds. The **rtrv-stpopts** command always displays the output in milliseconds, not seconds.

Cluster x-list maintenance data must be accessible.

To specify the **criticalminh=no** parameter, critical alarms cannot be currently inhibited in the system.

If the **npcfnti** parameter is specified, it must be in the format $m1-m2-m3-m4$ and all members must be specified. If the ITU national point code format is to only have two members, then two members of the **npcfnti** parameter must be specified as greater than zero, while the other two members must be specified as 0 (for example, **npcfnti=7-7-0-0**, **npcfnti=0-6-8-0**, or **npcfnti=0-0-4-10**).

If **npcfnti** is specified, the sum of the values specified for $m1+m2+m3+m4$ must be equal to 14.

The G-Flex, G-Port, or INP feature must be turned on before the **defcc**, **defndc**, or **dsmaud** parameter can be specified.

The **defcc** parameter value cannot already exist as an entry in the GSM Options Multiple Country Code (**multcc**) list.

The **defcc** parameter cannot be set to **none** if a GSM Options Multiple Country Code (**multcc**) has been defined.

The GSM Map Screening feature must be turned on (see the **enable-ctrl-feat** and **chg-ctrl-feat** commands) before the **gsmdflt** or **gsmsdecerr** parameter can be specified.

The **secmtpmate**, **secmtpsid**, **secmtpsnm** and **secscpcscmg** parameters cannot be specified unless the Network Security Enhancements controlled feature has been enabled and turned on.

Notes

If the database contains ITU national point codes of a particular format, and the format is changed with the **npcfnti** parameter of the **chg-stpopts** command, the format of the ITU national point codes in the database will be changed to the new format.

The format defined by the **npcfnti** parameter applies to all database entities that use ITU national point codes except gateway screening. Gateway screening allows the ITU national point code to be displayed and entered in the database only as a single number. If the system is using a format for the ITU national point code other than a single number, the point code will have to be converted from its current format to a single number in order to be used by gateway screening. The conversion is explained in "Converting ITU National Point Code Formats" in Appendix A.

For the STP option attributes supporting STP event message throttling, the values for the indicated parameters become effective in the next event-message output interval following their activation. All other updates become effective at the time of activation (immediately).

When the **slscnv=on** parameter is specified with the **chg-stpopts** command, the node acts as if the 5-bit to 8-bit SLS conversion is being performed on every linkset in the database, even those linksets that have the **slsci=no** parameter specified for them.

When the **slscnv=off** parameter is specified with the **chg-stpopts** command, the node acts as if the 5-bit to 8-bit SLS conversion has been turned off for every linkset in the database, even those linksets that have the **slsci=yes** parameter specified for them.

When the **slscnv=perls** parameter is specified with the **chg-stpopts** command, the 5-bit to 8-bit SLS conversion is performed only on the linksets that have the **slsci=yes** parameter specified for them.

When the value of the **dispactalms** parameter is changed, there could be a delay of up to five seconds as the VT320 screen refreshes to the selected display.

EAGLE 5 SAS Clocks with TDM-GTI

Figure 5-9 shows a general schematic of clocking, without any of the redundant backup features, in the EAGLE 5 SAS with the TDM-GTI card. There are two types of input clocks that can be plugged into the control shelf backplane: low and high speed reference clocks. The TDM card takes these input clocks and uses them as timing references to generate the low and high speed clocks that are distributed to the cards in the EAGLE 5 SAS STP. These distributed clocks are used for various purposes depending on what types of links or features are provisioned.

Figure 5-9. EAGLE 5 SAS Input and Internal Clocks with TDM-GTI

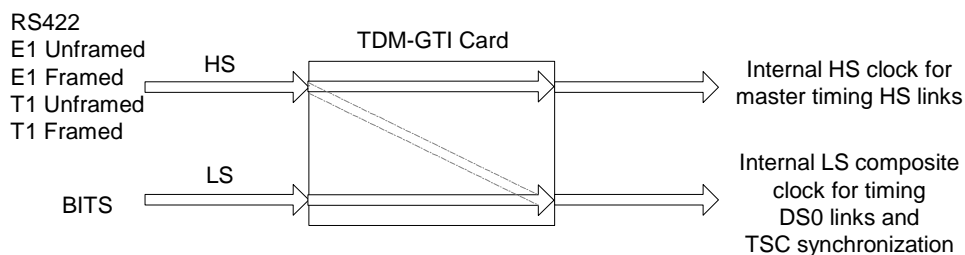

The high speed clock that is distributed to the cards in the EAGLE 5 SAS is used as the timing source only for high speed links that have been provisioned to use master timing. This clock can be derived only from the high speed input clock. Prior to TDM-GTI card the high speed input clock could be only the RS422 type. TDM-GTI adds the capability for this clock to be recovered from a framed or unframed E1 or T1 signal interface.

The low speed composite clock that is distributed to the cards in the EAGLE 5 SAS is used for timing DS0 links and for the Time Slot Counter Synchronization (TSCSYNC) feature that is required for the Sentinel product. Prior to TDM-GTI this low speed clock could be generated only from a BITS clock source plugged into the control shelf backplane. TDM-GTI can generate this low speed internal clock from the high speed input clock source, with the following restriction:

- When DS0 cards are provisioned in the system, the internal low speed clock can be generated only from a BITS clock as it is without TDM-GTI.
- When no DS0 cards are present and the BITS clocks are present and valid, the internal low speed clock is generated from the BITS clocks.
- When no DS0 cards are present and the BITS clocks are not present or not valid, the internal low speed clock is generated from the high speed input clock.

Output

```
chg-stpopts:mtpxlq=1000:mtpxlet=0200:mtpxlot=75
rlghncxa03w 04-07-07 11:43:04 EST EAGLE 31.6.0
CHG-STPOPTS: MASP A - COMPLTD
;
```

chg-t1**Change T1 Interface**

Use this command to change an interface for an E1/T1 MIM card or an HC-MIM card used as a T1 card. The T1 port number on the card and the T1 card location in the EAGLE 5 SAS must be specified.

Framing, line length, encoding, master/slave clocking options, and signaling bit setting can be specified.

On a HC-MIM card, T1 ports 1, 3, 5, and 7 (master ports) can be independently channel bridged with their adjacent even-numbered (slave) T1 ports 2, 4, 6, and 8 to allow non-signaling data pass-through.

Keyword: **chg-t1**

Related Commands: **dlt-t1, ent-t1, rtrv-t1, tst-t1**

Command Class: Database Administration

Parameters

:loc= (mandatory)

The card location as stenciled on the shelf of the system.

Range: **1101–1108, 1111–1112, 1201–1208, 1211–1218, 1301–1308, 1311–1318, 2101–2108, 2111–2118, 2201–2208, 2211–2218, 2301–2308, 2311–2318, 3101–3108, 3111–3118, 3201–3208, 3211–3218, 3301–3308, 3311–3318, 4101–4108, 4111–4118, 4201–4208, 4211–4218, 4301–4308, 4311–4318, 5101–5108, 5111–5118, 5201–5208, 5211–5218, 5301–5308, 5311–5318, 6101–6108, 6111–6118**

:t1port= (mandatory)

T1 port number. The value must be a T1 port for which an interface has already been configured on the specified T1 card.

Range: **1, 8**

Ports 3 through 8 can be specified only for HC-MIM cards.

:chanbrdg= (optional)

Indicates whether an HC-MIM odd numbered port is channel bridged with its adjacent even numbered port for non-signaling data pass through.

Range: **on, off**

Default: **off**

:encode= (optional)

Indicator for use of B8ZS or AMI encoding/decoding.

Range: **b8zs, ami**

Default: Current value

:framing= (optional)

Indicator for framing format.

Range: **sf, esf**

Default: Current value

:ll= (optional)

T1 cable length in feet between the EAGLE 5 SAS and the connecting node.

Range: **0 - 655**

Default: **133**

:t1tsel= (optional)

Timing source. Indicates master (external) or slave (line) timing source, or timing source recovered from the paired master port for the channel bridged slave port.

Range: line, external

Default: Current value

Example

```
chg-t1:loc=1205:t1port=1:encode=ami:t1tsel=external
```

```
chg-t1:loc=1205:t1port=2:encode=b8z:ll=250s
```

```
chg-t1:loc=1205:t1port=3:chanbrdg=on:t1tsel=recovered
```

Dependencies

At least one optional parameter must be specified.

The specified card location (**loc** parameter) must be equipped.

The card specified by the **loc** parameter must be a **limt1** card type.

The port specified by the **t1port** parameter must be already equipped with a T1 interface.

The **encode=ami** parameter can be specified only for an E1/T1 MIM card or an HC-MIM card.

All signaling links that are serviced by the specified T1 card must be deactivated before the values for the **encode**, **t1tsel**, **ll**, and **framing** parameters can be changed.

The **chanbrdg** parameter can be specified only for HC-MIM cards.

The **chanbrdg=on** parameter cannot be specified for HC-MIM card even-numbered T1 ports.

The **chanbrdg=on** parameter cannot be specified for HC-MIM card even-numbered card locations.

The timing source parameter **t1tsel** must be specified when **chanbrdg=on** is specified.

The **t1tsel=line** parameter cannot be specified when the specified HC-MIM T1 port is in channel bridging mode.

The **t1tsel=recovered** parameter cannot be specified when the specified HC-MIM T1 port is not in channel bridging mode.

The **t1port** parameter values **3** through **8** cannot be specified for an even-numbered HC-MIM card location.

The **force=yes** parameter must be specified to provision an odd-numbered T1 HC-MIM port to channel bridging mode if the adjacent even-numbered port is already provisioned with a T1 interface.

Parameter values cannot be changed for the even-numbered port interface in a channel bridged pair. The values must be changed in the odd-numbered port interface.

All signaling links assigned to its adjacent even-numbered T1 port must be deleted before an odd-numbered HC-MIM T1 port can be provisioned into channel bridging mode.

The fan feature bit must be on before HC-MIM cards can be used in an EAGLE 5 SAS shelf (see the **chg-feat** command). The system checks the fan feature bit when E1 or T1 ports 3 through 8 are specified.

HIPR cards must be equipped in card locations *xy09* and *xy10* (*x* is the frame, *y* is the shelf) on each shelf that contains one or more HC-MIM cards. The system checks for HIPR cards when E1 or T1 ports 3 through 8 are specified.

Notes

External timing is derived from the EAGLE 5 SAS High-Speed Master Clock (1.544 MHz for T1 or 2.048 MHz for E1); the Master Timing feature is required. Line timing is derived from its received data stream, if present.

Output

```
chg-t1:loc=1205:t1port=1:encode=ami:t1tsel=external
rlghncxa03w 04-01-20 09:07:58 EST EAGLE 31.3.0
CHG-T1: MASP A - COMPLTD
;
```

chg-th-alm

Change SCCP Alarm Thresholds

Use this command to change the alarm threshold values used by the system SCCP. The SCCP will alarm whenever the transactions-per-second (TPS) for the EAGLE 5 SAS (as a whole) exceeds the value set by this command. Additional Level 1 and Level 2 threshold alarms occur whenever provisioning levels of the TN, LRN, and LNP databases exceed predetermined occupancy limits, or the temperature of an HC-MIM card exceeds predetermined thermal limits.

NOTE: This command replaces the **chg-th-sccp** command, which is obsolete.

Keyword: **chg-th-alm**

Related Commands: **rtrv-th-alm**, **rept-stat-sccp**

Command Class: Database Administration

Parameters

:gttservlv1= (optional)

The percentage for the SCCP GTT Service error ratio level 1 (lower) Threshold Alarm.

Range: 1 - 100

Default 10

:gttservlv2= (optional)

The percentage for the SCCP GTT Service error ratio level 2 (lower) Threshold Alarm.

Range: 1 - 100 (must be greater than **gttservlv1**)

Default 20

:lnpdblvl1= (optional)

The percentage for the TN Database provisioned level 1 (lower) Capacity Threshold Alarm.

Range: 1 - 100

Default 80

:lnpdblvl2= (optional)

The percentage for the TN Database provisioned level 2 (upper) Capacity Threshold Alarm.

Range: 1 - 100

The specified value must be greater than the **lnpdblvl1** parameter value.

Default 90

:nongttservlv1= (optional)

The percentage for the SCCP Non-GTT Service (GPORT, GFLEX, EIR) error ratio level 1 (lower) Threshold Alarm.

Range: 1- 100

Default 10

:nongttservlv2= (optional)

The percentage for the SCCP Non-GTT Service (GPORT, GFLEX, EIR) error ratio level 2 (lower) Threshold Alarm.

Range: 1 - 100

Default 20

:sccptscap= (optional)

The percentage for the SCCP Load Capacity Threshold Alarm.

Range: 80

:sccpcalcmtld= (optional)

The TPS calculation method used to determine if the TPS Threshold Alarm levels have been exceeded or not.

Range: n, nplus1

n—All In Service Normal cards are used in the TPS calculation.

nplus1—All In Service Normal cards minus 1 card are used in the TPS calculation.

Default N

:thermallv1c= (optional)

The level 1 thermal limit for the HC-MIM cards, in degrees Celsius.

Range: 60 - 760

Default 75

:thermallv2c= (optional)

The level 2 thermal limit for the HC-MIM cards, in degrees Celsius.

Range: 60 - 82

Default 82

:thermallv1f= (optional)

The level 1 thermal limit for the HC-MIM cards, in degrees Fahrenheit.

Range: 140 - 167

Default 167

:thermallv2f= (optional)

The level 2 thermal limit for the HC-MIM cards, in degrees Fahrenheit.

Range: 142 - 180

Default 180

Example

```
chg-th-alm:lnptndblv1=85
chg-th-alm:sccptpscap=85
chg-th-alm:sccpcalcmtld=nplus1
chg-th-alm:gtservlv1=25:gtservlv2=28
```

Dependencies

The Thermal Alarm Level for **thermallv1f** must be less than the Thermal Alarm Level for the Fahrenheit equivalent of **thermallv2c** or the Celsius equivalent of **thermallv2f**.

The Thermal Alarm Level for **thermallv2f** must be greater than the Thermal Alarm Level for the Fahrenheit equivalent of **thermallv1c** or the Celsius equivalent of **thermallv1f**.

The Thermal Alarm Level for **thermallv1c** must be less than the Thermal Alarm Level for the **thermallv2c** or the Celsius equivalent of **thermallv2f**.

The Thermal Alarm Level for **thermallv2c** must be greater than the Thermal Alarm Level for the **thermallv1c** or the Celsius equivalent of **thermallv1f**.

The values for Thermal Alarm Level 1 and Level 2 cannot be the same.

Notes

All Fahrenheit Thermal Alarm Levels are converted to, stored, and displayed on the EAGLE 5 SAS in degrees Celsius. Slight differences may exist between the Fahrenheit temperature and the Celsius equivalent due to rounding.

The currently configured values for the Thermal Alarm Levels are displayed using the **rtrv-th-alm** command.

Output

```
chg-th-alm:sccptpscap=85
rlghncxa03w 05-01-07 11:43:04 EST EAGLE 34.0.0
CHG-TH-ALM: MASP A - COMPLTD
;
```

chg-th-sccp**Change SCCP Alarm Thresholds**

NOTE: This command is obsolete. Use the **chg-th-alm** command for these functions.

Use this command to change the value used for the system SCCP TPS (transactions-per-second) threshold alarm. An alarm (UAM 0330) triggers when the TPS for the EAGLE 5 SAS system is greater than the value set by the **chg-th-sccp** command. The alarm is a warning that the system is approaching the point where it might start losing global title transactions.

Keyword: **chg-th-sccp**

Related Commands: **rtrv-th-sccp**, **rept-stat-sccp**

Command Class: Database Administration

Parameters

:ldcap= (mandatory)
Load capacity in percentages.
Range: 0 - 100

Example

chg-th-sccp:ldcap=80

Dependencies

A threshold value must be set within the range of 0 to 100.

Notes

It is recommended that the threshold be set at 80%, which is the system default value for the **ldcap** parameter. It is recommended that the threshold is not set any higher than 90%, to allow time to obtain additional SCCP cards and reprovision the system if the TPS capacity is reached. Also, setting the threshold at too low a level can cause excessive alarms.

Output

```
chg-th-sccp:ldcap=80
rlghncxa03w 04-01-07 11:43:04 EST  EAGLE 31.3.0
Command entered at terminal #4.
Command Executed
;
```

chg-trm**Change Terminal**

Use the change terminal command to configure the operational characteristics of each of the 40 terminal ports used to connect modems, printers, and terminals to the system.

Keyword: **chg-trm**

Related Commands: **act-echo, canc-echo, chg-trm, dact-echo, inh-trm, rept-stat-trm, rmv-trm, rst-trm, rtrv-trm**

Command Class: Database Administration

Parameters

:trm= (mandatory)
The ID number of the terminal whose characteristics are to be changed.
Range: 1-40

:all= (optional)
Specifies whether you want to see unsolicited messages of all types (TRAF, LINK, SA, DB, SYS, PU, LNPDB, LNPSUB, UIMRD, APPSERV, APPSS, CARD, CLK, DBG, GTT, GWS, MEAS, MON, MPS, SEAS, SLAN) in the scroll area.

Range: **yes, no**
yes—Receive all.
no—Receive none.

The **all=no** parameter must be specified when the **type=oap** parameter is specified.

Default: **yes**—If **type=emsalm** is specified

Current value—if **type** parameter value is not **emsalm**

:appserv= (optional)

Specifies whether you want to see UAMs/UIMs assigned to the Application Server output group in the scroll area.

Range: **yes, no**

yes—Receive all.

no—Receive none.

Default: If **all** is specified—current **all** value

If **all** is not specified—current **appserv** value.

If **type=emsalm** is specified—**yes**

System Default: **no**

:appss= (optional)

Specifies whether you want to see UAMs/UIMs assigned to the Application Subsystem output group in the scroll area

Range: **yes, no**

yes—Receive all.

no—Receive none.

Default: If **all** is specified—current **all** value

If **all** is not specified—current **appss** value.

If **type=emsalm** is specified—**yes**

System Default: **no**

:baud= (optional)

The line speed (baud rate) for this terminal's serial port connection.

Range: **2400, 4800, 9600, 19200**

Default: If **type=oap**—**19200**

If **type** is not **oap**—no change to current value.

System Default: **9600**

:card= (optional)

Specifies whether you want to see UAMs/UIMs assigned to the Card output group in the scroll area.

Range= **yes, no**

yes—Receive all.

no—Receive none.

Default: If **all** is specified—current **all** value

If **all** is not specified—current **card** value.

If **type=emsalm** is specified—**yes**

System Default: **no**

:clk= (optional)

Specifies whether you want to see UAMs/UIMs assigned to the Clock output group in the scroll area.

Range: **yes, no**

yes—Receive all.
no—Receive none.

Default: If **all** is specified—current **all** value
If **all** is not specified—current **clk** value.
If **type=emsalm** is specified—**yes**
System Default: **no**

:db= (optional)

Specifies whether you want to see database-related unsolicited messages in the scroll area.

Range: **yes, no**

yes—Receive all.
no—Receive none.

Default: If **all** is specified—current **all** value
If **all** is not specified—current **db** value.
If **type=emsalm** is specified—**yes**
System Default: **no**

:dbg= (optional)

Specifies whether you want to see UAMs/UIMs assigned to the Debug output group in the scroll area.

Range: **yes, no**

yes—Receive all.
no—Receive none.

Default: If **all** is specified—current **all** value
If **all** is not specified—current **dbg** value.
If **type=emsalm** is specified—**yes**
System Default: **no**

:dural= (optional)

Terminal lockout time. Specifies the length of time the terminal is disabled after each failed login/unlock attempt in excess of the threshold configured on the **mxinv** parameter. The value can be specified as seconds (*ss*); minutes and seconds (*mmss*); or hours, minutes, and seconds (*hhmmss*).

Range: **0-59** (*ss*)
0-5959 (*mmss*)
0-995959 (*hhmmss*)
999999

Default: Current value.
System Default: **100** (1 minute, 0 seconds)

:fc= (optional)

The type of flow control used to regulate the flow of data between the system and an RS-232 connected device, so that no characters are lost (especially at high baud rates). The control setting of the system and the connected device must match.

Range: **hw, sw, both, or none**
hw—hardware flow control
sw—software flow control
both—hardware and software flow control
none—neither hardware nor software flow control

Default: If **type=oap**—**sw**
If **type** is **not oap**—no change to current value.
System Default: **sw**

:gtt= (optional)

Specifies whether you want to see UAMs/UIMs assigned to the GTT output group in the scroll area.

Range: **yes, no**
yes—Receive all.
no—Receive none.

Default: If **all** is specified—current **all** value
If **all** is not specified—current **gtt** value.
If **type=emsalm** is specified—**yes**
System Default: **no**

:gws= (optional)

Specifies whether you want to see UAMs/UIMs assigned to the GWS output group in the scroll area.

Range: **yes, no**
yes—Receive all.
no—Receive none.

Default: If **all** is specified—current **all** value
If **all** is not specified—current **gws** value.
If **type=emsalm** is specified—**yes**
System Default: **no**

:link= (optional)

Specifies whether you want to see link maintenance-related unsolicited messages in the scroll area.

Range: **yes, no**
yes—Receive all.
no—Receive none.

Default: If **all** is specified—current **all** value
If **all** is not specified—current **link** value.
If **type=emsalm** is specified—**yes**
System Default: **no**

:lnpdb= (optional)

LNP database. Specifies whether you want to see LNP database-related autonomous messages in the scroll area.

Range: **yes, no**
yes—Receive all.
no—Receive none.

Default: If **all** is specified—current **all** value
If **all** is not specified—current **lnpdb** value.
If **type=emsalm** is specified—**yes**
System Default: **no**

:lnpsub= (optional)

LNP subscription. Specifies whether you want to see LNP subscription-related autonomous messages in the scroll area.

Range: **yes, no**
yes—Receive all.
no—Receive none.

Default: If **all** is specified—current **all** value
If **all** is not specified—current **lnpsub** value.
If **type=emsalm** is specified—**yes**
System Default: **no**

:meas= (optional)

Specifies whether you want to see UAMs/UIMs assigned to the Measurements Maintenance output group in the scroll area.

Range: **yes, no**
yes—Receive all.
no—Receive none.

Default: If **all** is specified—current **all** value
If **all** is not specified—current **meas** value.
If **type=emsalm** is specified—**yes**
System Default: **no**

:mon= (optional)

Specifies whether you want to see UAMs/UIMs assigned to the Monitor output group in the scroll area.

Range: **yes, no**
yes—Receive all.
no—Receive none.

Default: If **all** is specified—current **all** value
If **all** is not specified—current **mon** value.
If **type=emsalm** is specified—**yes**
System Default: **no**

:mps= (optional)

Specifies whether you want to see UAMs/UIMs assigned to the MPS output group in the scroll area.

Range: **yes, no**
yes—Receive all.
no—Receive none.

Default: If **all** is specified—current **all** value
If **all** is not specified—current **mps** value.
If **type=emsalm** is specified—**yes**
System Default: **no**

:mxinv= (optional)

Login/unlock failure threshold. When a login or unlock failure occurs on a terminal, a counter of successive login failures is incremented by one. After the increment, if the counter is greater than or equal to the **mxinv** parameter value, the system sends an information message to all system administrator ports and locks out the port temporarily. The port is locked out for an interval that is specified in the **dural** parameter.

To disable the info message and temporary lockout function for the terminal, specify **mxinv=0**.

Range: 0-9

Default: Current value.

System Default: 5 (successive failed login/unlock attempts)

:prty= (optional)

The parity for this terminal's serial port connection.

Range: none, even, odd

Default: If **type=oap**—even

If **type** is not **oap**—current value.

System Default: even

:pu= (optional)

Specifies whether you want to see program update-related unsolicited messages in the scroll area.

Range: yes, no

yes—Receive all.

no—Receive none.

Default: If **all** is specified—current **all** value

If **all** is not specified—current **pu** value.

If **type=emsalm** is specified—**yes**

System Default: no

:sa= (optional)

Specifies whether you want to see security administration-related unsolicited messages in the scroll area.

Range: yes, no

yes—Receive all.

no—Receive none.

Default: If **all** is specified—current **all** value

If **all** is not specified—current **sa** value.

If **type=emsalm** is specified—**yes**

System Default: no

:sb= (optional)

The number of stop bits used in communications with the terminal.

Range: 1 or 2

Default: If **type=oap**—1

If **type** is not **oap**—current value.

System Default: even

:seas= (optional)

Specifies whether you want to see UAMs/UIMs assigned to the SEAS Maintenance output group in the scroll area.

Range: **yes, no**

yes—Receive all.
no—Receive none.

Default: If **all** is specified—current **all** value
If **all** is not specified—current **seas** value.
If **type=emsalm** is specified—**yes**
System Default: **no**

:slan= (optional)

Specifies whether you want to see UAMs/UIMs assigned to the SLAN Maintenance output group in the scroll area.

Range: **yes, no**

yes—Receive all.
no—Receive none.

Default: If **all** is specified—current **all** value
If **all** is not specified—current **slan** value.
If **type=emsalm** is specified—**yes**
System Default: **no**

:sys= (optional)

Specifies whether you want to see system maintenance-related unsolicited messages in the scroll area.

Range: **yes, no**

yes—Receive all.
no—Receive none.

Default: If **all** is specified—current **all** value
If **all** is not specified—current **sys** value.
If **type=emsalm** is specified—**yes**
System Default: **no**

:tmout= (optional)

Maximum channel idle time. Specifies the maximum amount of time that a login session can remain idle (that is, no user input) on a terminal before being automatically logged off. To disable idle time monitoring for a terminal, specify **tmout=0**.

Range: **0-99 (min.)**

Default: Current value.
System Default: **30** (minutes)

:traf= (optional)

Specifies whether you want to see traffic-related unsolicited messages displayed in the scroll area.

Range: **yes, no**

yes—Receive all.
no—Receive none.

Default: If **all** is specified—current **all** value
 If **all** is not specified—current **traf** value
 If **type=emsalm** is specified—**yes**
 System Default: **no**

:type= (optional)

The type of device being connected to this terminal.

Range: **vt320, ksr, oap, printer, sccs, mgmt, telnet, emsalm, none**

The **type=emsalm** parameter value is valid for terminals 1-40.

Only **telnet, emsalm, and none** are valid values for terminals 17 - 40.

The **all=no** parameter must be specified when the **type=oap** parameter is specified.

Default: Current value.

System Default: **v1320** for terminals 1 - 16

System Default: **telnet** for terminals 17 -40

:uimrd= (optional)

Specifies whether you want to see the unsolicited messages assigned to this group.

Range: **yes, no**

yes—Receive all.

no—Receive none.

Default: If **all** is specified—current **all** value

If **all** is not specified—current **uimrd** value.

If **type=emsalm** is specified—**yes**

System Default: **no**

Example

```
chg-trm:trm=8:type=oap:all=no
```

```
chg-trm:trm=2:all=yes
```

```
chg-trm:trm=13:type=ksr:baud=9600:uimrd=yes
```

```
chg-trm:trm=1:link=yes:sys=yes:db=yes:lnpdb=yes
```

```
chg-trm:trm=17:all=yes
```

```
chg-trm:trm=22:type=none
```

```
chg-trm:trm=22:type=emsalm
```

```
chg-trm:trm=10:link=yes:card=yes:clk=yes
```

```
chg-trm:trm=1:type=ksr:gtt=yes
```

```
chg-trm:trm=2:appserv=no:appss=yes:card=yes:clk=no:dbg=no:gtt=yes:gws=no
:meas=yes:mon=no:mps=yes:seas=no:slan=yes
```

Dependencies

At least one optional parameter must be specified.

The system requires that at least two terminals be configured as security administration terminals. If you have configured only two security administration terminals, you cannot change the **type** parameter to a value that would make the terminal unusable (**oap, printer, or none**) because only one security administration terminal would remain.

The combined total line speed (baud rate) for all active terminal ports cannot exceed **168,000**. This value allows for 16 terminal to be configured at 9600 bps each.

If **prty** is set to **none**, do not set **type** to **vt320**. A VT320 terminal does not support 7-bit data bytes and no parity. (The number of data bits cannot be changed).

If **prty** is set to **none**, do not set **type** to **sccs**. The **type=sccs** parameter and the **prty=none** parameter cannot be specified together in the command.

To connect a modem, specify the **type=vt320** parameter.

For terminals 1-16 the terminal **type** parameter value cannot be **telnet**.

For terminals 17 - 40, the terminal **type** parameter value can be only **telnet**, **emsalm**, or **none**.

The communications parameters (**baud**, **prty**, **sb**, **fc**) cannot be specified when the terminal **type** parameter value is **telnet**.

When the **type=telnet** parameter or the **type=emsalm** parameter is specified in the command for a telnet type terminal (IDs 17-40), an IPSM card must be equipped in the system. Parameters for a telnet type terminal cannot be changed unless an IPSM card has been added for the target terminal.

NOTE: If you install one IPSM card, telnet terminals 17-24 are available. If you install two IPSM cards, telnet terminal IDs 17-32 are available. If you install three IPSM cards, telnet terminal IDs 17-40 are available. If you remove an installed IPSM card, the eight terminal IDs that were assigned to that card are no longer available. For example, if you install three IPSM cards, and remove the second card that was installed, telnet terminal IDs 17-24 and 33-40 are available. To make the IDs consecutive again, you would need to remove and reinstall the third card that was previously installed. Then its available terminal IDs change from 33-40 to 25-32. You can enter the **rtrv-trm** command to display the available telnet terminal IDs.

When the **type=telnet** parameter or the **type=emsalm** parameter is specified in the command for a telnet type terminal (IDs 17-40), the IP User Interface feature must be enabled and turned on.

Communications parameters (**baud**, **prty**, **sb**, **fc**) cannot be changed when the terminal is already in use.

The port cannot be removed from service (**rmv-trm**) when the **type**, **baud**, **prty**, **sb**, and **fc** parameters are being changed.

The message status (parameters **all**, **traf**, **link**, **sa**, **db**, **sys**, **uimrd**, and **pu**) can be changed on any terminal, including the one you are using, regardless of the port status (inhibited or allowed).

The **all** parameter cannot be specified in the command with the other message status parameters (**traf**, **link**, **sa**, **db**, **sys**, or **pu**). If the **all** parameter and other message status parameters are specified together in the command, the terminal is assigned the other specified message status parameters and the **all** parameter is ignored.

The **dural** parameter must be specified in the range of **0 to 995959** or with a value of **999999**.

The hours portion of the **dural** parameter must be in the range **0-99**; the minutes portion in the range **0-59**; and the seconds portion in the range **0-59**.

Before the **type=oap** parameter is specified:

- Use the **rtrv-feat** command to verify that the SEAS or LNP feature is turned on.
- Do not specify any communication attributes (**baud**, **prty**, **sb**, **fc** parameters).
- Ensure that the number of OAP terminals does not exceed two.

The IP User Interface (Telnet) feature must be enabled and turned on before terminal IDs 17-40 can be specified.

The LNP feature must be turned on before the **lnpdb** and **lnpsub** parameters can be specified. If the **all=yes** parameter is specified, and the LNP feature has not been turned on, the **lnpdb** and **lnpsub** values default to **no**.

Notes

Refer to Appendix D, "Unsolicited Output Message Groups," in the *Maintenance Manual* for a list of unsolicited output messages that you might see for each output group.

This command cannot be entered when an upgrade is in progress.

If your terminal has the auto-wrap feature, you must disable the feature to use the terminal on the system.

To disable the informational message and temporary port lockout feature for a terminal, specify the **mxinv=0** parameter.

To prevent a terminal from being disabled, specify the **dural=0** parameter.

To make the lockout period for a terminal indefinite, specify the **dural=999999** parameter. When disabled, a terminal remains disabled until the port is inhibited (**inh-trm** command) and then allowed (**alw-trm** command).

Terminal idle time monitoring and auto-logout applies only if the terminal **type** is **vt320**, **ksr**, or **sccs**. The **chg-trm** command can be entered with a **tmout** parameter value for other terminal types, but it has no effect.

Using the terminal type of **none** (**type=none**) conveys to the terminal processor that a particular port is not connected or is no longer in use. The terminal processor does not service output queues for a terminal port that is configured as **type=none**.

When the terminal type for a terminal is changed to **type=emsalm**, the value for all output group parameters is set to **yes**.

When the terminal type for a terminal is changed from **type=emsalm** to another type, the current value for all output groups is not changed. A command must be entered to change one or more output group values to another value.

NOTE: Though the output groups are set to **yes**, terminals of type **emsalm** do not display any reports or any UIMs except "UIM 1083 system alive".

The number of data bits cannot be changed; it is set to 7.

Software flow control (XON and XOFF pacing), involves sending control codes between the system and the connected device.

Hardware flow control (RTS and CTS pacing) uses the RTS and CTS lines of the RS-232 interface to pause and restart the flow of data between the system and the connected device.

Software flow control is recommended if the connected device is a printer. Both software and hardware flow control are highly recommended if the connected device is a modem.

Output

chg-trm:trm=2:all=yes

```
rlghncxa03w 04-05-07 11:11:28 EST EAGLE 31.5.0
CHG-TRM: MASP A - COMPLTD
```

;

chg-ttmap

Change Translation Type Mapping

Use this command to change a mapped SS7 message translation type (TT) for a given gateway linkset name. With this command you can change the identification of the type of allowed global title translation in the SS7 message before and after translation type mapping. For example, suppose you are mapping the translation type 001 (before TT mapping) to 238 (after TT mapping). You can use this command to change that mapping to 001 (before) to 254 (after).

Keyword: chg-ttmap

Related Commands: dlt-ttmap, ent-ttmap, rtrv-ttmap

Command Class: Database Administration

Parameters

:ett= (mandatory)

Translation type before mapping. The identification of the type of global title translation in the SS7 message *before* translation type mapping. This attribute is the decimal representation of the 1-octet binary field used by the SS7 protocol to identify the translation type.

Range: 0-255

:io= (mandatory)

Incoming or outgoing. The system uses this parameter to indicate whether the translation type mapping data provisioned for the gateway linkset is for SS7 messages *received* or *sent* on the linkset.

Range: i, o

i—incoming

o—outgoing

:lsn= (mandatory)

Linkset name. The unique network identifier for the gateway linkset.

Range: 1 alphabetic character followed by 9 alphanumeric characters

:mtt= (mandatory)

Mapped translation type. The identification of the type of global title translation in the SS7 message *after* translation type mapping. This attribute is the decimal representation of the 1-octet binary field used by the SS7 protocol to identify the translation type.

Range: 0-255

Example

```
chg-ttmap:lsn=nc001:io=o:ett=128:mtt=55
```

Dependencies

The linkset must be defined.

Notes

None

Output

```
chg-ttmap:lsn=nc001:io=o:ett=128:mtt=55
rlghncxa03w 04-01-22 10:37:07 EST EAGLE 31.3.0
CHG-TTMAP: MASP A - COMPLTD

TTMAP table for nc001 is (2 of 64) 3% full
;
```

chg-uaps**Change UA Parameter Set**

Use this command to change the UA parameter set.

Keyword: chg-uaps

Related Commands: rtrv-uaps

Command Class: Database Administration

Parameters

:set= (mandatory)

UA parameter set to be changed.

Range: 1-10

Default: Current value

:parm= (optional)

Parameter number.

Range: 1-10

1—ASP SNM Options

2—ASP/AS Notifications

3—Unused

4-10—Unused

Default: Current value

:pvalue= (optional)

The numerical value that the parameter (**parm**) will be set to if specified. Each parameter value is 32 bits (decimal 4294967295); not all 32 bits are used for each parameter. Only the values of the used bits are evaluated to determine the parameter value.

Range: Enter a valid decimal or hexadecimal value shown in Table 5-33 on page 5-408 for the **pvalue** parameter for the specified parameter (**parm**).

NOTE: If the default setting for one bit is ON and you want to turn ON another bit in addition, specify the value that turns both bits ON. To turn OFF a bit that is ON and leave other bits ON, specify the value that turns ON just the bits that you want to be on. See the Notes section for this command for an explanation of the meanings of the bit settings.

Table 5-33. Valid and Default UAPS Parameter Values

Parameter (parm)	To Turn On Only Bit(s)	Decimal pvalue	Hexadecimal pvalue	System Default
1. ASP SNM Options Bit 0 = Broadcast Bit 1 = Response Method Bit 6 = Broadcast Congestion Status Change Bits 2-5 and 7-31 = Unused	0	1	h'1	
	1	2	h'2	
	6	64	h'40	Off
	0, 1	3	h'3	On
	0, 6	65	h'41	
	1, 6	66	h'42	
	0, 1, 6	67	h'43	
2. ASP/AS Notifications Bit 0 = ASP ACTIVE Notifications Bit 1 = ASP INACTIVE Notifications Bit 2 = ASP AS State Query Bits 3-31 = Unused	0	1	h'1	
	1	2	h'2	
	2	4	h'4	
	0, 1	3	h'3	
	0, 2	5	h'5	
	1, 2	6	h'6	
	0, 1, 2	7	h'7	Off
3. Unused	0	1	h'1	Off

Default: Current value

:srcset= (optional)

When specified, this source UAPS will be copied into the specified UAPS (**set**).

Range: 1-10

Default: Empty

:timer= (optional)

The Timer number within the UA parameter set.

Range: 1-10

1—Unused

2—False IP Connection Congestion Timer

3-10—Unused

Default: Current value

:tvalue= (optional)

The value that each timer will be set to. Though each timer value is 32 bits (decimal 4294967295), the **ss7ipgw** and **ipgwi** applications enforce 10-200 milliseconds for timer 1 and 0-30,000 milliseconds for timer 2.

Range: Timer 1—**10-2000** milliseconds
 Timer 2—**0-30000** milliseconds

Default: Current value.
 System Default: Timer 1—**10** milliseconds
 System Default: Timer 2—**3000** milliseconds

Example

The following example copies UA parameter set 1 into UA parameter set 2.

```
chg-uaps:set=2:srcset=1
```

The following example sets the Timer 1 value to 30 milliseconds.

```
chg-uaps:set=1:timer=1:tvalue=30
```

The following example sets the UA parameter set 2 value to hexadecimal 7, which turns on bits 0, 1, and 2.

```
chg-uaps:set=1:parm=2:pvalue=h'7
```

The following example sets the Timer 1 value to 30 milliseconds, and sets the value for UA parameter set 1 to decimal 64, which turns OFF bits 0 and 1 and turns ON only bit 6.

```
chg-uaps:set=2:timer=1:tvalue=30:parm=1:pvalue=64
```

Dependencies

The **srcset** and **set** parameter values cannot be the same.

At least one of the **timer**, **parm**, and **srcset** optional parameters must be entered.

If the **srcset** parameter is specified, no other optional parameters can be entered in the command.

If the **parm** parameter is specified, the **pvalue** parameter must be specified.

If the **timer** parameter is specified, the **tvalue** parameter must be specified.

Notes

There are 10 UA parameter sets. Each UA parameter set has 10 timers and 10 optional bit-mapped parameters. The bit-mapped parameter values control SNM and extended UA notification message behavior.

Timer 2 is the False IP Connection Congestion Timer, which controls the maximum amount of time (in milliseconds) that an association will be allowed to remain congested before failing due to false connection congestion. This timer value is limited to 0-30,000 milliseconds by the IPGWx application. The default value is 3000 milliseconds. If the timer is configured to have a value greater than 30,000, then IPGWx treats the timer as configured with 30,000.

The bit-mapped parameters contain the following flags, which are set by using the **pvalue** parameter to turn the bits on or off in each bit map:

Broadcast—Controls broadcast phase SNM TFPs, TFRs and TFAs sent when a destination's status changes. If this flag is on (set to 1), SNM TFPs, TFRs, and TFAs will be broadcast to all associations and sockets assigned to routing keys associated with the destination's network and group code. The default is to enable all broadcast phase messages.

Response Method—Sending a SNM TFC/UPU as a reply to a message received on an association or a socket for an unavailable destination. If this bit is on (set to 1), the SNM response message is sent. The default is to allow the response to be sent.

Broadcast Congestion Status Change—Controls sending unsolicited congestion status changes. If this flag is on (set to 1) for an ASP, unsolicited congestion status messages are sent by the ASP when a destination's congestion status changes. This flag is applicable only if **ipgwabate** has been turned on with the **chg-sg-opts** command. The default is do not generate unsolicited congestion status changes.

ASP ACTIVE Notifications—Controls sending ASP-Active notifications. If this flag is on (set to 1), the Secure Gateway will, when an ASP transitions to Active, send a Notify message to all inactive and active ASPs in the AS of status type "Other" and a newly defined status ID of "ASP Activation". The ASP Activation notification message will include the ASP ID of the ASP that activated, and is transmitted only if the ASP ID is present. This notification is an extension to RFC3332 and not implemented for M3UA Version 8 adapters. The default is do not send ASP Active Notifications.

ASP INACTIVE Notifications—Controls sending ASP-Inactive notifications. If this flag is on (set to 1), the Secure Gateway will, when an ASP transitions to Inactive, send a Notify message to all inactive and active ASPs in the AS of status type "Other" and a newly defined status ID of "ASP Inactivation". The ASP Inactivation notification message will include the ASP ID of the ASP that inactivated and is transmitted only if the ASP ID is present. This notification is an extension to RFC3332 and not implemented for M3UA Version 8 adapters. The default is do not send ASP Inactive Notifications.

ASP AS State Query—Controls sending ASP/AS State Notifications on request by ASP. If this flag is on (set to 1), the Secure Gateway will respond with ASP and AS state notifications if 1) the remote ASP sends ASP-UP or ASP-INACTIVE while the local ASP is in the ASP-INACTIVE state, or 2) the remote ASP sends ASP-ACTIVE while the local ASP is in the ASP-ACTIVE state. The default is do not send state notifications.

Output

chg-uaps:set=2:srcset=1

```
rlghncxa03w 02-03-07 11:11:28 EST EAGLE 30.0.0
CHG-UAPS: MASP A - COMPLTD
```

;

chg-user**Change User**

Use this command to change user access to commands, change user ID's, and change passwords.

Keyword: chg-user

Related Commands: act-user, chg-pid, dact-user, dlt-user, ent-user, login, logout, rept-stat-user, rtrv-secu-user, rtrv-user

Command Class: Security Administration

Parameters

:uid= (mandatory)

User ID

Range: 1 alphabetic character followed by up to 15 alphanumeric characters

:all= (optional)

Specifies whether or not the user ID is assigned all non-configurable command classes (LINK, SA, SYS, PU, DB, DBG, LNP, LNPDB, LNPSUB).

Range: yes, no

Default: Current value

:cc1= (optional)

Configurable command class name, and indicator to specify whether the User ID can enter commands assigned to the specified command class.

Range: 1 alphabetic character followed by 2 alphanumeric characters (ayy), followed by -no or -yes

Default: Current value

:cc2= (optional)

Configurable command class name, and indicator to specify whether the User ID can enter commands assigned to the specified command class.

Range: 1 alphabetic character followed by 2 alphanumeric characters (ayy), followed by -no or -yes

Default: Current value

:cc3= (optional)

Configurable command class name, and indicator to specify whether the User ID can enter commands assigned to the specified command class.

Range: 1 alphabetic character followed by 2 alphanumeric characters (ayy), followed by -no or -yes

Default: Current value

:cc4= (optional)

Configurable command class name, and indicator to specify whether the User ID can enter commands assigned to the specified command class.

Range: 1 alphabetic character followed by 2 alphanumeric characters (ayy), followed by -no or -yes

Default: Current value

:cc5= (optional)

Configurable command class name, and indicator to specify whether the User ID can enter commands assigned to the specified command class.

Range: 1 alphabetic character followed by 2 alphanumeric characters (ayy), followed by **-no** or **-yes**

Default: Current value

:cc6= (optional)

Configurable command class name, and indicator to specify whether the User ID can enter commands assigned to the specified command class.

Range: 1 alphabetic character followed by 2 alphanumeric characters (ayy), followed by **-no** or **-yes**

Default: Current value

:cc7= (optional)

Configurable command class name, and indicator to specify whether the User ID can enter commands assigned to the specified command class.

Range: 1 alphabetic character followed by 2 alphanumeric characters (ayy), followed by **-no** or **-yes**

Default: Current value

:cc8= (optional)

Configurable command class name, and indicator to specify whether the User ID can enter commands assigned to the specified command class.

Range: 1 alphabetic character followed by 2 alphanumeric characters (ayy), followed by **-no** or **-yes**

Default: Current value

:db= (optional)

Access to all commands in command class Database Administration.

Range: **yes, no**

Default: Current value

:dbg= (optional)

Access to all commands in command class Debug.

Range: **yes, no**

Default: Current value

:link= (optional)

Access to all commands in command class Link Maintenance.

Range: **yes, no**

Default: Current value

:lnpbas= (optional)

Access to all commands in the command class LNP Basic

Range: **yes, no**

Default: Current value

:lnpdb= (optional)

Access to all commands in the command class LNP Database

Range: yes, no

Default: Current value

:lnpsub= (optional)

Access to all commands in the command class LNP Subscription

Range: yes, no

Default: Current value

:nuid= (optional)

New user ID

Range: 1 alphabetic character followed by up to 15 alphanumeric characters

Default: Current value

:page= (optional)

The maximum age of the password, in days. The STP automatically prompts the user for a new password at login if the user's password is older than the value specified for the **page** parameter.

Range: 0-999 (days)

Default: Current value

:pid= (optional)

Password ID. Required only if changing the password of a user.

Range: yes, no

Default: Current value

:pu= (optional)

Access to all commands in command class Program Update.

Range: yes, no

Default: Current value

:revoke= (optional)

Revoke the user ID. The system rejects login attempts for a revoked user ID.

Range: yes, no

Default: Current value

rstlsl= (optional)

Reset the user ID. Use this command to reset the last successful login date, for this user ID, to the current date. If the user ID has been prevented login for non-use, use the **rstlsl=yes** parameter to allow the user ID access again.

Range: yes, no

Default: Current value

:sa= (optional)

Access to all commands in command class Security Administration.

Range: yes, no

Default: Current value

:sys= (optional)

Access to all commands in command class System Maintenance.

Range: yes, no

Default: Current value

:uout= (optional)

User ID aging interval. The number of successive days a user ID can go unused (that is, no successful login) before the system denies login of that user ID.

Range: 0-999 (days)

Default: The value specified for the **uout** parameter on the **chg-secu-dflt** command

Example

```
chg-user:uid=john:nuid=johnmayer
```

```
chg-user:uid=john:nuid=john*mayer
```

```
chg-user:uid=john:db=yes
```

```
chg-user:uid=user123:cc1=dab-no:cc2=krb=yes
```

Dependencies

Passwords cannot be created or modified from a telnet terminal (terminal IDs 17-40) unless the OA&M IP Security Enhancements feature is turned on.

Changes to a user ID cannot be made while that user is logged on the system.

The **revoke=yes** parameter cannot be specified for a user ID with system administration authorization.

The LNP feature must be turned on (see the **enable-ctrl-feat** command) before the **lnpbas**, **lnpdb**, or **lnpsub** parameter can be specified.

If the **all=yes** parameter is specified and the LNP feature has not been turned on, the **lnpbas**, **lnpdb**, and **lnpsub** parameter values default to **no**.

The Command Class Management feature must be enabled before a configurable command class name can be specified in the **cc1** - **cc8** parameters.

The values specified in the **cc1** - **cc8** parameters must be valid default (**u01-U32**) or provisioned configurable command class names.

Notes

When the **pid=yes** parameter is specified, the system issues a separate prompt for this password and disables character echo at the terminal so that the entered password is not displayed on the screen. After the password has been entered, the system issues a second prompt, and the password must be entered again. This feature ensures that no typing mistakes were made on the first entry. The password must adhere to all password provisioning rules as established by the **chg-secu-dflt** command. These rules are displayed on the screen when the password prompt is presented.

The current password is not required when assigning a new password.

Use the following rules for changing passwords:

- A new password cannot contain more than 12 characters.
- A new password must contain at least the number of characters that is specified in the **minlen** parameter of the **chg-secu-dflt** command.
- A new password must contain at least the number of alphabetic (**alpha** parameter), numeric (**num** parameter), and punctuation (**punc** parameter) characters that is specified in the **chg-secu-dflt** command.

A new password cannot contain the associated user ID.

As a default, the command class Basic is assigned to all users. If no other command class is assigned, the user still has access to commands in the Basic class.

Up to 8 configurable command class name parameters can be specified in one command. Additional commands can be entered to assign user access for more than 8 names. To assign user access for all 32 available configurable command class names, you could enter four commands with 8 names specified in each command.

Output

```
chg-user:uid=john:nuid=johnmayer
rlghncxa03w 04-01-07 11:11:28 EST EAGLE 31.3.0
CHG-USER: MASP A - COMPLTD
;
```

chg-x25-dstn

Change X.25 Destination

Use this command to change the association of an X.25 network address with either an SS7 point code, or a subsystem within that point code. If the node is actually in the X.25 domain, the X.25 address is a real network address and the point code is a dummy point code. If the node is in the SS7 domain, the point code is a real SS7 point code and the X.25 address is a dummy address.

NOTE: This command does not support 24-bit ITU national point codes.

Keyword: chg-x25-dstn

Related Commands: dlt-x25-dstn, ent-x25-dstn, rtrv-x25-dstn

Command Class: Database Administration

Parameters

NOTE: See “Point Code Formats and Conversion” in Appendix A for a detailed description of point code formats, rules for specification, and examples.

:xaddr= (mandatory)

The X.25 network address of the X.25 destination entity or the SS7 node.

Range: A number consisting of 4–15 digits.

:dpc= or :dpca (optional)

The real SS7 point code assigned to a real SS7 node or the dummy point code for an X.25 destination entity, with subfields *network indicator-network cluster-network cluster member (ni-nc-ncm)*.

Range: 000-255

Specify a valid value for each subfield of the point code, and separate the subfields with a dash (-).

When **chg-sid:pctype=ansi** is specified, *ni* = **000** is not valid.

When **chg-sid:pctype=ansi** is specified, *nc* = **000** is not valid if *ni* = **001-005**.

When **chg-sid:pctype=ansi** is specified, *nc* = **000** is valid if *ni* = **006-255**.

The point code **000-000-000** is not a valid point code.

Default: Current value

:ssn= (optional)

The subsystem number of the destination that is assigned to the X.25 address or the SS7 address.

Range: 1-255

Default: Current value

Example

```
chg-x25-dstn:xaddr=205255864567721:dpc=133-013-001:ssn=9
```

```
chg-x25-dstn:xaddr=205255864567721:dpc=133-013-013
```

```
chg-x25-dstn:xaddr=205255864567721:ssn=3
```

Dependencies

At least one optional parameter must be specified.

There must be at least four digits in the X.25 address.

The X.25 address must already exist as an X.25 destination.

The X.25 address must not be a part of an X.25 route.

The DPC must exist in the destination point code table.

The X.25 SS7 ANSI destination point code must be a full point code (*ni-nc-ncm*).

Notes

None

Output

```
chg-x25-dstn:xaddr=205255864567721:dpc=133-013-001:ssn=9
```

```
rlghncxa03w 04-01-10 11:43:04 EST EAGLE 31.3.0
```

```
X.25 DSTN TABLE 45 % FULL
```

```
CHG-X25-DSTN: MASP A - COMPLTD
```

```
;
```

chg-x25-rte**Change X.25 Route**

Use this command to change the X.25 connection type of a given X.25 route. All LIMs with the **ss7gx25** GPL share this information. Even though these connections apply to only one card, they are used by all cards.

Keyword: **chg-x25-rte**

Related Commands: **dlt-x25-rte, ent-x25-rte, rtrv-x25-rte**

Command Class: Database Administration

Parameters

:saddr= (mandatory)

The alias X.25 address assigned to the SS7 destination entity on the SS7 side of the circuit.

Range: A number consisting of 4–15 digits

:xaddr= (mandatory)

The X.25 address assigned to the X.25 destination entity on the X.25 side of the circuit.

Range: A number consisting of 4–15 digits

lc2nm= (optional)

Invokes SS7 MTP network management for failures and recoveries of logical channels.

Range: **yes, no**

Default: **no** if **rt=pc** is specified

:loc= (optional)

The card location containing the X.25 signaling link.

Range: **1101–1108, 1111–1112, 1201–1208, 1211–1218, 1301–1308, 1311–1318, 2101–2108, 2111–2118, 2201–2208, 2211–2218, 2301–2308, 2311–2318, 3101–3108, 3111–3118, 3201–3208, 3211–3218, 3301–3308, 3311–3318, 4101–4108, 4111–4118, 4201–4208, 4211–4218, 4301–4308, 4311–4318, 5101–5108, 5111–5118, 5201–5208, 5211–5218, 5301–5308, 5311–5318, 6101–6108, 6111–6118**

Default: All card locations are displayed.

:port= (optional)

The port on the card containing the X.25 signaling link.

Range: **a**

:rt= (optional)

The type of routing to perform for messages originating in the SS7 domain and destined for the X.25 domain. Two types of routing are available: (1) route on X.25 destination point code (XPC), and (2) route using X.25 origination and destination point code combinations (PC).

Range: **xpc, pc**

Default: Current value

:type= (optional)

The type of X.25 connection that the link is expected to maintain.

Range: **svca, svcr**

svca—automatic virtual circuit

svcr—remote virtual circuit

Example

```
chg-x25-rte:xaddr=225255:saddr=133131:type=svca:loc=1205:port=a
chg-x25-rte:xaddr=303545:saddr=234908:type=svcr
chg-x25-rte:xaddr=225255:saddr=133131:rt=xpc
```

Dependencies

Each X.25 address must have at least four digits.

The combination of the two X.25 addresses must exist in the X.25 route table.

The number of SVCAs cannot exceed the maximum number of SVCs defined for the signaling link.

One of the following parameters must be specified: **type**, **rt**, or **lc2nm**.

If **lc2nm=yes** is specified, **rt=xpc** must be specified.

If the X.25 domain destination is an adjacent entity, **lc2nm=no** must be specified.

If **rt=xpc** is specified, the **xaddr** parameter's alias SS7 point code must be unique in the X.25 route table.

If the connection type is **svca** (**type=svca**), the **loc** parameter must be specified.

The new connection type (**type=svca** or **type=svcr**) must be different from the currently defined connection type. For example, if the current connection type is **svca** (**type=svca**), the new connection type must be **svcr** (**type=svcr**).

If the **port** parameter is specified, the **loc** parameter must be specified.

If the connection type of the X.25 route is **pvc** (shown in the TYPE field of the **rtrv-x25-rte** output), the X.25 route cannot be changed.

Notes

The **lc2nm** parameter does not generate MTP level 3 network management messages to the network. Instead, it uses level 3 network management procedures internally to reroute traffic to an alternate route. If the **lc2nm** parameter is not specified, traffic is discarded when routed to a failed logical channel.

Output

```
chg-x25-rte:xaddr=225255:saddr=133131:type=svca:loc=1205:port=a
rlghncxa03w 04-01-10 11:43:04 EST EAGLE 31.3.0
CHG-X25-RTE: MASP A - X.25 Route table 45% full
CHG-X25-RTE: MASP A - COMPLTD
;
```

chg-x25-slk**Change X.25 Signaling Link Parameters**

Use this command to change any X.25 signaling link parameter.

Keyword: **chg-x25-slk**

Related Commands: **rtrv-x25-rte**, **rtrv-x25-slk**

Command Class: Database Administration

Parameters

:loc= (mandatory)

The card location containing the X.25 signaling link.

Range: 1101–1108, 1111–1112, 1201–1208, 1211–1218, 1301–1308, 1311–1318, 2101–2108, 2111–2118, 2201–2208, 2211–2218, 2301–2308, 2311–2318, 3101–3108, 3111–3118, 3201–3208, 3211–3218, 3301–3308, 3311–3318, 4101–4108, 4111–4118, 4201–4208, 4211–4218, 4301–4308, 4311–4318, 5101–5108, 5111–5118, 5201–5208, 5211–5218, 5301–5308, 5311–5318, 6101–6108, 6111–6118

Default: All card locations are displayed.

:port= (mandatory)

The port on the card containing the X.25 signaling link.

Range: a

Default: Only one port per LIM is supported for X.25.

:k= (optional)

The maximum number of outstanding I frames.

Range: 1–7

Default: Current value

System Default: 7

:l3mode= (optional)

The logical layer 3 address of the connection

Range: dte, dce

Default: dte

:mps= (optional)

The maximum packet size (in bytes) allowed on this X.25 signaling link.

Range: 128, 256

Default: 256

:n1= (optional)

The maximum number of bits in a frame.

Range: 1080, 2104

Default: Current value

System Default: 2104

:n2= (optional)

The maximum number of retransmission attempts to complete a transmission.

Range: 3–15

Default: Current value

System Default: 10

:pvc= (optional)

The total number of the permanent virtual circuits (PVCs) available on this X.25 signaling link.

Range: 0–255

Default: 0

:svc= (optional)

The total number of the switched virtual circuits (SVCs) available on this X.25 signaling link.

Range: 0–255

Default: 255 minus the value for the pvc parameter

:t1= (optional)

The amount of time to wait before retransmitting a frame.

Range: 3–10 seconds

Default: Current value

System Default: 5

:win= (optional)

The number of packets allowed for a window on this X.25 signaling link.

Range: 1–7

Default: 3

Example

```
chg-x25-slk:loc=1201:port=a:t1=3:n1=1080:n2=3:k=7
```

```
chg-x25-slk:loc=1204:pvc=10:svc=10
```

Dependencies

The **limds0**, **limocu**, and **limv35** card types are the only valid card types for this command. These card types must be running the **ss7gx25** application.

The shelf and card must be equipped.

At least one of the optional parameters **t1**, **n1**, **n2**, **k**, **l3mode**, **pvc**, **svc**, **win**, or **mps** must be specified.

The sum of the values for the **pvc** and **svc** parameters must be greater than or equal to 1 and less than or equal to 255.

If the **mps** parameter is equal to 128, then the **n1** parameter must be equal to 1080.

The specified card must be out-of-service maintenance-disabled (OOS-MT-DSBLD) before the X.25 signaling link parameters can be changed. Enter the **rept-stat-card** command with the card location containing the X.25 signaling link that you want to change, to verify the state of the card.

The new quantity of PVCs cannot be greater than the number of logical channels currently assigned to the X.25 signaling link. Enter the **rtrv-x25-rte** command with the card location and port (**loc** and **port**) of the X.25 signaling link to verify the number of logical channels assigned to the X.25 signaling link. This is shown in the **LC** field of the **rtrv-x25-rte** output.

Notes

To add, remove, or change an X.25 destination, linkset, signaling link, or route, follow the procedures in the “X.25 Gateway Configuration” chapter of the *Database Administration Manual - Features*.

Output

```

chg-x25-slk:loc=1201:port=a:t1=3:n1=1080:n2=3:k=7
  rlgmxcxa03w 04-01-10 11:43:04 EST EAGLE 31.3.0
  CHG-X25-SLK: MASP A - COMPLTD
;

```

chk-unref-ent**Check Unreferenced Entities**

Use this command to check for unreferenced entities in the STP gateway screening entity sets. Unreferenced entities are those entities not referenced by another entity using the next screening function identifier and next screening reference combination, or using the linkset screening reference.

Keyword: chk-unref-ent

Related Commands: aud-data, chg-scr-aftpc, chg-scr-blkdpc, chg-scr-blkopc, chg-scr-cdpa, chg-scr-cgpa, chg-scr-destfld, chg-scr-dpc, chg-scr-opc, chg-scr-sio, chg-scr-tt, chg-scrset, dlt-scr-aftpc, dlt-scr-blkdpc, dlt-scr-blkopc, dlt-scr-cdpa, dlt-scr-cgpa, dlt-scr-destfld, dlt-scr-dpc, dlt-scr-opc, dlt-scr-sio, dlt-scr-tt, dlt-scrset, ent-scr-aftpc, ent-scr-blkdpc, ent-scr-blkopc, ent-scr-cdpa, ent-scr-cgpa, ent-scr-destfld, ent-scr-dpc, ent-scr-opc, ent-scr-sio, ent-scr-tt, ent-scrset

Command Class: Database Administration

Parameters

:aftpc= (optional)

Affected point code. Specifies whether you want to audit the affected PC/SSN entity set.

Range: yes, no

Default: no

:all= (optional)

All entity types. Specifies whether you want to audit all of the entity sets.

Range: yes, no

Default: no

:blkdpc= (optional)

Blocked destination point code. Specifies whether you want to audit the blocked DPC entity set.

Range: yes, no

Default: no

:blkopc= (optional)

Blocked originating point code. Specifies whether you want to audit the blocked OPC entity set.

Range: yes, no

Default: no

:cdpa= (optional)

Called party address. Specifies whether you want to audit the allowed CDPA entity set.

Range: yes, no

Default: no

:cgpa= (optional)

Calling party address. Specifies whether you want to audit the allowed CGPA entity set.

Range: yes, no

Default: no

:destfld= (optional)

Affected destination field. Specifies whether you want to audit the affected DESTFLD entity set.

Range: yes, no

Default: no

:dpc= (optional)

Destination point code. Specifies whether you want to audit the allowed DPC entity set.

Range: yes, no

Default: no

:isup= (optional)

ISUP message type. Specifies whether you want to audit the ISUP message type entity set.

Range: yes, no

Default: no

:opc= (optional)

Originating point code. Specifies whether you want to audit the allowed OPC entity set.

Range: yes, no

Default: no

:sio= (optional)

Service information octet. Specifies whether you want to audit the allowed SIO entity set.

Range: yes, no

Default: no

:tt= (optional)

Translation type. Specifies whether you want to audit the allowed TT entity set.

Range: yes, no

Default: no

Example

```
chk-unref-ent:opc=yes:dpc=yes:sio=yes
```

```
chk-unref-ent:all=yes
```

```
chk-unref-ent:all=yes:blkopc=no:blkdpc=no
```

Dependencies

At least one entity set name must be specified.

A maximum of 10 entity set names can be specified.

The gateway screening database must be accessible.

Notes

None

Output

chk-unref-ent:opc=yes:dpc=yes:sio=yes

```
rlghncxa03w 04-01-18 08:29:15 EST EAGLE 31.3.0
ENTITY          UNREFERENCED
TYPE            ENTITIES
-----
OPC             <NONE>
DPC             DPC1
DPC             DPC2
SIO             <NONE>
```

;

chk-unref-ent:all=yes

```
rlghncxa03w 04-01-18 08:29:15 EST EAGLE 31.3.0
ENTITY          UNREFERENCED
TYPE            ENTITIES
-----
OPC             <NONE>
DPC             dpc1
                dpc2
BLKOPC          <NONE>
BLKDPC          <NONE>
SIO             <NONE>
CGPA            <NONE>
CDPA            <NONE>
TT              tt0-1
                tt-05
DESTFLD         <NONE>
AFTPC           <NONE>
ISUP            <NONE>
```

;

chk-unref-ent:all=yes:blkopc=no:blkdpc=no

```
rlghncxa03w 04-01-18 08:29:15 EST EAGLE 31.3.0
ENTITY          UNREFERENCED
TYPE            ENTITIES
-----
OPC             <NONE>
DPC             dpc1
                dpc2
SIO             <NONE>
CGPA            <NONE>
CDPA            <NONE>
TT              tt01
                tt05
AFTPC           <NONE>
```

;

Legend

ENTITY TYPE—This field displays which entity type is being checked.

UNREFERENCED ENTITIES—This field displays whether the entity type listed is referenced by another entity.

clr-imt-stats**Clear IMT Statistics**

Every card in the system has both a card location identifier (stenciled on the shelf and provided in all output) and an IMT address. Use this command to clear the following statistics:

- The IMT level 1 and level 2 statistics for specified IMT addresses and the hourly time period statistics for IMT errors.
- The card error statistics for HMUX or HIPR cards and the hourly time period statistics for HMUX or HIPR cards.
- All IMT, HMUX, and HIPR error and hourly time period statistics. When the hourly time period statistics for IMT errors, HMUX errors, or HIPR errors are cleared, the current hourly time period number is reset to 0 (zero) on all cards.

Keyword: `clr-imt-stats`

Related Commands: `rst-imt`, `conn-imt`, `disc-imt`, `rept-imt-info`, `rept-imt-lvl1`, `rept-imt-lvl2`, `rmv-imt`, `tst-imt`

Command Class: System Maintenance

Parameters

:all= (optional)

Clear all IMT, HMUX, and HIPR statistics.

Range: `yes, no`

Default: `no`

:e= (optional)

End address. This parameter specifies the IMT address of the last card in the range.

Range: `0-251`

(See the *Installation Manual - EAGLE 5 SAS* for an illustration with IMT addresses).

:eloc= (optional)

End location. Specifies the card location of the last card in the range.

Range: `1101-1113, 1115, 1201-1218, 1301-1318, 2101-2118, 2201-2218, 2301-2318, 3101-3118, 3201-3218, 3301-3318, 4101-4118, 4201-4218, 4301-4318, 5101-5118, 5201-5218, 5301-5318, 6101-6118`

Default: If `sloc` is specified—current `sloc` value

If `sloc` is not specified—`1115`, which corresponds to IMT address 251 (`e=251`).

:eshelf= (optional)

End shelf location for HMUX and HIPR statistics. This parameter specifies the shelf location of the last shelf in the range. (Both HMUX and HIPR statistics will be cleared if they exist in the range between and including the `sshelf` and `eshelf` locations).

Range: `1100, 1200 ...6100`

Default: If `sshelf` is specified—current `sshelf` value.

If `sshelf` is not specified—`6100`.

:s= (optional)

Start address. This parameter specifies the IMT address of the first (or only) card in the range.

Range: 0–251 (See the *Installation Manual - EAGLE 5 SAS* for an illustration with IMT addresses).

:sloc= (optional)

Start location. Specifies the card location of the first card in the range.

Range: 1101–1113, 1115, 1201–1218, 1301–1318, 2101–2118, 2201–2218, 2301–2318, 3101–3118, 3201–3218, 3301–3318, 4101–4118, 4201–4218, 4301–4318, 5101–5118, 5201–5218, 5301–5318, 6101–6118

Default: If **eloc** is specified—current **eloc** value

If **eloc** is not specified—1201, which corresponds to IMT address 0 (**s=0**).

:sshelf= (optional)

Start shelf location for HMUX and HIPR statistics. This parameter specifies the shelf location of the first shelf in the range. (Both HMUX and HIPR statistics will be cleared if they exist in the range between and including the **eshelf** and **sshelf** locations).

Range: 1100, 1200 ...6100

Default: If **eshelf** is specified—current **eshelf** value.

If **eshelf** is not specified—1100.

Example

```
clr-imt-stats:s=00
```

Dependencies

The **clr-imt-stats** command cannot be entered if any of the following commands is running: **rept-imt-info**, **rept-imt-lvl1**, **rept-imt-lvl2**, **tst-imt**.

If the **s** and **e** parameters are specified, do not specify the **sloc** and **eloc** parameters; conversely, if the **sloc** and **eloc** parameters are specified, do not specify the **s** and **e** parameters.

This command cannot be entered during IMT statistics collection following an hourly boundary.

Either the start address (**s** parameter) or start location (**sloc** parameter) must be specified.

Notes

The **sloc** and **eloc** parameters allow individual HMUX and HIPR cards to be cleared.

The **s** and **e** parameters will *not* clear HMUX and HIPR cards.

The **sshelf** and **eshelf** parameters clear both HMUX and HIPR cards on bus A and bus B.

Output

```
clr-imt-stats:s=00
```

```
rlghncxa03w 04-01-07 11:02:30 EST EAGLE 31.3.0
Clear IMT Statistics command issued
```

conn-imt**Connect IMT**

The interprocessor message transport bus (IMT bus) is the main communications artery between all subsystems in the system. Use this command to connect a manually disconnected card to the specified IMT bus. The card must have been manually disconnected from the bus previously by the **disc-imt** command. If the card was disconnected from the bus for other reasons, this command has no effect.

Keyword: conn-imt

Related Commands: clr-imt-stats, disc-imt, rept-imt-lvl1, rept-imt-lvl2, rept-stat-imt, rmv-imt, rst-imt

Command Class: System Maintenance

Parameters

:bus= (mandatory)

IMT bus to which the specified card is to be connected.

Range: a, b

:loc= (mandatory)

The card location as stenciled on the shelf of the system.

Range: 1101–1108, 1111–1112, 1201–1208, 1211–1218, 1301–1308, 1311–1318, 2101–2108, 2111–2118, 2201–2208, 2211–2218, 2301–2308, 2311–2318, 3101–3108, 3111–3118, 3201–3208, 3211–3218, 3301–3308, 3311–3318, 4101–4108, 4111–4118, 4201–4208, 4211–4218, 4301–4308, 4311–4318, 5101–5108, 5111–5118, 5201–5208, 5211–5218, 5301–5308, 5311–5318, 6101–6108, 6111–6118

Example

```
conn-imt:loc=1201:bus=a
```

Dependencies

The card being reconnected must first be disconnected manually from the bus by using the **disc-imt** command.

This command cannot be entered during an IMT Fault Isolation Test.

Notes

This command has no effect if the card was disconnected from the IMT bus in any way other than manually using the **disc-imt** command.

Output

```
conn-imt:loc=1201:bus=a
```

```
rlghncxa03w 04-01-07 11:02:30 EST EAGLE 31.3.0
Connect IMT Bus A command issued to card 1201

rlghncxa03w 04-01-07 11:02:30 EST EAGLE 31.3.0
0100.0006 IMT Bus A Card connected to IMT

rlghncxa03w 04-01-07 11:02:30 EST EAGLE 31.3.0
3112.0006 CARD 1201 CCS7ITU Card connected to IMT
;
```

copy-disk**Copy Disk**

Use this command to copy a mirror image of the active fixed disk to the standby fixed disk. When the fixed disk requires replacement, or needs to be repaired or updated, this command formats the standby fixed disk and copies the contents of the active fixed disk to the standby fixed disk.



CAUTION: Before entering the **copy-disk** command, contact Tekelec Technical Services at (888) FOR-TKLC. The Technical Services engineer may be able to propose a less intrusive method for copying to a fixed disk.



CAUTION: LNP database updates may be coming through an OAP terminal without maintenance people being aware of it. Before using this command, inhibit the OAP terminals to ensure that databases do not lose synchronization.



CAUTION: If the **copy-disk** command fails and the standby TDM boots continuously, insert a removable disk with the same release as the fixed disks in the MDAL. The standby MASP should successfully boot off the removable disk. After the MASP has booted completely, re-enter the **copy-disk** command.

Keyword: **copy-disk**

Related Commands: **chg-db**, **copy-gpl**, **copy-meas**, **disp-disk-dir**, **format-disk**, **rept-stat-db**

Command Class: System Maintenance

Parameters

:dloc= (mandatory)

This parameter must specify the location of the standby fixed disk. This is the destination drive for this function.

Range: **1114, 1116**
(TDM)

:force= (optional)

This parameter provides some protection against data loss from copying over a fixed disk. If the target medium is recognized as a valid system medium, the **force=yes** parameter must be specified.

Range: **yes, no**

Default: **no**

:format= (optional)

This parameter provides the choice whether or not to format the standby fixed disk before executing the copy. If a format is not necessary, specifying **no** can save a significant amount of time.

Range: **yes, no**

Default: **yes**

:sloc= (optional)

This parameter must specify the location of the active fixed disk. This will be the source drive for this function.

Range: **1114, 1116**
(TDM)

Default: The location of the active fixed disk

Example

```
copy-disk:sloc=1114:dloc=1116:force=yes
```

Dependencies



CAUTION: Do not turn off measurements at midnight because doing so can cause the loss of an entire day of measurements. Do not turn off measurements during the 30 minute measurements processing period, because this can result in the loss of the measurements for the 30 minute period being processed.

Measurements collection must be turned off or the **copy-disk** command cannot be executed. Do not issue the **chg-meas** command while the **copy-disk** command is in progress. This results in read and write errors, because the standby fixed disk is not accessible and the active fixed disk only allows read-only access.

OAM Measurements collection cannot be in progress when this command is entered. Retry the command after a period of waiting for the measurements collection to complete.

The **copy-disk** command reserves both the active and standby disks, preventing database updates for the duration of the command. Access is allowed for read-only; writing to the disk is prohibited.

All commands that affect the database are not allowed for the duration of the command. Attempts to use such commands are rejected, and an error message is displayed indicating that the command has been rejected because the **copy-disk** command is in use.

The EOAM GPL version that is running in the active OAM card location must be the same GPL version that is running in the standby OAM card location.

The **sloc** and **dloc** fixed disks must be available and compatible.

The **sloc** fixed disk must be coherent.

The **dloc** parameter must specify the standby fixed disk.

The **sloc** parameter must specify the active fixed disk.

The standby fixed disk cannot be initialized while un-uploaded security log entries exist.

The **force=yes** parameter is required if the destination medium is recognized as a system medium. This parameter is optional if the destination medium is not a system medium. Only media that contain the **dms.cfg** file are recognized as system media.

If the **force=yes** parameter is specified, the disk should not require low-level formatting, and the **format=no** parameter should also be specified.

Notes

The **format=no** parameter should be specified when upgrading a spare TDM. You should specify the **format=yes** parameter when there is a suspected hardware problem.

If the **copy-disk** command is initiated and the standby OAM initialization is not complete, command processing will be delayed. If standby initialization fails, the command proceeds to allow the standby TDM to recover from a previous **format-disk** or **copy-disk** failure. In such cases, the following messages appear:

```
Standby MASP has not finished initializing - please wait...  
Standby MASP initialization timed out - continuing...
```

The **format=no** parameter should be specified when upgrading a spare TDM. the **format=yes** parameter should be specified when there is a suspected hardware problem.

If the **copy-disk** command is initiated and the standby OAM initialization is not complete, command processing will be delayed. If standby initialization fails, the command proceeds to allow the standby TDM to recover from a previous **format-disk** or **copy-disk** failure. In such cases, the following messages appear:

Standby MASP has not finished initializing - please wait...

Standby MASP initialization timed out - continuing...

When the **copy-disk** command is processing, the system cannot log other commands to the security log because the active fixed disk is set to read-only. During this time, commands that would alter the database fail when entered.

The performance time required to copy a fixed disk to another fixed disk varies depending on database size and system activity. This operation should typically take no longer than 2.5 hours. (If you are not performing the low-level format (**format=no**), the operation should take no longer than an hour). If the **copy-disk** operation exceeds three hours, contact Tekelec Technical Services for assistance at (888) FOR-TKLC. If the **copy-disk** operation without the low-level format exceeds 1.5 hours, call Tekelec Technical Services.

Output

copy-disk:sloc=1114:dloc=1116:force=yes

```
rlghncxa03w 04-01-07 11:02:30 EST EAGLE 31.3.0
copy-disk:sloc=1114:dloc=1116:force=yes
Command entered at terminal #3.
```

```
Copy-disk (fixed): from active (1114) to standby (1116) started.
Extended processing required, please wait.
```

```
Copy-disk (fixed): from active (1114) to standby (1116) completed.
Measurements collection may be turned on now if desired.
```

copy-fts

Copy to or from the File Transfer Area

This command copies tables into or from the file transfer area (FTA).

Keyword: copy-fts

Related Commands: act-file-trns, disp-fts-dir, dlt-fts

Command Class: System Maintenance

Parameters

:dloc= (mandatory)

The card location of the destination or table.

Range: 1114, 1116

:sloc= (mandatory)

The card location of the source location or table.

Range: 1114, 1116, 1117

(TDMs or MDALs)

:dfile= (optional)

The name of the file that was copied into the FTA.

Range: The name of the file with its extension

Default: No filename is specified

:dtbl= (optional)

The number that identifies the destination table.

Range: 0-511

Default: No destination table is specified.

:sfile= (optional)

The name of the file in the FTA to be copied.

Range: The name of the file with its extension

Default: No filename is specified

:stbl= (optional)

The number that identifies the source table.

Range: 0-511

Default: No table is specified.

Example

copy-fts:sloc=1114:dloc=1114:stbl=2:dfile="F1_name.OUT"

copy-fts:sfile=dms.cfg:dtbl=0:sloc=1114:dloc=1116

Dependencies

This command is used to copy into the file transfer area or out of the file transfer area. The parameters, **stbl**, **dfile**, **sfile**, and **dtbl** are used to describe the nature of the copy. A copy from a DMS table into the file transfer area would use the **stbl** (source table) and **dfile** (destination file) parameters. Thus, data would move from a table into a transfer area file. To copy from the file transfer area to a DMS table, use the **sfile** (source file) and **dtbl** (destination table) parameters. Any other combination of these 4 parameters is invalid.

File name formats are limited to 8 + 3 DOS-compatible characters. When using DOS file names, if the file name contains a special character such as an underscore (_) or begins with a numeric, the file name must be in quotes (" "), for example, "**92_name.ext**".

A destination table must be specified when a source file is specified.

A destination file must be specified when a source table is specified.

A source table must be specified when a destination file is specified.

A source file must be specified when a destination table is specified.

A source and a destination must be specified.

Only one source parameter and one destination parameter can be specified.

Only one source and one destination can be specified.

The card location must be a valid fixed disk or removable cartridge location disk location.

This command cannot be entered to modify the security log.

Notes

None

Output**copy-fta:stbl=1:dfile="2F1.OUT":sloc=1114:dloc=1114**

```

rlghncxa03w 04-01-05 14:59:10 EST EAGLE 31.3.0
copy-fta:stbl=1:dfile="2F1.OUT":sloc=1114:dloc=1114
Command entered at terminal #1.
;
rlghncxa03w 04-01-05 14:59:26 EST EAGLE 31.3.0
Copied Table 1 successfully from FIXED to F1.OUT in FTA.
;
rlghncxa03w 04-01-05 15:00:49 EST EAGLE 31.3.0
copy-fta:sfile=dms.cfg:dtbl=0:sloc=1114:dloc=1117:drv=remove
Command entered at terminal #1.
;
rlghncxa03w 04-01-05 15:01:12 EST EAGLE 31.3.0
Copied DMS.CFG successfully from FTA to Table 0 on REMOVABLE.
;

```

copy-gpl**Copy Generic Program Load**

Use this command to copy all approved GPLs from one drive to another. The GPLs can be copied only from the fixed disk on the active TDM to the removable cartridge, or from the removable cartridge to the fixed disk on the standby TDM.

Keyword: copy-gpl

Related Commands: act-gpl, alw-card, chg-gpl, init-card, init-sys, rept-stat-gpl, rtrv-gpl

Command Class: System Maintenance

Parameters

:dloc= (optional)

The destination location of the the GPLs to be copied.

Range: 1114, 1116, 1117

1114, 1116—The standby TDM

1117—The removable cartridge

Default: 1117

:sloc= (optional)

The source location of the the GPLs to be copied.

Range: 1114, 1116, 1117

1114, 1116—The active TDM

1117—The removable cartridge

Default: The location of the active TDM

Example

```
copy-gpl
```

```
copy-gpl:sloc=1117:dloc=1116
```

```
copy-gpl:sloc=1116
```

Dependencies

While this command is executing, the **chg-gpl** and **act-gpl** commands cannot be entered.

Notes

This command has no effect on the GPLs stored on other cards (for example, SCCP).

Output

Copying the GPLs from the fixed disk on the active TDM (card location 1114) to the removable cartridge.

copy-gpl or

copy-gpl:sloc=1114:dloc=1117

```
rlghncxa03w 04-01-07 00:57:31 EST EAGLE 31.3.0
COPY GPL: MASP A - COPY STARTS ON ACTIVE MASP
COPY GPL: MASP A - COPY TO REMOVABLE CARTRIDGE COMPLETE
```

;

Copying the GPLs from the removable cartridge to the fixed disk on the standby TDM (card location 1116).

copy-gpl:sloc=1117:dloc=1116

```
rlghncxa03w 04-01-07 00:57:31 EST EAGLE 31.3.0
COPY GPL: MASP B - COPY STARTS FROM REMOVABLE CARTRIDGE TO STANDBY TDM
COPY GPL: MASP B - COPY TO STANDBY TDM COMPLETE
```

;

copy-isupvar-attrib

Copy ISUP Variant Attribute

Use this command to copy one ISUP Variant table entry to another ISUP Variant table entry.

Keyword: **copy-isupvar-attrib**

Related Commands: **chg-isupvar-attrib**, **rtrv-isupvar-attrib**, **ent-pstn-pres**, **rtrv-pstn-pres**

Command Class: Database Administration

Parameters

:dpstncat= (mandatory)

The PSTN category that identifies the destination Variant table entry where the source Variant table is being copied.

Range: **0-65535**

:dpstnid= (mandatory)

The PSTN ID that identifies the destination Variant table entry where the source Variant table is being copied.

Range: **0-65535**

:pstncat= (mandatory)

The PSTN category that identifies the source Variant table entry being copied.

Range: **0-65535**

:pstnid= (mandatory)

The PSTN ID that identifies the source Variant table entry being copied.

Range: 0-65535

Example

copy-isupvar-attrib:pstncat=1:pstnid=2:dpstncat=1:dpstnid=20

Dependencies

The **pstncat=1** and **pstnid=2** parameter combination is invalid.

Required controlled features must be enabled.

- ISUP Normalization controlled feature
- ON/OFF controlled feature for *Tekelec-defined* Variant
- Quantity controlled feature for *user-defined* Variant

The **pstncat** and **pstnid** values must have been previously defined with **ent-pstn-pres**.

The **dpstncat** and **dpstnid** values must have been previously defined with **ent-pstn-pres**.

Notes

The **copy-isupvar-attrib** command provides the user with an easy way to provision a new ISUP Variant table entry by copying all the data from another entry. Then the user changes the entry with the **chg-isupvar-attrib** command.

An ISUP Variant table entry exists for each Variant defined in the SG. Each entry contains ISUP message and parameter data specific to the ISUP protocol that Variant uses. A Variant is uniquely defined by its PSTN presentation value, consisting of a PSTN category and a PSTN ID.

The PSTN presentation is used to identify both the source and destination table entries. Both entries **must** be previously defined PSTN presentation values, such as either a *Tekelec-defined* PSTN or a *user-defined* PSTN by the **ent-pstn-pres** commands. Use the **rtrv-pstn-pres** command to display the **only** allowed values for the source and destination PSTNs.

If the source or destination Variant is a *Tekelec-defined* PSTN value, then its associated On/off control feature must be ENABLED.

The destination PSTN is not allowed to be normalized ISUP (etsiv3).

Output

The following example shows how to copy etsiv3 Variant to another Variant.

copy-isupvar-attrib:pstncat=1:pstnid=2:dpstncat=1:dpstnid=20

```
rlghncxa03w 04-01-07 00:57:31 EST EAGLE 31.3.0
COPY-ISUPVAR-ATTRIB: MASP A - COMPLTD
;
```

copy-meas**Copy Measurements**

Use this command to copy all measurements tables on the active fixed disk to a measurements removable cartridge. Do this when you need to perform off-line analysis of the raw measurements data.

NOTE: This command is not supported on the Measurements Platform feature.

Keyword: copy-meas

Related Commands: chg-meas, rept-meas, rtrv-meas-sched

Command Class: System Maintenance

Parameters

None

Example

copy-meas

Dependencies

This command requires a removable cartridge formatted for measurements data. See the **format-disk** command for details on how to use the system to format cartridges.

A valid system measurements removable cartridge must be inserted in the MDAL removable cartridge drive.

Notes

To execute this command, measurement collection must be turned **off**. If measurement collection is on, enter the **chg-meas:collect=off** command to turn off measurement collection.

The *Maintenance Manual* provides a description of all measurement report parameters.

Table 5-34. Performance for the **copy-meas** command

Activity	Approximate Performance*
Copy the raw measurements data from the active fixed disk to the measurements removable cartridge.	2 minutes
* Minimum time and dependent on system activity.	

Output**copy-meas**

```
COPY MEASUREMENTS: MASP A - COPY STARTS ON ACTIVE MASP
COPY MEASUREMENTS: MASP A - COPY TO REMOVABLE CARTRIDGE COMPLETE
```

```
;
```

copy-seculog

Copy Security Log Contents to FTA Area

Use this command to copy the contents of a security log to the file transfer area (FTA). If no parameters are specified, a file called **yymmdda.log** (see the description of the **dfile** parameter) is created in the FTA on the active fixed disk. The contents of the security log on the active fixed disk are copied into this file.

Keyword: copy-seculog

Related Commands: act-file-trns, copy-tbl, disp-fta-dir, dlt-fta

Command Class: Security Administration

Parameters

:dfile= (optional)

Target file name. This parameter specifies the name of the file that is to be created in the FTA and initialized with the security log contents.

Range: 1–32 characters

Default: If not specified, the file is named *yymmddx.log*, where *yymmdd* is the current year, month, and day, and *x* is either *a* or *s*, depending on whether the log on the active or standby fixed disk was copied.

:dloc= (optional)

Destination FTA. This parameter specifies which FTA is to receive the copy of the log.

Range: act, stb

act —Copies the log to the active fixed disk's FTA

stb—Copies the log to the standby fixed disk's FTA

Default: act

:slog= (optional)

Source log indicator. This parameter specifies which log is to be copied to the FTA.

Range: act, stb

act —Copies the log on the active fixed disk

stb —Copies the log on the standby fixed disk

Default: act

Example

```
copy-seculog
```

```
copy-seculog:dfile="somename.log"
```

```
copy-seculog:slog=stb
```

```
copy-seculog:slog=act
```

```
copy-seculog:slog=act:dloc=stb
```

Dependencies

No other security log command can be in progress when this command is entered.

No **copy-fta** command can be in progress when this command is entered.

Notes

For the **dfile** parameter, if the file name is not accepted by the system because it contains special characters such as blanks, colons, dashes, ampersands, or others; or because it does not start with an alphabetic character, enclose the file name in double quotes (Copies t) as in this example: Copies t.

Any scroll area failure message that can be produced by the **copy-fta** command can be produced also by the **copy-seculog** command.

Output

The following example shows that the log on the active fixed disk is copied to the FTA on the active fixed disk and given the default name (note the **a** in the log name).

copy-seculog

```
rlghncxa03w 04-01-04 15:59:06 EST EAGLE 31.3.0
Security log on TDM 1114 copied to file 960104a.log on TDM 1114
```

The following example shows that the log on the active fixed disk is copied to the FTA on the active fixed disk and given a user-specified name.

copy-seculog:dfile="sosome.log"

```
rlghncxa03w 04-01-04 15:59:06 EST EAGLE 31.3.0
Security log on TDM 1116 copied to file some.log on TDM 1114
```

The following example shows that the log on the standby fixed disk is copied to the FTA on the active fixed disk and given the default name (note the **s** in the log name).

copy-seculog:slog=stb

```
rlghncxa03w 04-01-04 15:59:06 EST EAGLE 31.3.0
Security log on TDM 1114 copied to file 960104s.log on TDM 1116
```

The following example shows that the copy of the log fails because a file already exists in the FTA with the same name.

copy-seculog:slog=act

```
rlghncxa03w 04-01-04 15:59:06 EST EAGLE 31.3.0
Command Failed - Destination File already exists in the File Transfer Area
```

The following example shows that the copy fails because there is not enough room in the FTA to contain the copy.

copy-seculog:slog=act:dloc=stb

```
rlghncxa03w 04-01-04 15:59:06 EST EAGLE 31.3.0
Command Failed - Not enough room exists in the File Transfer Area
```

6

Commands D–Q

This chapter contains commands that start with the letters D through Q. The commands are listed in alphabetical order starting on page 6-2.

Introduction

For each command listed in this chapter, the following information is given:

- A description of the command
- The command syntax
- A description of the command parameters
- An example of the command usage
- Rules, dependencies, and notes relevant to the command
- A list of related commands
- The command class to which the command belongs
- Sample command output

dact-alm-trns**Deactivate Alarm Transfer**

Use this command to return all audible alarm indications to the local office.

Keyword: dact-alm-trns

Related Commands: act-alm-trns, rept-stat-clk, rept-stat-trbl, rls-alm, rtrv-obit, rtrv-trbl

Command Class: System Maintenance

Parameters

This command has no parameters.

Example

dact-alm-trns

Dependencies

None

Notes

After you enter **dact-alm-trns**, enter **rept-stat-alm** to verify the status of the alarms.

Output

dact-alm-trns

```
rlghncxa03w 04-01-07 11:11:28 EST EAGLE 31.3.0
Alarms returned to Local Maintenance Center
;
```

dact-cdl**Deactivate Command Driven Loopback**

Use this command to deactivate a previously initiated command driven loopback for testing a signaling link, if the test is active. If it is not active, the command will attempt to clear both near-end and far-end latched loopback points

Keyword: dact-cdl

Related Commands: act-cdl, rept-stat-cdl, act-lbp, dact-lbp, tst-slk

Command Class: Link Maintenance

Parameters

:loc= (mandatory)

The card location as stenciled on the shelf of the system.

Range: 1101-1108, 1111-1112, 1201-1208, 1211-1218, 1301-1308, 1311-1318, 2101-2108, 2111-2118, 2201-2208, 2211-2218, 2301-2308, 2311-2318, 3101-3108, 3111-3118, 3201-3208, 3211-3218, 3301-3308, 3311-3318, 4101-4108, 4111-4118, 4201-4208, 4211-4218, 4301-4308, 4311-4318, 5101-5108, 5111-5118, 5201-5208, 5211-5218, 5301-5308, 5311-5318, 6101-6108, 6111-6118

:port= or :link= (mandatory)

SS7 signaling ports. The signaling port to which the SS7 signaling link being tested is assigned.

Range: a, b, a1-a31, b1-b31

Not all card types support all **link** parameter values.

See Table A-1 in Appendix A for valid **link** parameter range values for each type of card that can have assigned signaling links.

Example

```
dact-cdl:loc=1205:link=b
```

Dependencies

The card in the location specified in the **loc** parameter must be equipped and in service.

The signaling link specified in the **link** parameter must be equipped and not active.

Link Fault Sectionalization (LFS) must not be running on the specified signaling link when this command is entered.

Command Driven Loopback testing is not available during upgrade.

If a Command Driven Loopback test is in progress on the specified link when this command is entered, the test will be deactivated. If a test is not active, the command will attempt to clear near-end and far-end latched loopback points.

Notes

None

Output

```
dact-cdl:loc=1205:link=b
```

```
tekelecstp 05-01-21 17:00:36 EST EAGLE5 33.0.0
tekelecstp 03-11-21 17:00:36 EST EAGLE 31.3.0
Command Accepted: Stop Command Driven Loopback message is sent.
```

```
;
```

```
tekelecstp 05-01-21 17:00:36 EST EAGLE5 33.0.0
tekelecstp 03-11-21 17:00:36 EST EAGLE 31.3.0
Command Completed.
```

```
;
```

dact-cmd

Deactivate Command

This command halts processing and output of the commands listed in Table 6-1.

Used without the **trm** parameter, the **dact-cmd** command is entered on the same terminal that is currently running the command that you want to cancel.

Used with the **trm** parameter, the **dact-cmd** command is entered on a terminal other than the one that is currently running the command that you want to cancel.

Table 6-1. Commands for which **dact-cmd** Aborts Processing and Output

Command		
rept-imt-info	rtrv-appl-sock	rtrv-ls
rept-stat-as	rtrv-as	rtrv-map
rept-stat-assoc	rtrv-assoc	rtrv-mrn
rept-stat-card	rtrv-cmd	rtrv-obit (active OAM)
rept-stat-clk	rtrv-dcmps	rtrv-rte
rept-stat-dstn	rtrv-dstn	rtrv-seculog
rept-stat-ls	rtrv-gta	rtrv-secu-user
rept-stat-slk	rtrv-gtt	rtrv-slk
rept-stat-rte	rtrv-lbp	rtrv-tbl-capacity
rtrv-appl-rtkey	rtrv-log	rtrv-trbltx
		rtrv-uaps

Keyword: dact-cmd

Related Commands: rept-imt-info, rept-stat-as, rept-stat-assoc, rept-stat-card, rept-stat-dstn, rept-stat-ls, rept-stat-rte, rept-stat-slk, rtrv-appl-rtkey, rtrv-appl-sock, rtrv-assoc, rtrv-dcmps, rtrv-dstn, rtrv-gta, rtrv-gtt, rtrv-log, rtrv-ls, rtrv-map, rtrv-obit (active OAM), rtrv-rte, rtrv-seculog, rtrv-slk, rtrv-trbltx, rtrv-uaps

Command Class: Basic (for **dact-cmd**); Security Administration (for **dact-cmd:trm=x**)

Parameters

:trm= (optional)

The terminal on which the command is to be canceled.

Range: 1–40

Example

```
dact-cmd
```

```
dact-cmd:trm=3
```

Dependencies

You cannot specify the **trm** parameter in a **dact-cmd** command that you enter on the same terminal that is running the command that you want to cancel. The terminal will return an error: `system is busy`.

The **dact-cmd:trm=** command requires the security administration command class for the terminal and for the user.

Notes

The **dact-cmd** command (without the **trm** parameter) must be entered on the same terminal that is running the command you want to cancel.

If the **dact-cmd** command is entered on a terminal that is not running a command, the **dact-cmd** command completes successfully without returning an error. Likewise, if the **dact-cmd:trm=** command is entered and there is no command running on the specified terminal, the **dact-cmd:trm=** command completes successfully without returning an error.

Command aborted on terminal 2.

You might still see some output after the abort message if output accumulated in the output queue before you issued the **dact-cmd** command. When you cancel a command, the cancellation should take no longer than 25 seconds to take effect.

The **F9** function key provides the same functionality as the **dact-cmd** command (without the **trm** parameter). On a terminal in KSR mode, pressing <CTRL>I, also provides the same function.

The **dact-cmd** and the **F9** function key cannot be used for pure SEAS commands.

If you try to cancel a command other than one listed in Table 6-1 on page 6-4, the terminal accepts the command, but output and processing of the current command continue.

When the **dact-cmd** command is entered, a command status code of AB (command aborted) is logged in the security log as follows:

- When the **dact-cmd** (without the **trm** parameter) is entered, no entry is logged.
- When the **dact-cmd:trm=** command is entered, an entry is logged.
- When the **dact-cmd** (without the **trm** parameter) is entered as a SEAS flow-thru command, an entry is logged. The **dact-cmd:trm=** command is not allowed as a SEAS flow-thru command because the **dact-cmd:trm=** command belongs to the Security Administration Command Class.

For examples of the security log entries, see the **rtrv-secuolog** command.

Output

dact-cmd

```
rlghncxa03w 04-04-27 17:00:36 EST    EAGLE 31.6.0
dact-cmd
Command entered at terminal #2.
```

```
rlghncxa03w 04-04-27 17:00:36 EST    EAGLE 31.6.0
Command aborted on terminal 2.
```

;

dact-cmd:trm=2

```
rlghncxa03w 04-04-27 17:00:36 EST    EAGLE 31.6.0
dact-cmd:trm=2
Command entered at terminal #3.
```

```
rlghncxa03w 04-04-27 17:00:36 EST    EAGLE 31.6.0
Command aborted on terminal 2.
```

;

dact-echo

Deactivate Echo

Use this command to halt the echoing of command responses from the user's terminal to other terminals or printers.

Keyword: **dact-echo**

Related Commands: **act-echo, alw-trm, canc-echo, chg-trm, inh-trm, rept-stat-trm, rmv-trm, rst-trm, rtrv-trm**

Command Class: Basic

Parameters**:trm=** (optional)

The ID number of the terminal for which the echo is being canceled.

Range: 1-16**Default:** Cancels all active echoes**Example****dact-echo****Dependencies**

You cannot cancel the echo to the same terminal from which you are issuing the **dact-echo** command.

Notes

Only the echoing of command output responses can be halted by this command. To halt the printing of alarm and network messages, you must use the **chg-trm** command.

Output**dact-echo**

```
rlghncxa03w 04-01-07 11:11:28 EST EAGLE 31.3.0
Command entered at terminal #6.
Scroll Area Output echo disabled to all terminals.
```

;

dact-echo:trm=7

```
rlghncxa03w 04-01-07 11:11:28 EST EAGLE 31.3.0
Command entered at terminal #1.
Scroll Area Output echo disabled for terminal 7.
```

;

dact-lbp**Deactivate Loopback Point Test**

Use this command to deactivate a previously activated loopback point test, if a test is active. If no test is active, the command attempts to clear both near-end and far-end latched loopback points.

Keyword: dact-lbp**Related Commands:** act-lbp, chg-lbp, dlt-lbp, ent-lbp, rtrv-lbp, rept-stat-lfs**Command Class:** Link Maintenance**Parameters****:loc=** (mandatory)

Card location. The unique identifier of the card containing the signaling link on which loopback point testing is to be deactivated.

Range: 1101-1108, 1111-1112, 1201-1208, 1211-1218, 1301-1308, 1311-1318, 2101-2108, 2111-2118, 2201-2208, 2211-2218, 2301-2308, 2311-2318, 3101-3108, 3111-3118, 3201-3208, 3211-3218, 3301-3308, 3311-3318, 4101-4108, 4111-4118, 4201-4208, 4211-4218, 4301-4308, 4311-4318, 5101-5108, 5111-5118, 5201-5208, 5211-5218, 5301-5308, 5311-5318, 6101-6108, 6111-6118

:port= or **:link=** (mandatory)

SS7 signaling link. The signaling link for which the loopback point test is being deactivated.

Range: a, b, a1-a31, b1-b31

Not all card types support all **link** parameter values.

See Table A-1 in Appendix A for valid **link** parameter range values for each type of card that can have a location specified in the **loc** parameter.

Example

```
dact-lbp:loc=1205:link=b
```

Dependencies

The specified signaling link must be equipped and must not be active.

For clearing a remotely initiated loopback or LFS test stop, the card location (**loc** parameter) must contain a provisioned and equipped **limds0**, **limt1**, or **limch** (associated with a **limt1**) card configured with either an **ss7ansi** or **ccs7itu** application.

The **dact-lbp** command cannot be entered until any previously issued **act-lbp** or **dact-lbp** command is accepted.

If an LFS test is about to complete, a new **dact-lbp** command cannot be entered until the test completes.

The **dact-lbp** command cannot be entered to cancel a signaling link test (a **tst-slk** test).

The **dact-lbp** command cannot be entered to cancel a Command Driven Loopback test.

The **dact-lbp** command can be entered on a link only if there is an active LFS test active on that link.

The specified link is not found, and the max number of allowed LFS or signaling link tests are already in progress. At least one active LFS or signaling link test must be completed before this command can be entered again.

This command cannot be entered during upgrade.

Notes

After the deactivation of loopback point testing has started, you cannot cancel the process.

If an LFS test is aborted by a card reset, it could leave the remote far-end loop-back condition active. Use the **dact-lbp** command to cancel LFS tests.

Output

The following example output is generated only when a latched loopback is cleared and when there were no active loopback tests in progress.

NOTE: This situation could occur even if there were no latched loopbacks to be cleared.

```
dact-lbp:loc=1205:link=b
```

```
rlghncxa03w 04-02-17 16:02:05 EST EAGLE5 33.0.0
LOC = 1205 LINK = B
CLEAR STATUS = PASS, loopback was cleared.
```

```
;
```

The following example output is generated only when a latched loopback could not be cleared when there were no active loopback tests in progress.

```
dact-lbp:loc=1205:link=b
  rlghncxa03w 04-02-17 16:02:05 EST  EAGLE5 33.0.0
  LOC = 1205  LINK = B
  CLEAR STATUS = ERROR, loopback could not be cleared.
;
```

dact-rstst

Deactivate Route Set Test

Use this command to request deactivation of the routeset test being performed by the LIMs running the **ss7ansi** application. The system verifies that the point code and the linkset exist, and that the specified linkset is in the routeset of the specified point code. If it is, then a request to stop routeset testing procedures for the specified destination-linkset combination is sent to the LIM.

Keyword: dact-rstst

Related Commands: None

Command Class: System Maintenance

Parameters

:dpc= or dpca= (mandatory)

The ANSI destination point code of the destination, x-list entry, or cluster whose routeset testing is to be stopped, with subfields network indicator-network cluster-network cluster member (*ni-nc-ncm*).

Range: 000-255

Specify a valid value for each subfield of the point code, and separate the subfields with a dash (-).

When **chg-sid:pctype=ansi** is specified, *ni* = 000 is not valid.

When **chg-sid:pctype=ansi** is specified, *nc* = 000 is not valid if *ni* = 001-005.

When **chg-sid:pctype=ansi** is specified, *nc* = 000 is valid if *ni* = 006-255.

The point code 000-000-000 is not a valid point code.

:lsn= (mandatory)

The name of the linkset associated with the destination point code that is to have routeset testing stopped.

Range: ayyyyyyyyy

1 alphabetic character followed by 9 alphanumeric characters

Example

```
dact-rstst:dpc=1-2-*.lsn=lsn1a
```

```
dact-rstst:dpc=1-2-33:lsn=lsn1b
```

Dependencies

The specified DPC must be either provisioned or an x-list entry.

The specified linkset must be in the linkset table and in the DPC's routeset.

The destination address must be a full point code or a cluster point code specified as *ni-nc-**. A DPC cannot be specified as *ni-nc-*** or *ni-nc-**** for the **dact-rstst** command.

Notes

None

Output**dact-rstst:dpc=1-2-*:lsn=lsn1a**

```
rlghncxa03w 04-01-05 16:40:40 EST EAGLE 31.3.0
Stop routeset testing request sent to SNM (scroll area)
```

```
rlghncxa03w 04-01-05 16:40:40 EST EAGLE 31.3.0
Command Completed.
```

;

dact-slk**Deactivate Signaling Link**

Use this command to change the state of the specified link to OOS-MT-DSBLD (out-of-service maintenance-disabled).



CAUTION: This command impacts network performance, and should be used only during periods of low traffic.

Keyword: dact-slk

Related Commands: act-slk, blk-slk, dlt-slk, ent-slk, inh-slk, rept-stat-slk, rtrv-slk, tst-slk, ublk-slk, unhb-slk

Command Class: Link Maintenance

Parameters

:loc= (mandatory)

The card location as stenciled on the shelf of the system.

Range: 1101-1108, 1111-1112, 1201-1208, 1211-1218, 1301-1308, 1311-1318, 2101-2108, 2111-2118, 2201-2208, 2211-2218, 2301-2308, 2311-2318, 3101-3108, 3111-3118, 3201-3208, 3211-3218, 3301-3308, 3311-3318, 4101-4108, 4111-4118, 4201-4208, 4211-4218, 4301-4308, 4311-4318, 5101-5108, 5111-5118, 5201-5208, 5211-5218, 5301-5308, 5311-5318, 6101-6108, 6111-6118

:port= or :link= (mandatory)

Signaling link on the card specified in the **loc** parameter. The signaling links can be specified in any sequence or pattern.

Range: a, b, a1-a31, b1-b31

Not all card types support all **link** parameter values.

See Table A-1 in Appendix A for valid **link** parameter range values for each type of card that can have a location specified in the **loc** parameter.

Example

```
dact-slk:loc=1301:link=a
```

Dependencies

A card location must be specified that is valid and defined in the database.

No other action command can be in progress when this command is entered.

The card must be equipped and must be one of the following cards:

- A LIM card running the **ss7ansi**, **ss7gx25**, **atmansi**, or **ccs7itu** application
- A DCM or SSEDCCM card running the **ss7ipgw**, **ipgwi**, **iplim**, or **iplimi** application
- An E1/T1 MIM or HC-MIM card running the **ss7ansi** or **ccs7itu** application
- An E1 ATM card running the **atmitu** application

The card must contain signaling links.

The signaling link must be equipped in the database.

The link parameter values **a1**, **b1**, **a2**, **b2**, **a3**, and **b3** can be specified only for the following cards:

- A multi-port LIM
- An SSEDCCM running the **iplim** or **iplimi** application that supports 8 points
- An E1/T1 MIM or HC-MIM.

The link parameter values **a4-a31** and **b4-b31** can be specified only for the HC-MIM card.

Notes

The *Installation Manual - EAGLE 5 SAS* provides an illustration of card locations.

After **dact-slk** is entered, verify the cancellation by issuing the **rept-stat-slk** command.

Output

```
dact-slk:loc=1301:link=a
rlghncxa03w 04-01-07 11:11:28 EST EAGLE5 33.0.0
Deactivate Link message sent to card
;
```

dact-user

Deactivate User

Use this command to end a user session. The **logout** command has the same affect as the **dact-user** command.

Keyword: dact-user

Related Commands: act-user, chg-pid, chg-user, dlt-user, ent-user, login, logout, rept-stat-user, rtrv-secu-user, rtrv-user

Command Class: Basic

Parameters

This command has no parameters.

Example

```
dact-user
```

Dependencies

None

Notes

The **logout** or **canc-user** commands can be used in place of **dact-user**.

disc-imt**Disconnect IMT**

The interprocessor message transport bus (IMT bus) is the main communications artery between all subsystems in the system. Use this command to disconnect a card from the specified IMT bus.

Keyword: **disc-imt**

Related Commands: **clr-imt-stats**, **conn-imt**, **rept-imt-lvl1**, **rept-imt-lvl2**, **rept-stat-imt**, **rmv-imt**, **rst-imt**

Command Class: System Maintenance

Parameters

:bus= . (mandatory)

IMT bus to be disconnected from.

Range: **a, b**

:loc= (mandatory)

Card address. The card location as stenciled on the shelf of the system.

Range: **1101–1108, 1111–1112, 1201–1208, 1211–1218, 1301–1308, 1311–1318, 2101–2108, 2111–2118, 2201–2208, 2211–2218, 2301–2308, 2311–2318, 3101–3108, 3111–3118, 3201–3208, 3211–3218, 3301–3308, 3311–3318, 4101–4108, 4111–4118, 4201–4208, 4211–4218, 4301–4308, 4311–4318, 5101–5108, 5111–5118, 5201–5208, 5211–5218, 5301–5308, 5311–5318, 6101–6108, 6111–6118**

Example

```
disc-imt:loc=1213:bus=b
```

Dependencies

This command cannot be entered during an IMT Fault Isolation Test. The card cannot be isolated from both IMT busses.

Notes

The card can be reconnected by issuing the **conn-imt** command, or by re-inserting the card. A software reset does not affect connect status. (The **init-card** command performs a software reset).

Output

```
disc-imt:loc=1213:bus=b
```

```
rlghncxa03w 04-01-07 11:02:30 EST EAGLE 31.3.0
Disconnect IMT Bus B command issued to card 1213
```

```
;
```

disp-fts-dir**Display Contents of the File Transfer Area**

Use this command to display the files that are in the file transfer area (FTA) the layout of FTA, and the amount of free space in the FTA.

Keyword: **disp-fts-dir**

Related Commands: **act-file-trns, copy-fts, dlt-fts**

Command Class: System Maintenance

Parameters

:loc= (optional)

The location of the fixed disk whose FTA is to be displayed.

Range: **1114, 1116**
(TDMs)

Default: The active TDM location

Example

disp-fts-dir:loc=1114

Dependencies

This command must display the files (along with deleted files and free slots) in the order in which they appear in the file transfer area.

Notes

None

Output**disp-fts-dir:loc=1114**

```
rlghncxa03w 05-07-01 16:21:12 EST EAGLE 31.3.0
File Transfer Area Directory of fixed disk 1114:
```

FILENAME	LENGTH	LAST MODIFIED	LBA
oam.elf	1048576	05-07-01 16:51	40960
<deleted>	65536	-----	43008
sccp.elf	1048576	05-07-01 18:30	43136
<deleted>	1048576	-----	46704
tbl213.out	640000	05-07-01 06:39	48752
5 File(s) 21584896 bytes free			

dlt-acg-mic**Delete ACG Manually Initiated Control**

Use this command to delete ACG controls that apply to certain queries. The control can apply to all queries or to specific query services and called party digits. A particular control is selected to be deleted by either specifying that it is the **type=all** control or specifying its service and digits.

Keyword: **dlt-acg-mic**

Related Commands: **chg-acg-mic, ent-acg-mic, rept-stat-lnp, rtrv-acg-mic**

Command Class: LNP Database Administration

Parameters

:dgts= (optional)
 Digits
Range: 3-10 digits, values **0-9**

:serv= (optional)
 Query service
Range: **ain, in**

:type= (optional)
 Type of control
Range: **all, sd**
Default: **sd**

Example

```
dlt-acg-mic:type=all
dlt-acg-mic:serv=ain:dgts=9194602132
```

Dependencies

If the **type=all** parameter is specified, optional parameters **serv** and **dgts** are not allowed.

If the **type=sd** parameter is specified, optional parameters **sr** and **dgts** are required.

If the **type=all** parameter is specified, a MIC with **type=all** must exist.

If the **type=sd** parameter is specified, a MIC with the same service and digits must exist.

To enter the **dlt-acg-mic** command, the LNP feature must be turned on (see the **enable-ctrl-feat** command).

Notes

None

Output

```
dlt-acg-mic:type=all
rlghncxa03w 04-02-28 08:50:12 EST EAGLE 31.3.0
ACG MIC table is (10 of 256) 4% full of type SD
DLT-ACG-MIC: MASP A - COMPLTD
;
```

dlt-acg-noc**Delete ACG Node Overload Control**

Use this command to delete the definition of a node overload level. The definition is comprised of the threshold LNP query rates for node overload levels and the values for the Automatic Call Gappings (ACG) to be sent when at the level. If a level is not defined, it is not used. Level 10 cannot be deleted.

Keyword: **dlt-acg-noc**

Related Commands: **chg-acg-noc, ent-acg-noc, rept-stat-lnp, rtrv-acg-noc**

Command Class: LNP Database Administration

Parameters

:lvl= (mandatory)
Overload level.
Range: 1-9

Example

dlt-acg-noc:lvl=3

Dependencies

The specified overload level must be defined.

The LNP feature must be turned on (see the **enable-ctrl-feat** command) before this command can be entered.

Notes

None

Output

```
dlt-acg-noc:lvl=3
rlghncxa03w 04-02-28 08:50:12 EST  EAGLE 31.3.0
DLT-ACG-NOC: MASP A - COMPLTD
;
```

dlt-appl-rtkey**Delete Application Route Key Table**

Use this command to delete static or dynamic entries from the Routing Key table. These entries are used to associate a routing key with a socket name. A static entry is created using the **ent-appl-rtkey** command. A dynamic entry is one created by receipt of a TALI message from the socket to which it applies.

There are three types of routing keys, as follows:

- DPC, SI, SSN routing keys, which are used to route SCCP messages
- DPC, SI routing keys, which are used to route non-SCCP and non-ISUP messages
- DPC, SI, CIC routing keys, which are used to route ISUP messages

Keyword: **dlt-appl-rtkey**

Related Commands: **rtrv-appl-rtkey**, **ent-appl-rtkey**

Command Class: Database Administration

Parameters

:asname= (mandatory)
Application Server (AS) name; AS assigned to this routing key.
Range: ayyyyyyyyyyyyyy
Up to 15 alphanumeric characters; the first character must be a letter

:sname= (mandatory)
Name of socket. The routing key table and maintenance commands use these names to reference individual sockets.

Range: *aaaaaaaaaaaaaaaa*
Up to 15 alphanumeric characters; the first character must be a letter

:cice= (optional)

The end range of circuit identification codes assigned to the routing key. Specify **cice** along with **cics** to identify the routing key to be changed. Valid only if **si=4, 5, or 13** and required if **si=4, 5, or 13**.

Range: See Table A-4 in Appendix A for valid CIC values for specified SI and MSU types.

:cics= (optional)

The end range of circuit identification codes assigned to the routing key. Specify **cice** along with **cics** to identify the routing key to be changed. Valid only if **si=4, 5, or 13** and required if **si=4, 5, or 13**.

Range: See Table A-4 in Appendix A for valid CIC values for specified SI and MSU types.

:dpc/dpca/dpci/dpcn/dpcn24= (optional)

Destination point code.

NOTE: See “Point Code Formats and Conversion” in Appendix A for a detailed description of point code formats, rules for specification, and examples.

:dpc= or :dpca= (optional)

ANSI destination point code with subfields *network indicator-network cluster-network cluster member (ni-nc-ncm)*.

Range: **000-255**

Specify a valid value for each subfield of the point code, and separate the subfields with a dash (-).

When **chg-sid:pctype=ansi** is specified, *ni = 000* is not valid.

When **chg-sid:pctype=ansi** is specified, *nc = 000* is not valid if *ni = 001-005*.

When **chg-sid:pctype=ansi** is specified, *nc = 000* is valid if *ni = 006-255*.

The point code **000-000-000** is not a valid point code.

:dpci= (optional)

ITU international destination point code with subfields *zone-area-id*. The *prefix* subfield indicates a spare point code (*prefix-zone-area-id*).

Range: **s-, 0-255**

Specify a valid value for each subfield of the point code, and separate the subfields with a dash (-).

prefix—s-

zone—0-7

area—000-255

id—0-7

The point code **0-000-0** is not a valid point code.

:dpcn= (optional)

ITU national destination point code in the format of a 5-digit number (*nnnnn*); or 2, 3, or 4 numbers (members) separated by dashes (*m1-m2-m3-m4*) as defined by the

chg-stpopts:npcfnti flexible point code option. A group code must be specified when the ITUDUPPC feature is turned on (*nnnnn-gc*, *m1-m2-m3-m4-gc*). The *prefix* subfield indicates a spare point code (*prefix-nnnnn*, *prefix-nnnnn-gc*, *prefix-m1-m2-m3-m4*, *prefix-m1-m2-m3-m4-gc*).

Range: **s-**, **0-16383**, **aa-zz**

Specify a valid value for each subfield of the point code, and separate the subfields with a dash (-).

prefix—**s-**

nnnnn—**0-16383**

gc—**aa-zz**

m1-m2-m3-m4—**0-14** for each member; values must sum to 14

:dpcn24= (optional)

24-bit ITU national destination point code with subfields *main signaling area-sub signaling area-signaling point* (*msa-ssa-sp*).

Range: **000-255**

Specify a valid value for each subfield of the point code, and separate the subfields with a dash (-).

msa—**000-255**

ssa—**000-255**

sp—**000-255**

:loc= (optional)

Card location. This parameter is used to delete socket associations for dynamic entries in the Routing Key table of the SS7IPGW card at the specified location.

Range: **1101-1108, 1111-1112, 1201-1208, 1211-1218, 1301-1308, 1311-1318, 2101-2108, 2111-2118, 2201-2208, 2211-2218, 2301-2308, 2311-2318, 3101-3108, 3111-3118, 3201-3208, 3211-3218, 3301-3308, 3311-3318, 4101-4108, 4111-4118, 4201-4208, 4211-4218, 4301-4308, 4311-4318, 5101-5108, 5111-5118, 5201-5208, 5211-5218, 5301-5308, 5311-5318, 6101-6108, 6111-6118**

:opc/opca/opci/opcn/opcn24= (optional)

Originating point code. Valid only if **si=4, 5, or 13** and required if **si=4, 5, or 13**.

:opc= or **opca=** (optional)

ANSI originating point code with subfields *network indicator-network cluster-network cluster member* (*ni-nc-ncm*).

Range: **000-255**

Specify a valid value for each subfield of the point code, and separate the subfields with a dash (-).

When **chg-sid:pctype=ansi** is specified, *ni* = **000** is not valid.

When **chg-sid:pctype=ansi** is specified, *nc* = **000** is not valid if *ni* = **001-005**.

When **chg-sid:pctype=ansi** is specified, *nc* = **000** is valid if *ni* = **006-255**.

The point code **000-000-000** is not a valid point code.

:opci= (optional)

ITU international originating point code with subfields *zone-area-id*. The *prefix* subfield indicates a spare point code (*prefix-zone-area-id*)

Range: s-, 0-255

Specify a valid value for each subfield of the point code, and separate the subfields with a dash (-).

prefix—s-

zone—0-7

area—000-255

id—0-7

The point code **0-000-0** is not a valid point code.

:opcn= (optional)

ITU national originating point code in the format of a 5-digit number (*nnnnn*); or 2, 3, or 4 numbers (members) separated by dashes (*m1-m2-m3-m4*) as defined by the **chg-stpopts:npcfnti** flexible point code option. A group code must be specified when the ITUDUPPC feature is turned on (*nnnnn-gc*, *m1-m2-m3-m4-gc*). The *prefix* subfield indicates a spare point code (*prefix-nnnnn*, *prefix-nnnnn-gc*, *prefix-m1-m2-m3-m4*, *prefix-m1-m2-m3-m4-gc*).

Range: s-, 000-255

Specify a valid value for each subfield of the point code, and separate the subfields with a dash (-).

prefix—s-

nnnnn—0-16383

gc—aa-zz

m1-m2-m3-m4—0-14 for each member; values must sum to 14

:opcn24= (optional)

24-bit ITU national originating point code with subfields *main signaling area-sub signaling area-signaling point* (*msa-ssa-sp*).

Range: 000-255

Specify a valid value for each subfield of the point code, and separate the subfields with a dash (-).

msa—000-255

ssa—000-255

sp—000-255

:si= (optional)

The service indicator

Range: 0-15 or equivalent text values:

Number = Text—Description

0 = snm—Signaling network management messages

1 = regtest—Signaling network testing and maintenance regular

2 = spltest—Signaling network testing and maintenance special

3 = sccp—SCCP

4 = tup—Telephone user part

5 = isup—ISDN user part

13 = qbicc

:ssn= (optional)

The subsystem number.

Range: 0-255

:type= (optional)

The type of routing key that is being changed.

Range: full, partial, default

Default: full

Example

dlt-appl-rtkey:sname=tekelec:si=3:ssn=255

dlt-appl-rtkey:dpc=123-234-123:si=5:opc=122-124-125:cics=1:cice=1000:sname=socket3

dlt-appl-rtkey:loc=1105:dpc=6-6-1:si=3:ssn=5:sname=dynamicsock1

dlt-appl-rtkey:dpc=1-1-1:si=3:asname=as1:ssn=255

dlt-appl-rtkey:dpcn24=10-100-10:si=5:sname=socket01:opc24=10-100-11:cics=1:cice=100

dlt-appl-rtkey:dpci=s-3-11-1:si=5:opci=s-4-11-2:cics=1:cice=1000:asname=asitu

Dependencies

The subsystem number is valid, and must be specified, only when **si** is equal to 3 (or **sccp**); when **si** does not equal 3 (or **sccp**), **ssn** must not be specified.

The value entered for the starting circuit identification code (**cics**) must be less than or equal to the value entered for the ending circuit identification code (**cice**).

A circuit identification code range (**cics** to **cice**) that overlaps an existing routing key cannot be specified.

When the DPC is ANSI and **si=4**, a DPC/SI routing key must be specified (TUP is used only in an ITU network).

The **opc**, **cics**, and **cice** parameters are required and can be entered only if the **si** parameter value is 4, 5, or 13.

If **si=4**, 5, or 13 (or **tup**, **isup**, or **qbicc**) is specified, a value must also be specified for the **opc**, **cics**, and **cice** parameters used to route ISUP messages. The **opc**, **cics**, and **cice** parameters can be specified only if **si=4**, 5, or 13 (or **tup**, **isup**, or **qbicc**).

Table A-4 in Appendix A shows valid CIC values for SI types 4, 5, and 13.

The routing key must be in the Routing Key table.

The socket name must be in the Socket table.

If **asname** is specified, the AS name must already be defined in the AS table. The AS name and parameters specified for a routing key must use an address format that is valid for the adapter type used by the ASP associations assigned to the AS.

When **type=default**, **sname** and **loc** are other allowed parameters.

When **type=full**, **dpc** and **si** parameters must be specified.

The following types of partial routing keys are supported:

- DPC-SI-OPC (ignore CIC) can be used as a partial match key for CIC- based traffic.
- DPC-SI (ignore all other fields) can be used as a partial match key for CIC- based traffic or SCCP traffic.

- DPC only (ignore all other fields) can be used as a partial match for any type of traffic.
- SI only (ignore all other fields) can be used as a partial match for any type of traffic.

The following card locations are not valid for this command: 1113, 1115, 1117, 1118, and all xy09 and xy10 locations (where x is the frame and y is the shelf). The card must be equipped and in service.

The last RTKEY assigned to an AS cannot be deleted unless all associations in the AS provisioned for the RTKEY are OPEN=NO.

Notes

A specific routing key/socket name association can be deleted by specifying a fully qualified routing key (**dpc/dpca**, **si**, **ssn**, and **sname**). By default, socket associations in the static key entries are deleted using the **dlt-appl-rtkey** command. To delete a dynamic entry, use the **loc** parameter with the **dlt-appl-rtkey** command.

The originating point code (**opc**) and destination point code (**dp**) must not specify a cluster route.

Group codes are required for ITU-N point codes (DPCN/OPCN) when the Duplicate Point Code feature is turned on.

In this command, only ITU-international and ITU national point codes support the spare point code subtype prefix (**s-**).

Output

```
dlt-appl-rtkey:sname=tekelec:si=3:ssn=255
rlghncxa03w 04-02-17 15:35:05 EST EAGLE 31.3.0
DLT-APPL-RTKEY: MASP A - COMPLTD
;
```

dlt-appl-sock

Delete Application Socket

Use this command to delete the Socket table entries. The Socket table is used to associate the local host/local port to a remote host/remote port.

Keyword: dlt-appl-sock

Related Commands: rtrv-appl-sock, chg-appl-sock, ent-appl-sock

Command Class: Database Administration

Parameters

:sname= (mandatory)

Name of socket. The routing key table and maintenance commands use these names to reference individual sockets.

Range: ayyyyyyyyyyyyyy

Up to 15 alphanumeric characters; the first character must be a letter

Default: Delete all related sockets

Example

```
dlt-appl-sock:sname=tekelec
```

Dependencies

The socket specified in the **sname** parameter must be in an **open=no** state to modify table entries (**chg-appl-sock:open=no**).

An AS/socket entry cannot be deleted from the Socket table if it is assigned to a routing key.

Notes

None

Output

```
dlt-appl-sock:sname=tekelec
rlghncxa03w 04-02-17 15:35:05 EST EAGLE 31.3.0
DLT-APPL-SOCK: MASP A - COMPLTD
;
```

dlt-as**Delete Application Server**

Use this command to delete an AS.

Keyword: dlt-as

Related Commands: chg-as, ent-as, rept-stat-as, rtrv-as

Command Class: Database Administration

Parameters

:aname= (mandatory)

Name of the M3UA/SUA SCTP association to be deleted.

Range: Up to 15 alphanumeric characters; the first character must be a letter.

:asname= (mandatory)

Application Server (AS) name; AS assigned to this routing key.

Range: Up to 15 alphanumeric characters; the first character must be a letter

:aspname= (obsolete)

NOTE: This parameter can no longer be used.

Name assigned to the ASP in the ASP table.

Range: Up to 15 alphanumeric characters; the first character must be a letter.

Example

```
dlt-as:as=asx:aname=asxp1
```

Dependencies

The AS must be defined in the AS table.

The connection state for the associations assigned to the AS must be **open=no** before the AS can be deleted.

An AS that is still assigned to a routing key cannot be deleted.

The specified association name (**aname**) parameter must be defined in the AS.

Notes

None

Output

```
dlt-as:as=asx:as=asxp1  
rlghncxa03w 04-02-17 15:35:05 EST EAGLE 31.3.0  
DLT-AS: MASP A - COMPLTD  
;
```

dlt-asp

Delete Application Server Process

NOTE: This command is obsolete.

Use this command to delete an Application Server Process (ASP).

Keyword: dlt-asp

Related Commands: ent-asp, rept-stat-asp, rtrv-asp

Command Class: Database Administration

Parameters

:aspname= (mandatory)

Name assigned to this ASP.

Range: Up to 15 alphanumeric characters; the first character must be a letter.

Example

```
dlt-asp:aspname=asxp1
```

Dependencies

The ASP must already be defined.

An ASP that is still assigned to an AS cannot be deleted.

Notes

None

Output

```
dlt-asp:aspname=asxp1  
rlghncxa03w 04-02-17 15:35:05 EST EAGLE 31.3.0  
DLT-ASP: MASP A - COMPLTD  
;
```

dlt-assoc**Delete Association**

Use this command to delete the SCTP associations from the IPAPSOCK table.

Keyword: dlt-assoc

Related Commands: chg-assoc, ent-assoc, rtrv-assoc

Command Class: Database Administration

Parameters

:aname= (mandatory)

Name assigned to the association to be deleted.

Range: Up to 15 alphanumeric characters; the first character must be a letter

Example

```
dlt-assoc:aname=tekelec
```

Dependencies

The association name (**aname**) must already exist in the IP Socket/Association (IPAPSOCK) table.

An association that exists on any AS cannot be deleted from the IPAPSOCK table.

An AS assigned to a routing key cannot be deleted from the IPAPSOCK table.

The connection state must be **open=no** to delete the association from the IPAPSOCK table.

Notes

None.

Output

```
dlt-assoc:aname=tekelec
```

```
rlghncxa03w 04-02-17 15:35:05 EST EAGLE 31.3.0
DLT-ASSOC: MASP A - COMPLTD
```

```
;
```

dlt-card**Delete Card**

Use this command to remove a card entry from the system database.

Keyword: dlt-card

Related Commands: , init-card, rept-stat-card, rmv-card, rst-card, rtrv-card

Command Class: Database Administration

Parameters

:loc= (mandatory)

The card location as stenciled on the shelf of the system.

Range: 1101–1108, 1111–1112, 1201–1208, 1211–1218, 1301–1308, 1311–1318, 2101–2108, 2111–2118, 2201–2208, 2211–2218, 2301–2308, 2311–2318, 3101–3108, 3111–3118, 3201–3208, 3211–3218, 3301–3308, 3311–3318, 4101–4108, 4111–4118, 4201–4208, 4211–4218, 4301–4308, 4311–4318, 5101–5108, 5111–5118, 5201–5208, 5211–5218, 5301–5308, 5311–5318, 6101–6108, 6111–6118

Example

```
dlt-card:loc=1201
```

Dependencies

The card location slot must be between 1 and 16, but not 9 or 10.

The card location cannot be 1113–1118.

The shelf location must be 11xx, 12xx, 13xx, 21xx, 22xx, 23xx, 31xx, 32xx, 33xx, 41xx, 42xx, 43xx, 51xx, 52xx, 53xx, or 61xx.

The shelf and card must be equipped.

Before this command can be entered, all links (SS7 signaling links, X.25 signaling links, and TCP/IP data links) assigned to that card must be deleted.

Before an E1 card or an E1/T1 MIM card used as an E1 card can be deleted, any E1 interfaces assigned to the card must be deleted

Before an E1/T1 MIM card that is used as a T1 card can be deleted, any T1 interfaces assigned to the card must be deleted.

After the links are deleted, the card must be inhibited before it can be deleted. Use the **inh-card** command to set the card to the OOS-MT-DSBLD state.

Notes

None

Output

```
dlt-card:loc=1201
rlghncxa03w 04-01-07 11:11:28 EST EAGLE 31.3.0
DLT-CARD: MASP A - COMPLTD
;
```

dlt-csl

Delete Common Screening List

Use this command to delete an existing entry in the Common Screening List (CSL). The Common Screening List commands are used to tailor certain types of general screening information to specific features.

Keyword: dlt-csl

Related Commands: ent-csl, chg-csl, rtrv-csl, rtrv-ctrl-feat

Command Class: Database Administration

Parameters

NOTE: See "Point Code Formats and Conversion" on page A-6 for a detailed description of point code formats, rules for specification, and examples.

:ds= (Optional)

Digit String. This parameter specifies a unique string of digits that is used by the specified screening feature.

NOTE: Either the ds or the pc parameter must be specified. Both parameters cannot be specified in the same command.

Range: 1 - 15 digits

Valid digits are **0-9, a-f, A-F**

1-15 digits—IDP Screening for Prepaid **insl** list

4 digits—IDP Screening for Prepaid **skts** list

1-15 digits—Prepaid IDP Query Relay **ccnc** list

1-15 digits—Prepaid IDP Query Relay **ccnc** list

1-5 digits—Prepaid IDP Query Relay **delpfx** list

1-6 digits—Prepaid IDP Query Relay **gta** list

1-4 digits—Prepaid IDP Query Relay **skbcsm** list

:feature= (Optional)

Feature Name. The name of the enabled screening feature for which the command is entered. Enter the entire feature name as it appears in the **rtrv-ctrl-feat** command description output example.

NOTE: Either the pn parameter or the feature parameter must be specified to identify the feature.

Range: *abcdefghijklmnopqrstuvwxyz*

1 alphabetic character and up to 24 optional alphanumeric characters, including spaces and special characters, enclosed in double quotation marks (" ").

The following feature names are valid for this command:

- IDP Screening for Prepaid
- Prepaid IDP Query Relay

:list= (Optional)

The name of Common Screening List that is associated with the feature.

NOTE: The list parameter must be specified when the feature uses more than one type of Common Screening List.

Range: **ccnc, delpfx, gt, insl, skbcsm, skts**

ccnc—CC+NC List

delpfx—Delete Prefix List

gt—Global Title List

insl—In Network Subscriber List

skbcsm—SK+BCSM List

skts—Service Key + TeleService List

The following screening lists are valid for the indicated features:

- **skts, insl**—IDP Screening for Prepaid feature
- **ccnc, delpfx, gt, skbcsm**—Prepaid DP Query Relay feature

:pc= or :pca= (Optional)

ANSI point code with subfields *network indicator-network cluster-network cluster member (ni-nc-ncm)*.

Range: 000-255

Specify a valid value for each subfield of the point code, and separate the subfields with a dash (-).

When **chg-sid:pctype=ansi** is specified, *ni* = 000 is not valid.

When **chg-sid:pctype=ansi** is specified, *nc* = 000 is not valid if *ni* = 001-005.

When **chg-sid:pctype=ansi** is specified, *nc* = 000 is valid if *ni* = 006-255.

The point code 000-000-000 is not a valid point code.

:pc/pca/pci/pcn/pcn24= (Optional)

Point code. Either the **ds** or **pc** parameter must be specified for this command. Currently, there are no common screening list features that use point codes.

:pci= (Optional)

ITU international point code with subfields *zone-area-id*. The *prefix* subfield indicates a spare point code (*prefix-zone-area-id*).

Range: s-, 0-255

Specify a valid value for each subfield of the point code, and separate the subfields with a dash (-).

prefix—s-

zone—0-7

area—000-255

id—0-7

The point code 0-000-0 is not a valid point code.

:pcn= (Optional)

ITU national destination point code in the format of a 5-digit number (*nnnnn*); or 2, 3, or 4 numbers (members) separated by dashes (*m1-m2-m3-m4*) as defined by the **chg-stpopts:npcfmti** flexible point code option. A group code must be specified when the ITUDUPPC feature is turned on (*nnnnn-gc*, *m1-m2-m3-m4-gc*). The *prefix* subfield indicates a spare point code (*prefix-nnn-gc*, *prefix-m1-m2-m3-m4-gc*).

Range: s-, 0-16383, aa-zz

Specify a valid value for each subfield of the point code, and separate the subfields with a dash (-).

prefix—s-

nnnnn—0-16383

gc—aa - zz

m1-m2-m3-m4—0-14 for each member; values must sum to 14

:pcn24= (Optional)

24-bit ITU national point code with subfields *main signaling area-sub signaling area-signaling point* (*msa-ssa-sp*).

Range: 000-255

Specify a valid value for each subfield of the point code, and separate the subfields with a dash (-).

msa—000-255

ssa—000-255

sp—000-255

Default: No change to current value.

:pn= (Optional)

Part Number. The 9-digit "893xxxxxx" part number of the feature for which the command is entered. The **rtrv-ctrl-feat** command description shows the part number in the command output example.

NOTE: Either the **pn** parameter or the **feature** parameter must be specified to identify the feature.

Range: 893000000-893999999

The first three digits are **893**. Do not separate the digits with dashes or spaces.

The following part numbers are valid for this command:

- 893015501—IDP Screening for Prepaid feature
- 893016001—Prepaid IDP Query Relay feature.

Example

```
dlt-csl:feature="IDP Screening for Prepaid":list=insl:ds=246810
```

```
dlt-csl:pn=893015501:list=skts:ds=36ab
```

```
dlt-csl:feature="Prepaid IDP Query Relay":list=ccnc:ds=123456
```

```
dlt-csl:pn=893016001:list=skbcsm:ds=4321
```

```
dlt-csl:feature="Prepaid IDP Query Relay":list=delpfx:ds=54321:p1=0
```

```
dlt-csl:pn=893016001:list=gt:ds=123456789abcdEF
```

Dependencies

An enabled feature must be specified via either a valid part number (**pn**) or feature name (**feature**). The specified feature must use a Common Screening List.

The specified feature name must be for a feature that uses a Common Screening List.

The feature name must be specified as it appears in the **rtrv-ctrl-feat** command output example. The entire feature name must be entered.

The following features use a Common Screening List:

- IDP Screening for Prepaid
- Prepaid IDP Query Relay

The feature that is specified in the **feature** parameter must be enabled.

The **list** parameter must be specified for features that use more than one type of screening list.

The **list** parameter value must be valid for the specified screening feature.

The following **list** parameter values are valid for the indicated feature:

- **insl, skts**—IDP Screening for Prepaid feature
- **gt, ccnc, delpfx, skbcsm**—Prepaid IDP Query Relay feature

The specified screening list entry must exist in the screening list that is used by the feature.

The following parameters are allowed with the indicated common screening list type:

- **list=gt—ds** parameter
- **list=ccnc—ds** parameter
- **list=delpfx—ds** and **p1** parameters
- **list=skbcsm—ds** parameter
- **list=insl—ds** parameter
- **list=skts—ds** parameter

Notes

None

Output

```
dlt-csl:pn=893015501:list=insl:ds=123456789abcdEF
tekelecstp 05-09-21 15:18:41 EST EAGLE5 34.3.0
INSL List table is (5 of 50) 10% full
DLT-CSL: MASP A - COMPLTD
```

dlt-cspc

Delete Concerned Signaling Point Code

Use this command to remove a Concerned Signaling Point Code or an entire CSPC group.

Keyword: dlt-cspc

Related Commands: ent-cspc, rtrv-cspc

Command Class: Database Administration

Parameters

† One, but not both, of these optional parameters must be specified.

NOTE: See “Point Code Formats and Conversion” in Appendix A for a detailed description of point code formats, rules for specification, and examples.

:grp= (mandatory)

Group name

Range: ayyyyyyy

1 alphabetic character followed by up to 7 alphanumeric characters

:all= (optional)†

Use this parameter to confirm that all entries for this concerned signaling point code group are to be removed.

Range: yes, no

Default: no

:pc/pca/pci/pcn/pcn24= (optional)†

Concerned signaling point code.

:pc= or :pca= (optional)

ANSI point code with subfields *network indicator-network cluster-network cluster member (ni-nc-ncm)*.

Range: 000-255

Specify a valid value for each subfield of the point code, and separate the subfields with a dash (-).

When **chg-sid:pctype=ansi** is specified, *ni = 000* is not valid.

When **chg-sid:pctype=ansi** is specified, *nc = 000* is not valid if *ni = 001-005*.

When **chg-sid:pctype=ansi** is specified, *nc = 000* is valid if *ni = 006-255*.

The point code **000-000-000** is not a valid point code.

:pci= (optional)

ITU international point code with subfields *zone-area-id*. The prefix subfield indicates a spare point code (*prefix-zone-area-id*)

Range: s-, 0-255

Specify a valid value for each subfield of the point code, and separate the subfields with a dash (-).

prefix—s-

zone—0-7

area—000-255

id—0-7

The point code **0-000-0** is not a valid point code.

:pcn= (optional)

ITU national point code in the format of a 5-digit number (*nnnnn*); or 2, 3, or 4 numbers (members) separated by dashes (*m1-m2-m3-m4*) as defined by the **chg-stpopts:npfinti** flexible point code option. A group code must be specified when the ITUDUPPC feature is turned on (*nnnnn-gc, m1-m2-m3-m4-gc*). The *prefix* subfield indicates a spare point code (*prefix-nnnnn, prefix-nnnnn-gc, prefix-m1-m2-m3-m4, prefix-m1-m2-m3-m4-gc*).

Range: s-, 0-16383, aa-zz

Specify a valid value for each subfield of the point code, and separate the subfields with a dash (-).

prefix—s-

nnnnn—0-16383

gc—aa-zz

m1-m2-m3-m4—0-14 for each member; values must sum to 14

:pcn24= (optional)

24-bit ITU national point code with subfields *main signaling area-sub signaling area-signaling point (msa-ssa-sp)*.

Range: 000-255

Specify a valid value for each subfield of the point code, and separate the subfields with a dash (-).

msa—000-255

ssa—000-255

sp—000-255

Example

```
dlt-cspc:grp=grp01:pc=144-201-001
dlt-cspc:grp=grp01:pci=s-144-201-001
dlt-cspc:grp=grp01:all=yes
```

Dependencies

A concerned point code group name must be specified. The specified group name must exist in the database.

The **grp** parameter and the **all=yes** parameter must be entered with no point code parameter, to remove a group and all of its point codes.

If a point code is specified, the point code network type must match the group network type and the point code must exist in the specified concerned point code group. The specified point code is removed from the concerned point code group.

Either a point code parameter or the **all=yes** parameter must be specified.

The Spare Point Code Support feature must be enabled before the spare point code prefix **s-** can be specified for an ITU-I or ITU-N point code.

A point code parameter cannot be entered together with the **all** parameter in the same command.

Notes

The system issues a warning if a mate application entity could potentially use a group name that is being deleted.

In this command, only ITU-international and ITU national point codes support the spare point code subtype prefix (**s-**).

Output

```
dlt-cspc:grp=grp01:pci=2-2-2
tekelecstp 04-04-08 12:42:47 EST EAGLE 31.3.0
DLT-CSPC: MASP A - COMPLTD
;
```

dlt-dlk**Delete Data Link**

Use this command to remove a TCP/IP data link from the database. The TCP/IP data link is used for the STP LAN feature, connecting the system to a remote host for message processing.

Keyword: **dlt-dlk**

Related Commands: **act-dlk, canc-dlk, ent-dlk, rept-stat-dlk, rtrv-dlk, tst-dlk**

Command Class: Database Administration

Parameters

:loc= (mandatory)

The card location as stenciled on the shelf of the system.

Range: 1101–1108, 1111–1112, 1201–1208, 1211–1218, 1301–1308, 1311–1318, 2101–2108, 2111–2118, 2201–2208, 2211–2218, 2301–2308, 2311–2318, 3101–3108, 3111–3118, 3201–3208, 3211–3218, 3301–3308, 3311–3318, 4101–4108, 4111–4118, 4201–4208, 4211–4218, 4301–4308, 4311–4318, 5101–5108, 5111–5118, 5201–5208, 5211–5218, 5301–5308, 5311–5318, 6101–6108, 6111–6118

Example

```
dlt-dlk:loc=1201
```

Dependencies

The ACM is the only card type that is valid for this command.

The shelf and card must be equipped.

The specified ACM must have a TCP/IP data link assigned to it.

The specified ACM and data link must be out-of-service maintenance-disabled (OOS-MT-DSBLD). Enter the **rept-stat-card** and **rept-stat-dlk** commands to verify the state of the ACM and data link.

Notes

None

Output

```
dlt-dlk:loc=1201
  rlgncxa03w 04-02-10 11:43:02 EST  EAGLE 31.3.0
  DLT-DLK: MASP A - COMPLTD
;
```

dlt-dstn

Delete Destination

Use this command to delete destinations from the Destination entity set after the STP no longer routes to those destinations.

Keyword: dlt-dstn

Related Commands: chg-dstn, chg-rte, dlt-rte, ent-dstn, ent-rte, rept-stat-dstn, rtrv-dstn, rtrv-rte

Command Class: Database Administration

Parameters

NOTE: See “Point Code Formats and Conversion” in Appendix A for a detailed description of point code formats, rules for specification, and examples.

:dpc/dpca/dpci/dpcn/dpcn24= (mandatory)

Destination point code.

:dpc= or dpca= (mandatory)

ANSI destination point code with subfields *network indicator-network cluster-network cluster member (ni-nc-ncm)*. The *prefix* subfield indicates a private point code (*prefix-ni-nc-ncm*).

Range: **p-**, **000-255**
 Specify a valid value for each subfield of the point code, and separate the subfields with a dash (-).
prefix—**p-**
 When **chg-sid:pctype=ansi** is specified, *ni* = **000** is not valid.
 When **chg-sid:pctype=ansi** is specified, *nc* = **000** is not valid if *ni* = **001-005**.
 When **chg-sid:pctype=ansi** is specified, *nc* = **000** is valid if *ni* = **006-255**.
 The point code **000-000-000** is not a valid point code.

:dpci= (mandatory)

ITU international destination point code with subfields zone-area-id. The *prefix* subfield indicates a spare point code, private point code, or private and spare point code (*prefix-zone-area-id*).

Range: **s-**, **p-**, **ps-**, **0-255**
 Specify a valid value for each subfield of the point code, and separate the subfields with a dash (-).
prefix—**s-**, **p-**, **ps-**
zone—**0-7**
area—**000-255**
id—**0-7**
 The point code **0-000-0** is not a valid point code.

:dpcn= (mandatory)

ITU national destination point code in the format of a 5-digit number (*nnnnn*); or 2, 3, or 4 numbers (members) separated by dashes (*m1-m2-m3-m4*) as defined by the **chg-stpopts:npcfmti** flexible point code option. A group code (*gc*) must be specified when the ITUDUPPC feature is turned on. The *prefix* indicates a spare point code, private point code, or private and spare point code.

Range: **s-**, **p-**, **ps-**, **0-16383**, **aa=zz**
prefix—**s-**, **p**, **ps**
nnnnn—**0-16383**
gc—**aa-zz**
m1-m2-m3-m4—**0-14** for each member; values must sum to 14

:dpcn24= (mandatory)

24-bit ITU national destination point code with subfields *main signaling area-sub signaling area-signaling point*. The *prefix* subfield indicates a private point code.

Range: **p-**, **000-255**
 Specify a valid value for each subfield of the point code, and separate the subfields with a dash (-).
prefix—**p-**
msa—**000-255**
ssa—**000-255**
sp—**000-255**

Example

To delete destination **11-222-111**:

dlt-dstn:dpc=111-222-111

To delete a network destination:

dlt-dstn:dpc=21-*.*

To delete destination **8112-ge**:

dlt-dstn:dpcn=8112-ge

To delete ITU-N 24-bit destination **13-100-10**:

dlt-dstn:dpcn24=13-100-10

To delete destination spare point code **s-8112**:

dlt-dstn:dpcn=s-8112

Dependencies

The destination address must be either a full point code, a cluster point code, or a network destination point code.

The format of the specified **dpcn** parameter must match the format for ITU national point codes that was assigned with the **chg-stpopts:npcfmti** parameter.

The specified destination point code must already exist in the Destination entity set.

The destination cannot have routes assigned to it.

The specified destination point code cannot already be defined as a remote application internal point code (IPC).

The **dpc** parameter must be defined as a destination point code.

The specified destination point code cannot already be defined as an adjacent point code or a secondary adjacent point code.

The specified destination cannot be referenced by SCCP as a destination point codes in the Mate Application table.

The specified destination cannot be referenced by SCCP as a destination point code in the Mated Relay Node (MRN) table.

If the X.25/SS7 Gateway feature is turned on, any X.25 destinations that reference the specified destination must be removed from the database before the specified destination can be removed from the database.

Network routing is valid only if the Network Routing (NRT) feature is turned on.

When using network routing, if the destination point code has a value of * in the *nc* subfield, the *nem* subfield must also be * (for example, **dpc=21-*.***).

Notes

In this command, only ITU-international and ITU national point codes support the spare point code subtype prefix (**s-**) and the private and spare point code subtype prefix (**ps-**). All of the point code types support the private (internal) point code subtype prefix (**p-**).

Output

The following example shows the display of the destination memory space accounting command completion response with the NCR, NRT, and CRMD features off (disabled) and all Routes and Routesets features off (disabled):

dlt-dstn:dpc=111-222-111

```
rlghncxa03w 04-08-17 15:35:05 EST EAGLE 31.8.0
Destination table is (10 of 2000) 1% full
Alias table is (8 of 12000) 1% full
DLT-DSTN: MASP A - COMPLTD
```

;

The following example shows the display of the destination memory space accounting command completion response with the NCR, NRT, and CRMD features off (disabled) and the DSTN5000 (5000 Routes) feature on:

dlt-dstn:dpc=111-222-111

```
rlghncxa03w 04-08-18 08:29:15 EST EAGLE 31.8.0
Destination table is (10 of 5000) 1% full
Alias table is (8 of 12000) 1% full
DLT-DSTN: MASP A - COMPLTD
```

;

The following example shows the display of the destination memory space accounting command completion response with one or more of the NCR, NRT, or CRMD features on and the DSTN5000 (5000 Routes) feature on:

dlt-dstn:dpc=111-222-111

```
rlghncxa03w 04-08-18 08:29:15 EST EAGLE 31.8.0
DESTINATION ENTRIES ALLOCATED: 5000
  FULL DPC(s): 9
  NETWORK DPC(s): 0
  CLUSTER DPC(s): 1
  TOTAL DPC(s): 10
  CAPACITY (% FULL): 1%
ALIASES ALLOCATED: 12000
  ALIASES USED: 8
  CAPACITY (% FULL): 1%
X-LIST ENTRIES ALLOCATED: 500
DLT-DSTN: MASP A - COMPLTD
```

;

The following example shows the display of the destination memory space accounting command completion response with the NCR, NRT, and CRMD features off (disabled) and the 6000 Routesets feature on:

dlt-dstn:dpc=111-222-111

```
rlghncxa03w 04-08-18 08:29:15 EST EAGLE 31.8.0
Destination table is (60 of 6000) 1% full
Alias table is (8 of 12000) 1% full
DLT-DSTN: MASP A - COMPLTD
```

;

The following example shows the display of the destination memory space accounting command completion response with one or more of the NCR, NRT, or CRMD features on and the 6000 Routesets feature on:

dlt-dstn:dpc=111-222-111

```

rlghncxa03w 04-08-18 08:29:15 EST EAGLE 31.8.0
DESTINATION ENTRIES ALLOCATED: 6000
  FULL DPC(s): 46
  NETWORK DPC(s): 1
  CLUSTER DPC(s): 1
  TOTAL DPC(s): 12
  CAPACITY (% FULL): 1%
ALIASES ALLOCATED: 12000
  ALIASES USED: 8
  CAPACITY (% FULL): 1%
X-LIST ENTRIES ALLOCATED: 500
DLT-DSTN: MASP A - COMPLTD

```

;

The following example shows the display of the destination memory space accounting command completion response with the NCR, NRT, and CRMD features off (disabled). When the 7000 Routesets quantity feature is on, the Destination table line shows "...of 7000" as it appears in the example. When the 8000 Routesets quantity feature is on, the Destination table line shows "...of 8000".

dlt-dstn:dpc=111-222-111

```

rlghncxa03w 04-08-18 08:29:15 EST EAGLE 31.8.0
Destination table is (10 of 7000) 1% full
Alias table is (8 of 8000) 1% full
DLT-DSTN: MASP A - COMPLTD

```

;

The following example shows the display of the destination memory space accounting command completion response with one or more of the NCR, NRT, or CRMD features on. When the 8000 Routesets quantity feature is on, the DESTINATION ENTRIES ALLOCATED line shows "8000" as it appears in the example. When the 7000 Routesets quantity feature is on, the DESTINATION ENTRIES ALLOCATED line shows "7000".

dlt-dstn:dpc=111-222-111

```

rlghncxa03w 04-08-18 08:29:15 EST EAGLE 31.8.0
DESTINATION ENTRIES ALLOCATED: 8000
  FULL DPC(s): 46
  NETWORK DPC(s): 1
  CLUSTER DPC(s): 1
  TOTAL DPC(s): 12
  CAPACITY (% FULL): 1%
ALIASES ALLOCATED: 8000
  ALIASES USED: 8
  CAPACITY (% FULL): 1%
X-LIST ENTRIES ALLOCATED: 500
DLT-DSTN: MASP A - COMPLTD

```

;

dlt-e1**Delete E1 Interface**

Use this command to delete an interface for a 2-port E1 card, or for an E1/T1 MIM card or HC-MIM card used as an E1 card. The E1 port number on the card and the E1 card location in the EAGLE must be specified.

On a HC-MIM card, E1 ports 1, 3, 5, and 7 (master ports) can be independently channel bridged with their adjacent even numbered (slave) ports 2, 4, 6, and 8 to allow non-signaling data pass-through. The slave port interface is automatically deleted with the command that deletes its master port interface.

Keyword: dlt-e1

Related Commands: chg-e1, ent-e1, rtrv-e1, tst-e1

Command Class: Database Administration

Parameters

:e1port= (mandatory)

E1 port number. The value must be an E1 port that has already been configured on the specified E1 card.

Range: 1-8

Ports 3 through 8 can be specified only for HC-MIM cards.

:loc= (mandatory)

The card location as stenciled on the shelf of the system.

Range: 1101-1108, 1111-1112, 1201-1208, 1211-1218, 1301-1308, 1311-1318, 2101-2108, 2111-2118, 2201-2208, 2211-2218, 2301-2308, 2311-2318, 3101-3108, 3111-3118, 3201-3208, 3211-3218, 3301-3308, 3311-3318, 4101-4108, 4111-4118, 4201-4208, 4211-4218, 4301-4308, 4311-4318, 5101-5108, 5111-5118, 5201-5208, 5211-5218, 5301-5308, 5311-5318, 6101-6108, 6111-6118

Example

```
dlt-e1:loc=1205:e1port=1
```

```
dlt-e1:loc=1205:e1port=2
```

Dependencies

The specified card location (**loc** parameter) must be equipped.

The card in the specified card location (**loc** parameter) must be a **lime1** card type.

The port specified by the **e1port** parameter must be already equipped with an E1 interface.

All signaling links providing timeslots serviced by the specified E1 interface must be deleted before the E1 interface can be deleted.

An HC-MIM channel bridged slave (even-numbered) port cannot be specified in the **e1port** parameter. To delete channel bridged port interfaces, specify the master (odd-number) port in the **e1port** parameter. The slave port interface is automatically deleted when its master port interface is deleted.

Notes

None.

Output

```

dlt-e1:loc=1205:e1port=1
    r1ghncxa03w 04-02-20 09:07:58 EST  EAGLE 31.3.0
    dlt-E1: MASP A - COMPLTD
;

```

dlt-fta**Delete Entry from the File Transfer Area**

This command removes a file from the file transfer area (FTA).

Keyword: dlt-fta

Related Commands: act-file-trns, disp-disk-dir, copy-fta

Command Class: System Maintenance

Parameters

† At least one of these parameters, but not both, must be specified.

:all= (optional)†

This parameter allows all files to be removed from the FTA.

Range: yes, no

Default: no

:file= (optional)†

The name of the file to be removed.

Range: The name of the file with its extension.

Default: No filename is specified.

:force= (optional)

This parameter is required to delete the last file in the FTA. In such cases, the value must be set to **force=yes**.

Range: yes, no

Default: no

:loc= (optional)

The card location of the fixed disk containing the FTA.

Range: 1114, 1116 (TDM)

Default: The location of the active TDM

Example

```
dlt-fta:loc=1114:file="CAM.ELF"
```

```
dlt-fta:loc=1114:file="CAM.ELF":force=yes
```

```
dlt-fta:loc=1116:all=yes
```

Dependencies

Removing an individual file only frees up that file name for another transfer of that file.

The **all=yes** parameter not only removes all files from the FTA, but frees up the space in the FTA.

File name formats are limited to 8 + 3 DOS compatible characters. When using DOS file names, if the file name contains a special character such as an underscore (_) or begins with a numeric, the file name must be in quotes (" "), for example, "92_name.ext".

The **force=yes** parameter must be specified to remove the last file in the FTA.

Notes

None

Output

dlt-ftp:file=OAM.ELF:loc=1114

```
rlghncxa03w 04-02-05 15:31:59 EST EAGLE 31.3.0
File OAM.ELF deleted from File Transfer Area on fixed disk 1114.
```

;

dlt-ftp:all=yes:loc=1116

```
rlghncxa03w 04-02-05 15:33:32 EST EAGLE 31.3.0
All files deleted from File Transfer Area on fixed disk 1116.
```

;

dlt-ftp-serv

Delete FTP Server Entry

Use this command to delete an entry for an FTP server from the FTP Server table.

Keyword: dlt-ftp-serv

Related Commands: chg-ftp-serv, ent-ftp-serv, rtrv-ftp-serv

Command Class: Database Administration

Parameters

:app= (mandatory)

The FTP Client application at the EAGLE STP that interfaces with the FTP Server.

Range: **meas, user**

meas—the Measurements Platform application

user—the FTP-based Table Retrieve Application (FTRA)

:ipaddr= (mandatory)

IP Address of the FTP Server.

Range: 4 numbers separated by dots, with each number in the range of **000–255**.

Example

```
dlt-ftp-serv:app=meas:ipaddr=1.255.0.102
```

Dependencies

Both the **app** and **ipaddr** parameters must be entered in the command to delete an FTP server.

An entry must already exist in the FTP Server table for this application at the specified IP address.

The **app** parameter must specify an application that uses the FTP Support feature.

The **ipaddr** parameter must specify a valid IP address for the FTP server.

Notes

None

Output

```

dlt-ftp-serv:app=meas:ipaddr=1.255.0.102
  rlghncxa03w 04-02-20 09:07:58 EST  EAGLE 31.3.0
  FTP SERV table is (1 of 10) 10% full
  DLT-FTP-SERV: MASP A - COMPLTD
;

dlt-ftp-serv:app=user:ipaddr=1.255.0.102
  rlghncxa03w 04-02-20 09:07:58 EST  EAGLE 31.3.0
  FTP SERV table is (0 of 10) 0% full
  DLT-FTP-SERV: MASP A - COMPLTD
;

```

dlt-gsmmap-scrn**Delete GSM MAP Screening Entry**

Use this command to delete the GSM Map Screening CgPA and CdPA entries that are used to filter out or allow SCCP messages containing Map Op-Codes, CGPA GTA+NPV+NAIV, CDPA GTA+NPV+NAIV, and forbidden parameters.

Keyword: dlt-gsmmap-scrn

Related Commands: chg-gsmmap-scrn, ent-gsmmap-scrn, rtrv-gsmmap-scrn

Command Class: Database Administration

Parameters

:cgsr= (mandatory)

CgPA Screening Reference.

Range: ayyy

1 alphabetic character followed by up to 3 optional alphanumeric characters

:opname= (mandatory)

The user-defined name for the operation code. The **opname** value references the operation code (**opcode**) defined with the **ent-gsms-opcode** command.

Range: yyyyyyyy

Up to 8 alphanumeric characters

:cdsr= (optional)

CdPA Screening Reference.

Range: 1 alphabetic character followed by up to 3 optional alphanumeric characters

Example

```
dlt-gsmmap-scrn:opname=xyz:cgsr=fela:cdsr=fall
```

```
dlt-gsmmap-scrn:opname=xyz:cgsr=fela
```

Dependencies

The GSM Map Screening feature (see the **enable-ctrl-feat** command) must be enabled before this command can be entered.

The Enhanced GSM Map Screening (EGMS) feature must be enabled before the **cdsr** parameter can be specified.

The specified **cgsr** parameter value must exist in the database.

The specified **cdsr** parameter value must exist in the database.

A **cgpa** entry cannot be deleted if it is referred to by **cdpa** entries.

The specified **opname** parameter value must exist in the GSM Map Op-Code table.

Notes

Unlike GTT (Global Title Translation) entries, the GSM MAP screening commands do not support splits of ranges during deletion or changes of entries.

Output

dlt-gsmmap-scrn:opname=xyz:cgsr=fela:cdsr=fall

```
rlghncxa03w 04-02-29 08:51:12 EST EAGLE 31.4.0
GSM Map Screening table is (1 of 4000) 1% full
DLT-GSM MAP-SCRN: MASP A - COMPLTD
```

;

dlt-gsmmap-scrn:opname=xyz:cgsr=fela

```
rlghncxa03w 04-02-29 08:51:12 EST EAGLE 31.4.0
GSM Map Screening table is (0 of 4000) 0% full
DLT-GSM MAP-SCRN: MASP A - COMPLTD
```

;

dlt-gsms-opcode

Delete GSM MAP Screening Operation Code

Use this command to delete GSM (Global System for Mobile Telecommunication) MAP (Mobile Application Part) screening operation codes and the default screening action for that operation code.

Keyword: **dlt-gsms-opcode**

Related Commands: **ent-gsms-opcode**, **rtrv-gsms-opcode**, **chg-gsms-opcode**

Command Class: Database Administration

Parameters

:opname= (mandatory)

The user-defined name for the operation code. The **opname** value is defined with the **ent-gsms-opcode** command.

Range: Up to 8 alphanumeric characters

Example

This example deletes a MAP **opname** of **ati**:

```
dlt-gsms-opcode:opname=ati
```

Dependencies

- The reserved word **none** cannot be specified as a value for the **opname** parameter.
- The value specified for the **opname** parameter must exist in the GSM MAP Op-Code table.
- The **opname** value being deleted cannot be referenced in the GSM MAP Screening table.
- The GSM Map Screening feature must be enabled (see the **enable-ctrl-feat** command) before this command can be entered.

Notes

None

Output

dlt-gsms-opcode:opname=ati

```
rlghncxa03w 00-02-29 08:50:12 Rel 28.1.0
GSM MAP Op-Code Table is (1 of 256) 1% full
DLT-GSMS-OPCODE: MASP A - COMPLTD
;
```

dlt-gsmssn-scrn

Delete GSM Subsystem Number Screening Entry

Use this command to delete an SSN (subsystem number) from the GSM (Global System for Mobile Telecommunication) SSN screening table.

Keyword: **dlt-gsmssn-scrn**

Related Commands: **ent-gsmssn-scrn, rtrv-gsmssn-scrn**

Command Class: Database Administration

Parameters

:ssn= (mandatory)

Subsystem number.

Range: **000-255**

:type= (mandatory)

Subsystem type.

Range: **orig, dest**

orig—The origination SSN

dest—The destination SSN

Example

This example deletes a destination subsystem of 255 from the GMS SSN screening table:

```
dlt-gsmssn-scrn:ssn=255:type=dest
```

Dependencies

The GSM Map Screening feature must be enabled (see the **enable-ctrl-feat** command) before this command can be entered.

A value for the **ssn/type** parameter combination must be specified that exists in the GSM SSN screening table.

Notes

None

Output

```
dlt-gsmssn-scrn:ssn=255:type=dest
rlghncxa03w 04-02-20 09:04:21 EST EAGLE 31.3.0
DLT-GSMSSN-SCRN: MASP A - COMPLTD
;
```

dlt-gta

Delete Global Title Address Information

Use this command to delete the GTA (global title address) information applicable to a global title selector combination.

This command deletes the routing of SCCP messages for specified global title addresses from designated destinations and their subsystem numbers.

Keyword: **dlt-gta**

Related Commands: **chg-gta, dlt-gtt, ent-gta, rtrv-gta**

Command Class: Database Administration

Parameters

:gttsn= (mandatory)

GTT set name. A GTT set is an entity to which global title addresses and selectors are assigned.

Range: One leading alphabetic character and up to eight alphanumeric characters

:gta= (mandatory)

Start global title address.

Range: Maximum of 21 digits

:egta= (optional)

End global title address.

Range: Maximum of 21 digits

Default: Same as the specified **gta** value

Example

```
dlt-gta:gttsn=libd:gta=9195554321
dlt-gta:gttsn=t800:gta=919461:egta=919468
```

Dependencies

The EGTT feature must be turned on prior to using this command.

The **gttsn** parameter must be specified, may not have a value of **none**, and must match an existing **gttsn**.

The length of the specified **gta** parameter must match the number of digits provisioned for the specified GTT set (**gttsn**). If the VGTT (variable length GTT) feature is turned on, you can have up to 10 GTA lengths per GTT set. When you enter the **ent-gta** command to create entries, the software keeps track of the lengths and allows only ten different lengths. The global title address specified for the GTT set must have the same number of digits as an existing GTA.

The specified **gta/egta** range must exist for the specified GTT set in the STP active database. While an exact match is not required, you cannot specify an overlap with another range. If the range overlaps, an error is generated that displays a list of overlapped point codes. An example follows that shows what happens when the user attempts to enter a point code range (such as 8005550000 to 8005559999) that overlaps an existing range. The overlapping links must match. If they do not, error message E2401 is generated displaying the list of overlapped point codes:

```
The following GTA ranges overlap the input GTA range
START GTA          END GTA
8005550000         8005551999
8005552000         8005553999
8005554000         8005555999
DLT-GTA: MASP A - Command Aborted
```

If the **egta** parameter is specified, the **gta** and **egta** value must be the same length and the **egta** value must be greater than the **gta** value.

The GTT table cannot be full in case a delete command causes a split requiring more entries to be added.

Notes

When the EGTT feature is turned on, the GTT Selector (**ent/chg/dlt/rtrv-gttsel**), GTT Set (**ent/dlt/rtrv-gttset**), and GTA (**ent/chg/dlt/rtrv-gta**) commands replace the Translation Type (**ent/dlt/rtrv-tt**) and Global Title Translation (**ent/chg/dlt/rtrv-gtt**) commands. All data previously provisioned with these commands is maintained.

If a GTT is being deleted or changed and the point code (**dpc** or **rte**) is not found in the route table (unless the point code is the STP's true point code), the following message is displayed in the terminal scroll area:

```
NOTICE: No DPC and/or RTE found for GTT being deleted or changed.
```

The above situation may occur for the following reasons:

- A database was upgraded from a release prior to EAGLE Release 27.1 or IP⁷ Secure Gateway Release 3.0 when GTT entries were not linked to the route table and the deletion of the **dpc** was permitted. The GTT referenced a **dpc/rte** that was deleted, and the enforce reference counts between the GTT and route tables were not updated.
- A serious problem occurred in which the reference count rules were not enforced and a **dpc** and/or **rte** were deleted while being referenced by a GTT entry. This indicates a software error; notify the Customer Care Center at (888) FOR-TKLC.

Output

```

dlt-gta:gttsn=libd:gta=9195554321
  rlgncxa03w 04-02-20 09:04:21 EST EAGLE 31.3.0
  DLT-GTA: MASP A - CMPLTD
;

```

dlt-gtcnv**Delete Global Title Conversion**

Use this command to delete entries from the Default Global Title Conversion table. The particular entry to be deleted is identified by the direction in conjunction with the TTA or TTI, or with the TTI, NP, and NAI.

Keyword: **dlt-gtcnv**

Related Commands: **ent-gtcnv, chg-gtcnv, rtrv-gtcnv**

Command Class: Database Administration

Parameters

:dir= (mandatory)

Direction of conversion.

Range: **atoi, itoa, both**

atoi—ANSI to ITU conversion

itoa—ITU to ANSI conversion

both—Conversion in both directions

:tta= (optional)

ANSI translation type. This parameter is mandatory when **dir=atoi** or **dir=both** is specified.

Range: **0-255, ***

Default: No change to current value

:tti= (optional)

ITU translation type. This parameter is required when **dir=atoi** is specified.

Range: **0-255, ***

Default: No change to current value

:np= (optional)

Numbering Plan. This parameter is mandatory when **gtixlat=24** is specified, and cannot be specified when **gtixlat=22** is specified.

Range: **0-15, ***

Default: No change to current value

:nai= (optional)

Nature of Address Indicator. This parameter is mandatory when **gtixlat=24** is specified, and cannot be specified when **gtixlat=22** is specified.

Range: **0-63, ***

Default: No change to current value

Example

The following example deletes an ANSI-to-ITU entry using the TTA of **10** to identify the entry.

dlt-gtcnv:dir=atoi:tta=10

The following example deletes an ANSI-to-ITU entry using the TTA of **11** to identify the entry.

dlt-gtcnv:dir=atoi:tta=11

The following example deletes a ITU-to-ANSI entry using the TTI of **7**, NAI of **8**, and NP of **6** to identify the entry.

dlt-gtcnv:dir=ittoa:tti=7:nai=8:np=6

The following example deletes a BOTH (ANSI <-> ITU) entry using the TTI of **9** and TTA of **12** to identify the entry.

dlt-gtcnv:dir=both:tta=12:tti=9

The following example deletes a BOTH (ANSI <-> ITU) entry using the TTI of **7**, NAI of **6**, NP of **4**, and TTA of **12** to identify the entry.

dlt-gtcnv:dir=both:tta=12:tti=7:np=4:nai=6

The following example deletes an ANSI-to-ITU default entry using the TTA of ***** to identify the entry.

dlt-gtcnv:dir=atoi:tta=*

The following example deletes an ITU-to-ANSI default entry using the TTI of *****, NAI of ***** and NP of ***** to identify the entry.

dlt-gtcnv:dir=ittoa:tti=*:nai=*:np=*

Dependencies

The ANSI-ITU-China SCCP Conversion feature must be enabled before this command can be entered.

The entry that is to be deleted must exist in the database.

When **dir=atoi** is specified, the **tta** parameter must be specified.

When **dir=atoi** is specified, the **tta** parameter must be specified.

When **dir=atoi** is specified, **tti**, **nai**, and **np** parameters cannot be specified.

When **dir=ittoa** is specified, the **tti=*** parameter must be specified.

When **dir=ittoa** is specified, **nai** and **np** parameter values must be ***** if specified.

When **dir=both** is specified, at least the **tta** and **tti** parameters must be specified.

When **dir=both** is specified, asterisk values for other parameters cannot be specified.

If specified, the **nai** and **np** parameters must be specified together in the command.

When **gtixlat=22** and **dir=ittoa** are specified, asterisk entries cannot be specified. Specify **gtixlat=24** when **dir=ittoa** is specified and asterisk entries are specified.

Notes

To delete an ANSI-to-ITU entry, specify the direction (**dir**) and the TTA.

To delete an ITU-to-ANSI entry with a **gtixlat** of **22**, specify the direction (**dir**) and the TTI.

To delete an ITU-to-ANSI entry with a **gtixlat** of **24**, specify the direction (**dir**), TTI, NAI and NP.

To delete a BOTH (ANSI <-> ITU) entry with a **gtixlat** of **22**, specify the direction (**dir**), TTA and TTI.

To delete a BOTH (ANSI <-> ITU) entry with a **gtixlat** of **24**, specify the direction (**dir**), TTA, TTI, NP and NAI.

Output

dlt-gtcnv:dir=both:tta=12:tti=9

```
rlghncxa03w 03-03-18 08:50:12 EST EAGLE 31.3.0
DLT-GTCNV: MASP A - COMPLTD
```

;

dlt-gtt**Delete Global Title Translation**

Use this command to remove the routing of messages for specified global title addresses from designated destinations and their subsystem numbers.

NOTE: If the EGTT (Enhanced Global Title Translation) feature is turned on, the system will no longer accept GTT (Global Title Translation) and TT (Translation Type) commands. Refer to the new command sets that replace the GTT and TT commands: GTT Selector commands (ent/chg/dlt/rtrv-gttset), GTT Set commands (ent/dlt/rtrv-gttset), and GTA commands (ent/chg/dlt/rtrv-gta).

Keyword: dlt-gtt

Related Commands: chg-gtt, ent-gtt, rtrv-gtt

Command Class: Database Administration

Parameters

† At least one of these optional parameters must be specified.

:gta=. (mandatory)

Global title start address.

Range: 1-21 digits

:egta= (optional)

Global title end address.

Range: 1-21 digits

Default: egta same as gta

:ttn= (optional)†

Translation type name.

Range: 1 alphabetic character followed by up to 7 alphanumeric characters

Default: No translation name is given

:type/typea/typei/typen/typen24= (optional)†

Translation type identifies the translation type and network type. This parameter is the decimal representation of the 1-byte field used in SS7.

The **type** and **typea** parameters specify an ANSI network.

The **typei** parameter specifies an ITU-international network.

The **typen** parameter specifies an ITU-national network.

The **typen24** parameter specifies a 24-bit ITU-national network.

A translation type numeric value may be entered as ANSI (**type** or **typea**) and also as an ITU type (**typei** or **typen**). However, they are separate entities.

The point code domain translation types for GTT are handled by the EAGLE protocol processing as either ANSI or ITU; therefore, ITU applies to ITU-I, ITU-I Spare, ITU-N, and ITU-N Spare. ITU-I includes ITU-I Spare, and ITU-N includes ITU-N Spare.

Range: 0-255

Default: No translation type is specified

Example

```
dlt-gtt:type=252:ttn=lidb9:gta=408908:egta=408988
```

```
dlt-gtt:gta=919833:typen24=4
```

Dependencies

This command cannot be entered when the EGTT feature is turned on.

If translation type is specified, it must exist in the database.

If the **ttn** parameter is specified, the name must correspond to a translation type entry.

If both **ttn** and **type** are specified, **ttn** must correspond to the given translation type.

The **type** or **ttn** parameter must be specified.

The **gta** length must equal the number of digits specified by the translation type. If the VGTT (variable length GTT) feature is turned on, you can have up to 10 GTA lengths per translation type. When you enter the **ent-gtt** command to create entries, the software keeps track of the lengths and allows only ten different lengths. The global title address specified for the translation type must then have the same number of digits as an existing GTA.

The global title address range as expressed by the **gta** and **egta** parameters must already exist in the global title translation.

The range, as specified by the **gta** and the **egta**, must be exactly the same as a current entry or be contained within an existing range in the GTT data for the specified translation type. If the range overlaps, an error is generated that displays a list of overlapped point codes. An example follows that shows what happens when the user attempts to delete a point code range (such as 8005550000 to 8005559999) that overlaps an existing range. The overlapping links must match. If they do not, error message E2401 is generated displaying the list of overlapped point codes:

```
The following GTA ranges overlap the input GTA range
START GTA          END GTA
8005550000         8005551999
8005552000         8005553999
8005554000         8005555999
DLT-GTT: MASP A - Command Aborted
```

If the address range as specified by the start and end global title addresses does not exactly match the existing range, the range is split. All addresses in the existing range that are outside of the specified range are used to create new ranges. The specified range is deleted.

Notes

None.

Output

```
dlt-gtt:type=252:ttn=lidb9:gta=408908:egta=408988
rlghncxa03w 04-01-07 11:43:07 EST EAGLE 31.3.0
DLT-GTT: MASP A - COMPLTD
;
```

dlt-gttsel

Delete GTT Selectors

Use this command to delete an applicable global title translation (GTT) selector.

Keyword: **dlt-gttsel**

Related Commands: **chg-gttsel, dlt-tt, ent-gttsel, rtrv-gttsel**

Command Class: Database Administration

Parameters

:gti/gtia/gtii/gtin/gtin24= (mandatory)

Global title indicator. For all EGTT selector commands, the domain is defined as **gti** and **gtia** (ANSI), **gtii** (ITU international), **gtin** (ITU national), and **gtin24** (24-bit ITU national). For the selector commands, **gti** and **gtia** are equivalent; **gtii** and **gtin/gtin24** are mutually exclusive because the EGTT database does not distinguish between ITU national and ITU international translations. This means that while ITU-I and ITU-N selectors are stored separately, two separate ITU-I and ITU-N entries with the same selector values cannot exist. For example, if an entry with **gtii=2** and **tt=4** already exists, an entry of **gtin=2** and **tt=4** cannot be entered

Range: Supported value for ANSI: **gti=2** and **gtia=2**

Supported values for ITU: **gtii=2, 4** and **gtin/gtin24=2, 4**

:tt= (mandatory)

Translation type.

Range: 0–255

:nai= (optional)

Nature of address indicator (see Table A-5 in Appendix A).

Range: sub, rsvd, natl, intl, dflt

:naiv= (optional)

Nature of address indicator value (see Table A-5 in Appendix A).

Range: 0–127

NOTE: The nature of address indicator parameters (naiv or nai) can be specified by supplying either a mnemonic or an explicit value. At no time may both the mnemonic and the explicit value be specified at the same time for the same parameter. Either the naiv or nai parameter can be specified. Table A-5 in Appendix A shows the mapping between the naiv and the nai parameters.

:np= (optional)

Numbering plan (see Table A-6 in Appendix A).

Range: e164, generic, x121, f69, e210, e212, e214, private, dflt

:npv= (optional)

Numbering plan value (see Table A-6 in Appendix A).

Range: 0–15

NOTE: The numbering plan parameters (npv or np) can be specified by supplying either a mnemonic or an explicit value. At no time may both the mnemonic and the explicit value be specified as the same time for the same parameter. Either the npv or np parameter can be specified. Table A-6 in Appendix A shows the mapping between the npv and the np parameters.

Example

```
dlt-gttset:gti=2:tt=10
```

```
dlt-gttset:gtin=4:tt=0:np=dflt:nai=dflt
```

Dependencies

The EGTT feature must be turned on before this command can be entered.

An entry must already exist that matches the **gti**, **tt**, and **np(v)** and **nai(v)** combination of parameters.

An entry must already exist that matches the **gtii**, **tt**, and **np(v)** and **nai(v)** combination of parameters.

An entry must already exist that matches the **gtin**, **tt**, and **np(v)** and **nai(v)** combination of parameters.

The specified **gttsn** value must exist for the specified **gtin24**, **tt**, **np/npv/nai/naiv** parameter combination.

The **np** and **npv** parameters cannot be specified together in the same command.

The **nai** and **naiv** parameters cannot be specified together in the same command.

The parameter values **gtia=4**, **gti/gtia/gtii/gtin/gtin24=1**, and **gti/gtia/gtii/gtin/gtin24=3** cannot be specified.

When the **gti/gtia/gtii/gtin/gtin24=2** parameter is specified, the **np/npv** and **nai/naiv** parameter combinations cannot be specified.

When the **gtii/gtin/gtin24=4** parameter is specified, an **np(v)** and **nai(v)** parameter combination must be specified. These parameters can be specified in any combination: **np** and **naiv**, **npv** and **nai**, **np** and **nai**, or **npv** and **naiv**.

Notes

When the EGTT feature is turned on, the GTT Selector (**ent/chg/dlt/rtrv-gttset**), GTT Set (**ent/dlt/rtrv-gttset**), and GTA (**ent/chg/dlt/rtrv-gta**) commands replace the Translation Type (**ent/dlt/rtrv-tt**) and Global Title Translation (**ent/chg/dlt/rtrv-gtt**) commands. All data previously provisioned with these commands is maintained.

Output

dlt-gttset:gti=2:tt=10

```
rlghncxa03w 04-02-18 08:54:41 EST EAGLE 31.3.0
GTT Selector table is (113 of 1024) 11% full
DLT-GTTSEL: MASP A - Cmpltd
```

;

dlt-gttset

Delete GTT Set

Use this command to delete the specified global title translation set.

Keyword: **dlt-gttset**

Related Commands: **dlt-tt**, **ent-gttset**, **rtrv-gttset**

Command Class: Database Administration

Parameters

:gttsn= (mandatory)

The new GTT set name. A GTT set is an entity to which global title addresses and selectors are assigned.

Range: one leading alphabetic character and up to eight alphanumeric characters.

Example

```
dlt-gttset:gttsn=t800
```

Dependencies

The EGTT feature must be turned on prior to using this command.

The **gttsn** parameter must be specified, cannot have a value of **none**, and must match an existing **gttsn**.

The specified GTT set cannot have any GTT selectors using it.

The specified GTT set cannot have any GTAs assigned to it.

Notes

When the EGTT feature is turned on, the GTT Selector (**ent/chg/dlt/rtrv-gttset**), GTT Set (**ent/dlt/rtrv-gttset**), and GTA (**ent/chg/dlt/rtrv-gta**) commands replace the Translation Type (**ent/dlt/rtrv-tt**) and Global Title Translation (**ent/chg/dlt/rtrv-gtt**) commands. All data previously provisioned with these commands is maintained.

Output

dlt-gttset:gttsn=t800

```
rlghncxa03w 04-02-19 08:20:26 EST EAGLE 31.3.0
GTT Set table is (113 of 950) 11% full
DLT-GTTSET: MASP A - COMPLTD
```

;

dlt-gws-redirect

Delete Gateway Screening Redirect Command

Use this command to delete the provisioning of the redirect function and subsequently to disable the gateway screening redirect function. After the gateway screening redirect function is disabled, you must use **ent-gws-redirect** to enable the function again.

Keyword: **dlt-gws-redirect**

Related Commands: **chg-gws-redirect**, **ent-gws-redirect**, **rtrv-gws-redirect**

Command Class: Database Administration

Parameters

This command has no parameters.

Example

```
dlt-gws-redirect
```

Dependencies

The redirect function data that will be deleted (removed).with this command must exist in the database.

Notes

None

Output

dlt-gws-redirect

```
rlghncxa03w 04-02-10 11:43:04 EST EAGLE 31.3.0
DLT-GWS-REDIRECT: MASP A - COMPLTD
```

;

dlt-home-smsc**Delete HOME SMSC Address**

Use this command to delete HOME SMSC specific addresses currently used to identify Short Message Service Centers in the database. This command updates the HOME SMSCADDR table.

Keyword: **dlt-home-smsc**

Related Commands: **ent-home-smsc, rtrv-home-smsc**

Command Class: Database Administration

Parameters

:smc= (mandatory)

Short Message Service Center address.

Range: 1-21 hexadecimal digits

Example

```
dlt-home-smsc:smc=552611646
```

Dependencies

The Portability Check for Mobile Originated SMS (MNP SMS) feature must be enabled (**enable-home-smsc** command) before this command can be entered. (This controlled feature can be turned off with the **chg-ctrl-feat** command and the **dlt-home-smsc** command will still execute).

The specified HOME SMSC address must exist in the HOME SMSCADDR table.

Notes

None

Output

```
dlt-home-smsc:smc=552611646
```

```
rlghncxa03w 04-02-28 08:50:12 EST EAGLE 31.3.0
DLT-HOME-SMSC: MASP A - COMPLTD
```

```
;
```

dlt-homern**Delete Home Routing Number Prefix**

Use this command to delete a routing number prefix from the HOMERN table.

Keyword: **dlt-homern**

Related Commands: **ent-homern, rtrv-homern**

Command Class: Database Administration

Parameters

:rn= (mandatory)

The home routing number prefix

Range: 1 to 15 characters. Allowed characters are [0-9] [A-F] or [0-9] a-f].

Example

```
dlt-homern:rn=C441234
```

Dependencies

The INP or G-Port feature must be turned on before this command can be entered.

The specified routing number must already exist in the HOMERN table.

A value of **none** cannot be specified for the **rn** parameter.

Notes

None

Output

```
dlt-homern:rn=C441234
```

```
rlghncxa03w 04-02-28 08:50:12 EST EAGLE 31.3.0
HOMERN table is (1 of 100) 1% full
DLT-HOMERN: MASP A - COMPLTD
```

```
;
```

dlt-ip-host**Delete Internet Protocol Hostname**

Use this command to delete entries from the IP Host table. The IP Host table defines the local and remote host names and their associated IP addresses.

Keyword: **dlt-ip-host**

Related Commands: **ent-ip-host**, **rtrv-ip-host**

Command Class: Database Administration

Parameters

:host= (mandatory)

Host name. This parameter identifies the logical name assigned to the host device.

Range: **a-z, A-Z, 0-9, -, .**

Any string of characters beginning with a letter and comprising up to 60 characters in length.

Example

```
dlt-ip-host:host=gw100.nc.tekelec.com
```

Dependencies

Before an entry can be deleted from the IP Host table, it must first be deleted from the IP Link table.

Before an entry can be deleted from the IP Host table, all application socket or association references to the hostname must be deleted.

Notes

None

Output

```

dlt-ip-host:host=gw100.nc.tekelec.com
  rlgncxa03w 04-02-17 15:35:05 EST EAGLE 31.3.0
  DLT-IP-HOST: MASP A - COMPLTD
;

```

dlt-ip-node**Delete IP Node**

Use this command to remove an IP node from the database that is directly connected to a TCP/IP data link used for the STP LAN feature. You can remove a particular connection, a particular application on a node, or an entire node.

Keyword: **dlt-ip-node**

Related Commands: **ent-ip-node**, **rtrv-ip-node**

Command Class: Database Administration

Parameters

:ipaddr= (mandatory)

The node's IP address. This is a TCP/IP address expressed in standard dot notation. IP addresses consist of the system's network number and the machine's unique host number. An example IP address is **192.126.100.5**, where **192.126.100** is the network number and **5** is the machine's host number.

Range: **1-223, 0-255**
 4 numbers separated by dots
1-223—first number
0-255—the other three numbers

:force= (optional)

Whether or not to remove all applications associated with the node, thus removing the entire node from the database.

Range: **yes, no**
yes—Delete all connections to node
no—Delete specified application or connection

Default: **no**

:ipappl= (optional)

The IP application supported by the node.

Range: **stplan**
Default: Default value not given

:ipport= (optional)

The logical IP port that addresses the application on the node.

Range: **1024-5000**
Default: The logical IP port is not given.

:loc= (optional)

The card location as stenciled on the shelf of the system.

Range: 1101–1108, 1111–1112, 1201–1208, 1211–1218, 1301–1308, 1311–1318, 2101–2108, 2111–2118, 2201–2208, 2211–2218, 2301–2308, 2311–2318, 3101–3108, 3111–3118, 3201–3208, 3211–3218, 3301–3308, 3311–3318, 4101–4108, 4111–4118, 4201–4208, 4211–4218, 4301–4308, 4311–4318, 5101–5108, 5111–5118, 5201–5208, 5211–5218, 5301–5308, 5311–5318, 6101–6108, 6111–6118

Default: The card location is not given.

Example

To delete the connection for a TCP/IP link associated with an STPLAN on a specified location:

dlt-ip-node:ipaddr=193.4.201.50:ipappl=stplan:loc=1201

To delete the connection for a TCP/IP link associated with an IPPORT on a specified location:

dlt-ip-node:ipaddr=193.4.201.50:ippport=1024:loc=1201

To delete all connections for TCP/IP links associated with the STPLAN on all locations:

dlt-ip-node:ipaddr=193.4.201.50:ipappl=stplan

To delete the connection for TCP/IP links associated with an IPPORT:

dlt-ip-node:ipaddr=193.4.201.50:ippport=1024

To delete all connections for a TCP/IP link associated with any application on a specified location:

dlt-ip-node:ipaddr=193.4.201.50:loc=1201

To delete all connections for TCP/IP links associated with any application on any location:

dlt-ip-node:ipaddr=193.4.201.50:force=yes

Dependencies

The **force** parameter. must be specified to remove an entire node.

At least one of the following parameters must be specified: **ipappl**, **ippport**, **loc**, or **force=yes**.

If the **force=yes** parameter is specified, the **ipappl**, **ippport**, and **loc** parameters cannot be specified.

The **ipappl** and **ippport** parameters cannot be specified together in the command.

The ACM (shown by the entry ACMENET in the TYPE field in the **rtrv-card** command output) is the only valid card type for this command.

If the **loc** parameter is specified, the shelf and card must be equipped.

If the **loc** parameter is specified, the specified card must have a TCP/IP data link assigned to it.

If the **loc** parameter is specified, the IP port on the node must be assigned to the application for the specified TCP/IP data link.

If the **loc** and **ipaddr** parameters are specified, the specified IP address must match the IP address of the card location's remote IP node.

If the **loc** and **ipport** parameters are specified, the specified IP port must match the card location's remote IP port.

If the **loc** and **ipappl** parameters are specified, the specified IP application must match the card location's remote IP application.

The specified ACM (shown by the entry ACMENET in the TYPE field in the **rtrv-card** command output) must be out-of-service maintenance-disabled (OOS-MT-DSBLD). Enter the **rept-stat-card** command to verify the state of the ACM.

Notes

A particular application can be specified by giving either the application's name (**ipappl**) or its IP port (**ipport**) on the node.

Only Class A, Class B, and Class C IP addresses are supported STP LAN feature.

Output

dlt-ip-node:ipaddr=193.4.201.50:loc=1201

```
rlghncxa03w 04-02-10 11:43:04 EST EAGLE 31.3.0
Deleting multiple nodes on disk - please wait...
DLT-IP-NODE: MASP A - COMPLTD
```

;

dlt-ip-rte

Delete IP Route

Use this command to delete a static IP route entry from the Static IP Route table (destination IP address, subnet mask, and gateway IP address) for the specified card.



CAUTION: The deletion of static IP routes can adversely affect IP connection oriented transports.

Keyword: dlt-ip-rte

Related Commands: ent-ip-lnk, rtrv-ip-lnk

Command Class: Database Administration

Parameters

:loc= (mandatory)

Card location. The unique identifier of a specific IP card in the system.

Range: 1101-1108, 1111-1112, 1201-1208, 1211-1218, 1301-1308, 1311-1318, 2101-2108, 2111-2118, 2201-2208, 2211-2218, 2301-2308, 2311-2318, 3101-3108, 3111-3118, 3201-3208, 3211-3218, 3301-3308, 3311-3318, 4101-4108, 4111-4118, 4201-4208, 4211-4218, 4301-4308, 4311-4318, 5101-5108, 5111-5118, 5201-5208, 5211-5218, 5301-5308, 5311-5318, 6101-6108, 6111-6118

:dest= (mandatory)

Destination IP Address. The remote destination host or network destination IP Address that is to be removed.

Range: 4 numbers separated by dots, with each number in the range of 0-255,

:force= (optional)

A value of **yes** is required when the card is allowed and this command is to be completed.

Range: yes, no

Default: no

Example

```
dlt-ip-rte:loc=1301:dest=128.252.10.5
```

```
dlt-ip-rte:loc=1301:dest=128.252.10.5:force=yes
```

Dependencies

The **loc** parameter value must correspond to a DCM card or SSEDCCM card in the card table that is running the **ss7ipgw**, **ipgwi**, **iplim**, or **iplimi** application.

The specified destination IP address (**dest** parameter):

- Must not be the default route (0.0.0.0)
- Must not correspond to any loopback address (i.e. 127.X.X.X)
- Must not reside on this card's A or B network

The specified destination IP address must exist in the Static IP Route table.

The card in the location specified with the **loc** parameter should typically be inhibited for this command to complete successfully. The **force=yes** parameter is required when the card is allowed and the command is entered.

Notes

None

Output

```
dlt-ip-rte:loc=1301:dest=128.252.10.5
```

```
rlghncxa03w 04-02-17 15:35:05 EST EAGLE 31.3.0
```

```
DLT-IP-RTE: MASP A - COMPLTD
```

```
;
```

dlt-lbp

Delete Loopback Point

Use this command to delete one or all far-end loopback points maintained in the Link Fault Sectionalization table for testing data signaling link elements in a single CCS7 transmission path.

Keyword: dlt-lbp

Related Commands: act-lbp, chg-lbp, dact-lbp, ent-lbp, rtrv-lbp

Command Class: Database Administration

Parameters

:loc= (mandatory)

Card location. The unique identifier of a the card containing the signaling link you want to use for loopback point testing.

Range: 1101–1108, 1111–1112, 1201–1208, 1211–1218, 1301–1308, 1311–1318, 2101–2108, 2111–2118, 2201–2208, 2211–2218, 2301–2308, 2311–2318, 3101–3108, 3111–3118, 3201–3208, 3211–3218, 3301–3308, 3311–3318, 4101–4108, 4111–4118, 4201–4208, 4211–4218, 4301–4308, 4311–4318, 5101–5108, 5111–5118, 5201–5208, 5211–5218, 5301–5308, 5311–5318, 6101–6108, 6111–6118

:port= or **:link=** (mandatory)

SS7 signaling link. The SS7 signaling link that is to be tested.

Range: a, b, a1-a31, b1-b31

Not all card types support all **link** parameter values.

See Table A-1 in Appendix A for valid **link** parameter range values for each type of card that can have assigned signaling link ports.

:lbp= (optional)

Loopback point ID. This parameter identifies a far-end loopback point that lies along an SS7 signaling link path between the STP and the target device (up to and including the target device).

Range: 1–32

:all= (optional)

Deletes all loopback points for the specified signaling link or deletes only the link specified on the **lbp** parameter.

Range: yes

Example

```
dlt-lbp:loc=1101:link=a:lbp=1
```

```
dlt-lbp:loc=1101:link=a:all=yes
```

Dependencies

At least one optional parameter must be specified.

If the **lbp** parameter is specified, the **all** parameter cannot be specified.

If the **all** parameter is specified, the **lbp** parameter cannot be specified.

The Link Fault Sectionalization (LFS) feature must be on before this command can be entered.

The loopback point (LBP) must have been previously defined.

The card location (**loc** parameter) must identify a provisioned **limds0**, **limt1**, or **limch** (associated to a **limt1**) card configured with either an **ss7ansi** or **ccs7itu** application.

The card location specified in the **loc** parameter must be equipped.

The card location specified in the **loc** parameter cannot be reserved by the system

Notes

None

Output

```

dlt-lbp:loc=1101:link=a:lbp=1
  rlgncxa03w 05-02-17 15:35:05 EST  EAGLE5 33.0.0
  DLT-LBP: MASP A - COMPLTD
;

```

dlt-lnp-lrn**Delete LNP Location Routing Number**

NOTE: This command is obsolete.

Use this command to delete an existing location routing number (LRN) and its corresponding final overriding message relay global title translations from the database. You can delete an LRN only if it is not referenced by a 10-digit telephone number.

NOTE: If the LNP ELAP Configuration controlled feature is turned on, this command is no longer available. This function can be performed at the LSMS or using the ELAP user interface.

Keyword: dlt-lnp-lrn

Related Commands: chg-lnp-lrn, ent-lnp-lrn, rtrv-lnp-lrn

Command Class: LNP Database Administration

Parameters

:lrn= (mandatory)
The location routing number.
Range: 10 digits

:tt= (optional)
Translation type.
Range: 000-255
Default: delete all LRNs

Example

```

dlt-lnp-lrn:lrn=1234567890
dlt-lnp-lrn:lrn=1234567890:tt=16

```

Dependencies

The LNP feature must be turned on (see the **enable-ctrl-feat** command) before this command can be entered.

Translation type (**tt** parameter) values cannot be specified that are associated with AIN, IN, PCS, LNPQS, or WNP LNP queries.

If the **tt** parameter is specified, then a single override translation is deleted.

In all cases, if an LRN is not referenced by a 10-digit TN, and the override translation being deleted is the last translation, then the entire LRN record is removed from the database. If the LRN is referenced by a 10-digit TN, the LRN cannot be removed.

When the **tt** parameter is specified, the TT service must be assigned to the LRN.

The TT must be reserved for LNP.

Notes

None

Output**dlt-lnp-lrn:lrn=1234567890**

```
rlghncxa03w 04-02-18 08:50:12 EST EAGLE 31.3.0
DLT-LNP-LRN: MASP A - COMPLTD
```

;

dlt-lnp-npanxx**Delete LNP NPANXX****NOTE: This command is obsolete.**

Use this command to delete an LNP numbering plan area and exchange (NPANXX) and its associated LNP query or message relay default global title translations from the database.

NOTE: If the LNP ELAP Configuration controlled feature is turned on, this command is no longer available. This function can be performed at the LSMS or using the ELAP user interface.

Keyword: dlt-lnp-npanxx**Related Commands:** chg-lnp-npanxx, ent-lnp-npanxx, rtrv-lnp-npanxx**Command Class:** LNP Database Administration**Parameters****:npanxx=** (mandatory)

Numbering plan area.

:rmv= (optional)

Deletion type.

Range: all, alltt**Default:** Removes all npanxx and all its translation types**:tt=** (optional)

Translation type.

Range: 000-255**Default:** All translation types**Example****dlt-lnp-npanxx:npanxx=001-010-100:tt=16****dlt-lnp-npanxx:npanxx=001-010-100:rmv=allttmr****dlt-lnp-npanxx:npanxx=001-010-100:rmv=all****Dependencies**

The LNP feature must be turned on (see the **enable-ctrl-feat** command) before this command can be entered.

Translation type (**tt** parameter) values cannot be specified that are associated with LNPQS, PCS, or WNP LNP queries.

Either all translation types can be deleted with one command (**rmv=alltt** parameter), or each translation type can be deleted individually (**tt** parameter).

Before a translation type (**tt** parameter) can be deleted, no translation type names (**ttn** parameter) can exist.

An NPANXX cannot be deleted until all of its translation types have been deleted.

If the **tt** parameter is specified, the corresponding default translation is removed only if the 10-digit ported translation type names for the NPANXX do not exist in the LNP database.

If the **rmv=alltt** parameter is specified, all default translations are removed only if the 10-digit ported directory numbers for this NPANXX do not exist in the LNP database.

Specifying the **rmv=alltt** parameter does not delete the NPANXX. Also, when the **tt** parameter is specified, you cannot delete the NPANXX.

Specifying the **rmv=all** parameter deletes the entire portable NPANXX record only if the 10-digit ported translation type numbers for this NPANXX do not exist and a telephone number-location routing number (TN-LRN) for this NPANXX does not exist.

When all 10-digit ported translation type numbers associated with this NPANXX are removed, the portable NPANXX can be removed either by specifying the **rmv=all** parameter or by not specifying any optional parameters.

This command can be entered several times for the same NPANXX to incrementally delete default global title and eventually the NPANXX.

The **tt** and **rmv** parameters cannot be specified together in the same command.

The NPANXX must exist.

The NPANXX cannot be deleted if any associated 10-digit translation type numbers exist.

When the **tt** parameter is specified, the translation type must be assigned and must be a reserved service for LNP.

If message relay services exist, either the **tt** parameter or the **rmv** parameter must be specified.

The LNP database, the LNP MR table, and the LNP SERV table must all be accessible.

When the **rmv=alltt** parameter is specified, at least one translation type must be assigned.

Notes

None

Output

```
dlt-lnp-npanxx:npanxx=001-010-100:tt=16
  rlgncxa03w 04-02-18 08:50:12 EST  EAGLE 31.3.0
  DLT-LNP-NPANXX: MASP A - COMPLTD
;
```

dlt-lnp-serv

Delete LNP Service

NOTE: This command is obsolete.

Use this command to delete from the database an LNP service or an alias translation type associated with an LNP service.

Keyword: **dlt-lnp-serv**

Related Commands: **chg-lnp-serv, ent-lnp-serv, rtrv-lnp-serv**

Command Class: LNP Database Administration

Parameters

:serv= (mandatory)

Reserved service type name.

Range: **ain, in, pcs, wnp, class, lidb, cnam, isvm, lnpqs, wmsmc, udf1, udf2, udf3, udf4**

:alias= (optional)

The alias translation type.

Range: **000-255**

Example

```
dlt-lnp-serv:serv=lidb
```

```
dlt-lnp-serv:serv=lidb:alias=236
```

Dependencies

The LNP feature must be turned on (see the **enable-ctrl-feat** command) before the **dlt-lnp-serv** command can be entered.

The service type (**serv** parameter) must exist in the LNP database.

The service must not be referenced in the LNP database.

The **alias** that is specified must be associated with the LNP service that is specified in the command.

The value that is specified for the **alias** parameter must not already exist in the LNP database as a true translation type.

All aliases associated with the LNP service must be deleted before the service can be deleted.

Notes

When the LNP feature is on for up to 12 million TNs (see the **enable-ctrl-feat** command), the LNP services CLASS, CNAM, LIDB, and ISVM must be in the OAP configuration in the EAGLE database. You must update the OAP configuration (with the **act-oap-config** command) whenever you perform the following actions:

- Add LNP services to the database (with the **ent-lnp-serv** command).
- Remove services from the database (with the **dlt-lnp-serv** command).
- Change services (with the **chg-lnp-serv** command).

As a reminder, the following warning message is displayed:

```
CAUTION: LNP service TTs have changed, OAP configuration is required
```

Output**dlt-lnp-serv:serv=lidb**

```
rlghncxa03w 02-11-29 16:40:40 EST EAGLE 30.0.0
DLT-LNP-SERV: MASP A - COMPLTD
Command Completed.
```

;

dlt-lnp-sp**Delete LNP Service Provider**

NOTE: This command is obsolete.

Use this command to remove an LNP service provider from the database.

NOTE: If the LNP ELAP Configuration controlled feature is turned on, this command is no longer available, and all LNP provisioning is performed at the LSMS.

Keyword: dlt-lnp-sp

Related Commands: ent-lnp-sp, rtrv-lnp-sp

Command Class: LNP Database Administration

Parameters

:sp= (mandatory)

Service provider ID.

Range: 4 alphanumeric characters

Example

```
dlt-lnp-sp:sp=1234
```

Dependencies

The LNP feature must be turned **on** (see the **enable-ctrl-feat** command) before this command can be entered.

The service provider (**sp** parameter) must exist in the LNP database.

An LNP service provider cannot be deleted from the database if the service provider is referenced in the LNP database.

Notes

None

Output**dlt-lnp-sp:sp=1234**

```
rlghncxa03w 04-01-05 16:40:40 EST EAGLE 31.3.0
DLT-LNP-SP: MASP A - COMPLTD
```

;

dlt-lnp-sub**Delete LNP 10-Digit Telephone Number Subscription**

NOTE: This command is obsolete.

Use this command to remove the following items from the database: an LNP 10-digit ported telephone number (TN) message relay service, a pooled TN message relay service, an LRN, or the entire subscription.

NOTE: If the LNP ELAP Configuration controlled feature is turned on, this command is no longer available. This function can be performed at the LSMS or using the ELAP user interface.

Keyword: dlt-lnp-sub

Related Commands: chg-lnp-sub, ent-lnp-sub, rtrv-lnp-sub

Command Class: LNP Subscription

Parameters

:tn= (mandatory)

The telephone number.

Range: 10 digits—To specify a single TN subscription

7 digits with 3 asterisks (***) appended—To pool a block of 1000 TNs

:rmv= (optional)

Deletion type.

Range: all, alltt, lrn

Default: Removes all LNP 10-digit ported telephone number (TN) message relay services and all their translation types

:tt= (optional)

Translation type.

Range: 000–255

Default: delete all translation types

Example

```
dlt-lnp-sub:tn=1234567890
```

```
dlt-lnp-sub:tn=1234567890:rmv=alltt
```

```
dlt-lnp-sub:tn=1234567890:tt=16
```

```
dlt-lnp-sub:tn=1234567890:rmv=lrn
```

```
dlt-lnp-sub:tn=1234567890:rmv=all
```

```
dlt-lnp-sub:tn=1234567***
```

Dependencies

The LNP feature must be turned **on** (see the **enable-ctrl-feat** command) before this command can be entered.

For all cases, if the delete removes the last service (between message relay and LRN data), then the entire TN subscription is removed.

The **tt** and **rmv** parameters cannot be specified together in the command.

Translation type (**tt** parameter) values cannot be specified that are associated with AIN, IN, PCS, LNPQS, or WNP LNP queries.

If no options are specified, the default is to delete the entire TN subscription.

This command can be entered multiple times for the same TN to remove each TT.

The telephone number (**tn** parameter) range must not cross an NPANXX boundary.

The **tn** parameter value must exist or it must exist in a single range.

When the **rmv-lrn** parameter is specified, LRN must be assigned to the telephone number.

When the **tt** parameter is specified, the TT service must be assigned to the telephone number.

The translation type must be a reserved service for LNP.

If the **rmv=alltt** parameter is specified, the TT service must be assigned.

If message relay global title address with LRN is assigned to the telephone number, the message relay TT service must be deleted before the LRN can be removed.

Notes

The **rmv=alltt** parameter value is provided to remove all message relay translations and the entire TN subscription, if the LRN does not exist.

The **rmv=lrn** parameter option is provided to remove the LRN and the entire subscription, if message relay services (TT) do not exist.

The **rmv=all** parameter option is provided to remove the entire TN subscription record, including LRN and all message relay services.

The **tt** parameter is provided to delete a single message relay translation type, or to delete the entire TN subscription, if the LRN does not exist and **tt** is the last translation assigned.

Output

```
dlt-lnp-sub:tn=1234567890
  rlgncxa03w 04-02-18 08:50:12 EST EAGLE 31.3.0
  DLT-LNP-SUB: MASP A - COMPLTD
;
```

dlt-ls

Delete Linkset

Use this command to remove a linkset from the system database. A linkset is a group of signaling links carrying traffic to the same signaling point.

Keyword: dlt-ls

Related Commands: chg-l3t, ent-ls, rept-stat-ls, rtrv-ls

Command Class: Database Administration

Parameters

:lsn= (mandatory)

The name of the linkset. Only one linkset name per command can be specified.

Range: 1 alphabetic character followed by up to 9 alphanumeric characters

Example

```
dlt-ls:lsn=lsna
```

Dependencies

The linkset must be in the database.

The linkset can be removed only if all links associated with the linkset have been removed.

The linkset can be removed only if the linkset is not referenced by any routeset.

The specified linkset cannot be deleted if it has or is a mate linkset.

A gateway linkset can be deleted only from a SEAS terminal, and not from a system terminal.

Notes

When a linkset is removed from the system database, the related entries are removed automatically from the translation type mapping table.

Output

dlt-ls:lsn=lsna

```
rlghncxa03w 04-01-07 11:11:28 EST EAGLE 31.3.0
Link set table is (114 of 1024) 11% full
DLT-LS: MASP A - COMPLTD
;
```

dlt-map

Delete Mate Applications

Use this command to remove mate application entries or groups. This command removes one or more entries from the remote point code subsystem number table.

Keyword: dlt-map

Related Commands: chg-map, ent-map, rtrv-map

Command Class: Database Administration

Parameters

† At least one of these parameters must be specified.

:pc/pca/pci/pcn/pcn24= (mandatory)

Post-GTT-translated point code.

NOTE: See “Point Code Formats and Conversion” in Appendix A for a detailed description of point code formats, rules for specification, and examples.

:pc= or :pca= (mandatory)

ANSI point code with subfields network indicator-network cluster-network cluster member (*ni-nc-ncm*).

Range: 000-255

Specify a valid value for each subfield of the point code, and separate the subfields with a dash (-).

When **chg-sid:pctype=ansi** is specified, *ni* = 000 is not valid.

When **chg-sid:pctype=ansi** is specified, *nc* = 000 is not valid if *ni* = 001-005.

When **chg-sid:pctype=ansi** is specified, *nc* = 000 is valid if *ni* = 006-255.

The point code 000-000-000 is not a valid point code.

:pci= (mandatory)

ITU international point code with subfields *zone-area-id*. The *prefix* subfield indicates a spare point code (*prefix-zone-area-id*).

Range: **s-, 0-255**

Specify a valid value for each subfield of the point code, and separate the subfields with a dash (-).

prefix—s-

zone—0-7

area—000-255

id—0-7

The point code **0-000-0** is not a valid point code.

:pcn= (mandatory)

ITU national point code in the format of a 5-digit number (*nnnnn*); or 2, 3, or 4 numbers (members) separated by dashes (*m1-m2-m3-m4*) as defined by the **chg-stpopts:npfinti** flexible point code option. A group code must be specified when the ITUDUPPC feature is turned on (*nnnnn-gc*, *m1-m2-m3-m4-gc*). The *prefix* subfield indicates a spare point code (*prefix-nnnnn*, *prefix-nnnnn-gc*, *prefix-m1-m2-m3-m4*, *prefix-m1-m2-m3-m4-gc*).

Range: **s-, 0-16383, aa-zz**

Specify a valid value for each subfield of the point code, and separate the subfields with a dash (-).

prefix—s-

nnnnn—0-16383

gc—aa-zz

m1-m2-m3-m4—0-14 for each member; values must sum to 14

:pcn24= (mandatory)

24-bit ITU national point code with subfields *main signaling area-sub signaling area-signaling point* (*msa-ssa-sp*).

Range: **000-255**

Specify a valid value for each subfield of the point code, and separate the subfields with a dash (-).

msa—000-255

ssa—000-255

sp—000-255

:all= (optional)†

This parameter must be specified to remove all subsystem numbers associated with this point code. If this parameter is not specified, only the specified subsystem number is removed.

Range: **yes, no**

Default: **no**

:ssn= (optional)†

Subsystem Number.

Range: **2-255**

Default: The specified subsystem number is removed for the given point code.

Example

The following example deletes the single entry point code **1-1-1** with subsystem number **123** from its mated group. If this is the last entry in the group then the point code is deleted from the MAP tables as well:

```
dlt-map:pc=1-1-1:ssn=123
```

The following example deletes each entry of point code **1-1-1** and all subsystem numbers associated with the point code from each of the **pc/ssn** mated groups. The point code is also deleted from the MAP tables:

```
dlt-map:pc=1-1-1:all=yes
```

The following command deletes subsystem **10** associated with spare point code **1-1-0** from the MAP table.

```
dlt-map:pci=s-1-1-0:ssn=10
```

Dependencies

Either the **ssn** parameter or the **all** parameter can be specified, but not both.

All subsystem numbers for the given point code are removed if **all=yes** is specified.

The destination point code of the primary subsystem must be a full point code.

The specified remote point code must exist in the Mate Applications (MAP) table.

The specified subsystem number must exist in the MAP table entity set associated with the specified remote point code.

The STP true point code assigned to an INP, LNP, or Equipment Identity Register (EIR) subsystem cannot be deleted.

If the **pcn** parameter is specified, the format of the point code must match the format that was assigned with the **chg-stpopts:npcfnti** parameter.

Notes

In this command, only ITU-international and ITU national point codes support the spare point code subtype prefix (**s-**).

Output

```
dlt-map:pc=1-1-1:all=yes
rlghncxa03w 04-01-07 11:43:04 EST EAGLE 31.3.0
DLT-MAP: MASP A - COMPLTD
;
```

dlt-mrn**Delete Mated Relay Node**

Use this command to delete entries from the Mated Relay Node (MRN) table. A single command can delete a single point code from an group, or delete the entire group.

Keyword: **dlt-mrn**

Related Commands: **chg-mrn, ent-mrn, rtrv-mrn**

Command Class: Database Administration

Parameters

NOTE: See “Point Code Formats and Conversion” in Appendix A for a detailed description of point code formats, rules for specification, and examples.

:all= (optional)

This parameter is used to delete the entire group of point codes or MRN set that contains the specified point code in the MRN table.

Range: **yes**

:mrnset= (optional)

The MRN set ID.

Range: **1-3000, dflt**
dflt—The default **mrnset**.

:pc/pca/pci/pcn/pcn24= (optional)

Post-GTT-translated point code.

:pc= or **:pca=** (optional)

ANSI point code with subfields *network indicator-network cluster-network cluster member* (*ni-nc-ncm*).

Range: **000-255**

Specify a valid value for each subfield of the point code, and separate the subfields with a dash (-).

When **chg-sid:pctype=ansi** is specified, *ni* = **000** is not valid.

When **chg-sid:pctype=ansi** is specified, *nc* = **000** is not valid if *ni* = **001-005**.

When **chg-sid:pctype=ansi** is specified, *nc* = **000** is valid if *ni* = **006-255**.

The point code **000-000-000** is not a valid point code.

:pci= (optional)

ITU international point code with subfields *zone-area-id*. The *prefix* subfield indicates a spare point code (*prefix-zone-area-id*).

Range: **s-, 0-255**

Specify a valid value for each subfield of the point code, and separate the subfields with a dash (-).

prefix—**s-**

zone—**0-7**

area—**000-255**

id—**0-7**

The point code **0-000-0** is not a valid point code.

:pcn= (optional)

ITU national point code in the format of a 5-digit number (*nnnnn*); or 2, 3, or 4 numbers (members) separated by dashes (*m1-m2-m3-m4*) as defined by the **chg-stpopts:npfcm** flexible point code option. A group code must be specified when the ITUDUPPC feature is turned on (*nnnnn-gc, m1-m2-m3-m4-gc*). The *prefix* subfield indicates a spare point code (*prefix-nnnnn, prefix-nnnnn-gc, prefix-m1-m2-m3-m4, prefix-m1-m2-m3-m4-gc*).

Range: **s-, 0-16383, aa-zz**

Specify a valid value for each subfield of the point code, and separate the subfields with a dash (-).

prefix—**s-**

nnnnn—**0-16383**

gc—aa-zz

m1-m2-m3-m4—0-14 for each member; values must sum to 14

:pcn24= (optional)

24-bit ITU national point code with subfields *main signaling area-sub signaling area-signaling point (msa-ssa-sp)*.

Range: **000-255**

Specify a valid value for each subfield of the point code, and separate the subfields with a dash (-).

msa—000-255

ssa—000-255

sp—000-255

:pc1/pca1/pci1/pcn1/pcn241= (optional)

Alternate post-GTT-translated point code.

:pc1= or **:pca1=** (optional)

ANSI point code with subfields *network indicator-network cluster-network cluster member (ni-nc-ncm)*.

Range: **000-255, ***

Specify a valid value for each subfield of the point code, and separate the subfields with a dash (-).

The asterisk (*) value is not valid for the *ni* subfield.

When **chg-sid:pctype=ansi** is specified, *ni* = **000** is not valid.

When **chg-sid:pctype=ansi** is specified, *nc* = **000** is not valid if *ni* = **001-005**.

When **chg-sid:pctype=ansi** is specified, *nc* = **000** is valid if *ni* = **006-255**.

When **chg-sid:pctype=ansi** is specified, *ni*-*-*** is valid if *ni* = **006-255**.

The point code **000-000-000** is not a valid point code.

:pci1= (optional)

ITU international point code with subfields *zone-area-id*. The *prefix* subfield indicates a spare point code (*prefix-zone-area-id*)

Range: **s-, 0-255**

Specify a valid value for each subfield of the point code, and separate the subfields with a dash (-).

prefix—s-

zone—0-7

area—000-255

id—0-7

The point code **0-000-0** is not a valid point code.

:pcn1= (optional)

ITU national point code in the format of a 5-digit number (*nnnnn*); or 2, 3, or 4 numbers (members) separated by dashes (*m1-m2-m3-m4*) as defined by the **chg-stpopts:npcfmti** flexible point code option. A group code must be specified when the ITUDUPPC feature is turned on (*nnnnn-gc, m1-m2-m3-m4-gc*). The *prefix* subfield indicates a spare point code (*prefix-nnnnn, prefix-nnnnn-gc, prefix-m1-m2-m3-m4, prefix-m1-m2-m3-m4-gc*).

Range: **s-**, **0-16383**, **aa-zz**
Specify a valid value for each subfield of the point code, and separate the subfields with a dash (-).

prefix—**s-**

nnnnn—**0-16383**

gc—**aa-zz**

m1-m2-m3-m4—**0-14** for each member; values must sum to 14

:pcn241= (optional)

24-bit ITU national point code with subfields *main signaling area-sub signaling area-signaling point (msa-ssa-sp)*.

Range: **000-255**

Specify a valid value for each subfield of the point code, and separate the subfields with a dash (-).

msa—**000-255**

ssa—**000-255**

sp—**000-255**

:pc2/pca2/pci2/pcn2/pcn242= (optional)

Alternate post-GTT-translated point code.

:pc2= or **:pca2=** (optional)

ANSI point code with subfields *network indicator-network cluster-network cluster member (ni-nc-ncm)*.

Range: **000-255**

Specify a valid value for each subfield of the point code, and separate the subfields with a dash (-).

When **chg-sid:pctype=ansi** is specified, *ni* = **000** is not valid.

When **chg-sid:pctype=ansi** is specified, *nc* = **000** is not valid if *ni* = **001-005**.

When **chg-sid:pctype=ansi** is specified, *nc* = **000** is valid if *ni* = **006-255**.

When **chg-sid:pctype=ansi** is specified, *ni*ⁱ-*-ⁱ is valid if *ni* = **006-255**.

The point code **000-000-000** is not a valid point code.

:pci2= (optional)

ITU international point code with subfields *zone-area-id*. The *prefix* subfield indicates a spare point code (*prefix-zone-area-id*).

Range: **s-**, **0-255**

Specify a valid value for each subfield of the point code, and separate the subfields with a dash (-).

prefix—**s-**

zone—**0-7**

area—**000-255**

id—**0-7**

The point code **0-000-0** is not a valid point code.

:pcn2= (optional)

ITU national point code in the format of a 5-digit number (*nnnnn*); or 2, 3, or 4 numbers (members) separated by dashes (*m1-m2-m3-m4*) as defined by the **chg-stpopts:npcfinti** flexible point code option. A group code must be specified when the ITUDUPPC feature is turned on (*nnnnn-gc*, *m1-m2-m3-m4-gc*). The *prefix* subfield indicates a spare point code (*prefix-nnnnn*, *prefix-nnnnn-gc*, *prefix-m1-m2-m3-m4*, *prefix-m1-m2-m3-m4-gc*).

Range: **s-**, **0-16383**, **aa-zz**

Specify a valid value for each subfield of the point code, and separate the subfields with a dash (-).

prefix—s-

nnnnn—**0-16383**

gc—aa-zz

m1-m2-m3-m4—**0-14** for each member; values must sum to 14

:pcn242= (optional)

24-bit ITU national point code with subfields *main signaling area-sub signaling area-signaling point* (*msa-ssa-sp*).

Range: **000-255**

Specify a valid value for each subfield of the point code, and separate the subfields with a dash (-).

msa—**000-255**

ssa—**000-255**

sp—**000-255**

:pc3/pca3/pci3/pcn3/pcn243= (optional)

Post-GTT-translated point code.

:pc3= or **:pca3=** (optional)

ANSI point code with subfields *network indicator-network cluster-network cluster member* (*ni-nc-ncm*).

Range: **000-255**

Specify a valid value for each subfield of the point code, and separate the subfields with a dash (-).

When **chg-sid:pctype=ansi** is specified, *ni* = **000** is not valid.

When **chg-sid:pctype=ansi** is specified, *nc* = **000** is not valid if *ni* = **001-005**.

When **chg-sid:pctype=ansi** is specified, *nc* = **000** is valid if *ni* = **006-255**.

When **chg-sid:pctype=ansi** is specified, *ni*ⁱ-*-* is valid if *ni* = **006-255**.

The point code **000-000-000** is not a valid point code.

:pci3= (optional)

ITU international point code with subfields *zone-area-id*. The *prefix* subfield indicates a spare point code (*prefix-zone-area-id*).

Range: **s-**, **0-255**

Specify a valid value for each subfield of the point code, and separate the subfields with a dash (-).

prefix—s-

zone—**0-7**

area—**000-255**

id—**0-7**

The point code **0-000-0** is not a valid point code.

:pcn3= (optional)

ITU national point code in the format of a 5-digit number (*nnnnn*); or 2, 3, or 4 numbers (members) separated by dashes (*m1-m2-m3-m4*) as defined by the **chg-stpopts:npcfinti** flexible point code option. A group code must be specified when the ITUDUPPC feature is turned on (*nnnnn-gc, m1-m2-m3-m4-gc*). The *prefix* subfield indicates a spare point code (*prefix-nnnnn, prefix-nnnnn-gc, prefix-m1-m2-m3-m4, prefix-m1-m2-m3-m4-gc*).

Range: **s-, 0-16383, aa-zz**

Specify a valid value for each subfield of the point code, and separate the subfields with a dash (-).

prefix—s-

nnnnn—**0-16383**

gc—aa-zz

m1-m2-m3-m4—**0-14** for each member; values must sum to 14

:pcn243= (optional)

24-bit ITU national point code with subfields *main signaling area-sub signaling area-signaling point* (*msa-ssa-sp*).

Range: **000-255**

Specify a valid value for each subfield of the point code, and separate the subfields with a dash (-).

msa—**000-255**

ssa—**000-255**

sp—**000-255**

:pc4/pca4/pci4/pcn4/pcn244= (optional)

Alternate post-GTT-translated point code.

:pc4= or **:pca4=** (optional)

ANSI point code with subfields *network indicator-network cluster-network cluster member* (*ni-nc-ncm*).

Range: **000-255**

Specify a valid value for each subfield of the point code, and separate the subfields with a dash (-).

When **chg-sid:pctype=ansi** is specified, *ni* = **000** is not valid.

When **chg-sid:pctype=ansi** is specified, *nc* = **000** is not valid if *ni* = **001-005**.

When **chg-sid:pctype=ansi** is specified, *nc* = **000** is valid if *ni* = **006-255**.

The point code **000-000-000** is not a valid point code.

:pci4= (optional)

ITU international point code with subfields *zone-area-id*. The *prefix* subfield indicates a spare point code (*prefix-zone-area-id*)

Range: **s-, 0-255**

Specify a valid value for each subfield of the point code, and separate the subfields with a dash (-).

prefix—s-

zone—**0-7**

area—**000-255**

id—**0-7**

The point code **0-000-0** is not a valid point code.

:pcn4= (optional)

ITU national point code in the format of a 5-digit number (*nnnnn*); or 2, 3, or 4 numbers (members) separated by dashes (*m1-m2-m3-m4*) as defined by the **chg-stpopts:npcfinti** flexible point code option. A group code must be specified when the ITUDUPPC feature is turned on (*nnnnn-gc*, *m1-m2-m3-m4-gc*). The *prefix* subfield indicates a spare point code (*prefix-nnnnn*, *prefix-nnnnn-gc*, *prefix-m1-m2-m3-m4*, *prefix-m1-m2-m3-m4-gc*).

Range: **s-**, **0-16383**, **aa-zz**

Specify a valid value for each subfield of the point code, and separate the subfields with a dash (-).

prefix—**s-**

nnnnn—**0-16383**

gc—**aa-zz**

m1-m2-m3-m4—**0-14** for each member; values must sum to 14

:pcn244= (optional)

24-bit ITU national point code with subfields *main signaling area-sub signaling area-signaling point* (*msa-ssa-sp*).

Range: **000-255**

Specify a valid value for each subfield of the point code, and separate the subfields with a dash (-).

msa—**000-255**

ssa—**000-255**

sp—**000-255**

Example

The following example deletes the entire entry for the specified point code (the point code plus all of its associated point codes).

dlt-mrn:pc=1-1-0

The following example finds point codes 1-1-0 and 1-1-1, and deletes them from the group that contains them in the MRN table.

dlt-mrn:pc=1-1-0:pc1=1-1-1

The following example deletes from the MRN table the entire group of point codes that contains the specified point code.

dlt-mrn:pc=1-1-0:all=yes

The following examples include spare point codes.

dlt-mrn:pci=s-2-2-1

dlt-mrn:pcn=s-1-1-1-0235-aa

The following examples include the **mrnset** parameter.

dlt-mrn:pc=1-1-9:mrnset=dflt

dlt-mrn:pc=1-1-9:mrnset=111

dlt-mrn:pc=1-1-1:pc1=1-1-9:mrnset=111

dlt-mrn:pc=1-1-9:All=yes:mrnset=111

Dependencies

At least one optional parameter must be specified.

Point codes must be the format set by the **npcfnti** parameter of the **chg-stpopts** command. (Use the **rtrv-stpopts** command to display the STP option settings).

A point code specified by the **dlt-mrn** command must already exist in the MRN table.

One or more point codes in a group of the default MRN set, or a non-default MRN set if the Flexible GTT Load Sharing feature is enabled, cannot be deleted if it leaves only one point code remaining in the group. If only one point code would remain in the group, the entire group of point codes must be deleted.

Notes

In this command, only ITU-international and ITU national point codes support the spare point code subtype prefix (**s**).

Output

dlt-mrn:pc=1-1-0:pc1=1-1-1

```
rlghncxa03w 04-02-20 09:07:58 EST EAGLE 31.3.0
DLT-MRN: MASP A - COMPLTD
```

;

NOTE: The output examples below assume that at least two PCs still remain in the in the mrnset following the delete operation.

When FGTTLS is enabled, the **mrnset** parameter must be specified.

dlt-mrn:pc=1-1-1:mrnset=111

```
tekelecstp 05-05-17 10:19:51 EST EAGLE5 Rel 34.2.0
DLT-MRN : MASP A - COMPLTD
```

;

dlt-mrn:pc=1-1-1:mrnset=dflt

```
tekelecstp 05-05-17 10:19:51 EST EAGLE5 Rel 34.2.0
DLT-MRN : MASP A - COMPLTD
```

;

dlt-na

Delete Network Appearance

Use this command to delete a previously defined network appearance.

Keyword: dlt-na

Related Commands: ent-na, rtrv-na

Command Class: Database Administration

Parameters

:na= (mandatory)

Network appearance.

Range: 0-4294967295

:type= (mandatory)
 Type of the network appearance to be deleted.
Range: ansi, itui, ituis, itun, ituns, itun24

:gc= (optional)
 Group Code of the network appearance.
Range: aa-zz

Example

```
dlt-na:type=ansi:na=10
dlt-na:type=itui:na=11
dlt-na:type=itun:na=10
dlt-na:type=itun:na=11:gc=fr
dlt-na:type=ituis:na=4
```

Dependencies

Group Code (gc) is not allowed with network types **ansi**, **itui**, **ituis**, and **itun24**.
 The specified network appearance must exist in the Network Appearance table

Notes

The ITUDUPPC feature must be turned on before a group code can be deleted for an ITU-N network type

Output

```
dlt-na:pstncat=5000:pstnid=1:force=yes
rlghncxa03w 04-02-20 09:07:58 EST EAGLE 31.3.0
DLT-NA: MASP A - COMPLTD
;
```

dlt-prefix

Delete Prefix

Use this command to delete a prefix based on the name of the feature, its prefix, and its prefix number.

Keyword: dlt-prefix

Related Commands: chg-prefix, rtrv-prefix, rtrv-ctrl-feat

Command Class: Database Administration

Parameters

:feature= (mandatory)
 Feature Name. This parameter specifies the name of an enabled controlled feature that is supported by this command. The parameter value must match the feature name as it is displayed in the **rtrv-ctrl-feat** command output.

Range: 1 alphabetic character and up to 24 optional alphanumeric characters and spaces, enclosed in double quotation marks.
 The parameter value is not case-sensitive; upper case or lower case or both can be entered.

Part or all of the feature name can be entered. If part of the feature name is specified, the entry must start with the first letter of the name, and must contain enough of the name to uniquely identify the feature. For example, there are two feature names that begin with "GSM MAP." Enough additional characters to identify which GSM MAP feature is being entered (at least "GSM MAP SR" to identify the "GSM MAP SRI Redirect" feature). This command supports the following controlled features:

- GSM MAP SRI Redirect
- ISUP NP for EPAP

:prefix= (mandatory)

Prefix Value.

Range: 1-15 digits; valid digits are **0-9, a-f, A-F**

Default: Current value

:prefixnum= (mandatory)

Prefix Number. The prefix number identifies the prefix value to use for the specified feature name.

Range: 1-7

1-3 for GSM MAP SRI Redirect feature prefix values

1-5 for ISUP NP with EPAP feature prefix values

6 for the ISUP NP with EPAP feature Insertion Country Code

7 for the ISUP NP with EPAP feature Deletion Condition value

Default: Current value

Example

Delete a prefix with prefix number 1 for the ISUP NP with EPAP feature.

dlt-prefix:feature="isup np with epap":prefix=1004:prefixnum=1

Delete a prefix with prefix number 2 and specify part of the GSM MAP SRI Redirect feature name.

dlt-prefix:feature="GSM MAP SRI":prefix=104:prefixnum=2

Dependencies

The specified feature name must be the name of an enabled controlled feature as it is displayed in the **rtrv-ctrl-feat** command output; The specified feature must be one of the following features that are supported by this command:

- GSM MAP SRI Redirect
- ISUP NP for EPAP

The specified feature prefix value must already exist in the database.

The specified feature prefix value must be used by the specified feature in the database.

Notes

None

Output

```

dlt-prefix:feature="isup np with epap":prefix=1004:prefixnum=1
  rlgncxa03w 04-09-20 09:04:14 EST EAGLE 31.11.0
  DLT-PREFIX: MASP A - COMPLTD
;

```

dlt-pstn-pres**Delete PSTN Presentation**

Use this command to delete a previously defined Public Switched Telephone Network (PSTN) presentation value.

Keyword: dlt-pstn-pres

Related Commands: ent-pstn-pres, rtrv-pstn-pres

Command Class: Database Administration

Parameters

:pstncat= (mandatory)

PSTN category that identifies the new Variant being defined.

Range: 0-65535

:pstnid= (mandatory)

PSTN ID that identifies the new Variant being defined.

Range: 0-65535

:force= (mandatory)

The **force=yes** parameter must be specified to delete the PSTN presentation value.

Range: no, yes

Example

```
dlt-pstn-pres:pstncat=5000:pstndesc="Mexican ISUP v1.8"
```

Dependencies

The ISUP Normalization controlled feature must be enabled.

A controlled feature must exist for the **pstncat** and **pstnid** parameter combination.

You cannot delete the PSTN presentation value with parameters **pstncat=1** and **pstnid=2**.

The PSTN must have been previously defined with the **ent-pstn-pres** command.

Notes

The IP⁷ SG uses the PSTN presentation value, consisting of a PSTN category and a PSTN ID, to uniquely define an ISUP Variant.

Use the **rtrv-pstn-pres** command to display the **only** allowed values for the PSTN category and ID being deleted.

The entry in the ISUP Variant table associated with the deleted PSTN will be marked as available.

The **dlt-pstn-pres** command causes all the ISUP parameters provisioned for the Variant with the **chg-isupvar-attrb** command to be deleted.

Deleting the PSTN presentation value may cause a loss of traffic if SS7IP routing keys exist using that PSTN value. The user should use caution when performing this action. The user will also be required to use the **force** parameter.

Output

```
dlt-pstn-pres:pstncat=5000:pstnid=1:force=yes
  rlgncxa03w 04-01-07 11:43:04 EST EAGLE 31.3.0
  DLT-PSTN-PRES: MASP A - COMPLTD
;
```

dlt-rmt-appl

Delete Remote Application

Use this command to remove remote application assignments from the database.

Keyword: dlt-rmt-appl

Related Commands: ent-rmt-appl, rtrv-rmt-appl

Command Class: Database Administration

Parameters

:ipc/ipca/ipci/ipcn/ipcn24= (mandatory)

End node's internal point code.

:ipc= or :ipca= (mandatory)

ANSI point code with subfields *network indicator-network cluster-network cluster member* (*ni-nc-ncm*). The *prefix* subfield indicates a private point code (*prefix-ni-nc-ncm*).

Range: p-, 000-255

Specify a valid value for each subfield of the point code, and separate the subfields with a dash (-).

prefix—p-

When **chg-sid:pctype=ansi** is specified, *ni* = 000 is not valid.

When **chg-sid:pctype=ansi** is specified, *nc* = 000 is not valid if *ni* = 001–005.

When **chg-sid:pctype=ansi** is specified, *nc* = 000 is valid if *ni* = 006–255.

The point code 000-000-000 is not a valid point code.

:ipci= (mandatory)

ITU international point code with subfields *zone-area-id*. The *prefix* subfield indicates a spare point code, private point code, or private and spare point code (*prefix-zone-area-id*).

Range: s-, p-, ps-, 0-255

Specify a valid value for each subfield of the point code, and separate the subfields with a dash (-).

prefix—s-, p-, ps-

zone—0-7

area—000-255

id—0-7

The point code 0-000-0 is not a valid point code.

:ipcn= (mandatory)

ITU national point code in the format of a 5-digit number (*nnnnn*); or 2, 3, or 4 numbers (members) separated by dashes (*m1-m2-m3-m4*) as defined by the **chg-stpopts:npcfinti** flexible point code option. A group code must be specified when the ITUDUPPC feature is turned on (*nnnnn-gc, m1-m2-m3-m4-gc*). The *prefix* subfield indicates a spare point code, private point code, or private and spare point code (*prefix-nnnnn, prefix-nnnnn-gc, prefix-m1-m2-m3-m4, prefix-m1-m2-m3-m4-gc*).

Range: **s-, p-, ps-, 0-16383, aa-zz**

Specify a valid value for each subfield of the point code, and separate the subfields with a dash (-).

prefix—**s-, p-, ps-**

nnnnn—**0-16383**

gc—**aa-zz**

m1-m2-m3-m4—**0-14** for each member; values must sum to 14

:ipcn24= (mandatory)

24-bit ITU national point code with subfields *main signaling area-sub signaling area-signaling point (msa-ssa-sp)*. The *prefix* indicates a private point code (*prefix-msa-ssa-sp*).

Range: **p-, 000-255**

Specify a valid value for each subfield of the point code, and separate the subfields with a dash (-).

prefix—**p-**

msa—**000-255**

ssa—**000-255**

sp—**000-255**

:si= (mandatory)

Service indicator value that designates which user part is assigned to IPC.

Range: **3-15**

:ssn= (optional)

SCCP subsystem number. Valid only if **si=3**. Use **ssn** as the starting value of the range if **ssne** is specified.

Range: **0-255**

:ssne= (optional)

Specifies the end range of subsystem number.

Range: **0-255**

Example

dlt-rmt-appl:ipc=0-0-1:si=3:ssn=5

dlt-rmt-appl:ipc=0-0-1:si=5

dlt-rmt-appl:ipcn24=1-100-1:si=5

dlt-rmt-appl:ipci=ps-2-2-2:si=5

Dependencies

Partial point codes are not allowed.

The **ssn** parameter is required if **si=3**.

The **ssn** and **ssne** parameters are not allowed unless **si=3**.

The **ssne** parameter value must be greater than the **ssn** parameter value.

The specified **ipc** must be previously defined in the Destination table.

The new entry cannot conflict with an existing entry.

The **ipc**, **si**, and **ssn...ssne** parameter values must all match a value in the Destination table.

Notes

To specify a range of subsystem numbers, specify the **ssn** parameter value as the start of the range and the **ssne** parameter value as the end of the range.

In this command, only ITU-international and ITU national point codes support the spare point code subtype prefix (**s-**) and the private and spare point code subtype prefix (**ps-**). All of the point code types support the private (internal) point code subtype prefix (**p-**).

Output

```
dlt-rmt-appl:ipc=0-0-1:si=3:ssn=5
  rlgncxa03w 04-01-07 11:43:04 EST EAGLE 31.3.0
  DLT-RMT-APPL: MASP A - COMPLTD
;
```

dlt-rte

Delete Route

Use this command to remove either a single route or all routes from the system database.

Keyword: **dlt-rte**

Related Commands: **ent-rte**, **rept-stat-dstn**, **rtrv-rte**

Command Class: Database Administration

Parameters

:dpc/dpca/dpci/dpcn/dpcn24= (mandatory)
Destination point code.

NOTE: See “Point Code Formats and Conversion” in Appendix A for a detailed description of point code formats, rules for specification, and examples.

:dpc= or :dpca= (mandatory)

ANSI destination point code with subfields *network indicator-network cluster-network cluster member* (*ni-nc-ncm*). The *prefix* subfield indicates a private point code (*prefix-ni-nc-ncm*).

Range: **p-**, **000-255**

Specify a valid value for each subfield of the point code, and separate the subfields with a dash (-).

prefix—**p-**

When **chg-sid:pctype=ansi** is specified, *ni* = **000** is not valid.

When **chg-sid:pctype=ansi** is specified, *nc* = **000** is not valid if *ni* = **001-005**.

When **chg-sid:pctype=ansi** is specified, *nc* = **000** is valid if *ni* = **006-255**.

The point code **000-000-000** is not a valid point code.

:dpci= (mandatory)

ITU international destination point code with subfields zone-area-id. The *prefix* subfield indicates a spare point code, private point code, or private and spare point code (*prefix-zone-area-id*).

Range: **s-, p-, ps-, 0-255**

Specify a valid value for each subfield of the point code, and separate the subfields with a dash (-).

prefix—**s-, p-, ps-**

zone—**0-7**

area—**000-255**

id—**0-7**

The point code **0-000-0** is not a valid point code.

:dpcn= (mandatory)

ITU national destination point code in the format of a 5-digit number (*nnnnn*); or 2, 3, or 4 numbers (members) separated by dashes (*m1-m2-m3-m4*) as defined by the **chg-stpopts:npcfmti** flexible point code option. A group code must be specified when the ITUDUPPC feature is turned on (*nnnnn-gc, m1-m2-m3-m4-gc*). The *prefix* subfield indicates a spare point code, private point code, or private and spare point code (*prefix-nnnnn, prefix-nnnnn-gc, prefix-m1-m2-m3-m4, prefix-m1-m2-m3-m4-gc*).

Range: **s-, p-, ps-, 0-16383, aa-zz**

Specify a valid value for each subfield of the point code, and separate the subfields with a dash (-).

prefix—**s-, p-, ps-**

nnnnn—**0-16383**

gc—**aa-zz**

m1-m2-m3-m4—**0-14** for each member; values must sum to 14

:dpcn24= (optional)

24-bit ITU national point code with subfields *main signaling area-sub signaling area-signaling point* (*msa-ssa-sp*). The *prefix* subfield indicates a private point code (*prefix-msa-ssa-sp*).

Range: **p-, 000-255**

Specify a valid value for each subfield of the point code, and separate the subfields with a dash (-).

prefix—**p-**

msa—**000-255**

ssa—**000-255**

sp—**000-255**

:all= (optional)

Use this parameter if you want to remove all destinations from the system database.

Range: **yes, no**

Default: **no**

:lsn= (optional)

The linkset name associated with the route.

Range: 1 alphabetic character followed by 9 alphanumeric characters

Default: No linkset name is specified

Example

Delete route to **dpc 1-1-1** using linkset **hq435326**:

dlt-rte:dpc=1-1-1:lsn=hq435326

Delete all routes to **dpc 2-2-2**:

dlt-rte:dpc=2-2-2:all=yes

Delete all routes to **dpc 21-*-***:

dlt-rte:dpc=21-*-*:all=yes

Delete route to **dpcn=3-15-15-15-sp** using link **e1m2itun**:

dlt-rte:dpcn=3-15-15-15-sp:lsn=e1m2itun

Delete route for **dpcn24=10-100-14** using linkset **we123624**:

dlt-rte:dpcn24=10-100-14:lsn=we123624:rc=10

Delete route to private point code **dpc=p-1-1-1** using linkset **hq325426**:

dlt-rte:dpc=p-1-1-1:lsn=hq325426

Delete all routes to private point code **dpc=p-21-*-***:

dlt-rte:dpc=p-21-*-*:all=yes

Delete route to spare point code **dpci=s-1-100-1** using linkset **we123624**:

dlt-rte:dpci=s-1-100-1:lsn=we123624

Dependencies

At least one optional parameter must be specified.

The DPC must be in the database.

If the **lsn** parameter is specified, the linkset must be defined as a route.

The **lsn** parameter cannot be specified with the **all=yes** parameter.

If the **all=no** parameter is specified, the **lsn** parameter must be specified.

The destination point code of a route must be a full point code (*ni-nc-ncm*) or a cluster point code (*ni-nc-**).

If the specified destination address is a full point code address (*ni-nc-ncm*) and is a member of a provisioned cluster (**ni-nc-***), whether the ordered routes can be deleted is determined by the destination address's NCAI (nested cluster allowed indicator). The NCAI (**ncai=yes/no**) is set with the **ncai** parameter of the **ent/chg-dstn** commands:

- If the NCAI is set to **no**, the ordered route cannot be deleted.
- If the NCAI is set to **yes**, then the destination address is a member of a provisioned nested cluster where the ordered routes of the provisioned members can be deleted. Deletion of the ordered routes of a provisioned member results in the provisioned member assuming the attributes of its cluster.

If the specified destination address is a network cluster address (**ni-nc-***), how the specified ordered route attributes are deleted is determined by the setting of the destination address's NCAI (nested cluster allowed indicator). The NCAI is set (**ncai=yes/no**) with the **ncai** parameter of the **ent/chg-dstn** commands.

- If the NCAI is set to **no**, the specified ordered route is deleted for each signaling point code having the same network identifier (NI) and network cluster (NC) codes.
- If the NCAI is set to **yes**, then the specified destination is a nested cluster where deletion of the cluster route will not delete the ordered route of the provisioned member.

If the **dpcn** parameter is specified, the format of the point code(s) must match the format you assigned with the **chg-stpopts:npcfmti** parameter.

Make sure that the last route for the specified DPC being removed is not referenced by an X.25 route, a mated application, or a concerned signaling point code, depending on the feature configuration. If this route is removed and any of these references exist, those references will not be valid.

You cannot delete the last route to a destination referenced by an X.25 route.

You cannot delete the last route to a destination referenced by the redirect function destination parameter.

You cannot delete the last route to a destination point code that still exists in the Mated Node Relay (MRN) table until you delete the point code from the MRN table.

You cannot delete the last route to a destination point code that still exists in the Concerned Secondary Point Code (CSPC) table until you delete the point code from the CSPC table.

If a route to a destination in use by a GTT is the last route to that destination, you cannot delete it until you do one of the following: (1) delete the GTT using the route's destination, (2) change the route used by the GTT to a route using a different destination, or (3) add another route using the same destination.

Network routing is only valid if the NRT feature is on. The NRT feature is turned on with the **chg-feat** command.

When using network routing, if the destination point code has a value of * in the *nc* field, the *ncm* field must also be * (for example, **dpc=21-*-***).

Notes

In this command, only ITU-international and ITU national point codes support the spare point code subtype prefix (**s-**) and the private and spare point code subtype prefix (**ps-**). All of the point code types support the private (internal) point code subtype prefix (**p-**).

Output

dlt-rte:dpc=1-1-1:lsn=ls01

```
rlghncxa03w 04-01-07 11:43:04 EST EAGLE 31.3.0
DLT-RTE: MASP A - COMPLTD
```

;

In the following output, the GTT and X.25 Gateway features are turned on.

dlt-rte:dpc=2-2-2:all=yes

```
rlghncxa03w 04-01-07 11:43:04 EST EAGLE 31.3.0
WARNING - ROUTE MAY BE REFERENCED BY MAP, CSPC, OR X25 RTE.
DLT-RTE: MASP A - COMPLTD
```

;

In the following output, only the GTT feature is turned on.

dlt-rte:dpc=2-2-2:all=yes

```
rlghncxa03w 04-01-07 11:43:04 EST EAGLE 31.3.0
WARNING - ROUTE MAY BE REFERENCED BY MAP OR CSPC.
DLT-RTE: MASP A - COMPLTD
```

;

In the following output, only the X.25 Gateway feature is turned on.

dlt-rte:dpc=2-2-2:all=yes

```
rlghncxa03w 04-01-07 11:43:04 EST EAGLE 31.3.0
WARNING - ROUTE MAY BE REFERENCED BY X25 RTE.
DLT-RTE: MASP A - COMPLTD
```

;

dlt-sccp-serv

Delete SCCP Service

Use this command to remove PC entries from the SCCP service table. The command can delete a PC from a PC group or delete the entire PC group.

Keyword: dlt-sccp-serv

Related Commands: chg-sccp-serv, rtrv-sccp-serv

Command Class: Database Administration

Parameters

NOTE: See “Point Code Formats and Conversion” in Appendix A for a detailed description of point code formats, rules for specification, and examples.

:serv= (mandatory)

Name of the service.

Range: gflex, gport

:pc1/pca1/pci1/pcn1/pcn241= (optional)

Re-route point code.

:pc1= or **:pca1=** (optional)

ANSI point code with subfields *network indicator-network cluster-network cluster member* (*ni-nc-ncm*).

Range: 000-255

Specify a valid value for each subfield of the point code, and separate the subfields with a dash (-).

When **chg-sid:pctype=ansi** is specified, *ni* = 000 is not valid.

When **chg-sid:pctype=ansi** is specified, *nc* = 000 is not valid if *ni* = 001-005.

When **chg-sid:pctype=ansi** is specified, *nc* = 000 is valid if *ni* = 006-255.

The point code 000-000-000 is not a valid point code.

:pci1= (optional)

ITU international point code with subfields *zone-area-id*. The *prefix* subfield indicates a spare point code (*prefix-zone-area-id*).

Range: **s-**, **0-255**

Specify a valid value for each subfield of the point code, and separate the subfields with a dash (-).

The point code **0-000-0** is not a valid point code.

prefix—**s-**

zone—**0-7**

area—**000-255**

id—**0-7**

:pcn1= (optional)

ITU national point code in the format of a 5-digit number (*nnnnn*); or 2, 3, or 4 numbers (members) separated by dashes (*m1-m2-m3-m4*) as defined by the **chg-stpopts:npfnti** flexible point code option. A group code must be specified when the ITUDUPPC feature is turned on (*nnnnn-gc*, *m1-m2-m3-m4-gc*). The *prefix* subfield indicates a spare point code (*prefix-nnnnn*, *prefix-nnnnn-gc*, *prefix-m1-m2-m3-m4*, *prefix-m1-m2-m3-m4-gc*).

Range: **s-**, **0-16383**, **aa-zz**

Specify a valid value for each subfield of the point code, and separate the subfields with a dash (-).

prefix—**s-**

nnnnn—**0-16383**

gc—**aa - zz**

m1-m2-m3-m4—**0-14** for each member; values must sum to 14

:pcn241= (optional)

24-bit ITU national point code with subfields *main signaling area-sub signaling area-signaling point* (*msa-ssa-sp*).

Range: **000-255**

Specify a valid value for each subfield of the point code, and separate the subfields with a dash (-).

msa—**000-255**

ssa—**000-255**

sp—**000-255**

:pc2/pca2/pci2/pcn2/pcn242= (optional)

Alternate re-route point code.

:pc2 or **:pca2=** (optional)

ANSI point code with subfields *network indicator-network cluster-network cluster member* (*ni-nc-ncm*).

Range: **000-255**

Specify a valid value for each subfield of the point code, and separate the subfields with a dash (-).

When **chg-sid:pctype=ansi** is specified, *ni* = **000** is not valid.

When **chg-sid:pctype=ansi** is specified, *nc* = **000** is not valid if *ni* = **001-005**.

When **chg-sid:pctype=ansi** is specified, *nc* = **000** is valid if *ni* = **006-255**.

The point code **000-000-000** is not a valid point code.

:pci2= (optional)

ITU international point code with subfields *zone-area-id*. The *prefix* subfield indicates a spare point code (*prefix-zone-area-id*).

Range: **s-, 0-255**

Specify a valid value for each subfield of the point code, and separate the subfields with a dash (-).

The point code **0-000-0** is not a valid point code.

prefix—**s-**

zone—**0-7**

area—**000-255**

id—**0-7**

:pcn2= (optional)

ITU national point code in the format of a 5-digit number (*nnnnn*); or 2, 3, or 4 numbers (members) separated by dashes (*m1-m2-m3-m4*) as defined by the **chg-stpopts:npfnti** flexible point code option. A group code must be specified when the ITUDUPPC feature is turned on (*nnnnn-gc*, *m1-m2-m3-m4-gc*). The *prefix* subfield indicates a spare point code (*prefix-nnnnn*, *prefix-nnnnn-gc*, *prefix-m1-m2-m3-m4*, *prefix-m1-m2-m3-m4-gc*).

Range: **s-, 0-16383, aa-zz**

Specify a valid value for each subfield of the point code, and separate the subfields with a dash (-).

prefix—**s-**

nnnnn—**0-16383**

gc—**aa - zz**

m1-m2-m3-m4—**0-14** for each member; values must sum to 14

:pcn242= (optional)

24-bit ITU national point code with subfields *main signaling area-sub signaling area-signaling point* (*msa-ssa-sp*).

Range: **000-255**

Specify a valid value for each subfield of the point code, and separate the subfields with a dash (-).

msa—**000-255**

ssa—**000-255**

sp—**000-255**

:pc3/pca3/pci3/pcn3/pcn243= (optional)

Alternate re-route point code.

:pc3 or :pca3= (optional)

ANSI point code with subfields *network indicator-network cluster-network cluster member* (*ni-nc-ncm*).

Range: **000-255**

Specify a valid value for each subfield of the point code, and separate the subfields with a dash (-).

When **chg-sid:pctype=ansi** is specified, *ni* = **000** is not valid.

When **chg-sid:pctype=ansi** is specified, *nc* = **000** is not valid if *ni* = **001-005**.

When **chg-sid:pctype=ansi** is specified, *nc* = **000** is valid if *ni* = **006-255**.

The point code **000-000-000** is not a valid point code.

:pci3= (optional)

ITU international point code with subfields *zone-area-id*. The *prefix* subfield indicates a spare point code (*prefix-zone-area-id*).

Range: **s-**, **0-255**

Specify a valid value for each subfield of the point code, and separate the subfields with a dash (-).

The point code **0-000-0** is not a valid point code.

prefix—**s-**

zone—**0-7**

area—**000-255**

id—**0-7**

:pcn3= (optional)

ITU national point code in the format of a 5-digit number (*nnnnn*); or 2, 3, or 4 numbers (members) separated by dashes (*m1-m2-m3-m4*) as defined by the **chg-stpopts:npfnti** flexible point code option. A group code must be specified when the ITUDUPPC feature is turned on (*nnnnn-gc*, *m1-m2-m3-m4-gc*). The *prefix* subfield indicates a spare point code (*prefix-nnnnn*, *prefix-nnnnn-gc*, *prefix-m1-m2-m3-m4*, *prefix-m1-m2-m3-m4-gc*).

Range: **s-**, **0-16383**, **aa-zz**

Specify a valid value for each subfield of the point code, and separate the subfields with a dash (-).

prefix—**s**

nnnnn—**0-16383**

gc—**aa - zz**

m1-m2-m3-m4—**0-14** for each member; values must sum to 14

:pcn243= (optional)

24-bit ITU national point code with subfields *main signaling area-sub signaling area-signaling point* (*msa-ssa-sp*).

Range: **000-255**

Specify a valid value for each subfield of the point code, and separate the subfields with a dash (-).

msa—**000-255**

ssa—**000-255**

sp—**000-255**

:pc4/pca4/pci4/pcn4/pcn244= (optional)

Alternate re-route point code.

:pc4 or **:pca4=** (optional)

ANSI point code with subfields *network indicator-network cluster-network cluster member* (*ni-nc-ncm*).

Range: **000-255**

Specify a valid value for each subfield of the point code, and separate the subfields with a dash (-).

When **chg-sid:pctype=ansi** is specified, *ni* = **000** is not valid.

When **chg-sid:pctype=ansi** is specified, *nc* = **000** is not valid if *ni* = **001-005**.

When **chg-sid:pctype=ansi** is specified, *nc* = **000** is valid if *ni* = **006-255**.

The point code **000-000-000** is not a valid point code.

:pci4= (optional)

ITU international point code with subfields *zone-area-id*. The *prefix* subfield indicates a spare point code (*prefix-zone-area-id*).

Range: s-, 0-255

Specify a valid value for each subfield of the point code, and separate the subfields with a dash (-).

prefix—s-

zone—0-7

area—000-255

id—0-7

The point code **0-000-0** is not a valid point code.

:pcn4= (optional)

ITU national point code in the format of a 5-digit number (*nnnnn*); or 2, 3, or 4 numbers (members) separated by dashes (*m1-m2-m3-m4*) as defined by the **chg-stpopts:npfmt** flexible point code option. A group code must be specified when the ITUDUPPC feature is turned on (*nnnnn-gc*, *m1-m2-m3-m4-gc*). The *prefix* subfield indicates a spare point code (*prefix-nnnnn*, *prefix-nnnnn-gc*, *prefix-m1-m2-m3-m4*, *prefix-m1-m2-m3-m4-gc*).

Range: s-, 0-16383, aa-zz

Specify a valid value for each subfield of the point code, and separate the subfields with a dash (-).

prefix—s-

nnnnn—0-16383

gc—aa - zz

m1-m2-m3-m4—0-14 for each member; values must sum to 14

:pcn244= (optional)

24-bit ITU national point code with subfields *main signaling area-sub signaling area-signaling point* (*msa-ssa-sp*).

Range: 000-255

Specify a valid value for each subfield of the point code, and separate the subfields with a dash (-).

msa—000-255

ssa—000-255

sp—000-255

:rc1= (optional)

The relative cost of the route for alternate post-GTT-translated point code 1.

Range: 0-99

:rc2= (optional)

The relative cost of the route for alternate post-GTT-translated point code 2.

Range: 0-99

:rc3= (optional)

The relative cost of the route for alternate post-GTT-translated point code 3.

Range: 0-99

:rc4= (optional)

The relative cost of the route for alternate post-GTT-translated point code 4.

Range: 0-99

Example

dlt-sccp-serv:serv=gport:pca2=3-3-3

dlt-sccp-serv:serv=gport:all=yes:pca1=1-1-1

Dependencies

At least one point code must be specified.

The point code must already exist in the SCCP Service Table.

Notes

None.

Output

```
dlt-sccp-serv:serv=gport:pca2=3-3-3
tekelecstp 05-12-20 08:54:59 EST 34.3
dlt-sccp-serv:serv=gport:pca2=3-3-3
Command entered at terminal #4.
DLT-SCCP-SRV : MASP A - COMPLTD
;
```

dlt-scr-aftpc

Delete Allowed Affected Point Code

Use this command to remove a specific screening reference in the allowed affected point code category.

Keyword: dlt-scr-aftpc

Related Commands: chg-scr-aftpc, ent-scr-aftpc, rtrv-scr-aftpc

Command Class: Database Administration

Parameters

:sr= (mandatory)

Screening reference. This parameter specifies the point code's unique screening reference name.

Range: 1 alphabetic character followed by up to 3 alphanumeric characters

:ssn= (mandatory)

The subsystem number. An asterisk (*) indicates the full range of values from 1-255.

Range: 1-255, *

:area= (optional)

The ITU international area. The area is specified in the point code. The format of the point code is *zone-area-id*. An asterisk (*) indicates the full range of values from 000-255.

Range: 000-255, *

:id= (optional)

The ITU international ID. The parameter specifies the ID in the point code represented by format *zone-area-id*. An asterisk (*) indicates the full range of values from 0–7.

Range: 0–7, *

:msa= (optional)

The 24-bit ITU-national main signaling area (msa) value. It specifies the *msa* of the point code *msa-ssa-sp*. An asterisk (*) indicates the full range of values from 000–255.

Range: 000–255, *

:nc= (optional)

The network cluster (nc) value. This parameter specifies one or more nc values for the network indicator (ni) and network cluster member (ncm) values specified in the **ni** and **ncm** parameters. It specifies the *nc* of the point code represented by *ni-nc-ncm*. You can specify a single value or a range of values. An asterisk (*) indicates the full range of values from 000–255.

Range: 000–255, *

:ncm= (optional)

The network cluster member (*ncm*) value. This parameter specifies one or more **ncm** values for the network indicator (*ni*) and network cluster (*nc*) values identified in the **ni** and **nc** parameters. It specifies the *ncm* of the point code represented by *ni-nc-ncm*. You can specify a single value or a range of values. An asterisk (*) indicates the full range of values from 000–255.

Range: 0–255, *

:ni= (optional)

The network indicator (ni) value. This parameter specifies one or more ni values for the network cluster (nc) and network cluster member (ncm) values identified in the **nc** and **ncm** parameters. It specifies the *ni* of the point code represented by *ni-nc-ncm*. You can specify a single value or a range of values. An asterisk (*) indicates the full range of values from 000–255.

Range: 0–255, *

:npc= (optional)

The ITU national point code. An asterisk (*) indicates the full range of values from 00000–16383.

Range: 00000–16383, *

NOTE: Gateway screening allows the ITU national point code to be displayed and entered in the database only as a single number. If you are using multiple-part ITU national point codes, see “Converting ITU National Point Code Formats” in Appendix A for information on converting the point code format.

:pcst= (optional)

Point code subtype. This parameter indicates whether the specified ITU international or ITU national point code has no subtype prefix or has the spare point code prefix (s-).

Range: none, s

Default: none

:sp= (optional)

The 24-bit ITU national signaling point. This parameter specifies the signaling point (sp) in the point code represented by *msa-ssa-sp*. An asterisk (*) indicates the full range of values from **000-255**.

Range: **000-255, ***

:ssa= (optional)

The 24-bit ITU national sub signaling area. This parameter specifies the sub signaling area (ssa) in the point code represented by the format *msa-ssa-sp*. An asterisk (*) indicates the full range of values from **000-255**.

Range: **000-255, ***

:zone= (optional)

The ITU international zone. The parameter specifies the zone in the point code represented by format *zone-area-id*. An asterisk (*) indicates the full range of values from **0-7**.

Range: **0-7, ***

Example

dlt-scr-aftpc:sr=iec:ni=240:nc=010:ncm=010:ssn=012

dlt-scr-aftpc:sr=aft1:zone=1:area=2:id=3:ssn=1:pcst=s

Dependencies

A complete point code must be specified, and must be one, and only one of the four point code parameter combinations: **ni-nc-ncm**; **zone-area-id**; **msa-ssa-sp**; or **npc**.

The affected point code or point code range (given by **ni-nc-ncm/ssn** or **zone-area-id** or **msa-ssa-sp** or **npc**) to be removed from the table must already exist in the screening reference.

ANSI point code value **000-000-000** and ITU-International point code value **0-000-0** are not allowed.

If asterisk values are specified, the range cannot overlap or contain any of the point code ranges that already exist in the allowed affected point code screening category.

If **zone=*** is specified, **area=*** and **id=*** must be specified.

If **area=*** is specified, **id=*** must be specified.

If **ssa=*** is specified, **sp=*** must be specified.

If **msa=*** is specified, **ssa=*** and **sp=*** must be specified.

If the **nc** parameter is specified as a range, the **ncm** parameter must be specified as an asterisk or as the full range **000-255**

If the **nc** parameter is specified as a single value or a range, a single value must be specified for the **ni** parameter.

If the **nc** parameter is specified as an asterisk (**nc=***), the **ncm** parameter must be specified as an asterisk or as the full range **000-255**.

If the **ncm** parameter is specified as a single value, or a range other than the full range of **000-255**, the **ni** and the **nc** parameters must be specified with a single value.

If the **ni** parameter is specified as an asterisk (**ni=***) or as a range, the **nc** and **ncm** parameters must be specified as an asterisk or as the full range **000-255**.

The character **c** is not a valid value for the **ni**, **nc**, **ncm**, **zone**, **area**, **id**, **msa**, **ssa**, **sp**, and **npc** parameters.

The specified screening reference (**sr**) must already exist in the database.

The Spare Point Code Support feature must be enabled before the **pcst** parameter can be specified.

The spare point code subtype prefix (**s-**) is not supported for ANSI point codes (parameters **ni**, **nc**, **ncm**) or for 24-bit ITU national point codes (parameters **msa**, **ssa**, **sp**). The **pcst** parameter cannot be specified for ANSI and ITU-N24 point codes.

No AFTPC screening reference (**sr**) can be deleted that is referenced by an entity in another screening set.

You cannot remove the **sr**, **ni**, **nc**, **ncm**, and **ssn** parameters, or the **zone**, **area**, **id** and **npc** parameters, if they are the last entry in the screening reference and the screening reference is part of a screen set.

If only one entry exists, the **sr** must not be referenced by another screening table. If the **sr** is not referenced by another screening table, the entire screening table is deleted.

Notes

The asterisk is a parameter value indicating that the gateway screening process is screening all values for that parameter in the MSU. The asterisk parameter value does not mean that multiple entries whose values may be in the range implied by the asterisk will be removed. The only entry that will be removed by this command when the asterisk is specified as a parameter value is the entry that contains an asterisk as that parameter value.

For example, if the **dlt-scr-aftpc:sr=ied:ni=240:nc=010:ncm=*:ssn=*** command is entered, the only entry that will be removed from the database is the entry in screening reference **ied** that contains the values **ni=240**, **nc=010**, **ncm=***, and **ssn=***. For an entry to be specified in this command with asterisks as parameter values, that entry must be shown in the **rtrv-scr-aftpc** output with asterisks as the same parameter values specified in the **dlt-scr-aftpc** command.

A range of values is specified by separating the values that define the range by two ampersands (**&&**); for example, **ni=025&&100** specifies all network indicators for ANSI point codes from **25** to **100**.

The spare point code subtype prefix **s-** is supported only for ITU international and ITU national point codes. The **pcst** parameter indicates whether the specified point code has no subtype prefix or has the spare point code prefix.

Output

dlt-scr-aftpc:sr=iec:ni=240:nc=010:ncm=010:ssn=012

```
rlghncxa03w 04-01-07 11:43:04 EST EAGLE 31.3.0
DLT-SCR-AFTPC: SCREEN SET AFFECTED - IEC 25% FULL
DLT-SCR-AFTPC: MASP A - COMPLTD
```

;

Legend

DLT-SCR-AFTPC—The command entered that caused this output. This is echoed to the printer as a reference.

SCREEN SET AFFECTED - IEC—Identifies the screen set that was affected by the command. The screen set name is provided.

25% FULL—Indicates the relative size of the screen set.

dlt-scr-blkdpc**Delete Blocked DPC**

Use this command to remove a specific screening reference from the blocked DPC category. Deleting the last point code (c-c-c) also deletes the screening reference.

Keyword: dlt-scr-blkdpc

Related Commands: chg-scr-blkdpc, ent-scr-blkdpc, rtrv-scr-blkdpc

Command Class: Database Administration

Parameters

:sr= (mandatory)

Screening reference. This parameter specifies the point code's unique screening reference name.

Range: 1 alphabetic character followed by up to 3 alphanumeric characters

:area= (optional)

The ITU international area. The area is specified in the point code. The format of the point code is *zone-area-id*. An asterisk (*) indicates the full range of values from **000-255**.

Range: 000-255, *

:id= (optional)

The ITU international ID. The parameter specifies the ID in the point code represented by format *zone-area-id*. An asterisk (*) indicates the full range of values from **0-7**.

Range: 0-7, *

:msa= (optional)

The 24-bit ITU-national main signaling area (msa) value. It specifies the *msa* of the point code represented by *msa-ssa-spt*. An asterisk (*) indicates the full range of values from **000-255**.

Range: 000-255, *, c

:nc= (optional)

The network cluster (nc) value. This parameter specifies one or more nc values for the network indicator (ni) and network cluster member (ncm) values specified in the **ni** and **ncm** parameters. It specifies the *nc* of the point code represented by *ni-nc-ncm*. You can specify a single value or a range of values. An asterisk (*) indicates the full range of values from **000-255**.

Range: 000-255, *, c

:ncm= (optional)

The network cluster member (ncm) value. This parameter specifies one or more ncm values for the network indicator (ni) and network cluster (nc) values identified in the **ni** and **nc** parameters. It specifies the *ncm* of the point code represented by *ni-nc-ncm*. You can specify a single value or a range of values. An asterisk (*) indicates the full range of values from **000-255**.

Range: 0-255, *, c

:ni= (optional)

The network indicator (ni) value. This parameter specifies one or more ni values for the network cluster (nc) and network cluster member (ncm) values identified in the **nc** and **ncm** parameters. It specifies the *ni* of the point code represented by *ni-nc-ncm*. You can specify a single value or a range of values. An asterisk (*) indicates the full range of values from **000-255**.

Range: 0-255, *, c

:npc= (optional)

The ITU national point code. An asterisk (*) indicates the full range of values from **00000-16383**.

Range: 00000-16383, *, c

NOTE: Gateway screening allows the ITU national point code to be displayed and entered in the database only as a single number. If you are using multiple-part ITU national point codes, see “Converting ITU National Point Code Formats” in Appendix A for information on converting the point code format.

:pcst= (optional)

Point code subtype. This parameter indicates whether the specified ITU international or ITU national point code has no subtype prefix or has the spare point code prefix (s-).

Range: none, s

Default: none

:sp= (optional)

The 24-bit ITU national signaling point. This parameter specifies the signaling point (sp) in the point code represented by *msa-ssa-sp*. An asterisk (*) indicates the full range of values from **000-255**.

Range: 000-255, *, c

:ssa= (optional)

The 24-bit ITU national sub signaling area. This parameter specifies the sub signaling area (ssa) in the point code represented by the format *msa-ssa-sp*. An asterisk (*) indicates the full range of values from **000-255**.

Range: 000-255, *, c

:zone= (optional)

The ITU international zone. The parameter specifies the zone in the point code represented by format *zone-area-id*. An asterisk (*) indicates the full range of values from **0-7**.

Range: 0-7, *, c

Example

dlt-scr-blkdpc:sr=iec:ni=240:nc=010:ncm=010

dlt-scr-blkdpc:sr=bdp1:npc=128:pcst=s

Dependencies

At least one optional parameter must be specified.

A complete point code must be specified, and must be one, and only one of the four point code parameter combinations: **ni-nc-ncm**; **zone-area-id**; **msa-ssa-sp**; or **npc**.

The blocked DPC or blocked DPC range specified by **ni-nc-ncm**; **zone-area-id**; **msa-ssa-sp**; or the **npc** parameter must already exist in the specified screening reference.

The point code to delete cannot have the value **c-c-c** if there is another point code in the blocked screen reference. The last screen reference to be deleted must have **ni**, **zone**, **msa**, or **npc** equal to **c**.

ANSI point code value **000-000-000** and ITU-International point code value **0-000-0** are not allowed.

If **msa=*** is specified, **ssa=*** and **sp=*** must be specified.

If **msa=c** is specified, either the character **c** must also be specified for the **ssa** and **sp** parameters or the **ssa** and **sp** parameters must not be specified. If the **ssa** and **sp** parameters are not specified when **msa=c** is specified, the **ssa** and **sp** values default to the character **c** in the database.

If the **nc** parameter is specified as a range, the **ncm** parameter must be specified as an asterisk or as the full range **000-255**

If the **nc** parameter is specified as a single value or a range, a single value must be specified for the **ni** parameter.

If the **nc** parameter is specified as an asterisk (**nc=***), the **ncm** parameter must be specified as an asterisk or as the full range **000-255**.

If the **ncm** parameter is specified as a single value, or a range other than the full range of **000-255**, the **ni** and the **nc** parameters must be specified with a single value.

If the **ni** parameter is specified as an asterisk (**ni=***) or as a range, the **nc** and **ncm** parameters must be specified as an asterisk or as the full range **000-255**.

If **ni=c** is specified, either the character **c** must also be specified for the **nc** and **ncm** parameters or the **nc** and **ncm** parameters must not be specified. If the **nc** and **ncm** parameters are not specified when **ni=c** is specified, the **nc** and **ncm** values default to the character **c** in the database.

The last screening reference (**sr**) entry cannot be deleted if it is referenced by another screen.

The Spare Point Code Support feature must be enabled before the **pcst** parameter can be specified.

The spare point code subtype prefix (s-) is not supported for ANSI point codes (parameters **ni**, **nc**, **ncm**) or for 24-bit ITU national point codes (parameters **msa**, **ssa**, **sp**). The **pcst** parameter cannot be specified for ANSI and ITU-N24 point codes.

If **zone=c** is specified, either the character **c** must also be specified for the **area** and **id** parameters or the **area** and **id** parameters must not be specified. If the **area** and **id** parameters are not specified when **zone=c** is specified, the **area** and **id** values default to the character **c** in the database.

Notes

If the screening reference is not referenced by any other screen, and if all entries are removed, the entire screening reference can be removed using **ni-nc-ncm**, **zone-area-id**, or **msa-ssa-sp** equal to **c-c-c** or **npc=c**. If more than one entry exists, **ni-nc-ncm**, **zone-area-id**, **msa-ssa-sp**, or **npc** must not equal **c**.

The asterisk is a parameter value indicating that the gateway screening process is screening all values for that parameter in the MSU. The asterisk parameter value does not mean that multiple entries whose values may be in the range implied by the asterisk will be removed. The only entry that will be removed by this command when the asterisk is specified as a parameter value is the entry that contains an asterisk as that parameter value.

For example, if the **dlt-scr-blkdpc:sr=ied:ni=240:nc=010:ncm=":ssn=*** command is entered, the only entry that will be removed from the database is the entry in screening reference **ied** that contains the values **ni=240**, **nc=010**, **ncm=***, and **ssn=***. For an entry to be specified in this command with asterisks as parameter values, that entry must be shown in the **rtrv-scr-blkdpc** output with asterisks as the same parameter values specified in the **dlt-scr-blkdpc** command.

The asterisk (*) value cannot be specified with the character **c**. For example, a point code **c-c-*** is not allowed.

A range of values is specified by separating the values that define the range by two ampersands (&&); for example, **ni=025&&100** specifies all network indicators for ANSI point codes from **25** to **100**.

The character **c** is used in the blocked DPC screens to allow the screening process to continue for messages with point codes that do not match any point codes in the blocked DPC screens. When screening for a blocked DPC and the point code being screened does not match any of the point codes in the blocked DPC screens, the message is not rejected and the screening process continues.

There must be an entry in each unique blocked DPC screening reference to allow the screening process to continue. This entry consists of a screening reference, point code, **nsfi**, and **nsr**. The point code is in the form of subfields **ni-nc-ncm**, **zone-area-id**, or **msa-ssa-sp** equal to **c-c-c** or **npc=c**. When the character **c** is specified, the **nsfi** and **nsr** parameters must be specified.

When the point code does not match any entries in the blocked DPC screens, the screening process is directed to the screening reference with the point code **c-c-c**. The **nsfi** and **nsr** in this entry are examined to determine the next step in the screening process.

The spare point code subtype prefix **s-** is supported only for ITU international and ITU national point codes. The **pcst** parameter indicates whether the specified point code has no subtype prefix or has the spare point code prefix.

Output**dlt-scr-blkdpc:sr=iec:ni=240:nc=010:ncm=010**

```
rlghncxa03w 04-01-07 11:43:04 EST EAGLE 31.3.0
DLT-SCR-BLKDPC: SCREEN SET AFFECTED - IEC 25% FULL
DLT-SCR-BLKDPC: MASP A - COMPLTD
```

;

Legend

DLT-SCR-BLKDPC—The command entered that caused this output. This is echoed to the printer as a reference.

SCREEN SET AFFECTED - SS01—Identifies the screen set that was affected by the command. The screen set name is provided.

25% FULL—Indicates the relative size of the screen set.

dlt-scr-blkopc**Delete Blocked OPC**

Use this command to remove a specific screening reference from the blocked OPC category.

Keyword: **dlt-scr-blkopc**

Related Commands: **chg-scr-blkopc, ent-scr-blkopc, rtrv-scr-blkopc**

Command Class: Database Administration

Parameters

:sr= (mandatory)

Screening reference. This parameter specifies the point code's unique screening reference name.

Range: 1 alphabetic character followed by up to 3 alphanumeric characters

:area= (optional)

The ITU international area. The area is specified in the point code. The format of the point code is *zone-area-id*. An asterisk (*) indicates the full range of values from **000-255**.

Range: **000-255, *, c**

:id= (optional)

The ITU international ID. The parameter specifies the ID in the point code represented by format *zone-area-id*. An asterisk (*) indicates the full range of values from **0-7**.

Range: **0-7, ***

:msa= (optional)

The 24-bit ITU-national main signaling area (msa) value. It specifies the *msa* of the point code represented by *msa-ssa-spt*. An asterisk (*) indicates the full range of values from **000-255**.

Range: **000-255, *,c**

:nc= (optional)

The network cluster (nc) value. This parameter specifies one or more nc values for the network indicator (ni) and network cluster member (ncm) values specified in the **ni** and **ncm** parameters. It specifies the *nc* of the point code represented by *ni-nc-ncm*. You can specify a single value or a range of values. An asterisk (*) indicates the full range of values from **000–255**.

Range: **000–255, *, c**

:ncm= (optional)

The network cluster member (ncm) value. This parameter specifies one or more ncm values for the network indicator (ni) and network cluster (nc) values identified in the **ni** and **nc** parameters. It specifies the *ncm* of the point code represented by *ni-nc-ncm*. You can specify a single value or a range of values. An asterisk (*) indicates the full range of values from **000–255**.

Range: **0–255, *, c**

:ni= (optional)

The network indicator (ni) value. This parameter specifies one or more ni values for the network cluster (nc) and network cluster member (ncm) values identified in the **nc** and **ncm** parameters. It specifies the *ni* of the point code represented by *ni-nc-ncm*. You can specify a single value or a range of values. An asterisk (*) indicates the full range of values from **000–255**.

Range: **0–255, *, c**

:npc= (optional)

The ITU national point code. An asterisk (*) indicates the full range of values from **00000–16383**.

Range: **00000–16383, *, c**

NOTE: Gateway screening allows the ITU national point code to be displayed and entered in the database only as a single number. If you are using multiple-part ITU national point codes, see “Converting ITU National Point Code Formats” in Appendix A for information on converting the point code format.

:pcst= (optional)

Point code subtype. This parameter indicates whether the specified ITU international or ITU national point code has no subtype prefix or has the spare point code prefix (s-).

Range: **none, s**

Default: **none**

:sp= (optional)

The 24-bit ITU national signaling point. This parameter specifies the signaling point (sp) in the point code represented by *msa-ssa-sp*. An asterisk (*) indicates the full range of values from **000–255**.

Range: **000–255, *, c**

:ssa= (optional)

The 24-bit ITU national sub signaling area. This parameter specifies the sub signaling area (ssa) in the point code represented by the format *msa-ssa-sp*. An asterisk (*) indicates the full range of values from **000–255**.

Range: **000–255, *, c**

:zone= (optional)

The ITU international zone. The parameter specifies the zone in the point code represented by format *zone-area-id*. An asterisk (*) indicates the full range of values from 0-7.

Range: 0-7, *, c

Example

dlt-scr-blkopc:sr=iec:ni=240:nc=010:ncm=010

dlt-scr-blkopc:sr=bop1:npc=128:pcst=s

Dependencies

A complete point code must be specified, and must be one and only one of the four point code parameter combinations: **ni-nc-ncm**; **zone-area-id**; **msa-ssa-sp**; or **npc**, except in the special case of entering **c** for "continue".

The blocked OPC specified by **ni-nc-ncm**; **zone-area-id**; **msa-ssa-sp**; or the **npc** parameter must already exist in the screening reference or within an existing range of OPCs.

The point code to delete cannot have the value **c-c-c** if there is another point code in the blocked screen reference. The last screen reference to be deleted must have **ni**, **zone**, **msa**, or **npc** equal to **c**.

ANSI point code value **000-000-000** and ITU-International point code value **0-000-0** are not allowed.

If **msa=c** is specified, either the character **c** must also be specified for the **ssa** and **sp** parameters or the **ssa** and **sp** parameters must not be specified. If the **ssa** and **sp** parameters are not specified when **msa=c** is specified, the **ssa** and **sp** values default to the character **c** in the database.

If the **nc** parameter is specified as a range, the **ncm** parameter must be specified as an asterisk or as the full range **000-255**

If the **nc** parameter is specified as a single value or a range, a single value must be specified for the **ni** parameter.

If the **nc** parameter is specified as an asterisk (**nc=***), the **ncm** parameter must be specified as an asterisk or as the full range **000-255**.

If the **ncm** parameter is specified as a single value, or a range other than the full range of **000-255**, the **ni** and the **nc** parameters must be specified with a single value.

If the **ni** parameter is specified as an asterisk (**ni=***) or as a range, the **nc** and **ncm** parameters must be specified as an asterisk or as the full range **000-255**.

If **ni=c** is specified, either the character **c** must also be specified for the **nc** and **ncm** parameters or the **nc** and **ncm** parameters must not be specified. If the **nc** and **ncm** parameters are not specified when **ni=c** is specified, the **nc** and **ncm** values default to the character **c** in the database.

The spare point code subtype prefix (**s-**) is not supported for ANSI point codes (parameters **ni**, **nc**, **ncm**) or for 24-bit ITU national point codes (parameters **msa**, **ssa**, **sp**). The **pcst** parameter cannot be specified for ANSI and ITU-N24 point codes.

The Spare Point Code Support feature must be enabled before the **pcst** and **npcst** parameters can be specified.

The last screening reference (**sr**) entry cannot be deleted if it is referenced by another screen.

If **zone=c** is specified, either the character **c** must also be specified for the **area** and **id** parameters or the **area** and **id** parameters must not be specified. If the **area** and **id** parameters are not specified when **zone=c** is specified, the **area** and **id** values default to the character **c** in the database.

Notes

If the screening reference is not referenced by any other screen, and if all entries are removed, the entire screening reference can be removed using **ni-nc-ncm**, **zone-area-id**, or **msa-ssa-sp** equal to **c-c-c** or **npc=c**. If more than one entry exists, **ni-nc-ncm**, **zone-area-id**, **msa-ssa-sp**, or **npc** must not equal **c**.

The asterisk is a parameter value indicating that the gateway screening process is screening all values for that parameter in the MSU. The asterisk parameter value does not mean that multiple entries whose values may be in the range implied by the asterisk will be removed. The only entry that will be removed by this command when the asterisk is specified as a parameter value is the entry that contains an asterisk as that parameter value.

For example, if the **dlt-scr-blkopc:sr=ied:ni=240:nc=010:ncm=":ssn=*** command is entered, the only entry that will be removed from the database is the entry in screening reference **ied** that contains the values **ni=240**, **nc=010**, **ncm=***, and **ssn=***. For an entry to be specified in this command with asterisks as parameter values, that entry must be shown in the **rtrv-scr-blkopc** output with asterisks as the same parameter values specified in the **dlt-scr-blkopc** command.

The asterisk (*) value cannot be specified with the character **c**. For example, a point code **c-c-*** is not allowed.

A range of values is specified by separating the values that define the range by two ampersands (&&); for example, **ni=025&&100** specifies all network indicators for ANSI point codes from **25** to **100**.

The character **c** is used in the blocked OPC screens to allow the screening process to continue for messages with point codes that do not match any point codes in the blocked OPC screens. When screening for a blocked OPC and the point code being screened does not match any of the point codes in the blocked DPC screens, the message is not rejected and the screening process continues.

There must be an entry in each unique blocked OPC screening reference to allow the screening process to continue. This entry consists of a screening reference, point code, **nsfi**, and **nsr**. The point code is either **npc=c**, or in the form of subfields **ni-nc-ncm**, **zone-area-id**, or **msa-ssa-sp** equal to **c-c-c**. When the character **c** is specified, the **nsfi** and **nsr** must be specified.

When the point code does not match any entries in the blocked OPC screens, the screening process is directed to the screening reference with the point code **c-c-c**. The **nsfi** and **nsr** in this entry are examined to determine the next step in the screening process.

The spare point code subtype prefix **s-** is supported only for ITU international and ITU national point codes. The **pcst** parameter indicates whether the specified point code has no subtype prefix or has the spare point code prefix.

Output**dlt-scr-blkopc:sr=iec:ni=240:nc=010:ncm=010**

```
rlghncxa03w 04-01-07 11:43:04 EST EAGLE 31.3.0
DLT-SCR-BLKOPC: SCREEN SET AFFECTED - IEC 25% FULL
DLT-SCR-BLKOPC: MASP A - COMPLTD
```

;

Legend

DLT-SCR-BLKOPC—The command entered that caused this output. This is echoed to the printer as a reference.

SCREEN SET AFFECTED - IEC—Identifies the screen set that was affected by the command. The screen set name is provided.

25% FULL—Indicates the relative size of the screen set.

dlt-scr-cdpa**Delete Allowed Called Party Address**

Use this command to remove a specific screening reference from the allowed called party address category.

Keyword: **dlt-scr-cdpa**

Related Commands: **chg-scr-cdpa, ent-scr-cdpa, rtrv-scr-cdpa**

Command Class: Database Administration

Parameters

:sr= (mandatory)

Screening reference. This parameter specifies the point code's unique screening reference name.

Range: 1 alphabetic character followed by up to 3 alphanumeric characters

:ssn= (mandatory)

The subsystem number. An asterisk (*) indicates the full range of values from 1-255.

Range: 1-255, *

:area= (optional)

The ITU international area. The area is specified in the point code. The format of the point code is *zone-area-id*. An asterisk (*) indicates the full range of values from 000-255.

Range: 000-255, *, c

:id= (optional)

The ITU international ID. The parameter specifies the ID in the point code represented by format *zone-area-id*. An asterisk (*) indicates the full range of values from 0-7.

Range: 0-7, *

:msa= (optional)

The 24-bit ITU national signaling point. This parameter specifies the signaling point (sp) in the point code represented by *msa-ssa-sp*. An asterisk (*) indicates the full range of values from 000-255.

Range: 000-255, *

:nc= (optional)†

The network cluster (nc) value. This parameter specifies one or more nc values for the network indicator (ni) and network cluster member (ncm) values specified in the **ni** and **ncm** parameters. It specifies the *nc* of the point code represented by *ni-nc-ncm*. You can specify a single value or a range of values. An asterisk (*) indicates the full range of values from **000–255**.

Range: **000–255, ***

:ncm= (optional)

The network cluster member (ncm) value. This parameter specifies one or more ncm values for the network indicator (ni) and network cluster (nc) values identified in the **ni** and **nc** parameters. It specifies the *ncm* of the point code represented by *ni-nc-ncm*. You can specify a single value or a range of values. An asterisk (*) indicates the full range of values from **000–255**.

Range: **0–255, ***

:ni= (optional)

The network indicator (ni) value. This parameter specifies one or more ni values for the network cluster (nc) and network cluster member (ncm) values identified in the **nc** and **ncm** parameters. It specifies the *ni* of the point code represented by *ni-nc-ncm*. You can specify a single value or a range of values. An asterisk (*) indicates the full range of values from **000–255**.

Range: **0–255, ***

:npc= (optional)

The ITU national point code. An asterisk (*) indicates the full range of values from **00000–16383**.

Range: **00000–16383, *, c**

NOTE: Gateway screening allows the ITU national point code to be displayed and entered in the database only as a single number. If you are using multiple-part ITU national point codes, see “Converting ITU National Point Code Formats” in Appendix A for information on converting the point code format.

:scmgfid= (optional)

The SCCP management (SCMG) format ID, which consists of a one-octet field and uniquely defines the function and format of each SCMG message. You can specify a single value or a range of values. An asterisk (*) indicates the full range of values from **1–255**.

Range: **1–255, ***

:pcst= (optional)

Point code subtype. This parameter indicates whether the specified ITU international or ITU national point code has no subtype prefix or has the spare point code prefix (s-).

Range: **none, s**

Default: **none**

:sp= (optional)

The 24-bit ITU national signaling point. This parameter specifies the signaling point (sp) in the point code represented by *msa-ssa-sp*. An asterisk (*) indicates the full range of values from **000–255**.

Range: **000–255, ***

:ssa= (optional)

The 24-bit ITU national sub signaling area. This parameter specifies the sub signaling area (ssa) in the point code represented by the format *msa-ssa-sp*. An asterisk (*) indicates the full range of values from **000-255**.

Range: **000-255, ***

:zone= (optional)

The ITU international zone. The parameter specifies the zone in the point code represented by format *zone-area-id*. An asterisk (*) indicates the full range of values from **0-7**.

Range: **0-7, *, c**

Example

dlt-scr-cdpa:sr=iec:ni=240:nc=010:ncm=010:ssn=012

dlt-scr-cgpa:sr=cgpa:zone=1:area=2:id=3:ssn=1:scgpmt=9:ri=*:pcst=s

Dependencies

A complete point code must be specified, and must be one and only one of the four point code parameter combinations: **ni-nc-ncm**; **zone-area-id**; **msa-ssa-sp**; or **npc**, except in the special case of entering **c** for "continue".

The CDPA point code, **ssn**, and **scmgfid** to be removed must exist in the CDPA entity set.

ANSI point code value **000-000-000** and ITU-International point code value **0-000-0** are not allowed.

If the **nc** parameter is specified as a range, the **ncm** parameter must be specified as an asterisk or as the full range **000-255**

If the **nc** parameter is specified as a single value or a range, a single value must be specified for the **ni** parameter.

If the **nc** parameter is specified as an asterisk (**nc=***), the **ncm** parameter must be specified as an asterisk or as the full range **000-255**.

If the **ncm** parameter is specified as a single value, or a range other than the full range of **000-255**, the **ni** and the **nc** parameters must be specified with a single value.

If the **ni** parameter is specified as an asterisk (**ni=***) or as a range, the **nc** and **ncm** parameters must be specified as an asterisk or as the full range **000-255**.

The specified screening reference (**sr**) must already exist in the database.

The Spare Point Code Support feature must be enabled before the **pcst** parameter can be specified.

The spare point code subtype prefix (**s-**) is not supported for ANSI point codes (parameters **ni**, **nc**, **ncm**) or for 24-bit ITU national point codes (parameters **msa**, **ssa**, **sp**). The **pcst** parameter cannot be specified for ANSI and ITU-N24 point codes.

A CDPA screening reference (**sr**) cannot be deleted if it referenced by an entity in another screening set.

If the **ssn** parameter is a value other than **1**, the **scmgfid** parameter cannot be specified.

If the **ssn=1** parameter is specified, the **scmgfid** parameter must be specified.

Notes

If only one entry exists and is not referenced by another screening table, the entire screening table is removed.

The asterisk is a parameter value indicating that the gateway screening process is screening all values for that parameter in the MSU. The asterisk parameter value does not mean that multiple entries whose values may be in the range implied by the asterisk will be removed. The only entry that will be removed by this command when the asterisk is specified as a parameter value is the entry that contains an asterisk as that parameter value.

For example, if the **dlt-scr-cdpa:sr=ied:ni=240:nc=010:nccm=":ssn=*** command is entered, the only entry that will be removed from the database is the entry in screening reference **iec** that contains the values **ni=240**, **nc=010**, **ncm=***, and **ssn=***. For an entry to be specified in this command with asterisks as parameter values, that entry must be shown in the **rtrv-scr-cdpa** output with asterisks as the same parameter values specified in the **dlt-scr-cdpa** command.

A range of values is specified by separating the values that define the range by two ampersands (&&); for example, **:ni=025&&100** specifies all network indicators for ANSI point codes from **25** to **100**.

The spare point code subtype prefix **s-** is supported only for ITU international and ITU national point codes. The **pcst** parameter indicates whether the specified point code has no subtype prefix or has the spare point code prefix.

Output

```
dlt-scr-cdpa:sr=iec:ni=240:nc=010:ncm=010:ssn=012
rlghncxa03w 04-01-07 11:43:04 EST EAGLE 31.3.0
DLT-SCR-CDPA: SCREEN SET AFFECTED - IEC 25% FULL
DLT-SCR-CDPA: MASP A - COMPLTD
;
```

Legend

DLT-SCR-CDPA—The command entered that caused this output. This is echoed to the printer as a reference.

SCREEN SET AFFECTED - IEC—Identifies the screen set that was affected by the command. The screen set name is provided.

25% FULL—Indicates the relative size of the screen set.

dlt-scr-cgpa

Delete Allowed Calling Party Address

Use this command to remove a specific screening reference from the allowed calling party address category.

Keyword: **dlt-scr-cgpa**

Related Commands: **chg-scr-cgpa**, **ent-scr-cgpa**, **rtrv-scr-cgpa**

Command Class: Database Administration

Parameters

:ri= (mandatory)

Routing indicator that provides routing instructions to the receiving signaling point. In gateway screening, messages may be screened based on the value of the routing indicator.

Range: **dpc, gt, ***

dpc—Allow a called party address with a routing indicator value of “DPC/SSN.”

gt—Screening stops and gateway screening is bypassed as a forced pass.

*****—Allow both routing indicator values.

:sccpmt= (mandatory)

The SCCP message type. You can specify a single value or a range of values. An asterisk (*) indicates the full range of values.

Range: **9, 10, 17, 18, ***

9—UDT

10—UDTS

17—SUDT

18—XUDTS

:sr= (mandatory)

Screening reference. This parameter specifies the point code’s unique screening reference name.

Range: 1 alphabetic character followed by up to 3 alphanumeric characters

:ssn= (mandatory)

The subsystem number. An asterisk (*) indicates the full range of values from 1-255.

Range: **1-255, ***

:area= (optional)

The ITU international area. The area is specified in the point code. The format of the point code is *zone-area-id*. An asterisk (*) indicates the full range of values from 000-255.

Range: **000-255, ***

:id= (optional)

The ITU international ID. The parameter specifies the ID in the point code represented by format *zone-area-id*. An asterisk (*) indicates the full range of values from 0-7.

Range: **0-7, ***

:msa= (optional)

The 24-bit ITU-national main signaling area (msa) value. It specifies the *msa* of the point code represented by *msa-ssa-spt*. An asterisk (*) indicates the full range of values from 000-255.

Range: **000-255, ***

:nc= (optional)

The network cluster (nc) value. This parameter specifies one or more nc values for the network indicator (ni) and network cluster member (ncm) values specified in the **ni** and **ncm** parameters. It specifies the *nc* of the point code represented by *ni-nc-ncm*. You can specify a single value or a range of values. An asterisk (*) indicates the full range of values from 000-255.

Range: **000-255, ***

:ncm= (optional)

The network cluster member (ncm) value. This parameter specifies one or more ncm values for the network indicator (ni) and network cluster (nc) values identified in the **ni** and **nc** parameters. It specifies the *ncm* of the point code represented by *ni-nc-ncm*. You can specify a single value or a range of values. An asterisk (*) indicates the full range of values from **000-255**.

Range: 0-255, *

:ni= (optional)

The network indicator (ni) value. This parameter specifies one or more ni values for the network cluster (nc) and network cluster member (ncm) values identified in the **nc** and **ncm** parameters. It specifies the *ni* of the point code represented by *ni-nc-ncm*. You can specify a single value or a range of values. An asterisk (*) indicates the full range of values from **000-255**.

Range: 0-255, *

:npc= (optional)

The ITU national point code. An asterisk (*) indicates the full range of values from **00000-16383**.

Range: 00000-16383, *

NOTE: Gateway screening allows the ITU national point code to be displayed and entered in the database only as a single number. If you are using multiple-part ITU national point codes, see “Converting ITU National Point Code Formats” in Appendix A for information on converting the point code format.

:scmgfid= (optional)

The SCCP management (SCMG) format ID, which consists of a one-octet field and uniquely defines the function and format of each SCMG message. You can specify a single value or a range of values. An asterisk (*) indicates the full range of values from **1-255**.

Range: 1-255, *

:pcst= (optional)

Point code subtype. This parameter indicates whether the specified ITU international or ITU national point code has no subtype prefix or has the spare point code prefix (s-).

Range: none, s

Default: none

:sp= (optional)

The 24-bit ITU national signaling point. This parameter specifies the signaling point (sp) in the point code represented by *msa-ssa-sp*. An asterisk (*) indicates the full range of values from **000-255**.

Range: 000-255, *

:ssa= (optional)

The 24-bit ITU national sub signaling area. This parameter specifies the sub signaling area (ssa) in the point code represented by the format *msa-ssa-sp*. An asterisk (*) indicates the full range of values from **000-255**.

Range: 000-255, *

:zone= (optional)

The ITU international zone. The parameter specifies the zone in the point code represented by format *zone-area-id*. An asterisk (*) indicates the full range of values from 0-7.

Range: 0-7, *

Example

dlt-scr-cgpa:sr=iec:ni=240:nc=010:ncm=010:ssn=012

dlt-scr-cgpa:sr=cdp1:ni=5:nc=5:ncm=5:ssn=1:ri=dpc:sccpmt=009

dlt-scr-cgpa:sr=cgpa:zone=1:area=2:id=3:ssn=1:sccpmt=9:ri=*:pcst=s

Dependencies

A complete point code must be specified, and must be one, and only one of the four point code parameter combinations: **ni-nc-ncm**; **zone-area-id**; **msa-ssa-sp**; or **npc**.

ANSI point code value **000-000-000** and ITU-International point code value **0-000-0** are not allowed.

The CGPA point code, **ri**, **ssn**, and **sccpmt** to be removed must exist in the CGPA entity set.

If the **nc** parameter is specified as a range, the **ncm** parameter must be specified as an asterisk or as the full range **000-255**

If the **nc** parameter is specified as a single value or a range, a single value must be specified for the **ni** parameter.

If the **nc** parameter is specified as an asterisk (**nc=***), the **ncm** parameter must be specified as an asterisk or as the full range **000-255**.

If the **ncm** parameter is specified as a single value, or a range other than the full range of **000-255**, the **ni** and the **nc** parameters must be specified with a single value.

If the **ni** parameter is specified as an asterisk (**ni=***) or as a range, the **nc** and **ncm** parameters must be specified as an asterisk or as the full range **000-255**.

The specified screening reference (**sr**) must already exist in the database.

The Spare Point Code Support feature must be enabled before the **pcst** parameter can be specified.

The spare point code subtype prefix (**s-**) is not supported for ANSI point codes (parameters **ni**, **nc**, **ncm**) or for 24-bit ITU national point codes (parameters **msa**, **ssa**, **sp**). The **pcst** parameter cannot be specified for ANSI and ITU-N24 point codes.

A CDPA screening reference (**sr**) cannot be deleted if it referenced by an entity in another screening set.

Notes

The asterisk is a parameter value indicating that the gateway screening process is screening all values for that parameter in the MSU. The asterisk parameter value does not mean that multiple entries whose values may be in the range implied by the asterisk will be removed. The only entry that will be removed by this command when the asterisk is specified as a parameter value is the entry that contains an asterisk as that parameter value.

For example, if the **dlt-scr-cgpa:sr=ied:ni=240:nc=010:nccm=":ssn=*** command is entered, the only entry that will be removed from the database is the entry in screening reference **iec** that contains the values **ni=240**, **nc=010**, **ncm=***, and **ssn=***. For an entry to be specified in this command with asterisks as parameter values, that entry must be shown in the **rtrv-scr-cgpa** output with asterisks as the same parameter values specified in the **dlt-scr-cgpa** command.

A range of values is specified by separating the values that define the range by two ampersands (&&); for example, **:ni=025&&100** specifies all network indicators for ANSI point codes from **25** to **100**.

The routing indicator in the calling party address provides routing instructions for the receiving signaling point. When the routing indicator specifies global title, the message is routed based on the global title digits. If the routing indicator specifies DPC, the message is routed based on the DPC/subsystem number in the calling party address.

The spare point code subtype prefix **s-** is supported only for ITU international and ITU national point codes. The **pcst** parameter indicates whether the specified point code has no subtype prefix or has the spare point code prefix.

Output

```
dlt-scr-cgpa:sr=iec:ni=240:nc=010:nccm=010:ssn=012
rlghncxa03w 04-01-07 11:43:04 EST EAGLE 31.3.0
DLT-SCR-CGPA: SCREEN SET AFFECTED - IEC 25% FULL
DLT-SCR-CGPA: MASP A - COMPLTD
;
```

Legend

DLT-SCR-CGPA—The command entered that caused this output. This is echoed to the printer as a reference.

SCREEN SET AFFECTED - IEC—Identifies the screen set that was affected by the command. The screen set name is provided (such as IEC).

25% FULL—Indicates the relative size of the screen set.

dlt-scr-destfld

Delete an Allowed DESTFLD

Use this command to remove a specific screening reference from the allowed affected destination field (DESTFLD) category.

Keyword: **dlt-scr-destfld**

Related Commands: **chg-scr-destfld**, **ent-scr-destfld**, **rtrv-scr-destfld**

Command Class: Database Administration

Parameters

:sr= (mandatory)

Screening reference. This parameter specifies the point code's unique screening reference name.

Range: 1 alphabetic character followed by up to 3 alphanumeric characters

:area= (optional)

The ITU international area. The area is specified in the point code. The format of the point code is *zone-area-id*. An asterisk (*) indicates the full range of values from **000-255**.

Range: **000-255, ***

:id= (optional)

The ITU international ID. The parameter specifies the ID in the point code represented by format *zone-area-id*. An asterisk (*) indicates the full range of values from **0-7**.

Range: **0-7, ***

:msa= (optional)

The 24-bit ITU-national main signaling area (*msa*) value. It specifies the *msa* of the point code represented by *msa-ssa-spt*. An asterisk (*) indicates the full range of values from **000-255**.

Range: **000-255, ***

:nc= (optional)

The network cluster (*nc*) value. This parameter specifies one or more *nc* values for the network indicator (*ni*) and network cluster member (*ncm*) values specified in the **ni** and **ncm** parameters. It specifies the *nc* of the point code represented by *ni-nc-ncm*. A single value or a range of values can be specified. An asterisk (*) indicates the full range of values from **000-255**.

Range: **000-255, ***

:ncm= (optional)

The network cluster member (*ncm*) value. This parameter specifies one or more *ncm* values for the network indicator (*ni*) and network cluster (*nc*) values identified in the **ni** and **nc** parameters. It specifies the *ncm* of the point code represented by *ni-nc-ncm*. A single value or a range of values can be specified. An asterisk (*) indicates the full range of values from **000-255**.

Range: **0-255, ***

:ni= (optional)

The network indicator (*ni*) value. This parameter specifies one or more *ni* values for the network cluster (*nc*) and network cluster member (*ncm*) values identified in the **nc** and **ncm** parameters. It specifies the *ni* of the point code represented by *ni-nc-ncm*. A single value or a range of values can be specified. An asterisk (*) indicates the full range of values from **000-255**.

Range: **0-255, ***

:npc= (optional)

The ITU national point code. An asterisk (*) indicates the full range of values from **00000-16383**.

Range: **00000-16383, ***

NOTE: Gateway screening allows the ITU national point code to be displayed and entered in the database only as a single number. If you are using multiple-part ITU national point codes, see “Converting ITU National Point Code Formats” in Appendix A for information on converting the point code format.

:pcst= (optional)

Point code subtype. This parameter indicates whether the specified ITU international or ITU national point code has no subtype prefix or has the spare point code prefix (s-).

Range: none, s

Default: none

:sp= (optional)

The 24-bit ITU national signaling point. This parameter specifies the signaling point (sp) in the point code represented by *msa-ssa-sp*. An asterisk (*) indicates the full range of values from **000-255**.

Range: 000-255, *

:ssa= (optional)

The 24-bit ITU national sub signaling area. This parameter specifies the sub signaling area (ssa) in the point code represented by the format *msa-ssa-sp*. An asterisk (*) indicates the full range of values from **000-255**.

Range: 000-255, *

:zone= (optional)

The ITU international zone. The parameter specifies the zone in the point code represented by format *zone-area-id*. An asterisk (*) indicates the full range of values from **0-7**.

Range: 0-7, *

Example

```
dlt-scr-destfld:sr=iec:ni=240:nc=010:ncm=010
```

```
dlt-scr-destfld:sr=dst1:zone=1:area=2:id=3:pcst=s
```

Dependencies

A complete point code must be specified, and must be one, and only one of the four point code parameter combinations: **ni-nc-ncm**; **zone-area-id**; **msa-ssa-sp**; or **npc**.

ANSI point code value **000-000-000** and ITU-International point code value **0-000-0** are not allowed.

If **zone=*** is specified, **area=*** and **id=*** must be specified.

If **area=*** is specified, **id=*** must be specified.

If **ssa=*** is specified, **sp=*** must be specified.

If **msa=*** is specified, **ssa=*** and **sp=*** must be specified.

If the **nc** parameter is specified as a range, the **ncm** parameter must be specified as an asterisk or as the full range **000-255**

If the **nc** parameter is specified as a single value or a range, a single value must be specified for the **ni** parameter.

If the **nc** parameter is specified as an asterisk (**nc=***), the **ncm** parameter must be specified as an asterisk or as the full range **000-255**.

If the **ncm** parameter is specified as a single value, or a range other than the full range of **000-255**, the **ni** and the **nc** parameters must be specified with a single value.

If the **ni** parameter is specified as an asterisk (**ni=***) or as a range, the **nc** and **ncm** parameters must be specified as an asterisk or as the full range **000-255**.

The DESTFLD specified by **ni-nc-ncm**, **zone-area-id**, **msa-ssa-sp**, or the **npc** parameter must already exist in the screening reference.

If only one entry exists, the **sr** must not be referenced by another screening table. If the **sr** is not referenced by another screening table, the entire screening table is deleted.

The Spare Point Code Support feature must be enabled before the **pcst** parameter can be specified.

The spare point code subtype prefix (**s-**) is not supported for ANSI point codes (parameters **ni**, **nc**, **ncm**) or for 24-bit ITU national point codes (parameters **msa**, **ssa**, **sp**). The **pcst** parameter cannot be specified for ANSI and ITU-N24 point codes.

Notes

The asterisk is a parameter value indicating that the gateway screening process is screening all values for that parameter in the MSU. The asterisk parameter value does not mean that multiple entries whose values may be in the range implied by the asterisk will be removed. The only entry that will be removed by this command when the asterisk is specified as a parameter value is the entry that contains an asterisk as that parameter value.

For example, if the **dlt-scr-destfld:sr=ied:ni=240:nc=010:nccm=":ssn=*** command is entered, the only entry that will be removed from the database is the entry in screening reference **iec** that contains the values **ni=240**, **nc=010**, **ncm=***, and **ssn=***. For an entry to be specified in this command with asterisks as parameter values, that entry must be shown in the **rtrv-scr-destfld** output with asterisks as the same parameter values specified in the **dlt-scr-destfld** command.

A range of values is specified by separating the values that define the range by two ampersands (**&&**); for example, **:ni=025&&100** specifies all network indicators for ANSI point codes from **25** to **100**.

The spare point code subtype prefix **s-** is supported only for ITU international and ITU national point codes. The **pcst** parameter indicates whether the specified point code has no subtype prefix or has the spare point code prefix.

Output

dlt-scr-destfld:sr=iec:ni=240:nc=010:ncm=010

```
rlghncxa03w 04-02-13 11:49:47 EST EAGLE 31.3.0
DLT-SCR-DESTFLD: SCREEN SET AFFECTED - SS01 25% FULL
DLT-SCR-DESTFLD: MASP A - COMPLTD
```

;

dlt-scr-dpc**Delete Allowed DPC**

Use this command to remove a specific screening reference from the allowed DPC category.

Keyword: dlt-scr-dpc

Related Commands: chg-scr-dpc, ent-scr-dpc, rtrv-scr-dpc

Command Class: Database Administration

Parameters

:sr= (mandatory)

Screening reference. This parameter specifies the point code's unique screening reference name.

Range: 1 alphabetic character followed by up to 3 alphanumeric characters

:area= (optional)

The ITU international area. The area is specified in the point code. The format of the point code is *zone-area-id*. An asterisk (*) indicates the full range of values from **000-255**.

Range: 000-255, *

:id= (optional)

The ITU international ID. The parameter specifies the ID in the point code represented by format *zone-area-id*. An asterisk (*) indicates the full range of values from **0-7**.

Range: 0-7, *

:msa= (optional)

The 24-bit ITU-national main signaling area (msa) value. It specifies the *msa* of the point code represented by *msa-ssa-spt*. An asterisk (*) indicates the full range of values from **000-255**.

Range: 000-255, *

:nc= (optional)

The network cluster (*nc*) value. This parameter specifies one or more *nc* values for the network indicator (*ni*) and network cluster member (*ncm*) values specified in the **ni** and **ncm** parameters. It specifies the *nc* of the point code represented by *ni-nc-ncm*. A single value or a range of values can be specified. An asterisk (*) indicates the full range of values from **000-255**.

Range: 000-255, *

:ncm= (optional)

The network cluster member (*ncm*) value. This parameter specifies one or more *ncm* values for the network indicator (*ni*) and network cluster (*nc*) values identified in the **ni** and **nc** parameters. It specifies the *ncm* of the point code represented by *ni-nc-ncm*. A single value or a range of values can be specified. An asterisk (*) indicates the full range of values from **000-255**.

Range: 0-255, *

:ni= (optional)

The network indicator (*ni*) value. This parameter specifies one or more *ni* values for the network cluster (*nc*) and network cluster member (*ncm*) values identified in the **nc** and **ncm** parameters. It specifies the *ni* of the point code represented by *ni-nc-ncm*. A single value or a range of values can be specified. An asterisk (*) indicates the full range of values from **000-255**.

Range: 0-255, *

:npc= (optional)

The ITU national point code. An asterisk (*) indicates the full range of values from **00000-16383**.

Range: 00000-16383, *

NOTE: Gateway screening allows the ITU national point code to be displayed and entered in the database only as a single number. If you are using multiple-part ITU national point codes, see “Converting ITU National Point Code Formats” in Appendix A for information on converting the point code format.

:pcst= (optional)

Point code subtype. This parameter indicates whether the specified ITU international or ITU national point code has no subtype prefix or has the spare point code prefix (*s*).

Range: none, s

Default: none

:sp= (optional)

The 24-bit ITU national signaling point. This parameter specifies the signaling point (*sp*) in the point code represented by *msa-ssa-sp*. An asterisk (*) indicates the full range of values from **000-255**.

Range: 000-255, *

:ssa= (optional)

The 24-bit ITU national sub signaling area. This parameter specifies the sub signaling area (*ssa*) in the point code represented by the format *msa-ssa-sp*. An asterisk (*) indicates the full range of values from **000-255**.

Range: 000-255, *

:zone= (optional)

The ITU international zone. The parameter specifies the zone in the point code represented by format *zone-area-id*. An asterisk (*) indicates the full range of values from **0-7**.

Range: 0-7, *

Example

dlt-scr-dpc:sr=iec:ni=240:nc=010:ncm=010

dlt-scr-dpc:sr=dpc1:npc=128:pcst=s

Dependencies

A complete point code must be specified, and must be one, and only one of the four point code parameter combinations: **ni-nc-ncm**; **zone-area-id**; **msa-ssa-sp**; or **npc**.

The DPC specified by **ni-nc-ncm**, **zone-area-id**, **msa-ssa-sp**, or the **npc** parameter must already exist in the screening reference or within an existing range of DPCs.

ANSI point code value **000-000-000** and ITU-International point code value **0-000-0** are not allowed.

If the **nc** parameter is specified as a range, the **ncm** parameter must be specified as an asterisk or as the full range **000-255**

If the **nc** parameter is specified as a single value or a range, a single value must be specified for the **ni** parameter.

If the **nc** parameter is specified as an asterisk (**nc=***), the **ncm** parameter must be specified as an asterisk or as the full range **000-255**.

If the **ncm** parameter is specified as a single value, or a range other than the full range of **000-255**, the **ni** and the **nc** parameters must be specified with a single value.

If the **ni** parameter is specified as an asterisk (**ni=***) or as a range, the **nc** and **ncm** parameters must be specified as an asterisk or as the full range **000-255**.

If only one entry exists, the **sr** must not be referenced by another screening table. If the **sr** is not referenced by another screening table, the entire screening table is deleted.

The Spare Point Code Support feature must be enabled before the **pcst** parameter can be specified.

The spare point code subtype prefix (**s-**) is not supported for ANSI point codes (parameters **ni**, **nc**, **ncm**) or for 24-bit ITU national point codes (parameters **msa**, **ssa**, **sp**). The **pcst** parameter cannot be specified for ANSI and ITU-N24 point codes.

Notes

The asterisk is a parameter value indicating that the gateway screening process is screening all values for that parameter in the MSU. The asterisk parameter value does not mean that multiple entries whose values may be in the range implied by the asterisk will be removed. The only entry that will be removed by this command when the asterisk is specified as a parameter value is the entry that contains an asterisk as that parameter value.

For example, if the **dlt-scr-dpc:sr=ied:ni=240:nc=010:ncm=":ssn=*** command is entered, the only entry that will be removed from the database is the entry in screening reference **iec** that contains the values **ni=240**, **nc=010**, **ncm=***, and **ssn=***. For an entry to be specified in this command with asterisks as parameter values, that entry must be shown in the **rtrv-scr-dpc** output with asterisks as the same parameter values specified in the **dlt-scr-dpc** command.

A range of values is specified by separating the values that define the range by two ampersands (**&&**); for example, **ni=025&&100** specifies all network indicators for ANSI point codes from **25** to **100**.

The spare point code subtype prefix **s-** is supported only for ITU international and ITU national point codes. The **pcst** parameter indicates whether the specified point code has no subtype prefix or has the spare point code prefix.

Output

dlt-scr-dpc:sr=iec:ni=240:nc=010:ncm=010

```
rlghncxa03w 04-01-07 11:43:04 EST EAGLE 31.3.0
DLT-SCR-DPC: SCREEN SET AFFECTED - IEC 25% FULL
DLT-SCR-DPC: MASP A - COMPLTD
```

;

Legend

DLT-SCR-DPC—The command entered that caused this output. This is echoed to the printer as a reference.

SCREEN SET AFFECTED - IEC—Identifies the screen set that was affected by the command. The screen set name is provided.

25% FULL—Indicates the relative size of the screen set.

dlt-scr-isup**Delete Allowed ISUP Screening Reference**

Use this command to delete an allowed ISUP screening reference from the Allowed ISUP entity set.

Keyword: dlt-scr-isup

Related Commands: chg-scr-isup, ent-scr-isup, rtrv-scr-isup

Command Class: Database Administration

Parameters

:isupmt= or **:tupmt=** (mandatory)

ISUP message type or TUP message type. A single value or a range of values can be specified. An asterisk (*) indicates the full range of values from **000–255**. The **tupmt** parameter is not valid for SEAS.

Range: 000–255

:sr= (mandatory)

Screening reference. This parameter specifies the point code's unique screening reference name.

Range: 1 alphabetic character followed by up to 3 alphanumeric characters

Examples

```
dlt-scr-isup:sr=iec:isupmt=9
```

```
dlt-scr-isup:sr=iec:isupmt=1&&2
```

```
dlt-scr-isup:tupmt=1:sr=tu01
```

Dependencies

The specified **sr** must exist in the Allowed ISUP entity set.

The specified **isupmt** parameter or **tupmt** parameter value must already exist in the specified **sr**.

The last entry in the specified **sr** cannot be deleted if the entry is referenced by another screen.

Notes

An asterisk can be specified for a parameter value in the **chg-scr-isup** and **dlt-scr-isup** commands *only* if that parameter value was specified as an asterisk in the **ent-scr-isup** command to define the parameter value.

A range of values can be specified for the **isupmt** parameter or **tupmt** parameter, by separating the values that define the range by two ampersands (&&); for example, **:isupmt=025&&100** specifies all ISUP message types from **25** to **100**. The value to the left of the && must be less than the value to the right of the && in the range.

Output

When a screening reference is specified that is not associated with a screen set, the following output appears:

dlt-scr-isup:sr=iec:isupmt=9

```
tekelecstp 02-09-02 11:59:41 EST EAGLE 30.0.0
DLT-SCR-ISUP: MASP A - COMPLTD
```

;

dlt-scr-isup:sr=iec:isupmt=1&&2

```
tekelecstp 02-09-02 12:00:30 EST EAGLE 30.0.0
DLT-SCR-ISUP: MASP A - COMPLTD
```

;

When a screening reference is specified that is associated with one or more screen sets, the following output appears:

dlt-scr-isup:tupmt=1:sr=tu01

```
tekelecstp 03-11-02 12:00:30 EST EAGLE 31.3.0
Extended Processing Time Required -- Please Wait
Notice: The number of screensets affected is 2.
DLT-SCR-ISUP: SCREEN SET AFFECTED - ist1 1% FULL
DLT-SCR-ISUP: SCREEN SET AFFECTED - ist2 1% FULL
DLT-SCR-ISUP: MASP A - COMPLTD
```

;

dlt-scr-opc

Delete Allowed OPC

Use this command to remove a specific screening reference from the allowed OPC category.

Keyword: **dlt-scr-opc**

Related Commands: **chg-scr-opc**, **ent-scr-opc**, **rtrv-scr-opc**

Command Class: Database Administration

Parameters

:sr= (mandatory)

Screening reference. This parameter specifies the point code's unique screening reference name.

Range: 1 alphabetic character followed by up to 3 alphanumeric characters

:area= (optional)

The ITU international area. The area is specified in the point code. The format of the point code is *zone-area-id*. An asterisk (*) indicates the full range of values from **000-255**.

Range: **000-255, ***

:id= (optional)

The ITU international ID. The parameter specifies the ID in the point code represented by format *zone-area-id*. An asterisk (*) indicates the full range of values from **0-7**.

Range: **0-7, ***

:msa= (optional)

The 24-bit ITU-national main signaling area (msa) value. It specifies the *msa* of the point code represented by *msa-ssa-spt*. An asterisk (*) indicates the full range of values from **000-255**.

Range: **000-255, ***

:nc= (optional)

The network cluster (*nc*) value. This parameter specifies one or more *nc* values for the network indicator (*ni*) and network cluster member (*ncm*) values specified in the **ni** and **ncm** parameters. It specifies the *nc* of the point code represented by *ni-nc-ncm*. A single value or a range of values can be specified. An asterisk (*) indicates the full range of values from **000-255**.

Range: **000-255, ***

:ncm= (optional)

The network cluster member (*ncm*) value. This parameter specifies one or more *ncm* values for the network indicator (*ni*) and network cluster (*nc*) values identified in the **ni** and **nc** parameters. It specifies the *ncm* of the point code represented by *ni-nc-ncm*. You can specify a single value or a range of values. An asterisk (*) indicates the full range of values from **000-255**.

Range: **0-255, ***

:ni= (optional)

The network indicator (*ni*) value. This parameter specifies one or more *ni* values for the network cluster (*nc*) and network cluster member (*ncm*) values identified in the **nc** and **ncm** parameters. It specifies the *ni* of the point code represented by *ni-nc-ncm*. A single value or a range of values can be specified. An asterisk (*) indicates the full range of values from **000-255**.

Range: **0-255, ***

:npc= (optional)

The ITU national point code. An asterisk (*) indicates the full range of values from **00000-16383**.

Range: **00000-16383, ***

NOTE: Gateway screening allows the ITU national point code to be displayed and entered in the database only as a single number. If you are using multiple-part ITU national point codes, see “Converting ITU National Point Code Formats” in Appendix A for information on converting the point code format.

:pcst= (optional)

Point code subtype. This parameter indicates whether the specified ITU international or ITU national point code has no subtype prefix or has the spare point code prefix (**s-**).

Range: none, s

Default: none

:sp= (optional)

The 24-bit ITU national signaling point. This parameter specifies the signaling point (sp) in the point code represented by *msa-ssa-sp*. An asterisk (*) indicates the full range of values from **000-255**.

Range: 000-255, *

:ssa= (optional)

The 24-bit ITU national sub signaling area. This parameter specifies the sub signaling area (ssa) in the point code represented by the format *msa-ssa-sp*. An asterisk (*) indicates the full range of values from **000-255**.

Range: 000-255, *

:zone= (optional)

The ITU international zone. The parameter specifies the zone in the point code represented by format *zone-area-id*. An asterisk (*) indicates the full range of values from **0-7**.

Range: 0-7, *

Example

```
dlt-scr-opc:sr=iec:ni=240:nc=010:ncm=010
```

```
dlt-scr-opc:sr=opc1:npc=128:pcst=s
```

Dependencies

A complete point code must be specified, and must be one, and only one of the four point code parameter combinations: **ni-nc-ncm**; **zone-area-id**; **msa-ssa-sp**; or **npc**.

The OPC specified by **ni-nc-ncm**; **zone-area-id**, **msa-ssa-sp**, or the **npc** parameter must not already exist in the screening reference or within an existing range of OPCs.

ANSI point code value **000-000-000** and ITU-International point code value **0-000-0** are not allowed.

If the **nc** parameter is specified as a range, the **ncm** parameter must be specified as an asterisk or as the full range **000-255**

If the **nc** parameter is specified as a single value or a range, a single value must be specified for the **ni** parameter.

If the **nc** parameter is specified as an asterisk (**nc=***), the **ncm** parameter must be specified as an asterisk or as the full range **000-255**.

If the **ncm** parameter is specified as a single value, or a range other than the full range of **000-255**, the **ni** and the **nc** parameters must be specified with a single value.

If the **ni** parameter is specified as an asterisk (**ni=***) or as a range, the **nc** and **ncm** parameters must be specified as an asterisk or as the full range **000-255**.

If only one entry exists, the **sr** must not be referenced by another screening table. If the **sr** is not referenced by another screening table, the entire screening table is deleted.

The Spare Point Code Support feature must be enabled before the **pcst** parameter can be specified.

The spare point code subtype prefix (**s-**) is not supported for ANSI point codes (parameters **ni**, **nc**, **ncm**) or for 24-bit ITU national point codes (parameters **msa**, **ssa**, **sp**). The **pcst** parameter cannot be specified for ANSI and ITU-N24 point codes.

Notes

The asterisk is a parameter value indicating that the gateway screening process is screening all values for that parameter in the MSU. The asterisk parameter value does not mean that multiple entries whose values may be in the range implied by the asterisk will be removed. The only entry that will be removed by this command when the asterisk is specified as a parameter value is the entry that contains an asterisk as that parameter value.

For example, if the **dlt-scr-dpc:sr=ied:ni=240:nc=010:nccm=":ssn=*** command is entered, the only entry that will be removed from the database is the entry in screening reference **iec** that contains the values **ni=240**, **nc=010**, **ncm=***, and **ssn=***. For an entry to be specified in this command with asterisks as parameter values, that entry must be shown in the **rtrv-scr-dpc** output with asterisks as the same parameter values specified in the **dlt-scr-dpc** command.

A range of values is specified by separating the values that define the range by two ampersands (**&&**); for example, **ni=025&&100** specifies all network indicators for ANSI point codes from **25** to **100**.

The spare point code subtype prefix **s-** is supported only for ITU international and ITU national point codes. The **pcst** parameter indicates whether the specified point code has no subtype prefix or has the spare point code prefix.

Output

dlt-scr-opc:sr=iec:ni=240:nc=010:ncm=010

```
rlghncxa03w 04-01-07 11:43:04 EST EAGLE 31.3.0
DLT-SCR-OPC: SCREEN SET AFFECTED - IEC 25% FULL
DLT-SCR-OPC: MASP A - COMPLTD
```

;

Legend

DLT-SCR-OPC—The command entered that caused this output. This is echoed to the printer as a reference.

SCREEN SET AFFECTED - IEC—Identifies the screen set that was affected by the command. The screen set name is provided.

25% FULL—Indicates the relative size of the screen set.

dlt-scr-sio**Delete Allowed SIO**

Use this command to remove a specific screening reference from the allowed service indicator octet (SIO) category.

Keyword: dlt-scr-sio

Related Commands: chg-scr-sio, ent-scr-sio, rtrv-scr-sio

Command Class: Database Administration

Parameters

:nic= (mandatory)

The network indicator code identifies whether the message originated from an international (0) or national (2) network. You can specify a single value or a range of values. An asterisk (*) indicates the full range of values from 0-3.

Range: 0-3, *

:pri= (mandatory)

New message priority. This parameter specifies the new message priority in the SIO. You can specify a single value or a range of values. An asterisk (*) indicates the full range of values from 0-3.

Range: 0-3, *

Default: Current value

:si= (mandatory)

Service indicator. The service indicator identifies the type of message. The values are defined in Telcordia TR-NWT-000246.

Range: 00, 01- 15

:sr= (mandatory)

Screening reference. This parameter specifies the point code's unique screening reference name.

Range: 1 alphabetic character followed by up to 3 alphanumeric characters

:h0= (optional)

H0 Heading Code. This parameter specifies an H0 heading code for the screening reference specified in the sr parameter. A single value or a range of values can be specified. An asterisk (*) indicates the full range of values from 0-15.

This parameter is mandatory if the service indicator (si) value is 00, 01, 02, or 03. Otherwise, the h0 parameter is undefined.

Range: 0-15, *

Default: Current value or undefined

:h1= (optional)

H1 Heading Code. This parameter specifies an H1 heading code for the screening reference specified in the sr parameter. A single value or a range of values can be specified. An asterisk (*) indicates the full range of values from 0-15.

This parameter is mandatory if the service indicator (si) value is 00, 01, 02, or 03. Otherwise, the h1 parameter is undefined.

Range: 0-15, *

Default: Current value or undefined

Example

dlt-scr-sio:sr=iec:nic=1:si=1:h0=4:h1=2:pri=*

dlt-scr-sio:sr=iec:nic=1:si=3:pri=2

Dependencies

The **nh0** and **nh1** parameters cannot be specified if the **nsi** parameter is specified and is not equal to **00**, **01**, or **02**.

The **sr**, **nic**, **si**, **pri**, and **h0/h1** parameters to be removed must be in the screening reference.

Table 6-2 shows the valid combinations of the **h0/h1** parameter:

Table 6-2. Valid Combinations for the **h0/h1** and **nh0/nh1** Parameters (**chg-scr-sio**)

If the h0 (nh0) parameter is specified as:	The h1 (nh1) parameter value can be specified as:
A single value	A single value
A single value	A range
A single value	An asterisk (*) entry
A range	An asterisk (*) entry
An asterisk (*) entry	An asterisk (*) entry

The **sr**, **nic**, **si**, **pri**, and **h0/h1** parameters cannot be removed if they are the last entry in the screening reference and the screening reference is part of a screen set.

Notes

The network identifier specifies whether the message originated from an international (**0**) or a national (**2**) network.

The asterisk is a parameter value indicating that the gateway screening process is screening all values for that parameter in the MSU. The asterisk parameter value does not mean that multiple entries whose values may be in the range implied by the asterisk will be removed. The only entry that will be removed by this command when the asterisk is specified as a parameter value is the entry that contains an asterisk as that parameter value.

For example, if the **dlt-scr-sio:sr=ied:ni=240:nc=010:nccm=":ssn=*** command is entered, the only entry that will be removed from the database is the entry in screening reference **iec** that contains the values **ni=240**, **nc=010**, **nccm=***, and **ssn=***. For an entry to be specified in this command with asterisks as parameter values, that entry must be shown in the **rtrv-scr-sio** output with asterisks as the same parameter values specified in the **dlt-scr-sio** command.

A range of values is specified by separating the values that define the range by two ampersands (**&&**); for example, **ni=025&&100** specifies all network indicators for ANSI point codes from **25** to **100**.

Output

dlt-scr-sio:sr=iec:nic=1:si=3:pri=2

```

rlghncxa03w 04-02-14 16:45:50 EST EAGLE 31.3.0
DLT-SCR-SIO: SCREEN SET AFFECTED - SS01 25% FULL
DLT-SCR-SIO: SCREEN SET AFFECTED - SS04 35% FULL
DLT-SCR-SIO: MASP A - COMPLTD
;

```

Legend

DLT-SCR-SIO—The command entered that caused this output. This is echoed to the printer as a reference.

SCREEN SET AFFECTED - SS01—Identifies the screen set that was affected by the command. The screen set name is provided.

25% FULL—Indicates the relative size of the screen set.

dlt-scr-tt

Delete Allowed Translation Type

Use this command to remove a specific screening reference from the allowed translation type category.

Keyword: dlt-scr-tt

Related Commands: chg-scr-tt, ent-scr-tt, rtrv-scr-tt

Command Class: Database Administration

Parameters

:sr= (mandatory)

Screening reference. This parameter specifies the point code's unique screening reference name.

Range: 1 alphabetic character followed by up to 3 alphanumeric characters

:type= (mandatory)

Translation type. The translation type identifies the global title translation type value in the called party address. You can enter a single value or a range of values. An asterisk (*) indicates the full range of values from **0-255**.

Range: 000-255, *

Example

```
dlt-scr-tt:sr=iec:type=012
```

Dependencies

The screening reference must exist.

You cannot remove the **sr** and **type** parameters if they are the last entry in the screening reference and the screening reference is part of a screen set.

The allowed **type** to be removed must already exist in the screening reference.

The single value or range specified for the allowed **type** to be deleted from the TT screen for the allowed TT screening reference must already exist in that TT screen.

Notes

The asterisk is a parameter value indicating that the gateway screening process is screening all values for that parameter in the MSU. The asterisk parameter value does not mean that multiple entries whose values may be in the range implied by the asterisk will be removed. The only entry that will be removed by this command when the asterisk is specified as a parameter value is the entry that contains an asterisk as that parameter value.

For example, if the **dlt-scr-tt:sr=ied:type=":ssn=*** command is entered, the only entry that will be removed from the database is the entry in screening reference **iec** that contains an asterisk as the value for the **type** parameter. For an entry to be specified in this command with an asterisk as the value for the **type** parameter, that entry must be shown in the **rtrv-scr-tt** output with an asterisk as the value for the **type** parameter.

Output

dlt-scr-tt:sr=iec:type=012

```
rlghncxa03w 04-01-07 11:43:04 EST EAGLE 31.3.0
DLT-SCR-TT: SCREEN SET AFFECTED - IEC 25% FULL
DLT-SCR-TT: MASP A - COMPLTD
;
```

Legend

DLT-SCR-TT—The command entered that caused this output. This is echoed to the printer as a reference.

SCREEN SET AFFECTED - IEC—Identifies the screen set that was affected by the command. The screen set name is provided.

25% FULL—Indicates the relative size of the screen set.

dlt-scrset

Delete Screen Set

Use this command to remove a screen set definition from the database. A screen set is a group of screening references that belong to various categories. This command does not remove any gateway screening tables.

Keyword: dlt-scrset

Related Commands: chg-scrset, ent-scrset, rtrv-scrset

Command Class: Database Administration

Parameters

:scrn= (mandatory)

Screen set name. Each screening reference must have a unique name.

Range: 1 alphabetic character followed by up to 3 alphanumeric characters

Example

```
dlt-scrset:scrn=nc27
```

Dependencies

The screen set name must exist.

Before the screen set can be removed, it must be removed from all linksets.

Notes

The system validates the command to ensure that the specified screen set name is in use.

Output

```
dlt-scrset:scrn=nc27
    rlghncxa03w 04-01-07 11:43:04 EST EAGLE 31.3.0
    DLT-SCRSET: MASP A - COMPLTD
;
```

dlt-shlf

Delete Shelf

Use this command to remove a shelf from the system database.

Keyword: dlt-shlf

Related Commands: ent-shlf, rtrv-shlf

Command Class: Database Administration

Parameters

:loc= (mandatory)

The shelf location.

Range: 1200, 1300, 2100, 2200, 2300, 3100, 3200, 3300, 4100, 4200, 4300, 5100, 5200, 5300, 6100

Example

```
dlt-shlf:loc=2300
```

Dependencies

The frame and shelf values of the shelf location parameter (**loc**) must be within the valid range (*xyzz*, where *x*=frame and *y*=shelf; *zz* is always 00 for this command).

The equipment shelf must have been configured previously.

The equipment shelf must not have any cards configured for it.

Notes

All shelves in the system can be removed, except the control shelf (**1100**).

Before a shelf can be removed from the database, all SS7 signaling links and TCP/IP data links must be deactivated and removed from the database. All TSMs must be placed out of service. All X.25 signaling links, and the X.25 routes assigned to them, must be removed from the database. Then all cards in the shelf must be removed from the database. See the *Database Administration Manual - SS7* for more information on shelf removal.

Refer to the *Installation Manual - EAGLE 5 SAS* for an illustration of shelf locations.

Output

```

dlt-shlf:loc=2300
    rlgncxa03w 04-01-07 11:11:28 EST EAGLE 31.3.0
    DLT-SHLF: MASP A - COMPLTD
;

```

dlt-slk**Delete Signaling Link**

Use this command to remove a signaling link from the system database.

Keyword: dlt-slk

Related Commands: act-slk, blk-slk, dact-slk, ent-slk, inh-slk, rept-stat-slk, rtrv-slk, tst-slk, ublk-slk, unhb-slk

Command Class: Database Administration

Parameters

:loc= (mandatory)

The card location as stenciled on the shelf of the system.

Range: 1101-1108, 1111-1112, 1201-1208, 1211-1218, 1301-1308, 1311-1318, 2101-2108, 2111-2118, 2201-2208, 2211-2218, 2301-2308, 2311-2318, 3101-3108, 3111-3118, 3201-3208, 3211-3218, 3301-3308, 3311-3318, 4101-4108, 4111-4118, 4201-4208, 4211-4218, 4301-4308, 4311-4318, 5101-5108, 5111-5118, 5201-5208, 5211-5218, 5301-5308, 5311-5318, 6101-6108, 6111-6118

:port= or :link= (mandatory)

Signaling link on the card specified in the **loc** parameter. The links can be specified in any sequence or pattern.

Range: a, b, a1-a31, b1-b31

Not all card types support all **link** parameter values.

See Table A-1 in Appendix A for valid link parameter range values for each type of card that can have a location specified in the **loc** parameter.

:force= (optional)

This parameter must be used to remove the last link in a linkset without having to remove all of the routes that referenced the linkset.

Range: yes, no

Default: no

Example

```
dlt-slk:loc=1211:link=a
```

```
dlt-slk:loc=1201:link=b:force=yes
```

The following example deletes a multi-port LIM or E1/T1 MIM or HC-MIM link from link **a1** on the card at card location **1205**:

```
dlt-slk:loc=1205:link=a1
```

Dependencies

The slot portion of the specified card location (**loc**) can be **1** through **8** and **11** through **18**. Slots **09** and **10** cannot be specified. (The card location is *xyss*, where *x* is the frame, *y* is the shelf, and *ss* is the slot).

Card locations **1113** through **1118** cannot be specified.

The frame and shelf portions of the specified card location (**loc**) can be **11** through **13**, **21** through **23**; **31** through **33**; **41** through **43**; **51** through **53**; and **61**. (The card location is *xyss*, where *x* is the frame, *y* is the shelf, and *ss* is the slot).

The **link** parameter values **a1**, **b1**, **a2**, **b2**, **a3**, and **b3** can be specified only for the following cards:

- A multi-port LIM
- An SSED CM running the **iplim** or **iplimi** application that supports 8 points
- An E1/T1 MIM or an HC-MIM.

The **link** parameter values **a4-a31** and **b4-b31** can be specified only for HC-MIM cards that are used as E1 cards or T1 cards:

Links **a4-a31** and **b4-b31** cannot be specified for even-numbered card locations. HC-MIM cards are dual-slot cards. The links are assigned only to the cards in odd-numbered locations.

Links **a4-a31** and **b4-b31** cannot be specified for Channel cards.

The specified link must exist in the database.

If the GPL type of the specified card is **ss7gx25**, **atmitu**, **atmansi**, **ipgwi**, or **ss7ipgw**, you can specify only the value **a** for the **link** parameter.

If the GPL type of the specified card is **iplim** or **iplimi** that supports 2 point-to-point links, you can specify only **link** parameter values **link=a** or **link=b**.

The signaling link must be in the unavailable (UAV) state before it can be removed. Enter the **rept-stat-slk** command to verify the state of the signaling link.

The **limatm**, **lime1atm**, **limds0**, **limocu**, **limv35**, **lime1**, **limt1**, **limch**, **iplim**, and **iplimi** card types are the only valid card types for this command.

The shelf and card must be equipped.

The signaling link cannot have an active LFS test in progress when you enter the command to delete the link.

The **force=yes** parameter must be specified to remove the last signaling link in a linkset that is assigned to a route.

To remove an X.25 signaling link that has X.25 routes associated with it, the X.25 routes must be removed first.

To remove the last signaling link on a card, the state of the card must be OOS-MT-DSBLD. Enter the **rept-stat-card** command to verify the state of the card.

The card must be inhibited before you delete the last link on the card.

An IPLIMx or IPGWx signaling link assigned to a local host cannot be deleted if it has a socket or association with connection status **open=yes**.

Notes

This command disassociates the equipment of a link from a logical signaling link. The link must first be placed in the unavailable (UAV) state by entering the **chg-slk** (or **canc-slk**) command before this command can be used to disconnect it. Entering this command results in the link entity being deleted from the STP's link entity set. The link is then considered to be "disconnected." The link on the STP becomes unassigned (spare) but retains the existing equipment type and options; the link remains in the "equipped" provisioning state unless that state is changed by subsequent local craft activity. The link is also no longer associated with its assigned linkset.

Not every card location represents a signaling link. Be sure to address a signaling link in this command.

The *Installation Manual - EAGLE 5 SAS* provides an illustration of card locations.

Output

dlt-slk:loc=1211:port=a

```
rlghncxa03w 05-02-07 11:11:28 EST EAGLE5 33.0.0
DLT-SLK: MASP A - COMPLTD
```

;

dlt-spc

Delete Secondary Point Code

Use this command to delete an SPC (secondary point code) from the database. Also use this command to change an SPC by first removing the SPC from the database and then using the **ent-spc** command to enter the new SPC value.

Keyword: **dlt-spc**

Related Commands: **ent-spc**, **rtrv-spc**

Command Class: Database Administration

Parameters

:spc/spca/spci/spcn/pcn24= (mandatory)

Secondary point code.

NOTE: See "Point Code Formats and Conversion" in Appendix A for a detailed description of point code formats, rules for specification, and examples.

:spc= or :spca= (mandatory)

ANSI destination point code with subfields *network indicator-network cluster-network cluster member* (*ni-nc-ncm*).

Range: **000-255**

Specify a valid value for each subfield of the point code, and separate the subfields with a dash (-).

When **chg-sid:pctype=ansi** is specified, *ni* = **000** is not valid.

When **chg-sid:pctype=ansi** is specified, *nc* = **000** is not valid if *ni* = **001-005**.

When **chg-sid:pctype=ansi** is specified, **nc = 000** is valid if **ni = 006-255**.
The point code **000-000-000** is not a valid point code.

:spci= (mandatory)

ITU international point code with subfields *zone-area-id*. The *prefix* subfield indicates a spare point code (*prefix-zone-area-id*).

Range: **s-**, **0-255**

Specify a valid value for each subfield of the point code, and separate the subfields with a dash (-).

prefix—**s-**

zone—**0-7**

area—**000-255**

id—**0-7**

The point code **0-000-0** is not a valid point code.

:spcn= (mandatory)

ITU international point code with subfields *zone-area-id*. The *prefix* subfield indicates a spare point code (*prefix-zone-area-id*).

Range: **s-**, **0-255**

Specify a valid value for each subfield of the point code, and separate the subfields with a dash (-).

prefix—**s-**

zone—**0-7**

area—**000-255**

id—**0-7**

The point code **0-000-0** is not a valid point code.

:spcn24= (mandatory)

24-bit ITU national point code with subfields *main signaling area-sub signaling area-signaling point* (*msa-ssa-sp*).

Range: **000-255**

Specify a valid value for each subfield of the point code, and separate the subfields with a dash (-).

msa—**000-255**

ssa—**000-255**

sp—**000-255**

Example

dlt-spc:spc=10-20-30

dlt-spc:spcn24=98-98-98

dlt-spc:spcn=s-12345

Dependencies

The Spare Point Code Support feature must be enabled before a spare point code (prefix **s-**) can be specified in the command.

A secondary point code that is referenced in the Destination table cannot be deleted.

Notes

In this command, only ITU-international and ITU national point codes support the spare point code subtype prefix (**s-**). All of the point code types support the private (internal) point code subtype prefix (**p-**).

Output**dlt-spc:spc=10-20-30**

```
rlghncxa03w 04-02-18 08:50:12 EST EAGLE 31.3.0
Secondary Point Code table is (7 of 40) 17% full
DLT-SPC: MASP A - COMPLTD
```

```
;
```

dlt-split-npa**Delete Split NPANXX**

NOTE: This command is obsolete.

Use this command to remove the NPANXX from the database. This command verifies that the NPANXX input is in a split-NPA condition with another NPANXX.

NOTE: If the LNP ELAP Configuration controlled feature is turned on, this command is no longer available. This function can be performed at the LSMS or using the ELAP user interface.

Keyword: dlt-split-npa

Related Commands: ent-split-npa, rtrv-split-npa

Command Class: LNP Database Administration

Parameters

:npanxx= (mandatory)

Numbering plan area.

Range: 6 digits

Example

dlt-split-npa:npanxx=214254

Dependencies

The LNP feature must be turned on (see the **enable-ctrl-feat** command) before this command can be entered.

The NPANXX must exist and it must be already split.

Notes

None

Output**dlt-split-npa:npanxx=214254**

```
rlghncxa03w 04-02-18 08:50:12 EST EAGLE 31.3.0
DLT-SPLIT-NPA: MASP A - COMPLTD
```

```
;
```

dlt-srvsel**Delete Service Selector**

Use this command to delete a service selector.

Keyword: dlt-srvsel

Related Commands: chg-srvsel, ent-srvsel, rtrv-srvsel

Command Class: Database Administration

Parameters

:gti/gtia/gtii/gtin/gtin24= (mandatory)

Global title indicator. For all service selector commands, the domain is defined as **gti** and **gtia** (ANSI), **gtii** (ITU international), and **gtin** (ITU national). For the service selector commands, **gti** and **gtia** are equivalent.

Range: Supported value for ANSI:

gti=2 and **gtia=2**

Supported values for ITU:

gtii=2, 4, gtin=2, 4, gtin24=2, 4

:ssn= (mandatory)

Subsystem number.

Range: 0-255, *

:tt= (mandatory)

Translation type.

Range: 0-255

:nai= (optional)

Nature of address indicator (see Table A-5 in Appendix A).

Range: sub, rsvd, natl, intl

:naiv= (optional)

Nature of address indicator value (see Table A-5 in Appendix A).

Range: 0-127

NOTE: The nature of address indicator parameters (naiv or nai) can be specified by supplying either a mnemonic or an explicit value. At no time may both the mnemonic and the explicit value be specified at the same time for the same parameter. Either the naiv or nai parameter can be specified. Table A-5 in Appendix A shows the mapping between the naiv and the nai parameters.

:np= (optional)

Numbering plan (see Table A-6 in Appendix A).

Range: e164, generic, x121, f69, e210, e212, e214, private

:npv= optional)

Numbering plan value (see Table A-6 in Appendix A).

Range: 0-15

NOTE: The numbering plan parameters (npv or np) can be specified by supplying either a mnemonic or an explicit value. At no time may both the mnemonic and the explicit value be specified at the same time for the same parameter. You can specify either the npv or np parameter. Table A-6 in Appendix A shows the mapping between the npv and the np parameters.

Example

```
dlt-srvsel:gti=2:tt=10
dlt-srvsel:gtin=4:tt=0:np=e164:nai=sub
dlt-srvsel:gtin24=4:tt=4:np=e164:nai=intl
dlt-srvsel:gtii=4:tt=4:np=e164:nai=intl:ssn=9
dlt-srvsel:gtii=4:tt=5:np=e164:nai=intl:ssn=*
```

Dependencies

The G-Flex, G-Port, or INP feature must be turned on or the Equipment Identity Register (EIR) feature must be enabled before this command can be entered.

The **np** and **npv** parameters cannot be specified together.

The **nai** and **naiv** parameters cannot be specified together.

The value **4** is not valid for the **gti/gtia** parameters.

The values **1** and **3** are not valid for the **gti/gtia/gtii/gtin/gtin24** parameters.

When the **gtii/gtin/gtin24=4** parameter is specified, an **np(v)** and **nai(v)** parameter combination must be specified. These parameters can be specified in the following combinations: **np** and **naiv**, **npv** and **nai**, **np** and **nai**, or **npv** and **naiv**.

When the **gti/gtia/gtii/gtin/gtin24=2** parameter is specified, no **np(v)** and **nai(v)** parameter combinations can be specified.

An entry must already exist that matches the **gti/gtia/gtii/gtin/gtin24**, **tt**, **ssn**, and **np(v)** and **nai(v)** combination of parameters.

Notes

None

Output

```
dlt-srvsel:gti=2:tt=10
rlghncxa03w 04-01-05 16:40:40 EST EAGLE 31.3.0
Service Selector table is (114 of 1024) 11% full
DLT-SRVSEL: MASP A - COMPLTD
;
```

dlt-ss-appl

Delete Subsystem Application

Use this command to remove the application from the LNP database.

Keyword: dlt-ss-appl

Related Commands: chg-ss-appl, ent-ss-appl, rtrv-ss-appl

Command Class: Database Administration

Parameters

:appl= (mandatory)
Application type.
Range: **lnp, inp, eir**

Example

```
dlt-ss-appl:appl=lnp
dlt-ss-appl:appl=inp
dlt-ss-appl:appl=eir
```

Dependencies

The LNP feature must be turned on (see the **enable-ctrl-feat** command) before the **dlt-ss-appl:appl=lnp** command can be entered.

The INP feature must be turned on before the **dlt-ss-appl:appl=inp** command can be entered.

The Equipment Identity Register (EIR) feature must be turned on before the **dlt-ss-appl:appl=eir** command can be entered.

The application type (**appl** parameter) must exist in the SS-APPL table.

The subsystem must be inhibited before **status=offline** can be specified.

Notes

None

Output

```
dlt-ss-appl:appl=lnp
  rlgncxa03w 04-01-05 16:40:40 EST  EAGLE 31.3.0
  DLT-SS-APPL: MASP A - COMPLTD
;
```

dlt-subnetid**Delete Subnet ID**

Use this command to delete a Subnet ID entry from the Subnet ID list, for the ISUP NP with EPAP feature.

Keyword: **dlt-subnetid**

Related Commands: **ent-subnetid, rtrv-subnetid**

Command Class: Database Administration

Parameters

:subnetid= (mandatory)
Subnet ID

Range: 0-FFFFFFFFFFFFFFF

1-15 digits; the entry must contain the number of digits defined by the **subnetidlen** parameter value. Valid digits are **0-9**, **A-F**, and **a-f**.

Example

```
dlt-subnetid:subnetid=886933
```

Dependencies

The value **none** cannot be specified for the **subnetid** parameter.

The specified Vendor ID entry must already exist in the SUBNETID table.

Notes

None.

Output

```
dlt-subnetid:subnetid=886933
```

```
rlghncxa03w 04-10-07 11:11:28 EST EAGLE 31.11.0
SUBNETID table is (6 of 50) 3% full
DLT-SUBNETID: MASP A - COMPLTD
```

```
;
```

dlt-t1

Delete T1 Interface

Use this command to delete a T1 interface from an E1/T1 MIM card or an HC-MIM card used as a T1 card. The T1 port number on the card and the T1 card location in the EAGLE must be specified.

On an HC-MIM card, T1 ports 1, 3, 5, and 7 (master ports) can be independently channel bridged with their adjacent even numbered (slave) ports 2, 4, 6, and 8 to allow non-signaling data pass-through. The slave port channel bridging definition is automatically deleted when the command is entered to delete its master port interface.

Keyword: dlt-t1

Related Commands: chg-t1, ent-t1, rtrv-t1, tst-t1

Command Class: Database Administration

Parameters

:t1port= (mandatory)

T1 card port number. The value must be a T1 port for which an interface has already been configured on the specified T1 card.

Range: 1, 8

Ports 3-8 are valid only for HC-MIM cards.

:loc= (mandatory)

The card location as stenciled on the shelf of the system.

Range: 1101–1108, 1111–1112, 1201–1208, 1211–1218, 1301–1308, 1311–1318, 2101–2108, 2111–2118, 2201–2208, 2211–2218, 2301–2308, 2311–2318, 3101–3108, 3111–3118, 3201–3208, 3211–3218, 3301–3308, 3311–3318, 4101–4108, 4111–4118, 4201–4208, 4211–4218, 4301–4308, 4311–4318, 5101–5108, 5111–5118, 5201–5208, 5211–5218, 5301–5308, 5311–5318, 6101–6108, 6111–6118

Example

```
dlt-t1:loc=1205:t1port=1
```

```
dlt-t1:loc=1205:t1port=2
```

Dependencies

The specified card location (**loc** parameter) must be equipped.

The card in the specified card locations (**loc** parameter) must be a **limt1** card type.

The port specified by the **t1port** parameter must be already equipped with a T1 interface.

All signaling links that provide timeslots serviced by the specified T1 interface must be deleted before the T1 interface can be deleted.

An HC-MIM even-numbered channel-bridged (slave) port cannot be specified in the **t1port** parameter. To delete channel bridged port interfaces, specify the master (odd-numbered) port in the **port** parameter. Slave port interface definitions are automatically deleted when their master port interface is deleted.

Notes

None.

Output

```
dlt-t1:loc=1205:t1port=1
```

```
rlghncxa03w 04-02-20 09:07:58 EST EAGLE 31.3.0
DLT-T1: MASP A - COMPLTD
```

```
;
```

dlt-tt

Delete Translation Type

Use this command to remove a translation type from the system database.

NOTE: If the EGTT (Enhanced Global Title Translation) feature is turned on, the system will no longer accept GTT (Global Title Translation) and TT (Translation Type) commands. Refer to the new command sets that replace the GTT and TT commands: GTT Selector commands (**ent/chg/dlt/rtrv-gttset**), GTT Set commands (**ent/dlt/rtrv-gttset**), and GTA commands (**ent/chg/dlt/rtrv-gta**).

Keyword: dlt-tt

Related Commands: ent-tt, rtrv-tt

Command Class: Database Administration

Parameters

:alias= (optional)

The global title translation type

Range: 000–255

Default: No translation type given

:ttn= (optional)

Translation type name.

Range: 1 alphabetic character followed by up to 7 alphanumeric characters

Default: No translation name is given

type/typea/typeei/typen/typen24= (optional)

Translation type identifies the translation type and network type. This parameter is the decimal representation of the 1-byte field used in SS7.

Type and **typea** specify an ANSI network, **typeei** specifies an ITU-international network, **typen** specifies an ITU-national network, and **typen24** specifies a 24-bit ITU national network. A translation type numeric value may be entered as ANSI (**type** or **typea**) and also as an ITU type (**typeei**, **typen**, or **typen24**). However, they are separate entities.

Range: 0–255

Default: No translation type is specified

Example

dlt-tt:type=230

dlt-tt:ttn=lidb

dlt-tt:type=230:ttn=lidb

dlt-tt:type=230:ttn=lidb:alias=030

Dependencies

This command is not valid when the EGTT feature is turned on.

Asterisk (*) parameter values are not allowed in this command.

To delete a translation type, the translation type, the translation name, or both, must be specified.

If the translation type is specified, it must already exist in the database for the network type.

If the translation name is specified, it must already exist in the database.

If the translation type is specified, it cannot be an **alias** value.

If both the translation type and translation name are specified, they must correspond.

The translation type cannot be deleted if there are current GTT entries that reference it.

To delete an **alias**, both the **alias** and the translation type must be specified, and both must already exist in the database for the network type.

If an **alias** is specified, it must be associated with the specified translation type and cannot be the value of an existing translation type.

Either the **type** parameter or **ttn** parameter must be specified.

If the **type** parameter is specified, the translation type must exist in the translation table. If the **type** or **ttn** parameter, or both, are specified, they must be the same as the values entered with the **ent-tt** command.

If the translation name is specified, it must be associated with a translation type.

If aliases exist, they must be removed from the database before the translation types can be removed.

Notes

If the specified translation type entry is not referenced by a current global title translation entry and does not have any aliases, the translation type entry is removed.

Output

dlt-tt:type=230

```
rlghncxa03w 04-01-07 11:43:04 EST EAGLE 31.3.0
DLT-TT: MASP A - COMPLTD
```

;

dlt-ttmap

Delete Translation Type Mapping

Use this command to delete from the database a mapped SS7 message translation type (TT) for a given gateway linkset name. For example, suppose you are mapping the translation type 001 (before TT mapping) to 238 (after TT mapping). You can use this command to delete that mapping from the database.

Keyword: dlt-ttmap

Related Commands: chg-ttmap, ent-ttmap, rtrv-ttmap

Command Class: Database Administration

Parameters

:lsn= (mandatory)

Linkset name. The unique network identifier for the gateway linkset.

Range: 1 alphabetic character followed by 9 alphanumeric characters.

:ett= (optional)

Translation type before mapping. The identification of the type of global title translation in the SS7 message *before* translation type mapping. This attribute is the decimal representation of the 1-octet binary field used by the SS7 protocol to identify the translation type.

Range: 0-255

:io= optional)

Incoming or outgoing. The system uses this parameter to indicate whether the translation type mapping data provisioned for the gateway linkset is for SS7 messages *received* or *sent* on the linkset.

Range: i, o

i—incoming

o—outgoing

Default: Both incoming and outgoing

Example

```
dlt-ttmap:lsn=n c001:io=i:ett=128:mtt=55
```

Dependencies

None

Notes

None

Output**dlt-ttmap:lsn=n c001:io=i:ett=128:mtt=55**

```
rlghncxa03w 04-02-22 11:18:50 EST EAGLE 31.3.0
DLT-TTMAP: MASP A - COMPLTD
```

```
TTMAP table for nc001 is (2 of 64) 3% full
```

;

dlt-uim-acthresh**Delete Activity Level Threshold for STP UIM Activity Reporting**

Use this command to clear the level of activity threshold that is used to report UIM messages.

Keyword: **dlt-uim-acthresh**

Related Commands: **set-uim-acthresh, rtrv-uim-acthresh**

Command Class: Database Administration

Parameters

:uimn= (mandatory)

The UIM number.

Range: **1000-1499**

Example

Clears UIM number 1333 message threshold:

dlt-uim-acthresh:uimn=1333

Dependencies

The **uimn** parameter value must be a numeric value in the range of **1000-1499**.

The specified **uimn** value must exist in the UIM Threshold database table.

Notes

None

Output**dlt-uim-acthresh:uimn=1333**

```
rlghncxa03w 04-02-01 08:50:12 EST EAGLE 31.3.0
DLT-UIM-ACTHRESH: MASP A - COMPLTD
```

;

dlt-user**Delete User**

Use this command to remove a user from the system database.

Keyword: dlt-user

Related Commands: act-user, chg-pid, chg-user, dact-user, ent-user, login, logout, rept-stat-user, rtrv-secu-user, rtrv-user

Command Class: Security Administration

Parameters

:uid= (mandatory)

User ID

Range: 1 alphabetic character followed by up to 15 alphanumeric characters.

Example

```
dlt-user:uid=terryjohnson
```

Dependencies

The first character must be a letter.

Notes

If the user being removed is logged onto the system, this command logs the user off immediately.

Output

```
dlt-user:uid=terryjohnson
rlghncxa03w 04-01-07 11:11:28 EST EAGLE 31.3.0
DLT-USER: MASP A - COMPLTD
;
```

dlt-vendid**Delete Vendor ID**

Use this command to delete a Vendor ID entry from the Vendor ID list, for the GSM MAP SRI Redirect to Serving HLR feature.

Keyword: dlt-vendid

Related Commands: ent-vendid, rtrv-vendid

Command Class: Database Administration

Parameters

:vendid= (mandatory)

Vendor ID

Range: 0-FFFFFFFFFFFFFFF

1-15 digits; the entry must contain the number of digits defined by the vendidlen parameter value. Valid digits are 0-9, A-F, and a-f.

Example

```
dlt-vendid:vendid=886933
```

Dependencies

The value **none** cannot be specified for the **vendid** parameter.

The specified Vendor ID entry must already exist in the VendID table.

Notes

None.

Output

dlt-vendid:vendid=886933

```
rlghncxa03w 04-10-07 11:11:28 EST EAGLE 31.11.0
VENDID table is (6 of 200) 3% full
DLT-VENDID: MASP A - COMPLTD
```

;

dlt-x25-dstn**Delete X.25 Destination**

Use this command to remove the association of an X.25 network address with an SS7 point code.

Keyword: **dlt-x25-dstn**

Related Commands: **chg-x25-dstn**, **ent-x25-dstn**, **rtrv-x25-dstn**

Command Class: Database Administration

Parameters

:xaddr= (mandatory)

The X.25 network address of the X.25 destination entity or the SS7 node.

Range: A number consisting of 4–15 digits.

Example

dlt-x25-dstn:xaddr=205255864567721

Dependencies

An X.25 address must have a minimum of four digits.

The X.25 address must already exist as an X.25 destination.

The X.25 address cannot be assigned to an X.25 route.

Notes

None

Output

dlt-x25-dstn:xaddr=205255864567721

```
rlghncxa03w 04-02-10 11:43:04 EST EAGLE 31.3.0
X.25 DSTN TABLE 45 % FULL
DLT-X25-DSTN: MASP A - COMPLTD
```

;

dlt-x25-rte**Delete X.25 Route**

Use this command to remove X.25 routes from the database.

Keyword: dlt-x25-rte

Related Commands: chg-x25-rte, ent-x25-rte, rtrv-x25-rte

Command Class: Database Administration

Parameters

:saddr= (mandatory)

The alias X.25 address assigned to the SS7 destination entity on the SS7 side of the circuit.

Range: A number consisting of 4–15 digits

:xaddr= (mandatory)

The X.25 address assigned to the X.25 destination entity on the X.25 side of the circuit.

Range: A number consisting of 4–15 digits

Example

```
dlt-x25-rte:xaddr=225255:saddr=133131
```

Dependencies

Each X.25 address must have at least four digits.

The combination of the two X.25 addresses must be in the X.25 routing table.

Notes

None

Output

```
dlt-x25-rte:xaddr=225255:saddr=133131
rlghncxa03w 04-02-10 11:43:04 EST EAGLE 31.3.0
DLT-X25-RTE: MASP A - X.25 Route table 45% full
DLT-X25-RTE: MASP A - COMPLTD
;
```

enable-ctrl-feat**Enable Controlled Feature**

Use this command to enable a controlled feature that the customer has purchased.

NOTE: The “LNP (Local Number Portability) feature” is turned on when the LNP ported TNs quantity is greater than 0 in the rtrv-ctrl-feat command output. An LNP ported TNs quantity feature access key has been enabled and turned on.

Keyword: enable-ctrl-feat

Related Commands: chg-ctrl-feat, rtrv-ctrl-feat

Command Class: Database Administration

Parameters

:partnum= (mandatory)

The Part Number for the feature.

Range: 893000000 - 893999999

Do not include dashes in the 9-digit number.

:fak= (mandatory)

The Feature Access Key for the feature.

Range: 13 alphanumeric characters; the first character must be a letter.

The Feature Access Key cannot contain any special characters, including spaces and dashes. Upper-case characters are folded to lower case.

Example

enable-ctrl-feat:partnum=893xxxxxx:fak=xxxxxxxxxxxxxx

Dependencies

The system serial number must be entered in the database and locked before you can enter this command for the feature (see the **ent-serial-num** command).

The feature access key must be valid for the specified feature part number and for the system serial number.

A feature with a temporary feature key cannot be enabled when the feature has already been enabled with the temporary feature key.

If the specified temporary feature key has expired, you must purchase the feature before you can enter a feature access key for the feature again.

A temporary feature access key is not allowed for any of the following features:

- XGTT or XMAP table expansion
- 1500 Links
- 7000 or 8000 Routesets
- Flexible GTT Load Sharing
- Any LNP Quantity
- Prepaid IDP Query Relay
- IDP Screening for Prepaid

A controlled feature cannot be enabled that is already permanently enabled, or implicitly enabled because a higher quantity entry is already permanently enabled.



CAUTION: Never install or initialize MCAP cards in card slots 1113 and 1115 after GPSM-II cards are provisioned in these slots. Attempting to initialize MCAP cards after GPSM-II cards have been provisioned in slots 1113 and 1115 will cause a system outage. Before replacing an existing GPSM-II card in slot 1113 or slot 1115, contact Tekelec Customer Service.

1500 Links

Both cards that run the OAM must be of type GPSM-II to support more than 700 links in the system.

ANSI-ITU-China SCCP Conversion

The ANSI-ITU-China SCCP Conversion feature cannot be enabled if either the SCCP Conversion feature (SCCPCNV) or the TCAP Conversion feature (TCAPCVN) is turned on.

The system must contain at least TSM cards before the ANSI-ITU-China SCCP Conversion feature can be enabled.

Enhanced GSM MAP Screening (EGMS)

The GSM Map Screening feature must be enabled and turned on before the Enhanced GSM Map Screening feature can be enabled.

The Enhanced GSM Map Screening feature requires DSM cards running the **vsccp** application.

Equipment Identity Register (EIR)

The GTT feature must be turned on before the EIR feature can be enabled.

The EIR feature cannot be enabled if the INP feature is turned on.

The EIR feature cannot be enabled if the LNP feature is turned on.

All DSM cards in the system must be at least 2 GB DSMs before the EIR feature can be enabled.

The EIR feature cannot be enabled if the **ansigflex** system option is enabled (see the **chg-stpopts** command)

Flexible GTT Load Sharing

The Flexible GTT Load Sharing feature requires a DSM card running the **vsccp** application.

GSM MAP Screening (GMS)

The GTT feature must be turned on before the GSM Map Screening feature can be enabled.

GSM MAP SRI Redirect for Serving HLR

The G-Port feature must be turned on before the GSM MAP SRI Redirect for Serving HLR feature can be enabled (see the **chg-feat** command).

IDP Screening for Prepaid

The IDP Screening for Prepaid feature cannot be enabled unless GTT is on.

The IDP Screening for Prepaid feature cannot be enabled if an ASM/TSM card is present.

A temporary feature access key cannot be used with the IDP Screening for Prepaid feature.

IntraCarrier Number Portability (ICNP)

The ICNP feature requires DSM cards with 4 Gigabytes of memory to enable the feature.

The Measurements Platform cannot be on if the ICNP feature is enabled.

The INP feature must be turned on before the ICNP feature can be enabled.

ISUP NP with EPAP

The G-Port feature and the GWS (Gateway Screening) feature must be turned on before the ISUP NP with EPAP feature can be enabled (see the **chg-feat** command).

LNP 192 Million TNs, LNP 300,000 NPANXXs, LNP 150,000 LRNs, and LNP ELAP Configuration Features

The GTT feature must be turned on (see the **chg-feat** and **rtrv-feat** commands) before these features can be enabled.

The GSM Mobile Number Portability (G-Port) feature must not be turned on (see the **chg-feat** and **rtrv-feat** commands) when these features are enabled.

The INP feature must not be turned on (see the **chg-feat** and **rtrv-feat** commands) when these features are enabled.

The G-Flex feature must not be turned on (see the **chg-feat** and **rtrv-feat** commands) when these features are enabled.

The LNP feature (an LNP ported TNs quantity feature key) must be enabled before the following features can be enable:

- The LNP 150,000 LRNs feature
- The LNP 300,000 NPANXXs feature

The LNP ELAP Configuration feature must be enabled, and turned on with the **chg-ctrl-feat** command, before the features for the following quantities can be enabled:

- LNP 24 Million TNs through LNP 192 Million TNs
- LNP 300,000 NPANXXs
- LNP 150,000 LRNs

DSM cards running the **vscpp** application are required when the LNP feature and the VGTT feature are turned on together.

Table 6-3 on page 6-143 lists the types and memory capacity for the SCCP cards required by each LNP quantity feature. The quantity feature cannot be enabled if the required hardware is not present in the system.

Table 6-3. Minimum Hardware Required for LNP Quantity Features

Object / Capacity	Minimum Hardware	Feature Access Key
2 Million TNs	256 MB TSM	893-0110-01
4 Million TNs	512 MB TSM	893-0110-02
6 Million TNs	768 MB TSM	893-0110-03
8 Million TNs	1 GB TSM	893-0110-04
12 Million TNs	1 GB TSM or 1 GB DSM	893-0110-05

Table 6-3. Minimum Hardware Required for LNP Quantity Features (Continued)

Object / Capacity	Minimum Hardware	Feature Access Key
24 Million TNs	2 GB DSM	893-0110-06
36 Million TNs	3 GB DSM	893-0110-07
48 Million TNs	4 GB DSM	893-0110-08
60 Million TNs	4 GB DSM	893-0110-09
72 Million TNs	4 GB DSM	893-0110-10
84 Million TNs	4 GB DSM	893-0110-11
96 Million TNs	4 GB DSM	893-0110-12
108 Million TNs	4 GB DSM	893-0110-13
120 Million TNs	4 GB DSM	893-0110-14
132 Million TNs	4 GB DSM	893-0110-15
144 Million TNs	4 GB DSM	893-0110-16
156 Million TNs	4 GB DSM	893-0110-17
168 Million TNs	4 GB DSM	893-0110-18
180 Million TNs	4 GB DSM	893-0110-19
192 Million TNs	4 GB DSM	893-0110-20
150,000 NPANXXs	Any TSM or 1 GB DSM	893-0094-01
300,000 NPANXXs	2 GB DSM	893-0094-02
100,000 LRNs	Any TSM or 1 GB DSM	893-0105-05
150,000 LRNs	2 GB DSM	893-0105-01

LNP Short Message Service Feature

Before the LNP Short Message Service (LNP SMS) controlled feature can be enabled,

- An LNP quantity feature access key for at least 24 million TNs must be enabled and turned on
- The LNP ELAP Configuration feature access key must be enabled and turned on
- The WNP feature must be turned on (see the **chg-feat** command).

MTP MAP Screening

The Enhanced GSM MAP Screening feature must be enabled and turned on before the MTP Map Screening feature can be enabled.

The Measurements Platform feature must be turned on and the Measurements Platform collection function must be enabled (see the **chg-measopts:platformenable=on** parameter) before the MTP MAP screening feature can be enabled (at least one MCPM card is active).

Portability Check for Mobile Originated Short Message Service (MNP SMS) Feature

The G-Port feature must be turned on before the MNP SMS feature can be enabled.

Prepaid IDP Query Relay

The GTT feature must be on before the Prepaid IDP Query Relay feature can be enabled.

The Prepaid IDP Query Relay feature and the LNP cannot be enabled at the same time in the system.

The Prepaid IDP Query Relay feature cannot be enabled if ASM or TSM cards running the SCCP application are present in the system.

Prepaid Short Message Service Intercept (PPSMS) Feature

The G-Port feature must be turned on before the PPSMS feature can be enabled.

Routesets Features

The DSTN5000 (5000 Routes) feature bit must be turned on (see the **chg-feat** command) before the 6000 Routesets, 7000 Routesets, or 8000 Routesets feature access key can be enabled.

The 7000 Routesets and 8000 Routesets quantity keys can not be enabled if the number of provisioned alias destinations is greater than 8000.

Spare Point Code Support

The Spare Point Code Support feature cannot be enabled if TALI sockets have been provisioned for an IPGWI card.

XGTT or XMAP (GTT or MAP Table Increase) Feature

The GTT feature must be turned on before the XGTT feature can be enabled.

Both cards that run the OAM must be of type GPSM-II before the XGTT or XMAP feature can be enabled.

For the XGTT (269,999 to 400,000 entries) and XMAP (2000 and 3000 entries) features, all SCCP GPLs must be running on TSM cards or a combination of TSM and DSM cards.

The XGTT feature with 1,000,000 entries requires all SCCP GPLs to be running on DSM cards.

A temporary feature access key is not allowed for the XGTT or XMAP feature.

Notes***1500 Links***

After the 1500 Links feature is enabled, the feature cannot be disabled or turned off.

IPGWx Signaling TPS

This quantity is the total maximum transactions per second (TPS) allowed for all IPGWx links in the system.

An alarm appears when the actual system IPGWx TPS exceeds a threshold that is a configurable percent of this maximum (see the **chg-sg-opts** command). The default threshold is 80% of the enabled maximum IPGWx Signaling TPS. The system clears the alarm when the system IPGWx TPS drops below the configured threshold.

A feature access key can be enabled for a greater IPGWx Signaling TPS quantity, but not for a smaller quantity. A default quantity of 200 TPS is enabled in the system.

A temporary feature access key is not allowed for the IPGWx Signaling TPS feature.

SE-HSL SLK Capacity

Table 6-4 lists the total number of signaling links that can be assigned to SE-HSL cards in the system when each SE-HSL SLK Capacity quantity feature access key is enabled.

Table 6-4. SE-HSL SLK Capacity Feature Quantities

Part Number	Maximum SE-HSL Links Allowed in the System
893-0130-01	4
893-0130-02	8
893-0130-03	16
893-0130-04	24
893-0130-05	32
893-0130-06	40
893-0130-07	48
893-0130-08	56
893-0130-09	64

XGTT or XMAP (GTT or MAP Table Increase) Feature

After the XGTT feature is enabled, the feature cannot be disabled or turned off.

After the XMAP feature is enabled, the feature cannot be disabled or turned off.

Output

```
enable-ctrl-feat:partnum=893xxxxxx:fak=xxxxxxxxxxxxxx
```

```
rlghncxa03w 05-07-29 16:40:40 EST EAGLE 34.3.0
```

```
ENABLE-CTRL-FEAT: MASP A - COMPLTD
```

```
;
```

ent-acg-mic**Enter ACG Manually Initiated Control**

Use this command to assign Automatic Call Gapping (ACG) controls to certain queries. The control can apply to all queries or to specific query services and called party digits. If the EAGLE LNP query service receives a query to which a control applies, then the EAGLE sends an ACG component, encoded as configured, with the response.

Keyword: ent-acg-mic

Related Commands: chg-acg-mic, dlt-acg-mic, rept-stat-lnp, rtrv-acg-mic

Command Class: LNP Database Administration

Parameters

:drtn= (mandatory)

Duration index. The amount of time that the ACG is in effect. This number is mapped to a time value at the LNP node. Refer to the chapter on Automatic Call Gapping configuration in the *LNP Feature Activation Guide* for a description of the use of the duration index.

Range: 1-13

Default: The current value

:aintvl= (optional)

AIN interval index

Range: 1-15

Default: The current value

:dgts= (optional)

Digits

Range: 000-999, 000000-999999999

:intvl= (optional)

Interval index. The amount of time between ACGs. This number is mapped to a time value for the LNP node. Refer to the chapter on Automatic Call Gapping configuration in the *Database Administration - LNP Manual* for a description of the use of the gap interval index.

Range: 0-15

Default: Current value

:nd= (optional)

Number of digits

Range: 3, 6-10

Default: The current value

:serv= (optional)

Query service

Range: ain, in

:type= (optional)

Type of control

Range: all, sd

Default: sd

Example

```
ent-acg-mic:type=all:nd=6:drtn=6:intvl=2:aintvl=7
ent-acg-mic:serv=ain:dgts=9194602132:drtn=13:aintvl=1
ent-acg-mic:type=sd:serv=in:dgts=919:drtn=8:intvl=3
```

Dependencies

If the **type=all** parameter is specified, the optional parameters **nd**, **intvl**, and **aintvl** must be specified.

If the **type=all** parameter is specified, the optional parameters **serv** and **dgts** cannot be specified.

If the **type=sd** parameter is specified, the optional parameters **serv** and **dgts** must be specified.

If the **type=sd** parameter is specified, the optional parameter **nd** cannot be specified.

If the **serv=ain** parameter is specified, the optional parameter **aintvl** cannot be specified.

If the **serv=ain** parameter is specified, the optional parameter **intvl** cannot be specified.

If the **serv=in** parameter is specified, the optional parameter **intvl** must be specified.

If the **serv=in** parameter is specified, the optional parameter **aintvl** cannot be specified.

The **dgts** parameter value must be specified as 3 or 6–10 digits.

The **nd** parameter value must be 3 or 6–10.

The LNP feature must be turned on. (see the **enable-ctrl-feat** command) before the **ent-acg-mic** command can be entered.

If the **type=all** parameter is specified, a manually initiated control (MIC) with the **type=all** parameter must not already exist.

If the **type=sd** parameter is specified, a MIC with the same service and digits must not already exist.

A maximum of 256 **type=sd** MICs are allowed.

Notes

None

Output

```
ent-acg-mic:type=all:nd=6:drtn=6:intvl=2:aintvl=7
rlghncxa03w 04-02-28 08:50:12 EST EAGLE 31.3.0
ACG MIC table is (11 of 256) 4% full of type SD
ENT-ACG-MIC: MASP A - COMPLTD
;
```

ent-acg-noc**Enter ACG Node Overload Control**

Use this command to enter the values for the automatic call gapping (ACG) controls that you want to send when you reach the specified node overload level. The definition is comprised of the threshold LNP query rates for node overload levels and the values for the ACG to be sent when at the level. If a level is not defined, it is not used. Level 10 is predefined.

Keyword: ent-acg-noc

Related Commands: chg-acg-noc, dlt-acg-noc, rept-stat-lnp, rtrv-acg-noc

Command Class: LNP Database Administration

Parameters

:drtn= (mandatory)

Duration index. The amount of time that the ACG is in effect. This number is mapped to a time value at the LNP node. Refer to the chapter on Automatic Call Gapping configuration in the *LNP Feature Activation Guide* for a description of the use of the duration index.

Range: 1–13

Default: The current value

:intvl= (mandatory)

Interval index. The amount of time between ACGs. This number is mapped to a time value for the LNP node. Refer to the chapter on Automatic Call Gapping configuration in the *LNP Feature Activation Guide* for a description of the use of the gap interval index.

Range: 0–15

Default: Current value

:lvl= (mandatory)

Overload level.

Range: 1–9

:qr= (mandatory)

Query rate. The number of LNP queries, which define a particular overload level, in a 30-second period.

Range: 1–2147483647

:and= (optional)

AIN number of digits. The number of digits in the global title address of an AIN query.

Range: 6, 10

Default: 6

:ind= (optional)

IN number of digits. The number of digits in the global title address of an IN query.

Range: 6, 10

Default: 6

Example

```
ent-acg-noc:lvl=3:qr=300000:and=10:ind=6:drtn=6:intvl=3
```

Dependencies

The LNP feature must be turned on (see the **enable-ctrl-feat** command) before the **ent-acg-noc** command can be entered.

Either **6** or **10** must be specified for the **and** and the **ind** parameters.

The specified overload level must not already be defined.

Notes

None

Output

```
ent-acg-noc:lvl=3:qr=300000:and=10:ind=6:drtn=6:intvl=3
rlghncxa03w 04-02-28 08:50:12 EST EAGLE 31.3.0
ENT-ACG-NOC: MASP A - COMPLTD
;
```

ent-appl-rtkey

Enter Application Route Key Table

Use this command to configure static entries in the Routing Key table, which associates a routing key with a socket name.

There are three types of routing keys, as follows:

- DPC, SI, SSN routing keys, which are used to route SCCP messages
- DPC, SI routing keys, which are used to route non-SCCP and non-ISUP messages
- DPC, SI, CIC routing keys, which are used to route ISUP messages

Keyword: **ent-appl-rtkey**

Related Commands: **rtrv-appl-rtkey**, **dlt-appl-rtkey**

Command Class: Database Administration

Parameters

:asname= (mandatory)

Application Server (AS) name assigned to this routing key.

Range: Up to 15 alphanumeric characters; the first character must be a letter

:sname= (mandatory)

Socket name as provisioned in the Socket table and associated with this routing key.

Range: Up to 15 alphanumeric characters; the first character must be a letter

:cice= (optional)

The end range of circuit identification codes assigned to the routing key.

Range: See Table A-4 in Appendix A for valid CIC values for specified SI and MSU types.

:cics= (optional)

The start range of circuit identification codes assigned to the routing key.

This parameter is valid only if **si=4, 5, or 13** and is required if **si=4, 5, or 13** and **type=full**.

Range: See Table A-4 in Appendix A for valid CIC values for specified SI and MSU types.

:dpc/dpca/dpci/dpcn/dpcn24= (optional)

Destination point code.

NOTE: See “Point Code Formats and Conversion” in Appendix A for a detailed description of point code formats, rules for specification, and examples.

:dpc= or :dpca= (optional)

ANSI destination point code with subfields *network indicator-network cluster-network cluster member* (*ni-nc-ncm*).

Range: **000-255**

Specify a valid value for each subfield of the point code, and separate the subfields with a dash (-).

When **chg-sid:pctype=ansi** is specified, *ni* = **000** is not valid.

When **chg-sid:pctype=ansi** is specified, *nc* = **000** is not valid if *ni* = **001-005**.

When **chg-sid:pctype=ansi** is specified, *nc* = **000** is valid if *ni* = **006-255**.

The point code **000-000-000** is not a valid point code.

:dpci= (optional)

ITU international destination point code with subfields *zone-area-id*. The *prefix* subfield indicates a spare point code (*prefix-zone-area-id*)

Range: **s-, 0-255**

Specify a valid value for each subfield of the point code, and separate the subfields with a dash (-).

prefix—s-

zone—0-7

area—000-255

id—0-7

The point code **0-000-0** is not a valid point code.

:dpcn= (optional)

ITU national destination point code in the format of a 5-digit number (*nnnnn*); or 2, 3, or 4 numbers (members) separated by dashes (*m1-m2-m3-m4*) as defined by the **chg-stpopts:npcfmti** flexible point code option. A group code must be specified when the ITUDUPPC feature is turned on (*nnnnn-gc*, *m1-m2-m3-m4-gc*). The *prefix* subfield indicates a spare point code (*prefix-nnnnn*, *prefix-nnnnn-gc*, *prefix-m1-m2-m3-m4*, *prefix-m1-m2-m3-m4-gc*).

Range: **s-, 0-16383, aa-zz**

Specify a valid value for each subfield of the point code, and separate the subfields with a dash (-).

prefix—s-

nnnnn—0-16383

gc—aa-zz

m1-m2-m3-m4—0-14 for each member; values must sum to 14

:dpcn24= (optional)

24-bit ITU national destination point code with subfields *main signaling area-sub signaling area-signaling point* (*msa-ssa-sp*).

Range: 000-255

Specify a valid value for each subfield of the point code, and separate the subfields with a dash (-).

msa—**000-255**

ssa—**000-255**

sp—**000-255**

:opc/opca/opci/opcn/opcn24= (optional)

Originating point code.

This parameter is valid only if **si=4, 5, or 13** and required if **si=4, 5, or 13** and **type=full**.

:opc= or :opca= (optional)

ANSI originating point code with subfields *network indicator-network cluster-network cluster member* (*ni-nc-ncm*).

Range: 000-255

Specify a valid value for each subfield of the point code, and separate the subfields with a dash (-).

ni = **000** is not valid.

nc = **000** is not valid if *ni* = **001-005**.

nc = **000** is valid if *ni* = **006-255**.

The point code **000-000-000** is not a valid point code.

:opci= (optional)

ITU international destination point code with subfields *zone-area-id*. The *prefix* subfield indicates a spare point code (*prefix-zone-area-id*)

Range: s-, 0-255

Specify a valid value for each subfield of the point code, and separate the subfields with a dash (-).

prefix—**s-**

zone—**0-7**

area—**000-255**

id—**0-7**

The point code **0-000-0** is not a valid point code.

:opcn= (optional)

New ITU national originating point code in the format of a 5-digit number (*nnnnn*); or 2, 3, or 4 numbers (members) separated by dashes (*m1-m2-m3-m4*) as defined by the **chg-stpopts:npcfmti** flexible point code option. A group code must be specified when the ITUDUPPC feature is turned on (*nnnnn-gc, m1-m2-m3-m4-gc*). The *prefix* subfield indicates a spare point code (*prefix-nnnnn, prefix-nnnnn-gc, prefix-m1-m2-m3-m4, prefix-m1-m2-m3-m4-gc*).

Range: s-, 0-16383, aa-zz

Specify a valid value for each subfield of the point code, and separate the subfields with a dash (-).

prefix—**s-**

nnnnn—**0-16383**

gc—**aa-zz**

m1-m2-m3-m4—**0-14** for each member; values must sum to 14

:opc_n24= (optional)

24-bit ITU national originating point code with subfields *main signaling area-sub signaling area-signaling point (msa-ssa-sp)*.

Range: 000-255

Specify a valid value for each subfield of the point code, and separate the subfields with a dash (-).

msa—000-255

ssa—000-255

sp—000-255

:rcontext= (optional)

Routing Context. The routing context parameter can be used to assign a new routing context to a routing key. The routing context uniquely identifies the routing key.

- Routing context is mandatory for routing keys associated with SUA Application Servers.
- Routing context is optional for routing keys associated with M3UA Application Servers.
- Routing context is invalid for routing keys associated with TALI connections.

An AS cannot be simultaneously assigned to a routing key with routing contexts and routing keys without routing contexts.

An AS can be associated with multiple routing keys that do not contain routing context.

An AS can be associated with only 1 routing key with routing context.

In order for an M3UA or SUA association to be assigned to multiple routing keys with routing context, the M3UA/SUA association must be assigned to multiple AS's and then each AS must be assigned to a routing key with routing context.

Range: 0-4294967295

:si= (optional)

Service indicator.

Range: 0-15 or equivalent text values:

Number = Text—Description

0 = snm—Signaling network management messages

1 = regtest—Signaling network testing and maintenance regular

2 = spltest—Signaling network testing and maintenance special

3 = sccp—SCCP

4 = tup—Telephone user part

5 = isup—ISDN user part

13 = qbicc

:ssn= (optional)

Subsystem number.

This parameter is valid only if **si=3** and required if **si=3** and **type=full**.

Range: 0-255

:type= (optional)

The type of routing key.

Range: full, partial, default

Default: full

Example

```
ent-appl-rtkey:dpc=123-230-245:si=3:ssn=250:sname=coname
ent-appl-rtkey:dpcn=2000-aa:si=5:sname=socket01:opcn=2001-aa:cics=1:cice=1000
ent-appl-rtkey:dpcn24=10-100-10:si=5:sname=socket01:opcn24=10-100-11:cics=1:cice=1000
ent-appl-rtkey:asname=suaas1:dpc=8-8-8:si=3:ssn=5:rcontext=100
ent-appl-rtkey:asname=suaas2:dpc=8-8-8:si=3:type=partial:rcontext=101
ent-appl-rtkey:asname=suaas3:dpc=8-8-8:type=partial:rcontext=102
ent-appl-rtkey:asname=suaas4:si= 3:type=partial:rcontext=103
ent-appl-rtkey:asname=suaas5:type=default:rcontext=104
ent-appl-rtkey:asname=m3uaas1:dpc=8-8-9:si=5:opc=3-3-3:cics=1:cice=100:rcontext=200
ent-appl-rtkey:asname=m3uaas2:dpc=8-8-9:si=5:opc=3-3-3:type=partial:rcontext=201
ent-appl-rtkey:asname=m3uaas3:dpc=8-8-9:si=5:type=partial:rcontext=202
ent-appl-rtkey:asname=m3uaas4:dpc=8-8-9:type=partial:rcontext=203
ent-appl-rtkey:asname=m3uaas5:si= 5:type=partial:rcontext=204
ent-appl-rtkey:asname=m3uaas6:type=default:rcontext=205
ent-appl-rtkey:dpci=s-3-11-1:si=5:opci=s-4-11-1:cics=1:cice=1000:asname=asitu
ent-appl-rtkey:dpc=123-230-246:si=5:sname=sock1:opc=123-222-123:cics=1:cice=1000
ent-appl-rtkey:dpc=1-1-1:si=3:asname=as1:ssn=255
ent-appl-rtkey:dpci=3-11-1:si=3:opci=4-11-1:cics=1:cice=1000:asname=asitu:rcontext=7
```

Dependencies

The **srkq** parameter value in the **chg-sg-opts** command limits the maximum number of static routing keys that can be provisioned using the **ent-appl-rtkey** command.

- For **ss7ipgw** and **ipgwi** applications running on dual-slot DCM cards (870-1945-xx), there is a limit of 1000 routing keys in the system. The **chg-sg-opts** command will not allow the **srkq** parameter to be set to a value greater than 1000.
- For **ss7ipgw** and **ipgwi** applications running on SSED CM cards (870-2732-xx), there is a limit of 2500 routing keys in the system. See the **chg-sg-opts** command for parameter values that allow 2500 routing keys to be defined in the system.

The subsystem number (**ssn**) is valid only when **si** is equal to 3 (or **sccp**); when **si** does not equal 3 (or **sccp**), **ssn** must not be specified.

The value entered for the starting circuit identification code (**cics**) must be less than or equal to the value entered for the ending circuit identification code (**cice**).

The ISUP routing-over-IP feature must be turned on before a DPC/SI/CIC routing key to route ISUP messages can be specified. You can turn the ISUP routing-over-IP feature on by entering the command **chg-feat:ipisup=on**.

A circuit identification code range (**cics** to **cice**) cannot be specified that overlaps an existing routing key.

When **si=4, 5, or 13** (or **tup, isup, or qbicc**), the **opc**, **cics**, and **cice** parameters are required. The **opc**, **cics**, and **cice** parameters can be specified only if **si=4, 5, or 13**. See Table A-4 in Appendix A for valid **cic** and **si** values for MSU types.

Partial point codes are not allowed; no asterisks can be specified in the routing key in the command.

Mixed point code types are not allowed; **opc** and **dpc** types must match.

A DPC/SI routing key must be specified when the DPC is ANSI and **si=4** (TUP is used only in an ITU network).

Either the **asname** parameter or the **sname** parameter must be specified in this command.

TALI sockets cannot be specified (**sname**) for IPGWI cards when the Spare Point Code Support Feature is enabled.

When the **type=full** parameter is specified, the **dpc** and **si** parameters must also be specified.

When the **type=default** parameter is specified, the **sname** parameter is the only other parameter allowed.

The group codes for the **dpc** and **opc** parameter values must match when you enter both parameters in the command.

The **rcontext** parameter must be specified for routing keys that are associated with SUA Application Servers.

The specified **rcontext** parameter value must not already exist in the database.

If specified, the service indicator parameter must be **si=3** for routing keys that are associated with SUA Application Servers.

An AS cannot be simultaneously assigned to a routing key with routing contexts and routing keys without routing context.

In order for an M3UA or SUA association to be assigned to multiple routing keys with routing context, the M3UA/SUA association must be assigned to multiple AS's and then each AS must be assigned to a routing key with routing context.

The AS name and parameters specified for a routing key must use an address format that is valid for the adapter type used by the ASP associations assigned to the AS.

Only the **sname**, **asname**, and **rcontext** parameters are allowed for a default routing key.

The spare point code prefix (**s-**) cannot be specified for routing key point codes in routing keys when the **sname** parameter is specified for TALI connections.

The following four types of partial routing keys are supported:

- DPC-SI-OPC (ignore CIC) can be used as a partial match key for CIC- based traffic.
- DPC-SI (ignore all other fields) can be used as a partial match key for CIC- based traffic or SCCP traffic.

- DPC only (ignore all other fields) can be used as a partial match for any type of traffic.
- SI only (ignore all other fields) can be used as a partial match for any type of traffic.

Notes

The Routing Key table associates a routing key with a socket name or an Application Server (AS).

The routing key can be associated with up to 16 socket names or with 1 AS.

The originating point code (**opc**) and destination point code (**dpc**) must not specify a cluster route.

Group codes are required for ITU-N point codes and spare point codes (DPCN/OPCN) when the ITU Duplicate Point Code feature (ITUDUPPC) is turned on, and not allowed when the feature is off.

Routing key attributes for normalization and PSTN presentation will be set to default values (**pstncat=0**, **pstnid=0**, **norm=0**). Use the **chg-appl-rtkey** command to change routing key attributes.

Routing context is a routing key parameter that uniquely identifies routing keys. Routing context is mandatory for routing keys associated with SUA Application Servers, optional for routing keys associated with M3UA Application Servers, and invalid for routing keys associated with TALI connections.

An AS cannot be simultaneously assigned to routing keys with routing contexts and routing keys without routing contexts.

In this command, only ITU-international and ITU national point codes support the spare point code subtype prefix (**s-**).

Output

```
ent-appl-rtkey:dpc=123-230-245:si=3:ssn=250:sname=tekelec
```

```
rlghncxa03w 05-05-17 15:35:05 EST EAGLE 34.0.0
ENT-APPL-RTKEY: MASP A - COMPLTD
```

```
;
```

```
ent-appl-rtkey:dpcn=2000-AA:si=5:sname=socket01:opc=2001-AA:cics=1:cice=1000
```

```
rlghncxa03w 05-05-17 15:35:05 EST EAGLE 34.0.0
ENT-APPL-RTKEY: MASP A - COMPLTD
```

```
;
```

ent-appl-sock

Enter Application Socket

Use this command for the **iplim**, **iplimi**, **ss7ipgw**, or **ipgwi** application to configure the Socket table, which is used to associate the local host/local port to a remote host/remote port.

Keyword: ent-appl-sock

Related Commands: rtrv-appl-sock, dlt-appl-sock, chg-appl-sock

Command Class: Database Administration

Parameters

:lhost= (mandatory)

Local host name. The logical name assigned to the local host device.

Range: a-z, A-Z, 0-9, -, .

Any string of characters beginning with a letter and comprising up to 60 characters in length

:sname= (mandatory)

Name of socket. The routing key table and maintenance commands use these names to reference individual sockets.

Range: Up to 15 alphanumeric characters; the first character must be a letter

:lport= (optional)

The TCP port number for the local host.

Range: 1024-65535

Default: System Default: 0

:port= or :link= (optional)

The signaling **link** associated with this socket.

Range: a, b, a1, b1, a2, b2, a3, b3

Not all card types support all **link** parameter values.

See Table A-1 in Appendix A for valid **link** parameter range values for each type of card that can have signaling links.

Default: a

:rhost= (optional)

Remote host name. The logical name assigned to the remote host device.

Range: a-z, A-Z, 0-9, -, .

Any string of characters beginning with a letter and comprising up to 60 characters in length.

:rport= (optional)

The TCP port number of the remote host.

Range: 1024-65535

Default: System Default: 0

Example

```
ent-appl-sock:sname=socket1:lhost=gw105.nc.coname.com:lport=1030
:rhost=gw100.nc.tekelec.com:rport=1030
```

Dependencies

The **link** parameter is used to associate a socket with a signaling link.

- Only port **a** is valid on cards that execute the **ss7ipgw** or **ipgwi** application.
- Ports **a** and **b** are valid on dual-slot DCM cards or SSED CM cards that execute the **iplim** or **iplimi** application and support 2 point-to-point links.
- Ports **a**, **b**, **a1**, **b1**, **a2**, **b2**, **a3**, and **b3** are valid only on SSED CM cards that execute the **iplim** or **iplimi** application and support 8 point-to-point links.

The allowed maximum is 2 sockets per local host on DCM or SSEDCCM IPLIMx cards that support 2 point-to-point links, and 8 sockets per local host on SSEDCCM IPLIMx cards that support 8 point-to-point links. (IPLIMx refers to cards that execute the **iplim** or **iplimi** application).

The allowed maximum is 1 socket per signaling link on IPLIMx cards.

The allowed maximum is 50 sockets per local host on SS7IPGW or IPGWI cards.

The allowed maximum is 4000 IP connections per system.

TALI sockets cannot be defined for IPGWI cards when the Spare Point Code Support Feature is enabled.

The socket name (**sname**) must be unique (not already used).

The specified local host name must exist in the IP Host table.

The **rhost** value must exist in the IP Host table.

To assign a socket on an IPLIMx card for a local host, the signaling link associated with the signaling link port must have its **ipliml2** value set to **saaltali**.

The **lhost** parameter must be provisioned in the IP Host table as local to this EAGLE 5 SAS.

If the entered **lhost** corresponds to an IP address associated with the B Ethernet Interface hosted by a present dual-slot DCM card, an error will be generated. If the entered **lhost** corresponds to an IP address associated with the B Ethernet Interface hosted by a provisioned but not present dual-slot DCM card, the card will be auto-inhibited upon insertion of the card. If an SSEDCCM card is inserted, the card will be allowed to boot.

If port **a1**, **b1**, **a2**, **b2**, **a3**, or **b3** is entered for an **iplim** or **iplimi** application and a non-SSEDCCM card is inserted, the card will be auto-inhibited upon insertion of the card. If an SSEDCCM card is inserted, the card will be allowed to boot.

Notes

Two sockets can be provisioned for each DCM card that runs an **iplim** or **iplimi** application and supports 2 point-to-point links. One socket is associated with signaling link port **a** and one with signaling link port **b**. Both sockets use the same physical interface connection and the same IP address.

Eight sockets can be provisioned for each SSEDCCM card that runs an **iplim** or **iplimi** application and supports 8 point-to-point links. One socket is associated with each of ports **a**, **b**, **a1**, **b1**, **a2**, **b2**, **a3** and **b3**.

The Socket table is used to associate the Local Host/Local Port to a Remote Host/Remote Port. This fully specifies the connection.

The Socket table also contains fields that receive default values even though there are no parameters in the **ent-appl-sock** command for populating these fields. These fields and their default values are:

- open=no
- alw=yes
- server=yes

- dcmps=10
- rexmit=fixed
- rtt=60

Use the **chg-appl-sock** command if you want to enter a value other than the default value or if the host names entered are too long to fit on the command with the other parameters.

Output

```
ent-appl-sock:sname=socket1:lhost=gw105.nc.coname.com:lport=1030
:rhost=gw100.nc.coname.com:rport=1030
```

```
rlghncxa03w 04-02-17 15:35:05 EST EAGLE 31.3.0
ENT-APPL-SOCK: MASP A - COMPLTD
```

```
;
```

ent-as

Enter Application Server

Use this command to create an Application Server (AS) as a logical entity to serve a specific routing key. This command enters a new AS into the AS table or adds an M3UA or SUA SCTP association to an existing AS.

Keyword: ent-as

Related Commands: chg-as, dlt-as, rtrv-as

Command Class: Database Administration

Parameters

:aname= (mandatory)

Name of the M3UA or SUA SCTP association.

Range: *aaaaaaaaaaaaaaaa*

Up to 15 alphanumeric characters; the first character must be a letter.

:asname= (mandatory)

Name of the Application Server (AS).

Range: Up to 15 alphanumeric characters; the first character must be a letter.

:aspname= (obsolete)

Name of the Application Server Process (ASP).

NOTE: This parameter is obsolete.

Range: Up to 15 alphanumeric characters; the first character must be a letter.

Example

```
ent-as:asname=asx:aname=asxp1
```

Dependencies

The specified **aname** must exist in the IPAPSOCK table.

The adapter layer for each association assigned to the AS must be defined.

SUA Application Servers must have routing keys with assigned routing contexts.

The service indicator must be **si=3** for routing keys that are associated with SUA Application Servers.

The adapter layer must be the same for all M3UA/SUA associations assigned to the AS.

IPLIMx connections cannot reside in an AS.

Notes

The DCM card has 16 MB of memory. Socket/association limits are based on card memory, as is the ratio of associations to sockets. This ratio, known as the trade ratio, defines the number of sockets that are equivalent to one association with respect to memory consumption.

By default the AS recovery timer value is set to 200 ms when an AS is entered. This value can be changed at any time using the **chg-as** command. The new timer value will be used the next time the AS enters the AS-Pending state.

The trade ratio states the quantity of associations to sockets that may be provisioned on a certain card, as follows:

$$\text{Trade Ratio} = a:s$$

Where:

$$a=\text{association} : s=\text{socket}$$

Table 6-5 shows the maximum sockets/associations per DCM card.

Table 6-5. Maximum Sockets/Associations per Card

Card Type	Socket to Assoc Ratio	Max Sockets	Max Associations
DCM	8:1	50	4

Output

```
ent-as:asame=asx:aname=asxp1
  rlgncxa03w 05-05-17 15:35:05 EST EAGLE 34.0.0
  ENT-AS: MASP A - COMPLTD
;
```

ent-asp

Enter Application Server Process

NOTE: This command is obsolete.

Use this command to enter an Application Server Process (ASP) and bind an SCTP association with it. An ASP contains an SCTP endpoint and can be configured to process signaling traffic.

Keyword: ent-asp

Related Commands: chg-asp, dlt-asp, rtrv-asp

Command Class: Database Administration

Parameters

:aspname= (mandatory)
Name of the Application Server Process (ASP).

Range: Up to 15 alphanumeric characters; the first character must be a letter.

:aname= (mandatory)

Name of the association assigned to this Application Server Process (ASP).

Range: Up to 15 alphanumeric characters; the first character must be a letter.

Example

```
ent-asp:aspname=asp1:aname=asxp1
```

Dependencies

The ASP cannot already be defined.

The association name must already be defined.

The association cannot already be associated with an ASP.

An ASP cannot be assigned to an association with adapter type **m2pa**.

Notes

When a new ASP is entered, it defaults to using UA parameter set (UAPS) 10. You can use the **chg-asp** command to change the UAPS for an ASP that is assigned to an M3UA association.

Output

```
ent-asp:aspname=asp1:aname=asxp1
```

```
rlghncxa03w 04-02-17 15:35:05 EST EAGLE 31.3.0
ENT-ASP: MASP A - COMPLTD
```

```
;
```

ent-assoc

Enter Association

Use this command to configure the SCTP associations in the IPAPSOCK table. This command associates the local host and local port to a remote host and remote port in the IPAPSOCK table. This command provides the association to transport protocol data units and adapter layer peer messages. Each association is connected to a process on the far end.

Keyword: ent-assoc

Related Commands: chg-assoc, dlt-assoc, rtrv-assoc

Command Class: Database Administration

Parameters

:aname= (mandatory)

Name assigned to this association (in IPAPSOCK table).

Range: Up to 15 alphanumeric characters; the first character must be a letter

:lhost= (mandatory)

The local host name as defined in the IP Host table.

Range: a-z, A-Z, 0-9, -, .

Any string of characters beginning with a letter and comprising up to 60 characters in length.

:adapter= (optional)

The adapter layer for this association.

Range: **m3ua, sua, m2pa**

Default: **m3ua**

m3ua if the **lhost** is an IPGWx card.

m2pa if the **lhost** is an IPLIMx card.

:alhost= (optional)

Name of alternate local host. When specified, this parameter configures the SCTP association as a multi-homed endpoint.

Range: **a–z, A–Z, 0–9, -, .** or **none**

Any string of characters beginning with a letter and comprising up to 60 characters in length.

none—the **alhost** is not configured; the SCTP association is configured as a uni-homed endpoint

:lport= (optional)

The SCTP port number for the Local Host.

Range: **1024–65535**

Default: **0**

:m2patset= (optional)

The M2PA timer set assigned to this association.

Range: **1–20**

Default: **1**

:port= or **:link=** (optional)

The signaling **link** for this association.

Range: **a, b, a1, b1, a2, b2, a3, b3**

Not all card types support all **link** parameter values.

See Table A-1 in Appendix A for valid **link** parameter range values for each type of card that can have assigned signaling links ports.

Default: **a**

:rhost= (optional)

Name of Remote Host as defined in the IP Host table.

Range: **a–z, A–Z, 0–9, -, .**

Any string of characters beginning with a letter and comprising up to 60 characters in length.

:rport= (optional)

The SCTP port number for the Remote Host.

Range: **1024–65535**

Default: **0**

Example

```
ent-assoc:aname=assoc1:lhost=gw105.nc.tekelec.com:lport=1030
:rhost=gw100.nc.tekelec.com:rport=1030:adapter=m3ua
```

Dependencies

The association name (**:aname**) must already exist in the IP Socket/Association (IPAPSOCK) table.

If the application is IPLIMx and the association's **adapter** value equals **m2pa**, the M2PA version supported is set to **rfc** by default. The **chg-assoc** command can be used if a different M2PA version is desired.

The hostnames specified in the **lhost** and **alhost** parameters must refer to different IP addresses.

The IP host names specified in the **lhost** and **alhost** parameters must exist in the IP Host table and must be provisioned as local to this EAGLE 5 SAS.

The hostnames specified in the **lhost** and **alhost** parameters must refer to IP addresses on the same IP card.

Only the **port=a** parameter can be specified if the card is running the **ss7ipgw** or **ipgwi** application.

Only the **port=a** or **port=b** parameter can be specified for the **port** parameter value if the card is a dual-slot DCM card running the **iplim** or **iplimi** application.

Ports **a**, **b**, **a1**, **b1**, **a2**, **b2**, **a3**, and **b3** can be specified if the card is an SSEDCCM card running the **iplim** or **iplimi** application.

To assign an association on an IPLIMx card for a local host, the signaling link associated with the signaling link port must specify the **ipliml2=m2pa** parameter.

If the **m2patset** parameter is specified, the **adapter** parameter value must be **m2pa**.

You cannot assign an association with **adapter=sua** or **m3ua** for an **lhost** on a card running the **iplim** or **iplimi** application.

Association connection parameters (**lhost**, **rhost**, **lport**, **rport**) must be unique.

The card location for the card associated with the **lhost** and **alhost** must exist in the IP Link table.

If the entered **lhost** or **alhost** corresponds to an IP address associated with the B Ethernet Interface hosted by a present dual-slot DCM card, an error will be generated. If the entered **lhost** or **alhost** corresponds to an IP address associated with the B Ethernet Interface hosted by a provisioned but not present DCM card, the card will be auto-inhibited upon insertion. If an SSEDCCM card is inserted, the card will be allowed to boot.

The allowed maximum is 1 association per signaling link on IPLIMx cards.

There is a maximum of 50 connections (association-to-AS assignments + sockets) per Local Host on IPGWx cards.

A maximum of 4000 connections (association-to-AS assignments + sockets) are allowed per system.

Notes

The IPAPSOCK table is used to associate the Local Host/Local Port to a Remote Host/Remote Port. This fully specifies the connection.

SCTP associations can be configured as either uni-homed or multi-homed endpoints. Uni-homed endpoints are SCTP associations configured with the **lhost** parameter specified and the **alhost** parameter not specified. In this case, the **lhost** represents an IP address that corresponds to either the A or B network of the IP application card (see **chg-ip-lnk**). Multi-homed endpoints are SCTP associations configured with both the **lhost** and **alhost** parameters specified. In this case, the **lhost** represents an IP address corresponding to one of the networks (A or B) of the IP card while the **alhost** represents an IP address corresponding to the other network of the same IP card.

If a valid **lhost** parameter is specified that equates to a valid IP address, the **lhost** maps directly to a card location in the IP Link table, which can then determine the card's application (IPLIMx or SS7IPGWx). If the application is an IPLIMx, two additional validation checks are made:

- The **adapter** parameter value must equal **m2pa**.
- The **ipliml2** value for the IPLIMx signaling link must be the same as the association **adapter** parameter value.

If the determination of the application running on the card or the signal link cannot be performed when the **ent-assoc** command is executed, the check is performed by the **chg-assoc** command.

An association with an adapter value of **m2pa** cannot be assigned to an SS7IPGW or IPGWI host.

There are fields in the IPAPSOCK table that receive default values even though there are no parameters on this command for changing those fields. If a different value is desired, the **chg-assoc** command must be used. The **chg-assoc** command can also be used if the hostnames are too long to fit on the command line with other parameters. The fields in question and their default values are:

- open=no
- alw=no
- rmode=lin
- rmin=120
- rmax=800
- rtimes=10
- cwmin=3000
- ver=rfc
- istrms=2
- ostrms=2

Output

```
ent-assoc:aname=assoc1:lhost=gw105.nc.tekelec.com:lport=1030
:rhost=gw100.nc.tekelec.com:rport=1030:adapter=m3ua
  rlghncxa03w 04-02-17 15:35:05 EST  EAGLE 31.3.0
  ENT-ASSOC: MASP A - COMPLTD
;
```

ent-card**Enter Card**

Use this command to add a card to the database. The card type and application specifies the function assigned to the card.

Keyword: ent-card

Related Commands: dlt-card, init-card, rept-stat-card, rtrv-card, rmv-card, rst-card

Command Class: Database Administration

Parameters

:appl= (mandatory)

The application for this card.

Range: atmansi, atmitu, ccs7itu, ebdablm, ebdadcm, emdc, eroute, gls, ipgwi, iplim, iplimi, ips, mcp, sccp, ss7ansi, ss7gx25, ss7ipgw, stplan, vsccp, vxwslan

atmansi—The GPL is used by the LIM cards to support the high-speed ATM signaling link feature.

atmitu—The GPL is used by the E1 ATM cards to support the high-speed E1 ATM signaling link

ccs7itu—This GPL is used by the LIM cards for ITU-TSS MTP functionality, and for the 2-port E1 card, the E1/T1 MIM card, and the HC-MIM card.

ebdablm—This GPL is used by the TSM card for enhanced bulk download.

ebdadcm—This GPL is used by the DCM card to transmit the LSMS LNP database to the EAGLE at high speed over an ethernet connection for enhanced bulk download.

emdc—This GPL is used by the DCM card for CMIP/OSI measurement collection interface as defined by Telcordia GR-376.

eroute—This GPL is used by the STC card for EAGLE Support for Integrated Sentinel functions.

gls—This GPL is used by the TSM cards for downloading gateway screening to LIM cards.

ipgwi—This GPL is used by the DCM card for TCP/IP point-to-point connectivity for ITU point codes. The system allows a maximum of 64 cards to be assigned the **ipgwi** application.

iplim—This GPL is used by the DCM card for TCP/IP point-to-point connectivity for ANSI point codes.

iplimi—This GPL is used by the DCM card for TCP/IP point-to-point connectivity for ITU point codes.

ips—This GPL is used by the IPSM card for the IP User Interface feature.

mcp—This GPL is used by the MCPM card for the Measurements Platform feature.

sccp—This GPL is used by the TSMs for the global title translation application.

ss7ansi—This application is used by the LIM cards, the E1/T1 MIM card, and the HC-MIM card for the MTP functionality.

The MPL or MPL-T (multi-port LIM) card is provisioned with the **ss7ansi** application to allow the card to replace a two-port LIM without having to re-provision the LIM in the database. Both types of LIMs perform the same

functions. Although the MPLs are provisioned with the **ss7ansi** application, the MPLs run the **ss7ml** GPL. The **ss7ml** GPL allows the MPL cards to support 8 signaling link ports. The MPL cards support the DS0 interface only.

The E1/T1 MIM card is provisioned with the **ss7ansi** application. The card can replace a two-port E1 card without having to re-provision the E1 card in the database, and can function as a T1 card. Both types of E1 cards perform the same functions. The E1/T1 MIM card runs the **ss7ml** GPL. The **ss7ml** GPL allows the E1/T1 MIM card to support 8 signaling links.

The HC-MIM card is provisioned with the **ss7ansi** application. The card can function as an E1 card or a T1 card that supports up to 64 signaling links.

ss7gx25—This GPL is used by the LIM cards to support X.25 functionality.

ss7ipgw—The application software for TCP/IP point-to-multipoint connectivity. The system allows a maximum of 64 cards to be assigned the **ss7ipgw** application.

stplan—This GPL is used by the ACM card to support the STP LAN application.

vsccp—This GPL is used by the DSM card to support the G-Flex, G-Port, INP, and LNP ELAP Configuration features. If the G-Flex, G-Port, INP, or LNP ELAP Configuration feature is not turned on, and a DSM card is present, the VSCCP GPL processes normal GTT traffic.

vxwslan—This GPL is used by the DCM card to support the STP LAN application.

:loc= (mandatory)

The card location as stenciled on the shelf of the system.

Range: 1101–1108, 1111–1112, 1201–1208, 1211–1218, 1301–1308, 1311–1318, 2101–2108, 2111–2118, 2201–2208, 2211–2218, 2301–2308, 2311–2318, 3101–3108, 3111–3118, 3201–3208, 3211–3218, 3301–3308, 3311–3318, 4101–4108, 4111–4118, 4201–4208, 4211–4218, 4301–4308, 4311–4318, 5101–5108, 5111–5118, 5201–5208, 5211–5218, 5301–5308, 5311–5318, 6101–6108, 6111–6118

:type= (mandatory)

The type of hardware (daughterboard) being added.

Range: acmenet, dcm, dsm, ipsm, limatm, limds0, lime1atm, limocu, limv35, lime1, limt1, limch, mcpm, stc, tsm

acmenet—Data link card for the STP LAN feature. The application type (**appl**) for this card type is **stplan**.

dcm—Database Communications Module card to support the STP LAN, enhanced bulk download, and GR-376 features. The application types (**appl**) for this card type are **ebdadcm**, **vxwslan**, and **emdc**. The DCM card also runs either the **ss7ipgw**, **iplim**, or **iplimi** application.

dsm—Database Services Module card to support the G-Flex, G-Port, and INP features. The application type (**appl**) for this card type is **vsccp**.

ipsm—IP Services Module card to support the IP User Interface feature. The application type (**appl**) for this card type is **ips**.

limatm—High speed ATM signaling link. The application type (**appl**) for this card type is **atmansi**.

- limds0**—Signaling link with DS0 interface. For a two-port LIM, the application types (**appl**) for this card type are **ss7ansi**, **ss7gx25**, and **ccs7itu**. For a multi-port LIM, the application type (**appl**) for this card type must be **ss7ansi**.
- lime1atm**—High speed E1 ATM signaling link. The application type (**appl**) for this card type is **atmitu**.
- limocu**—Signaling link with OCU interface. The application types (**appl**) for this card type are **ss7ansi**, **ss7gx25**, and **ccs7itu**.
- limv35**—Signaling link with V.35 interface. The application types (**appl**) for this card type are **ss7ansi**, **ss7gx25**, and **ccs7itu**.
- lime1**—E1 card or E1/T1 MIM card or HC-MIM card used as an E1 card. The application types (**appl**) for this card type are **ss7ansi** and **ccs7itu**.
- limt1**—E1/T1 MIM card or HC-MIM card used as a T1 card. The application types (**appl**) for this card type are **ss7ansi** and **ccs7itu**.
- limch**—E1 card or E1/T1 MIM card defined as a Channel card. The application types (**appl**) for this card type are **ss7ansi** and **ccs7itu**.
- mcpm**—Measurement Collection and Polling Module card used for the Measurements Platform feature. The application type for this card type is **mcp**.
- stc**—Sentinel Transport card used for the EAGLE Support for Integrated Sentinel feature. The application type for this card type is **eroute**.
- tsm**—Memory card for GTT, gateway screening, and the enhanced bulk download feature. The application types (**appl**) for this card type are **gls**, **sccp** and **ebdablm**.

For more information on the above cards, see Table 6-6 on page 6-168.

:force= (optional)

Allows a LIM card to be added to the database even if its addition would exceed the SCCP TPS (transactions-per-second) threshold set using the **chg-th-alm** command.

The purpose of the threshold is to warn the user if the TPS capacity of the EAGLE cannot support the additional TPS contributed from the card to be added.

The default value for this parameter is **no**, which does not allow the LIM card to be added to the database unless there are enough SCCP cards in the database.

If the GTT feature is not on or the GTT and LNP features are not on, this parameter has no meaning and should not be used.

If the **force=yes** parameter is used to add a LIM to the database, it is recommended that you add the required number of SCCP cards to the database after the LIM is added to avoid the loss of global title translation traffic.

Range: **yes, no**

Default: **no**

Example

```
ent-card:loc=1301:type=limocu:appl=ss7gx25
ent-card:loc=1201:type=tsm:appl=sccp
ent-card:loc=1302:type=acmenet:appl=stplan
ent-card:loc=1303:type=limv35:appl=ss7ansi
ent-card:loc=1204:type=limatm:appl=atmansi
ent-card:loc=1205:type=dcn:appl=iplim
```

ent-card:loc=1207:type=dcm:appl=ss7ipgw
 ent-card:loc=1206:type=limatm:appl=atmansi:force=yes;
 ent-card:loc=1208:type=limatm:appl=atmansi:force=no;
 ent-card:loc=1211:type=dsm:appl=vsccp
 ent-card:loc=1304:type=dcm:appl=iplimi
 ent-card:loc=1206:type=limds0:appl=ss7ansi
 ent-card:loc=1212:type=dcm:appl=ipgwi
 ent-card:loc=1214:type=mcpm:appl=mcp
 ent-card:loc=1215:type=stc:appl=eroute
 ent-card:loc=1305:type=lime1:appl=ss7ansi
 ent-card:loc=1205:type=lime1:appl=ccs7itu
 ent-card:loc=1206:type=limch:appl=ccs7itu
 ent-card:loc=1301:type=limt1:appl=ss7ansi
 ent-card:loc=1306:type=lime1atm:appl=atmitu
 ent-card:loc=1307:type=ipsm:appl=ips

Dependencies

Table 6-6 on page 6-168 shows the card names, the only valid card type (**type**) and application (**appl**) combinations, the card part numbers, and the maximum number of cards allowed in the database.

Table 6-6. Valid ent-card Applications (**appl**) and Card Types (**type**)

Card Name (as shown on card label)	Part Number	Card Type (:type)	Application Type (:appl)	Maximum Cards in the Database
ACM-ENET	870-1008-XX	acmenet	stplan	32
DCM	870-1945-XX	dcm	ebdadcm vxwslan emdc iplim, iplimi ss7ipgw, ipgwi	1 for ebdadcm 32 for vxwslan 2 for emdc 41 for iplim or iplimi Total of 64 ss7ipgw, ipgwi, or combination 32 for eroute (minimum of 17 for 500 links)
		stc	eroute	
DCM (SSEDCM)	870-2372-01	dcm	iplim, iplimi ss7ipgw, ipgwi	100 for iplim or iplimi Total of 64 ss7ipgw, ipgwi, or combination 32 for eroute (minimum of 14 for 500 links)
		stc	eroute	
DSM	870-1984-02 to 870-1984-05	dsm	vsccp	25 for vsccp
DSM-1G	870-2371-02	ipsm	ips	3 for ips
EDSM-2G*	870-2372-03	mcpm	mcp	250 for mcp
E1/T1 MIM††	870-2198-XX	lime1, limt1, limch	ss7ansi, ccs7itu	250 for each application

Table 6-6. Valid ent-card Applications (**appl**) and Card Types (**type**) (Continued)

Card Name (as shown on card label)	Part Number	Card Type (:type)	Application Type (:appl)	Maximum Cards in the Database
E1 ATM	870-2455-XX	lime1atm	atmitu	115
EILA	870-2049-XX	limds0, limocu, limv35	ss7ansi, ss7gx25, ccs7itu	250 for each application
HC-MIM††	870-2671-01	lime1, limt1	ss7ansi, ccs7itu	125 for each application
ILA	870-1484-XX	limds0, limocu, limv35	ss7ansi, ss7gx25, ccs7itu	250 for each application
LIM** or LIM-AINF	870-1014-XX 870-1488-XX	limds0, limocu, limv35	ss7ansi, ss7gx25, ccs7itu	250 for each application
LIM-ATM	870-1293-XX	limatm	atmansi	115
LIM-DS0	870-1009-XX 870-1485-XX	limds0	ss7ansi, ss7gx25, ccs7itu	250 for each application
LIM-E1††	870-1379-XX	limocu, limds0, limv35 lime1, limch	ss7ansi, ccs7itu	250 for each application
LIM-OCU	870-1010-XX 870-1486-XX	limocu	ss7ansi, ss7gx25, ccs7itu	250 for each application
LIM-V.35	870-1012-XX 870-1487-XX	limv35	ss7ansi, ss7gx25, ccs7itu	250 for each application
MPL MPL-T	870-2061-XX 870-2061-02	limds0	ss7ansi	250 for ss7ansi
TSM-256† TSM-512 TSM-768 TSM-1024	870-1289-XX 870-1290-XX 870-1291-XX 870-1292-XX	tsm	sccp gls ebdablm	25 for sccp 8 for gls 1 for ebdablm

*Though the system allows 250 MCPM cards, practical usage is 2.
 **A LIM, EILA, or ILA is a link interface module using the AINF interface and can be installed in place of the LIM-DS0A, LIM-OCU, or LIM-V.35. It is configured in the database as either a LIM-DS0A, LIM-OCU, or LIM-V.35 card.
 †TSMs or DSMs are required for the LNP feature. For more information about turning the LNP feature on, refer to the *LNP Feature Activation Guide* and the *Database Administration - LNP Manual*.
 ††For the E1 or T1 interface, either SS7 application (SS7ANSI or CCS7ITU) can be assigned to these cards. For more information on the E1 or T1 interface go to Chapter 3 “System Administration Procedures” in the *Database Administration Manual - SS7*.

The card location must not be **1113-1118**, or **xy09** and **xy10** where *x* is the frame and *y* is the shelf.

The shelf location must be equipped.

A card cannot be entered into a nonconfigured shelf.

The specified card location cannot already be provisioned in the database.

The SSEDCCM card occupies only one slot in an EAGLE shelf; the dual-slot DCM cards take two slots. The provisioning rules for DCM/STC cards allow provisioning of any slot where a DCM or STC card can physically be inserted. The slot located immediately to the right of an SSEDCCM card can be provisioned.

The DSM card must be inserted into an odd-numbered location. The $n+1$ slot next to the DSM card must be empty, where n is the odd-numbered location (for example, if the DSM is in location 1101, then the 1102 slot must be empty and unprovisioned).

When the 15 Minute Measurements feature is enabled, no EMDC cards can be provisioned.

The **force** parameter can be specified only if the GTT feature or the GTT and LNP features are turned on.

For some values of the **appl** parameter, the corresponding feature must be turned on with the **chg-feat** command before the **ent-card** command can be entered to provision the card.

For features that are turned on using the **chg-feat** command, you can enter the **rtrv-feat** command to display the **on** or **off** status of the features. The following rules apply:

- The GTT feature must be turned on for **appl=sccp** or **appl=vsccp**.
- The X25G feature must be turned on for **appl=ss7gx25**.
- The LAN feature must be turned on for **appl=stplan** and **appl=vxwslan**.
- The Measurements Platform feature must be turned on before the command can be entered for an MCPM card (**:type=mcpm:appl=mcp**).

NOTE: The “LNP feature” is turned on when the LNP ported TNs quantity is greater than 0 in the **rtrv-ctrl-feat** command output. An LNP quantity feature access key has been enabled and turned on. See the **enable-ctrl-feat** and **chg-ctrl-feat** commands for more information about turning on the LNP feature.

For features that are enabled by using the **enable-ctrl-feat** command, you can verify whether a feature is enabled or turned on by entering the **rtrv-ctrl-feat** command. The following rule applies:

- The LNP feature must be turned on for **appl=ebdablm** and **appl=ebdadcm**.
- If the LNP ELAP Configuration feature is turned on, the following **appl** parameter values cannot be specified: **sccp**, **ebdablm**, or **ebdadcm**.

The following features require DSM cards running the **vsccp** application: G-Flex, INP, G-Port, Enhanced GSM MAP Screening (EGMS), Flexible GTT Load Sharing, and LNP ELAP Configuration.

Notes

SCCP Cards

When LIMs containing SS7 links or DCMs containing IP links (also known as SS7 cards) are added to the database, the system must contain enough SCCP cards to handle the maximum number of SCCP transactions-per-second (TPS) that the LIM and DCM cards send to the SCCP cards. The EAGLE calculates the current system TPS capacity based on the number and type of provisioned SCCP cards available in the system. An SCCP card is a TSM running the SCCP application or a DSM running the VSCCP application.

ITU Environment

Each SCCP card can handle the following number of transactions-per-second: 850 for a TSM and 1700 for a DSM.

When the **ent-card** command is entered to add a card that requests service from either an SCCP or VSCCP card, the EAGLE adds the current TPS level to the estimated TPS level for the new card. The EAGLE uses the following values to derive the TPS estimate: 53 for low-speed links (cards provisioned as SS7ANSI, CCS7ITU or SS7GX25 cards), 480 for ATM, and 1000 for IPLIM cards. The EAGLE then compares the sum to a user-configured threshold (SCCP TPS Threshold) that is set using the **chg-th-alm** command. The purpose of the SCCP TPS threshold is to generate an alarm (UAM 0330) if the threshold is exceeded. The SCCP TPS threshold also triggers an error message (E3715) if you issue the **ent-card** command and the resulting TPS level (the current TPS plus the estimated TPS for the new card) would be greater than the threshold configured:

```
E3715: Cmd Rej - Insufficient #SCCP cards to support LIM - use FORCE=YES
```

The **force** parameter can be specified to add the card even if its addition would exceed the SCCP TPS threshold. If the **force=yes** parameter is specified, the command is accepted but the following warning message appears:

```
WARNING: System current rated TPS unable to support additional SS7 card = use FORCE=YES.
```

If the **force=yes** parameter is specified, it is recommended that the required number of SCCP cards be added to the database after the SS7 card is added. This action avoids the loss of GTT traffic. Another option is to add additional SCCP cards or to increase the SCCP TPS threshold, and then add the SS7 card. This action prevents the alarm from being triggered.

For additional information on using the **force** parameter, see Chapter 4 "System Administration" of the *Database Administration Manual - System Management*.

If the G-Flex, G-Port, INP, or LNP ELAP Configuration feature is turned on, the system cannot contain a mix of SCCP and VSCCP card types.

ANSI Environment

In an ANSI environment with only the G-Flex feature turned on, only DSMs in the system, and the **ansigflex** system option enabled, each VSCCP card can handle up to 1700 TPS.

LIM Cards

The provisioning method of an MPL or MPL-T (multi-port LIM) and a two-port LIM is the same. The two-port LIM supports the LIMDS0, LIMOCU, or LIMV35 interface, and the **appl** value can be **ss7ansi**, **ccs7itu**, or **ss7gx25**. The MPL cards support only the LIMDS0 interface, and the **appl** value must be **ss7ansi**. The MPL cards support eight ports, namely, **a**, **b**, **a1**, **b1**, **a2**, **b2**, **a3** and **b3**. The **rtv-card** command displays the status of all ports of the MPL cards.

Use the **ent-card** command to set the card type for a 2-port E1 card or Channel card (**lime1** or **limch**) in the database. Do not use the DIP switches, if any exist on the E1 card.

STC Cards

The **type=stc** and **appl=eroute** parameters apply only when the EAGLE Support for Integrated Sentinel feature is turned on.

Output

```
ent-card:loc=1206:type=limds0:appl=ss7ansi
  r1ghncxa03w 04-07-07 11:11:28 EST EAGLE 31.6.0
  ENT-CARD: MASP A - COMPLTD
;
```

ent-csl

Enter Common Screening List

Use this command to enter new screening data into the Common Screening List (CSL). The Common Screening List commands are used to tailor certain types of general screening information to specific features.

Keyword ent-csl

Related Commands: chg-csl, dlt-csl, rtrv-csl, rtrv-ctrl-feat

Command Class: Database Administration

Parameters

NOTE: See "Point Code Formats and Conversion" on page A-6 for a detailed description of point code formats, rules for specification, and examples.

:ds= (Optional)

Digit String. This parameter specifies a unique string of digits that is used by the specified screening feature.

NOTE: Either the ds or the pc parameter must be specified. Both parameters cannot be specified in the same command.

Range: 1 - 15 digits

Valid digits are **0-9, a-f, A-F**

1-15 digits—IDP Screening for Prepaid **insl** list

4 digits—IDP Screening for Prepaid **skts** list

1-15 digits—Prepaid IDP Query Relay **ccnc** list

1-15 digits—Prepaid IDP Query Relay **ccnc** list

1-5 digits—Prepaid IDP Query Relay **delpfx** list

1-6 digits—Prepaid IDP Query Relay **gta** list

1-4 digits—Prepaid IDP Query Relay **skbcsm** list

:feature= (Optional)

Feature Name. The name of the enabled screening feature for which the command is entered. Enter the entire feature name as it appears in the **rtrv-ctrl-feat** command description output example.

NOTE: Either the pn parameter or the feature parameter must be specified to identify the feature.

Range: *abcdefghijklmnopqrstuvwxyz0-9*

1 alphabetic character and up to 24 optional alphanumeric characters, including spaces and special characters, enclosed in double quotation marks (" ").

The following feature names are valid for this command:

- IDP Screening for Prepaid
- Prepaid IDP Query Relay

:list= (Optional)

The name of Common Screening List that is associated with the feature.

NOTE: The list parameter must be specified when the feature uses more than one type of Common Screening List.

Range: **ccnc, delpfx, gt, insl, skbcm, skts**

ccnc—CC+NC List

delpfx—Delete Prefix List

gt—Global Title List

insl—In Network Subscriber List

skbcm—SK+BCSM List

skts—Service Key + TeleService List

The following screening lists are valid for the indicated features:

- **skts, insl**—IDP Screening for Prepaid feature
- **ccnc, delpfx, gt, skbcm**—Prepaid DP Query Relay feature

:p1= (Optional)

Parameter value 1. The parameter value is specific to the feature and list name that use this parameter.

Range: 1 digit

Valid digit values are:

0-1—For the Prepaid IDP Query Relay feature **delpfx** list, where **0**=National, **1**=International

:p2= (Optional)

Parameter value 2. The parameter value is specific to the feature and list name that use this parameter. No feature currently uses this parameter.

:p3= (Optional)

Parameter value 3. The parameter value is specific to the feature and list name that use this parameter. No feature currently uses this parameter.

:pc= or :pca= (Optional)

ANSI point code with subfields *network indicator-network cluster-network cluster member* (*ni-nc-ncm*).

Range: **000-255**

Specify a valid value for each subfield of the point code, and separate the subfields with a dash (-).

When **chg-sid:pctype=ansi** is specified, *ni* = **000** is not valid.

When **chg-sid:pctype=ansi** is specified, *nc* = **000** is not valid if *ni* = **001-005**.

When **chg-sid:pctype=ansi** is specified, *nc* = **000** is valid if *ni* = **006-255**.

The point code **000-000-000** is not a valid point code.

:pc/pca/pci/pcn/pcn24= (Optional)

Point code. Either the **ds** or **pc** parameter must be specified from this command.

Currently, there are no common screening list features that use point codes.

:pci= (Optional)

ITU international point code with subfields *zone-area-id*. The *prefix* subfield indicates a spare point code (*prefix-zone-area-id*).

Range: s-, 0-255

Specify a valid value for each subfield of the point code, and separate the subfields with a dash (-).

prefix—s-

zone—0-7

area—000-255

id—0-7

The point code **0-000-0** is not a valid point code.

:pcn= (Optional)

ITU national destination point code in the format of a 5-digit number (*nnnnn*); or 2, 3, or 4 numbers (members) separated by dashes (*m1-m2-m3-m4*) as defined by the **chg-stpopts:npcfmti** flexible point code option. A group code must be specified when the ITUDUPPC feature is turned on (*nnnnn-gc*, *m1-m2-m3-m4-gc*). The *prefix* subfield indicates a spare point code (*prefix-nnn-gc*, *prefix-m1-m2-m3-m4-gc*).

Range: s-, 0-16383, aa-zz

Specify a valid value for each subfield of the point code, and separate the subfields with a dash (-).

prefix—s

nnnnn—0-16383

gc—aa - zz

m1-m2-m3-m4—0-14 for each member; values must sum to 14

:pcn24= (Optional)

24-bit ITU national point code with subfields *main signaling area-sub signaling area-signaling point* (*msa-ssa-sp*).

Range: 000-255

Specify a valid value for each subfield of the point code, and separate the subfields with a dash (-).

msa—000-255

ssa—000-255

sp—000-255

Default: No change to current value.

:pn= (Optional)

Part Number. The 9-digit "893xxxxxx" part number of the feature for which the command is entered. The **rtrv-ctrl-feat** command description shows the part number in the command output example.

NOTE: Either the **pn** parameter or the **feature** parameter must be specified to identify the feature.

Range: 893000000-893999999

The first three digits are **893**. Do not separate the digits with dashes or spaces. The following part numbers are valid for this command:

- 893015501—IDP Screening for Prepaid feature
- 893016001—Prepaid IDP Query Relay feature.

Example

```
ent-csl:pn=893015001:list=insl:ds=123456789bcdEF
```

```
ent-csl:feature="IDP Screening for Prepaid":list=skts:ds=36ab
```

```
ent-csl:feature="Prepaid IDP Query Relay":list=ccnc:ds=123456
ent-csl:feature="Prepaid IDP Query Relay":list=skbcsm:ds=4321
ent-csl:feature="Prepaid IDP Query Relay":list=delpfx:ds=54321:p1=0
```

Dependencies

An enabled feature must be specified using either a valid part number (**pn**) or feature name (**feature**). The specified feature must use a Common Screening List.

The specified feature name must be for a feature that uses a Common Screening List.

The feature that is specified in the **feature** parameter must be enabled.

The feature name must be specified as it appears in the **rtrv-ctrl-feat** command output example. The entire feature name must be specified.

The following features use a Common Screening List:

- IDP Screening for Prepaid
- Prepaid IDP Query Relay

The feature that is specified in the **feature** parameter must be enabled.

The **list** parameter must be specified for features that use more than one type of screening list.

The **list** parameter value must be valid for the specified screening feature.

The following **list** parameter values are valid for the indicated feature:

- **insl, skts**—IDP Screening for Prepaid feature
- **gt, ccnc, delpfx, skbcsm**—Prepaid IDP Query Relay feature

The length of the digit string that is specified for the **ds** parameter must be valid for the screening feature and list type.

A valid **ds** parameter is required for the specified feature and list type.

The following parameters are allowed with the indicated common screening list type:

- **list=gt**—**ds** parameter
- **list=ccnc**—**ds** parameter
- **list=delpfx**—**ds** and **p1** parameters
- **list=skbcsm**—**ds** parameter
- **list=insl**—**ds** parameter
- **list=skts**—**ds** parameter

The leading digit pattern in the specified digit string (**ds** parameter) must be unique in the specified screening list for the indicated feature:

- **insl, skts**—IDP Screening for Prepaid feature
- **gt, ccnc, delpfx, skbcsm**—Prepaid IDP Query Relay feature

The specified **ds** parameter value must be valid for the specified screening list (**list** parameter).

The value that is specified for a common screening list parameter must be valid for the specified common screening list feature.

Each list table is allowed to contain a maximum number of entries:

- **ccnc** list—20 entries
- **delpfx** list—10 entries
- **gt** list—50 entries
- **insl** list—50 entries
- **skbcm** list—25 entries
- **skts** list—25 entries

Notes

None

Output

```
ent-csl:pn=893015501:list=insl:ds=123456789bcdEF
tekelecstp 05-09-21 15:18:41 EST EAGLE 34.3.0
INSL List table is (1 of 50) 2% full
ENT-CSL: MASP A - COMPLTD
;
```

ent-cspc

Enter Concerned Signaling Point Code

Use this command to add signaling points to a current broadcast signaling point code group. These point codes are notified of the receipt by the system of subsystem-prohibited (SSP) and subsystem-allowed (SSA) SS7 SCCP management messages from an application at an adjacent signaling point and subsystem. This command can also be used to add new groups to the table.

NOTE: The command must be entered first with the group only (no point code); then the command must be entered again with the group code and the point code.

Keyword: ent-cspc

Related Commands: dlt-cspc, rtrv-cspc

Command Class: Database Administration

Parameters

NOTE: See “Point Code Formats and Conversion” in Appendix A for a detailed description of point code formats, rules for specification, and examples.

:grp= (mandatory)

Name of the group. This parameter is a character string associated with this broadcast list.

Range: 1 alphabetic character followed by up to 7 alphanumeric characters

:pc/pca/pci/pcn/pcn24= (optional)

Point code.

This parameter is mandatory when the group and point code are entered, after the group has been entered.

:pc= or :pca= (optional)

ANSI point code with subfields *network indicator-network cluster-network cluster member* (*ni-nc-ncm*).

Range: **000-255**

Specify a valid value for each subfield of the point code, and separate the subfields with a dash (-).

When **chg-sid:pctype=ansi** is specified, *ni = 000* is not valid.

When **chg-sid:pctype=ansi** is specified, *nc = 000* is not valid if *ni = 001-005*.

When **chg-sid:pctype=ansi** is specified, *nc = 000* is valid if *ni = 006-255*.

The point code **000-000-000** is not a valid point code.

:pci= (optional)

ITU international point code with subfields *zone-area-id*. The *prefix* subfield indicates a spare point code (*prefix-zone-area-id*)

Range: **s-, 0-255**

Specify a valid value for each subfield of the point code, and separate the subfields with a dash (-).

prefix—s-

zone—0-7

area—000-255

id—0-7

The point code **0-000-0** is not a valid point code.

:pcn= (optional)

ITU national point code in the format of a 5-digit number (*nnnnn*); or 2, 3, or 4 numbers (members) separated by dashes (*m1-m2-m3-m4*) as defined by the **chg-stpopts:npcfinti** flexible point code option. A group code must be specified when the ITUDUPPC feature is turned on (*nnnnn-gc*, *m1-m2-m3-m4-gc*). The *prefix* subfield indicates a spare point code (*prefix-nnnnn*, *prefix-nnnnn-gc*, *prefix-m1-m2-m3-m4*, *prefix-m1-m2-m3-m4-gc*).

Range: **s-, 0-16383, aa-zz**

Specify a valid value for each subfield of the point code, and separate the subfields with a dash (-).

prefix—s-

nnnnn—0-16383

gc—aa-zz

m1-m2-m3-m4—0-14 for each member; values must sum to 14

:pcn24= (optional)

24-bit ITU national point code with subfields *main signaling area-sub signaling area-signaling point* (*msa-ssa-sp*).

Range: **000-255**

Specify a valid value for each subfield of the point code, and separate the subfields with a dash (-).

msa—000-255

ssa—000-255

sp—000-255

Example

When the ANSI-ITU-China SCCP Conversion feature is not on, a CSPC group can contain point codes of only one network type.

```
ent-cspc:grp=grp01:pc=144-201-001
```

```
ent-cspc:grp=group02:pcn24=10-100-10
```

When the ANSI-ITU-China SCCP Conversion feature is on, a CSPC group can contain point codes of more than one network type. ITU-N and ITU-N24 point codes are not allowed in the same group.

```
ent-cspc:grp=grp01
```

```
ent-cspc:grp=grp01:pc=240-3-55
```

```
ent-cspc:grp=grp01:pci=7-233-5
```

```
ent-cspc:grp=grp01:pci=s-7-233-5
```

```
ent-cspc:grp=grp01:pcn24=234-56-245
```

Dependencies

Reserved words (for example, “**none**”) cannot be used to name a group.

The specified CSPC Broadcast group name must not exist if a point code is not specified. If the specified group name does not exist, and a point code is not specified, a new group is created.

The Spare Point Code Support feature must be enabled before the spare point code prefix **s-** can be specified for an ITU-I or ITU-N point code.

If the CSPC group name and a point code are specified, the group name must exist in the database.

The specified point code must exist in the Routing Table and cannot already exist in the specified group.

The destination point code must be a full point code (*ni-nc-ncm*).

The concerned signaling point code must have been specified previously as a full point code destination, or it must be a member of a previously specified cluster.

A maximum of 2549 Concerned Signaling Point Code Broadcast groups can be defined.

A maximum of 96 point codes can be defined for each group.

When the ANSI-ITU-China SCCP Conversion feature is not on, the first point code to be entered defines the network type for the group. All subsequent point codes for the group must be for the same network type. For example,

- **pc** and **pca** cause the group to be an ANSI group
- **pci** causes the group to be an ITU international group

- **pcn** causes the group to be an ITU national group
- **pcn24** causes the group to be a 24-bit ITU national group, which is administered as a subset of an ITU national group

When the ANSI-ITU-China SCCP Conversion feature is on, the point codes in a group can be of different network types. The only exception is that **pcn** and **pcn24** point codes are not allowed in the same group.

Notes

To broadcast SSPs and SSAs to one or more mated applications, each mate's point code must be added to the CSPC group. Otherwise, the broadcast is not sent to the mate.

In this command, only ITU-international and ITU national point codes support the spare point code subtype prefix (s-).

Output

The command must be entered with just the **grp** parameter to define a new group in the database.

ent-cspc:grp=grp01

```
rlghncxa03w 04-01-07 11:43:04 EST EAGLE 31.3.0
ENT-CSPC: MASP A - COMPLTD
```

;

The command must specify an existing group and a point code to add the point code to the group.

ent-cspc:grp=grp01:pc=144-201-001

```
rlghncxa03w 04-01-07 11:43:04 EST EAGLE 31.3.0
ENT-CSPC: MASP A - COMPLTD
```

;

ent-dlk

Enter Data Link

Use this command to add a TCP/IP data link to the database. The TCP/IP data link is used to send copies of SS7 MSUs (selected by the gateway screening feature) to a remote host for further processing.

Keyword: ent-dlk

Related Commands: act-dlk, canc-dlk, dlt-dlk, rept-stat-dlk, rtrv-dlk, tst-dlk

Command Class: Database Administration

Parameters

:ipaddr= (mandatory)

The TCP/IP data link's IP address. This is a TCP/IP address expressed in standard dot notation. IP addresses consist of the system's network number and the machine's unique host number. An example IP address is **192.126.100.5**, where **192.126.100** is the network number and **5** is the machine's host number.

Range: 1-223, 0-255

4 numbers separated by dots

1-223—first number

0-255—the other three numbers

:loc= (mandatory)

The card location as stenciled on the shelf of the system.

Range: 1101–1108, 1111–1112, 1201–1208, 1211–1218, 1301–1308, 1311–1318, 2101–2108, 2111–2118, 2201–2208, 2211–2218, 2301–2308, 2311–2318, 3101–3108, 3111–3118, 3201–3208, 3211–3218, 3301–3308, 3311–3318, 4101–4108, 4111–4118, 4201–4208, 4211–4218, 4301–4308, 4311–4318, 5101–5108, 5111–5118, 5201–5208, 5211–5218, 5301–5308, 5311–5318, 6101–6108, 6111–6118

:speed= (optional)

The Ethernet speed in Mbps.

Range: 10, 100

Default: 10

Example

```
ent-dlk:loc=1201:ipaddr=196.3.202.45
```

```
ent-dlk:loc=1201:ipaddr=196.3.202.45:speed=100
```

Dependencies

The shelf and card must be equipped.

The IP address (**ipaddr**) cannot be in the TCP/IP link table and cannot be a TCP/IP node.

The specified card cannot contain any data links.

The specified card's status must be out of service maintenance disabled (OOS-MT-DSBLD). Enter the **rept-stat-card** command to verify the state of the card.

The specified TCP/IP data link cannot be in the database.

The specified card must be running the **stplan** GPL.

The Gateway Screening feature and the STP LAN feature must be turned on before this command can be entered.

A VXWSLAN card must be required for a 100 Mbps data link.

Notes

If the first octet of the IP address is **127**, an error message is issued because the number **127** represents a loopback address.

The value of the **ipaddr** parameter cannot match the TCP/IP default router's IP address (the **iprte** parameter of the **ent-ip-node** command).

Output

```
ent-dlk:loc=1201:ipaddr=196.3.202.45
```

```
rlghncxa03w 04-02-10 11:43:04 EST EAGLE 31.3.0
ENT-DLK: MASP A - COMPLTD
```

```
;
```

In the following example, the first octet of the IP address is **127**. An error message is issued because the number **127** represents a loopback address.

ent-dlk:loc=1201:ipaddr=127.3.202.45

```
rlghncxa03w 04-02-10 11:43:04 EST EAGLE 31.3.0
Command Rejected : First octet of IPADDR cannot be 127.
ENT-DLK: MASP A - COMPLTD
```

;

ent-dstn

Enter Destination

Use this command to add a destination address (a destination point code, capability point code, or network cluster address) and the associated destination attributes to the destination point code table.



CAUTION: When using the Network Routing feature, limited network management is provided for point codes not covered by full point code routing, Cluster Routing, or Nested Cluster Routing.

Keyword: ent-dstn

Related Commands: chg-dstn, chg-rte, dlt-dstn, dlt-rte, ent-rte, rept-stat-dstn, rtrv-dstn, rtrv-rte

Command Class: Database Administration

Parameters

NOTE: See “Point Code Formats and Conversion” in Appendix A for a detailed description of point code formats, rules for specification, and examples.

:dpc/dpca/dpci/dpcn/dpcn24= (mandatory)

Destination point code.

:dpc= or **:dpca=** (mandatory)

ANSI destination point code with subfields *network indicator-network cluster-network cluster member* (*ni-nc-ncm*). The *prefix* subfield indicates a private point code (*prefix-ni-nc-ncm*).

Range: **p-**, **000-255**

Specify a valid value for each subfield of the point code, and separate the subfields with a dash (-).

prefix—p-

When **chg-sid:pctype=ansi** is specified, *ni* = **000** is not valid.

When **chg-sid:pctype=ansi** is specified, *nc* = **000** is not valid if *ni* = **001–005**.

When **chg-sid:pctype=ansi** is specified, *nc* = **000** is valid if *ni* = **006–255**.

The point code **000-000-000** is not a valid point code.

:dpci= (mandatory)

ITU international destination point code with subfields *zone-area-id*. The *prefix* subfield indicates a spare point code, private point code, or private and spare point code (*prefix-zone-area-id*).

Range: s-, p-, ps-, 0-255

Specify a valid value for each subfield of the point code, and separate the subfields with a dash (-).

The point code **0-000-0** is not a valid point code.

prefix—s-, p-, ps-

zone—0-7

area—000-255

id—0-7

:dpcn= (mandatory)

ITU national destination point code in the format of a 5-digit number (*nnnnn*); or 2, 3, or 4 numbers (members) separated by dashes (*m1-m2-m3-m4*) as defined by the

chg-stpopts:npcfnti flexible point code option. A group code must be specified when the ITUDUPPC feature is turned on (*nnnnn-gc*, *m1-m2-m3-m4-gc*). The *prefix* subfield indicates a spare point code, private point code, or private and spare point code (*prefix-nnnnn*, *prefix-nnnnn-gc*, *prefix-m1-m2-m3-m4*, *prefix-m1-m2-m3-m4-gc*).

Range: s-, p-, ps-, 0-16383, aa-zz

Specify a valid value for each subfield of the point code, and separate the subfields with a dash (-).

prefix—s-, p-, ps-

nnnnn—0-16383

gc—aa-zz

m1-m2-m3-m4—0-14 for each member; values must sum to 14

:dpcn24= (mandatory)

24-bit ITU national point code with subfields *main signaling area-sub signaling area-signaling point* (*msa-ssa-sp*). The *prefix* indicates a private point code (*prefix-msa-ssa-sp*).

Range: p-, 000-255

Specify a valid value for each subfield of the point code, and separate the subfields with a dash (-).

prefix—p-

msa—000-255

ssa—000-255

sp—000-255

Default: No change to current value.

:aliasa/aliasi/aliasn/aliasn24= (optional)

Alias point code.

:aliasa= (optional)

ANSI alias point code with subfields *network indicator-network cluster-network cluster member* (*ni-nc-ncm*). This parameter is not valid if an ANSI (**dpc** or **dpca**) point code is entered.

Range: 000-255

Specify a valid value for each subfield of the point code, and separate the subfields with a dash (-).

The point code **000-000-000** is not a valid point code.

:aliasi= (optional)

ITU international alias point code with subfields *zone-area-id*. This parameter is not valid if an ITU international (**dpci**) point code is entered. The *prefix* subfield indicates a spare point code (*prefix-zone-area-id*).

Range: **s-, 0-255**

Specify a valid value for each subfield of the point code, and separate the subfields with a dash (-).

The point code **0-000-0** is not a valid point code.

prefix—**s-**

zone—**0-7**

area—**000-255**

id—**0-7**

:aliasn= (optional)

ITU national alias point code in the format of a 5-digit number (*nnnnn*); or 2, 3, or 4 numbers (members) separated by dashes (*m1-m2-m3-m4*) as defined by the **chg-stpopts:npfcmfti** flexible point code option. A group code must be specified when the ITUDUPPC feature is turned on (*nnnnn-gc*, *m1-m2-m3-m4-gc*). The *prefix* subfield indicates a spare point code (*prefix-nnnnn*, *prefix-nnnnn-gc*, *prefix-m1-m2-m3-m4*, *prefix-m1-m2-m3-m4-gc*). This parameter is not valid if an ITU international (**dpcn**) point code is entered.

Range: **s-, 0-16383, aa-zz**

Specify a valid value for each subfield of the point code, and separate the subfields with a dash (-).

prefix—**s-**

nnnnn—**0-16383**

gc—**aa-zz**

m1-m2-m3-m4—**0-14** for each member; values must sum to 14

:aliasn24= (optional)

24-bit ITU national alias point code with subfields *main signaling area-sub signaling area-signaling point* (*msa-ssa-sp*). This parameter is not valid if a 24-bit ITU national (**dpcn24**) point code is entered.

Range: **000-255**

Specify a valid value for each subfield of the point code, and separate the subfields with a dash (-).

msa—**000-255**

ssa—**000-255**

sp—**000-255**

:bei= (optional)

Broadcast exception indicator. This parameter specifies whether the STP broadcasts network management messages to adjacent signaling points. The network management messages contain information about the indicated cluster and any of that cluster's member signaling points that are on its exception list. The messages whose broadcast is determined by this parameter are:

- **TFP**—transfer prohibited
- **TCP**—transfer cluster prohibited

Range: **yes, no**

yes—Network management messages are not broadcast

no—Network management messages are broadcast

Default: **yes**— for DPCs in the X.25 domain or if the DPC is a member whose associated cluster destination has **bei=yes** specified.

no—for DPCs in the cluster or if the DPC is a member whose associated cluster destination has **bei=no** specified or the **bei** parameter is not specified.

:cli= (optional)

The Common Language Location Identifier assigned to this destination.

Range: *ayyyyyyyyyy*

1 alphabetic character followed by 10 alphanumeric characters

Default: **none**

:domain= (optional)

The network in which the destination entity or node exists.

Range: **x25, ss7**

Default: **ys7**

:lei= (optional)

Exception-list exclusion indicator, for cluster destinations only. This parameter specifies whether the system *excludes* or *includes (maintains)* a dynamic status exception list (x-list) for each cluster route used to reach the member signaling points that make up the cluster.

Range: **yes, no**

yes—Do not maintain a dynamic status x-list

no—Maintain a dynamic status x-list

Default: **No**

:ipgwapc= (optional)

IP gateway adjacent point code indicator.

Range: **yes, no**

Default: **no**

:ncai= (optional)

Nested cluster allowed indicator. Specifies whether the route to the cluster point code can be different for provisioned members of the cluster. A point code is a member of a cluster point code if it has the same network identifier (NI) and network cluster (NC) values as the cluster point code. This parameter can be specified only for cluster point codes.

Nested cluster routing is allowed if this parameter is set to **yes** and the CRMD and NCR features are turned on.

Range: **yes, no**

yes—The cluster point code is a nested cluster point code. Point codes that are members of this cluster point code can be assigned to route sets that are different from the route set assigned to the cluster point code.

no—The cluster point code is not a nested cluster point code. Point codes that are members of this cluster point code must be assigned to the same route set assigned to the cluster point code.

Default: **no**

:spc/spca/spci/spcn/spcn24= (optional)

Secondary point code.

:spc= or **:spca=** (optional)

ANSI secondary point code with subfields *network indicator-network cluster-network cluster member* (*ni-nc-ncm*). The *prefix* subfield indicates a private point code (*prefix-ni-nc-ncm*).

Range: **p-**, **000-255**, **none**

Specify a valid value for each subfield of the point code, and separate the subfields with a dash (-).

prefix—**p-**

When **chg-sid:pctype=ansi** is specified, *ni* = **000** is not valid.

When **chg-sid:pctype=ansi** is specified, *nc* = **000** is not valid if *ni* = **001-005**.

When **chg-sid:pctype=ansi** is specified, *nc* = **000** is valid if *ni* = **006-255**.

The point code **000-000-000** is not a valid point code.

Enter **none** to delete the **spc** or **spca**.

:spci= (optional)

ITU international secondary point code with subfields *zone-area-id*. The *prefix* subfield indicates a spare point code, private point code, or private and spare point code (*prefix-zone-area-id*).

Range: **s-**, **p-**, **ps-**, **0-255**, **none**

Specify a valid value for each subfield of the point code, and separate the subfields with a dash (-).

The point code **0-000-0** is not a valid point code.

prefix—**s-**, **p-**, **ps-**

zone—**0-7**

area—**000-255**

id—**0-7**

Enter **none** to delete the **spci**.

:spcn= (optional)

ITU national secondary point code in the format of a 5-digit number (*nnnnn*); or 2, 3, or 4 numbers (members) separated by dashes (*m1-m2-m3-m4*) as defined by the **chg-stpopts:npcfmti** flexible point code option. A group code must be specified when the ITUDUPPC feature is turned on (*nnnnn-gc*, *m1-m2-m3-m4-gc*). The *prefix* subfield indicates a spare point code, private point code, or private and spare point code (*prefix-nnnnn*, *prefix-nnnnn-gc*, *prefix-m1-m2-m3-m4*, *prefix-m1-m2-m3-m4-gc*).

Range: **s-**, **p-**, **ps-**, **0-16383**, **aa-zz**, **none**

Specify a valid value for each subfield of the point code, and separate the subfields with a dash (-).

prefix—**s-**, **p-**, **ps-**

nnnnn—**0-16383**

gc—**aa-zz**

m1-m2-m3-m4—**0-14** for each member; values must sum to 14

Enter **none** to delete the **spcn**.

Default: **none**

:spcn24= (optional)

24-bit ITU national point code with subfields *main signaling area-sub signaling area-signaling point* (*msa-ssa-sp*). The *prefix* subfield indicates a private point code (*prefix-msa-ssa-sp*).

Range: **p-**, **000-255**, **none**
Specify a valid value for each subfield of the point code, and separate the subfields with a dash (-).

prefix—**p-**
msa—**000-255**
ssa—**000-255**
sp—**000-255**

Default: **none**

Example

To add destination **8-1-1** with **cli** of **systest1**:

ent-dstn:dpc=8-1-1:cli=systest1:bei=yes

To add destination **8-8-8** with ITU and national aliases:

ent-dstn:dpc=8-8-8:aliasi=1-2-3:aliasn=124

To add cluster **20-2-***:

ent-dstn:dpc=20-2-*:elei=yes:bei=yes

To add a destination with an SPC of **100-100-100**:

ent-dstn:dpc=20-2-2:spc=100-100-100

To add nested cluster **21-2-***:

ent-dstn:dpc=21-2-*:elei=yes:bei=yes:ncai=yes

To add network routing destination **21-*.***:

ent-dstn:dpc=21-*.*

To add ITU national destination **7654** with a group code of **fr** and secondary point code of **7050**:

ent-dstn:dpcn=7654-fr:spc=7050-fr

To add ITU-N 24-bit destination **15-100-10**:

ent-dstn:dpcn24=15-100-10:bei=no

To add a 24-bit ITU-N destination with a 24-bit ITU-N secondary point code of **99-99-99**:

ent-dstn:dpcn24=12-12-12:spcn24=99-99-99

To add destination **1-6-1** with a 24-bit ITU-N alias:

ent-dstn:dpci=1-6-1:aliasn24=4-4-4

To add private ANSI destination point code **p-100-100-101**:with spare point code alias **s-1-123-1**

ent-dstn:dPCA=p-100-100-101:spca=2-2-3:aliasi=s-1-123-1:aliasn=128

To add spare ITU-I destination point code **s-2-100-1** with ANSI alias point code **121-120-120** and ITU-N alias spare point code **s-129**:

ent-dstn:dpci=s-2-100-1:spci=s-2-129-9:aliasa=121-120-120:aliasn=s-129

To add spare ITU-N destination point code **s-231** with ITU-N secondary point code **129**, ANSI alias point code **120-120-122**, and ITU-I alias spare point code **s-2-123-2**:

```
ent-dstn:dpcn=s-231:spcn=129:aliasa=120-120-122:aliasi=s-2-123-2
```

Dependencies

NOTE: A *full point code* contains numerical values for all three segments of the point code.

A destination is defined with a mandatory true point code of one format, and two optional alias point codes that are of the other two formats. Alias point codes are used to provide alternate point codes for a particular destination. The true point code must be of the same format as the point code used for the self ID of the system and must match the format of the point code used for the destination node. For example, if the destination node uses an ANSI point code, then the true point code must be an ANSI point code.

The ANSI self-ID destination point code for the STP must be defined before ANSI destinations can be entered.

The ITU-I self-ID destination point code for the STP must be defined before ITU-I destinations can be entered.

The ITU-N self-ID destination point code for the STP must be defined before ITU-N destinations can be entered.

The 24-bit ITU-N self-ID destination point code for the STP must be defined before 24-bit ITU-N destinations can be entered. (See the **chg-sid** command).

The Destination point code table can contain up to 2000 entries.

The destination address must be a full point code or a cluster point code.

The specified destination address cannot already exist in the Destination entity set.

A destination address cannot already be defined as an alias address.

The Spare Point Code Support feature must be enabled before the spare point code prefix **s-** can be specified for an ITU-I or ITU-N destination, secondary, or alias point code.

When a private point code is specified, the destination address must be a full point code.

The specified **dpc** value cannot match the point code, secondary point code, or capability point code of the system.

A destination can have up to two alias point codes. A destination alias point code type (ANSI, ITU-I, ITU-N, ITU-N24) must not match that destination's true point code type. If both alias point codes are defined, the point code types of the aliases must not match.

Alias point codes are supported only for destinations in the SS7 domain (**domain=ss7**).

Alias point codes are supported only for full point code destinations.

Alias point codes for destinations must be full point codes.

An alias point code cannot already be defined as a destination point code.

The format of the specified **dpcn** or **aliasn** parameter must match the format that was assigned with the **chg-stpopts:npcfnti** parameter.

When the 7000 Routesets or 8000 Routesets feature is enabled, the total number of provisioned aliases in the system cannot exceed 8000.

If an ANSI or ITU-I point code is specified, either the **aliasn** or the **aliasn24** parameter can be specified, but not both.

A 24-bit ITU-N point code cannot have:

- A 14-bit ITU-N alias point code
- An ANSI alias point code

A 24-bit ITU-National point code can have an ITU-I point code alias. This allows conversion of 14-bit ITU-I routing label to 24-bit routing label and vice versa.

An ITU-I point code can have either a 14-bit ITU-N alias or a 24-bit ITU-N alias, but not both.

A 14-bit ITU-N point code cannot have a 24-bit ITU-N alias point code.

An ANSI point code cannot have a 24-bit ITU-N alias point code.

The X.25/SS7 Gateway feature (X25G) feature must be turned on before the **domain=x25** parameter can be specified.

If the **dpci**, **dpcn**, or **dpcn24** parameter is specified, the **domain=x25** parameter cannot be specified.

Cluster destinations are not supported in the X.25 domain (**domain=x25**).

Cluster destinations are allowed only if the CRMD feature is turned on.

A cluster destination cannot be defined using the same network identifier (*ni*) and network cluster (*nc*) subfields of any previously defined alias ANSI point codes.

The CRMD (Cluster Routing and Management Diversity) and NCR (Nested Cluster Routing) features must be turned on before the **ncai** parameter can be specified.

If the **ncai** parameter is set to **yes**, the maximum number of provisioned nested clusters must be no greater than 500.

When a cluster point code is specified, the collection of signaling points sharing the same network identifier (*ni*) and network cluster (*nc*) subfields must have the same route set.

Cluster DPCs are not allowed to inherit cluster members that have routes with A or E linkset types.

Network routing is valid only if the Network Routing (NRT) feature is turned on.

When using network routing, if the destination point code has a value of * in the *nc* subfield, the *ncm* subfield must also be * (for example, **dpc=21-*-***).

The **ncai** parameter can be specified only for cluster destinations.

The **bei** parameter can be specified only for cluster destinations.

Alias ANSI point codes cannot have the same network identifier (*ni*) and network cluster (*nc*) subfields as a cluster point code that is already defined.

The CRMD feature must be turned on before the **elei** parameter can be specified.

The **elei** parameter can be specified only for cluster destinations (for example **dpc=ni-nc-***).

The **cli** of the destination point code cannot match the **cli** of the system.

A reserved word cannot be specified for the destination identifier (**cli**).

If the corresponding destination for the specified destination point code is an adjacent signaling point (matched a Far End point code in its linkset entity set), the **cli** of the specified destination point code cannot be assigned to any other destination address.

If the system is configured to use ANSI point codes, the network indicator value (*ni*) of the specified destination point code must be equal to or greater than **6** when the cluster value (*nc*) is **0**.

If specified, the **spc** parameter value must be already be configured as a secondary point code in the Secondary Point Code table.

If specified, the **spc** parameter value must be a full point code (except when **spc=none**).

If the **spc** parameter is specified, the **domain=ss7** parameter must be specified.

If the **spc** parameter is specified (except when **spc=none**), the specified destination point code (**dpc**) must be a full point code.

If the **spc** parameter is specified (except when **spc=none**), its network type must match the network type for the destination point code (**dpc**).

If an ITU national destination is provisioned and the ITUDUPPC feature is turned on, the following applies depending on whether the destination uses a secondary point code (SPC):

- If the destination does **not** use an SPC, the group code of the destination must be the same as the group code of the ITU national true point code.
- If the destination uses an SPC, then the group code of the destination must match the group code of the SPC.

For example, if the ITU national true point code has a group code of **ee**, then you can add destinations with group codes of **ee** without using an SPC. Destinations with a group code of **ff**, however, must use an SPC with a group code of **ff**.

The Route table cannot be full.

Notes

Upon initial installation of the system, the self point code must be entered before you enter any destination.

When you define a DPC with the unique destination signaling point of a provisioned cluster, the DPC automatically inherits the route set of its cluster if the **ncai** parameter is set to **no**. If the **ncai** parameter is set to **yes**, the provisioned members can have a different route set.

When you define a cluster point code for previously defined destination signaling points, the cluster automatically inherits the unique route set of its members.

For ITU national duplicate point codes, you cannot change a destination's group code. To move a destination from one group to another, provision a new destination that uses the new group code and delete the old destination.

The system requires that the destination point code of each routeset be entered in the database. For example, to enter 6000 routesets in the database, 6000 destination point codes must be entered in the database.

If you have turned on the 5000 Routes feature, prior to provisioning the additional routing table entries, you must issue the **chg-sptopts** command to specify the maximum number of allowed DPCs and dynamic x-list entries.

When the 6000, 7000, or 8000 Routesets feature is enabled, if you want to enter more than 2000 destination point codes, the maximum number of point codes that can be configured on the system must be changed to 6000, 7000, or 8000 respectively, using the **mtpdpcq** parameter of the **chg-sptopts** command.

In this command, only ITU-international and ITU national point codes and aliases support the spare point code subtype prefix (**s-**). Only ITU-international and ITU national point codes support the private and spare point code subtype prefix (**ps-**). All of the point code types support the private (internal) point code subtype prefix (**p-**). Aliases do not support the private (internal) point code prefix.

Output

The following example shows the display of the destination memory space accounting command completion response with the NCR, NRT, and CRMD features off (disabled) and all Routes and Routesets features off (disabled):

```
ent-dstn:dpc=8-8-8:aliasi=1-2-3:aliasn=124
rlghncxa03w 04-08-17 15:35:05 EST EAGLE 31.8.0
Destination table is (10 of 2000) 1% full
Alias table is (8 of 12000) 1% full
ENT-DSTN: MASP A - COMPLTD
;
```

The following example shows the display of the destination memory space accounting command completion response with the NCR, NRT, and CRMD features off (disabled) and the DSTN5000 (5000 Routes) feature on:

```
ent-dstn:dpc=8-8-8:aliasi=1-2-3:aliasn=124
rlghncxa03w 04-08-18 08:29:15 EST EAGLE 31.8.0
Destination table is (10 of 5000) 1% full
Alias table is (8 of 12000) 1% full
ENT-DSTN: MASP A - COMPLTD
;
```

The following example shows the display of the destination memory space accounting command completion response with one or more of the NCR, NRT, or CRMD features on and the DSTN5000 (5000 Routes) feature on:

ent-dstn:dpc=8-8-8:aliasi=1-2-3:aliasn=124

```
rlghncxa03w 04-08-18 08:29:15 EST EAGLE 31.8.0
DESTINATION ENTRIES ALLOCATED: 5000
  FULL DPC(s): 9
  NETWORK DPC(s): 0
  CLUSTER DPC(s): 1
  TOTAL DPC(s): 10
  CAPACITY (% FULL): 1%
ALIASES ALLOCATED: 12000
  ALIASES USED: 8
  CAPACITY (% FULL): 1%
X-LIST ENTRIES ALLOCATED: 500
ENT-DSTN: MASP A - COMPLTD
```

;

The following example shows the display of the destination memory space accounting command completion response with the NCR, NRT, and CRMD features off (disabled) and the 6000 Routesets feature on:

ent-dstn:dpc=8-8-8:aliasi=1-2-3:aliasn=124

```
rlghncxa03w 04-08-18 08:29:15 EST EAGLE 31.8.0
Destination table is (60 of 6000) 1% full
Alias table is (8 of 12000) 1% full
ENT-DSTN: MASP A - COMPLTD
```

;

The following example shows the display of the destination memory space accounting command completion response with one or more of the NCR, NRT, or CRMD features on and the 6000 Routesets feature on:

ent-dstn:dpc=8-8-8:aliasi=1-2-3:aliasn=124

```
rlghncxa03w 04-08-18 08:29:15 EST EAGLE 31.8.0
DESTINATION ENTRIES ALLOCATED: 6000
  FULL DPC(s): 46
  NETWORK DPC(s): 1
  CLUSTER DPC(s): 1
  TOTAL DPC(s): 12
  CAPACITY (% FULL): 1%
ALIASES ALLOCATED: 12000
  ALIASES USED: 8
  CAPACITY (% FULL): 1%
X-LIST ENTRIES ALLOCATED: 500
ENT-DSTN: MASP A - COMPLTD
```

;

The following example shows the display of the destination memory space accounting command completion response with the NCR, NRT, and CRMD features off (disabled). When the 7000 Routesets quantity feature is on, the Destination table line shows "...of 7000" as it appears in the example. When the 8000 Routesets quantity feature is on, the Destination table line shows "...of 8000".

ent-dstn:dpc=8-8-8:aliasi=1-2-3:aliasn=124

```
rlghncxa03w 04-08-18 08:29:15 EST EAGLE 31.8.0
Destination table is (60 of 7000) 1% full
Alias table is (8 of 8000) 1% full
ENT-DSTN: MASP A - COMPLTD
```

;

The following example shows the display of the destination memory space accounting command completion response with one or more of the NCR, NRT, or CRMD features on: When the 7000 Routesets quantity feature is on, the DESTINATION ENTRIES ALLOCATED line shows "8000" as it appears in the example. When the 7000 Routesets quantity feature is on, the DESTINATION ENTRIES ALLOCATED line shows "7000".

ent-dstn:dpc=8-8-8:aliasi=1-2-3:aliasn=124

```
rlghncxa03w 04-08-18 08:29:15 EST EAGLE 31.8.0
DESTINATION ENTRIES ALLOCATED: 8000
  FULL DPC(s): 9
  NETWORK DPC(s): 0
  CLUSTER DPC(s): 1
  TOTAL DPC(s): 10
  CAPACITY (% FULL): 1%
ALIASES ALLOCATED: 8000
  ALIASES USED: 8
  CAPACITY (% FULL): 1%
X-LIST ENTRIES ALLOCATED: 500
ENT-DSTN: MASP A - COMPLTD
```

;

ent-e1**Enter E1 Interface**

Use this command to enter an interface into the system for a 2-port E1 card, an E1/T1 MIM card, an HC-MIM card used as an E1 card, or an HC-MIM card used as an SE-HSL card. You must specify the E1 port number on the card and the E1 card location in the EAGLE 5 SAS.

CRC4, CAS, CCS, encoding, timing source, and NFAS signaling bit options can be set with the command parameters. Do not use the DIP switches, if any, on E1 and Channel cards to define the E1 interface.

The E1 card can have a DIP switch called E1BKEN, which is used to enable or disable data transmission on the E1 backplane. Because there is no command parameter that corresponds to the DIP switch, the default value of enabled is assumed. The backplane is enabled for data transmit and receive on E1 port number 1.

On a HC-MIM card, E1 ports 1, 3, 5, and 7 (master ports) can be independently channel bridged with their adjacent even-numbered (slave) E1 ports 2, 4, 6, and 8 to allow non-signaling data pass-through.

Any 2 of the 8 ports on an HC-MIM card can be specified when the card is used as an HC-MIM card. No more than 2 ports on the SE-HSL card can have defined E1 interfaces.

Keyword: ent-e1

Related Commands: chg-e1, dlt-e1, rtrv-e1, tst-e1

Command Class: Database Administration

Parameters

:e1port= (mandatory)

E1 card port number. The value must be a E1 port for which an interface has not been configured on the specified E1 card.

Range: 1-8

Ports 3 through 8 can be specified only for HC-MIM cards.

Any 2 of the 8 ports on an HC-MIM card can be specified when the card is used as an SE-HSL card.

:loc= (mandatory)

The card location as stenciled on the shelf of the system.

Range: 1101–1108, 1111–1112, 1201–1208, 1211–1218, 1301–1308, 1311–1318, 2101–2108, 2111–2118, 2201–2208, 2211–2218, 2301–2308, 2311–2318, 3101–3108, 3111–3118, 3201–3208, 3211–3218, 3301–3308, 3311–3318, 4101–4108, 4111–4118, 4201–4208, 4211–4218, 4301–4308, 4311–4318, 5101–5108, 5111–5118, 5201–5208, 5211–5218, 5301–5308, 5311–5318, 6101–6108, 6111–6118

:crc4= (optional)

CRC4 enable or disable indicator.

Range: on, off

Default: on

:cas= (optional)

CAS multiframing (**on**) or CCS (**off**) indicator.

Range: on, off

CAS cannot be specified for HC-MIM cards.

Default: off

:chanbrdg= (optional)

Port bridging status. Indicates whether an HC-MIM card odd-numbered E1 port is channel bridged with its adjacent even-numbered E1 port for non-signaling data pass through.

Range: on, off

Default: off

:encode= (optional)

Indicator for use of HDB3 or AMI encoding/decoding.

NOTE: AMI is not supported for the 2-port E1 card; AMI is supported for an E1/T1 MIM card, or HC-MIM card, that is used as an E1 card.

Range: hdb3, ami

Default: hdb3

:e1tsel= (optional)

Timing source. Indicates master (external) or slave (line) timing source, or timing source recovered from the paired master port for channel bridged slave ports.

Range: line, external, recovered

Default: line

:linkclass= (optional)

Link class for links that are assigned to HC-MIM cards ("channelized" links) or SE-HSL cards ("unchannelized" links).

Range: chan, unchan

Default: chan

:minsurate= (optional)

Minimum signal unit rate. Indicates the minimum number of SUs present on a link uniformly distributed. This parameter is valid only when the **linkclass=unchan** parameter is specified for an SE-HSL card.

Range: 500-2000

Default: 2000

:si= (optional)

Value of two Spare International bits of NFAS data.

Range: One digit, values 0-3

Default: 0

:sn= (optional)

Value of five Spare International bits of NFAS data.

Range: 0-31

One or two digits

Default: 0

Example

```
ent-e1:loc=1205:e1port=1:crc4=off:cas=on:encode=hdb3:e1tsel=external:si=2:sn=12
```

```
ent-e1:loc=1205:e1port=2:cas=off:encode=ami
ent-e1:loc=1203:e1port=1:chanbrdg=on:e1tsel=recovered
ent-e1:loc=1203:e1port=3:chanbrdg=on:e1tsel=external
ent-e1:loc=1203:crc4=on:e1port=2:encode=hdb3:e1tsel=line:linkclass=unchan
:minsrate=2000
```

Dependencies

The specified card location (**loc** parameter) must be equipped.

When the **linkclass=unchan** is specified for an SE-HSL card (the card occupies 2 slots), the even-numbered card location for the card must be unequipped. Only the odd-numbered card location can be specified in the **loc** parameter.

The card specified by the **loc** parameter must be a **lime1** card type.

The port specified by the **e1port** parameter must not already be equipped with an E1 interface.

The value of **ami** for the **encode** parameter is supported only for the E1/T1 MIM card or the HC-MIM card used as an E1 card, and not for the 2-port E1 card.

The **cas=on** parameter cannot be specified for HC-MIM cards.

The **cas=on** parameter cannot be specified when the **linkclass=unchan** parameter is specified.

The **chanbrdg** parameter can be specified only for HC-MIM cards.

The **chanbrdg=on** parameter cannot be specified for HC-MIM card even-numbered E1 ports.

The **chanbrdg=on** parameter cannot be specified for HC-MIM card even-numbered card locations.

The timing source parameter **e1tsel** must be specified if **chanbrdg=on** is specified.

The **e1tsel=line** parameter cannot be specified if the specified HC-MIM E1 port is in channel bridging mode.

The **e1tsel=recovered** parameter cannot be specified if the specified HC-MIM E1 port is not in channel bridging mode.

The **e1port** parameter values **3** through **8** cannot be specified for an even-numbered HC MIM card location.

Only 2 ports can be used for E1 interfaces on an HC-MIM card that is used as an SE-HSL card. Any 2 of the 8 ports can be used on the SE-HSL card.

When provisioning an odd-numbered E1 HC-MIM port to channel bridging mode, **force=yes** must be specified if the adjacent even-numbered port is already provisioned.

All signaling links assigned to its adjacent even-numbered E1 port must be deleted before an odd-numbered HC-MIM E1 port can be provisioned into channel bridging mode.

The fan feature bit must be on before HC-MIM cards (used as E1 cards or as SE-HSL cards) can be used in an EAGLE shelf (see the **chg-feat** command). The system checks the fan feature bit when E1 ports **3** through **8** are specified.

HIPR cards must be equipped in card locations *xy09* and *xy10* (*x* is the frame, *y* is the shelf) on each shelf that contains one or more HC-MIM cards that are used as E1 cards of SE-HSL cards. The system checks for HIPR cards when HC-MIM E1 ports **3** through **8** are specified.

The **chanbrdg=on** parameter cannot be specified when the **linkclass=unchan** parameter is specified.

An SE-HSL feature quantity must be enabled before the **linkclass=unchan** parameter can be specified for an SE-HSL card. (See the **enable-ctrl-feat** command and the SEHSL SLK Capacity entry in the **rtv-ctrl-feat** command output example).

The **linkclass=unchan** parameter cannot be specified for even numbered card locations.

The **minsurate** parameter can be specified only when the **linkclass=unchan** parameter is specified.

Channelized and unchannelized E1 ports (mixed mode) are not allowed on a single HC-MIM card (the card cannot be used as an HC-MIM E1 card and an SE-HSL card at the same time).

Notes

One or two E1 interfaces must be defined on an E1 card after the E1 and any associated Channel cards (types **lime1** and **limch**) are defined in the database (with the **ent-card** command), and before the signaling links and associated timeslots are defined for the E1 card and any associated Channel cards (with the **ent-slk** command).

For an SE-HSL card, the **minsurate** parameter indicates the least number of SUs present on a link uniformly distributed. The number of SUs present is:

- Without link traffic, the **minsurate** parameter value.
- With link traffic, the **minsurate** value minus the number of MSUs.

When **e1tsel=external** is specified, a user-supplied BITS clock is required.

External timing is derived from the EAGLE High-Speed Master Clock (1.544 MHz for T1 or 2.048 MHz for E1); the Master Timing feature is required. Line timing is derived from its received data stream, if present.

Up to 8 E1 interfaces can be defined on an HC-MIM card used as a E1 card after the E1 card type (**lime1**) is defined in the database (with the **ent-card** command), and before the signaling links and associated timeslots are defined for the E1 card.

On a HC-MIM card, E1 ports 1, 3, 5, and 7 (master ports) can be independently channel bridged with their adjacent even-numbered (slave) ports 2, 4, 6, and 8 to allow non-signaling data pass-through. The **chanbrdg** parameter must be specified for the odd-numbered E1 port.

Output

```
ent-e1:loc=1205:e1port=1:crc4=off:cas=on:encode=hdb3:e1tsel=external:si=2:sn=12
  rlgncxa03w 04-02-20 09:07:58 EST EAGLE 31.3.0
  ENT-E1: MASP A - COMPLTD
;
```

ent-ftp-serv**Enter FTP Server Entry**

Use this command to write an entry into the FTP Server table for an FTP Server.

NOTE: The FTP Serve table entry for the FTP-based Table Retrieve Application (FTRA) is entered through input from FTRA. Though the entry can be made with this command at the EAGLE, the information entered at the EAGLE will be overwritten by the information sent by FTRA.

Keyword: ent-ftp-serv

Related Commands: chg-ftp-serv, dlt-ftp-serv, rtrv-ftp-serv

Command Class: Database Administration

Parameters

:app= (mandatory)

The FTP Client application that interfaces with the FTP server.

Range: meas, user

meas—the Measurements Platform application

user—the FTP-based Table Retrieve Application (FTRA)

:ipaddr= (mandatory)

IP Address of the FTP Server.

Range: 4 numbers separated by dots, with each number in the range of 000–255.

:login= (mandatory)

FTP Server Username (A prompt for entering a password appears on a separate line).

Range: 1 to 15 alphanumeric characters; mixed-case is allowed

:path= (mandatory)

FTP path used to locate the file that will be sent.

Range: Up to 100 characters; mixed-case string in double quotes with valid FTP path format

Default: User's home directory

:prio= (mandatory)

Priority of this FTP server when there is more than one FTP Server for this application.

Range: 1-10

Example

```
ent-ftp-serv:app=meas:ipaddr=1.255.0.102:login=ftpmeas1:path="~meas":prio=1
```

```
ent-ftp-serv:app=user:ipaddr=1.255.0.102:login=tekiperson1:path="~/data":prio=1
```

Dependencies

A separate prompt appears for you to enter the FTP server password that will be used with the FTP Server Username (**login**). You must enter a password that is at least 1 and not more than 15 characters long. If you enter an invalid password (you press the Return key without entering a password, or you enter more than 15 characters), you must enter the entire command again to cause the password prompt to appear again. The password that you enter is not displayed as you enter it.

An entry for the specified application ID at the specified priority cannot already exist.

An entry for the specified application ID at the specified IP address cannot already exist.

The FTP Server table can contain entries for a maximum of 10 FTP servers. The number of FTP servers supported by an application might be less than 10. For an application, you cannot make entries for more than the maximum number of FTP servers supported by the application.

- The Measurements Platform application (**app=meas**) supports 2 FTP servers.
- The FTP-based Table Retrieve Application (FTRA) (**app=user**) supports 2 FTP servers.

The **app** parameter must specify an application that uses the FTP Support feature.

The **ipaddr** parameter must specify a valid IP address for the FTP server.

The **path** parameter value must be in a valid FTP path format.

The **prio** parameter specifies a priority for use of an FTP server by an application when the application has more than one FTP server defined in the table. Each FTP server defined for use by the application must have a priority from 1 to 10 assigned. The available FTP server with the highest priority (smallest number) will be used first by the application.

Notes

The same FTP server can be defined more than once, but the specified application must be different for each entry.

Output

```
ent-ftp-serv:app=meas:ipaddr=1.255.0.102:login=ftpmeas1:path=~meas":prio=1
```

```
Enter Password:*****
```

```
rlghncxa03w 04-02-20 09:07:58 EST EAGLE 31.3.0
FTP SERV table is (1 of 10) 10% full
ENT-FTP-SERV: MASP A - COMPLTD
```

```
;
```

```
ent-ftp-serv:app=user:ipaddr=1.255.0.102:login=teperson1:path=~data":prio=1
```

```
rlghncxa03w 04-02-20 09:07:58 EST EAGLE 31.3.0
```

```
Enter Password:*****
```

```
rlghncxa03w 04-02-20 09:07:58 EST EAGLE 31.3.0
FTP SERV table is (2 of 10) 20% full
ENT-FTP-SERV: MASP A - COMPLTD
```

```
;
```

ent-gsmmap-scrn**Enter GSM MAP Screening Entry**

Use this command to assign the GSM (Global System for Mobile Telecommunication) MAP (Mobile Application Part) screening entries that filter or allow TCAP messages for certain MAP operation codes. The messages are filtered or allowed based on CgPA GTA+NPV+NAIV, CdPA GTA+NPV+NAIV, and forbidden (**forbid**) parameters. Each CgPA entry is associated with one or more CdPA entries and one or more CgPA entries are associated with a MAP Opcode. This command provisions both CgPA and CdPA entries into the database.

Keyword: ent-gsmmap-scrn

Related Commands: chg-gsmmap-scrn, chg-map, dlt-gsmmap-scrn, dlt-map, rtrv-gsmmap-scrn, rtrv-map

Command Class: Database Administration

Parameters

NOTE: See “Point Code Formats and Conversion” in Appendix A for a detailed description of point code formats, rules for specification, and examples.

:cgsr= (mandatory)

The CGPA screening reference. CGSR uniquely identifies a CGPA entry for a specified OPNAME.

Range: 1 alphabetic character and up to 3 optional alphanumeric characters

:opname= (mandatory)

The user-defined name for the operation code. The **opname** value references the operation code (**opcode**) defined with the **ent-gsms-opcode** command. GSM Map Screening is performed on the specified address or addresses for the referenced operation code.

Range: Up to 8 alphanumeric characters

:cdsr= (optional)

The CDPA screening reference. CDSR uniquely identifies a CDPA entry for a specified combination of CGSR and OPNAME.

Range: 1 alphabetic character and up to 3 optional alphanumeric characters

:action= (optional)

The screening action to take if a message is forbidden as defined by the **forbid** parameter.

Range: **atierr, discard, dupdisc, duplicate, forward, pass, route**

atierr—An ATI (Any Time Interrogation) reject message is generated. This option is only valid for ATI MAP operation codes.

discard—The MSU is to be discarded.

dupdisc—Route the original message to the duplicate node. The original message will not be sent to the original node. If, however, the duplicate node is not available for routing, the MSU is routed to the original node.

duplicate—Route the message as normal to the original destination and route a copy of the original message to the duplicate node. If the MSU fails to route to the duplicate node, a UIM is generated indicating the duplicate routing failure.

forward—Route the original message to the forward node. The original message will not be sent to the original node. If, however, the forward node is not available for routing, the MSU is routed to the original node.

pass—Route the message as normal to the destination.

route—Route the message as normal to the original destination node; no UIM will be generated. The original destination is the node to which normal GTT would be sent if no GSM MAP actions are taken.

Default: **discard**

:eaddr= (optional)

The ending origination address to be screened.

In association with **npv**, **naiv**, and **cgsr**, it is for the ending CGPA address in the range to be screened.

In association with **npv**, **naiv**, **cgsr**, and **cdsr**, it is for the ending CDPA address in the range to be screened.

Range: 1–15 hexadecimal digits of values **0–9, a-f, A-F**

:forbid= (optional)

The forbidden parameter value. Indicates a forbidden parameter for the entered address. If a forbidden parameter is detected the message is rejected by the action defined by the **action** parameter.

Range: **all, none, state, location**

all—All parameters are forbidden. Take the specified screening action defined by the **action** parameter for messages arriving at the system.

none—None of the parameters are forbidden. Route the message to its destination.

state—Take the specified screening action defined by the **naction** parameter for messages arriving at the system that contain **state** as the forbidden parameter for the entered address/operation code combination. Note: The **state** parameter is valid only for GSM ATI messages.

location—Take the specified screening action defined by the **naction** parameter for messages arriving at the system that contain **location** as the forbidden parameter for the entered address/operation code combination. Note: The **location** parameter is valid only for GSM ATI messages.

Default: **all**

:force= (optional)

Check Mated Application Override. This parameter must be used to complete command execution if the **pc/pca/pci/pcn/pcn24** and **ssn** parameter combination specified in the command is not already defined in the SCCP Application entity set (Remote Point Code/Mated Application Table).

Range: **yes, no**

Default: **no**

:naiv= (optional; must be specified together with **npv**)

Nature of Address value for the address or range of CgPA and CdPA addresses. If a message is screened and does not contain matching **npv** and **naiv** values, the message is rejected. The message is rejected with the default action defined by the **ent-gsms-opcode** command for the operation code (**opcode**) parameter entry referenced by the operation name (**opname**) parameter.

Range: **0–127, ***

Default: *****

:npv= (optional must be specified together with **naiv**)

Numbering Plan value for the address or range of CgPA and CdPA addresses. If a message is screened and does not contain matching **npv** and **naiv** values, the message is rejected. The message is rejected with the default action defined by the **ent-gsms-opcode** command for the operation code (**opcode**) parameter entry referenced by the operation name (**opname**) parameter.

Range: 0-15, *

Default: *

:pc/pca/pci/pcn/pcn24= (optional)

Point code. The **pc/pca/pci/pcn/pcn24** and **nssn** parameters are used when the default screening action (**dfact**) is **forward**, **duplicate**, or **dupdisc** (duplicate and discard). These parameters are used to enter the node to which the input message will be routed.

:pc= or **:pca=** (optional)

ANSI point code with subfields *network indicator-network cluster-network cluster member* (*ni-nc-ncm*).

Range: 000-255

Specify a valid value for each subfield of the point code, and separate the subfields with a dash (-).

When **chg-sid:pctype=ansi** is specified, *ni* = 000 is not valid.

When **chg-sid:pctype=ansi** is specified, *nc* = 000 is not valid if *ni* = 001-005.

When **chg-sid:pctype=ansi** is specified, *nc* = 000 is valid if *ni* = 006-255.

The point code 000-000-000 is not a valid point code.

:pci= (optional)

ITU international point code with subfields *zone-area-id*. The *prefix* subfield indicates a spare point code (*prefix-zone-area-id*).

Range: s-, 0-255

Specify a valid value for each subfield of the point code, and separate the subfields with a dash (-).

The point code 0-000-0 is not a valid point code.

prefix—s-

zone—0-7

area—000-255

id—0-7

:pcn= (optional)

ITU national point code in the format of a 5-digit number (*nnnnn*); or 2, 3, or 4 numbers (members) separated by dashes (*m1-m2-m3-m4*) as defined by the **chg-stpopts:npcfinti** flexible point code option. A group code must be specified when the ITUDUPPC feature is turned on (*nnnnn-gc*, *m1-m2-m3-m4-gc*). The *prefix* subfield indicates a spare point code (*prefix-nnnnn*, *prefix-nnnnn-gc*, *prefix-m1-m2-m3-m4*, *prefix-m1-m2-m3-m4-gc*).

Range: s-, 0-16383, aa-zz

Specify a valid value for each subfield of the point code, and separate the subfields with a dash (-).

prefix—s-

nnnnn—0-16383

gc—aa-zz

m1-m2-m3-m4—0-14 for each member; values must sum to 14

:pcn24= (optional)

24-bit ITU national point code with subfields *main signaling area-sub signaling area-signaling point* (*msa-ssa-sp*).

Range: 000-255

Specify a valid value for each subfield of the point code, and separate the subfields with a dash (-).

msa—000-255

ssa—000-255

sp—000-255

:saddr= (optional)

The starting origination address.

In association with **npv**, **naiv**, and **cgsr**, it is for the single CGPA entry or the starting CGPA address in the range to be screened.

In association with **npv**, **naiv**, and **cdsr**, it is for the single CDPA entry or the starting CDPA address in the range to be screened.

Range: 1–15 hexadecimal digits, *

Valid digit values are 0–9, a–f, A–F

Default: *

:ssn= (optional)

Subsystem Number. The **pc**/**pca**/**pci**/**pcn**/**pcn24** and **ssn** parameters are used when the screening action (**action**) is **forward**, **duplicate**, or **dupdisc** (duplicate and discard). These parameters allow the technician to change the defined node to which the input message will be routed.

Range: 002-255

Example

The following example adds a MAP **opname** of **ati** with a range of allowed addresses, defines a forbidden parameter for that range of addresses and an action to take if the forbidden parameter is detected, and sets the **npv** and **naiv** values. This example is wrapped to the next line for readability:

```
ent-gsmmap-scrn:saddr=919461:eaddr=919462:opname=ati:action=discard:forbid=state
:npv=1:naiv=4:cgcr=fela
```

The following example adds a MAP **opname** of **ati** with a range of allowed addresses, defines a forbidden parameter for that range of addresses and an action to take if the forbidden parameter is detected, and sets the **npv** and **naiv** values. The command also defines an ITU International Point Code with Subsystem Number 5, and forbids by **location** messages that have an **action** of **forward**. This example is wrapped to the next line for readability:

```
ent-gsmmap-scrn:saddr=919461:eaddr=919462:opname=ati:action=forward:pci=1-1-1
:ssn=5:force=yes:forbid=location:cgcr=fela
```

The following example adds a MAP **opname** of **xyz** with an allowed hexadecimal address of **abcdefabcdefabc**, defines the action **discard** to take if a forbidden parameter is detected, and sets the **npv** and **naiv** values. The command also defines a CGSR of **fela**. This example is wrapped to the next line for readability:

```
ent-gsmmap-scrn:opname=xyz:saddr=abcdefabcdefabc:npv=10:naiv=10:cgcr=fela
:action=discard
```

The following example shows a spare point code:

```
ent-gsmmap-scrn:opname=test2:cgsr=t1:cdsr=cd3:saddr=125:pci=s-1-1-1:ssn=10
:action=duplicate
```

Dependencies

The GSM Map Screening feature must be turned on (see the **enable-ctrl-feat** and **chg-ctrl-feat** commands) before this command can be entered.

The Enhanced GSM Map Screening (EGMS) feature must be turned on before:

- **saddr=*** can be specified
- **saddr** and **eaddr** values can contain hexadecimal digits
- **cdsr** can be specified
- **pc/pca** can be specified

If the **eaddr** parameter is specified, the **saddr** parameter must be specified.

If the **eaddr** parameter is specified, its value must contain the same number of digits as the **saddr** parameter value.

If the **eaddr** parameter is specified, its value must be greater than the **saddr** parameter value.

If **saddr=*** is specified, the **eaddr** parameter cannot be specified.

If the **opname** parameter is specified, its value must exist in the GSM MAP Op-Code table.

A value of **state** or **location** cannot be specified for the **forbid** parameter unless the operation code (**opcode**) referenced by **opname** is **71**. An operation code of **71** signifies an ATI MAP operation code.

A value of **atierr** cannot be specified for the **action** parameter unless the operation code (**opcode**) referenced by **opname** is **71**. The **atierr** option is only valid for ATI MAP operation codes; **opcode=71** signifies an ATI MAP operation code.

The GSM MAP Screening table cannot be full.

The GSM MAP Screening table must have at least two free entries to provision a CgPA entry, because a default wildcard CdPA entry is created for each CgPA entry.

If a single entry is specified for the CgPA/CdPA (that is, the **eaddr** parameter is not specified), then the **saddr/npv/naiv** and **opname** combination must not already exist in the GSM MAP screening table.

If a range entry is specified for the CgPA/CdPA (that is, the **eaddr** parameter is specified), the **saddr/eaddr/npv/naiv** and **opname** combination must not already exist or overlap another range entry in the GSM MAP screening table.

If a CdPA entry is being created, the **cgsr** must already exist for the specified **opname**.

If a CgPA entry is being created, the **cgsr** cannot already exist for the specified **opname**.

The specified **cdsr** cannot already exist for the specified **cgsr**.

If specified, the **pc/pca/pci/pcn/pcn24** parameter must be a full point code.

If the **action** parameter is specified and its value is **forward**, **duplicate**, or **dupdisc**, the **pc/pca/pci/pcn/pcn24** parameter and the **ssn** parameter must be specified.

The **pc/pca/pci/pcn/pcn24** parameter and the **ssn** parameter can be specified only if the **action** parameter is specified and its value is **forward**, **duplicate**, or **dupdisc**.

The **force** parameter can be specified only if the **pc/pca/pci/pcn/pcn24** parameter and the **ssn** parameter are specified.

If the **pc/pca/pci/pcn/pcn24** parameter and the **ssn** parameter are specified, and the **force** parameter is not specified as **yes**, the PC-SSN must be populated in the SCCP Application entity set (Remote Point Code / Mated Application Table).

The specified **npv** and **naiv** parameter values must be either both numbers or both asterisks (*). The parameters cannot be specified as **:npv=*:naiv=9** or **:npv=9:naiv=***, for example.

If specified, the **pc/pca/pci/pcn/pcn24** parameter value must exist as a destination in the Ordered Route entity set or reside in a cluster (ANSI only) that exists as a destination in the Ordered Route entity set (for global title routing).

Notes

GSM screening entries are handled differently from other screening entries such as GWS (gateway screening) in the system database. The following differences apply to provisioning GSM screening entries:

- GSM screening entries can be either single entries or range entries.
- Single entries have precedence in screening over range entries. Thus the single entries are searched first and if a match is found, the range entries are never searched.
- Range entries can overlap single entries.

In this command, only ITU-international and ITU national point codes support the spare point code subtype prefix (s-).

Output

```
ent-gsmmap-scrn:saddr=123deed:opname=xyz:npv=9:naiv=9:cdsr=fall:cgsr=fela
```

```
rlghncxa03w 04-07-29 08:50:12 EST EAGLE 31.6.0
GSM Map Screening table is (2 of 4000) 1% full
ENT-GSM MAP-SCRN: MASP A - COMPLTD
```

```
;
```

```
ent-gsmmap-scrn:saddr=abcdefabcdefabc:eaddr=abcdefabcdefabd:opname=xyz  
:npv=10:naiv=10:cgsr=fela:action=discard
```

```
rlghncxa03w 04-07-29 08:50:12 EST EAGLE 31.6.0
GSM Map Screening table is (1 of 4000) 1% full
ENT-GSM MAP-SCRN: MASP A - COMPLTD
```

```
;
```

ent-gsms-opcode**Enter GSM MAP Screening Operation Code**

Use this command to assign the concerned GSM (Global System for Mobile Telecommunication) MAP (mobile application part) screening operation codes and the default screening action for the operation code. This command allows the technician to provision a list of all operation codes that the system uses in performing GSM screening.

Keyword: ent-gsms-opcode

Related Commands: chg-gsms-opcode, dlt-gsms-opcode, rtrv-gsms-opcode

Command Class: Database Administration

Parameters

NOTE: See “Point Code Formats and Conversion” in Appendix A for a detailed description of point code formats, rules for specification, and examples.

:opcode= (mandatory)

MAP operation code. This parameter refers to the actual decimal value of the MAP operation codes from the TCAP layer of GSM MAP messages.

Range: 0–255, *

If a decimal Map Opcode is not found in the database, then the asterisk (wildcard *), if provisioned, will constitute a match when screening the MSUs.

:opname= (mandatory)

Name for the operation code. The **opname** value is defined with the **ent-gsms-opcode** command.

Range: Up to 8 alphanumeric characters

:dfltact= (optional)

Default screening action for a MAP operation code. The default screening action is used when a matching CGPA address+NPV+NAIV entry is not found in the GSM MAP screening table.

Range: **atierr, discard, dupdisc, duplicate, forward, pass, route**

atierr—Do not route the MSU. An ATI (Any Time Interrogation) reject message is generated. This option is only valid for ATI MAP operation codes.

discard—Do not route the MSU. The MSU is discarded (thrown away) and an appropriate UIM is issued.

dupdisc—Route the original message to the duplicate node. The original message will not be sent to the original node. If, however, the duplicate node is not available for routing, the MSU is routed to the original node.

duplicate—Route the message as normal to the original destination and route a copy of the original message to the duplicate node. If the MSU fails to route to the duplicate node, a UIM is generated indicating the duplicate routing failure.

forward—Route the original message to the forward node. The original message will not be sent to the original node. If, however, the forward node is not available for routing, the MSU is routed to the original node.

pass—Route the message as normal to the destination.

route—Route the message as normal to the original destination node; no UIM will be generated. The original destination is the node to which normal GTT would be sent if no GSM MAP actions are taken.

Default: discard

:force= (optional)

Check Mated Application Override. This parameter must be used to complete command execution if the **pc/pca/pci/pcn/pcn24** and **ssn** parameter combination specified in the command is not already defined in the SCCP Application entity set (Remote Point Code/Mated Application Table).

Range: yes, no

Default: no

:pc/pca/pci/pcn/pcn24= (optional)

Point code. The **pc/pca/pci/ncn/pcn24** and **ssn** parameters are used when the default screening action (**dfiltact**) is **forward**, **duplicate** or **dupdisc** (duplicate and discard). These parameters allow the technician to change the defined node to which the input message will be routed.

:pc= or :pca= (optional)

ANSI point code with subfields *network indicator-network cluster-network cluster member* (*ni-nc-ncm*).

Range: 000-255

Specify a valid value for each subfield of the point code, and separate the subfields with a dash (-).

When **chg-sid:pctype=ansi** is specified, *ni* = 000 is not valid.

When **chg-sid:pctype=ansi** is specified, *nc* = 000 is not valid if *ni* = 001-005.

When **chg-sid:pctype=ansi** is specified, *nc* = 000 is valid if *ni* = 006-255.

The point code 000-000-000 is not a valid point code.

:pci= (optional)

ITU international point code with subfields *zone-area-id*. The *prefix* subfield indicates a spare point code (*prefix-zone-area-id*).

Range: s-, 0-255

Specify a valid value for each subfield of the point code, and separate the subfields with a dash (-).

The point code 0-000-0 is not a valid point code.

prefix—s-

zone—0-7

area—000-255

id—0-7

:pcn= (optional)

ITU national point code in the format of a 5-digit number (*nnnnn*); or 2, 3, or 4 numbers (members) separated by dashes (*m1-m2-m3-m4*) as defined by the **chg-stpopts:npfnti** flexible point code option. A group code must be specified when the ITUDUPPC feature is turned on (*nnnnn-gc*, *m1-m2-m3-m4-gc*). The *prefix* subfield indicates a spare point code (*prefix-nnnnn*, *prefix-nnnnn-gc*, *prefix-m1-m2-m3-m4*, *prefix-m1-m2-m3-m4-gc*).

Range: s-, 0-16383, aa-zz

Specify a valid value for each subfield of the point code, and separate the subfields with a dash (-).

prefix—s-

nnnnn—0-16383

gc—**aa-zz**

m1-m2-m3-m4—**0-14** for each member; values must sum to 14

:pcn24= (optional)

24-bit ITU national point code with subfields *main signaling area-sub signaling area-signaling point (msa-ssa-sp)*.

Range: **000-255**

Specify a valid value for each subfield of the point code, and separate the subfields with a dash (-).

msa—**000-255**

ssa—**000-255**

sp—**000-255**

:ssn= (optional)

Subsystem Number. The **pc/pca/pci/pcn/pcn24** and **ssn** parameters are used when the default screening action (**dfltact**) is **forward**, **duplicate** or **dupdisc** (duplicate and discard). These parameters allow the technician to change the defined node to which the input message will be routed.

Range: **002-255**

Example

The following example adds a MAP operation code of **71** with a name of **ati** with a default action of **discard**:

```
ent-gsms-opcode:opcode=71:opname=ati:dfltact=discard
```

The following example adds a MAP operation code of **71** with a name of **ati** with a default action of **forward**, an international point code of **1-1-1**, a subsystem number of **5**, and forces:

```
ent-gsms-opcode:opcode=71:opname=ati:dfltact=forward:pci=1-1-1:ssn=5:force=yes
```

The following example adds a MAP operation code of **71** with a name of **ati** with a default action of **duplicate**, an international point code of **1-1-1**, a subsystem number of **5**, and forces:

```
ent-gsms-opcode:opcode=71:opname=ati:dfltact=duplicate:pci=1-1-1:ssn=5:force=yes
```

The following example adds a MAP operation code of **71** with a name of **ati** with a default action of **dupdisc**, an international point code of **1-1-1**, a subsystem number of **5**, and forces:

```
ent-gsms-opcode:opcode=71:opname=ati:dfltact=dupdisc:pci=1-1-1:ssn=5:force=yes
```

The following example adds a MAP operation code of ***** with a name of **xyz** with a default action of **duplicate**, an ANSI point code of **8-8-8**, a subsystem number of **20**:

```
ent-gsms-opcode:opcode=*:opname=xyz:pca=8-8-8:dfltact=duplicate:ssn=20
```

The following example adds a MAP operation code of **22** with a name of **ati** with a default action of **discard**:

```
ent-gsms-opcode:opcode=22:opname=ati:dfltact=discard
```

The following example shows a spare point code:

```
ent-gsms-opcode:opname=test3:opcode=3:pci=s-1-1-1:dfltact=duplicate:ssn=10:force
```

Dependencies

The GSM Map Screening feature (see the **enable-ctrl-feat** command) must be turned on before this command can be entered.

If the **dftact** parameter is specified, one of the following values must be specified: **pass**, **discard**, **atierr**, **route**, **forward**, **duplicate**, or **dupdisc**.

The **opcode** parameter value must be specified as a number in the range **0-255**, or as *****.

The reserved word **none** cannot be specified as a value for the **opname** parameter.

The **pc/pca/pci/pcn/pcn24** and **ssn** parameters can be specified only if the **dftact** parameter is specified and its value is **forward**, **duplicate**, or **dupdisc**.

A **pc/pca/pci/pcn/pcn24** parameter and the **ssn** parameter must be specified if the **dftact** parameter is specified and its value is **forward**, **duplicate**, or **dupdisc**.

The **force** parameter can be specified only if a **pc/pca/pci/pcn/pcn24** parameter and the **ssn** parameter are specified.

A value of **atierr** for the **dftact** parameter cannot be specified unless the value of the operation code (**opcode**) referenced by the **opname** parameter is **71**. The **atierr** option is valid only for ATI MAP operation codes; **opcode=71** signifies an ATI MAP operation code.

The value specified for the **opcode** parameter cannot already exist in the GSM Map Op-Code table.

The value specified for the **opname** parameter cannot already be used in the GSM Map Op-Code table.

If the **pc/pca/pci/pcn/pcn24** parameter and the **ssn** parameter are specified, and the **force** parameter is not specified as **yes**, the PC-SSN must exist in the SCCP Application entity set (Remote Point Code / Mated Application Table).

The Enhanced GSM Map Screening feature must be enabled and turned on before **opcode=*** can be specified and before **pc/pca** can be specified.

If specified, the **pc/pca/pci/pcn/pcn24** parameter value must be a full point code.

If specified, the **pc/pca/pci/pcn/pcn24** parameter value must exist as a destination in the Ordered Route entity set or reside in a cluster (ANSI only) that exists as a destination in the Ordered Route entity set (for global title routing).

Notes

Origination Addresses are considered to be the SCCP CGPA address as well as the Numbering Plan and Nature of Address values.

In this command, only ITU-international and ITU national point codes support the spare point code subtype prefix (**s-**).

Output

```
ent-gsms-opcode:opcode=71:opname=ati:dftact=discard
```

```
rlghncxa03w 04-01-10 11:43:04 EST EAGLE 31.3.0
GSM Map Op-code Table is (1 of 256) 1% full
ENT-GSMS-OPCODE: MASP A - COMPLTD
```

```
;
```

ent-gsmssn-scrn**Enter GSM Subsystem Number Screening Entry**

Use this command to provision origination and destination SSNs (subsystem numbers) to be screened using the GSM (Global System for Mobile Telecommunication) MAP (mobile application part) screening feature. The value of the **ssn** parameter that is entered with this command is added to the GSM SSN screening table. All the MAP messages with the originating or destination **ssn** entered are screened using the GSM Map screening feature.

Keyword: ent-gsmssn-scrn

Related Commands: dlt-gsmssn-scrn, rtrv-gsmssn-scrn

Command Class: Database Administration

Parameters

:ssn= (mandatory)

Subsystem number.

Range: 000–255

:type= (mandatory)

Subsystem type.

Range: dest, orig

dest—The destination SSN

orig—The origination SSN

Example

The following example adds an originating subsystem of 10 to the GSM SSN Screening table:

```
ent-gsmssn-scrn:ssn=10:type=orig
```

Dependencies

The GSM Map Screening feature must be turned on (see the **enable-ctrl-feat** command) before this command can be entered.

A value for the **ssn** and **type** parameter combination cannot be specified that already exists in the GSM SSN screening table.

Notes

None

Output

```
ent-gsmssn-scrn:ssn=10:type=orig
```

```
rlghncxa03w 04-01-10 11:43:04 EST EAGLE 31.3.0  
ENT-GSMSSN-SCRN: MASP A - COMPLTD
```

```
;
```

ent-gta**Enter Global Title Address Information Command**

Use this command to specify the GTA (global title address) information for applicable global title selectors required to specify a global title entry.

This command adds the routing object (a destination address and a subsystem number) for messages requiring a global title translation. The translation is performed on the basis of the global title address (GTA), global title indicator (GTI), numbering plan (NP), nature of address indicator (NAI), and translation type (TT) of each SS7 SCCP message directed to the STP with a routing indicator of 0, indicating a GTT is required.

Keyword: ent-gta

Related Commands: chg-gta, dlt-gta, ent-gtt, rtrv-gta

Command Class: Database Administration

Parameters

NOTE: See “Point Code Formats and Conversion” in Appendix A for a detailed description of point code formats, rules for specification, and examples.

:gta= (mandatory)

Start global title address.

Range: Maximum of 21 digits

:gttsn= (mandatory)

GTT set name. A GTT set is an entity to which global title addresses and selectors are assigned.

Range: 1 leading alphabetic character and up to 8 alphanumeric characters

:pc/pca/pci/pcn/pcn24= (mandatory)

Translated point code.

:pc= or :pca= (mandatory)

ANSI point code with subfields *network indicator-network cluster-network cluster member* (*ni-nc-ncm*). The *prefix* subfield indicates a private point code (*prefix-ni-nc-ncm*).

Range: p-, 000-255

Specify a valid value for each subfield of the point code, and separate the subfields with a dash (-).

prefix—p-

When **chg-sid:pctype=ansi** is specified, *ni = 000* is not valid.

When **chg-sid:pctype=ansi** is specified, *nc = 000* is not valid if *ni = 001–005*.

When **chg-sid:pctype=ansi** is specified, *nc = 000* is valid if *ni = 006–255*.

The point code **000-000-000** is not a valid point code.

:pci= (mandatory)

ITU international destination point code with subfields *zone-area-id*. The *prefix* subfield indicates a spare point code, private point code, or private and spare point code (*prefix-zone-area-id*).

Range: **s-, p-, ps-, 0-255**

Specify a valid value for each subfield of the point code, and separate the subfields with a dash (-).

The point code **0-000-0** is not a valid point code.

prefix—**s-, p-, ps-**

zone—**0-7**

area—**000-255**

id—**0-7**

:pcn= (mandatory)

ITU national point code in the format of a 5-digit number (*nnnnn*); or 2, 3, or 4 numbers (members) separated by dashes (*m1-m2-m3-m4*) as defined by the **chg-stpopts:npcfmti** flexible point code option. A group code must be specified when the ITUDUPPC feature is turned on (*nnnnn-gc, m1-m2-m3-m4-gc*). The *prefix* subfield indicates a spare point code, private point code, or private and spare point code (*prefix-nnnnn, prefix-nnnnn-gc, prefix-m1-m2-m3-m4, prefix-m1-m2-m3-m4-gc*).

Range: **s-, p-, ps-, 0-16383, aa-zz**

Specify a valid value for each subfield of the point code, and separate the subfields with a dash (-).

prefix—**s-, p-, ps-**

nnnnn—**0-16383**

gc—**aa-zz**

m1-m2-m3-m4—**0-14** for each member; values must sum to 14

:pcn24= (mandatory)

24-bit ITU national point code with subfields *main signaling area-sub signaling area-signaling point (msa-ssa-sp)* The *prefix* subfield indicates a private point code (*prefix-ni-nc-ncm*).

Range: **p-, 000-255**

Specify a valid value for each subfield of the point code, and separate the subfields with a dash (-).

prefix—**p-**

msa—**000-255**

ssa—**000-255**

sp—**000-255**

:ri= (mandatory)

Routing indicator.

Range: **gt, ssn**

gt—Allow a called party address with a routing indicator value of “global title.”

ssn—Allow a called party address with a routing indicator value of “DPC/SSN.”

xlat= (mandatory)

Translate indicator.

Range: **dpc, dpcngt, dpcssn**

:ccgt= (optional)

Cancel called global title indicator.

Range: yes, no

Default: no

:egta= (optional)

End global title address.

Range: Maximum of 21 digits

Default: Same as the specified **gta** value

:force= (optional)

Check mated application override. This parameter must be used to complete command execution if the **pci/pcn** and **ssn** parameter combination specified in the command is not already defined in the SCCP Application entity set (Remote Point Code/Mated Application Table).

Range: yes, no

Default: no

:mrnset= (optional)

The MRN set ID.

Range: 1-3000, dflt, none

dflt—The default MRN set.

none—The GTA translation does not participate in any load sharing.

:ngti= (optional)

New GTI code. When the ANSI-ITU-China SCCP Conversion and MGTT features are on and the Translated Point Code is of a different network type, the **ngti** parameter specifies whether the new GTI translation format is GTI type 2 or GTI type 4.

Range: 2, 4

:nmai= (optional)

New Nature of Address Indicator

This parameter identifies Nature of Address Indicator with which to replace the received Nature of Address Indicator.

Range: 0–127

Default: 0xFFFF

:nnp= (optional)

New Numbering Plan

This parameter identifies Numbering Plan with which to replace the received Numbering Plan.

Range: 0–15

Default: 0xFFFF

:npdd= (optional)

New Prefix Digits to be Deleted

This parameter identifies New Prefix Digits to be Deleted with which to replace the received Prefix Digits to be Deleted.

Range: 0–21

Default: 0

:npds= (optional)

New Prefix Digits String

This parameter identifies New Prefix Digits String with which to replace the received Prefix Digits String.

Range: Maximum of 21 digits

Default: No digits

:nsdd= (optional)

New Suffix Digits to be Deleted. This parameter identifies the New Suffix Digits to be Deleted with which to replace the received Suffix Digits to be Deleted.

Range: 0-21

Default: 0

:nsds= (optional)

New Suffix Digits String. This parameter identifies the New Suffix Digits String with which to replace the received Suffix Digits String.

Range: Maximum of 21 digits

Default: No digits

:ntt= (optional)

New translation type.

The point code domain translation types for EGTT are handled by the EAGLE protocol processing as either ANSI or ITU; therefore, ITU applies to ITU-I, ITU-I Spare, ITU-N, and ITU-N Spare. ITU-I includes ITU-I Spare, and ITU-N includes ITU-N Spare.

Range: 000-255

Default: No ntt value provided

:ssn= (optional)

New translated subsystem number.

Range: 000-255

Default: No ssn value provided

Example

The lines in some examples are wrapped for readability:

```
ent-gta:gttsn=lidb:gta=9195554321:xlat=dpc:ri=gt:pc=001-255-253
```

```
ent-gta:gttsn=t800:gta=919460:xlat=dpc:ri=gt:pc=001-255-252
```

```
ent-gta:gttsn=t800:gta=919461:egta=919468:xlat=dpc:ssn:ri=ssn:pc=001-255-252:ssn=254
```

```
ent-gta:gttsn=setint000:gta=391951212000000:egta=391951212399999:xlat=dpc:ssn
:ri=ssn:pci=1-253-1:ssn=255
```

```
ent-gta:gttsn=imsi:gta=591975593000000:egta=591975593299999:xlat=dpcngt:ri=gt
:pci=004-167-25:ntt=4
```

```
ent-gta:gttsn=test:gta=100000:egta=199999:pca=1-1-1:ssn=123:xlat=dpcngt
:ri=gt:npdd=2:nnp=3:nnai=120
```

```
ent-gta:gttsn=test2:gta=123:egta=321:pcn=222:ssn=10:xlat=dpcngt
:ri=gt:npds=999:nnai=100
```

```
ent-gta:xlat=dpc:ssn:ri=ssn:pcn24=8-8-8:gttsn=any:gta=919833:ssn=20
```

```

ent-gta:xlat=dpcssn:ri=ssn:ssn=10:gta=12345678901:egta=23456789012
:nnp=14:nnai=3:pcn=s-124:gttsn=setnat003
ent-gta:xlat=dpcssn:ri=ssn:ssn=10:gta=12345688901:egta=23456889012
:nnp=14:nnai=3:pcn=s-128-aa:gttsn=setnat003
ent-gta:gta=987666799012345678901:egta=987667321099765432101
xlat=dpcngt:ri=gt:pcn=s-124-aa:ntt=234:ccgt=no:gttsn=setnat003:nnp=12:nnai=26
ent-gta:xlat=dpcssn:ri=ssn:ssn=10:gta=13345688901:egta=24456889012
:nnp=14:nnai=3:pci=s-1-230-2:gttsn=itui1
ent-gta:gttsn=tbla:xlat=dpc:ri=gt:pc=1-1-1:gta=1234567700:mrnset=dflt
ent-gta:gttsn=tbla:xlat=dpc:ri=gt:pc=1-1-1:gta=1234567890:egta=2234567890:mrnset=23
ent-gta:gttsn=tbla:xlat=dpcngt:ri=gt:pc=1-1-2:
gta=2345678901:egta=3456789012:mrnset=54
ent-gta:gttsn=tbla:xlat=dpcngt:ri=gt:pc=1-1-3:
gta=3456789012:egta=4567890123:mrnset=none

```

Dependencies

The EGTT feature must be turned on before this command can be entered.

The MGTT feature must be turned on before the **nnp**, **nnai**, **ngti**, **nsdd**, **nsds**, **npdd**, and **npds** parameters can be specified.

The ANSI-ITU-China SCCP Conversion feature must be enabled and turned on before the **ngti** parameter can be specified.

The ANSI-ITU-China SCCP Conversion feature must be enabled and turned on before a translated point code that is of a different domain than the **gttsn** can be specified.

The ANSI-ITU-China SCCP Conversion feature must be on before a translated point code and a translation type in different network types can be specified.

Asterisks cannot be specified for the **ssn** and **ri** parameters.

The **gttsn** parameter must be specified, cannot not have a value of **none**, and must match an existing **gttsn**.

The **pc/pca/pci/pcn/pcn24** parameter cannot be out of range and must be a full point code.

If the **egta** parameter is specified, the **gta** and **egta** values must be the same length and the **egta** value must be greater than the **gta** value.

The length of the specified **gta** parameter must match the number of digits provisioned for the specified GTT set (**gttsn**). If the VGTT (variable length GTT) feature is turned on, there can be up to 10 GTA lengths per GTT set. When the **ent-gta** command is entered to create entries, the software keeps track of the lengths and allows only 10 different lengths. The global title address specified for the GTT set must have the same number of digits as an existing GTA.

The maximum length of the resulting GTA string must not exceed 21 digits when translation is complete.

The specified **gta/egta** range must exist for the specified GTT set in the STP active database. While an exact match is not required, you cannot specify an overlap with another range. If the range overlaps, an error is generated that displays a list of overlapped point codes. An example follows that shows what happens when the user attempts to enter a point code range (such as 8005550000 to 8005559999) that overlaps an existing range. The overlapping links must match. If they do not, error message E2401 is generated displaying the list of overlapped point codes:

```
The following GTA ranges overlap the input GTA range
START GTA          END GTA
8005550000         8005551999
8005552000         8005553999
8005554000         8005555999
ENT-GTA: MASP A - Command Aborted
```

The new translation type (**ntt**) must match that of an existing ANSI GTT selector that is assigned to a GTT set (**gttsn**).

The new translation type (**ntt**) cannot already be defined as an alias.

When the ANSI-ITU-China SCCP Conversion feature is on and the **ntt** parameter is specified, the **ri=gt** parameter must be specified.

When the ANSI-ITU-China SCCP Conversion feature is on, the **ntt** parameter can be specified only when the **xlat** parameter value is **dpc** or **dpcngt**.

The **ngti** parameter can be specified only when the translated point code and the translation type are in different domains, or are both in the ITU domain.

The **nsdd** and **nsds** parameters cannot be used in the same command with the **npdd** and **npds** parameters.

When **ngti=4** is specified, **nnp** and **nnai** must be specified.

When **ngti=4** is specified, the translated point code cannot be ANSI. For ANSI point codes, the GTI value must be 2.

When **ngti=2** is specified, **nnp** and **nnai** cannot be specified.

The **ccgt** and **ngti** parameters cannot be specified together in the command.

When the ANSI-ITU-China SCCP Conversion feature is not on and the specified GTT set is an ANSI set, the **pc/pca** parameter must be a valid ANSI point code.

When the ANSI-ITU-China SCCP Conversion feature is not on and the specified GTT set is an ITU set, the **pci/pcn/pcn24** parameter must be a valid ITU point code.

If the **xlat=dpcngt** parameter is specified, the **ri=gt** parameter must be specified.

If **xlat=dpcngt** is specified, the **ntt** parameter must be specified.

If the **ntt** parameter is specified, the **xlat=dpcngt** parameter must be specified.

If the **ssn** parameter is specified, the **xlat=dpcssn** parameter must be specified.

If **xlat=dpcssn** is specified, then the **ssn** parameter must be specified.

The **mrnset** parameter must not be specified if the **ri = ssn**.

If the value specified for the **pc/pca/pci/pcn/pcn24** parameter is the STP's true point code, the **xlat=dpcssn** and **ri=ssn** parameters must be specified.

If the value specified for the **pc/pca/pci/pcn/pcn24** parameter is the STP's true point code and the **ssn** parameter is specified, the **ssn** parameter must exist in the SS-APPL table.

Except when the point code is the STP true point code, the value specified for the **pc/pca/pci/pcn/pcn24** parameter must exist as a destination in the Route table or reside in a cluster that exists as a destination in the Route table (for global routing).

If a final GTT (**ri=ssn**) is specified with the **xlat=dpc** parameter and without the **force=yes** parameter, the point code (**pc/pca/pci/pcn/pcn24**) must exist in the Remote Point Code/Mated Application (MAP) table. The **force=yes** parameter can be specified to execute the command when the point code is not in the table; the following warning message is displayed in the scroll area of the terminal:

CAUTION: DPC DOES NOT EXIST IN MATED APPLICATION TABLE.

If the **ccgt=yes** parameter is specified, the **ri=ssn** parameter must be specified.

If the **pc/pca/pci/pcn/pcn24** parameter is any of the STP's point codes or capability point codes, the **ccgt=no** parameter must be specified.

If the XGTT feature is enabled, the GTT table can contain up to either 400,000 or 1,000,000 entries, depending on the controlled feature Part Number that is enabled. If XGTT is not enabled, the GTT table can contain up to 269,999 user entries. An error message is displayed if a command entry would result in more than the allowed maximum number of entries in the table.

The specified PC (**pc**) must already exist in the specified MRN set if the Flexible GTT Load Sharing feature is enabled.

The specified MRN set must already exist in the MRN table.

The **mrnset** parameter must be specified if the Flexible GTT Load Sharing feature is enabled.

The **mrnset** parameter must be specified if the **ri = gt** parameter is specified.

Notes

When the EGTT feature is turned on, the GTT Selector (**ent/chg/dlt/rtrv-gttset**), GTT Set (**ent/dlt/rtrv-gttset**), and GTA (**ent/chg/dlt/rtrv-gta**) commands replace the Translation Type (**ent/dlt/rtrv-tt**) and Global Title Translation (**ent/chg/dlt/rtrv-gtt**) commands. All data previously provisioned with these commands is maintained.

In this command, only ITU-international and ITU national point codes support the spare point code subtype prefix (**s-**) and the private and spare point code subtype prefix (**ps-**). All of the point code types support the private (internal) point code subtype prefix (**p-**).

The Flexible GTT Load Sharing feature allows multiple relationships to be defined among sets of destination point codes in the Mated Relay Node (MRN) table. The relationship used in a particular translation is based on the GTA digits used for translation.

The MRN set along with the post-translation PC formulates a key that is used for a lookup in the MRN table. The MRN table lookup provides a set of alternate PCs for routing the MSU in the most cost effective way.

The default MRN set consists of multiple load sharing groups of PCs that allow both GTT features and MPS-based features to run in parallel. However, MPS-based features are limited to using ONLY the default MRN set. GTT features can be provisioned to use the default MRN set as well. To operate on entries in the default mrnset, specify **dflt** as the value of the MRN Set.

Output

```
ent-gta:gtsn=lidb:gta=9195554321:xlat=dpc:ri=gt:pc=001-255-253
```

```
rlghncxa03w 04-01-20 09:07:58 EST EAGLE 31.3.0
ENT-GTA: MASP A - CMPLTD
```

```
;
```

ent-gtcnv

Enter Global Title Conversion

Use this command to provision the Default Global Title Conversion table. The table is used during conversion for MTP-routed cross network SCCP UDT, UDTS and SCCP Management messages. It is also used during conversion for GT routed messages when a matching entry exists in the Global Title address table but the NGTI value is not provisioned.

Keyword: ent-gtcnv

Related Commands: chg-gtcnv, dlt-gtcnv, rtrv-gtcnv

Command Class: Database Administration

Parameters

:dir= (mandatory)

Direction of conversion.

Range: atoi, itoa, both

atoi—ANSI to ITU conversion

itoa—ITU to ANSI conversion

both—conversion in both directions

:gtixlat= (mandatory)

Global Title Indicator conversion. This parameter is expressed in the form of the ANSI GTI and the ITU GTI.

Range: 22, 24

22—Converts an incoming ANSI GTI 2 to an outgoing ITU GTI 2 or an incoming ITU GTI 2 to an outgoing ANSI GTI 2

24—Converts an incoming ANSI GTI 2 to an outgoing ITU GTI 4 or an incoming ITU GTI 4 to an outgoing ANSI GTI 2

:tta= (mandatory)

ANSI translation type.

Range: 0-255, *

:tti= (mandatory)

ITU translation type.

Range: 0-255, *

:np= (optional)

Numbering Plan. This parameter is mandatory when **gtixlat=24** is specified, and not specified when **gtixlat=22** is specified.

Range: 0-15, *

Default: Not set

:nai= (optional)

Nature of Address Indicator. This parameter is mandatory when **gtixlat=24** is specified, and not specified when **gtixlat=22** is specified.

Range: 0-63, *

Default: Not set

:npdd= (optional)

The number of New Prefix Digits to be Deleted, which will be replaced with the New Prefix Digits String (**npds**)

Range: 0-21

Default: 0

:npds= (optional)

The New Prefix Digits String with which to replace the received Prefix Digits String that is deleted (**npdd**).

Range: Maximum of 21 digits

Default: No digits

:nsdd= (optional)

New Suffix Digits to be Deleted. This parameter identifies the New Suffix Digits to be Deleted with which to replace the received Suffix Digits to be Deleted.

Range: 0-21

Default: 0

:nsds= (optional)

New Suffix Digits String. This parameter identifies the New Suffix Digits String with which to replace the received Suffix Digits String.

Range: Maximum of 21 digits

Default: No digits

Example

The following example assigns an entry used for ANSI to ITU conversion where the conversion is from GTI 2 to GTI 2.

```
ent-gtcnv:dir=atoi:gtixlat=22:tta=10:tti=5
```

The following example assigns an entry used for ANSI to ITU conversion where the conversion is from GTI 2 to GTI 4. The **nsdd** parameter specifies that the last 3 digits are to be removed from the end of the address digits, and the **nsds** parameter specifies that the digits **123** are to be appended to the end of the remaining address digits.

```
ent-gtcnv:dir=atoi:gtixlat=24:tta=11:tti=7:nai=8:np=6:nsdd=3:nsds=123
```

The following example assigns an entry used for ITU to ANSI conversion where the conversion is from GTI 2 to GTI 2. The **npdd** parameter specifies that the first 3 digits are to be deleted from the beginning of the address digits, and the **npds** parameter specifies that the digits 407 should be appended to the beginning of the remaining address digits.

```
ent-gtcnv:dir=itoe:gtixlat=22:tta=11:tti=7:npdd=3:npds=407
```

The following example assigns an entry used for ITU to ANSI conversion where the conversion is from GTI 2 to GTI 4. The **nsds** Parameter specifies that the digits 45667 are to be appended to the end of the address digits.

```
ent-gtcnv:dir=itoe:gtixlat=24:tta=11:tti=7:nai=8:np=6:nsds=45667
```

The following example assigns an entry used for ANSI/ITU conversion in both directions where the conversion is from GTI 2 to GTI 2.

```
ent-gtcnv:dir=both:gtixlat=22:tta=11:tti=7
```

The following example assigns an entry used for ANSI/ITU conversion where an incoming ANSI GTI 2 is converted to an outgoing ITU GTI 4 or an incoming ITU GTI 4 to an outgoing ANSI GTI 2.

```
ent-gtcnv:dir=both:gtixlat=24:tta=12:tti=9:nai=6:np=4
```

The following example assigns a default entry for ANSI to ITU conversion where the conversion is from GTI 2 to GTI 2.

```
ent-gtcnv:dir=atoi:gtixlat=24:tta=*:tti=4:nai=6:np=5
```

The following example assigns a default entry for ITU to ANSI where the conversion is from GTI 2 to GTI 4. The **npds** parameter specifies that the digits 919 are to be appended to the beginning of the address digits.

```
ent-gtcnv:dir=itoe:gtixlat=24:tta=17:tti=*:nai=*:np=*:npds=919
```

Dependencies

The ANSI-ITU-China SCCP Conversion feature must be turned on before this command can be entered.

If **gtixlat=22** is specified, the **nai** and **np** parameters cannot be specified.

If **gtixlat=24** is specified, the **nai** and **np** parameters must be specified.

When **dir=both** is specified, no asterisk (*) parameter values can be specified.

When **dir=atoi** is specified, the asterisk parameter value (*) can be specified only for the **tta** parameter.

When **dir=itoe** is specified, the asterisk parameter value (*) must be specified for the **tti**, **np**, and **nai** parameters.

The specified **dir**, **tta**, **tti**, **np**, and **nai** parameter combination cannot already exist in the database.

The **nsdd** and **nsds** parameters cannot be used in the same command with the **npdd** and **npds** parameters.

The Default Global Title Conversion table can contain a maximum of 1000 entries.

Notes

The use of asterisks (wildcards) is allowed only once for each direction of ANSI to ITU and ITU to ANSI. This provides a configurable default.

In the conversion direction of ANSI to ITU, an asterisk can be specified only for the ANSI **tta** parameter.

In the conversion direction of ITU to ANSI, the asterisk value must be specified for the **itu tti**, **np**, and **nai** parameters.

Asterisks are not allowed when conversion is in both directions (**dir=both**).

The suffix digit manipulation parameters **nsdd** and **nsds** cannot be specified in the same command with the prefix digit manipulation parameters **npdd** and **npds** parameters. The **npdd** and **nsdd** parameters specify how many digits to delete, if any, from the beginning or end respectively of the Global Title address digits. The **npds** and **nsds** parameters specify what digits, if any, to append to the beginning or end respectively of the Global Title address digits.

The **gtixlat** parameter is expressed in the form of the ANSI GTI and the ITU GTI. The **gtixlat** parameter is used to indicate the conversion of the Global Title Indicator between the ANSI and ITU standards. For example: A **gtixlat** value of **24** converts an incoming ANSI GTI 2 to an outgoing ITU GTI 4 or an incoming ITU GTI 4 to an outgoing ANSI GTI 2.

Output

```
ent-gtcnv:dir=atoi:gtixlat=22:tta=10:tti=5
  rlgncxa03w 04-01-07 11:43:07 EST EAGLE 31.3.0
  ENT-GTCNV: MASP A - COMPLTD
;
```

ent-gtt

Enter Global Title Translation

Use this command to add the routing object, DPC, and subsystem number for messages requiring global title translation. The translation is performed on the basis of the global title address (GTA) and translation type (TT) for each SS7 SCCP message directed to the STP's self-identity DPC or CPC with a routing indicator of 0, indicating a GTT is required.

NOTE: If the EGTT (Enhanced Global Title Translation) feature is turned on, the system will no longer accept **-gtt** (Global Title Translation) and **-tt** (Translation Type) commands. Refer to the new command sets that replace the **-gtt** and **-tt** commands: GTT Selector commands (**ent/chg/dlt/rtrv-gttset**), GTT Set commands (**ent/dlt/rtrv-gttset**), and GTA commands (**ent/chg/dlt/rtrv-gta**).

NOTE: With the ANSI-ITU-China SCCP Conversion feature turned on, the Translated Point Code (**pc**, **pca**, **pci**, **pcn**, and **pcn24** parameters) can be of a different network type than the Translation Type (**type** parameter).

NOTE: When the ANSI-ITU-China SCCP Conversion and MGTT features are on and the Translated Point Code is of a different network type, the **ngti** parameter specifies whether the new GTI translation format is GTI type 2 or GTI type 4.

NOTE: When the MGTT feature is off, **ngti** cannot be specified and the Default GT Conversion Table is used for conversion. With the ANSI-ITU-China SCCP Conversion feature off, mixed network types are not allowed.

Keyword: ent-gtt

Related Commands: chg-gtt, dlt-gtt, rtrv-gtt

Command Class: Database Administration

Parameters

† At least one of these parameters must be specified.

NOTE: See “Point Code Formats and Conversion” in Appendix A for a detailed description of point code formats, rules for specification, and examples.

:gta= (mandatory)

Global title start address. This parameter, along with the **egta** parameter, identifies all valid global titles for the given translation type to translate to the given **pc**, **ssn**, or **ngt**. These are the non-SS7 addresses transmitted to the STP for translation.

Range: 1-21 digits

:pc/pca/pci/pcn/pcn24= (mandatory)

Point code.

:pc= or :pca= (mandatory)

ANSI point code with subfields *network indicator-network cluster-network cluster member (ni-nc-ncm)*. The *prefix* subfield indicates a private point code (*prefix-ni-nc-ncm*).

Range: **p-**, **000-255**

Specify a valid value for each subfield of the point code, and separate the subfields with a dash (-).

prefix—**p-**

When **chg-sid:pctype=ansi** is specified, *ni* = **000** is not valid.

When **chg-sid:pctype=ansi** is specified, *nc* = **000** is not valid if *ni* = **001-005**.

When **chg-sid:pctype=ansi** is specified, *nc* = **000** is valid if *ni* = **006-255**.

The point code **000-000-000** is not a valid point code.

:pci= (mandatory)

ITU international point code with subfields *zone-area-id*. The *prefix* subfield indicates a spare point code, private point code, or private and spare point code (*prefix-zone-area-id*).

Range: **s-**, **p-**, **ps-**, **0-255**

Specify a valid value for each subfield of the point code, and separate the subfields with a dash (-).

The point code **0-000-0** is not a valid point code.

prefix—**s-**, **p-**, **ps-**

zone—**0-7**

area—**000-255**

id—**0-7**

:pcn= (mandatory)

ITU national point code in the format of a 5-digit number (*nnnnn*); or 2, 3, or 4 numbers (members) separated by dashes (*m1-m2-m3-m4*) as defined by the **chg-stpopts:npcfmti** flexible point code option. A group code must be specified when the ITUDUPPC feature is turned on (*nnnnn-gc*, *m1-m2-m3-m4-gc*). The *prefix* subfield indicates a spare point code, private point code, or private and spare point code (*prefix-nnnnn*, *prefix-nnnnn-gc*, *prefix-m1-m2-m3-m4*, *prefix-m1-m2-m3-m4-gc*).

Range: **s-, p-, ps-, 0-16383, aa-zz**
Specify a valid value for each subfield of the point code, and separate the subfields with a dash (-).

prefix—**s-, p-, ps-**

nnnnn—**0-16383**

gc—**aa-zz**

m1-m2-m3-m4—**0-14** for each member; values must sum to 14

:pcn24= (mandatory)

24-bit ITU national point code with subfields *main signaling area-sub signaling area-signaling point (msa-ssa-sp)* The *prefix* subfield indicates a private point code (*prefix-ni-nc-ncm*).

Range: **p-, 000-255**

Specify a valid value for each subfield of the point code, and separate the subfields with a dash (-).

prefix—**p-**

msa—**000-255**

ssa—**000-255**

sp—**000-255**

:ri= (mandatory)

Route indicator. This parameter indicates whether a subsequent global title translation is required.

Range: **gt, ssn**

gt—Indicates that a subsequent translation is required.

ssn—Indicates that no further translation is required.

:xlat= (mandatory)

Translate indicator. This parameter defines the type of global title translation that is to be performed.

Range: **dpc, dpcssn, dpcngt**

:egta= (optional)

Global title end address. This parameter, along with the **gta** parameter, identifies all valid global titles for the given translation type to translate to the given **pc**, **ssn**, or **ngt**. These are the non-SS7 addresses transmitted to the STP for translation.

Range: 1-21 digits

Default: **egta** same as **gta**

:force= (optional)

When a final GTT is specified, the DPC and subsystem number must be configured in the mated application table (**xlat=dpc** and **ri=ssn**). The **force=yes** parameter allows you to override this restriction.

Range: **yes, no**

Default: **no**

:mrnset= (optional)

The MRN set ID.

Range: **1-3000, dflt, none**

dflt—The default mrnset.

none—The GTA translation does not participate in any load sharing.

:ngt= (optional)

New global title

This parameter identifies the type of global title translation with which to replace the received global title.

Range: 000-255

Default: If **xlat=dpcngt** is specified, the **ngt** parameter must be specified.

If **xlat=dpcngt** is not specified, an **ngt** parameter value cannot be specified.

:ngti= (optional)

New Global Title Indicator code. When the ANSI-ITU-China SCCP Conversion and MGTG features are on and the Translated Point Code is of a different network type, the **ngti** parameter specifies whether the new GTI translation format is GTI type 2 or GTI type 4.

Range: 2, 4

:nmai= (optional)

New Nature of Address Indicator. This parameter identifies Nature of Address Indicator with which to replace the received Nature of Address Indicator.

Range: 0-127

Default: 0xFFFF

nnp= (optional)

New Numbering Plan. This parameter identifies Numbering Plan with which to replace the received Numbering Plan.

Range: 0-15

Default: 0xFFFF

:npdd= (optional)

New Prefix Digits to be Deleted. This parameter identifies New Prefix Digits to be Deleted with which to replace the received Prefix Digits to be Deleted.

Range: 0-21

Default: 0

:npds= (optional)

New Prefix Digits String. This parameter identifies New Prefix Digits String with which to replace the received Prefix Digits String.

Range: Maximum of 21 digits

Default: No digits

:nsdd= (optional)

New Suffix Digits to be Deleted. This parameter identifies the New Suffix Digits to be Deleted with which to replace the received Suffix Digits to be Deleted.

Range: 0-21

Default: 0

:nsds= (optional)

New Suffix Digits String. This parameter identifies the New Suffix Digits String with which to replace the received Suffix Digits String.

Range: Maximum of 21 digits

Default: No digits

:ssn= (optional)

Subsystem number. This parameter identifies the subsystem address that is to receive the message.

Range: 1-255

Default: If **xlat=dpcngt** is specified, the **ssn** parameter must be specified.

If **xlat=dpcngt** is not specified, an **ssn** parameter value cannot be specified.

:ttn= (optional)†

Translation type name. The name is of local significance only, and is related to the translation type.

Range: 1 alphabetic character followed by up to 7 alphanumeric characters

Default: No translation name is given

:type/typea/typeei/typen/typen24= (optional)†

Translation type identifies the translation type and network type. This parameter is the decimal representation of the 1-byte field used in SS7.

The **type** and **typea** parameters specify an ANSI network.

The **typei** parameter specifies an ITU-international network.

The **typen** parameter specifies an ITU-national network.

The **typen24** parameter specifies a 24-bit ITU-national network.

A translation type numeric value may be entered as ANSI type (**type** or **typea**) and also as an ITU type (**typei** or **typen**). However, they are separate entities.

The point code domain translation types for GTT are handled by the EAGLE protocol processing as either ANSI or ITU; therefore, ITU applies to ITU-I, ITU-I Spare, ITU-N, and ITU-N Spare. ITU-I includes ITU-I Spare, and ITU-N includes ITU-N Spare.

Range: 000-255

Default: No translation type is specified

Example

The lines in the following examples are wrapped for readability:

```
ent-gtt:type=3:gta=9195551212:egta=9195552000:xlat=dpcssn:ri=ssn:pc=001-255-255
:ssn=255
```

```
ent-gtt:ttn=lidb1:gta=9105551212:egta=9105554000:xlat=dpcngt:ri=gt:pc=001-255-254
:ngt=4
```

```
ent-gtt:ttn=c800:gta=9195554321:xlat=dpc:ri=gt:pc=001-255-253
```

```
ent-gtt:type=4:gta=919460:xlat=dpc:ri=ssn:pc=001-255-252
```

```
ent-gtt:type=4:gta=919461:xlat=dpcssn:ri=gt:ssn=254
```

```
ent-gtt:typea=210:ttn=test:gta=100000:egta=199999:pca=1-1-1:ssn=123:xlat=dpcngt
:ri=gt:npdd=2:nnp=3:nnai=120
```

```
ent-gtt:type=100:ttn=test2:gta=123:egta=321:pcn=222:ssn=10:xlat=dpcngt:ri=gt
:npds=999:nnai=100
```

```
ent-gtt:pcn24=8-8-8:gta=919833:xlat=dpcssn:ri=ssn:ssn=20:typen24=4
```

```
ent-gtt:typea=100:ttn=test2:gta=123:egta=321:pci=2-2-2:ssn=10:xlat=dpcngt:ri=gt
:nsdd=3:nsds=567:nnai=62:nnp=4:ngti=4
```

```
ent-gtt:xlat=dpcssn:ssn=10:ri=gt:pci=s-1-21-1:gta=123456:typei=3
```

```

ent-gtt:xlat=dpcssn:ssn=10:ri=gt:pcn=s-124:gta=123456:typen=3
ent-gtt:xlat=dpcssn:ssn=10:ri=gt:pcn=s-125-aa:gta=123456:typen=3
ent-gtt:type=1:xlat=dpc:ri=gt:pc=1-1-1: gta=1234567890:egta=2234567890:mrnset=23
ent-gtt:type=1:xlat=dpcngt:ri=gt:pc=1-1-2: gta=2345678901:egta=3456789012:mrnset=54
ent-gtt:type=1:xlat=dpcngt:ri=gt:pc=1-1-3: gta=3456789013:egta=3456789019:mrnset=dflt
ent-gtt:type=1:xlat=dpcngt:ri=gt:pc=1-1-3:
gta=3456789012:egta=4567890123:mrnset=none

```

Dependencies

This command is not valid when the EGTT feature is turned on.

The end address must be greater than or equal to the start address.

If the **pcn** parameter is specified, its format must match the format that was assigned with the **chg-stpopts:npcfnti** parameter.

If **xlat=dpcngt**, an **ngt** value must be specified; if the **xlat** parameter value is not **dpcngt**, no **ngt** value can be specified.

Point code entries must be full point codes. Partial point codes are not allowed.

The start global title address length must be equal to the number of digits specified by the given translation type. If the VGTT (variable length GTT) feature is turned on, you can provision up to 10 GTA lengths per translation type. When you enter the **ent-gtt** command to create entries, the software keeps track of the lengths and allows only ten different lengths. The global title address specified for the translation type must then have the same number of digits as an existing GTA.

If the end global title address is specified, its length must equal the length of the start global title address.

The maximum length of the resulting GTA string must not exceed 21 digits when translation is complete.

The MGTT feature must be on before the **nnp**, **nnai**, **nsdd**, **nsds**, **npdd**, and **npds** parameters can be specified in the command.

The **nsdd** and **nsds** parameters cannot be used in the same command with the **npdd** and **npds** parameters.

If the translation type is specified, it must already exist and cannot be an alias.

If the translation type is ANSI (**type** or **typea**), the **pc** type must be ANSI (**pc** or **pca**). If the translation type is one of the ITU types (**typei**, **typen** or **typen24**), the **pc** type can be one of the ITU types (**pci**, **pcn**, or **pcn24**).

The ANSI-ITU-China SCCP Conversion feature must be on before a translated point code and a translation type in different network types can be specified.

The **ngti** parameter can be specified only when the translated point code and the translation type are in different domains, or are both in the ITU domain.

When **ngti=4** is specified, **nnp** and **nnai** must be specified.

When **ngti=4** is specified, the translated point code cannot be ANSI. For ANSI point codes, the GTI value must be 2.

When **ngti=2** is specified, **nnp** and **nnai** cannot be specified.

The **mrnset** parameter must not be specified if **ri = ssn**.

The range, as specified by the start and end global title addresses, cannot exist in the global title translation data for the specified translation type. Each range may be contained completely within a previously defined range, in which case splitting is performed. However, if the ranges overlap, splitting cannot occur, the command is rejected, and a list of overlapped point codes is displayed. An example follows that shows what happens when the user attempts to enter a point code range (such as 8005550000 to 8005559999) that overlaps an existing range. The overlapping links must match. If they do not, error message E2401 is generated displaying the list of overlapped point codes:

```
The following GTA ranges overlap the input GTA range
START GTA          END GTA
8005550000         8005551999
8005552000         8005553999
8005554000         8005555999
ENT-GTT: MASP A - Command Aborted
```

If a final GTT is specified with **ri=ssn**, and if the **xlat=dpc** parameter is specified and the **force=yes** parameter is not specified, the point code must be configured in the Remote Point Code/Mated Application Table.

If **xlat=dpcssn** is specified, the point code and subsystem combination must be an existing subsystem in the subsystem table for the remote point code.

If **xlat=dpcssn** is specified, an **ssn** value must be specified; if the **xlat** parameter value is not **dpcssn**, an **ssn** value cannot be specified.

When the ANSI-ITU-China SCCP Conversion feature is not on and **xlat=dpcngt** is specified, an **ngt** value must be specified and the **ri** value must be **gt**; if **xlat** is not **dpcngt**, an **ngt** value cannot be specified.

When the ANSI-ITU-China SCCP Conversion feature is turned on and **ngt** is specified, **ri=gt** must be specified.

When the ANSI-ITU-China SCCP Conversion feature is not on, the **ngt** parameter can be specified only when **xlat=dpcngt** is specified.

When the ANSI-ITU-China SCCP Conversion feature is turned on, the **ngt** parameter can be specified only when **xlat=dpc** or **xlat=dpcngt** is specified.

Table 6-7 shows the valid combinations for the **xlat**, **ri**, **ssn**, and **ngt** parameters. All other combinations are rejected.

Table 6-7. Valid **ent-gtt** Routing Parameter Combinations

XLAT Value	RI Value	Routing Action	SSN Value	NGT Value
DPC	GT	Translate DPC only and route on GT	Cannot specify	Cannot specify unless ANSI-ITU-China SCCP Conversion is enabled
DPC	SSN	Translate DPC only and route on SSN	Cannot specify	Cannot specify
DPCSSN	GT	Translate DPC and SSN and route on GT	Must specify	Cannot specify

Table 6-7. Valid ent-gtt Routing Parameter Combinations

XLAT Value	RI Value	Routing Action	SSN Value	NGT Value
DPCSSN	SSN	Translate DPC and SSN and route on SSN	Must specify	Cannot specify
DPCNGT	GT	Translate DPC , new translation type (TT), and route on GT	Cannot specify	Must specify

If the XGTT feature is enabled, the GTT table can have up to either 400,000 or 1,000,000 entries, depending on the controlled feature Part Number that is enabled. If XGTT is not enabled, the GTT table can contain up to 269,999 user entries.

To enter this command, the Remote Point Code table cannot be full.

To enter this command, the subsystem table for primary remote point codes cannot be full.

The specified PC must already exist in the specified MRNSET if the Flexible GTT Load Sharing feature is enabled.

The specified MRNSET must already exist in the MRN table.

The **mrnset** parameter must be specified if the Flexible GTT Load Sharing feature is enabled and the routing indicator **ri = gt**.

Notes

The routing indicator provides routing instructions to the receiving signaling point. If the routing indicator specifies global title, global title translation then needs to be performed at another signaling point.

Up to 200,00 entries are allowed for an individual translation type if all SCCP cards are TSMs or DSMs.

The ANSI point code **0-0-0** and the ITU-I point code **0-000-0** are not valid point codes.

The EAGLE does not require a MAP table entry to be configured prior to provisioning a GTT entry. The EAGLE assumes that the GTT entry is for a solitary point code/subsystem and automatically creates a MAP entry for the point code/subsystem.

The suffix digit manipulation parameters **nsdd** and **nsds** are available only with the MGTT feature on. The **nsdd** and **nsds** suffix digit manipulation parameters cannot be specified together with the **npdd** and **npds** prefix digit manipulations parameters in the command.

In this command, only ITU-international and ITU national point codes support the spare point code subtype prefix (**s-**) and the private and spare point code subtype prefix (**ps-**). All of the point code types support the private (internal) point code subtype prefix (**p-**).

The Flexible GTT Load Sharing feature allows multiple relationships to be defined among sets of destination point codes in the Mated Relay Node (MRN) table. The relationship used in a particular translation is based on the GTA digits used for translation.

The **mrnset** along with the post-translation PC formulates a key that is used for a lookup in the MRN table. The MRN table lookup provides a set of alternate PCs for routing the MSU in the most cost effective way.

The default **mrnset** consists of multiple load sharing groups of PCs that allow both GTT features and MPS-based features to run in parallel. However, MPS-based features are limited to using ONLY the **dflt** mrnset. GTT features can be provisioned to use the **dflt** mrnset as well. To operate on entries in the default mrnset, specify **dflt** as the value of the MRN Set.

Output

```
ent-gtt:ttn=c800:gta=9195554321:xlat=dpc:ri=gt:pc=001-255-253
```

```
rlghncxa03w 04-01-07 11:43:07 EST EAGLE 31.3.0
```

```
ENT-GTT: MASP A - COMPLTD
```

```
;
```

ent-gttset

Enter GTT Selectors

Use this command to assign applicable global title selectors to a GTT set (**gttsn**) for enhanced global title translations.

Keyword: ent-gttset

Related Commands: chg-gttset, dlt-gttset, ent-tt, rtrv-gttset

Command Class: Database Administration

Parameters

:gti/gtia/gtii/gtin/gtin24= (mandatory)

Global title indicator. For all EGTT selector commands, the domain is defined as **gti** and **gtia** (ANSI), **gtii** (ITU international), **gtin** (ITU national), and **gtin24** (24-bit ITU national). For the selector commands, **gti** and **gtia** are equivalent; **gtii** and **gtin/gtin24** are mutually exclusive because the EGTT database does not distinguish between ITU national and ITU international translations. This means that while ITU-I and ITU-N selectors are stored separately, two separate ITU-I and ITU-N entries with the same selector values cannot exist. For example, if an entry with **gtii=2** and **tt=4** already exists, an entry of **gtin=2** and **tt=4** cannot be entered.

Range: Supported value for ANSI: **gti=2** and **gtia=2**

Supported values for ITU: **gtii=2, 4** and **gtin/gtin24=2, 4**

:gttsn= (mandatory)

The new GTT set name. A GTT set is an entity to which global title addresses and selectors are assigned.

Range: 1 leading alphabetic character and up to 8 alphanumeric characters.

:tt= (mandatory)

Translation type.

Range: 0-255

:nai= (optional)

Nature of address indicator (see Table A-5 in Appendix A).

Range: sub, rsvd, natl, intl, dflt

:naiv= (optional)

Nature of address indicator value (see Table A-5 in Appendix A).

Range: 0–127

NOTE: The nature of address indicator parameters (**naiv** or **nai**) can be specified by supplying either a mnemonic or an explicit value. At no time may both the mnemonic and the explicit value be specified at the same time for the same parameter. You can specify either the **naiv** or **nai** parameter. Table A-5 in Appendix A shows the mapping between the **naiv** and the **nai** parameters.

:np= (optional)

Numbering plan (see Table A-6 in Appendix A).

Range: e164, generic, x121, f69, e210, e212, e214, private, dflt

:npv= (optional)

Numbering plan value (see Table A-6 in Appendix A).

Range: 0–15

NOTE: The numbering plan parameters (**npv** or **np**) can be specified by supplying either a mnemonic or an explicit value. At no time may both the mnemonic and the explicit value be specified at the same time for the same parameter. You can specify either the **npv** or **np** parameter. Table A-6 in Appendix A shows the mapping between the **npv** and the **np** parameters.

Example

```
ent-gtttsel:gtia=2:tt=9:gttsn=lidb
```

```
ent-gtttsel:gtia=2:tt=10:gttsn=t800
```

```
ent-gtttsel:gtia=2:tt=253:gttsn=setans253
```

```
ent-gtttsel:gtii=4:tt=0:np=e164:nai=intl:gttsn=setint000
```

```
ent-gtttsel:gtii=2:tt=0:gttsn=setint000
```

```
ent-gtttsel:gtin=4:tt=9:np=e214:nai=natl:gttsn=imsi
```

```
ent-gtttsel:gtii=4:tt=0:np=e164:nai=sub:gttsn=setint000
```

Dependencies

The EGTT feature must be turned on before this command can be entered.

The **np** and **npv** parameters cannot be specified together in the same command.

The **nai** and **naiv** parameters cannot be specified together in the same command.

The parameter values **gtia=4**, **gti/gtia/gtii/gtin/gtin24=1**, and **gti/gtia/gtii/gtin/gtin24=3** cannot be specified.

When the **gti/gtia/gtii/gtin/gtin24=2** parameter is specified, the **np/npv** and **nai/naiv** parameter combinations cannot be specified.

When the **gtii/gtin/gtin24=4** parameter is specified, an **np(v)** and **nai(v)** parameter combination must be specified. These parameters can be specified in any combination: **np** and **naiv**, **npv** and **nai**, **np** and **nai**, or **npv** and **naiv**.

For existing TTs with **gtii/gtin/gtin24=4**, the domain of the new entry must match the existing domain.

The **gttsn** parameter must be specified, cannot have a value of **none**, and must match an existing **gttsn**.

An entry cannot already exist that matches the specified **gti**, **tt**, and **np(v)** and **nai(v)** combination of parameters.

An entry cannot already exist that matches the specified **gtii**, **tt**, and **np(v)** and **nai(v)** combination of parameters.

An entry cannot already exist that matches the specified **gtin**, **tt**, and **np(v)** and **nai(v)** combination of parameters.

The specified **gttsn** value cannot already exist for the specified **gtin24**, **tt**, **np/npv/nai/nai** parameter combination.

The network domain (ANSI or ITU) of the new selector must match that of the existing GTTset entry specified by the **gttsn** parameter.

Notes

When the EGTT feature is turned on, the GTT Selector (**ent/chg/dlt/rtrv-gttset**), GTT Set (**ent/dlt/rtrv-gttset**), and GTA (**ent/chg/dlt/rtrv-gta**) commands replace the Translation Type (**ent/dlt/rtrv-tt**) and Global Title Translation (**ent/chg/dlt/rtrv-gtt**) commands. All data previously provisioned with these commands is maintained.

For **gtii/gtin=4**, although DFLT may appear in the **rtrv-gttset** output, **dflt** cannot be specified as value for the **np** or **nai** parameters when the **ent-gttset** command is entered. If a new GTT selector is specified that matches an existing GTT selector's **gti** and **tt** and the existing selector has **dflt** as the value for the **np** and/or **nai** parameters, a new entry is created with the new **np** and **nai** parameter values. The existing GTT selector entry with the **dflt** value is also retained. The **np/nai** parameter value **dflt** can be specified for the **chg/dlt/rtrv-gttset** commands.

Output

```
ent-gttset:gtia=2:tt=9:gttsn=lidb
rlghncxa03w 04-02-18 08:50:27 EST EAGLE 31.3.0
GTT Selector table is (114 of 1024) 11% full
ENT-GTTSEL: MASP A - CMLPTD
;
```

ent-gttset

Enter GTT Set

Use this command to specify the attributes of a new GTT set (a set of global title translations). A GTT set consists of a GTT set name, the number of digits allocated for the GTA (global title address), the domain of the point codes used in the translation, and a pointer to a GTA tree. After the GTT set is provisioned, you can enter subsequent GTT Selector and GTA commands.

Keyword: **ent-gttset**

Related Commands: **dlt-gttset**, **ent-tt**, **rtrv-gttset**

Command Class: Database Administration

Parameters

:gttsn= (mandatory)

GTT set name. A GTT set is an entity to which global title addresses and selectors are assigned.

Range: 1 leading alphabetic character and up to 8 alphanumeric characters.

:netdom= (mandatory)

Network domain. Note that the choices are for either ANSI or ITU. This command does not distinguish between ITU national or ITU international because the Enhanced Global Title Translation feature does not discriminate between the ITU-I and ITU-N translations.

Range: **ansi, itu**

:ndgt= (optional)

Number of digits required for GTAs (global title addresses) associated with this GTT set. This parameter is not valid if the VGTT (variable length GTT) feature is turned on.

Range: **1-21**

Default: **6**

Not applicable if **vgtt=on**.

Example

```
ent-gttset:gttsn=lidb:ndgt=10:netdom=ansi
```

```
ent-gttset:gttsn=t800:netdom=ansi
```

```
ent-gttset:gttsn=setint000:netdom=itu:ndgt=15
```

Dependencies

The EGTT feature must be turned on prior to using this command.

The GTT set table cannot contain more than 950 entries.

The **gttsn** parameter must be specified, cannot have a value of **none**, and must not match an existing **gttsn**.

The **ndgt** parameter is not valid if the VGTT (variable length GTT) feature is turned on.

Notes

GTT sets can only be entered, deleted, and retrieved. There is no change command.

When the EGTT feature is turned on, the GTT Selector (**ent/chg/dlt/rtrv-gttset**), GTT Set (**ent/dlt/rtrv-gttset**), and GTA (**ent/chg/dlt/rtrv-gta**) commands replace the Translation Type (**ent/dlt/rtrv-tt**) and Global Title Translation (**ent/chg/dlt/rtrv-gtt**) commands. All data previously provisioned with these commands is maintained.

Output

```
ent-gttset:gttsn=lidb:ndgt=10:netdom=ansi
```

```
rlghncxa03w 04-02-19 08:20:17 EST EAGLE 31.3.0
GTT Set table is (114 of 950) 12% full
ENT-GTTSET: MASP A - CMLTD
```

```
;
```

ent-gws-redirect**Enter Gateway Screening Redirect Command**

Use this command to provision the gateway screening redirect function. The Redirect table must be provisioned before configuring gateway screening to redirect received MSUs. The values that are specified with this command are stored in the Redirect table, and they are used to set the variable fields of the MSUs being redirected. For example, if the **ri=gt** parameter is specified, the value **gt** is set for the routing indicator in the called party address (CDPA) of the MSU being redirected.

Keyword: ent-gws-redirect

Related Commands: chg-gws-redirect, dlt-gws-redirect, rtrv-gws-redirect

Command Class: Database Administration

Parameters

NOTE: See “Point Code Formats and Conversion” in Appendix A for a detailed description of point code formats, rules for specification, and examples.

:dpc/dpca/dpci/dpcn/dpcn24= (mandatory)

Destination point code.

:dpc= or dpca= (mandatory)

Specifies the value used to set the ANSI destination point code field in the routing label of the MSU that is being redirected. The ANSI point code has subfields *network indicator-network cluster-network cluster member (ni-nc-ncm)*.

Range: 000-255

Specify a valid value for each subfield of the point code, and separate the subfields with a dash (-).

When **chg-sid:pctype=ansi** is specified, *ni = 000* is not valid.

When **chg-sid:pctype=ansi** is specified, *nc = 000* is not valid if *ni = 001–005*.

When **chg-sid:pctype=ansi** is specified, *nc = 000* is valid if *ni = 006–255*.

The point code **000-000-000** is not a valid point code.

:dpci= (mandatory)

Specifies the value used to set the ITU international destination point code field in the routing label of the MSU that is being redirected. The point code has subfields *zone-area-id*.

Range: 0-255

Specify a valid value for each subfield of the point code, and separate the subfields with a dash (-).

The point code **0-000-0** is not a valid point code.

zone—0–7

area—000–255

id—0–7

:dpcn= (mandatory)

Specifies the value used to set the ITU national destination point code field in the routing label of the MSU that is being redirected. The point code is in the format of a 5-digit number (*nnnnn*); or 2, 3, or 4 numbers (members) separated by dashes (*m1-m2-m3-m4*) when the **chg-stpopts:npfnti** flexible point code option is on. A group code (*gc*) must be specified when the ITUDUPPC feature is on (*nnnnn-gc, m1-m2-m3-m4-gc*).

Range: 0-16383, aa-zz

Specify a valid value for each subfield of the point code, and separate the subfields with a dash (-).

nnnnn—0-16383

gc—aa-zz

m1-m2-m3-m4—0-14 for each member; values must sum to 14

:dpcn24= (mandatory)

Specifies the value used to set the 24-bit ITU national destination point code field in the routing label of the MSU that is being redirected. The point code has subfields *main signaling area-sub signaling area-signaling point* (*msa-ssa-sp*).

Range: 000-255

Specify a valid value for each subfield of the point code, and separate the subfields with a dash (-).

msa—000-255

ssa—000-255

sp—000-255

gta= (mandatory)

Specifies the value used to set the global title address (dialed digits) in the SCCP called party address of the MSU being redirected.

Range: 1-21 digits

ri= (mandatory)

Specifies the value used to set the routing indicator in the SCCP called party address of the MSU being redirected. Use the **gt** value to route by global title digits or use the **ssn** value to route by subsystem number.

Range: **gt, ssn**

ssn= (mandatory)

Specifies the value used to set the subsystem number (SSN) in the SCCP called party address of the MSU being redirected. This number is the SSN of the SCP to which all MSUs meeting the redirect criteria are to be redirected.

Range: 000-255

ssn= (mandatory)

Identifies the type of the global title translation (GTT). It is the decimal representation of the 1-byte field used in SS7. This value is used to set the type of the GTT in the SCCP called party address of the MSU being redirected.

Range: 000-255

:tt= (mandatory)

identifies the type of the Global Title Translation. It is the decimal representation of the 1-byte field used in SS7.

Range: 000-255

:enabled= (optional)

Specifies whether MSUs that have passed gateway screening are to be redirected (**enabled=on**) or routed as normal (**enabled=off**).

Range: **on, off**

Default: **on**

Example

```
ent-gws-redirect:dpc=1-40-1:ri=gt:ssn=10:tt=1:gta=180833:enabled=on
ent-gws-redirect:dpc=1-40-1:ri=ssn:ssn=10:tt=1:gta=1800833:enabled=off
```

Dependencies

The **dpc/dpca/dpci/dpcn/dpcn24** parameter must be defined in the Destination table or defined as the STP site point code.

If the **dpc/dpca/dpci/dpcn/dpcn24** parameter is defined as a destination, it must have at least one route defined.

The redirect function data can be entered only once.

Notes

The SCCP screening functions (CGPA, TT, CDPA, and AFTPC) cannot select an MSU to be redirected.

Do not apply a Redirect Stop Action on the Adjacent Node point code for the BLKOPC and OPC screening functions.

Do not apply a Redirect Stop Action for an allowed DPC screen rule if the rule contains the self-identity point code of EAGLE where the screening rule is applied. This is because the redirection of SLTAs and SLTMs (Signal Link Test Messages and Acknowledgements) will not return to the originating EAGLE and will cause the link to fail.

If **gwsa=off** and **gws=off** are specified for all linksets, gateway screening and the GWS redirect function for the DTA feature are disabled.

Output

```
ent-gws-redirect:dpc=1-40-1:ri=gt:ssn=10:tt=1:gta=180833:enabled=on
rlghncxa03w 03-11-10 11:43:04 EST EAGLE 31.6.0
ENT-GWS-REDIRECT: MASP A - COMPLTD
;
```

ent-home-smsc**Enter HOME SMSC Address**

Use this command to enter HOME SMSC specific addresses, currently used to identify Short Message Service Centers in the database. This command updates the HOME SMSCADDR table.

Keyword: ent-home-smsc

Related Commands: dlt-home-smsc, rtrv-home-smsc

Command Class: Database Administration

Parameters

smsc= (mandatory)

Identifies the type of the Short Message Service Center address.

Range: 1-21 hexadecimal digits (**0-9, a-f, A-F**)

Example

```
ent-home-smsc:smc=256489
ent-home-smsc:smc=256489a98bccee56ad237
```

Dependencies

The Portability Check for Mobile Originated SMS (MNP SMS) controlled feature must be enabled (**enable-dtrl-feat** command) and turned on before this command can be entered.

The specified HOME SMSC address cannot already exist in the HOME SMSCADDR table.

The HOME SMSCADDR table can contain a maximum of 500 entries.

Notes

None

Output

```
ent-home-smsc:smc=256489
rlghncxa03w 04-02-28 08:50:12 EST EAGLE 31.3.0
ENT-HOME-SMSC: MASP A - COMPLTD
;
```

ent-homern**Enter Home Routing Number Prefix**

Use this command to enter up to 100 routing number prefixes for the operating network into the HOMERN table.

Keyword: ent-homern

Related Commands: dlt-homern, rtrv-homern

Command Class: Database Administration

Parameters

rn= (mandatory)

The home routing number prefix.

Range: 1-15 hexadecimal digits (**0-9, a-f, A-F**)

Example

```
ent-homern:rn=C441234
```

Dependencies

The INP or G-Port feature must be turned on before this command can be entered.

The HOMERN table cannot be full.

The routing number must not already exist in the HOMERN table.

A value of **none** cannot be specified for the **rn** parameter.

Notes

None

Output

ent-homern:rn=C441234

```
rlghncxa03w 04-01-28 08:50:12 EST EAGLE 31.3.0
HOMERN table is (1 of 100) 1% full
ENT-HOMERN: MASP A - COMPLTD
```

;

ent-ip-host

Enter Internet Protocol Hostname

Use this command to configure the IP Host table. The IP Host table defines local and remote host names for IP addresses.

Keyword: ent-ip-host

Related Commands: rtrv-ip-host, dlt-ip-host

Command Class: Database Administration

Parameters

:host= (mandatory)

Host name. The logical name of the device associated with the indicated IP address.

Range: a–z, A–Z, 0–9, -, .

Any string of characters beginning with a letter and comprising up to 60 characters in length.

:ipaddr= (mandatory)

The IP address associated with the host name. This is a TCP/IP address expressed in standard dot notation. IP addresses consist of the system's network number and the machine's unique host number. An example IP address is **192.126.100.5**, where **192.126.100** is the system's network number and **5** is the machine's host number.

Range: 4 numbers separated by dots, with each number in the range of **0–255**.

:type= (optional)

The residency attribute of the host entry.

Range: local, remote

local—The IP host name and IP address resides on the IP card in this EAGLE 5 SAS.

remote—The IP host name and IP address resides on equipment not in this EAGLE 5 SAS.

Default: local

Example

```
ent-ip-host:host=gw100.nc.tekelec.com:ipaddr=150.001.001.001
```

```
ent-ip-host:host=gw100.nc.tekelec.com:ipaddr=150.001.001.001:type=local
```

Dependencies

The host name and IP address must be unique.

The host table must have an empty element.

The IP address of the local host must exist in the IP Link table.

The IP address of the remote host must not exist in the IP Link table.

Notes

None

Output

```

ent-ip-host:host=gw100.nc.tekelec.com:ipaddr=150.001.001.001
  rlghncxa03w 04-01-17 15:35:05 EST EAGLE 31.3.0
  ENT-IP-HOST: MASP A - COMPLTD
;

ent-ip-host:host=gw100.nc.tekelec.com:ipaddr=150.001.001.001:type=local
  rlghncxa03w 05-07-17 15:35:05 EST EAGLE 34.0.0
  ENT-IP-HOST: MASP A - COMPLTD
;

```

ent-ip-node**Enter IP Node**

Use this command to define the IP address of a node that will be receiving messages from the STPLAN application.

Keyword: ent-ip-node

Related Commands: dlt-ip-node, rtrv-ip-node

Command Class: Database Administration

Parameters

:cap= (mandatory)

The maximum percentage of ethernet capacity for this node connection. This capacity is added to other connections to this node for the total capacity of the node.

Range: 0-100

:ipaddr= (mandatory)

The node's IP address. This is a TCP/IP address expressed in standard dot notation. IP addresses consist of the system's network number and the machine's unique host number. An example IP address is **192.126.100.5**, where **192.126.100** is the network number and **5** is the machine's host number.

Range: 1-223, 0-255

4 numbers separated by dots

1-223—first number

0-255—the other three numbers

:ipappl= (mandatory)

The IP application supported by the node.

Range: stplan

Default: Default value not given

:ipport= (mandatory)

The logical IP port that addresses the application on the node.

Range: 1024-5000

Default: The logical IP port is not given.

:loc= (mandatory)

The card location as stenciled on the shelf of the system that contains the TCP/IP link that will be directly connected to the node.

Range: 1101–1108, 1111–1112, 1201–1208, 1211–1218, 1301–1308, 1311–1318, 2101–2108, 2111–2118, 2201–2208, 2211–2218, 2301–2308, 2311–2318, 3101–3108, 3111–3118, 3201–3208, 3211–3218, 3301–3308, 3311–3318, 4101–4108, 4111–4118, 4201–4208, 4211–4218, 4301–4308, 4311–4318, 5101–5108, 5111–5118, 5201–5208, 5211–5218, 5301–5308, 5311–5318, 6101–6108, 6111–6118

:iprte= (optional)

The default router IP address. This is a TCP/IP address expressed in standard dot notation. IP addresses consist of the system's network number and the machine's unique host number. An example IP address is **192.126.100.5**, where **192.126.100** is the network number and **5** is the machine's host number.

Range: 1-223, 0-255
4 numbers separated by dots
1-223—first number
0-255—the other three numbers

Example

```
ent-ip-node:ipaddr=13.49.210.50:ipappl=stplan:ippport=1024:loc=1201:cap=15
:iprte=193.4.201.84
```

Dependencies

The ACM is the only valid card type for this command.

The shelf and card must be equipped.

The node IP address cannot be **127.x.x.x**, where **x** is a number from **1** to **254**.

The specified card location must be equipped with a TCP/IP data link.

The IP address must be unique to the TCP/IP link table and to the TCP/IP nodes.

Only one node can be connected for each data link and each application. The IP address, IP application, and card location combination must be unique in the database.

The IP port on each node cannot be assigned to another application. The IP address and IP port combination must always use the same IP application.

The class of the IP address (**ipaddr**) must match the class of the assigned TCP/IP data link's IP address. The system supports three classes of IP addresses, Class A, Class B, and Class C. Class A IP addresses can contain only the values **1** to **126** in the first field of the IP address. Class B IP addresses can contain only the values **128** to **191** in the first field of the IP address. Class C IP addresses can contain only the values **192** to **223** in the first field of the IP address.

The network portion of the IP address (**ipaddr**) must match the network portion of the IP address assigned to the TCP/IP data link. The network portion of the IP address is based on the class of the IP address. If the IP address is a Class A IP address, the first field is the network portion of the IP address. If the IP address is a Class B IP address, the first two fields are the network portion of the IP address. If the IP address is a Class C IP address, the first three fields are the network portion of the IP address.

If the network portion and class of the IP address of the TCP/IP node matches the class of the assigned TCP/IP data link's IP address, the **iprte** parameter cannot be specified. The **iprte** parameter can be specified only with the **ent-ip-node** command when the network portion and class of the TCP/IP node does not match the class of the assigned TCP/IP data link's IP address. The values of the **ipaddr** parameter, the IP address of the TCP/IP node, and the **iprte** parameter cannot be the same.

The capacity of all connections to the given node cannot be greater than 100%.

Notes

If the IP address is a Class A IP address, do not use the IP addresses **127.x.x.x**, where *x* is a number from **1** to **254**. These addresses are reserved for loopback.

Output

**ent-ip-node:ipaddr=13.49.210.50:ipappl=stplan:ipport=1024:loc=1201:cap=15
:iprte=193.4.201.84**

```
rlghncxa03w 04-01-18 08:50:12 EST EAGLE 31.3.0
ENT-IP-NODE: OAM A - COMPLTD
```

;

**ent-ip-node:ipaddr=172.42.21.250:ipappl=stplan:ipport=1024:loc=1318:cap=5
:iprte=127.24.2.150**

```
rlghncxa03w 04-01-18 08:50:51 EST EAGLE 31.3.0
IPRTE contains loopback address.
ENT-IP-NODE: OAM A - COMPLTD
```

;

ent-ip-rte

Enter IP Route

Use this command to configure the destination IP address, subnet mask, and the gateway IP address for the specified card in the Static IP Route table.

Keyword: ent-ip-rte

Related Commands: dlt-ip-rte, rtrv-ip-rte

Command Class: Database Administration

Parameters

:loc= (mandatory)

Card location. The unique identifier of a specific IP card in the system.

Range: 1101–1108, 1111–1112, 1201–1208, 1211–1218, 1301–1308, 1311–1318, 2101–2108, 2111–2118, 2201–2208, 2211–2218, 2301–2308, 2311–2318, 3101–3108, 3111–3118, 3201–3208, 3211–3218, 3301–3308, 3311–3318, 4101–4108, 4111–4118, 4201–4208, 4211–4218, 4301–4308, 4311–4318, 5101–5108, 5111–5118, 5201–5208, 5211–5218, 5301–5308, 5311–5318, 6101–6108, 6111–6118

:dest= (mandatory)

Destination IP Address. The IP Address of a remote destination host or network to be reached.

Range: 4 numbers separated by dots, with each number in the range of **0–255**
The IP address **0.0.0.0** is not valid.

:submask= (mandatory)

The subnet mask of the destination IP address, in the form of an IP address with a restricted range of values. This parameter is required if the **ipaddr** parameter is entered.

Range: **255.255.255.255** if the destination IP address represents a host address
A value that identifies the network ID and host ID portions, if the destination IP address represents a network address. The value must be valid for the class of the entered IP address as shown in Table 6-8 on page 6-240.

Table 6-8. Valid Subnet Mask Values

Valid for Class A Networks	Valid for Class A or B Networks	Valid for Class A, B, or C Networks
255.0.0.0	255.255.0.0	255.255.255.0
255.192.0.0	255.255.192.0	255.255.255.192
255.224.0.0	255.255.224.0	255.255.255.224
255.240.0.0	255.255.240.0	255.255.255.240
255.248.0.0	255.255.248.0	255.255.255.248
255.252.0.0	255.255.252.0	255.255.255.252
255.254.0.0	255.255.254.0	
255.255.128.0	255.255.255.128	

:gtwy= (mandatory)

Gateway IP Address. The IP address assigned to the gateway router that will properly forward IP datagrams with the destination IP address (**dest**) to the next-hop gateway router or final destination host.

Range: 4 numbers separated by dots, with each number in the range of **000–255**.
The IP address **0.0.0.0** is not valid.

Example

ent-ip-rte:loc=1301:dest=128.252.10.5:submask=255.255.255.255:gtwy=140.188.13.33

ent-ip-rte:loc=1301:dest=126.252.0.0:submask=255.255.0.0:gtwy=140.188.13.34

Dependencies

The specified destination IP address (**dest** parameter):

- Must not be the default route (0.0.0.0)
- Must not correspond to any loopback address (i.e. 127.X.X.X)
- Must be unique per card
- Must not reside on this card's A or B local network

The specified gateway IP address (**gtwy** parameter):

- Must not be the default route (0.0.0.0)
- Must not correspond to any loopback address (i.e. 127.X.X.X)
- Must correspond to a host IP address that resides on this card's A or B local network

The IP address must be defined for the A or B network, or both, for the card before this command can be entered. (See the **chg-ip-card** command).

Each destination IP address entered into the Static IP Route table must be unique for the card.

A maximum of 64 static IP routes can be defined for a card.

A maximum of 1024 static IP routes can be defined in the IP Route table.

The **loc** parameter value must correspond to a DCM or SSEDCCM card running the **ss7ipgw**, **ipgwi**, **iplim**, or **iplimi** application.

Notes

The Static IP Route table is used to store static IP route entries. Static routes are maintained across card initialization, failures, and reloads. These types of routes are used when the IP Layer cannot determine routes dynamically. Static IP route entries can be added or deleted dynamically.

Output

```
ent-ip-rte:loc=1301:dest=128.252.10.5:submask=255.255.255.255:gtwy=140.188.13.33
  IP Route table is (1 of 256) 1% full

  rlghncxa03w 04-01-17 15:35:05 EST EAGLE 31.3.0
  ENT-IP-RTE: MASPP A - COMPLTD
;
```

ent-lbp

Enter Loopback Point

Use this command to assign a far-end loopback point for testing data signaling link elements in a SS7 transmission path.

Keyword: **ent-lbp**

Related Commands: **act-lbp**, **chg-lbp**, **dact-lbp**, **dlt-lbp**, **rtrv-lbp**

Command Class: Database Administration

Parameters

:lbp= (mandatory)

Loopback point ID. This parameter identifies a far-end loopback point that lies along an SS7 signaling link path between the STP and the target device (up to *and including* the target device).

Range: 1-32

:loc= (mandatory)

Card location. The unique identifier of a specific application subsystem located in the STP.

Range: 1101-1108, 1111-1112, 1201-1208, 1211-1218, 1301-1308, 1311-1318, 2101-2108, 2111-2118, 2201-2208, 2211-2218, 2301-2308, 2311-2318, 3101-3108, 3111-3118, 3201-3208, 3211-3218, 3301-3308, 3311-3318, 4101-4108, 4111-4118, 4201-4208, 4211-4218, 4301-4308, 4311-4318, 5101-5108, 5111-5118, 5201-5208, 5211-5218, 5301-5308, 5311-5318, 6101-6108, 6111-6118

:port= or **:link=** (mandatory)

SS7 signaling link. The SS7 signaling link that is to be tested.

Range: a, b, a1-a31, b1-b31

Not all card types support all **link** parameter values.

See Table A-1 in Appendix A for valid **link** parameter range values for each type of card that can have assigned signaling link ports.

:rle= (mandatory)

Remote link element. The link element to be looped back for testing.

Range: ds0, ocu, csu, dsu, nei

:cli= (optional)

The Common Language Location Identifier (CLLI) code, or other mnemonic identifier, used to refer to the given loopback point.

Range: 1 alphabetic character followed by up to 10 alphanumeric characters.

:lfst= (optional)

Link fault sectionalization test. The type of link fault sectionalization loopback test to be performed.

Range: llt, nlt

llt—latching loopback test

nlt—nonlatching loopback test

:rep= (optional)

Repetition count. The number of link elements of the same type (not including the target device) that lie between the STP and the link element to be tested.

Range: 0–31

Default: 0—If the link element to be looped back for testing is NEI (**rle=nei** is specified)

0—If the LFS test is NLT (non-latched); **lfst=nlt** is specified

0—If no other LBP for this link has the same **rle** value

1–30—Next sequential number for subsequent loopback points of the link to be tested (**rle** is specified as anything but **nei**)

Example

```
ent-lbp:loc=1101:link=a:lbp=1:rle=ds0:lfst=llt:rep=0:cli=rlghncxa05w
```

```
ent-lbp:loc=1101:port=a:lbp=2:rle=nei:lfst=llt
```

```
ent-lbp:loc=1205:port=a1:lbp=1:rle=ds0:lfst=llt:cli=rlghncxa05w:rep=1
```

Dependencies

The Link Fault Sectionalization (LFS) feature must be on before this command can be entered.

The card location (**loc** parameter) must be equipped, and must contain a provisioned **limds0**, **limt1**, or **limch** (associated to a **limt1**) card that is running an **ss7ansi** or **ccs7itu** application.

The **rle=ds0** parameter and the **rle=nei** parameter cannot be specified when the **lfst=nlt** parameter is specified. The DS0 and Network Element Interface (NEI) link elements do not support non-latching loopbacks.

If the **rle=nei** parameter is specified, the **rep=0** parameter must be specified.

The **rep** parameter can be specified only if the **lfst=llt** parameter is specified.

Each specified **rep** parameter value must be greater than any previously specified **rep** value. The **rep** parameter must be specified if taking the default value results in duplicate **rep** values for loopback points.

The specified **cli** cannot be a reserved word.

The loopback point (LBP) cannot have been previously defined.

The value specified for the **lbp** parameter cannot exceed the **lbp** parameter value previously defined for a loopback point with **rle=nei** specified.

For each SS7 signaling link, only one loopback point with **rle=nei** specified can be defined, and that loopback point must be the terminating SS7 signaling link element.

Space must be available in the LFS table.

Notes

None

Output

```
ent-lbp:loc=1101:link=a:lbp=2:rle=nei:lfst=llt
    rlgncxa03w 05-02-17 15:35:05 EST EAGLE5 33.0.0
    ENT-LBP: MASP A - COMPLTD
;
```

ent-lnp-lrn

Enter LNP Location Routing Number

NOTE: This command is obsolete.

Use this command to enter a location routing number (LRN) and its corresponding message relay override global title translations into the database. This command updates the LNP LRN Table. This command can assign a maximum of two overriding message relay global title translations at a time. If an LRN already exists, only the newly defined override service is added.

NOTE: If the LNP ELAP Configuration feature is turned on, this command is no longer available. This function can be performed at the LSMS or using the ELAP user interface.

Keyword: ent-lnp-lrn

Related Commands: chg-lnp-lrn, dlt-lnp-lrn, rtrv-lnp-lrn

Command Class: LNP Database

Parameters

:lrn= (mandatory)

The location routing number.

Range: 10 digits

:nmrgt1= (optional)

New message relay global title entry 1.

Range: tt, pc, ssn, xlat, ri, ngt, rgta

Default: Null or current value

:nmrgt2= (optional)

New message relay global title entry 2.

Range: **tt, pc, ssn, xlat, ri, ngt, rgta**

Default: Null or current value

The following arguments allow you to incrementally change default global title translations by entering the **nmrgt1** and **nmrgt2** parameters several times. When **nmrgt1** or **nmrgt2** parameters are used, the constituent values must *all* be entered and separated by a comma (,) or a dash (-) in the order **tt-pc-ssn-xlat-ri-ngt-rgta**.

tt-

Translation type

Range: **000-255**

pc-

ANSI destination point code with subfields *network indicator-network cluster-network cluster member (ni-nc-ncm)*.

Range: **000-255**

Specify a valid value for each subfield of the point code, and separate the subfields with a dash (-).

When **chg-sid:pctype=ansi** is specified, *ni = 000* is not valid.

When **chg-sid:pctype=ansi** is specified, *nc = 000* is not valid if *ni = 001-005*.

When **chg-sid:pctype=ansi** is specified, *nc = 000* is valid if *ni = 006-255*.

The point code **000-000-000** is not a valid point code.

ssn-

Subsystem number

Range: **000-255**

xlat-

Translate.

Range: **dpc, dpcssn, dpcngt**

r-

Routing indicator.

Range: **gt, ssn**

ngt-

New global title translation type.

Range: **0-255**

rgta-

Replace global title address (TN) with LRN.

Range: **yes, no**

:sp= (optional)

Service provider ID.

Range: 1-4 alphanumeric characters

Default: Null or current value.

Example

ent-lnp-lrn:lrn=1234567891:sp=a123:mrgt1=16-233-233-233-20-dpcssn-ssn-0-no

Dependencies

The LNP feature must be turned on (see the **enable-ctrl-feat** command) before this command can be entered.

When **mrgt1** parameter or the **mrgt2** parameter is specified, the constituent values must be entered in this order: **tt, pc, ssn, xlat, ri, ngt, rgta**

An existing override service cannot be assigned to an existing LRN.

The same TT value cannot be specified more than once.

When the **xlat=dpcssn** parameter is specified, the **ssn** parameter value must not be zero.

When the **xlat** parameter is specified with a value other than **dpcssn**, **ssn=0** must be specified.

When a value other than **dpcngt** is specified for the **xlat** parameter, **ngt=0** must be specified.

When the **xlat=dpcngt** parameter is specified, the **ri=gt** parameter must be specified.

The point code must be an ANSI point code, and it must be a valid DPC (**0-0-0** is not a valid ANSI point code) that exists in the routing table. Point code entries must be full point codes. Partial point codes are not allowed.

The MRGT# message relay translation type must not already be assigned.

The MRGT# message relay translation type must be a reserved service for LNP.

The MRGT# message relay translation type must not be the TT associated with the AIN, IN, PCS, LNPQS, or WNP service.

The service provider must be specified if not already assigned, and it must match a service provider that is already assigned.

The LRN and SP tables must not be full.

Notes

The maximum number of service provider IDs allowed is 10,000.

The LNP EAGLE stores the 10-digit override global title NGT (new global title) value on a per service, point code, and subsystem combination basis. This design allows a user to always modify the NGT field for all LRNs assigned the same service, point code, and subsystem combination instantly with one command. Conversely, the LSMS stores the NGT field independently for each 10-digit override (LRN) global title translation entered.

When an NGT field is modified or assigned to a particular LNP 10-digit override global title translation (either via the LSMS interface or directly from an EAGLE terminal), every existing LRN entry in the LNP EAGLE with the same combination of service, point code, and subsystem will reflect that NGT. Because of this difference in how this information is stored on the LSMS versus how it is stored on the EAGLE, a user could get into a situation where the NGT values in the LSMS are not reflective of those stored in the EAGLE 5 SAS. The NGT value must be specified correctly every time a 10-digit override (LRN) global title translation is updated or the LNP service on the EAGLE could be seriously impacted.

Output

```
ent-lnp-lrn:lrn=1234567891:sp=a123:mrgt1=16-233-233-233-20-dpcssn-ssn-0-no
  rlgncxa03w 04-02-18 08:50:12 EST EAGLE 31.3.0
  ENT-LNP-LRN: MASP A - COMPLTD
;
```

ent-lnp-npanxx**Enter LNP NPANXX**

NOTE: This command is obsolete.

Use this command to enter an LNP NPANXX and its associated LNP default global title translations into the database.

NOTE: If the LNP ELAP Configuration feature is turned on, this command is no longer available. This function can be performed at the LSMS or using the ELAP user interface.

Keyword: ent-lnp-npanxx

Related Commands: chg-lnp-npanxx, dlt-lnp-npanxx, rtrv-lnp-npanxx

Command Class: LNP Database Administration

Parameters

:npanxx= (mandatory)

Numbering plan area.

Range: 6 digits

:gt1= (optional)

Default global title entry 1.

Range: **ngt, pc, ri, ssn, tt, xlat**

Default: Null or current value.

:gt2= (optional)

Default global title entry 2.

Range: **ngt, pc, ri, ssn, tt, xlat**

Default: Null or current value.

The following arguments allow you to incrementally change default global title translations by entering the **ngt1** and **ngt2** parameters several times. When **ngt1** or **ngt2** parameters are used, the constituent values must *all* be entered and separated by a comma (,) or a dash (-) in the order **tt-pc-ssn-xlat-ri-ngt-ngta**

tt-

Translation type

Range: **000-255**

NOTE: See “Point Code Formats and Conversion” in Appendix A for a detailed description of point code formats, rules for specification, and examples.

pc-

ANSI destination point code with subfields *network indicator-network cluster-network cluster member (ni-nc-ncm)*.

Range: 000-255

Specify a valid value for each subfield of the point code, and separate the subfields with a dash (-).

When **chg-sid:pctype=ansi** is specified, *ni* = **000** is not valid.

When **chg-sid:pctype=ansi** is specified, *nc* = **000** is not valid if *ni* = **001-005**.

When **chg-sid:pctype=ansi** is specified, *nc* = **000** is valid if *ni* = **006-255**.

The point code **000-000-000** is not a valid point code.

ssn-

Subsystem number

Range: 000-255**xlat-**

Translate.

Range: dpc, dpcssn, dpcngt**r-**

Routing indicator.

Range: gt, ssn**ngt-**

New global title translation type.

Range: 000-255

:mr= (optional)

Message relay 10-digit TN search indication.

Range: yes, no

Default: yes

Example

```
ent-lnp-npanxx:npanxx=111111
```

```
ent-lnp-npanxx:npanxx=111111:mr=no:gt1=16-233-233-233-0-dpcngt-gt-18
```

Dependencies

The LNP feature must be turned on (see the **enable-ctrl-feat** command) before this command can be entered.

The MR portability indicator defaults to an active MR portable NPANXX indication.

Translation type values associated with PCS, LNPQS, or WNP LNP queries are not allowed to be administered as NPANXX default message relay global title translations.

If the NPANXX has already been created, at least one optional parameter must be specified.

The **mr** parameter applies only to message relay default global title translations, and means a 10-digit search for ported TN's is allowed for this NPANXX.

The **mr** parameter is valid only if message relay default global title translations are assigned.

The message relay global title must exist in the route table.

The LNP query default global title point code must exist in the route table, or must be the EAGLE's true point code and LNP subsystem.

The **gt1** and **gt2** parameters can be used to administer default message relay or LNP query global title.

The **gt1** and **gt2** parameters translation type must not already be assigned, and they must be a reserved service for the LNP

The NPANXX table cannot be full.

The same translation type value cannot be specified more than once.

When the **xlat=dpcssn** parameter is specified, the **ssn** parameter value must not be zero.

When the **xlat** parameter is specified with a value other than **dpcssn**, **ssn=0** must be specified.

When a value other than **dpcngt** is specified for the **xlat** parameter, **ngt=0** must be specified.

When the **xlat=dpcngt** parameter is specified, **ri=gt** must be specified.

The point code must be an ANSI point code, and it must be a valid DPC (**0-0-0** is not a valid ANSI point code). Point code entries must be full point codes. Partial point codes are not allowed.

The subsystem number (**ssn**) parameter must be in the LNP database.

Notes

You can enter this command several times for the same NPANXX to incrementally add default global title translations.

The maximum number of NPANXX entries allowed is 150,000.

The LNP EAGLE stores the 6-digit default global title NGT (new global title) value on a per service, point code, and subsystem combination basis, not on an NPA-NXX basis. This design allows a user to modify the NGT field for all NPA-NXXs assigned the same service, point code, and subsystem combination instantly with one command. Conversely, the LSMS stores the NGT field independently for each 6-digit default (NPA-NXX) global title translation entered.

When an NGT field is modified or assigned to a particular LNP 6-digit global title translation (either via the LSMS interface or directly from an EAGLE terminal), every existing NPA-NXX entry in the LNP EAGLE with the same combination of service, point code, and subsystem will reflect that NGT. Because of this difference in how this information is stored on the LSMS versus how it is stored on the EAGLE, a user could get into a situation where the NGT values in the LSMS are not reflective of those stored in the EAGLE 5 SAS. The NGT value must be specified correctly every time a 6-digit default (NPA-NXX) global title translation is updated or the LNP service on the EAGLE could be seriously impacted.

Output

```
ent-lnp-npanxx:npanxx=11111
```

```
rlghncxa03w 04-01-18 08:50:12 EST EAGLE 31.3.0
ENT-LNP-NPANXX: MASP A - COMPLTD
```

```
;
```

ent-lnp-serv**Enter LNP Service**

Use this command to reserve an LNP translation type for a unique LNP service. The available services include up to five query services (**ain**, **in**, **pcs**, **lnpqs**, and **wnp**) and any combination of six message relay or user-defined services. Translation type names can also be defined and are defaulted to the corresponding reserved service type names.

A maximum of 10 LNP services can be assigned in systems with up to 12 million numbers, and a maximum of 14 LNP services can be assigned in systems with more than 12 million numbers (using ELAP). Two of these assigned services will always be reserved for administration of AIN and IN Translation Types. Administration of Message Relay user defined services will also be allowed.

Keyword: **ent-lnp-serv**

Related Commands: **chg-lnp-serv**, **dlt-lnp-serv**, **rtrv-lnp-serv**

Command Class: LNP Database Administration

Parameters

:serv= (mandatory)

Reserved service type name.

Range: **ain, in, pcs, wnp, class, lidb, cnam, isvm, lnpqs, wsmc, udf1, udf2, udf3, udf4**

:alias= (optional)

The alias translation type.

Range: **000-255**

:dv= (optional)

Digits valid.

Range: **sccp, tcap**

Default: **sccp**—If **serv=class, lidb, cnam, isvm, wsmc, udf1, udf2, udf3, udf4**

tcap—If **serv=ain, in, pcs, wnp, lnpqs**

:tt= (optional)

Translation type.

Range: **000-255**

:ttn= (optional)

User defined TT name.

Range: 1 to 8 alphabetic characters, the value **none** is not allowed.

Default: Reserved service type name (**serv** parameter)

Example

```
ent-lnp-serv:serv=lidb:tt=16:dv=tcap:ttn=mrlidb
```

Dependencies

The LNP feature must be turned on (see the **enable-ctrl-feat** command) before this command can be entered.

To specify the **nserv=pcs** parameter, the PCS 1900 LNP (PLNP) feature must be turned on.

To specify the **nserv=wnp** parameter, the WNP feature must be turned on.

To specify the **serv=wsmisc** parameter, the LNP SMS feature must be turned on.

The **tt** parameter, the **ttn** parameter, and the **dv** parameter cannot be specified in the same command with the **alias** parameter.

The **tt** parameter must be specified if the **alias** parameter is not specified in the command.

NONE is considered a reserved name; it cannot be used for a translation type name (**ttn** parameter).

The value for the **dv** parameter must be **sccp** when a user-defined service type value is specified for the **serv** parameter.

The value for the **dv** parameter must be **tcap** when the **lnpqs**, **ain**, **in**, **pcs**, or **wnp** value is specified for the **serv** parameter.

A reserved service type name can be specified for the **ttn** parameter only if it matches the **serv** parameter value.

Neither the translation type (**tt**) parameter nor the translation type name (**ttn**) parameter can already exist in the LNP database.

The service type (**serv**) parameter must not exist in the LNP database when you are assigning a true translation type (**tt**).

LNP database when you are assigning a true translation type (**tt**) parameter.

A maximum of 6 Message Relay services are allowed.

When an **alias** is specified in the command, the service type for the **alias** must already have a true translation type assigned.

When the **alias** parameter is specified, its value cannot already exist in the LNP database as a true translation type for this service.

When the **alias** parameter is specified, the specified alias cannot be in use.

The LNP database and the LNP TT SERV table must be accessible.

When the **tt** parameter is specified, its value cannot already exist in the LNP database as an **alias** for this service.

Notes

Translation type names must be unique for LNP services.

A translation type name can be a reserved service type name only if it matches the specified service.

When the LNP feature is on for up to 12 million TNs (see the **enable-ctrl-feat** command), the LNP services CLASS, CNAM, LIDB, and ISVM must be in the OAP configuration in the EAGLE database. You must update the OAP configuration (with the **act-oap-config** command) whenever you perform the following actions:

- Add LNP services to the database (with the **ent-lnp-serv** command).
- Remove services from the database (with the **dlt-lnp-serv** command).
- Change services (with the **chg-lnp-serv** command).

As a reminder, the following warning message is displayed:

CAUTION: LNP service TTs have changed, OAP configuration is required

Output

```
ent-lnp-serv:serv=lidb:tt=16:dv=tcap:ttn=mrlidb
  rlgncxa03w 02-11-18 08:50:12 EST EAGLE 30.0.0
  ENT-LNP-SERV: MASP A - COMPLTD
;
```

ent-lnp-sp

Enter LNP Service Provider

NOTE: This command is obsolete.

Use this command to enter an LNP service provider.

NOTE: If the LNP ELAP Configuration feature is turned on, this command is no longer available, and all LNP provisioning is performed at the LSMS.

Keyword: ent-lnp-sp

Related Commands: dlt-lnp-sp, rtrv-lnp-sp

Command Class: LNP Database Administration

Parameters

:sp= (mandatory)
Service provider ID
Range: 1-4 alphanumeric characters

Example

```
ent-lnp-sp:sp=a123
```

Dependencies

The LNP feature must be turned on (see the **enable-ctrl-feat** command) before this command can be entered.

The service provider must not already exist in the LNP database.

The LNP SP table cannot be full.

Notes

The maximum number of service provider IDs allowed is 10,000.

Output

```
ent-lnp-sp:sp=a123
  rlgncxa03w 04-01-29 16:40:40 EST EAGLE 31.3.0
  ENT-LNP-SP: MASP A - COMPLTD
;
```

ent-lnp-sub**Enter LNP 10-Digit TN Subscription**

NOTE: This command is obsolete.

Use this command to enter an LNP 10-digit ported telephone number (TN) or a single pooled block of 1000 TNs along with the TN's related services into the database. Related services include LNP query LRN and message relay global title information. You can assign a maximum of two services at a time: either one LRN and one MRGT# or two MRGT#s.

NOTE: If the LNP ELAP Configuration feature is turned on, this command is no longer available. This function can be performed at the LSMS or using the ELAP user interface.

Keyword: ent-lnp-sub

Related Commands: chg-lnp-sub, dlt-lnp-sub, rtrv-lnp-sub

Command Class: LNP Subscription

Parameters

:tn= (mandatory)

Telephone number.

Range: 10 digits—To specify a single TN subscription

7 digits with 3 asterisks (***) appended—To pool a block of 1000 TNs

:lrn= (optional)

Location routing number.

Range: 10 digits

Default: Null or current value

:mrgt1= (optional)

Message relay global title entry number 1.

Range: tt, pc, ssn, xlat, ri, ngt, rgta

:mrgt2= (optional)

Message relay global title entry number 2.

Range: ngt, pc, ri, ssn, tt, xlat

The following arguments allow you to incrementally change default global title translations by entering the **mrgt1** and **mrgt2** parameters several times. When **mrgt1** or **mrgt2** parameters are used, the constituent values must *all* (mandatory) be entered and separated by a comma (,) or a dash (-) in the order **tt-pc-ssn-xlat-ri-ngt-rgta**.

tt-

Translation type

Range: 0-255

NOTE: See “Point Code Formats and Conversion” in Appendix A for a detailed description of point code formats, rules for specification, and examples.

pc-

ANSI destination point code with subfields *network indicator-network cluster-network cluster member (ni-nc-ncm)*.

Range: 000-255

Specify a valid value for each subfield of the point code, and separate the subfields with a dash (-).

When **chg-sid:pctype=ansi** is specified, *ni* = 000 is not valid.

When **chg-sid:pctype=ansi** is specified, *nc* = 000 is not valid if *ni* = 001-005.

When **chg-sid:pctype=ansi** is specified, *nc* = 000 is valid if *ni* = 006-255.

The point code 000-000-000 is not a valid point code.

ssn-

Subsystem number

Range: 0-255

xlat-

Translate.

Range: dpc, dpcssn, dpcngt

ri-

Routing indicator.

Range: gt, ssn

ngt-

New global title translation type.

Range: 0-255

rgta-

Replace global title address (TN) with LRN.

Range: yes, no

:sp= (optional)

Service provider ID.

Range: 4 alphanumeric characters

Default: Null or current value.

Example

```
ent-lnp-sub:tn=1234567890:sp=a123:lrn=1234567890
:mrgt1=16,233-233-233,0,dpc,gt,28,yes
```

```
ent-lnp-sub:tn=1234567***:sp=a123:lrn=1234567890
:mrgt1=16,233-233-233,0,dpc,gt,28,yes
```

```
ent-lnp-sub:tn=1234567000:etn=1234567999:sp=a123:lrn=1234567890
:mrgt1=16,233-233-233,0,dpc,gt,28,yes
```

Dependencies

The LNP feature must be turned on (see the **enable-ctrl-feat command**) before this command can be entered.

The LNP database must be accessible.

When the **nmmrgt1** or **nmmrgt2** parameter is used, the constituent values must be entered in this order: **tt, pc, ssn, xlat, ri, ngt, rgta**

If the telephone number (**tn** parameter) already exists, the newly entered nonfinal message relay global title translation or LRN is added.

A command cannot be entered that assigns an existing TT service to an existing telephone number.

Translation type values associated with AIN, IN, PCS, LNPQS, or WNP LNP queries are not allowed as message relay global title translations.

This command automatically creates an NPANXX for a TN-LRN record if the NPANXX does not already exist.

A maximum of 6 message relay GTTs can be assigned per TN.

The same translation type value cannot be specified more than once.

When the **xlat=dpcssn** parameter is specified, the **ssn** parameter value must not be zero.

When a value other than **dpcssn** is specified for the **xlat** parameter, **ssn=0** must be specified.

When a value other than **dpcngt** is specified for the **xlat** parameter, **ngt=0** must be specified.

When the **xlat=dpcngt** parameter is specified, the **ri=gt** parameter must be specified.

Either the location routing number or global title entry number must be specified.

The point code must be a valid ANSI point code. Point code entries must be full point codes. Partial point codes are not allowed.

The MRGT# message relay translation type must not already be assigned.

The MRGT# message relay translation type must be a reserved service for LNP.

When the **lrn** parameter is specified, the LRN must not already be assigned.

The point code must exist in the route table.

The service provider ID must be specified if not already assigned.

The service provider ID specified must match the SP already assigned.

If an MRGT# is specified, an NPANXX must exist.

When **rgta=yes** is specified, the **lrn** parameter must be specified.

The GT# message relay translation type must not already be assigned.

The GT# message relay translation type must be reserved for LNP.

The **tt** and **rmv** parameters cannot be specified together in the command.

Notes

You can enter this command several times for the same TN to incrementally add services.

This command updates data normally administered from the NPAC.

The maximum number of service provider IDs allowed is 10,000.

Pooled TNs are allocated on an even 1000-block boundary and cannot cross an NPANXX's boundary. Specific ported TNs can overlap a pooled block and contain different routing.

The LNP EAGLE stores the 10-digit subscription global title NGT (new global title) value on a per service, point code, and subsystem combination basis. This design allows a user to modify the NGT field for all 10-digit subscriptions assigned the same service, point code, and subsystem combination instantly with one command. Conversely, the LSMS stores the NGT field independently for each 10-digit subscription global title translation entered.

When an NGT field is modified or assigned to a particular LNP 10-digit global title translation (either via the LSMS interface or directly from an EAGLE terminal), every existing subscription entry in the LNP EAGLE with the same combination of service, point code, and subsystem will reflect that NGT. Because of this difference in how this information is stored on the LSMS versus how it is stored on the EAGLE, a user could get into a situation where the NGT values in the LSMS are not reflective of those stored in the EAGLE 5 SAS. The NGT value must be specified correctly every time a 10-digit subscription global title translation is updated or the LNP service on the EAGLE could be seriously impacted.

Output

```
ent-lnp-sub:tn=1234567890:sp=a123:lrn=1234567890
:mrgt1=16,233-233-233,0,dpc,gt,28,yes
    rlgncxa03w 04-01-18 08:50:12 EST EAGLE 31.3.0
    ENT-LNP-SUB: MASP A - COMPLTD
;
```

ent-ls

Enter Linkset

Use this command to add a linkset, with its assigned far-end point code and other linkset attributes, to the database.

Keyword: ent-ls

Related Commands: chg-ls, chg-slt, dlt-ls, rtrv-ls

Command Class: Database Administration

Parameters

:apc/apca/apci/apcn/apcn24= (mandatory)

Adjacent point code. The DPC of the adjacent signaling node at the far end of the linkset.

NOTE: See “Point Code Formats and Conversion” in Appendix A for a detailed description of point code formats, rules for specification, and examples.

:apc= or apca= (mandatory)

ANSI point code with subfields *network indicator-network cluster-network cluster member (ni-nc-ncm)*. The *prefix* subfield indicates a private point code (*prefix-ni-nc-ncm*).

Range: p-, 000-255

Specify a valid value for each subfield of the point code, and separate the subfields with a dash (-).

prefix—p-

When **chg-sid:pctype=ansi** is specified, *ni* = 000 is not valid.

When **chg-sid:pctype=ansi** is specified, *nc* = 000 is not valid if *ni* = 001-005.

When **chg-sid:pctype=ansi** is specified, *nc* = 000 is valid if *ni* = 006-255.

The point code 000-000-000 is not a valid point code.

:apci= (mandatory)

ITU international point code with subfields *zone-area-id*. The *prefix* subfield indicates a spare point code, private point code, or private and spare point code (*prefix-zone-area-id*).

Range: **s-, p-, ps-, 0-255**

Specify a valid value for each subfield of the point code, and separate the subfields with a dash (-).

The point code **0-000-0** is not a valid point code.

prefix—**s-, p-, ps-**

zone—**0-7**

area—**000-255**

id—**0-7**

:apcn= (mandatory)

ITU national point code in the format of a 5-digit number (*nnnnn*); or 2, 3, or 4 numbers (members) separated by dashes (*m1-m2-m3-m4*) as defined by the **chg-stpopts:npcfmti** flexible point code option. A group code must be specified when the ITUDUPPC feature is turned on (*nnnnn-gc*, *m1-m2-m3-m4-gc*). The *prefix* subfield indicates a spare point code, private point code, or private and spare point code (*prefix-nnnnn*, *prefix-nnnnn-gc*, *prefix-m1-m2-m3-m4*, *prefix-m1-m2-m3-m4-gc*).

Range: **s-, p-, ps-, 0-16383, aa-zz**

Specify a valid value for each subfield of the point code, and separate the subfields with a dash (-).

prefix—**s-, p-, ps-**

nnnnn—**0-16383**

gc—**aa-zz**

m1-m2-m3-m4—**0-14** for each member; values must sum to 14

apcn24= (mandatory)

24-bit ITU national point code with subfields *main signaling area-sub signaling area-signaling point* (*msa-ssa-sp*). The *prefix* indicates a private point code (*prefix-msa-ssa-sp*).

Range: **p-, 000-255**

prefix—**p-**

msa—**000-255**

ssa—**000-255**

sp—**000-255**

:apcntype= (optional)

ITU-N Adjacent Point Code Type. The ITU National or ITU National China Adjacent Point Code types indicate the format that will be used for changeover and changeover acknowledgement messages.

Range: **itun, itunchina**

Default: **itun**

:lsn= (mandatory)

The name of the linkset. The linkset name must be unique.

Range: 1 alphabetic character followed by up to 9 alphanumeric characters

:lst= (mandatory)

The linkset type of the specified linkset. This parameter indicates whether the specified link is an access link, bridge link, cross link, diagonal link, or extended link, as defined in Telcordia GR-246-CORE, T1.111.5.

Range: a, b, c, d, e

a—Access links

b—Bridge links

c—Cross links

d—Diagonal links

e—Extended links

:asl8= (optional)

Adjacent SLS 8-bit indicator. Specifies whether the adjacent node is sending MSUs with 8-bit SLSs.

Range: yes, no

Default: no

:bei= (optional)

The broadcast exception indicator. This parameter indicates whether TFP (transfer prohibited) messages are allowed to be broadcast on the linkset. The **yes** parameter means TFPs are not broadcast, and the **no** parameter means TFPs are broadcast.

Range: yes, no

Default: yes—for X.25

no—for SS7

:cli= (optional)

The far-end Common Language Location Identifier (CLLI) assigned to this linkset.

Range: 1 alphabetic character followed by up to 10 alphanumeric characters

Default: CLLI of the adjacent point code

:gmscrn= (optional)

GSM MAP screening allowed.

Range: on, off

Default: off

:gwsa= (optional)

Gateway screening action. This parameter determines whether gateway screening (GWS) is on or off for the specified linkset.

Range: on, off

Default: on—if **scrn** is specified

off—if **scrn** is not specified

:gwsd= (optional)

Use gateway screening MSU discard to turn on or off the discarding of MSUs that bypass the gateway screening function due to load-shedding. Also use this parameter with the redirect function; MSUs that cannot be screened are discarded if **gwsd=on** is specified.

Range: on, off

Default: off

:gwsms= (optional)

Gateway screening messaging. This parameter determines whether messages are generated for each message screened by gateway screening.

Range: on, off

Default: off

:iptps= (optional)

IPGWx Linkset TPS. This value is a user-defined portion of the total enabled system IP signaling TPS shown in the **rtrv-ctrl-feat** command output. This parameter is allowed and required only for IPGWx linksets (when **ipgwapc=yes** is specified).

Range: 100-112000

The specified value must be divisible by 10.

The sum of the **iptps** values assigned to all linksets in the system cannot exceed the enabled system IPGWx Signaling TPS value (see the **rtrv-ctrl-feat** command).

NOTE: The maximum range value for the **iptps** parameter is 188000 for future expansion. However, the maximum system IPGWx Signaling TPS capacity currently available is 112000.

:ipgwapc= (optional)

IP gateway adjacent point code. Specifying **ipgwapc=yes** indicates that the linkset is entered for a card of application type SS7IPGW or IPGWI and the adjacent point code specified is an IP gateway adjacent point code.

Range: yes, no

Default: no

:itutfr= (optional)

ITU TFR (Transfer Restricted) procedure indicator. This parameter is used to enable or disable the TFR procedure on a per-linkset basis. This parameter is valid for ITU national linksets only.

Range: on, off

Default: off

:l3tset= (optional)

Link timer set, defined with the **chg-l3t** command.

Range: 1

Default: 1

:lsusealm= (optional)

IPTPS linkset alarm threshold percent. The percent of the linkset TPS (**iptps**) at which an alarm is generated to indicate that the actual linkset TPS is approaching the configured **iptps** value for the linkset.

Range: 10-100

Default: 100

:mtprese= (optional)

ANSI or ITU MTP Restart equipped. This parameter indicates whether the node adjacent to the linkset is equipped with MTP Restart.

Range: **yes, no**
yes—equipped
no—not equipped

Default: **no**

:multgc= (optional)

Multiple group codes. This parameter indicates whether multiple group codes are allowed.

Range: **yes, no**

Default: **no**

:nis= (optional)

This parameter determines whether the Network Indicator Spare option is on or off for the specified linkset. When this option is enabled, the Network Spare value for network indicator for both ANSI and ITU-National (ITU-N) links is supported by the system.

Range: **on, off**

Default: **off**

:scrn= (optional)

The name of the screen set to be assigned to this linkset if gateway screening is to be used.

Range: 1 alphabetic character followed by up to 3 alphanumeric characters, or **none**
none—Deletes screen set association with the linkset

:slkusealm= (Optional)

IPTPS signaling link alarm threshold percent. The percent of the link "fair share" TPS at which an alarm is generated to indicate that the actual link TPS is approaching the link's "fair share" of its linkset's configured TPS (**iptps**). The "fair share" of the linkset TPS for a link is the configured linkset TPS divided by the number of in-service links in the linkset

Range: **10-100**

Default: **80**

:slsci= (optional)

5-bit to 8-bit SLS conversion indicator. Specifies whether the 5-bit to 8-bit SLS conversion feature is used to select links for outgoing messages direct to the given linkset. When enabled, the system replaces any 5-bit SLS values contained in received messages, with a random 8-bit value before the 5-bit SLS values are used by the STP to select the outgoing link in that linkset.

Range: **yes, no**

yes—enabled

no—disabled

Default: **no**

:slsobit= (optional)

Other CIC (Circuit Identification Code) Bit. If the SLSOCB feature is turned on, this parameter allows you to specify whether the Other CIC Bit option is to be used during link selection. If the option is to be used, you specify which bit (5- 16) of the CIC is to be used as the other CIC bit. During link selection, the specified bit acts as the most significant bit of the new SLS and bits 2 through 4 of the received CIC become the least significant bits of the new SLS. This parameter is used for ITU-ISUP messages. The SLS is not modified in the outgoing message. The following example shows a received CIC where bit 9 is the other CIC bit (**slsobit=9**). The new SLS is 0100.

16	15	14	13	12	11	10	9	8	7	6	5	4	3	2	1
0	0	0	0	1	0	0	0	1	0	0	1	1	0	0	1
New SLS								0				1	0	0	

Range: 5–16, none

Default: None

:slrsb= (optional)

Rotated SLS (Signaling Link Selection) Bit. This parameter is used for ITU messages on a per-linkset basis to select the bit (1–4) to rotate as the new SLS LSB (Least Significant Bit). The SLS is not modified in the outgoing message. Table 6-9 on page 6-260 shows how the rotation affects the four bits of the SLS during linkset selection:

Range: 1–4

Default: 1

Table 6-9. SLS Bit Rotation

If This Bit Is Selected . . .	Then Bit Locations 4 3 2 1 Are Rotated To . . .	Description
Bit 4	3 2 1 4	SLS = 0110 becomes Rotated SLS = 1100 SLS = 1011 becomes Rotated SLS = 0111
Bit 3	2 1 4 3	SLS = 0110 becomes Rotated SLS = 1001 SLS = 1011 becomes Rotated SLS = 1110
Bit 2	1 4 3 2	SLS = 0110 becomes Rotated SLS = 0011 SLS = 1011 becomes Rotated SLS = 1101
Bit 1	No rotation is performed because bit 1 is the existing LSB.	

:sltset= (optional)

The SLTM record to be associated with the linkset

Range: 1–20

Default: 1 for ANSI
2 for ITU

Example

Adds linkset **wy644368** with **apc 144-201-1** with **lst c**:

ent-ls:lsn=wy644368:apc=144-201-001:lst=c

Adds linkset **lsitua1** with **apcn 5-5-5-1** with **lst c**. The **apcn** parameter is using a four-part format where the maximum number of bits in each position is defined by the **chg-stpopts:npcfmti** parameter :

ent-ls:lsn=lsitua1:apcn=5-5-5-1:lst=c

In this example, the ITU national duplicate point code (ITUDUPPC) feature is turned on, so the ITU national point code contains a group code. Adds linkset **exp123** with **apcn 2-3-4-5-aa**, which has a duplicate point code group of **aa** and linkset type **a**:

ent-ls:lsn=exp123:apcn=2-3-4-5-aa:lst=a

Add a linkset in which all applicable MSUs arriving on the linkset are screened using the GSM MAP screening feature:

ent-ls:lsn=lsitu1:apcn=5000:lst=a:gsmscrn=on

Adds a link set **lsn24** with 24-bit ITU-N **apcn24 10-100-10** and linkset type **a**:

ent-ls:lsn=lsn24:apcn24=10-100-10:lst=a

Adds link set **lsa2** with private APC **p-1-2-4**

ent-ls:lst=a:lsn=lsa2:apc=p-1-2-4

Adds link set **lsn410234** with private and spare APCN **ps-1-1-1-2047-aa**:

ent-ls:lst=b:lsn=lsn410234:apcn=ps-1-1-1-2047-aa

Adds link set **lsi00001** with spare APCI **s-1-1-209-7**:

ent-ls:lst=b:lsn=lsi00001:apci=s-1-1-209-7

Adds link set **lsn24** with APCN24 **10-100-10** with **apcntype=itunchina** and linkset type **a**.

ent-ls:lsn=lsn24:apcn24=10-100-10:lst=a:apcntype=itunchina

Dependencies

The adjacent point code must be a full point code.

The specified adjacent point code cannot exist as an alias point code.

If the **gwsa=on**, **gwsn=on**, and **gwsd=on** parameters are specified, the **scrn** parameter must be specified.

If the **apcn** parameter is specified, its format must match the format that was assigned with the **chg-stpopts:npcfmti** parameter.

The specified adjacent point code cannot be the same as the self-ID destination point code of the STP.

The specified adjacent point code cannot be the same as any self-ID capability point codes of the STP.

If the system is configured for ANSI formatted point codes, the network indicator value of the far-end point code parameter (**ni**) must be **6** or greater when the cluster value is **0 (nc)**.

The specified linkset name cannot already exist in the database.

The specified adjacent point code cannot be assigned to any other linkset.

Private (**p-**) and private and spare (**ps-**) point codes can be assigned only to IPGW linksets (**ipgwapc=yes** is specified).

The maximum number of linksets that can be defined in the system is 1024.

The specified far-end **clli** value cannot be assigned to any other linkset.

The specified screen set (**scrn**) must exist in the database.

If the **gwsd=on** parameter is specified, the **gwsa=on** parameter must be specified.

If a destination point code matching the specified far-end point code exists, the far-end CLLI for the given linkset must match the destination identifier (DI) of that matching destination.

If the adjacent point code is in the X.25 domain, the **bei=yes** parameter must be specified or the **bei** parameter must be omitted from the command.

The specified adjacent point code cannot be referenced by an X.25 route with **lc2nm=yes**.

The **slsci** parameter can be specified only for ANSI linksets.

The **mtrprse** parameter can be specified only if the MTP Restart feature, MTPRS (for ANSI) or ITUMTPRS (for ITU), is turned on. The **rtrv-feat** command can be used to verify whether the feature is turned on (mtrprs=yes or itumtrprs=yes in the output).

The **mtrprse=yes** parameter is not valid for IPGW Adjacent Point Code linksets (**ipgwapc=yes** parameter).

The **asl8=yes** parameter can be assigned only to an ANSI linkset (a linkset containing an adjacent point code in the SS7 domain).

The **apcntype** parameter can be specified only for ITU-N and ITU-N24 linksets.

The Other CIC (Circuit Identification Code) Bit Used feature (SLSOCB) feature must be turned on before the **slsobit** parameter can be specified.

The **slsobit** parameter is valid only for ITU linksets.

The **slsrbs** parameter is valid only for ITU linksets.

The GSM Map Screening feature must be turned on (see the **enable-ctrl-feat** and **chg-ctrl-feat** commands) before the **gsmscrn** parameter can be specified.

The **itutfr** parameter is valid only for ITU national linksets on the EAGLE STP and for ITU linksets on the IP⁷ Secure Gateway.

The ITU National Duplicate Point Code (ITUDUPPC) feature must be turned on before the **multgc=yes** parameter can be specified.

The **multgc=yes** parameter is valid only for ITU-N or ITU-I point codes.

The **iptps** parameter must be specified for IPGWx linksets

The **iptps** parameter cannot be specified for linksets that are not IPGWx.

The specified **iptps** parameter value must be divisible by 10.

The total of the **iptps** parameter values for all linksets cannot exceed the IPGWx Signaling TPS feature quantity that is enabled in the system.

The **lsusealm** parameter cannot be specified for linksets that are not IPGWx.

The **slkusealm** parameter cannot be specified for linksets that are not IPGWx.

The Enhanced GSM Map Screening feature must be turned on before **gsmscrn=on** can be specified for an ANSI linkset.

Notes

Of the 1024 maximum linksets supported, up to 255 of the linksets can be gateway linksets.

The system supports a maximum of 700 links. If you define more than 700 linksets, a maximum of 700 of the defined linksets can be in use at any one time.

The links that directly connect the system with an adjacent node are grouped into one or more linksets. A linkset can contain up to 8 (international standards) or 16 (national standards) signaling links, depending on how the system was configured when the network was created.

Each linkset must be assigned the same physical links at both ends of the link (local and adjacent signaling points) and each link must be assigned the same link number.

Signaling link acknowledgments (SLTA) are the same type of maintenance message as the SLTMs received on the link.

If the **gwsa=off** and **gwsn=off** parameters are specified, all MSUs are passed.

If the **gwsa=off** and **gwsn=off** parameters are specified for all linksets, gateway screening and the GWS redirect function for the DTA feature are disabled.

If the **gwsa=off** and **gwsn=on** parameters are specified, all MSUs pass, but MRNs are generated if an MSU matches a screening condition.

If the **gwsa=on** and **gwsn=off** parameters are specified, MSUs are screened but messages are not generated.

If the **gwsa=on** and **gwsn=on** parameters are specified, MSUs are screened and MRNs are generated at the rate of one MRN every 20 seconds per link.

If the **asl8=yes** parameter is specified with the **lst=a** parameter (a linkset containing access signaling links), this indicates that the originator of the MSUs is generating 8-bit SLSs. For other linkset types, the **asl8=yes** parameter indicates that the adjacent STP is converting 5-bit SLSs to 8-bit SLSs. The SLS in MSUs received by the system on a linkset that has the **asl8=yes** parameter assigned to it will not be converted. These MSUs are assumed to contain 8-bit SLSs.

The Network Indicator Spare (NIS) parameter can be specified only for ANSI and ITU-N links.

The **mtrpse** parameter value can be specified independently of the value specified on the **mtrpsi** parameter of the **chg-stpopts** command.

The MTP restart option (**mtrpse**) is not a valid option on TCP/IP point-to-multipoint links (DCM cards equipped as SS7IPGW links).

When two linksets are used as a combined linkset, each linkset should have the same **slsci** and **asl8** values. MTP restart provides an orderly process for bringing signaling links back into service after the system has been isolated and restarted. A greater preference is given to restoring the STP to network service in an orderly fashion than to the speed of recovery. The time required is system dependent; Table 6-10 provides examples of some approximate times:

Table 6-10. Link Alignment Performance

System Size (Number of LIMs)	Link Alignment Delay (seconds)
up to 64	62
64 to 127	97
128 to 191	132
more than 191	167

The **slsru** parameter alone does not provide an even distribution of ITU-ISUP messages across all links within a linkset. The system uses all four bits of the SLS to determine the actual link to route messages. Because the static bit is simply rotated within the SLS, all possible values of the SLS field will still not be realized. The **slsru** parameter must also be specified to provide an even distribution across all links within the linkset. If both parameters are specified for a given linkset, the SLS field is processed in the following order.

1. The SLS is modified using the Other CIC Bit option.
2. The modified SLS is modified again using the Rotated SLS Bit option.
3. The modified SLS is used by the existing linkset and link selection algorithms to select a link
4. The ISUP message is sent out the link containing the original, unmodified SLS field.

If the ITU National Duplicate Point Code (ITUDUPPC) feature is turned on, for each group that is defined, a separate ITU national C linkset must be provisioned. The C linkset is used as the alternate route for point codes in the group.

In this command, only ITU-international and ITU national point codes support the spare point code subtype prefix (**s-**) and the private and spare point code subtype prefix (**ps-**). All of the point code types support the private (internal) point code subtype prefix (**p-**).

The ITU National and ITU National China Adjacent Point Code types indicate the format that is used for changeover and changeover acknowledgement messages. China specifies a 16-bit field for data in changeover messages. The FSN occupies the first 12 bits. The trailing 4 bits are spare and are coded as 0. ITU uses a 24-bit field for data in the extended changeover/changeover acknowledgement messages. The FSN is encoded in the first 12 bits. The last 12 bits of the field are spare and are coded as zero.

Output

```
ent-ls:lsn=wy644368:apc=144-201-001:lst=c
  rlgncxa03w 04-02-17 16:23:21 EST EAGLE 31.3.0
  Link set table is (114 of 1024) 11% full
  ENT-LS: MASP A - COMPLTD
;
```

ent-map**Enter Mate Applications**

Use this command to allow the assignment of mated applications for use with SCCP network management. A mated application is used in the event the local application becomes unavailable.

Keyword: ent-map

Related Commands: chg-map, dlt-map, rtrv-map

Command Class: Database Administration

Parameters

NOTE: See “Point Code Formats and Conversion” in Appendix A for a detailed description of point code formats, rules for specification, and examples.

:pc/pca/pci/pcn/pcn24= (mandatory)

Primary remote point code.

:pc= or :pca= (mandatory)

ANSI point code with subfields *network indicator-network cluster-network cluster member (ni-nc-ncm)*.

Range: 000-255

Specify a valid value for each subfield of the point code, and separate the subfields with a dash (-).

When **chg-sid:pctype=ansi** is specified, *ni* = 000 is not valid.

When **chg-sid:pctype=ansi** is specified, *nc* = 000 is not valid if *ni* = 001-005.

When **chg-sid:pctype=ansi** is specified, *nc* = 000 is valid if *ni* = 006-255.

The point code 000-000-000 is not a valid point code.

:pci= (mandatory)

ITU international point code with subfields *zone-area-id*. The *prefix* subfield indicates a spare point code (*prefix-zone-area-id*).

Range: s-, 0-255

Specify a valid value for each subfield of the point code, and separate the subfields with a dash (-).

prefix—s-

zone—0-7

area—000-255

id—0-7

The point code 0-000-0 is not a valid point code.

:pcn= (mandatory)

ITU national point code in the format of a 5-digit number (*nnnnn*); or 2, 3, or 4 numbers (members) separated by dashes (*m1-m2-m3-m4*) as defined by the **chg-stpopts:npcfmti** flexible point code option. A group code must be specified when the ITUDUPPC feature is turned on (*nnnnn-gc*, *m1-m2-m3-m4-gc*). The *prefix* subfield indicates a spare point code (*prefix-nnnnn*, *prefix-nnnnn-gc*, *prefix-m1-m2-m3-m4*, *prefix-m1-m2-m3-m4-gc*).

Range: **s-**, **0-16383**, **aa-zz**
Specify a valid value for each subfield of the point code, and separate the subfields with a dash (-).

prefix—**s-**

nnnnn—**0-16383**

gc—**aa-zz**

m1-m2-m3-m4—**0-14** for each member; values must sum to 14

:pcn24= (mandatory)

24-bit ITU national point code with subfields *main signaling area-sub signaling area-signaling point (msa-ssa-sp)*.

Range: **000-255**

Specify a valid value for each subfield of the point code, and separate the subfields with a dash (-).

msa—**000-255**

ssa—**000-255**

sp—**000-255**

:ssn= (mandatory)

Subsystem number. This parameter identifies the application's subsystem number. This attribute is composed of the decimal representation of the 1-byte field used in the SS7 protocol.

Range: **2-255**

:grp= (optional)

The concerned point code broadcast list (CSPC) group name. This parameter is the name of a group of point codes that should be notified of the subsystem status. A different CSPC group can be assigned to each mated PC/SSN. For ANSI, the EAGLE broadcasts SSP or SSA to the mate subsystem only if the mate's point code is provisioned as part of the CSPC group to receive an SSP or SSA. This parameter must be provisioned for a node if the node is to receive SSP or SSA broadcasts, even if the node is a mated application.

Range: 1 alphabetic character followed by up to 7 alphanumeric characters

Default: No broadcast list for this mated application.

:materc= (optional)

Mate relative cost. The EAGLE determines the multiplicity mode based on the relative costs (the **rc** and **materc** parameters) of the subsystem. (See Notes for additional information on multiplicity modes).

Range: **00-99**

Default: **50**

:mpc/mpca/mpci/mpcn/mpcn24= (optional)

Mate remote point code.

NOTE: See “Point Code Formats and Conversion” in Appendix A for a detailed description of point code formats, rules for specification, and examples.

:mpc= or :mpca= (optional)

ANSI point code with subfields *network indicator-network cluster-network cluster member (ni-nc-ncm)*.

Range: **000-255**
 Specify a valid value for each subfield of the point code, and separate the subfields with a dash (-).
 When **chg-sid:pctype=ansi** is specified, *ni* = **000** is not valid.
 When **chg-sid:pctype=ansi** is specified, *nc* = **000** is not valid if *ni* = **001-005**.
 When **chg-sid:pctype=ansi** is specified, *nc* = **000** is valid if *ni* = **006-255**.
 The point code **000-000-000** is not a valid point code.

Default: **000-000-000**

:mpci= (optional)

ITU international destination point code with subfields *zone-area-id*. The *prefix* subfield indicates a spare point code (*prefix-zone-area-id*).

Range: **s-, 0-255**
 Specify a valid value for each subfield of the point code, and separate the subfields with a dash (-).
 The point code **0-000-0** is not a valid point code.

prefix—s-
zone—0-7
area—000-255
id—0-7

Default: **0-000-0**

:mpcn= (optional)†

ITU national point code with subfield ITU number (*nnnnn*). The *prefix* subfield indicates a spare point code.

Range: **s-, 0-16383**
prefix—s-
nnnnn—0-16383

Default: **00000**

:mpcn24= (optional)†

24-bit ITU national point code with subfields *main signaling area-sub signaling area-signaling point* (*msa-ssa-sp*).

Range: **000-255**
 Specify a valid value for each subfield of the point code, and separate the subfields with a dash (-).

msa—000-255
ssa—000-255
sp—000-255

Default: **000-000-000**

:mrc= (optional)

Message routing under congestion. This parameter defines the handling of Class 0 messages during congestion conditions.

Range: **yes, no**

Default: **yes**—if ANSI
no—if ITU

:mssn= (optional)

Mate subsystem number. This parameter identifies the mate application's subsystem number. This attribute is the decimal representation of the one-byte field used in the SS7 protocol.

Range: 2–255

Default: Parameter is not used

:rc= (optional)

Relative cost. The EAGLE determines the multiplicity mode based on the relative costs (the **rc** and **materc** parameters) of the subsystem. (See Notes for additional information on multiplicity modes).

Range: 00–99

Default: 10

:srm= (optional)

Subsystem routing messages. This parameter defines whether subsystem routing messages (SBR, SNR) are transmitted between the mated applications.

Range: yes, no

Default: yes—if ANSI
no—if ITU

:sso= (optional)

Subsystem Status Option. Indicates whether or not the PC/SSN is to initiate a subsystem test when a RESUME is received for the PC.

Range: on, off

Default: off

Example

As shown in the following example, the **rc** parameter is not required for a solitary **pc/ssn** pair. If the **rc** parameter is not specified, the relative cost defaults to **10**.

```
ent-map:pc=1-1-1:ssn=10:grp=xyz
```

The following example enters both **1-1-0/10** and **1-1-1/10** into the map table. both the **rc** and **materc** parameter are required for this command, which defines a map group.

```
ent-map:pc=1-1-0:ssn=10:rc=10:mpc=1-1-1:mssn=10:materc=20:grp=xyz:srm=on
```

The following example enters a solitary point code in the MAP table with the Subsystem Status Option (**sso**) set to **on**.

```
ent-map:pc=1-1-3:ssn=20:grp=abc:sso=on
```

The following two commands enter a solitary point code in the MAP table with the Subsystem Status Option (**sso**) set to **off**.

```
ent-map:pc=2-2-2:ssn=20:grp=abc:sso=off
```

```
ent-map:pc=2-2-3:ssn=20:grp=abc
```

The following example sets the Subsystem Status Option (**sso**) set to **on** for the primary and mate.

```
ent-map:pc=1-1-4:ssn=10:rc=10:mpc=1-1-1:mssn=10:materc=20:sso=on
```

The following two commands set the Subsystem Status Option (**sso**) set to **off** (default) for the primary and mate:

```
ent-map:pc=1-1-5:ssn=10:rc=10:mpc=1-1-2:mssn=10:materc=20:sso=off
```

```
ent-map:pc=1-1-6:ssn=10:rc=10:mpc=1-1-7:mssn=10:materc=20
```

The following command enters spare point codes **1-1-0** with **rc=10** and **1-1-1** with **rc=10** into the MAP table. Both the **rc** and **materc** parameters are required for this command, to define a MAP group.

```
ent-map:pci=s-1-1-0:ssn=10:rc=10:mpci=s-1-1-1:mssn=10:materc=20:grp=xyz:srm=no
```

Dependencies

The **pc/ssn** pair must not already exist in the Mate Application entity set.

If an **mpc/mssn** pair is specified, that pair must not already exist in the Mate Application entity set and the **mpc** must already exist in the Routing table.

If **pc** is entered as **pc** or **pca**, the **mpc**, if specified, must be **mpc** or **mpca**. If **pc** is entered as **pci** or **pcn**, the **mpc**, if specified, must be **mpci** or **mpcn**, respectively.

ITU-I, ITU-N, ITU-I spare, and ITU-N spare true point codes must be entered with the same subsystem number (**ssn**).

If the ANSI-ITU-China SCCP Conversion feature is turned on, concerned point code broadcast group and PC network types can be mixed.

If the ANSI-ITU-China SCCP Conversion feature is not turned on,

- If **pc** is entered as **pc** or **pca**, the specified point codes in the concerned point code broadcast group must have been entered as **pc** or **pca**.
- If **pc** is entered as **pci** or **pcn**, the specified point codes in the concerned point code broadcast group must have been entered as **pci** or **pcn**, respectively.

If the point code values are ITU values (**pci** or **pcn**), **srm=yes** cannot be specified.

The primary remote point code must exist in the Routing table.

If a mate point code is specified, a mate subsystem number must be specified.

If a mate subsystem number (**mssm**) or relative cost (**materc**) is specified, the mate point code (**mpc**) must be specified.

If a concerned signaling point code broadcast list group name is specified, it must already exist.

The Spare Point Code Support feature must be enabled before an ITU-I or ITU-N spare point code can be specified.

A maximum of 1024 unique remote point codes are allowed.

A maximum of 12 SSNs per remote point code can be entered.

The destination point codes of the primary subsystem and the mate subsystem must be full point codes.

If the cluster routing and management diversity (CRMD) feature is on, point codes in the mate applications table must be full point code entries in the Routing table. Partial point codes are not allowed.

The LNP feature must be turned on (see the **enable-ctrl-feat** command) before an EAGLE true point code and LNP subsystem can be specified.

If the **pcn** parameter or the **mpcn** parameter is specified, the format must match the format that was assigned with the **chg-stpopts:npcfmti** parameter.

The INP feature or the Equipment Identity Register (EIR) feature must be turned on before a value that is a true point code can be specified for the **pcn** parameter.

The EIR feature must be turned on before a value that is a true point code can be specified for the **pci** parameter.

ITU-I and ITU-N true point codes must be specified with the same EIR subsystem number.

If a mate remote point code is specified, the mate remote point code must exist in the Routing table.

The **srm** or **mrc** parameters cannot be specified for a solitary **pc/ssn** pair entry.

If the **mpc** and **mssn** parameters are specified, the **materc** parameter must be specified.

If the **pc/ssn** and **mpc/mssn** parameter pairs are specified, the **rc** parameter must be specified.

If the **mpc** parameter is specified, the following parameters must be specified: **mssn**, **materc**, and **rc**.

If the **pc** parameter value is an EAGLE true point code, the subsystem must have a lower relative cost than all other mated subsystems in the group.

If the **pc** parameter value is equal to the true point code and the **materc** parameter is specified, the **rc** parameter value must be less than the **materc** parameter value.

If the **mpc** parameter value is equal to the true point code, the **rc** parameter value must be greater than the **materc** parameter value.

The **sso** parameter cannot be specified with a point code value that is the system true point code.

A true point code cannot be routed to itself.

Notes

Up to 8 PC/SSN pairs can be entered into a mated PC/SSN group.

The EAGLE supports four multiplicity modes for nodes/subsystems. A description of each mode follows.

- When a PC/SSN pair is not replicated, the pair is in solitary mode. The subsystem acts as the only application, with no backup. If this subsystem fails, messages routed to it are discarded and SCCP management returns “Subsystem Unavailable” messages to the originator.
- A group of replicated PC/SSN pairs are in *dominant* mode if each PC/SSN pair in the group has a unique relative cost. The specified subsystem acts as the primary subsystem, while the mate subsystem acts as a backup. In the event of congestion, messages route to the mate subsystem. When the congestion subsides, messages are again routed to the primary (dominant) subsystem.

- A group of replicated PC/SSN pairs are in *load sharing* mode if each PC/SSN pair in the group has the same relative cost. All messages are evenly distributed at the SCCP level to all nodes/subsystems in the group. In the event of congestion or failure, the non-affected subsystem assumes the load of its failed or congested mate.
- The *combined load sharing/dominant* mode supports a combination of loadsharing and dominant mode and is new for the Weighted SCP Load Balancing feature. A group of PC/SSN pairs are in combined load sharing/dominant mode when at least two of the PC/SSN pairs have the same relative cost and another node subsystem in the group has a different relative cost. A combination of node accessibility and relative cost determines the preferred PC/SSN.

If the XMAP feature is enabled, the MAP table can have up to either 2000 or 3000 entries, depending on the controlled feature Part Number that is enabled. If XMAP is not enabled, the MAP table can contain up to 1024 user entries.

The **ss** parameter changes the initialization of the subsystem status (“prohibited” or “allowed”) for PC/SSN MAP entries. The EAGLE previously marked the subsystem status “allowed” for each PC/SSN entry. The **ss** parameter marks the subsystem status “prohibited” for each new entry that has **ss=on**. This causes the EAGLE to generate an SST to the remote point-code when an MTP-RESUME is received. Upon reception of an SSA, the subsystem status is marked “allowed”.

When the ANSI-ITU-China SCCP Conversion feature is turned on, the Concerned Point Code (CSPC) Group’s network type can be of a different network than the mated application’s network type. For example, the mated application’s network type could be ANSI and the CSPC Group could be ITU or mixed with ANSI, ITU, and ITUN concerned point codes.

In this command, only ITU-international and ITU national point codes support the spare point code subtype prefix (s-).

Output

```
ent-map:pc=1-1-1:ssn=10:grp=xyz
  rlgncxa03w 04-01-07 11:43:04 EST EAGLE 31.3.0
  ENT-MAP: MASP A - COMPLTD
;
```

ent-mrn

Enter Mated Relay Node

Use this command to assign point codes to point code groups in the Mated Relay Node (MRN) table.

Use this command to create a new MRNSET, or add entries to an existing MRNSET.

Keyword: ent-mrn

Related Commands: chg-mrn, dlt-mrn, rtrv-mrn

Command Class: Database Administration

Parameters

NOTE: See “Point Code Formats and Conversion” in Appendix A for a detailed description of point code formats, rules for specification, and examples.

:pc/pca/pci/pcn/pcn24= (mandatory)

Post-GTT-translated point code.

:pc= or **:pca=** (mandatory)

ANSI point code with subfields *network indicator-network cluster-network cluster member* (*ni-nc-ncm*).

Range: **000-255**

Specify a valid value for each subfield of the point code, and separate the subfields with a dash (-).

When **chg-sid:pctype=ansi** is specified, *ni* = **000** is not valid.

When **chg-sid:pctype=ansi** is specified, *nc* = **000** is not valid if *ni* = **001-005**.

When **chg-sid:pctype=ansi** is specified, *nc* = **000** is valid if *ni* = **006-255**.

The point code **000-000-000** is not a valid point code.

:pci= (mandatory)

ITU international point code with subfields *zone-area-id*. The *prefix* subfield indicates a spare point code (*prefix-zone-area-id*).

Range: **s-, 0-255**

Specify a valid value for each subfield of the point code, and separate the subfields with a dash (-).

prefix—**s-**

zone—**0-7**

area—**000-255**

id—**0-7**

The point code **0-000-0** is not a valid point code.

:pcn= (mandatory)

ITU national point code in the format of a 5-digit number (*nnnnn*); or 2, 3, or 4 numbers (members) separated by dashes (*m1-m2-m3-m4*) as defined by the **chg-stpopts:npcfmti** flexible point code option. A group code must be specified when the ITUDUPPC feature is turned on (*nnnnn-gc*, *m1-m2-m3-m4-gc*). The *prefix* subfield indicates a spare point code (*prefix-nnnnn*, *prefix-nnnnn-gc*, *prefix-m1-m2-m3-m4*, *prefix-m1-m2-m3-m4-gc*).

Range: **s-, 0-16383, aa-zz**

Specify a valid value for each subfield of the point code, and separate the subfields with a dash (-).

prefix—**s-**

nnnnn—**0-16383**

gc—**aa-zz**

m1-m2-m3-m4—**0-14** for each member; values must sum to 14

:pcn24= (mandatory)

24-bit ITU national point code with subfields *main signaling area-sub signaling area-signaling point* (*msa-ssa-sp*).

Range: **000-255**

Specify a valid value for each subfield of the point code, and separate the subfields with a dash (-).

msa—**000-255**

ssa—**000-255**

sp—**000-255**

:mrnset= (optional)

The MRN set ID.

Range: 1-3000, dflt, new

dflt—The default mrnset.

new—Create a new mrnset.

:pc1/pca1/pci1/pcn1/pcn241= (optional)

Alternate post-GTT-translated point code.

:pc1= or :pca1= (optional)

ANSI point code with subfields *network indicator-network cluster-network cluster member* (*ni-nc-ncm*).

Range: 000-255

Specify a valid value for each subfield of the point code, and separate the subfields with a dash (-).

When **chg-sid:pctype=ansi** is specified, *ni* = 000 is not valid.

When **chg-sid:pctype=ansi** is specified, *nc* = 000 is not valid if *ni* = 001-005.

When **chg-sid:pctype=ansi** is specified, *nc* = 000 is valid if *ni* = 006-255.

The point code 000-000-000 is not a valid point code.

:pci1= (optional)

ITU international point code with subfields *zone-area-id*. The *prefix* subfield indicates a spare point code, (*prefix-zone-area-id*).

Range: s-, 0-255

Specify a valid value for each subfield of the point code, and separate the subfields with a dash (-).

prefix—s-

zone—0-7

area—000-255

id—0-7

The point code 0-000-0 is not a valid point code.

:pcn1= (optional)

ITU national point code in the format of a 5-digit number (*nnnnn*); or 2, 3, or 4 numbers (members) separated by dashes (*m1-m2-m3-m4*) as defined by the **chg-stpopts:npfnti** flexible point code option. A group code must be specified when the ITUDUPPC feature is turned on (*nnnnn-gc*, *m1-m2-m3-m4-gc*). The *prefix* subfield indicates a spare point code (*prefix-nnnnn*, *prefix-nnnnn-gc*, *prefix-m1-m2-m3-m4*, *prefix-m1-m2-m3-m4-gc*).

Range: s-, 0-16383, aa-zz

Specify a valid value for each subfield of the point code, and separate the subfields with a dash (-).

prefix—s-

nnnnn—0-16383

gc—aa-zz

m1-m2-m3-m4—0-14 for each member; values must sum to 14

:pcn241= (optional)

24-bit ITU national point code with subfields *main signaling area-sub signaling area-signaling point* (*msa-ssa-sp*).

Range: **000-255**

Specify a valid value for each subfield of the point code, and separate the subfields with a dash (-).

msa—**000-255**

ssa—**000-255**

sp—**000-255**

:pc2/pca2/pci2/pcn2/pcn242= (optional)

Alternate post-GTT-translated point code.

:pc2 or **:pca2=** (optional)

ANSI point code with subfields *network indicator-network cluster-network cluster member* (*ni-nc-ncm*).

Range: **000-255**

Specify a valid value for each subfield of the point code, and separate the subfields with a dash (-).

When **chg-sid:pctype=ansi** is specified, *ni* = **000** is not valid.

When **chg-sid:pctype=ansi** is specified, *nc* = **000** is not valid if *ni* = **001-005**.

When **chg-sid:pctype=ansi** is specified, *nc* = **000** is valid if *ni* = **006-255**.

The point code **000-000-000** is not a valid point code.

:pci2= (optional)

ITU international point code with subfields *zone-area-id*. The *prefix* subfield indicates a spare point code (*prefix-zone-area-id*).

Range: **s-, 0-255**

Specify a valid value for each subfield of the point code, and separate the subfields with a dash (-).

prefix—**s-**

zone—**0-7**

area—**000-255**

id—**0-7**

The point code **0-000-0** is not a valid point code.

:pcn2= (optional)

ITU national point code in the format of a 5-digit number (*nnnnn*); or 2, 3, or 4 numbers (members) separated by dashes (*m1-m2-m3-m4*) as defined by the **chg-stpopts:npfcmfi** flexible point code option. A group code must be specified when the ITUDUPPC feature is turned on (*nnnnn-gc*, *m1-m2-m3-m4-gc*). The *prefix* subfield indicates a spare point code (*prefix-nnnnn*, *prefix-nnnnn-gc*, *prefix-m1-m2-m3-m4*, *prefix-m1-m2-m3-m4-gc*).

Range: **s-, 0-16383, aa-zz**

Specify a valid value for each subfield of the point code, and separate the subfields with a dash (-).

prefix—**s-**

nnnnn—**0-16383**

gc—**aa-zz**

m1-m2-m3-m4—**0-14** for each member; values must sum to 14

:pcn242= (optional)

24-bit ITU national point code with subfields *main signaling area-sub signaling area-signaling point (msa-ssa-sp)*.

Range: **000-255**

Specify a valid value for each subfield of the point code, and separate the subfields with a dash (-).

msa—**000-255**

ssa—**000-255**

sp—**000-255**

:pc3/pca3/pci3/pcn3/pcn243= (optional)

Alternate post-GTT-translated point code.

:pc3 or **:pca3=** (optional)

ANSI point code with subfields *network indicator-network cluster-network cluster member (ni-nc-ncm)*.

Range: **000-255**

Specify a valid value for each subfield of the point code, and separate the subfields with a dash (-).

When **chg-sid:pctype=ansi** is specified, *ni* = **000** is not valid.

When **chg-sid:pctype=ansi** is specified, *nc* = **000** is not valid if *ni* = **001-005**.

When **chg-sid:pctype=ansi** is specified, *nc* = **000** is valid if *ni* = **006-255**.

The point code **000-000-000** is not a valid point code.

:pci3= (optional)

ITU international point code with subfields *zone-area-id*. The *prefix* subfield indicates a spare point code (*prefix-zone-area-id*).

Range: **s-, 0-255**

Specify a valid value for each subfield of the point code, and separate the subfields with a dash (-).

prefix—**s-**

zone—**0-7**

area—**000-255**

id—**0-7**

The point code **0-000-0** is not a valid point code.

:pcn3= (optional)

ITU national point code in the format of a 5-digit number (*nnnnn*); or 2, 3, or 4 numbers (members) separated by dashes (*m1-m2-m3-m4*) as defined by the **chg-stpopts:npcfmti** flexible point code option. A group code must be specified when the ITUDUPPC feature is turned on (*nnnnn-gc*, *m1-m2-m3-m4-gc*). The *prefix* subfield indicates a spare point code (*prefix-nnnnn*, *prefix-nnnnn-gc*, *prefix-m1-m2-m3-m4*, *prefix-m1-m2-m3-m4-gc*).

Range: **s-, 0-16383, aa-zz**

Specify a valid value for each subfield of the point code, and separate the subfields with a dash (-).

prefix—**s-**

nnnnn—**0-16383**

gc—**aa-zz**

m1-m2-m3-m4—**0-14** for each member; values must sum to 14

:pcn243= (optional)

24-bit ITU national point code with subfields *main signaling area-sub signaling area-signaling point* (*msa-ssa-sp*).

Range: **000-255**

Specify a valid value for each subfield of the point code, and separate the subfields with a dash (-).

msa—**000-255**

ssa—**000-255**

sp—**000-255**

:pc4/pca4/pci4/pcn4/pcn244= (optional)

Alternate post-GTT-translated point code.

:pc4 or **:pca4=** (optional)

ANSI point code with subfields *network indicator-network cluster-network cluster member* (*ni-nc-ncm*).

Range: **000-255**

Specify a valid value for each subfield of the point code, and separate the subfields with a dash (-).

When **chg-sid:pctype=ansi** is specified, *ni* = **000** is not valid.

When **chg-sid:pctype=ansi** is specified, *nc* = **000** is not valid if *ni* = **001-005**.

When **chg-sid:pctype=ansi** is specified, *nc* = **000** is valid if *ni* = **006-255**.

The point code **000-000-000** is not a valid point code.

:pci4= (optional)

ITU international point code with subfields *zone-area-id*. The *prefix* subfield indicates a spare point code (*prefix-zone-area-id*).

Range: **s-, 0-255**

Specify a valid value for each subfield of the point code, and separate the subfields with a dash (-).

prefix—**s-**

zone—**0-7**

area—**000-255**

id—**0-7**

The point code **0-000-0** is not a valid point code.

:pcn4= (optional)

ITU national point code in the format of a 5-digit number (*nnnnn*); or 2, 3, or 4 numbers (members) separated by dashes (*m1-m2-m3-m4*) as defined by the **chg-stpopts:npfcmfi** flexible point code option. A group code must be specified when the ITUDUPPC feature is turned on (*nnnnn-gc*, *m1-m2-m3-m4-gc*). The *prefix* subfield indicates a spare point code (*prefix-nnnnn*, *prefix-nnnnn-gc*, *prefix-m1-m2-m3-m4*, *prefix-m1-m2-m3-m4-gc*).

Range: **s-, 0-16383, aa-zz**

Specify a valid value for each subfield of the point code, and separate the subfields with a dash (-).

prefix—**s-**

nnnnn—**0-16383**

gc—**aa-zz**

m1-m2-m3-m4—**0-14** for each member; values must sum to 14

:pcn244= (optional)

24-bit ITU national point code with subfields *main signaling area-sub signaling area-signaling point (msa-ssa-sp)*.

Range: 000-255

Specify a valid value for each subfield of the point code, and separate the subfields with a dash (-).

msa—000-255

ssa—000-255

sp—000-255

:rc= (optional)

The relative cost of the route for the post-GTT-translated point code.

Range: 0-99

:rc1= (optional)

The relative cost of the route for alternate post-GTT-translated point code 1.

Range: 0-99

:rc2= (optional)

The relative cost of the route for alternate post-GTT-translated point code 2.

Range: 0-99

:rc3= (optional)

The relative cost of the route for alternate post-GTT-translated point code 3.

Range: 0-99

:rc4= (optional)

The relative cost of the route for alternate post-GTT-translated point code 4.

Range: 0-99

Example

The following example enters point code **1-1-0** into the MRN table with a relative cost of **10** and associates point code **1-1-1** with it as a point code with a relative cost of **20**.

```
ent-mrn:pc=1-1-0:rc=10:pc1=1-1-1:rc1=20
```

The following example updates the group containing point code **1-1-0** in the MRN table, to add point code **1-1-2** with relative cost of **20** and point code **1-1-10** with relative cost of **30** to the group.

```
ent-mrn:pc=1-1-0:rc=10:pc1=1-1-1:rc1=20:pc2=1-1-10:rc2=30
```

The following examples include spare point codes.

```
ent-mrn:pci=s-2-2-1:rc=10:pci1=s-2-2-2:rc1=11:pci2=2-100-1:rc2=12
```

```
ent-mrn:pcn=s-1-1-1-123-aa:rc=1:pcn1=1-1-1-235-aa:rc1=2:pcn2=s-1-1-1-235-aa:rc2=3
```

```
ent-mrn:pc=1-1-1:rc=10:pc1=1-1-2:rc1=10:mrnset=df1t
```

```
ent-mrn:pc=1-1-1:rc=10:pc1=1-1-2:rc1=20:pc2=1-1-3:rc2=30:apc3=1-1-4:rc3=40:apc4=1-1-5:rc4=50:mrnset=new
```

```
ent-mrn:pc=1-1-3:pc1=1-1-6:rc1=60:pc2=1-1-7:rc2=70:mrnset=111
```

Dependencies

The Intermediate Global Title Translation Load Sharing (IGTTLS) feature must be turned on before this command can be entered.

A new point code must have the same network type as existing point codes.

When a point code is specified, its relative cost must be specified; a point code value and its relative cost value must be specified together in the command.

Point codes cannot have the same value as the EAGLE SID.

The same point code value cannot be entered more than once in the MRN table unless the Flexible GTT Load Sharing feature is enabled. Then the same point code can be entered once in the default mrnset and once in multiple mrnsets.

Point codes must be the format set by the **npcfmti** parameter of the **chg-stpopts** command. (Use the **rtrv-stpopts** command to display the STP option settings).

Remote point codes must already exist as destinations in the Ordered Route entity set or reside in a cluster destination for which ordered routes are specified.

A point code that is specified as new in the command must not already exist in the MRN table.

The MRN table has a maximum of 6000 point code entries. Each point code group can contain a maximum of 8 point codes.

The **mrnset** parameter must be specified if the Flexible GTT Load Sharing (FGTTLS) feature is enabled and the routing indicator **ri=gt**.

The specified PC must already exist in the specified **mrnset** if entering additional point codes to an existing mrnset.

The relative cost (**rc**) parameter must be specified with every PC when **mrnset=new**.

To create a new mrnset, specify **mrnset=new**.

Multiple groups of load sharing PCs can only exist in the default **mrnset**.

Notes

The **ent-mrn** command cannot be used to change the relative cost value for a point code; the **chg-mrn** command must be used.

In this command, only ITU-international and ITU national point codes support the spare point code subtype prefix (**s-**).

The Flexible GTT Load Sharing feature allows multiple relationships to be defined among sets of destination point codes in the Mated Relay Node (MRN) table. The relationship used in a particular translation is based on the GTA digits used for translation.

The **mrnset** along with the post-translation PC formulates a key that is used for a lookup in the MRN table. The MRN table lookup provides a set of alternate PCs for routing the MSU in the most cost effective way.

The default **mrnset** consists of multiple load sharing groups of PCs that allow both GTT features and MPS-based features to run in parallel. However, MPS-based features are limited to using ONLY the **dflt** mrnset. GTT features can be provisioned to use the **dflt** mrnset as well. To operate on entries in the default mrnset, specify **dflt** as the value of the MRN Set.

Output

```
ent-mrn:pc=1-1-0:rc=10:pc1=1-1-1:rc1=20
    rlgncxa03w 04-02-20 09:07:58 EST EAGLE 31.3.0
    ENT-MRN: MASP A - COMPLTD
;

ent-mrn:pc=1-1-1:rc=10:pc1=1-1-2:rc1=10:mrnset=dflt
    tekelecstp 05-05-17 10:19:51 EST EAGLE5 34.2.0
    ENT-MRN : MASP A - COMPLTD
;

ent-mrn:pc=1-1-1:rc=10:pc1=1-1-2:rc1=20:mrnset=new
    tekelecstp 05-05-17 10:19:51 EST EAGLE5 34.2.0
    New MRNSET Created : MRNSETID = 112
    ENT-MRN : MASP A - COMPLTD
;

ent-mrn:pc=1-1-1:pc1=1-1-3:rc1=20:mrnset=112
    tekelecstp 05-05-17 10:19:51 EST EAGLE5 34.2.0
    ENT-MRN : MASP A - COMPLTD
;
```

ent-na

Enter Network Appearance

Use this command to enter a new network appearance in the Network Appearance table.

Keyword: ent-na

Related Commands: dlt-na, rtrv-na

Command Class: Database Administration

Parameters

:na= (mandatory)
Network appearance.
Range: 0-4294967295

:type= (mandatory)
Type of the network appearance.
Range: ansi, itu, ituis, itun, ituns, itun24

:gc= (optional)
Group Code of the network appearance.
Range: aa-zz

Example

```
ent-na:type=ansi:na=10
ent-na:type=itui:na=11
```

```

ent-na:type=itun:na=10
ent-na:type=itun:na=11:gc=fr
ent-na:type=itun24:na=3
ent-na:type=ituis:na=4

```

Dependencies

The network appearance (**na**) must not already exist in the Network appearance table.

The Network Appearance table can contain a maximum of 45 entries.

Group Code (**gc**) must not already be equipped.

Group Code (**gc**) is not allowed with network types **ansi** , **itui** , **ituis** , and **itun24**.

Group Code (**gc**) is required for network type **itun** or **ituns** when the ITUDUPPC feature is turned on.

Group Code (**gc**) is not allowed for network type **itui** when the ITUDUPPC feature is turned off.

Group Code (**gc**) must be in the SID or SPC table.

The Spare Point Code Support feature must be enabled before the **ituis** or **ituns** network type can be specified.

The specified network appearance must exist in the Network Appearance table.

Notes

Network Appearance identifies the SS7 network context of the message, for the purposes of logically separating signaling traffic between the SGP and ASP over a common SCTP association. A unique network appearance value can be associated with ANSI, ITUI, 14-bit ITU-N or 24-bit ITU-N networks. When the ITUDUPPC (ITU National Duplicate Point Code) feature is turned on, network appearance can be associated with a specific 14-bit ITU-N group code.

Output

```

ent-na:type=ansi:na=10
  rlgncxa03w 04-02-20 09:07:58 EST  EAGLE 31.3.0
  ENT-NA: MASP A - COMPLTD
;

```

ent-pstn-pres

Enter PSTN Presentation

Use this command to define new Public Switched Telephone Network (PSTN) presentation values.

Keyword: ent-pstn-pres

Related Commands: chg-pstn-pres, dlt-pstn-pres, rtrv-pstn-pres, copy-isupvar-attrb, chg-isupvar-attrb, rtrv-isupvar-attrb, chg-appl-rtkey, rtrv-appl-rtkey

Command Class: Database Administration

Parameters

:pstncat= (mandatory)

PSTN category that identifies the new Variant being defined.

Range: 0-65535

:pstnid= (mandatory)

PSTN ID that identifies the new Variant being defined.

Range: 0-65535

:pstndesc= (optional)

A test description of the PSTN presentation value.

Range: Any alphanumeric string of 0-31 characters in length, in double quotes

Default: Blank spaces

Example

```
ent-pstn-pres:pstncat=5000:pstndesc="Mexican ISUP v1.8"
```

Dependencies

Required controlled features must be enabled.

- ISUP Normalization feature
- ON/OFF controlled feature for *Tekelec-defined* Variant
- The Tekelec-defined Variants are listed in section “*Tekelec-defined ISUP Normalization Variants*” in Appendix A.
- Quantity controlled feature for *user-defined* Variant

Combination of **pstncat** and **pstnid** values must be valid.

- A controlled feature must exist for the **pstncat/pstnid** combination.
- The **pstncat** and **pstnid** must not already be defined.
- The maximum number of Variants the IP⁷ SG supports cannot be exceeded.

The quantity controlled feature must have available capacity.

You cannot exceed the maximum number of *user-defined* Variants associated with the quantity controlled feature.

Notes

The IP⁷ SG uses the PSTN presentation value, consisting of a PSTN category and a PSTN ID, to uniquely define an ISUP Variant. The assignment of a new PSTN value also creates a new entry in the ISUP Variant table. The new PSTN value **must** be unique.

The **ent-pstn-pres** command is used to define values within the Tekelec-defined range (PSTN category 0-4095) as long as an associated ON/OFF control feature exists and its status is ENABLED.

The **ent-pstn-pres** command is used to define values within the user-defined range (PSTN category 4096-65535) as long as an associated ISUP normalization quantity control feature exists and its status is ENABLED and its capacity is not going to be exceeded.

The **ent-pstn-pres** command also creates a new entry in the ISUP Variant table initialized to default values. There **must** be an available entry in the table or this command will be rejected.

Output

The following output example defines a new *user-defined* PSTN presentation value.

```
ent-pstn-pres:pstncat=5000:pstnid=1:pstndesc="mexican isup v1.8"
```

```
rlghncxa03w 04-01-07 11:11:28 EST EAGLE 31.3.0
ENT-PSTN-PRES: MASP A - COMPLTD
```

```
;
```

ent-rmt-appl

Enter Remote Application

Use this command to assign user parts to an internal point code that, in turn, assigns user parts to an End Office node.

Keyword: ent-rmt-appl

Related Commands: dlt-rmt-appl, rtrv-rmt-appl

Command Class: Database Administration

Parameters

:ipc/ipca/ipci/ipcn/ipcn24= (mandatory)

End Node's internal point code.

NOTE: See "Point Code Formats and Conversion" in Appendix A for a detailed description of point code formats, rules for specification, and examples.

:ipc= or :ipca= (mandatory)

ANSI point code with subfields network indicator-network cluster-network cluster member (*ni-nc-ncm*). The *prefix* subfield indicates a private point code (*prefix-ni-nc-ncm*).

Range: p-, 000-255

Specify a valid value for each subfield of the point code, and separate the subfields with a dash (-).

prefix—p-

ni = 000 is not valid.

nc = 000 is not valid if *ni* = 001-005.

nc = 000 is valid if *ni* = 006-255.

The point code 000-000-000 is not a valid point code.

:ipci= (mandatory)

ITU international destination point code with subfields *zone-area-id*. The *prefix* subfield indicates a spare point code, private point code, or private and spare point code (*prefix-zone-area-id*).

Range: s-, p-, ps-, 0-255

Specify a valid value for each subfield of the point code, and separate the subfields with a dash (-).

prefix—s-, p-, ps-

zone—0-7

area—000-255

id—0-7

The point code **0-000-0** is not a valid point code.

:ipcn= (mandatory)

ITU national point code with subfield ITU number (*nnnnn*). The *prefix* subfield indicates a spare point code, private point code, or private and spare point code (*prefix-nnnnn*, *prefix-nnnnn-gc*, *prefix-m1-m2-m3-m4*, *prefix-m1-m2-m3-m4-gc*).

Range: s-, p-, ps-, 0-16383, aa-zz

Specify a valid value for each subfield of the point code, and separate the subfields with a dash (-).

prefix—s-, p-, ps-

nnnnn—0-16383

gc—aa-zz

m1-m2-m3-m4—0-14 for each member; values must sum to 14

:ipcn24= (mandatory)

24-bit ITU national point code with subfields *main signaling area-sub signaling area-signaling point* (*msa-ssa-sp*). The *prefix* indicates a private point code (*prefix-msa-ssa-sp*).

Range: p-, 000-255

Specify a valid value for each subfield of the point code, and separate the subfields with a dash (-).

prefix—p-

msa—000-255

ssa—000-255

sp—000-255

:si= (mandatory)

Service indicator value that designates which user part is assigned to the IPC.

Range: 3-15

:ssn= (optional)

SCCP subsystem number. Valid **only** if **si=3**. Use **ssn** as the starting value of the range if **ssne** is specified.

Range: 0-255

:ssne= (optional)

Specifies the end of the range of subsystem numbers.

Range: 0-255

Example

```
ent-rmt-appl:ipc=0-0-1:si=3:ssn=5
```

```
ent-rmt-appl:ipc=0-0-1:si=3:ssn=5:ssne=100
```

```
ent-rmt-appl:ipc=0-0-1:si=5
```

```
ent-rmt-appl:ipcn24=1-100-1:si=5
ent-rmt-appl:ipc=p-1-1-1:si=3:ssn=5:ssne=102
ent-rmt-appl:ipci=ps-2-2-2:si=5
```

Dependencies

Partial point codes are not allowed.

The **ssn** parameter is required if **si=3**.

The **ssn** and **ssne** parameters are not allowed unless **si=3**.

The **ssne** parameter value must be greater than the **ssn** parameter value.

The specified IPC **must** be previously defined in the destination table.

The new entry cannot conflict with an existing entry.

Notes

To specify a range of subsystem numbers, specify the **ssn** parameter value as the start of the range and the **ssne** parameter value as the end of the range.

In this command, only ITU-international and ITU national point codes support the spare point code subtype prefix (s-) and the private and spare point code subtype prefix (**ps-**). All of the point code types support the private (internal) point code subtype prefix (**p-**).

Output

```
ent-rmt-appl:ipc=0-0-1:si=3:ssn=5
rlghncxa03w 04-01-07 11:11:28 EST EAGLE 31.3.0
ENT-RMT-APPL: MASP A - COMPLTD
;
```

ent-rte

Enter Route

Use this command to add a route to the system.



CAUTION: When using the Network Routing feature, limited network management is provided for point codes not covered by full point code routing, Cluster Routing, or Nested Cluster Routing.

Keyword: ent-rte

Related Commands: dlt-rte, rept-stat-dstn, rtrv-rte

Command Class: Database Administration

Parameters

NOTE: See “Point Code Formats and Conversion” in Appendix A for a detailed description of point code formats, rules for specification, and examples.

:dpc/dpca/dpci/dpcn= (mandatory)

Destination point code.

:dpc= or :dpca= (mandatory)

ANSI destination point code with subfields network indicator-network cluster-network cluster member (*ni-nc-ncm*). The *prefix* subfield indicates a private point code (*prefix-ni-nc-ncm*).

Range: **p-, 000-255, ***

Specify a valid value for each subfield of the point code, and separate the subfields with a dash (-).

prefix—**p-**

The asterisk (*) value is not valid for the *ni* subfield.

When **chg-sid:pctype=ansi** is specified, *ni* = **000** is not valid.

When **chg-sid:pctype=ansi** is specified, *nc* = **000** is not valid if *ni* = **001-005**.

When **chg-sid:pctype=ansi** is specified, *nc* = **000** is valid if *ni* = **006-255**.

When **chg-sid:pctype=ansi** is specified, *ni*-*- is valid if *ni* = **006-255**.

The point code **000-000-000** is not a valid point code.

:dpci= (mandatory)

ITU international point code with subfields *zone-area-id*. The *prefix* subfield indicates a spare point code, private point code, or private and spare point code (*prefix-zone-area-id*).

Range: **s-, p-, ps-, 0-255**

Specify a valid value for each subfield of the point code, and separate the subfields with a dash (-).

prefix—**s-, p-, ps-**

zone—**0-7**

area—**000-255**

id—**0-7**

The point code **0-000-0** is not a valid point code.

:dpcn= (mandatory)

ITU national point code in the format of a 5-digit number (*nnnnn*); or 2, 3, or 4 numbers (members) separated by dashes (*m1-m2-m3-m4*) as defined by the **chg-stpopts:npfmti** flexible point code option. A group code must be specified when the ITUDUPPC feature is turned on (*nnnnn-gc*, *m1-m2-m3-m4-gc*). The *prefix* subfield indicates a spare point code, private point code, or private and spare point code (*prefix-nnnnn*, *prefix-nnnnn-gc*, *prefix-m1-m2-m3-m4*, *prefix-m1-m2-m3-m4-gc*).

Range: **s-, p-, ps-, 0-16383, aa-zz**

Specify a valid value for each subfield of the point code, and separate the subfields with a dash (-).

prefix—**s-, p-, ps-**

nnnnn—**0-16383**

gc—**aa-zz**

m1-m2-m3-m4—**0-14** for each member; values must sum to 14

:dpcn24= (mandatory)

24-bit ITU national point code with subfields *main signaling area-sub signaling area-signaling point (msa-ssa-sp)*. The *prefix* indicates a private point code (*prefix-msa-ssa-sp*).

Range: **p-, 000-255**

Specify a valid value for each subfield of the point code, and separate the subfields with a dash (-).

prefix—**p-**

msa—**000-255**

ssa—**000-255**

sp—**000-255**

:lsn= (mandatory)

The linkset name associated with this route.

Range: 1 alphabetic character followed by 9 alphanumeric characters

:rc= (mandatory)

The relative cost of the route

Range: **0-99**

:force= (optional)

This parameter allows a route to be added to the database even if the linkset to be assigned to the route does not have any signaling links in it.

Range: **yes, no**

Default: **no**

Example

Adds route for **dpc 1-1-1** to linkset **we123642**:

ent-rte:dpc=1-1-1:lsn=we123642:rc=25

Adds route for **dpc 21-*-*** to linkset **we123642**:

ent-rte:dpc=21-*-*:lsn=we123642:rc=25

Adds route for **dpcn24 10-100-14** to linkset **we123624**:

ent-rte:dpcn24=10-100-14:lsn=we123624:rc=10

Adds route for private **dpc p-1-1-1** to linkset **we123642**.

ent-rte:dpc=p-1-1-1:lsn=we123642:rc=25

Adds route for private and spare **dpcn ps-4082-ge** to linkset **e1ntitun**.

ent-rte:dpc=ps-4082-ge:lsn=e1ntitun:rc=10

Adds route for private **dpcn24 p-10-100-14** to linkset **we123642**.

ent-rte:dpcn24=p-10-100-1:lsn=we123642:rc=10

Adds route for private and spare **dpci s-1-100-1** to linkset **ue123642**.

ent-rte:dpci=s-1-100-1:lsn=ue123642:rc=10

Dependencies

All the linksets for the route must be defined, using the **ent-ls** command, before this command can be entered.

The **force=yes** parameter must be specified if a linkset is assigned to a route that has no links in it.

The DPC must be in the destination point code table.

The destination point code of a route must be a full point code (ni-nc-ncm), a cluster point code (ni-nc-*), or a network point code (ni-*-*).

If the specified destination address is a full point code address (ni-nc-ncm) and is a member of a provisioned cluster (ni-nc-*), whether ordered routes can be assigned is determined by the destination address's NCAI (nested cluster allowed indicator). The NCAI (**ncai=yes/no**) is set with the **ncai** parameter of the **ent/chg-dstn** commands.

- If the NCAI is set to **no**, destinations comprising a cluster inherit their ordered routes from the cluster.
- If the NCAI is set to **yes**, then the destination address is a member of a provisioned nested cluster where ordered routes can be assigned to a provisioned member.

If the specified destination address is a network cluster address (ni-nc-*), how the specified ordered route attributes can be assigned is determined by the setting of the destination address's NCAI (nested cluster allowed indicator). The NCAI (**ncai=yes/no**) is set with the **ncai** parameter of the **ent/chg-dstn** commands.

- If the NCAI is set to **no**, the collection of signaling point codes having the same network identifier (**ni**) and network cluster (**nc**) code are assigned the specified ordered route.
- If the NCAI is set to **yes**, then the specified destination is a network cluster address where provisioned members's signaling point codes can be assigned the same or different ordered routes from the cluster.

If the **dpcn** parameter is specified, the format of the point code(s) must match the format that was assigned with the **chg-stpopts:npcfmti** parameter.

Only IPGW routes are allowed for private point codes.

The route destination's type must match the route's linkset adjacent point code or the route's linkset secondary adjacent point code type.

If the ITU Duplicate Point Code feature is on, the group code must match for all linksets that are not IPGWx linksets.

A maximum of 6 routes can be defined for each DPC.

The linkset must be defined with at least one link.

A maximum of 2 linksets can be assigned with same cost (**rc**) value.

A linkset can be entered only once as a route for each destination.

If the specified destination address is a network cluster address (ni-nc-*), the linkset type used in the route must be consistent with cluster routing; that is, the linkset must be a B, C, or D linkset.

Combined linksets are not allowed for X.25 destinations. In other words, routes of equal cost destined for X.25 domains are not allowed.

If the route is assigned a destination that is marked for the X.25 domain, then that destination must be assigned to at least one X.25 destination and the linkset assigned to that route must have an adjacent point code assigned to the X.25 domain.

If the route is assigned a destination that is marked for the SS7 domain, then the linkset assigned to that route must have an adjacent point code assigned to the SS7 domain.

All routes with ANSI DPCs must use ANSI linkset APCs. A route with an ITU-I DPC can go over an ITU-N APC and an ITU-N DPC can go over an ITU-I APC.

If the link set name (**lsn**) references a link set that has **ipgwapc=yes** specified, the destination point code must not be a cluster route.

Network routing is valid only if the NRT feature is on. The NRT feature is turned on with the **chg-feat** command.

When using network routing, if the destination point code has a value of * in the *nc* field, the *ncm* field must also be * (for example, **dpc=21-*-***).

Notes

In this command, only ITU-international and ITU national point codes support the spare point code subtype prefix (**s-**) and the private and spare point code subtype prefix (**ps-**). All of the point code types support the private (internal) point code subtype prefix (**p-**).

Output

```
ent-rte:dpc=1-1-1:lsn=we123642:rc=25
  rlghncxa03w 04-01-07 11:11:28 EST EAGLE 31.3.0
  ENT-RTE: MASP A - COMPLTD
;
```

ent-scr-aftpc

Enter Allowed Affected Point Code

Use this command to add a specific allowed affected point code (AFTPC) screening reference in the AFTPC entity set.

Keyword: ent-scr-aftpc

Related Commands: chg-scr-aftpc, dlt-scr-aftpc, rtrv-scr-aftpc

Command Class: Database Administration

Parameters

NOTE: See “Point Code Formats and Conversion” in Appendix A for a detailed description of point code formats, rules for specification, and examples.

:nsfi= (mandatory)

This parameter specifies the next screening category that is used in the gateway screening process. If specified, the parameter value must be **stop**.

Range: stop

stop—The gateway screening process ends and the message proceeds through normal routing.

:sr= (mandatory)

Screening reference. This parameter specifies the point code's unique screening reference name.

Range: 1 alphabetic character followed by up to 3 alphanumeric characters

:ssn= (mandatory)

The subsystem number. An asterisk (*) indicates the full range of values from **1-255**.

Range: 1-255, *

:actname= (optional)

The name of the gateway screening stop action set. Stop actions must be administered using the **actname** parameter in conjunction with the gateway screening stop action table (see **chg-gws-actset** and **rtrv-gws-actset**).

Range: 1 alphabetic character followed by up to 5 alphanumeric characters.

:area= (optional)

The ITU international area. The area is specified in the point code. The format of the point code is *zone-area-id*. An asterisk (*) indicates the full range of values from **000-255**.

Range: 000-255, *

:id= (optional)

The ITU international ID. The parameter specifies the ID in the point code represented by format *zone-area-id*. An asterisk (*) indicates the full range of values from **0-7**.

Range: 0-7, *

:msa= (optional)

The 24-bit ITU-national main signaling area (msa) value. It specifies the **msa** of the point code represented by *msa-ssa-sp*. An asterisk (*) indicates the full range of values from **000-255**.

Range: 000-255, *

:nc= (optional)

The network cluster (nc) value. This parameter specifies one or more nc values for the network indicator (ni) and network cluster member (ncm) values specified in the **ni** and **ncm** parameters. It specifies the *nc* of the point code represented by *ni-nc-ncm*. A single value or a range of values can be specified. An asterisk (*) indicates the full range of values from **000-255**.

Range: 000-255, *

:ncm= (optional)

The network cluster member (ncm) value. This parameter specifies one or more ncm values for the network indicator (ni) and network cluster (nc) values identified in the **ni** and **nc** parameters. It specifies the *ncm* of the point code represented by *ni-nc-ncm*. A single value or a range of values can be specified. An asterisk (*) indicates the full range of values from **000-255**.

Range: 0-255, *

:ni= (optional)

The network indicator (ni) value. This parameter specifies one or more ni values for the network cluster (nc) and network cluster member (ncm) values identified in the **nc** and **ncm** parameters. It specifies the *ni* of the point code represented by *ni-nc-ncm*. A single value or a range of values can be specified. An asterisk (*) indicates the full range of values from **000-255**.

Range: 0-255, *

:npc= (optional)

The ITU national point code. An asterisk (*) indicates the full range of values from **00000-16383**.

Range: 00000-16383, *

NOTE: Gateway screening allows the ITU national point code to be displayed and entered in the database only as a single number. If you are using multiple-part ITU national point codes, see “Converting ITU National Point Code Formats” in Appendix A for information on converting the point code format.

:nsp= (optional)

The new 24-bit ITU national signaling point (sp). It specifies the new **sp** of the point code represented by *msa-ssa-sp*. An asterisk (*) indicates the full range of values from **000-255**.

Range: 000-255, *

:nsr= (optional)

Next screening reference (nsr). The parameter indicates which screening reference in the specified screening category (**nsfi**) is to be used in the screening process. If **nsfi=stop**, the **nsr** parameter cannot be specified.

Range: 1 alphabetic character followed by up to 3 alphanumeric characters

Default: Current value

:pcst= (optional)

Point code subtype. This parameter indicates whether the specified ITU international or ITU national point code has no subtype prefix or has the spare point code prefix (s-).

Range: none, s

Default: none

:sp= (optional)

The 24-bit ITU national signaling point. This parameter specifies the signaling point (sp) in the point code represented by *msa-ssa-sp*. An asterisk (*) indicates the full range of values from **000-255**.

Range: 000-255, *

:ssa= (optional)

The 24-bit ITU national sub signaling area. This parameter specifies the sub signaling area (ssa) in the point code represented by the format *msa-ssa-sp*. An asterisk (*) indicates the full range of values from **000-255**.

Range: 000-255, *

:zone= (optional)

The ITU international zone. The parameter specifies the zone in the point code represented by format *zone-area-id*. An asterisk (*) indicates the full range of values from **0-7**.

Range: 0-7, *

Example

```
ent-scr-aftpc:sr=iec:ni=240:nc=010:ncm=010:ssn=012:nsfi=stop
ent-scr-aftpc:sr=iec:ni=240:nc=010:ncm=010:ssn=012:nsfi=stop:actname=copy
ent-scr-aftpc:nsfi=stop:sr=af01:ssn=1:msa=255:ssa=255:sp=255
ent-scr-aftpc:sr=aft1:zone=1:area=2:id=3:nsfi=stop:ssn=1:pcst=s
```

Dependencies

CAUTION: Even though gateway screening is in the screen test mode, as defined by the parameters **gwsa=off** and **gwsn=on**, the gateway screening action in the stop action set specified by the **actname** parameter of the screen set *will* be performed at the end of the screening process.

A complete point code must be specified, and must be one, and only one of the four point code parameter combinations: **ni-nc-ncm**; **zone-area-id**; **msa-ssa-sp**; or **npc**.

ANSI point code value **000-000-000** and ITU-International point code value **0-000-0** are not allowed.

The value of the **actname** parameter must already be defined in the Gateway Screening Stop Action table with the **chg-gws-actset** command. These values are shown in the **ACT NAME** field of the **rtrv-gws-actset** command output.

The character **c** is not a valid value for the **ni**, **nc**, **ncm**, **zone**, **area**, **id**, **msa**, **ssa**, **sp**, and **npc** parameters.

If **zone=*** is specified, **area=*** and **id=*** must be specified.

If **area=*** is specified, **id=*** must be specified.

If **msa=*** is specified, **ssa=*** and **sp=*** must be specified.

If **ssa=*** is specified, **sp=*** must be specified.

If specified, the **nsfi** parameter value must be **stop**.

If the **nsfi=stop** parameter is specified, the **nsr** parameter cannot be specified.

If the screening reference exists (**sr**), the new affected point code and subsystem number to be added cannot already exist in the AFTPC entity set.

The Spare Point Code Support feature must be enabled before the **pcst** parameter can be specified.

The spare point code subtype prefix (**s-**) is not supported for ANSI point codes (parameters **ni**, **nc**, **ncm**) or for 24-bit ITU national point codes (parameters **msa**, **ssa**, **sp**). The **pcst** and **npcst** parameters cannot be specified for ANSI and ITU-N24 point codes.

The Gateway Screening Rules table can contain a maximum of 372,600 rules.

If the **nc** parameter is specified as a range, the **ncm** parameter must be specified as an asterisk or as the full range **000-255**.

If the **nc** parameter is specified as a single value or a range, a single value must be specified for the **ni** parameter.

If the **nc** parameter is specified as an asterisk (**nc=***), the **ncm** parameter must be specified as an asterisk or as the full range **000-255**.

If the **ncm** parameter is specified as a single value, or a range other than the full range of **000-255**, the **ni** and the **nc** parameters must be specified with a single value.

If the **ni** parameter is specified as an asterisk (**ni=***) or as a range, the **nc** and **ncm** parameters must be specified as an asterisk or as the full range **000-255**.

Notes

A range of values is specified by separating the values that define the range by two ampersands (&&); for example, **:ni=025&&100** specifies all network indicators for ANSI point codes from **25** to **100**.

If the screening reference is valid, but does not exist, a new AFTPC screen is created.

If the screening reference exists, a new rule is added to the AFTPC screening table.

If asterisks or ranges are specified for the allowed AFTPCs, nothing that matches the specified range of AFTPCs can already exist in the AFTPC screen for the screening reference.

If the screen set reaches 100% capacity (indicated by the 100% Full message), the system allows subsequent entries. An error occurs, however, when downloading the screen set to an LIM. Ensure that screen sets do not exceed 100% capacity. Remove screen set entries until the capacity is below 100%.

An asterisk cannot not be specified for a parameter value in this command unless an asterisk was specified for the parameter value in the original **ent-scr-aftp** command.

The spare point code subtype prefix **s-** is supported only for ITU international and ITU national point codes. The **pcst** parameter indicates whether the specified point code has no subtype prefix or has the spare point code prefix.

Output

```
ent-scr-aftp:sr=iec:ni=240:nc=010:ncm=010:ssn=012:nsfi=stop
rlghncxa03w 04-01-07 11:43:04 EST EAGLE 31.3.0
ENT-SCR-AFTPC: SCREEN SET AFFECTED - IEC 25% FULL
ENT-SCR-AFTPC: MASP A - COMPLTD
;
```

Legend

ENT-SCR-AFTPC—The command entered that caused this output. This is echoed to the printer as a reference.

SCREEN SET AFFECTED - IEC—Identifies the screen set that was affected by the command. The screen set name is provided.

25% FULL—Indicates the relative size of the screen set.

ent-scr-blkdpc**Enter Blocked DPC**

Use this command to add a specific blocked destination point code (BLKDPC) screening reference, and associated attributes, to the BLKDPC's table. The associated attributes are: destination point code, next screening function identifier, and next screening reference. The destination point codes listed on this screen are prohibited from sending SS7 messages to the network.

Keyword: ent-scr-blkdpc

Related Commands: chg-scr-blkdpc, dlt-scr-blkdpc, rtrv-scr-blkdpc

Command Class: Database Administration

Parameters

:nsfi= (mandatory)

This parameter specifies the next screening category that is used in the gateway screening process, or it indicates that the gateway screening process should stop.

Range: cgpa, destfld, fail, isup, stop

cgpa—Allowed CGPA is the next screening category.

destfld—Allowed destination field (DESTFLD) is the next screening category.

fail—Discard the received message.

isup—ISUP message type (ISUP) is the next screening category.

stop—The gateway screening process ends and the message proceeds through normal routing.

:sr= (mandatory)

Screening reference. This parameter specifies the point code's unique screening reference name.

Range: 1 alphabetic character followed by up to 3 alphanumeric characters

:actname= (optional)

The name of the gateway screening stop action set. Stop actions must be administered using the **actname** parameter in conjunction with the gateway screening stop action table (see **chg-gws-actset** and **rtrv-gws-actset**).

Range: 1 alphabetic character followed by up to 5 alphanumeric characters.

:area= (optional)

The ITU international area. The area is specified in the point code. The format of the point code is *zone-area-id*. An asterisk (*) indicates the full range of values from **000–255**.

Range: 000–255, *, c

:id= (optional)

The ITU international ID. The parameter specifies the ID in the point code represented by format *zone-area-id*. An asterisk (*) indicates the full range of values from **0–7**.

Range: 0–7, *

:msa= (optional)

The 24-bit ITU-national main signaling area (msa) value. It specifies the **msa** of the point code represented by *msa-ssa-sp*. An asterisk (*) indicates the full range of values from **000–255**.

Range: 000–255, *, c

:nc= (optional)

The network cluster (nc) value. This parameter specifies one or more nc values for the network indicator (ni) and network cluster member (ncm) values specified in the **ni** and **ncm** parameters. It specifies the *nc* of the point code represented by *ni-nc-ncm*. A single value or a range of values can be specified. An asterisk (*) indicates the full range of values from **000-255**.

Range: **000-255, *, c**

:ncm= (optional)

The network cluster member (ncm) value. This parameter specifies one or more ncm values for the network indicator (ni) and network cluster (nc) values identified in the **ni** and **nc** parameters. It specifies the *ncm* of the point code represented by *ni-nc-ncm*. A single value or a range of values can be specified. An asterisk (*) indicates the full range of values from **000-255**.

Range: **0-255, *, c**

:ni= (optional)

The network indicator (ni) value. This parameter specifies one or more ni values for the network cluster (nc) and network cluster member (ncm) values identified in the **nc** and **ncm** parameters. It specifies the *ni* of the point code represented by *ni-nc-ncm*. A single value or a range of values can be specified. An asterisk (*) indicates the full range of values from **000-255**.

Range: **0-255, *, c**

:npc= (optional)

The ITU national point code. An asterisk (*) indicates the full range of values from **00000-16383**.

Range: **00000-16383, *, c**

NOTE: Gateway screening allows the ITU national point code to be displayed and entered in the database only as a single number. If you are using multiple-part ITU national point codes, see “Converting ITU National Point Code Formats” in Appendix A for information on converting the point code format.

:nsr= (optional)

The next screening reference parameter indicates which screening reference in the specified screening category (**nsfi**) is to be used in the screening process. This parameter is mandatory if **nsfi** is other than **stop** or **fail**. The **nsr** parameter cannot be specified if **nsfi** is **stop** or **fail**.

Range: 1 alphabetic character followed by up to 3 alphanumeric characters

Default: No value given

:pcst= (optional)

Point code subtype. This parameter indicates whether the specified ITU international or ITU national point code has no subtype prefix or has the spare point code prefix (s-).

Range: **none, s**

Default: **none**

:sp= (optional)

The 24-bit ITU national signaling point. This parameter specifies the signaling point (sp) in the point code represented by *msa-ssa-sp*. An asterisk (*) indicates the full range of values from **000-255**.

Range: 000-255, *, c

:ssa= (optional)

The 24-bit ITU national sub signaling area. This parameter specifies the sub signaling area (ssa) in the point code represented by the format *msa-ssa-sp*. An asterisk (*) indicates the full range of values from 000-255.

Range: 000-255, *, c

:zone= (optional)

The ITU international zone. The parameter specifies the zone in the point code represented by format *zone-area-id*. An asterisk (*) indicates the full range of values from 0-7.

Range: 0-7, *, c

Example

```
ent-scr-blkdpc:sr=iec:ni=c:nc=c:ncm=c:nsfi=cgpa:nsr=wrds
```

```
ent-scr-blkdpc:sr=iec:ni=c:nc=c:ncm=c:nsfi=stop
```

```
ent-scr-blkdpc:sr=iec:ni=c:nc=c:ncm=c:nsfi=stop:actname=copy
```

```
ent-scr-blkdpc:sr=iec:ni=240:nc=*:ncm=*:nsfi=fail
```

```
ent-scr-blkdpc:sr=bdp1:zone=1:area=2:id=3:nsfi=fail:pcst=none
```

```
ent-scr-blkdpc:sr=bdp1:zone=2:area=2:id=3:nsfi=fail:pcst=s
```

```
ent-scr-blkdpc:sr=bdp1:npc=128:nsfi=fail:pcst=s
```

Dependencies



CAUTION: Even though gateway screening is in the screen test mode, as defined by the parameters *gwsa=off* and *gws=on*, the gateway screening action in the stop action set specified by the *actname* parameter of the screen set *will* be performed at the end of the screening process.

The Gateway Screening Rules table can contain a maximum of 362, 700 rules.

A complete point code must be specified, and must be one and only one of the four point code parameter combinations: **ni-nc-ncm**; **zone-area-id**; **msa-ssa-sp**; or **npc**, except in the special case of entering **c** for "continue".

ANSI point code value **000-000-000** and ITU-International point code value **0-000-0** are not allowed.

At least one optional parameter must be specified.

When a blocked DPC screen is created, the first entry for the **ni-nc-ncmzone-area-id**, or **msa-ssa-sp** must be **c-c-c** or **npc** must be **c**. Subsequent entries can be specific point codes.

If the **actname** parameter is specified, the **nsfi-stop** parameter must be specified.

The value of the **actname** parameter must already be defined in the Gateway Screening Stop Action table with the **chg-gws-actset** command. These values are shown in the **ACT NAME** field of the **rtrv-gws-actset** command output.

If **area=*** is specified, **id=*** must be specified.

If **msa=*** is specified, **ssa=*** and **sp=*** must be specified.

If **msa=c** is specified, either the character **c** must also be specified for the **ssa** and **sp** parameters or the **ssa** and **sp** parameters must not be specified. If the **ssa** and **sp** parameters are not specified when **msa=c** is specified, the **ssa** and **sp** values default to the character **c** in the database.

If the **nc** parameter is specified as a range, the **ncm** parameter must be specified as an asterisk or as the full range **000-255**.

If the **nc** parameter is specified as a single value or a range, a single value must be specified for the **ni** parameter.

If the **nc** parameter is specified as an asterisk (**nc=***), the **ncm** parameter must be specified as an asterisk or as the full range **000-255**.

If the **ncm** parameter is specified as a single value, or a range other than the full range of **000-255**, the **ni** and the **nc** parameters must be specified with a single value.

If the **ni** parameter is specified as an asterisk (**ni=***) or as a range, the **nc** and **ncm** parameters must be specified as an asterisk or as the full range **000-255**.

If **ni=c** is specified, either the character **c** must also be specified for the **nc** and **ncm** parameters or the **nc** and **ncm** parameters must not be specified. If the **nc** and **ncm** parameters are not specified when **ni=c** is specified, the **nc** and **ncm** values default to the character **c** in the database.

If the specified **ni-nc-ncm** or **zone-area-id** or **msa-ssa-sp** is not equal to **c-c-c** or **npc** is not equal to **c**, **nsfi=fail** must be specified and the **nsr** parameter cannot be specified.

If the **nsfi** parameter has a value other than **stop** or **fail**, the **nsr** parameter must be specified and must exist.

The next screening function identifier (**nsfi**) and the next screening reference (**nsr**) must point to an existing screen, or the **nsfi** must be equal to **stop** and the **nsr** must not be specified.

If the specified screening reference (**sr**) does not exist:

- The **ni-nc-ncmzone-area-id**, or **msa-ssa-sp** must equal **c-c-c** or **npc** must equal **c**.
- The **nsfi** parameter cannot be **fail**.
- A new BLKDPC table is created.

If the specified screening reference (**sr**) exists:

- The **ni-nc-ncmzone-area-id**, or **msa-ssa-sp** must equal **c-c-c** or **npc** must not equal **c**.
- The **nsfi** parameter must be **fail**.
- The **nsr** parameter cannot be specified.
- The blocked DPC, given by **ni-nc-ncm** (or **zone-area-id** or **npc**), to be added to the BLKDPC screening table for the blocked DPC screening reference cannot exist as defined or within an existing range of DPCs.

The Spare Point Code Support feature must be enabled before the **pcst** parameter can be specified.

The **pcst** parameter cannot be specified with **c** for a blocked screen reference (**sr**).

The spare point code subtype prefix (s-) is not supported for ANSI point codes (parameters **ni**, **nc**, **ncm**) or for 24-bit ITU national point codes (parameters **msa**, **ssa**, **sp**). The **pcst** parameter cannot be specified for ANSI and ITU-N24 point codes.

If **ssa=*** is specified, **sp=*** must be specified.

If **zone=*** is specified, **area=*** and **id=*** must be specified.

If **zone=c** is specified, either the character **c** must also be specified for the **area** and **id** parameters or the **area** and **id** parameters must not be specified. If the **area** and **id** parameters are not specified when **zone=c** is specified, the **area** and **id** values default to the character **c** in the database.

Notes

When a blocked DPC screening reference is created, the first entry for a point code must be **c-c-c**, or **c** for the **npc** parameter. Subsequent entries must be specific point codes.

The character **c** is used in the blocked DPC screens to allow the screening process to continue for messages with point codes that do not match any point codes in the blocked DPC screens. When screening for a blocked DPC and the point code being screened does not match any of the point codes in the blocked DPC screens, the message is not rejected and the screening process continues.

There must be an entry in the blocked DPC screens to allow the screening process to continue. This entry consists of a screening reference, point code, **nsfi**, and **nsr**. The point code is in the form of **npc=c** or of subfields equal to **c-c-c**. When the character **c** is specified, the **nsfi** and **nsr** parameters must be specified.

If the character **c** is specified for the parameters **ni-nc-ncm** or **zone-area-id** or **msa-ssa-sp**, the character **c** is the only value that can be specified for all three parameters. No other values can be used. For example, a point code **c-c-255** is not allowed. The point code must be **c-c-c**. The asterisk (*) value cannot be used with the character **c** (for example, a point code **c-c-*** is not allowed).

When the point code does not match any entries in the blocked DPC screens, the screening process is directed to the screening reference with the point code **c-c-c** or **npc=c**. The **nsfi** and **nsr** in this entry are examined to determine the next step in the screening process.

If the current **ni-nc-ncm** or **zone-area-id** or **msa-ssa-sp** is equal to **c-c-c** or **npc=c**, only the **nsfi** and **nsr** can be changed. Otherwise, only the blocked DPC can be changed.

A range of values is specified by separating the values that define the range by two ampersands (&&); for example, **:ni=025&&100** specifies all network indicators for ANSI point codes from **25** to **100**.

An asterisk cannot not be specified for a parameter value in this command unless an asterisk was specified for the parameter value in the original **ent-scr-blkdpc** command.

If the screen set reaches 100% capacity (indicated by the 100% Full message), the system allows subsequent entries. An error occurs, however, when downloading the screen set to an LIM. Ensure that screen sets do not exceed 100% capacity. Remove screen set entries until the capacity is below 100%.

The spare point code subtype prefix **s-** is supported only for ITU international and ITU national point codes. The **pcst** parameter indicates whether the specified point code has no subtype prefix or has the spare point code prefix.

Output

```
ent-scr-blkdpc:sr=iec:ni=c:nc=c:ncm=c:nsfi=cgpa:nsr=wrds5
  rlgncxa03w 04-01-07 11:43:04 EST EAGLE 31.3.0
  ENT-SCR-BLKDPC: SCREEN SET AFFECTED - IEC 25% FULL
  ENT-SCR-BLKDPC: MASP A - COMPLTD
;
```

Legend

ENT-SCR-BLKDPC—The command entered that caused this output. This is echoed to the printer as a reference.

SCREEN SET AFFECTED - SS01—Identifies the screen set that was affected by the command. The screen set name is provided.

25% FULL—Indicates the relative size of the screen set.

ent-scr-blkopc

Enter Blocked OPC

Use this command to add a specific blocked originating point code (BLKOPC) screening reference and associated attributes OPC, **nsfi**, and **nsr** to the BLKOPC entity set. Any messages received on the link assigned to this screening reference that match the attributes in this table are blocked from entering the network.

Keyword: ent-scr-blkopc

Related Commands: chg-scr-blkopc, dlt-scr-blkopc, rtrv-scr-blkopc

Command Class: Database Administration

Parameters

:nsfi= (mandatory)

This parameter specifies the next screening category that is used in the gateway screening process, or it indicates that the gateway screening process should stop.

Range: blkdpc, cgpa, dpc, fail, sio, stop

blkdpc—Blocked DPC is the next screening category.

cgpa—Allowed CGPA is the next screening category.

dpc—Allowed DPC is the next screening category.

fail—Discard the received message.

sio—Allowed SIO is the next screening category.

stop—The gateway screening process ends and the message proceeds through normal routing.

:sr= (mandatory)

Screening reference. This parameter specifies the point code's unique screening reference name.

Range: 1 alphabetic character followed by up to 3 alphanumeric characters

:actname= (optional)

The name of the gateway screening stop action set. Stop actions must be administered using the **actname** parameter in conjunction with the gateway screening stop action table (see **chg-gws-actset** and **rtrv-gws-actset**).

Range: 1 alphabetic character followed by up to 5 alphanumeric characters.

:area= (optional)

The ITU international area. The area is specified in the point code. The format of the point code is *zone-area-id*. An asterisk (*) indicates the full range of values from **000–255**.

Range: **000–255, *, c**

:id= (optional)

The ITU international ID. The parameter specifies the ID in the point code represented by format *zone-area-id*. An asterisk (*) indicates the full range of values from **0–7**.

Range: **0–7, ***

:msa= (optional)

The 24-bit ITU-national main signaling area (msa) value. It specifies the **msa** of the point code represented by *msa-ssa-sp*. An asterisk (*) indicates the full range of values from **000–255**.

Range: **000–255, *, c**

:nc= (optional)

The network cluster (nc) value. This parameter specifies one or more nc values for the network indicator (ni) and network cluster member (ncm) values specified in the **ni** and **ncm** parameters. It specifies the *nc* of the point code represented by *ni-nc-ncm*. A single value or a range of values can be specified. An asterisk (*) indicates the full range of values from **000–255**.

Range: **000–255, *, c**

:ncm= (optional)

The network cluster member (ncm) value. This parameter specifies one or more ncm values for the network indicator (ni) and network cluster (nc) values identified in the **ni** and **nc** parameters. It specifies the *ncm* of the point code represented by *ni-nc-ncm*. A single value or a range of values can be specified. An asterisk (*) indicates the full range of values from **000–255**.

Range: **0–255, *, c**

:ni= (optional)

The network indicator (ni) value. This parameter specifies one or more ni values for the network cluster (nc) and network cluster member (ncm) values identified in the **nc** and **ncm** parameters. It specifies the *ni* of the point code represented by *ni-nc-ncm*. A single value or a range of values can be specified. An asterisk (*) indicates the full range of values from **000–255**.

Range: **0–255, *, c**

:npc= (optional)

The ITU national point code. An asterisk (*) indicates the full range of values from **00000–16383**.

Range: **00000–16383, *, c**

NOTE: Gateway screening allows the ITU national point code to be displayed and entered in the database only as a single number. If you are using multiple-part ITU national point codes, see “Converting ITU National Point Code Formats” in Appendix A for information on converting the point code format.

:nsr= (optional)

Next screening reference (nsr). The parameter indicates which screening reference in the specified screening category (**nsfi**) is to be used in the screening process. If **nsfi=stop**, the **nsr** parameter cannot be specified.

Range: 1 alphabetic character followed by up to 3 alphanumeric characters

Default: No value given

:pcst= (optional)

Point code subtype. This parameter indicates whether the specified ITU international or ITU national point code has no subtype prefix or has the spare point code prefix (s-).

Range: none, s

Default: none

:sp= (optional)

The 24-bit ITU national signaling point. This parameter specifies the signaling point (sp) in the point code represented by *msa-ssa-sp*. An asterisk (*) indicates the full range of values from **000-255**.

Range: 000-255, *, c

:ssa= (optional)

The 24-bit ITU national sub signaling area. This parameter specifies the sub signaling area (ssa) in the point code represented by the format *msa-ssa-sp*. An asterisk (*) indicates the full range of values from **000-255**.

Range: 000-255, *, c

:zone= (optional)

The ITU international zone. The parameter specifies the zone in the point code represented by format *zone-area-id*. An asterisk (*) indicates the full range of values from **0-7**.

Range: 0-7, *, c

Example

```
ent-scr-blkopc:sr=iec:ni=c:nc=c:ncm=c:nsfi=cgpa:nsr=wr5
```

```
ent-scr-blkopc:sr=iec:ni=c:nc=c:ncm=c:nsfi=stop
```

```
ent-scr-blkopc:sr=iec:ni=c:nc=c:ncm=c:nsfi=stop:actname=copy
```

```
ent-scr-blkopc:sr=iec:ni=240:nc=*:ncm=*:nsfi=fail
```

```
ent-scr-blkopc:sr=bo30:nsfi=stop:msa=c:ssa=c:sp=c
```

```
ent-scr-blkopc:sr=bo30:nsfi=fail:msa=1:ssa=2:sp=3
```

```
ent-scr-blkopc:sr=bo30:nsfi=fail:msa=3:ssa=*:sp=*
```

```
ent-scr-blkopc:sr=bo30:nsfi=fail:msa=255:ssa=2:sp=3
```

```
ent-scr-blkopc:sr=bop1:zone=1:area=2:id=3:nsfi=fail:pcst=none
```

```
ent-scr-blkopc:sr=bop1:zone=2:area=2:id=3:nsfi=fail:pcst=s
```

```
ent-scr-blkopc:sr=bop1:npc=128:nsfi=fail:pcst=s
```

Dependencies



CAUTION: Even though gateway screening is in the screen test mode, as defined by the parameters **gwsa=off** and **gwsm=on**, the gateway screening action in the stop action set specified by the **actname** parameter of the screen set *will* be performed at the end of the screening process.

The Gateway Screening Rules table can contain a maximum of 362, 700 rules.

A complete point code must be specified, and must be one and only one of the four point code parameter combinations: **ni-nc-ncm**; **zone-area-id**; **msa-ssa-sp**; or **npc**, except in the special case of entering **c** for "continue".

ANSI point code value **000-000-000** and ITU-International point code value **0-000-0** are not allowed.

At least one optional parameter must be specified.

When a blocked OPC screen is created, the first entry for the **ni-nc-ncmzone-area-id**, or **msa-ssa-sp** must be **c-c-c** or **npc** must be **c**. Subsequent entries can be specific point codes.

If asterisks or ranges are specified for the blocked OPCs, nothing that matches the specified range of blocked OPCs can already exist in the BLKOPC screening table for the screening reference.

If the **actname** parameter is specified, the **nsfi-stop** parameter must be specified.

The value of the **actname** parameter must already be defined in the Gateway Screening Stop Action table with the **chg-gws-actset** command. These values are shown in the **ACT NAME** field of the **rtrv-gws-actset** command output.

If **area=*** is specified, **id=*** must be specified.

If **msa=*** is specified, **ssa=*** and **sp=*** must be specified.

If **msa=c** is specified, either the character **c** must also be specified for the **ssa** and **sp** parameters or the **ssa** and **sp** parameters must not be specified. If the **ssa** and **sp** parameters are not specified when **msa=c** is specified, the **ssa** and **sp** values default to the character **c** in the database.

If the **nc** parameter is specified as a range, the **ncm** parameter must be specified as an asterisk or as the full range **000-255**.

If the **nc** parameter is specified as a single value or a range, a single value must be specified for the **ni** parameter.

If the **nc** parameter is specified as an asterisk (**nc=***), the **ncm** parameter must be specified as an asterisk or as the full range **000-255**.

If the **ncm** parameter is specified as a single value, or a range other than the full range of **000-255**, the **ni** and the **nc** parameters must be specified with a single value.

If the **ni** parameter is specified as an asterisk (**ni=***) or as a range, the **nc** and **ncm** parameters must be specified as an asterisk or as the full range **000-255**.

If **ni=c** is specified, either the character **c** must also be specified for the **nc** and **ncm** parameters or the **nc** and **ncm** parameters must not be specified. If the **nc** and **ncm** parameters are not specified when **ni=c** is specified, the **nc** and **ncm** values default to the character **c** in the database.

If the specified **ni-nc-ncm** or **zone-area-id** or **msa-ssa-sp** is not equal to **c-c-c** or **npc** is not equal to **c**, **nsfi=fail** must be specified and the **nsr** parameter cannot be specified.

If the **nsfi** parameter has a value other than **stop** or **fail**, the **nsr** parameter must be specified and must exist.

The next screening function identifier (**nsfi**) and the next screening reference (**nsr**) must point to an existing screen, or the **nsfi** must be equal to **stop** and the **nsr** must not be specified.

If the specified screening reference (**sr**) does not exist:

- The **ni-nc-ncm**, **zone-area-id**, or **msa-ssa-sp** must equal **c-c-c** or **npc** must equal **c**.
- The **nsfi** parameter cannot be **fail**.
- A new BLKDPC table is created.

If the specified screening reference (**sr**) exists:

- The **ni-nc-ncm**, **zone-area-id**, or **msa-ssa-sp** must equal **c-c-c** or **npc** must not equal **c**.
- The **nsfi** parameter must be **fail**.
- The **nsr** parameter cannot be specified.
- The blocked OPC, specified by **ni-nc-ncm**, **zone-area-id**, **msa-ssa-sp**, or **npc**, to be added to the BLKOPC screening table for the blocked OPC screening reference cannot exist as defined or within an existing range of OPCs.

The Spare Point Code Support feature must be enabled before the **pcst** parameter can be specified.

The **pcst** parameter cannot be specified with **c** for a blocked screen reference (**sr**).

The spare point code subtype prefix (**s-**) is not supported for ANSI point codes (parameters **ni**, **nc**, **ncm**) or for 24-bit ITU national point codes (parameters **msa**, **ssa**, **sp**). The **pcst** parameter cannot be specified for ANSI and ITU-N24 point codes.

If **ssa=*** is specified, **sp=*** must be specified.

If **zone=*** is specified, **area=*** and **id=*** must be specified.

If **zone=c** is specified, either the character **c** must also be specified for the **area** and **id** parameters or the **area** and **id** parameters must not be specified. If the **area** and **id** parameters are not specified when **zone=c** is specified, the **area** and **id** values default to the character **c** in the database.

Notes

When a blocked DPC screening reference is created, the first entry for a point code must be **c-c-c**, or **c** for the **npc** parameter. Subsequent entries must be specific point codes.

The character **c** is used in the blocked DPC screens to allow the screening process to continue for messages with point codes that do not match any point codes in the blocked DPC screens. When screening for a blocked DPC and the point code being screened does not match any of the point codes in the blocked DPC screens, the message is not rejected and the screening process continues.

There must be an entry in the blocked DPC screens to allow the screening process to continue. This entry consists of a screening reference, point code, **nsfi**, and **nsr**. The point code is in the form of **npc=c** or subfields equal to **c-c-c**. When the character **c** is specified, the **nsfi** and **nsr** parameters must be specified.

If the character **c** is specified for the parameters **ni-nc-ncm** or **zone-area-id** or **msa-ssa-sp**, the character **c** is the only value that can be specified for all three parameters. No other values can be used. For example, a point code **c-c-255** is not allowed. The point code must be **c-c-c**. The asterisk (*) value cannot be used with the character **c** (for example, a point code **c-c-*** is not allowed).

When the point code does not match any entries in the blocked DPC screens, the screening process is directed to the screening reference with the point code **c-c-c** or **npc=c**. The **nsfi** and **nsr** in this entry are examined to determine the next step in the screening process.

If the current **ni-nc-ncm** or **zone-area-id** or **msa-ssa-sp** is equal to **c-c-c** or **npc=c**, only the **nsfi** and **nsr** can be changed. Otherwise, only the blocked DPC can be changed.

A range of values is specified by separating the values that define the range by two ampersands (&&); for example, **:ni=025&&100** specifies all network indicators for ANSI point codes from **25** to **100**.

An asterisk cannot not be specified for a parameter value in this command unless an asterisk was specified for the parameter value in the original **ent-scr-blkopc** command.

If the screen set reaches 100% capacity (indicated by the 100% Full message), the system allows subsequent entries. An error occurs, however, when downloading the screen set to an LIM. Ensure that screen sets do not exceed 100% capacity. Remove screen set entries until the capacity is below 100%.

The spare point code subtype prefix **s-** is supported only for ITU international and ITU national point codes. The **pcst** parameter indicates whether the specified point code has no subtype prefix or has the spare point code prefix.

Output

```
ent-scr-blkopc:sr=iec:ni=c:nc=c:ncm=c:nsfi=cgpa:nsr=wrds
rlghncxa03w 04-01-07 11:43:04 EST EAGLE 31.3.0
ENT-SCR-BLKOPC: SCREEN SET AFFECTED - IEC 25% FULL
ENT-SCR-BLKOPC: MASP A - COMPLTD
;
```

Legend

ENT-SCR-BLKOPC—The command entered that caused this output. This is echoed to the printer as a reference.

SCREEN SET AFFECTED - IEC—Identifies the screen set that was affected by the command. The screen set name is provided.

25% FULL—Indicates the relative size of the screen set.

ent-scr-cdpa**Enter Allowed Called Party Address**

Use this command to add a specific allowed called party address (CDPA) screening reference in the CDPA entity set.

Keyword: ent-scr-cdpa

Related Commands: chg-scr-cdpa, dlt-scr-cdpa, rtrv-scr-cdpa

Command Class: Database Administration

Parameters

:nsfi= (mandatory)

This parameter specifies the next screening category that is used in the gateway screening process, or it indicates that the gateway screening process should stop.

Range: aftpc, stop

aftpc—Allowed affected point code is the next screening category.

stop—The gateway screening process ends and the message proceeds through normal routing.

:sr= (mandatory)

Screening reference. This parameter specifies the point code's unique screening reference name.

:ssn= (mandatory)

The subsystem number. An asterisk (*) indicates the full range of values from 1-255.

Range: 1-255, *

:actname= (optional)

The name of the gateway screening stop action set. Stop actions must be administered using the **actname** parameter in conjunction with the gateway screening stop action table (see **chg-gws-actset** and **rtrv-gws-actset**).

Range: 1 alphabetic character followed by up to 5 alphanumeric characters.

:area= (optional)

The ITU international area. The area is specified in the point code. The format of the point code is *zone-area-id*. An asterisk (*) indicates the full range of values from 000-255.

Range: 000-255, *

:id= (optional)†

The ITU international ID. The parameter specifies the ID in the point code represented by format *zone-area-id*. An asterisk (*) indicates the full range of values from 0-7.

Range: 0-7, *

:msa= (optional)

The 24-bit ITU-national main signaling area (msa) value. It specifies the **msa** of the point code represented by *msa-ssa-sp*. An asterisk (*) indicates the full range of values from 000-255.

Range: 000-255, *

:nc= (optional)

The network cluster (nc) value. This parameter specifies one or more nc values for the network indicator (ni) and network cluster member (ncm) values specified in the **ni** and **ncm** parameters. It specifies the *nc* of the point code represented by *ni-nc-ncm*. A single value or a range of values can be specified. An asterisk (*) indicates the full range of values from **000-255**.

Range: **000-255, ***

:ncm= (optional)

The network cluster member (ncm) value. This parameter specifies one or more ncm values for the network indicator (ni) and network cluster (nc) values identified in the **ni** and **nc** parameters. It specifies the *ncm* of the point code represented by *ni-nc-ncm*. A single value or a range of values can be specified. An asterisk (*) indicates the full range of values from **000-255**.

Range: **0-255, ***

:ni= (optional)

The network indicator (ni) value. This parameter specifies one or more ni values for the network cluster (nc) and network cluster member (ncm) values identified in the **nc** and **ncm** parameters. It specifies the *ni* of the point code represented by *ni-nc-ncm*. A single value or a range of values can be specified. An asterisk (*) indicates the full range of values from **000-255**.

Range: **0-255, ***

:npc= (optional)

The ITU national point code. An asterisk (*) indicates the full range of values from **00000-16383**.

Range: **00000-16383, ***

NOTE: Gateway screening allows the ITU national point code to be displayed and entered in the database only as a single number. If you are using multiple-part ITU national point codes, see “Converting ITU National Point Code Formats” in Appendix A for information on converting the point code format.

:nsr= (optional)

Next screening reference (nsr). The parameter indicates which screening reference in the specified screening category (**nsfi**) is to be used in the screening process. If **nsfi=stop**, the **nsr** parameter cannot be specified.

Range: 1 alphabetic character followed by up to 3 alphanumeric characters

Default: No value given

:scmgfid= (optional)

The SCMG Format ID. A single value or a range of values can be specified. An asterisk (*) indicates the full range of values from **1-255**. The following SCCP message types are screened against the Allowed CDPA table and all others are passed: UDT, UDTS, XUDT, XUDTS.

Range: **1-255, ***

:pcst= (optional)

Point code subtype. This parameter indicates whether the specified ITU international or ITU national point code has no subtype prefix or has the spare point code prefix (s-).

Range: none, s

Default: none

:sp= (optional)

The 24-bit ITU national signaling point. This parameter specifies the signaling point (sp) in the point code represented by *msa-ssa-sp*. An asterisk (*) indicates the full range of values from **000-255**.

Range: 000-255, *

:ssa= (optional)

The 24-bit ITU national sub signaling area. This parameter specifies the sub signaling area (ssa) in the point code represented by the format *msa-ssa-sp*. An asterisk (*) indicates the full range of values from **000-255**.

Range: 000-255, *

:zone= (optional)

The ITU international zone. The parameter specifies the zone in the point code represented by format *zone-area-id*. An asterisk (*) indicates the full range of values from **0-7**.

Range: 0-7, *

Example

```
ent-scr-cdpa:sr=iec:ni=240:nc=010:ncm=*:ssn=224:nsfi=afpc:nsr=wr5
```

```
ent-scr-cdpa:sr=iec:ni=240:nc=010:ncm=*:ssn=224:nsfi=stop:actname=copy
```

```
ent-scr-cdpa:sr=cdp1:zone=1:area=2:id=3:ssn=1:nsfi=stop:scmgfid=1:pcst=s
```

Dependencies



CAUTION: Even though gateway screening is in the screen test mode, as defined by the parameters **gwsa=off** and **gws=on**, the gateway screening action in the stop action set specified by the **actname** parameter of the screen set *will* be performed at the end of the screening process.

The Gateway Screening Rules table can contain a maximum of 372,600 rules.

A complete point code must be specified, and must be one and only one of the four point code parameter combinations: **ni-nc-ncm**; **zone-area-id**; **msa-ssa-sp**; or **npc**, except in the special case of entering **c** for "continue".

ANSI point code value **000-000-000** and ITU-International point code value **0-000-0** are not allowed.

At least one optional parameter must be specified.

The new CDPA entry to be added cannot match any specific, range, or asterisk entry already existing in the specified screening table.

The character **c** is not a valid value for the **ni**, **nc**, **ncm**, **zone**, **area**, **id**, **msa**, **ssa**, **sp**, and **npc** parameters.

The value of the **actname** parameter must already be defined in the Gateway Screening Stop Action table with the **chg-gws-actset** command. These values are shown in the *ACT NAME* field of the **rtrv-gws-actset** command output.

When the **actname** parameter is specified, the **nsfi=stop** parameter must be specified.

If the **nc** parameter is specified as a range, the **ncm** parameter must be specified as an asterisk or as the full range **000-255**

If the **nc** parameter is specified as a single value or a range, a single value must be specified for the **ni** parameter.

If the **nc** parameter is specified as an asterisk (**nc=***), the **ncm** parameter must be specified as an asterisk or as the full range **000-255**.

If the **ncm** parameter is specified as a single value, or a range other than the full range of **000-255**, the **ni** and the **nc** parameters must be specified with a single value.

If the **ni** parameter is specified as an asterisk (**ni=***) or as a range, the **nc** and **ncm** parameters must be specified as an asterisk or as the full range **000-255**.

If the **nnc** parameter is specified as a range, the **nncm** parameter must be specified as an asterisk or as the full range **000-255**

When **nsfi=aftpc** is specified, the **ssn=1** parameter must be specified.

When **nsfi** is a value other than **stop**, the **nsr** parameter must be specified.

When **nsfi=stop** is specified, the **nsr** parameter cannot be specified.

When **ssn=1** is specified, the **scmgfid** parameter must be specified.

When **ssn** is not **1**, the **scmgfid** parameter cannot be specified.

The Spare Point Code Support feature must be enabled before the **pcst** parameter can be specified.

The spare point code subtype prefix (**s-**) is not supported for ANSI point codes (parameters **ni**, **nc**, **ncm**) or for 24-bit ITU national point codes (parameters **msa**, **ssa**, **sp**). The **pcst** parameter cannot be specified for ANSI and ITU-N24 point codes.

Notes

If the screening reference is valid, but does not exist, a new CDPA screen is created.

If the screening reference exists, a new rule is added to the CDPA screening table.

A range of values is specified by separating the values that define the range by two ampersands (**&&**); for example, **:ni=025&&100** specifies all network indicators for ANSI point codes from **25** to **100**.

If the screen set reaches 100% capacity (indicated by the 100% Full message), the system will allow subsequent entries. An error will occur, however, when downloading the screen set to a LIM. Screen sets should not exceed 100% capacity. Remove screen set entries until the capacity is below 100%.

An asterisk cannot not be specified for a parameter value in this command unless an asterisk was specified for the parameter value in the original **ent-scr-cdpa** command.

The spare point code subtype prefix **s-** is supported only for ITU international and ITU national point codes. The **pcst** parameter indicates whether the specified point code has no subtype prefix or has the spare point code prefix.

Output

```
ent-scr-cdpa:sr=iec:ni=240:nc=010:ncm=*:ssn=224:nsfi=afipc:nsr=wr5
```

```
rlghncxa03w 04-01-07 11:43:04 EST EAGLE 31.3.0
ENT-SCR-CDPA: SCREEN SET AFFECTED - IEC 25% FULL
ENT-SCR-CDPA: MASP A - COMPLTD
```

```
;
```

Legend

ENT-SCR-CDPA—The command entered that caused this output. This is echoed to the printer as a reference.

SCREEN SET AFFECTED - IEC—Identifies the screen set that was affected by the command. The screen set name is provided.

25% FULL—Indicates the relative size of the screen set.

ent-scr-cgpa**Enter Allowed Calling Party Address**

Use this command to add a specific allowed calling party address (CGPA) screening reference in the CGPA entity set.

Keyword: ent-scr-cgpa

Related Commands: chg-scr-cgpa, dlt-scr-cgpa, rtrv-scr-cgpa

Command Class: Database Administration

Parameters

:nsfi= (mandatory)

This parameter specifies the next screening category that is used in the gateway screening process, or it indicates that the gateway screening process should stop.

Range: cdpa, stop, tt

cdpa—Allowed called party address is the next screening category.

stop—The gateway screening process ends and the message proceeds through normal routing.

tt—Allowed translation type is the next screening category.

:ri= (mandatory)

The routing indicator provides routing instructions to the receiving signaling point. In gateway screening, messages may be screened based on the value of the routing indicator.

Range: dpc, gt, *

dpc—Allow a called party address with a routing indicator value of “DPC/SSN.”

gt—Screening stops and gateway screening is bypassed as a forced pass.

*****—A full range of values.

:sr= (mandatory)

Screening reference. This parameter specifies the point code’s unique screening reference name.

Range: 1 alphabetic character followed by up to 3 optional alphanumeric characters

:ssn= (mandatory)

The subsystem number. An asterisk (*) indicates the full range of values from **1-255**.

Range: **1-255, ***

:actname= (optional)

The name of the gateway screening stop action set. Stop actions must be administered using the **actname** parameter in conjunction with the gateway screening stop action table (see **chg-gws-actset** and **rtrv-gws-actset**).

Range: 1 alphabetic character followed by up to 5 alphanumeric characters.

:area= (optional)

The ITU international area. The area is specified in the point code. The format of the point code is *zone-area-id*. An asterisk (*) indicates the full range of values from **000-255**.

Range: **000-255, ***

:id= (optional)

The ITU international ID. The parameter specifies the ID in the point code represented by format *zone-area-id*. An asterisk (*) indicates the full range of values from **0-7**.

Range: **0-7, ***

:msa= (optional)

The 24-bit ITU-national main signaling area (msa) value. It specifies the **msa** of the point code represented by *msa-ssa-sp*. An asterisk (*) indicates the full range of values from **000-255**.

Range: **000-255, ***

:nc= (optional)

The network cluster (nc) value. This parameter specifies one or more nc values for the network indicator (ni) and network cluster member (ncm) values specified in the **ni** and **ncm** parameters. It specifies the *nc* of the point code represented by *ni-nc-ncm*. A single value or a range of values can be specified. An asterisk (*) indicates the full range of values from **000-255**.

Range: **000-255, ***

:ncm= (optional)

The network cluster member (ncm) value. This parameter specifies one or more ncm values for the network indicator (ni) and network cluster (nc) values identified in the **ni** and **nc** parameters. It specifies the *ncm* of the point code represented by *ni-nc-ncm*. A single value or a range of values can be specified. An asterisk (*) indicates the full range of values from **000-255**.

Range: **0-255, ***

:ni= (optional)

The network indicator (ni) value. This parameter specifies one or more ni values for the network cluster (nc) and network cluster member (ncm) values identified in the **nc** and **ncm** parameters. It specifies the *ni* of the point code represented by *ni-nc-ncm*. A single value or a range of values can be specified. An asterisk (*) indicates the full range of values from **000-255**.

Range: **0-255, ***

:npc= (optional)

The ITU national point code. An asterisk (*) indicates the full range of values from **00000-16383**.

Range: 0000–16383, *

NOTE: Gateway screening allows the ITU national point code to be displayed and entered in the database only as a single number. If you are using multiple-part ITU national point codes, see “Converting ITU National Point Code Formats” in Appendix A for information on converting the point code format.

:nsr= (optional)

Next screening reference (nsr). The parameter indicates which screening reference in the specified screening category (**nsfi**) is to be used in the screening process. If **nsfi=stop**, the **nsr** parameter cannot be specified.

Range: 1 alphabetic character followed by up to 3 alphanumeric characters

Default: No value given.

:sccpmt= (optional)

The SCCP message type. An asterisk (*) indicates all possible allowed values.

Range: 9, 10, 17, 18, *

9—UDT

10—UDTS

17—XUDT

18—XUDTS

Default: *

:pcst= (optional)

Point code subtype. This parameter indicates whether the specified ITU international or ITU national point code has no subtype prefix or has the spare point code prefix (**s**).

Range: none, s

Default: none

:sp= (optional)

The 24-bit ITU national signaling point. This parameter specifies the signaling point (sp) in the point code represented by *msa-ssa-sp*. An asterisk (*) indicates the full range of values from 000-255.

Range: 000–255, *

:ssa= (optional)

The 24-bit ITU national sub signaling area. This parameter specifies the sub signaling area (ssa) in the point code represented by the format *msa-ssa-sp*. An asterisk (*) indicates the full range of values from 000-255.

Range: 000–255, *

:zone= (optional)

The ITU international zone. The parameter specifies the zone in the point code represented by format *zone-area-id*. An asterisk (*) indicates the full range of values from 0–7.

Example

```
ent-scr-cgpa:sr=iec:ni=240:nc=010:ncm=*:ssn=224:nsfi=aftpc:nsr=wr5:ri=dpc
```

```
ent-scr-cgpa:sr=iec:ni=240:nc=010:ncm=*:ssn=224:nsfi=stop:ri=dpc:actname=copy
```

```
ent-scr-cgpa:sr=cdp1:ni=5:nc=5:ncm=5:ssn=1:ri=dpc:sccpmt=9:nsfi=sdpa:nsr=cdp1
```

```
ent-scr-cgpa:sr=cgpa:zone=1:area=2:id=3:ssn=1:sccpmt=9:ri=*:nsfi=stop:pcst=s
```

Dependencies



CAUTION: Even though gateway screening is in the screen test mode, as defined by the parameters **gwsa=off** and **gwsm=on**, the gateway screening action in the stop action set specified by the **actname** parameter of the screen set *will* be performed at the end of the screening process.

The Gateway Screening Rules table can contain a maximum of 372,600 rules.

A complete point code must be specified, and must be one, and only one of the four point code parameter combinations: **ni-nc-ncm**; **zone-area-id**; **msa-ssa-sp**; or **npc**.

ANSI point code value **000-000-000** and ITU-International point code value **0-000-0** are not allowed.

The new CGPA point code, **ri**, **sccpmt**, and subsystem number (**ssn**) to be added can not already exist in the CGPA entity set.

The character **c** is not a valid value for the **ni**, **nc**, **ncm**, **zone**, **area**, **id**, **msa**, **ssa**, **sp**, and **npc** parameters.

The value of the **actname** parameter must already be defined in the Gateway Screening Stop Action table with the **chg-gws-actset** command. These values are shown in the **ACT NAME** field of the **rtrv-gws-actset** command output.

When the **actname** parameter is specified, the **nsfi=stop** parameter must be specified.

If **area=*** is specified, **id=*** must be specified.

If **msa=*** is specified, **ssa=*** and **sp=*** must be specified.

If the **nc** parameter is specified as a range, the **ncm** parameter must be specified as an asterisk or as the full range **000-255**

If the **nc** parameter is specified as a single value or a range, a single value must be specified for the **ni** parameter.

If the **nc** parameter is specified as an asterisk (**nc=***), the **ncm** parameter must be specified as an asterisk or as the full range **000-255**.

If the **ncm** parameter is specified as a single value, or a range other than the full range of **000-255**, the **ni** and the **nc** parameters must be specified with a single value.

If the **ni** parameter is specified as an asterisk (**ni=***) or as a range, the **nc** and **ncm** parameters must be specified as an asterisk or as the full range **000-255**.

The Spare Point Code Support feature must be enabled before the **pcst** parameter can be specified.

The spare point code subtype prefix (**s-**) is not supported for ANSI point codes (parameters **ni**, **nc**, **ncm**) or for 24-bit ITU national point codes (parameters **msa**, **ssa**, **sp**). The **pcst** parameter cannot be specified for ANSI and ITU-N24 point codes.

The screen referenced by **nsfi** and **nsr** must already exist.

When **nsfi** is a value other than **stop**, the **nsr** parameter must be specified.

When **nsfi=stop** is specified, the **nsr** parameter cannot be specified.

The **nsfi=tt** parameter can be specified only if the **ri=gt** parameter or the **ri=*** parameter is specified.

The **nsfi=cdpa** parameter can be specified only if the **ri=dpc** parameter or the **ri=*** parameter is specified.

If **ssa=*** is specified, **sp=*** must be specified.

If **zone=*** is specified, **area=*** and **id=*** must be specified.

Notes

A range of values is specified by separating the values that define the range by two ampersands (&&); for example, **ni=025&&100** specifies all network indicators for ANSI point codes from **25** to **100**.

If the screening reference is valid, but does not exist, a new CGPA screening table is created.

If the screening reference exists, a new rule is added to the CGPA screening table. Only one rule may exist for a given **ni-nc-ncm/ssn/ri/sccpmt** (or **zone-area-id** or **npc**) combination. This implies that for a given **ni-nc-ncm/ssn/ri/sccpmt** (or **zone-area-id** or **npc**), only one value of **ri** may be specified. The **ri** for a given combination can be **dpc**, **gt**, or *****, but not **dpc** and **gt** independently.

If the screen set reaches 100% capacity (indicated by the 100% Full message), the system will allow subsequent entries. An error will occur, however, when downloading the screen set to a LIM. Screen sets should not exceed 100% capacity. Remove screen set entries until the capacity is below 100%.

An asterisk cannot not be specified for a parameter value in this command unless an asterisk was specified for the parameter value in the original **ent-scr-cgpa** command.

The spare point code subtype prefix **s-** is supported only for ITU international and ITU national point codes. The **pcst** parameter indicates whether the specified point code has no subtype prefix or has the spare point code prefix.

Output

```
ent-scr-cgpa:sr=iec:ni=240:nc=010:ncm=*.ssn=224:nsfi=aftpc:nsr=wr5:ri=dpc
rlghncxa03w 04-01-07 11:43:04 EST EAGLE 31.3.0
ENT-SCR-CGPA: SCREEN SET AFFECTED - IEC 25% FULL
ENT-SCR-CGPA: MASP A - COMPLTD
;
```

Legend

ENT-SCR-CGPA—The command entered that caused this output. This is echoed to the printer as a reference.

SCREEN SET AFFECTED - IEC—Identifies the screen set that was affected by the command. The screen set name is provided.

25% FULL—Indicates the relative size of the screen set.

ent-scr-destfld**Add an Allowed DESTFLD**

Use this command to add an allowed affected destination field (DESTFLD) screening reference and associated attributes (destination point code, next screening function identifier, and next screening reference) to the allowed DESTFLD entity set. One or more point codes can be associated with the allowed DESTFLD screening reference. MTP Network Management messages regarding the DESTFLDs listed in this entity set are accepted from another network.

Keyword: ent-scr-destfld

Related Commands: chg-scr-destfld, dlt-scr-destfld, rtrv-scr-destfld

Command Class: Database Administration

Parameters

:nsfi= (mandatory)

This parameter indicates that the gateway screening process should stop. If this parameter is specified for this command, it must have the value of **stop**.

Range: stop

stop—The gateway screening process ends and the message proceeds through normal routing.

:sr= (mandatory)

Screening reference. This parameter specifies the point code's unique screening reference name.

Range: 1 alphabetic character followed by up to 3 alphanumeric characters.

:actname= (optional)

The name of the gateway screening stop action set. Stop actions must be administered using the **actname** parameter in conjunction with the gateway screening stop action table (see **chg-gws-actset** and **rtrv-gws-actset**).

Range: 1 alphabetic character followed by up to 5 alphanumeric characters.

:area= (optional)

The ITU international area. The area is specified in the point code. The format of the point code is *zone-area-id*. An asterisk (*) indicates the full range of values from **000–255**.

Range: 000–255, *

:id= (optional)

The ITU international ID. The parameter specifies the ID in the point code represented by format *zone-area-id*. An asterisk (*) indicates the full range of values from **0–7**.

Range: 0–7, *

:msa= (optional)

The 24-bit ITU-national main signaling area (msa) value. It specifies the **msa** of the point code represented by *msa-ssa-sp*. An asterisk (*) indicates the full range of values from **000–255**.

Range: 000–255, *

:nc= (optional)

The network cluster (nc) value. This parameter specifies one or more nc values for the network indicator (ni) and network cluster member (ncm) values specified in the **ni** and **ncm** parameters. It specifies the *nc* of the point code represented by *ni-nc-ncm*. A single value or a range of values can be specified. An asterisk (*) indicates the full range of values from **000–255**.

Range: **000–255, ***

:ncm= (optional)

The network cluster member (ncm) value. This parameter specifies one or more ncm values for the network indicator (ni) and network cluster (nc) values identified in the **ni** and **nc** parameters. It specifies the *ncm* of the point code represented by *ni-nc-ncm*. A single value or a range of values can be specified. An asterisk (*) indicates the full range of values from **000–255**.

Range: **0–255, ***

:ni= (optional)

The network indicator (ni) value. This parameter specifies one or more ni values for the network cluster (nc) and network cluster member (ncm) values identified in the **nc** and **ncm** parameters. It specifies the *ni* of the point code represented by *ni-nc-ncm*. A single value or a range of values can be specified. An asterisk (*) indicates the full range of values from **000–255**.

Range: **0–255, ***

:npc= (optional)

The ITU national point code. An asterisk (*) indicates the full range of values from **00000–16383**.

Range: **00000–16383, ***

NOTE: Gateway screening allows the ITU national point code to be displayed and entered in the database only as a single number. If multiple-part ITU national point codes are used, see “Converting ITU National Point Code Formats” in Appendix A for information on converting the point code format.

:nsr= (optional)

Next screening reference (nsr). The parameter indicates which screening reference in the specified screening category (**nsfi**) is to be used in the screening process. If **nsfi=stop**, the **nsr** parameter cannot be specified.

Range: 1 alphabetic character followed by up to 3 alphanumeric characters

Default: No value given

:pcst= (optional)

Point code subtype. This parameter indicates whether the specified ITU international or ITU national point code has no subtype prefix or has the spare point code prefix (s-).

Range: **none, s**

Default: **none**

:sp= (optional)

The 24-bit ITU national signaling point. This parameter specifies the signaling point (sp) in the point code represented by *msa-ssa-sp*. An asterisk (*) indicates the full range of values from **000–255**.

Range: **000–255, ***

:ssa= (optional)

The 24-bit ITU national sub signaling area. This parameter specifies the sub signaling area (ssa) in the point code represented by the format *msa-ssa-sp*. An asterisk (*) indicates the full range of values from **000-255**.

Range: **000-255, ***

:zone= (optional)

The ITU international zone. The parameter specifies the zone in the point code represented by format *zone-area-id*. An asterisk (*) indicates the full range of values from **0-7**.

Range: **0-7, ***

Example

```
ent-scr-destfld:sr=iec:ni=240:nc=010:ncm=010-012:nsfi=stop
```

```
ent-scr-destfld:sr=iec1:ni=1:nc=1:ncm=1:nsfi=stop:actname=copy
```

```
ent-scr-destfld:sr=dst1:zone=1:area=2:id=3:nsfi=stop:pcst=s
```

Dependencies



CAUTION: Even though gateway screening is in the screen test mode, as defined by the parameters **gwsa=off** and **gwsm=on**, the gateway screening action in the stop action set specified by the **actname** parameter of the screen set *will* be performed at the end of the screening process.

The Gateway Screening Rules table can contain a maximum of 362,700 rules.

The destination point code specified by **ni-nc-ncm**, **zone-area-id**, **msa-ssa-sp**, or the **npc** parameter must not already exist in the screening reference or within an existing range of DPCs.

ANSI point code value **000-000-000** and ITU-International point code value **0-000-0** are not allowed.

The **actname** parameter can be specified only when the **nsfi=stop** parameter is specified.

The value of the **actname** parameter must already be defined in the Gateway Screening Stop Action table with the **chg-gws-actset** command. These values are shown in the **ACT NAME** field of the **rtrv-gws-actset** command output.

If **area=*** is specified, **id=*** must be specified.

If **msa=*** is specified, **ssa=*** and **sp=*** must be specified.

If the **nc** parameter is specified as a range, the **ncm** parameter must be specified as an asterisk or as the full range **000-255**

If the **nc** parameter is specified as a single value or a range, a single value must be specified for the **ni** parameter.

If the **nc** parameter is specified as an asterisk (**nc=***), the **ncm** parameter must be specified as an asterisk or as the full range **000-255**.

If the **ncm** parameter is specified as a single value, or a range other than the full range of **000-255**, the **ni** and the **nc** parameters must be specified with a single value.

If the **ni** parameter is specified as an asterisk (**ni=***) or as a range, the **nc** and **ncm** parameters must be specified as an asterisk or as the full range **000-255**.

The **nsfi=stop** parameter must be specified in the command.

The **nsr** parameter cannot be specified for this command, because **nsfi=stop** must be specified. The **nsr** parameter cannot be specified when **nsfi=stop**.

If **ssa=*** is specified, **sp=*** must be specified.

If **zone=*** is specified, **area=*** and **id=*** must be specified.

The Spare Point Code Support feature must be enabled before the **pcst** parameter can be specified.

The spare point code subtype prefix (**s-**) is not supported for ANSI point codes (parameters **ni**, **nc**, **ncm**) or for 24-bit ITU national point codes (parameters **msa**, **ssa**, **sp**). The **pcst** and **npcst** parameters cannot be specified for ANSI and ITU-N24 point codes.

Notes

A range of values is specified by separating the values that define the range by two ampersands (&&); for example, **:ni=025&&100** specifies all network indicators for ANSI point codes from **25** to **100**.

An asterisk cannot not be specified for a parameter value in this command unless an asterisk was specified for the parameter value in the original **ent-scr-destfld** command.

The spare point code subtype prefix **s-** is supported only for ITU international and ITU national point codes. The **pcst** parameter indicates whether the specified point code has no subtype prefix or has the spare point code prefix.

Output

```
ent-scr-destfld:sr=iec:ni=240:nc=010:ncm=010-012:nsfi=stop
rlghncxa03w 04-02-13 11:49:47 EST EAGLE 31.3.0
ENT-SCR-DESTFLD: SCREEN SET AFFECTED - IEC 25% FULL
ENT-SCR-DESTFLD: MASP A - COMPLTD
;
```

ent-scr-dpc

Enter Allowed DPC

Use this command to add an allowed DPC screening reference and associated attributes (destination point code, next screening function identifier, next screening function reference) to the allowed DPC entity set. One or more DPCs may be associated with the allowed DPC screening reference. The DPCs listed in this entity set are allowed to receive SS7 messages from another network.

Keyword: **ent-scr-dpc**

Related Commands: **chg-scr-dpc**, **dlt-scr-dpc**, **rtrv-scr-dpc**

Command Class: Database Administration

Parameters

:nsfi= (mandatory)

This parameter specifies the next screening category that is used in the gateway screening process, or it indicates that the gateway screening process should stop.

Range: **blkdpc, cgpa, destfld, isup, stop**

blkdpc—Blocked DPC is the next screening category.

cgpa—Allowed CGPA is the next screening category.

destfld—Allowed destination field (DESTFLD) is the next screening category.

isup—ISUP message type (ISUP) is the next screening category.

stop—The gateway screening process ends and the message proceeds through normal routing.

:sr= (mandatory)

The allowed DPC screening reference name. This parameter identifies a set of one or more allowed destination point codes.

Range: 1 alphabetic character followed by up to 3 alphanumeric characters.

:actname= (optional)

The name of the gateway screening stop action set. Stop actions must be administered using the **actname** parameter in conjunction with the gateway screening stop action table (see **chg-gws-actset** and **rtrv-gws-actset**).

Range: 1 alphabetic character followed by up to 5 alphanumeric characters.

:area= (optional)

The ITU international area. The area is specified in the point code. The format of the point code is *zone-area-id*. An asterisk (*) indicates the full range of values from **000-255**.

Range: **000-255, ***

:id= (optional)

The ITU international ID. The parameter specifies the ID in the point code represented by format *zone-area-id*. An asterisk (*) indicates the full range of values from **0-7**.

Range: **0-7, ***

:msa= (optional)

The 24-bit ITU-national main signaling area (msa) value. It specifies the **msa** of the point code represented by *msa-ssa-sp*. An asterisk (*) indicates the full range of values from **000-255**.

Range: **000-255, ***

:nc= (optional)

The network cluster (nc) value. This parameter specifies one or more nc values for the network indicator (ni) and network cluster member (ncm) values specified in the **ni** and **ncm** parameters. It specifies the *nc* of the point code represented by *ni-nc-ncm*. A single value or a range of values can be specified. An asterisk (*) indicates the full range of values from **000-255**.

Range: **000-255, ***

:ncm= (optional)

The network cluster member (ncm) value. This parameter specifies one or more ncm values for the network indicator (ni) and network cluster (nc) values identified in the **ni** and **nc** parameters. It specifies the *ncm* of the point code represented by *ni-nc-ncm*. A single value or a range of values can be specified. An asterisk (*) indicates the full range of values from **000-255**.

Range: **0-255, ***

:ni= (optional)

The network indicator (ni) value. This parameter specifies one or more ni values for the network cluster (nc) and network cluster member (ncm) values identified in the **nc** and **ncm** parameters. It specifies the *ni* of the point code represented by *ni-nc-ncm*. A single value or a range of values can be specified. An asterisk (*) indicates the full range of values from **000-255**.

Range: 0-255, *

:npc= (optional)

The ITU national point code. An asterisk (*) indicates the full range of values from **00000-16383**.

Range: 00000-16383, *

NOTE: Gateway screening allows the ITU national point code to be displayed and entered in the database only as a single number. If you are using multiple-part ITU national point codes, see “Converting ITU National Point Code Formats” in Appendix A for information on converting the point code format.

:nsr= (optional)

Next screening reference (nsr). The parameter indicates which screening reference in the specified screening category (**nsfi**) is to be used in the screening process. If **nsfi=stop**, the **nsr** parameter cannot be specified.

Range: 1 alphabetic character followed by up to 3 alphanumeric characters

Default: No value given

:pcst= (optional)

Point code subtype. This parameter indicates whether the specified ITU international or ITU national point code has no subtype prefix or has the spare point code prefix (**s-**).

Range: none, s

Default: none

:sp= (optional)

The 24-bit ITU national signaling point. This parameter specifies the signaling point (sp) in the point code represented by *msa-ssa-sp*. An asterisk (*) indicates the full range of values from **000-255**.

Range: 000-255, *

:ssa= (optional)

The 24-bit ITU national sub signaling area. This parameter specifies the sub signaling area (ssa) in the point code represented by the format *msa-ssa-sp*. An asterisk (*) indicates the full range of values from **000-255**.

Range: 000-255, *

:zone= (optional)

The ITU international zone. The parameter specifies the zone in the point code represented by format *zone-area-id*. An asterisk (*) indicates the full range of values from **0-7**.

Range: 0-7, *, c

Example

```
ent-scr-dpc:sr=iec:ni=240:nc=010:ncm=010:nsfi=stop:actname=cncf
```

```
ent-scr-dpc:sr=iec:ni=240:nc=010:ncm=010:nsfi=blkdpc:nsr=bdp1
```

ent-scr-dpc:sr=dpc1:zone=1:area=2:id=3:nsfi=fail:pcst=none

ent-scr-dpc:sr=dpc1:zone=2:area=2:id=3:nsfi=fail:pcst=s

ent-scr-dpc:sr=dpc1:npc=128:nsfi=fail:pcst=s

Dependencies



CAUTION: Even though gateway screening is in the screen test mode, as defined by the parameters **gwsa=off** and **gws=on**, the gateway screening action in the stop action set specified by the **actname** parameter of the screen set *will* be performed at the end of the screening process.

The Gateway Screening Rules table can contain a maximum of 362,700 rules.

The destination point code specified by **ni-nc-ncm**, **zone-area-id**, **msa-ssa-sp**, or the **npc** parameter must not already exist in the screening reference or within an existing range of DPCs.

The **actname** parameter can be specified only when the **nsfi=stop** parameter is specified.

ANSI point code value **000-000-000** and ITU-International point code value **0-000-0** are not allowed.

The value of the **actname** parameter must already be defined in the Gateway Screening Stop Action table with the **chg-gws-actset** command. These values are shown in the **ACT NAME** field of the **rtrv-gws-actset** command output.

If **area=*** is specified, **id=*** must be specified.

If **msa=*** is specified, **ssa=*** and **sp=*** must be specified.

If the **nc** parameter is specified as a range, the **ncm** parameter must be specified as an asterisk or as the full range **000-255**.

If the **nc** parameter is specified as a single value or a range, a single value must be specified for the **ni** parameter.

If the **nc** parameter is specified as an asterisk (**nc=***), the **ncm** parameter must be specified as an asterisk or as the full range **000-255**.

If the **ncm** parameter is specified as a single value, or a range other than the full range of **000-255**, the **ni** and the **nc** parameters must be specified with a single value.

If the **ni** parameter is specified as an asterisk (**ni=***) or as a range, the **nc** and **ncm** parameters must be specified as an asterisk or as the full range **000-255**.

The next screening function identifier (**nsfi**) and the next screening reference (**nsr**) must point to an existing screen, or the **nsfi** must be equal to **stop** and the **nsr** must not be specified.

The **nsr** parameter must be specified if **nsfi** is not equal to **stop**.

If **ssa=*** is specified, **sp=*** must be specified.

If **zone=*** is specified, **area=*** and **id=*** must be specified.

The Spare Point Code Support feature must be enabled before the **pcst** parameter can be specified.

The spare point code subtype prefix (**s-**) is not supported for ANSI point codes (parameters **ni**, **nc**, **ncm**) or for 24-bit ITU national point codes (parameters **msa**, **ssa**, **sp**). The **pcst** parameter cannot be specified for ANSI and ITU-N24 point codes.

Notes

When a DPC screening reference is created, the first entry for a point code must be **c-c-c**, or **c** for the **npc** parameter. Subsequent entries must be specific point codes.

The character **c** is used in the DPC screens to allow the screening process to continue for messages with point codes that do not match any point codes in the DPC screens. When screening for a DPC and the point code being screened does not match any of the point codes in the DPC screens, the message is not rejected and the screening process continues.

There must be an entry in the DPC screens to allow the screening process to continue. This entry consists of a screening reference, point code, **nsfi**, and **nsr**. The point code is in the form of **npc=c** or subfields equal to **c-c-c**. When the character **c** is specified, the **nsfi** and **nsr** parameters must be specified.

If the character **c** is specified for the parameters **ni-nc-ncm** or **zone-area-id** or **msa-ssa-sp**, the character **c** is the only value that can be specified for all three parameters. No other values can be used. For example, a point code **c-c-255** is not allowed. The point code must be **c-c-c**. The asterisk (*) value cannot be used with the character **c** (for example, a point code **c-c-*** is not allowed).

When the point code does not match any entries in the blocked DPC screens, the screening process is directed to the screening reference with the point code **c-c-c** or **npc=c**. The **nsfi** and **nsr** in this entry are examined to determine the next step in the screening process.

If the current **ni-nc-ncm** or **zone-area-id** or **msa-ssa-sp** is equal to **c-c-c** or **npc=c**, only the **nsfi** and **nsr** can be changed. Otherwise, only the blocked DPC can be changed.

A range of values is specified by separating the values that define the range by two ampersands (&&); for example, **:ni=025&&100** specifies all network indicators for ANSI point codes from **25** to **100**.

An asterisk cannot not be specified for a parameter value in this command unless an asterisk was specified for the parameter value in the original **ent-scr-dpc** command.

If the screen set reaches 100% capacity (indicated by the 100% Full message), the system allows subsequent entries. An error occurs, however, when downloading the screen set to an LIM. Ensure that screen sets do not exceed 100% capacity. Remove screen set entries until the capacity is below 100%.

The spare point code subtype prefix **s-** is supported only for ITU international and ITU national point codes. The **pcst** parameter indicates whether the specified point code has no subtype prefix or has the spare point code prefix.

Output

ent-scr-dpc:sr=iec:ni=240:nc=010:ncm=010:nsfi=stop:actname=cncf

```
rlghncxa03w 04-01-07 11:43:04 EST EAGLE 31.3.0
ENT-SCR-DPC: SCREEN SET AFFECTED - IEC 25% FULL
ENT-SCR-DPC: MASP A - COMPLTD
```

;

Legend

ENT-SCR-DPC—Command entered that caused this output. This is echoed to the printer.

SCREEN SET AFFECTED - IEC—Identifies the screen set that was affected by the command. The screen set name is provided.

25% FULL—Indicates the relative size of the screen set.

ent-scr-isup**Enter Allowed ISUP Screening Reference**

Use this command to add an allowed ISUP or TUP screening reference to the Allowed ISUP entity set. One or more message types can be associated with the allowed ISUP screening reference. The ISUP message types listed in this entity set are accepted from another network.

Keyword: ent-scr-isup

Related Commands: chg-scr-isup, dlt-scr-isup, rtrv-scr-isup

Command Class: Database Administration

Parameters

:isupmt= or **:tupmt=** (mandatory)

ISUP message type or TUP message type. A single value or range of values can be entered. An asterisk (*) indicates the entire range of **000-255**. TUP is not valid for SEAS.

Range: 000-255, *

:sr= (mandatory)

The the individual ISUP screening reference to which this rule will be added. If the specified **sr** does not exist, it will be created

Range: 1 alphabetic character followed by up to 3 alphanumeric characters.

:actname= (optional)

The name of the gateway screening stop action set. Stop actions must be administered using the **actname** parameter in conjunction with the gateway screening stop action table (see **chg-gws-actset** and **rtrv-gws-actset**).

Range: 1 alphabetic character followed by up to 5 alphanumeric characters.

:nsfi= (optional)

This parameter specifies the next screening category that is used in the gateway screening process. If specified, the parameter value must be **stop**.

Range: stop

stop—The gateway screening process ends and the message proceeds through normal routing.

:nsr= (optional)

Next screening reference. The parameter indicates which screening reference in the specified screening category (**nsfi**) is to be used in the screening process. If **nsfi=stop**, the **nsr** parameter cannot be specified.

Range: 1 alphabetic character followed by up to 3 alphanumeric characters

Default: No value given

Examples

ent-scr-isup:sr=iec:isupmt=1:nsfi=stop

ent-scr-isup:sr=iec:isupmt=9:nsfi=stop

ent-scr-isup:sr=ibig:isupmt=1&&128:nsfi=stop

ent-scr-isup:sr=iall:isupmt=*:nsfi=stop

ent-scr-isup:tupmt=20:sr=tu01:nsfi=stop

Dependencies

If the **actname** parameter is specified, the **nsfi=stop** parameter must be specified.

The value of the **actname** parameter must already be defined in the Gateway Screening Stop Action table with the **chg-gws-actset** command. These values are shown in the *ACT NAME* field of the **rtv-gws-actset** command output.

The specified **isupmt** parameter or **tupmt** parameter value must not already exist in the specified **sr**.

If the **nsfi** parameter is specified, the value must be **stop**.

The **nsr** parameter cannot be specified if the **nsfi=stop** parameter is specified.

Notes

A range of values can be specified for the **isupmt** parameter or **tupmt** parameter, by separating the values that define the range by two ampersands (&&); for example, **:isupmt=025&&100** specifies all ISUP message types from **25** to **100**. The value to the left of the && must be less than the value to the right of the && in the range.

An asterisk cannot not be specified for a parameter value in this command unless an asterisk was specified for the parameter value in the original **ent-scr-isup** command.

TUP does not apply to SEAS. ISUP Message Type is the default.

To use TUP message type screening, an SIO screening reference with **si=04** (TUP) must exist in the SIO table. The TUP screening reference specifies the SIO screening reference as the next screening reference parameter (**nsr**) value.

To use ISUP message type screening, an SIO screening reference with **si=05** (ISUP) must exist in the SIO table. The ISUP screening reference specifies the ISUP SIO screening reference as the next screening reference parameter (**nsr**) value.

To screen for TUP and ISUP message types using a combined ISUP/TUP screen set, the SIO screening reference with **si=4** and the SIO screening reference with **si=5** must be two different screening references. The TUP screening reference specifies the SIO screening reference as the next screening reference parameter (**nsr**) value, and the ISUP screening reference specifies the SIO ISUP screening reference as the next screening reference parameter (**nsr**) value.

Output

When a screen reference is specified that is not yet associated with a screen set, the following output appears:

ent-scr-isup:sr=iec:isupmt=1:nsfi=stop

```
tekelecstp 04-09-02 09:39:13 EST Rel 31.3.0
ENT-SCR-ISUP: MASP A - COMPLTD
```

;

When a screen reference is specified that is already associated with one or more screen sets, the following output appears:

ent-scr-isup:tupmt=20:sr=tu01:nsfi=stop

```
tekelecstp 04-11-17 16:22:27 EST EAGLE 31.4.0
Extended Processing Time Required -- Please Wait
Notice: The number of screensets affected is 2.
ENT-SCR-ISUP: SCREEN SET AFFECTED - ist1 1% FULL
ENT-SCR-ISUP: SCREEN SET AFFECTED - ist2 1% FULL
ENT-SCR-ISUP: MASP A - COMPLTD
```

;

ent-scr-opc

Enter Allowed OPC

Use this command to add an allowed OPC screening reference and associated attributes (originating point code, next screening function identifier, next screening function reference) to the allowed OPC entity set. One or more OPCs may be associated with the allowed OPC screening reference. Each OPC listed in this entity set is allowed to send SS7 messages to the customer's network.

Keyword: ent-scr-opc

Related Commands: chg-scr-opc, dlt-scr-dpc, rtrv-scr-dpc

Command Class: Database Administration

Parameters

:nsfi= (mandatory)

This parameter specifies the next screening category that is used in the gateway screening process, or it indicates that the gateway screening process should stop.

Range: blkdpc, blkopc, cgpa, dpc, sio, stop

blkdpc—Blocked DPC is the next screening category.

blkopc—Blocked OPC is the next screening category.

cgpa—Allowed CGPA is the next screening category.

dpc—Allowed DPC is the next screening category.

sio—Allowed SIO is the next screening category.

stop—The gateway screening process ends and the message proceeds through normal routing.

:sr= (mandatory)

Screening reference. This parameter identifies a set of one or more allowed OPCs.

Range: 1 alphabetic character followed by up to 3 alphanumeric characters

:actname= (optional)

The name of the gateway screening stop action set. Stop actions must be administered using the **actname** parameter in conjunction with the gateway screening stop action table (see **chg-gws-actset** and **rtrv-gws-actset**).

Range: 1 alphabetic character followed by up to 5 alphanumeric characters.

:area= (optional)

The ITU international area. The area is specified in the point code. The format of the point code is *zone-area-id*. An asterisk (*) indicates the full range of values from **000-255**.

Range: **000-255, ***

:id= (optional)

The ITU international ID. The parameter specifies the ID in the point code represented by format *zone-area-id*. An asterisk (*) indicates the full range of values from **0-7**.

Range: **0-7, ***

:msa= (optional)

The 24-bit ITU-national main signaling area (msa) value. It specifies the **msa** of the point code represented by *msa-ssa-sp*. An asterisk (*) indicates the full range of values from **000-255**.

Range: **000-255, ***

:nc= (optional)

The network cluster (*nc*) value. This parameter specifies one or more *nc* values for the network indicator (*ni*) and network cluster member (*ncm*) values specified in the **ni** and **ncm** parameters. It specifies the *nc* of the point code represented by *ni-nc-ncm*. A single value or a range of values can be specified. An asterisk (*) indicates the full range of values from **000-255**.

Range: **000-255, ***

:ncm= (optional)

The network cluster member (*ncm*) value. This parameter specifies one or more *ncm* values for the network indicator (*ni*) and network cluster (*nc*) values identified in the **ni** and **nc** parameters. It specifies the *ncm* of the point code represented by *ni-nc-ncm*. A single value or a range of values can be specified. An asterisk (*) indicates the full range of values from **000-255**.

Range: **0-255, ***

:ni= (optional)

The network indicator (*ni*) value. This parameter specifies one or more *ni* values for the network cluster (*nc*) and network cluster member (*ncm*) values identified in the **nc** and **ncm** parameters. It specifies the *ni* of the point code represented by *ni-nc-ncm*. A single value or a range of values can be specified. An asterisk (*) indicates the full range of values from **000-255**.

Range: 0-255, *

:npc= (optional)

The ITU national point code. An asterisk (*) indicates the full range of values from 00000-16383.

Range: 00000-16383, *

NOTE: Gateway screening allows the ITU national point code to be displayed and entered in the database only as a single number. If you are using multiple-part ITU national point codes, see “Converting ITU National Point Code Formats” in Appendix A for information on converting the point code format.

:nsr= (optional)

Next screening reference (nsr). The parameter indicates which screening reference in the specified screening category (**nsfi**) is to be used in the screening process. If **nsfi=stop**, the **nsr** parameter cannot be specified.

Range: 1 alphabetic character followed by up to 3 alphanumeric characters

Default: No value given

:pcst= (optional)

Point code subtype. This parameter indicates whether the specified ITU international or ITU national point code has no subtype prefix or has the spare point code prefix (s-).

Range: none, s

Default: none

:sp= (optional)

The 24-bit ITU national signaling point. This parameter specifies the signaling point (sp) in the point code represented by *msa-ssa-sp*. An asterisk (*) indicates the full range of values from 000-255.

Range: 000-255, *

:ssa= (optional)

The 24-bit ITU national sub signaling area. This parameter specifies the sub signaling area (ssa) in the point code represented by the format *msa-ssa-sp*. An asterisk (*) indicates the full range of values from 000-255.

Range: 000-255, *

:zone= (optional)

The ITU international zone. The parameter specifies the zone in the point code represented by format *zone-area-id*. An asterisk (*) indicates the full range of values from 0-7.

Range: 0-7, *

Example

ent-scr-opc:sr=iec:nsfi=stop

ent-scr-opc:sr=iec:ni=240:nsfi=sio:nsr=iec

ent-scr-opc:sr=iec:ni=240:nc=010:ncm=010:nsfi=stop:actname=copy

ent-scr-opc:sr=iec:ni=240:nc=010:ncm=010:nsfi=dpc:nsr=iec

ent-scr-opc:sr=opc1:zone=1:area=2:id=3:nsfi=fail:pcst=none

ent-scr-opc:sr=opc1:zone=2:area=2:id=3:nsfi=fail:pcst=s

ent-scr-opc:sr=opc1:npc=128:nsfi=fail:pcst=s

Dependencies



CAUTION: Even though gateway screening is in the screen test mode, as defined by the parameters **gwsa=off** and **gws=on**, the gateway screening action in the stop action set specified by the **actname** parameter of the screen set *will* be performed at the end of the screening process.

The Gateway Screening Rules table can contain a maximum of 362,700 rules.

A complete point code must be specified, and must be one, and only one of the four point code parameter combinations: **ni-nc-ncm**; **zone-area-id**; **msa-ssa-sp**; or **npc**.

The OPC specified by **ni-nc-ncm**, **zone-area-id**, **msa-ssa-sp**, or the **npc** parameter must already exist in the screening reference or within an existing range of OPCs.

ANSI point code value **000-000-000** and ITU-International point code value **0-000-0** are not allowed.

The **actname** parameter can be specified only when the **nsfi=stop** parameter is specified.

The value of the **actname** parameter must already be defined in the Gateway Screening Stop Action table with the **chg-gws-actset** command. These values are shown in the *ACT NAME* field of the **rtrv-gws-actset** command output.

If **area=*** is specified, **id=*** must be specified.

If **msa=*** is specified, **ssa=*** and **sp=*** must be specified.

If the **nc** parameter is specified as a range, the **ncm** parameter must be specified as an asterisk or as the full range **000-255**

If the **nc** parameter is specified as a single value or a range, a single value must be specified for the **ni** parameter.

If the **nc** parameter is specified as an asterisk (**nc=***), the **ncm** parameter must be specified as an asterisk or as the full range **000-255**.

If the **ncm** parameter is specified as a single value, or a range other than the full range of **000-255**, the **ni** and the **nc** parameters must be specified with a single value.

If the **ni** parameter is specified as an asterisk (**ni=***) or as a range, the **nc** and **ncm** parameters must be specified as an asterisk or as the full range **000-255**.

The next screening function identifier (**nsfi**) and the next screening reference (**nsr**) must point to an existing screen, or the **nsfi** must be equal to **stop** and the **nsr** must not be specified.

The **nsr** parameter must be specified if **nsfi** is not equal to **stop**.

The **nsr** parameter must be specified if **nsfi** is not equal to **stop**.

If **ssa=*** is specified, **sp=*** must be specified.

If **zone=*** is specified, **area=*** and **id=*** must be specified.

The Spare Point Code Support feature must be enabled before the **pcst** parameter can be specified.

The spare point code subtype prefix (**s-**) is not supported for ANSI point codes (parameters **ni**, **nc**, **ncm**) or for 24-bit ITU national point codes (parameters **msa**, **ssa**, **sp**). The **pcst** parameter cannot be specified for ANSI and ITU-N24 point codes.

Notes

When an OPC screening reference is created, the first entry for a point code must be **c-c-c**, or **c** for the **npc** parameter. Subsequent entries must be specific point codes.

The character **c** is used in the OPC screens to allow the screening process to continue for messages with point codes that do not match any point codes in the OPC screens. When screening for a DPC and the point code being screened does not match any of the point codes in the DPC screens, the message is not rejected and the screening process continues.

There must be an entry in the OPC screens to allow the screening process to continue. This entry consists of a screening reference, point code, **nsfi**, and **nsr**. The point code is in the form of **npc=c** or subfields equal to **c-c-c**. When the character **c** is specified, the **nsfi** and **nsr** parameters must be specified.

If the character **c** is specified for the parameters **ni-nc-ncm** or **zone-area-id** or **msa-ssa-sp**, the character **c** is the only value that can be specified for all three parameters. No other values can be used. For example, a point code **c-c-255** is not allowed. The point code must be **c-c-c**. The asterisk (*) value cannot be used with the character **c** (for example, a point code **c-c-*** is not allowed).

When the point code does not match any entries in the blocked OPC screens, the screening process is directed to the screening reference with the point code **c-c-c** or **npc=c**. The **nsfi** and **nsr** in this entry are examined to determine the next step in the screening process.

If the current **ni-nc-ncm** or **zone-area-id** or **msa-ssa-sp** is equal to **c-c-c** or **npc=c**, only the **nsfi** and **nsr** can be changed. Otherwise, only the OPC can be changed.

A range of values is specified by separating the values that define the range by two ampersands (&&); for example, **:ni=025&&100** specifies all network indicators for ANSI point codes from **25** to **100**.

An asterisk cannot not be specified for a parameter value in this command unless an asterisk was specified for the parameter value in the original **ent-scr-opc** command.

If the screen set reaches 100% capacity (indicated by the 100% Full message), the system allows subsequent entries. An error occurs, however, when downloading the screen set to an LIM. Ensure that screen sets do not exceed 100% capacity. Remove screen set entries until the capacity is below 100%.

The spare point code subtype prefix **s-** is supported only for ITU international and ITU national point codes. The **pcst** parameter indicates whether the specified point code has no subtype prefix or has the spare point code prefix.

Output

ent-scr-opc:sr=iec:nsfi=stop

```
rlghncxa03w 04-01-07 11:43:04 EST EAGLE 31.3.0
ENT-SCR-OPC: SCREEN SET AFFECTED - IEC 25% FULL
ENT-SCR-OPC: MASP A - COMPLTD
```

;

Legend

ENT-SCR-OPC—The command entered that caused this output. This is echoed to the printer as a reference.

SCREEN SET AFFECTED - IEC—Identifies the screen set that was affected by the command. The screen set name is provided.

25% FULL—Indicates the relative size of the screen set.

ent-scr-sio**Enter Allowed SIO**

Use this command to add an allowed SIO screening reference and associated attributes (network indicator, service indicator, message priority, H0 heading code, H1 heading code, next screening function identifier, next screening function reference) to the allowed SIO entity set.

NOTE: To use TUP message type screening, an SIO screening reference with **si=04 (TUP)** must be defined in the SIO table. This SIO screening reference is specified in the **ent-scr-isup** command as the next screening reference (**nsr**) value in a screening reference for TUP message types

Keyword: ent-scr-sio

Related Commands: chg-scr-sio, dlt-scr-sio, rtrv-scr-sio

Command Class: Database Administration

Parameters

:nic= (mandatory)

Network indicator code (NIC). This parameter specifies an NIC for the SIO screening reference specified in the **sr** parameter. The NIC is the last 2 bits of the subservice field of an SIO. A single value or a range of values can be specified. An asterisk (*) indicates the full range of values from 0–3.

Range: 0–3, *

:nsfi= (mandatory)

This parameter specifies the next screening category that is used in the gateway screening process, or it indicates that the gateway screening process should stop.

Range: blkdpc, cdpa, cgpa, destfld, dpc, isup, stop

blkdpc—Blocked DPC is the next screening category.

cgpa—Allowed CGPA is the next screening category.

cgpa—Allowed CGPA is the next screening category.

destfld—Allowed destination field (DESTFLD) is the next screening category.

dpc—Allowed DPC is the next screening category.

isup—ISUP message type (ISUP) is the next screening category.

stop—The gateway screening process ends and the message proceeds through normal routing.

:pri= (mandatory)

Message priority. This parameter specifies a single priority, or the beginning of a range of priorities for the SIO screening reference specified by the **sr** parameter. A single value or a range of values can be specified. An asterisk (*) indicates the full range of values from 0–3.

Range: 0-3, *

:si= (mandatory)

Service indicator. This parameter specifies an SI for the SIO screening reference specified in the **sr** parameter. The SI is the first 4 bits of an SIO. The SS7 code directs the message to the MTP-user at the destination code.

Range: 00-15

:sr= (mandatory)

The allowed SIO screening reference name. This parameter identifies a set of one or more **si/nic/pri** combinations.

Range: 1 alphabetic character followed by up to 5 alphanumeric characters.

:actname= (optional)

The name of the gateway screening stop action set. Stop actions must be administered using the **actname** parameter in conjunction with the gateway screening stop action table (see **chg-gws-actset** and **rtrv-gws-actset**).

Range: 1 alphabetic character followed by up to 5 alphanumeric characters.

:h0= (optional)

H0 heading code. This parameter specifies a new H0 heading code for the screening reference specified in the **sr** parameter. A single value or a range of values can be specified. An asterisk (*) indicates the full range of values from 0-15.

Range: 0-15, *

Default: Value given if **si** value is 00, 01, or 02

:h1= (optional)

H1 Heading Code. This parameter specifies an H1 heading code for the screening reference specified in the **sr** parameter. A single value or a range of values can be specified. An asterisk (*) indicates the full range of values from 0-15.

Range: 0-15, *

Default: Value given if **si** value is 00, 01, or 02

:nsr= (optional)

Next screening reference (NSR). The parameter indicates which screening reference in the specified screening category (**nsfi**) is to be used in the screening process. If **nsfi=stop**, the **nsr** parameter cannot be specified.

Range: 1 alphabetic character followed by up to 3 alphanumeric characters

Default: No value given

Example

```
ent-scr-sio:sr=iec:nic=1:si=1:h0=01&&03:h1=*:pri=*:nsfi=dpc:nsr=abc
```

```
ent-scr-sio:sr=iec:nic=1:si=3:pri=2:nsfi=stop
```

```
ent-scr-sio:sr=iec:nic=1:si=4:pri=3:nsfi=stop:actname=cncf
```

Dependencies



CAUTION: Even though gateway screening is in the screen test mode, as defined by the parameters **gwsa=off** and **gws=on**, the gateway screening action in the stop action set specified by the **actname** parameter of the screen set *will* be performed at the end of the screening process.

The **actname** parameter can be specified only when the **nsfi=stop** parameter is specified.

The value of the **actname** parameter must already be defined in the Gateway Screening Stop Action table with the **chg-gws-actset** command. These values are shown in the *ACT NAME* field of the **rtv-gws-actset** command output.

If the **si** parameter is equal to **00**, **01**, or **02**, the **h0** and **h1** parameters must be specified. Otherwise, the **h0** parameter cannot be specified.

Table 6-11 shows the valid combinations of the **h0/h1** parameters:

Table 6-11. Valid Combinations for the **h0/h1** Parameters
(ent-scr-sio)

If the h0 parameter is specified as:	The h1 parameter can be specified as:
A single value	A single value
A single value	A range
A single value	An asterisk (*) entry
A range	An asterisk (*) entry
An asterisk (*) entry	An asterisk (*) entry

When the **chg-scr-sio** command is entered with the **nh0** or **nh1** parameters, the specified values must be valid with the **h0** or **h1** values currently in the database.

If the screening reference exists, the **nic**, **si**, **h0/h1**, and priorities to be added to the allowed SIO entity set for the SIO screening reference cannot exist in that allowed SIO entity set.

If asterisks or ranges are specified for the heading codes, nothing that matches the combination of **nic**, **si**, and the specified heading codes can already exist in the allowed SIO entity set for the screening reference.

If the screening reference does not exist, a new screening reference for the allowed SIO entity set is created.

The **nsfi** and the **nsr** values to be added must point to one or more existing entities in another entity set or the **nsfi** parameter to be added must be equal to **stop** and the **nsr** to be added cannot be specified.

Use Table 6-12 to determine an acceptable combination of the **nsfi** and **si** parameters:

Table 6-12. Valid ent-scr-sio **nsfi** and **si** Parameter Combinations

If the nsfi parameter is...	...the si parameter must be:
destfl	00
cdpa	03
cgpa	03
isup	05

Use Table 6-13 to determine the acceptable combination of the specified parameter values:

Table 6-13. Additional Valid **ent-scr-sio** Parameter Combinations

si value:	nic value	pri value	h0 value:	h1 value:
00	s, *	s, *, r	s	s, *, r
00	s, *	s, *, r	*, r	*
01, 02	s, *	s, *, r	s	s, *, r
01, 02	s, *	s, *, r	*, r	*
03-15	s, *	s, *, r	u	u
<p>Legend s = single value r = range * = asterisk u = unspecified</p>				

Notes

A range of values is specified by separating the values that define the range by two ampersands (&&); for example, **pri=0&&2** specifies all message priorities for the range 0 to 2.

If the screen set reaches 100% capacity (indicated by the **100% Full** message), the system will allow subsequent entries. An error will occur, however, when downloading the screen set to a LIM. Screen sets should not exceed 100% capacity. Remove screen set entries until the capacity is below 100%.

To use TUP message type screening, an SIO screening reference with **si=04** (TUP) must be defined in the SIO table. To use ISUP message type screening, a rule with **si=05** (ISUP) must be defined in the SIO table. To use a combined ISUP/TUP screen set for TUP and ISUP message screening, the SIO screening reference with **si=4** and the SIO screening reference with **si=5** must be two different screening references.

The **h0** and **h1** parameters cannot be specified if **si** is not equal to **00**, **01**, or **02**.

An asterisk cannot not be specified for a parameter value in this command unless an asterisk was specified for the parameter value in the original **ent-scr-sio** command.

Output

```
ent-scr-sio:sr=iec:nic=1:si=1:h0=01&&03:h1=*:pri=*.nsfi=dpc:nsr=abc
rlghncxa03w 04-02-14 16:45:50 EST EAGLE 31.3.0
ENT-SCR-SIO: SCREEN SET AFFECTED - SS01 25% FULL
ENT-SCR-SIO: SCREEN SET AFFECTED - SS04 35% FULL
ENT-SCR-SIO: MASP A - COMPLTD
;
```

Legend

ENT-SCR-SIO—The command entered that caused this output. This is echoed to the printer as a reference.

SCREEN SET AFFECTED - SS01—Identifies the screen set that was affected by the command. The screen set name is provided.

25% FULL—Indicates the relative size of the screen set.

ent-scr-tt**Enter Allowed Translation Type**

Use this command to add a specific allowed translation type (TT) screening reference in the TT entity set.

Keyword: ent-scr-tt

Related Commands: chg-scr-tt, dlt-scr-tt, rtrv-scr-tt

Command Class: Database Administration

Parameters

:nsfi= (mandatory)

This parameter specifies the next screening category that is used in the gateway screening process, or it indicates that the gateway screening process should stop.

Range: cdpa, stop

cdpa—Allowed CDPA is the next screening category.

stop—The gateway screening process ends and the message proceeds through normal routing.

:sr= (mandatory)

Name of the screening reference.

Range: 1 alphabetic character followed by up to 3 alphanumeric characters

:type= (mandatory)

Translation type. The translation type identifies the global title translation type value in the called party address. It is the decimal representation of the 1-byte field used in SS7. A single value or a range of values can be specified. An asterisk (*) indicates the full range of values from 0–255.

Range: 000–255, *

:actname= (optional)

The name of the gateway screening stop action set. Stop actions must be administered using the **actname** parameter in conjunction with the gateway screening stop action table (see **chg-gws-actset** and **rtrv-gws-actset**).

Range: 1 alphabetic character followed by up to 5 alphanumeric characters.

:nsr= (optional)

Next screening reference (nsr). The parameter indicates which screening reference in the specified screening category (**nsfi**) is to be used in the screening process. This parameter is mandatory if **nsfi** is other than **stop**. The **nsr** parameter cannot be entered if **nsfi** is **stop**. If **nsfi=stop**, the **nsr** parameter cannot be specified.

Range: 1 alphabetic character followed by up to 3 alphanumeric characters

Default: No value given

Example

```
ent-scr-tt:sr=iec:type=012:nsfi=cdpa:nsr=wrds
```

```
ent-scr-tt:sr=iec:type=012:nsfi=stop:actname=copy
```

Dependencies



CAUTION: Even though gateway screening is in the screen test mode, as defined by the parameters `gwsa=off` and `gwsn=on`, the gateway screening action in the stop action set specified by the `actname` parameter of the screen set *will* be performed at the end of the screening process.

If the screening reference is valid, but does not exist, a new TT screen is created.

If the screening reference exists, a new rule is added to the TT screening table.

An asterisk cannot not be specified for a parameter value in this command unless an asterisk was specified for the parameter value in the original `ent-scr-tt` command.

If the `actname` parameter is specified, the `nsfi-stop` parameter must be specified.

The value of the `actname` parameter must already be defined in the Gateway Screening Stop Action table with the `chg-gws-actset` command. These values are shown in the `ACT NAME` field of the `rtrv-gws-actset` command output.

If the `nsfi=stop` parameter is specified, the `nsr` parameter cannot be specified.

If the `nsfi` parameter has a value other than `stop`, the `nsr` parameter must be specified.

If the `nsr` parameter is specified, the specified screening reference must exist.

If the screening reference(`sr`) exists, the single value or range specified for the allowed `type` to be added to the TT screen for the allowed TT screening reference must not already exist in that TT screen.

If an asterisk is specified for the allowed `type`, nothing can already exist in the TT screen for the screening reference.

Notes

If the screen set reaches 100% capacity (indicated by the 100% Full message), the system will allow subsequent entries. An error will occur, however, when downloading the screen set to a LIM. Screen sets should not exceed 100% capacity. Remove screen set entries until the capacity is below 100%.

Output

```
ent-scr-tt:sr=iec:type=012:nsfi=cdpa:nsr=wrds
```

```
rlghncxa03w 04-01-07 11:43:04 EST EAGLE 31.3.0
ENT-SCR-TT: SCREEN SET AFFECTED - IEC 25% FULL
ENT-SCR-TT: MASP A - COMPLTD
```

```
;
```

Legend

ENT-SCR-TT—The command entered that caused this output. This is echoed to the printer as a reference.

SCREEN SET AFFECTED - IEC—Identifies the screen set that was affected by the command. The screen set name is provided.

25% FULL—Indicates the relative size of the screen set.

ent-scrset**Enter Screen Set**

Use this command to create a new screen set and point it to its first screen. A screen set is a set of screens (filters) that can be assigned to a linkset. SS7 messages transmitted on a linkset assigned to a screen set require screening by the system, if screening is enabled.

Keyword: ent-scrset

Related Commands: chg-scrset, dlt-scrset, rtrv-scrset

Command Class: Database Administration

Parameters

:nsfi= (mandatory)

This parameter specifies the next screening category that is used in the gateway screening process, or it indicates that the gateway screening process should stop.

Range: blkdpc, blkopc, dpc, opc, sio, stop

blkdpc—Blocked DPC is the next screening category.

blkopc—Blocked OPC is the next screening category.

dpc—Allowed DPC is the next screening category.

opc—Allowed OPC is the next screening category.

sio—Allowed SIO is the next screening category.

stop—The gateway screening process ends and the message proceeds through normal routing.

:scrn= (mandatory)

Screen set name.

Range: 1 alphabetic character followed by up to 3 alphanumeric characters

:actname= (optional)

The name of the gateway screening stop action set. Stop actions must be administered using the **actname** parameter in conjunction with the gateway screening stop action table (see **chg-gws-actset** and **rtrv-gws-actset**).

Range: 1 alphabetic character followed by up to 5 alphanumeric characters.

:destfld= (optional)

This parameter turns on and off the automatic allowed affected destination screening for network management messages against the routing table, self point codes, and capability point codes. When this parameter is **on**, the automatic screening is applied at the end of the provisioned screen set.

Range: yes, no

Default: yes

:nsr= (optional)

Next screening reference (**nsr**). The parameter indicates which screening reference in the specified screening category (**nsfi**) is to be used in the screening process. If **nsfi=stop**, the **nsr** parameter cannot be specified.

Range: 1 alphabetic character followed by up to 3 alphanumeric characters

Default: No value given

Example

```
ent-scrset:scrn=ss01:nsfi=opc:nsr=iec
```

```
ent-scrset:scrn=ss02:nsfi=stop
```

```
ent-scrset:scrn=empt:nsfi=stop:destfld=yes
```

```
ent-scrset:scrn=scr1:nsfi=stop:actname=copy
```

Dependencies



CAUTION: Even though gateway screening is in the screen test mode, as defined by the parameters **gwsa=off** and **gws=on**, the gateway screening action in the stop action set specified by the **actname** parameter of the screen set *will* be performed at the end of the screening process.

The **actname** parameter can be specified only when the **nsfi=stop** parameter is specified.

The value of the **actname** parameter must already be defined in the Gateway Screening Stop Action table with the **chg-gws-actset** command. These values are shown in the **ACT NAME** field of the **rtrv-gws-actset** command output.

The **nsr** parameter is required if **nsfi** does not equal **stop**. The **nsr** parameter cannot be entered if **stop** is specified.

The specified screen set name cannot be in use by another screen set.

A maximum of 63 user-defined screen sets can be defined in the database.

The next screening function identifier and the next screening reference to be added must point to one or more existing entities in another entity set. If this is not the case, the next screening function identifier added must equal **stop** and the next screening reference added cannot be specified.

Notes

Entering a new screen set may take a few minutes of processor time. The following message appears in the scroll area:

```
Extended processing time required-please wait
```

If the screen set reaches 100% capacity (indicated by the 100% Full message), the system will allow subsequent entries. An error will occur, however, when downloading the screen set to a LIM. Screen sets should not exceed 100% capacity. Remove screen set entries until the capacity is below 100%.

Output

```
ent-scrset:scrn=ss01:nsfi=opc:nsr=iec
r1ghncxa03w 04-01-07 11:43:04 EST EAGLE 31.3.0
ENT-SCRSET: SCREEN SET AFFECTED - SS01 25% FULL
ENT-SCRSET: MASP A - COMPLTD
;
```

Legend

ENT-SCRSET—The command entered that caused this output. This is echoed to the printer as a reference.

SCREEN SET AFFECTED - SS01—Identifies the screen set that was affected by the command. The screen set name is provided.

25% FULL—Indicates the relative size of the screen set.

ent-serial-num

Enter Serial Number

Use this command to enter the NT serial number into the database for an EAGLE STP IP7 Secure Gateway system.

You must enter the serial number at least once without specifying the **lock** parameter. As long as you enter the command without the **lock** parameter, you can enter the system serial number as many times as needed. After the correct serial number is entered, you must use the **lock=yes** parameter to lock the serial number table. You cannot change the serial number with administration commands after the table is locked.

Keyword: ent-serial-num

Related Commands: rtrv-serial-num

Command Class: Database Administration

Parameters

:serial= (mandatory)

The system NT Serial Number.

Range: Up to 15 alphanumeric characters; mixed case is allowed.

The first two characters (the prefix) must be letters.

The remaining characters must be numbers.

The serial number cannot contain spaces or special characters.

:lock= (optional)

This parameter is used to lock the Serial Number table when the serial number is entered for the system.



CAUTION: After the serial number is locked, you cannot enter it again or change it in the database. You can use the command without the lock parameter to enter the serial number as many times as needed; then enter the command with the lock parameter and the correct serial number to lock the serial number table.

Range: yes

Default: Not locked

Example

```
ent-serial-num:serial=nt00000123
ent-serial-num:serial=nt00000123:lock=yes
```

Dependencies

The serial number must be entered at least once without specifying the **lock** parameter.

The system serial number that is entered when the **lock** parameter is specified must match the serial number that was previously entered in the Serial Number table by using the command without the **lock** parameter.

The system serial number cannot be entered again after the Serial Number table is locked.

Notes

None

Output

```
ent-serial-num:serial=nt00000123
rlghncxa03w 04-01-05 16:40:40 EST EAGLE 31.3.0
ENT-SERIAL-NUM: MASP A - COMPLTD
;
```

ent-shlf**Enter Shelf**

Use this command to add an equipment shelf to the database.

Keyword: ent-shlf

Related Commands: dlt-shlf, rtrv-shlf

Command Class: Database Administration

Parameters

:loc= (mandatory)

The shelf location.

Range: 1200, 1300, 2100, 2200, 2300, 3100, 3200, 3300, 4100, 4200, 4300, 5100, 5200, 5300, 6100

:type= (mandatory)

The type of equipment shelf to be configured.

Range: ext

Example

```
ent-shlf:type=ext:loc=1200
```

Dependencies

The frame and shelf values of the shelf location parameter (**loc**) must be within the valid range (xyzz, where x=frame and y=shelf; zz is always 00 for this command).

The specified shelf location must not have been configured previously.

Notes

None

Output

```

ent-shlf:type=ext:loc=1200
    rlgncxa03w 04-01-07 11:11:28 EST EAGLE 31.3.0
    ENT-SHLF: MASP A - COMPLTD
;

```

ent-sid**Enter Self Identification**

Use this command to define additional true point codes for an STP. This command allows newly defined true point codes to be distributed to the cards without requiring system initialization.

Keyword: ent-sid

Related Commands: chg-sid, rtrv-sid

Command Class: Database Administration

Parameters

:pc/pca/pci/pcn/pcn24= (optional)
STP true point code.

:pc= or :pca= (optional)
ANSI point code with subfields *network indicator-network cluster-network cluster member* (*ni-nc-ncm*).

Range: **000-255**
Specify a valid value for each subfield of the point code, and separate the subfields with a dash (-).
When **chg-sid:pctype=ansi** is specified, *ni* = **000** is not valid.
When **chg-sid:pctype=ansi** is specified, *nc* = **000** is not valid if *ni* = **001-005**.
When **chg-sid:pctype=ansi** is specified, *nc* = **000** is valid if *ni* = **006-255**.
The point code **000-000-000** is not a valid point code.

:pci= (optional)
ITU international point code with subfields *zone-area-id*. The *prefix* subfield indicates a spare point code (*prefix-zone-area-id*).

Range: **s-, 0-255**
Specify a valid value for each subfield of the point code, and separate the subfields with a dash (-).
The point code **0-000-0** is not a valid point code.
prefix—s-
zone—0-7
area—000-255
id—0-7

:pcn= (optional)

ITU national point code in the format of a 5-digit number (*nnnnn*); or 2, 3, or 4 numbers (members) separated by dashes (*m1-m2-m3-m4*) as defined by the **chg-stpopts:npcfinti** flexible point code option. A group code must be specified when the ITUDUPPC feature is turned on (*nnnnn-gc*, *m1-m2-m3-m4-gc*). The *prefix* subfield indicates a spare point code (*prefix-nnnnn*, *prefix-nnnnn-gc*, *prefix-m1-m2-m3-m4*, *prefix-m1-m2-m3-m4-gc*).

Range: **s-**, **0-16383**, **aa-zz**

Specify a valid value for each subfield of the point code, and separate the subfields with a dash (-).

prefix—**s-**

nnnnn—**0-16383**

gc—**aa - zz**

m1-m2-m3-m4—**0-14** for each member; values must sum to 14

:pcn24= (optional)

24-bit ITU national point code with subfields *main signaling area-sub signaling area-signaling point* (*msa-ssa-sp*).

Range: **000-255**

Specify a valid value for each subfield of the point code, and separate the subfields with a dash (-).

msa—**000-255**

ssa—**000-255**

sp—**000-255**

Example

To create a site identification STP Point Code for ITU-N and ITU-I:

ent-sid:pcn=123:pci=1-1-1

To create a site identification STP Point Code for ITU-N Spare and ITU-I Spare:

ent-sid:pcn=s-123:pci=s-1-1-1

Dependencies

At least one optional parameter must be specified.

The Spare Point Code Support feature must be enabled before an ITU-I or ITU-N spare point code can be specified.

If the system is configured for ANSI format point codes, the specified network indicator value (*ni*) of the **pc** parameter must be **6** or greater when the specified cluster value is **0** (*nc*).

Only the **pcn** parameter or the **pcn24** parameter can be specified in a command; both parameters cannot be specified in the same command.

The specified STP point code must not have been previously defined as a capability point code.

An STP point code cannot exist that is the same type (ANSI, ITU-I, ITU-N, ITU-N24, ITU-ISpare, or ITU-NSpare) as the specified STP point code.

The STP point code can be specified only as a full point code.

ITU-N STP destination point codes can be specified only as full point codes.

Notes

The SID Table can simultaneously contain the node's true point codes of any following point code types: ANSI, ITU-I, ITU-N or ITU-N24, ITU-ISpare, and ITU-NSpare. (Only ITU-N or ITU-N24, not both, can be defined in the SID Table).

In this command, only ITU-international and ITU national point codes support the spare point code subtype prefix (s-).

Output

```
ent-sid:pcn=123:pci=1-1-1
  rlgncxa03w 05-01-07 11:11:28 EST EAGLE 31.12.0
  ENT-SID: MASP A - COMPLTD
;
```

ent-slk

Enter Signaling Link

Use this command to add a low-speed or high-speed (ATM or IP) signaling link to a linkset in the database.

For 2-port E1 cards, E1/T1 MIM cards, HC-MIM cards, or Channel cards, use this command to associate a signaling link and a timeslot with the E1 or T1 interface on an E1 card or T1 card that will service the timeslot.

For HC-MIM cards used for SE-HSL links, use this command to assign links **a** and **b** on any 2 of the 8 HC-MIM card ports.

Signaling links are the only elements in the database directly supported by a hardware device. When a link is added to a linkset, the link remains in the state OOS-MT-DSBLD (out of service maintenance disabled) until it is activated.

Up to 64 signaling links can be assigned to one HC-MIM card, allowing links **a**, **a1** through **a31**, **b**, and **b1** through **b31** to be provisioned.

NOTE: The link parameter has been added as a synonym for the port parameter. Either port or link can be used for a few more EAGLE 5 SAS releases; then the port parameter will be removed.

Keyword: ent-slk

Related Commands: act-slk, blk-slk, canc-slk, dact-slk, dlt-slk, inh-slk, rept-stat-slk, rtrv-slk, tst-slk, ublk-slk, unhb-slk

Command Class: Database Administration

Parameters

:loc= (mandatory)

The card location as stenciled on the shelf of the system.

If the signaling link is being assigned to an E1 or T1 card for a Channel card, specify the location of the Channel card. If the link is being assigned for the E1 or T1 card itself, specify the location of the E1 or T1 card.

Range: 1101–1108, 1111–1112, 1201–1208, 1211–1218, 1301–1308, 1311–1318, 2101–2108, 2111–2118, 2201–2208, 2211–2218, 2301–2308, 2311–2318, 3101–3108, 3111–3118, 3201–3208, 3211–3218, 3301–3308, 3311–3318, 4101–4108, 4111–4118, 4201–4208, 4211–4218, 4301–4308, 4311–4318, 5101–5108, 5111–5118, 5201–5208, 5211–5218, 5301–5308, 5311–5318, 6101–6108, 6111–6118

:lsn= (mandatory)

The name of the linkset. The linkset name must be unique.

Range: 1 alphabetic character followed by up to 9 alphanumeric characters

:port= or **:link=** (mandatory)

The signaling link on the card specified in the **loc** parameter. The links can be specified in any sequence or pattern.

Range: a, b, a1-a31, b1-b31

Not all card types support all **link** parameter values.

See Table A-1 in Appendix A for valid **link** parameter range values for each type of card that can have a location specified in the **loc** parameter.

:slc= (mandatory)

The signaling link code.

The SLC must be unique within the linkset. It must be the same at both the system location and the distant node.

Range: 0–15

:bps= (optional)

The transmission rate for the link in bits per second. E1 links running at 56000 bps and 64000 bps are allowed in linksets with other links running at 56000 bps or 64000 bps, or both, in the same linkset. T1 links running at 56000 bps or 64000 bps are allowed in linksets with other links that are running at 56000 bps or 64000 bps, or both. All other types of links in one linkset are required to have the same *provisioned* link speed. See Table 6-15 on page 6-346.

Range: 4800, 9600, 19200, 56000, 64000, 1544000, 1984000, 2048000

Default: 36000

:ecm= (optional)

Error correction method.

Range: basic, pcr

Default: basic

:ipliml2= (optional) ^{IP Only}

IPLIM level 2 stack.

Range: saaltali, m2pa

Default: m2pa

:l1mode= (optional) ^{LSL Only}

The mode of operation used to select the link clocking source at layer 1. One end of a V.35 link must be DTE and the other end must be DCE.

Range: dte, dce

Default: dte

:l2tset= (optional) ^{LSL, E1, T1, SE-HSL}

Level 2 timer set. A signaling link can be assigned to any of the thirty timer sets.

Range: 1-10 for ANSI low speed links
 11-20 for ITU low speed links
 21-25 for ITUN China high speed links
 26-30 for ITUN Q703.A high speed links

Default: 1 for ANSI low speed links
 11 for ITU low speed links
 21 for ITUN China high speed links (SE-HSL link in a linkset defined with the **apctype=ituchina** parameter)
 26 for ITUN Q703.A high speed links (SE-HSL link in a linkset defined with the **apctype=itun** parameter)

:pcrn1= (optional) ^{LS, E1, T1}

The threshold of the number of MSUs available for retransmission. If the error correction method being used is PCR and this threshold is reached, no new MSUs or FISUs are sent. The retransmission cycle is continued up to the last MSU entered into the retransmission buffer in the order in which they were originally transmitted.

Range: 1-127

Default: 76

:pcrn2= (optional) ^{LSL, E1, T1}

The threshold of the number of MSU octets available for retransmission. If the error correction method being used is PCR, and this threshold is reached, no new MSUs or FISUs are sent. The retransmission cycle is continued up to the last MSU entered into the retransmission buffer in the order in which they were originally transmitted.

Range: 300-35500

Default: 3800

:tset= (optional) ^{LSL Only}

Transmitter signal element timing.

Range: on, off

Default: off

The parameters that follow (**e1loc**, **e1port**, and **ts**) are allowed only when entering a signaling link for an E1 card (2-port E1 or E1/T1 MIM or HC-MIM) or Channel card. Only the **e1port** parameter is allowed for SE-HSL cards. All ATM and E1 ATM high speed link parameters (**atmtsel**, **e1atmcrc4**, **e1atmsn**, **e1atmsi**, **l1mode**, **l2set**, **ll**, **tset**, **vci**, and **vpi**) are not valid when entering E1 link parameters.

:e1loc= (optional) ^{E1 Only}

Card location of an E1 card with an E1 interface that will service the link assigned for a Channel card. This parameter cannot be specified for an HC-MIM card.

Range: 1101-1108, 1111-1112, 1201-1208, 1211-1218, 1301-1308, 1311-1318, 2101-2108, 2111-2118, 2201-2208, 2211-2218, 2301-2308, 2311-2318, 3101-3108, 3111-3118, 3201-3208, 3211-3218, 3301-3308, 3311-3318, 4101-4108, 4111-4118, 4201-4208, 4211-4218, 4301-4308, 4311-4318, 5101-5108, 5111-5118, 5201-5208, 5211-5218, 5301-5308, 5311-5318, 6101-6108, 6111-6118

:e1port= (optional) ^{E1, SE-HSL}

The port for the E1 interface on the E1 card to which a signaling link and timeslot are being assigned, or to which an SE-HSL link is being assigned.

Range: 1, 8

Ports 3 through 8 can be specified only for HC-MIM cards.

Any 2, but no more than 2, of the 8 ports on an HC-MIM card can be specified when the card is used as an SE-HSL card.

Default: 1

:ts= (optional) ^{E1, T1}

E1 timeslot for the assigned signaling link.

Range: 1-31

The parameters that follow (**t1loc**, **t1port**, and **ts**) are allowed only when entering a signaling link for an E1/T1 MIM card used as a T1 card or Channel card, or for an HC MIM card used as a T1 card. All ATM and E1 ATM high speed link parameters (**atmtsel**, **e1atmcr4**, **e1atmsn**, **e1atmsi**, **l1mode**, **l2set**, **ll**, **tset**, **vci**, and **vpi**) are not valid when entering T1 parameters.

:t1loc= (optional) ^{T1 Only}

Card location of a T1 card with a T1 interface that will service the signaling link assigned for a Channel card. This parameter cannot be specified for an HC-MIM card.

Range: 1101-1108, 1111-1112, 1201-1208, 1211-1218, 1301-1308, 1311-1318, 2101-2108, 2111-2118, 2201-2208, 2211-2218, 2301-2308, 2311-2318, 3101-3108, 3111-3118, 3201-3208, 3211-3218, 3301-3308, 3311-3318, 4101-4108, 4111-4118, 4201-4208, 4211-4218, 4301-4308, 4311-4318, 5101-5108, 5111-5118, 5201-5208, 5211-5218, 5301-5308, 5311-5318, 6101-6108, 6111-6118

:t1port= (optional) ^{T1 Only}

The port for the T1 interface on the T1 card to which a signaling link and timeslot are being assigned.

Range: 1, 8

Ports 3 through 8 can be specified only for HC-MIM cards.

Default: 1

:ts= (optional) ^{E1, T1}

T1 timeslot for the assigned signaling link.

Range: 1-24

The parameters that follow (**atmtse1**, **ll**, **lpset**, **vci**, and **vpi**) are allowed only when the signaling link is an ATM high-speed link. When entering an ATM high-speed link, the low-speed link parameters (**ecm**, **l1mode**, **l2set**, **pcrn1**, **pcrn2**, and **tset**), the parameters for E1 and T1 links (**e1loc**, **e1port**, **ts**, **t1loc**, and **t1port**), and the parameters for E1 ATM high speed links (**crc4**, **e1atm**, **e1atmsn**, **e1atmsi**) are not allowed.

:atmtsel= (optional) ^{ATM (ANSI and E1 ATM)}

ATM timing selector. The timing source for the ATM signaling link—internal, line, or external. Internal timing is derived from an internal clock source operating at 1.544 MHz ± 200 Hz for ANSI links and 2.048 MHz ± 103 Hz for ITU links. External timing is derived from the High-Speed Master Clock (T1 or E1). Line timing is derived from its received data stream, if present.

Range: external, internal, line

CAUTION: The internal timing source is used for debug purposes only, and is not to be used for production operation.



Default: line

NOTE: If you are using the 2.048 MHz reference clock as the timing source for E1 signaling links, the `atmtsel=external` parameter must be specified for high-speed ATM signaling links. The `atmtsel` parameter is not valid in the command when the `e1loc` or `e1port` parameter is specified for an E1 signaling link. For information on the E1 interface, see Appendix D, “E1 Interface” in the *Database Administration Manual -SS7*.

`:ll=` (optional) ATM (ANSI Only)

ATM line length. Use Table 6-14 to select a value for the `ll` parameter:

Table 6-14. Values for the `ll` Parameter

Value	Cable Length (in feet)
0	0–110
1	110–220
2	220–330
3	330–440
4	440–550
5	550–660
6	More than 660 ft.
7	Allows use of external line buildout networks

Range: 0-7

Default: 0

`:lpset=` (optional) ATM (ANSI and E1 ATM)

Link parameter set identifier.

Range: 1-30

Default: 1—for ANSI

21—for ITU

`:vci=` (optional) ATM (ANSI and E1 ATM)

Virtual channel identifier.

Range: 5, 32–65535

0–4 and 6–31 are reserved values; they cannot be specified in the command.

Default: 5

`:vpi=` (optional) ATM (ANSI and E1 ATM)

Virtual path identifier.

Range: 0-4095

Default: 0

The following parameters (`e1atmcr4`, `e1atmsi`, `e1atmsn`) are allowed only when the signaling link is of type E1 ATM. When entering an E1 ATM high-speed link, the ATM high speed link parameters specific to the `atmansi` application except the `ll` parameter are allowed. The low-speed link parameters (`ecm`, `l1mode`, `l2tset`, `pcrn1`, `pcrn2`, and `tset`) and the parameters for E1 and T1 links (`e1loc`, `e1port`, `ts`, `t1loc`, and `t1port`) are not allowed.

:e1atmcr4= (optional) ^{E1 ATM Only}
CRC4 multi-frame structure enable/disable indicator.

Range: on, off

Default: on

:e1atmsi= (optional) ^{E1 ATM Only}
Value of two Spare International bits of NFAS data.

Range: 0-3

Default: 3

:e1atmsn= (optional) ^{E1 ATM Only}
Value of five Spare National bits of NFAS data.

Range: 0-31

Default: 0

Example

ent-slk:loc=1201:link=a:slc=3:lsn=c1201001:l2tset=3:l1mode=dte:bps=64000:ecm=basic

ent-slk:loc=1201:link=a:slc=3:lsn=c1201001:l2tset=3:ecm=pcr:pcrn1=50:pcrn2=4000

ent-slk:loc=1302:link=a:slc=5:lsn=atm1302a:lpset=3:vci=10:vpi=15
:ll=0:atmtsel=internal

ent-slk:loc=1302:link=a:slc=5:lsn=atm1302a:lpset=3:vci=10:vpi=15
:ll=0:atmtsel=external

The following example adds a link to linkset **ls1** at 56 KB for a multi-port LIM:

ent-slk:loc=1205:link=a1:slc=0:lsn=ls1

The following example assigns a timeslot for the signaling link on an E1 card that uses E1 port 1.

ent-slk:loc=1206:link=a:slc=0:lsn=e1jwk:ts=1

The following example assigns a timeslot for a signaling link on an E1 card that uses E1 port 2.

ent-slk:loc=1205:link=b:slc=0:lsn=e1typ:ts=1:e1port=2

The following example assigns a timeslot for a signaling link on a Channel card in the location specified by the **loc** parameter. The Channel card is serviced by the E1 assigned to the E1 card in the location specified by the **e1loc** parameter.

ent-slk:loc=1206:link=a:slc=0:lsn=e1jwk:ts=2:e1loc=1205

The following example adds a timeslot for a signaling link on an E1/T1 MIM card using E1 port 2 and signaling link **b2**.

ent-slk:loc=1205:link=b2:slc=0:lsn=e1typ:ts=1:e1port=2

The following example adds a timeslot for a signaling link on an E1/T1 MIM card used as an E1 Channel card in card location **1206**. The command specifies signaling link port **a1**. The E1 interface that services the Channel card is on the E1 card in card location **1205** (**e1loc** parameter).

ent-slk:loc=1206:link=a1:slc=1:lsn=e1jwk:ts=2:e1loc=1205

The following example adds a timeslot for a signaling link on an E1/T1 MIM card using signaling link **a2**. The T1 interface defaults to the interface defined for T1 port 1 (**t1port** parameter not specified)

```
ent-slk:loc=1207:link=a2:slc=0:lsn=t1jwk:bps=64000:ts=1
```

The following example adds a timeslot for a signaling link on an E1/T1 MIM card using T1 port 2 and signaling link **b2**.

```
ent-slk:loc=1207:link=b2:slc=0:lsn=t1typ:ts=1:t1port=2
```

The following example adds a timeslot for a signaling link on an E1/T1 MIM card used as an T1 Channel card in card location 1208. The command specifies signaling link **a1**. The T1 interface that services the Channel card is on the T1 card in card location 1207 (**t1loc** parameter).

```
ent-slk:loc=1208:link=a3:slc=1:lsn=t1jwk:bps=64000:ts=2:t1loc=1207
```

The following example adds a signaling link to linkset **ls1** at 2048000 bps for an E1 ATM card that will use the CRC4 multi-frame structure

```
ent-slk:loc=1205:link=a:slc=0:lsn=ls1:bps=2048000:atmsel=line:e1atmcrc4=on
```

The following example adds a signaling link to link set **e1e2a** using the SAALTALI Level 2 stack.

```
ent-slk:loc=1301:link=a:lsn=e1e2a:slc=0:ipliml2=saaltali
```

The following example adds a link to link set **ls1** at 56 Kbps for an HC-MIM card that is provisioned as an E1 card:

```
ent-slk:loc=1205:link=a31:slc=0:lsn=ls1:e1port=4:ts=4
```

The following example adds a link to link set **l21** at 64 Kbps for an HC-MIM card that is provisioned as a T1 card:

```
ent-slk:loc=1207:link=b27:slc=3:lsn=ls2:t1port=8:ts=6:bps=64000
```

Dependencies

The slot portion of the specified card location (**loc**) can be **1** through **8** and **11** through **18**. Slots **09** and **10** cannot be specified. (The card location is *xyss*, where *x* is the frame, *y* is the shelf, and *ss* is the slot).

Card locations **1113** through **1118** cannot be specified.

The frame and shelf portions of the specified card location (**loc**) can be **11** through **13**, **21** through **23**; **31** through **33**; **41** through **43**; **51** through **53**; and **61**. (The card location is *xyss*, where *x* is the frame, *y* is the shelf, and *ss* is the slot).

The **pcrn1** parameter and the **pcrn2** parameter can be specified for **ss7ansi** and **ccs7itu** applications only when the **ecm=pcr** parameter is specified.

Use Table 6-15 to select a valid transmission rate for the **bps** parameter.

Table 6-15. Transmission Rate for the **bps** Parameter

Card Application	bps Transmission Rate	Domain
ss7ansi	56000 or 64000	SS7
ss7gx25	4800, 9600, 19200, 56000, or 64000	X.25

Table 6-15. Transmission Rate for the **bps** Parameter

Card Application	bps Transmission Rate	Domain
ccs7itu	56000 or 64000	SS7
atmansi	1544000	SS7
ss7ansi, ccs7itu (SE-HSL cards)	1984000	SS7
atmitu	2048000	SS7

The value of the **bps** parameter must be **56000** or **64000** if the card application is **ss7ansi** or **ccs7itu** (except for SE-HSL cards, for which the **bps** parameter must be **1984000**).

The value of the **bps** parameter must be **56000** if the card type is either **limds0** or **limocu**.

The value of the **bps** parameter must be **1544000** if the card application is **atmansi**.

The value of the **bps** parameter can be **1544000** only if the card application is **atmansi**.

The value of the **bps** parameter must be **56000** if the card is a multi-port LIM.

The value of the **bps** parameter must be **2048000** if the card type is **lime1atm**.

The value of the **bps** parameter can be **2048000** only if the card application is **atmitu**.

The value of the **bps** parameter must be **1984000** if the card is an HC-MIM card used for SE-HSL links (**linkclass=unchan** is specified in the E1 interface definition).

E1 links running at 56000 bps and 64000 bps are allowed in linksets with other links running at 56000 bps and 64000 bps in the same linkset. T1 links running at 56000 bps and 64000 bps are allowed in linksets with other links that are running at 56000 bps and 64000 bps links in the same linkset. In linksets that contain other types of links, all links in one linkset must use the same transmission rate.

The values **0** through **4** and **6** through **31** cannot be specified for the **vci** parameter; these values are reserved system values.

The linkset adjacent point code (APC) type must be the same as the card application type (ANSI or ITU).

The specified linkset name must exist in the database.

The value that is specified for the **slc** parameter cannot be in use for the specified linkset.

A card must be equipped in the specified card location.

The card in the specified card location must be a LIM or MIM and must exist.

The link that is specified in the **link** parameter must not already be assigned.

The parameters that are specified for the command must be valid for the type of card in the specified card location.

When a low-speed link is assigned to a card (card application is not **atmansi** or **atmitu**), the ATM high-speed link and E1 ATM parameters (**atmtsel**, **e1atmcr4**, **etatmsi**, **e1atmsn**, **ll**, **lpset**, **vci**, and **vpi**) cannot be specified.

When an ATM high-speed link is assigned to a card (card application is **atmansi**), the low-speed link parameters (**ecm**, **l1mode**, **l2set**, **pcrn1**, **pcrn2**, and **tset**) cannot be specified.

When an E1 ATM high-speed link is assigned to a card (card application is **atmitu**), the low-speed link parameters (**ecm**, **l1mode**, **l2tset**, **pcrn1**, **pcrn2**, and **tset**) cannot be specified.

When an IP link is assigned to a card (card application is **ss7ipgw**, **ipgwi**, **iplim**, or **iplimi**), the following low-speed link parameters, ATM high-speed link parameters, and E1 ATM high-speed link parameters cannot be specified: **lpset**, **vci**, **vpi**, **ll**, **atmtsel**, **e1atmcr4**, **e1atmsi**, **e1atmsn**, **ecm**, **l1mode**, **l2tset**, **pcrn1**, **pcrn2**, and **tset**.

If the card application is **ss7gx25**, the **l2tset** parameter cannot be specified.

The **link** parameter values **a1**, **b1**, **a2**, **b2**, **a3**, and **b3** can be specified only for the following cards:

- A multi-port LIM card and the card type is **limds0** (as specified with the **ent-card** command)
- An SSEDCCM card that runs the **iplim** or **iplimi** application, that supports 8 point-to-point links, and that has an **ipliml2** parameter value of **saaltali** or **m2pa**.
- An E1/T1 MIM card and the card type is **lime1**, **limt1**, or **limch** (as specified with the **ent-card** command)
- An HC-MIM card that is used as an E1 or T1 card and the card type is **lime1** or **limt1** (as specified with the **ent-card** command)

The **link** parameter values **a1**, **b1**, **a2**, **b2**, **a3**, and **b3** can be specified only when:

- The card type is **limds0** and the card application is **ss7ansi**.
- The card is an SSEDCCM and the card application is **iplim** or **iplimi**.
- The card type is **lime1**, **limt1**, or **limch** (and the card is not an SE-HSL card) and the card application is **ss7ansi** or **ccs7itu**.

The **link** parameter values **a4-a31** and **b4-b31** can be specified only when the card type is **lime1** or **limt1** for an HC-MIM card that is used as an E1 or T1 card and the card application is **ss7ansi** or **ccs7itu**. The **link** parameter values **a4-a31** and **b4-b31** cannot be specified for a Channel card or for an SE-HSL card.

HIPR cards must be in card locations **xy09** and **xy10** on any shelf that contains one or more HC-MIM cards. When **link** parameter values **a4-a31** and **b4-b31** are specified, the system verifies that HIPR cards are in card locations **xy09** and **xy10** on the same shelf with the specified HC-MIM card.

Links **a4-a31** and **b4-b31** cannot be specified for even-numbered card locations. HC-MIM cards are dual-slot cards. The links are assigned only to the cards in odd-numbered locations.

If the card application is **ss7gx25**, only **link=a** can be specified.

If the card application is **ss7gx25**, the **l2tset** parameter cannot be specified.

If the card application is **ss7ipgw** or **ipgwi**, only **link=a** can be specified.

The **tset** parameter can be specified only when the **l1mode=dce** parameter is specified. When the **l1mode=dce** parameter is specified and the **tset** parameter is not specified, the **tset** parameter value is set to **off**.

If the card is an HC-MIM used for SE-HSL links, only **link=a** or **link=b** can be specified.

If the specified linkset has a mate linkset, only 1 SS7IPGW or IPGWI signaling link can be assigned to the specified linkset. The assigned link must be an SS7IPGW or IPGWI link.

Up to 8 IPGWx signaling links can be assigned to one linkset if the linkset is not mated.

When SCTP associations are provisioned for LHOSTs on a dual-slot DCM card that is running the **iplim** or **iplimi** application, only 2 point-to-point links can be assigned to the card. Only **link=a** or **link=b** can be specified.

If the card application is **atmansi** or **atmitu**, only **link=a** can be specified.

When an IP link is assigned to a card running card application **ipgwx**, the **lsn** parameter must reference a linkset that specifies an IP gateway adjacent point code (**ent-ls:ipgwapc=yes**).

When an IP link is assigned to a card running card application **ipgwi**, the **lsn** parameter must reference a linkset that specifies an IP gateway adjacent point code (**ent-ls:ipgwapc=yes**).

When an IP link is assigned to a card running card application **ipgwi**, the specified link set must be empty; only 1 IPGWI link can be assigned to a link set.

When the specified linkset name (**lsn**) is defined with **ipgwapc=yes**, the card application must be **ipgwx** or **ipgwi**.

When the specified linkset name (**lsn**) is defined with **multgc=yes**, all links assigned to the linkset must be of the same type (**ipgwi** links or **iplimi** links).

When the specified linkset name (**lsn**) is defined with **multgc=yes**, the card in the specified card location must be running the **ipgwi** or **iplimi** card application.

The **ipliml2** parameter can be specified only for IPLIM signaling links.

All IPLIM links assigned to the same linkset must be defined with the same **ipliml2** parameter value.

Linksets containing 24-bit ITU-N APCs or SAPCs cannot contain IPLIMI SAALTALI or E1 ATM links. These links do not support 24-bit ITU-N traffic.

Linksets with both 14-bit ITU-N and 24-bit ITU-N APCs or SAPCs can contain only IPGWI or IPLIMI M3UA links. These links support 14-bit ITU-N and 24-bit ITU-N traffic simultaneously.

A maximum of 1200 or 1500 links is allowed in the system. The maximum depends on the enabled Large System # Links quantity (see the **rtrv-ctrl-feat** command output). A feature access key is required to enable support for more than 1200 links. A mixture of ATM high-speed, E1 ATM high-speed, and low-speed signaling links is supported. If the addition of either a low-speed signaling link or an ATM high-speed signaling link exceeds the total number of low-speed and ATM high-speed signaling links allowed in the system, the **ent-slk** command is rejected.

HC-MIM cards cannot be used as or with Channel cards. The **e1loc** and **t1loc** parameters cannot be specified for HC-MIM cards.

When a card location is specified in the **loc** parameter for an E1 card, a T1 card, or a Channel card (card type **lime1**, **limt1**, or **limch**), a timeslot (**ts**) must be specified for the link. When a card location is specified for a Channel card (card type **limch**) assigned to an E1 interface, the **e1loc** parameter must be specified. When a card location is specified for a Channel card (card type **limch**) assigned to a T1 interface, the **t1loc** parameter must be specified.

A specific timeslot can be assigned in the **ts** parameter to only one E1 signaling link for the E1 interface that services that timeslot.

A specific timeslot can be assigned in the **ts** parameter to only one T1 signaling link for the T1 interface that services that timeslot.

The **ts** parameter value for a T1 link must be in the range **1-24**.

The **ts** parameter cannot be specified for HC-MIM cards that are used for SE-HSL links (**linkclass=unchan** is specified in the E1 interface definition).

If the E1 interface has CAS multi-framing enabled for an E1 card or a Channel card, timeslot 16 cannot be specified.

When the **e1loc** parameter and the **e1port** parameter are specified together in the command, the **atmtsel** parameter cannot be specified.

If a card location is specified in the **loc** parameter for a Channel card (card type **limch**),

- The card in the location specified by the **e1loc** parameter must be an E1 card (card type **lime1**).
- When a Channel card location is specified in the **loc** parameter, the **e1loc** parameter must be specified to identify the associated E1 card. The specified E1 card must be equipped.
- The port specified in the **e1port** parameter must be equipped with an E1 interface for the card specified in the **e1loc** parameter.
- Port 1 must be specified (**e1port=1**) for the associated E1 card port.
- A Channel card (**e1loc** parameter) must be located on the same shelf with its associated E1 card (**loc** parameter).

If a card location is specified in the **loc** parameter for an E1 card (card type **lime1**),

- The **e1port** parameter can be specified to select either port 1 or port 2 for the E1 interface to service the signaling link on a 2-port E1 card or an E1/T1 MIM card. The default is port 1.
- The **e1port** parameter can be specified to select ports 1 through 8 for the E1 interface to service the signaling link on an HC-MIM card. The default is port 1.
- The E1 interface for the specified or default port must already be defined (see the **ent-e1** command).

The parameters **t1loc**, **t1port**, and **ts** are allowed only when entering a signaling link for an E1/T1 MIM used as a T1 or Channel card or for an HC-MIM card used as a T1 card. All V.35 and HSL parameters (**l1mode**, **l2tset**, **atmtsel**, **vci**, **vpi**, **ll**, and **tset**) are invalid when entering **T1** parameters.

If a card location is specified in the **loc** parameter for a T1 Channel card (card type **limch**),

- The card in the location specified by the **t1loc** parameter must be an E1/T1 MIM card used as a T1 card (card type **limt1**).
- When a Channel card location is specified in the **loc** parameter, the **t1loc** parameter must be specified to identify the associated T1 card. The specified T1 card must be equipped.
- The port specified in the **t1port** parameter must be equipped with a T1 interface for the card specified in the **t1loc** parameter.
- Port 1 must be specified (**t1port=1**) for the associated T1 card port.
- A Channel card (**t1loc** parameter) must be located on the same shelf with its associated T1 card (**loc** parameter).

If a card location is specified in the **loc** parameter for a T1 card (card type **limt1**),

- The **t1port** parameter can be specified to select either port 1 or port 2 for the T1 interface to service the signaling link on a 2-port E1 card or an E1/T1 MIM card. The default is port 1.
- The **t1port** parameter can be specified to select ports 1 through 8 for the T1 interface to service the signaling link on an HC-MIM card. The default is port 1.
- The T1 interface for the specified or default port must already be defined (see the **ent-t1** command).

If a card location is specified in the **loc** parameter for an HC-MIM card,

- A maximum of 64 links can be assigned to one HC-MIM card (see Table A-1 in Appendix A).
- Signaling links cannot be assigned to channel-bridged even-numbered ports.
- An even-numbered port that is in channel-bridged to an odd-numbered port cannot be specified for assigning a signaling link.
- The fan feature bit must be turned on before links can be assigned to HC-MIM cards (see the **chg-feat** command). The system verifies that the fan feature bit is on when links **a4-a31** and **b4-b31** are assigned.
- HIPR cards must be in the **xy09** and **xy10** card locations (*x* is the frame, *y* is the shelf) in each shelf that contains one or more HC-MIM cards.

Notes

The **ll** parameter is not available in the SEAS database.

When a signaling link is assigned to a card that is running the **atmansi** application or the **atmitu** application, and the **bps**, **vci**, **vpi**, **e1atmcr4**, **e1atmsi**, **e1atmsn**, **ll**, **atmsel**, and **lpset** parameters are not specified, the ATM default values are assigned for these parameters.

The MTP Level 2 timers (**l2tset** parameter) are not valid for IP links or for ATM links.

A link is *equipped* when it is physically operational, that is, when the hardware is in place that is needed to support the link.

Signaling Links for 2-port E1 Cards

If you are configuring signaling links for an E1 or Channel card, each signaling link must be associated with a timeslot assigned in the command. Each signaling link/timeslot assigned for an E1 card or a Channel card must be associated with an E1 interface that has been defined for one of the ports on the E1 card (see the **ent-e1** command).

Timeslots and signaling links are defined in the **ent-slk** command by a combination of card location (**loc** parameter), the signaling link that uses the timeslot, the signaling link port (a or b), the timeslot number, and the card location and port for the servicing E1 interface on the E1 card (**e1port** and **e1loc** parameters). Timeslot numbers must be unique to the E1 interface that services the timeslot; that is, the same timeslot cannot be assigned to the same E1 interface for different signaling links.

If the link and timeslot are for a Channel card, the Channel card location is specified in the **loc** parameter, and the associated E1 card is specified in the **e1loc** parameter.

If the link and timeslot are for the E1 card itself, the E1 card location is specified in the **loc** parameter, and the E1 interface port (1 or 2) that will service the link is specified in the **e1port** parameter.

The E1 card can service 2 timeslots assigned to signaling links for itself, and 1-31 timeslots assigned to signaling links for Channel cards on the same shelf. If the E1 card is not servicing any Channel cards, 2 links with associated timeslots can be defined—both on the interface on port 1, both on the interface on port 2, or 1 on the interface on each port. The links for any Channel cards serviced by the E1 card must be serviced by the interface on port 1. Each Channel card can have 1 or 2 links assigned to the E1 interface on port 1, for a total of 16 Channel cards and up to 31 links. (Timeslot 0 cannot be used). All links for a Channel card must be assigned to the same E1 card. If the E1 card is servicing any Channel cards, the 2 links for the E1 card itself can be assigned to the interface on port 2 (which cannot service Channel card links and can service only 2 links).

Signaling Links for E1/T1 MIM Cards

One E1/T1 MIM card can be used for E1 card functions or T1 card functions, but not both at the same time. E1 cards and T1 cards can coexist in the same EAGLE 5 SAS.

If you are configuring signaling links for an E1, T1, or Channel card, each signaling link must be associated with a timeslot assigned in the command. Each signaling link/timeslot assigned for an E1, T1, or Channel card must be associated with an E1 or T1 interface that has been defined for one of the ports on the E1/T1 MIM card (see the **ent-e1** or **ent-t1** command).

Timeslots and signaling links are defined in the **ent-slk** command by a combination of card location (**loc** parameter), the signaling link that uses the timeslot, the signaling link port (**a**, **a1**, **a2**, **a3**, **b**, **b1**, **b2**, or **b3**), the timeslot number, and the card location and port for the servicing E1 or T1 interface on the E1 or T1 card (**e1loc** and **e1port** or **t1loc** and **t1port** parameters). Timeslot numbers must be unique to the E1 or T1 interface that services the timeslot; that is, the same timeslot cannot be assigned to the same E1 or T1 interface for different signaling links.

If the link and timeslot are for a Channel card, the Channel card location is specified in the **loc** parameter, and the associated E1 or T1 card is specified in the **e1loc** or **t1loc** parameter.

If the link and timeslot are for the E1 or T1 card itself, the E1 or T1 card location is specified in the **loc** parameter, and the E1 or T1 interface port (1 or 2) that will service the link is specified in the **e1port** or **t1port** parameter.

The E1/T1 MIM used as an E1 card can service 8 timeslots assigned to signaling links for itself, and 1-31 timeslots assigned to signaling links for Channel cards on the same shelf. If the E1 card is not servicing any Channel cards, 8 links with associated timeslots can be defined—all on the interface on port 1, all on the interface on port 2, or some on the interface on each port. If the E1 card is servicing Channel card links, the links for the E1 card itself can be assigned either to the port 1 interface or the port 2 interface. But for each E1 link assigned to the port 1 interface, the number of links is decreased by one that can be assigned to that port interface for a Channel card. All links for any Channel cards serviced by an the E1 card must be serviced by the interface on port 1. Each Channel card can have up to 8 links assigned to the E1 interface on port 1, for a total of up to 31 links. (Timeslot 0 cannot be used). All links for a Channel card must be assigned to the same E1 card. If the E1 card is servicing any Channel cards, the 8 links for the E1 card itself can all be assigned to the interface on port 2 (which cannot service Channel card links and can service only 8 links).

The E1/T1 MIM used as a T1 card can service 8 timeslots assigned to signaling links for itself, and 1-24 timeslots assigned to signaling links for Channel cards on the same shelf. If the T1 card is not servicing any Channel cards, 8 links with associated timeslots can be defined—all on the interface on port 1, all on the interface on port 2, or some on the interface on each port. If the T1 card is servicing Channel card links, the links for the T1 card itself can be assigned either to the port 1 interface or the port 2 interface. But for each T1 link assigned to the port 1 interface, the number of links is decreased by one that can be assigned to that port interface for a Channel card. All links for any Channel cards serviced by the T1 card must be serviced by the interface on port 1. Each Channel card can have up to 8 links assigned to the T1 interface on port 1, for a total of up to 24 links. All links for a Channel card must be assigned to the same T1 card. If the T1 card is servicing any Channel cards, the 8 links for the T1 card itself can all be assigned to the interface on port 2 (which cannot service Channel card links and can service only 8 links).

Signaling Links for HC-MIM Cards

An HC-MIM card can be used for E1 card functions or T1 card functions, but not both at the same time. E1 cards and T1 cards can coexist in the same EAGLE 5 SAS.

Each signaling link for an E1 card or a T1 card must be associated with a timeslot assigned in the **ent-slk** command. Each signaling link and timeslot assigned for an E1 card or a T1 card must be associated with an E1 or T1 interface that has been defined for one of the ports on the HC-MIM card (see the **ent-e1** command or the **ent-t1** command).

Timeslots and signaling links are defined in the **ent-slk** command by a combination of card location (**loc** parameter), the signaling link that uses the timeslot (**a**, **a1-a31**, **b**, **b1-b31**), the timeslot number (**ts**), and the port for the servicing E1 or T1 interface on the E1 or T1 card (**e1port** or **t1port** parameter). Timeslot numbers must be unique to the E1 or T1 interface that services the timeslot; that is, the same timeslot cannot be assigned to the same E1 or T1 interface for more than one signaling link.

Each HC-MIM used as an E1 card can have up to 64 signaling links assigned to the card. Each E1 interface on an HC-MIM card can service 1-31 timeslots.

Each HC-MIM used as an T1 card can have up to 64 signaling links assigned to the card. Each T1 interface on an HC-MIM card can service 1-24 timeslots.

Output

```
ent-slk:loc=1201:link=a:slc=3:lsn=c1201001:l2tset=3:l1mode=dte:bps=64000:ecm=basic
r1ghncxa03w 05-02-07 11:11:28 EST EAGLES 33.0.0
ENT-SLK: MASP A - COMPLTD
;
```

ent-spc

Enter Secondary Point Code

Use this command to enter an SPC (secondary point code) into the database.

Keyword: ent-spc

Related Commands: dlt-spc, rtrv-spc

Command Class: Database Administration

Parameters

:spc/spca/spci/spcn/spcn24= (mandatory)

Secondary point code.

NOTE: See “Point Code Formats and Conversion” in Appendix A for a detailed description of point code formats, rules for specification, and examples.

:spc= or :spca= (mandatory)

ANSI point code with subfields network indicator-network cluster-network cluster member (*ni-nc-ncm*).

Range: 000-255

Specify a valid value for each subfield of the point code, and separate the subfields with a dash (-).

When **chg-sid:pctype=ansi** is specified, *ni* = 000 is not valid.

When **chg-sid:pctype=ansi** is specified, *nc* = 000 is not valid if *ni* = 001–005.

When **chg-sid:pctype=ansi** is specified, *nc* = 000 is valid if *ni* = 006–255.

The point code 000-000-000 is not a valid point code.

:spci= (mandatory)

ITU international secondary point code with subfields *zone-area-id*. The *prefix* subfield indicates a spare point code (*prefix-zone-area-id*).

Range: s-, 0-255

Specify a valid value for each subfield of the point code, and separate the subfields with a dash (-).

The point code 0-000-0 is not a valid point code.

prefix—s-

zone—0-7

area—000-255

id—0-7

:spcn= (mandatory)

ITU national point code in the format of a 5-digit number (*nnnnn*); or 2, 3, or 4 numbers (members) separated by dashes (*m1-m2-m3-m4*) as defined by the **chg-stpopts:npfnti** flexible point code option. A group code must be specified when the ITUDUPPC feature is turned on (*nnnnn-gc*, *m1-m2-m3-m4-gc*). The *prefix* subfield indicates a spare point code (*prefix-nnnnn*, *prefix-nnnnn-gc*, *prefix-m1-m2-m3-m4*, *prefix-m1-m2-m3-m4-gc*).

Range: **s-**, **0-16383**, **aa-zz**
Specify a valid value for each subfield of the point code, and separate the subfields with a dash (-).

prefix—**s-**

nnnnn—**0-16383**

gc—**aa-zz**

m1-m2-m3-m4—**0-14** for each member; values must sum to 14

:spcn24= (mandatory)

24-bit ITU national point code with subfields *main signaling area-sub signaling area-signaling point (msa-ssa-sp)*.

Range: **000-255**

Specify a valid value for each subfield of the point code, and separate the subfields with a dash (-).

msa—**000-255**

ssa—**000-255**

sp—**000-255**

Example

The following example adds a secondary point code:

ent-spc:spc=10-20-30

The following example adds a 24-bit ITU-N secondary point code:

ent-spc:spcn24=99-99-99

The following example adds a spare ITU-N secondary point code:

ent-spc:spcn=s-12345

Dependencies

The Spare Point Code Support feature must be enabled before a spare point code (prefix **s-**) can be specified in the command.

The specified secondary point code must be a full point code. A *full point code* contains numerical values for all three segments of the point code.

The point code **0-0-0** is not a valid ANSI or ITU-I secondary point code.

The specified secondary point code to be added must not already exist as a secondary point code.

A maximum of 40 secondary point codes may be defined.

The MPC feature must be turned on before a secondary point code can be added using this command.

The specified secondary point code must not already exist as a destination or an alias in the Destination table.

The specified secondary point code cannot match an existing true point code or capability point code in the Site Identification table.

Notes

If the **spcn** parameter is specified, its format must match the format that was assigned with the **chg-stpopts:npcfnti** parameter.

In this command, only ITU-international and ITU national point codes support the spare point code subtype prefix (**s-**).

Output

ent-spc:spc=10-20-30

```
rlghncxa03w 04-02-18 08:50:12 EST EAGLE 31.3.0
Secondary Point Code table is (7 of 40) 17% full
ENT-SPC: MASP A - COMPLTD
;
```

ent-split-npa

Enter Split NPANXX

NOTE: This command is obsolete.

Use this command to force two different NPANXXs to reference the same last 4-digit telephone number (TN) in the database. During this time, updates to either NPANXX will update the same last 4-digit entry of a 10-digit ported TN. All existing NPANXX data is copied automatically to the new NPANXX for the split.

NOTE: If the LNP ELAP Configuration feature is turned on, this command is no longer available. This function can be performed at the LSMS or using the ELAP user interface.

Keyword: ent-split-npa

Related Commands: dlt-split-npa, rtrv-split-npa

Command Class: LNP Database Administration

Parameters

:npanxx= (mandatory)
New numbering plan area.

Range: 6 digits

:npanxx= (mandatory)
Numbering plan area.

Range: 6 digits

Example

```
ent-split-npa:npanxx=214254:nnpanxx=972254
```

Dependencies

The LNP feature must be turned **on** (see the **enable-ctrl-feat** command) before this command can be entered.

The NPANXX must not already be split.

Notes

The maximum number of NPANXX entries allowed is 150,000.

Output

```

ent-split-npa:npanxx=214254:nnpanxx=972254
  rlgncxa03w 04-02-18 08:50:12 EST EAGLE 31.3.0
  ENT-SPLIT-NPA: MASP A - COMPLTD
;

```

ent-srvsel**Enter Service Selector**

Use this command to assign the applicable service selectors required to specify a service entry for DSM services.

Keyword: ent-srvsel

Related Commands: chg-srvsel, dlt-srvsel, rtrv-srvsel

Command Class: Database Administration

Parameters

:gti/gtia/gtii/gtin/gtin24= (mandatory)

Global title indicator. For all service selector commands, the domain is defined as **gti** and **gtia** (ANSI), **gtii** (ITU international), and **gtin** (ITU national). For the service selector commands, **gti** and **gtia** are equivalent.

Range: Supported value for ANSI: **gti=2** and **gtia=2**
Supported values for ITU: **gtii=2, 4; gtin=2, 4; gtin24=2, 4**

:serv= (mandatory)

The DSM service.

NOTE: The **gport** service cannot be used for Prepaid SMS Intercept; use the **smsmr** service. The **gport** service cannot be used for Portability Check for Mobile Originated SMS; use the **mnpsms** service.

Range: **eir, gflex, gport, idpr, idps, inpq, inpmr, mnpsms, smsmr,**
eir—Equipment Identity Register
gflex—GSM flexible numbering
gport—GSM number portability
idpr—Prepaid IDP Query Relay
idps—IDP Screening for Prepaid
inpq—INP query
inpmr—INP message relay
mnpsms—Portability Check for Mobile Originated SMS
smsmr—Prepaid SMS Intercept

:ssn= (mandatory)

Subsystem number.

Range: 10-255, *

:tt= (mandatory)

Translation type.

Range: 10-255

:nai= (optional)

Nature of Address Indicator (see Table A-5 in Appendix A).

Range: **1sub, rsvd, natl, intl**

:naiv= (optional)

Nature of Address Indicator Value (see Table A-5 in Appendix A).

Range: **0–127**

NOTE: The Nature of Address Indicator parameters (**naiv** or **nai**) can be specified by supplying either a mnemonic or an explicit value. At no time may both the mnemonic and the explicit value be specified at the same time for the same parameter. Either the **naiv** or **nai** parameter can be specified. Table A-5 in Appendix A shows the mapping between the **naiv** and the **nai** parameters.

:np= (optional)

Numbering Plan (see Table A-6 in Appendix A).

Range: **1e164, generic, x121, f69, e210, e212, e214, private**

:npv= (optional)

Numbering Plan Value (see Table A-6 in Appendix A).

Range: **10–15**

NOTE: The Numbering Plan parameters (**npv** or **np**) can be specified by supplying either a mnemonic or an explicit value. At no time may both the mnemonic and the explicit value be specified at the same time for the same parameter. Either the **npv** or **np** parameter can be specified. Table A-6 in Appendix A shows the mapping between the **npv** and the **np** parameters.

:snai= (optional)

The service nature of address indicator.

Range: **1sub, natl, intl, rmidn, rnmndn, rnsdn, ccrndn**

sub—Subscriber number

natl—National significant number

intl—International number

rmidn—Routing number prefix and international dialed/directory number

rmndn—Routing number prefix and national dialed/directory number

rnsdn—Routing number prefix and subscriber dialed/directory number

ccrndn—Country code, routing number, and national directory number

:snp= (optional)

The service numbering plan.

Range: **1e164, e212, e214**

Example

ent-srvsel:gtia=2:tt=9:snp=e212:snai=natl:serv=gflex

ent-srvsel:gtia=2:tt=10:snp=e164:snai=intl:serv=gflex

ent-srvsel:gtia=2:tt=253:snp=e214:snai=intl:serv=gflex

ent-srvsel:gtin=4:tt=0:npv=10:naiv=125:serv=inpq

ent-srvsel:gtin=4:tt=9:np=e214:nai=natl:snp=e164:snai=intl:serv=gflex

ent-srvsel:gtii=4:tt=0:np=e164:nai=sub:snp=e164:snai=rnsdn:serv=inpqr

ent-srvsel:gtii=4:tt=10:npv=10:nai=125:snp=e164:snai=rnndn:serv=inpq
 ent-srvsel:gtii=4:tt=0:np=e164:nai=intl:serv=gport:snai=intl:snp=e164
 ent-srvsel:gtii=4:tt=0:np=e164:nai=128:serv=gport:snai=rmidn:snp=e164
 ent-srvsel:gtin24=4:tt=4:np=e164:nai=intl:serv=gport:snp=e164:snai=intl
 ent-srvsel:gtii=4:tt=20:np=e164:nai=intl:serv=eir:ssn=*
 ent-srvsel:gtin24=4:tt=4:np=e164:nai=intl:serv=gport:snp=e164:snai=intl:ssn=9
 ent-srvsel:gtii=4:tt=4:np=e164:nai=intl:serv=eir:ssn=11
 ent-srvsel:gtii=4:tt=4:np=e164:nai=intl:serv=smsmr:snp=e164:snai=intl:ssn=10
 ent-srvsel:gtii=4:tt=4:np=e164:nai=intl:serv=mnpsms:snp=e164:snai=intl:ssn=255
 ent-srvsel:gtin=4:tt=9:np=e214:nai=natl:snp=e164:snai=intl:serv=gflex:ssn=250
 ent-srvsel:gtin=4:tt=100:np=e214:nai=natl:snp=e164:snai=intl:serv=gflex:ssn=*
 ent-srvsel:gtii=4:tt=20:np=e164:nai=intl:serv=idpr:ssn=*

Dependencies

The G-Flex feature must be turned on before the **serv=gflex** parameter can be specified.

The INP feature must be turned on before the **serv=inpvr** or **serv=inpq** parameter can be specified.

The G-Port feature must be turned on before the **serv=gport** parameter can be specified.

The Prepaid SMS Intercept Phase 1 feature must be turned on before the **serv=smsmr** parameter can be specified.

The Portability Check for Mobile Originated SMS feature must be turned on before the **serv=mnpsms** parameter can be specified.

The Equipment Identity Register (EIR) feature must be turned on before the **serv=eir** parameter can be specified.

The **np** and **npv** parameters cannot be specified together in the command.

The **nai** and **naiv** parameters cannot be specified together in the command.

The value **4** is not valid for the **gtia** parameter.

The values **1** and **3** are not valid for the **gti/gtia/gtii/gtin/gtin24** parameters.

When the **gti/gtia/gtii/gtin/gtin24=2** parameter is specified, no **np(v)** and **nai(v)** parameter combinations can be specified.

When the **gtii/gtin/gtin24=4** parameter is specified, an **np(v)** and **nai(v)** parameter combination must be specified. The parameters can be specified in these combinations: **np** and **naiv**, **npv** and **nai**, **np** and **nai**, or **npv** and **naiv**.

When the **serv** parameter value is **inpvr**, **inpq**, **gport**, **eir**, **mnpsms**, or **smsmr**, the **gtia** and **gti** parameters cannot be specified.

When the **serv=inpvr** parameter is specified, the **snp=e164** parameter must be specified.

When the **serv=inpq** parameter is specified, the **gtii** parameter cannot be specified.

When the **serv=gport** parameter is specified, the **gti/gtia** parameter cannot be specified.

When **snai=rnidn**, **rncdn**, or **rnsdn** is specified, a **serv** parameter value of **inpmr**, **gport**, **smsmr**, or **mnpsms** must be specified.

When the **serv** parameter value **gflex**, **gport**, **inpmr**, **mnpsms**, or **smsmr** is specified, the **snai** and **snp** parameters must be specified.

When the **serv** parameter value **inpq** or **eir** is specified, the **snai** and **snp** parameters cannot be specified.

When the **snai=ccrncdn** parameter is specified, the **serv** parameter value **gport**, **mnpsms**, or **smsmr** must be specified.

When the **serv** parameter value **gport**, **mnpsms**, or **smsmr** is specified, the **snp=e164** parameter must be specified.

An entry must not already exist that matches the new **gti/gtii/gtin/gtin24**, **tt**, **ssn**, **np(v)**, and **nai(v)** combination of parameters.

For the specified **gti/gtia/gtii/gtin**, **tt**, **np(v)**, **nai(v)**, and **ssn=*** , one entry matching a specific **ssn** cannot already exist.

For the specified **gti/gtia/gtii/gtin**, **tt**, **np(v)**, **nai(v)**, and specific **ssn**, an entry matching **ssn=*** cannot already exist.

An ITU Service Selector cannot be entered when the **ansigflex** STP option is enabled (see the **chg-stpotps** command)

When the **serv=idpr** parameter is specified, the Prepaid IDP Query Relay feature must be on.

When the **serv=idpr** parameter is specified, the only valid mandatory service parameters are **tt**, **serv**, **ssn**, **gtii** and **gtin**.

When the **serv=idpr** parameter is specified, the only valid optional parameters are **np** and **nai**.

When the **serv=inpq/eir/idpr** parameter is specified, the **snai** and **snp** parameters must not be specified.

When the **serv=idps** parameter is specified, the IDP Screening for Prepaid feature must be on.

Notes

Table 6-16 provides examples of acceptable and unacceptable parameter combinations for the ent-srvsel command:

Table 6-16. Examples of ent-srvsel Parameter Combinations

Command	Comments
ent-srvsel:gtii=2:tt=123:snai=natl:snp=e164:serv=gflex	Acceptable parameter combination
ent-srvsel:gtii=2:tt=123:np=e164: nai=intl:snai=natl:snp=e164 :serv=gflex	np(v) and nai(v) must not be specified when gtix=2
ent-srvsel:gtii=2:tt=123:npv=2: naiv=13:snai=natl:snp=e164 :serv=gflex	np(v) and nai(v) must not be specified when gtix=2
ent-srvsel:gtii=4:tt=123:snai=natl:snp=e164:serv=gflex	np(v) and nai(v) must be specified when gtii/n=4

Table 6-16. Examples of ent-srvsel Parameter Combinations (Continued)

Command	Comments
ent-srvsel:gtii=4:tt=123:np=e164:snai=natl:snp=e164:serv=gflex	np(v) and nai(v) must be specified when gtii/n=4
ent-srvsel:gtii=4:tt=123:naiv=13:snai=natl:snp=e164:serv=gflex	np(v) and nai(v) must be specified when gtii/n=4
ent-srvsel:gtii=4:tt=123:np=e164:nai=sub:snai=natl:snp=e164:npv=2:serv=gflex	np and npv must not be specified together
ent-srvsel:gtii=4:tt=123:nai=intl:naiv=13:np=e164:snai=natl:snp=e164:serv=gflex	nai and naiv must not be specified together
ent-srvsel:gtii=4:tt=123:nai=intl:np=e164:snai=natl:snp=e164:serv=gflex	Acceptable parameter combination
ent-srvsel:gtii=4:tt=123:naiv=13:npv=2:snai=natl:snp=e164:serv=gflex	Acceptable parameter combination

Output

```
ent-srvsel:gtia=2:tt=9:snp=e212:snai=natl:serv=gflex
rlghncxa03w 04-01-05 16:40:40 EST EAGLE 31.3.0
Service Selector table is (114 of 1024) 11% full
ENT-SRVSEL: MASP A - COMPLTD
;
```

ent-ss-appl

Enter Subsystem Application

Use this command to reserve a subsystem number for an application and set the application status to be online or offline. You can define only one subsystem per application. The application must be unique.

Keyword: ent-ss-appl

Related Commands: chg-ss-appl, dlt-ss-appl, rtrv-ss-appl

Command Class: Database Administration

Parameters

:appl= (mandatory)
Application type.
Range: lnp, inp, eir

:ssn= (mandatory)
Primary subsystem number.
Range: 2-255

:stat= (optional)
Status.
Range: offline, online
Default: offline

Example

```
ent-ss-appl: appl=lnp:ssn=16:stat=online
ent-ss-appl: appl=inp:ssn=15:stat=offline
ent-ss-appl: appl=eir:ssn=11:stat=offline
```

Dependencies

The LNP feature must be turned on (see the **enable-ctrl-feat** command) before the **ent-ss-appl:appl=lnp** command can be entered.

The INP feature must be turned on before the **ent-ss-appl:appl=inp** command can be entered.

The Equipment Identity Register (EIR) feature must be turned on before the **ent-ss-appl:appl=eir** command can be entered.

The specified application (**appl** parameter) must not already be assigned.

The maximum number of applications must not already be assigned.

For LNP, the STP true point code and LNP subsystem must exist in the MAP table.

For INP, the STP true point code and INP subsystem must exist in the MAP table.

For EIR, the STP true point code and EIR subsystem must exist in the MAP table.

Notes

If not specified, the application subsystem status defaults to **offline**. When the application is **offline**, the application subsystem is down.

The LNP application status applies to both message relay and LNP query.

Output

```
ent-ss-appl: appl=lnp:ssn=16:stat=online
  rlgncxa03w 04-01-05 16:40:40 EST EAGLE 31.3.0
  ENT-SS-APPL: MASP A - COMPLTD
;
```

ent-subnetid**Enter Subnet ID**

Use this command to enter elements into the Subnet ID list, for the ISUP NP with EPAP feature. Each entry is identified by the Subnet ID and the Subnet number.

The Subnet ID length (**subnetidlen** parameter) must be entered first, before the command is entered the second time to enter the Subnet ID and Subnet Number.

Keyword: ent-subnetid

Related Commands: dlt-subnetid, rtrv-subnetid

Command Class: Database Administration

Parameters

```
:subnetid= (optional)
Vendor ID
```

Range: 1-15 digits; the number of digits defined by the **subnetidlen** parameter value. Valid digits are **0-9, A-F, and a-f**.

:subnetidlen= (optional)

Subnet ID Length. All Subnet IDs defined for the ISUP NP with EPAP feature must contain this number of digits.

Range: **0-FFFFFFFFFFFFFF**

1-15 digits; must be the number of digits defined by the **subnetidlen** parameter value. Valid digits are **0-9, A-F, and a-f**.

:subnetnum= (optional)

Subnet Number. The Subnet Number is used as a reference to the prefix number for the ISUP NP with EPAP feature.

Range: **1-5**

- 1**—Corresponds to the prefix defined with prefix number 1 (see the **chg-prefix** command).
- 2**—Corresponds to the prefix defined with prefix number 2 (see the **chg-prefix** command).
- 3**—Corresponds to the prefix defined with prefix number 3 (see the **chg-prefix** command).
- 4**—Corresponds to the prefix defined with prefix number 4 (see the **chg-prefix** command).
- 5**—Corresponds to the prefix defined with prefix number 5 (see the **chg-prefix** command).

Example

```
ent-subnetid:subnetidlen=6
```

```
ent-subnetid:subnetid=886933:subnetnum=1
```

Dependencies

The value **none** cannot be specified for the **subnetid** parameter.

The ISUP NP with EPAP feature must be enabled before this command can be entered.

The SUBNETID table can contain a maximum of 50 entries.

The specified ID entry cannot already exist in the SUBNETID table.

All SUBNETID table entries must have the number of digits defined by the **subnetidlen** parameter value.

The prefix with the same prefix number as the specified Subnet Number must already be provisioned for the ISUP NP with EPA feature.

The Subnet ID length cannot be changed unless the SUBNETID table is empty. All Subnet IDs must be deleted from the table before a different Subnet ID length can be entered.

The Subnet ID length must be entered before any Subnet IDs can be defined.

The **subnetidlen** parameter cannot be specified in the same command with the **subnetid** and **subnetnum** parameters.

Either the **subnetidlen** parameter, or the **subnetid** and **subnetnum** parameters can be specified in one command.

Notes

None.

Output

The Subnet ID length must be entered first.

ent-subnetid:subnetidlen=6

```
rlghncxa03w 04-10-07 11:11:28 EST EAGLE 31.11.0
ENT-SUBNETID: MASP A - COMPLTD
;
```

The first Subnet ID and Subnet number can be entered after the Subnet ID length has been entered.

ent-subnetid:subnetid=886933:subnetnum=1

```
rlghncxa03w 04-10-07 11:11:28 EST EAGLE 31.11.0
VENDID table is (6 of 50) 11% full
ENT-SUBNETID: MASP A - COMPLTD
;
```

ent-t1**Enter T1 Interface**

Use this command to enter an interface for an E1/T1 MIM card or an HC-MIM card used as a T1 card. The T1 port number on the card and the T1 card location in the EAGLE must be specified.

Framing, line length, encoding, master/slave clocking options, and the signaling bit setting can be specified.

On a HC-MIM card, T1 ports 1, 3, 5, and 7 (master ports) can be independently channel bridged with their adjacent even-numbered (slave) T1 ports 2, 4, 6, and 8 to allow non-signaling data pass-through.

Keyword: ent-t1

Related Commands: chg-t1, dlt-t1, rtrv-t1, tst-t1

Command Class: Database Administration

Parameters

:t1port= (mandatory)

T1 card port number. The value must be a T1 port for which an interface has not been configured on the specified T1 card.

Range: 1, 8

Ports 3 through 8 can be specified only for HC-MIM cards.

:loc= (mandatory)

The card location as stenciled on the shelf of the system.

Range: 1101–1108, 1111–1112, 1201–1208, 1211–1218, 1301–1308, 1311–1318, 2101–2108, 2111–2118, 2201–2208, 2211–2218, 2301–2308, 2311–2318, 3101–3108, 3111–3118, 3201–3208, 3211–3218, 3301–3308, 3311–3318, 4101–4108, 4111–4118, 4201–4208, 4211–4218, 4301–4308, 4311–4318, 5101–5108, 5111–5118, 5201–5208, 5211–5218, 5301–5308, 5311–5318, 6101–6108, 6111–6118

:chanbrdg= (optional)

Indicates whether an HC-MIM odd numbered port is channel bridged with its adjacent even numbered port for non-signaling data pass through.

Range: on, off

Default: off

:encode= (optional)

Indicator for use of B8ZS or AMI encoding/decoding.

Range: b8zs, ami

Default: b8zs

:framing= (optional)

Indicator for framing format.

Range: sf, esf

Default: sf

:ll= (optional)

T1 cable length in feet between the EAGLE and the connecting node.

Range: 0-655

Default: 133

:t1tsel= (optional)

Timing source. Indicates master (external) or slave (line) timing source, or timing source recovered from the paired master port for the channel bridged slave port.

Range: line, external, recovered

Default: line

Example

```
ent-t1:loc=1205:t1port=1:encode=ami:t1tsel=external:framing=sf:ll=100
```

```
ent-t1:loc=1205:t1port=2:encode=b8zs:t1tsel=external:framing=esf
```

```
ent-t1:loc=1203:t1port=1:chanbrdg=on:t1tsel=recovered
```

```
ent-t1:loc=1203:t1port=3:chanbrdg=on:t1tsel=external
```

Dependencies

The specified card location (**loc** parameter) must be equipped.

The card specified by the **loc** parameter must be a **limt1** card type.

The port specified by the **t1port** parameter must not be already equipped with a T1 interface.

The value of **ami** for the **encode** parameter is supported only for the E1/T1 MIM card or the HC-MIM card used as a T1 card, and not for the 2-port E1 card.

The **chanbrdg** parameter can be specified only for HC-MIM cards.

The **chanbrdg=on** parameter cannot be specified for HC-MIM card even-numbered T1 ports

The **chanbrdg=on** parameter cannot be specified for HC-MIM card even-numbered card locations.

The timing source parameter **e1tsel** must be specified if **chanbrdg=on** is specified.

The **t1tsel=line** parameter cannot be specified if the specified HC-MIM T1 port is in channel bridging mode.

The **t1tsel=recovered** parameter cannot be specified if the specified HC-MIM T1 port is not in channel bridging mode.

The **t1port** parameter values **3** through **8** cannot be specified for an even-numbered HC-MIM card location.

When provisioning an odd-numbered T1 HC-MIM port to channel bridging mode, **force=yes** must be specified if the adjacent even-numbered port is already provisioned.

All signaling links assigned to its adjacent even-numbered T1 port must be deleted before an odd-numbered HC-MIM T1 port can be provisioned into channel bridging mode.

The fan feature bit must be on before HC-MIM cards can be used in an EAGLE shelf (see the **chg-feat** command). The system checks the fan feature bit when E1 ports **3** through **8** are specified.

HIPR cards must be equipped in card locations *xy09* and *xy10* (*x* is the frame, *y* is the shelf) on each shelf that contains one or more HC-MIM cards. The system checks for HIPR cards when HC-MIM T1 ports **3** through **8** are specified.

Notes

One or two T1 interfaces must be defined on an E1/T1 MIM card used as a T1 card after the T1 and any associated Channel card types (**limt1** and **limch**) are defined in the database (with the **ent-card** command), and before the signaling links and associated timeslots are defined for the T1 card and any associated Channel cards (with the **ent-slk** command).

External timing is derived from the EAGLE High-Speed Master Clock (1.544 MHz for T1 or 2.048 MHz for E1); the Master Timing feature is required. Line timing is derived from its received data stream, if present.

Up to 8 T1 interfaces can be defined on an HC-MIM card used as a T1 card after the T1 card type (**limt1**) is defined in the database (with the **ent-card** command), and before the signaling links and associated timeslots are defined for the T1 card.

On a HC-MIM card, T1 ports 1, 3, 5, and 7 (master ports) can be independently channel bridged with their adjacent even-numbered (slave) ports 2, 4, 6, and 8 to allow non-signaling data pass-through. The **chanbrdg** parameter must be specified for the odd-numbered T1 port.

Output

```
ent-t1:loc=1205:t1port=1:encode=ami:t1tsel=external:framing=sf:ll=100
```

```
rlghncxa03w 04-02-20 09:07:58 EST EAGLE 31.3.0
ENT-T1: MASP A - COMPLTD
```

```
;
```

ent-tt**Enter Translation Type**

Use this command to add a translation type to the system database.

NOTE: If the EGTT (Enhanced Global Title Translation) feature is turned on in the system, the system will no longer accept GTT (Global Title Translation) and TT (Translation Type) commands. Refer to the new command sets that replace the GTT and TT commands: GTT Selector commands (ent/chg/dlt/rtrv-gttset), GTT Set commands (ent/dlt/rtrv-gttset), and GTA commands (ent/chg/dlt/rtrv-gta).

Keyword: ent-tt

Related Commands: dlt-tt, rtrv-tt

Command Class: Database Administration

Parameters

:type/typea/typei/typen/typen24= (mandatory)

Translation type identifies the translation type and network type. This parameter is the decimal representation of the 1-byte field used in SS7.

The **type** and **typea** parameters specify an ANSI network.

The **typei** parameter specifies an ITU-international network.

The **typen** parameter specifies an ITU-national network.

The **typen24** parameter specifies a 24-bit ITU-national network.

A translation type numeric value may be entered as ANSI type (**type** or **typea**) and also as an ITU type (**typei** or **typen**). However, they are separate entities.

Range: 000-255

Default: No translation type is specified

:alias= (optional)

The alias of the global title translation type

Range: 000-255

Default: No alias assignment is made.

:ndgt= (optional)

The number of digits contained in the global title translation. This parameter is not valid if the VGTT (variable length GTT) feature is turned on.

Range: 1-21

Default: 6 (not applicable if the VGTT feature is on)

:ttn= (optional)

Translation type name.

Range: 1 alphabetic character followed by up to 7 alphanumeric characters

Default: No translation name is given

Example

```
ent-tt:type=230:ttn=lidb:ndgt=5
```

```
ent-tt:type=230:ttn=lidb:alias=007
```

```
ent-tt:type=2:ndgt=5
```

```
ent-tt:type=3
```

Dependencies

This command is not valid when the EGTT feature is turned on.

Asterisk (*) parameter values are not allowed for this command.

The translation type specified by **type** or **typea** cannot already exist in the database containing the ANSI types. A translation type specified by **typei**, **typen**, or **typen24** cannot already exist in the database containing the ITU types.

The translation name cannot already exist in either the ANSI or ITU database.

If an alias is specified, the translation type must be specified and must already exist in the database for the network type. If the translation name is specified when defining an alias, the name must already be associated with the translation type.

The translated signaling point code must be a full point code (*ni-nc-ncm*).

The translated signaling point code must have been specified previously as a full point code destination, or it must be a member of a previously specified cluster.

The **alias** parameter and the **ndgt** parameter cannot be specified together in the command.

If an alias is specified, the **alias** value cannot already be defined as either a translation type or an alias for the respective (ANSI or ITU) type.

The translation type name must be unique.

The **ndgt** parameter is not valid if the VGTT (variable length GTT) feature is turned on.

Notes

The new translation type is entered into the translation type table along with the translation name and the number of digits used by the translation type.

The **ttn** parameter always refers to a translation type. Aliases do not have translation type names.

Output

```
ent-t1:loc=1205:t1port=1:encode=ami:t1tsel=internalexternal:framing=sf:ll=100
```

```
rlghncxa03w 04-01-07 11:43:04 EST EAGLE 31.3.0
ENT-TT: MASP A - COMPLTD
```

```
;
```

ent-ttmap

Enter Translation Type Mapping

Use this command to add a mapped SS7 message translation type (TT) for a given gateway linkset name. With this command you can add to the database the identification of the type of allowed global title translation in the SS7 message before and after translation type mapping. For example, you can use this command to add to the database that you want the SS7 message translation type 001 (before TT mapping) mapped to 254 (after TT mapping).

Keyword: ent-ttmap

Related Commands: chg-ttmap, dlt-ttmap, rtrv-ttmap

Command Class: Database Administration

Parameters

:ett= (mandatory)

Translation type before mapping. The identification of the type of global title translation in the SS7 message *before* translation type mapping. This attribute is the decimal representation of the 1-octet binary field used by the SS7 protocol to identify the translation type.

Range: 000–255

:io= (mandatory)

Incoming or outgoing. The system uses this parameter to indicate whether the translation type mapping data provisioned for the gateway linkset is for SS7 messages *received* or *sent* on the linkset.

Range: **i, o**

i—incoming

o—outgoing

:lsn= (mandatory)

Linkset name. The unique network identifier for the gateway linkset.

Range: 1 alphabetic character followed by 9 alphanumeric characters

:mtt= (mandatory)

Mapped translation type. The identification of the type of global title translation in the SS7 message *after* translation type mapping. This attribute is the decimal representation of the 1-octet binary field used by the SS7 protocol to identify the translation type.

Range: 000–255

Example

```
ent-ttmap:lsn=nc001:io=i:ett=128:mtt=16
```

Dependencies

The linkset must be defined.

The Translation Type Mapping table must not be full for the linkset specified in the **lsn** parameter.

Notes

None

Output

```
ent-ttmap:lsn=nc001:io=i:ett=128:mtt=16
```

```
rlghncxa03w 04-02-21 13:09:27 EST EAGLE 31.3.0
ENT-TTMAP: MASP A - COMPLTD
```

```
TTMAP table for nc001 is (2 of 64) 3% full
```

```
;
```

ent-user**Enter User**

Use this command to add a user to the database. When you first enter the command, the system prompts you for the user's password, which must follow the administered password guidelines. For security reasons, the password is not displayed. After successfully entering a user password, you are prompted to verify it by entering it again.

Keyword: ent-user

Related Commands: act-user, chg-pid, chg-user, dact-user, dlt-user, login, logout, rept-stat-user, rtrv-secu-user, rtrv-user

Command Class: Security Administration

Parameters

:uid= (mandatory)

User ID

Range: 1 alphabetic character followed by up to 15 alphanumeric characters (including asterisks, single quotes, and commas)

:all= (optional)

Specifies whether or not the user ID is assigned all non-configurable command classes (LINK, SA, SYS, PU, DB, DBG, LNP, LNPDB, LNPSUB).

Range: yes, no

Default: no

:cc1= (optional)

Configurable command class name, and indicator to specify whether the User ID can enter commands assigned to the specified command class.

Range: 1 alphabetic character followed by 2 alphanumeric characters (ayy), followed by -no or -yes

Default: Current value

:cc2= (optional)

Configurable command class name, and indicator to specify whether the User ID can enter commands assigned to the specified command class.

Range: 1 alphabetic character followed by 2 alphanumeric characters (ayy), followed by -no or -yes

Default: Current value

:cc3= (optional)

Configurable command class name, and indicator to specify whether the User ID can enter commands assigned to the specified command class.

Range: 1 alphabetic character followed by 2 alphanumeric characters (ayy), followed by -no or -yes

Default: Current value

:cc4= (optional)

Configurable command class name, and indicator to specify whether the User ID can enter commands assigned to the specified command class.

Range: 1 alphabetic character followed by 2 alphanumeric characters (ayy), followed by -no or -yes

Default: Current value

:cc5= (optional)

Configurable command class name, and indicator to specify whether the User ID can enter commands assigned to the specified command class.

Range: 1 alphabetic character followed by 2 alphanumeric characters (ayy), followed by **-no** or **-yes**

Default: Current value

:cc6= (optional)

Configurable command class name, and indicator to specify whether the User ID can enter commands assigned to the specified command class.

Range: 1 alphabetic character followed by 2 alphanumeric characters (ayy), followed by **-no** or **-yes**

Default: Current value

:cc7= (optional)

Configurable command class name, and indicator to specify whether the User ID can enter commands assigned to the specified command class.

Range: 1 alphabetic character followed by 2 alphanumeric characters (ayy), followed by **-no** or **-yes**

Default: Current value

:cc8= (optional)

Configurable command class name, and indicator to specify whether the User ID can enter commands assigned to the specified command class.

Range: 1 alphabetic character followed by 2 alphanumeric characters (ayy), followed by **-no** or **-yes**

Default: Current value

:db= (optional)

Access to all commands in command class Database Administration.

Range: **yes, no**

Default: **no**

:dbg= (optional)

Access to all commands in command class Debug.

Range: **yes, no**

Default: **no**

:link= (optional)

Access to all commands in command class Link Maintenance.

Range: **yes, no**

Default: **no**

:lnpbas= (optional)

Access to all commands in the command class LNP Basic

Range: **yes, no**

Default: **no**

:lnpdb= (optional)

Access to all commands in the command class LNP Database

Range: yes, no

Default: no

:lnpsub= (optional)

Access to all commands in the command class LNP Subscription

Range: yes, no

Default: no

:page= (optional)

The maximum age of the password, in days. The STP automatically prompts the user for a new password at login if the user's password is older than the value specified for the **page** parameter.

Range: 0-999 days

Default: The value specified for the **page** parameter on the **chg-secu-dflt** command

:pu= (optional)

Access to all commands in command class Program Update.

Range: yes, no

Default: no

:revoke= (optional)

Revoke the user ID. The system rejects login attempts for a revoked user ID.

Range: yes, no

Default: no

:sa= (optional)

Access to all commands in command class Security Administration.

Range: yes, no

Default: no

:sys= (optional)

Access to all commands in command class System Maintenance.

Range: yes, no

Default: no

:uout= (optional)

User ID aging interval. The number of successive days a user ID can go unused (that is, no successful login) before the system denies login of that user ID.

Range: 0-999 days

Default: The value specified for the **uout** parameter on the **chg-secu-dflt** command

Example

```
ent-user:uid=john:db=yes
```

```
ent-user:uid=john*mayer:db=yes
```

```
ent-user:uid=user123:cc5=u21-yes:cc8=u32-yes
```

Dependencies

Passwords cannot be created or modified from a telnet terminal (terminal IDs 17-40) without the OA&M IP Security Enhancements feature turned on.

All new users are given access to the command class Basic as a default.

The specified user ID cannot already exist.

The LNP feature must be turned on (see the **enable-ctrl-feat** command) before the **lnpbas**, **lnpdb**, and **lnpsub** parameters can be specified.

If the **all=yes** parameter is specified, and the LNP feature has not been turned on, the **lnpbas**, **lnpdb**, and **lnpsub** parameter values default to **no**.

The user IDs **seas** or **none** cannot be entered because they are reserved for system use. Up to 100 users can be entered.

The **revoke=yes** parameter cannot be specified for a user ID with system administration authorization.

The Command Class Management feature must be enabled before a configurable command class name can be specified in the **cc1-cc8** parameters.

The **cc1-cc8** parameter values must have valid default or provisioned configurable command class names. Default names are **u01-u32**.

Notes

To disable user ID aging, specify the **uout=0** parameter.

The *Database Administration Manual - SS7* provides a list of all commands allowed within each command class.

Up to 8 configurable command class name parameters can be specified in one command. Additional commands can be entered to assign user access for more than 8 names. To assign user access for all 32 available configurable command class names, four commands could be entered with 8 names specified in each command.

A password must be entered for the newly-created userID. The system issues a separate prompt for this password and disables character echo at the terminal so that the entered password is not displayed on the screen.

After the password has been entered, the system issues a second prompt, and the password must be entered again. This ensures that no typing mistakes were made on the first entry.

Use the following rules for creating passwords:

- A new password cannot contain more than 12 characters.
- A new password must contain at least the number of characters that is specified in the **minlen** parameter of the **chg-secu-dflt** command.
- A new password must contain at least the number of alphabetic (**alpha** parameter), numeric (**num** parameter), and punctuation (**punc** parameter) characters that is specified in the **chg-secu-dflt** command.
- A new password cannot contain the associated user ID.

Output

```
ent-user:uid=john*mayer:db=yes
rlghncxa03w 04-01-07 11:11:28 EST EAGLE 31.3.0
ENT-USER: MASP A - COMPLTD
;
```

ent-vendid

Enter Vendor ID

Use this command to enter elements into the Vendor ID list, for the GSM MAP SRI Redirect to Serving HLR (also called GSM MAP SRI Redirect) feature. Each entry is identified by the Vendor ID and the Vendor number.

The Vendor ID length (**vendidlen** parameter) must be entered first, before the command is entered the second time to enter the Vendor ID and Vendor Number.

Keyword: ent-vendid

Related Commands: dlt-vendid, rtrv-vendid

Command Class: Database Administration

Parameters

:vendid= (optional)

Vendor ID

Range: 0-FFFFFFFFFFFFFFF

0-15 digits; the entry must contain the number of digits defined by the **vendidlen** parameter value. Valid digits are **0-9, A-F, and a-f**.

:vendidlen= (optional)

Vendor ID Length. All Vendor IDs defined for the GSM MAP SRI Redirect for Serving HLR feature must contain this number of digits.

Range: 0-15

:vendnum= (optional)

Vendor Number. The Vendor Number is used as a reference to the prefix for the GSM MAP SRI Redirect for Serving HLR feature.

Range: 1-3

1—Corresponds to the prefix defined with prefix number 1 (see the **chg-prefix** command).

2—Corresponds to the prefix defined with prefix number 2 (see the **chg-prefix** command).

3—Corresponds to the prefix defined with prefix number 3 (see the **chg-prefix** command).

:vendtype= (optional)

Vendor Type. The Vendor Type is used with the GSM MAP SRI Redirect for Serving HLR feature to allow multiple networks for the same equipment vendor.

Range: 1-2

Example

```
ent-vendid vend:len=6
```

```
ent-vendid:vendid=886933:vendnum=1:vendtype=1
```

Dependencies

The value **none** cannot be specified for the **vendid** parameter.

The GSM MAP SRI Redirect feature must be enabled before this command can be entered.

The VENDID table can contain a maximum of 200 entries.

The specified ID entry cannot already exist in the VENDID table.

All VENDID table entries must have the number of digits defined by the **vendidlen** parameter value.

The prefix with the same prefix number as the specified Vendor Number must already be provisioned for the GSM MAP SRI Redirect feature.

The Vendor ID length cannot be changed unless the VENDID table is empty. All Vendor IDs must be deleted from the table before a different Vendor ID length can be entered.

The Vendor ID length must be entered before any Vendor IDs can be defined.

The **vendidlen** parameter cannot be specified in the same command with the **vendid**, **vendidlen**, and **vendtype** parameters. Either the **vendidlen** parameter, or the **vendid**, **vendidlen**, and **vendtype** parameters can be specified in one command.

Notes

None.

Output

The Vendor ID length must be entered first, before any Vendor IDs can be entered.

ent-vendid:vendidlen=6

```
rlghncxa03w 04-10-07 11:11:28 EST EAGLE 31.11.0
ENT-VENDID: MASP A - COMPLTD
```

;

ent-vendid:vendid=886933:vendnum=1:vendtype=1

```
rlghncxa03w 04-10-07 11:11:28 EST EAGLE 31.11.0
VENDID table is (6 of 200) 3% full
ENT-VENDID: MASP A - COMPLTD
```

;

ent-x25-dstn

Enter X.25 Destination

Use this command to associate an X.25 network address with an existing SS7 point code in the routing table, and optionally, a subsystem within that point code. If the node is actually in the X.25 domain, the X.25 address is a real network address and the point code is a dummy point code. If the node is in the SS7 domain, the point code is a real SS7 point code and the X.25 address is a dummy address.

Keyword: ent-x25-dstn

Related Commands: chg-x25-dstn, dlt-x25-dstn, rtrv-x25-dstn

Command Class: Database Administration

Parameters

:dpc= or :dpca= (mandatory)

This parameter is the real SS7 point code assigned to a real SS7 node or the dummy point code for an X.25 destination entity. The value for this parameter is a point code with subfields network indicator-network cluster-network cluster member (*ni-nc-ncm*).

Range: 000-255

Specify a valid value for each subfield of the point code, and separate the subfields with a dash (-).

When **chg-sid:pctype=ansi** is specified, *ni* = **000** is not valid.

When **chg-sid:pctype=ansi** is specified, *nc* = **000** is not valid if *ni* = **001-005**.

When **chg-sid:pctype=ansi** is specified, *nc* = **000** is valid if *ni* = **006-255**.

The point code **000-000-000** is not a valid point code.

:xaddr= (mandatory)

The X.25 network address of the X.25 destination entity or the SS7 node.

Range: A number consisting of 4-15 digits.

:ssn= (optional)

The subsystem number of the destination that is assigned to the X.25 address or the SS7 address.

Range: 1-255

Default: 5

Example

```
ent-x25-dstn:xaddr=220525586456772:dpc=133-013-001:ssn=123
```

```
ent-x25-dstn:xaddr=255864567:dpc=033-001-013
```

Dependencies

Each X.25 address must have at least four digits.

The DPC must exist in the destination table.

The X.25 SS7 ANSI destination point code must be a full point code (*ni-nc-ncm*).

The X.25 address cannot exist in X.25 destination table.

The maximum number of X.25 destinations is 1024.

Notes

None

Output

```
ent-x25-dstn:xaddr=220525586456772:dpc=133-013-001:ssn=123
```

```
rlghncxa03w 04-02-10 11:43:04 EST EAGLE 31.3.0
```

```
X.25 DSTN TABLE 45 % FULL
```

```
ENT-X25-DSTN: MASP A - COMPLTD
```

```
;
```

ent-x25-rte**Enter X.25 Route**

Use this command to define the routing parameters needed by the gateway portion of the LIMs with the LIMs with the **ss7gx25** application for establishing a virtual circuit that is permanently maintained by the system STP.

Keyword: ent-x25-rte

Related Commands: chg-x25-rte, dlt-x25-rte, rtrv-x25-rte

Command Class: Database Administration

Parameters

:saddr= (mandatory)

The alias X.25 address assigned to the SS7 destination entity on the SS7 side of the circuit.

Range: A number consisting of 4–15 digits

:type (mandatory)

The type of X.25 connection that the link is expected to maintain.

Range: pvc, svca, svcr

pvc—Permanent virtual circuit

svca—automatic virtual circuit

svcr—remote virtual circuit

:xaddr= (mandatory)

The X.25 address assigned to the X.25 destination entity on the X.25 side of the circuit.

Range: A number consisting of 4–15 digits

lc= (optional)

The number of the logical channel on the X.25 signaling link to which the PVC connection is assigned. This parameter is mandatory if the **type=pvc** parameter is specified. If the **type=svca** or **type=svcr** parameters are specified, the logical channel number is arbitrary and cannot be specified.

Range: 1-255

Default: The logical channel is not given.

lc2nm= (optional)

Invokes SS7 MTP network management for failures and recoveries of logical channels.

Range: yes, no

Default: yes—if rt=xpc is specified

no—if rt=pc is specified

no—if rt is not specified

:loc= (optional)

The card location containing the X.25 signaling link that will maintain the connection. For an automatic virtual circuit, this link is the link on which the system STP initially attempts the connection. However, if this attempt fails, the connection may be established by the X.25 destination entity on any other link in this link's linkset.

Range: 1101–1108, 1111–1112, 1201–1208, 1211–1218, 1301–1308, 1311–1318, 2101–2108, 2111–2118, 2201–2208, 2211–2218, 2301–2308, 2311–2318, 3101–3108, 3111–3118, 3201–3208, 3211–3218, 3301–3308, 3311–3318, 4101–4108, 4111–4118, 4201–4208, 4211–4218, 4301–4308, 4311–4318, 5101–5108, 5111–5118, 5201–5208, 5211–5218, 5301–5308, 5311–5318, 6101–6108, 6111–6118

Default: The card location is not given

:port= (optional)

The port on the card containing the X.25 signaling link.

Range: a

Default: The port is not given

:rt= (optional)

The type of routing to perform for messages originating in the SS7 domain and destined for the X.25 domain. Two types of routing are available: (1) Route on X.25 destination point code (XPC) and (2) Route using X.25 origination and destination point code combinations (PC).

Range: xpc, pc

Default: pc

Example

```
ent-x25-rte:xaddr=225255:saddr=133131:type=pvc:loc=1201:port=a:lc=3
```

```
ent-x25-rte:xaddr=225255:saddr=133132:type=svca:loc=1201:port=a
```

```
ent-x25-rte:xaddr=225255:saddr=133132:type=svcr
```

```
ent-x25-rte:xaddr=225255:saddr=133132:type=svcr:rt=xpc:lc2nm=yes
```

Dependencies

Each X.25 address must have at least four digits.

The **limds0**, **limdscs**, **limocu** and **limv35** card types are the only valid card types for this command. These card types must be running the **ss7gx25** GPL type.

The shelf and card must be equipped.

The logical channel number cannot be specified if the connection type is an automatic virtual circuit or a remote virtual circuit (**type=svca** or **type=svcr**).

The logical channel number must be specified if the connection type is PVC (**type=pvc**).

If **lc2nm=yes** is specified, **rt=xpc** must be specified.

If the X.25 domain destination is an adjacent entity, **lc2nm=no** must be specified.

The **loc** and **port** parameters cannot be specified if the connection type is a remote switched virtual circuit (**type=svcr**). The far end initiates a remote switched virtual circuit and sends the system the location and port information.

The card location (**loc**) must be specified if the connection type is a permanent virtual circuit or an automatic virtual circuit (**type=pvc** or **type=svca**).

Each X.25 address must exist in X.25 destination table.

The X.25 address must be assigned to a destination in the X.25 domain.

The SS7 address must be assigned to a destination in the SS7 domain.

The combination of the two X.25 addresses must be unique in the X.25 route table.

The combination of point code/SSNs assigned to the two X.25 addresses must be unique in the X.25 route table.

The maximum number of X.25 routes in a system is 1024.

The point codes assigned to each of the X.25 destinations must also be assigned to routes.

The signaling link must be assigned to a LIM with the **ss7gx25** application.

The signaling link assigned to the X.25 route must be in the database and must be assigned to a linkset. The linkset must be assigned to a route associated with an X.25 destination and must contain an APC in the X.25 domain. This can be verified by entering the following commands:

- **rtrv-slk**—Displays the signaling links
- **rtrv-ls**—Displays the linksets
- **rtrv-rte**—Displays the routes
- **rtrv-x25-dstn**—Displays the X.25 destinations
- **rtrv-dstn**—Displays the destination point codes.

The logical channel number cannot be greater than the maximum number of permanent virtual circuits allowed for the signaling link. For example, if the total number of permanent virtual circuits allowed for the signaling link is 15, the logical channel number for this signaling link cannot be greater than 15.

The logical channel of the signaling link cannot already be assigned to an X.25 route.

The number of permanent virtual circuits cannot exceed the maximum number of permanent virtual circuits defined for the signaling link.

The number of automatic virtual circuits cannot exceed the maximum number of switched virtual circuits defined for the signaling link.

If **rt=xpc** is specified, the **xaddr** parameter's alias SS7 point code must be unique in the X.25 route table.

Notes

The connection can be one of three types, a permanent virtual circuit, an automatic virtual circuit, or a remote virtual circuit.

Permanent virtual circuits are permanent X.25 virtual connections between two signaling points established on one of the logical channels of an X.25 signaling link. This connection is setup by the network, therefore no setup is required by the system to establish a permanent virtual circuit connection.

Automatic virtual circuits are essentially the same as permanent virtual circuits, except that the connection must be established by either the system or the X.25 destination entity.

Remote virtual circuits are also essentially the same as automatic virtual circuits, except that the connection can be established only by the X.25 destination entity.

All LIMs with the **ss7gx25** application share this information. Even though these connections apply to only one card, they are used by all cards.

Output

```
ent-x25-rte:xaddr=225255:saddr=133131:type=pvc:loc=1201:port=a:lc=3
  rlgncxa03w 04-02-10 11:43:04 EST EAGLE 31.3.0
  ENT-X25-RTE: MASP A - X.25 Route table 45% full
  ENT-X25-RTE: MASP A - COMPLTD
;
```

flash-card**Flash-Card**

Use this command to load all flash images (GPL) supported by a specified card. This command performs the same functions as the **init-flash** and the **act-flash** commands.

Keyword: flash-card

Related Commands: act-flash, init-flash

Command class: System Maintenance

Parameters

:code= (mandatory)

The GPL type to be loaded.

Range: **appr**, **trial**

appr—Approved GPL

trial—Trial GPL

:loc= (mandatory)

Card address. The location of the card as stenciled on the shelf of the system.

Range: **1101–1112, (1113 and 1115 OAM), 1201–1218, 1301–1318, 2101–2118, 2201–2218, 2301–2318, 3101–3118, 3201–3218, 3301–3318, 4101–4118, 4201–4218, 4301–4318, 5101–5118, 5201–5218, 5301–5318, 6101–6118**

:force= (optional)

This parameter is used to force the command to work on an IS-NR card. Links provisioned on the card are inhibited during command execution. The card and inhibited links are restored to their previous state when the command is completed.

Range: **yes**, **no**

Default: **no**

Example

```
flash-card:loc=1105:code=trial
```

```
flash-card:loc=1105:code=appr:force=yes
```

Dependencies

CAUTION: Possible loss of traffic. Use of the force parameter to flash an active running card inhibits the links and could result in a loss of traffic.

A related command must not be in progress.

Cards do not have to be provisioned to use the **flash-card** command. However, if the specified card is provisioned and not inhibited, use of the **force** parameter is required.

The specified card locations must be running a flashable software image.

HMUX or HIPR cards are not supported.

If the even-numbered TDM (1114,1116) is specified, the flash occurs on the odd-numbered GPSM-II running OAM (1113,1115).

The specified card location cannot be the active MASP (either the active GPSM-II or the active TDM).

Notes

The specified card must be present and able to communicate over the IMT.

A card that is already running the specified code load cannot be reflashed using the **force** parameter. The **act-flash** and **init-flash** commands must then be used to reload the same code level.

Output

flash-card:loc=1105:code=trial

```

tekelecstp 05-04-11 01:52:11 EST EAGLE5 Rel 34.0.0
Flash Card: Downloading BLBIOS on card 1105.
;
tekelecstp 05-04-11 01:52:11 EST EAGLE5 Rel 34.0.0
Flash Card: Card 1105 download BLBIOS complete.
;
tekelecstp 05-04-11 01:52:11 EST EAGLE5 Rel 34.0.0
Flash Card: Downloading BLDIAG on card 1105.
;
tekelecstp 05-04-11 01:52:11 EST EAGLE5 Rel 34.0.0
Flash Card: Card 1105 download BLDIAG complete.
;
tekelecstp 05-04-11 01:52:11 EST EAGLE5 Rel 34.0.0
Flash Card: Downloading PLDE1T1 on card 1105.
;
tekelecstp 05-04-11 01:52:11 EST EAGLE5 Rel 34.0.0
Flash Card: Card 1105 download PLDE1T1 complete.
;
tekelecstp 05-04-11 01:52:11 EST EAGLE5 Rel 34.0.0
Flash Card: Downloading IMTPCI on card 1105.
;
tekelecstp 05-04-11 01:52:11 EST EAGLE5 Rel 34.0.0
Flash Card: Card 1105 download IMTPCI complete.
;
tekelecstp 05-04-11 01:52:11 EST EAGLE5 Rel 34.0.0
Flash Card: Downloading BLVXW on card 1105.
;
tekelecstp 05-04-11 01:52:11 EST EAGLE5 Rel 34.0.0
Flash Card: Card 1105 download BLVXW complete.
;
tekelecstp 05-04-11 01:52:11 EST EAGLE5 Rel 34.0.0
Flash Card: Downloading PLDPMC1 on card 1105.
;
tekelecstp 05-04-11 01:52:11 EST EAGLE5 Rel 34.0.0
Flash Card: Card 1105 download PLDPMC1 complete.
;
tekelecstp 05-04-11 01:52:11 EST EAGLE5 Rel 34.0.0
Flash Card: Activating BLBIOS on card 1105.
;
tekelecstp 05-04-11 01:52:11 EST EAGLE5 Rel 34.0.0
Flash Card: Card 1105 activation BLBIOS complete.
;

```

```
tekelecstp 05-04-11 01:52:11 EST EAGLE5 Rel 34.0.0
Flash Card: Activating BLDIAG on card 1105.
;
tekelecstp 05-04-11 01:52:11 EST EAGLE5 Rel 34.0.0
Flash Card: Card 1105 activation BLDIAG complete.
;
tekelecstp 05-04-11 01:52:11 EST EAGLE5 Rel 34.0.0
Flash Card: Activating PLDE1T1 on card 1105.
;
tekelecstp 05-04-11 01:52:11 EST EAGLE5 Rel 34.0.0
Flash Card: Card 1105 activation PLDE1T1 complete.
;
tekelecstp 05-04-11 01:52:11 EST EAGLE5 Rel 34.0.0
Flash Card: Activating IMTPCI on card 1105.
;
tekelecstp 05-04-11 01:52:11 EST EAGLE5 Rel 34.0.0
Flash Card: Card 1105 activation IMTPCI complete.
;
tekelecstp 05-04-11 01:52:11 EST EAGLE5 Rel 34.0.0
Flash Card: Activating BLVXW on card 1105.
;
tekelecstp 05-04-11 01:52:11 EST EAGLE5 Rel 34.0.0
Flash Card: Card 1105 activation BLVXW complete.
;
tekelecstp 05-04-11 01:52:11 EST EAGLE5 Rel 34.0.0
Flash Card: Activating PLDPMC1 on card 1105.
;
tekelecstp 05-04-11 01:52:11 EST EAGLE5 Rel 34.0.0
Flash Card: Card 1105 activation PLDPMC1 complete.
;
tekelecstp 05-04-11 01:52:11 EST EAGLE5 Rel 34.0.0
Flash Card: Downloading BLCPLD on card 1105.
;
tekelecstp 05-04-11 01:52:11 EST EAGLE5 Rel 34.0.0
Flash Card: Card 1105 download BLCPLD complete.
;
tekelecstp 05-04-11 01:52:11 EST EAGLE5 Rel 34.0.0
Flash Card: Activating BLCPLD on card 1105.
;
tekelecstp 05-04-11 01:52:11 EST EAGLE5 Rel 34.0.0
Flash Card: Card 1105 activation BLCPLD complete.
;
tekelecstp 05-04-11 01:52:11 EST EAGLE5 Rel 34.0.0
Command Completed.
```

flash-card:loc=1105:code=appr:force=yes

```
tekelecstp 05-04-11 01:52:11 EST EAGLE5 Rel 34.0.0
Flash Card: Canceling links on card 1105.
;
tekelecstp 05-04-11 01:52:11 EST EAGLE5 Rel 34.0.0
Flash Card: Inhibiting card 1105.
;
tekelecstp 05-04-11 01:52:11 EST EAGLE5 Rel 34.0.0
Flash Card: Downloading BPMP1 on card 1105.
;
tekelecstp 05-04-11 01:52:11 EST EAGLE5 Rel 34.0.0
Flash Card: Card 1105 download BPMP1 complete.
;
tekelecstp 05-04-11 01:52:11 EST EAGLE5 Rel 34.0.0
Flash Card: Allowing card 1105.
;
```

```

tekelecstp 05-04-11 01:52:11 EST EAGLE5 Rel 34.0.0
Flash Card: Activating BPMPPL on card 1105.
;
tekelecstp 05-04-11 01:52:11 EST EAGLE5 Rel 34.0.0
Flash Card: Card 1105 activation BPMPPL complete.
;
tekelecstp 05-04-11 01:52:11 EST EAGLE5 34.0.0
Flash Card: Activating links on card 1105.
;
tekelecstp 05-04-11 01:52:11 EST EAGLE5 34.0.0
Command Completed.
;

```

format-disk

Format Disk

Use this command to format and initialize a system removable cartridge or standby Terminal Disk Module (TDM).

NOTE: The **format-disk** command leaves the disk unusable until the **chg-db** and **copy-gpl** commands are entered.

Keyword: **format-disk**

Related Commands: **chg-db**, **copy-disk**, **copy-gpl**, **copy-meas**, **disp-disk-dir**, **rept-stat-db**, **rtrv-gpl**

Command Class: System Maintenance

Parameters

:type= (mandatory)

The type of removable cartridge to format.

Range: **fixed**, **meas**, **system**

fixed—The standby fixed disk on the standby TDM

meas—The measurement cartridge

system—The system cartridge

:force= (optional)

This parameter provides some protection against data loss due to reformatting a used system removable cartridge.

Range: **yes**, **no**

Default: **no**

:low= (optional)

This parameter provides control over whether a low-level format will be performed on the target disk. Specifying **low=no** can be used to decrease formatting time.

Range: **yes**, **no**

Default: **no**

Example

```
format-disk:type=system
```

```
format-disk:type=meas:force=yes
```

Dependencies

The EOAM GPL version that is running in the active OAM card location must be the same GPL version that is running in the standby OAM card location.

To format a cartridge that already contains system data, the **force=yes** parameter must be specified.

The **force=yes** parameter must be specified if the cartridge to be formatted is recognized as a system removable cartridge. This parameter is optional if the cartridge is not recognized as a system removable cartridge. Only cartridges that have a **dms.cfg** file are recognized as system removable cartridges.

Measurements collection must be inhibited during execution of the **format-disk** command. If measurements are not inhibited, **format-disk** cannot be executed.

- Do not enter the **chg-measopts:collect=on** command while the **format-disk** command is in progress. This results in read and write errors, because the standby disk is not accessible.
- Do not enter **format-disk** until the 30 minute measurements processing or the midnight measurements processing has completed, because inhibiting measurements during these periods results in the loss of measurement data for the period being processed.

OAM Measurements collection cannot be in progress when this command is entered. Retry the command after a period of waiting for the measurements collection to complete.

If the **force=yes** parameter is specified, the disk should not require low-level formatting, and the **format=no** parameter should be specified.

Notes

The **low=no** parameter should be specified when upgrading a spare TDM. The **low=yes** parameter should be specified when there is a suspected hardware problem.

When the **type=meas** parameter is specified, a measurements removable cartridge is built.

When the **type=system** parameter is specified, a system removable cartridge is built.

A system removable cartridge can contain only GPLs and the database. Measurement data cannot be placed on a system removable cartridge. After a system removable cartridge is formatted, the cartridge does not contain any data, but is ready to be used as the destination disk of the **copy-gpl** and **chg-db:action=backup:dest=remove** commands. The **copy-gpl** command copies all approved GPLs from the fixed disk on the active TDM to a system removable cartridge, providing a backup copy of the approved GPLs. The **chg-db:action=backup:dest=remove** command copies the database from the current partition of the fixed disk on the active TDM to a system removable cartridge, providing a backup copy of the database.

A measurements removable cartridge can contain only measurement data. Database information and GPLs cannot be placed on a measurements removable cartridge. After a measurements removable cartridge is formatted, the cartridge does not contain any data, but is ready to be used as the destination disk of the **copy-meas** command. The **copy-meas** command copies all measurement data from the fixed disk on the active TDM to a measurements removable cartridge for offline processing of the measurement data.

The database audit and GPL audit facilities are automatically disabled during execution of this command. When this command has completed (successful or not), the database and GPL audit facilities are automatically re-enabled.

All commands that affect the database are disallowed for the duration of the command. Attempts to use such commands are rejected, and an error message is displayed explaining that the command has been rejected.

During the upgrade process, files made obsolete by the upgrade process are deleted, freeing up disk space.

The format of magneto-optical removable cartridges allows the cartridges to be used in DOS/Windows environments in addition to being used on the system.

If the **format-disk** command is initiated and the standby OAM initialization is not complete, command processing is delayed. If standby initialization fails, the command proceeds to allow the standby TDM to recover from a previous **format-disk** or **copy-disk** failure. In such cases, the following messages appear:

Standby MASP has not finished initializing - please wait...

Standby MASP initialization timed out - continuing...

The **dms.cfg** file on either the active TDM or a system formatted removable cartridge is used by the **format-disk** command when formatting the target disk. The location of the **dms.cfg** file cannot be specified by the **format-disk** command. The value of the **type** parameter is used to determine the target disk to format and the location of the **dms.cfg** file on which to base the format. Table 6-17 shows the location of the **dms.cfg** file based on the value of the **type** parameter for the **format-disk** command.

Table 6-17. DMS.CFG File Location for format-disk Command

Value of the type Parameter	Target Disk (Card Location)	Location of the DMS.CFG File
fixed	Standby TDM (1114 or 1116)	Removable Cartridge (1117)
system	Removable Cartridge (1117)	Active TDM (1114 or 1116)
meas	Removable Cartridge (1117)	Active TDM (1114 or 1116)

The **format-disk** command can create a maximum disk partition size of 2047 Mbytes, based on a 16-bit cluster size. A cluster is composed of 64 512-Kilobyte sectors. The physical capacity of the disk being formatted determines the formatted size of the disk and the number of partitions created on the disk.

Table 6-18 shows the format capacities of each type of disk used on the system and the number of partitions created on each disk.

Table 6-18. Disk Format Capacity

Target Disk Type	Disk Location	Target Capacity	Number of Partitions	Formatted Size of the Partition
SyQuest Removable Cartridge	1117	256 Mbytes	1	256 Mbytes
Magneto-Optical Removable Cartridge	1117	1096 Mbytes*	1	1024 Mbytes
TDM	1114 or 1116	540 Mbytes	1	507 Mbytes
TDM	1114 or 1116	2 Gigabytes	1	2014 Mbytes
TDM	1114 or 1116	4 Gigabytes	2	2047 Mbytes

* The magneto-optical removable cartridge is a double-sided cartridge that contains 2.3 gigabytes of data, but only one side of the disk can be formatted and used when it is inserted into the removable cartridge drive. The target capacity given for the magneto-optical removable cartridge is for one side of the disk in the cartridge and is approximately one half of the total capacity of the magneto-optical removable cartridge.

Output

format-disk:type=system

```
rlghncxa03w 04-01-07 00:57:31 EST EAGLE 31.3.0
Format-disk of system removable cartridge started.

rlghncxa03w 04-01-07 00:57:31 EST EAGLE 31.3.0
Format-disk (removable cartridge) format in progress.

rlghncxa03w 04-01-07 00:57:31 EST EAGLE 31.3.0
Format-disk (removable cartridge) format in progress.

rlghncxa03w 04-01-07 00:57:31 EST EAGLE 31.3.0
Format-disk (removable cartridge) format is complete.

rlghncxa03w 04-01-07 00:57:31 EST EAGLE 31.3.0
Format-disk of system removable cartridge completed.
Measurements collection may be turned on now if desired.
```

;

format-disk:type=fixed:low=no:force=yes

```
rlghncxa03w 04-01-07 00:57:31 EST EAGLE 31.3.0
Format-disk of standby fixed disk started.
Extended processing required, please wait.

rlghncxa03w 04-01-07 00:57:31 EST EAGLE 31.3.0
Format-disk (fixed) format in progress.

rlghncxa03w 04-01-07 00:57:31 EST EAGLE 31.3.0
Format-disk of standby fixed disk completed.
Measurements collection may be turned on now if desired.
```

;

inh-alm**Inhibit Alarm Reporting**

Use this command to inhibit the reporting of alarms for the given device. Inhibited alarms will not generate unsolicited output or cause alarm indicators to be turned on. All **rept-stat-xxx** commands continue to display the alarm with an indication that the device has its alarms inhibited.

The frame alarm LEDs are off for the inhibited alarm. This command does not affect the alarm counts on the VT320 banner. The fourth box on the right of the VT320 Control Area indicates the number of devices in the system with inhibited alarms.

Keyword: inh-alm

Related Commands: rept-stat-alm, rept-stat-card, rept-stat-cdt, rept-stat-dlk, rept-stat-dstn, rept-stat-ls, rept-stat-rte, rept-stat-seas, rept-stat-slk, rept-stat-sys, rept-stat-trbl, rept-stat-trm, rtrv-log, unhb-alm

Command Class: System Maintenance

Parameters

NOTE: See “Point Code Formats and Conversion” in Appendix A for a detailed description of point code formats, rules for specification, and examples.

:dev= (mandatory)

The device for which you want to inhibit the reporting of alarms.

Range: applsock, as, card, cdt, clock, dlk, e1port, ls, lsmsconn, ndclk, ndcq3, route, seasx25, slk, t1port, trm

applsock—IP gateway application socket

as—IP gateway application Application Server

card—Cards in the database

cdt—Customer defined troubles

clock—System clock

dlk— The IP ports on the VSCCP, EROUTE, SLAN, VXWSLAN and MCP application cards.

e1port—E1 port on E1/T1 MIM or HC-MIM cards

ls—Linksets

lsmsconn—Communication link between the LSMS and the EMS

ndclk—Network Data Collection links

ndcq3—Q.3 association for the Network Data Collection

route—Route

seasx25—The SEAS X.25 links

slk—Signaling links

t1port—T1 port on E1/T1 MIM or HC-MIM cards

trm—Terminals

:asname= (optional)

Gateway Application Server name. When used with the **dev=as** parameter, this parameter can be used to inhibit alarms for the named Application Server.

Range: Up to 15 alphanumeric characters; the first character must be a letter.

:dpc/dpca/dpci/dpcn/dpcn24= (optional)

Destination point code.

:dpc= or :dpca= (optional)

ANSI destination point code with subfields network indicator-network cluster-network cluster member (*ni-nc-ncm*). The *prefix* subfield indicates a private point code (*prefix-ni-nc-ncm*).

Range: **p-, 000-255, ***

Specify a valid value for each subfield of the point code, and separate the subfields with a dash (-).

prefix—**p-**

The asterisk value (*) is not valid for the *ni* subfield.

When **chg-sid:pctype=ansi** is specified, *ni* = **000** is not valid.

When **chg-sid:pctype=ansi** is specified, *nc* = **000** is not valid if *ni* = **001-005**.

When **chg-sid:pctype=ansi** is specified, *nc* = **000** is valid if *ni* = **006-255**.

When **chg-sid:pctype=ansi** is specified, *ni*ⁱ-*-* is valid if *ni* = **006-255**.

The point code **000-000-000** is not a valid point code.

:dpci= (optional)

ITU international destination point code with subfields *zone-area-id*. The *prefix* subfield indicates a spare point code, private point code, or private and spare point code (*prefix-zone-area-id*).

Range: **s-, p-, ps-, 0-255**

Specify a valid value for each subfield of the point code, and separate the subfields with a dash (-).

The point code **0-000-0** is not a valid point code.

prefix—**s-, p-, ps-**

zone—**0-7**

area—**000-255**

id—**0-7**

:dpcn= (optional)

ITU national destination point code in the format of a 5-digit number (*nnnnn*); or 2, 3, or 4 numbers (members) separated by dashes (*m1-m2-m3-m4*) as defined by the **chg-stpopts:npcfnti** flexible point code option. A group code must be specified when the ITUDUPPC feature is turned on (*nnnnn-gc*, *m1-m2-m3-m4-gc*). The *prefix* subfield indicates a spare point code, private point code, or private and spare point code (*prefix-nnnnn*, *prefix-nnnnn-gc*, *prefix-m1-m2-m3-m4*, *prefix-m1-m2-m3-m4-gc*).

Range: **s-, p-, ps-, 0-16383, aa-zz**

Specify a valid value for each subfield of the point code, and separate the subfields with a dash (-).

prefix—**s-, p-, ps-**

nnnnn—**0-16383**

gc—**aa-zz**

m1-m2-m3-m4—**0-14** for each member; values must sum to 14

:dpcn24= (optional)

24-bit ITU national destination point code with subfields *main signaling area-sub signaling area-signaling point*. The *prefix* subfield indicates a private point code.

Range: **p-**, **000-255**
Specify a valid value for each subfield of the point code, and separate the subfields with a dash (-).

prefix—**p-**
msa—**000-255**
ssa—**000-255**
sp—**000-255**

dur= (optional)

The duration (temporary or permanent) of the alarm inhibit. A temporary duration of alarm inhibit means that if whatever caused the alarm is cleared, the alarm inhibit is cleared (that is, the device has alarms uninhibited).

Range: **perm**, **temp**

Default: **perm**—major or minor alarm
temp—critical

:e1port= (optional)

Port ID. E1 port on the specified HC-MIM card.

This parameter is mandatory if **dev=e1port** is specified.

Range: **1-8**

Ports 3 through 8 can be specified only for HC-MIM cards.

:force= (optional)

Allows critical alarms to be inhibited on a device.

This parameter is mandatory if **lvl=crit** is specified.

Range: **yes**, **no**

Default: **no**

:id= (optional)

The identification number of the customer-defined trouble (**5-16**). Customer-defined troubles **1** through **4** are generated critical alarms, and because critical alarms cannot be turned off, customer defined troubles **1** through **4** cannot be specified as values for the **id** parameter.

Range: **5-16**

:lvl= (optional)

The alarm severity level (critical, major, or minor).

Range: **crit**, **majr**, **minr**

Default: **majr**

:loc= (optional)

The card location as stenciled on the shelf of the system.

Range: **1101-1113**, **1115**, **1201-1218**, **1301-1318**, **2101-2118**, **2201-2218**, **2301-2318**,
3101-3118, **3201-3218**, **3301-3318**, **4101-4118**, **4201-4218**, **4301-4318**, **5101-5118**,
5201-5218, **5301-5318**, **6101-6118**

:lsn= (optional)

Linkset name. The name of the linkset for which the report information is to be displayed.

Range: 1 alphabetic character followed by up to 9 alphanumeric characters.

:port= or **:link=** (optional)

Signaling link on the card specified in the **loc** parameter.

Range: **a, b, a1-a31, b1-b31**

a, b—For **dev=dlk, dev=slk** for a two-port LIM

a1, a2, b1, b2—For **dev=ndclk/seasx25/lsmconn**

a, b, a1, b1, a2, b2, a3, b3—For **dev=slk** for a multi-port LIM

a, b, a1-a31, b1-b31—For **dev=slk** for an HC-MIM

:sname= (optional)

Gateway application socket. When used with the **dev=applsock** parameter, this parameter can be used to inhibit alarms for the named application socket.

Range: 1 to 15 alphanumeric characters.

:t1port= (optional)

Port ID. T1 port on the specified HC-MIM card.

This parameter is mandatory if **dev=t1port** is specified.

Range: 1-8

Ports 3 through 8 can be specified only for HC-MIM cards.

:trm (optional)

Terminal ID.

Range: 1-40

Example

inh-alm:dev=route:dpc=1-1-1:dur=perm:lvl=crit:force=yes

Dependencies

This command is not allowed in upgrade mode.

Table 6-19 shows the valid parameter combinations for the **inh-alm** command. The **dur** and **lvl** parameters are valid with all **dev** parameter values.

Table 6-19. Parameter Combinations for the **inh-alm** command

Value (:dev)	a								l								
Device Parameter	p			c		e		s	n	n	r	a					
	l			l		p		c	d	d	o	s					
	s		a	c	o	d	o	o	c	c	u	x	s	o	t		
	o		r	d	c	k	k	t	n	l	q	t	2	l	r	r	
	c		d	t	k	k	t	s	n	k	3	e	5	k	t	m	
No Parameters					x						x						
:sname		x															
:dpc/dpca/dpci/dpcn/dpcn24												x					
:id				x													
:loc			x			x	x							x	x		
:lsn								x									

Table 6-19. Parameter Combinations for the **inh-alm** command (Continued)

Value (:dev)	a								l								
Device Parameter	s	c	a	c	o	d	o	l	s	n	n	r	a	s		t	
	k	d	r	t	k	k	t	s	n	k	3	e	5	k	t	r	m
:e1port=1-8							x										
:link=a, b						x								x			
:link=a, b, a1, a2, b1, b2, a3, a3														x			
:link=a1, a2, b1, b2									x	x			x				
:sname	x																
:t1port=1-8																x	
:trm																	x

No other action command can be in progress when this command is entered.

The linkset specified by the **lsn** parameter must be equipped in the database.

This command will not execute while the signaling link is running either a Link Fault Sectionalization test or a Loopback test. An AST of LFS or LPBK must be cleared before signaling link alarms can be inhibited.

This command cannot be used to permanently inhibit XLIST point codes.

Before critical alarms can be inhibited, the STP option **criticalminh** must be enabled. The **chg-stpopts:criticalminh=yes** command enables this option.

Alarms cannot already be inhibited for the specified device.

When the **lvl=crit** parameter is specified, the **force=yes** parameter must be specified.

When the **dev=card** parameter is specified, the **loc** parameter must be specified.

When the **dev=dlk** parameter is specified, the **loc** parameter must be specified.

When the **dev=slk** parameter is specified, the **loc** parameter and the **link** parameter must be specified.

When the **dev=ndclk** parameter is specified, the **link** parameter must be specified. The range of values for the **link** parameter is as follows:

- a1—EMDC A to EMAP A link
- a2—EMAP A to NDC OS link
- b1—EMDC B to EMAP B link
- b2—EMAP B to NDC OS link

When the **dev=e1port** parameter is specified, the **loc** parameter and the **e1port** parameter must be specified.

When the **dev=t1port** parameter is specified, the **loc** parameter and the **t1port** parameter must be specified.

When the **dev=ls** parameter is specified, the **lsn** parameter must be specified.

When the **dev=trm** parameter is specified, the **trm** parameter must be specified.

When the **dev=cdt** parameter is specified, the **id** parameter must be specified.

When the **dev=seasx25** parameter is specified, the **link** parameter must be specified.

When the **dev=lsmsconn** parameter is specified, the **link** parameter must be specified.

When the **dev=route** parameter is specified, a **dpc/dpca/dpci/dpcn/dpcn24** parameter must be specified.

When the **dev=applsock** parameter is specified, the **sname** parameter must be specified.

When the **dev=as** parameter is specified, the **asname** parameter must be specified.

If the **sname** parameter is specified, the socket name must exist in the IPASOCK table.

If a point code parameter is specified, the point code must exist in the Routing table.

If the **dev=slk** parameter or **dev=dlk** parameter is specified, the specified **link** must exist in the database.

If the **dpcn** parameter is specified, its format must match the format that was assigned with the **chg-stpopts:npcfmti** parameter.

The card location that is specified in the **loc** parameter must be equipped.

The specified device type must be supported by the card in the specified card location.

Notes

If critical alarms are inhibited, all alarms (critical, major, and minor) are disabled. Likewise, if major alarms are inhibited, both major and minor alarms are disabled.

The **dur** parameter allows alarms to be inhibited on a temporary basis. If a device has its alarms temporarily disabled, the device's alarms are automatically enabled after the alarm clears.

In this command, only ITU-international and ITU national point codes support the spare point code subtype prefix (**s-**) and the private and spare point code subtype prefix (**ps-**). All of the point code types support the private (internal) point code subtype prefix (**p-**).

The EMDC card provisioned in the lowest IMT address is defined as EMDC A. The mated EMAP is defined as EMAP A. If a second EMDC card is provisioned in the system, the EMDC card at the higher IMT address and its mated EMAP are defined EMDC B and EMAP B.

Output

```
inh-alm:dev=route:dpc=1-1-1:dur=perm:lvl=crit
```

```
rlghncxa03w 04-02-23 13:20:59 EST EAGLE 31.3.0
Alarms are permanently inhibited.
```

```
;
```

```
rlghncxa03w 04-02-23 13:20:59 EST EAGLE 31.3.0
Command Completed.
```

```
;
```

inh-card

Inhibit Card

Use this command to change the state of the card from in-service normal (IS-NR) to Out-of-Service Maintenance-Disabled (OOS-MT-DSBLD). A technician then can test the DCM/LIM/ACM/TSM/DSM/GPSM-II/MIM card or physically remove it from the shelf.

Keyword: inh-card

Related Commands: alw-card, dlt-card, ent-card, init-card, rept-stat-card, rmv-card, rst-card, rtrv-card

Command Class: System Maintenance

Parameters

:loc= (mandatory)

Card address. The card location as stenciled on the shelf of the system.

Range: 1101-1108, 1111-1112, 1201-1208, 1211-1218, 1301-1308, 1311-1318, 2101-2108, 2111-2118, 2201-2208, 2211-2218, 2301-2308, 2311-2318, 3101-3108, 3111-3118, 3201-3208, 3211-3218, 3301-3308, 3311-3318, 4101-4108, 4111-4118, 4201-4208, 4211-4218, 4301-4308, 4311-4318, 5101-5108, 5111-5118, 5201-5208, 5211-5218, 5301-5308, 5311-5318, 6101-6108, 6111-6118

:force= (optional)

Force indicator. This parameter is required when this card is the last card supporting a linkset, SCCP subsystem, MPS-to-DSM connection, E1, T1, Measurements Platform subsystem, or GLS. This parameter is also required if the TDM contains a security log with un-uploaded entries or any other TDM process in progress.

- The specified card is the last card supporting a linkset, SCCP subsystem, MPS-to-DSM connection, E1, T1, Measurements Platform subsystem, or GLS.
- The TDM contains a security log with un-uploaded entries or any other TDM process in progress.
- The specified HC-MIM card is in channel bridging mode.

Range: yes, no

Default: no

Example

```
inh-card:loc=1101
```

```
inh-card:loc=1201:force=yes
```

Dependencies

No other action commands can be in progress when this command is entered.

The card must be a TSM, ACM, DCM, DSM, LIM, GPSM-II, E1/T1 MIM, or HC-MIM.

The card location cannot be 1114, 1116, or 1117.

If the card is the only linkset, SCCP, or GLS card remaining, the **force=yes** parameter must be specified in the command to inhibit the card.

If the card contains signaling or data links, all links must be out of service (OOS-MT-DSBLD) before the card can be inhibited.

If the card is type **lime1**, all signaling links providing timeslots serviced by the E1 interfaces assigned to the card must be deactivated, unless **force=yes** is specified.

If the card is type **limt1**, all signaling links providing timeslots serviced by the T1 interfaces assigned to the card must be deactivated, unless **force=yes** is specified.

The shelf and card must be equipped.

If the specified card is the only in-service EMDCA-DCM or MPS-DSM the **force=yes** parameter is required.

If the specified card is the only in-service TSM, LIM, or MCPM, the **force=yes** parameter is required.

If the specified HC-MIM card is in channel bridging mode, the **force=yes** parameter is required.

If inhibiting the VSCCP card would cause less than 80% of the in-service normal (IS-NR) LIM cards to have VSCCP service (i.e., cause the system to enter an unstable loading mode), the **force=yes** parameter must be specified.

The card that is specified cannot be running the active OAM.

Notes

The function of this command is the same as the **rmv-card** command.

When this command is entered, the card is initialized and enters the OOS-MT-DSBLD state. It has no affect if the card is already OOS-MT-DSBLD.



CAUTION: You can use this command to disable Measurements Platform measurements collection after the collection function has been enabled with the **chg-measopts:platformenable=on** command. To disable collection, you must inhibit ALL MPCM cards in the system. THIS CAN RESULT IN LOSING ALL PAST MEASUREMENT DATA ON THE CARDS. (Use the **alw-card** command to enable measurements collection after the MCPM cards have been inhibited).

Output

inh-card:loc=1101

```
rlghncxa03w 04-01-07 11:11:28 EST EAGLE 31.3.0
Card has been inhibited.
```

;

inh-imt

Inhibit IMT

The interprocessor message transport bus (IMT bus) is the main communications artery between all subsystems in the system. This command removes the IMT bus from service.



CAUTION: Use this command only when directed by Tekelec Technical Service at (888) FOR-TKLC.

Keyword: inh-imt

Related Commands: alw-imt, clr-imt-stats, conn-imt, disc-imt, rept-imt-lvl1, rept-imt-lvl2, rept-stat-imt, rmv-imt, rst-imt

Command Class: System Maintenance

Parameters

:bus= (mandatory)
IMT bus to be inhibited
Range: a, b

Example

inh-imt:bus=a

Dependencies

The function of this command is the same as the **rmv-imt** command.

The alternate IMT bus must be in-service normal (IS-NR) in order for the specified bus to be inhibited.

This command cannot be entered during an IMT Fault Isolation Test.

Notes

Cards not connected to the other IMT bus will reinitialize.

All traffic is rerouted to the alternate IMT bus.

Output

inh-imt:bus=a

```
rlghncxa03w 04-01-07 11:11:28 EST EAGLE 31.3.0
Inhibit IMT Bus A command issued
```

```
rlghncxa03w 04-01-07 13:12:41 EST EAGLE 31.3.0
3116.0098 IMT BUS A IMT inhibited
```

;

inh-map-ss

Inhibit Mated Application Subsystem

Use this command to shut down (inhibit) a mated application subsystem. The command requires a parameter specifying the SSN to be inhibited. Currently, the LNPQS, INPQS, and Equipment Identity Register (EIR) subsystems are the subsystems that may be inhibited. The specified subsystem attempts a coordinated shutdown. If the coordinated shutdown fails, a UIM is issued indicating the shutdown failed. If the **force** parameter is specified, the subsystem is forced to shut down, and a coordinated shutdown is not performed.



CAUTION: After the LNP subsystem is inhibited before performing an LNP ELAP bulk download, **chg-ss-appl:appl=lnp:nstat=offline** must be entered to ensure that the subsystem remains down through DSM card replacements and reloads.

Keyword: inh-map-ss

Related Commands: alw-map-ss, rept-stat-lnp, rept-stat-sccp

Command Class: System Maintenance

Parameters

:ssn= (mandatory)

The LNP, INP, or EIR subsystem number.

Range: 12-255

:force= (optional)

Force the shutdown of the LNP, INP, or EIR subsystem.

Range: yes, no

Default: no

Example

```
inh-map-ss:ssn=10
```

```
inh-map-ss:ssn=10:force=yes
```

Dependencies

The LNP feature (see the **enable-ctrl-feat** command) or the INP feature must be turned on, or the EIR feature must be enabled and turned on, before this command can be entered.

No other action command can be in progress when this command is entered.

The specified **ssn** parameter value must represent the LNPQS, INPQS, or EIR subsystem.

The EAGLE must be configured with at least one card running the **sccp** application.

Notes

If the LNPQS subsystem is disabled, any GTT requiring Message Relay is also disabled because they both use the same database. This causes the EAGLE to generate a TFP for the EAGLE CPCs. Traffic is then routed to the mate. If both Message Relay GTT and non Message Relay GTT use the same CPC, this could affect the GTT.

Table 6-20. Route Set Test When LNP is Offline

Network Management	Concerned PC	Network Management
RSP	CPC	TFA concerning CPC
RSP	LNP CPC	None
RSP	TPC	TFA concerning TPC
RSR	CPC	TFA concerning CPC
RSR	LNP CPC	TFP concerning LNP CPC
RSR	TPC	TFA concerning TPC

Table 6-21 shows what actions EAGLE takes when LNP is offline and a message arrives requiring LNP. This table assumes that SCCP cards are available.

Table 6-21. Receiving Messages when LNP is Offline

Routing Indicator in Incoming Message	DPC	Result of GTT	Message Handling	Network Management
rt-on-gt	Capability PC	rt-on-ssn, LNP subsystem	Reroute to mate	TFP concerning CPC
rt-on-gt	True PC	rt-on-ssn, LNP subsystem	Reroute to mate	None
rt-on-gt	Capability PC	Message Relay required	Generate UDTS	TFP concerning CPC
rt-on-gt	True PC	Message Relay required	Generate UDTS	None
rt-on-ssn	Capability PC	Not applicable	Generate UDTS	None
rt-on-ssn	True PC	Not applicable	Generate UDTS	SSP concerning True PC

Output

inh-map-ss:ssn=10

or

inh-map-ss:ssn=10:force=yes

```
rlghncxa03w 04-02-24 10:37:22 EST EAGLE 31.0.0
Inhibit map subsystem command sent to all SCCP cards.
Command Completed.
```

;

inh-map-ss:ssn=30

```
rlghncxa03w 04-02-24 10:37:22 EST EAGLE5 31.0.0
Inhibit map subsystem command sent to all SCCP cards.
Command Completed.
```

;

inh-map-ss:ssn=30:force=yes

```
rlghncxa03w 04-02-24 10:37:22 EST EAGLE5 31.0.0
Inhibit map subsystem command sent to all SCCP cards.
Command Completed.
```

;

inh-map-ss:ssn=11

```
integrat40 04-02-24 10:37:22 EST EAGLE5 31.0.0
Inhibit map subsystem command sent to all SCCP cards.
Command Completed.
```

;

inh-map-ss:ssn=11:force=yes

```
integrat40 04-02-24 10:37:22 EST EAGLE5 31.0.0
Inhibit map subsystem command sent to all SCCP cards.
Command Completed.
```

;

inh-slk

Inhibit Signaling Link

Use this command to prevent message signal units (MSU) from being transmitted on a specified, previously uninhibited signaling link.

NOTE: The signaling link's inhibited status is not preserved across a LIM reboot.

Keyword: inh-slk

Related Commands: act-slk, blk-slk, dact-slk, dlt-slk, ent-slk, rept-stat-slk, rtrv-slk, tst-slk, ublk-slk, unhb-slk

Command Class: Link Maintenance

Parameters

:loc= (mandatory)

The card location as stenciled on the shelf of the system.

Range: 1101–1108, 1111–1112, 1201–1208, 1211–1218, 1301–1308, 1311–1318, 2101–2108, 2111–2118, 2201–2208, 2211–2218, 2301–2308, 2311–2318, 3101–3108, 3111–3118, 3201–3208, 3211–3218, 3301–3308, 3311–3318, 4101–4108, 4111–4118, 4201–4208, 4211–4218, 4301–4308, 4311–4318, 5101–5108, 5111–5118, 5201–5208, 5211–5218, 5301–5308, 5311–5318, 6101–6108, 6111–6118

:port= or :link= (mandatory)

The signaling linkport on the card that is specified in the **loc** parameter. The ports can be specified in any sequence or pattern.

Range: a, b, a1-a31, b1-b31

Not all card types support all **link** parameter values.

See Table A-1 in Appendix A for valid **link** parameter range values for each type of card that can have a location specified in the **loc** parameter.

Example

inh-slk:loc=1307:link=b

Dependencies

A card location must be specified that is valid and defined in the database.

No other action command can be in progress when this command is entered.

The card must be equipped and must be one of the following cards:

- A LIM card running the **ss7ansi**, **ss7gx25**, **atmansi**, or **ccs7itu** application
- An E1 ATM card running the **atmitu** application
- A dual-slot DCM or EDCM card running the **iplim** or **iplimi** application with links having **ipliml2=saaltali**
- An SSEDCCM card running the **iplim** or **iplimi** application with links having **ipliml2=m2pa** or **ipliml2=saaltali**
- An E1/T1 MIM card or HC-MIM card running the **ss7ansi** or **ccs7itu** application

This command cannot be entered for an IPLIMx signaling link that has an **ipliml2** parameter value of **m3ua**.

This command is not valid on TCP/IP point to multipoint links (DCM cards equipped as SS7IPGW or IPGWI links).

The card must contain signaling links.

The signaling link must be equipped in the database.

The **link** parameter values **a1**, **b1**, **a2**, **b2**, **a3**, and **b3** can be specified only for the following cards:

- A multi-port LIM
- An SSEDCCM running the **iplim** or **iplimi** application that supports 8 points
- An E1/T1 MIM or an HC-MIM

Notes

If the link is already inhibited, the system does not execute the command.

If the link is aligned, it attempts to perform a changeover to alternate links. If it is not aligned, it cannot carry traffic.

If the link is the last link in the linkset or if the node assigned to the link is inaccessible by another route, the inhibit request is denied. If a command request is denied, it is because the SS7 changeover procedure cannot take place.

If the **inh-slk** command is followed by the **init-card** command, the inhibition of the signaling link is not preserved after the **init-card** command completes.

Card locations are illustrated in the *Installation Manual - EAGLE 5 SAS*.

The **inh-slk** command might time-out if a far-end remote does not respond to the inhibit message.

Output

```
inh-slk:loc=1301:link=a
    rlghncxa03w 05-01-07 11:11:28 EST EAGLE5 33.0.0
    Inhibit Link message sent to card
;
```

inh-trm

Inhibit Terminal

Use this command to set the primary state of a serial port to OOS-MT-DSBLD. It sets the secondary state to MANUAL. The serial port is not available to perform service functions. There is no outgoing traffic from the serial port, and all incoming traffic is ignored.

Keyword: **inh-trm**

Related Commands: **act-echo**, **alw-trm**, **canc-echo**, **chg-trm**, **dact-echo**, **rept-stat-trm**, **rmv-trm**, **rst-trm**, **rtrv-trm**

Command Class: System Maintenance

Parameters

:trm= (mandatory)

The ID of serial port to be inhibited

Range: 1-40

:force= (optional)

Forces the removal of the specified terminal, even if it is the last in-service OAP port available.

Range: yes, no

Default: no

Example

```
inh-trm:trm=5
```

```
inh-trm:trm=1:force=yes
```

Dependencies

No other action command can be in progress when this command is entered.

The IP User Interface feature must be enabled before terminal ports 17 through 40 can be specified in the **trm** parameter.

The terminal specified by the **trm** parameter must be equipped.

The **force=yes** parameter must be specified to inhibit the last in-service OAP port.

This command cannot be used to inhibit the terminal from which the command is entered.

Notes

When inhibiting an already inhibited terminal, a warning message is echoed to the scroll area, but no action is taken.

Output

```
inh-trm:trm=5
```

```
rlghncxa03w 04-01-07 11:11:28 EST EAGLE 31.3.0
```

```
Inhibit message sent to terminal
```

```
;
```

init-card

Initialize Card

Use this command to cause a soft reset of a card. It has the same result as a hard reset (card boots, application, and data load), except that connect status is not affected; that is, if a card is not connected, it stays that way.

When the command is issued to the OAM software, there is a 10-second wait before the card is reset. This wait period is intended to ensure that all database updates are complete before the card is reset.



CAUTION: When a LIME1 or LIMT1 card has associated channel cards (LIMCH) with provisioned links, the **init-card** command entered for the LIME1 or LIMT1 card causes all links on the associated channel cards to go out of service.

Keyword: init-card

Related Commands: dlt-card, ent-card, rept-stat-card, rmv-card, rst-card, rtrv-card, init-sys

Command Class: System Maintenance

Parameters

:appl= (optional)

Application. The type of application residing on the card.



CAUTION: Because the `appl` parameter causes all LIMs running the assigned application to reload, it should be used only during periods of low traffic.

Range: `atmansi`, `atmitu`, `ccs7itu`, `ebdablm`, `ebdadcm`, `emdc`, `eroute`, `gls`, `ipgwi`, `iplim`, `iplimi`, `ips`, `mcp`, `oam`, `sccp`, `ss7ansi`, `ss7gx25`, `ss7ipgw`, `stplan`, `vsccp`, `vxwslan`, all

atmansi—This application is used by the LIM cards to support the high-speed ATM signaling link feature.

atmitu—This application is used by the E1 ATM cards to support the high-speed E1 ATM signaling link feature.

ccs7itu—This application is used by the LIM cards for ITU-TSS MTP functionality.

ebdablm—This application is used by the TSM card for enhanced bulk download.

ebdadcm—This application is used by the DCM card to transmit the LSMS LNP database to the system at high speed over an ethernet connection for enhanced bulk download.

emdc—This application is used by the DCM card for CMIP/OSI measurement collection interface as defined by Telcordia GR-376.

eroute—This application is used by the STC cards for the EAGLE Support for Integrated Sentinel feature.

gls—This application is used by the TSM cards for downloading gateway screening to LIM cards.

ipgwi—This application is used by the system to support ITU TCP/IP point-to-multipoint connectivity.

iplim—This application is used by the DCM card for TCP/IP point-to-point connectivity for ANSI point codes.

iplimi—This application is used by the DCM card for TCP/IP point-to-point connectivity for ITU point codes.

ips—This application is used by the IPSM card for the IP User Interface feature.

oam—This application is a software load that runs in a GPSM-II card in card slots 1113 and 1115.

mcp—This application is used by the MCPM card for the Measurements Platform feature.

sccp—This application is used by the TSM cards for the global title translation application.

ss7ansi—This application is used by the LIM cards for the MTP functionality.

ss7gx25—This application is used by the LIM cards to support X.25 functionality.

ss7ipgw—This application is used by the system to support TCP/IP point-to-multipoint connectivity.

stplan—This application is used by the ACM card to support the STP LAN application.

vsccp—This application is used by the DSM card to support the G-Flex, G-Port, INP, and LNP ELAP Configuration features. This application is used by the DSM card to support the G-Flex, G-Port, LNP ELAP Configuration, and INP features. If the G-Flex, G-Port, LNP ELAP Configuration, or INP feature is not turned on, and a DSM card is present, the VSCCP GPL processes normal GTT traffic.

vxwslan—This application is used by the DCM card to support the STP LAN application.

all—All cards are to be initialized.

Default: The application assigned to the card.

:data= (optional)

High memory refresh. This parameter causes data to be reloaded to the specified card. This parameter is used to reload data if the LNP, G-Flex, G-Port, or INP feature is on. This parameter is applicable only to network cards containing the LNP database (SCCP, EBDABLM), or the MPS database (VSCCP).

Range: **refresh, persist**

refresh—Causes data to be reloaded to the specified card.

persist—Indicates that the database is not to be reloaded to the card. Used to request that the EAGLE perform a warm restart of the requested cards. The EAGLE performs various checks to ensure that all conditions necessary to initiate the warm restart are in place (for example, that the TSM/BLM card is present and ready and that the downloaded LNP database is coherent. The LNP database audit cannot be performed prior to the card reset). The **force** parameter is required if all of the specified cards do not meet the warm restart requirements. During the card initialization and loading sequence, a warm restart is performed for all cards that meet the warm restart conditions.

Default: **refresh**

:force= (optional)

Force indicator. Enables the command to be processed under the following conditions:

- If **serial=yes** and all cards of the specified GPL type are not IS-NR or OOS-MT-DSBLD.
- If **data=persist** and all cards of the GPL type cannot maintain a persistent LNP database over the reset.
- If **initclk=yes** and the TDM card specified in the **loc** parameter is the only good HS clock source that is currently active. A temporary clock outage will occur.
- If **initclk=yes** and **appl=eoam** is specified (bit-files on both TDMs will be initialized). A temporary clock outage will occur.

Range: **yes, no**

Default: **no**

:initclk= (optional)

Initialize TDM bit-file indicator. If TDM reload would cause a system clock outage, the **initclk** parameter cannot be specified unless **force=yes** is also specified.

CAUTION: **The resulting clock outage will probably cause loss of traffic on all links.**

The following scenarios will cause such clock outages:

- Simplex MASP configuration (a system with a single TDM).
- Bad clock status on the remaining TDM.



Range: yes, no

If **initclk=yes** is specified with a single TDM card location, the bit-file for the specified TDM reloads.

If **initclk=yes** is specified with **appl=eoam** and **force=yes**, the bit-file reloads on both TDMs.

:loc= (optional)

Card address. The card location as stenciled on the shelf of the system.

Range: When the **initclk** parameter is not specified, card locations **1101-1108**, **1111-1112**, **1201-1208**, **1211-1218**, **1301-1308**, **1311-1318**, **2101-2108**, **2111-2118**, **2201-2208**, **2211-2218**, **2301-2308**, **2311-2318**, **3101-3108**, **3111-3118**, **3201-3208**, **3211-3218**, **3301-3308**, **3311-3318**, **4101-4108**, **4111-4118**, **4201-4208**, **4211-4218**, **4301-4308**, **4311-4318**, **5101-5108**, **5111-5118**, **5201-5208**, **5211-5218**, **5301-5308**, **5311-5318**, **6101-6108**, **6111-6118** are valid.

When the **initclk** parameter is specified with the **loc** parameter, only card locations **1113** and **1115** are valid.

Default: All valid card locations are initialized.

:serial= (optional)

Controls the manner in which cards are initialized. If **serial=yes** is specified, cards of the specified GPL type are initialized one at a time. If **serial=no** is specified, cards of the specified GPL type are initialized simultaneously.

Range: yes, no

Default: no

Example

```
init-card:loc=1201
```

```
init-card:loc=1101:data=persist
```

```
init-card:loc=1113:initclk=yes
```

```
init-card:appl=eoam:initclk=yes:force=yes
```

Dependencies

The shelf and card must be equipped.

Either the **loc** or **appl** parameter, but not both parameters, must be specified in the command.

The following card locations (**loc** parameter) are not allowed for this command: 1114, 1116, 1117, 1118, and all **xy09** and **xy10** card locations (where **x** is the frame and **y** is the shelf).

If the **loc** parameter is specified with the **initclk** parameter, the **loc** parameter value must be card location **1113** or **1115**.

If the **appl** parameter is specified with the **initclk** parameter, the **appl** parameter value must be **eoam**.

If TDM reload would system clocks to fail that are required to keep links active or TSCSYNC available, the **initclk** parameter cannot be specified unless **force=yes** is also specified.



CAUTION: The resulting clock outage will probably cause loss of traffic on all links.

Clocks are required in the following situations:

- When at least one DS0 card is provisioned, one BITS clocks is required.
- When a high speed link is being master-timed, at least one high speed clock is required.
- When TSCSYNC is turned on, both SYSTEM clocks (A&B) are required.

The **initclk** parameter can be specified only for TDM cards that support bit-file reloading (TDM-15 or later).

The **force** parameter must be specified for cards that are not the In-service Normal state.

The **serial** parameter is valid only when used with the **appl** parameter.

The **appl=all** parameter can be specified only the **serial=yes** parameter is also specified.

If the **serial** parameter is specified, the value of the **appl** parameter must be one of the following: **atmansi**, **ccs7itu**, **gls**, **sccp**, **ss7ansi**, **ss7gx25**, **stplan**, **emdc**, or **all**.

If the **data=persist** parameter is specified and any SCCP or EBDABLM cards present in the system cannot maintain a persistent LNP database over the reset, the **force** parameter must be specified.

The **force** parameter is valid only with the **initclk**, **appl**, and **data** parameters.

The **data** parameter is valid only for SCCP and EBDABLM card locations or GPLs, or MPS database (VSCCP) card locations or GPLs.

Notes

The TDM card has a processor but no application.

The LNP (see the **enable-ctrl-feat** command), G-Flex, G-Port, or INP feature must be turned on before the **data** parameter can be specified.

Various conditions in the system can prevent the persistence of the LNP data on the SCCP/EBDABLM cards. When this occurs and the **force** parameter is not specified, the following error is generated:

```
E3849 Cmd Rej: Card(s) cannot warm restart - FORCE parameter required
Verifying card(s) persistent LNP database - please wait
The following cards require a full data download:
Card      Reason
----      -
zzzz      xxxxxxxx
```

where **zzzz** is the card requiring the full data download, and **xxxxxxx** is one of the values listed in Table 6-22:

Table 6-22. Reason That Card Requires a Full Data Download

xxxxxxx value	Description
POWER ON	Power on reset
XILINX VERSION	M256 Xilinx version has changed
DB VERSION	LNP Database version has changed

Table 6-22. Reason That Card Requires a Full Data Download (Continued)

xxxxxxx value	Description
DB LEVEL	Database level is not supported or difference exceeds incremental loading capability
DB STATUS	Database status is incoherent
HW ERROR	Hardware error bit checks on the card fail
AUDIT FAILED	Checksum comparisons of the LNP database fail
AUDIT TIMEOUT	LNP initialization audit timed out
NO AUDIT	Unable to perform LNP DB audit. LNP audit not on or excessive number of unknown checksums
USER REQUEST	User initiated init-card or init-sys command reload type cold
UNKNOWN	Unknown
OTHER	Other

Output

init-card:loc=1201

Init Card command issued to card 1201

```
3021.0013 * CARD 1201 CCS7ITU      Card is isolated from the system

3022.0201 * SLK 1201,A lsnssp2     SLK unavailable for traffic
          SLC=0      FECLLI=-----

3023.1201 * SLK 1201,B lsnstpi     SLK unavailable for traffic
          SLC=0      FECLLI=-----

;
```

init-card:apl=all:serial=yes

Command entered at terminal #3.

Init Card command issued to card 1201

```
* 3021.0013 * CARD 1201 SS7ANSI    Card is isolated from the system

** 3022.0236 ** SLK 1201,A lsnssp2  REPT-LKF: not aligned
          SLC=0      FECLLI=-----          CLASS=MTP2

3023.0014   CARD 1201 SS7ANSI      Card is present

3024.0200   SLK 1201,A lsnssp2      RCVRV-LKF: link available
          SLC=0      FECLLI=-----          CLASS=MTP2

Init Card command issued to card 1202

* 3026.0013 * CARD 1202 ATMANSI    Card is isolated from the system

** 3026.0236 ** SLK 1202,A lsnssp3  REPT-LKF: not aligned
          SLC=0      FECLLI=-----          CLASS=SAAL

3027.0014   CARD 1202 ATMANSI      Card is present

3028.0200   SLK 1202,A lsnssp3      RCVRV-LKF: link available
          SLC=0      FECLLI=-----          CLASS=SAAL

;
```

init-card:loc=1101:data=refresh

Command entered at terminal #10.

Init Card command issued to card 1101

```
** 1127.0013 ** CARD 1101 SCCP      Card is isolated from the system
          ASSY SN:  97361659

1128.0329   SCCP SYSTEM              SCCP capacity normal, card(s) abnormal

1129.0014   CARD 1101 SCCP          Card is present
          ASSY SN:  97361659

1234.1238   SYSTEM      INFO Full LNP database reload initiated:
          CARD=1101     GPL=SCCP   CAUSE=USER REQUEST
Report Date: 00-02-24   Time: 16:27:19

5402.1241   SYSTEM      INFO REPT EVT: LNP Incremental Loading.
          database levels loaded :      0 of  1145
Report Date: 00-02-24   Time: 16:52:04

1234.1239   SYSTEM      INFO LNP updates inhibited: loading stability
Report Date: 00-02-24   Time: 16:52:07

1234.1240   SYSTEM      INFO LNP updates allowed: loading stability
Report Date: 00-02-24   Time: 16:52:09

1130.0096   CARD 1101 SCCP          Card has been reloaded

1131.0328   SCCP SYSTEM              SCCP is available
;
```

init-card:loc=1115:initclk=yes

```
tekelecstp 04-07-17 13:01:59 EST  EAGLE 31.6.0
Init Card command issued to card 1115
;

tekelecstp 04-07-17 13:01:59 EST  EAGLE 31.6.0
* 3021.0013 * CARD 1115 EOAM      Card is isolated from the system
;

tekelecstp 04-07-17 13:03:10 EST  EAGLE 31.6.0
3022.0014   CARD 1115 EOAM      Card is present
          ASSY SN:  1216115
;
```

init-flash**Initialize Flash**

Use this command to load the Board PROM to the inactive FLASH memory of a specified card or range of cards. When a card is reinitialized, it runs this version of the GPL in the card's inactive FLASH memory.

Keyword: init-flash

Related Commands: act-flash, clr-imt-stats, flash-card, init-imt-gpl, rept-imt-info, rept-imt-lvl1, rept-imt-lvl2, tst-imt

Command Class: System Maintenance

Parameters**:code=** (mandatory)

The version of the GPL being loaded onto the card.

Range: **appr**, **trial****appr**—The approved GPL version**trial**—The trial GPL version**:appl=** (obsolete)This parameter is obsolete; use the **gpl** parameter.The **appl** parameter has been replaced with the **gpl** parameter to more accurately indicate that a GPL, and not an application, is specified for the parameter value.**:boot=** (optional)

This parameter indicates whether the HC-MIM card should boot or not boot after the command successfully completes.

Multiple images can be flashed without having to boot after each flash. If multiple images are being flashed to the HC-MIM card, this parameter can be used to prevent the HC-MIM card from booting after each image is flashed. If multiple images are being flashed and the card is allowed to boot after each flash, an image that is not activated after the HC-MIM card boots will be lost on a subsequent reset of the HC-MIM card.

Range: **yes**, **no****yes**—Reboot the HC-MIM card after the command completes successfully.**no**—Do not reboot the HC-MIM card after the command completes successfully.**Default:** **yes****:eloc=** (optional)

End location. Location of the last card of a range of cards to be initialized.

Range: **1101–1113**, **1115**, **1201–1218**, **1301–1318**, **2101–2118**, **2201–2218**, **2301–2318**,
3101–3118, **3201–3218**, **3301–3318**, **4101–4118**, **4201–4218**, **4301–4318**, **5101–5118**,
5201–5218, **5301–5318**, **6101–6118****:force=** (optional)This parameter is required to force the TDM-GTI bit-file reload if a clock outage will occur when **initclk=yes** is specified.**Range:** **yes**, **no****Default:** **no****:gpl=** (optional)

The flash GPL type that is running on the cards in the specified range of cards.

Range: **blbios**, **blepld**, **bldiag**, **blvxw**, **bpdcn**, **bphcap**, **bphcapt**, **bphmux**, **bpmpl**,
bpmp1t, **hipr**, **imtpci**, **plde1t1**, **pldpmc1**

:initclk= (optional)

If this parameter is specified for an EOAM card location (1113 or 1115), it determines whether or not the TDM-GTI bit-file should be reloaded, causing a clock initialization.

The command will be accepted if the TDM being initialized is a TDM-GTI and the following conditions are true:

- The card being flashed is in location 1113 or 1115.
- Any required clocks from the mate OAM are valid, or the **force=yes** parameter is used.

Range: yes, no

Default: no

:loc= (optional)

The location of a single card to be initialized.

Range: 1101-1113, 1115, 1201-1218, 1301-1318, 2101-2118, 2201-2218, 2301-2318, 3101-3118, 3201-3218, 3301-3318, 4101-4118, 4201-4218, 4301-4318, 5101-5118, 5201-5218, 5301-5318, 6101-6118

:sloc= (optional)

Start location. Location of the first card of a range of cards to be initialized.

Range: 1101-1113, 1115, 1201-1218, 1301-1318, 2101-2118, 2201-2218, 2301-2318, 3101-3118, 3201-3218, 3301-3318, 4101-4118, 4201-4218, 4301-4318, 5101-5118, 5201-5218, 5301-5318, 6101-6118

Example

init-flash:loc=1105:code=trial

init-flash:sloc=1101:eloc=1112:gpl=bpdcm:code=appr

init-flash:loc=1113:code=appr:initclk=yes

init-flash:loc=1115:code=appr:initclk=yes:force=yes

init-flash:loc=1115:code=trial:initclk=no

Dependencies

The specified card for this command must be an HCAP, HCAP-T, DCM, DSM, E1/T1 MIM, HC-MIM, GPSM-II, MPL, or MPL-T. An HMUX card or a HIPR card can be specified, but only for locations xy09 and xy10 (x is the frame and y is the shelf).

Each specified card does not have to be defined in the database, but it does have to be aligned on the IMT bus.

If the card in the specified card location is provisioned, the card must be inhibited before this command is entered (unless the card is an HMUX card or a HIPR card).

If the target card is HMUX or HIPR, both of the card locations specified in the **sloc** and **eloc** parameters must contain HMUX cards or HIPR cards on the same IMT bus. For HMUX or HIPR the bus is implicit based on the specified location. Location xy09 specifies HMUX or HIPR A Bus, and location xy10 specifies HMUX or HIPR B Bus (where x is the frame and y is the shelf). For example, **sloc=1109:eloc=6109** specifies all HMUX cards or HIPR cards on the A Bus only; **sloc=1110:eloc=6110** specifies all HMUX cards or HIPR cards on the B Bus only. HMUX cards or HIPR cards from both the A bus and B bus cannot be flash downloaded simultaneously.

If the target card is HC-MIM, the **gpl** parameter must be specified when the **loc** parameter is specified.

The **boot** parameter can be specified only if the target card is HC-MIM.

The **boot** parameter cannot be specified for the **blcpld** HC-MIM GPL.

The HC-MIM card cannot support a valid trial version of the **blbios** and **blcpld** GPLs at the same time. One of these GPLs must be downloaded and activated before the other one can be downloaded.

The **init-flash** command cannot be entered during an IMT statistics collection period following an hourly boundary (IMT performance monitoring).

A card location that contains the active MASP cannot be specified for the **loc**, **sloc**, or **eloc** parameter.

The provisioning subsystem mode (simple, duplex) must be established prior to executing the command.

The **loc** parameter cannot be specified with the **eloc** and **sloc** parameters.

Either the **loc** parameter or the **eloc** and **sloc** parameters must be specified.

If the **eloc** and **sloc** parameters are specified, the **gpl** parameter must be specified. The cards in the locations specified in the **sloc** and **eloc** parameters must be running the specified general program load (**gpl**). Other cards in the range of card locations can be running other GPLs, but will not be initialized. Only the cards within the range that are running the specified GPL will be initialized.

The **sloc** parameter value must be greater than the **eloc** parameter value, when the two parameters are specified.

The specified card cannot be running an inactive flash GPL when the command is executed.

If **initclk** is specified, the card location parameter value must be **1113** or **1115**.

If TDM reload would cause a system clock outage, the **initclk** parameter cannot be specified unless **force=yes** is also specified.



CAUTION: The resulting clock outage will probably cause loss of traffic on all links.

The command will be accepted if the TDM being initialized is a TDM-GTI and the following conditions are true:

- The card being flashed is in location 1113 or 1115.
- Any required clocks from the mate OAM are valid, or the **force=yes** parameter is used.

The **initclk** parameter can be specified only for TDM cards that support bit-file reloading (TDM-15 or later).

Notes

Card locations **1114**, **1116**, and **1117** are not valid and cannot be specified.

For the HC-MIM card, multiple images can be flashed without having to boot the card after each flash. If multiple images are being flashed to the HC-MIM card the **boot=no** parameter can be used to prevent the HC-MIM card from booting after each image is flashed. After flashing any number of images, the HC-MIM card can be reset either by entering the **init-flash** command with the **boot=yes** parameter or by entering the **init-card** command. If multiple images are being flashed and the card is allowed to boot after each flash, any images that are not activated after the HC-MIM card boots will be lost on a subsequent reset of the HC-MIM card.

Output

init-flash:loc=1105:code=trial

```
rlghncxa03w 04-01-05 13:05:05 EST EAGLE 31.3.0
FLASH Memory Downloading for card 1105 Started.
```

```
rlghncxa03w 04-01-05 13:05:05 EST EAGLE 31.3.0
BPHCAP Downloading for card 1105 Complete.
```

```
rlghncxa03w 04-01-05 13:05:05 EST EAGLE 31.3.0
Command Completed.
```

;

init-flash:sloc=1101:eloc=1112:gpl=bpdcn:code=appr

```
rlghncxa03w 05-01-02 13:05:05 EST EAGLE 33.0.0
FLASH Memory Download for cards 1101 - 1112 Started.
```

;

```
rlghncxa03w 05-01-02 13:05:05 EST EAGLE 33.0.0
FLASH Memory Download for cards 1101 - 1112 Completed.
LOC 1101 : PASSED
LOC 1102 : PASSED
LOC 1112 : PASSED
```

```
ALL CARD RESULTS PASSED
```

;

```
rlghncxa03w 05-01-02 13:05:05 EST EAGLE 33.0.0
Command Completed.
```

;

init-flash:loc=1113:code=appr:initclk=yes

```
rlghncxa03w 04-03-08 10:02:04 EST EAGLE 31.6.0
FLASH Memory Download for card 1113 Started.
```

;

```
rlghncxa03w 04-03-08 10:02:23 EST EAGLE 31.6.0
FLASH Memory Download for card 1113 Completed.
```

;

init-imt-gpl**Initialize IMT GPL**

Use this command to load the specified IMT GPL software to the specified card and to reset that card. The application software is reloaded following IMT reset.

Keyword: **init-imt-gpl**

Related Commands: **alw-card, inh-card, init-card, rept-stat-card**

Command Class: System Maintenance

Parameters

:code= (mandatory)

Specifies which IMT GPL to load to the card.

Range: **appr, refresh, trial**

appr—The approved GPL version

refresh—Reload approved GPL version without card reset

trial—The trial GPL version

:loc= (optional)

Specifies the address of the card to be initialized.

Range: **1101–1108, 1111–1112, 1201–1208, 1211–1218, 1301–1308, 1311–1318, 2101–2108, 2111–2118, 2201–2208, 2211–2218, 2301–2308, 2311–2318, 3101–3108, 3111–3118, 3201–3208, 3211–3218, 3301–3308, 3311–3318, 4101–4108, 4111–4118, 4201–4208, 4211–4218, 4301–4308, 4311–4318, 5101–5108, 5111–5118, 5201–5208, 5211–5218, 5301–5308, 5311–5318, 6101–6108, 6111–6118**

Default: All locations

Example

```
init-imt-gpl:loc=1201:code=trial
```

```
init-imt-gpl:code=refresh
```

```
init-imt-gpl:code=appr
```

Dependencies

The card location shelf must be within the allowed ranges as specified on the **loc** parameter. The shelf is the first two digits of the **loc** parameter.

The card location slot must be within the allowed ranges as specified on the **loc** parameter. The slot is the second two digits of the **loc** parameter.

The card location cannot contain a card with flash memory (HCAP, HCAP-T, DCM, MPL, MPL-T, HC-MIM, HIPR, or HMUX).

When this command is entered, no other action command can be in progress.

If the **code=appr** parameter is specified, the **loc** parameter must be specified.

If the **code=trial** parameter is specified, the **loc** parameter must be specified, and the specified card location must be equipped and in service.

If the **code=appr** or the **code=refresh** parameter is specified, the card must be connected to at least one IMT bus and communicating with the active MASP when the command is entered.

The **init-imt-gpl** command cannot be entered if any of the following commands is running: **clr-imt-stats**, **rept-imt-info**, **rept-imt-lvl1**, **rept-imt-lvl2**, **tst-imt**.

This command must not be entered during IMT statistics collection following an hourly boundary.

Notes

None

Output

init-imt-gpl:loc=1201:code=trial

```

rlghncxa03w 04-02-27 16:53:22 EST   EAGLE 31.3.0
  Initializing IMT GPL for card 1201.

rlghncxa03w 04-02-27 16:53:22 EST   EAGLE 31.3.0
* 0192.0013  * CARD 1201 SS7ANSI     Card is isolated from the system

rlghncxa03w 04-02-27 16:53:22 EST   EAGLE 31.3.0
0193.0014   CARD 1201 SS7ANSI       Card is present

rlghncxa03w 04-02-27 16:53:22 EST   EAGLE 31.3.0
0194.0096   CARD 1201 SS7ANSI       Card has been reloaded
;

```

init-mux

Initialize High-Speed Multiplexer

Use this command to reset a single HMUX or HIPR card or all HMUX or HIPR cards on the specified HMUX or HIPR bus.

If the command is entered between the **init-flash** command and the **act-flash** command, the command boots the HMUX or HIPR processor and brings down the respective IMT bus temporarily (approximately 10 seconds) until the HMUX or HIPR card or cards come back into service.

If the command entry is not between the **init-flash** command and the **act-flash** command, the command boots the HMUX or HIPR processor without bringing down the respective IMT bus.

Keyword: **init-mux**

Related Commands: **act-flash**, **init-flash**

Command Class: System Maintenance

Parameters

:bus= (optional)

The HMUX or HIPR bus to be reset. All HMUX or HIPR cards on the specified bus will be reset.

Range: a or b

Default: a

:force= (optional)

Use this parameter to override normal safeguards. The **force=yes** parameter can be used to:

- Reset an entire HMUX or HIPR bus when the alternate bus is non-functional
- Reset one HMUX or HIPR card during a fault isolation test (**tst-imt**) command

Range: yes, no

Default: no

:loc= (optional)

The card location of a single HMUX or HIPR card to be reset.

Range: xy09, xy10 (x=frame, y=shelf)

Default: If not specified, all HMUX or HIPR cards on bus A or bus B are reset.

Example

```
init-mux:bus=a
```

```
init-mux:loc=1109
```

Dependencies

An **act-flash** or **init-flash** command cannot be in progress when this command is entered.

Either the **bus** parameter or the **loc** parameter, but not both, must be specified.

This command is not allowed during an IMT Fault Isolation test (**tst-imt**), unless the **force=yes** parameter is specified.

This command is not allowed during the IMT statistics collection period following an hourly boundary (IMT performance monitoring).

Notes

None

Output

```
init-mux:loc=1109
```

```
rlghncxa03w 05-07-13 08:15:10 EAGLE 31.3.0
Command Completed.
```

```
;
```

init-network

Initialize the Network

Use this command to reset all the network cards. The network cards are ACMs, TSMs, and LIMs; that is, anything not part of the Maintenance and Administration Subsystem (MAS). This command resets all the network cards by reloading GPLs and data to the cards. Use of this command requires maintenance personnel to be located at the site.



CAUTION: Using this command causes network nodal isolation; however, if the network nodal isolation is less than two seconds, it may not be detected and may not be reported. Also, in some cases when network nodal isolation has been detected and a large number of maintenance troubles are being reported, the network nodal isolation message may not be reported. An alarm is generated, however.

Keyword: `init-network`

Related Commands: None

Command Class: System Maintenance

Parameters

:force= (optional)

Force the resetting of all the network cards.

Range: `yes, no`

Default: `no`

Example

```
init-network
```

Dependencies

The MASP must be in either *Upgrade Phase 3* mode or *Full Function* mode. (See the “Notes” section for this command for more information).

The system database must be coherent when this command is entered.

At least one card with either the **ss7ansi** or the **ccs7itu** application installed must exist with an in-service active signaling link.

The **force=yes** parameter must be specified to override the required four-card **ss7ansi** or **ccs7itu** configuration. The system then selects the best available of the remaining **ss7ansi** or **ccs7itu** cards.

Notes

Upgrade Phase 3 mode means that the MASPs are running GPLs that match the major revision defined for the approved GPLs, but the other network processors are only prepared to be upgraded.

Full Function mode means that all MASPs are running GPLs that match the major revision defined for the approved GPLs. *Full Function* mode is the normal operating mode for the MASP.

Output

The command output scrolls into the scroll area of your display contiguously. However, for purposes of this example, each part has an explanation preceding it.

init-network

```
rlghncxa03w 05-07-01 08:15:10 EAGLE 31.3.0
(Reports the selection of an alternate card.)
rlghncxa03w 05-07-01 16:30:00 EST EAGLE 31.3.0
1234.1107 SYSTEM INFO INW ALT card as first to be preloaded
CARD=1201 GPL=SS7ANSI
Report Date: 05-07-01 Time: 16:29:15
```

(Reports the selection of a main card).

```
rlghncxa03w 05-07-01 16:30:01 EST EAGLE 31.3.0
1234.1108 SYSTEM INFO INW MAIN card as last to be reset
CARD=1202 GPL=SS7ANSI
Report Date: 05-07-01 Time: 16:29:17
```

(Reports that the card cross loading is inhibited).

```
rlghncxa03w 05-07-01 16:30:02 EST EAGLE 31.3.0
1234.1109   SYSTEM          INFO  Asserted DDL inhibition
          CARD=1113      GPL=OAM
          Report Date: 05-07-01  Time: 16:27:18
```

(Reports that a card reset has been issued).

```
rlghncxa03w 05-07-01 16:32:02 EST EAGLE 31.3.0
1234.1110   SYSTEM          INFO  Card reset command issued
          CARD=1204      GPL=SS7ANSI
          Report Date: 05-07-01  Time: 16:30:18
```

(Reports that a card is being allowed to load).

```
rlghncxa03w 05-07-01 16:32:02 EST EAGLE 31.3.0
1234.1111   SYSTEM          INFO  Allowing card to load
          CARD=1204      GPL=SS7ANSI
          Report Date: 05-07-01  Time: 16:30:18
```

(Reports that INW is waiting for validation of card loading).

```
rlghncxa03w 05-07-01 16:32:02 EST EAGLE 31.3.0
1234.1112   SYSTEM          INFO  Waiting for validation of card loading
          CARD=1204      GPL=SS7ANSI
          Report Date: 05-07-01  Time: 16:30:18
```

(Reports that INW has detected successful completion of card loading).

```
rlghncxa03w 05-07-01 16:32:02 EST EAGLE 31.3.0
1234.1113   SYSTEM          INFO  Detected card loaded
          CARD=1204      GPL=SS7ANSI
          Report Date: 05-07-01  Time: 16:30:18
```

(Reports that INW has detected the reset or removal of a card).

```
rlghncxa03w 05-07-01 16:32:02 EST EAGLE 31.3.0
1234.1114   SYSTEM          INFO  Detected card reset or removed
          CARD=1204      GPL=SS7ANSI
          Report Date: 05-07-01  Time: 16:30:18
```

(Reports that the card is being allowed to crossload).

```
rlghncxa03w 05-07-01 16:32:02 EST EAGLE 31.3.0
1234.1115   SYSTEM          INFO  Allowed card to skip DDL inhibited
          CARD=1204      GPL=SS7ANSI
          Report Date: 05-07-01  Time: 16:30:18
```

(Reports that DDL inhibition has been removed).

```
rlghncxa03w 05-07-01 16:32:02 EST EAGLE 31.3.0
1234.1116   SYSTEM          INFO  Removed DDL inhibition
          CARD=1113      GPL=OAM
          Report Date: 05-07-01  Time: 16:30:18
```

(If **init-network** is entered during an upgrade, reports that the upgrade is to continue).

```
rlghncxa03w 05-07-01 16:32:02 EST EAGLE 31.3.0
1234.1117   SYSTEM          INFO  Initialize OAMs to continue upgrade
          CARD=1113      GPL=OAM
          Report Date: 05-07-01  Time: 16:30:18
```

(Reports that a card must be reset manually or removed).

```
rlghncxa03w 05-07-01 16:32:02 EST EAGLE 31.3.0
1234.1118   SYSTEM          INFO Card must be manually reset/removed
          CARD=1204      GPL=SS7ANSI
          Report Date: 05-07-01 Time: 16:30:18
```

(Reports that a card has failed to reset).

```
rlghncxa03w 05-07-01 16:32:02 EST EAGLE 31.3.0
1234.1119   SYSTEM          INFO Card failed to reset
          CARD=1204      GPL=SS7ANSI
          Report Date: 05-07-01 Time: 16:30:18
```

(Reports that a DDL inhibition assertion has failed).

```
rlghncxa03w 05-07-01 16:32:02 EST EAGLE 31.3.0
1234.1120   SYSTEM          INFO Failed to assert DDL inhibition
          CARD=1113      GPL=OAM
          Report Date: 05-07-01 Time: 16:30:18
```

(Reports that an internal error has stopped an **init-network**).

```
rlghncxa03w 05-07-01 16:32:02 EST EAGLE 31.3.0
Command Aborted : Internal error.
```

(Reports that a failure to load a card has stopped an **init-network**).

```
rlghncxa03w 05-07-01 16:32:02 EST EAGLE 31.3.0
Command Aborted : Card 1206 failed to load.
```

init-oap

Initialize OAP Processor

Use this command to send a hardware signal to the indicated OSS/Application Processor (OAP), causing it to reset and reinitialize its operational software.

NOTE: This command cannot be used for EOAPs (Enhanced Operation System Support Application Processes).

Keyword: init-oap

Related Commands: chg-trm, rept-stat-seas

Command Class: System Maintenance

Parameters

:oap= (mandatory)

The OAP that is to be initialized. Any value (**a**, **b**, or **both**) can be specified, regardless of the actual or intended OAP configuration.

Range: a, b, both

:force= (optional)

If the specified OAP is operational (that is, if its state is IS-NR or IS-ANR), and it is the only operational OAP, then The**force=yes** parameter must be specified to reset it. If the specified OAP is not operational, then **force=yes** is not required.

Range: yes, no

Default: no

Example**init-oap:oap=a****init-oap:oap=b****init-oap:oap=both:force=yes****Dependencies**

The SEAS feature must be turned on before this command can be entered.

No other action command can be in progress when this command is entered.

The **force=yes** parameter must be specified to reset the last OAP.

Notes

The EAGLE determines the OAP configuration (single vs. dual) by querying the OAP. If one or both of the OAPs are not operational, then the EAGLE might receive incorrect information about the OAP configuration. Furthermore, if no OAP terminals are defined, no OAP queries are sent, the OAM defaults to a single configuration, and this information may be incorrect.

To allow an OAP to be reset by an OAM not configured for it or when no OAP terminals are yet defined, the **init-oap** command can be used to specify either OAP or both OAPs, even if doing so conflicts with the actual OAP configuration.

Output**init-oap:oap=a**

```
rlghncxa03w 05-07-01 16:40:40 EST  EAGLE 31.3.0
Initialization signal sent to OAP A
Command Completed.
```

init-oap:oap=both:force=yes

```
rlghncxa03w 05-07-01 16:40:40 EST  EAGLE 31.3.0
Initialization signal sent to OAP A
Initialization signal sent to OAP B
Command Completed.
```

In the following example, assume that the MDAL is malfunctioning when the command is entered.

init-oap:oap=b

```
rlghncxa03w 05-07-01 16:40:40 EST  EAGLE 31.3.0
Info: MDAL is not operational. OAP initialization may not occur.
Initialization signal sent to OAP B
Command Completed.
```

;

init-sys**Initialize System**

Use this command to reset all cards in the system (except HMUX and HIPR cards). Use this command also to log out the current users. When you first enter this command, a caution message is displayed in the scroll area requesting that you re-enter the command to confirm the operation. You have 30 seconds to re-enter the command. The only valid commands that you can enter after entering the **init-sys** command the *second* time are the commands **login** and **act-user**.



CAUTION: This command causes a complete system reload, and you should use it only during periods of low traffic. Use this command only when directed by Tekelec Technical Service at (888) FOR-TKLC.



CAUTION: When the `init-sys` command executes, the system does not retain the manually initiated state (for example, OOS-MT-DSBLD) for the signaling link, card, or the terminal. After the command executes, the system attempts to bring all provisioned links, cards, and terminals on line, including those that were previously out of service. You will need to manually put each device back into its previous state after the system is back on line. It is, therefore, advisable to print or electronically capture the output of the `rept-stat-slk`, `rept-stat-card`, and `rept-stat-trm` commands for reference prior to issuing the `init-sys` command. To restore a device to its previous state, issue the appropriate inhibit/deactivate command listed in this manual in the section for each of the above `rept-stat` commands.

Keyword: `init-sys`

Related Commands: `act-gpl`, `chg-db`, `chg-gpl`, `copy-gpl`, `copy-meas`, `disp-disk-dir`, `rept-stat-db`

Command Class: System Maintenance

Parameters

:data= (optional)

High memory refresh. This parameter causes data to be reloaded to the specified card. This parameter is used to reload data if the *LNP*, *G-Flex*, *G-Port*, or *INP* feature is on. This parameter is applicable only to network cards containing the LNP database (SCCP, EBDABLM) or the MPS database (VSCCP).

Range: `refresh`, `persist`

refresh—Causes data to be reloaded to the specified card.

persist—Indicates that the database is not to be reloaded to the card. Used to request that the EAGLE perform a warm restart of the requested cards. The EAGLE performs various checks to ensure that all conditions necessary to initiate the warm restart are in place (for example, that the TSM/BLM card is present and ready and that the downloaded LNP database is coherent. The LNP database audit cannot be performed prior to the card reset). The **force** parameter is required if all of the specified cards do not meet the warm restart requirements. During the card initialization and loading sequence, a warm restart is performed for all cards that meet the warm restart conditions.

Default: `refresh`

:force= (optional)

Allows the command to be processed if the **data=persist** parameter is specified and all the network cards containing the LNP database (SCCP, EBDABLM) cannot maintain a persistent LNP database over the reset.

Range: `yes`, `no`

Default: `no`

Example

```
init-sys
```

```
init-sys:data=persist
```

Dependencies

When this command is entered, another **init-sys** command cannot be in progress on another port.

If the **data=persist** parameter is specified and any SCCP or EBDABLM cards present in the system cannot maintain a persistent LNP database over the reset, the **force** parameter must be specified.

The **force** parameter is valid only with the **data** parameter.

The LNP, G-Flex, G-Port, or INP feature must be turned on before the **data** parameter can be specified,

When the **init-sys** command is entered with parameters, the parameters that are entered the first time must be the same parameters that are entered the second time for the confirmation command.

Notes

When the **init-sys** command is entered the first time, you have 30 seconds to enter the command again. After the command is accepted, a delay of 10 seconds gives the system time to broadcast the information message regarding the system initialization.

From the time that the **init-sys** command is accepted, you must wait approximately two minutes before you can log into the system. If the system terminal is in the VT-100/VT-320 mode, the terminal display will be refreshed with nonzero alarm counts. During this 2-minute interval, an intermediate screen refresh caused by the MASPs' role change from active to standby, and from standby to active. This screen refresh is typically a partial refresh and the alarm indicators are set to zero.

If you are logged into the system in the KSR mode, you receive UAM 0009 (MASP became active) to indicate that you are now able to log into the system. UAM 0009 could be issued twice due to possible transient MASP role change (switching from active to standby). Following the execution of the **init-sys** command, the MASP that was active before the **init-sys** command was entered will be the active MASP when the system has finished reinitializing. TSM cards are reloaded only in the event of power failure or hardware reboot. The execution of this command does not require the TSM cards to be reloaded.

Various conditions in the system may prevent the persistence of the LNP data on the SCCP/EBDABLM cards. When this occurs and the **force** parameter is not specified, the following error is generated:

```
E3849 Cmd Rej: Card(s) cannot warm restart - FORCE parameter required
Verifying card(s) persistent LNP database - please wait
The following cards require a full data download:
Card      Reason
----      -
zzzz     xxxxxxxx
```

where **zzzz** is the card requiring the full data download, and **xxxxxx** is one of the values listed in Table 6-23:

Table 6-23. Reason That Card Requires a Full Data Download

xxxxxxx value	Description
POWER ON	Power on reset
XILINX VERSION	M256 Xilinx version has changed
DB VERSION	LNP Database version has changed
DB LEVEL	Database level is not supported or difference exceeds incremental loading capability
DB STATUS	Database status is incoherent
HW ERROR	Hardware error bit checks on the card fail
AUDIT FAILED	Checksum comparisons of the LNP database fail
AUDIT TIMEOUT	LNP initialization audit timed out
NO AUDIT	Unable to perform LNP DB audit. LNP audit not on or excessive number of unknown checksums
USER REQUEST	User initiated init-card or init-sys command reload type cold
UNKNOWN	Unknown
OTHER	Other

When the OA&M IP Security feature is turned on, and an IPSM card is inserted and initialized for the first time or is removed, inserted, and initialized again, the "SSH Host Keys Regenerated" UIM is displayed. The UIM shows the generated SSH Host Key fingerprint that must be provided at the secure client in order for secure information transfer to occur. The SSH Host Key fingerprint is changed whenever power is lost and restored to an IPSM card.

```
rlghncxa03 03-07-11 07:05:00 EST EAGLE 30.2.0
0021.1493 CARD 1111 INFO SSH Host Keys Regenerated
DSA Server Host Key FTRA-formatted Fingerprint=
84 7c 92 8b c 7c ds 19 1c 6 4b de 5c 8f c5 4d
Report Date:03-07-11 Time:22:27:36
```

When the OA&M IP Security feature is turned on, and an IPSM card is restarted with this command, the "SSH Host Keys Loaded" UIM is displayed. The UIM shows the current SSH Host Key fingerprint. The SSH Host Key fingerprint is not changed if the IPSM card does not lose power.

```
rlghncxa03 01-07-11 07:05:00 EST EAGLE 30.2.0
0021.1493 CARD 1111 INFO SSH Host Keys Loaded
DSA Server Host Key FTRA-formatted Fingerprint=
84 7c 92 8b c 7c ds 19 1c 6 4b de 5c 8f c5 4d
Report Date:03-07-11 Time:22:27:36
```

Output

The following example shows what happens when you enter the **init-sys** command and then enter it a second time within 30 seconds, causing the system to start resetting all its cards.

init-sys

(enter the command the first time)

```
rlghncxa03w 04-01-07 07:05:00 EST EAGLE 31.3.0
Command entered at terminal #3

rlghncxa03w 04-01-07 07:05:01 EST EAGLE 31.3.0
CAUTION: This command causes a complete system reload, and
will result in traffic loss.
Re-enter command within 30 seconds to confirm.
```

init-sys

(re-enter the command)

```
rlghncxa03w 04-01-07 07:05:16 EST EAGLE 31.3.0
Command entered at terminal #3

rlghncxa03w 04-01-07 07:05:17 EST EAGLE 31.3.0
Init System command issued at terminal #3
```

The following example shows what happens if you enter the **init-sys** command and then allow 30 seconds to pass with no other keyboard entry.

(enter the command the first time)

init-sys

```
rlghncxa03w 04-01-05 07:05:00 EST EAGLE 31.3.0
Command entered at terminal #3.

rlghncxa03w 04-01-05 07:05:01 EST EAGLE 31.3.0
CAUTION: This command causes a complete system reload, and
will result in traffic loss.
Re-enter command within 30 seconds to confirm.
```

(30 seconds pass)

```
rlghncxa03w 04-01-05 07:05:31 EST EAGLE 31.3.0
Init System command aborted due to confirmation timeout
```

The following example shows what happens when you enter the **init-sys** command, then enter another command, subsequently letting the 30 second timer expire.

(enter the command the first time)

init-sys

```
rlghncxa03w 04-01-05 07:05:00 EST EAGLE 31.3.0
Command entered at terminal #3

rlghncxa03w 04-01-05 07:05:01 EST EAGLE 31.3.0
CAUTION: This command causes a complete system reload, and
will result in traffic loss.
Re-enter command within 30 seconds to confirm.
```

(the 30-second timer starts)

(enter another command)

rls-alm:lvl=minr

```
rlghncxa03w 04-01-05 07:05:10 EST EAGLE 31.3.0
Command entered at terminal #3
```

```
rlghncxa03w 04-01-05 07:05:11 EST EAGLE 31.3.0
All the minor alarms are released
```

```
rlghncxa03w 04-01-05 07:05:12 EST EAGLE 31.3.0
Command Completed
```

(the 30-second timer expires)

```
rlghncxa03w 04-01-05 07:05:31 EST EAGLE 31.3.0
Init System command aborted due to confirmation timeout
```

The following example shows the **init-sys** command entered twice within 30 seconds.

(enter the command the first time)

init-sys:data=persist

```
rlghncxa03w 04-01-05 07:05:31 EST EAGLE 31.3.0
Command entered at terminal #3
```

```
rlghncxa03w 04-01-05 07:05:31 EST EAGLE 31.3.0
CAUTION: This command causes a complete system reload, and will result in
traffic loss.
Re-enter command within 30 seconds to confirm.
```

(re-enter the command)

init-sys:data=persist

```
rlghncxa03w 04-01-05 07:05:31 EST EAGLE 31.3.0
Command entered at terminal #3
rlghncxa03w 04-01-05 07:05:31 EST EAGLE 31.3.0
Init System command issued at terminal #3
```

lock

Lock Keyboard

Use this command to lock a terminal's keyboard. When the keyboard is locked, the system accepts no keyboard commands other than the **unlock** command. The keyboard remains locked until the logged on user's login password is entered at the UNLOCK prompt. When the keyboard is locked, any idle terminal monitor in effect for the terminal is suspended temporarily.

Keyword: lock

Related Commands: unlock

Command Class: Basic

Parameters

This command has no parameters.

Example

```
lock
```

Dependencies

The terminal cannot be an OAP terminal.

The terminal cannot be an **mgmt** terminal used for Network Surveillance.

The terminal cannot be a **telnet** terminal (terminal IDs 17-40).

Notes

As an alternative, you can unlock a locked terminal by entering the **inh-trm** command, followed by the **alw-trm** command.

Output**lock**

```
rlghncxa03w 04-02-17 16:02:05 EST EAGLE 31.3.0
Terminal keyboard is locked. Enter UNLOCK command to unlock.
;
```

login**Login**

Use this command to login to the system. After you enter this command, the system requests a password. For security reasons, the password is not displayed at the terminal.

Keyword: login

Related Commands: act-user, chg-pid, chg-secu-dflt, chg-user, dact-user, dlt-user, ent-user, logout, rept-stat-user, rtrv-secu-dflt, rtrv-secu-user, rtrv-user

Command Class: Basic

Parameters

:uid= (mandatory)

User ID. The system prompts the user for a valid password after entering in this ID.

Range: 1 alphabetic character followed by up to 15 alphanumeric characters

Example

```
login:uid=john
```

Dependencies

All the following dependencies assume the appropriate features are turned **on**.

The user ID must not be logged in to another port already, and it must not be revoked.

The user ID must have been logged in successfully within the number of days specified on the **uout** parameter of the **ent-user** command.

If the OA&M IP Security Enhancements feature is not turned on, you cannot change the password at the prompt from an IP User Interface telnet terminal (IDs 17-40) when:

- It is the first time the user is logging in with the assigned Userid and password
- The password has expired because of aging out.

You must log in with a new Userid and password for the first time or change an expired password from a serial terminal (terminal IDs 1-16).

Use the following rules for creating passwords:

- A new password cannot contain more than 12 characters.
- A new password must contain at least the number of characters that you specify on the **minlen** parameter of the **chg-secu-dflt** command.
- A new password must contain at least the number of alphabetic (**alpha** parameter), numeric (**num** parameter), and punctuation (**punc** parameter) characters that you specify on the **chg-secu-dflt** command.
- A new password cannot contain the associated user ID.
- A new password cannot contain the associated user ID.

Notes

The **act-user** command can be used in place of **login**. The **act-user** command has been provided in compliance with TL1 standards.

When a new system is shipped, the user ID and password are set to the system. These should be changed immediately to ensure system security.

logout

Logout

Use this command to end a user session. The **logout** command has the same affect as the **dact-user** and **canc-user** commands.

Keyword: **logout**

Related Commands: **act-user, chg-pid, chg-user, dact-user, dlt-user, ent-user, login, rept-stat-user, rtrv-secu-user, rtrv-user**

Command Class: Basic

Parameters

This command has no parameters.

Example

```
logout
```

Dependencies

This command cannot be entered from a terminal that is configured as an OAP terminal.

Notes

The **dact-user** or **canc-user** commands can be used in place of **logout**.

pass**Pass**

Use this command to pass a command string to an individual card for processing. This command reduces the reliance on the OAM build for card and on application-specific information.

Keyword: pass

Related Commands: None

Command Class: System Maintenance

Parameters

:cmd= (mandatory)

Command string including quotes (" "). The command represented in the quoted string is sent to the specified card. Maximum command string length including quotes is 132 characters.

Range: arp, aslog, assocrtt, connmgr, drklog, ftptest, help, linkinfo, msucount, msuroute, msutrace, netstat, nslookup, ping, sctp, sockrtt, sockstate, traceroute, ualog

Any string of quoted characters that represent a pass-through command. See Chapter 9, "Pass-Through Commands" for information on pass-through commands.

NOTE: Pass commands shown in online help that are not documented in Chapter 9 are not supported at this time.

:loc= (mandatory)

The card location as stenciled on the shelf of the system.

Range: 1101-1108, 1111-1112, 1201-1208, 1211-1218, 1301-1308, 1311-1318, 2101-2108, 2111-2118, 2201-2208, 2211-2218, 2301-2308, 2311-2318, 3101-3108, 3111-3118, 3201-3208, 3211-3218, 3301-3308, 3311-3318, 4101-4108, 4111-4118, 4201-4208, 4211-4218, 4301-4308, 4311-4318, 5101-5108, 5111-5118, 5201-5208, 5211-5218, 5301-5308, 5311-5318, 6101-6108, 6111-6118

Example

```
pass:loc=1201:cmd="ping 198.89.1.2"
```

```
pass:loc=1201:cmd="help"
```

Dependencies

The **loc** parameter value must correspond to an SSEMD C card location, or for INP, a VSCCP card location. SS7IPGW, IPGWI, IPLIM, and IPLIMI card locations are valid.

Notes

See Chapter 9, "Pass-Through Commands" for information on pass-through commands.

Output

pass:loc=1201:cmd="ping 198.89.1.2"

NOTE: The following example is not definitive of the output of the ping command. It is intended to show how pass command output from a card might appear.

```
rlghncxa03w 04-02-17 15:35:05 EST EAGLE 31.3.0
ping - Command Accepted by 1201.
PASS: MASP A - COMPLTD
;
OUTPUT FROM 1201:
Pinging 192.168.100.4 with 32 bytes of data:
Reply from 192.168.100.3: bytes=32 time<10ms TTL=255
Reply from 192.168.100.3: bytes=32 time<10ms TTL=255
Reply from 192.168.100.3: bytes=32 time=140ms TTL=255
Reply from 192.168.100.3: bytes=32 time=10ms TTL=255
ping - Command Completed.
END OUTPUT FROM 1201.
;
```

Commands R–Z

This chapter contains commands that start with the letters R through Z. The commands are listed in alphabetical order starting on page 7-2.

Introduction

For each command listed in this chapter, the following information is given:

- A description of the command
- The command syntax
- A description of the command parameters
- An example of the command usage
- Rules, dependencies, and notes relevant to the command
- A list of Related Commands
- The command class to which the command belongs
- Sample command output

rept-ftp-meas**Report Measurements to FTP**

Use this command to manually initiate generation and FTP transfer of a measurements report from the Measurements Platform MCPM to the customer's FTP server.

Keyword: **rept-ftp-meas**

Related Commands: **rept-meas**

Command Class: Link Maintenance

Parameters

:enttype= (mandatory)

Entity type to report on in the measurements report.

Range: **eir, link, lnkset, lnp, lsdestni, lsonismt, lsortgni, mapscrn, np, origni, originc, stp, stplan, tt**

eir—Measurements for Equipment Identity Register

link—Measurements for signaling links

lnkset—Measurements for linksets

lnp—Measurements for local number portability

lsdestni—Measurements for linkset destination network identifiers

lsonismt—Measurements for ISUP message type screening

lsorigni—Measurements for linkset originating network identifiers

mapscrn—Measurements for GSM MAP message screening

np—Measurements for INP and G-Port

origni—Measurements for originating network identifiers greater than 5

originc—Measurements for originating network identifiers (less than 5, small networks) for network clusters

stp—Measurements for all nodes

stplan—Measurements for TCP/IP links.

tt—Measurements for translation types

:type= (mandatory)

The measurement report type.

Range: **avl, avld, avldth, comp, gtwy, mtcd, mtcdth, mtch, mtcs, nm, rbase, systot**

avl—Availability measurements

avld—Daily availability measurements

avldth—Day to hour availability measurements.

comp—Component measurements

gtwy—Internetwork gateway-related data from the STP for ANSI and ITU measurements. ANSI gateway measurements are pegged on a per-linkset, per-Network Indicator basis, whereas ITU measurements are pegged on a per-linkset basis.

mtcd—Daily maintenance measurements

mtcdth—Day-to-hour maintenance measurements

mtch—Hourly maintenance measurements

mtcs—Link/linkset maintenance status

nm—Network management, on-demand

rbase—Schedule-report type record base measurements

systot—STP system totals

:day= (optional)

Day of the week for the specified daily measurement report.

Range: **mon, tue, wed, thu, fri, sat, sun**

Default: If not specified, the previous single day is reported.

:hh= (optional)

The specific half-hour for the specified report. The entry implies the ending time for the collection interval. For example, the parameter **hh=0300** generates a report for the interval 2:30-3:00.

Range: *hhmm* where *hh* = **00-24** (hour) and *mm* = **00** or **30** (minute)

:period= (optional)

The relative period for the report.

Range: **active, last, specific**

:qh= (optional)

The specific quarter-hour for the specified report. The entry implies the ending time for the collection interval. For example, the parameter **qh=0315** generates a report for the interval **3:00-3:15**.

Range: *hhmm* where *hh* = **00-24** (hour) and *mm* = **00, 15, 30, or 45** (minute)

Example

rept-ftp-meas:type=systot:enttype=stp

rept-ftp-meas:type=mtch:enttype=lnp

Dependencies

Only one **rept-ftp-meas** command can be in progress at any one time.

The Measurements Platform feature must be turned on (**chg-feat** command) and the Measurements Platform collection function (**chg-measopts:platformenable=on** command) must be enabled before this command can be entered.

A primary MCPM card must be available when this command is entered.

The 15 Minute Measurements feature must be turned on and the 15 Minute Measurements collection option (**chg-measopts:collect15min=on** command) must be on before the **qh** parameter can be specified.

The LNP feature must be turned on (see the **enable-ctrl-feat** command) before:

- The **mtchlnp=on** parameter or the **mtcdlnp=on** parameter can be specified
- Entity type **lnp** can be specified

The GSM Map Screening feature (see the **enable-ctrl-feat** and **chg-ctrl-feat** commands) must be turned on before

- The **mtcdmap=on** parameter can be specified.
- Entity type **mapscrn** can be specified

Either the G-Port feature or the INP feature must be turned on before

- The **mtchnp=on** parameter or the **mtcdnp=on** parameter can be specified
- Entity type **np** can be specified

The Equipment Identity Register (EIR) feature must be enabled and turned on before the **enttype=eir** parameter can be specified.

The **hh** parameter must specify a half-hourly boundary (the end of the requested half-hour for the report) for valid report types (**mtcd** and **nm** are excluded with message “E2307: QH or HH is not valid for this TYPE”).

The **qh** parameter must specify a quarter-hourly boundary (the end of the requested quarter-hour for the report) for valid report types (**avld**, **mtcd**, **nm**, **rbase**, and **mtcs** are excluded with message “E2307: QH or HH is not valid for this TYPE”).

Hourly collection and report processing cannot be in progress when report type **mtch** is specified.

Day-to-hour collection and report processing cannot be in progress

- When report type **mtcd** is specified
- When report type **mtcdth** is specified

Daily collection and report processing cannot be in progress when report type **mtcd** is specified.

Half-hourly collection and report processing cannot be in progress when report type **comp**, **systot**, **avl**, or **gtwy** is specified.

Quarter-hourly collection and report processing cannot be in progress when report type **comp**, **systot**, **avl**, or **gtwy** is specified.

5-minute collection and report processing cannot be in progress when report type **nm** is specified.

The **mtcdth** report type is unavailable between midnight and 1:00 AM (0100).

The **day** parameter can be specified only for report type **mtcd** and entity types **eir**, **lnp**, **np**, and **mapscrm**.

The **hh** and **qh** parameters cannot be specified together in the command.

When the **period=last** parameter is specified, the **hh** parameter, the **qh** parameter, and the **day** parameter cannot be specified.

When the **period=active** parameter is specified, the **qh** parameter cannot be specified.

When the **period=specific** parameter is specified, the **hh** parameter, the **qh** parameter, or the **day** parameter must be specified.

A half-hour boundary must be specified for the **hh** parameter, except for report type **mtch**; an hourly boundary must be specified for report type **mtch**.

A quarter-hour boundary must be specified for the **qh** parameter, except for report type **mtch**; an hourly boundary must be specified for report type **mtch**.

Table 7-1 on page 7-5 indicates with an X valid parameter combinations for measurements reports; invalid combinations will generate an error message.

Table 7-1. rept-ftp-meas Valid and Invalid Parameter Combinations

Parameter Value	:type Parameter Values											
	avl	avld	avldth	comp	gtwy	mtcd	mtchth	mtch	mtcs	nm	systot	rbase
:entity												
link	X	X	X	X		X	X		X		X	X
lnkset				X	X	X	X		X		X	X
lnp						X		X		X		
lsdestni					X							
lsorigni					X							
lsonismt					X							
mapscrn								X		X		
np						X		X		X		
origni					X							
originnc					X							
stp					X	X	X				X	X
stplan	X					X	X					
tt						X						
:period												
last	X	X	X	X	X	X	X	X		X	X	
specific	X			X	X	X		X			X	
active									X			X

Notes

None

Output

rept-ftp-meas:type=mtcd:enttype=lnp

```
rlghncxa03w 04-02-27 12:47:07 EST EAGLE 31.3.0
Measurement Reports will be generated to FTP
```

```
rlghncxa03w 04-02-27 12:47:07 EST EAGLE 31.3.0
REPT-FTP-MEAS command was successful.
```

;

rept-imt-info**Display IMT Error and Use Statistics**

Use this command to display the following statistics:

- The IMT bus error statistics currently stored in the IMT fault isolation hourly statistics
- The current IMT bus use statistics (Bus use is the percentage of the capacity of the IMT bus that is used for data during a particular time).
- The HMUX and HIPR card error statistics

Keyword: `rept-imt-info`

Related Commands: `clr-imt-stats`, `init-imt-gpl`, `rept-imt-lvl1`, `rept-imt-lvl2`, `tst-imt`

Command Class: System Maintenance

Parameters

:report= (mandatory)

Type of report to generate.

Range: `err`, `util`, `hmutexerr`, `hiprerr`

`err`—Produces a report of the IMT bus error statistics

`util`—Produces a report of the IMT bus use (utilization) statistics

`hiprerr`—Produces a report of the HIPR card error statistics

`hmutexerr`—Produces a report of the HMUX card error statistics

:ebucket= (optional)

End bucket. Specifies the last one-hour time period (*bucket*) for which error statistics are reported.

This parameter cannot be specified when `report=util` is specified.

Range: `0-15`

Default: If `sbucket` is specified—current `sbucket` value; information for only that time period is displayed.

If `sbucket` is not specified—`15`, the report includes statistics for all 16 time periods

:eloc= (optional)

End location. Specifies the card location of the last card in the range for the report.

Range: `1101-1113`, `1115`, `1201-1218`, `1301-1318`, `2101-2118`, `2201-2218`, `2301-2318`,
`3101-3118`, `3201-3218`, `3301-3318`, `4101-4118`, `4201-4218`, `4301-4318`, `5101-5118`,
`5201-5218`, `5301-5318`, `6101-6118`

Default: If `sloc` is specified—current `sloc` value; displays information for one card

If `sloc` is not specified—`1115`, which corresponds to IMT address 251 (`e=251`); displays information for entire range of locations.

:erronly= (optional)

Use this parameter to filter output to display only non-zero counts in the error report.

This parameter can be specified only if `report=err` is specified.

Range: `yes`, `no`

Default: `yes`

:eshelf= (optional)

End shelf location for HMUX or HIPR statistics. This parameter specifies the shelf location of the last shelf in the range.

This parameter can be specified only if **report=hmuxerr** or **report=hiprerr** is specified.

Range: 1100, 1200, 1300, 2100, 2200, 2300, 3100, 3200, 3300, 4100, 4200, 4300, 5100, 5200, 5300, 6100

Default: If **sshelf** is specified—current **sshelf** value.

If **sshelf** is not specified—**6100**, displays information for entire range of shelves.

:eslot= (optional)

Ending slot location for HIPR statistics for the cards in the HIPR shelf.

This parameter can be specified only if **report=hiprerr** is specified.

Range: 1-8, 11-18

Default: If **sslot** is specified—current **sslot** value.

If **sslot** is not specified—not used.

:mode= (optional)

Display mode to use for error report.

This parameter can be specified only if **report=err** is specified.

Range: full, stats, summary

full—Displays information for each card along with a summary report

stats—Displays only individual card statistics

summary—Displays the summary portion of the report

Default: summary

:sbucket= (optional)

Start bucket. Specifies the first one-hour time period (*bucket*) for which error statistics are reported.

This parameter cannot be specified when **report=util** is specified.

Range: 0-15

Default: 0

:sshelf= (optional)

Start shelf location for HMUX or HIPR statistics. This parameter specifies the shelf location of the first shelf in the range.

This parameter can be specified only if **report=hmuxerr** or **report=hiprerr** is specified.

Range: 1100, 1200, 1300, 2100, 2200, 2300, 3100, 3200, 3300, 4100, 4200, 4300, 5100, 5200, 5300, 6100

Default: If **eshelf** is specified—current **eshelf** value.

If **eshelf** is not specified—**1100**, displays information for entire range of shelves.

:sloc= (optional)

Start location. Specifies the card location of the first card in the range for the report.

Range: 1101-1113, 1115, 1201-1218, 1301-1318, 2101-2118, 2201-2218, 2301-2318, 3101-3118, 3201-3218, 3301-3318, 4101-4118, 4201-4218, 4301-4318, 5101-5118, 5201-5218, 5301-5318, 6101-6118

Default: If **eloc** is specified—current **eloc** value.

If **eloc** is not specified—**1201**, which corresponds to IMT address 0; displays information for entire range of card locations.

:slot= (optional)

Starting slot location for HIPR or SIFB statistics for the cards in the HIPR shelf.

This parameter can be specified only if **report=hiprerr** is specified.

Range: 1-8, 11-18

Default: If **eslot** is specified—current **eslot** value.
If **eslot** is not specified—not used.

:trm= (optional)

The serial port (printer location) to which the report is to be sent.

Range: 1-16

Default: Report displays on the terminal where the command is issued.

Example

```
rept-imt-info:report=err
```

```
rept-imt-info:report=err:sloc=1101:eloc=1102:mode=stats
```

```
rept-imt-info:report=err:sloc=1101:eloc=1102:mode=full:erronly=no
```

```
rept-imt-info:report=util
```

```
rept-imt-info:report=hmuxerr
```

```
rept-imt-info:report=hiprerr:sbucket=0
```

```
rept-imt-info: report=hiprerr:sshelf=1100:sslot=1:eslot=2:sbucket=0
```

Dependencies

No related IMT command can be in progress when the **rept-imt-info** command is entered. Only one report can be active at a time.

This command cannot be entered at a telnet terminal (terminal ID 17-40).

The **rept-imt-info** command cannot be entered during an IMT statistics collection period following an hourly boundary (IMT performance monitoring).

The following **report** parameter combinations are not valid in the command:

- When the **report=util** parameter is specified, the **ebucket**, **erronly**, **mode**, and **sbucket** parameters cannot be specified.
- When the **report=hmuxerr** parameter or the **report=hiprerr** parameter is specified, the **erronly** and **mode** parameters cannot be specified.
- When the **report** parameter values **err**, **util**, and **hmuxerr** are specified, the **sslot** and **eslot** parameters cannot be specified.

The ending hourly time period cannot be less than the starting hourly time period. For example, **rept-imt-info:report=err:sbucket=5:ebucket=3** cannot be specified.

When the **sslot** and **eslot** parameters are specified, the **sshelf** parameter must be specified and the **eshelf** parameter cannot be specified (slot information is reported for a single shelf).

The **sshelf** and **eshelf** parameters can be specified only when the **report=hmuxerr** parameter or the **report=hiprerr** parameter is specified.

The HIPR card slots (**09** and **10**) cannot be specified for the **sslot** and **eslot** parameter values.

Notes

This command can be canceled using the **F9** function key or the **canc-cmd** command. See **canc-cmd** for more information.

IMT Bus Error Statistics: Each hourly time period (*bucket*) contains the IMT bus error statistics for a single hour. A total of 16 hourly time periods, numbered **0** to **15**, exist. Hourly time period **0** is the most-recent (current), and hourly time period **15** is the least-recent (oldest).

Each hour the statistics for the current hourly time period expire, and the hourly time periods advance. That is, after the advance, the statistics previously reported in hourly time period **0** are now reported in the hourly time period **1**, and so on. The statistics reported in the hourly time period **15** are no longer available after the change.

When a card is reinitialized, it begins collecting statistics in hourly time period **0** and changes to hourly time period **1** at the start of the next hour. Thus, the first statistics that a card collects after being reinitialized may be for a partial hour.

IMT Bus Use Statistics: The statistics are calculated for all cards in the specified range and summarized. Only the summarized statistics are displayed. *IMT bus use* is the percentage of the capacity of the IMT bus that is used for data during a particular time.

HMUX or HIPR Statistics (Bucket Summary): Each hourly time period (*bucket*) contains the HMUX or HIPR statistics for a single hour. A total of 16 hourly buckets, numbered **0** to **15**, exist. Bucket **0** is the most-recent (current) bucket; bucket **15** is the least-recent (oldest).

Each hour on the hour, the least-recent bucket expires and the hourly time periods advance. That is, after the advance, the statistics previously reported in bucket **0** are now reported in bucket **1**, and so on. The statistics that were reported in bucket **15** are no longer available after the change.

If a card booted within the past 16 hours, a message is displayed indicating that no data is available for that card. When a card boots, it starts to collect statistics in bucket **0**. It changes to bucket **1** at the start of the next hour. Thus, the first bucket of statistics that a card collects after booting might be for part of an hour.

A HIPR card stores the statistics separately for each card on its shelf. When the **sloc** and **eloc** parameters are specified, the HIPR card sends the statistics for each card to the OAM application for display. When the **sloc** and **eloc** parameters are not specified, the HIPR card sends an aggregate number to the OAM application to represent statistics for all cards on its shelf.

HMUX or HIPR Statistics (Cumulative): HMUX or HIPR cumulative statistics maintain running totals of the error count for each parameter from card initialization. The error counts can be cleared by entering a **clr-imt-stats:all=yes** command to clear all HMUX and HIPR cards, or a **clr-imt-stats** command to clear a specific card.

Table 7-2 explains the **rept-imt-info:report=hmuxerr** statistics.

"Excessive" is primarily determined by the operator, based upon:

- Overall system behavior
- Duration of time since the last statistics were taken
- Statistics of an individual card in relation to other cards

Table 7-2. Explanation of **rept-imt-info:report=hmuxerr** Statistics

IMT Statistic	Explanation Of Statistic	Probable Causes	Recommended Action
LOW SPEED STATS			
IMT Rx Packet CRC Error	Bad Checksum in received IMT packet. Usually caused by corrupted data. Detected by hardware.	Card insertion/ removal or boot. May occur infrequently in a normal system.	None if card has booted or was just inserted. Otherwise, call Tekelec Technical Services if count is excessive in relation to other cards.
IMT Rx Packet Format Error	Occurs when the Start of Message byte of the IMT packet is followed by unexpected data. Detected by hardware.	Card insertion/removal or boot.	None if card has booted or was just inserted. Otherwise call Tekelec Technical Services if count is excessive in relation to other cards.
IMT Rx Violation Error	Received an illegal character from the IMT. Detected by hardware.	Card insertion/removal or boot.	None if card has booted or was just inserted. Otherwise call Tekelec Technical Services if count is excessive in relation to other cards.
CPU Rx FIFO Full	HMUX's IMT interface is congested. Detected by hardware.	Indicates that data was received at a higher rate than could be processed	Call Tekelec Technical Services if count is excessive in relation to other HMUX cards.
CPU Rx FIFO Half Full	HMUX's IMT interface is becoming congested. Detected by hardware.	Indicates that data was received at a higher rate than could be switched for a short period.	None. FIFO half full is just an indication; no action is required.
CPU Rx FIFO Empty Before SOM	Occurs when valid packet data is read from the CPU Rx FIFO by the FPGA but the FPGA is unable to locate the beginning (SOM) of the packet before all the data was read.	The SOM was corrupted while being written into the CPU Rx FIFO from the low speed link.	None. This error will automatically empty the FIFO so that it is ready to continue receiving data. However, if the problem persists, there might be some type of FPGA problem that requires further investigation.
CPU Rx FIFO Empty Before EOM	Occurs when valid packet data is read from the CPU Rx FIFO by the FPGA but the FPGA is unable to locate the end (EOM) of the packet before all of the data was read.	The SOM was corrupted while being written into the CPU Rx FIFO or a partial packet was written into the FIFO from the low speed link.	None. This error will automatically empty the FIFO so that it is ready to continue receiving data. If the problem persists, some type of FPGA or high-speed link problem might require further investigation.

Table 7-2. Explanation of `rept-imt-info:report=hmuxerr` Statistics (Continued)

IMT Statistic	Explanation Of Statistic	Probable Causes	Recommended Action
CPU Rx Packet SOM Before EOM	A Start of Message was received when an End of Message was expected from the IMT bus.	Packet was corrupted in the system (EOM lost) and has another packet appended to it.	None.
CPU Rx Packet CRC Error	Occurs when valid packet data is read from the CPU Rx FIFO by the FPGA and transferred to the processor memory, and the FPGA calculated CRC does NOT match the CRC word at the end of the packet.	The data was corrupted while being written into the CPU Rx FIFO, or data coming from the low speed link is corrupted.	None. If the problem persists, some type of FPGA or high-speed link problem might require further investigation.
DMA Terminal Count Interrupt	Received IMT packet length is longer than the max allowed. Detected by hardware.	Card insertion/removal or boot.	None if card has booted or was just inserted. Otherwise, call Tekelec Technical Services if count is excessive in relation to other cards.
CPU Tx Buffer EOB	A packet that was being transmitted from the CPU Tx Buffer did not have an EOM. Therefore, the full 512 bytes from the Tx buffer were transmitted.	The data was corrupted while being written into or being read from the FIFO.	None. If the problem persists, some type of FPGA problem might require further investigation.
CPU Tx Buffer Full	The Tx Buffer has had 512 bytes written to it and can accept no more.	A packet is being sent that is too large.	Write the EOM insert command to send the packet, write an abort command to reset the Tx buffer control interface, or issue a Tx Buffer reset from the processor.
CPU Tx Buffer Half Full	The Tx Buffer has had 256 bytes written to it.	256 bytes have been written to the Tx Buffer.	None.
IMT Bypass FIFO Full	The IMT Bypass FIFO has 32K bytes of data in it.	The low-speed link is experiencing very heavy traffic conditions, or the HMUX IMT Transmitter has been disabled or is not operating correctly.	Determine why IMT traffic is so heavy. Make sure the HMUX IMT Transmitter is enabled.
IMT Bypass FIFO Half Full	The IMT Bypass FIFO has 16K bytes of data in it.	The low-speed link is experiencing very heavy traffic conditions, or the HMUX IMT Transmitter has been disabled or is not operating correctly.	Determine why IMT traffic is so heavy. Make sure the HMUX IMT Transmitter is enabled. Under normal operation this condition should clear itself.
IMT Tx FIFO Full	HMUX's IMT Transmit FIFO Full	TAXI transmitter logic for this channel is not operating properly.	Reset Tx FIFO. If all channels exhibit this problem, there might be an internal FPGA problem with the 125MHz clock.
IMT Tx FIFO Half Full	HMUX's IMT Transmit Half FIFO Full	High burst rate or multiple large packet transmissions from IXP1250.	None

Table 7-2. Explanation of **rept-imt-info:report=hmuxerr** Statistics (Continued)

IMT Statistic	Explanation Of Statistic	Probable Causes	Recommended Action
HIGH SPEED STATS			
IMT Rx Packet Format Error	Packet was received with a format error (for example, no EOM)	Packet was transmitted incorrectly or was corrupted by another device in the system.	None
IMT Rx Disparity Error	Fibre Channel transceiver received a disparity error on a character.	Noisy high-speed ring.	This is a hardware level issue. If the error persists, more detailed high-speed bus analysis is required.
IMT Rx Sync Lost Error	Fibre Channel transceiver is not receiving sync characters	Noisy high-speed ring. High-speed cable was disconnected. One of the HMUXs in the ring was removed.	This is a hardware level issue. If the error persists, more detailed high-speed bus analysis is required.
IMT Rx Code Word Error	Fibre Channel transceiver has received an invalid code word.	Noisy high-speed ring. Wrong command transmitted.	This is a hardware level issue. If the error persists, more detailed high-speed bus analysis is required.
CPU Receive FIFO Full	Communication CPU on the card is congested. Detected by hardware	Indicates that data was received at a higher rate than could be processed by the Communications processor.	Call Tekelec Technical Services if count is excessive in relation to other cards.
CPU Receive FIFO Half Full	Communication CPU on the card is becoming congested. Detected by hardware.	Indicates that data was received at a higher rate than could be processed for a short period.	None. FIFO half full is just an indication; no action is required.
CPU Rx FIFO Empty Before SOM	Occurs when valid packet data is read from the CPU Rx FIFO by the FPGA, but the FPGA is unable to locate the beginning (SOM) of the packet before all the data was read.	The SOM was corrupted while being written into the CPU Rx FIFO from the high speed link.	None. This error will automatically empty the FIFO so that it is ready to continue receiving data. However, if the problem persists, there might be some type of FPGA problem that requires further investigation.
CPU Rx FIFO Empty Before EOM	Occurs when valid packet data is read from the CPU Rx FIFO by the FPGA, but the FPGA is unable to locate the end (EOM) of the packet before all of the data was read.	The SOM was corrupted while being written into the CPU Rx FIFO, or a partial packet was written into the FIFO from the high speed link.	None. This error will automatically empty the FIFO so that it is ready to continue receiving data. If the problem persists, some type of FPGA or low-speed link problem might require further investigation.
CPU Rx Packet SOM Before EOM	A Start of Message was received when an End of Message was expected from the Fibre Channel bus.	Packet was corrupted in the system (EOM lost) and has another packet appended to it.	None.
CPU Rx Packet CRC Error	A packet received for this shelf contains a CRC error.	Packet was transmitted incorrectly or was corrupted by another device in the system.	Discard packet. If this problem persists, a more detailed analysis of the system is needed.

Table 7-2. Explanation of `rept-imt-info:report=hmuxerr` Statistics (Continued)

IMT Statistic	Explanation Of Statistic	Probable Causes	Recommended Action
DMA Terminal Count Interrupt	Received IMT packet length (on Fibre Channel) is longer than the maximum allowed. Detected by hardware.	Card insertion/removal or boot.	None if card has booted or was just inserted. Otherwise call Tekelec Technical Services if count is excessive in relation to other cards.
CPU Tx Buffer EOB	A packet that was being transmitted from the CPU Tx Buffer did not have an EOM. Therefore, the full 512 bytes from the Tx buffer were transmitted.	The data was corrupted while being written into or being read from the FIFO.	None. If the problem persists, some type of FPGA problem might require further investigation.
CPU Tx Buffer Full	The Tx Buffer has had 512 bytes written to it and can accept no more.	A packet is being sent that is too large.	Write the EOM insert command to send the packet, write an abort command to reset the Tx buffer control interface, or issue a Tx Buffer reset from the processor.
CPU Tx FIFO Half Full	The Tx Buffer has had 256 bytes written to it.	256 bytes have been written to the Tx Buffer.	None.
IMT (High-speed) Bypass FIFO Full	The High-speed Bypass FIFO has 2K bytes of data in it.	The high-speed link is experiencing very heavy traffic conditions, or the HMUX High-speed Transmitter has been disabled or is not operating correctly.	Determine why high-speed traffic is so heavy. Make sure the HMUX High-speed Transmitter is enabled.
IMT (High-speed) Bypass FIFO Half Full	The High-speed Bypass FIFO has 1K bytes of data in it.	The high-speed link is experiencing very heavy traffic conditions or the HMUX High-speed Transmitter has been disabled or is not operating correctly.	Determine why high-speed traffic is so heavy. Make sure HMUX High-speed Transmitter is enabled. Under normal operation this condition should clear itself.
IMT (High-speed) Rx FIFO Full	The High-speed Rx FIFO has 128K bytes of data in it.	The high-speed link is experiencing heavy traffic conditions. The Low-speed Transmitter is disabled, experiencing heavy traffic loads, or not operating correctly.	Determine why high-speed traffic is so heavy. Determine why low speed traffic is so heavy. Make sure the HMUX Low-speed Transmitter is enabled.
IMT (High-speed) Rx FIFO Half Full	The High-speed Rx FIFO has 1K bytes of data in it.	The high-speed link is experiencing heavy traffic conditions. The Low-speed Transmitter is disabled, experiencing heavy traffic loads, or not operating correctly.	Determine why high-speed traffic is so heavy. Make sure the HMUX Low-speed Transmitter is enabled. Under normal operation this condition should clear itself.

Table 7-2. Explanation of **rept-imt-info:report=hmuxerr** Statistics (Continued)

IMT Statistic	Explanation Of Statistic	Probable Causes	Recommended Action
MISC STATS			
Shelf ID UART Framing Error	UART Framing error received by HMUX in Shelf address data stream received from OAM.	Noisy or bad clock cable from Control Shelf to shelf in which error is reported.	Occasionally happens. This count should be low. Only if this count is VERY HIGH, bring it to the attention of Tekelec Technical Services.
Shelf ID UART Overrun Error	UART Overrun error received by HMUX in Shelf address data stream received from OAM.	Noisy or bad clock cable from Control Shelf to shelf in which error is reported.	Occasionally happens. This count should be low. Only if this count is VERY HIGH, bring it to the attention of Tekelec Technical Services.

Table 7-3 explains the **rept-imt-info:report=hiprerr** statistics.

"Excessive" is primarily determined by the operator, based upon:

- Overall system behavior
- Duration of time since the last statistics were taken
- Statistics of an individual card in relation to other cards

Table 7-3. Explanation of **rept-imt-info:report=hiprerr** Statistics

IMT Statistic	Explanation Of Statistic	Probable Causes	Recommended Action
LOW SPEED STATS			
IMT Rx Packet CRC Error	Bad Checksum in received IMT packet. Usually caused by corrupted data. Detected by hardware.	Card insertion, removal or boot. May occur infrequently in a normal system.	None if card has booted or was just inserted. Otherwise, call Tekelec Technical Services if count is excessive in relation to other cards.
IMT Rx Packet Format Error	Occurs when the Start of Message byte of the IMT packet is followed by unexpected data. Detected by hardware.	Card insertion/removal or boot.	None if card has booted or was just inserted. Otherwise call Tekelec Technical Services if count is excessive in relation to other cards.
IMT Rx Violation Error	Received an illegal character from the IMT. Detected by hardware.	Card insertion/removal or boot.	None if card has booted or was just inserted. Otherwise, call Tekelec Technical Services if count is excessive in relation to other cards.
IMT Rx Command Error	An invalid TAXI command detected in a received packet.	Packet was corrupted in the system.	None.
IMT Rx FIFO Full	HIPR's IMT interface is congested. Detected by hardware.	Indicates that data was received at a higher rate than could be processed	Call Tekelec Technical Services if count is excessive in relation to other HIPR cards.

Table 7-3. Explanation of **rept-imt-info:report=hiprerr** Statistics (Continued)

IMT Statistic	Explanation Of Statistic	Probable Causes	Recommended Action
IMT Rx FIFO Half Full	HIPR's IMT interface is becoming congested. Detected by hardware.	Indicates that data was received at a higher rate than could be switched for a short period.	None. FIFO half full is just an indication; no action is required.
IMT Tx FIFO Full	HIPR's IMT Transmit FIFO Full	TAXI transmitter logic for this channel is not operating properly.	Reset Tx FIFO. If all channels exhibit this problem, there might be an internal FPGA problem with the 125MHz clock.
IMT Tx FIFO Half Full	HIPR's IMT Transmit Half FIFO Full	High burst rate or multiple large packet transmissions from IXP1250.	None
HIGH SPEED STATS			
IMT Rx Packet Format Error	Packet was received with a format error (for example, no EOM)	Packet was transmitted incorrectly or was corrupted by another device in the system.	None
IMT Rx Disparity Error	Fibre Channel transceiver received a disparity error on a character.	Noisy high-speed ring.	This is hardware level issue. If the error persists, more detailed high-speed bus analysis is required.
IMT Rx Sync Lost Error	Fibre Channel transceiver is not receiving sync characters	Noisy high-speed ring. High-speed cable was disconnected. One of the HIPRs in the ring was removed.	This is hardware level issue. If the error persists, more detailed high-speed bus analysis is required.
IMT Rx Code Word Error	Fibre Channel transceiver has received an invalid code word.	Noisy high-speed ring. Wrong command transmitted.	This is hardware level issue. If the error persists, more detailed high-speed bus analysis is required.
IMT Rx Packet SOM Before EOM	A Start of Message was received when an End of Message was expected from the Fibre Channel bus.	Packet was corrupted in the system (EOM lost) and has another packet appended to it.	None.
IMT Rx Packet CRC Error	A packet received for this shelf contains a CRC error.	Packet was transmitted incorrectly or was corrupted by another device in the system	Discard packet. If this problem persists, a more detailed analysis of the system is needed.
IMT Bypass FIFO Full	The high-speed shelf bypass FIFO has been overflowed with data.	Fibre Channel transmit logic not operating correctly. Very high simultaneous data traffic rates on the high-speed ring and on the low-speed to high-speed path within the shelf.	System is operating above limits. Reduce data traffic. Reset FIFO.
IMT Bypass FIFO Half Full	The high-speed shelf bypass FIFO is half full.	Data traffic burst on the high-speed bus.	None
IMT Rx FIFO Full	The 128k FIFO has been overflowed with data.	IXP1250 not removing data from FPGA.	Reset FIFO. Determine why IXP1250 not removing data.

Table 7-3. Explanation of **rept-imt-info:report=hiprerr** Statistics (Continued)

IMT Statistic	Explanation Of Statistic	Probable Causes	Recommended Action
IMT Rx FIFO Half Full	The 128k FIFO has gone half full with data.	Large burst of traffic on high-speed ring.	None
IMT Tx FIFO Full	The high-speed transmit FIFO has been overflowed with data.	The Fibre Channel transmit logic is not operating. The 106.25MHz is not operating. The data in the FIFO is incorrectly formatted (no EOM).	Reset Tx FIFO.
IMT Tx FIFO Half Full	The high-speed transmit FIFO is half full with data.	High burst rate or multiple large packet transmissions from IXP1250.	None
IXP Rx FIFO Full	IXP1250 FIFO has been overflowed with data.	IXP1250 not removing data from the FPGA. Data coming in faster than IXP1250 can process.	Reset the IXP1250 FIFO.
IXP Rx FIFO Half Full	IXP1250 FIFO is half full with data	Large burst of data on the high-speed ring.	None
MISC STATS			
Shelf ID UART Framing Error	UART Framing error received by HIPR in Shelf address data stream received from OAM.	Noisy or bad clock cable from Control Shelf to shelf in which error is reported.	Occasionally happens. This count should be low. Only if this count is VERY HIGH, bring it to the attention of Tekelec Technical Services.
Shelf ID UART Overrun Error	UART Overrun error received by HIPR in Shelf address data stream received from OAM.	Noisy or bad clock cable from Control Shelf to shelf in which error is reported.	Occasionally happens. This count should be low. Only if this count is VERY HIGH, bring it to the attention of Tekelec Technical Services.

Output

rept-imt-info:report=err

```
rlghncxa03w 04-02-27 12:47:07 EST EAGLE 31.3.0
```

```
IMT Fault Isolation Error Statistics
```

```
=====
```

```
SUMMARY REPORT: Totals accumulated from all requested cards for all buckets
```

```
Statistic                Bus A Value    Bus B Value
-----                -
Rcv CRC Err                12             1
Primary Ctl Rcv Err        23             3
Violation Err              34             5
CPU Rcv FIFO Full         45             12
;
```

rept-imt-info:report=err:sloc=1101:eloc=1102:mode=stats

rlghncxa03w 04-02-27 12:47:07 EST EAGLE 31.3.0
 IMT Fault Isolation Error Statistics

 Totals accumulated from all requested cards for each bucket

Bucket	Statistic	Bus A Value	Bus B Value
00	Rcv CRC Err	1	2
	Rcv Invalid Len	1012345678	0
	CPU Rcv FIFO Full	23	123

01 No errors in this bucket.
 .
 . (data continues for each hourly time period)
 ;

rept-imt-info:report=err:sloc=1101:eloc=1102:mode=full:erronly=no

rlghncxa03w 04-02-27 12:47:07 EST EAGLE 31.3.0
 IMT Fault Isolation Error Statistics

 Totals accumulated from all requested cards for each bucket

Bucket	Statistic	Bus A Value	Bus B Value
00	Rcv CRC Err	0	0
	Rcv Format Err	0	0
	Rcv Invalid Len	1	0
	Primary Ctl Rcv Err	0	0
	Primary Ctl Tx Err	0	0
	Primary Ctl Sanity Err	0	0
	Violation Err	1	0
	IMT Rcv FIFO Half Full	0	0
	IMT Rcv FIFO Full	0	0
	CPU Rcv FIFO Half Full	0	0
	CPU Rcv FIFO Full	0	0
	MSU Retransmitted	0	0
	DMA Terminal Ct Intrpt	0	0
	SSU Pkts Txd	0	0
	SSU Pkts Rcvd	0	0
01	Rcv CRC Err	3	0
	Rcv Format Err	0	0
	Rcv Invalid Len	0	0
	Primary Ctl Rcv Err	0	0
	Primary Ctl Tx Err	0	0
	Primary Ctl Sanity Err	0	0
	Violation Err	0	0
	IMT Rcv FIFO Half Full	0	0
	IMT Rcv FIFO Full	0	0
	CPU Rcv FIFO Half Full	0	0
	CPU Rcv FIFO Full	0	0
	MSU Retransmitted	0	0
	DMA Terminal Ct Intrpt	0	0
	SSU Pkts Txd	0	0
	SSU Pkts Rcvd	0	0

.
 (data continues for each hourly time period)

```

=====
SUMMARY REPORT: Totals accumulated from all requested cards for all buckets
Statistic                Bus A Value    Bus B Value
-----                -
Rcv CRC Err              3              0
Rcv Format Err            0              0
Rcv Invalid Len          1              0
Primary Ctl Rcv Err     1012345678    0
Primary Ctl Tx Err      0              0
Primary Ctl Sanity Err  0              0
Violation Err            1              0
IMT Rcv FIFO Half Full  0              0
IMT Rcv FIFO Full       0              0
CPU Rcv FIFO Half Full  23             0
CPU Rcv FIFO Full       0              0
MSU Retransmitted       0              0
DMA Terminal Ct Intrpt  0              0
SSU Pkts Txd            1              0
SSU Pkts Rcvd           0              0
;

```

rept-imt-info:report=util

```

rlghncxa03w 04-02-27 12:47:07 EST EAGLE 31.3.0
IMT Utilization Statistics

```

```

=====
SUMMARY REPORT: Combined statistics from all requested cards.
Statistic                Bus A Value    Bus B Value
-----                -
Utilization              10%            9%
Pkts Tx                  1234           613
Avg MSU Length (bytes)   73             152
;

```

rept-imt-info:report=hmuxerr:sbucket=0

Table 7-2 on page 7-10 explains the meaning of each statistic that can be displayed in the **rept-imt-info:report=hmuxerr** output.

rlghncxa03w 04-02-27 12:47:07 EST EAGLE 31.3.0
 HMUX SUMMARY REPORT: Summed across all requested shelves and buckets

HMUX Hourly Bucket Statistics

=====

Bucket	Low Speed Statistic	Bus A	Bus B
00	IMT Rx Packet CRC Error	0123456789	0123456789
	IMT Rx Packet Format Error	0123456789	0123456789
	IMT Rx Violation Error	0123456789	0123456789
	CPU Rx FIFO Full	0123456789	0123456789
	CPU Rx FIFO Half Full	0123456789	0123456789
	CPU Rx FIFO Empty Before SOM	0123456789	0123456789
	CPU Rx FIFO Empty Before EOM	0123456789	0123456789
	CPU Rx Packet SOM Before EOM	0123456789	0123456789
	CPU Rx Packet CRC Error	0123456789	0123456789
	DMA terminal count	0123456789	0123456789
	CPU Tx Buffer EOB	0123456789	0123456789
	CPU Tx Buffer Full	0123456789	0123456789
	CPU Tx FIFO Half Full	0123456789	0123456789
	IMT Bypass FIFO Full	0123456789	0123456789
	IMT Bypass FIFO Half Full	0123456789	0123456789
	IMT Rx FIFO Full	0123456789	0123456789
	IMT Rx FIFO Half Full	0123456789	0123456789

High Speed Statistic	Bus A	Bus B
IMT Rx Packet Format Error	0123456789	0123456789
IMT Rx Disparity Error	0123456789	0123456789
IMT Rx Sync Lost Error	0123456789	0123456789
IMT Rx Code Word Error	0123456789	0123456789
CPU Rx FIFO Full	0123456789	0123456789
CPU Rx FIFO Half Full	0123456789	0123456789
CPU Rx FIFO Empty Before SOM	0123456789	0123456789
CPU Rx FIFO Empty Before EOM	0123456789	0123456789
CPU Rx Packet SOM Before EOM	0123456789	0123456789
CPU Rx Packet CRC Error	0123456789	0123456789
DMA terminal count	0123456789	0123456789
CPU Tx Buffer EOB	0123456789	0123456789
CPU Tx Buffer Full	0123456789	0123456789
CPU Tx Buffer Half Full	0123456789	0123456789
IMT Bypass FIFO Full	0123456789	0123456789
IMT Bypass FIFO Half Full	0123456789	0123456789
IMT Rx FIFO Full	0123456789	0123456789
IMT Rx FIFO Half Full	0123456789	0123456789

Misc Speed Statistic	Bus A	Bus B
Shelf ID UART Framing Error	0123456789	0123456789
Shelf ID UART Overrun Error	0123456789	0123456789

HMUX Cumulative Statistics

```

=====
Low Speed Statistic          Bus A      Bus B
-----
IMT Rx Packet CRC Error     0123456789 0123456789
IMT Rx Packet Format Error   0123456789 0123456789
IMT Rx Violation Error      0123456789 0123456789
CPU Rx FIFO Full            0123456789 0123456789
CPU Rx FIFO Half Full       0123456789 0123456789
CPU Rx FIFO Empty Before SOM 0123456789 0123456789
CPU Rx FIFO Empty Before EOM 0123456789 0123456789
CPU Rx Packet SOM Before EOM 0123456789 0123456789
CPU Rx Packet CRC Error     0123456789 0123456789
DMA terminal count          0123456789 0123456789
CPU Tx Buffer EOB            0123456789 0123456789
CPU Tx Buffer Full           0123456789 0123456789
CPU Tx FIFO Half Full       0123456789 0123456789
IMT Bypass FIFO Full        0123456789 0123456789
IMT Bypass FIFO Half Full   0123456789 0123456789
IMT Rx FIFO Full            0123456789 0123456789
IMT Rx FIFO Half Full       0123456789 0123456789

High Speed Statistic        Bus A      Bus B
-----
IMT Rx Packet Format Error   0123456789 0123456789
IMT Rx Disparity Error       0123456789 0123456789
IMT Rx Sync Lost Error      0123456789 0123456789
IMT Rx Code Word Error      0123456789 0123456789
CPU Rx FIFO Full            0123456789 0123456789
CPU Rx FIFO Half Full       0123456789 0123456789
CPU Rx FIFO Empty Before SOM 0123456789 0123456789
CPU Rx FIFO Empty Before EOM 0123456789 0123456789
CPU Rx Packet SOM Before EOM 0123456789 0123456789
CPU Rx Packet CRC Error     0123456789 0123456789
DMA terminal count          0123456789 0123456789
CPU Tx Buffer EOB            0123456789 0123456789
CPU Tx Buffer Full           0123456789 0123456789
CPU Tx Buffer Half Full      0123456789 0123456789
IMT Bypass FIFO Full        0123456789 0123456789
IMT Bypass FIFO Half Full   0123456789 0123456789
IMT Rx FIFO Full            0123456789 0123456789
IMT Rx FIFO Half Full       0123456789 0123456789

Misc Speed Statistic        Bus A      Bus B
-----
Shelf ID UART Framing Error  0123456789 0123456789
Shelf ID UART Overrun Error  0123456789 0123456789

```

rlghncxa03w 04-02-27 12:47:07 EST EAGLE 31.3.0
 HMUX Maintenance Statistics

;

=====

HMUX SUMMARY REPORT: Summed across all requested shelves and buckets

Low Speed Statistic	Bucket Summary		Cumulative	
	Bus A	Bus B	Bus A	Bus B
-----	-----	-----	-----	-----
IMT Rx Packet CRC Error	0123456789	0123456789	0123456789	0987654321
IMT Rx Packet Format Error	0123456789	0123456789	0123456789	0987654321
IMT Rx Violation Error	0123456789	0123456789	0123456789	0987654321
CPU Rx FIFO Full	0123456789	0123456789	0123456789	0987654321
CPU Rx FIFO Half Full	0123456789	0123456789	0123456789	0987654321
CPU Rx FIFO Empty Before SOM	0123456789	0123456789	0123456789	0987654321
CPU Rx FIFO Empty Before EOM	0123456789	0123456789	0123456789	0987654321
CPU Rx Packet SOM Before EOM	0123456789	0123456789	0123456789	0987654321
CPU Rx Packet CRC Error	0123456789	0123456789	0123456789	0987654321
CPU Tx Buffer EOB	0123456789	0123456789	0123456789	0987654321
CPU Tx Buffer Full	0123456789	0123456789	0123456789	0987654321
CPU Tx FIFO Half Full	0123456789	0123456789	0123456789	0987654321
IMT Bypass FIFO Full	0123456789	0123456789	0123456789	0987654321
IMT Bypass FIFO Half Full	0123456789	0123456789	0123456789	0987654321
IMT Rx FIFO Full	0123456789	0123456789	0123456789	0987654321
IMT Rx FIFO Half Full	0123456789	0123456789	0123456789	0987654321
IMT Rx FIFO Sanity	0123456789	0123456789	0123456789	0987654321

High Speed Statistic	Bucket Summary		Cumulative	
	Bus A	Bus B	Bus A	Bus B
-----	-----	-----	-----	-----
IMT Rx Packet Format Error	0123456789	0123456789	0123456789	0987654321
IMT Rx Disparity Error	0123456789	0123456789	0123456789	0987654321
IMT Rx Sync Lost Error	0123456789	0123456789	0123456789	0987654321
IMT Rx Code Word Error	0123456789	0123456789	0123456789	0987654321
CPU Rx FIFO Full	0123456789	0123456789	0123456789	0987654321
CPU Rx FIFO Half Full	0123456789	0123456789	0123456789	0987654321
CPU Rx FIFO Empty Before SOM	0123456789	0123456789	0123456789	0987654321
CPU Rx FIFO Empty Before EOM	0123456789	0123456789	0123456789	0987654321
CPU Rx Packet SOM Before EOM	0123456789	0123456789	0123456789	0987654321
CPU Rx Packet CRC Error	0123456789	0123456789	0123456789	0987654321
CPU Tx Buffer EOB	0123456789	0123456789	0123456789	0987654321
CPU Tx Buffer Full	0123456789	0123456789	0123456789	0987654321
CPU Tx Buffer Half Full	0123456789	0123456789	0123456789	0987654321
IMT Bypass FIFO Full	0123456789	0123456789	0123456789	0987654321
IMT Bypass FIFO Half Full	0123456789	0123456789	0123456789	0987654321
IMT Bypass FIFO Sanity	0123456789	0123456789	0123456789	0987654321
IMT Rx FIFO Full	0123456789	0123456789	0123456789	0987654321
IMT Rx FIFO Half Full	0123456789	0123456789	0123456789	0987654321

Misc Statistic	Bucket Summary		Cumulative	
	Bus A	Bus B	Bus A	Bus B
-----	-----	-----	-----	-----
Shelf ID UART Framing Error	0123456789	0123456789	0123456789	0987654321
Shelf ID UART Overrun Error	0123456789	0123456789	0123456789	0987654321

;

rept-imt-info:report=hiprerr:sbucket=0

Table 7-3 on page 7-14 explains the meaning of each statistic that can be displayed in the **rept-imt-info:report=hiprerr** output.

tekelecstp 05-01-12 14:01:34 EST EAGLE 33.0.0

HIPR Maintenance Statistics

;

=====

HIPR SUMMARY REPORT: Summed across all requested shelves and buckets

HIPR Hourly Bucket Statistics

=====

BUCKET	LOC	Low Speed Statistic	Bus A	Bus B
00	---	-----	-----	-----
		IMT Rx Packet CRC Error	0123456789	0123456789
		IMT Rx Packet Format Error	0123456789	0123456789
		IMT Rx Violation Error	0123456789	0123456789
		IMT Rx Command Error	0123456789	0123456789
		IMT Rx Packet CRC Error	0123456789	0123456789
		IMT Rx FIFO Full	0123456789	0123456789
		IMT Rx FIFO Half Full	0123456789	0123456789
		IMT Tx FIFO Full	0123456789	0123456789
		IMT Tx FIFO Half Full	0123456789	0123456789
		High Speed Statistic	Bus A	Bus B
		-----	-----	-----
		IMT Rx Packet Format Err	0123456789	0123456789
		IMT Rx Disparity Error	0123456789	0123456789
		IMT Rx Sync Lost Error	0123456789	0123456789
		IMT Rx Code Word Error	0123456789	0123456789
		IMT Rx Packet SOM Before EOM	0123456789	0123456789
		IMT Rx Packet CRC Error	0123456789	0123456789
		IMT Bypass FIFO Full	0123456789	0123456789
		IMT Bypass FIFO Half Full	0123456789	0123456789
		IMT Rx FIFO Full	0123456789	0123456789
		IMT Rx FIFO Half Full	0123456789	0123456789
		IMT Tx FIFO Full	0123456789	0123456789
		IMT Tx FIFO Half Full	0123456789	0123456789
		IXP Rx FIFO Full	0123456789	0123456789
		IXP Rx FIFO Half Full	0123456789	0123456789
		Misc Statistic	Bus A	Bus B
		-----	-----	-----
		Shelf ID UART Framing Error	0123456789	0123456789
		Shelf ID UART Overrun Error	0123456789	0123456789

HIPR CUMULATIVE Statistics

```

=====
Low Speed Statistic          Bus A      Bus B
-----
IMT Rx Packet CRC Error     0123456789 0123456789
IMT Rx Packet Format Error   0123456789 0123456789
IMT Rx Violation Error      0123456789 0123456789
IMT Rx Command Error        0123456789 0123456789
IMT Rx Packet CRC Error     0123456789 0123456789
IMT Rx FIFO Full            0123456789 0123456789
IMT Rx FIFO Half Full       0123456789 0123456789
IMT Tx FIFO Full            0123456789 0123456789
IMT Tx FIFO Half Full       0123456789 0123456789

High Speed Statistic        Bus A      Bus B
-----
IMT Rx Packet Format Err     0123456789 0123456789
IMT Rx Disparity Error       0123456789 0123456789
IMT Rx Sync Lost Error      0123456789 0123456789
IMT Rx Code Word Error      0123456789 0123456789
IMT Rx Packet SOM Before EOM 0123456789 0123456789
IMT Rx Packet CRC Error     0123456789 0123456789
IMT Bypass FIFO Full        0123456789 0123456789
IMT Bypass FIFO Half Full   0123456789 0123456789
IMT Rx FIFO Full            0123456789 0123456789
IMT Rx FIFO Half Full       0123456789 0123456789
IMT Tx FIFO Full            0123456789 0123456789
IMT Tx FIFO Half Full       0123456789 0123456789
IXP Rx FIFO Full            0123456789 0123456789
IXP Rx FIFO Half Full       0123456789 0123456789

Misc Statistic              Bus A      Bus B
-----
Shelf ID UART Framing Error  0123456789 0123456789
Shelf ID UART Overrun Error  0123456789 0123456789
    
```

;

rept-imt-info:report=hiprerr:sshelf=1100:sslot=1:eslot=2:sbucket=0

Table 7-3 on page 7-14 explains the meaning of each statistic that can be displayed in the **rept-imt-info:report=hiprerr** output.

tekelecstp 05-01-12 14:01:34 EST EAGLE 33.0.0

HIPR Maintenance Statistics

;

=====

HIPR SUMMARY REPORT: Summed across all requested shelves and buckets

HIPR Hourly Bucket Statistics

=====

BUCKET	LOC	Low Speed Statistic	Bus A	Bus B
00	1101	-----	-----	-----
		IMT Rx Packet CRC Error	0123456789	0123456789
		IMT Rx Packet Format Error	0123456789	0123456789
		IMT Rx Violation Error	0123456789	0123456789
		IMT Rx Command Error	0123456789	0123456789
		IMT Rx FIFO Full	0123456789	0123456789
		IMT Rx FIFO Half Full	0123456789	0123456789
		IMT Tx FIFO Full	0123456789	0123456789
		IMT Tx FIFO Half Full	0123456789	0123456789

BUCKET	LOC	Low Speed Statistic	Bus A	Bus B
00	1102	-----	-----	-----
		IMT Rx Packet CRC Error	0123456789	0123456789
		IMT Rx Packet Format Error	0123456789	0123456789
		IMT Rx Violation Error	0123456789	0123456789
		IMT Rx Command Error	0123456789	0123456789
		IMT Rx FIFO Full	0123456789	0123456789
		IMT Rx FIFO Half Full	0123456789	0123456789
		IMT Tx FIFO Full	0123456789	0123456789
		IMT Tx FIFO Half Full	0123456789	0123456789

High Speed Statistic	Bus A	Bus B
-----	-----	-----
IMT Rx Packet Format Err	0123456789	0123456789
IMT Rx Disparity Error	0123456789	0123456789
IMT Rx Sync Lost Error	0123456789	0123456789
IMT Rx Code Word Error	0123456789	0123456789
IMT Rx Packet SOM Before EOM	0123456789	0123456789
IMT Rx Packet CRC Error	0123456789	0123456789
IMT Bypass FIFO Full	0123456789	0123456789
IMT Bypass FIFO Half Full	0123456789	0123456789
IMT Rx FIFO Full	0123456789	0123456789
IMT Rx FIFO Half Full	0123456789	0123456789
IMT Tx FIFO Full	0123456789	0123456789
IMT Tx FIFO Half Full	0123456789	0123456789
IXP Rx FIFO Full	0123456789	0123456789
IXP Rx FIFO Half Full	0123456789	0123456789

Misc Statistic	Bus A	Bus B
-----	-----	-----
Shelf ID UART Framing Error	0123456789	0123456789
Shelf ID UART Overrun Error	0123456789	0123456789

HIPR CUMULATIVE Statistics

```

=====
Low Speed Statistic          Bus A      Bus B
-----
IMT Rx Packet CRC Error    0123456789 0123456789
IMT Rx Packet Format Error  0123456789 0123456789
IMT Rx Violation Error     0123456789 0123456789
IMT Rx Command Error       0123456789 0123456789
IMT Rx FIFO Full           0123456789 0123456789
IMT Rx FIFO Half Full      0123456789 0123456789
IMT Tx FIFO Full           0123456789 0123456789
IMT Tx FIFO Half Full      0123456789 0123456789

High Speed Statistic        Bus A      Bus B
-----
IMT Rx Packet Format Err    0123456789 0123456789
IMT Rx Disparity Error     0123456789 0123456789
IMT Rx Sync Lost Error     0123456789 0123456789
IMT Rx Code Word Error     0123456789 0123456789
IMT Rx Packet SOM Before EOM 0123456789 0123456789
IMT Rx Packet CRC Error    0123456789 0123456789
IMT Bypass FIFO Full       0123456789 0123456789
IMT Bypass FIFO Half Full  0123456789 0123456789
IMT Rx FIFO Full           0123456789 0123456789
IMT Rx FIFO Half Full      0123456789 0123456789
IMT Tx FIFO Full           0123456789 0123456789
IMT Tx FIFO Half Full      0123456789 0123456789
IXP Rx FIFO Full           0123456789 0123456789
IXP Rx FIFO Half Full      0123456789 0123456789

Misc Statistic              Bus A      Bus B
-----
Shelf ID UART Framing Error 0123456789 0123456789
Shelf ID UART Overrun Error 0123456789 0123456789

```

;

Legend

IMT Statistics:

BUCKET—The hourly time periods (*buckets*) for which a report was requested.

STATISTIC—The error statistic type for the IMT buses A and B.

BUS A VALUE—The number of occurrences of the type of error displayed in the STATISTIC column for the IMT bus A.

BUS B VALUE—The number of occurrences of the type of error displayed in the STATISTIC column for the IMT bus B.

LOW SPEED STATISTIC—The error statistic type for the low speed 125 Mbps secondary rings with HMUX cards installed on buses A (xy09 card locations) and B (xy10 card locations).

HIGH SPEED STATISTIC—The error statistic type for the high-speed 1 Gbps primary ring with HMUX cards installed on buses A (xy09 card locations) and B (xy10 card locations).

MISC SPEED STATISTICS—Shelf ID Universal Asynchronous Receiver Transmitter (UART) error counts on the HMUX cards installed on buses A (xy09 card locations) and B (xy10 card locations).

BUCKET SUMMARY—The error count for each parameter for one hour for HMUX cards installed on buses A (xy09 card locations) and B (xy10 card locations). (The count is for the most recent part of an hour if the card was booted within an hour of executing the **rept-imt-info** command).

CUMULATIVE—The running total error count for each parameter since card initialization for HMUX cards installed on buses A (xy09 card locations) and B (xy10 card locations).

HMUX Statistics:

BUCKET—The hourly time periods (*buckets*) for which a report was requested.

LOW SPEED STATISTIC—The error statistic type for the low speed 125 Mbps secondary rings with HMUX cards installed on buses A (xy09 card locations) and B (xy10 card locations).

HIGH SPEED STATISTIC—The error statistic type for the high-speed 1 Gbps primary ring with HMUX cards installed on buses A (xy09 card locations) and B (xy10 card locations).

MISC SPEED STATISTIC—The miscellaneous error statistic type.

BUS A—The number of occurrences of the type of error displayed in the **STATISTIC** column for the IMT bus A.

BUS B—The number of occurrences of the type of error displayed in the **STATISTIC** column for the IMT bus B.

HIPR Statistics:

BUCKET—The hourly time periods (*buckets*) for which a report was requested.

LOC—The card location (shelf and slot) for which information is displayed.

LOW SPEED STATISTIC—The error statistic type for the low speed 125 Mbps secondary rings with HMUX cards installed on buses A (xy09 card locations) and B (xy10 card locations).

HIGH SPEED STATISTIC—The error statistic type for the high-speed 1 Gbps primary ring with HMUX cards installed on buses A (xy09 card locations) and B (xy10 card locations).

MISC SPEED STATISTIC—The miscellaneous error statistic type.

BUS A—The number of occurrences of the type of error displayed in the **STATISTIC** column for the IMT bus A.

BUS B—The number of occurrences of the type of error displayed in the **STATISTIC** column for the IMT bus B.

rept-imt-lvl1**Report IMT Level 1**

Use this command to display the IMT level 1 statistics for a card or a range of cards. If more than one card is specified, a summary report of totals for all cards can be generated.

Keyword: `rept-imt-lvl1`

Related Commands: `clr-imt-stats`, `conn-imt`, `disc-imt`, `rept-imt-info`, `rept-stat-imt`, `rept-imt-lvl2`, `rmv-imt`, `rst-imt`, `tst-imt`

Command Class: System Maintenance

Parameters

:e= (optional)

End address. This parameter specifies the IMT address of the last card in the range. A decimal value or a hexadecimal value can be specified for this parameter (see Table 7-4 on page 7-28 to map the values by card location).

Range: `0-251` (decimal) or `h'00-h'fb` (hexadecimal)

Default: If the start address (`s`) value is specified, the `e` parameter default value is the specified `s` parameter value.

If the `s` parameter is not specified, the `e` parameter is not specified and the `sloc` parameter must be specified.

:eloc= (optional)

End location. Specifies the card location of the last card in the range.

Range: `1101-1108`, `1111-1113`, `1115`, `1201-1208`, `1211-1218`, `1301-1308`, `1311-1318`,
`2101-2108`, `2111-2118`, `2201-2208`, `2211-2218`, `2301-2308`, `2311-2318`, `3101-3108`,
`3111-3118`, `3201-3208`, `3211-3218`, `3301-3308`, `3311-3318`, `4101-4108`, `4111-4118`,
`4201-4208`, `4211-4218`, `4301-4308`, `4311-4318`, `5101-5108`, `5111-5118`, `5201-5208`,
`5211-5218`, `5301-5308`, `5311-5318`, `6101-6108`, `6111-6118`

Default: If `sloc` is specified—current `sloc` value; displays information for one card

If `sloc` is not specified—`1115`, which corresponds to IMT address 251 (`e=251`); displays information for entire range of locations.

:r= (optional)

Report type value

Range: `full`, `stats`, `summary`

`full`—Displays information for each card along with a summary report.

`stats`—Displays only individual card statistics.

`summary`—Displays the summary portion of the report.

Default: `full`

:s= (optional)

Start address. This parameter specifies the IMT address of the first (or only) card in the range. A decimal value or a hexadecimal value can be specified for this parameter (see Table 7-4 on page 7-28 to map the values by card location).

Range: `0-251` (decimal) or `h'00-h'fb` (hexadecimal)

:sloc= (optional)

Start location. Specifies the card location of the first card in the range.

Range: 1101–1108, 1111–1113, 1115, 1201–1208, 1211–1218, 1301–1308, 1311–1318, 2101–2108, 2111–2118, 2201–2208, 2211–2218, 2301–2308, 2311–2318, 3101–3108, 3111–3118, 3201–3208, 3211–3218, 3301–3308, 3311–3318, 4101–4108, 4111–4118, 4201–4208, 4211–4218, 4301–4308, 4311–4318, 5101–5108, 5111–5118, 5201–5208, 5211–5218, 5301–5308, 5311–5318, 6101–6108, 6111–6118

Default: If **eloc** is specified—current **eloc** value
If **eloc** is not specified—**1201**, which corresponds to IMT address 0 (**s=0**).

:trm= (optional)

The serial port (printer location) where the report is to be sent.

Range: 1–16

Default: Report displays on the terminal where the command was issued

Example

rept-imt-lvl1:s=00:e=01

Dependencies

Only one report status command can be in progress at a time.

Either the start address (**s** parameter) or the start location (**sloc** parameter) must be specified.

This command cannot be entered during IMT statistics collection following an hourly boundary.

The **rept-imt-lvl1** command cannot be entered if any of the following commands is running: **clr-imt-stats**, **rept-imt-info**, **rept-imt-lvl2**, **tst-imt**.

If the **s** and **e** parameters are specified, the **sloc** and **eloc** parameters cannot be specified; conversely, if the **sloc** and **eloc** parameters are specified, the **s** and **e** parameters cannot be specified.

Notes

Table 7-4 maps each card location to the decimal and hexadecimal values that can be specified for the **s** and **e** parameters.

Table 7-4. Hexadecimal/Decimal Values for **s** and **e** parameters

Card Location	Hexadecimal Value	Decimal Value	Card Location	Hexadecimal Value	Decimal Value
Control Shelf 11					
1101	h'f0	240	1102	h'f1	241
1103	h'f2	242	1104	h'f3	243
1105	h'f4	244	1106	h'f5	245
1107	h'f6	246	1108	h'f7	247
1111	h'f8	248	1112	h'f9	249
1113	h'fa	250	1115	h'fb	251

Table 7-4. Hexadecimal/Decimal Values for s and e parameters (Continued)

Card Location	Hexadecimal Value	Decimal Value	Card Location	Hexadecimal Value	Decimal Value
Extension Shelf 12					
1201	h'00	0	1202	h'01	1
1203	h'02	2	1204	h'03	3
1205	h'04	4	1206	h'05	5
1207	h'06	6	1208	h'07	7
1211	h'08	8	1212	h'09	9
1213	h'0a	10	1214	h'0b	11
1215	h'0c	12	1216	h'0d	13
1217	h'0e	14	1218	h'0f	15
Extension Shelf 13					
1301	h'10	16	1302	h'11	17
1303	h'12	18	1304	h'13	19
1305	h'14	20	1306	h'15	21
1307	h'16	22	1308	h'17	23
1311	h'18	24	1312	h'19	25
1313	h'1a	26	1314	h'1b	27
1315	h'1c	28	1316	h'1d	29
1317	h'1e	30	1318	h'1f	31
Extension Shelf 21					
2101	h'20	32	2102	h'21	33
2103	h'22	34	2104	h'23	35
2105	h'24	36	2106	h'25	37
2107	h'26	38	2108	h'27	39
2111	h'28	40	2112	h'29	41
2113	h'2a	42	2114	h'2b	43
2115	h'2c	44	2116	h'2d	45
2117	h'2e	46	2118	h'2f	47

Table 7-4. Hexadecimal/Decimal Values for s and e parameters (Continued)

Card Location	Hexadecimal Value	Decimal Value	Card Location	Hexadecimal Value	Decimal Value
Extension Shelf 22					
2201	h'30	48	2202	h'31	49
2203	h'32	50	2204	h'33	51
2205	h'34	52	2206	h'35	53
2207	h'36	54	2208	h'37	55
2211	h'38	56	2212	h'39	57
2213	h'3a	58	2214	h'3b	59
2215	h'3c	60	2216	h'3d	61
2217	h'3e	62	2218	h'3f	63
Extension Shelf 23					
2301	h'40	64	2302	h'41	65
2303	h'42	66	2304	h'43	67
2305	h'44	68	2306	h'45	69
2307	h'46	70	2308	h'47	71
2311	h'48	72	2312	h'49	73
2313	h'4a	74	2314	h'4b	75
2315	h'4c	76	2316	h'4d	77
2317	h'4e	78	2318	h'4f	79

Table 7-4. Hexadecimal/Decimal Values for s and e parameters (Continued)

Card Location	Hexadecimal Value	Decimal Value	Card Location	Hexadecimal Value	Decimal Value
Extension Shelf 31					
3101	h'50	80	3102	h'51	81
3103	h'52	82	3104	h'53	83
3105	h'54	84	3106	h'55	85
3107	h'56	86	3108	h'57	87
3111	h'58	88	3112	h'59	89
3113	h'5a	90	3114	h'5b	91
3115	h'5c	92	3116	h'5d	93
3117	h'5e	94	3118	h'5f	95
Extension Shelf 32					
3201	h'60	96	3202	h'61	97
3203	h'62	98	3204	h'63	99
3205	h'64	100	3206	h'65	101
3207	h'66	102	3208	h'67	103
3211	h'68	104	3212	h'69	105
3213	h'6a	106	3214	h'6b	107
3215	h'6c	108	3216	h'6d	109
3217	h'6e	110	3218	h'6f	111
Extension Shelf 33					
3301	h'70	112	3302	h'71	113
3303	h'72	114	3304	h'73	115
3305	h'74	116	3306	h'75	117
3307	h'76	118	3308	h'77	119
3311	h'78	120	3312	h'79	121
3313	h'7a	122	3314	h'7b	123
3315	h'7c	124	3316	h'7d	125
3317	h'7e	126	3318	h'7f	127

Table 7-4. Hexadecimal/Decimal Values for s and e parameters (Continued)

Card Location	Hexadecimal Value	Decimal Value	Card Location	Hexadecimal Value	Decimal Value
Extension Shelf 41					
4101	h'80	128	4102	h'81	129
4103	h'82	130	4104	h'83	131
4105	h'84	132	4106	h'85	133
4107	h'86	134	4108	h'87	135
4111	h'88	136	4112	h'89	137
4113	h'8a	138	4114	h'8b	139
4115	h'8c	140	4116	h'8d	141
4117	h'8e	142	4118	h'8f	143
Extension Shelf 42					
4201	h'90	144	4202	h'91	145
4203	h'92	146	4204	h'93	147
4205	h'94	148	4206	h'95	149
4207	h'96	150	4208	h'97	151
4211	h'98	152	4212	h'99	153
4213	h'9a	154	4214	h'9b	155
4215	h'9c	156	4216	h'9d	157
4217	h'9e	158	4218	h'9f	159
Extension Shelf 43					
4301	h'a0	160	4302	h'a1	161
4303	h'a2	162	4304	h'a3	163
4305	h'a4	164	4306	h'a5	165
4307	h'a6	166	4308	h'a7	167
4311	h'a8	168	4312	h'a9	169
4313	h'aa	170	4314	h'ab	171
4315	h'ac	172	4316	h'ad	173
4317	h'ae	174	4318	h'af	175

Table 7-4. Hexadecimal/Decimal Values for s and e parameters (Continued)

Card Location	Hexadecimal Value	Decimal Value	Card Location	Hexadecimal Value	Decimal Value
Extension Shelf 51					
5101	h'b0	176	5102	h'b1	177
5103	h'b2	178	5104	h'b3	179
5105	h'b4	180	5106	h'b5	181
5107	h'b6	182	5108	h'b7	183
5111	h'b8	184	5112	h'b9	185
5113	h'ba	186	5114	h'bb	187
5115	h'bc	188	5116	h'bd	189
5117	h'be	190	5118	h'bf	191
Extension Shelf 52					
5201	h'c0	192	5202	h'c1	193
5203	h'c2	194	5204	h'c3	195
5205	h'c4	196	5206	h'c5	197
5207	h'c6	198	5208	h'c7	199
5211	h'c8	200	5212	h'c9	201
5213	h'ca	202	5214	h'cb	203
5215	h'cc	204	5216	h'cd	205
5217	h'ce	206	5218	h'cf	207
Extension Shelf 53					
5301	h'd0	208	5302	h'd1	209
5303	h'd2	210	5304	h'd3	211
5305	h'd4	212	5306	h'd5	213
5307	h'd6	214	5308	h'd7	215
5311	h'd8	216	5312	h'd9	217
5313	h'da	218	5314	h'db	219
5315	h'dc	220	5316	h'dd	221
5317	h'de	222	5318	h'df	223

Table 7-4. Hexadecimal/Decimal Values for **s** and **e** parameters (Continued)

Card Location	Hexadecimal Value	Decimal Value	Card Location	Hexadecimal Value	Decimal Value
Extension Shelf 61					
6101	h'e0	224	6102	h'e1	225
6103	h'e2	226	6104	h'e3	227
6105	h'e4	228	6106	h'e5	229
6107	h'e6	230	6108	h'e7	231
6111	h'e8	232	6112	h'e9	233
6113	h'ea	234	6114	h'eb	235
6115	h'ec	236	6116	h'ed	237
6117	h'ee	238	6118	h'ef	239

Output**rept-imt-lvl1:s=00:e=01**

```
rlghncxa03w 04-02-28 09:25:56 EST EAGLE 31.3.0
Retrieving data from cards...
```

```
;
```

```
rlghncxa03w 04-02-28 09:25:56 EST EAGLE 31.3.0
```

```
-----
Card: H'0000      Elapsed Time (day - h:m:s):  0 - 00:08:31.2
```

```
Count                Bus A Value      Bus B Value
-----                -
Transmit Packet                0                0
Transmit Byte                  0                0
Receive Packet                 0                0
Receive Byte                   0                0
Receive Packet with CRC Error   36                2
Receive Packet with Format Error 0                1
Receive Packet with Invalid Length 0                0
Primary Control Receive Error   0                0
Primary Control Transmit Error  0                0
Primary Control Sanity Error    0                0
Violation Error                 291               2
CPU Receive FIFO Full          0                0
IMT Error Interrupt            0                0
Error Interrupt Overflow       0                0
DMA Terminal Count Interrupt   0                0
MSU Retransmitted              0                0
MSU Safety Packet              0                0
ASU Safety Packet              0                0
TSU Safety Packet              0                0
BSU Safety Packet              0                0
SSU Safety Packet              0                0;
```



```

Card: H'0001      Elapsed Time (day - h:m:s):  3 - 03:20:07.7
Count            Bus A Value      Bus B Value
-----
Transmit Packet                0          0
Transmit Byte                   0          0
Receive Packet                  0          0
Receive Byte                     0          0
Receive Packet with CRC Error   14          2
Receive Packet with Format Error 0          0
Receive Packet with Invalid Length 0          0
Primary Control Receive Error   0          0
Primary Control Transmit Error  0          0
Primary Control Sanity Error    0          0
Violation Error                 320         12
CPU Receive FIFO Full           0          0
IMT Receive FIFO Half Full      0          0
CPU Receive FIFO Half Full      0          0
DMA Terminal Count Interrupt    0          0
MSU Retransmitted               1          0
MSU Safety Packet               0          0
ASU Safety Packet               0          0
TSU Safety Packet               0          0
IMT Receive FIFO Full           0          0
SSU Safety Packet               0          0

```

```

;
rlghncxa03w 04-02-28 09:25:56 EST  EAGLE 31.3.0

```

=====

SUMMARY REPORT: Totals accumulated from all requested cards

```

Count            Bus A Value      Bus B Value
-----
Transmit Packet                0          0
Transmit Byte                   0          0
Receive Packet                  0          0
Receive Byte                     0          0
Receive Packet with CRC Error   50          4
Receive Packet with Format Error 0          1
Receive Packet with Invalid Length 0          0
Primary Control Receive Error   0          0
Primary Control Transmit Error  0          0
Primary Control Sanity Error    0          0
Violation Error                 611         14
CPU Receive FIFO Full           0          0
IMT Receive FIFO Half Full      0          0
CPU Receive FIFO Half Full      0          0
DMA Terminal Count Interrupt    0          0
MSU Retransmitted               1          0
MSU Safety Packet               0          0
ASU Safety Packet               0          0
TSU Safety Packet               0          0
IMT Receive FIFO Full           0          0
SSU Safety Packet               0          0

```

```

;
END OF REPORT
;

```

Legend

CARD—The IMT address of the card in hexadecimal

ELAPSED TIME (day - h:m:s)—The amount of time that has elapsed since a card reset has occurred or the IMT statistics were cleared with the **clr-imt-stats** command. This is shown in the format **day - h:m:s**, where **day** is the number of days that have elapsed, and **h:m:s** is the amount of time in the current day in hours, minutes, and seconds (and tenths of seconds).

COUNT—The IMT level 1 statistics displayed in this report.

BUS A VALUE and **BUS B VALUE**—The values of the IMT level 1 statistics on IMT bus A and IMT bus B.

Table 7-5 describes the statistics that are shown in the report for each card and in the Summary of totals for all requested cards, and their possible causes and corrective actions.

"Excessive" count is primarily determined by the operator based upon:

- Overall system behavior
- Duration of time from when the last statistics were taken
- Statistics of an individual card in relation to other cards

The following types of Safety Packets are included in the counts:

SAFETY PACKET—When an IMT packet goes around the IMT, a pre determined value in the packet is decremented by each card. When this value reaches zero, the card that receives the value equal to zero logs this as a safety packet and removes the IMT packet from the IMT.

MESSAGE SIGNALING UNIT (MSU)—IMT packet containing data

ACKNOWLEDGEMENT SIGNALING UNIT (ASU)—**ack** for an MSU that is sent from the destination card back to the originating card.

TEST SIGNALING UNIT (TSU)—Typically used to keep the card on the bus. There are many types of TSU's one of which performs a heartbeat function.

BROADCAST SIGNALING UNIT (BSU)—Function is the same as an MSU except that each card will process the BSU and then copy it to the next card for processing. Used for IMT maintenance functions.

SAFETY SIGNALING UNIT (SSU)—Anytime a packet times out (Safety Packet), the card that logged a safety packet sends an SSU to make sure the originating card is still on the IMT bus.

Table 7-5. rept-imt-lvl1 Statistics Explanation

IMT Statistic	Explanation Of Statistic	Probable Causes	Recommended Action
Transmit Packet	Number of transmitted IMT packets	N/A	N/A
Transmit Byte	Number of transmitted IMT Bytes	N/A	N/A

Table 7-5. rept-imt-lvl1 Statistics Explanation (Continued)

IMT Statistic	Explanation Of Statistic	Probable Causes	Recommended Action
Receive Packet	Number of received IMT Packets	N/A	N/A
Receive Byte	Number of received IMT Bytes	N/A	N/A
Receive Packet with CRC Error	Bad Checksum in received IMT packet. Usually caused by corrupted data. Detected by hardware	Card insertion, removal, or boot. Might occur infrequently in a normal system.	<ul style="list-style-type: none"> • None if card has booted or was just inserted. • Contact Tekelec Technical Services if count is excessive in relation to other cards.
Receive Packet with Format Error	Occurs when the Start of Message byte of the IMT packet is followed by unexpected data. Detected by hardware.	Card insertion, removal, or boot	<ul style="list-style-type: none"> • None if card has booted or was just inserted. • Contact Tekelec Technical Services if count is excessive in relation to other cards.
Receive Packet with Invalid Length	Card received an IMT packet where the actual length of the packet did not match the length indicated in the length field. Detected by software	Card insertion, removal, or boot	<ul style="list-style-type: none"> • None if card has booted or was just inserted. • Contact Tekelec Technical Services if count is excessive in relation to other cards.
Primary Control Receive Error	Corrupted packet. Detected by hardware	Card insertion, removal, or boot	<ul style="list-style-type: none"> • None if card has booted or was just inserted. • Contact Tekelec Technical Services if count is excessive in relation to other cards.
Primary Control Transmit Error	Transmitted IMT packet is greater than allowed size. Detected by hardware	Card insertion, removal, or boot	<ul style="list-style-type: none"> • None if card has booted or was just inserted. • Contact Tekelec Technical Services if count is excessive in relation to other cards.
Primary Control Sanity Error	Internal hardware monitoring self check failed. Detected by hardware	Generally indicates Bad hardware or corrupt packets.	<ul style="list-style-type: none"> • None if card has booted or was just inserted. • Contact Tekelec Technical Services if count is excessive in relation to other cards.
Violation Error	Received an illegal character from the IMT. Detected by hardware	Card insertion, removal, or boot	<ul style="list-style-type: none"> • None if card has booted or was just inserted. • Contact Tekelec Technical Services if count is excessive in relation to other cards.

Table 7-5. rept-imt-lvl1 Statistics Explanation (Continued)

IMT Statistic	Explanation Of Statistic	Probable Causes	Recommended Action
CPU Receive FIFO Full	Communication CPU on the card is congested. Detected by hardware	Indicates that data was received at a higher rate than could be processed by the Communications processor.	<ul style="list-style-type: none"> • Contact Tekelec Technical Services if count is excessive in relation to other cards.
IMT Receive FIFO Half Full	IMT interface on the card is becoming congested. Detected by hardware.	Indicates that data was received at a higher rate than could be switched for a short period.	<ul style="list-style-type: none"> • None. • FIFO Half Full is just an indication; no action is required.
CPU Receive FIFO Half Full	Communication CPU on the card is becoming congested. Detected by hardware	Indicates that data was received at a higher rate than could be processed for a short period.	<ul style="list-style-type: none"> • None. • FIFO Half Full is just an indication; no action is required.
DMA Terminal Count Interrupt	Received IMT packet length is longer than the max allowed. Detected by hardware	Card insertion, removal, or boot	<ul style="list-style-type: none"> • None if card has booted or was just inserted. • Contact Tekelec Technical Services if count is excessive in relation to other cards.
MSU Retransmitted	Retransmissions occur typically when an MSU goes around the IMT bus and times out (safety packet issued). Detected by software	Card insertion, removal, or boot. Might occur infrequently in a normal system.	<ul style="list-style-type: none"> • None if card has booted or was just inserted. • Contact Tekelec Technical Services if count is excessive in relation to other cards.
MSU Safety Packet	MSU has timed out on the IMT. Detected by hardware	Card insertion, removal, or boot	<ul style="list-style-type: none"> • None if card has booted or was just inserted. • Contact Tekelec Technical Services if count is excessive in relation to other cards.
ASU Safety Packet	ASU Unit has timed out on the IMT. Detected by hardware	Card insertion, removal, or boot	<ul style="list-style-type: none"> • None if card has booted or was just inserted. • Contact Tekelec Technical Services if count is excessive in relation to other cards.
TSU Safety Packet	TSU Unit has timed out on the IMT. Detected by hardware	Card insertion, removal, or boot	<ul style="list-style-type: none"> • None if card has booted or was just inserted. • Contact Tekelec Technical Services if count is excessive in relation to other cards.

Table 7-5. rept-imt-lvl1 Statistics Explanation (Continued)

IMT Statistic	Explanation Of Statistic	Probable Causes	Recommended Action
BSU Safety Packet	BSU Unit has timed out on the IMT. Detected by hardware	Card insertion, removal, or boot	<ul style="list-style-type: none"> • None if card has booted or was just inserted. • Contact Tekelec Technical Services if count is excessive in relation to other cards.
SSU Safety Packet	SSU Unit has timed out on the IMT. Detected by hardware	Card insertion, removal, or boot	<ul style="list-style-type: none"> • None if card has booted or was just inserted. • Contact Tekelec Technical Services if count is excessive in relation to other cards.

rept-imt-lvl2

Report IMT Level 2

Use this command to display the IMT level 2 statistics for a card. This report displays IMT traffic statistics for either one or both IMT busses in the system. The report can be filtered as follows:

- Report statistics between the source card (specified with the **loc** or **l** parameters), whose statistics pool is queried for report information, and another card (specified with the **sloc** or **s** parameter).
- Report statistics between the source card and a range of cards (specified with both the **sloc** and **eloc** or the **s** and **e** parameter combinations).

Keyword: rept-imt-lvl2

Related Commands: clr-imt-stats, conn-imt, disc-imt, rept-imt-info, rept-stat-imt, rept-imt-lvl1, rmv-imt, rst-imt, tst-imt

Command Class: System Maintenance

Parameters

:b= (optional)

IMT bus identification.

Range: a, b, both

a—Displays statistics for IMT bus A.

b—Displays statistics for IMT bus B.

both—Displays statistics for both IMT busses, A and B.

Default: both

:e= (optional)

End address. This parameter specifies the IMT address of the last card in the range. A decimal value or a hexadecimal value can be specified for this parameter (see Table 7-4 on page 7-28 to map the values by card location).

Range: 0-251 (decimal) or h'00-h'fb (hexadecimal)

Default: If the **s** parameter is specified, the default is the **s** parameter value.

If the **s** parameter is not specified, the default is 251.

:eloc= (optional)

End location. Specifies the card location of the last card in the range.

Range: 1101–1108, 1111–1113, 1115, 1201–1208, 1211–1218, 1301–1308, 1311–1318,
2101–2108, 2111–2118, 2201–2208, 2211–2218, 2301–2308, 2311–2318, 3101–3108,
3111–3118, 3201–3208, 3211–3218, 3301–3308, 3311–3318, 4101–4108, 4111–4118,
4201–4208, 4211–4218, 4301–4308, 4311–4318, 5101–5108, 5111–5118, 5201–5208,
5211–5218, 5301–5308, 5311–5318, 6101–6108, 6111–6118

Default: If **sloc** is specified—current **sloc** value; displays information for one card
If **sloc** is not specified—1115, which corresponds to IMT address 251 (**e=251**);
displays information for entire range of locations.

:l= (optional)

Source card IMT address. The IMT address of the card whose statistics pool is to be queried for report information.

Range: 0–251

(See the *Installation Manual - EAGLE 5 SAS* for an illustration of the card locations).

:loc= (optional)

Source card location. The location of the card whose "statistics pool" is to be queried for report information.

Range: 1101–1108, 1111–1113, 1115, 1201–1208, 1211–1218, 1301–1308, 1311–1318,
2101–2108, 2111–2118, 2201–2208, 2211–2218, 2301–2308, 2311–2318, 3101–3108,
3111–3118, 3201–3208, 3211–3218, 3301–3308, 3311–3318, 4101–4108, 4111–4118,
4201–4208, 4211–4218, 4301–4308, 4311–4318, 5101–5108, 5111–5118, 5201–5208,
5211–5218, 5301–5308, 5311–5318, 6101–6108, 6111–6118

:s= (optional)

Start address. This parameter specifies the IMT address of the first (or only) card in the range. A decimal value or a hexadecimal value can be specified for this parameter (see Table 7-4 on page 7-28 to map the values by card location).

Range: 0–251 (decimal) or h'00–h'fb (hexadecimal)

Default: If **e** is specified—current **l** parameter value.
If **e** is not specified—0.

:sloc= (optional)

Start location. Specifies the card location of the first card in the range.

Range: 1101–1108, 1111–1113, 1115, 1201–1208, 1211–1218, 1301–1308, 1311–1318,
2101–2108, 2111–2118, 2201–2208, 2211–2218, 2301–2308, 2311–2318, 3101–3108,
3111–3118, 3201–3208, 3211–3218, 3301–3308, 3311–3318, 4101–4108, 4111–4118,
4201–4208, 4211–4218, 4301–4308, 4311–4318, 5101–5108, 5111–5118, 5201–5208,
5211–5218, 5301–5308, 5311–5318, 6101–6108, 6111–6118

Default: If **eloc** is specified—current **sloc** value.
If **eloc** is not specified—IMT address 0 (**s=0**).

:trm= (optional)

The serial port (printer location) where the report is to be sent.

Range: 1–40

Default: The report displays on the terminal where the command was issued.

Example

```
rept-imt-lvl2:l=00:s=00:e=02:b=a
```

Dependencies

If the **s** and **e** parameters are specified, the **sloc** and **eloc** parameters cannot be specified; conversely, if the **sloc** and **eloc** parameters are specified, the **s** and **e** parameters cannot be specified.

The **rept-imt-lvl2** command cannot be entered if any of the following commands is running: **clr-imt-stats**, **rept-imt-info**, **rept-imt-lvl1**, **tst-imt**.

Either the source address (**l** parameter) or the source location (**loc** parameter) must be specified; but not both at the same time.

This command cannot be entered during IMT statistics collection following an hourly boundary.

Notes

None

Output

NOTE: If the source card location falls within the range of cards specified with the **sloc** and **eloc** parameters or the **s** and **e** parameters, the output report for the source card will show zeros. The zeros are reported because the source card location does not use the IMT to communicate with itself and, therefore, does not report any values or pegs for traffic routed to itself. This command reports only the values or pegs received or transmitted across the IMT bus.

NOTE: In the following example, the output for the source card location (**loc=1213**) is shown in column **0a** (the equivalent card location expressed as a hexadecimal digit). The **0a** column displays zeros because **loc=1213**, falls within the range specified for the start and end card location (**sloc=1211** and **eloc=1215**). (Note that the Receive FSN row displays a value of one, which is not a count, but rather the initial sequence number of the FSN that the source card location expects to receive). Columns **09** and **0b** display zeros because these slots are not provisioned with any card (the adjacent card slots (**08** and **0c**) contain DCM cards).

rept-imt-lvl2:sloc=1211:eloc=1215:loc=1213

rlghncxa03w 04-02-28 09:26:34 EST EAGLE 31.3.0

Retrieving data from card...

Card: H'000a Bus: A

Field		08	09	0a	0b	0c
Link Status		ALGN	-OS-	ALGN	-OS-	ALGN
OS Count	(dec)	0	0	0	0	0
Transmit BSN	(dec)	84	0	0	0	0
Transmit FSN	(dec)	99	0	0	0	34
Receive BSN	(dec)	99	0	0	0	34
Receive FSN	(dec)	85	1	1	1	1
Unack Messages	(dec)	0	0	0	0	0
Invalid Length	(dec)	0	0	0	0	0
Invalid rx BSN	(dec)	0	0	0	0	0
Invalid rx FSN	(dec)	0	0	0	0	0
Invalid LSSU	(dec)	0	0	0	0	0
Invalid ASU	(dec)	0	0	0	0	0
RTB Address	(hex)	0000	0000	0000	0000	0000
Average ack time	(ms)	0	0	0	0	0
Minimum ack time	(ms)	0	0	0	0	0
Maximum ack time	(ms)	0	0	0	0	0

rlghncxa03w 04-02-28 09:26:34 EST EAGLE 31.3.0

Card: H'00f4 Bus: B

Field		f0	f1	f2	f3	f4	f5	f6	f7
Link Status		-OS-	-OS-	ALGN	ALGN	ALGN	-OS-	ALGN	-OS-
OS Count	(dec)	0	0	2	2	3	0	1	0
Transmit BSN	(dec)	0	0	0	0	0	0	0	0
Transmit FSN	(dec)	0	0	0	0	0	0	0	0
Receive BSN	(dec)	0	0	0	0	0	0	0	0
Receive FSN	(dec)	0	0	1	1	1	0	1	0
Unack Messages	(dec)	0	0	0	0	0	0	0	0
Invalid Length	(dec)	0	0	0	0	0	0	0	0
Invalid rx BSN	(dec)	0	0	0	0	0	0	0	0
Invalid rx FSN	(dec)	0	0	0	0	0	0	0	0
Invalid LSSU	(dec)	0	0	0	0	0	0	0	0
Invalid ASU	(dec)	0	0	0	0	0	0	0	0
RTB Address	(hex)	0000	0080	0100	0180	0200	0280	0300	0380
Average ack time	(ms)	0	0	0	0	0	0	0	0
Minimum ack time	(ms)	0	0	0	0	0	0	1	1
Maximum ack time	(ms)	2	2	3	3	3	3	3	3

END OF REPORT

;

Legend**CARD**—The IMT address of the card location specified by the **I** parameter in this command in hexadecimal.**BUS**—The IMT bus for which the IMT level 2 statistics are being reported.**FIELD**—The IMT level 2 statistics displayed in this report.**00 - EF**—The IMT address of the cards on the IMT bus in hexadecimal.**LINK STATUS**—The status of the link, either **ALGN** (aligned) or **OS** (out of service).

OS COUNT—The number of times the link has cycled between being aligned and being out of service.

TRANSMIT BSN—The number of BSNs transmitted.

TRANSMIT FSN—The number of FSNs transmitted.

RECEIVE BSN—The number of BSNs received.

RECEIVE FSN—The sequence number for the next FSN that the source card location expects to receive.

UNACK MESSAGES—The number of unacknowledged messages received.

INVALID LENGTH—The number of messages received with invalid length indicators.

INVALID RX BSN—The number of invalid BSNs received.

INVALID RX FSN—The number of invalid FSNs received.

INVALID LSSU—The number of invalid LSSUs received.

INVALID ASU—The number of invalid ASUs received.

RTB ADDRESS—The address of the retransmission buffer, in hexadecimal.

AVERAGE ACK TIME—The average amount of time for an acknowledgment, in milliseconds.

MINIMUM ACK TIME—The minimum amount of time for an acknowledgment, in milliseconds.

MAXIMUM ACK TIME—The maximum amount of time for an acknowledgment, in milliseconds.

rept-meas

Report Measurements

Use this command to generate measurement reports on demand. The reports display on the UI terminal, and are not transferred to the customer FTP server when the Measurements Platform feature is enabled.

ITU gateway measurements are done for **stp** and, on a per-linkset basis, for **lnkset**, **lsonismt**, **lsdestni**, and **lsorigni** entity types.

Keyword: **rept-meas**

Related Commands: **chg-meas**, **copy-meas**, **rtrv-meas-sched**, **rept-ftp-meas**

Command Class: Link Maintenance

Parameters

:enttype= (mandatory)

The entity type to report on.

Range: **link**, **lnkset**, **lnp**, **lsdestni**, **lsonismt**, **lsorigni**, **mapscrn**, **np**, **origni**, **origninc**, **stp**, **stplan**, **tt**

link—Measurements for signaling links

lnkset—Measurements for linksets

lnp—Measurements for local number portability

lsdestni—Measurements for linkset destination network identifiers
lsonismt—Measurements for ISUP message type screening
lsorigni—Measurements for linkset originating network identifiers
np—Measurements for INP and G-Port
origni—Measurements for originating network identifiers greater than 5
origninc—Measurements for originating network identifiers (less than 5, small networks) for network clusters
stp—Measurements for all nodes
stplan—Measurements for TCP/IP links.
tt—Measurements for translation types
mapscrn—Measurements for GSM MAP message screening

:type= (mandatory)

The type of measurement report.

Range: **avl, avld, avldth, comp, gtwy, mtcd, mtccth, mtch, mtcs, nm, rbase, systot**

avl—Availability measurements

avld—Daily availability measurements

avldth—Day to hour availability measurements.

comp—Component measurements

gtwy—Internetwork gateway-related data from the STP for ANSI and ITU measurements. ANSI gateway measurements are pegged on a per-linkset, per-Network Indicator basis, whereas ITU measurements are pegged on a per-linkset basis.

mtcd—Daily maintenance measurements

mtccth—Day-to-hour maintenance measurements

mtch—Hourly maintenance measurements

mtcs—Link/linkset maintenance status

nm—Network management, on-demand

rbase—Schedule-report type record base measurements

systot—STP system totals

:appl= (optional)

The GPL to report measurements on. This parameter can be used only with the **stplan-avl (enttype=stplan:type=avl)** measurement report. The **rtrv-gpl:gpl=all** command can be entered to list all valid applications.

Range: **atmansi, atmitu, ccs7itu, ipgwi, iplim, iplimi, ips, sccp, ss7ansi, ss7gx25, ss7ipgw, ss7ml, stplan, vsccp, vxwslan**

Default: No value given.

:day= (optional)

The specific day of the week for daily LNP measurement reports.

Range: **mon, tue, wed, thu, fri, sat, sun**

Default: The previous single day report is generated.

:hh= (optional)

The specific half-hour interval. The **hh** parameter implies the ending time for the collection interval; for example, **hh=0300** generates a report for **2:30-3:00**.

Range: **hhmm** where **hh = 00-24** (hour) and **mm = 00 or 30** (minute)

Default: The **hh** parameter value is not given.

:loc= (optional)

The card location as stenciled on the shelf of the system.

Range: 1101-1108, 1111-1112, 1201-1208, 1211-1218, 1301-1308, 1311-1318, 2101-2108, 2111-2118, 2201-2208, 2211-2218, 2301-2308, 2311-2318, 3101-3108, 3111-3118, 3201-3208, 3211-3218, 3301-3308, 3311-3318, 4101-4108, 4111-4118, 4201-4208, 4211-4218, 4301-4308, 4311-4318, 5101-5108, 5111-5118, 5201-5208, 5211-5218, 5301-5308, 5311-5318, 6101-6108, 6111-6118

Default: The **loc** parameter value is not given.

:lsn= (optional)

The name of the linkset for which link or linkset measurements are reported.

Range: 1 alphabetic character followed by up to 9 alphanumeric characters

Default: The **lsn** value is not given.

:nc= (optional)

The network cluster for the specified GTWY measurement report.

Range: 0-255

Default: The **nc** parameter value is not given.

:ni= (optional)

The network indicator for the specified GTWY measurement report.

Range: 1-255

Default: The **ni** parameter value is not given.

:nzo= (optional)

Print non-zero measurements only.

Range: yes, no

Default: yes for types **avl**, **avld**, and **avldth**.

This parameter is not used with the other report types.

:period= (optional)

The relative time period to report.

Range: last, specific, active, all

last—The previous collection interval

specific—A specific half-hourly interval (specified with the **hh** parameter)

active—The current collection interval

all—All collection intervals.

Default: The **period** parameter value is not given.

:port= or :link= (optional)

The link on the card specified in the **loc** parameter

Range: a, b, a1-a31, b1-b31

Not all card types support all **link** parameter values.

See Table A-1 in Appendix A for valid **link** parameter range values for each type of card that can have assigned signaling link ports.

Default: The **link** parameter value is not given.

:qh= (optional)

The specific quarter-hour interval. The **qh** parameter implies the ending time for the collection interval; for example, **qh=0315** generates a report for **3:00-3:15**.

Range: *hhmm* where *hh* = 00-24 (hour) and *mm* = 00, 15, 30, or 45 (minute)

Default: The **qh** value is not given.

:trm= (optional)

The serial port (printer location) where the report is to be sent.

Range: 1-16

Default: The **trm** value is not given.

:tt= (optional)

A specific translation type to be reported.

Range: 0-255

Default: The **tt** parameter value is not given.

Example

```
rept-meas:type=systot:enttype=stp
rept-meas:type=comp:enttype=lnkset:lsn=sp1
rept-meas:enttype=link:type=avl:loc=1201:link=a
rept-meas:enttype=lnp:type=mtcd
rept-meas:enttype=lnp:type=mtch:period=last
rept-meas:enttype=lnp:type=mtch:period=specific:hh=1300
rept-meas:enttype=lnp:type=mtcd:period=specific:day=tue
rept-meas:enttype=stplan:type=avl:appl=atmansi
rept-meas:type=systot:enttype=tt:tt=26
rept-meas:type=mtcd:enttype=mapscrn
rept-meas:type=mtch:enttype=mapscrn
```

Dependencies

Only one **rept-meas** command can be in progress at any one time.

The valid parameter combinations depend on the report type specified. These combinations are shown in Table 7-6 on page 7-49. An X in a cell indicates that the parameter is valid for the report type shown.

When the Enhanced GSM MAP Screening (EGMS) feature is turned on, this command cannot be used to generate EGMS measurements reports.

The entity specified by the **loc**, **port**, or **lsn** parameter must be in the database.

The link specified by the **loc** and **link** parameters must already be defined in the database.

When **enttype=link** is specified, the card in the location specified by the **loc** parameter must be a LIM.

Hourly collection and report processing cannot be in progress when report type **mtch** is specified.

Quarter-hourly collection and report processing cannot be in progress when report type **comp**, **systot**, **avl**, or **gtwy** is specified.

The **mtcdth** report type is unavailable between midnight and 1:00 AM (0100).

Day-to-hour collection and report processing cannot be in progress

- When report type **mtcd** is specified
- When report type **mtcdth** is specified

Daily collection and report processing cannot be in progress when report type **mtcd** is specified.

Half-hourly collection and report processing cannot be in progress when report type **comp**, **systot**, **avl**, or **gtwy** is specified.

5-minute collection and report processing cannot be in progress when report type **nm** is specified.

When **enttype=lnp**, only **mtcd** and **mtch** can be specified for the **type** parameter.

If **nc** is specified for **enttype=originnc** reports, **ni** must also be specified.

If **ni** is specified for **enttype=origni** reports, measurements data must be available at the time the command is entered.

The **day** parameter can be specified only for report type **mtcd** and entity types **lnp** and **mapscrn**.

The **period=all** parameter can be specified only for **type=avl** and **enttype=lnp:type=mtcd** reports.

The LNP feature must be turned on (see the **enable-ctrl-feat** command) before the **enttype=lnp** parameter can be specified.

The GSM Map Screening feature (see the **enable-ctrl-feat** and **chg-ctrl-feat** commands) must be turned on before the **enttype=mapscrn** parameter can be specified.

Either the G-Port feature or the INP feature must be turned on before the **entity=np** parameter can be specified.

A primary MCPM card must be available when the Measurements Platform collection option is enabled and this command is entered.

The 15 Minute Measurements feature must be turned on and the 15 Minute Measurements collection option must be on before the **qh** parameter can be specified.

The **qh** parameter must specify a quarter-hourly boundary (the end of the requested quarter-hour for the report) for valid report types (**avld**, **mtcd**, **nm**, **rbase**, and **mtcs** are excluded with message "E2307: QH or HH is not valid for this TYPE").

The **hh** parameter must specify a half-hourly boundary (the end of the requested half-hour for the report) for valid report types (**mtcd** and **nm** are excluded with message "E2307: QH or HH is not valid for this TYPE").

The **hh** and **qh** parameters cannot be specified together in the command.

When the **period=last** parameter is specified, the **hh** parameter, the **qh** parameter, or the **day** parameter cannot be specified.

When the **period=active** parameter or the **period=all** parameter is specified, the **hh** and **qh** parameters cannot be specified.

When the **period=specific** parameter is specified, the **hh** parameter, the **qh** parameter, or the **day** parameter must be specified. The **hh**, **qh**, and **day** parameters can be specified only if the **period=specific** parameter is specified.

A half-hour boundary must be specified for the **hh** parameter, except for report type **mtch**; an hourly boundary must be specified for report type **mtch** (that is, only half hours ending in **00**, such as **0100**, **0200** or **0300**).

A quarter-hour boundary must be specified for the **qh** parameter, except for report type **mtch**; an hourly boundary must be specified for report type **mtch** (that is, only quarter hours ending in **00**, such as **0100**, **0200** or **0300**).

The **hh** parameter and the **qh** parameter cannot be specified when report type **avld**, **mtcd**, **nm**, **rbase**, or **mtcs** is specified.

If the **link** parameter is specified, the **loc** parameter must be specified.

The **lsn** parameter cannot be specified in the same command with the **loc** parameter or the **port** parameter.

When entity type **link** is specified, either the **loc** and **port** parameters or the **lsn** parameter must be specified.

The **appl** parameter can be specified only when the **enttype=stplan** and the **type=avl** parameters are specified.

When the **appl** parameter is specified, the **period=active** parameter and the **period=all** parameter cannot be specified.

The **period=active** parameter cannot be specified when the **enttype=stp** parameter or the **enttype=tt** parameter is specified.

The **ni** parameter cannot be specified for ITU linksets (for **enttype=lsdestni** and **enttype=lsorigni** reports)

The **lsn** parameter cannot be specified with the following parameters:
enttype=stp/tt/stplan/origni/origninc/lnp/np/mapscrn or **type=systot**.

For entity type **lnkset**, the **lsn** parameter must be specified, regardless of whether the value of the **lsn** parameter is an ANSI or an ITU linkset.

For entity type **avl**, if **period=all** is specified, the **loc** and **port** parameters must be specified.

The **nzo** parameter is used only for entity types **avl**, **avld**, and **avldth**.

The **loc** and **lnkset** parameters cannot be specified in the same command. Either the **loc** parameter or the **lnkset** parameters can be specified, but not both. For example, the following command is not a valid parameter combination:

```
rept-meas:type=mtcd:enttype=link:loc=1211:link=a:lnkset=nc2785
```

The **appl** and **loc** parameters cannot be specified in the same command line.

When **enttype=lnp**, the **trm** parameter cannot be specified because LNP measurements can be written only to the FTA. To retrieve this data, use the procedure described with the **act-file-trns** command information.

For the **stplan-avl** reports (**enttype=stplan** and **type=avl** parameters), if the **appl** parameter is specified, the **period=active** and **period=all** parameters cannot be specified.

The **type=systot** and **loc** parameters cannot be specified in the same command line.

When **enttype=lnp** and **type=mtch**, only **last** and **specific** can be specified for the **period** parameter.

When **enttype=lnp**, **nzo=yes** cannot be specified.

When **enttype=lnp**, the **appl**, **loc**, **port**, **lsn**, **ni**, and **nc** parameters cannot be specified.

The **tt** parameter must be specified when **enttype=tt**. The only time the **tt** parameter is valid is when it is specified with **enttype=tt**.

If the **type=gtwy:enttype=lsorigni/lsdestni/lsonismt** parameter combination is specified, the **ni** parameter cannot be specified for ITU linksets. The **ni** parameter is allowed only for ANSI linksets.

If the **type=gtwy:enttype=stp** parameter combination is specified, no additional parameters may be specified.

If the **type=gtwy:enttype=lsdestni** parameter combination is specified for an ITU linkset, only the **lsn** parameter can be specified.

If the **type=gtwy:enttype=lsorigni** parameter combination is specified for an ITU linkset, only the **lsn** parameter can be specified.

If the **type=gtwy:enttype=lsonismt** parameter combination is specified for an ITU linkset, only the **lsn** parameter can be specified.

Table 7-6. Valid Parameter Combinations for the **type** Parameter

Parameter Value	Report Types (type parameter)											
	systot	comp	mtcd	mtcdth	mtch	mtcs	nm	avl	avld	avldth	gtwy	rbase
enttype=												
stp	X		X	X		X					X	X
link		X	X	X		X	X	X	X	X		X
lnkset		X	X	X		X	X				X	X
lnp			X		X							
tt	X											
stplan	X		X	X				X				
origni											X	
originic											X	
lsdestni											X	
lsonismt											X	
lsorigni											X	
np			X		X							
mapscrn			X		X							

Table 7-6. Valid Parameter Combinations for the **type** Parameter (Continued)

Parameter Value	Report Types (type parameter)											
	systot	comp	mtcd	mtcdth	mtch	mtcs	nm	avl	avld	avldth	gtwy	rbase
period=												
last	X	X	X	X	X		X	X	X	X	X	
specific	X	X			X			X			X	
active		X				X	X	X				X
all			X					X				
nzo								X	X	X		

Notes

The *Maintenance Manual* provides a description of all report parameters.

INP, GSM MAP screening, and LNP measurements are sent to the FTA (file transfer area) rather than to the EAGLE 5 SAS terminal. Refer to Chapter 2 of the *Maintenance Manual* for procedural information on accessing the FTA.

If an on-demand report is requested while the collection for that interval is in progress, the requested report will not be generated. The **rept-meas** command must be entered again.

For the entity types **avld** and **avldth**, if no link or linkset is specified, all links are reported.

Output

rept-meas:type=systot:enttype=stp

```
rlghncxa03w 03-07-27 16:53:22 EST EAGLE 31.3.0
Measurements Report will be generated.
```

```
rlghncxa03w 05-07-27 16:53:22 EST EAGLE 34.0.0
TYPE OF REPORT: STP SYSTEM TOTAL MEASUREMENTS ON STP
REPORT PERIOD: LAST
REPORT INTERVAL: 05-07-27 12:00:00 THRU 12:29:59
STP-SYSTOT MEASUREMENTS
```

```

ORIGMSUS = 425, TRMDMSUS = 420, THRSWMSU = 730980,
ORMSUOCT = 8490, TRMSUOCT = 8400, TSMSUOCT = 14619600,
DURINTFL = 0, DTAMSULOST = 0, MSINVDPC = 5,
MSINVSIO = 0, OMSINVDPC = 0, MSINVLNK = 0,
MSINVSIF = 0, MSNACDPC = 5, MSINVSLC = 0,
GTTPERFD = 0, GTTUNONS = 0, GTTUN1NT = 0,
MSSCCPFL = 0, MSULOST1 = 0, MSULOST2 = 0,
MSULOST3 = 0, MSULOST4 = 0, MSULOST5 = 0,
CRSYSAL = 1, MASYSAL = 2, MISYSAL = 9,
XLXTSPACE = 0, XLXTELEI = 0, MSUDSCRD = 0,
OVSZMSG = 0, GFMTMATCH = 0, GFGTNOMCH = 0,
GFGTNOLKUP = 0, MSUSCCPFLR = 0, NMSCCPMH = 4567,
PKSCCPMH = 38495, MSSCCPDISC = 23, IDPRMSERR = 2,
IDPRMSFAIL = 12, IDPRMSRCV = 8374, IDPRMSSUCC = 8360

```

;

```
rlghncxa03w 03-07-27 16:53:22 EST EAGLE 31.3.0
END OF HALF-HOURLY STP-SYSTOT MEASUREMENT REPORT
```

;

rept-meas:type=comp:enttype=lnkset:lsn=xy212

```
rlghncxa03w 03-07-27 16:53:22 EST EAGLE 31.3.0
```

Measurements Report will be generated.

```
rlghncxa03w 03-07-27 16:53:22 EST EAGLE 31.3.0
```

TYPE OF REPORT: COMPONENT MEASUREMENTS ON LNKSET

REPORT PERIOD: LAST

REPORT INTERVAL: 03-07-16 10:00:00 THRU 10:29:59

LNKSET-COMP MEASUREMENTS: lsn1 (SAAL)

```
MSUTRAN      = 120755, MSURECVD      = 147190, OCTTRAN      = 2415100,
OCTRECVD     = 2943800, MSUSRGTT     = 0, OCTRCGTT     = 0,
TDLSINAC    = 0, MSGWSDSLIM    = 0, ZTTMAPO     = 0,
ZTTMAPI     = 0, ATMNDCTRN     = 0, ATMNDCRCV    = 0,
SDUSTRAN    = 0, SDURECVD     = 0, SDURETRN     = 0
MTPMSCNVTD  = 0, GTTMSCNVTD  = 0
```

;

```
rlghncxa03w 03-07-27 16:53:22 EST EAGLE 31.3.0
```

LNKSET-COMP MEASUREMENTS: lsn2

```
MSUTRAN      = 120740, MSURECVD      = 147196, OCTTRAN      = 2414790,
OCTRECVD     = 2943920, MSUSRGTT     = 0, OCTRCGTT     = 0,
TDLSINAC    = 0, MSGWSDSLIM    = 0, ZTTMAPO     = 0,
ZTTMAPI     = 0, MTPMSCNVTD     = 0, GTTMSCNVTD  = 0
```

;

```
rlghncxa03w 03-07-27 16:53:22 EST EAGLE 31.3.0
```

LNKSET-COMP MEASUREMENTS: lsn3

```
MSUTRAN      = 144895, MSURECVD      = 147190, OCTTRAN      = 2897900,
OCTRECVD     = 2943800, MSUSRGTT     = 0, OCTRCGTT     = 0,
TDLSINAC    = 0, MSGWSDSLIM    = 0, ZTTMAPO     = 0,
ZTTMAPI     = 0, MTPMSCNVTD     = 0, GTTMSCNVTD  = 0
```

;

```
rlghncxa03w 03-07-27 16:53:22 EST EAGLE 31.3.0
```

```
MSUTRAN      = 0, MSURECVD      = 0, OCTTRAN      = 0,
OCTRECVD     = 0, MSUSRGTT     = 0, OCTRCGTT     = 0,
TDLSINAC    = 0, MSGWSDSLIM    = 0, ZTTMAPO     = 0,
ZTTMAPI     = 0, ATMNDCTRN     = 0, ATMNDCRCV    = 0,
SDUSTRAN    = 0, SDURECVD     = 0, SDURETRN     = 0,
MTPMSCNVTD  = 0, GTTMSCNVTD  = 0
```

;

```
rlghncxa03w 03-07-27 16:53:22 EST EAGLE 31.3.0
```

END OF HALF-HOURLY LNKSET-COMP MEASUREMENT REPORT

;

rept-meas:type=comp:enttype=link:lsn=ls1201a0

rlghncxa03w 04-03-28 01:00:04 EST EAGLE 31.4.0
 TYPE OF REPORT: COMPONENT MEASUREMENTS ON LINK
 REPORT PERIOD: LAST
 REPORT INTERVAL: 04-03-28 00:30:00 THRU 00:59:59

LINK-COMP MEASUREMENTS: LOC: 1201, PORT: A , LSN: e2m1s1

These measurements are from 04-03-28, 00:30:00 through 00:59:59.

MSUTRAN	=	20,	MSURECVD	=	20,	MSURETRN	=	0,
OCTRETRN	=	0,	OCTTRAN	=	400,	OCTRECVD	=	400,
MTCEUSG	=	0,	DURLKOTG	=	0,	MSUSRGTT	=	0,
OCTRCGTT	=	0,	TDCNGLV1	=	0,	TDCNGLV2	=	0,
TDCNGLV3	=	0,	ECCNGLV1	=	0,	ECCNGLV2	=	0,
ECCNGLV3	=	0,	MSUDISCO	=	0,	MSUDISC1	=	0,
MSUDISC2	=	0,	MSUDISC3	=	0,	LNKAVAIL	=	183,
NMGWSDSABL	=	0						

;

rlghncxa03w 04-03-28 01:00:05 EST EAGLE 31.4.0
 LINK-COMP MEASUREMENTS: LOC: 1201, PORT: B , LSN: e2m1s2

These measurements are from 04-03-28, 00:30:00 through 00:59:59.

MSUTRAN	=	20,	MSURECVD	=	20,	MSURETRN	=	0,
OCTRETRN	=	0,	OCTTRAN	=	400,	OCTRECVD	=	400,
MTCEUSG	=	0,	DURLKOTG	=	0,	MSUSRGTT	=	0,
OCTRCGTT	=	0,	TDCNGLV1	=	0,	TDCNGLV2	=	0,
TDCNGLV3	=	0,	ECCNGLV1	=	0,	ECCNGLV2	=	0,
ECCNGLV3	=	0,	MSUDISCO	=	0,	MSUDISC1	=	0,
MSUDISC2	=	0,	MSUDISC3	=	0,	LNKAVAIL	=	183,
NMGWSDSABL	=	0						

;

rlghncxa03w 04-03-28 01:00:05 EST EAGLE 31.4.0
 LINK-COMP MEASUREMENTS: LOC: 1202, PORT: B , LSN: e2m1s3 (SAAL)

These measurements are from 04-03-28, 00:30:00 through 00:59:59.

MSUTRAN	=	5,	MSURECVD	=	1,	OCTTRAN	=	89,
OCTRECVD	=	17,	MTCEUSG	=	0,	DURLKOTG	=	117,
MSUSRGTT	=	0,	OCTRCGTT	=	0,	TDCNGLV1	=	0,
TDCNGLV2	=	0,	TDCNGLV3	=	0,	ECCNGLV1	=	0,
ECCNGLV2	=	0,	ECCNGLV3	=	0,	MSUDISCO	=	0,
MSUDISC1	=	0,	MSUDISC2	=	0,	MSUDISC3	=	0,
LNKAVAIL	=	1684,	NMGWSDSABL	=	0,	ATMNDCTRN	=	16845,
ATMNDCRCV	=	16841,	SDUSTRAN	=	16845,	SDURECVD	=	16841,
SDURETRN	=	0						

;

rlghncxa03w 04-03-28 01:00:06 EST EAGLE 31.4.0
 END OF HALF-HOURLY LINK-COMP MEASUREMENT REPORT

;

rept-meas:enttype=link:type=avl:loc=1201:link=a

rlghncxa03w 02-03-27 16:53:22 EST EAGLE 30.0.0
 Measurements Report will be generated.

rlghncxa03w 02-03-27 16:53:22 EST EAGLE 30.0.0
 TYPE OF REPORT: AVAILABILITY MEASUREMENTS ON LINK
 REPORT PERIOD: LAST
 REPORT INTERVAL: 02-03-06, 10:30:00 THROUGH 10:59:59

LINK-AVL MEASUREMENTS: LOC: 1201, PORT: A , LSN: lsn123

These measurements are from 02-03-06, 10:30:00 through 10:59:59.
 WARNING - measurement data represents an incomplete interval.
 SUSRECVD = 1161096, SUSTRAN = 1164935

rlghncxa03w 02-03-27 16:53:22 EST EAGLE 30.0.0
 END OF ON-DEMAND LINK-AVL MEASUREMENT REPORT

;

rept-meas:type=avl:enttype=link:loc=1201:link=a:nzo=no

rlghncxa03w 2-03-06 11:01:35 EST EAGLE 30.0.0
 Measurements Report will be generated.

rlghncxa03w 02-03-06 11:01:35 EST EAGLE 30.0.0
 TYPE OF REPORT: AVAILABILITY MEASUREMENTS ON LINK
 REPORT PERIOD: LAST
 REPORT INTERVAL: 02-03-06, 10:30:00 THROUGH 10:59:59

LINK-AVL MEASUREMENTS: LOC: 1201, PORT: A , LSN: lsn123

These measurements are from 02-03-06, 10:30:00 through 10:59:59.
 WARNING - measurement data represents an incomplete interval.

NEARMGINH =	0,	FARMGINH =	0,	NMDCLFLR =	0,
DRDCLFLR =	0,	SURCVERR =	0,	DRLNKINH =	0,
NDCLFABN =	0,	NDCLFSYNC =	0,	NDCLFXDA =	0,
NDCLFXER =	0,	NDCLFXDC =	0,	NDCLFALP =	0,
NDCLFINTR =	0,	NMFEPRO =	0,	NMLCLPRO =	0,
DRFEPRO =	0,	DRLCLPRO =	0,	SUSRECVD =	1161096,
SUSTRAN =	1164935				

rlghncxa03w 02-03-06 11:01:35 EST EAGLE 30.0.0
 END OF ON-DEMAND LINK-AVL MEASUREMENT REPORT

;

In the following example, the final counts also show ITU measurement data also shown.

rept-meas:type=gtwy:enttype=stp

```
rlghncxa03w 01-03-05 11:01:35 EST EAGLE 28.1.0
TYPE OF REPORT: GATEWAY MEASUREMENTS ON STP
REPORT PERIOD: LAST
REPORT INTERVAL: 01-03-05, 12:00:00 THROUGH 12:29:59
```

STP-GTWY MEASUREMENTS

These measurements are from 01-03-05, 12:00:00 through 12:29:59.

```
TTMAPPF      =      450, GTTPFDIC      =      0, MSUDSCRD      =      880,
MSURJOPC     =      0, MSURJDPC      =      0, MSURJSIO      =      0,
MSURJCPA     =      0, MSURJAPC      =      0, MSURJPCS      =      779,
MSURJDST     =      230, MSURJTT      =      0, MSURJDSN      =      0,
MSURJTFC     =      0, MSURJSRT      =      0
```

01

```
rlghncxa03w 00-03-05 11:01:35 EST EAGLE 28.1.0
END OF ON-DEMAND STP-GTWY MEASUREMENT REPORT
```

;

The following example specifies an ANSI gateway linkset for the **lsn** parameter with the **enttype=lsdestni** parameter:

rept-meas:type=gtwy:enttype=lsdestni:lsn=ls1201:ni=5

```
rlghncxa03w 04-02-19 12:30:16 EST EAGLE 31.3.0
TYPE OF REPORT: GATEWAY MEASUREMENTS ON LSDESTNI
REPORT PERIOD: LAST
REPORT INTERVAL: 04-02-19, 12:00:00 THROUGH 12:29:59
```

LSDESTNI-GTWY MEASUREMENTS: LSN: ls1201, NI: 5

These measurements are from 04-02-19, 12:00:00 through 12:29:59.

```
MSURCVNA     = 5040000, OCTRCVNA     = 201600K, MSUTRNNNA    = 834033,
OCTTRNNA     = 14757021, TFCGTRAN    = 0
```

;

```
rlghncxa03w 04-02-19 12:30:18 EST EAGLE 31.3.0
END OF ON-DEMAND LSDESTNI-GTWY MEASUREMENT REPORT
```

;

The following example specifies an ITU gateway linkset for the **lsn** parameter with the **enttype=lnkset** parameter. The output format is the same as for an ANSI gateway linkset:

rept-meas:type=gtwy:enttype=lnkset:lsn=lsnitu

```
rlghncxa03w 00-03-06 11:01:35 EST EAGLE 29.0.0
TYPE OF REPORT: GATEWAY MEASUREMENTS ON LINKSET
REPORT PERIOD: LAST
REPORT INTERVAL: 00-03-05, 13:00:00 THROUGH 13:29:59
```

LINKSET-GTWY MEASUREMENTS: lsnitu

These measurements are from 00-03-05, 13:00:00 through 13:29:59.

```
TFPTRAN = 0, TFPRECD = 5790, TFRTRAN = 0,
TFRRECD = 0, TFATRAN = 5810, TFARECD = 0,
SRSTTRAN = 0, SRSTRECD = 0, SLTRECD = 0,
SRSCTRAN = 0, SRSCRECD = 0, TSTMTRCD = 0,
SSPTRAN = 330, SSPRECD = 0, SSATRAN = 0,
SSARECD = 520, SSTTRAN = 0, SSTRECD = 0
```

```
rlghncxa03w 00-03-06 11:01:35 EST EAGLE 29.0.0
END OF ON-DEMAND LINKSET-GTWY MEASUREMENT REPORT
;
```

The following example specifies an ITU gateway linkset for the **lsn** parameter with the **enttype=lsdestni** parameter. The output format is the same as for an ANSI gateway linkset. For ITU linksets, the **ni** parameter is not applicable.

rept-meas:type=gtwy:enttype=lsdestni:lsn=lsnitu

```
rlghncxa03w 04-02-06 11:01:35 EST EAGLE 31.3.0
TYPE OF REPORT: GATEWAY MEASUREMENTS ON LSDESTNI
REPORT PERIOD: LAST
REPORT INTERVAL: 04-02-05, 12:00:00 THROUGH 12:29:59
```

LSDESTNI-GTWY MEASUREMENTS: ITU LSN: lsnitu

These measurements are from 04-02-05, 12:00:00 through 12:29:59.

```
MSURCVNA = 5040000, OCTRCVNA = 201600K, MSUTRNNNA = 834033,
OCTTRNNA = 14757021, TFCGTRAN = 0
```

```
rlghncxa03w 04-02-06 11:01:35 EST EAGLE 31.3.0
END OF ON-DEMAND LSDESTNI-GTWY MEASUREMENT REPORT
;
```

The following example specifies an ITU gateway linkset for the **lsn** parameter with the **enttype=lsorigni** parameter. The output format is the same as for an ANSI gateway linkset:

rept-meas:type=gtwy:enttype=lsorigni:lsn=lsnitu

```
rlghncxa03w 04-02-06 11:01:35 EST EAGLE 31.3.0
TYPE OF REPORT: GATEWAY MEASUREMENTS ON LSORIGNI
REPORT PERIOD: LAST
REPORT INTERVAL: 04-02-05, 11:30:00 THROUGH 11:59:59

LSORIGNI-GTWY MEASUREMENTS: ITU LSN: lsnitu

These measurements are from 04-02-05, 11:30:00 through 11:59:59.
TFCRECD = 0, MSURJOPC = 834033, MSURJDPC = 834034,
MSURJCPA = 14757021, MSURJAPC = 14757039, MSURJPCS = 0,
MSURJTFC = 0, MSURJSRT = 0, MSUDSCRD = 0,
MSURJSIO = 0, MSURJDST = 0, MSURJTT = 0,
MSURJDSN = 0
```

```
rlghncxa03w 04-02-06 11:01:35 EST EAGLE 31.3.0
END OF ON-DEMAND LSORIGNI-GTWY MEASUREMENT REPORT
```

;

The following example specifies an ANSI gateway linkset for the **lsn** parameter where **enttype=lsonismt**. The output format is the same as for an ITU gateway linkset:

rept-meas:type=gtwy:enttype=lsonismt:lsn=ls1201a:ni=43

```
rlghncxa03w 02-12-06 11:01:35 EST EAGLE 30.0.0
TYPE OF REPORT: GATEWAY MEASUREMENTS ON LSONISMT
REPORT PERIOD: LAST
REPORT INTERVAL: 02-12-19, 12:00:00 THROUGH 12:29:59

LSONISM-TGWY MEASUREMENTS: LSN: ls1201a, NI: 43, ISMT: 6

These measurements are from 02-12-19, 12:00:00 through 12:29:59.
MSUISPMT = 45397
```

;

```
LSONISM-TGWY MEASUREMENTS: LSN: ls1201a, NI: 43, ISMT: 7
```

```
These measurements are from 02-12-19, 12:00:00 through 12:29:59.
MSUISPMT = 61423
```

;

```
rlghncxa03w 02-12-06 11:01:35 EST EAGLE 30.0.0
END OF ON-DEMAND LSONISM-TGWY MEASUREMENT REPORT
```

;

The following example shows output when measurements files are sent to the FTA area:

rept-meas:type=mtcd:enttype=mapscrn

```
rlghncxa03w 04-02-06 11:01:35 EST EAGLE 31.3.0
Measurement Reports will be generated to active File Transfer Area.
MTCD MAPSCRN SYSTEM report generated to mon_map.csv in FTA.
MTCD MAPSCRN PER-SERVER report generated to mon_serv.csv in FTA.
```

;

Legend

TYPE OF REPORT—The type of report, defined by the **type** and **enttype** parameters.

REPORT PERIOD—The date and the time period for which the report was generated.

REPORT INTERVAL—The time period for which the report was generated.

LINK-AVL MEASUREMENTS: LOC—For the link reports (in this example the availability report), the card location, port, and linkset name of the link for which the report is being generated.

LINK-COMP MEASUREMENTS: LOC—For the link reports (in this example the components report), the card location, port, and linkset name of the link for which the report is being generated.

LINKSET-COMP MEASUREMENTS—For the linkset components report, the name of the linkset for which the report was generated.

STPLAN-AVL MEASUREMENTS: LOC—For the STPLAN availability reports, the card location for which the report is being generated.

<ENTITY>-GTWY MEASUREMENTS—For Gateway Measurements reports, where the **entity** value will be one of the following: STP, LNKSET, ORIGNI, ORIGNINC, LSDESTNI, LSONISMT, LSORIGNI, depending on what is being reported.

The remainder of the items displayed are the measurements that were made. For more information of these measurements, refer to the *Maintenance Manual*.

rept-stat-alm**Report Status Alarm**

Use this command to provide status of all alarms.

Keyword: `rept-stat-alm`

Related Commands: `dact-alm-trns`, `rept-stat-clk`, `rept-stat-trbl`, `rtrv-obit`, `rtrv-trbl`

Command Class: System Maintenance

Parameters

:dev= (mandatory)

Type of device for which alarms are displayed. The **display=inhb** parameter must be specified when this parameter is specified.

Range: `applsock`, `as`, `card`, `cdt`, `clock`, `dlk`, `ls`, `lsmsconn`, `ndclk`, `ndcq3`, `route`, `seasx25`, `slk`, `trm`

:display= (optional)

Type of alarms to be displayed. When **disply=inhb** is specified, the Alarm Inhibit Report appears in the command output, to provide information about inhibited alarms in the system. The **dev** parameter can be specified with this parameter to display the Alarm Inhibit Report for a specific device type.

Range: `inhb`

Example

```
rept-stat-alm
rept-stat-alm:display=inhb
rept-stat-alm:display=inhb:dev=card
```

Dependencies

No other **rept-stat-xxx** command can be in progress when this command is entered.

The **display** parameter must be specified when the **dev** parameter is specified.

Notes

None

Output

The following example shows output when the system is clean and before a maintenance baseline has been established:

rept-stat-alm

```
rlghncxa03w 04-02-19 15:00:53 EST EAGLE 31.3.0
ALARM TRANSFER= LMC
ALARM MODE CRIT= SILENT MAJR= SILENT MINR= SILENT
ALARM FRAME 1 CRIT= 0 MAJR= 0 MINR= 0
ALARM FRAME 2 CRIT= 0 MAJR= 0 MINR= 0
ALARM FRAME 3 CRIT= 0 MAJR= 0 MINR= 0
ALARM FRAME 4 CRIT= 0 MAJR= 0 MINR= 0
ALARM FRAME 5 CRIT= 0 MAJR= 0 MINR= 0
ALARM FRAME 6 CRIT= 0 MAJR= 0 MINR= 0
ALARM FRAME OAP CRIT= 0 MAJR= 0 MINR= 0
ALARM FRAME GPF CRIT= 0 MAJR= 0 MINR= 0
TOTAL ALARMS CRIT= 0 MAJR= 0 MINR= 0
PERM. INH. ALARMS CRIT= 0 MAJR= 0 MINR= 0
TEMP. INH. ALARMS CRIT= 0 MAJR= 0 MINR= 0
ACTIVE ALARMS CRIT= 0 MAJR= 0 MINR= 0
Command Completed.
;
```

The following example shows output after critical and minor alarms are generated. Major alarms still show SILENT:

rept-stat-alm

```
rlghncxa03w 04-02-23 13:20:37 EST EAGLE 31.3.0
ALARM TRANSFER= LMC
ALARM MODE          CRIT= AUDIBLE      MAJR= SILENT      MINR= AUDIBLE
ALARM FRAME 1      CRIT= 7            MAJR= 0           MINR= 10
ALARM FRAME 2      CRIT= 0            MAJR= 0           MINR= 0
ALARM FRAME 3      CRIT= 0            MAJR= 0           MINR= 0
ALARM FRAME 4      CRIT= 0            MAJR= 0           MINR= 0
ALARM FRAME 5      CRIT= 0            MAJR= 0           MINR= 0
ALARM FRAME 6      CRIT= 0            MAJR= 0           MINR= 0
ALARM FRAME OAP    CRIT= 0            MAJR= 0           MINR= 0
ALARM FRAME GPF    CRIT= 0            MAJR= 0           MINR= 0
PERM. INH. ALARMS  CRIT= 2            MAJR= 0           MINR= 0
TEMP. INH. ALARMS  CRIT= 3            MAJR= 0           MINR= 0
ACTIVE ALARMS      CRIT= 2            MAJR= 0           MINR= 10
TOTAL ALARMS       CRIT= 7            MAJR= 0           MINR= 10
Command Completed.
```

;

The following example shows inhibited alarms:

rept-stat-alm

```
rlghncxa03w 04-02-19 15:00:53 EST EAGLE 31.3.0
ALARM TRANSFER= RMC
ALARM MODE          CRIT= AUDIBLE      MAJR= SILENT      MINR= AUDIBLE
ALARM FRAME 1      CRIT= 3            MAJR= 16          MINR= 22
ALARM FRAME 2      CRIT= 0            MAJR= 0           MINR= 0
ALARM FRAME 3      CRIT= 0            MAJR= 0           MINR= 0
ALARM FRAME 4      CRIT= 0            MAJR= 0           MINR= 0
ALARM FRAME 5      CRIT= 0            MAJR= 0           MINR= 0
ALARM FRAME 6      CRIT= 0            MAJR= 0           MINR= 0
ALARM FRAME OAP    CRIT= 0            MAJR= 0           MINR= 0
ALARM FRAME GPF    CRIT= 1            MAJR= 2           MINR= 1
PERM. INH. ALARMS  CRIT= 0            MAJR= 10          MINR= 0
TEMP. INH. ALARMS  CRIT= 0            MAJR= 8           MINR= 0
ACTIVE ALARMS      CRIT= 4            MAJR= 0           MINR= 22
TOTAL ALARMS       CRIT= 4            MAJR= 18          MINR= 23
Command Completed.
```

;

The following examples includes the Alarm Inhibit report. The third example includes point codes with point code subtype prefixes:

NOTE: A plus sign (+) following the alarm level indicates that the current alarm is not inhibited because the level of the inhibit is less than the level of the alarm.

rept-stat-alm:display=inhb

```
rlghncxa03w 04-02-19 15:00:53 EST EAGLE 31.3.0
ALARM TRANSFER= RMC
ALARM MODE          CRIT= SILENT      MAJR= SILENT      MINR= SILENT
ALARM FRAME 1      CRIT= 11          MAJR= 24          MINR= 17
ALARM FRAME 2      CRIT= 0            MAJR= 0           MINR= 0
ALARM FRAME 3      CRIT= 0            MAJR= 0           MINR= 0
ALARM FRAME 4      CRIT= 0            MAJR= 0           MINR= 0
ALARM FRAME 5      CRIT= 0            MAJR= 0           MINR= 0
ALARM FRAME 6      CRIT= 0            MAJR= 0           MINR= 0
ALARM FRAME OAP    CRIT= 1            MAJR= 6           MINR= 1
PERM. INH. ALARMS  CRIT= 0            MAJR= 4           MINR= 2
```

```
TEMP. INH. ALARMS CRIT= 1 MAJR= 3 MINR= 1
ACTIVE ALARMS CRIT= 11 MAJR= 23 MINR= 15
TOTAL ALARMS CRIT= 12 MAJR= 30 MINR= 18
```

ALARM INHIBIT REPORT

```
-----
DEVICE ELEMENT DURATION ALM INH LVL CUR ALM LVL
-----
CARD 1301 PERM MAJR MAJR
SLK 1101,A PERM MAJR MAJR
LS ls1 PERM MAJR MAJR
TERM 10 PERM MINR MINR
CLOCK ----- PERM MAJR ----
DLK 1305,A PERM MAJR MINR
CDT 1 PERM MAJR ----
SEASX25 A1 TEMP MAJR MAJR
LSMSCONN A1 TEMP CRIT MAJR
ROUTE 004-004-002 PERM MINR CRIT+
ROUTE 004-004-004 PERM MAJR CRIT+
ROUTE 004-005-006 TEMP CRIT CRIT
NDCLK DCM A 1301 TEMP CRIT MAJR
NDCQ3 EMAP TEMP CRIT MINR
APPLSOCK sock1234567890 PERM MINR MAJR+
AS asname12345678 PERM MAJR MAJR
Command Completed.
```

;

rept-stat-alm:display=inhb:dev=card

```
rlghncxa03w 04-02-19 15:00:53 EST EAGLE 31.3.0
ALARM TRANSFER= RMC
ALARM MODE CRIT= SILENT MAJR= SILENT MINR= SILENT
ALARM FRAME 1 CRIT= 11 MAJR= 24 MINR= 17
ALARM FRAME 2 CRIT= 0 MAJR= 0 MINR= 0
ALARM FRAME 3 CRIT= 0 MAJR= 0 MINR= 0
ALARM FRAME 4 CRIT= 0 MAJR= 0 MINR= 0
ALARM FRAME 5 CRIT= 0 MAJR= 0 MINR= 0
ALARM FRAME 6 CRIT= 0 MAJR= 0 MINR= 0
ALARM FRAME OAP CRIT= 1 MAJR= 6 MINR= 1
PERM. INH. ALARMS CRIT= 0 MAJR= 4 MINR= 2
TEMP. INH. ALARMS CRIT= 1 MAJR= 3 MINR= 1
ACTIVE ALARMS CRIT= 11 MAJR= 23 MINR= 15
TOTAL ALARMS CRIT= 13 MAJR= 30 MINR= 18
```

ALARM INHIBIT REPORT

```
-----
DEVICE ELEMENT DURATION ALM INH LVL CUR ALM LVL
-----
CARD 1301 PERM MAJR MAJR
Command Completed.
```

;

rept-stat-alm:display=inhb

```

rlghncxa03w 05-01-07 15:00:53 EST EAGLE 31.12.0
ALARM TRANSFER= RMC
ALARM MODE          CRIT= SILENT          MAJR= SILENT          MINR= SILENT
ALARM FRAME 1      CRIT= 11              MAJR= 24              MINR= 17
ALARM FRAME 2      CRIT= 0               MAJR= 0               MINR= 0
ALARM FRAME 3      CRIT= 0               MAJR= 0               MINR= 0
ALARM FRAME 4      CRIT= 0               MAJR= 0               MINR= 0
ALARM FRAME 5      CRIT= 0               MAJR= 0               MINR= 0
ALARM FRAME 6      CRIT= 0               MAJR= 0               MINR= 0
ALARM FRAME OAP    CRIT= 1               MAJR= 6               MINR= 1
PERM. INH. ALARMS  CRIT= 0               MAJR= 6               MINR= 2
TEMP. INH. ALARMS CRIT= 1               MAJR= 3               MINR= 1
ACTIVE ALARMS      CRIT= 11              MAJR= 23              MINR= 15
TOTAL ALARMS       CRIT= 12              MAJR= 32              MINR= 18
    
```

ALARM INHIBIT REPORT

```

-----
DEVICE  ELEMENT          DURATION  ALM INH LVL  CUR ALM LVL
-----  -----
CARD    1301              PERM      MAJR         MAJR
SLK     1101,A            PERM      MAJR         MAJR
LS      ls1                  PERM      MAJR         MAJR
TERM    10                PERM      MINR         MINR
CLOCK   -----            PERM      MAJR         ----
DLK     1305,A            PERM      MAJR         MINR
CDT     1                  PERM      MAJR         ----
SEASX25 A1              TEMP      MAJR         MAJR
LSMSCONN A1              TEMP      CRIT         MAJR
ROUTE   004-004-002        PERM      MINR         CRIT+
ROUTE   s-004-004-004    PERM      MAJR         CRIT+
ROUTE   ps-004-005-006   TEMP      CRIT         CRIT
NDCLK   DCM A 1301          TEMP      CRIT         MAJR
NDCQ3   EMAP                TEMP      CRIT         MINR
APPLSOCK sock1234567890    PERM      MINR         MAJR+
AS      asname12345678        PERM      MAJR         MAJR
E1PORT  1101,1                PERM      MAJR         MAJR
T1PORT  1301,3                PERM      MAJR         MAJR
Command Completed.
    
```

;

Legend

ALARM TRANSFER—The destination of the alarms. LMC=Local Maintenance Center, RMC=Remote Maintenance Center.

ALARM MODE—Displays whether the critical, major, and minor alarms are silent or audible

ALARM FRAME 1—The number of critical, major, and minor alarms detected in the control frame CF-00 (frame 1).

ALARM FRAME 2—The number of critical, major, and minor alarms detected in extension frame EF-00 (frame 2).

ALARM FRAME 3—The number of critical, major, and minor alarms detected in extension frame EF-01 (frame 3).

ALARM FRAME 4—The number of critical, major, and minor alarms detected in extension frame EF-02 (frame 4).

ALARM FRAME 5—The number of critical, major, and minor alarms detected in extension frame EF-03 (frame 5).

ALARM FRAME 6—The number of critical, major, and minor alarms detected in extension frame EF-04 (frame 6).

ALARM FRAME OAP—The number of critical, major, and minor alarms detected in the OAP Frame.

ALARM FRAME GPF—The number of critical, major, and minor alarms detected at the MPS (multi-purpose server). If the LNP ELAP Configuration feature is turned on, the number includes alarms for any applications running on the MPS. If the G-Flex, G-Port, or INP feature is turned on, the number includes alarms for any applications running on the GSM subsystem and the DSM/EPAP links.

PERM. INH. ALARMS—(permanently inhibited alarms) - The number of alarms that are permanently inhibited per alarm level.

TEMP. INH. ALARMS—(temporarily inhibited alarms) - The number of alarms that are temporarily inhibited per alarm level.

ACTIVE ALARMS—The number of alarms still active per alarm level.

TOTAL ALARMS—The total number of alarms per alarm level. The inhibited alarm count plus the active alarm count equals the total alarm count.

CRIT—Critical alarms with silent/audible indicator.

MAJOR—Major alarms with silent/audible indicator.

MINOR—Minor alarms with silent/audible indicator.

Alarm Inhibit Report:

DEVICE—The device for which alarms are currently inhibited. Only devices that are alarm inhibited are shown.

ELEMENT—The element of the device for which alarms are inhibited (such as card location, port, routing key, socket or association name)

DURATION—Indicates whether the device is alarm inhibited permanently or temporarily

ALM INH LVL—Level in which devices are alarm inhibited (Critical, Major, Minor). The **inh-alm** command defaults the level to Major. Devices cannot be alarm inhibited at a critical level unless the **chg-stpopt** command **critalminh** parameter is turned on.

CUR ALM LVL—Level of the current alarm on the device (Critical, Major, Minor). "None" indicates that there is currently no alarm on the device (DURATION should show "PERM". A plus sign (+) seen following the alarm level indicates that the current alarm is not inhibited because the level of the inhibit is less than the level of the alarm.

rept-stat-applsock**Report Status Application Socket**

Use this command to display the status of the IP application sockets.

Keyword: `rept-stat-applsock`

Related Commands: `ent-appl-sock`, `chg-appl-sock`, `rtrv-appl-sock`

Command Class: System Maintenance

Parameters

:lhost= (optional)

Local host name. The logical name assigned to the local host device.

Range: `a-z, A-Z, 0-9, -, .`

Any string of characters beginning with a letter and comprising up to 60 characters in length

Default: Current value

:port= or :link= (optional)

The signaling **link** associated with this socket.

Range: `a, b, a1, b1, a2, b2, a3, b3`

Not all card types support all parameter values.

See Table A-1 in Appendix A for valid **link** parameter range values for each type of card that can have signaling links.

Default: Current value

:rhost= (optional)

Remote host name. The logical name assigned to the remote host device.

Range: `a-z, A-Z, 0-9, -, .` (any string of characters beginning with a letter and comprising up to 60 characters in length)

Default: Current value

:sname= (optional)

Socket name. The name of the IP application socket that is to be reported.

Range: Up to 15 alphanumeric characters; the first character must be a letter

Default: All IP application sockets are reported

Example

```
rept-stat-applsock
```

```
rept-stat-applsock:port=b
```

Dependencies

The **sname** parameter value, if specified, must exist in the Socket table.

Notes

This command displays the primary states (PST) and the secondary state (SST). Primary states are:

IS-NR—In-service normal

IS-ANR—In-service abnormal (congested)

OOS-MT—Out of service

OOS-MT-DSBLD—Out-of-service maintenance-disabled (provisioned to be out of service by closing, prohibiting, or deactivation)

Secondary states are:

CONNECTING

OOS—Out-Of-Service

NEA-FEA—Near-End Allowed, Far-End Allowed

NEA-FEP—Near-End Allowed, Far-End Prohibited

NEP-FEA—Near-End Prohibited, Far-End Allowed

NEP-FEP—Near-End Prohibited, Far-End Prohibited

Output

rept-stat-applsock

```
rlghncxa03w 04-02-17 15:35:05 EST EAGLE 31.3.0
SOCKET          PST          SST
socred          OOS-MT      ALMINH
socyellow      IS-ANR      ----
socblue        OOS-MT-DSBLD  ----
Command Completed
```

;

rept-stat-applsock

```
rlghncxa03w 04-02-17 15:35:05 EST EAGLE 31.3.0
SOCKET          PST          SST
ipg11051       IS-NR      NEA-FEA
ipg11071       IS-NR      NEA-FEA
ipl1201        IS-NR      NEA-FEA
Command Completed.
```

;

rept-stat-applsock:link=b

```
rlghncxa03w 05-02-17 15:35:05 EST EAGLE 34.0.0
SOCKET          PST          SST
ipl1201b       IS-NR      NEA-FEA
Command Completed.
```

;

rept-stat-as

Report Status AS Association

Use this command to generate a report of the Application Server (AS) association status.

Keyword: `rept-stat-as`

Related Commands: `chg-as`, `ent-as`, `rtrv-as`

Command Class: System Maintenance

Parameters

:aname= (optional)

Association name to report on.

When the **aname** parameter is specified, the **rept-stat-as** command will report the ASP states for a given association in all of the AS's that it is assigned to.

Range: Up to 15 alphanumeric characters; the first character must be a letter

:asname= (optional)

Application Server name; the AS name to report on.

When the **asname** parameter is specified, the **rept-stat-as** command will report the PST, SST, ASP state, and ASP-ID for each Association in the AS.

Range: Up to 15 alphanumeric characters; the first character must be a letter

Example

```
rept-stat-as
```

Dependencies

If an association is specified in the command, the specified association must exist in the AS table.

The optional **aname** and **asname** parameters cannot be specified on the same command line.

Notes

This command can be canceled using the **F9** function key or the **canc-cmd** command. See **canc-cmd** for more information.

If the command is specified without a parameter, status for all AS associations is displayed.

This command displays the following states: ACTIVE, DOWN, INACTIVE, PENDING, PRIMARY (PST), SECONDARY (SST), UP.

The Primary States (PST) for the AS are:

- IS-NR—In Service Normal
- IS-ANR—In Service Abnormal (AS-pending)
- OOS-MT—Out Of Service
- OOS-MT-DSBLD—Out Of Service Maintenance Disabled (provisioned to be out of service by closing or prohibiting all associations in the AS)

The Secondary States (SST) for the AS are:

- AS-ACTIVE—one or more Osculations in the AS have an ASP State of ASP-Active
- AS-INACTIVE—one or more Associations in the AS have an ASP State of ASP-Inactive but none have an ASP State of ASP-Active
- AS-DOWN—all Associations in the AS have an ASP State of ASP-Down
- AS-PENDING—there are no Associations in the AS with an ASP State of ASP-Active, the AS Recovery timer is active

Output**rept-stat-asp**

```

rlghncxa03w 05-02-04 12:57:21 EST EAGLE 34.0.0
ASNAME          PST          SST
m3ua0001        OOS-MT        AS-INACTIVE
m3ua0002        IS-NR         AS-ACTIVE
m3ua0003        OOS-MT-DSBLD AS-DOWN
m3ua0004        IS-ANR        AS-PENDING

```

Command Completed.

;

rept-stat-asp: asname=m3ua0001

```

rlghncxa03w 05-02-04 12:57:21 EST EAGLE 34.0.0
ASNAME          PST          SST
m3ua0001        OOS-MT        AS-INACTIVE

```

```

ANAME           PST          SST          ASP STATE    ASPID
m3ua_1301      OOS-MT-DSBLD  ---         ASP-DOWN     undefined
m3ua_1302      OOS-MT        CONNECTING   ASP-DOWN     undefined
m3ua_1303      IS-NR         ESTABLISHED  ASP-INACTIVE 123456789

```

Command Completed.

;

rept-stat-asp: aname= m3ua_1303

```

rlghncxa03w 05-02-04 12:57:21 EST EAGLE 34.0.0
ASNAME          ANAME          ASP STATE
m3ua0001        m3ua_1303     ASP-INACTIVE
m3ua0002        m3ua_1303     ASP-ACTIVE
m3ua0003        m3ua_1303     ASP-DOWN

```

Command Completed.

;

rept-stat-asp**Report Status ASP**

NOTE: This command is obsolete.

Use this command to generate a report of the Application Server Process (ASP) status.

Keyword: rept-stat-asp

Related Commands: ent-asp, rtrv-asp

Command Class: System Maintenance

Parameters

:aspname= (optional)

Application Server Process (ASP) name to report on.

Range: Up to 15 alphanumeric characters; the first character must be a letter.

Example

```
rept-stat-asp
```

Dependencies

If an ASP name is specified in the command, the specified name must exist in the ASP table.

Notes

This command can be canceled using the **F9** function key or the **canc-cmd** command. See **canc-cmd** for more information.

If the command is specified without a parameter, status for all ASPs is displayed.

This command displays the following states: ACTIVE, DOWN, UP.

Output

rept-stat-asp

```
rlghncxa03w 05-07-04 12:57:21 EST EAGLE 30.0.0
ASP      ASP ID      PST      SST
asp1     0x00000001    IS-NR    ASP-ACTIVE
asp2     undefined     OOS-MT   CONNECTING
asp3     0x00000003    OOS-MT   ASP-INACTIVE
asp4     undefined     OOS-MT   ASP-INACTIVE
asp5     undefined     OOS-MT   ASP-DOWN
Command Completed.
```

;

rept-stat-assoc

Report Status SCTP Association

Use this command to generate a report of the SCTP association's status.

Keyword: **rept-stat-assoc**

Related Commands: **ent-assoc, chg-assoc, rtrv-assoc**

Command Class: System Maintenance

Parameters

:aname= (optional)

Name of association to report on.

Range: Up to 15 alphanumeric characters; the first character must be a letter

:lhost= (optional)

The Local Host name as defined in the IP Host table.

Range: **a-z, A-Z, 0-9, -, .** (any string of characters beginning with a letter and comprising up to 60 characters in length)

:port= or :link= (optional)

The signaling **link** associated with this socket.

Range: **a, b, a1, b1, a2, b2, a3, b3**

Not all card types support all **link** parameter values.

See Table A-1 in Appendix A for valid **link** parameter range values for each type of card that can have signaling links.

Default: Current value

:rhost= (optional)

Name of Remote Host as defined in the IP Host table.

Range: a-z, A-Z, 0-9, -, .

Any string of characters beginning with a letter and comprising up to 60 characters in length.

Example

```
rept-stat-assoc
```

Dependencies

If an association is specified in the command, the specified association must exist in the AS table.

Notes

This command can be canceled using the **F9** function key or the **canc-cmd** command. See **canc-cmd** for more information.

This command displays the primary states (PST) and the secondary state (SST).

Primary states are:

IS-NR—In-Service Normal

IS-ANR—In-Service Abnormal (congested)

OOS-MT—Out Of Service

OOS-MT-DSBLD—Out-of-service maintenance-disabled (provisioned to be out of service by closing, prohibiting, or deactivation)

Secondary states are:

ASP ACTIVE—(Not valid for M2PA associations)

ASP DOWN—(Not valid for M2PA associations)

ASP UP—(Not valid for M2PA associations)

CONNECTING

ESTABLISHED—Valid only for M2PA associations

Output

```
rept-stat-assoc
```

```
rlghncxa03w 04-02-04 12:57:21 EST EAGLE 31.3.0
ASSOCIATION      PST          SST
a1               IS-NR       ASP-ACTIVE
a2               IS-ANR      ASP-ACTIVE
a3               OOS-MT-DSBLD ----
a4               OOS-MT      Connecting
a5               OOS-MT      ASP-DOWN
a6               OOS-MT      ASP-UP
Command Completed.
```

```
;
```

rept stat assoc

```

rlghncxa03w 05-02-04 12:57:21 EST EAGLE 34.0.0
ASSOCIATION      PST      SST
a1                OOS-MT-DSBLD  ----
a2                OOS-MT      CONNECTING
a3                IS-NR      ESTABLISHED
a4                IS-ANR      ESTABLISHED

```

Command Completed.

;

rept-stat-card**Report Status Card**

Use this command to display the card status and maintenance activity states. The output includes card location, the GPL version being used by the card, device type, device primary state, device secondary state, and device associated state.

Keyword: rept-stat-card

Related Commands: dlt-card, ent-card, init-card, rmv-card, rst-card, rtrv-card

Command Class: System Maintenance

Parameters

:appl= (optional)

Application. Report status on cards running the specified application.

Range: atmansi, atmitu, ccs7itu, ebdablm, ebdadcm, emdc, eroute, gls, ipgwi, iplim, iplimi, ips, mcp, sccp, ss7ansi, ss7gx25, ss7ipgw, stplan, vsccp, vxwslan

atmansi—The application is used by the LIM cards to support the ATM high-speed signaling link feature.

atmitu—The application is used by the E1 ATM cards to support the E1 ATM high-speed signaling link feature.

ccs7itu—This application is used by the LIM cards, the E1/T1 MIM card, and the HC-MIM card for ITU-TSS MTP functionality.

ebdablm—This application is used by the TSM card for enhanced bulk download.

ebdadcm—This application is used by the DCM card to transmit the LSMS LNP database to the EAGLE 5 SAS at high speed over an ethernet connection for enhanced bulk download.

emdc—This application is used by the DCM card for CMIP/OSI measurement collection interface as defined by Telcordia GR-376.

eroute—This EAGLE Router application is used by the STC card for the EAGLE Support for application Sentinel feature.

gls—This application is used by the TSM cards for downloading gateway screening to LIM cards.

ipgwi—This application is used by the DCM card for TCP/IP point-to-point connectivity for ITU point codes. The system allows a maximum of 2 cards to be assigned the **ipgwi** application.

iplim—This application is used by the DCM card for TCP/IP point-to-point connectivity for ANSI point codes. The system allows a maximum of 41 cards to be assigned the **iplim** or **iplimi** application if a maximum of 700 links are assigned in the system. The system allows a maximum of 100 cards to be

assigned the **iplim** or **iplimi** application if between 701 and 1500 links are assigned in the system.

iplimi—This application is used by the DCM card for TCP/IP point-to-point connectivity for ITU point codes. The system allows a maximum of 41 cards to be assigned the **iplimi** or **iplim** application if a maximum of 700 links are assigned in the system. The system allows a maximum of 100 cards to be assigned the **iplim** or **iplimi** application if between 701 and 1500 links are assigned in the system.

ips—This application is used by the IPSM card for the IP User Interface feature.

mcp—This application is used by the MCPM card for the Measurements Platform application.

sccp—This application is used by the TSM cards for the global title translation application.

ss7ansi—This application is used by the LIM cards, the E1/T1 MIM card, and the HC-MIM card for the MTP functionality.

The MPL or MPL-T (multi-port LIM) card is provisioned with the **ss7ansi** application to allow the card to replace a two-port LIM without having to reprovision the LIM in the database. Both types of LIMs perform the same functions. Although the MPLs are provisioned with the **ss7ansi** application, the MPLs run the **ss7ml** GPL. The **ss7ml** GPL allows the MPL cards to support 8 signaling links. The MPL cards support the DS0 interface only.

The E1/T1 MIM card is provisioned with the **ss7ansi** application. The card can replace a two-port E1 card without having to reprovision the E1 card in the database, and can function as a T1 card. Both types of E1 cards perform the same functions. Although the E1/T1 MIM card is provisioned with the **ss7ansi** application, the E1/T1 MIM card runs the **ss7ml** GPL. The **ss7ml** GPL allows the E1/T1 MIM card to support eight signaling links.

The HC-MIM card is provisioned with the **ss7ansi** application. The card can function as an E1 card or a T1 card. The HC-MIM card supports up to 64 signaling links.

ss7gx25—This application is used by the LIM cards to support X.25 functionality.

ss7ipgw—The application software for TCP/IP point-to-multipoint connectivity. The system allows a maximum of 2 cards to be assigned the **ss7ipgw** application.

stplan—This application is used by the ACM card to support the STPLAN application.

vsccp—This application is used by the DSM card to support the G-Flex, G-Port, INP, and LNP ELAP Configuration features. If the G-Flex, G-Port, INP, or LNP ELAP Configuration feature is not turned on, and a DSM card is present, the VSCCP GPL processes normal GTT traffic.

vxwslan—This application is used by the DCM card to support the STPLAN application.

:links= (optional)

Filter specification. Report the maximum number of links, only equipped links, or only unequipped links on the card in the specified card location (**loc**).

Range: **all, equip, unequip**

all—Reports the maximum number of links available on the card in the specified **loc**

equip—Reports only links that are equipped

unequip—Reports only links that are unequipped

Default: **equip**

:loc= (optional)

Card address. The card location as stenciled on the shelf of the system.

Range: **1101-1117, 1201-1218, 1301-1318, 2101-2118, 2201-2218, 2301-2318, 3101-3118, 3201-3218, 3301-3318, 4101-4118, 4201-4218, 4301-4318, 5101-5118, 5201-5218, 5301-5318, 6101-6118**

Default: A status of all cards is displayed.

:mode= (optional)

Mode. The type of display.

Range: **full**

Default: A summary report is displayed.

:stat= (optional)

Primary state filter. This parameter cannot be used with the **loc** or **mode** parameters. This filter allows printing of cards in a specified state (all in-service cards, for example).

Range: **all, alminh, anr, dsbld, mt, nr**

all—All of the primary states

alminh—Alarms inhibited

anr—In service abnormal (IS-ANR)

dsbld—Out of service maintenance disabled (OOS-MT-DSBLD)

mt—Out of service maintenance (OOS-MT)

nr—In service normal (IS-NR)

Default: **all**

Example

```
rept-stat-card
```

```
rept-stat-card:loc=1201
```

```
rept-stat-card:loc=1106:mode=full
```

```
rept-stat-card:loc=1201:mode=full
```

```
rept-stat-card:stat=alminh
```

```
rept-stat-card:loc=1109:mode=full
```

```
rept-stat-card:appl=ss7ansi
```

```
rept-stat-card:loc=1205:links=equip:mode=full
```

Dependencies

No other command can be in progress when this command is entered.

The **mode** parameter can be specified only when the **loc** parameter is specified.

Only one of the **loc** parameter, the **stat** parameter, and the **appl** parameter can be specified in the command.

The shelf and card must be equipped.

Notes

ATM, SS7 LIM, and X.25 cards show TVG results for SNM (signaling network management), SCCP and, SLAN traffic. SCCP cards show only SNM traffic statistics for TVG.

This command can be canceled using the **F9** function key or the **canc-cmd** command. See **canc-cmd** for more information.

The **mode=full** parameter gives more information than the summary report.

In the output, the SCCP service card field shows which TSM is providing the specified card with GTT service.

The group ticket voucher (TVG) status for low-speed signaling links, ATM high-speed signaling links, and TSMs is displayed when the **mode=full** and **loc** parameters are specified. The status displayed is for the previous 5 minutes and the previous 24 hours.

A plus (+) symbol in the output indicates that the flash GPL (**bphcap**, **bphcapt**, **bpmpl**, **bpmp1t**, or the **bpdcn**) currently being run has not yet been activated on the card.

E1 alarms are displayed in the alarm status field. When **mode=full** is specified, separate fields display status information from the UAM for each E1 interface on the card. For each E1 interface, the display shows the highest priority E1 failure that exists on that E1 card. When no E1 errors exist, the clearing E1 UAM text is displayed. When an E1 interface is not assigned to the card, no output is generated for that E1 position.

T1 alarms are displayed in the alarm status field. When **mode=full** is specified, separate fields display status information from the UAM for each T1 interface on the card. For each T1 interface, the display shows the highest priority T1 failure that exists on that T1 card. When no T1 errors exist, the clearing T1 UAM text is displayed. When an T1 interface is not assigned to the card, no output is generated for that T1 position.

If the **links** parameter is set to **all**, 64 links are displayed.

If the **links** parameter is set to **unequip** but the card has not been installed or loaded, 64 unequipped links are displayed.

If the **links** parameter is set to **unequip** and the card is or has been installed or loaded, the number of links displayed is equal to 64 minus the provisioned links.

If the **links** parameter is set to **equip**, only provisioned links are displayed.

Output

The clock status fields are reported when the **mode=full** report is selected. The clock status report includes a CLOCK A, CLOCK B, and CLOCK I status. The High Speed clock status report (displayed for ATM, E1 and T1 cards) includes HS CLOCK A, HS CLOCK B, and HS CLOCK I. The valid values for each clock status are "----", "Idle", "Active", and "Fault". The meanings of these values are:

---- (dashes)—Undefined, card must be OOS

Idle—Clock is available but is not being used by the card

Active—Clock is available and is being used by the card

Fault—Clock is unavailable

Idle and **Active** are shown when the CLK or HS CLK distribution to the card is good. The **Active** value does not denote that the card is actually using the clock source for link alignment. Use the **rtrv-slk rtrv-e1**, and **rtrv-t1** commands to determine what clock source each card is using for link alignment.

rept-stat-card

```
rlghncxa03w 05-01-04 12:57:21 EST EAGLE5 33.0.0
CARD VERSION TYPE APPL PST SST AST
1101 125-020-000 TSM GLS IS-NR Active -----
1102 125-020-000 TSM SCCP IS-NR Active -----
1103 125-020-000 DSM VSCCP IS-NR Active -----
1105 125-020-000 DSM VSCCP IS-NR Active -----
1107 125-020-000 STC EROUTE IS-NR Active -----
1109 125-020-000 HMUX BPHMUX IS-NR Active -----
1110 125-020-000 HMUX BPHMUX IS-NR Active -----
1111 125-020-000 IPSM IPS IS-NR Active -----
1113 070-019-002 GPSM EOAM IS-NR Standby -----
1114 ----- TDM IS-NR Active -----
1115 070-019-002 GPSM EOAM IS-NR Active -----
1116 ----- TDM IS-NR Active -----
1117 ----- MDAL IS-NR Active -----
1201 125-020-000 LIME1 SS7ANSI IS-NR Active -----
1202 ----- LIMCH SS7ANSI OOS-MT-DSBLD Manual -----
1203 125-020-000 LIMCH SS7ANSI IS-NR Active -----
1209 125-020-000 HMUX BPHMUX IS-NR Active -----
1210 125-020-000 HMUX BPHMUX IS-NR Active -----
1301 048-019-022 LIME1 SS7ANSI IS-NR Active -----
1303 125-022-000 LIME1 SS7ANSI IS-NR Active M BIP ERR
1305 125-022-000 LIME1 CCS7ITU IS-NR Active M BIP ERR
1309 125-017-000 HIPR HIPR IS-NR Active -----
1310 125-017-000 HIPR HIPR IS-NR Active -----
1311 125-020-000 STC EROUTE IS-NR Active -----
Command Completed.
```

;

rept-stat-card:loc=1113:mode=full

```
rlghncxa03w 05-07-27 16:43:42 EST EAGLE 30.0.0
CARD VERSION TYPE APPL PST SST AST
1113 023-102-000 GPSM EOAM IS-NR Active -----
ALARM STATUS = No Alarms.
BPDCM GPL version = 023-001-000
IMT BUS A = Conn
IMT BUS B = Conn
CLOCK A = Active
CLOCK B = Idle
CLOCK I = Idle
MBD BIP STATUS = valid
DB STATUS = valid
DBD MEMORY SIZE = 256M
TROUBLE TEXT VER. = Rev 1.6
Command Completed.
```

;

rept-stat-card:loc=1201

```

rlghncxa03w 05-07-04 15:10:19 EST EAGLE 30.0.0
CARD  VERSION      TYPE      APPL      PST          SST          AST
1201  101-006-000  LIMDS0   SS7ANSI   IS-NR        Active       -----
  ALARM STATUS      = No Alarms.
  IMT  VERSION      = 101-006-000
  PROM VERSION      = 023-002-000
  IMT BUS A         = Conn
  IMT BUS B         = Conn
  SLK A  PST        = OOS-MT          LS=ls1201    CLLI=-----
  SLK B  PST        = OOS-MT          LS=ls1201    CLLI=-----
  PORT A Connection = CONN
  PORT B Connection = CONN
Command Completed
;

```

rept-stat-card:stat=alminh

```

rlghncxa03w 04-02-04 12:57:21 EST EAGLE 31.6.0
CARD  VERSION      TYPE      APPL      PST          SST          AST
1211  023-001-000  LIMATM  ATMANSI   IS-NR        Active       ALMINH
1212  023-001-000  TSM     SCCP      IS-NR        Active       ALMINH
Command Completed.
;

```

The following example shows the high-speed clock status that is displayed for ATMANSI cards.

rept-stat-card:loc=1106:mode=full

```

rlghncxa03w 04-02-27 16:43:42 EST EAGLE 31.3.0
CARD  VERSION      TYPE      APPL      PST          SST          AST
1106  023-101-000  LIMATM  ATMANSI   IS-NR        Active       -----
  ALARM STATUS      = No Alarms.
  IMT  VERSION      = 023-001-000
  PROM VERSION      = 023-001-000
  IMT BUS A         = Conn
  IMT BUS B         = Conn
  CLOCK A          = Active
  CLOCK B          = Idle
  CLOCK I          = Idle
  HS CLOCK A       = Active
  HS CLOCK B       = Idle
  HS CLOCK I       = Idle
  MBD BIP STATUS   = valid
  DB STATUS        = valid
  DBD MEMORY SIZE  = 256M
  SCCP % OCCUP     = 0%
  SNM TVG RESULT   = 24 hr: -----, 5 min: -----
Command Completed.
;

```

rept-stat-card:loc=1201

```
rlghncxa03w 04-02-27 16:43:42 EST EAGLE 31.3.0
CARD  VERSION      TYPE    APPL      PST          SST          AST
1201  25-1-0          DCM     EMDC      IS-NR        Idle         -----
ALARM STATUS      = ** 0084 DCM A IP CONNECTION UNAVAILABLE
IMT VERSION        = 025-000-000
PROM VERSION       = 025-000-000
IMT BUS A          = Conn
IMT BUS B          = Conn
DCM A IP CONNECTION      OOS-MT        Unavail      -----
DCM-DCM IP CONNECTION   IS-NR         Avail        -----
Command Completed.
;
```

The following example shows the socket status, which appears in output for all card types only when the EAGLE Support for Integrated Sentinel feature is turned on.

rept-stat-card:loc=1101

```
rlghncxa03w 02-02-04 12:57:21 EST EAGLE 30.0.0
CARD  VERSION      TYPE    APPL      PST          SST          AST
1101  114-003-000     LIMATM  ATMANSI   IS-NR        Active       -----
ALARM STATUS      = No Alarms
BPHCAP GPL version = 002-109-010
IMT BUS A          = Conn
IMT BUS B          = Conn
SLK A  PST          = IS-NR          LS=lsa1101    CLLI=-----
SOCKET A = INACTIVE
Command Completed.
;
```

In the following example, EMAP-related status information is indicated as “----” when the direct IP link between DCM and EMAP is unavailable.

rept-stat-card:loc=1201:mode=full

```
rlghncxa03w 04-02-27 16:43:42 EST EAGLE 31.3.0
CARD  VERSION      TYPE    APPL      PST          SST          AST
1201  25-1-0          DCM     EMDC      IS-NR        Idle         -----
ALARM STATUS      = ** 0084 DCM A IP CONNECTION UNAVAILABLE
IMT VERSION        = 025-000-000
PROM VERSION       = 025-000-000
IMT BUS A          = Conn
IMT BUS B          = Conn
CLOCK A           = Idle
CLOCK B           = Active
CLOCK I           = Idle
MBD BIP STATUS    = valid
DCM A IP CONNECTION      OOS-MT        Unavail      -----
EMAP A IP CONNECTION   ----         ----         -----
EMAP A NDC AGENT      ----         ----         -----
EMAP A NDC Q.3 ASSOCIATION  ----         ----         -----
DCM-DCM IP CONNECTION   IS-NR         Avail        -----
Command Completed.
;
```

The following example shows the level of completion (as a percentage in the AST column) for a card that is performing a warm restart and is currently data loading. The percentage indicates the percentage of tables that have been downloaded for GPLs that support a persistent LNP database (**sccp**, **ebdablm**).

rept-stat-card:loc=1101

```
rlghncxa03w 04-02-18 16:46:07 EDT EAGLE 31.6.0
CARD  VERSION      TYPE      APPL      PST      SST      AST
1101  -----      TSM      SCCP      IS-ANR   Standby  96%
  ALARM STATUS      = No Alarms.
  IMT  VERSION      = 026-013-000
  PROM VERSION      = 022-005-000
  IMT BUS A         = Conn
  IMT BUS B         = Conn
  SCCP % OCCUP      = 0%
Command Completed.
;
```

The following example shows the output where the card is a multi-port LIM (location 1203). The APPL column, which displays the GPL running on the card, enables you to differentiate between the two-port LIMDS0 and the multi-port LIM. A multi-port LIM always displays SS7ML in the APPL column.

rept-stat-card:loc=1203:mode=full

```
rlghncxa03w 05-07-04 15:10:19 EST EAGLE 30.0.0
CARD  VERSION      TYPE      APPL      PST      SST      AST
1203  104-001-000    LIMDS0   SS7ML     IS-NR     Active   -----
  ALARM STATUS      = * 0022 Clock B for card failed
  IMT  VERSION      = 104-001-000
  PROM VERSION      = 023-001-000
  IMT BUS A         = Conn
  IMT BUS B         = Conn
  CLOCK A           = Active
  CLOCK B           = Fault
  CLOCK I           = Idle
  MBD BIP STATUS    = valid
  DB STATUS         = valid
  DBD MEMORY SIZE   = 0M
  SLK A  PST        = IS-NR      LS=lsnssp2   CLLI=-----
  SLK A1 PST        = IS-NR      LS=lsnstpi   CLLI=-----
  SLK A2 PST        = IS-NR      LS=-----   CLLI=-----
  SLK B  PST        = IS-NR      LS=lsnstpi   CLLI=-----
  SLK B3 PST        = IS-NR      LS=lsnstpi   CLLI=-----
  SCCP TVG RESULT   = 24 hr: -----, 5 min: -----
Command Completed.
;
```

The following examples include output for an E1 card and a Channel card (card types **lime1** and **limch**).

rept-stat-card

```
rlghncxa03w 05-07-04 15:10:19 EST EAGLE 31.6.0
CARD VERSION TYPE APPL PST SST AST
1113 104-002-000 GPSPM EOAM IS-NR Active -----
1114 ----- TDM ----- IS-NR Active -----
1115 ----- GPSPM EOAM OOS-MT Isolated -----
1116 ----- TDM ----- OOT-MT Isolated -----
1201 104-002-000 LIMV35 CCS7ITU IS-NR Active -----
1202 104-001-000 LIME1 CCS7ITU IS-NR Active -----
1203 104-001-000 LIMCH CCS7ITU IS-NR Active -----
1212 104-001-000 TSM SCCP IS-NR Active -----
Command Completed.
;
```

rept-stat-card:loc=1203:mode=full

```
rlghncxa03w 05-07-04 15:10:19 EST EAGLE 30.0.0
CARD VERSION TYPE APPL PST SST AST
1203 104-001-000 LIMCH CCS7ITU IS-NR Active -----
ALARM STATUS = * 0022 Clock B for card failed
IMT VERSION = 104-001-000
PROM VERSION = 023-001-000
IMT BUS A = Conn
IMT BUS B = Conn
CLOCK A = Active
CLOCK B = Fault
CLOCK I = Idle
MBD BIP STATUS = valid
DB STATUS = valid
DBD MEMORY SIZE = 0M
SLK A PST = IS-NR LS=lsnsspn2 CLLI=-----
SLK B PST = IS-NR LS=lsnstpi CLLI=-----
SNM TVG RESULT = 24 hr: -----, 5 min: -----
Command Completed.
;
```

rept-stat-card:loc=1203:mode=full

```
rlghncxa03w 05-07-04 15:10:19 EST EAGLE 30.0.0
CARD VERSION TYPE APPL PST SST AST
1203 025-001-000 LIME1 CCS7ITU IS-NR Active -----
ALARM STATUS = REPT-E1F:FAC-E1 Port 2 AIS detected
IMT VERSION = 025-001-000
PROM VERSION = 023-001-000
IMT BUS A = Conn
IMT BUS B = Conn
CLOCK A = Active
CLOCK B = Fault
CLOCK I = Idle
MBD BIP STATUS = valid
DB STATUS = valid
DBD MEMORY SIZE = 0M
SLK A PST = IS-NR LS=lsnsspn2 CLLI=-----
SLK B PST = IS-NR LS=lsnstpi CLLI=-----
SNM TVG RESULT = 24 hr: -----, 5 min: -----
E1 PORT #1 = RCVRY-E1F: E1 Port 1 available
E1 PORT #2 = REPT-E1F:FAC-E1 Port 2 AIS detected
Command Completed.
;
```

The following examples include HC-MIM cards (TYPE is LIME1, APPL is the SS7HC GPL) and HIPR cards:

rept-stat-card

```
rlghncxa03w 05-02-04 15:10:19 EST EAGLE5 33.0.0
CARD  VERSION      TYPE      APPL      PST      SST      AST
1109  125-016-000    HMUX      BPHMUX    IS-NR    Active   -----
1110  125-016-000    HMUX      BPHMUX    IS-NR    Active   -----
1113  125-020-000    GPSM      EOAM      IS-NR    Standby  -----
1114  -----         TDM              IS-NR    Active   -----
1115  125-020-000    GPSM      EOAM      IS-NR    Active   -----
1116  -----         TDM              IS-NR    Active   -----
1117  -----         MDAL              IS-NR    Active   -----
1209  125-016-000    HMUX      BPHMUX    IS-NR    Active   -----
1210  125-016-000    HMUX      BPHMUX    IS-NR    Active   -----
1301  125-020-000    LIME1     SS7ANSI   IS-NR    Active   -----
1303  125-020-000    LIME1     CCS7ITU   IS-NR    Active   -----
1305  125-020-000    LIME1     SS7ANSI   IS-NR    Active   -----
1307  125-020-000    LIME1     CCS7ITU   IS-NR    Active   -----
1309  125-016-000    HIPR      HIPR      IS-NR    Active   -----
1310  023-018-006    HIPR      HIPR      IS-NR    Active   -----
```

;

rept-stat-card:loc=1301

```
rlghncxa03w 05-02-04 15:10:19 EST EAGLE5 33.0.0
CARD  VERSION      TYPE      APPL      PST      SST      AST
1301  125-020-000    LIME1     SS7ANSI   IS-NR    Active   -----
ALARM STATUS          = No Alarms.
IMTPCI  GPL version = 125-020-000
BLCPLD  GPL version = 125-020-000
BLDIAG  GPL version = 125-020-000
BLBIOS  GPL version = 125-020-000
BLVXW   GPL version = 125-020-000
PLDE1T1 GPL version = 125-020-000
PLDPMC1 GPL version = 125-020-000
IMT BUS A          = Conn
IMT BUS B          = Conn
SIGNALING LINK STATUS
      SLK  PST          LS          CLLI
      A   IS-NR        lsa1301    -----
      B   IS-NR        lsa1301    -----
Command Completed.
```

;

rept-stat-card:appl=ccs7itu

```
rlghncxa03w 05-02-04 15:10:19 EST EAGLE5 33.0.0
CARD  VERSION      TYPE      APPL      PST      SST      AST
1201  118-020-000    LIM0CU    CCS7ITU   IS-NR    Active   -----
1202  118-020-000    LIMDS0    CCS7ITU   IS-NR    Active   M BIP ERR
1205  118-020-000    LIME1     CCS7ITU   IS-NR    Active   M BIP ERR
```

Command Completed.

;

rept-stat-card:loc=1205:links=all

```
rlghncxa03w 05-02-04 15:10:19 EST EAGLE5 33.0.0
CARD VERSION TYPE APPL PST SST AST
1205 060-002-004 LIME1 SS7ANSI IS-NR Active -----
ALARM STATUS = No Alarms.
BPMLT GPL version = 002-103-004
IMT BUS A = Conn
IMT BUS B = Conn
SIGNALING LINK STATUS
SLK PST LS CLLI E5IS
A OOS-MT ls111 ----- INACTIVE
B OOS-MA ----- INACTIVE
A1 OOS-MA ----- INACTIVE
B1 OOS-MA ----- INACTIVE
A2 OOS-MA ----- INACTIVE
B2 OOS-MA ----- INACTIVE
A3 OOS-MA ----- INACTIVE
B3 OOS-MA ----- INACTIVE
```

Command Completed.

;

rept-stat-card:loc=1205:links= equip

```
rlghncxa03w 05-02-04 15:10:19 EST EAGLE5 33.0.0
CARD VERSION TYPE APPL PST SST AST
1205 060-002-004 LIME1 SS7ML IS-NR Active -----
ALARM STATUS = No Alarms.
BPMLT GPL version = 002-103-004
IMT BUS A = Conn
IMT BUS B = Conn
SIGNALING LINK STATUS
SLK PST LS CLLI E5IS
A OOS-MT ls111 ----- INACTIVE
```

Command Completed.

;

rept-stat-card:loc=1205:links=unequip

```
rlghncxa03w 05-02-04 15:10:19 EST EAGLE5 33.0.0
CARD VERSION TYPE APPL PST SST AST
1205 060-002-004 LIME1 SS7ANSI IS-NR Active -----
ALARM STATUS = No Alarms.
BPMLT GPL version = 002-103-004
IMT BUS A = Conn
IMT BUS B = Conn
SIGNALING LINK STATUS
SLK PST LS CLLI E5IS
B OOS-MA ----- INACTIVE
A1 OOS-MA ----- INACTIVE
B1 OOS-MA ----- INACTIVE
A2 OOS-MA ----- INACTIVE
B2 OOS-MA ----- INACTIVE
A3 OOS-MA ----- INACTIVE
B3 OOS-MA ----- INACTIVE
```

Command Completed.

;

rept-stat-card:loc=1205:mode=full

```

rlghncxa03w 05-02-04 15:10:19 EST EAGLE5 33.0.0
CARD  VERSION      TYPE      APPL      PST      SST      AST
1205  060-002-004  LIME1     SS7ANSI   IS-NR    Active   -----
ALARM STATUS      = No Alarms.
BPMLPT  GPL version = 002-103-004
IMT BUS A         = Conn
IMT BUS B         = Conn
CLOCK A          = Idle
CLOCK B          = Active
CLOCK I          = Idle
HS CLOCK A       = Fault
HS CLOCK B       = Fault
HS CLOCK I       = Idle
MBD BIP STATUS   = valid
DB STATUS        = valid
DBD MEMORY SIZE  = 0M
HW VERIFICATION CODE = ----
SIGNALING LINK STATUS
  SLK  PST          LS          CLLI          E5IS
  A    OOS-MT      ls111      -----      INACTIVE
TVG STATUS
SNM    TVG RESULT  = 24 hr: -----, 5 min: -----
SLAN   TVG RESULT  = 24 hr: -----, 5 min: -----
SCCP   TVG RESULT  = 24 hr: -----, 5 min: -----
EROUTE TVG RESULT  = 24 hr: -----, 5 min: -----
INM    TVG RESULT  = 24 hr: -----, 5 min: -----
Command Completed.
;

```

The following example shows the **mode=full** output where the card is an HMUX in location 1109:

rept-stat-card:loc=1109:mode=full

```

rlghncxa03w 05-07-04 15:10:19 EST EAGLE 30.0.0
CARD  VERSION      TYPE      APPL      PST      SST      AST
1109  239-009-010  HMUX     BPHMUX   IS-NR    Active   -----
ALARM STATUS      = No Alarms
TRIAL VERSION     = 101-009-000
FPGA VERSION      = 022-005
TROUBLE TEXT VER. = Rev 101.2
Command Completed.
;

```

rept-stat-card:loc=1205:mode=full:links=all

```

rlghncxa03w 05-02-04 15:10:19 EST EAGLE5 33.0.0
CARD  VERSION      TYPE      APPL      PST      SST      AST
1205  060-002-004  LIME1    SS7ANSI   IS-NR    Active   -----
ALARM STATUS      = No Alarms.
BPMLPT  GPL version = 002-103-004
IMT BUS A          = Conn
IMT BUS B          = Conn
CLOCK A           = Idle
CLOCK B           = Active
CLOCK I           = Idle
HS CLOCK A        = Fault
HS CLOCK B        = Fault
HS CLOCK I        = Idle
MBD BIP STATUS    = valid
DB STATUS         = valid
DBD MEMORY SIZE   = 0M
HW VERIFICATION CODE = ----
SIGNALING LINK STATUS
  SLK  PST          LS          CLLI          E5IS
  A    OOS-MT       ls111      -----      INACTIVE
  B    OOS-MA       -----      -----      INACTIVE
  A1   OOS-MA       -----      -----      INACTIVE
  B1   OOS-MA       -----      -----      INACTIVE
  A2   OOS-MA       -----      -----      INACTIVE
  B2   OOS-MA       -----      -----      INACTIVE
  A3   OOS-MA       -----      -----      INACTIVE
  B3   OOS-MA       -----      -----      INACTIVE
TVG STATUS
SNM    TVG RESULT  = 24 hr: -----, 5 min: -----
SLAN   TVG RESULT  = 24 hr: -----, 5 min: -----
SCCP   TVG RESULT  = 24 hr: -----, 5 min: -----
EROUTE TVG RESULT  = 24 hr: -----, 5 min: -----
INM    TVG RESULT  = 24 hr: -----, 5 min: -----
Command Completed.
;

```

The following examples include output for E1/T1 MIM cards used as E1, T1, and Channel cards (card types **lime1**, **limt1**, and **limch**).

rept-stat-card

```

rlghncxa03w 05-07-04 15:10:19 EST EAGLE 31.6.0
CARD  VERSION      TYPE      APPL      PST      SST      AST
1109  023-102-000  HMUX     BPHMUX   IS-NR    Active   -----
1110  023-102-000  HMUX     BPHMUX   IS-NR    Active   -----
1113  104-002-000  GPSM     EOAM     IS-NR    Active   -----
1114  -----      TDM     -----  IS-NR    Active   -----
1115  -----      GPSM     EOAM     OOS-MT   Isolated -----
1116  -----      TDM     -----  OOT-MT   Isolated -----
1117  -----      MDAL     -----  IS-NR    Active   -----
1201  104-002-000  LIMV35   CCS7ITU  IS-NR    Active   -----
1202  104-001-000  LIMT1    CCS7ITU  IS-NR    Active   -----
1203  104-001-000  LIMCH    CCS7ITU  IS-NR    Active   -----
1204  104-001-000  LIME1    SS7ANSI  IS-NR    Active   -----
1209  023-102-000  HMUX     BPHMUX   IS-NR    Active   -----
1210  023-102-000  HMUX     BPHMUX   IS-NR    Active   -----
1212  104-001-000  TSM      SCCP     IS-NR    Active   -----
Command Completed.
;

```

rept-stat-card:loc=1204:mode=full

```

rlghncxa03w 05-07-04 15:10:19 EST EAGLE 30.0.0
CARD VERSION      TYPE      APPL      PST      SST      AST
1204 025-001-000 LIME1    SS7ANSI  IS-NR      Active   -----
  ALARM STATUS    = REPT-E1F:FAC-E1 Port 2 AIS detected
  IMT VERSION     = 025-001-000
  PROM VERSION    = 023-001-000
  IMT BUS A      = Conn
  IMT BUS B      = Conn
  CLOCK A        = Active
  CLOCK B        = Fault
  CLOCK I        = Idle
  HS CLOCK A     = Active
  HS CLOCK B     = Idle
  HS CLOCK I     = Idle
  MBD BIP STATUS = valid
  DB STATUS      = valid
  DBD MEMORY SIZE = 0M
  SLK A  PST     = IS-NR          LS=lsne1ln1  CLLI=-----
  SLK A1 PST     = IS-NR          LS=lsne1ln2  CLLI=-----
  SLK A2 PST     = IS-NR          LS=lsne1ln3  CLLI=-----
  SLK A3 PST     = IS-NR          LS=lsne1ln4  CLLI=-----
  SLK B  PST     = IS-NR          LS=lsne1ln5  CLLI=-----
  SLK B1 PST     = IS-NR          LS=lsne1ln6  CLLI=-----
  SLK B2 PST     = IS-NR          LS=lsne1ln7  CLLI=-----
  SLK B3 PST     = IS-NR          LS=lsne1ln8  CLLI=-----
  SNM TVG RESULT = 24 hr: -----, 5 min: -----
  E1 PORT #1     = RCVRY-E1F: E1 Port 1 available
  E1 PORT #2     = REPT-E1F:FAC-E1 Port 2 AIS detected
Command Completed
;

```

rept-stat-card:loc=1202:mode=full

```

rlghncxa03w 05-07-04 15:10:19 EST EAGLE 30.0.0
CARD VERSION      TYPE      APPL      PST      SST      AST
1202 025-001-000 LIMT1    CCS7ITU  IS-NR      Active   -----
  ALARM STATUS    = REPT-T1F:FAC-T1 Port 2 AIS detected
  IMT VERSION     = 025-001-000
  PROM VERSION    = 023-001-000
  IMT BUS A      = Conn
  IMT BUS B      = Conn
  CLOCK A        = Active
  CLOCK B        = Fault
  CLOCK I        = Idle
  HS CLOCK A     = Active
  HS CLOCK B     = Idle
  HS CLOCK I     = Idle
  MBD BIP STATUS = valid
  DB STATUS      = valid
  DBD MEMORY SIZE = 0M
  SLK A  PST     = IS-NR          LS=lsnssp2   CLLI=-----
  SLK A1 PST     = IS-NR          LS=lsnt1ln1  CLLI=-----
  SLK B  PST     = IS-NR          LS=lsnstpi   CLLI=-----
  SLK B3 PST     = IS-NR          LS=lsnstpi   CLLI=-----
  SNM TVG RESULT = 24 hr: -----, 5 min: -----
  T1 PORT #1     = RCVRY-T1F: T1 Port 1 available
  T1 PORT #2     = REPT-T1F:FAC-T1 Port 2 AIS detected
Command Completed
;

```

rept-stat-card:loc=1203:mode=full

```

rlghncxa03w 05-07-04 15:10:19 EST EAGLE 30.0.0
CARD VERSION      TYPE      APPL      PST          SST          AST
1203 025-001-000 LIMCH     CCS7ITU     IS-NR        Active       -----
  ALARM STATUS      = No Alarms.
  IMT VERSION        = 025-001-000
  PROM VERSION       = 023-001-000
  IMT BUS A          = Conn
  IMT BUS B          = Conn
  CLOCK A            = Active
  CLOCK B            = Fault
  CLOCK I            = Idle
  MBD BIP STATUS     = valid
  DB STATUS          = valid
  DBD MEMORY SIZE    = 0M
  SLK A PST          = IS-NR          LS=lsnssp2    CLLI=-----
  SLK A1 PST         = IS-NR          LS=lsnt1ln1   CLLI=-----
  SLK B PST          = IS-NR          LS=lsnstpi    CLLI=-----
  SLK B3 PST         = IS-NR          LS=lsnstpi    CLLI=-----
  SNM TVG RESULT     = 24 hr: -----, 5 min: -----
Command Completed
;

```

The following examples include output for the STC card used by the EAGLE Support for Integrated Sentinel feature.

rept-stat-card:loc=1107

```

rlghncxa03w 04-02-04 15:10:19 EST EAGLE 31.3.0
CARD VERSION      TYPE      APPL      PST          SST          AST
1107 100-015-000 STC        EROUTE     IS-NR        Active       -----
  ALARM STATUS      = No Alarms.
  BPDCM GPL version = 002-108-000
  IMT BUS A          = Conn
  IMT BUS B          = Conn
  CARDS DENIED EROUTE SERVICE: 1104
  EROUTE % OCCUP     = 0%
  NTP broadcast      = valid
Command Completed.
;

```

rept-stat-card:loc=1107:mode=full

```

rlghncxa03w 04-02-04 15:10:19 EST EAGLE 31.3.0
CARD VERSION      TYPE      APPL      PST          SST          AST
1107 100-015-000 STC        EROUTE     IS-NR        Active       -----
  ALARM STATUS      = No Alarms.
  BPDCM GPL version = 002-108-000
  IMT BUS A          = Conn
  IMT BUS B          = Conn
  CLOCK A            = Active
  CLOCK B            = Idle
  CLOCK I            = Idle
  MBD BIP STATUS     = valid
  DB STATUS          = valid
  DBD MEMORY SIZE    = 0M
  EROUTE % OCCUP     = 0%
  SOCKET A           = INACTIVE
Command Completed.
;

```

The following examples include output for the MCPM card used by the Measurements Platform feature.

rept-stat-card:loc=1105

```
rlghncxa03w 04-02-04 15:10:19 EST EAGLE 31.3.0
CARD VERSION TYPE APPL PST SST AST
1105 111-001-000 MCPM MCP IS-NR Idle -----
ALARM STATUS = ** 0084 MCP A IP CONNECTION UNAVAILABLE
IMT VERSION = 104-001-000
PROM VERSION = 023-000-000
IMT BUS A = Conn
IMT BUS B = Conn
MCP IP CONNECTION OOS-MT Unavail
Command Completed.
;
```

rept-stat-card:loc=1105:mode=full

```
rlghncxa03w 04-02-04 15:10:19 EST EAGLE 31.3.0
CARD VERSION TYPE APPL PST SST AST
1105 111-001-000 MCPM MCP IS-NR Active -----
ALARM STATUS = No Alarms
IMT VERSION = 104-001-000
PROM VERSION = 023-001-000
IMT BUS A = Conn
IMT BUS B = Conn
CLOCK A = Active
CLOCK B = Fault
CLOCK I = Idle
MBD BIP STATUS = valid
DB STATUS = valid
DBD MEMORY SIZE = 2048M
MCP IP CONNECTION IS-NR Available
Command Completed.
;
```

The following example shows output for the GPSM-II card that is running the EOAM application in card location 1113.

rept-stat-card:loc=1113:mode=full

```
rlghncxa03w 02-02-04 15:10:19 EST EAGLE 30.0.0
CARD VERSION TYPE APPL PST SST AST
1113 111-017-000 GPSM EOAM IS-NR Active -----
ALARM STATUS = No Alarms.
IMT VERSION = 111-001-000
PROM VERSION = 111-001-000
IMT BUS A = Conn
IMT BUS B = Conn
CLOCK A = Active
CLOCK B = Idle
CLOCK I = Idle
MBD BIP STATUS = valid
DB STATUS = valid
DBD MEMORY SIZE = 256M
TROUBLE TEXT VER. = Rev 1.6
Command Completed.
;
```

The following example shows output for a card running the **iplim** application:

rept-stat-card:loc=1213

```
rlghncxa03w 05-07-04 15:10:19 EST EAGLE 30.0.0
CARD VERSION TYPE APPL PST SST AST
1213 001-002-000 DCM IPLIM IS-NR Active -----
ALARM STATUS = No Alarms.
BPDCM GPL = 001-001-000+
IMT BUS A = Conn
IMT BUS B = Conn
SLK A PST = IS-NR LS=lsnsspn2 CLLI=-----
SNM TVG RESULT = 24 hr: -----, 5 min: -----
Command Completed.
;
```

The following examples include output for a card running the **ipgwi** application:

rept-stat-card

```
rlghncxa03w 05-07-04 15:10:19 EST EAGLE 30.0.0
CARD VERSION TYPE APPL PST SST AST
1109 023-102-000 HMUX BPHMUX IS-NR Active -----
1110 023-102-000 HMUX BPHMUX IS-NR Active -----
1113 003-001-000 GPSM EOAM IS-NR Active -----
1114 ----- TDM ----- IS-NR Active -----
1115 ----- GPSM EOAM OOS-MT Isolated -----
1116 ----- TDM ----- OOT-MT Isolated -----
1117 ----- MDAL ----- IS-NR Active -----
1201 003-001-000 LIMOCU CCS7ITU IS-NR Active -----
1202 003-001-000 LIMDS0 CCS7ITU IS-NR Active M BIP ERR
1203 003-001-000 LIMDS0 SS7ANSI IS-NR Active -----
1205 003-001-000 LIMDS0 CCS7ITU IS-NR Active M BIP ERR
1207 003-001-000 LIMATM ATMANSI IS-NR Active -----
1209 023-102-000 HMUX BPHMUX IS-NR Active -----
1210 023-102-000 HMUX BPHMUX IS-NR Active -----
1211 003-001-000 LIMATM ATMANSI IS-NR Active ALMINH
1212 003-001-000 TSM SCCP IS-NR Active ALMINH
1213 003-001-000 DCM IPLIM IS-NR Active -----
1215 003-001-000 DCM SS7IPGW IS-NR Active -----
1217 003-001-000 DCM IPLIMI IS-NR Active -----
1301 003-001-000 DCM IPGWI IS-NR Active -----
1309 023-102-000 HMUX BPHMUX IS-NR Active -----
1310 023-102-000 HMUX BPHMUX IS-NR Active -----
Command Completed.
;
```

rept-stat-card:loc=1301:mode=full

```
rlghncxa03w 05-07-04 15:10:19 EST EAGLE 30.0.0
CARD VERSION TYPE APPL PST SST AST
1301 003-001-000 DCM IPGWI IS-NR Active -----
ALARM STATUS = No Alarms.
BPDCM GPL = 003-001-000
IMT BUS A = Conn
IMT BUS B = Conn
CLOCK A = Active
CLOCK B = Idle
CLOCK I = idle
MBD BIP STATUS = valid
DB STATUS = valid
DBD MEMORY SIZE = 0M
```

```

SLK A PST           = IS-NR           LS=lsnssp2     CLLI=-----
SCCP TVG RESULT    = 24 hr: GDNHSI, 5 min: GDNHSI
SLAN TVG RESULT    = 24 hr: -D-H-I, 5 min: -D-H-I
SNM TVG RESULT     = 24 hr: GDNHSI, 5 min: -----
Command Completed.
;

```

The following examples include output for an E1 ATM card running the **atmitu** application:

rept-stat-card:loc=1201

```

tekelecstp 01-03-25 10:02:42 EST EAGLE 30.0.0
CARD  VERSION      TYPE      APPL      PST      SST      AST
1201  114-002-000  LIME1ATM  ATMITU    IS-NR    Active   -----
ALARM STATUS      = No Alarms.
IMT BUS A         = Conn
IMT BUS B         = Conn
Slk A PST         = IS-NR           LS=lsnssp2     CLLI=-----
Command Completed.
;

```

rept-stat-card:loc=1201

```

tekelecstp 01-03-25 10:02:42 EST EAGLE 30.0.0
CARD  VERSION      TYPE      APPL      PST      SST      AST
1201  114-003-000  LIME1ATM  ATMITU    IS-NR    Active   -----
ALARM STATUS      = No Alarms.
IMT BUS A         = Conn
IMT BUS B         = Conn
Slk A PST         = IS-NR           LS=lsnssp2     CLLI=-----
SENTINEL SOCKET A = INACTIVE
Command Completed.
;

```

The following example includes output for an IPSM card running the **ips** application:

rept-stat-card:loc=1105

```

tekelecstp 04-02-25 10:02:42 EST EAGLE 31.3.0
CARD  VERSION      TYPE      APPL      PST      SST      AST
1105  028-013-026  IPSM      IPS       IS-NR    Active   -----
ALARM STATUS      = No Alarms.
BPDCM GPL version = 002-123-012
IMT BUS A         = Conn
IMT BUS B         = Conn
Command Completed.
;

```

The following example shows a Hardware Verification Code for an auto-inhibited card. The HW VERIFICATION CODE field is shown only in the **mode=full** report. “-----” is shown in the HW VERIFICATION CODE field for cards with valid hardware detected. A numerical value is shown when invalid hardware is detected, and all such cards will be auto-inhibited. The numerical values are listed in Table 7-7 on page 7-88. The MDAL and HMUX cards do not display the field in **mode=full** reports on their locations.

rept-stat-card:loc=1108:mode=full

```
tekelecstp 02-09-30 09:41:08 EST EAGLE 30.0.0
CARD   VERSION      TYPE      APPL      PST          SST          AST
1108   118-021-000   DSM       VSCCP     OOS-MT-DSBLD MEA          -----
ALARM STATUS      = ** 441 Incorrect Motherboard - CPU
IMT   VERSION      = 118-021-000
PROM  VERSION      = 028-002-001
IMT BUS A         = Disc
IMT BUS B         = Conn
CLOCK A           = Idle
CLOCK B           = Active
CLOCK I           = Idle
MBD BIP STATUS    = valid
DB STATUS         = valid
DBD MEMORY SIZE   = 1024M
HW VERIFICATION CODE = 004
SCCP % OCCUP      = 0%
SNM   TVG RESULT  = 24 hr: -----, 5 min: -----
Command Completed.
```

Legend

CARD—The location of the card.

VERSION—The version number of the application loaded on the card. Dashes (- - - -) in the version column indicate one of the following conditions about the card:

- The card is configured but is not physically present in the system.
- The card does not run a GPL, such as TDM or MDAL cards.
- The card is configured but is not physically present in the system.
- The card is IS-ANR or is in the process of being loaded.

TYPE—The card type entered in the database. (The DCM and SSEDCCM cards show card type DCM).

APPL—The application loaded on this card.

PST—The primary state of the card. The possible values are described in section “Possible Values for PST/SST/AST” in Appendix A.

SST—The secondary state of the card. The possible values are described in “Possible Values for PST/SST/AST” in Appendix A.

AST—The associated state of the card. The possible values are described in “Possible Values for PST/SST/AST” in Appendix A.

The group ticket voucher status is displayed in these fields: SCCP TVG RESULT (for SCCP messages), SLAN TVG RESULT (for STPLAN messages), and SNM TVG RESULT (for SNM messages). Group ticket voucher status output is displayed as a series of these letters:

G—Service Granted. Indicates normal system behavior.

D—Service Denied. Indicates an overload, but the group ticket voucher hardware and software are working correctly.

N—No granter in the system. For GTT or STPLAN traffic, there can be no TSM-SCCP cards or ACMs in the system. If there are TSM SCCP cards or ACMs in the system, then a serious failure is indicated (hardware or software bug or hardware failure).

H—Hardware time-out. Indicates the hardware timed out waiting for a group ticket voucher packet to return. Group ticket voucher packets can be lost when a card is plugged in or booted. This is a serious condition if cards have not been connecting or disconnecting from the IMT.

S—Software time-out. No result was ever returned from hardware, indicating a probable hardware failure.

I—Invalid result from hardware.

The HW VERIFICATION CODE field is shown only in the **mode=full** report. “-----” is shown in the HW VERIFICATION CODE field for cards with valid hardware detected. One of the following numerical values is shown when invalid hardware is detected, and all such cards will be auto-inhibited.

Table 7-7. Auto-Inhibit Hardware Verification Codes

HW Verification Code	Card or Application Code	Description	Associated UAM Code
002*	VSCCP	VSCCP card equipped with non-DSM MPS feature is on	99
003*	VSCCP	VSCCP card equipped with non-DSM LNP and VGTT feature is on	99
004*	VSCCP	VSCCP card equipped with non-DSM XGTT 1,000,000 feature is on	99
005*	VSCCP	VSCCP card equipped w/non-DSM when EGMS enabled	99
050	VSCCP	VSCCP card equipped with no daughterboards	99
051	VSCCP	VSCCP card equipped with less than 4GB when LNP ported TNs key equal to or greater than 48 million is on	422
052	VSCCP	VSCCP card equipped with less than 3GB when LNP ported TNs key equal to or greater than 36 million is on	422
053	VSCCP	VSCCP card equipped with less than 2GB when LNP NPANXX 150,000 or LNP LRN 100,000 feature key is on	422

Table 7-7. Auto-Inhibit Hardware Verification Codes (Continued)

HW Verification Code	Card or Application Code	Description	Associated UAM Code
054	SCCP EBDA	SCCP or EBDA card with less than 2GB when LNP ported TNs key equal to 24 million is on	422
055	SCCP EBDA	SCCP or EBDA card DB memory insufficient for LNP ported TNs key equal to 4 million (Requires a minimum of 512 MB)	422
056	SCCP EBDA	SCCP or EBDA card DB memory insufficient for LNP ported TNs key equal to 6 million (Requires a minimum of 768 MB)	422
057	SCCP EBDA	SCCP or EBDA card DB memory insufficient for LNP ported TNs key equal to 8-12 million (Requires a minimum of 1024 MB)	422
058	SCCP	SCCP card equipped with less than 256K or greater than the MAX of extended memory	422
059	VSCCP	MPS database has been detected to exceed capacity of DSM extended memory (only for GPORT, GFLEX, INP, EIR features). UAMs 281, 283, and 185 are used for LNP and LNP ELAP Configuration features.	422
100	SS7IPGW IPGWI	DCM with IP connection on B port only when debug enabled	276
101	SS7IPGW IPGWI IPLIM IPLIMI	DCM only supports SLK/IP on ports A or B	276
102*	SS7IPGW IPGWI	Non-DCM detected in slot	276
103	SS7IPGW IPGWI IPLIM IPLIMI	DCM does not support more than 2 associations per card (IPLIMx) -or- DCM does not support more than 4 associations (IPGWx) -or- EDCM does not support more than 50 associations (IPGWx)	276
104	SS7IPGW IPGWI IPLIM IPLIMI	DCM does not support more than 2 sockets per card (IPLIMx) -or- EDCM with no associations cannot support more than 8 sockets (IPLIMx) -or- EDCM with at least 1 association cannot support more than 2 sockets (IPLIMx) -or- Card does not support more than 50 sockets (IPGWx)	276
110	SS7IPGW IPGWI	(SRKQ = DRKQ > 1000) not supported on DCM	276
119	LIME1	2-port E1 card provisioned with signaling link greater than B (A1-B3)	297

Table 7-7. Auto-Inhibit Hardware Verification Codes (Continued)

HW Verification Code	Card or Application Code	Description	Associated UAM Code
120	LIMDS0	2-port LIM card provisioned with signaling link greater than B (A1-B3)	297
121	LIME1	2 port LIM card does not support MIM with E1 port AMI encoding provisioned.	297
122	MIM	Card is not a MIM - provisioned as a T1 card or as a T1 channel card associated with T1 interface	99
123	MPL	MPL cannot run with port A or B provisioned for speeds not equal to 56K	297
124	MIM/HC-MIM	Card is not a MIM or HC-MIM and is provisioned as a T1 card.	99
125	MIM/MPL	MIM or MPL card with a signaling link greater than B3 provisioned.	297
126	LIME1	2-port E1 card with a signaling link provisioned on E1 port 2-7	297
127	MIM	MIM card with a signaling link provisioned on E1/T1 port 2-7	297
128	HC-MIM	Fan feature bit must be on for HC-MIM cards	43
129	HC-MIM	HC-MIM card does not support CAS framing.	99
130	LIME1/MIM	Card is not a LIME1 or MIM card and is provisioned as and E1 channel card.	297
131	HC-MIM	Card has channel bridging mode active, but is not running the HC-MIM GPL ss7hc .	297
132	MPL	Card is not a LIME1 or MIM and is provisioned as and E1 card.	99
133	LIME1, LIMDS0, MIM, MPL	Card cannot support unchannelized mode.	99
140	MCP	MCP card not running with D2G memory	422
141	IPS	IPSM card not running with D2G memory	422
150	ASM	Card is obsolete	47
160	MCP	The application must run on an EDSM card,	441

* It is possible that the card will continually boot in these cases, before the alarm is ever displayed.

rept-stat-cdl**Report Command Driven Loopback Status**

Use this command to generate a report of the signaling links currently in Command Driven Loopback (CDL) testing, including the amount of time the link has been in CDL testing.

Command Driven Loopback is the ability to locally drive a signaling link into a manual line loopback. The data received on the signaling link is echoed (transmitted) back. This is effectively the reverse of the **tst-slk:loopback=lxvr**, which loops the transmitted data back to the receive.

Keyword: rept-stat-cdl

Related Commands: act-cdl, dact-cdl

Command Class: Link Maintenance

Parameters

:loc= (optional)

The card location as stenciled on the shelf of the system.

Range: 1101-1108, 1111-1112, 1201-1208, 1211-1218, 1301-1308, 1311-1318, 2101-2108, 2111-2118, 2201-2208, 2211-2218, 2301-2308, 2311-2318, 3101-3108, 3111-3118, 3201-3208, 3211-3218, 3301-3308, 3311-3318, 4101-4108, 4111-4118, 4201-4208, 4211-4218, 4301-4308, 4311-4318, 5101-5108, 5111-5118, 5201-5208, 5211-5218, 5301-5308, 5311-5318, 6101-6108, 6111-6118

Default: All cards containing signaling links that are in CDL testing are displayed.

:loopback= (optional)

Loopback test type.

Range: line, payload

The **payload** value is valid only on LIM-ATM and E1-ATM cards.

Default: All loopback tests are displayed.

:port= or :link= (optional)

The SS7 signaling **link** that is being tested.

Range: a, b, a1-a31, b1-b31

Not all card types support all **link** parameter values.

See Table A-1 in Appendix A for valid **link** parameter range values for each type of card that can have assigned signaling link ports.

Default: All signaling links that are in CDL testing are displayed.

Example

```
rept-stat-cdl
```

```
rept-stat-cdl:loc=1201
```

```
rept-stat-cdl:loc=1203:link=a
```

```
rept-stat-cdl:loopback=payload
```

Dependencies

If the **link** parameter is specified, the **loc** parameter must be specified.

The card in the location specified in the **loc** parameter must be equipped.

The signaling link specified in the **link** parameter must be assigned.

This command is not available during upgrade.

Notes

This command can be canceled using the **F9** function key or the **canc-cmd** command. See **canc-cmd** for more information

Output

rept-stat-cdl

```
tekelecstp 03-11-27 01:29:06 EST EAGLE 31.3.0
SLK        CDL        CDL-TIME
1102,A1    LINE        00:04:01
1201,A     PAYLOAD     01:04:11
1203,A     LINE        00:22:21
1203,B     LINE        20:04:01
1208,A     LINE        01:05:22
1211,A     PAYLOAD     00:14:01
;
```

Legend

SLK—The card and assigned signaling link that is in CDL testing.

CDL—Command Driven Loopback test type (LINE or PAYLOAD).

CDL-TIME—The length of time that the signaling link has been in CDL testing. This value can be up to 99:59:59. The test can run longer than 100 hours, but this field will not record times longer than 100 hours.

rept-stat-cdt

Report Status Customer Defined Troubles

Use this command to display the customer-defined troubles. The Customer-Definable Alarms feature can be used to connect up to 10 external devices to the system for alarm reporting. These devices are defined in the system database as customer-defined troubles, and they are monitored so that any change in the state of these devices is reported as an unsolicited alarm message (UAM).

Keyword: **rept-stat-cdt**

Related Commands: **act-alm-trns, canc-alm-trns, dact-alm-trns, rept-stat-clk, rept-stat-trbl, rls-alm, rtrv-obit, rtrv-trbl**

Command Class: System Maintenance

Parameters

This command has no parameters.

Example

```
rept-stat-cdt
```

Dependencies

No other status command can be in progress when this command is entered.

Notes

These troubles are customer-defined and configured by the factory.

Output**rept-stat-cdt**

```
rlghncxa03w 04-01-07 20:20:43 EST EAGLE 31.3.0
ID                ALARM STATUS
 1   *C 0058   Critical Customer Trouble detected
 2   *C 0050   Critical Holdover Clock trouble detected
 3   *C 0058   Critical Customer Trouble detected
 4   *C 0058   Critical Customer Trouble detected
 5   I ** 0059   Major Customer Trouble detected
 6   ** 0052   Major Holdover Clock trouble detected
 7   ** 0059   Major Customer Trouble detected
 8   ** 0059   Major Customer Trouble detected
 9   I * 0060   Minor Customer Trouble detected
10   * 0054   Minor Holdover Clock trouble detected
11   * 0060   Minor Customer Trouble detected
12   * 0060   Minor Customer Trouble detected
13   * 0060   Minor Customer Trouble detected
14   I * 0060   Minor Customer Trouble detected
15   * 0060   Minor Customer Trouble detected
16   * 0060   Minor Customer Trouble detected
;
```

Legend

ID—The customer defined trouble ID number followed by the status of the customer-defined trouble.

ALARM STATUS—The status of the alarm for the specified device.

rept-stat-clk**Report Status Clock**

Use this command to display the clock status summary for cards in the system.

Keyword: `rept-stat-clk`

Related Commands: `rept-stat-card`, `rept-stat-imt`, `rept-stat-ls`, `rept-stat-dstn`, `rept-stat-sccp`, `rept-stat-slk`, `rept-stat-trbl`

Command Class: System Maintenance

Parameters

:mode= (optional)

Display mode. When **mode=full** is specified, the "Cards with bad clock source" section of the report is displayed

Range: `full`

Example

```
rept-stat-clk
```

Dependencies

No other **rept-stat-xxx** command can be in progress when this command is entered.

Notes

The clock status report includes a CLOCK A, CLOCK B, and CLOCK I status. The High Speed clock status report (displayed for ATM, E1-ATM, and E1/T1 MIM cards) includes HS CLOCK A, HS CLOCK B, and HS CLOCK I.

The Time Slot Counter Synchronization (TSC) clock is displayed only if the Time Slot Counter Synchronization (TSCSYNC) feature is turned on. See the **chg-feat** command.

HS clock sections are displayed only when at least 1 HS clock capable card is provisioned, or when the TDM type is TDM-GTI and the TSC Synchronization feature has been turned on. The HS clock sections of the report are the HS PRIMARY CLK, HS SECONDARY CLK, HS CLK TYPE, and HS CLK LINELEN fields at the top of the report; the HS SYSTEM CLOCK section; and the HS clock columns in the **mode=full** "Cards with bad clock source" section.

HS clock capable cards are those that can support a link provisioned to use HS Master Timing (including ATMANSI, ATMITU, and E1/T1 MIM cards). The clock status values are the same as those listed in the **rept-stat-card:mode=full:loc=xxx** report.

The "Cards with bad clock source" section is displayed when the **mode=full** report is specified. When HS clock A and B status is included in this section, cards that cannot be provisioned to use HS Master Timing display dashes for HS clock A and B status. The valid values for each clock status are:

-----Undefined, card must be OOS

Idle—Clock is available but is not being used by the card

Active—Clock is available and is being used by the card, but does not mean that the card is using the clock for link alignment. Use the **rtrv-slk rtrv-e1**, and **rtrv-t1** commands to determine what clock source each card is using for link alignment.

Fault—Clock is unavailable

Output

The following example shows output when **mode=full** is not specified, with no HS clock sections, and when the TSCSYNC feature is not on:

rept-stat-clk

```
rlghncxa03w 04-04-07 08:51:31 EST EAGLE 31.6.0
CARD LOC = 1114 (Active )          CARD LOC = 1116 (Isolated )
PRIMARY BITS = Active              PRIMARY BITS = -----
SECONDARY BITS = Fault            SECONDARY BITS = -----

SYSTEM CLOCK                      PST          SST          AST
OOS-MT                             Fault         -----

ALARM STATUS = No Alarms.
# Cards using CLK A = 4            # Cards with bad CLK A = 0
# Cards using CLK B = 0            # Cards with bad CLK B = 4
# Cards using CLK I = 0

Command Completed.
```

;

The following example shows output when **mode=full** is specified, with no HS clock sections, and the TSCSYNC feature is not on:

```

rlghncxa03w 04-04-07 08:51:31 EST EAGLE 31.6.0
CARD LOC = 1114 (Active )          CARD LOC = 1116 (Isolated )
PRIMARY BITS = Active              PRIMARY BITS = -----
SECONDARY BITS = Fault            SECONDARY BITS = -----

                                PST          SST          AST
SYSTEM CLOCK                    OOS-MT         Fault         -----
ALARM STATUS = No Alarms.
# Cards using CLK A = 4           # Cards with bad CLK A = 0
# Cards using CLK B = 0           # Cards with bad CLK B = 4
# Cards using CLK I = 0

Cards with bad clock source:
CARD          CLK A      CLK B
1103          Active     Fault
1104          Active     Fault
1106          Active     Fault
1113          Active     Fault

Command Completed.
;

```

If the Time Slot Counter Synchronization feature (TSCSYNC) is turned on, the output includes the TSC clock status.

rept-stat-clk

```

rlghncxa03w 04-04-07 08:51:31 EST EAGLE 31.6.0
CARD LOC = 1114 (Active )          CARD LOC = 1116 (Isolated )
PRIMARY BITS = Active              PRIMARY BITS = -----
SECONDARY BITS = Fault            SECONDARY BITS = -----
TSC CLOCK = Clock A              TSC CLOCK = -----

                                PST          SST          AST
SYSTEM CLOCK                    OOS-MT         Fault         -----
ALARM STATUS = No Alarms.
# Cards using CLK A = 4           # Cards with bad CLK A = 0
# Cards using CLK B = 0           # Cards with bad CLK B = 4
# Cards using CLK I = 0

Command Completed.
;

```

The following example includes output that appears when **mode=full** is not specified; at least one HS clock capable card is provisioned, or the TDM cards are TDM-GTI cards (TDM-15 or later) and the TSCSYNC feature is turned on:

rept-stat-clk

```

rlghncxa03w 04-04-07 08:51:31 EST EAGLE 31.6.0
CARD LOC = 1114 (Active )          CARD LOC = 1116 (Isolated )
PRIMARY BITS = Active              PRIMARY BITS = -----
SECONDARY BITS = Idle             SECONDARY BITS = -----
HS PRIMARY CLK = Active           HS PRIMARY CLK = -----
HS SECONDARY CLK = Idle           HS SECONDARY CLK = -----
HS CLK TYPE = E1 UNFRAMED        HS CLK TYPE = -----
HS CLK LINELEN = SHORThAUL       HS CLK LINELEN = -----
TSC CLOCK = Unavail              TSC CLOCK = -----

                                PST          SST          AST
SYSTEM CLOCK                    OOS-MT         Fault         -----

```

```
ALARM STATUS = No Alarms.
# Cards using CLK A = 4          # Cards with bad CLK A = 1
# Cards using CLK B = 0          # Cards with bad CLK B = 5
# Cards using CLK I = 1

                                PST          SST          AST
HS SYSTEM CLOCK                 IS-NR          Idle          -----
# Cards using HS CLK A = 0      # Cards with bad HS CLK A = 1
# Cards using HS CLK B = 0      # Cards with bad HS CLK B = 1
# Cards using HS CLK I = 0
```

;

The following example includes output that appears when **mode=full** is not specified; at least one HS clock capable card is provisioned and the TSCSYNC feature is not turned on:

rept-stat-clk

```
rlghncxa03w 04-04-07 08:51:31 EST EAGLE 31.6.0
CARD LOC= 1114 (Active )      CARD LOC= 1116 (Isolated )
PRIMARY BITS = Active        PRIMARY BITS = -----
SECONDARY BITS = Idle        SECONDARY BITS = -----
HS PRIMARY CLK = Active      HS PRIMARY CLK = -----
HS SECONDARY CLK = Idle      HS SECONDARY CLK = -----
HS CLK TYPE = E1 UNFRAMED    HS CLK TYPE = -----
HS CLK LINELEN = SHORThAUL    HS CLK LINELEN = -----

                                PST          SST          AST
SYSTEM CLOCK                    IS-NR          ACTIVE        ALMINH
ALARM STATUS = No Alarms.
# Cards using CLK A = 9      # Cards with bad CLK A = 0
# Cards using CLK B = 0      # Cards with bad CLK B = 9
# Cards using CLK I = 0

                                PST          SST          AST
HS SYSTEM CLOCK                 IS-NR          ACTIVE        ALMINH
ALARM STATUS = No Alarms.
# Cards using HSCLK A = 1    # Cards with bad HSCLK A = 0
# Cards using HSCLK B = 0    # Cards with bad HSCLK B = 2
# Cards using HSCLK I = 0
Command Completed.
```

;

The following example includes output that appears when **mode=full** is specified; at least one HS clock capable card is provisioned, or the TDM cards are TDM-GTI cards (TDM-15 or later) and the TSCSYNC feature is turned on:

rept-stat-clk:mode=full

```
rlghncxa03w 04-04-07 08:51:31 EST EAGLE 31.6.0
CARD LOC = 1114 (Active )      CARD LOC = 1116 (Isolated )
PRIMARY BITS = Active        PRIMARY BITS = -----
SECONDARY BITS = Idle        SECONDARY BITS = -----
HS PRIMARY CLK = Active      HS PRIMARY CLK = -----
HS SECONDARY CLK = Idle      HS SECONDARY CLK = -----
HS CLK TYPE = E1 UNFRAMED    HS CLK TYPE = -----
HS CLK LINELEN = SHORThAUL    HS CLK LINELEN = -----
TSC CLOCK = Unavail          TSC CLOCK = -----
```

```

SYSTEM CLOCK
ALARM STATUS = No Alarms.
# Cards using CLK A = 4      # Cards with bad CLK A = 1
# Cards using CLK B = 0      # Cards with bad CLK B = 5
# Cards using CLK I = 1

PST          SST          AST
OOS-MT       Fault        -----

HS SYSTEM CLOCK
ALARM STATUS = No Alarms.
# Cards using HS CLK A = 0    # Cards with bad HS CLK A = 1
# Cards using HS CLK B = 0    # Cards with bad HS CLK B = 1
# Cards using HS CLK I = 0

PST          SST          AST
IS-NR       Idle         -----

Cards with bad clock source:
CARD          CLK A      CLK B      HS CLK A    HS CLK B
1103          Active     Fault      -----    -----
1104          Active     Fault      Fault        Fault
1106          Active     Fault      -----    -----
1113          Active     Fault      -----    -----
1205          Fault      Fault      -----    -----

Command Completed.
;

```

Legend

CARD LOC—The card location of the TDM and the status of the MASP

PRIMARY BITS—The status of the primary BITS clock

SECONDARY BITS—The status of the secondary BITS clock

HS PRIMARY CLK—The status of the high-speed primary clock

HS SECONDARY CLK—The status of the high-speed secondary clock

Possible values for HS PRIMARY CLK and HS SECONDARY CLK status are:

---- (dashes)—Undefined or not applicable

ACTIVE—High-speed primary clock is valid and is the current reference being distributed by TDMx to all system shelves.

FAULT—High-speed primary clock source from TDMx is currently invalid.

IDLE—High-speed primary clock is valid, the high-speed secondary clock is the current reference being distributed by TDMx to all system shelves.

HS CLK TYPE—HS clock source (see the **chg-stpopts** command)

HS CLK LINELEN—HS clock line length (see the **chg-stpopts** command)

TSC CLOCK—The status of the Time Slot Counter Synchronization (TSC) clock; appears only when the TSCSYNC feature is turned on.

SYSTEM CLOCK—System clock status

PST—The primary state of the clock. The possible values are described in “Possible Values for PST/SST/AST” in Appendix A.

SST—The secondary state of the clock. The possible values are described in “Possible Values for PST/SST/AST” in Appendix A.

AST—The associated state of the clock. The possible values are described in “Possible Values for PST/SST/AST” in Appendix A.

ALARM STATUS—System clock alarms; "No alarms" is shown when there are no alarms.

CARDS USING CLK A, B, I—The number of cards using clock A, clock B, and clock I.

CARDS WITH BAD CLK A, B—The number of cards using clock A or clock B, when clock A or B is bad.

HS SYSTEM CLOCK—HS system clock status

PST—The primary state of the clock. The possible values are described in “Possible Values for PST/SST/AST” in Appendix A.

SST—The secondary state of the clock. The possible values are described in “Possible Values for PST/SST/AST” in Appendix A.

AST—The associated state of the clock. The possible values are described in “Possible Values for PST/SST/AST” in Appendix A.

ALARM STATUS—HS System clock alarms; "No alarms" is shown when there are no alarms.

CARDS USING HSCLK A, B, I—The number of cards using high-speed clock A, B, and I.

NOTE: The value for the internal high-speed clock (# Cards using HSCLK I) is generated differently from the internal system clock (Cards using CLK I). The internal high speed clock is generated by the XILINX on the ATM applique’s card. The internal system clock is generated by TDMx when both BITS clock sources are invalid and then distributed to all system shelves.

The use of HSCLK I is not automatic when both the high-speed primary and secondary clocks are invalid. A LIM-ATM card must be provisioned (with the **ent-slk:atmtsel=internal** parameter) to use the high-speed internal clock.

CARDS WITH BAD HSCLK A, B—The number of cards using high-speed clock A or B, when high-speed clock A or B is bad.

rept-stat-cluster

Report Status Cluster-Related DPC

Use this command to report summary status and statistical information for all provisioned clusters. Use this command also to report detailed routeset information for a specific cluster, provisioned cluster member, or dynamically-created x-list entry.

NOTE: This command does not support 24-bit ITU national point codes.

Keyword: rept-stat-cluster

Related Commands: chg-feat, chg-stpopts, rept-stat-cluster, rtrv-stpopts

Command Class: System Maintenance

Parameters

:dpc or :dpca= (optional)

ANSI destination point code of the cluster whose status is to be reported, with subfields *network indicator-network cluster-network cluster member (ni-nc-ncm)*. The *prefix* subfield indicates a private point code (*prefix-ni-nc-ncm*).

Range: **p- ,000-255, ***

Specify a valid value for each subfield of the point code, and separate the subfields with a dash (-).

prefix—p-

The asterisk value * is not valid for the *ni* subfield.

When **chg-sid:pctype=ansi** is specified, *ni = 000* is not valid.

When **chg-sid:pctype=ansi** is specified, *nc = 000* is not valid if *ni = 001-005*.

When **chg-sid:pctype=ansi** is specified, *nc = 000* is valid if *ni = 006-255*.

When **chg-sid:pctype=ansi** is specified, *ni-*-** is valid if *ni = 006-255*.

The point code **000-000-000** is not a valid point code.

Default: Display summary for all provisioned clusters

:mode= (optional)

The type of display. Specify **mode=full** to display additional information for the specified DPC.

Range: **full**

Default: Display summary report

:stat= (optional)

This parameter reports on destinations whose status is the same as the state indicated by the parameter.

Range: **all, alminh, anr, dsbld, mt, nr**

all—All of the primary states

alminh—Alarms inhibited

anr—In service abnormal (IS-ANR)

dsbld—Out of service maintenance disabled (OOS-MT-DSBLD)

mt—Out of service maintenance (OOS-MT)

nr—In service normal (IS-NR)

Default: **all**

Example

```
rept-stat-cluster
```

```
rept-stat-cluster:stat=alminh
```

```
rept-stat-cluster:stat=MT
```

```
rept-stat-cluster:dpc=20-2-*
```

```
rept-stat-cluster:dpc=20-2-*:mode=full
```

```
rept-stat-cluster:dpc=20-2-5
```

Dependencies

If the **mode=full** parameter is specified, the **dpc/dpca** parameter must be specified.

The **stat** parameter cannot be specified with the **dpc/dpca** parameter in the command.

The Cluster Routing and Management Diversity (CRMD) feature must be turned on before this command can be entered.

The specified DPC must exist.

If a DPC is specified, it must be an x-list entry, a cluster DPC, or a member of a provisioned cluster.

The destination address must be a full point code or a cluster point code specified as *ni-nc-**. A DPC as *ni-nc-*** or *ni-nc-**** cannot be specified for the **rept-stat-cluster** command.

In this command, the point codes support only the private (internal) point code subtype prefix (p-).

Notes

If no parameters are specified, a summary report is produced, showing all provisioned clusters and their status.

If an FPC corresponding to a provisioned cluster member or an x-list entry is specified, then the status of only the specified FPC, along with routeset status, is displayed.

If a cluster destination is specified on the **dpc/dpca** parameter, then the status of the cluster and the routesets that have been defined for that cluster is displayed.

If the **mode=full** parameter and a DPC are specified, the Route/Destination table is searched, and all entries (cluster DPCs, provisioned cluster member DPCs, and x-list DPCs) belonging to the parent cluster are displayed along with their status. Also, if circular routing is in effect for the DPC, information useful in diagnosing and correcting the situation is displayed.

In the summary report, and in the detailed output when a cluster DPC is being reported, the number of provisioned members of the cluster, and the number of x-list entries that have been created for the cluster, are reported in the PROV and X-LIST columns, respectively.

When detailed information for an x-list entry is being reported, the reasons that the x-list entry was created, and the amount of time remaining on the x-list expiration timer, if applicable, in the format hh:mm is shown in the X-REASON and X-TIME columns, respectively. In x-list entries for which the expiration timer is not applicable, dashes "----" are displayed.

Output

When no parameters are specified, summary information for all of the defined cluster DPCs is shown. Note that the report shows the number of provisioned and x-list members of each cluster.

rept-stat-cluster

```
rlghncxa03w 04-01-07 08:51:31 EST EAGLE 31.3.0
DPCA          ORIG    PST     SST      AST      PROV  X-LIST
020-002-*     CLUST  IS-NR   Allowed  ACCESS   2     3
020-020-*     CLUST  IS-NR   Allowed  ACCESS   3     5
020-021-*     CLUST  OOS-MT  Prohibit INACCESS 5     2
020-022-*     CLUST  IS-NR   Allowed  ALMINH   2     3
Command Completed.
```

;

When a provisioned cluster member DPC is specified, the report shows status information for the specified DPC plus route information.

rept-stat-cluster:dpc=20-2-1

```
rlghncxa03w 04-01-07 08:51:31 EST EAGLE 31.3.0
DPCA          ORIG   PST    SST      AST
020-002-001  PROV  IS-ANR Restrict ACCESS
ALARM STATUS  = No Alarms.
RTE COST  LSN      APCA          LS STAT  NON-ADJ  ROUTE STAT
1   10   lsnppp  003-003-003  Allowed  Allowed  Allowed
2   --   -----  ***-***-***  -----  -----  -----
3   --   -----  ***-***-***  -----  -----  -----
4   --   -----  ***-***-***  -----  -----  -----
5   --   -----  ***-***-***  -----  -----  -----
6   --   -----  ***-***-***  -----  -----  -----
Command Completed.
```

;

When a specific cluster DPC is specified, the report shows count information about the cluster's provisioned and x-list members, plus the route information.

rept-stat-cluster:dpc=20-2-*

```
rlghncxa03w 04-01-07 08:51:31 EST EAGLE 31.3.0
DPCA          ORIG   PST    SST      AST      PROV  X-LIST
020-002-*    CLUST IS-NR   Allowed ACCESS      2      3
ALARM STATUS  = No Alarms.
RTE COST  LSN      APCA          LS STAT  NON-ADJ  ROUTE STAT
1   10   lsnppp  003-003-003  Allowed  Allowed  Allowed
2   --   -----  ***-***-***  -----  -----  -----
3   --   -----  ***-***-***  -----  -----  -----
4   --   -----  ***-***-***  -----  -----  -----
5   --   -----  ***-***-***  -----  -----  -----
6   --   -----  ***-***-***  -----  -----  -----
Command Completed.
```

;

When an x-list cluster member DPC is specified, the report shows x-list related information (X-REASON, X-TIME) plus the route information. Note that the output report identifies the specified DPC as an x-list DPC.

rept-stat-cluster:dpc=20-2-5

```
rlghncxa03w 04-01-07 08:51:31 EST EAGLE 31.3.0
DPCA          ORIG   PST    SST      AST      X-REASON  X-TIME
020-002-005  X-LIST IS-ANR Restrict ACCESS  RT      08:20
ALARM STATUS  = No Alarms.
RTE COST  LSN      APCA          LS STAT  NON-ADJ  ROUTE STAT
1   10   lsnppp  003-003-003  Allowed  Allowed  Allowed
2   --   -----  ***-***-***  -----  -----  -----
3   --   -----  ***-***-***  -----  -----  -----
4   --   -----  ***-***-***  -----  -----  -----
5   --   -----  ***-***-***  -----  -----  -----
6   --   -----  ***-***-***  -----  -----  -----
Command Completed.
```

;

Specifying a cluster **dpc** and **mode=full** expands the report to show summary status information for all of the provisioned and x-list DPCs that are members of the specified cluster.

rept-stat-cluster:dpc=20-2-*.mode=full

```
rlghncxa03w 04-01-07 08:51:31 EST EAGLE 31.3.0
DPCA          ORIG    PST     SST     AST     PROV  X-LIST
020-002-*    CLUST  IS-NR   Allowed ACCESS    2      3
ALARM STATUS  = No Alarms.
RTE  COST  LSN      APCA          LS STAT  NON-ADJ  ROUTE STAT
 1   10   lsnppp   003-003-003  Allowed  Allowed   Allowed
 2   --   -----  ***-***-***  -----  -----   -----
 3   --   -----  ***-***-***  -----  -----   -----
 4   --   -----  ***-***-***  -----  -----   -----
 5   --   -----  ***-***-***  -----  -----   -----
 6   --   -----  ***-***-***  -----  -----   -----
DPCA          ORIG    PST     SST     AST     X-REASON X-TIME
020-002-*    CLUST  IS-NR   Allowed ACCESS    -----  -----
020-002-001  PROV   OOS-MT  Prohibit INACCESS -----  -----
020-002-002  PROV   IS-ANR  Restrict ACCESS    -----  -----
020-002-126  X-LIST IS-ANR  Restrict ACCESS    RT      08:20
020-002-127  X-LIST OOS-MT  Prohibit INACCESS CR      -----
020-002-128  X-LIST IS-ANR  Restrict ACCESS    CG RT   05:40
CIRCULAR ROUTING
XMIT LSN= ----- RC=--
RCV LSN= -----
MEMBER = ***-***-***
Command Completed.
```

;

When the **stat** parameter is specified, only those clusters having a primary state (PST) matching the specified value are reported.

rept-stat-cluster:stat=alminh

```
rlghncxa03w 04-01-07 08:51:31 EST EAGLE 31.3.0
DPCA          ORIG    PST     SST     AST     PROV  X-LIST
020-022-*    CLUST  IS-NR   Allowed ALMINH    2      3
Command Completed.
```

;

If a circular routing alarm is raised for a cluster member DPC, specifying the **dpc** and **mode=full** parameters displays information pertinent to the cluster member that is experiencing the circular routing condition. This information may be useful in correcting the problem.

rept-stat-cluster:dpc=20-2-127.mode=full

```
rlghncxa03w 04-01-07 08:51:31 EST EAGLE 31.3.0
DPCA          ORIG    PST     SST     AST
020-002-127  PROV   OOS-MT  Prohibit INACCESS
ALARM STATUS  = *C 0319 Circular routing detected
RTE  COST  LSN      APCA          LS STAT  NON-ADJ  ROUTE STAT
 1   10   lsnppp   003-003-003  Allowed  Allowed   Allowed
 2   --   -----  ***-***-***  -----  -----   -----
 3   --   -----  ***-***-***  -----  -----   -----
 4   --   -----  ***-***-***  -----  -----   -----
 5   --   -----  ***-***-***  -----  -----   -----
 6   --   -----  ***-***-***  -----  -----   -----
```

```

DPCA          ORIG      PST      SST      AST      X-REASON  X-TIME
020-002-*    CLUST    IS-NR    Allowed  ACCESS    -----  -----
020-002-001  PROV     OOS-MT   Prohibit  ACCESS    -----  -----
020-002-002  PROV     IS-ANR   Restrict  ACCESS    -----  -----
020-002-126  X-LIST   IS-ANR   Restrict  ACCESS    RT        08:20
020-002-127  X-LIST   OOS-MT   Prohibit  INACCESS  CG CR     -----
020-002-128  X-LIST   IS-ANR   Restrict  ACCESS    CR CG RT  05:40
CIRCULAR ROUTING
  XMIT LSN= lsnppp RC=--
  RCV  LSN= lsn01a
  MEMBER = ***-***-***
Command Completed.

```

If a circular routing alarm is raised for a cluster DPC (that is, no x-list entry could be created for the cluster member), then specifying the **dpc** and **mode=full** parameters displays information pertinent to the cluster member that is experiencing the circular routing condition. This information may be useful in correcting the problem. The value for the MEMBER field in this example represents the cluster member that had the circular routing condition. This is the same member for which an x-list entry could not be created.

NOTE: The circular routing member information shown in this output report displays as *-***-*** if the specified destination point code is not a cluster destination point code or the information is not known by maintenance at the time the report is generated.**

rept-stat-cluster:dpc=20-2-*:mode=full

```

rlghncxa03w 04-01-07 08:51:31 EST  EAGLE 31.3.0
DPCA          ORIG      PST      SST      AST      PROV  X-LIST
020-002-*    CLUST    IS-NR    Allowed  ACCESS    2      3
ALARM STATUS  = *C 0319 Circular routing detected
RTE COST  LSN      APCA          LS STAT  NON-ADJ  ROUTE STAT
  1  10  lsnppp  003-003-003  Allowed  Allowed  Allowed
  2  --  -----  ***-***-***  -----  -----  -----
  3  --  -----  ***-***-***  -----  -----  -----
  4  --  -----  ***-***-***  -----  -----  -----
  5  --  -----  ***-***-***  -----  -----  -----
  6  --  -----  ***-***-***  -----  -----  -----
DPCA          ORIG      PST      SST      AST      X-REASON  X-TIME
020-002-*    CLUST    IS-NR    Allowed  ACCESS    -----  -----
020-002-001  PROV     OOS-MT   Prohibit  INACCESS  -----  -----
020-002-002  PROV     IS-ANR   Restrict  ACCESS    -----  -----
020-002-126  X-LIST   IS-ANR   Restrict  ACCESS    RT        08:20
020-002-127  X-LIST   OOS-MT   Prohibit  INACCESS  CR        -----
020-002-128  X-LIST   IS-ANR   Restrict  ACCESS    CG RT     05:40
CIRCULAR ROUTING
  XMIT LSN= lsnppp RC=--
  RCV  LSN= lsn01a
  MEMBER = 020-002-129
Command Completed.

```

The following example includes private point codes:

rept-stat-cluster:dpc=20-2-*.mode=full

rlghncxa03w 05-01-06 10:09:59 EST EAGLE 30.12.0

DPCA	ORIG	PST	SST	AST	PROV	XLIST
020-002-*	CLUST	OOS-MT	Idle	INACCESS	0	0
ALARM STATUS = No Alarms.						
RTE	COST	LSN	APCA	LS STAT	NON-ADJ	ROUTE STAT
1	10	ls11345678	p-001-001-003	Allowed	Allowed	Allowed
2	--	-----	---*---*---*---	-----	-----	-----
3	--	-----	---*---*---*---	-----	-----	-----
4	--	-----	---*---*---*---	-----	-----	-----
5	--	-----	---*---*---*---	-----	-----	-----
6	--	-----	---*---*---*---	-----	-----	-----

DPCA	ORIG	PST	SST	AST	X-REASON	X-TIME
020-002-*	CLUST	IS-NR	Allowed	ACCESS	-----	-----
p-020-002-001	PROV	OOS-MT	Prohibit	INACCESS	-----	-----
p-020-002-002	PROV	IS-ANR	Restrict	ACCESS	-----	-----
020-002-126	X-LIST	IS-ANR	Restrict	ACCESS	RT	08:20
020-002-127	X-LIST	OOS-MT	Prohibit	INACCESS	CR	-----
020-002-128	X-LIST	IS-ANR	Restrict	ACCESS	CG RT	05:40
CIRCULAR ROUTING INFO:						
XMIT LSN=-----		RC=--				
RCV LSN=-----						
MEMBER =-----						
Command Completed.						

;

Legend

ORIG—Indicates the origination of the destination point code being reported. The possible values that can appear in the column are:

CLUST—Entry is a provisioned cluster (*ni-nc-**) DPC

PROV—Entry is a provisioned cluster member (*ni-nc-ncm*)

X-LIST—Entry is a non-provisioned (i.e. dynamically-created) x-list cluster member

PST—The primary state of the cluster. The possible values are described in “Possible Values for PST/SST/AST” in Appendix A.

SST—The secondary state of the cluster. The possible values are described in “Possible Values for PST/SST/AST” in Appendix A.

AST—The associated state of the cluster. The possible values are described in “Possible Values for PST/SST/AST” in Appendix A.

X-REASON—Indicates the reasons that the X-LIST entries currently exist. The two-letter indicator values that can appear in this column are:

RT—X-LIST entry created due to routing

CG—X-LIST entry created due to congestion

CR—X-LIST entry created due to circular routing

The circular routing transmit/receive linkset information shown in the **mode=full** detailed output report displays as “-----” if no circular routing alarm exists for the DPC or the information is not known by maintenance at the time the report is generated.

rept-stat-db

Report Status Database

Use this command to display a report showing various status indicators for the active and standby OAM database and the status of the database on each of the network cards.

If the G-Flex, G-Port, INP, or LNP ELAP Configuration feature is turned on, the status of the MPS databases and VSCCP cards is also displayed.

Keyword: **rept-stat-db**

Related Commands: **chg-db, copy-meas, disp-disk-dir**

Command Class: Database Administration

Parameters

:db= (optional)

The report section or sections to display in the output. The content of each section depends on the specified or default value of the **display** parameter, MPS output appears only if a feature that uses the MPS is turned on in the system (G-Flex, G-Port, INP, or the LNP ELAP Configuration controlled feature).

Range: **all, mps, stp**

all—Displays database and card output for both the STP and MPS report sections.

mps—Displays only the database and card output for the MPS report section.

stp—Displays only the database and card output for the STP report section.

Default: **all**

:display= (optional)

The type of output

Range: **all, brief, except, version**

all—Displays the operational status of all databases (MASP A, MASP B, and MDAL) and all cards equipped in the database on the system.

brief—Displays the operational status of the databases in the active and standby MASP, and of the MPS databases if a feature that uses the MPS is turned on.

except—Displays the operational status information contained in the **display=brief** output along with the cards whose database level does not match the active fixed disk current partition or active MPS database.

version—Displays all of the same information that is displayed with the **display=all** parameter except that the individual database status column is replaced with the database format version and status. In addition, details of the status of the backup databases are displayed for MASP cards. No version information is shown for MPS databases; use the **rept-stat-mps** command.

Default: **brief**

:loc= (optional)

The card location as stenciled on the shelf of the system.

Range: 1101–1108, 1111–1112, 1114, 1116, 1117, 1201–1208, 1211–1218, 1301–1308, 1311–1318, 2101–2108, 2111–2118, 2201–2208, 2211–2218, 2301–2308, 2311–2318, 3101–3108, 3111–3118, 3201–3208, 3211–3218, 3301–3308, 3311–3318, 4101–4108, 4111–4118, 4201–4208, 4211–4218, 4301–4308, 4311–4318, 5101–5108, 5111–5118, 5201–5208, 5211–5218, 5301–5308, 5311–5318, 6101–6108, 6111–6118

Example

```
rept-stat-db
rept-stat-db:display=brief
rept-stat-db:display=except
rept-stat-db:display=all
rept-stat-db:display=version
rept-stat-db:loc=1207
rept-stat-db:db=all
rept-stat-db:db=stp
rept-stat-db:db=mps
```

Dependencies

The **display** and **loc** parameters cannot be specified at the same time.

The **db** and **loc** parameters cannot be specified at the same time.

The following card locations are not valid for this command: 1113, 1115, and all xy09 and xy10 locations (where x is the frame and y is the shelf).

The G-Flex, G-Port, INP, EIR, or LNP ELAP Configuration feature must be turned on before the **db=mps** parameter can be specified.

Notes

If the **display** parameter, the **db** parameter, or the **loc** parameter is specified and the database for a particular card location is not accessible, hyphens are displayed in place of the data.

The output of the **rept-stat-db** command with no parameters specified or with the **display=brief** parameter shows the following information:

- Activity status of both the active and standby MASP, the date and time the last backup was performed on the removable cartridge (if inserted) and the fixed disk backup partition, coherency, the number of updates (level) to the backup partition of the fixed disk, and the current partition of the fixed disk
- If the G-Flex, G-Port, EIR, or INP feature is turned on, EPAP A and EPAP B database status followed by VSCCP card database status
- If the LNP ELAP Configuration controlled feature is turned on, ELAP A and ELAP B database status followed by VSCCP card database status

The output of the **rept-stat-db** command with the **display=except** parameter shows the coherency and the number of updates for all the cards whose database level does not match the active fixed disk current partition, reference database level, or is incoherent. All databases that are not accessible are also displayed. In addition, the time stamp for the last database update is displayed for every card.

The output of the **rept-stat-db** command with the **display=all** parameter shows the coherency and the number of updates for all of the distributed databases. In addition, the time stamp for the last database update is displayed for every card.

The output of the **rept-stat-db** command with the **display=version** parameter shows the coherency and the number of updates for the active and standby databases, along with the database version and the operational status of each of these databases. If the LNP feature is turned on (see the **enable-ctrl-feat** command), the version of the LNP database is shown. No version is shown for EPAP or ELAP databases; use the **rept-stat-mps** command to display version information for these databases.

The output of the **rept-stat-db** command with the **loc** parameter specifying an equipped card shows the coherency and the number of updates to its database. In addition, the time stamp for the last database update is displayed for the specific card location.

The **db** parameter is used to limit the output of the **rept-stat-db** command to either just the STP information or just the MPS information. The information is displayed as indicated by the **display** parameter value (**display=version** is not valid for **db=mps**; the command does not display the MPS database versions). The default **db** parameter value is **all**, which displays the information for the STP and MPS databases and cards as indicated by the **display** parameter value.

Output

The report for the specified card is displayed. The report shows that the disk is OFF-LINE indicating the disk has been dismounted. This is not necessarily a problem.

rept-stat-db:loc=1114

CARD/APPL	LOC	C	T	LEVEL	TIME LAST UPDATE	EXCEPTION
TDM-CRNT	1114	-	-	-	-	OFF-LINE
TDM-BKUP	1114	-	-	-	-	-

;

The report for the specified VSCCP (DSM) card used for EPAP or ELAP is displayed. The G-Flex, G-Port, EIR, INP or LNP ELAP Configuration feature is turned on in the system.

rept-stat-db:loc=1201

CARD/APPL	LOC	C	T	LEVEL	TIME LAST UPDATE	EXCEPTION
VSCCP	1201	Y	N	12	02-01-29 08:53:48	-

EAGLE RTDB REPORT

CARD/APPL	LOC	C	BIRTHDATE	LEVEL	EXCEPTION
VSCCP	1201	Y	02-01-29 16:12:50	12345	-

;

The database in the following example has no errors, as indicated by the OK status. The G-Flex, G-Port, EIR, INP, and LNP ELAP Configuration features are not turned on in the system.

rept-stat-db

```
tekelecstp 02-10-29 08:38:25 NZST EAGLE 30.0.0
DATABASE STATUS: >> OK <<
      TDM 1114 ( ACTV )                TDM 1116 ( STDBY)
      C  LEVEL    TIME LAST BACKUP    C  LEVEL    TIME LAST BACKUP
-----
FD BKUP Y        11 02-10-29 08:20:13 NZST Y        11 02-10-29 08:20:13 NZST
FD CRNT Y         11                               Y         11
      MDAL 1117
      - - - - -
RD BKUP Y         1 02-10-24 15:44:20 NZST
;

```

The database in the following example has no errors, as indicated by the OK status. The G-Flex, G-Port, EIR, INP, and LNP ELAP Configuration features are not turned on in the system.

rept-stat-db:display=all

```
tekelecstp 02-10-29 08:39:24 NZST EAGLE 31.0.0
DATABASE STATUS: >> OK <<
      TDM 1114 ( ACTV )                TDM 1116 ( STDBY)
      C  LEVEL    TIME LAST BACKUP    C  LEVEL    TIME LAST BACKUP
-----
FD BKUP Y        11 02-10-29 08:20:13 NZST Y        11 02-10-29 08:20:13 NZST
FD CRNT Y         11                               Y         11
      MDAL 1117
      - - - - -
RD BKUP Y         1 02-10-24 15:44:20 NZST
CARD/APPL  LOC  C  T  LEVEL           TIME LAST UPDATE   EXCEPTION
-----
SS7ANSI    1102 Y  N  11           02-10-29 08:04:00   -
SS7ANSI    1103 Y  N  11           02-10-29 08:04:00   -
VSCCP      1105 Y  N  11           02-10-29 08:04:00   -
STPLAN     1107 Y  N  11           02-10-29 08:04:00   -
TDM-CRNT   1114 Y  N  11           02-10-29 08:04:00   -
TDM-BKUP   1114 Y  -  11           02-10-29 08:04:00   -
TDM-CRNT   1116 Y  N  11           02-10-29 08:04:00   -
TDM-BKUP   1116 Y  -  11           02-10-29 08:04:00   -
MDAL       1117 Y  -  1           02-10-24 15:06:29   DIFF LEVEL
VSCCP      1201 Y  N  11           02-10-29 08:04:00   -
VSCCP      1203 Y  N  11           02-10-29 08:04:00   -
;

```

The database in the following example has no errors, as indicated by the OK status. The G-Flex, G-Port, EIR, INP, and LNP ELAP Configuration features are not turned on in the system.

NOTE: The rept-stat--db command does not display version information for MPS databases. Use the rept-stat-mps command to display the MPS database version information.

rept-stat-db:display=version

```
tekelecstp 02-10-29 08:51:21 NZST EAGLE 31.0.0
rept-stat-db:display=version
Command entered at terminal #4.
DATABASE STATUS: >> OK <<
      TDM 1114 ( ACTV )                TDM 1116 ( STDBY)
      C  LEVEL    TIME LAST BACKUP    C  LEVEL    TIME LAST BACKUP
-----
FD BKUP Y          11 02-10-29 08:20:13 NZST Y          11 02-10-29 08:20:13 NZST
FD CRNT Y          11                                Y          11
      MDAL 1117
-----
RD BKUP Y          1 02-10-24 15:44:20 NZST
```

The database in the following example has no errors, as indicated by the OK status. The LNP feature is turned on in the system (see the **enable-ctrl-feat** command).

rept-stat-db:display=version

```
tekelecstp 02-10-29 08:51:21 NZST EAGLE 30.0.0
rept-stat-db:display=version
Command entered at terminal #4.
DATABASE STATUS: >> OK <<
      TDM 1114 ( ACTV )                TDM 1116 ( STDBY)
      C  LEVEL    TIME LAST BACKUP    C  LEVEL    TIME LAST BACKUP
-----
FD BKUP Y          11 02-10-29 08:20:13 NZST Y          11 02-10-29 08:20:13 NZST
FD CRNT Y          11                                Y          11
      MDAL 1117
-----
RD BKUP Y          1 02-10-24 15:44:20 NZST
CARD/APPL  LOC  C  T  LEVEL            TIME LAST UPDATE  VERSION STATUS
-----
TDM-CRNT   1114 Y  N  11              02-10-29 08:04:00  111-000-000  NORMAL
LNP
TDM-BKUP   1114 Y  -  11              02-10-29 08:04:00  111-000-000  NORMAL
LNP
TDM-CRNT   1116 Y  N  11              02-10-29 08:04:00  111-000-000  NORMAL
LNP
TDM-BKUP   1116 Y  -  11              02-10-29 08:04:00  111-000-000  NORMAL
LNP
MDAL       1117 Y  -  1              02-10-24 15:06:29  114-000-000  NORMAL
LNP
```

The database in the following example has no errors, as indicated by the OK status. The G-Flex, G-Port, EIR, INP, and LNP ELAP Configuration features are not turned on in the system.

rept-stat-db:display=except

```
tekelecstp 02-10-29 08:55:54 NZST EAGLE 31.0.0
rept-stat-db:display=except
Command entered at terminal #4.
DATABASE STATUS: >> OK <<
      TDM 1114 ( ACTV )                      TDM 1116 ( STDBY)
      C  LEVEL    TIME LAST BACKUP          C  LEVEL    TIME LAST BACKUP
      - - - - -
FD BKUP Y        11 02-10-29 08:20:13 NZST Y        11 02-10-29 08:20:13 NZST
FD CRNT Y        12                                Y        12
      MDAL 1117
      - - - - -
RD BKUP Y        1 02-10-24 15:44:20 NZST
CARD/APPL  LOC  C  T  LEVEL          TIME LAST UPDATE    EXCEPTION
-----
SS7ANSI     1103 Y  N  10            02-10-29 08:03:48    DIFF LEVEL
TDM-BKUP    1114 Y  -  11            02-10-29 08:04:00    DIFF LEVEL
TDM-BKUP    1116 Y  -  11            02-10-29 08:04:00    DIFF LEVEL
MDAL        1117 Y  -  1            02-10-24 15:06:29    DIFF LEVEL
;

```

The database in the following example has no errors, as indicated by the OK status. The LNP ELAP Configuration controlled feature is enabled and turned on (see the **enable-ctrl-feat** command) in the system, and ELAP is being used.

rept-stat-db

```
tekelecstp 02-10-29 08:39:24 NZST EAGLE 30.0.0
rept-stat-db
Command entered at terminal #4.
DATABASE STATUS: >> OK <<
      TDM 1114 ( ACTV )                      TDM 1116 ( STDBY)
      C  LEVEL    TIME LAST BACKUP          C  LEVEL    TIME LAST BACKUP
      - - - - -
FD BKUP Y        11 02-10-29 08:20:13 NZST Y        11 02-10-29 08:20:13 NZST
FD CRNT Y        11                                Y        11
      MDAL 1117
      - - - - -
RD BKUP Y        1 02-10-24 15:44:20 NZST
      ELAP A ( ACTV )
      C  BIRTHDATE          LEVEL          EXCEPTION
      - - - - -
RTDB          Y  02-10-29 08:20:04          12345          -
RTDB-EAGLE    02-10-29 08:20:04          12345          -
      ELAP B ( STDBY )
      C  BIRTHDATE          LEVEL          EXCEPTION
      - - - - -
RTDB          Y  02-10-29 08:20:04          12345          -
RTDB-EAGLE    02-10-29 08:20:04          12345          -
;

```

The database in the following example has no errors, as indicated by the OK status. The LNP ELAP Configuration controlled feature is enabled and turned on (see the **enable-ctrl-feat** command) in the system, and ELAP is being used.

rept-stat-db:display=all

```

tekelecstp 02-10-29 08:39:24 NZST EAGLE 30.0.0
rept-stat-db:display=all
Command entered at terminal #4.
DATABASE STATUS: >> OK <<
      TDM 1114 ( ACTV )                      TDM 1116 ( STDBY)
      C  LEVEL    TIME LAST BACKUP          C  LEVEL    TIME LAST BACKUP
-----
FD BKUP Y      11 02-10-29 08:20:13 NZST Y      11 02-10-29 08:20:13 NZST
FD CRNT Y      11
      MDAL 1117
-----
RD BKUP Y      1 02-10-24 15:44:20 NZST
CARD/APPL  LOC  C  T  LEVEL          TIME LAST UPDATE    EXCEPTION
-----
SS7ANSI    1102 Y  N  11          02-10-29 08:04:00    -
SS7ANSI    1103 Y  N  11          02-10-29 08:04:00    -
VSCCP      1105 Y  N  11          02-10-29 08:04:00    -
STPLAN     1107 Y  N  11          02-10-29 08:04:00    -
TDM-CRNT   1114 Y  N  11          02-10-29 08:04:00    -
TDM-BKUP   1114 Y  -  11          02-10-29 08:04:00    -
TDM-CRNT   1116 Y  N  11          02-10-29 08:04:00    -
TDM-BKUP   1116 Y  -  11          02-10-29 08:04:00    -
MDAL       1117 Y  -  1          02-10-24 15:06:29    DIFF LEVEL
VSCCP      1201 Y  N  11          02-10-29 08:04:00    -
VSCCP      1203 Y  N  11          02-10-29 08:04:00    -
      ELAP A ( ACTV )
      C  BIRTHDATE          LEVEL          EXCEPTION
      -  -----
RTDB       Y  02-10-29 08:20:04    12345          -
RTDB-EAGLE      02-10-29 08:20:04    12345          -
      ELAP B ( STDBY )
      C  BIRTHDATE          LEVEL          EXCEPTION
      -  -----
RTDB       Y  02-10-29 08:20:04    12345          -
RTDB-EAGLE      02-10-29 08:20:04    12345          -
      EAGLE RTDB REPORT
CARD/APPL  LOC  C  BIRTHDATE          LEVEL          EXCEPTION
-----
VSCCP      1201 Y  02-10-29 08:20:04    12345          -
VSCCP      1203 Y  02-10-29 08:20:04    12345          -
VSCCP      1105 Y  02-10-29 08:20:04    12345          -

```

;

The database in the following example has no errors, as indicated by the OK status. The LNP ELAP Configuration controlled feature is enabled and turned on (see the **enable-ctrl-feat** command) in the system, and ELAP is being used.

rept-stat-db:display=except

```
tekelecstp 02-10-29 08:55:54 NZST EAGLE 30.0.0
rept-stat-db:display=except
Command entered at terminal #4.
DATABASE STATUS: >> OK <<
      TDM 1114 ( ACTV )                      TDM 1116 ( STDBY)
      C  LEVEL    TIME LAST BACKUP          C  LEVEL    TIME LAST BACKUP
      - - - - -
FD BKUP Y      11 02-10-29 08:20:13 NZST Y      11 02-10-29 08:20:13 NZST
FD CRNT Y      12                                Y      12
      MDAL 1117
      - - - - -
RD BKUP Y      1 02-10-24 15:44:20 NZST
CARD/APPL LOC  C  T  LEVEL          TIME LAST UPDATE    EXCEPTION
-----
SS7ANSI      1103 Y  N  10          02-10-29 08:03:48    DIFF LEVEL
TDM-BKUP     1114 Y  -  11          02-10-29 08:04:00    DIFF LEVEL
TDM-BKUP     1116 Y  -  11          02-10-29 08:04:00    DIFF LEVEL
MDAL         1117 Y  -  1          02-10-24 15:06:29    DIFF LEVEL
      ELAP A ( ACTV )
      C  BIRTHDATE          LEVEL          EXCEPTION
      - - - - -
RTDB         Y  02-10-29 08:20:04    12345          -
RTDB-EAGLE  Y  02-10-29 08:20:04    12345          -
      ELAP B ( STDBY )
      C  BIRTHDATE          LEVEL          EXCEPTION
      - - - - -
RTDB         Y  02-10-29 08:20:04    12345          -
RTDB-EAGLE  Y  02-10-29 08:20:04    12345          -
      EAGLE RTDB REPORT
CARD/APPL LOC  C  BIRTHDATE          LEVEL          EXCEPTION
-----
VSCCP      1203 Y  02-10-29 08:20:04    12340          DIFF LEVEL
;
```

The database in the following example has no errors, as indicated by the OK status. The G-Flex, G-Port, EIR, or INP feature is turned on in the system, and EPAP is being used.

rept-stat-db

```
tekelecstp 02-10-29 08:39:24 NZST EAGLE 31.0.0
rept-stat-db
Command entered at terminal #4.
DATABASE STATUS: >> OK <<
      TDM 1114 ( ACTV )                      TDM 1116 ( STDBY)
      C  LEVEL    TIME LAST BACKUP          C  LEVEL    TIME LAST BACKUP
      - - - - -
FD BKUP Y      11 02-10-29 08:20:13 NZST Y      11 02-10-29 08:20:13 NZST
FD CRNT Y      11                                Y      11
      MDAL 1117
      - - - - -
RD BKUP Y      1 02-10-24 15:44:20 NZST
```

```

EPAP A ( ACTV )
C BIRTHDATE          LEVEL          EXCEPTION
- - - - -
PDB                  Y 02-10-29 08:20:04    12345      -
RTDB                 Y 02-10-29 08:20:04    12345      -
RTDB-EAGLE          Y 02-10-29 08:20:04    12345      -
    
```

```

EPAP B ( STDBY )
C BIRTHDATE          LEVEL          EXCEPTION
- - - - -
PDB                  Y 02-10-29 08:20:04    12345      -
RTDB                 Y 02-10-29 08:20:04    12345      -
RTDB-EAGLE          Y 02-10-29 08:20:04    12345      -
    
```

The database in the following example has no errors, as indicated by the OK status. The G-Flex, G-Port, EIR, or INP feature is turned on in the system, and EPAP is being used.

rept-stat-db:display=all

```

tekelecstp 02-10-29 08:39:24 NZST EAGLE 31.0.0
DATABASE STATUS: >> OK <<
      TDM 1114 ( ACTV )          TDM 1116 ( STDBY )
      C  LEVEL    TIME LAST BACKUP    C  LEVEL    TIME LAST BACKUP
      - - - - -
FD BKUP Y      11 02-10-29 08:20:13 NZST Y      11 02-10-29 08:20:13 NZST
FD CRNT Y      11                                Y      11
      MDAL 1117
      - - - - -
RD BKUP Y      1 02-10-24 15:44:20 NZST

CARD/APPL  LOC  C  T  LEVEL          TIME LAST UPDATE    EXCEPTION
- - - - -
SS7ANSI    1102 Y  N  11          02-10-29 08:04:00    -
SS7ANSI    1103 Y  N  11          02-10-29 08:04:00    -
STPLAN     1107 Y  N  11          02-10-29 08:04:00    -
TDM-CRNT   1114 Y  N  11          02-10-29 08:04:00    -
TDM-BKUP   1114 Y  -  11          02-10-29 08:04:00    -
TDM-CRNT   1116 Y  N  11          02-10-29 08:04:00    -
TDM-BKUP   1116 Y  -  11          02-10-29 08:04:00    -
MDAL       1117 Y  -  1          02-10-24 15:06:29    DIFF LEVEL
VSCCP      1201 Y  N  11          02-10-29 08:04:00    -
VSCCP      1203 Y  N  11          02-10-29 08:04:00    -

EPAP A ( ACTV )
C BIRTHDATE          LEVEL          EXCEPTION
- - - - -
PDB                  Y 02-10-29 08:20:04    12345      -
RTDB                 Y 02-10-29 08:20:04    12345      -
RTDB-EAGLE          Y 02-10-29 08:20:04    12345      -

EPAP B ( STDBY )
C BIRTHDATE          LEVEL          EXCEPTION
- - - - -
PDB                  Y 02-10-29 08:20:04    12345      -
RTDB                 Y 02-10-29 08:20:04    12345      -
RTDB-EAGLE          Y 02-10-29 08:20:04    12345      -
    
```

```

                                EAGLE RTDB REPORT
CARD/APPL  LOC  C  BIRTHDATE          LEVEL      EXCEPTION
-----
VSCCP      1201 Y  02-10-29 08:20:04      12345      -
VSCCP      1203 Y  02-10-29 08:20:04      12345      -
VSCCP      1105 Y  02-10-29 08:20:04      12345      -
;

The database in the following example has no errors, as indicated by the OK status. The
G-Flex, G-Port, EIR, or INP feature is turned on in the system, and EPAP is being used.

rept-stat-db:display=except
tekelecstp 02-10-29 08:55:54 NZST EAGLE 31.0.0
rept-stat-db:display=except
Command entered at terminal #4.
DATABASE STATUS: >> OK <<
      TDM 1114 ( ACTV )                TDM 1116 ( STDBY )
      C  LEVEL      TIME LAST BACKUP  C  LEVEL      TIME LAST BACKUP
-----
FD BKUP Y          11 02-10-29 08:20:13 NZST Y          11 02-10-29 08:20:13 NZST
FD CRNT Y          12
      MDAL 1117
-----
RD BKUP Y          1 02-10-24 15:44:20 NZST

CARD/APPL  LOC  C  T  LEVEL      TIME LAST UPDATE  EXCEPTION
-----
SS7ANSI    1103 Y  N  10          02-10-29 08:03:48  DIFF LEVEL
TDM-BKUP   1114 Y  -  11          02-10-29 08:04:00  DIFF LEVEL
TDM-BKUP   1116 Y  -  11          02-10-29 08:04:00  DIFF LEVEL
MDAL       1117 Y  -  1          02-10-24 15:06:29  DIFF LEVEL

      EPAP A ( ACTV )
      C  BIRTHDATE          LEVEL      EXCEPTION
      -  -----
PDB       Y  02-10-29 08:20:04      12345      -
RTDB      Y  02-10-29 08:20:04      12345      -
RTDB-EAGLE Y  02-10-29 08:20:04      12345      -

      EPAP B ( STDBY )
      C  BIRTHDATE          LEVEL      EXCEPTION
      -  -----
PDB       Y  02-10-29 08:20:04      12345      -
RTDB      Y  02-10-29 08:20:04      12345      -
RTDB-EAGLE Y  02-10-29 08:20:04      12345      -

                                EAGLE RTDB REPORT
CARD/APPL  LOC  C  BIRTHDATE          LEVEL      EXCEPTION
-----
VSCCP      1203 Y  02-10-29 08:20:04      12340      DIFF LEVEL
;

```

The database in the following example has no errors, as indicated by the OK status. The G-Flex, G-Port, EIR, INP, and LNP ELAP Configuration features are not turned on in the system.

rept-stat-db:db=stp

```
tekelecstp 02-10-29 08:39:24 NZST EAGLE 31.0.0
rept-stat-db:db=stp
Command entered at terminal #4.
DATABASE STATUS: >> OK <<
      TDM 1114 ( ACTV )                TDM 1116 ( STDBY)
      C  LEVEL    TIME LAST BACKUP    C  LEVEL    TIME LAST BACKUP
-----
FD BKUP Y        11 02-10-29 08:20:13 NZST Y        11 02-10-29 08:20:13 NZST
FD CRNT Y         11                    Y         11
      MDAL 1117
-----
RD BKUP Y         1 02-10-24 15:44:20 NZST
;
```

The database in the following example has no errors, as indicated by the OK status. The G-Flex, G-Port, EIR, INP, and LNP ELAP Configuration features are not turned on in the system.

rept-stat-db:display=all:db=stp

```
tekelecstp 02-10-29 08:39:24 NZST EAGLE 31.0.0
rept-stat-db:display=all:db=stp
Command entered at terminal #4.
DATABASE STATUS: >> OK <<
      TDM 1114 ( ACTV )                TDM 1116 ( STDBY)
      C  LEVEL    TIME LAST BACKUP    C  LEVEL    TIME LAST BACKUP
-----
FD BKUP Y        11 02-10-29 08:20:13 NZST Y        11 02-10-29 08:20:13 NZST
FD CRNT Y         11                    Y         11
      MDAL 1117
-----
RD BKUP Y         1 02-10-24 15:44:20 NZST

CARD/APPL  LOC  C  T  LEVEL          TIME LAST UPDATE  EXCEPTION
-----
SS7ANSI    1102 Y  N  11          02-10-29 08:04:00  -
SS7ANSI    1103 Y  N  11          02-10-29 08:04:00  -
VSCCP      1105 Y  N  11          02-10-29 08:04:00  -
STPLAN     1107 Y  N  11          02-10-29 08:04:00  -
TDM-CRNT   1114 Y  N  11          02-10-29 08:04:00  -
TDM-BKUP   1114 Y  -  11          02-10-29 08:04:00  -
TDM-CRNT   1116 Y  N  11          02-10-29 08:04:00  -
TDM-BKUP   1116 Y  -  11          02-10-29 08:04:00  -
MDAL       1117 Y  -  1           02-10-24 15:06:29  DIFF LEVEL
VSCCP      1201 Y  N  11          02-10-29 08:04:00  -
VSCCP      1203 Y  N  11          02-10-29 08:04:00  -
;
```

The database in the following example has no errors, as indicated by the OK status. The G-Flex, G-Port, EIR, INP, and LNP ELAP Configuration features are not turned on in the system.

rept-stat-db:display=except:db=stp

```
tekelecstp 02-10-29 08:55:54 NZST EAGLE 31.0.0
rept-stat-db:display=except:db=stp
Command entered at terminal #4.
DATABASE STATUS: >> OK <<
      TDM 1114 ( ACTV )
      C  LEVEL      TIME LAST BACKUP
      - - - - -
FD BKUP Y          11 02-10-29 08:20:13 NZST
FD CRNT Y          12
      MDAL 1117
      - - - - -
RD BKUP Y          1 02-10-24 15:44:20 NZST

CARD/APPL  LOC  C  T  LEVEL      TIME LAST UPDATE  EXCEPTION
-----
SS7ANSI    1103 Y  N  10          02-10-29 08:03:48  DIFF LEVEL
TDM-BKUP   1114 Y  -  11          02-10-29 08:04:00  DIFF LEVEL
TDM-BKUP   1116 Y  -  11          02-10-29 08:04:00  DIFF LEVEL
MDAL       1117 Y  -  1          02-10-24 15:06:29  DIFF LEVEL
```

;

The LNP ELAP Configuration controlled feature is enabled and turned on (see the **enable-ctrl-feat** command) in the system, and ELAP is being used.

rept-stat-db:db=mps

```
tekelecstp 02-10-29 08:55:54 NZST EAGLE 30.0.0
rept-stat-db:db=mps
Command entered at terminal #4.
      ELAP A ( ACTV )
      C  BIRTHDATE      LEVEL      EXCEPTION
      - - - - -
RTDB      Y  02-10-29 08:20:04  12345      -
RTDB-EAGLE  Y  02-10-29 08:20:04  12345      -

      ELAP B ( STDBY )
      C  BIRTHDATE      LEVEL      EXCEPTION
      - - - - -
RTDB      Y  02-10-29 08:20:04  12345      -
RTDB-EAGLE  Y  02-10-29 08:20:04  12345      -
```

;

The LNP ELAP Configuration controlled feature is enabled and turned on (see the **enable-ctrl-feat** command) in the system, and ELAP is being used.

Card 1203 indicates a value 12 in the exception column. The value indicates the number of times that the Corruption Cross Correction function has corrected the card during the time that the card has been in service. More specifically, the card has encountered 12 corrupted records and has subsequently repaired them. This value persists until the card is reset.

rept-stat-db:display=all:db=mps

```
tekelecstp 02-10-29 08:55:54 NZST EAGLE 31.6.0
rept-stat-db:display=all:db=mps
Command entered at terminal #4.
      ELAP A ( ACTV )
      C BIRTHDATE          LEVEL          EXCEPTION
      - - - - -
RTDB      Y 02-10-29 08:20:04      12345          -
RTDB-EAGLE      02-10-29 08:20:04      12345          -

      ELAP B ( STDBY )
      C BIRTHDATE          LEVEL          EXCEPTION
      - - - - -
RTDB      Y 02-10-29 08:20:04      12345          -
RTDB-EAGLE      02-10-29 08:20:04      12345          -

      EAGLE RTDB REPORT
      CARD/APPL  LOC  C BIRTHDATE          LEVEL          EXCEPTION          IN-SRVC
      - - - - -
VSCCP      1201  Y 02-10-29 08:20:04      12345          -          10d 23h 21m
VSCCP      1203  Y 02-10-29 08:20:04      12345          12          10d 23h 21m
VSCCP      1105  Y 02-10-29 08:20:04      12345          -          5d 3h 1m
VSCCP      1201  Y 02-10-29 08:20:04      12345          -
VSCCP      1203  Y 02-10-29 08:20:04      12345          -
VSCCP      1105  Y 02-10-29 08:20:04      12345          -
;

```

The LNP ELAP Configuration controlled feature is enabled and turned on (see the **enable-ctrl-feat** command) in the system, and ELAP is being used.

rept-stat-db:display=except:db=mps

```
tekelecstp 02-10-29 08:55:54 NZST EAGLE 31.6.0
rept-stat-db:display=except:db=mps
Command entered at terminal #4.
      ELAP A ( ACTV )
      C BIRTHDATE          LEVEL          EXCEPTION
      - - - - -
RTDB      Y 02-10-29 08:20:04      12345          -
RTDB-EAGLE      Y 02-10-29 08:20:04      12345          -

      ELAP B ( STDBY )
      C BIRTHDATE          LEVEL          EXCEPTION
      - - - - -
RTDB      Y 02-10-29 08:20:04      12345          -
RTDB-EAGLE      Y 02-10-29 08:20:04      12345          -

      EAGLE RTDB REPORT
      CARD/APPL  LOC  C BIRTHDATE          LEVEL          EXCEPTION          IN-SRVC
      - - - - -
VSCCP      1203  Y 02-10-29 08:20:04      12340          DIFF LEVEL          10d 23h 21m
;

```

The G-Flex, G-Port, EIR, or INP feature is turned on in the system, and EPAP is being used.

rept-stat-db:db=mps

tekelecstp 02-10-29 08:55:54 NZST EAGLE 31.0.0

rept-stat-db:db=mps

Command entered at terminal #4.

EPAP A (ACTV)					
	C	BIRTHDATE		LEVEL	EXCEPTION
	-	-----		-----	-----
PDB	Y	02-10-29 08:20:04		12345	-
RTDB	Y	02-10-29 08:20:04		12345	-
RTDB-EAGLE	Y	02-10-29 08:20:04		12345	-

EPAP B (STDBY)					
	C	BIRTHDATE		LEVEL	EXCEPTION
	-	-----		-----	-----
PDB	Y	02-10-29 08:20:04		12345	-
RTDB	Y	02-10-29 08:20:04		12345	-
RTDB-EAGLE	Y	02-10-29 08:20:04		12345	-

;

The G-Flex, G-Port, EIR, or INP feature is turned on in the system, and EPAP is being used.

rept-stat-db:display=all:db=mps

tekelecstp 02-10-29 08:55:54 NZST EAGLE 31.6.0

rept-stat-db:display=all:db=mps

Command entered at terminal #4.

EPAP A (ACTV)						
	C	BIRTHDATE		LEVEL	EXCEPTION	
	-	-----		-----	-----	
PDB	Y	02-10-29 08:20:04		12345	-	
RTDB	Y	02-10-29 08:20:04		12345	-	
RTDB-EAGLE	Y	02-10-29 08:20:04		12345	-	

EPAP B (STDBY)						
	C	BIRTHDATE		LEVEL	EXCEPTION	
	-	-----		-----	-----	
PDB	Y	02-10-29 08:20:04		12345	-	
RTDB	Y	02-10-29 08:20:04		12345	-	
RTDB-EAGLE	Y	02-10-29 08:20:04		12345	-	

EAGLE RTDB REPORT							
CARD/APPL	LOC	C	BIRTHDATE		LEVEL	EXCEPTION	IN-SRVC
		-	-----		-----	-----	
VSCCP	1201	Y	02-10-29 08:20:04		12345	-	10d 23h 21m
VSCCP	1203	Y	02-10-29 08:20:04		12345	-	10d 23h 21m
VSCCP	1105	Y	02-10-29 08:20:04		12345	-	5d 3h 1m

;

The G-Flex, G-Port, EIR, or INP feature is turned on in the system, and EPAP is being used.

rept-stat-db:display=except:db=mps

```
tekelecstp 02-10-29 08:55:54 NZST EAGLE 31.6.0
rept-stat-db:display=except:db=mps
Command entered at terminal #4.
      EPAP A ( ACTV )
      C BIRTHDATE          LEVEL          EXCEPTION
      - -----
PDB      Y 02-10-29 08:20:04      12345          -
RTDB     Y 02-10-29 08:20:04      12345          -
RTDB-EAGLE Y 02-10-29 08:20:04      12345          -

      EPAP B ( STDBY )
      C BIRTHDATE          LEVEL          EXCEPTION
      - -----
PDB      Y 02-10-29 08:20:04      12345          -
RTDB     Y 02-10-29 08:20:04      12345          -
RTDB-EAGLE Y 02-10-29 08:20:04      12345          -

      EAGLE RTDB REPORT
      CARD/APPL LOC C BIRTHDATE          LEVEL          EXCEPTION          IN-SRVC
      -----
VSCCP      1203 Y 02-10-39 08:20:04      12340          DIFF LEVEL          10d 23h 21m
;

```

Legend

DATABASE STATUS—An indication of any database alarms on the MASPs. This indicator is not used with the **loc** parameter output.

>> **OK**<<—There are no database alarms

>> **NOT OK**<<—Database alarms are present

(ACTV MASP)—The specified MASP is the active processor. This is not used with the **loc** parameter output.

(STDBY MASP)—The specified MASP is the standby processor. This is not used with the **loc** parameter output.

(NOACCS)—The specified processor is not accessible. This is not used with the **loc** parameter output.

C—An indicator of whether the database is coherent.

Y—the database is coherent

N—the database is not coherent

Dash (-)—the database is not accessible.

LEVEL—The number of updates made to the database partitions.

TIME LAST BACKUP—The date and time the last change was performed on the removable cartridges (if inserted) and the backup partition of the fixed disk. This field is not used with the **loc** parameter output.

RD BKUP—Removable cartridge backup partition.

FD BKUP—Fixed disk backup partition.

FD CRNT—Fixed disk current partition. This field is not used with the **loc** parameter output.

DIFF CONTENTS—The specified database's contents are different when compared to the other database in that partition.

DIFF LEVEL—The specified database's level does not match the level of the current partition of the active fixed disk (**FD CRNT**).

DIFF TIME—The specified database's level matches the level of the current partition of the active fixed disk (**FD CRNT**), but the time that the database was updated, when compared to the current partition of the active fixed disk (**FD CRNT**), is different. This exception indicator appears only if the time and date stamp in an update packet or in memory becomes corrupted.

CORRUPTED—The specified database is corrupted.

INCOHERENT—The specified database is incoherent.

EXCEPTION—The following values can appear:

- The condition of the specified database with which the system has detected a problem. These conditions are: **DIFF CONTENTS**, **DIFF LEVEL**, **DIFF TIME**, **CORRUPTED**, and **INCOHERENT**. A "-" indicates that the database was not accessible. A blank entry indicates that the database has no problems. This field is used with the **display=except**, **display=all**, and **loc** parameter outputs.
- A value that indicates the number of times that the Corruption Cross Correction function has corrected the card during the time that the card has been in service. This value persists until the card is reset.

IN-SRVC—The length of time that the card has been in service.

CARD/APPL—The card type or the application assigned to the card specified in the **LOC** field. This field is not used with the **display=brief** (default) parameter output.

TDM-BKUP—Backup partition on the fixed disk on the TDM.

TDM-CRNT—Current partition on the fixed disk on the TDM.

LOC—The card location of the database. This field is not used with the **display=brief** (default) parameter output.

T—An indicator of whether the specified database is in transition. A database is in transition when the database for the link interface module (LIM) or TSM is in the process of being loaded with the new screen set information after an update to the database, and the database has not reached the current reported database level. This field is not used with the **display=brief** (default) parameter output.

Y—the database is in transition

N—the database is not in transition.

TIME LAST BACKUP—The date and time the last change was performed on the specified card and its associated database. A dash (-) in this field for the fixed drive (FD) or removable drive (RD) indicates that no backup has been created on that drive. This field is not used with the **display=brief** (default) parameter output.

VERSION—The version number of each database (including the LNP database if the LNP feature is on).

xxx-xxx-xxx—The version number of the database.

UNKNOWN—The **rept-stat-db** command can show the version number only for a database that is version 20.0.0 or later. Any database version that is earlier than version 20.0.0 cannot be determined and UNKNOWN is displayed for the database version number.

A dash “-” —The database is not available. This field is used only with the **display=version** parameter output.

STATUS—The operational status of the database version. This field is used only with the **display=version** parameter output.

NORMAL—The database version is fully operational.

Blank entry—A blank entry indicates that the database is not available or is unknown. A numeric value indicates that the database is invalid. The value displayed is the status value found in the field and is for diagnostic purposes.

BIRTHDATE—The date and time when the database was created.

EPAP A (ACTV)—The active EAGLE Provisioning Application Processor. This section of the report appears only if the G-Port, G-Flex, EIR, or INP features are turned on.

PDB—The provisioning database status information.

RTDB—The provisioning database status information that was used to create the resident real-time database. The RTDB information may be different than the PDB information if the PDB has been reloaded, or if the RTDB has not been loaded from the PDB. If the birthdate of the RTDB is different than the birthdate of the PDB or if the level is too old to be able to resynchronize the databases, then a "Reload Required" alarm is generated.

RTDB-EAGLE—The EPAP resident real-time database status information. This database is downloaded to DSM cards. If the birthdate or level do not match the DSM card, then the DSM card generates an alarm. The RTDB database is reloaded from the PDB, and the birthdate and level are reset and do not match the database status information. This database status mismatch condition indicates an abnormal condition that requires DSM cards to be reloaded.

EPAP B (STDBY)—The standby EAGLE Provisioning Application Processor. This section of the report appears only if the G-Port, G-Flex, EIR, or INP features are turned on.

PDB—The provisioning database status information.

RTDB—The provisioning database status information that was used to create the resident real-time database. The RTDB information may be different than the PDB information if the PDB has been reloaded, or if the RTDB has not been loaded from the PDB. If the RTDB birthdate is different than the PDB or if the level is too old to be able to resynchronize the databases, then a "Reload Required" alarm is generated.

RTDB-EAGLE—The EPAP resident real-time database status information. This database is downloaded to DSM cards. If the birthdate or level do not match the DSM card, then the DSM card generates an alarm. The RTDB database is reloaded from the PDB, and the birthdate and level are reset and do not match the database status

information. This database status mismatch condition indicates an abnormal condition that requires DSM cards to be reloaded.

ELAP A (ACTV)—The active EAGLE LNP Application Processor. This section of the report appears only if the LNP ELAP Configuration controlled feature (see the **enable-ctrl-feat** command) is turned on.

RTDB-EAGLE—The ELAP resident real-time database status information. This database is downloaded to DSM cards. If the birthdate or level do not match the DSM card, then the DSM card generates an alarm.

TIME LAST UPDATE—The date and time of the last update of the RTDB database from the LSMS.

ELAP B (STDBY)—The standby EAGLE LNP Application Processor. This section of the report appears only if the LNP ELAP Configuration controlled feature (see the **enable-ctrl-feat** command) is turned on.

RTDB-EAGLE—The ELAP resident real-time database status information. This database is downloaded to DSM cards. If the birthdate or level do not match the DSM card, then the DSM card generates an alarm.

TIME LAST UPDATE—The date and time of the last update of the RTDB database from the LSMS.

rept-stat-dlk

Report Status Data Link

Use this command to show the status of the TCP/IP data links. The secondary state (SST) of the TCP/IP data links shows whether the link is available, unavailable, or manually removed from service.

Keyword: **rept-stat-dlk**

Related Commands: **act-dlk, canc-dlk, dlt-dlk, ent-dlk, rtrv-dlk, tst-dlk**

Command Class: System Maintenance

Parameters

:loc= (optional)

The card location as stenciled on the shelf of the system.

Range: **1101-1108, 1111-1112, 1201-1208, 1211-1218, 1301-1308, 1311-1318, 2101-2108, 2111-2118, 2201-2208, 2211-2218, 2301-2308, 2311-2318, 3101-3108, 3111-3118, 3201-3208, 3211-3218, 3301-3308, 3311-3318, 4101-4108, 4111-4118, 4201-4208, 4211-4218, 4301-4308, 4311-4318, 5101-5108, 5111-5118, 5201-5208, 5211-5218, 5301-5308, 5311-5318, 6101-6108, 6111-6118**

Default: All data links are shown.

Example

```
rept-stat-dlk
```

```
rept-stat-dlk:loc=1104
```

Dependencies

No other **rept-stat-xxx** command can be in progress when this command is entered.

The ACM is the only valid card type for this command.

The shelf and card must be equipped.

The specified card must have a TCP/IP data link assigned to it.

Only one data link port on the ACM is supported. Reports are generated only on port A of the card.

Notes

None

Output**rept-stat-dlk**

```
rlghncxa03w 04-02-27 17:00:36 EST   EAGLE 31.3.0
DLK          PST          SST          AST
1104         IS-NR        Avail       ----
1206         IS-NR        Avail       ALMINH
Command Completed.
```

;

rept-stat-dlk:loc=1104

```
rlghncxa03w 04-02-27 17:00:36 EST   EAGLE 31.3.0
DLK          PST          SST          AST
1104         IS-NR        Avail       ----
ALARM STATUS      = No Alarms.
Command Completed.
```

;

Legend

DLK—The card location of the TCP/IP data link

PST—The primary state of the TCP/IP data link. The possible values are described in “Possible Values for PST/SST/AST” in Appendix A.

SST—The secondary state of the TCP/IP data link. The possible values are described in “Possible Values for PST/SST/AST” in Appendix A.

AST—The associated state of the TCP/IP data link. The possible values are described in “Possible Values for PST/SST/AST” in Appendix A.

rept-stat-dstn**Report Status Destination**

Use this command to generate a report of the MTP point code status for provisioned point codes. Any provisioned destination can be specified, including a cluster destination (*ni-nc-**) or a network destination (*ni-*.**).

Keyword: **rept-stat-dstn**

Related Commands: **chg-dstn, chg-rte, dlt-dstn, dlt-rte, ent-dstn, ent-rte, rtrv-dstn, rtrv-rte**

Command Class: System Maintenance

Parameters

NOTE: See “Point Code Formats and Conversion” in Appendix A for a detailed description of point code formats, rules for specification, and examples.

:dpc/dpca/dpci/dpcn/dpcn24= (optional)

Destination point code.

:dpc= or **:dpca=** (optional)

ANSI point code with subfields *network indicator-network cluster-network cluster member (ni-nc-ncm)*. The *prefix* subfield indicates a private point code (*prefix-ni-nc-ncm*).

Range: **p-**, **000-255**, *****, ******, *******

Specify a valid value for each subfield of the point code, and separate the subfields with a dash (-).

prefix—**p-**

The asterisk values *****, ******, and ******* are not valid for the *ni* subfield.

The asterisk values ****** and ******* are valid only for the *ncm* subfield.

When **chg-sid:pctype=ansi** is specified, *ni* = **000** is not valid.

When **chg-sid:pctype=ansi** is specified, *nc* = **000** is not valid if *ni* = **001-005**.

When **chg-sid:pctype=ansi** is specified, *nc* = **000** is valid if *ni* = **006-255**.

When **chg-sid:pctype=ansi** is specified, *ni*ⁱ-*-* is valid if *ni* = **006-255**.

The point code **000-000-000** is not a valid point code.

:dpci= (optional)

ITU international point code with subfields *zone-area-id*. The *prefix* subfield indicates a spare point code, private point code, or private and spare point code (*prefix-zone-area-id*).

Range: **s-**, **p-**, **ps**, **0-255**

Specify a valid value for each subfield of the point code, and separate the subfields with a dash (-).

The point code **0-000-0** is not a valid point code.

prefix—**s-**, **p-**, **ps-**

zone—**0-7**

area—**000-255**

id—**0-7**

:dpcn= (optional)

ITU national point code in the format of a 5-digit number (*nnnnn*); or 2, 3, or 4 numbers (members) separated by dashes (*m1-m2-m3-m4*) as defined by the **chg-stpopts:npfmti** flexible point code option. A group code must be specified when the ITUDUPPC feature is turned on (*nnnnn-gc*, *m1-m2-m3-m4-gc*). The *prefix* subfield indicates a spare point code, private point code, or private and spare point code (*prefix-nnnnn*, *prefix-nnnnn-gc*, *prefix-m1-m2-m3-m4*, *prefix-m1-m2-m3-m4-gc*).

Range: **s-**, **p-**, **ps-**, **0-16383**, **aa-zz**

Specify a valid value for each subfield of the point code, and separate the subfields with a dash (-).

prefix—**s-**, **p-**, **ps-**

nnnnn—**0-16383**

gc—**aa - zz**

m1-m2-m3-m4—**0-14** for each member; values must sum to 14

:dpcn24= (optional)

24-bit ITU national destination point code with subfields *main signaling area-sub signaling area-signaling point (msa-ssa-sp)*. The *prefix* subfield indicates a private point code (*prefix-msa-ssa-sp*).

Range: **p-, 000-255**

Specify a valid value for each subfield of the point code, and separate the subfields with a dash (-).

prefix—**p-**

msa—**000-255**

ssa—**000-255**

sp—**000-255**

:mode= (optional)

The type of display to produce.

Range: **full**

Default: A summary report is displayed.

:stat= (optional)

The primary state filter. This parameter lets you choose the state of the destination for which you want a report. In other words, if you want a report for all destinations whose state is DSBLD, specify **:stat=dsbld**.

Range: **all, alminh, anr, dsbld, mt, nr**

all—All of the primary states

alminh—Alarms inhibited

anr—In service abnormal (IS-ANR)

dsbld—Out of service maintenance disabled (OOS-MT-DSBLD)

mt—Out of service maintenance (OOS-MT)

nr—In service normal (IS-NR)

Default: **all**

Example

rept-stat-dstn

rept-stat-dstn:dpci=2-004-1:mode=full

rept-stat-dstn:dpc=9-3-6:mode=full

rept-stat-dstn:dpc=9-3-*:mode=full

rept-stat-dstn:dpc=9-3-*

rept-stat-dstn:dpc=9-3-**

rept-stat-dstn:dpc=9-3-***

rept-stat-dstn:dpc=9-3-*:stat=mt**

rept-stat-dstn:dpc=9-4-*:stat=alminh**

Dependencies

No other **rept-stat-xxx** command can be in progress when this command is entered.

The mode parameter can be specified only if a **dpc** parameter is specified; however, any of the *ni-nc-** formats cannot be specified for the **dpc** parameter when the **mode** parameter is specified.

If a **dpc** parameter is specified, it must be the true destination point code (not an alias) and it must be defined in the database.

A summary report is displayed if the **stat** parameter is specified.

The **stat** parameter can be specified with the **dpc** parameter only if the **dpc** parameter specifies one of the *ni-nc-** formats.

An x-list DPC cannot be specified in the **dpc** parameter.

If the **dpcn** parameter is specified, its format must match the format that was assigned with the **chg-stpopts:npcfmti** parameter.

Notes

This command can be canceled using the **F9** function key or the **canc-cmd** command. See **canc-cmd** for more information.

This command does not report the x-list point codes. Use the **rept-stat-cluster** command for a report of x-list point codes.

If the **mode=full** parameter is specified, additional linkset and route information associated with the specified destination is displayed, along with information that can be used to correct circular routing.

In this command, only ITU-international and ITU national point codes support the spare point code subtype prefix (s-) and the private and spare point code subtype prefix (**ps-**). All of the point code types support the private (internal) point code subtype prefix (**p-**).

Table 7-8 provides a summary description of the reports that are produced by the various DPC parameter syntaxes.

Table 7-8. Summary of DPC Parameter Syntaxes

DPC format	Meaning
rept-stat-dstn:dpc=ni-nc-ncm	Requests a report for fully provisioned destination <i>ni-nc-ncm</i> .
rept-stat-dstn:dpc=ni-*.*	Requests a report for provisioned network destination with the specified network indicator. Note that if * is specified in the <i>nc</i> field, * must be specified in the <i>ncm</i> field.
rept-stat-dstn:dpc=ni-**-*	Requests a report for the full network cluster for the specified <i>ni</i> .
rept-stat-dstn:dpc=ni-***-*	Requests a report for the full network cluster and the network cluster address (if any) for the specified <i>ni</i> .
rept-stat-dstn:dpc=ni-nc-*	Requests a report for provisioned cluster destination <i>ni-nc-*</i> .
rept-stat-dstn:dpc=ni-nc-**-*	Requests a report showing all destinations whose network (<i>ni</i>) and cluster (<i>nc</i>) components match those specified. Note, however, that the network cluster address on <i>ni-nc-*</i> (if it exists) is not reported.
rept-stat-dstn:dpc=ni-nc-***-*	Requests a report showing all destinations whose network (<i>ni</i>) and cluster (<i>nc</i>) components match those specified. The network cluster address <i>ni-nc-*</i> (if it exists) is also reported.
rept-stat-dstn:dpcn24=msa-ssa-sp	Requests a report for fully provisioned 24-bit destination <i>main signaling area-sub signaling area-signaling point</i> .

Output

The following example shows a private adjacent point code:

rept-stat-dstn:mode=full:dpc=1-1-2

```
rlghncxa03w 05-01-07 13:30:00 EST EAGLE 31.12.0
DPCA          PST          SST          AST
001-001-002   OOS-MT      Idle      INACCESS
ALARM STATUS   = No Alarms.
RTE COST  LSN          APCA          LS STAT  NON-ADJ  ROUTE STAT
 1   01   ls11234567      001-001-002  Prohibit  Allowed  Prohibit
 2   02   ls12345678   p-001-001-002  Prohibit  Allowed  Prohibit
 3   --   -----          -*****-      -----
 4   --   -----          -*****-      -----
 5   --   -----          -*****-      -----
 6   --   -----          -*****-      -----
SSN  SUBSYSTEM STATUS

          ALIASA          ALIASN          ALIASI
          000-000-001  -----          -----
CIRCULAR ROUTING INFO:
XMIT LSN=-----          RC=--
RCV LSN=-----
MEMBER =-----
Command Completed.
```

;

The following example shows how, when no parameters are specified, summary information for all provisioned cluster and noncluster DPCs is reported.

rept-stat-dstn

```
rlghncxa03w 04-07-07 14:59:11 EST EAGLE 31.9.0
DPCA          PST          SST          AST
009-000-000   IS-ANR      Allowed  ACCESS
009-003-*     IS-ANR      Allowed  ACCESS
009-003-006   OOS-MT      Prohibit INACCESS
009-003-001   IS-NR       Allowed  ACCESS
009-003-002   IS-NR       Allowed  ACCESS
009-003-003   OOS-MT      Prohibit INACCESS
009-004-006   IS-NR       Allowed  ALMINH
004-002-002   IS-NR       Allowed  ACCESS
006-000-000   IS-ANR      Allowed  ACCESS
007-001-001   IS-NR       Allowed  ACCESS
101-033-*     IS-NR       Allowed  ACCESS

DPCI          PST          SST          AST
2-004-1       IS-NR       Allowed  ACCESS
2-004-3       IS-ANR      Allowed  ACCESS
2-004-2       IS-ANR      Allowed  ACCESS
2-004-4       IS-NR       Allowed  ACCESS

DPCN          PST          SST          AST
02096         IS-NR       Allowed  ACCESS
02097         IS-ANR      Allowed  ACCESS
02098         OOS-MT      Prohibit INACCESS
02099         OOS-MT      Prohibit INACCESS
Command Completed.
```

;

The following example shows that specifying a cluster destination on the **dpc** parameter shows the cluster status and routeset information. Note that information on cluster members (both provisioned and x-list) is not shown. Use **rept-stat-cluster** to obtain this information.

rept-stat-dstn:dpc=9-3-*

```
rlghncxa03w 04-07-07 14:59:11 EST EAGLE 31.9.0
DPCA          PST          SST          AST
009-003-*     IS-NR          Allowed    ACCESS
ALARM STATUS      = No Alarms.
RTE COST  LSN      APCA          LS STAT    NON-ADJ    ROUTE STAT
 1   10  lsnstpa   042-036-123 Allowed    Allowed    Allowed
 2   20  lsnstpb   092-240-103 Allowed    Allowed    Allowed
 3   30  lsnstpc   128-101-022 Allowed    Allowed    Allowed
 4   --  -----   ***-***-*** -----    -----    -----
 5   --  -----   ***-***-*** -----    -----    -----
 6   --  -----   ***-***-*** -----    -----    -----
;
```

The following example shows how specifying either an FPC or cluster destination for which circular routing has been detected, along with the **mode=full** parameter, displays the name of the linkset on which the circular routing test message was transmitted. It also displays the linkset on which the circularly routed message was received. This information may be useful in correcting the circular routing situation.

rept-stat-dstn:dpc=9-3-6:mode=full

```
rlghncxa03w 04-07-07 14:59:11 EST EAGLE 31.9.0
DPCA          PST          SST          AST
009-003-006   OOS-MT          Prohibit    INACCESS
ALARM STATUS      = = *C   xxxx Circular routing detected
RTE COST  LSN      APCA          LS STAT    NON-ADJ    ROUTE STAT
 1   10  lsnstpa   042-036-123 Allowed    Allowed    Allowed
 2   20  lsnstpb   092-240-103 Allowed    Allowed    Allowed
 3   30  lsnstpc   128-101-022 Allowed    Allowed    Allowed
 4   --  -----   ***-***-*** -----    -----    -----
 5   --  -----   ***-***-*** -----    -----    -----
 6   --  -----   ***-***-*** -----    -----    -----
SSN  SUBSYSTEM STATUS

ALIASA      ALIASN      ALIASI
-----
CIRCULAR ROUTING
XMIT LSN= lsnstpb
RCV  LSN= lsn01a
MEMBER= ***-***-***
Command Completed.
;
```

The following example shows a typical report when a cluster destination and **mode=full** was specified. The interpretation of the circular routing status for cluster destinations is slightly different from an FPC's.

rept-stat-dstn:dpc=9-3-*:mode=full

```
rlghncxa03w 04-07-07 14:59:11 EST EAGLE 31.9.0
DPCA          PST          SST          AST
009-003-*     IS-NR          Allowed    ACCESS
ALARM STATUS  = *C  xxxx Circular routing detected
RTE COST  LSN      APCA          LS STAT  NON-ADJ  ROUTE STAT
1   10  lsnstpa  042-036-123  Allowed  Allowed  Allowed
2   20  lsnstpb  092-240-103  Allowed  Allowed  Allowed
3   30  lsnstpc  128-101-022  Allowed  Allowed  Allowed
4   --  -----  ***-***-***  -----  -----  -----
5   --  -----  ***-***-***  -----  -----  -----
6   --  -----  ***-***-***  -----  -----  -----
SSN  SUBSYSTEM STATUS
ALIASA      ALIASN      ALIASI
-----
CIRCULAR ROUTING INFO:
XMIT LSN=lsnstpb  RC=20
RCV  LSN=lsn01a
MEMBER= 009-003-006
Command Completed.
```

;

The following example shows how **rept-stat-dstn** displays the circular routing alarm for a cluster destination. Note that a circular routing alarm for a cluster destination indicates that circular routing was detected for a member of the cluster, but no x-list entry could be created for that cluster. Note, also, that circular routing detected on a cluster destination does not automatically force the output to display the status of the cluster as “OOS-MT Prohibit INACCESS” as it does for an FPC destination.

rept-stat-dstn:dpc=9-3-*

```
rlghncxa03w 04-07-07 14:59:11 EST EAGLE 31.9.0
DPCA          PST          SST          AST
009-003-*     IS-NR          Allowed    ACCESS
ALARM STATUS  = *C  xxxx Circular routing detected
RTE COST  LSN      APCA          LS STAT  NON-ADJ  ROUTE STAT
1   10  lsnstpa  042-036-123  Allowed  Allowed  Allowed
2   20  lsnstpb  092-240-103  Allowed  Allowed  Allowed
3   30  lsnstpc  128-101-022  Allowed  Allowed  Allowed
4   --  -----  ***-***-***  -----  -----  -----
5   --  -----  ***-***-***  -----  -----  -----
6   --  -----  ***-***-***  -----  -----  -----
Command Completed.
```

;

The following example shows how **rept-stat-dstn** displays a subsystem information header but no subsystem information, just as it would if an FPC is specified for which no subsystems are defined. In addition, because aliases cannot be defined for cluster destinations, this report shows only an empty header, just as it does when an FPC is specified for which no aliases are defined. Note that the circular routing information portion of the **mode=full** report displays "-----" for the linkset names when no circular routing condition exists for the DPC.

rept-stat-dstn:dpc=9-3-*.mode=full

```
rlghncxa03w 04-07-07 14:59:11 EST EAGLE 31.9.0
DPCA          PST          SST          AST
009-003-*     IS-NR          Allowed     ACCESS
ALARM STATUS      = No Alarms.
RTE COST  LSN      APCA          LS STAT    NON-ADJ    ROUTE STAT
 1*  10  lsnstpa  042-036-123  Allowed    Allowed    Allowed
 2   20  lsnstpb  092-240-103  Allowed    Allowed    Allowed
 3   30  lsnstpc  128-101-022  Allowed    Allowed    Allowed
 4   --  -----  ***-***-***  -----    -----    -----
 5   --  -----  ***-***-***  -----    -----    -----
 6   --  -----  ***-***-***  -----    -----    -----
SSN      SUBSYSTEM STATUS

ALIASA          ALIASN          ALIASI
-----

CIRCULAR ROUTING
XMIT LSN= -----
RCV  LSN= -----
MEMBER= ***-***-***
Command Completed.
```

;

The following example shows how specifying the **stat** parameter along with the **ni-nc-*** or **ni-nc-***** DPC formats causes the output summary report to include only those destinations whose status matches the state specified.

rept-stat-dstn:dpc=9-4-*:stat=alminh**

```
rlghncxa03w 04-02-31 13:30:00 EST EAGLE 31.9.0
DPCA          PST          SST          AST
009-004-006   IS-NR          Allowed     ALMINH
Command Completed.
```

;

The following example shows a retrieval specifying an ITU national point code where the **chg-stpopts:npcfnti** parameter has been set to **1-1-1-11**:

rept-stat-dstn:dpcn=1-1-1-1000

```
rlghncxa03w 04-02-31 13:30:00 EST EAGLE 31.3.0
CAUTION : Node isolated...route status out of date!
DPCN          PST          SST          AST
1-1-1-1000    OOS-MT          Prohibit    INACCESS
ALARM STATUS   = *C 0313 DPC is prohibited
RTE COST  LSN          APCN          LS STAT    NON-ADJ    ROUTE STAT
1   10   lsitu          1-1-1-1000    Prohibit    Allowed     Prohibit
2   --   -----          ***-***-***    -----    -----    -----
3   --   -----          ***-***-***    -----    -----    -----
4   --   -----          ***-***-***    -----    -----    -----
5   --   -----          ***-***-***    -----    -----    -----
6   --   -----          ***-***-***    -----    -----    -----
Command Completed.
```

;

The asterisks in the space after the route numbers in the following examples indicate which route (or combined route) is carrying traffic.

rept-stat-dstn:dpc=1-1-1

```
tekelecstp 04-09-24 09:19:04 EST EAGLE 31.9.0
DPCA          PST          SST          AST
001-001-001   IS-NR          Allowed     ACCESS
ALARM STATUS   = No Alarms.
RTE COST  LSN          APCA          LS STAT    NON-ADJ    ROUTE STAT
1*  05   lse1e1          001-001-001    Allowed    Allowed    Allowed
2*  05   lse1e2          001-002-001    Allowed    Allowed    Allowed
3   10   lse1e3          001-003-001    Allowed    Allowed    Allowed
4   --   -----          ---***-***-***  -----    -----    -----
5   --   -----          ---***-***-***  -----    -----    -----
6   --   -----          ---***-***-***  -----    -----    -----
Command Completed.
```

;

rept-stat-dstn:dpc=1-1-1

No asterisk appears after the route number in the following example; no routes were carrying traffic at the time.

```
tekelecstp 04-09-24 09:19:04 EST EAGLE 31.9.0
DPCA          PST          SST          AST
001-001-001   OOS-MT          Prohibit    INACCESS
ALARM STATUS   = *C 0313 DPC is prohibited
RTE COST  LSN          APCA          LS STAT    NON-ADJ    ROUTE STAT
1   05   lse1e1          001-001-001    Prohibit    Allowed     Prohibit
2   05   lse1e2          001-002-001    Prohibit    Allowed     Prohibit
3   10   lse1e3          001-003-001    Prohibit    Allowed     Prohibit
4   --   -----          ***-***-***    -----    -----    -----
5   --   -----          ***-***-***    -----    -----    -----
6   --   -----          ***-***-***    -----    -----    -----
Command Completed.
```

;

In the following example, the primary route is not carrying traffic.

rept-stat-dstn:dpc=1-1-1

```
tekelecstp 04-09-24 09:19:04 EST EAGLE 31.9.0
DPCA          PST          SST          AST
001-001-001   IS-ANR          Restrict  ACCESS
ALARM STATUS   = *C 0334 DPC Subsystem is Abnormal
RTE COST  LSN          APCA          LS STAT  NON-ADJ  ROUTE STAT
1    05   lse1e1      001-001-001  Prohibit  Allowed  Prohibit
2    05   lse1e2      001-002-001  Prohibit  Allowed  Prohibit
3*  10   lse1e3      001-003-001  Allowed   Allowed  Allowed
4    --   -----   ***-***-***  -----  -----  -----
5    --   -----   ***-***-***  -----  -----  -----
6    --   -----   ***-***-***  -----  -----  -----
Command Completed.
```

;

Legend

DPC/DPCA—The ANSI destination point code of the route

PST—The primary state of the subsystem. The possible values are described in “Possible Values for PST/SST/AST” in Appendix A.

SST—The secondary state of the subsystem. The possible values are described in “Possible Values for PST/SST/AST” in Appendix A.

AST—The associated state of the subsystem. The possible values are described in “Possible Values for PST/SST/AST” in Appendix A.

rept-stat-e1

Report Status E1

Use this command to display the E1 port status and signaling link status for cards with provisioned E1 ports.

Keyword: **rept-stat-e1**

Related Commands: None

Command Class: System Maintenance

Parameters

:e1port= (optional)

The E1 port number. When this parameter is specified, only the information for the specified E1 port on the card in the specified card location is displayed.

Range: 1-8

Ports 3 through 8 can be specified only for HC-MIM cards.

:loc= (optional)

Card location. The unique identifier of a specific **lime1** card located in the STP.

Range: 1101–1108, 1111–1112, 1201–1208, 1211–1218, 1301–1308, 1311–1318, 2101–2108, 2111–2118, 2201–2208, 2211–2218, 2301–2308, 2311–2318, 3101–3108, 3111–3118, 3201–3208, 3211–3218, 3301–3308, 3311–3318, 4101–4108, 4111–4118, 4201–4208, 4211–4218, 4301–4308, 4311–4318, 5101–5108, 5111–5118, 5201–5208, 5211–5218, 5301–5308, 5311–5318, 6101–6108, 6111–6118

Default: Information for all **lime1** cards is reported.

Example

rept-stat-e1

Dependencies

No other **rept-stat-xxx** command can be in progress when this command is entered.

The **loc** parameter must be specified when the **e1port** parameter is specified.

The active TDM location cannot be specified in the **loc** parameter.

Card locations 1117 and 1118 and the HMUX or HIPR card locations (*xy09* and *xy10* where *x* is the frame and *y* is the shelf) cannot be specified in the **loc** parameter.

Notes

Specifying the command without any parameters displays E1 port status for all cards with provisioned E1 ports.

If the **loc** parameter is specified, status is displayed for all E1 ports provisioned on the card in the specified location.

If the **loc** and **e1port** parameters are specified, the E1 port status summary is displayed for all E1 ports provisioned on the card in the specified location, followed by the status of all signaling links assigned to the specified E1 port on the card.

Output

When no parameters are specified in the command, E1 port status is displayed for all cards with provisioned E1 ports. Ports 3 through 8 are on HC-MIM cards only.

rept-stat-e1

```
rlghncxa03w 05-01-04 07:01:08 EST EAGLE5 33.0.0
LOC    E1PORT  PST          SST          AST
1203   1        IS-NR        Avail        PARENT
1203   2        IS-NR        Avail        PAIRED
1203   3        IS-NR        Avail        -----
1203   7        OOS-MT       Unavail      -----
1207   1        IS-NR        Avail        -----
1207   2        IS-NR        Avail        -----
Command Completed.
```

;

When the **loc** parameter is specified, status is displayed for all E1 ports provisioned on the card in the specified location.

rept-stat-e1:loc=1203

```
rlghncxa03w 05-01-04 07:01:08 EST EAGLE5 33.0.0
LOC    E1PORT  PST          SST          AST
1203   1        IS-NR        Avail        PARENT
1203   2        IS-NR        Avail        PAIRED
1203   3        IS-NR        Avail        -----
1203   7        OOS-MT       Unavail      -----
Command Completed.
```

;

When the **loc** and **e1port** parameters are specified, the E1 port status summary is displayed for all E1 ports provisioned on the card in the specified location, followed by the status of all signaling links assigned to the specified E1 port on the card.

rept-stat-e1:loc=1203:e1port=1

```
rlghncxa03w 05-01-04 07:01:08 EST EAGLE5 33.0.0
LOC   E1PORT   PST           SST           AST
1203  1         IS-NR         Avail         PARENT
ALARM STATUS      = No Alarms.
UNAVAIL REASON    = --
SLK   TS   PST           SST           AST
A     1   IS-NR         Avail         ---
A1    2   IS-NR         Avail         ---
Command Completed.
```

;

rept-stat-e1:loc=1203:e1port=2

```
rlghncxa03w 05-01-04 07:01:08 EST EAGLE5 33.0.0
LOC   E1PORT   PST           SST           AST
1203  2         IS-NR         Avail         PAIRED
ALARM STATUS      = No Alarms.
UNAVAIL REASON    = --
Command Completed.
```

;

Legend

LOC—Card location

E1PORT—Number of the E1 port provisioned on the card in the specified location.

PST—The primary state of the card. The possible values are described in “Possible Values for PST/SST/AST” in Appendix A.

SST—The secondary state of the card. The possible values are described in “Possible Values for PST/SST/AST” in Appendix A.

AST—The associated state of the card. The possible values are described in “Possible Values for PST/SST/AST” in Appendix A. The values PARENT and PAIRED refer to odd and even adjacent ports on the card that are provisioned in channel bridging mode.

ALARM STATUS—Either "No Alarms" or current alarm number and text

UNAVAIL REASON—Reason for the E1 port being unavailable

SLK—Signaling link assigned to the E1 port

TS—Timeslot assigned to the signaling link

PST—The primary state of the signaling link. The possible values are described in “Possible Values for PST/SST/AST” in Appendix A.

SST—The secondary state of the signaling link. The possible values are described in “Possible Values for PST/SST/AST” in Appendix A.

AST—The associated state of the signaling link. The possible values are described in “Possible Values for PST/SST/AST” in Appendix A.

rept-stat-eroute**Report Status EROUTE**

Use this command to display the status of the STC cards that run the **eroute** application for the EAGLE Support for Integrated Sentinel (EIS) feature.

Keyword: **rept-stat-eroute**

Related Commands: None

Command Class: System Maintenance

Parameters

:loc= (optional)

Card location. The unique identifier of a specific STC card located in the STP.

Range: 1101-1108, 1111-1112, 1201-1208, 1211-1218, 1301-1308, 1311-1318, 2101-2108, 2111-2118, 2201-2208, 2211-2218, 2301-2308, 2311-2318, 3101-3108, 3111-3118, 3201-3208, 3211-3218, 3301-3308, 3311-3318, 4101-4108, 4111-4118, 4201-4208, 4211-4218, 4301-4308, 4311-4318, 5101-5108, 5111-5118, 5201-5208, 5211-5218, 5301-5308, 5311-5318, 6101-6108, 6111-6118

Default: All STC cards are reported.

:mode= (optional)

Mode of reporting for the command. When **mode=perf** is specified, only subsystem performance information is displayed.

Range: **perf**

Default: None.

Example

```
rept-stat-eroute
rept-stat-eroute:mode=perf
rept-stat-eroute:loc=1213
```

Dependencies

The **mode** and **loc** parameters cannot be specified in the same command.

No other **rept-stat-xxx** command can be in progress when this command is entered.

At least one STC card running the **eroute** application must be configured before this command can be entered.

Notes

When the **loc** parameter is specified, only the card information for the specified card is displayed.

When the **mode=perf** parameter is specified, only subsystem performance information is displayed.

Output

When no parameters are specified in the command, the report shows card, subsystem, and alarm information.

rept-stat-eroute

```
rlghncxa03w 04-02-04 07:01:08 EST EAGLE 31.3.0
EROUTE SUBSYSTEM REPORT IS-ANR      Busy      -----
STC Cards Configured= 8  Cards IS-NR= 4
EISCOPY BIT = ON
System Threshold = 80% Total Capacity
System Peak EROUTE Load:           8000 Buffers/Sec
System Total EROUTE Capacity:      9600 Buffers/Sec
SYSTEM ALARM STATUS = * 0472 EROUTE System Threshold Exceeded
```

CARD	VERSION	PST	SST	AST	TVG USAGE	CPU USAGE
1205	236-024-005	IS-NR	Active	-----	22%	33%
1211	236-024-005	IS-NR	Active	-----	22%	33%
1303	255-255-255	OOS-MT	Isolated	-----	0%	0%
1311	255-255-255	OOS-MT	Isolated	-----	0%	0%
1313	255-255-255	OOS-MT	Isolated	-----	0%	0%
2211	236-024-005	IS-ANR	Active	-----	0%	0%
2213	236-024-005	IS-NR	Active	-----	22%	33%
1105	236-024-005	IS-NR	Active	-----	22%	33%

```
-----
EROUTE Service Average TVG Capacity = 22% Average CPU Capacity = 33%
```

Command Completed.

;

rept-stat-eroute

```
rlghncxa03w 04-02-04 07:01:08 EST EAGLE 31.3.0
EROUTE SUBSYSTEM REPORT IS-ANR      Busy      -----
STC Cards Configured= 2  Cards IS-NR= 2
EISCOPY BIT = ON
System Threshold = 80% Total Capacity
System Peak EROUTE Load:           4800 Buffers/Sec
System Total EROUTE Capacity:      4800 Buffers/Sec

SYSTEM ALARM STATUS = * 0472 EROUTE System Threshold Exceeded
```

CARD	VERSION	PST	SST	AST	TVG USAGE	CPU USAGE
1213	111-024-000	IS-NR	Active	-----	80%	53%
1105	111-024-000	IS-NR	Active	-----	80%	53%

```
-----
EROUTE Service Average TVG Capacity = 80% Average CPU Capacity = 53%
```

Command Completed.

;

When **mode=perf** is specified in the command, only subsystem performance information is displayed. The CARDS DENIED EROUTE SERVICE line appears only if there is at least one card that is denied service when the command is entered.

rept-stat-eroute:mode=perf

```
rlghncxa03w 04-02-04 07:01:08 EST EAGLE 31.3.0
EROUTE SUBSYSTEM REPORT IS-ANR Ovrflw=1 -----
STC Cards Configured= 1 Cards IS-NR= 1
EISCOPY BIT = ON
System Threshold = 80% Total Capacity
System Peak EROUTE Load: 8000 Buffers/Sec
System Total EROUTE Capacity: 9600 Buffers/Sec

SYSTEM ALARM STATUS = * 0482 Card(s) have been denied EROUTE service

STATISTICS
=====
CARD CPU USAGE TVG RATE
-----
1213 33% 1000
-----
AVERAGE TVG USAGE = 22%
AVERAGE CPU USAGE = 33%
TOTAL TVG RATE = 8000

STATISTICS FOR PAST 30 SECONDS
=====
TOTAL TVG: 8000
TOTAL EROUTE: 0

CARDS DENIED EROUTE SERVICE: 1302, 1305
Command Completed.
;
```

rept-stat-eroute:mode=perf

```
rlghncxa03w 04-02-04 07:01:08 EST EAGLE 31.3.0
EROUTE SUBSYSTEM REPORT IS-ANR Busy -----
STC Cards Configured= 2 Cards IS-NR= 2
EISCOPY BIT = ON
System Threshold = 80% Total Capacity
System Peak EROUTE Load: 4800 Buffers/Sec
System Total EROUTE Capacity: 4800 Buffers/Sec

SYSTEM ALARM STATUS = * 0472 EROUTE System Threshold Exceeded

STATISTICS
=====
CARD CPU USAGE TVG RATE
-----
1213 53% 1920
1105 53% 1920
-----
AVERAGE TVG Capacity = 80%
AVERAGE CPU USAGE = 53%
TOTAL TVG RATE = 3840
Command Completed.
;
```

When the **loc** parameter is specified in the command, only the information for the specified card is displayed.

rept-stat-eroute:loc=1213

```
rlghncxa03w 04-02-04 07:01:08 EST EAGLE 31.3.0
CARD  VERSION      TYPE   PST           SST           AST
1213  227-023-002  STC   IS-NR        Active        -----
CARD ALARM STATUS = * 0480 Timestamp Invalid
TOTAL CPU USAGE = 0%
```

Command Completed.

;

The following report shows the alarm status and error status of the ports associated with the provisioned card.

rept-stat-eroute:loc=1105

Command Accepted - Processing

;

```
tekelecstp 05-08-23 13:09:08 EST EAGLE5 34.0.0
CARD  VERSION      TYPE   PST           SST           AST
1105  055-038-006  STC   IS-NR        Active        -----
CARD ALARM STATUS = * 0480 Timestamp Invalid
TOTAL CPU USAGE = 5%
NTP broadcast = INVALID
STC IP PORT A:           IS-NR        Active        -----
    ALARM STATUS = No Alarms.
STC IP PORT B:           OOS-MT      Unavail       -----
    ALARM STATUS = ** 0084 IP Connection Unavailable
    ERROR STATUS = DHCP Lease. Physical Link.
```

Command Completed.

;

Legend

When no parameters are specified in the command, the following information appears in the report:

EROUTE SUBSYSTEM REPORT—State of the subsystem

STC CARDS CONFIGURED—Number of STC cards configured in the system

CARDS IS-NR—Number of STC cards in IS-NR state

EISCOPY BIT—Indicates whether EIS copy function is turned On or Off

SYSTEM THRESHOLD—% of system total capacity being used

SYSTEM PEAK EROUTE LOAD—Current load in Buffers/Second

SYSTEM TOTAL EROUTE CAPACITY—Total capacity in Buffers/Second

SYSTEM ALARM STATUS—Either "No Alarms" or current alarm number and text

CARD—Card location

VERSION—The version number of the GPL loaded on the card. Dashes (- - - -) in the version column indicate one of the following conditions about the card:

- The card does not run a GPL, such as TDM or MDAL cards.
- The card is configured but is not physically present in the system.
- The card is IS-ANR or is in the process of being loaded.

TYPE—The card type entered in the database.

PST—The primary state of the card. The possible values are described in “Possible Values for PST/SST/AST” in Appendix A.

SST—The secondary state of the card. The possible values are described in “Possible Values for PST/SST/AST” in Appendix A.

AST—The associated state of the card. The possible values are described in “Possible Values for PST/SST/AST” in Appendix A.

EROUTE SERVICE AVERAGE TVG CAPACITY—%

AVERAGE CPU CAPACITY—%

When **mode=perf** is specified, the following performance statistics are displayed:

STATISTICS

CARD—Card location

CPU USAGE—%

TVG RATE

AVERAGE TVG USAGE—%

AVERAGE CPU CAPACITY—%

TOTAL TVG RATE

STATISTICS FOR PAST 30 SECONDS

TOTAL TVG

TOTAL EROUTE

When the **loc** parameter is specified in the command, only card information for the specified card is displayed: **CARD**, **VERSION**, **TYPE**, **PST**, **SST**, and **AST** as shown above, and the following information:

CARD ALARM STATUS—Either “No alarms” or current alarm number and text

TOTAL CPU USAGE—%

When the **loc** parameter specifies a card location and either of the 2 ports associated with the provisioned card are alarmed, an optional line of output for each alarmed port indicates the “**ERROR STATUS**” and either one or both of the following statements:

DHCP LEASE—The DHCP lease for this link has expired; therefore the link is unavailable until a new lease is obtained

PHYSICAL LINK—The physical path for the link to its destination is unavailable.

rept-stat-gpl

Report Status Generic Program Load

Use this command to display the version of GPLs currently running for an application, plus the approved and trial versions of the GPL that will run if the card is restarted.

Keyword: `rept-stat-gpl`

Related Commands: `act-gpl`, `alw-card`, `chg-gpl`, `copy-gpl`, `init-card`, `init-sys`, `rtrv-gpl`

Command Class: Program Update

Parameters

:appl= (obsolete)

This parameter is obsolete; use the **gpl** parameter.

The **appl** parameter has been replaced with the **gpl** parameter to more accurately indicate that a GPL, and not an application, is specified for the parameter value.

:display= (optional)

Display mode. Specifies whether the report displays only application GPL data for all cards, or both IMT and application GPL data.

Range: `all`, `brief`

Default: `brief`

:gpl= (optional)

The type of GPL to report on.

Range: `atmansi`, `atmitu`, `blbios`, `blcpld`, `bldiag`, `blvxw`, `bpdcn`, `bphcap`, `bphcapt`, `bphmux`, `bpmpl`, `bpmpnt`, `ccs7itu`, `cdu`, `ebdablm`, `ebdadcm`, `emdc`, `eroute`, `gls`, `hipr`, `imt`, `imtpci`, `ipgwi`, `iplim`, `iplimi`, `ips`, `mcp`, `oap`, `plde1t1`, `pldpmc1`, `sccp`, `ss7ansi`, `ss7gx25`, `ss7hc`, `ss7ipgw`, `ss7ml`, `stplan`, `vcdu`, `vscpp`, `vxwslan`

atmansi—The GPL is used by the LIM cards to support the ATM high-speed signaling link feature.

atmitu—The GPL is used by the E1 ATM cards to support the E1 ATM high-speed signaling link feature.

blbios —A flash GPL containing the BIOS ROM image on HC-MIM cards that are used for E1 or T1 signaling links.

blcpld —A flash GPL containing the bit-files for the CPLD on HC-MIM cards that are used for E1 or T1 signaling links.

bldiag —A flash GPL containing the diagnostic code on HC-MIM cards that are used for E1 or T1 signaling links.

blvxw —A flash GPL containing the VxWorks operating system on HC-MIM cards that are used for E1 or T1 signaling links.

bpdcn—This GPL is used in communications in the **init-flash** process.

bphcap—This GPL is used to support Board PROM for HCAP flash memory.

bphcapt—This GPL is used to support Board PROM for HCAP-T flash memory.

bphmux—This GPL is used to support Board PROM on the HMUX card.

bpmpl—This GPL is used to support Board PROM for MPL flash memory.

bpmpnt—This GPL is used to support Board PROM for E1/T1 MIM flash memory and board Prom for MPL-T flash memory.

cdu—This GPL is used in the card manufacturing process for testing, and when directed by Tekelec Technical Services.

- ccs7itu**—This GPL is used by the LIM cards for ITU-TSS MTP functionality.
- ebdablm**—This GPL is used by the TSM card for enhanced bulk download.
- ebdadcm**—This GPL is used by the DCM card to transmit the LSMS LNP database to the EAGLE 5 SAS at high speed over an ethernet connection for enhanced bulk download.
- emap**—This GPL is the software that is running on the EOAP used for the GR-376 feature. This GPL transfers the System Release ID table from the removable cartridge to the fixed disk. This GPL is used to alert the technician when the EOAP GPLs are not compatible with an EAGLE 5 SAS release.
- emdc**—This GPL is used by the DCM card for CMIP/OSI measurement collection interface as defined by Telcordia GR-376.
- eroute**—This GPL is used by the STC card for the EAGLE Support for Integrated Sentinel feature.
- gls**—This GPL is used by the TSM cards for downloading gateway screening to LIM cards.
- hipr** —The communication software used on the High Speed IMT Packet Router (HIPR) card.
- imt**—This GPL is the communication processor on the logical processing element (LPE).
- imtpci** —The communication software that operates the IMT bus on HC-MIM cards.
- ipgwi**—This GPL is used by the DCM card for TCP/IP point-to-point connectivity for ITU point codes.
- iplim**—This GPL is used by the DCM card for TCP/IP point-to-point connectivity for ANSI point codes.
- iplimi**—This GPL is used by the DCM card for TCP/IP point-to-point connectivity for ITU point codes.
- ips**—This GPL is used by the IPSM card for the IP User Interface feature.
- mcp**—This GPL is used by the MCPM card for the Measurements Platform feature.
- oap**—This GPL is the software running on the OAP used for the SEAS and LNP features. This GPL transfers the System Release ID table from the removable cartridge to the fixed disk. This GPL is used to alert the technician when the OAP GPLs are not compatible with an EAGLE 5 SAS release.
- plde1t1** —A flash GPL that is used on HC-MIM cards for E1 and T1 signaling links.
- pldpmc1** —A flash GPL that is used on HC-MIM cards for E1 and T1 signaling links.
- sccp**—This GPL is used by the TSM cards for the global title translation application.
- ss7ansi**—This GPL is used by the LIM cards for the MTP functionality.
- ss7gx25**—This GPL is used by the LIM cards to support X.25 functionality.
- ss7hc**—This GPL is used to support the functionality for the HC-MIM (High Capacity Multi-Channel Interface Module) card. The HC-MIM card runs either the **ss7ansi** or **ccs7itu** application; the **ss7hc** GPL allows the card to support 64 signaling links for E1 and T1 functions.
- ss7ipgw**—This GPL is used to support TCP/IP point-to-multipoint connectivity.

ss7ml—This GPL is used to support the functionality for the multi-port LIM (MPL or MPL-T) cards and the E1/T1 MIM (Multi-Channel Interface Module) card.

The MPL cards run only the **ss7ansi** application on a LIMDS0 card (as in the command **ent-card:type=limds0:appl=ss7ansi**); the **ss7ml** GPL allows the card to support 8 signaling ports rather than the usual 2 ports for LIM cards. The MPL cards support only the DS0 interface. The E1/T1 MIM card runs either the **ss7ansi** or **ccs7itu** application; the **ss7ml** GPL allows the card to support 8 signaling ports for E1 and T1 functions. The older E1 card supports 2 signaling ports for E1 functions).

stplan—This GPL is used by the ACM card to support the STPLAN application.

vcdu—This GPL is used in the card manufacturing process for testing, and when directed by Tekelec Technical Services.

vsccp—This GPL is used by the DSM card to support the G-Flex, G-Port, and INP features. If the G-Flex, G-Port, or INP feature is not turned on, and a DSM card is present, the VSCCP GPL processes normal GTT traffic.

vxwslan—This GPL is used by the DCM card to support the STPLAN application.

Default: All GPLs, except IMT, are shown.

:loc= (optional)

Target card address. Displays the versions of all GPLs running at the specified card location. For HC-MIM cards this includes all non-activated flash GPLs. For non-HC-MIM cards, there is no additional data; this parameter simply limits the report to the target card address.

Range: 1101–1108, 1111–1113, 1115, 1201–1208, 1211–1212, 1301–1308, 1311–1318, 2101–2108, 2111–2118, 2201–2208, 2211–2218, 2301–2308, 2311–2318, 3101–3108, 3111–3118, 3201–3208, 3211–3218, 3301–3308, 3311–3318, 4101–4108, 4111–4118, 4201–4208, 4211–4218, 4301–4308, 4311–4318, 5101–5108, 5111–5118, 5201–5208, 5211–5218, 5301–5308, 5311–5318, 6101–6108, 6111–6118

Example

```
rept-stat-gpl
rept-stat-gpl:display=all
rept-stat-gpl:loc=1201
rept-stat-gpl:gpl=ss7ansi
rept-stat-gpl:gpl=oam
rept-stat-gpl:gpl=imt
rept-stat-gpl:gpl=bphmux
rept-stat-gpl:gpl=ss7ml
rept-stat-gpl:gpl=hipr
rept-stat-gpl:gpl=ss7hc
```

Dependencies

No other **rept-stat-xxxx** command can be in progress when this command is entered.

None of the following parameters can be specified together in the same command: **display=all** parameter, **loc** parameter, **gpl** parameter.

Notes

To check the version of the EPAP or ELAP application, use the **rept-stat-mps** command.

When this command is entered, information is displayed only for the cards that are IS-NR or IS-ANR.

Use the **chg-gpl** command to turn auditing on and off.

Use the **rtrv-gpl** command to display the audit state.

The approved GPL is the GPL that resides on the active fixed disk and was made the approved version by specifying the GPL version number while executing the **act-gpl** command.

The trial GPL is the version of the GPL that was downloaded from the removable cartridge, but not activated by the **act-gpl** command.

When the **act-gpl** command is executed, the version specified becomes the approved GPL and the previously approved GPL becomes the trial GPL.

If any card is not running the active MASP system release version of a GPL, "ALM" is displayed to indicate that the card is in GPL alarm condition.

If GPL auditing is on, a minor alarm is shown, and "ALM" is displayed for each APPROVED GPL (**rtrv-gpl**) and for each RUNNING GPL (**rept-stat-gpl**) that does not match the GPL in the RELEASE column of the **rtrv-gpl** command output. If GPL auditing is off, the minor alarm is not activated, but "ALM" is displayed for each GPL that does not match the GPL in the RELEASE column.

If no **gpl** parameter is specified, the approved and trial versions for all GPLs are displayed.

If a GPL is not found, a version of "-----" is displayed. This should happen only for utility and OAM GPLs when the cartridge is not inserted. A utility trial version is never displayed because it can never be run.

If the removable cartridge is inserted, an "*" (asterisk) is displayed next to the OAM trial version. The asterisk serves as a reminder that the trial version of a GPL is loaded when the card that is running the OAM is restarted. All other cards load their approved versions of GPLs when they are restarted.

If a card is inhibited, "-----" is displayed for the running version.

When the **gpl** parameter is not specified, the default is to display all application GPLs that are running on provisioned cards. The flashable GPLs (those loaded on the card by using the **init-flash** command) are not displayed.

When the **gpl=imt** parameter is specified, only the IMT GPLs for each configured card connected to the IMT are displayed.

A plus (+) symbol in the output when the **gpl** parameter value **blbios**, **blcpld**, **bldiag**, **blvxw**, **bphcap**, **bphcapt**, **bpmppl**, **bpmppl**, **bpdcn**, **imtpci**, **plde1t1**, or **pldpmc1** is specified indicates that the GPL currently being run has not yet been activated on the card.

When a GPL is specified in the **gpl** parameter, the specified GPL for each card connected to the IMT is displayed.

Output

The following example shows output that includes an MPL or MPL-T (multi-port LIM) at location 1105. The `GPL` column, which displays the GPL running on the card, enables you to differentiate between the two-port LIMDS0 and the multi-port LIM. If an MPL or MPL-T is running in the system, the multi-port LIM always displays `SS7ML` in the `GPL` column; whereas, a two-port LIMDS0 would show `SS7ANSI`.

rept-stat-gpl

(cartridge not inserted)

```
rlghncxa03w 05-01-04 07:01:08 EST EAGLE 33.0.0
GPL          CARD      RUNNING      APPROVED      TRIAL
EOAM         1113      025-002-000  025-002-000  -----
EOAM         1115      025-002-000  025-002-000  -----
SCCP         1212      025-001-000  025-001-000  025-001-000
VSCCP        1103      026-001-000  026-001-000  026-001-000
CCS7ITU      1201      025-001-000  025-001-000  025-001-000
CCS7ITU      1202      025-001-000  025-001-000  025-001-000
ATMANSI      1205      025-001-000  025-001-000  025-001-000
ATMANSI      1211      025-001-000  025-001-000  025-001-000
SS7ANSI      1203      025-001-000  025-001-000  025-001-000
SS7ANSI      1207      025-001-000  025-001-000  025-001-000
IPLIM        1213      025-001-000  025-001-000  025-001-000
SS7IPGW      1215      025-001-000  025-001-000  025-001-000
SS7ML        1105      027-001-000  027-001-000  027-001-000
OAP*         A          025-001-000  025-001-000  -----
OAP*         B          025-001-001 ALM  025-001-000  -----
EMAP*        A          025-015-000  025-015-000  -----
EMAP*        B          025-015-001 ALM  025-015-000  -----
```

Command Completed.

;

*These entries appear in the output only if an OAP is provisioned and running. Systems that use two OAPs will show two entries for the OAP: OAP A and OAP B. The EMAP GPL should always be a dual configuration since a single GR-376 EOAP is not a valid configuration.

rept-stat-gpl:gpl=utility

(cartridge inserted or not inserted)

```
rlghncxa03w 05-01-07 10:23:93 EST EAGLE 33.0.0
GPL          CARD      RUNNING      APPROVED      TRIAL
UTILITY      1101      101-016-000  101-016-000  -----
Command Completed.
```

;

rept-stat-gpl:gpl=ss7ansi

```
rlghncxa03w 05-01-07 10:23:93 EST EAGLE 33.0.0
  GPL      CARD      RUNNING      APPROVED      TRIAL
  SS7ANSI  1102      101-016-000      101-016-000      101-016-000
  SS7ANSI  1103      101-016-000      101-016-000      101-016-000
  SS7ANSI  1201      101-016-000      101-016-000      101-016-000
  SS7ANSI  1202      101-016-000      101-016-000      101-016-000
  SS7ANSI  1207      101-016-000      101-016-000      101-016-000
  SS7ANSI  1208      101-016-000      101-016-000      101-016-000
  SS7ANSI  1214      101-016-000      101-016-000      101-016-000
  SS7ANSI  1215      101-016-000      101-016-000      101-016-000
  SS7ANSI  1216      101-016-000      101-016-000      101-016-000
  SS7ANSI  1217      101-016-000      101-016-000      101-016-000
Command Completed.
```

;

In the following example, the active MASP system release version is not **101-016-000**.

rept-stat-gpl:gpl=stplan

```
rlghncxa03w 05-01-07 10:23:93 EST EAGLE 33.0.0
  GPL      CARD      RUNNING      APPROVED      TRIAL
  STPLAN   1104      101-016-000 ALM      101-005-001      101-016-000
  STPLAN   1206      101-005-001      101-005-001      101-016-000
Command Completed.
```

;

In the following example, the active MASP system release version is **22-9-0**.

rept-stat-gpl:gpl=stplan

```
rlghncxa03w 05-01-07 10:23:93 EST EAGLE 33.0.0
  GPL      CARD      RUNNING      APPROVED      TRIAL
  STPLAN   1104      101-016-000      101-005-001      101-016-000
  STPLAN   1206      101-005-001      101-005-001      101-016-000
Command Completed.
```

;

In the following example, the active MASP system release version is not **101-016-000**.

rept-stat-gpl:gpl=stplan

```
rlghncxa03w 05-01-07 10:23:93 EST EAGLE 33.0.0
  GPL      CARD      RUNNING      APPROVED      TRIAL
  STPLAN   1104      101-016-000 ALM      101-016-000      101-005-001
  STPLAN   1206      101-016-000      101-016-000      101-005-001
Command Completed.
```

;

rept-stat-gpl:gpl=imt

```

rlghncxa03w 05-01-07 10:23:93 EST EAGLE 33.0.0
GPL          CARD          RUNNING          APPROVED          TRIAL
IMT          1101          101-016-000          -----          -----
IMT          1102          101-016-000          -----          -----
IMT          1103          101-016-000          -----          -----
IMT          1105          101-016-000          -----          -----
IMT          1113          101-016-000          -----          -----
IMT          1115          101-016-000          -----          -----
IMT          1201          101-016-000          -----          -----
IMT          1202          101-016-000          -----          -----
IMT          1203          101-016-000          -----          -----
IMT          1213          101-016-000          -----          -----
IMT          1214          101-016-000          -----          -----
IMT          1215          101-016-000          -----          -----
Command Completed.

```

;

In the following example, card 3108 is running the older, approved GPL. Cards 2108 and 2208 are each running a new nonapproved version. Card 2108 has had this version activated, and card 2208 is still running this version in a trial mode.

rept-stat-gpl:gpl=bphcap

```

rlghncxa03w 05-01-07 10:23:93 EST EAGLE 33.0.0
GPL          CARD          RUNNING          APPROVED          TRIAL
BPHCAP      2108          101-005-001 ALM   101-016-000          101-005-001
BPHCAP      2208          101-005-001 ALM+ 101-016-000          101-005-001
BPHCAP      3108          101-016-000          101-016-000          101-005-001
Command Completed.

```

;

rept-stat-gpl:gpl=iplim

```

rlghncxa03w 05-01-07 10:23:93 EST EAGLE 33.0.0
GPL          CARD          RUNNING          APPROVED          TRIAL
IPLIM       1201          001-000-000          001-000-000          001-001-000
IPLIM       1202          001-000-000          001-000-000          -----
Command Completed.

```

;

rept-stat-gpl:gpl=hipr

```

rlghncxa03w 05-01-04 07:01:08 EST EAGLE5 33.0.0
GPL          CARD          RUNNING          APPROVED          TRIAL
HIPR         1109          118-020-000          118-020-000          118-020-000
HIPR         1110          118-020-000          118-020-000          -----
HIPR         1209          118-020-000          118-020-000          118-020-000
HIPR         1210          118-020-000          118-020-000          -----
Command Completed.

```

;

rept-stat-gpl:gpl=bphmux

```

rlghncxa03w 05-01-07 10:23:93 EST EAGLE 33.0.0
GPL          CARD          RUNNING          APPROVED          TRIAL
BPHMUX      1109          027-005-000          027-005-000          027-005-000
BPHMUX      1110          027-005-000          027-005-000          -----
BPHMUX      1209          027-005-000          027-005-000          027-005-000
BPHMUX      1210          027-005-000          027-005-000          -----
Command Completed.

```

;

rept-stat-gpl:gpl=eoam

```
rlghncxa03w 05-01-07 10:23:93 EST EAGLE 33.0.0
GPL          CARD          RUNNING          APPROVED          TRIAL
EOAM         1113          028-002-000          028-002-000          -----
EOAM         1115          028-002-000          028-002-000          -----
Command Completed.
```

;

The following examples specify the **display=all** parameter. The second example includes an HC-MIM card in the system.

rept-stat-gpl:display=all

```
rlghncxa03w 05-01-07 10:23:93 EST EAGLE 33.0.0
GPL          CARD          RUNNING          APPROVED          TRIAL
EOAM         1113          027-002-000          027-002-000          -----
EOAM         IMT          027-001-000          027-001-000          210-001-003
EOAM         1115          027-002-000          027-002-000          -----
EOAM         IMT          027-001-000          027-001-000          210-001-003
SCCP         1212          027-001-000          027-001-000          027-001-000
SCCP         IMT          027-001-000          027-001-000          210-001-003
CCS7ITU     1201          027-001-000          027-001-000          027-001-000
CCS7ITU     IMT          027-001-000          027-001-000          210-001-003
ATMANSI     1203          027-001-000          027-001-000          027-001-000
ATMANSI     BPHCAP          027-001-000          027-001-000          210-001-003
SS7ML*      1105          027-001-000          027-001-000          027-001-000
SS7ML*      BPMPL          230-001-001          230-001-001          230-001-001
IPLIM       1213          027-001-000          027-001-000          027-001-000
IPLIM       BPDPCM          027-001-000          027-001-000          210-001-003
SS7IPGW     1215          027-001-000          027-001-000          210-001-000
SS7IPGW     BPDPCM          210-001-003          ALM+ 027-001-000          210-001-003
BPHMUX      1109          027-005-000          027-005-000          027-005-000
BPHMUX      1110          027-005-000          027-005-000          027-005-000
BPHMUX      1209          027-005-000          027-005-000          027-005-000
BPHMUX      1210          027-005-000          027-005-000          027-005-000
OAP**       A          027-001-000          027-001-000          -----
OAP**       B          027-001-001          ALM 027-001-000          -----
EMAP**      A          027-015-000          027-015-000          -----
EMAP**      B          027-015-001          ALM 027-015-000          -----
Command Completed.
```

;

* The SS7ML entry in the GPL column at location 1105 indicates that a multi-port LIM, as opposed to a two-port LIM, is running on the system. Both cards are provisioned in the database with the **ss7ansi** application so that the two-port LIM can be replaced without having to reprovision the database, but the MPL and MPL-T run the **ss7ml** GPL to support 8 signaling link ports.

** These entries only appear if an OAP is provisioned and running. Systems that use two OAPs show two entries for the OAP: OAP A and OAP B. The EMAP GPL should always be dual configuration since a single GR-376 EOAP is not a valid configuration.

rept-stat-gpl:display=all

rlghncxa03w 05-01-07 10:23:93 EST EAGLE5 33.0.0
 GPL Auditing ON

GPL	CARD	RUNNING	APPROVED	TRIAL	
EOAM	1113	125-002-000 ALM	125-001-000	125-002-000	*
	BPDCM	002-126-000	002-126-000	002-126-000	
EOAM	1115	125-002-000 ALM	125-001-000	125-001-000	*
	BPDCM	002-123-020 ALM	002-126-000	002-126-000	
SS7ANSI	1205	125-001-000	125-001-000	125-002-000	
	IMT	125-001-000	125-001-000	125-002-000	
GLS	1106	125-001-000	125-001-000	125-002-000	
	IMT	125-001-000	125-001-000	125-002-000	
UTILITY	1101	125-001-000	125-001-000	-----	
	IMT	125-001-000	125-001-000	125-002-000	
SS7GX25	1206	125-001-000	125-001-000	125-002-000	
	IMT	125-001-000	125-001-000	125-002-000	
EBDADCM	1217	125-001-000	125-001-000	125-002-000	
	BPDCM	002-126-001 ALM	002-126-000	002-126-000	
SS7IPGW	1213	125-001-000	125-001-000	125-002-000	
	BPDCM	002-125-002 ALM	002-126-000	002-126-000	
VSCCP	1111	125-001-000	125-001-000	125-002-000	
	BPDCM	002-125-002 ALM	002-126-000	002-126-000	
BPHMUX	1109	125-001-000	125-001-000	125-002-000	
BPHMUX	1110	125-001-000	125-001-000	125-002-000	
BPHMUX	1209	125-001-000	125-001-000	125-002-000	
BPHMUX	1210	125-001-000	125-001-000	125-002-000	
MPLGA	1102	125-001-000	125-001-000	125-002-000	
	BPMP	125-001-000	125-001-000	125-002-000	
SS7HC	1215	125-001-000	125-001-000	125-002-000	
	IMTPCI	125-001-000	125-001-000	125-002-000	
	BLBIOS	125-001-000	125-001-000	125-002-000	
	BLCPLD	125-001-000	125-001-000	125-002-000	
	BLVXW	125-001-000	125-001-000	125-002-000	
	BLDIAG	125-001-000	125-001-000	125-002-000	
	PLDE1T1	125-001-000	125-001-000	125-002-000	
	PLDPMC1	125-001-000	125-001-000	125-002-000	
EMAP	A	----- ALM	026-016-000	-----	

Command Completed.

;

The following example shows output when the **loc** parameter is specified for an HC-MIM card.

rept-stat-gpl:loc=1203

```

rlghncxa03w 05-01-07 10:23:93 EST EAGLE5 33.0.0
GPL Auditing ON

GPL          CARD          RUNNING          APPROVED          TRIAL
SS7HC        1203          125-001-000      125-001-000      125-001-000
              IMTPCI          125-001-000      125-001-000      125-001-000
              BLBIOS          125-001-000      125-001-000      125-001-000
              BLCPLD          125-001-000      125-001-000      125-001-000
              BLVXW          125-001-000      125-001-000      125-001-000
              BLDIAG          125-001-000      125-001-000      125-001-000
              PLDE1T1          125-001-000      125-001-000      125-001-000

              ACTIVE          INACTIVE
              IMTPCI          125-001-000      125-002-000 * -----      Note 1
              BLBIOS          125-001-000      125-001-000      125-003-000 *      Note 2
              BLCPLD          125-001-000      125-001-000 * -----
              BLVXW          125-002-000ALM      125-002-000 * -----      Note 3
              BLDIAG          125-003-000ALM+      125-002-000 * 125-003-000      Note 4

              PLDE1T1          125-001-000 +      125-002-000 * 125-001-000      Note 5
Command Completed.
;

```

Notes in the last six lines of this example:

1. IMTPCI has been downloaded with the **init-flash** command, the card has reset, and IMTPCI was activated normally with the **act-flash** command.
2. BLBIOS has been downloaded with the **init-flash** command, but the card has not been initialized. The inactive version will load when the card is next initialized.
3. BLVXW has been downloaded with the **init-flash** command, the card has been reset. BLVXW was activated with the **act-flash** command, but it is not the approved version on the TDM.
4. BLDIAG has been downloaded with the **init-flash** command, and the card has been reset; the inactive version is running. The ALM indicates that it is not the approved version and the '+' indicates that it has not been activated yet. The '*' next to the active version indicates that if the card resets again, the active version will run.
5. PLDE1T1 has been downloaded with the **init-flash** command and the card has been reset, but the GPL has not been activated yet. This is the same condition as Note 4, except that there is no alarm condition.

The following example shows output when the **loc** parameter is specified for a card that is not an HC-MIM card.

rept-stat-gpl:loc=1217

```
rlghncxa03w 05-01-07 10:23:93 EST EAGLE 33.0.0
GPL Auditing ON

GPL      CARD      RUNNING      APPROVED      TRIAL
ATMANSI 1217      125-001-000  125-001-000  125-001-000
          BPHCAP  125-001-000  125-001-000  125-001-000
Command Completed.
```

;

Legend

GPL—The type of GPL associated with the cards in the display.

CARD—The card location.

RUNNING—The GPL version the card is running. If the card is not running the active MASP system release GPL, ALM appears after the GPL version number in this column.

APPROVED—The GPL version that is the approved GPL.

TRIAL—The GPL version that is the trial GPL.

ACTIVE—The GPL version that has been downloaded using the **init-flash** command and activated using the **act-flash** command.

INACTIVE—The GPL version that has been downloaded using the **init-flash** command but has not been activated using the **act-flash** command.

----- (dashes)—GPL is not present at the specified location.

*—The trial version will run if the card boots. (Shown to the right of the TRIAL column)

ALM—An alarm indicator showing that the system has an approved GPL that is not the GPL required for this software release according to the active MASP system release table.

+—The currently running flash GPL has not been activated. (Shown between the RUNNING and APPROVED columns)

rept-stat-imt

Report IMT Status

The interprocessor message transport bus (IMT bus) is the main communications artery between all subsystems in the system. Use this command to display the primary, secondary, and associated maintenance states of the IMT bus. The primary state indicates whether the bus is normal, abnormal, or OOS for maintenance activity. The secondary state indicates the active/inhibited status of a card for a particular IMT bus.

Keyword: **rept-stat-imt**

Related Commands: **clr-imt-stats, conn-imt, disc-imt, rept-imt-lvl1, rept-imt-lvl2, rmv-imt, rst-imt**

Command Class: System Maintenance

Parameters

:mode= (optional)

Use this parameter to provide additional output listing the cards that currently have IMT alarm conditions outstanding. The additional output is repeated for each IMT bus following the bus status information. If no alarms are active on a given bus, no additional output is generated.

Range: full

Default: "not full"

Example

```
rept-stat-imt
rept-stat-imt:mode=full
```

Dependencies

No other **rept-stat-xxx** command can be in progress when this command is entered.

Notes

The card locations are stored only by the active MASP. The information is lost if the system switches from the active to the standby MASP.

The trouble locations are displayed sorted by card location.

Output

rept-stat-imt

```
rlghncxa03w 04-02-27 16:50:24 EST EAGLE 31.3.0
IMT  PST          SST          AST
A    IS-NR        Active      -----
ALARM STATUS      = No alarms
IMT  PST          SST          AST
B    IS-ANR       Fault       -----
ALARM STATUS      = ** 0108 Major IMT Failure Detected
Command Completed.
```

rept-stat-imt:mode=full

```
rlghncxa03w 04-02-23 13:10:30 EST EAGLE 31.3.0
IMT  PST          SST          AST
A    IS-NR        Active      -----
ALARM STATUS      = No Alarms.

IMT  PST          SST          AST
B    OOS-MT-DSBLD Fault       -----
ALARM STATUS      = ** 0108 Major IMT failure detected.

CARDS WITH ACTIVE IMT B ALARMS:
CARD  DATE        TIME
1102  04-02-23 11:59:23
1103  04-02-23 12:01:23
1204  04-02-23 23:14:07
1205  04-02-23 23:14:07
1206  04-02-23 23:14:07
Command Completed.
```

Legend

IMT—IMT bus A or IMT bus B.

PST—The primary state of the subsystem. The possible values are described in “Possible Values for PST/SST/AST” in Appendix A.

SST—The secondary state of the subsystem. The possible values are described in “Possible Values for PST/SST/AST” in Appendix A.

AST—The associated state of the subsystem. The possible values are described in “Possible Values for PST/SST/AST” in Appendix A.

ALARM STATUS—A listing of any trouble text alarm messages that have been generated for the specified IMT bus.

*—Minor Alarm

**—Major Alarm

*C—Critical Alarm

The states of the IMT bus are combined from the PST and the SST as shown in Table 7-9.

Table 7-9. IMT Bus States

PST	SST	Definition
IS-NR	Active	The IMT bus is operating normally.
IS-ANR	Fault	The IMT bus has had a failure on at least one but not all cards.
IS-ANR	Manual	The IMT bus is inhibited, but some cards have been connected to it.
OOS-MT	Fault	The IMT bus has a failure on all cards.
OOS-MT-DSBLD	Manual	The IMT bus is inhibited and no cards are connected to it.

rept-stat-iptps**Report Status IPGWx TPS Utilization**

Use this command to display current and peak IPGWx TPS usage for each IPGWx linkset in the system or for each IPGWx link in the IPGWx linkset.

Keyword: **rept-stat-iptps**

Related Commands: **chg-sg-opts, rtrv-sg-opts, ent-ls, chg-ls, rtrv-ls, chg-ctrl-feat, enable-ctrl-feat, rtrv-ctrl-feat**

Command Class: System Maintenance

Parameters

:lsn= (optional)

Linkset name. The name of the linkset for which the report information is to be displayed.

Range: 1 alphabetic character followed by up to 9 alphanumeric characters

Default All linksets are displayed

:peakreset= (optional)
Reset peak values to the current TPS values.
Range: yes, no
Default: no

Example

```
rept-stat-iptps
rept-stat-iptps:lsn=lsgw1101
rept-stat-iptps:peakreset=yes
```

Dependencies

This command cannot be entered for linksets that are not IPGWx linksets.

The specified linkset must exist in the database.

Notes

Traffic peak data are stored only in OAM memory and are not preserved when the card that is running the OAM boots, or in the case of an active/standby switchover.

Output

The **rept-stat-iptps** command reports on IPGWx system and linkset IP TPS. The report includes the following information for the system and for each IPGWx linkset:

- Configured IPGWx IP TPS alarm threshold
- Configured IPGWx IP TPS
- Current IPGWx IP TPS transmit and receive usage for 15 seconds
- Peak IPGWx IP TPS transmit and receive usage and timestamp for all 15 second periods since last reset

When **lsn** is specified, the command reports the same information for the individual links in the linkset.

When **peakreset=yes** is specified, the command resets all the stored peak values to the current actual usage for each link, and recalculates linkset and system peaks before reporting usage.

When **lsn** is specified with **peakreset=yes**, the command recalculates peaks for the specified linkset and resets all the stored peak values to the current actual usage for each link contained in the linkset before reporting usage.

NOTE 1: The peaks for transmit and receive, and for link, linkset and system IPGWx IP TPS may all occur at different times.

NOTE 2: The IP TPS System value shown in the **rept-stat-iptps** command may contain one extra MSU. Because the alarm calculations are implemented using integer math, there is the potential for rounding to occur at each entity (link, linkset, system) when the IP TPS value for the entity is not evenly divisible by 15. This could occur when performing an IPTPS report for multiple linksets in the system or a linkset that has more than one link configured.

rept-stat-iptps

rlghncxa03w 03-05-06 09:49:20 EST EAGLE 31.6.0

IP TPS USAGE REPORT

	THRESH	CONFIG		TPS	PEAK	PEAKTIMESTAMP

SYSTEM						
CLLI1234567	100%	100000	TX:	4127	4550	03-05-05 09:49:19
			RCV:	3962	4450	03-05-05 09:49:19

LSN						
LSGW1101	80%	4000	TX:	3700	4000	03-05-05 09:49:19
			RCV:	3650	4000	03-05-05 09:49:19
LSGW1103	80%	500	TX:	427	550	03-05-05 09:49:19
			RCV:	312	450	03-05-05 09:49:19

Command Completed.

;

rept-stat-iptps:lsn=lsgw1101

rlghncxa03w 03-05-06 09:49:20 EST EAGLE 31.6.0

IP TPS USAGE REPORT

	THRESH	CONFIG		TPS	PEAK	PEAKTIMESTAMP

LSN						
LSGW1101	100%	188000	TX:	800	800	03-05-05 09:49:19
			RCV:	800	800	03-05-05 09:49:19

LOC PORT						
1101	A	80%	----	TX:	800	800 03-05-05 09:49:19
				RCV:	800	800 03-05-05 09:49:19
1103	A	80%	----	TX:	800	800 03-05-05 09:49:19
				RCV:	800	800 03-05-05 09:49:19

Command Completed.

;

rept-stat-iptps:peakreset=yes

rlghncxa03w 03-05-06 09:49:20 EST EAGLE 31.6.0

IP TPS USAGE REPORT

	THRESH	CONFIG		TPS	PEAK	PEAKTIMESTAMP

SYSTEM						
CLLI1234567	100%	100000	TX:	4427	4427	03-05-05 09:49:19
			RCV:	4312	4312	03-05-05 09:49:19

LSN						
LSN1234567	80%	4000	TX:	4000	4000	03-05-05 09:49:19
			RCV:	4000	4000	03-05-05 09:49:19
LSGW1103	80%	500	TX:	427	427	03-05-05 09:49:19
			RCV:	312	312	03-05-05 09:49:19

Command Completed.

;

Legend

SYSTEM—CLLI of the EAGLE 5 SAS

THRESH—The system threshold at which an alarm will be generated to indicate that the actual system TPS is approaching the enabled system TPS quantity (**iptpsalmthresh** value as shown in **rtrv-sg-opts** output).

CONFIG—The enabled system IP Signaling TPS quantity as shown in **rtrv-ctrl-feat** output.

TPS—The current transmit (TX) and receive (RCV) TPS for 15 seconds.

PEAK—The peak transmit (TX) and receive (RCV) TPS usage for all 15 second periods since the last peak reset.

PEAKTIMESTAMP—The date and time that the displayed transmit and receive TPS peaks occurred.

LSN—The linkset name.

THRESH—The threshold at which an alarm will be generated to indicate that the actual linkset TPS is approaching the configured linkset **iptps** value (**lsusealm** value as shown in **rtrv-ls** output).

CONFIG—The **iptps** value as shown in **rtrv-ls** output.

TPS—The current transmit (TX) and receive (RCV) TPS for 15 seconds.

PEAK—The peak transmit (TX) and receive (RCV) TPS usage for all 15 second periods since the last peak reset.

PEAKTIMESTAMP—The date and time that the displayed transmit and receive TPS peaks occurred.

When a linkset name is specified (**lsn**), the IPGWx TPS information is displayed for the specified linkset and for each link in the linkset.

LSN—The linkset name.

THRESH—The threshold at which an alarm will be generated to indicate that the actual linkset TPS is approaching the configured linkset **iptps** value (**lsusealm** value as shown in **rtrv-ls** output).

CONFIG—The **iptps** value as shown in **rtrv-ls** output

TPS—The current transmit (TX) and receive (RCV) TPS for 15 seconds.

PEAK—The peak transmit (TX) and receive (RCV) TPS usage for all 15 second periods since the last peak reset.

PEAKTIMESTAMP—The date and time that the displayed transmit and receive TPS peaks occurred.

LOC—Location of the card that contains a displayed link in the linkset.

PORT—A signaling link in the linkset.

THRESH—The **slkusethresh** value as shown in **rtrv-ls** output

CONFIG—Dashes (----). There is no configurable TPS for links.

TPS—The current transmit (TX) and receive (RCV) TPS for 15 seconds.

PEAK—The peak transmit (TX) and receive (RCV) TPS usage for all 15 second periods since the last peak reset.

PEAKTIMESTAMP—The date and time that the displayed transmit and receive TPS peaks occurred.

rept-stat-lfs

Report LFS Test Status

Use this command to generate a report of all the SS7 links that are under LFS test. Along with the link identification information, the command output lists the current LBP, the test pattern, the maximum bit-errors threshold, the bit-errors since the beginning of this test, the maximum test time, and the time elapsed since the beginning of the test.

Keyword: `rept-stat-lfs`

Related Commands: `rept-stat-slk`

Command Class: Link Maintenance

Parameters

:loc= (optional)

The card location containing the signaling link or links to be displayed.

This parameter is mandatory when the **port** parameter is specified.

Range: 1101–1108, 1111–1112, 1201–1208, 1211–1212, 1301–1308, 1311–1318, 2101–2108, 2111–2118, 2201–2208, 2211–2218, 2301–2308, 2311–2318, 3101–3108, 3111–3118, 3201–3208, 3211–3218, 3301–3308, 3311–3318, 4101–4108, 4111–4118, 4201–4208, 4211–4218, 4301–4308, 4311–4318, 5101–5108, 5111–5118, 5201–5208, 5211–5218, 5301–5308, 5311–5318, 6101–6108, 6111–6118

:port= or :link= (optional)

The signaling link port on the card specified in the **loc** parameter.

Range: a, b, a1-a31, b1-b31

Not all card types support all **link** parameter values.

See Table A-1 in Appendix A for valid **link** parameter range values for each type of card that can have assigned signaling link ports.

Example

```
rept-stat-lfs
```

```
rept-stat-lfs:loc=1201
```

```
rept-stat-lfs:loc=1201:link=a1
```

Dependencies

The LFS feature must be turned on before this command can be entered.

The card location that is specified in the **loc** parameter must be equipped.

The signaling link that is specified in the **link** parameter must be assigned to the card in the **loc** parameter location.

Card locations 1113, 1114, 1115, 1116, 1117, 1118, and all xy09 and xy10 locations (x is the frame and y is the shelf) cannot be specified in the **loc** parameter.

The card location (**loc** parameter) must identify a provisioned **limds0**, **limt1**, or **limch** (associated with a **limt1**) card configured with either an **ss7ansi** or **ccs7itu** application.

If the **link** parameter is specified, the **loc** parameter must be specified.

This command cannot be entered during upgrade.

Notes

This command can be canceled using the **F9** function key or the **canc-cmd** command. See **canc-cmd** for more information.

Output

If no parameters are specified, all links that are in LFS test are displayed.

rept-stat-lfs

```
rlghncxa03w 04-02-27 16:50:24 EST EAGLE 31.3.0
SLK   LBP   PATTERN   MAX-ERRORS  BIT_ERRORS  MAX-TIME  TEST-TIME
1201,A 5   B0247      56           30  01:00:00  00:00:50
1202,A 3   B511       56           27  01:00:00  00:01:05
1203,A 1   OCTET      56           12  01:00:00  00:02:07
1204,A 6   ALTERNATE  56           28  01:00:00  00:04:08
1205,A 2   B0247      56           36  01:00:00  00:03:05
1206,A 1   B0247      56           15  01:00:00  00:06:06
1207,A 3   B0247      56           19  01:00:00  00:02:04
1208,A 5   B0247      56           23  01:00:00  00:04:01
```

;

If only the **loc** parameter is specified, all links in LFS test on the specified card are displayed.

rept-stat-lfs:loc=1208

```
rlghncxa03w 04-02-27 16:50:24 EST EAGLE 31.3.0
SLK   LBP   PATTERN   MAX-ERRORS  BIT_ERRORS  MAX-TIME  TEST-TIME
1208,A 5   B0247      56           23  01:00:00  00:04:01
1208,B1 4   B0247      56           23  01:00:00  00:08:01
```

;

If the **loc** and **link** parameters are specified, only the specified link on the specified card is displayed.

rept-stat-lfs:loc=1208:link=a

```
rlghncxa03w 04-02-27 16:50:24 EST EAGLE 31.3.0
SLK   LBP   PATTERN   MAX-ERRORS  BIT_ERRORS  MAX-TIME  TEST-TIME
1208,A 5   B0247      56           23  01:00:00  00:04:01
```

;

Legend

SLK—The signaling link identifier; same as **loc** and **link** parameters of **act-lbp** command.

LBP—The loopback point of this test; same as **lbp** parameter of **act-lbp** command.

PATTERN—The test pattern; same as **pattern** parameter of **act-lbp** command.

MAX-ERRORS—The bit-error threshold allowed for this LFS test; same as **maxerr** parameter of **act-lbp** command.

BIT_ERRORS—Number of bit-errors since the beginning of this test.

MAX-TIME—The time window for testing each loop-back point; same as **time** parameter of **act-lbp** command.

TEST-TIME—Amount of time the test has run.

rept-stat-lnp

LNP Status Report

Use this command to generate a report of the local number portability (LNP) status information.

When the **rept-stat-lnp** command is entered with no parameters, a summary of the LNP status of all equipped SCCP cards is provided. This summary includes Global Title Translation (GTT) and LNP function status for every SCCP card, as well as LNPQS system information.

When the **loc** parameter is specified, a detailed status of LNP information for the specified SCCP card is provided. These detailed reports include information for each of the following functions: Global Title Translation (GTT), LNP Message Relay (LNPMR), LNP Query Service (LNPQS), Personal Communication Service LNP Query Service (PLNPQS) (if the PLNP feature is turned on), Wireless LNP Query Service (WNPQS) (if the WNP feature is turned on), Triggerless LNP (TLNP) (if the TLNP feature is turned on), and Automatic Call Gap (ACG).

When the **card=sccp all** parameter is specified, a detailed status of LNP information for all SCCP cards is provided.

Keyword: **rept-stat-lnp**

Related Commands: **chg-th-alm, rept-stat-sccp, rtrv-th-alm**

Command Class: System Maintenance

Parameters

:card= (optional)

Specify **card=sccp-all** to display a report of the LNP status of all equipped SCCP cards. The **card** parameter is not valid with the **loc** parameter.

Range: **sccp-all** (the only choice)

:loc= (optional)

The card location as stenciled on the shelf of the EAGLE 5 SAS. The **loc** parameter is not valid with the **card** parameter.

Range: **1101-1108, 1111-1112, 1201-1208, 1211-1218, 1301-1308, 1311-1318, 2101-2108, 2111-2118, 2201-2208, 2211-2218, 2301-2308, 2311-2318, 3101-3108, 3111-3118, 3201-3208, 3211-3218, 3301-3308, 3311-3318, 4101-4108, 4111-4118, 4201-4208, 4211-4218, 4301-4308, 4311-4318, 5101-5108, 5111-5118, 5201-5208, 5211-5218, 5301-5308, 5311-5318, 6101-6108, 6111-6118**

Default: A summary for all cards is displayed.

Example

```
rept-stat-lnp
```

```
rept-stat-lnp:card=sccp-all
```

```
rept-stat-lnp:loc=1106
```

Dependencies

The LNP feature must be turned on (see the **enable-ctrl-feat** command) before this command can be entered.

Only one optional parameter can be specified in the command. The **card** and **loc** parameters cannot be specified together in the same command.

The only valid value for the **card** parameter is **sccp-all**.

No other **rept-stat-xxx** command can be in progress when this command is issued.

At least one SCCP card must be configured in the system.

The card location (**loc** parameter) must identify a configured TSM card running the **sccp** application.

Notes

The error information on this report is based on 30-second intervals. The values for number of errors and total messages are for the last 30-second period. The usage information is also updated once every 30 seconds.

When the **rept-stat-lnp** command is entered with no parameters, a summary of the LNP subsystem status is reported, followed by a summary of the LNP status of all equipped SCCP cards. This summary includes global title translation (GTT) and LNP function status for every SCCP card, as well as LNPQS system information. The GTT status is either ACT (active) or SWDL (software loading). The LNP status is either ACT, OFFLINE, or SWDL. LNPQS system information is then provided in the following fields:

- The SSN STATUS and MATE SSN STATUS fields show the state of the LNP subsystems: Prohibited, Restricted, or Allowed.
- The ACG OVERLOAD LEVEL field shows the ACG node overload control level used by the system.
- The system average MIC usage is expressed as a percentage of the number of MICs sent by all cards, divided by the number of responses sent by all cards.

The **rept-stat-lnp** command also provides a summary of the following system-wide LNP statistics.

- The average GTT usage is expressed as the average percentage of GTT usage per card.
- The average LNPMR usage is expressed as the average percentage of LNPMR usage per card.
- The average LNPQS usage is expressed as the average percentage of LNPQS usage per card.
- The average WNPQS usage is expressed as the average percentage of WNPQS usage per card. WNPQS information is displayed only if the WNP feature is turned on.
- The average PLNPQS usage is expressed as the average percentage of PLNPQS usage per card. PLNPQS information is displayed only if the PCS 1900 Number Portability feature (PLNP) is turned on.

- The average CPU usage is expressed as the average percentage of CPU usage per card.
- The total number of GTT, LNPMR, LNPQS, WNPQS (if turned on), TLNP (if turned on), and PLNPQS (if turned on) errors for corresponding messages received across all cards.

When the **rept-stat-lnp** command is entered for a specific card (for example, **rept-stat-lnp:loc=xxxx**), status information for the card at the specified location is provided, followed by the alarm status and detailed LNP status information and statistics for each LNP function.

- GTT STATUS, either ACT (active) or SWDL (software loading).
- GTT USAGE, expressed as a percentage of the amount of CPU used to process GTT messages during the last 30 seconds by the specified card.
- GTT ERRORS, the number of GTT errors detected for the total number of GTT messages received by the specified card.
- LNPMR STATUS, either ACT (active), OFFLINE, or SWDL (software loading).
- LNPMR USAGE, expressed as a percentage of the amount of CPU used to process LNP message relay messages during the last 30 seconds by the specified card.
- LNPMR ERRORS, the number of LNP message relay errors detected for the total number of LNP message relay messages received by the specified card.
- LNPQS STATUS, either ACT (active), OFFLINE, and SWDL (software loading).
- LNPQS USAGE, expressed as a percentage of the amount of CPU used to process LNP query messages during the last 30 seconds by the specified card.
- LNPQS ERRORS, the number of LNP query errors detected for the total number of LNP query messages received by the specified card.
- WNPQS STATUS, either ACT (active), OFFLINE, and SWDL (software loading).
- WNPQS USAGE, expressed as a percentage of the amount of CPU used to process WNP query messages during the last 30 seconds by the specified card.
- WNPQS ERRORS, the number of WNP query errors detected for the total number of WNP query messages received by the specified card.

NOTE: IS-41 LNP Queries with a TT associated with the LNPQS service are pegged as IS-41 LNP Queries with a TT associated with the WNP service under the WNPQS counter. The WNPQS STATUS, WNPQS USAGE, and WNPQS ERRORS fields are displayed only if the Wireless Number Portability feature is ON.

- PLNPQS STATUS, either ACT (active), OFFLINE, and SWDL (software loading).
- PLNPQS USAGE, expressed as the amount of CPU used to process PCS 1900 LNP Query messages over the last 30-second period by the specific card.
- PLNPQS ERRORS, the number of PCS query errors detected for the total number of PCS query messages received by the specified card.

NOTE: PCS 1900 LNP Queries with a TT associated with the LNPQS service are processed and pegged as IN LNP Queries under the LNPQS counter. The PLNPQS STATUS, PLNPQS USAGE, and PLNPQS ERRORS fields are displayed only if the PCS 1900 Number Portability (PLNP) feature is ON.

- TLNP STATUS, either ACT (active), OFFLINE, and SWDL (software loading).
- TLNP USAGE, expressed as a percentage of the amount of CPU used to process Triggerless LNP Encapsulated IAM messages over the last 30-second period by the specific card.
- TLNP ERRORS, the number of TLNP query errors detected for the total number of TLNP query messages received by the specified card.

NOTE: The TLNP STATUS, TLNP USAGE, and TLNP ERRORS fields are displayed only if the Triggerless LNP (TLNP) feature is ON.

- ACG OVERLOAD LEVEL, the ACG node overload control level being used by the system.
- MIC USAGE, expressed as a percentage of the number of MICs sent by the specific card divided by the number of responses sent by the specified card during the last 30 seconds.
- CPU USAGE, expressed as a percentage of the amount of CPU used to process messages by the specified card during the last 30 seconds.

When the **:card=sccp-all** parameter is specified, detailed information is provided about the status of all SCCP cards. The information displayed in the output is the same as that displayed for the **:loc=xxxx** parameter.

Output

In the following example, the WNP, PLNP, and TLNP features are off.

rept-stat-lnp

```
rlghncxa03w 02-11-24 10:37:22 EST EAGLE 30.0.0
LNP SUBSYSTEM REPORT OOS-MT-DSBLD Active -----
LNP Cards Configured= 3
CARD PST SST GTT STATUS LNP STATUS CPU USAGE
1106 IS-NR Active ACT OFFLINE 10%
1201 IS-NR Active ACT OFFLINE 12%
1310 OOS-MT-DSBLD Manual ----- 0%

LNPQS:
SSN STATUS = Prohibited MATE SSN STATUS = Allowed
ACG: OVERLOAD LEVEL = 0 MIC UASGE = 0%

AVERAGE USAGE:
GTT = 13% LNPQR = 0% LNPQS = 0%
AVERAGE CPU USAGE = 11%
TOTAL ERRORS:
GTT: 0 out of 2000
LNPQR: 0 out of 0
LNPQS: 0 out of 0
Command Completed
```

;

In the following example, the WNP, PLNP, and TLNP features are on.

rept-stat-lnp

```

rlghncxa03w 02-11-07 08:50:14 EST EAGLE 30.0.0
LNP SUBSYSTEM REPORT IS-ANR Active -----
ASSUMING MATE'S LOAD
LNP Cards Configured= 5
CARD PST SST GTT STATUS LNP STATUS CPU USAGE
1106 IS-NR Active ACT ACT 23%
1201 IS-ANR Standby SWDL SWDL 0%
1205 OOS-MT-DSBLD Manual ----- 0%
1302 OOS-MT FLT ----- 0%
1310 IS-ANR Standby ACT SWDL 0%

LNPQS:
SSN STATUS = Allowed MATE SSN STATUS = Prohibited
ACG: OVERLOAD LEVEL = 0 MIC USAGE = 100%

AVERAGE USAGE:
GTT = 13% LNPMR = 0% LNPQS = 0%
WNPQS = 0% TLNP = 10% PLNPQS = 0%

AVERAGE CPU USAGE = 23%
TOTAL ERRORS:
GTT: 1 out of 2000
LNPMR: 0 out of 0
LNPQS: 1 out of 500
WNPQS: 0 out of 0
PLNPQS: 0 out of 0
TLNP: 1 out of 500

Command Completed.
;

```

In the following example, the WNP, PLNP and TLNP features are on.

rept-stat-lnp:loc=1106

```

rlghncxa03w 04-04-24 10:37:22 EST EAGLE 31.6.0
CARD VERSION TYPE PST SST AST
1106 021-101-000 TSM IS-NR Active -----
ALARM STATUS = No Alarms.
GTT: STATUS = ACT USAGE = 10% ERRORS: 1 out of 1000
LNPMR: STATUS = ACT USAGE = 13% ERRORS: 0 out of 1300
LNPQS: STATUS = ACT USAGE = 20% ERRORS: 1 out of 2000
WNPQS: STATUS = ACT USAGE = 0% ERRORS: 0 out of 0
PLNPQS: STATUS = ACT USAGE = 0% ERRORS: 0 out of 0
TLNP: STATUS = ACT USAGE = 0% ERRORS: 0 out of 0
ACG: OVERLOAD LEVEL = 0 MIC USAGE = 100%
CPU USAGE = 43%
Command Completed.
;

```

After LNP 192 Million feature is implemented with WNP, PLNP and TLNP features enabled.

rept-stat-lnp

```

Integrat40 05-07-24 10:37:22 EST EAGLE5 34.0.0
LNP SUBSYSTEM REPORT IS-ANR Active -----
ASSUMING MATE'S LOAD
LNP Cards Configured= 5
CARD PST SST GTT STATUS LNP STATUS CPU USAGE
1106 IS-NR Active ACT ACT 23%
1201 IS-ANR Standby SWDL SWDL 0%
1205 OOS-MT-DSBLD Manual ----- 0%
1302 OOS-MT FLT ----- 0%
1310 IS-ANR Standby ACT SWDL 0%

LNPQS:
SSN STATUS = Allowed MATE SSN STATUS = Prohibited
ACG: OVERLOAD LEVEL = 0 MIC USAGE = 100%

AVERAGE USAGE:
GTT = 13% LNPMT = 0% LNPQS = 0%
WNPQS = 0% TLNP = 10% PLNPQS = 0%
AVERAGE CPU USAGE = 23%

TOTAL ERRORS:
GTT: 1 out of 2000
LNPMT: 0 out of 0
LNPQS: 0 out of 0
WNPQS: 0 out of 0
PLNPQS: 0 out of 0
TLNP: 1 out of 500

PROVISIONED TABLE QTY:
TN: 76800000 of 96000000 ( 80%)
NPA: 135000 of 150000 ( 90%)
LRN: 90000 of 100000 ( 90%)
Command Completed.
    
```

;

Legend

CARD—The locations of the SCCP cards.

VERSION—The version number of the GPL the cards are running.

TYPE—The type of SCCP card.

PST—The primary state of the card. The possible values are described in “Possible Values for PST/SST/AST” in Appendix A.

SST—The secondary state of the card. The possible values are described in “Possible Values for PST/SST/AST” in Appendix A.

AST—The associated state of the card. The possible values are described in “Possible Values for PST/SST/AST” in Appendix A.

rept-stat-ls**Report Status Linkset**

Use this command to generate a report of the status of the MTP linksets. When a specific linkset is requested, the output displays a list of the links in the linkset and their secondary status. Output is generated for each of the 16 signaling link codes (SLC).

Keyword: **rept-stat-ls**

Related Commands: **chg-l3t, dlt-ls, ent-ls, rtrv-ls**

Command Class: System Maintenance

Parameters

:lsn= (optional)

Linkset name. The name of the linkset for which the report information is to be displayed.

Range: 1 alphabetic character followed by up to 9 alphanumeric characters

Default All linksets are displayed

:stat= (optional)

The primary state filter. This parameter indicates the state of the linksets for which a report will be displayed. For example, to display a report for all linksets whose state is DSBLD, specify the **stat=dsbld** parameter.

Range: **all, alminh, anr, dsbld, mt, nr**

all—All of the primary states

alminh—Alarms inhibited

anr—In service abnormal (IS-ANR)

dsbld—Out of service maintenance disabled (OOS-MT-DSBLD)

mt—Out of service maintenance (OOS-MT)

nr—In service normal (IS-NR)

Default: **all**

Example

```
rept-stat-ls
```

```
rept-stat-ls:lsn=lsnstpa
```

Dependencies

No other **rept-stat-xxx** command can be in progress when this command is entered.

The linkset specified by the **lsn** parameter must be equipped in the database.

Notes

This command can be canceled using the **F9** function key or the **canc-cmd** command. See **canc-cmd** for more information.

If no link is equipped for the SLC, the output is “___,___ UEQ.”

In this command, only ITU-international and ITU national point codes support the spare point code subtype prefix (**s-**) and the private and spare point code subtype prefix (**ps-**). All of the point code types support the private (internal) point code subtype prefix (**p-**).

Output

rept-stat-ls

eagle10207 02-08-23 10:09:59 EST EAGLE 30.0.0

LSN	APCA	PST	SST	AST
ls11234567	001-001-002	OOS-MT	Prohibit	GWS
ls11345678	001-001-003	OOS-MT	Prohibit	-----
ls11345679	001-001-004	OOS-MT	Idle	-----
ls1134567	001-001-005	OOS-MT	Prohibit	-----
ls113456	001-001-006	OOS-MT	Prohibit	-----
ls11345	001-001-007	OOS-MT	Prohibit	GWS
ls113467	001-001-008	OOS-MT	Prohibit	-----
ls1134	001-001-009	OOS-MT	Prohibit	-----
ls987	009-008-007	OOS-MT	Idle	-----
z	009-008-009	OOS-MT	Idle	-----
cap8	008-008-008	OOS-MT	Idle	-----

LSN	APCN	PST	SST	AST
lsnational	16383-aa	OOS-MT	Idle	-----

LSN	APCN24	PST	SST	AST

LSN	APCI	PST	SST	AST

Command Completed.

;

rept-stat-ls:lsn=lsnstpa

rlghncxa03w 04-02-27 14:59:11 EST EAGLE 31.3.0

LSN	APCA	PST	SST	AST
lsnstpa	110-15-08	IS-NR	Allowed	-----

ALARM STATUS = No Alarms.

SCRSET = ----

GWSA = ----

GWSM = ----

GWSD = ----

SLC	SLK	SST	SLC	SLK	SST
0	1207,A	Avail	8	-----,-	UEQ
1	1203,A	Avail	9	-----,-	UEQ
2	1103,B	LPBK	10	-----,-	UEQ
3	-----,-	UEQ	11	-----,-	UEQ
4	-----,-	UEQ	12	-----,-	UEQ
5	-----,-	UEQ	13	-----,-	UEQ
6	-----,-	UEQ	14	-----,-	UEQ
7	-----,-	UEQ	15	-----,-	UEQ

Command Completed.

;

The following example includes output for linksets that contain 24-bit ITU-N adjacent point codes.

rept-stat-ls

```
tekelecstp 02-03-20 21:22:04 EST EAGLE 31.0.0
LSN      APCA          PST          SST          AST
lsansi   001-005-001      OOS-MT      Prohibit     -----

LSN      APCN          PST          SST          AST

LSN      APCN24        PST          SST          AST
ls24     004-004-004      OOS-MT      Prohibit     -----
test20   020-020-020      OOS-MT      Idle         -----

LSN      APCI          PST          SST          AST
Command Completed.
```

;

The following example includes output for linksets that contain spare and private adjacent point codes.

rept-stat-ls

```
tekelecstp 02-03-20 21:22:04 EST EAGLE 31.12.0
LSN      APCA          PST          SST          AST
ls11234567 001-001-002      OOS-MT      Prohibit     GWS
ls11345678 001-001-003      OOS-MT      Prohibit     -----
ls11345679 001-001-004      OOS-MT      Idle         -----
ls1134567 001-001-005      OOS-MT      Prohibit     -----
ls113456 001-001-006      OOS-MT      Prohibit     -----
ls11345  p-001-001-007      OOS-MT      Prohibit     GWS
ls113467 001-001-008      OOS-MT      Prohibit     -----
ls1134  p-001-001-009      OOS-MT      Prohibit     -----
ls987 009-008-007      OOS-MT      Idle         -----
z 009-008-009      OOS-MT      Idle         -----
cap8 008-008-008      OOS-MT      Idle         -----

LSN      APCN          PST          SST          AST
lsnational s-09-14-05-3-ab  OOS-MT      Idle         -----

LSN      APCN24        PST          SST          AST

LSN      APCI          PST          SST          AST
Command Completed.
```

;

Legend

LSN—The name of the linkset

APCA/APCI/APCN/APCN24—The adjacent point code of the linkset (ANSI, ITU-I, ITU-N, ITU-N 24-bit)

PST—The primary state of the linkset. The possible values are described in “Possible Values for PST/SST/AST” in Appendix A.

SST—The secondary state of the linkset. The possible values are described in “Possible Values for PST/SST/AST” in Appendix A.

AST—The associated state of the linkset. The possible values are described in “Possible Values for PST/SST/AST” in Appendix A.

ALARM STATUS—A listing of any trouble text alarm messages that have been generated for the specified card.

SCRN—The name of the gateway screening screen set associated with the linkset.

GWSA—Shows whether gateway screening is used for the specified linkset.

GWSM—Shows whether gateway screening messaging is turned on for the specified linkset.

GWSD—Shows whether the discarding of MSUs that bypass the gateway screening function due to load-shedding is turned on.

SLC—The signaling link codes associated with the links that are contained in the specified linkset.

SLK—The signaling links that are contained in the linkset, shown by the card location containing the signaling link and the port on the card containing the signaling link.

rept-stat-lsms

Report the Status of LSMS

NOTE: This command is obsolete.

Use this command to generate a summary report of the status of the Local Service Management System (LSMS) subsystem on the EAGLE 5 SAS.

NOTE: If the LNP ELAP Configuration feature is turned on in the system, the **rept-stat-lsms** command is no longer available. Instead, use the **rept-stat-mps** command.

Keyword: **rept-stat-lsms**

Related Commands: **alw-trm, chg-trm, inh-trm, rept-stat-seas, rept-stat-sys, rept-stat-trbl, rept-stat-trm**

Command Class: System Maintenance

Parameters

This command has no parameters.

Example

```
rept-stat-lsms
```

Dependencies

The LNP feature must be turned on (see the **enable-ctrl-feat** command) before this command can be entered.

The **rept-stat-lsms** command is not available when the LNP ELAP Configuration feature is turned on. The **rept-stat-mps** command must be entered.

No other **rept-stat-xxx** command can be in progress when this command is entered.

Notes

None

Output**rept-stat-lsms**

```

rlghncxa03w 04-02-17 14:59:11 EST EAGLE 31.3.0
                                GPL          PST          SST          AST
-----
LSMS SYSTEM                    IS-ANR          Restricted  -----
TDM Port                        6              IS-NR          Active      -----
OAP A                          A 220-001-000  OOS-MT        Isolated    -----
OAP B                          B -----      OOS-MT        Isolated    -----
LSMS Conn A1                   A1            IS-NR          Active      -----
LSMS Conn B1                   B1            OOS-MT        Fault       -----

LSMS SYSTEM ALARM STATUS = ** 0362 LSMS is at min service limit
OAP A        ALARM STATUS = No Alarms.
OAP B        ALARM STATUS = ** 0341 OAP unavailable
LSMS Conn A1 ALARM STATUS = No Alarms.
LSMS Conn B1 ALARM STATUS = ** 0359 LSMS connection unavailable

```

Command Completed.

;

Legend

GPL—Generic program load number of the subsystem component.

PST—The primary state of the subsystem. The possible values are described in “Possible Values for PST/SST/AST” in Appendix A.

SST—The secondary state of the subsystem. The possible values are described in “Possible Values for PST/SST/AST” in Appendix A.

AST—The associated state of the subsystem. The possible values are described in “Possible Values for PST/SST/AST” in Appendix A.

rept-stat-meas**Report Measurement Status**

Use this command to report the status of the Measurements Subsystem, including card location and state, alarm level, and subsystem state.

Keyword: **rept-stat-meas**

Related Commands: **rept-stat-card**

Command Class: System Maintenance

Parameters

This command has no parameters.

Example

```
rept-stat-meas
```

Dependencies

The Measurements Platform feature must be turned on prior to issuing this command.

At least one MCPM card must be configured in the system.

No other **rept-stat-xxx** commands can be in progress when this command is issued.

Notes

The MCPM card status is independent of the IP Network Link status (Port A). The card can be IS-NR even if the network link has failed.

The version of the GPL is shown in the command output if the MCPM card is in the IS-NR or IS-ANR state. (The **rept-stat-card** command will not show the GPL version if the card is ISANR).

Output

rept-stat-meas

```

                                PST           SST           AST
MEAS SS                          OOS-MT       Fault       -----

ALARM STATUS =   ** 0516 MEAS degraded with card out of service

CARD  VERSION          TYPE    PST           SST           AST
1107  P 101-9-000      MCPM    IS-NR        Active       -----
      IP Link A                IS-NR        Active       Available
1109  101-9-000      MCPM    OOS-MT       Fault        -----
      IP Link A                OOS-MT       Fault        Unavailable

CARD 1107 ALARM STATUS = No Alarms
CARD 1109 ALARM STATUS = Card is isolated from the system
Command Completed.
;
    
```

Legend

MEAS SS—The Measurements Subsystem application running on the MCPM card.

ALARM STATUS—A listing of any trouble text alarm messages that have been generated for the MCPM and the applications running on the MCPM.

CARD—The location of the MCPM card. The MCPM card with the letter “P” to the right of its card location is the primary MCPM. The primary MCPM transfers scheduled measurements report files to the primary FTP server. When the primary state (PST) of the MCPM is IS-NR, the secondary state (SST) indicates whether the MCPM is active or standby.

VERSION—The version number of the GPL that the specified MCPM card is running. The version is shown if the card is in the IS-NR or IS-ANR state.

TYPE—MCPM; the card that is running the Measurements Subsystem application.

PST—The primary state of the Measurements Subsystem or card. The possible values are described in “Possible Values for PST/SST/AST” in Appendix A.

SST—The secondary state of the Measurements Subsystem or card. The possible values are described in “Possible Values for PST/SST/AST” in Appendix A.

AST—The associated state of the Measurements Subsystem or card. The possible values are described in “Possible Values for PST/SST/AST” in Appendix A.

CARD XXXX ALARM STATUS—A listing of any trouble text alarm messages that have been generated for the card.

rept-stat-mps

Report the MPS Status

Use this command to display the overall status of the application running on the MPS (multi-purpose server).

- If the LNP ELAP Configuration feature is turned on, the status of the ELAP (EAGLE LNP Application Processor) subsystem is displayed.
- If the INP (INAP number portability) feature is turned on, the status of the EPAP (EAGLE Provisioning Application Processor) subsystem is displayed.
- If the G-Port (GSM mobile number portability) feature or G-Flex (GSM flexible numbering) feature is turned on, the status of the GSM (Global System for Mobile Telecommunications) and the EPAP (EAGLE Provisioning Application Processor) is displayed.
- If the EIR (Equipment Identity Register) feature is enabled and turned on, the status of the EIR component on the card is displayed.

Keyword: `rept-stat-mps`

Related Commands: `rept-stat-card`, `rept-stat-sccp`

Command Class: System Maintenance

Parameters

:loc= (optional)

The card location of the VSCCP card to be reported on, as stenciled on the shelf of the EAGLE 5 SAS.

Range: 1101–1108, 1111–1117, 1201–1208, 1211–1218, 1301–1308, 1311–1318, 2101–2108, 2111–2118, 2201–2208, 2211–2218, 2301–2308, 2311–2318, 3101–3108, 3111–3118, 3201–3208, 3211–3218, 3301–3308, 3311–3318, 4101–4108, 4111–4118, 4201–4208, 4211–4218, 4301–4308, 4311–4318, 5101–5108, 5111–5118, 5201–5208, 5211–5218, 5301–5308, 5311–5318, 6101–6108, 6111–6118

Example

```
rept-stat-mps:loc=1106
```

Dependencies

The card location specified in the **loc** parameter, must contain a VSCCP card.

The INP, G-Port, G-Flex, Equipment Identity Register (EIR), or LNP ELAP Configuration feature must be on before this command can be entered.

At least one VSCCP card must be configured in the system before this command can be entered.

To specify the **rept-stat-mps** command, no other **rept-stat-xxxx** command can be in progress.

Notes

When the MPS does not have an alarm on it, the **rept-stat-mps** report indicates in the SST field of the report which MPS is the active and which is the standby. When the MPS has an alarm on it, the SST field shows "Fault," and the Active/Standby information is displayed in the AST field as long as there is an alarm. After the alarm clears, the Active/Standby information appears in the SST field as before.

Output

The following example shows the possible system response if the G-Flex or G-Port feature and the INP feature are turned on:

rept-stat-mps

```

rlghncxa03w 04-01-07 10:23:93 EST EAGLE 31.3.0
                VERSION      PST          SST          AST
EPAP A          027-015-000  IS-NR       Active       -----
    CRITICAL PLATFORM  ALARM DATA = No Alarms
    MAJOR    PLATFORM  ALARM DATA = No Alarms
    MINOR    PLATFORM  ALARM DATA = No Alarms
    CRITICAL APPLICATION ALARM DATA = No Alarms
    MAJOR    APPLICATION ALARM DATA = No Alarms
    MINOR    APPLICATION ALARM DATA = No Alarms
                ALARM STATUS = No Alarms

                VERSION      PST          SST          AST
EPAP B          027-015-000  OOS-MT      Fault        Standby
    CRITICAL PLATFORM  ALARM DATA = No Alarms
    MAJOR    PLATFORM  ALARM DATA = h'0123456789ABCDEF
    MINOR    PLATFORM  ALARM DATA = h'0123456789ABCDEF
    CRITICAL APPLICATION ALARM DATA = No Alarms
    MAJOR    APPLICATION ALARM DATA = h'0123456789ABCDEF
    MINOR    APPLICATION ALARM DATA = No Alarms
                ALARM STATUS = ** 0371 Major Platform Failure(s)

CARD  PST          SST          GSM STAT  INP STAT
1106 P IS-NR       Active     ACT        ACT
1201 IS-ANR       Active     SWDL       SWDL
1205 OOS-MT-DSBLD Manual     -----
1302 OOS-MT       Isolated  -----
1310 IS-ANR       Standby   SWDL       SWDL

CARD 1106 ALARM STATUS = No Alarms
    DSM PORT A:      ALARM STATUS      = No Alarms
    DSM PORT B:      ALARM STATUS      = No Alarms
CARD 1201 ALARM STATUS = No Alarms
    DSM PORT A:      ALARM STATUS      = ** 0084 IP Connection Unavailable
    DSM PORT B:      ALARM STATUS      = ** 0084 IP Connection Unavailable
CARD 1205 ALARM STATUS = No Alarms
    DSM PORT A:      ALARM STATUS      = ** 0084 IP Connection Unavailable
    DSM PORT B:      ALARM STATUS      = ** 0084 IP Connection Unavailable
CARD 1302 ALARM STATUS = ** 0013 Card is isolated from the system
    DSM PORT A:      ALARM STATUS      = ** 0084 IP Connection Unavailable
    DSM PORT B:      ALARM STATUS      = ** 0084 IP Connection Unavailable
CARD 1310 ALARM STATUS = No Alarms
    DSM PORT A:      ALARM STATUS      = ** 0084 IP Connection Unavailable
    DSM PORT B:      ALARM STATUS      = ** 0084 IP Connection Unavailable
Command Completed.
;

```

The following example shows the possible system response if the G-Flex or G-Port feature is turned on and the INP feature is off:

rept-stat-mps

```

rlghncxa03w 04-01-07 10:23:93 EST EAGLE 31.3.0
                VERSION      PST          SST          AST
EPAP A          027-015-000  IS-NR       Active       -----
  CRITICAL PLATFORM  ALARM DATA = No Alarms
  MAJOR   PLATFORM  ALARM DATA = No Alarms
  MINOR   PLATFORM  ALARM DATA = No Alarms
  CRITICAL APPLICATION ALARM DATA = No Alarms
  MAJOR   APPLICATION ALARM DATA = No Alarms
  MINOR   APPLICATION ALARM DATA = No Alarms
                ALARM STATUS = No Alarms

                VERSION      PST          SST          AST
EPAP B          027-015-000  OOS-MT      Fault        Standby
  CRITICAL PLATFORM  ALARM DATA = No Alarms
  MAJOR   PLATFORM  ALARM DATA = h'0123456789ABCDEF
  MINOR   PLATFORM  ALARM DATA = h'0123456789ABCDEF
  CRITICAL APPLICATION ALARM DATA = No Alarms
  MAJOR   APPLICATION ALARM DATA = h'0123456789ABCDEF
  MINOR   APPLICATION ALARM DATA = No Alarms
                ALARM STATUS = ** 0371 Major Platform Failure(s)

CARD  PST          SST          GSM STAT
1106 P IS-NR       Active      ACT
1201 IS-ANR       Active      SWDL
1205 OOS-MT-DSBLD Manual      -----
1302 OOS-MT       Isolated   -----
1310 IS-ANR       Standby    SWDL

CARD 1106 ALARM STATUS = No Alarms
  DSM PORT A:          ALARM STATUS      = No Alarms
  DSM PORT B:          ALARM STATUS      = No Alarms
CARD 1201 ALARM STATUS = No Alarms
  DSM PORT A:          ALARM STATUS      = ** 0084 IP Connection Unavailable
  DSM PORT B:          ALARM STATUS      = ** 0084 IP Connection Unavailable
CARD 1205 ALARM STATUS = No Alarms
  DSM PORT A:          ALARM STATUS      = ** 0084 IP Connection Unavailable
  DSM PORT B:          ALARM STATUS      = ** 0084 IP Connection Unavailable
CARD 1302 ALARM STATUS = ** 0013 Card is isolated from the system
  DSM PORT A:          ALARM STATUS      = ** 0084 IP Connection Unavailable
  DSM PORT B:          ALARM STATUS      = ** 0084 IP Connection Unavailable
CARD 1310 ALARM STATUS = No Alarms
  DSM PORT A:          ALARM STATUS      = ** 0084 IP Connection Unavailable
  DSM PORT B:          ALARM STATUS      = ** 0084 IP Connection Unavailable

Command Completed.
;

```

The following example shows the possible system response if the G-Flex and G-Port features are turned off and the INP feature is turned on:

rept-stat-mps

```

rlghncxa03w 04-01-07 10:23:93 EST EAGLE 31.3.0
          VERSION      PST          SST          AST
EPAP A      027-015-000  IS-NR          Active      -----
  CRITICAL PLATFORM    ALARM DATA = No Alarms
  MAJOR    PLATFORM    ALARM DATA = No Alarms
  MINOR    PLATFORM    ALARM DATA = No Alarms
  CRITICAL APPLICATION ALARM DATA = No Alarms
  MAJOR    APPLICATION ALARM DATA = No Alarms
  MINOR    APPLICATION ALARM DATA = No Alarms
          ALARM STATUS = No Alarms

          VERSION      PST          SST          AST
EPAP B      027-015-000  IS-NR          Standby     -----
  CRITICAL PLATFORM    ALARM DATA = No Alarms
  MAJOR    PLATFORM    ALARM DATA = No Alarms
  MINOR    PLATFORM    ALARM DATA = No Alarms
  CRITICAL APPLICATION ALARM DATA = No Alarms
  MAJOR    APPLICATION ALARM DATA = No Alarms
  MINOR    APPLICATION ALARM DATA = No Alarms
          ALARM STATUS = No Alarms

CARD  PST          SST          INP STAT
1106 P IS-NR          Active      ACT
1201  IS-ANR        Active      SWDL
1205  OOS-MT-DSBLD Manual      -----
1302  OOS-MT        Isolated   -----
1310  IS-ANR        Standby    SWDL

CARD 1106 ALARM STATUS = No Alarms
  DSM PORT A:          ALARM STATUS      = No Alarms
  DSM PORT B:          ALARM STATUS      = No Alarms
CARD 1201 ALARM STATUS = No Alarms
  DSM PORT A:          ALARM STATUS      = ** 0084 IP Connection Unavailable
  DSM PORT B:          ALARM STATUS      = ** 0084 IP Connection Unavailable
CARD 1205 ALARM STATUS = No Alarms
  DSM PORT A:          ALARM STATUS      = ** 0084 IP Connection Unavailable
  DSM PORT B:          ALARM STATUS      = ** 0084 IP Connection Unavailable
CARD 1302 ALARM STATUS = ** 0013 Card is isolated from the system
  DSM PORT A:          ALARM STATUS      = ** 0084 IP Connection Unavailable
  DSM PORT B:          ALARM STATUS      = ** 0084 IP Connection Unavailable
CARD 1310 ALARM STATUS = No Alarms
  DSM PORT A:          ALARM STATUS      = ** 0084 IP Connection Unavailable
  DSM PORT B:          ALARM STATUS      = ** 0084 IP Connection Unavailable

Command Completed.
;

```

The following example shows the possible system response if the LNP ELAP Configuration feature is turned on:

rept-stat-mps

```

rlghncxa03w 04-01-07 10:23:93 EST EAGLE 31.3.0
          VERSION      PST          SST          AST
ELAP A    027-015-000  OOS-MT      Fault        Standby
  CRITICAL PLATFORM    ALARM DATA = No Alarms
  MAJOR    PLATFORM    ALARM DATA = h'0123456789ABCDEF
  MINOR    PLATFORM    ALARM DATA = h'0123456789ABCDEF
  CRITICAL APPLICATION ALARM DATA = No Alarms
  MAJOR    APPLICATION ALARM DATA = h'0123456789ABCDEF
  MINOR    APPLICATION ALARM DATA = No Alarms
          ALARM STATUS = ** 0371 Major Platform Failure(s)

          VERSION      PST          SST          AST
ELAP B    027-015-000  OOS-MT      Fault        Active
  CRITICAL PLATFORM    ALARM DATA = No Alarms
  MAJOR    PLATFORM    ALARM DATA = No Alarms
  MINOR    PLATFORM    ALARM DATA = No Alarms
  CRITICAL APPLICATION ALARM DATA = h'0123456789ABCDEF
  MAJOR    APPLICATION ALARM DATA = h'0123456789ABCDEF
  MINOR    APPLICATION ALARM DATA = No Alarms
          ALARM STATUS = *C 0373 Critical Application Failure(s)

CARD  PST          SST          LNP STAT
1106 P IS-NR      Active      ACT
1201 IS-ANR      Active      SWDL
1205 OOS-MT-DSBLD Manual      -----
1302 OOS-MT      Isolated   -----
1310 IS-ANR      Standby    SWDL

CARD 1106 ALARM STATUS = No Alarms
  DSM PORT A:    ALARM STATUS      = No Alarms
  DSM PORT B:    ALARM STATUS      = No Alarms
CARD 1201 ALARM STATUS = No Alarms
  DSM PORT A:    ALARM STATUS      = ** 0084 IP Connection Unavailable
  DSM PORT B:    ALARM STATUS      = ** 0084 IP Connection Unavailable
CARD 1205 ALARM STATUS = No Alarms
  DSM PORT A:    ALARM STATUS      = ** 0084 IP Connection Unavailable
  DSM PORT B:    ALARM STATUS      = ** 0084 IP Connection Unavailable
CARD 1302 ALARM STATUS = ** 0013 Card is isolated from the system
  DSM PORT A:    ALARM STATUS      = ** 0084 IP Connection Unavailable
  DSM PORT B:    ALARM STATUS      = ** 0084 IP Connection Unavailable
CARD 1310 ALARM STATUS = No Alarms
  DSM PORT A:    ALARM STATUS      = ** 0084 IP Connection Unavailable
  DSM PORT B:    ALARM STATUS      = ** 0084 IP Connection Unavailable
Command Completed.
;

```

The following example shows the possible system response if the EIR feature is enabled and turned on:

rept-stat-mps

```

rlghncxa03w 03-06-24 10:37:22 EST EAGLE 31.0.0
          VERSION      PST          SST          AST
EPAP A      027-015-000  IS-NR          Active      -----
  CRITICAL PLATFORM    ALARM DATA = No Alarms
  MAJOR    PLATFORM    ALARM DATA = No Alarms
  MINOR    PLATFORM    ALARM DATA = No Alarms
  CRITICAL APPLICATION ALARM DATA = No Alarms
  MAJOR    APPLICATION ALARM DATA = No Alarms
  MINOR    APPLICATION ALARM DATA = No Alarms
          ALARM STATUS = No Alarms

          VERSION      PST          SST          AST
EPAP B      027-015-000  OOS-MT         Fault       Standby
  CRITICAL PLATFORM    ALARM DATA = No Alarms
  MAJOR    PLATFORM    ALARM DATA = h'0123456789ABCDEF
  MINOR    PLATFORM    ALARM DATA = h'0123456789ABCDEF
  CRITICAL APPLICATION ALARM DATA = No Alarms
  MAJOR    APPLICATION ALARM DATA = h'0123456789ABCDEF
  MINOR    APPLICATION ALARM DATA = No Alarms
          ALARM STATUS = ** 0371 Major Platform Failure(s)

CARD  PST          SST          EIR STAT
1106 P IS-NR          Active      ACT
1201  IS-ANR        Active      SWDL
1205  OOS-MT-DSBLD Manual      -----
1302  OOS-MT         Isolated   -----
1310  IS-ANR        Standby    SWDL

CARD 1106 ALARM STATUS = No Alarms
  DSM PORT A:          ALARM STATUS      = No Alarms
  DSM PORT B:          ALARM STATUS      = No Alarms
CARD 1201 ALARM STATUS = No Alarms
  DSM PORT A:          ALARM STATUS      = ** 0084 IP Connection Unavailable
  DSM PORT B:          ALARM STATUS      = ** 0084 IP Connection Unavailable
CARD 1205 ALARM STATUS = No Alarms
  DSM PORT A:          ALARM STATUS      = ** 0084 IP Connection Unavailable
  DSM PORT B:          ALARM STATUS      = ** 0084 IP Connection Unavailable
CARD 1302 ALARM STATUS = ** 0013 Card is isolated from the system
  DSM PORT A:          ALARM STATUS      = ** 0084 IP Connection Unavailable
  DSM PORT B:          ALARM STATUS      = ** 0084 IP Connection Unavailable
CARD 1310 ALARM STATUS = No Alarms
  DSM PORT A:          ALARM STATUS      = ** 0084 IP Connection Unavailable
  DSM PORT B:          ALARM STATUS      = ** 0084 IP Connection Unavailable

Command Completed.
;

```

The following example shows the possible system response if the EIR feature is enabled and turned on, and the G-Port or G-Flex feature is turned on:

rept-stat-mps

```

rlghncxa03w 03-06-24 10:37:22 EST EAGLE 31.0.0
                VERSION      PST          SST          AST
EPAP A          027-015-000  IS-NR       Active       -----
  CRITICAL PLATFORM  ALARM DATA = No Alarms
  MAJOR   PLATFORM  ALARM DATA = No Alarms
  MINOR   PLATFORM  ALARM DATA = No Alarms
  CRITICAL APPLICATION ALARM DATA = No Alarms
  MAJOR   APPLICATION ALARM DATA = No Alarms
  MINOR   APPLICATION ALARM DATA = No Alarms
                ALARM STATUS = No Alarms

                VERSION      PST          SST          AST
EPAP B          027-015-000  OOS-MT      Fault        Standby
  CRITICAL PLATFORM  ALARM DATA = No Alarms
  MAJOR   PLATFORM  ALARM DATA = h'0123456789ABCDEF
  MINOR   PLATFORM  ALARM DATA = h'0123456789ABCDEF
  CRITICAL APPLICATION ALARM DATA = No Alarms
  MAJOR   APPLICATION ALARM DATA = h'0123456789ABCDEF
  MINOR   APPLICATION ALARM DATA = No Alarms
                ALARM STATUS = ** 0371 Major Platform Failure(s)

CARD  PST          SST          GSM STAT  EIR STAT
1106 P IS-NR       Active     ACT        ACT
1201 IS-ANR       Active     SWDL       SWDL
1205 OOS-MT-DSBLD Manual     -----
1302 OOS-MT       Isolated  -----
1310 IS-ANR       Standby   SWDL       SWDL

CARD 1106 ALARM STATUS = No Alarms
  DSM PORT A:  ALARM STATUS = No Alarms
  DSM PORT B:  ALARM STATUS = No Alarms
CARD 1201 ALARM STATUS = No Alarms
  DSM PORT A:  ALARM STATUS = ** 0084 IP Connection Unavailable
  DSM PORT B:  ALARM STATUS = ** 0084 IP Connection Unavailable
CARD 1205 ALARM STATUS = No Alarms
  DSM PORT A:  ALARM STATUS = ** 0084 IP Connection Unavailable
  DSM PORT B:  ALARM STATUS = ** 0084 IP Connection Unavailable
CARD 1302 ALARM STATUS = ** 0013 Card is isolated from the system
  DSM PORT A:  ALARM STATUS = ** 0084 IP Connection Unavailable
  DSM PORT B:  ALARM STATUS = ** 0084 IP Connection Unavailable
CARD 1310 ALARM STATUS = No Alarms
  DSM PORT A:  ALARM STATUS = ** 0084 IP Connection Unavailable
  DSM PORT B:  ALARM STATUS = ** 0084 IP Connection Unavailable

Command Completed.
;

```

The following example shows the possible system response when a specific DSM card is queried:

rept-stat-mps:loc=1205

```
rlghncxa03w 04-01-07 10:23:93 EST EAGLE 31.3.0
CARD   VERSION      TYPE   PST           SST           AST
1205   -----      DSM   OOS-MT-DSBLD Manual        -----
      DSM PORT A
          ALARM STATUS   = ** 0084 IP Connection Unavailable
      DSM PORT B
          ALARM STATUS   = ** 0084 IP Connection Unavailable
      INP STAT          = -----
      CARD ALARM STATUS = No Alarms.
      DSM MEMORY USAGE = 0%
      Command Completed.
;
```

The following example shows the possible system response if a specific DSM card is queried and the EIR feature is enabled and turned on:

rept-stat-mps:loc=1205

```
rlghncxa03w 03-10-24 10:37:22 EST EAGLE 31.0.0
CARD   VERSION      TYPE   PST           SST           AST
1205   -----      DSM   OOS-MT-DSBLD Manual        -----
      DSM PORT A
          ALARM STATUS   = ** 0084 IP Connection Unavailable
      DSM PORT B
          ALARM STATUS   = ** 0084 IP Connection Unavailable
      EIR STAT          = -----
      CARD ALARM STATUS = No Alarms.
      DSM MEMORY USAGE = 0%
      Command Completed.
;
```

The following example shows the possible system response with the INP and GPORT or GFLEX feature bits turned on.

rept-stat-mps

```
Integrat40 01-10-24 10:37:22 EST EAGLE5 34.0.0
      VERSION      PST           SST           AST
EPAP A  027-015-000 IS-NR        Active        -----
      CRITICAL PLATFORM ALARM DATA = No Alarms
      MAJOR   PLATFORM ALARM DATA = No Alarms
      MINOR   PLATFORM ALARM DATA = No Alarms
      CRITICAL APPLICATION ALARM DATA = No Alarms
      MAJOR   APPLICATION ALARM DATA = No Alarms
      MINOR   APPLICATION ALARM DATA = No Alarms
      ALARM STATUS = No Alarms
      VERSION      PST           SST           AST
EPAP B  027-015-000 OOS-MT        Fault         Standby
      CRITICAL PLATFORM ALARM DATA = No Alarms
      MAJOR   PLATFORM ALARM DATA = h'0123456789ABCDEF
      MINOR   PLATFORM ALARM DATA = h'0123456789ABCDEF
      CRITICAL APPLICATION ALARM DATA = No Alarms
      MAJOR   APPLICATION ALARM DATA = h'0123456789ABCDEF
      MINOR   APPLICATION ALARM DATA = No Alarms
      ALARM STATUS = ** 0371 Major Platform Failure(s)
      CARD   PST           SST           GSM STAT   INP STAT
```

```

1106 P IS-NR      Active   ACT      ACT
1201  IS-ANR      Active   SWDL     SWDL
1205  OOS-MT-DSBLD Manual   -----
1302  OOS-MT       Isolated -----
1310  IS-ANR      Standby  SWDL     SWDL

CARD 1106 ALARM STATUS = No Alarms
  DSM PORT A:      ALARM STATUS      = No Alarms
  DSM PORT B:      ALARM STATUS      = No Alarms
CARD 1201 ALARM STATUS = No Alarms
  DSM PORT A:      ALARM STATUS      = ** 0084 IP Connection Unavailable
    Failed Channels: Prov Dnld TCP UDP
  DSM PORT B:      ALARM STATUS      = ** 0084 IP Connection Unavailable
    Failed Channels: Prov UDP
CARD 1205 ALARM STATUS = No Alarms
  DSM PORT A:      ALARM STATUS      = ** 0084 IP Connection Unavailable
    Failed Channels: Prov Dnld TCP UDP
  DSM PORT B:      ALARM STATUS      = ** 0084 IP Connection Unavailable
    Failed Channels: Prov Dnld TCP UDP
CARD 1302 ALARM STATUS = ** 0013 Card is isolated from the system
  DSM PORT A:      ALARM STATUS      = ** 0084 IP Connection Unavailable
    Failed Channels: Prov Dnld TCP UDP
  DSM PORT B:      ALARM STATUS      = ** 0084 IP Connection Unavailable
    Failed Channels: Prov Dnld TCP UDP
CARD 1310 ALARM STATUS = No Alarms
  DSM PORT A:      ALARM STATUS      = ** 0084 IP Connection Unavailable
    Failed Channels: Dnld TCP UDP
  DSM PORT B:      ALARM STATUS      = ** 0084 IP Connection Unavailable
    Failed Channels: Prov Dnld TCP

```

Command Completed.

;

The following example shows the possible system response if INP and GPORT or GFLEX feature bits turned on.

rept-stat-mps

Integrat40 01-10-24 10:37:22 EST EAGLE5 34.0.0

```

                VERSION      PST          SST          AST
EPAP A          027-015-000  IS-NR       Active       -----
CRITICAL PLATFORM ALARM DATA = No Alarms
MAJOR   PLATFORM ALARM DATA = No Alarms
MINOR   PLATFORM ALARM DATA = No Alarms
CRITICAL APPLICATION ALARM DATA = No Alarms
MAJOR   APPLICATION ALARM DATA = No Alarms
MINOR   APPLICATION ALARM DATA = No Alarms
        ALARM STATUS = No Alarms
    
```

```

                VERSION      PST          SST          AST
EPAP B          027-015-000  OOS-MT      Fault        Standby
CRITICAL PLATFORM ALARM DATA = No Alarms
MAJOR   PLATFORM ALARM DATA = h'0123456789ABCDEF
MINOR   PLATFORM ALARM DATA = h'0123456789ABCDEF
CRITICAL APPLICATION ALARM DATA = No Alarms
MAJOR   APPLICATION ALARM DATA = h'0123456789ABCDEF
MINOR   APPLICATION ALARM DATA = No Alarms
        ALARM STATUS = ** 0371 Major Platform Failure(s)
    
```

```

CARD  PST          SST          GSM STAT  INP STAT
1106 P IS-NR       Active     ACT        ACT
1201 IS-ANR        Active     SWDL       SWDL
1205 OOS-MT-DSBLD Manual     -----   -----
1302 OOS-MT        Isolated  -----   -----
1310 IS-ANR        Standby   SWDL       SWDL
    
```

```

CARD 1106 ALARM STATUS = No Alarms
  DSM PORT A: ALARM STATUS = No Alarms
  DSM PORT B: ALARM STATUS = No Alarms
CARD 1201 ALARM STATUS = No Alarms
  DSM PORT A: ALARM STATUS = ** 0084 IP Connection Unavailable
    Failed Channels: Prov Dnld TCP UDP
  DSM PORT B: ALARM STATUS = ** 0084 IP Connection Unavailable
    Failed Channels: Prov UDP
CARD 1205 ALARM STATUS = No Alarms
  DSM PORT A: ALARM STATUS = ** 0084 IP Connection Unavailable
    Failed Channels: Prov Dnld TCP UDP
  DSM PORT B: ALARM STATUS = ** 0084 IP Connection Unavailable
    Failed Channels: Prov Dnld TCP UDP
CARD 1302 ALARM STATUS = ** 0013 Card is isolated from the system
  DSM PORT A: ALARM STATUS = ** 0084 IP Connection Unavailable
    Failed Channels: Prov Dnld TCP UDP
  DSM PORT B: ALARM STATUS = ** 0084 IP Connection Unavailable
    Failed Channels: Prov Dnld TCP UDP
CARD 1310 ALARM STATUS = No Alarms
  DSM PORT A: ALARM STATUS = ** 0084 IP Connection Unavailable
    Failed Channels: Dnld TCP UDP
  DSM PORT B: ALARM STATUS = ** 0084 IP Connection Unavailable
    Failed Channels: Prov Dnld TCP
    
```

Command Completed.

;

The following example shows the possible system response when the EIR feature key is enabled and turned on, and the GFLEX or GPORT feature bits are turned on.

The following example also shows that DSM Port A has an IP Connection Unavailable alarm due to failed channels Dnld, TCP, and UDP. DSM Port B has an IP Connection Unavailable alarm due to failed channels Dnld and TCP.

rept-stat-mps:loc=1205

```

Integrat40 05-05-24 10:37:22 EST EAGLE5 34.0.0

CARD   VERSION      TYPE   PST           SST           AST
1205   -----      DSM   OOS-MT-DSBLD Manual        -----
      DSM PORT A
          ALARM STATUS      = ** 0084 IP Connection Unavailable
                                Failed Channels: Dnld TCP UDP

      DSM PORT B
          ALARM STATUS      = ** 0084 IP Connection Unavailable
                                Failed Channels: Dnld TCP

      GSM STAT              = -----
      EIR STAT              = -----
      CARD ALARM STATUS     = No Alarms.
      DSM MEMORY USAGE      = 0%
      Command Completed.
;

```

The following example shows the possible system response when the EIR feature key is enabled and turned on, and the GFLEX or GPORT feature bits are turned on.

The following example also shows that DSM Port A has an IP Connection Unavailable alarm due to failed channels Dnld, TCP, and UDP. DSM Port B has an IP Connection Unavailable alarm due to failed channels Dnld and TCP.

rept-stat-mps:loc=1205

```

Integrat40 05-05-24 10:37:22 EST EAGLE5 34.0.0

CARD   VERSION      TYPE   PST           SST           AST
1205   -----      DSM   OOS-MT-DSBLD Manual        -----
      DSM PORT A
          ALARM STATUS      = ** 0084 IP Connection Unavailable
                                Failed Channels: Dnld TCP UDP

      DSM PORT B
          ALARM STATUS      = ** 0084 IP Connection Unavailable
                                Failed Channels: Dnld TCP

      GSM STAT              = -----
      EIR STAT              = -----
      CARD ALARM STATUS     = No Alarms.
      DSM MEMORY USAGE      = 0%
      Command Completed.
;

```

Legend

CARD—The location of the VSCCP card. The VSCCP card with the designator “P” to the right of its card location is the primary DSM as selected by the active ELAP/EPAP. The primary DSM provides the ELAP/EPAP status to the OAM. When the primary state (PST) of the ELAP/EPAP is IS-NR, the secondary state (SST) indicates whether the ELAP/EPAP is active or standby.

VERSION—The version number of the GPL that the specified ELAP/EPAP or card is running.

PST—The primary state of the ELAP/EPAP or card. The possible values are described in “Possible Values for PST/SST/AST” in Appendix A.

SST—The secondary state of the ELAP/EPAP or card. The possible values are described in “Possible Values for PST/SST/AST” in Appendix A.

AST—The associated state of the ELAP/EPAP or card. The possible values are described in “Possible Values for PST/SST/AST” in Appendix A.

EPAP/ELAP A/B—The application running on the MPS (multi-purpose server) platform. If the LNP ELAP Configuration feature is turned on, the output shows ELAP A/B. If INP, G-Flex, or G-Port is turned on, the output shows EPAP A/B.

ALARM STATUS—A listing of any trouble text alarm messages that have been generated for the MPS and the applications running on the MPS. Each alarm is listed as a 16-character hexadecimal string where each bit represents a unique platform or application alarm. To decode the string, use the procedure in the *EPAP Administration Manual* or the *ELAP Administration Manual*. There are 6 categories of MPS alarms:

- Critical platform alarm data
- Major platform alarm data
- Minor platform alarm data
- Critical application alarm data
- Major application alarm data
- Minor application alarm data

GSM STAT—The possible states are either ACT (active) or SWDL (indicates that the GSM component on that card is currently inactive until the software download completes). The GSM STAT information is not displayed if the G-Port and G-Flex features are turned off.

INP STAT—The possible states of INP status include ACT (active), OFFL (offline) and SWDL (indicates that the INP component on that card is currently inactive until the software download completes). The INP STAT information is not displayed if the INP feature is turned off.

LNP STAT—The possible states of LNP status include ACT (active), OFFL (offline) and SWDL (indicates that the LNP component on that card is currently inactive until the software download completes). The LNP STAT information is not displayed if the LNP ELAP Configuration feature is turned off.

EIR STAT—The possible states of EIR Status include ACT (active), OFFL (offline), and SWDL (Indicates the EIR component on that card is currently inactive until software download completes). The EIR STAT information is not displayed if the EIR feature is not enabled.

DSM MEMORY USAGE—The percentage of DSM memory used to store the ELAP/EPAP database.

For EPAP, the percentage of the card memory is displayed. For example, 50% of the memory on a 2G DSM card means that 1G is used.

For ELAP/LNP, the percentage that is displayed depends on the enabled or default feature access key (FAK) quantity for LNP ported TNs, LNP ported LRNs, and LNP

ported NPANXXs in the system (see the **rtrv-ctrl-feat** command output). The percentage is the greatest of: 1) TNs provisioned divided by LNP ported TNs FAK quantity, 2) LRNs provisioned divided by LNP ported LRNs FAK quantity, or 3) NPANXXs provisioned divided by LNP ported NPANXXs FAK quantity.

CARD XXXX ALARM STATUS—A listing of any trouble text alarm messages that have been generated for the card.

DSM PORT A/B—A listing of any trouble text alarm messages that have been generated for the port on the card.

IP CONNECTION UNAVAILABLE—Indicates the failed channel(s) on those ports with IP Connection Unavailable alarms. The possible channels reported are:

- Prov—RTDB Provisioning Channel
- Dnld—RTDB Download Channel
- TCP—Transmission Control Protocol Channel
- UDP—User Datagram Protocol Channel

rept-stat-mux

Report the MPS Status

Use this command to list all the HMUX and HIPR cards, their location, and their status.

Keyword: **rept-stat-mux**

Related Commands: **rept-stat-card**

Command Class: System Maintenance

Parameters

This command has no parameters.

Example

rept-stat-mux

Dependencies

None

Notes

None

Output

rept-stat-mux

```
rlghncxa03w 04-09-07 10:23:93 EST EAGLE 32.0.0
CARD  TYPE      PST      SST      AST
1109  HMUX      IS-NR    Active   ALMINH
1110  HMUX      IS-NR    Active   -----
1209  HIPR      IS-NR    Active   ALMINH
1210  HIPR      IS-NR    Active   -----
```

Command Completed.

;

Legend

CARD—The HMUX or HIPR card location.

TYPE—The type of card (HMUX or HIPR).

PST—The primary state of the card. The possible values are described in “Possible Values for PST/SST/AST” in Appendix A.

SST—The secondary state of the card. The possible values are described in “Possible Values for PST/SST/AST” in Appendix A.

AST—The associated state of the card. The possible values are described in “Possible Values for PST/SST/AST” in Appendix A.

rept-stat-ndc**Report Status of NDC system**

Use this command to generate a summary report of the status of the NDC subsystem on the EAGLE 5 SAS. The connectivity status for each DCM and its mated EMAP/NDC QAF devices are reported. Additionally, an alarm status summary is printed if any alarms exist.

The status summary includes the status of the following:

- EMDC-DCM to EMAP IP link(s)
- The NDC agent
- The NDC agent-to-manager association and IP link

Keyword: `rept-stat-ndc`

Related Commands: `rept-stat-card`, `rept-stat-alm`, `rept-stat-trbl`

Command Class: System Maintenance

Parameters

This command has no parameters.

Example

```
rept-stat-ndc
```

Dependencies

No other **rept-stat-xxx** command can be in progress when this command is issued.

The NDC system must be configured with the EMDC cards defined in the system.

Notes

If the direct DCM to EMAP IP connection is unavailable the EMAP related statuses (NDC Agent, EMAP IP connection, and Q.3 association) are unknown and are shown in the output as dashes.

Output

rept-stat-ndc

```

rlghncxa03w 04-02-18 16:46:07 EDT EAGLE 31.3.0
NDC SUBSYSTEM REPORT      OOS-MT          Fault      -----
NDC Cards Configured= 2   Cards IS-NR= 2
CARD   VERSION           TYPE           APPL           PST           SST           AST
-----
1215   219-009-000   DCM           EMDC           IS-NR         Active        -----
DCM A IP CONNECTION                IS-NR         Avail         -----
EMAP A IP CONNECTION                -----        -----        -----
EMAP  NDC Q3 Association                -----        -----        -----
EMAP A NDC Agent                    -----        -----        -----

EMAP A GPL version = -----

1217   219-009-000   DCM           EMDC           IS-NR         Idle          -----
DCM B IP CONNECTION                IS-NR         Avail         -----
EMAP B IP CONNECTION                -----        -----        -----
EMAP  NDC Q3 Association                -----        -----        -----
EMAP B NDC Agent                    -----        -----        -----

EMAP B GPL version = -----

DCM-DCM IP CONNECTION                IS-NR         Avail         -----
EMAP-EMAP Serial Connection                -----        -----        -----

ALARM STATUS
3538.0179 * EMAP           NDC Q.3 association is Unavailable
3537.0084 ** EMAP A       IP Connection Unavailable
3536.0084 ** EMAP B       IP Connection Unavailable
3539.0181 *C NDC SYSTEM   NDC Subsystem is not available
Command Completed.
;

```

rept-stat-rte**Report Status Route**

This command displays the signaling route status for a particular destination.

Keyword: `rept-stat-rte`

Related Commands: `dlt-rte`, `ent-rte`, `rtrv-rte`

Command Class: System Maintenance

Parameters

NOTE: See “Point Code Formats and Conversion” in Appendix A for a detailed description of point code formats, rules for specification, and examples.

:dpc/dpca/dpci/dpcn/dpcn24= (optional)

Destination point code.

ANSI point code with subfields *network indicator-network cluster-network cluster member* (*ni-nc-ncm*). The *prefix* subfield indicates a private point code (*prefix-ni-nc-ncm*).

Range: **p-**, **000-255**, *****, ******, *******
 Specify a valid value for each subfield of the point code, and separate the subfields with a dash (-).
prefix—**p-**
 The asterisk values *****, ******, and ******* are not valid for the *ni* subfield.
 The asterisk values ****** and ******* are valid only for the *ncm* subfield.
 When **chg-sid:pctype=ansi** is specified, *ni* = **000** is not valid.
 When **chg-sid:pctype=ansi** is specified, *nc* = **000** is not valid if *ni* = **001-005**.
 When **chg-sid:pctype=ansi** is specified, *nc* = **000** is valid if *ni* = **006-255**.
 When **chg-sid:pctype=ansi** is specified, *ni*-*-***** is valid if *ni* = **006-255**.
 The point code **000-000-000** is not a valid point code.

:dpci= (optional)

ITU international destination point code with subfields *zone-area-id*. The *prefix* subfield indicates a spare point code, private point code, or private and spare point code (*prefix-zone-area-id*).

Range: **s-**, **p-**, **ps**, **0-255**
 Specify a valid value for each subfield of the point code, and separate the subfields with a dash (-).

The point code **0-000-0** is not a valid point code.

prefix—**s-**, **p-**, **ps-**

zone—**0-7**

area—**000-255**

id—**0-7**

:dpcn= (optional)

ITU national destination point code in the format of a 5-digit number (*nnnnn*); or 2, 3, or 4 numbers (members) separated by dashes (*m1-m2-m3-m4*) as defined by the **chg-stpopts:npcfmti** flexible point code option. A group code must be specified when the ITUDUPPC feature is turned on (*nnnnn-gc*, *m1-m2-m3-m4-gc*). The *prefix* subfield indicates a spare point code, private point code, or private and spare point code (*prefix-nnnnn*, *prefix-nnnnn-gc*, *prefix-m1-m2-m3-m4*, *prefix-m1-m2-m3-m4-gc*).

Range: **s-**, **p-**, **ps-**, **0-16383**, **aa-zz**
 Specify a valid value for each subfield of the point code, and separate the subfields with a dash (-).

prefix—**s-**, **p-**, **ps-**

nnnnn—**0-16383**

gc—**aa - zz**

m1-m2-m3-m4—**0-14** for each member; values must sum to 14

:dpcn24= (optional)

24-bit ITU national destination point code with subfields *main signaling area-sub signaling area-signaling point* (*msa-ssa-sp*). The *prefix* subfield indicates a private point code (*prefix-msa-ssa-sp*).

Range: **p-**, **000-255**
 Specify a valid value for each subfield of the point code, and separate the subfields with a dash (-).

prefix—**p-**

msa—**000-255**

ssa—000-255

sp—000-255

:mode= (optional)

The type of display. This parameter displays the point code's subsystem status along with the normal output.

Range: **full**

Default: The point code's subsystem status is not displayed.

:stat= (optional)

The primary state filter. This parameter displays all entries with the specified primary state filter.

Range: **all, anr, dsbld, mt, nr**

all—All primary states

anr—In service abnormal

dsbld—Out of service maintenance disabled

mt—Out of service maintenance

nr—In service normal

Default: All primary states are displayed.

Example

```
rept-stat-rte
```

```
rept-stat-rte:dpc=5-25-0
```

```
rept-stat-rte:dpci=5-5-0:mode=full
```

Dependencies

The **stat** parameter cannot be specified with the **dpc** parameter or the **mode** parameter.

If the **dpcn** parameter is specified, its format must match the format that was assigned with the **chg-stpopts:npcfmti** parameter.

Notes

Each DPC can have up to six routes associated with it.

This command's functions are now performed by **rept-stat-dstn** and this command will be deleted in a future software release.

In this command, only ITU-international and ITU national point codes support the spare point code subtype prefix (**s-**) and the private and spare point code subtype prefix (**ps-**). All of the point code types support the private (internal) point code subtype prefix (**p-**).

Table 7-10 provides a summary description of the reports that are produced by the various DPC parameter syntaxes.

This command can be canceled using the **F9** function key or the **canc-cmd** command. See **canc-cmd** for more information.

Table 7-10. Summary of DPC Parameter Syntaxes

DPC format	Meaning
rept-stat-rte:dpc=ni-nc-ncm	Requests a report for fully provisioned destination <i>ni-nc-ncm</i> .
rept-stat-rte:dpc=ni.*.*	Requests a report for provisioned network destination with the specified network indicator (<i>ni</i>). Note that if * is specified in the <i>nc</i> field, * must be specified in the network cluster member (<i>ncm</i>) field.
rept-stat-rte:dpc=ni.**.*	Requests a report for the full network cluster for the specified <i>ni</i> .
rept-stat-rte:dpc=ni.***.*	Requests a report for the full network cluster and the network cluster address (if any) for the specified <i>ni</i> .
rept-stat-rte:dpc=ni-nc.*	Requests a report for provisioned cluster destination <i>ni-nc.*</i> .
rept-stat-rte:dpc=ni-nc.**	Requests a report showing all destinations whose network indicator (<i>ni</i>) and cluster (<i>nc</i>) components match those specified. Note, however, that the network cluster address on <i>ni-nc.*</i> (if it exists) is not reported.
rept-stat-rte:dpc=ni-nc.***	Requests a report showing all destinations whose network indicator (<i>ni</i>) and cluster (<i>nc</i>) components match those specified. The network cluster address <i>ni-nc.*</i> (if it exists) is also reported.
rept-stat-rte:dpcn24=msa-ssa-sp	Requests a report for fully provisioned 24-bit destination <i>main signaling area-sub signaling area-signaling point</i> .

Output

The following example shows how, when no parameters are specified, summary information for all provisioned cluster and noncluster DPCs is reported.

rept-stat-rte

```

rlghncxa03w 04-01-07 14:59:11 EST EAGLE 31.3.0
DPCA          PST          SST          AST
009-000-000   IS-ANR         Allowed     ACCESS
009-003-*     IS-ANR         Allowed     ACCESS
009-003-006   OOS-MT         Prohibit    INACCESS
009-003-001   IS-NR          Allowed     ACCESS
009-003-002   IS-NR          Allowed     ACCESS
009-003-003   OOS-MT         Prohibit    INACCESS
009-004-006   IS-NR          Allowed     ALMINH
004-002-002   IS-NR          Allowed     ACCESS
006-000-000   IS-ANR         Allowed     ACCESS
007-001-001   IS-NR          Allowed     ACCESS
101-033-*     IS-NR          Allowed     ACCESS

DPCI          PST          SST          AST
2-004-1       IS-NR          Allowed     ACCESS
2-004-3       IS-ANR         Allowed     ACCESS
2-004-2       IS-ANR         Allowed     ACCESS
2-004-4       IS-NR          Allowed     ACCESS

DPCN          PST          SST          AST
02096         IS-NR          Allowed     ACCESS
02097         IS-ANR         Allowed     ACCESS
02098         OOS-MT         Prohibit    INACCESS
02099         OOS-MT         Prohibit    INACCESS
Command Completed.
;
    
```

The following example shows that specifying a cluster destination on the **dpc** parameter shows the cluster status and routeset information. Note that information on cluster members (both provisioned and x-list) is not shown. Use **rept-stat-cluster** to obtain this information.

rept-stat-rte:dpc=9-3-*

```
rlghncxa03w 04-07-07 14:59:11 EST EAGLE 31.9.0
DPCA          PST          SST          AST
009-003-*     IS-NR          Allowed    ACCESS
ALARM STATUS   = No Alarms.
RTE COST  LSN          APCA          LS STAT    NON-ADJ    ROUTE STAT
1*  10  lsnstpa    042-036-123  Allowed    Allowed    Allowed
2   20  lsnstpb    092-240-103  Allowed    Allowed    Allowed
3   30  lsnstpc    128-101-022  Allowed    Allowed    Allowed
4   --  -----    ***-***-***  -----    -----    -----
5   --  -----    ***-***-***  -----    -----    -----
6   --  -----    ***-***-***  -----    -----    -----
;
```

The following example shows how specifying either an FPC or cluster destination for which circular routing has been detected, along with the **mode=full** parameter, displays the name of the linkset on which the circular routing test message was transmitted. It also displays the linkset on which the circularly routed message was received. This information may be useful in correcting the circular routing situation.

rept-stat-rte:dpc=9-3-6:mode=full

```
rlghncxa03w 04-01-07 14:59:11 EST EAGLE 31.3.0
DPCA          PST          SST          AST
009-003-006   OOS-MT          Prohibit    INACCESS
ALARM STATUS   = = *C  xxxx Circular routing detected
RTE COST  LSN          APCA          LS STAT    NON-ADJ    ROUTE STAT
1   10  lsnstpa    042-036-123  Allowed    Allowed    Allowed
2   20  lsnstpb    092-240-103  Allowed    Allowed    Allowed
3   30  lsnstpc    128-101-022  Allowed    Allowed    Allowed
4   --  -----    ***-***-***  -----    -----    -----
5   --  -----    ***-***-***  -----    -----    -----
6   --  -----    ***-***-***  -----    -----    -----
SSN  SUBSYSTEM STATUS

ALIASA      ALIASN      ALIASI
-----
CIRCULAR ROUTING
  XMIT LSN= lsnstpb
  RCV  LSN= lsn01a
MEMBER= ***-***-***
Command Completed.
;
```

The following example shows a typical report when a cluster destination and **mode=full** was specified. The interpretation of the circular routing status for cluster destinations is slightly different from an FPC's.

rept-stat-rte:dpc=9-3-*.mode=full

```
rlghncxa03w 04-01-07 14:59:11 EST EAGLE 31.3.0
DPCA          PST          SST          AST
009-003-*     IS-NR        Allowed    ACCESS
ALARM STATUS  = *C  xxxx Circular routing detected
RTE COST  LSN      APCA          LS STAT  NON-ADJ  ROUTE STAT
 1   10  lsnstpa   042-036-123 Allowed   Allowed   Allowed
 2   20  lsnstpb   092-240-103 Allowed   Allowed   Allowed
 3   30  lsnstpc   128-101-022 Allowed   Allowed   Allowed
 4   --  -----   ***-***-*** -----   -----   -----
 5   --  -----   ***-***-*** -----   -----   -----
 6   --  -----   ***-***-*** -----   -----   -----
SSN  SUBSYSTEM STATUS
ALIASA      ALIASN      ALIASI
-----
CIRCULAR ROUTING INFO:
XMIT LSN=lsnstpb  RC=20
RCV  LSN=lsn01a
MEMBER= 009-003-006
Command Completed.
```

;

The following example shows how **rept-stat-rte** displays the circular routing alarm for a cluster destination. Note that a circular routing alarm for a cluster destination indicates that circular routing was detected for a member of the cluster, but no x-list entry could be created for that cluster. Note, also, that circular routing detected on a cluster destination does not automatically force the output to display the status of the cluster as “OOS-MT Prohibit INACCESS” as it does for an FPC destination.

rept-stat-rte:dpc=9-3-*

```
rlghncxa03w 04-01-07 14:59:11 EST EAGLE 31.3.0
DPCA          PST          SST          AST
009-003-*     IS-NR        Allowed    ACCESS
ALARM STATUS  = *C  xxxx Circular routing detected
RTE COST  LSN      APCA          LS STAT  NON-ADJ  ROUTE STAT
 1   10  lsnstpa   042-036-123 Allowed   Allowed   Allowed
 2   20  lsnstpb   092-240-103 Allowed   Allowed   Allowed
 3   30  lsnstpc   128-101-022 Allowed   Allowed   Allowed
 4   --  -----   ***-***-*** -----   -----   -----
 5   --  -----   ***-***-*** -----   -----   -----
 6   --  -----   ***-***-*** -----   -----   -----
Command Completed.
```

;

The following example shows how **rept-stat-rte** displays a subsystem information header but no subsystem information, just as it would if an FPC is specified for which no subsystems are defined. In addition, because aliases cannot be defined for cluster destinations, this report shows only an empty header, just as it does when an FPC is specified for which no aliases are defined. Note that the circular routing information portion of the **mode=full** report displays "-----" for the linkset names when no circular routing condition exists for the DPC.

rept-stat-rte:dpc=9-3-*.mode=full

```

rlghncxa03w 04-07-07 14:59:11 EST EAGLE 31.9.0
DPCA          PST          SST          AST
009-003-*     IS-NR          Allowed     ACCESS
ALARM STATUS      = No Alarms.
RTE COST  LSN      APCA          LS STAT    NON-ADJ    ROUTE STAT
 1*  10  lsnstpa   042-036-123 Allowed    Allowed    Allowed
 2   20  lsnstpb   092-240-103 Allowed    Allowed    Allowed
 3   30  lsnstpc   128-101-022 Allowed    Allowed    Allowed
 4   --  -----   ***-***-*** -----    -----    -----
 5   --  -----   ***-***-*** -----    -----    -----
 6   --  -----   ***-***-*** -----    -----    -----
SSN      SUBSYSTEM STATUS

ALIASA          ALIASN          ALIASI
-----

CIRCULAR ROUTING
XMIT LSN= -----
RCV LSN= -----
MEMBER= ***-***-***
Command Completed.

```

;

The following example shows how specifying the **stat** parameter along with the **ni-nc-*** or **ni-nc-***** DPC formats causes the output summary report to include only those destinations whose status matches the state specified.

rept-stat-rte:dpc=9-4-*;stat=alminh**

```

rlghncxa03w 04-02-31 13:30:00 EST EAGLE 31.3.0
DPCA          PST          SST          AST
009-004-006   IS-NR          Allowed     ALMINH
Command Completed.

```

;

The following example shows a retrieval specifying an ITU national point code where the **chg-stpopts:npcfmti** parameter has been set to **1-1-1-11**:

rept-stat-rte:dpcn=1-1-1-1000

```
rlghncxa03w 04-02-31 13:30:00 EST EAGLE 31.3.0
CAUTION : Node isolated...route status out of date!
DPCN          PST          SST          AST
1-1-1-1000    OOS-MT          Prohibit  INACCESS
ALARM STATUS  = *C 0313 DPC is prohibited
RTE COST  LSN          APCN          LS STAT  NON-ADJ  ROUTE STAT
1   10  lsitu          1-1-1-1000    Prohibit  Allowed  Prohibit
2   --  -----          ***-***-***  -----  -----  -----
3   --  -----          ***-***-***  -----  -----  -----
4   --  -----          ***-***-***  -----  -----  -----
5   --  -----          ***-***-***  -----  -----  -----
6   --  -----          ***-***-***  -----  -----  -----
Command Completed.
```

;

The following example shows a private adjacent point code:

rept-stat-rte:mode=full:dpc=1-1-2

```
rlghncxa03w 05-01-07 13:30:00 EST EAGLE 31.12.0
DPCA          PST          SST          AST
001-001-002   OOS-MT          Idle       INACCESS
ALARM STATUS  = No Alarms.
RTE COST  LSN          APCA          LS STAT  NON-ADJ  ROUTE STAT
1   01  ls11234567    001-001-002   Prohibit  Allowed  Prohibit
2   02  ls12345678    p-001-001-002 Prohibit  Allowed  Prohibit
3   --  -----          ---***---***  -----  -----  -----
4   --  -----          ---***---***  -----  -----  -----
5   --  -----          ---***---***  -----  -----  -----
6   --  -----          ---***---***  -----  -----  -----
SSN        SUBSYSTEM STATUS

          ALIASA          ALIASN          ALIASI
          000-000-001    -----          -----
CIRCULAR ROUTING INFO:
XMIT LSN=----- RC=--
RCV LSN=-----
MEMBER =-----
Command Completed.
```

;

The asterisks in the space after the route numbers in the following examples indicate which route (or combined route) is carrying traffic.

rept-stat-rte:dpc=1-1-1

```
tekelecstp 04-09-24 09:19:04 EST EAGLE 31.9.0
DPCA          PST          SST          AST
001-001-001   IS-NR          Allowed  ACCESS
ALARM STATUS  = No Alarms.
RTE COST  LSN          APCA          LS STAT  NON-ADJ  ROUTE STAT
1*  05  lse1e1          001-001-001   Allowed  Allowed  Allowed
2*  05  lse1e2          001-002-001   Allowed  Allowed  Allowed
3   10  lse1e3          001-003-001   Allowed  Allowed  Allowed
4   --  -----          ---***---***  -----  -----  -----
5   --  -----          ---***---***  -----  -----  -----
6   --  -----          ---***---***  -----  -----  -----
Command Completed.
```

;

rept-stat-rte:dpc=1-1-1

No asterisk appears after the route number in the following example; no routes were carrying traffic at the time.

```
tekelecstp 04-09-24 09:19:04 EST EAGLE 31.9.0
DPCA          PST          SST          AST
001-001-001   OOS-MT          Prohibit  INACCESS
ALARM STATUS   = *C 0313 DPC is prohibited
RTE COST  LSN          APCA          LS STAT  NON-ADJ  ROUTE STAT
 1   05   lse1e1         001-001-001  Prohibit  Allowed  Prohibit
 2   05   lse1e2         001-002-001  Prohibit  Allowed  Prohibit
 3   10   lse1e3         001-003-001  Prohibit  Allowed  Prohibit
 4   --   -----   ***-***-***  -----  -----
 5   --   -----   ***-***-***  -----  -----
 6   --   -----   ***-***-***  -----  -----
Command Completed.
```

;

In the following example, the primary route is not carrying traffic.

rept-stat-rte:dpc=1-1-1

```
tekelecstp 04-09-24 09:19:04 EST EAGLE 31.9.0
DPCA          PST          SST          AST
001-001-001   IS-ANR          Restrict  ACCESS
ALARM STATUS   = *C 0334 DPC Subsystem is Abnormal
RTE COST  LSN          APCA          LS STAT  NON-ADJ  ROUTE STAT
 1   05   lse1e1         001-001-001  Prohibit  Allowed  Prohibit
 2   05   lse1e2         001-002-001  Prohibit  Allowed  Prohibit
 3*  10   lse1e3         001-003-001  Allowed   Allowed  Allowed
 4   --   -----   ***-***-***  -----  -----
 5   --   -----   ***-***-***  -----  -----
 6   --   -----   ***-***-***  -----  -----
Command Completed.
```

;

Legend

DPC/DPCA—The ANSI destination point code of the route

DPCN—The ITU-TSS national destination point code of the route

DPCN24—The 24-bit ITU national destination point code of the route

DPCI—The ITU-TSS international destination point code of the route

PST—The primary state of the subsystem. The possible values are described in “Possible Values for PST/SST/AST” in Appendix A.

SST—The secondary state of the subsystem. The possible values are described in “Possible Values for PST/SST/AST” in Appendix A.

AST—The associated state of the subsystem. The possible values are described in “Possible Values for PST/SST/AST” in Appendix A.

rept-stat-rtkey**Report the Status of Routing Keys**

Use this command to generate a summary report of the status of the system routing keys.

Keyword: `rept-stat-rtkey`

Related Commands: `chg-appl-rtkey`, `ent-appl-rtkey`, `dlt-appl-rtkey`, `rtrv-appl-rtkey`

Command Class: System Maintenance

Parameters

This command has no parameters.

Example

```
rept-stat-rtkey
```

Dependencies

None

Notes

The report generated by the **rept-stat-rtkey** command contains the following information:

- The maximum of static entries (SRKQ) in the routing key table.
- The current number of static routing key entries and socket associations provisioned in the routing key table.
- The percentage of the static routing key table entries that is provisioned.
- The maximum number of dynamic entries of each SS7IPGW or IPGWI card's routing key table (DRKQ) and maximum number of socket associations available in each SS7IPGW or IPGWI card's dynamic routing key table.
- The current number of routing key entries and socket associations provisioned in each SS7IPGW or IPGWI card's dynamic routing key table.
- The percentage of each SS7IPGW or IPGWI card's dynamic routing key table that is provisioned.

Output**rept-stat-rtkey**

```
rlghncxa03w 04-02-17 14:59:11 EST EAGLE 31.3.0
SRKQ = 250 DRKQ = 300
```

```
Static Route Key table is (50 of 250) 20% full
1105 Route Key table is (25 of 250) 10% full
1107 Route Key table is (25 of 250) 10% full
```

```
Static Route Key Socket Association table is (80 of 4000) 2% full
1105 Route Key Socket Association table is (40 of 4000) 1% full
1107 Route Key Socket Association table is (40 of 4000) 1% full
```

```
Command Completed.
```

```
;
```

rept-stat-sccp

Report Status SCCP

Use this command to display the following types of reports:

- **rept-stat-sccp** (with no parameters)—displays the status of the SCCP and VSCCP cards and the GTT (Global Title Translation), G-Flex (GSM Flexible Numbering), G-Port (GSM Mobile Number Portability), INP (INAP-based Number Portability), and EIR (Equipment Identity Register) services executing on those cards. This command also displays any cards that are denied SCCP service.
- **rept-stat-sccp:mode=perf**—targets the general SCCP traffic performance for both SCCP and VSCCP cards. The report supplies message rates for group ticket voucher (TVG) performance.
- **rept-stat-sccp:loc=nnnn**—provides a detailed view of the status of SCCP services provided by a specific SCCP/VSCCP card. Fields are omitted if an associated feature is not turned on.

NOTE: The **rept-stat-sccp** and **rept-stat-sccp:mode=perf** reports include the status of TSM and DSM cards but do not differentiate between these card types.

NOTE: To retrieve traffic statistics for the LNP feature, use the **rept-stat-lnp** command.

Keyword: **rept-stat-sccp**

Related Commands: **chg-th-alm, rtrv-th-alm**

Command Class: System Maintenance

Parameters

:loc= (optional)

Card Address. Use this parameter to specify the location of the SCCP/VSCCP card to be reported on.

Range: 1101–1108, 1111–1117, 1201–1208, 1211–1218, 1301–1308, 1311–1318, 2101–2108, 2111–2118, 2201–2208, 2211–2218, 2301–2308, 2311–2318, 3101–3108, 3111–3118, 3201–3208, 3211–3218, 3301–3308, 3311–3318, 4101–4108, 4111–4118, 4201–4208, 4211–4218, 4301–4308, 4311–4318, 5101–5108, 5111–5118, 5201–5208, 5211–5218, 5301–5308, 5311–5318, 6101–6108, 6111–6118

Default: Report a summary of all cards.

:mode= (optional)

Use this parameter to provide extended performance information, including output about group ticket voucher (TVG) performance and message rates for direct assignments.

Range: **perf**

Default: No extended performance information is displayed.

Example

```
rept-stat-sccp
```

```
rept-stat-sccp:mode=perf
```

```
rept-stat-sccp:loc=1106
```

Dependencies

- No other **rept-stat-xxx** command can be in progress when this command is entered.
- At least one SCCP or VSCCP card must be configured in the system before this command can be entered.
- Only one optional parameter at a time can be specified in the command.
- If the **loc** parameter is specified, the **loc** parameter value must be the card location of a VSCCP card.

Notes

None

Output

The following example shows the output of the **rept-stat-sccp** command with the G-Flex, G-Port, and INP features off and the EIR feature not enabled. The **ansigflex** system option is disabled.

rept-stat-sccp

```
tekelecstp 05-05-26 13:34:22 EST EAGLE 31.6.0
SCCP SUBSYSTEM REPORT IS-NR Active -----
SCCP ALARM STATUS = No Alarms

SCCP Cards Configured=1 Cards IS-NR=1
System Daily Peak SCCP Load 2044 TPS 05-03-25 14:11:56
System Overall Peak SCCP Load 2044 TPS 05-03-25 14:11:56
System Total SCCP Capacity 3400 TPS ( 3400 max SCCP Capacity)
System SCCP Capacity Calc. Method (N)
System TPS Alarm Threshold 2720 TPS ( 80% System N SCCP Capacity)

TPS STATISTICS
=====
CARD CPU TOTAL CLASS 0 Class 1
USAGE MSU RATE TVG RATE TVG RATE
-----
1212 31% 490 400 90
-----
Average MSU Capacity = 44%
Average CPU Capacity = 24%
TOTAL MSU RATE = 490

STATISTICS FOR PAST 30 SECONDS
=====
TOTAL TRANSACTIONS: 8500
TOTAL ERRORS: 5
Command Completed.
```

;

The following example shows the output of the **rept-stat-sccp** command with the G-Flex, G-Port, and INP features on. The EIR feature is not enabled, and the **ansigflex** system option is disabled.

rept-stat-sccp

```
tekelecstp 05-05-26 13:34:22 EST EAGLE 31.0.0
SCCP SUBSYSTEM REPORT IS-NR          Active
      SCCP ALARM STATUS = No Alarms
INPQ SUBSYSTEM REPORT IS-ANR          Restricted  -----
      ASSUMING MATE'S LOAD
      INPQ: SSN STATUS = Allowed      MATE SSN STATUS = Prohibited
      INPQ ALARM STATUS = No Alarms

SCCP Cards Configured=4  Cards IS-NR=2
System Daily Peak SCCP Load          2044  TPS 05-03-25 14:11:56
System Overall Peak SCCP Load        2044  TPS 05-03-25 14:11:56
System Total SCCP Capacity            3400  TPS ( 3400 max SCCP Capacity)
System SCCP Capacity Calc. Method (N)
System TPS Alarm Threshold            2720  TPS ( 80% System  N SCCP Capacity)

CARD  VERSION      PST          SST          AST          MSU USAGE  CPU USAGE
-----
1212  101-001-000    IS-NR        Active        ALMINH        45%         30%
1301 P 101-001-000    IS-NR        Active        -----        35%         40%
1305  -----        OOS-MT        Isolated      -----        0%          0%
2112  -----        OOS-MT-DSBLD Manual        -----        0%          0%
-----
SCCP Service Average MSU Capacity = 40%      Average CPU Capacity = 35%

AVERAGE CPU USAGE PER SERVICE:
GTT   = 15%  GFLEX = 5%  GPORT = 10%
INPMR = 2%  INPQ  = 3%

TOTAL SERVICE STATISTICS:
SERVICE  SUCCESS  ERRORS  WARNINGS  FORWARD TO GTT  TOTAL
GTT:      1995    5       -          -                2000
GFLEX:     500    1       4          10               515
GPORT:     800    0       2          3                805
INPMR:     50    5       0          15               70
INPQ:     499    1       -          -                500

Command Completed.
```

;

The following example shows the output of the **rept-stat-sccp** command with the G-Flex, G-Port, and INP features turned off, and the EIR feature enabled and turned on. The **ansigflex** system option is disabled.

rept-stat-sccp

```
tekelecstp 05-05-26 13:34:22 EST EAGLE5 31.0.0
SCCP SUBSYSTEM REPORT ISNR          Active
      SCCP ALARM STATUS = No Alarms
EIR SUBSYSTEM REPORT IS-ANR          Restricted  -----
      ASSUMING MATE'S LOAD
      EIR: SSN STATUS = Allowed      MATE SSN STATUS = Prohibited
      EIR ALARM STATUS = * 0457 EIR Subsystem normal,card(s) abnormal
```

```

SCCP Cards Configured=4  Cards IS-NR=2
System Daily Peak SCCP Load      2044  TPS 05-03-25 14:11:56
System Overall Peak SCCP Load    2044  TPS 05-03-25 14:11:56
System Total SCCP Capacity       3400  TPS ( 3400 max SCCP Capacity)
System SCCP Capacity Calc. Method (N)
System TPS Alarm Threshold       2720  TPS ( 80% System  N SCCP Capacity)

CARD   VERSION      PST           SST           AST           MSU USAGE   CPU USAGE
-----
1212   101-001-000    IS-NR        Active        ALMINH        45%          30%
1301 P 101-001-000    IS-NR        Active        -----        35%          20%
1305   -----        OOS-MT       Isolated      -----        0%           0%
2112   -----        OOS-MT-DSBLD Manual      -----        0%           0%
-----
SCCP Service Average MSU Capacity = 40%      Average CPU Capacity = 25%

AVERAGE CPU USAGE PER SERVICE:
GTT   = 15%
EIR   = 2%

TOTAL SERVICE STATISTICS:
SERVICE  SUCCESS  ERRORS  WARNINGS  FORWARD TO GTT  TOTAL
GTT:      1995    5       -          -                2000
EIR:      55     5       -          -                60

Command Completed.
;

```

The following example shows the output of the **rept-stat-sccp** command with the G-Flex feature on, the G-Port and INP features off, and the EIR feature enabled and turned on. The **ansigflex** system option is disabled.

rept-stat-sccp

```

tekelecstp 05-03-26 13:34:22 EST  EAGLES 31.0.0
SCCP SUBSYSTEM REPORT IS-NR      Active
SCCP ALARM STATUS = No Alarms
EIR  SUBSYSTEM REPORT IS-ANR     Restricted -----
ASSUMING MATE'S LOAD
EIR: SSN STATUS = Allowed      MATE SSN STATUS = Prohibited
EIR ALARM STATUS = No Alarms

SCCP Cards Configured=4  Cards IS-NR=2
System Daily Peak SCCP Load      2044  TPS 05-03-25 14:11:56
System Overall Peak SCCP Load    2044  TPS 05-03-25 14:11:56
System Total SCCP Capacity       3400  TPS ( 3400 max SCCP Capacity)
System SCCP Capacity Calc. Method (N)
System TPS Alarm Threshold       2720  TPS ( 80% System  N SCCP Capacity)

CARD   VERSION      PST           SST           AST           MSU USAGE   CPU USAGE
-----
1212   101-001-000    IS-NR        Active        ALMINH        45%          30%
1301 P 101-001-000    IS-NR        Active        -----        35%          20%
1305   -----        OOS-MT       Isolated      -----        0%           0%
2112   -----        OOS-MT-DSBLD Manual      -----        0%           0%
-----
SCCP Service Average MSU Capacity = 40%      Average CPU Capacity = 25%

AVERAGE CPU USAGE PER SERVICE:
GTT   = 15%  GFLEX = 10%  GPORT = --%
EIR   = 2%

```

```
TOTAL SERVICE STATISTICS:
SERVICE      SUCCESS      ERRORS      WARNINGS      FORWARD TO GTT      TOTAL
GTT:          1995          5            -              -                  2000
GFLEX:        500           1            4              10                 515
EIR:          55            5            -              -                  60
```

Command Completed.

;

The following example shows the output of the **rept-stat-sccp** command with the G-Flex feature on and the G-Port and INP features off. The EIR feature is not enabled, and the **ansigflex** system option is disabled.

rept-stat-sccp

```
tekelecstp 05-03-26 13:34:22 EST EAGLE5 31.0.0
SCCP SUBSYSTEM REPORT IS-NR          Active      -----

SCCP Cards Configured=4  Cards IS-NR=4
System Daily Peak SCCP Load          2044      TPS 05-03-25 14:11:56
System Overall Peak SCCP Load         2044      TPS 05-03-25 14:11:56
System Total SCCP Capacity             3400      TPS ( 3400 max SCCP Capacity)
System SCCP Capacity Calc. Method (N)
System TPS Alarm Threshold             2720      TPS ( 80% System  N SCCP Capacity)

CARD   VERSION      PST           SST           AST           MSU USAGE   CPU USAGE
-----
1212   101-001-000    IS-NR         Active        ALMINH        45%          30%
1301 P 101-001-000    IS-NR         Active        -----        35%          20%
1305   -----        OOS-MT        Isolated      -----        0%           0%
2112   -----        OOS-MT-DSBLD Manual        -----        0%           0%
-----
SCCP Service Average MSU Capacity = 40%      Average CPU Capacity = 25%

AVERAGE CPU USAGE PER SERVICE:
GTT   = 15%  GFLEX = 10%  GPORT = --%
```

```
TOTAL SERVICE STATISTICS:
SERVICE      SUCCESS      ERRORS      WARNINGS      FORWARD TO GTT      TOTAL
GTT:          1995          5            -              -                  2000
GFLEX:        500           1            4              10                 515
GPORT:        ---           -            -              -                  ----
Command Completed.
```

;

The following example shows the output of the **rept-stat-sccp** command with the EIR, G-Flex and G-Port features off and the INP feature on.

rept-stat-sccp

```
tekelecstp 05-03-26 13:34:22 EST EAGLE5 31.0.0
SCCP SUBSYSTEM REPORT IS-NR          Active      -----
INPQ SUBSYSTEM REPORT IS-ANR        Restricted  -----
ASSUMING MATE'S LOAD
INPQ: SSN STATUS = Allowed           MATE SSN STATUS = Prohibited

SCCP Cards Configured=4  Cards IS-NR=4
System Daily Peak SCCP Load          2044      TPS 05-03-25 14:11:56
System Overall Peak SCCP Load         2044      TPS 05-03-25 14:11:56
System Total SCCP Capacity             3400      TPS ( 3400 max SCCP Capacity)
System SCCP Capacity Calc. Method (N)
System TPS Alarm Threshold             2720      TPS ( 80% System  N SCCP Capacity)
```

CARD	VERSION	PST	SST	AST	MSU USAGE	CPU USAGE
1212	101-001-000	IS-NR	Active	ALMINH	45%	30%
1301 P	101-001-000	IS-NR	Active	-----	35%	20%
1305	-----	OOS-MT	Isolated	-----	0%	0%
2112	-----	OOS-MT-DSBLD	Manual	-----	0%	0%

SCCP Service Average MSU Capacity = 40% Average CPU Capacity = 25%

AVERAGE CPU USAGE PER SERVICE:
 GTT = 15%
 INPMR = 2% INPQ = 8%

TOTAL SERVICE STATISTICS:

SERVICE	SUCCESS	ERRORS	WARNINGS	FORWARD TO GTT	TOTAL
GTT:	1995	5	-	-	2000
INPMR:	50	5	0	15	70
INPQ:	499	1	-	-	500

Command Completed.

The following example displays output showing the G-Flex and G-Port service, service alarm status, and number of messages routed.

rept-stat-sccp

```
tekelecstp 05-05-26 13:34:22 EST EAGLE 34.3.0
SCCP SUBSYSTEM REPORT IS-ANR Active -----
SCCP ALARM STATUS = No Alarms
EIR SUBSYSTEM REPORT OOS-MT Unavail -----
EIR: SSN STATUS = ----- MATE SSN STATUS = -----
EIR ALARM STATUS = *C 0455 EIR Subsystem is not available
GFLEX SERVICE REPORT OOS-MT Unavail -----
GFLEX ALARM STATUS = XXXX
GPORT SERVICE REPORT OOS-MT Unavail -----
GPORT ALARM STATUS = XXXX
SCCP Cards Configured=25 Cards IS-NR= 2
System Daily Peak SCCP Load 0 TPS 05-12-29 00:00:27
System Overall Peak SCCP Load 0 TPS 00-00-00 00:00:00
System Total SCCP Capacity 1700 TPS (1700 max SCCP Capacity)
System SCCP Capacity Calc. Method (N)
System TPS Alarm Threshold 1530 TPS ( 90% System N SCCP Capacity)
CARD VERSION PST SST AST MSU CPU
USAGE USAGE
-----
1217 ----- OOS-MT Isolated ----- 0% 0%
1317 ----- OOS-MT Isolated ----- 0% 0%
1105 155-044-000 IS-NR Active DB_DIFF 0% 0%
1107 155-044-000 IS-NR Active DB_DIFF 0% 3%
-----
SCCP Service Average MSU Capacity = 0% Average CPU Capacity = 2%
AVERAGE CPU USAGE PER SERVICE:
GTT = 0% GFLEX = 0% GPORT = 0%
EIR = 0%
TOTAL SERVICE STATISTICS:
SERVICE SUCCESS ERRORS FAIL REROUTE/ FORWARD TOTAL
RATIO WARNINGS TO GTT
GTT: 0 0 0% - - 0
GFLEX: 0 0 0% 0 0 0
GPORT: 0 0 0% 0 0 0
EIR: 0 0 0% - - 0
Command Completed.
```

Report type: **rept-stat-sccp:mode=perf**

The following example shows the output of the **rept-stat-sccp:mode=perf** command with the G-Flex, G-Port, and INP features off and the EIR feature not enabled. The **ansigflex** system option is disabled.

rept-stat-sccp:mode=perf

```
tekelecstp 05-03-28 13:34:22 EST EAGLE5 34.0.0
SCCP SUBSYSTEM REPORT IS-NR Ovflw-1 -----
      SCCP ALARM STATUS = No Alarms
SCCP Cards Configured= 4      Cards IS-NR= 4
System Daily Peak SCCP Load      2044   TPS 05-03-25 14:11:56
System Overall Peak SCCP Load    2044   TPS 05-03-25 14:11:56
System Total SCCP Capacity        3400   TPS ( 3400 max SCCP Capacity)
System SCCP Capacity Calc. Method (N)
System TPS Alarm Threshold        2720   TPS ( 80% System  N SCCP Capacity)

TPS STATISTICS
=====
CARD   CPU      TOTAL      CLASS 0   Class 1
      USAGE    MSU RATE   TVG RATE  TVG RATE
-----
1217   54%      850        770       80
1218   31%      490        400       90
4118    5%       80         80        0
4211    5%       80         80        0
-----
AVERAGE MSU USAGE = 44%
AVERAGE CPU USAGE = 24%
TOTAL MSU RATE     = 1500

STATISTICS FOR PAST 30 SECONDS
=====
TOTAL TRANSACTIONS:  8500
TOTAL ERRORS:        5
Command Completed.
```

;

In the following example, all four cards are VSCCP cards with 1700 TPS capacity per card. The **ansigflex** system option is enabled.

rept-stat-sccp:mode=perf

```
eaglestp 05-03-25 20:38:58 EST EAGLE5 31.6.0
SCCP SUBSYSTEM REPORT IS-NR Ovflw-1 -----
      SCCP ALARM STATUS = No Alarms

SCCP Cards Configured=4 Cards IS-NR=4
System Daily Peak SCCP Load      2044   TPS 05-03-25 14:11:56
System Overall Peak SCCP Load    2044   TPS 05-03-25 14:11:56
System Total SCCP Capacity        3400   TPS ( 3400 max SCCP Capacity)
System SCCP Capacity Calc. Method (N)
System TPS Alarm Threshold        2720   TPS ( 80% System  N SCCP Capacity)
```

```

TPS STATISTICS
=====
CARD      CPU      TOTAL      CLASS 0   Class 1
          USAGE    MSU RATE   TVG RATE  TVG RATE
-----
1217     54%      1200       1000      200
1218     31%       900        750       150
4118      5%       800        650       150
4211      5%      1000        800       200
-----
AVERAGE MSU USAGE = 44%
AVERAGE CPU USAGE = 24%
TOTAL MSU RATE     = 3900

STATISTICS FOR PAST 30 SECONDS
=====
TOTAL TRANSACTIONS:  35000
TOTAL ERRORS:        5
Command Completed.

```

;

The following example shows an SCCP performance report with no changes for G-Flex, EIR, and INP. The statistics include all traffic on the card including G-Flex, EIR and INP.

rept-stat-sccp:mode=perf

```

eaglestp 05-03-26 20:38:58 EST  EAGLE5 31.0.0
SCCP SUBSYSTEM REPORT IS-NR      Ovflw-1  -----
      SCCP ALARM STATUS = No Alarms
SCCP Cards Configured=4  Cards IS-NR=4
System Daily Peak SCCP Load      2044  TPS 05-03-25 14:11:56
System Overall Peak SCCP Load    2044  TPS 05-03-25 14:11:56
System Total SCCP Capacity      3400  TPS ( 3400 max SCCP Capacity)
System SCCP Capacity Calc. Method (N)
System TPS Alarm Threshold      2720  TPS ( 80% System  N SCCP Capacity)

```

```

TPS STATISTICS
=====
CARD      CPU      TOTAL      CLASS 0   Class 1
          USAGE    MSU RATE   TVG RATE  TVG RATE
-----
1217     54%       850        770        80
1218     31%       490        400        90
4118      5%        80         80         0
4211      5%        80         80         0
-----
AVERAGE MSU USAGE = 44%
AVERAGE CPU USAGE = 24%
TOTAL MSU RATE     = 1500

STATISTICS FOR PAST 30 SECONDS
=====
TOTAL MSUS:        8500
TOTAL ERRORS:      5
Command Completed.

```

;

Report type: **rept-stat-sccp:loc=nnnn**

The following example provides status on services for the specified card. In this example, the G-Flex, G-Port, and INP features are on; the EIR feature is off:

rept-stat-sccp:loc=1106

```
tekelecstp 05-03-28 13:34:22 EST EAGLE5 34.0.0
CARD VERSION      TYPE   PST      SST      AST
1106 101-010-000 DSM    IS-NR    Active   -----
CARD ALARM STATUS      = No Alarms.
SCCP Cards Configured=4 Cards IS-NR=4
System Daily Peak SCCP Load      2044 TPS 05-03-25 14:11:56
System Overall Peak SCCP Load    2044 TPS 05-03-25 14:11:56
System Total SCCP Capacity      3400 TPS ( 3400 max SCCP Capacity)
System SCCP Capacity Calc. Method (N)
System TPS Alarm Threshold      2720 TPS ( 80% System N SCCP Capacity)
GTT:  STAT = ACT      CPU USAGE = 10%
GFLEX: STAT = ACT      CPU USAGE = 10%
GPORT: STAT = ACT      CPU USAGE = 10%
INPMR: STAT = ACT      CPU USAGE = 13%
INPQ:  STAT = ACT      CPU USAGE = 20%
TOTAL      = 63%
```

CARD SERVICE STATISTICS:

SERVICE	SUCCESS	ERRORS	WARNINGS	FORWARD TO GTT	TOTAL
GTT:	1995	5	-	-	2000
GFLEX:	500	1	4	10	515
GPORT:	500	1	4	10	515
INPMR:	50	2	3	15	70
INPQ:	499	1	-	-	500

Command Completed.

;

The following example provides status on services for the specified card. In this example, the G-Flex feature is on, and the G-Port, EIR, and INP features are off:

rept-stat-sccp:loc=1106

```
tekelecstp 05-03-28 13:34:22 EST EAGLE5 31.0.0
CARD VERSION      TYPE   PST      SST      AST
1106 101-010-000 DSM    IS-NR    Active   -----
CARD ALARM STATUS      = No Alarms.

SCCP Cards Configured=4 Cards IS-NR=4
System Daily Peak SCCP Load      2044 TPS 05-03-25 14:11:56
System Overall Peak SCCP Load    2044 TPS 05-03-25 14:11:56
System Total SCCP Capacity      3400 TPS ( 3400 max SCCP Capacity)
System SCCP Capacity Calc. Method (N)
System TPS Alarm Threshold      2720 TPS ( 80% System N SCCP Capacity)
GTT:  STAT = ACT      CPU USAGE = 15%
GFLEX: STAT = ACT      CPU USAGE = 10%
TOTAL      = 25%
```

CARD SERVICE STATISTICS:

SERVICE	SUCCESS	ERRORS	WARNINGS	FORWARD TO GTT	TOTAL
GTT:	1995	5	-	-	2000
GFLEX:	500	1	4	10	515

Command Completed.

;

The following example provides status on services for the specified card. In this example, the EIR, G-Flex, and G-Port features are off and the INP feature is on:

rept-stat-sccp:loc=1106

```
tekelecstp 05-03-28 13:34:22 EST EAGLE5 34.0.0
CARD VERSION      TYPE    PST      SST      AST
1106 101-010-000 DSM     IS-NR    Active   -----
CARD ALARM STATUS      = No Alarms.

SCCP Cards Configured=4 Cards IS-NR=4
System Daily Peak SCCP Load      2044 TPS 05-03-25 14:11:56
System Overall Peak SCCP Load    2044 TPS 05-03-25 14:11:56
System Total SCCP Capacity      3400 TPS ( 3400 max SCCP Capacity)
System SCCP Capacity Calc. Method (N)
System TPS Alarm Threshold      2720 TPS ( 80% System N SCCP Capacity)
GTT:  STAT = ACT      CPU USAGE = 10%
INPMR: STAT = ACT      CPU USAGE = 13%
INPQ:  STAT = ACT      CPU USAGE = 20%
TOTAL      = 43%

CARD SERVICE STATISTICS:
SERVICE  SUCCESS  ERRORS  WARNINGS  FORWARD TO GTT  TOTAL
GTT:      1995      5        -          -              2000
INPMR:    50        2        3          15             70
INPQ:    499      1        -          -              500
Command Completed.
```

;

The following example provides status on services for the specified card. In this example, the G-Flex, G-Port, EIR, and INP features are off:

rept-stat-sccp:loc=1106

```
tekelecstp 05-03-28 13:34:22 EST EAGLE5 34.0.0
CARD VERSION      TYPE    PST      SST      AST
1106 101-010-000 DSM     IS-NR    Active   -----
CARD ALARM STATUS      = No Alarms.

SCCP Cards Configured=4 Cards IS-NR=4
System Daily Peak SCCP Load      2044 TPS 05-03-25 14:11:56
System Overall Peak SCCP Load    2044 TPS 05-03-25 14:11:56
System Total SCCP Capacity      3400 TPS ( 3400 max SCCP Capacity)
System SCCP Capacity Calc. Method (N)
System TPS Alarm Threshold      2720 TPS ( 80% System N SCCP Capacity)
GTT:  STAT = ACT      CPU USAGE = 10%
TOTAL      = 10%

CARD SERVICE STATISTICS:
SERVICE  SUCCESS  ERRORS  WARNINGS  FORWARD TO GTT  TOTAL
GTT:      1995      5        -          -              2000
Command Completed.
```

;

The following example provides status on services for the specified card. In this example, the G-Flex, INP, and G-Port features are off and the EIR feature is enabled and turned on:

rept-stat-sccp:loc=1106

```
tekelecstp 05-03-28 13:34:22 EST EAGLE5 31.0.0
CARD VERSION      TYPE    PST      SST      AST
1106 101-010-000 DSM     IS-NR    Active   -----
CARD ALARM STATUS      = No Alarms.
```

```

SCCP Cards Configured=4 Cards IS-NR=4
System Daily Peak SCCP Load      2044 TPS 05-03-25 14:11:56
System Overall Peak SCCP Load    2044 TPS 05-03-25 14:11:56
System Total SCCP Capacity       3400 TPS ( 3400 max SCCP Capacity)
System SCCP Capacity Calc. Method (N)
System TPS Alarm Threshold       2720 TPS ( 80% System N SCCP Capacity)
GTT:  STAT = ACT CPU USAGE = 10%
EIR:  STAT = ACT CPU USAGE = 15%
-----
TOTAL      = 25%

```

CARD SERVICE STATISTICS:

SERVICE	SUCCESS	ERRORS	WARNINGS	FORWARD TO GTT	TOTAL
GTT:	1995	5	-	-	2000
EIR:	500	1	-	-	501

Command Completed.

;

The following example provides status on services for the specified card. In this example, the G-Flex feature is on, the G-Port feature is off, and the EIR feature is enabled and turned on:

rept-stat-sccp:loc=1102

```

eagle10610 05-03-26 19:10:55 EDT EAGLE5 31.0.0
CARD VERSION      TYPE PST          SST          AST
1102  251-026-000 DSM   IS-NR        Active       -----
CARD ALARM STATUS = No Alarms.

SCCP Cards Configured=4 Cards IS-NR=4
System Daily Peak SCCP Load      2044 TPS 05-03-25 14:11:56
System Overall Peak SCCP Load    2044 TPS 05-03-25 14:11:56
System Total SCCP Capacity       3400 TPS ( 3400 max SCCP Capacity)
System SCCP Capacity Calc. Method (N)
System TPS Alarm Threshold       2720 TPS ( 80% System N SCCP Capacity)
GTT:  STAT = ACT CPU USAGE = 10%
GFLEX: STAT = ACT CPU USAGE = 15%
EIR:  STAT = ACT CPU_USAGE = 10%
-----
TOTAL      = 35%

```

CARD SERVICE STATISTICS

SERVICE	SUCCESS	ERRORS	WARNINGS	FORWARD TO GTT	TOTAL
GTT:	1995	5	-	-	2000
GFLEX:	500	1	4	10	515
EIR:	500	1	-	-	501

Command Completed.

;

The following example provides status on services for the specified card. In this example, the G-Flex feature is on, the G-Port and INP features are off, and the EIR feature is not on:

rept-stat-sccp:loc=1102

```

eagle10610 05-03-26 19:10:55 EDT EAGLE5 31.0.0
CARD VERSION      TYPE PST          SST          AST
1102  251-026-000 TSM   IS-NR        Active       -----
CARD ALARM STATUS = No Alarms.

SCCP Cards Configured=4 Cards IS-NR=4
System Daily Peak SCCP Load      2044 TPS 05-03-25 14:11:56
System Overall Peak SCCP Load    2044 TPS 05-03-25 14:11:56

```

```

System Total SCCP Capacity          3400   TPS ( 3400 max SCCP Capacity)
System SCCP Capacity Calc. Method (N)
System TPS Alarm Threshold          2720   TPS ( 80% System   N SCCP Capacity)
GTT:      STAT = ACT          CPU USAGE = 10%
GFLEX:    STAT = ACT          CPU USAGE = 15%
-----
TOTAL            = 25%

CARD SERVICE STATISTICS
SERVICE      SUCCESS      ERRORS      WARNINGS      FORWARD TO GTT      TOTAL
GTT:          1995          5           -             -             2000
GFLEX:        500          1           4             10            515
Command Completed.

```

Report type: **rept-stat-sccp:mode=perf**

The following example provides SCCP alarm status with 192 Million LNP Numbers statistics, TPS Threshold information and TPS Peak Load information.

rept-stat-sccp:mode=perf

```

Integrat40 05-03-26 10:37:22 EST  EAGLE5 34.0.0
SCCP SUBSYSTEM REPORT IS-NR          Active      -----
SCCP ALARM STATUS = No Alarms

SCCP Cards Configured= 2          Cards IS-NR= 2
System Daily Peak SCCP Load          2044   TPS 05-03-25 14:11:56
System Overall Peak SCCP Load        2044   TPS 05-03-25 14:11:56
System Total SCCP Capacity          3400   TPS ( 3400 max SCCP Capacity)
System SCCP Capacity Calc. Method (N)
System TPS Alarm Threshold          2720   TPS ( 80% System   N SCCP Capacity)

TPS STATISTICS
=====
CARD   CPU      TOTAL      CLASS 0   CLASS 1
      USAGE    MSU RATE  TVG RATE  TVG RATE
-----
1101   75%      1022      511       511
1103   75%      1022      511       511
-----

System SCCP Capacity Calc. Method N
AVERAGE MSU USAGE = 70%
AVERAGE CPU USAGE = 75%
TOTAL MSU RATE     = 2044
STATISTICS FOR PAST 30 SECONDS
=====
TOTAL MSUS:          0
TOTAL ERRORS:        0

HIGHEST 10 OVERALL DAILY PEAKS          LAST 10 DAILY PEAK SCCP LOADS
=====
002044 TPS 05-03-25 14:11:56          002044 TPS 05-03-25 14:11:56
001904 TPS 05-03-23 11:04:50          001878 TPS 05-03-24 07:11:44
001894 TPS 05-01-25 02:47:03          001904 TPS 05-03-23 11:04:50
001880 TPS 05-03-22 09:57:33          001880 TPS 05-03-22 09:57:33
001878 TPS 05-03-24 07:11:44          001860 TPS 05-03-21 14:43:26
001866 TPS 05-03-19 18:06:48          001854 TPS 05-03-20 15:07:52
001860 TPS 05-03-21 14:43:26          001866 TPS 05-03-19 18:06:48
001854 TPS 05-03-20 15:07:52          001848 TPS 05-03-18 16:21:59
001850 TPS 05-03-16 20:01:26          001784 TPS 05-03-17 14:11:56
001848 TPS 05-03-18 16:21:59          001850 TPS 05-03-16 20:01:26
Command Completed.

```

The following example provides SCCP load status with 192 Million LNP Number statistics and GFLEX on, GPORT off, and the EIR feature on.

rept-stat-sccp

```

Integrat40 05-03-26 10:37:22 EST EAGLE5 34.0.0
SCCP SUBSYSTEM REPORT IS-NR          Active      -----
      SCCP ALARM STATUS = No Alarms
EIR  SUBSYSTEM REPORT IS-ANR          Restricted  -----
      ASSUMING MATE'S LOAD
      EIR: SSN STATUS = Allowed        MATE SSN STATUS = Prohibited
      EIR ALARM STATUS = No Alarms

SCCP Cards Configured= 4      Cards IS-NR= 2
System Daily Peak SCCP Load      2044      TPS 05-03-25 14:11:56
System Overall Peak SCCP Load    2044      TPS 05-03-25 14:11:56
System Total SCCP Capacity        3400      TPS ( 3400 max SCCP Capacity)
System SCCP Capacity Calc. Method (N)
System TPS Alarm Threshold        2720      TPS ( 80% System N SCCP Capacity)

CARD   VERSION      PST           SST           AST           MSU   CPU
                                     USAGE  USAGE
-----
1212   101-001-000   IS-NR        Active        ALMINH        45%   30%
1301 P 101-001-000   IS-NR        Active        -----        35%   20%
1305   -----      OOS-MT        Isolated     -----        0%    0%
2112   -----      OOS-MT-DSBLD Manual      -----        0%    0%
-----
SCCP Service Average MSU Capacity = 40%   Average CPU Capacity = 25%

AVERAGE CPU USAGE PER SERVICE:
GTT   = 15%  GFLEX = 10%  GPORT = --%
EIR   = 2%

TOTAL SERVICE STATISTICS:
SERVICE  SUCCESS  ERRORS  RATIO  FAIL  WARNINGS  FORWARD  TOTAL
GTT:      1995      5      0%    -      -      -      2000
GFLEX:     500      1      0%    4      10     515
EIR:       55      5      8%    -      -      60
Command Completed.
;
    
```

The following example provides SCCP status with the 192 Million LNP Numbers feature enabled and turned on along with the WNP, PLNP and the TLNP features enabled.

rept-stat-sccp

```

Integrat40 05-03-26 10:37:22 EST EAGLE5 34.0.0
SCCP SUBSYSTEM REPORT IS-NR Active -----
      SCCP ALARM STATUS = No Alarms
EIR SUBSYSTEM REPORT IS-ANR Restricted -----
      ASSUMING MATE'S LOAD

SCCP Cards Configured= 4      Cards IS-NR= 2
System Daily Peak SCCP Load      2044 TPS 05-03-25 14:11:56
System Overall Peak SCCP Load    2044 TPS 05-03-25 14:11:56
System Total SCCP Capacity      1700 TPS ( 3400 max SCCP Capacity)
System SCCP Capacity Calc. Method (N+1)
System TPS Alarm Threshold      1360 TPS ( 80% System N+1 SCCP Capacity)
    
```

CARD	VERSION	PST	SST	AST	MSU USAGE	CPU USAGE
1212	101-001-000	IS-NR	Active	ALMINH	45%	30%
1301 P	101-001-000	IS-NR	Active	-----	35%	20%
1305	-----	OOS-MT	Isolated	-----	0%	0%
2112	-----	OOS-MT-DSBLD	Manual	-----	0%	0%

 SCCP Service Average MSU Capacity = 40% Average CPU Capacity = 25%

AVERAGE CPU USAGE PER SERVICE:
 GTT = 15%

TOTAL SERVICE STATISTICS:

SERVICE	SUCCESS	ERRORS	FAIL RATIO	WARNINGS	FORWARD TO GTT	TOTAL
GTT:	1500	45	2%	-	-	1545
WNP:	0	0	0%	-	-	0
PLNPQS:	75	1	0%	-	-	76
TLNP:	95	5	5%	-	-	100

Command Completed.

;

rept-stat-sccp:peakreset=yes

```

Integrat40 05-07-24 10:37:22 EST EAGLE5 34.0.0
Command Completed.
    
```

;

Legend

This section defines the fields of the three **rept-stat-sccp** reports:

- **rept-stat-sccp** with no parameters
- **rept-stat-sccp:mode=perf**
- **rept-stat-sccp:loc=nnnn**

A dash (-) in an output field indicates that the statistic does not apply.

NOTE: The **ERRORS** and **TOTAL ERRORS** fields indicate that errors have occurred for SCCP cards in the system. Refer to UIMs generated by the system for the specific errors, and refer to the *Maintenance Manual* for error explanations and recovery procedures.

Report Type: rept-stat-sccp with no parameters

SCCP SUBSYSTEM REPORT, INPQ/EIR SUBSYSTEM REPORT—The summaries of the SCCP subsystem, INPQ (INP Query) subsystem, and EIR subsystem status. Information about the status of GSM, INPMR (INP Message Relay), and EIR services is provided in the SCCP subsystem status summary report. The INPQ subsystem status is displayed only if the INP feature bit is turned on. The EIR subsystem status is displayed only if the EIR feature key is enabled and turned on. The ALARM STATUS for the SCCP and INPQ/EIR Subsystems is displayed in this section of the report.

SCCP CARDS CONFIGURED—The number of SCCP/VSCCP cards provisioned.

CARD IS-NR—The number of SCCP/VSCCP cards that can be used by the system (status is in-service normal, IS-NR).

SYSTEM TPS ALARM THRESHOLD—The percentage of traffic that when reached, triggers an alarm to warn that the EAGLE 5 SAS is approaching the total system SCCP transactions-per-second (TPS) capacity. This value is set using the **chg-th-alm** command.

SYSTEM DAILY PEAK SCCP LOAD—The peak SCCP transactions-per-second (TPS) load processed by the EAGLE within the past 24 hours.

SYSTEM OVERALL PEAK SCCP LOAD—The peak SCCP transactions-per-second (TPS) processed by the EAGLE 5 SAS.

SYSTEM SCCP CAPACITY—The current total system SCCP TPS capacity. This value is the sum of the maximum capacity of all active SCCP cards. When the **ansigflex** system option is enabled in an ANSI system, the maximum capacity of each DSM is 1700 TPS.

SYSTEM MAXIMUM SCCP CAPACITY CALC. METHOD (N)—A TPS calculation method used to determine if the TPS Threshold Alarm levels have been exceeded. This method uses all In Service Normal cards in the TPS calculation. This value is set using the **chg-th-alm** command.

SYSTEM SCCP CAPACITY CALC. METHOD (N+1)—A TPS calculation method used to determine if the TPS Threshold Alarm levels have been exceeded. This method uses all In Service Normal cards minus 1 card in the TPS calculation. This value is set using the **chg-th-alm** command.

NOTE: The capacity calculation methods listed above do not consider as part of the capacity calculation, the number of provisioned SCCP cards in the system since card slots may be provisioned and not equipped or not in-service.

CARD—The card location of the TSMs running the SCCP application and of the DSMs running the VSCCP application.

P—When G-Flex, G-Port, or INP is turned on, or EIR is enabled and turned on, a P indicates the primary DSM. The primary DSM provides the MPS status to the EAGLE 5 SAS. This indicator is displayed between the card location and the GPL version.

VERSION—The version number of the SCCP/VSCCP GPL the card is running.

PST—The primary state of the card. The possible values are described in “Possible Values for PST/SST/AST” in Appendix A.

SST—The secondary state of the card. The possible values are described in “Possible Values for PST/SST/AST” in Appendix A.

AST—The associated state of the card. The possible values are described in “Possible Values for PST/SST/AST” in Appendix A.

MSU USAGE—The percentage of the maximum number of MSUS (850 MSUS per second) received by each card during the last 30 seconds.

CPU USAGE—The percentage of the amount of CPU used by each card during the last 30 seconds to process messages and to handle other foreground and background tasks.

SCCP SERVICE AVERAGE MSU CAPACITY—The average MSU capacity used over the last 30-second interval. This field includes all services provided by the SCCP/VSCCP cards.

AVERAGE CPU CAPACITY—The average CPU capacity used over the last 30-second interval. This field includes all services provided by the SCCP/VSCCP cards.

AVERAGE CPU USAGE PER SERVICE—A system-wide view of the service traffic composition. This report is available only if the G-Flex, G-Port, or INP feature is turned on or if the EIR feature is enabled and turned on. Fields are omitted if the associated feature is not turned on. The services include GTT, EIR, G-Flex, INPQ, G-Port, and INPMR.

TOTAL SERVICE STATISTICS—A system-wide view of per-service statistics. This report is available only if the G-Flex, G-Port, or INP feature is turned on or if the EIR feature is enabled and turned on. Fields are omitted if the associated feature is not turned on.

An "A" in the field indicates that the statistic does not apply.

The report tracks the following information:

SERVICE—The services include GTT, EIR, G-Flex, INPQ, G-Port, and INPMR.

SUCCESS—The total number of successful messages processed by the specified card for each service. Applies to all services.

ERRORS—The total number of messages with errors for each service. Applies to all services.

WARNINGS—The total number of messages that output UIM warnings and were forwarded to GTT by the specified card for G-Flex, G-Port, and INPMR.

FORWARD TO GTT—The total number of messages that could not find a match in the MPS (Multi-Purpose Server) database (did not produce any errors or warnings) and were successfully forwarded to GTT by the specified card for G-Flex, G-Port, and INPMR.

Report Type: rept-stat-sccp:mode=perf

The report displays general SCCP traffic performance for both SCCP and VSCCP cards and supplies message rates for TVG.

NOTE: This report includes the status of TSM and DSM cards, but does not differentiate between these card types.

SCCP SUBSYSTEM REPORT—The summary status of the SCCP subsystem, and the SCCP Alarm Status.

SCCP CARDS CONFIGURED—The number of SCCP/VSCCP cards provisioned.

CARD IS-NR—The number of SCCP/VSCCP cards that can be used by the system (status is in-service normal, IS-NR).

SYSTEM TPS ALARM THRESHOLD—The percentage of traffic that when reached triggers an alarm to warn that the EAGLE is approaching the total system SCCP transactions-per-second (TPS) capacity. This value is set by the **chg-th-alm** command.

SYSTEM PEAK SCCP LOAD—The highest SCCP transactions-per-second (TPS) processed by the EAGLE 5 SAS.

SYSTEM TOTAL SCCP CAPACITY—The current total system SCCP transactions-per-second (TPS) capacity. This value is the sum of the maximum capacity of all active SCCP cards.

TPS STATISTICS—The section of the report that provides TPS statistics on each SCCP or VSCCP card.

CARD—The card location of the TSM cards running the SCCP application and of the DSMs running the VSCCP application.

CPU USAGE—The percentage of the amount of CPU used to process messages by each card during the last 30 seconds.

TOTAL MSU RATE—The total number of messages processed per second. This and the other message rates are obtained from statistics maintained by the SCCP or VSCCP card for the last 30-second period.

CLASS 0 AND CLASS 1 TVG RATE—The number of messages per second received.

The next section of the **rept-stat-sccp:mode=perf** report provides system-wide SCCP traffic statistics.

AVERAGE MSU USAGE—The total of the MSU usage fields from each SCCP card divided by the number of active SCCP cards.

AVERAGE CPU USAGE—The total of the CPU usage fields from each SCCP card divided by the number of active SCCP cards.

TOTAL MSU RATE—The sum of all GTT, EIR, G-Flex, G-Port, and INP MSUs processed by all active SCCP cards.

STATISTICS FOR PAST 30 SECONDS—statistics that represent the last 30-second period.

TOTAL MSUS—The sum of all transactions on all active SCCP cards.

TOTAL ERRORS—The sum of all errors on all active SCCP cards.

HIGHEST 10 OVERALL DAILY PEAKS—The highest 10 Overall Daily peaks are listed in descending order based on TPS rate. Only the highest peak of a given day is stored as an entry.

LAST 10 DAILY SCCP LOADS—The last 10 Daily Peaks are listed in reverse chronological order, with the latest highest TPS at the top.

Report Type: `rept-stat-sccp:loc=nnnn`

CARD—The card location of the TSM running the SCCP application or of the DSM running the VSCCP application.

VERSION—The version number of the GPL the card is running.

TYPE—The type (TSM/DSM) of the card.

PST—The primary state of the card. The possible values are described in “Possible Values for PST/SST/AST” in Appendix A.

SST—The secondary state of the card. The possible values are described in “Possible Values for PST/SST/AST” in Appendix A.

AST—The associated state of the card. The possible values are described in “Possible Values for PST/SST/AST” in Appendix A.

CARD ALARM STATUS—If there are no card alarms present, this field displays `No Alarms`.

The next section of the `rept-stat-sccp:loc=nnnn` report supplies the status of the individual services provided by the card and the associated CPU usage for the service. Fields are omitted if the associated feature is not turned on.

GTT: STAT—Possible values are ACTIVE and SWDL (software loading).

GFLEX: STAT—Possible values are ACTIVE and SWDL (software loading).

GPORT: STAT—Possible values are ACTIVE and SWDL (software loading).

INPMR: STAT—Possible values are ACTIVE, OFFLINE, and SWDL (software loading).

INPQ: STAT—Possible values are ACTIVE, OFFLINE, and SWDL (software loading).

EIR: STAT—Possible values are ACTIVE, OFFLINE and SWDL (software loading).

TOTAL—The sum of the CPU usage for the services running over the previous 30-second period.

CARD SERVICE STATISTICS—The card service statistics for the specified card. This report is available only if the G-Flex, G-Port, or INP feature is turned on, or the EIR feature is enabled and turned on. Fields are omitted if their associated feature is not turned on. The report tracks the following:

SERVICE—The services include GTT, EIR, G-Flex, G-Port, INPQ, and INPMR.

SUCCESS—The total number of successful messages processed by the specified card for each service. Applies to all services.

ERRORS—The total number of messages with errors for each service. Applies to all services.

WARNINGS—The total number of messages that output UIM warnings and were forwarded to GTT by the specified card for EIR, G-Flex, G-Port, and INPMR.

FORWARD TO GTT—The total number of messages that could not find a match in the MPS database (did not produce any errors or warnings) and were successfully forwarded to GTT by the specified card for EIR, G-Flex, G-Port, and INPMR.

rept-stat-seas

Report Status SEAS Command

Use this command to generate a summary report of the status of the SEAS subsystem on the EAGLE 5 SAS. This command reports single OSS/Application Processor (OAP) or dual OAP configuration status, depending on the OAP hardware configuration used. See the *Maintenance Manual* for information on the SEAS subsystem.

Keyword: `rept-stat-seas`

Related Commands: `alw-trm`, `chg-trm`, `inh-trm`, `rept-stat-trm`, `rept-stat-sys`, `rept-stat-trbl`

Command Class: System Maintenance

Parameters

This command has no parameters.

Example

```
rept-stat-seas
```

Dependencies

The SEAS feature must be turned on prior to using this command.

At least one OAP terminal must be defined using the `chg-trm` command.

No other `rept-stat-xxx` command can be in progress when this command is entered.

Notes

None

Output

rept-stat-seas

```
rlghncxa03w 04-02-04 15:59:06 EST EAGLE 31.3.0
SEAS Subsystem Report      IS-NR      Active  -----
SEAS Interfaces Configured = 2  Interfaces IS-NR = 2
      GPL          PST          SST          AST
-----
SEAS SYSTEM                IS-NR      Active  -----
TDM Port                    4          IS-NR      Active  -----
TDM Port                    10         IS-NR      Active  -----
OAP                         A    250-001-000 IS-NR      Active  -----
OAP                         B    250-001-000 IS-NR      Active  -----
X.25 Link                   A1         IS-NR      Active  -----
X.25 Link                   B1         IS-NR      Active  -----
```

```
SEAS SYSTEM  ALARM STATUS = No Alarms.
OAP A        ALARM STATUS = No Alarms.
OAP B        ALARM STATUS = No Alarms.
X25 Link A1  ALARM STATUS = No Alarms.
X25 Link A2  ALARM STATUS = No Alarms.
X25 Link B1  ALARM STATUS = No Alarms.
X25 Link B2  ALARM STATUS = No Alarms.

X25 A1 PVCs IS-NR    = 1,2,3
X25 A1 PVCs OOS-MT   = ---
X25 B1 PVCs IS-NR    = 1,2,3
X25 B1 PVCs OOS-MT   = ---

X25 A2 PVCs IS-NR    = 1,2,3
X25 A2 PVCs OOS-MT   = ---
X25 B2 PVCs IS-NR    = 1,2,3
X25 B2 PVCs OOS-MT   = ---
Command Completed.
;
```

Legend

SEAS COMPONENT—The name of the subsystem component.

PST—The primary state of the subsystem. The possible values are described in “Possible Values for PST/SST/AST” in Appendix A.

SST—The secondary state of the subsystem. The possible values are described in “Possible Values for PST/SST/AST” in Appendix A.

AST—The associated state of the subsystem. The possible values are described in “Possible Values for PST/SST/AST” in Appendix A.

rept-stat-seculog

Display Security Log Status Information

Use this command to display the following information about the security log on the active and standby OAMs:

- The active or standby status of each log
- The number of new (that is, not uploaded) entries in each log
- The percentage of log space used by those new entries
- Whether overflow has occurred since the last upload
- Whether a recording failure has occurred since the last upload
- The date and time of the oldest and newest records in the log
- The date and time when the last successful upload of the log occurred

Keyword: **rept-stat-seculog**

Related Commands: **chg-attr-seculog, rtrv-attr-seculog**

Command Class: Security Administration

Parameters

This command has no parameters.

Example

```
rept-stat-seculog
```

Dependencies

No other security log command can be in progress when this command is entered.

Notes

The %FULL field displays the amount of space in the log taken up by new (not uploaded) entries. That number is obtained by dividing the number displayed in the ENTRIES field by the overall storage capacity of the log (10,000 entries). Because the log stays full of entries at all times, new entries overwrite existing entries.

The percentage full computed is rounded up to the next integer with one exception: the value of 100 is not displayed until the log is truly 100% full.

The log capacity is 10,000 records. To determine how many more commands can be logged before an overflow condition occurs, subtract the value displayed in the ENTRIES field from 10,000.

The status of the active OAM's log is always reported first in the output report, followed by the status of the standby log; in other words, they are not *necessarily* displayed numerically by the location number.

The report displays dates in the format *yy-mm-dd*, where *yy* is the year, *mm* is the month, and *dd* is the date. The report displays times in the format of *hh:mm:ss*, where *hh* is hours, *mm* is minutes, and *ss* is seconds.

Output

The following example shows the normal security log state. All of the un-uploaded records appear in the log on the active OAM.

rept-stat-seculog

```
rlghncxa03w 05-07-29 16:40:40 EST EAGLE 28.1.0
-- SINCE LAST UPLOAD -- OLDEST NEWEST LAST
LOC ROLE ENTRIES %FULL OFLO FAIL RECORD RECORD UPLOAD
1114 Active 8312 84 No No 96-08-12 05-07-04 05-07-16
11:23:56 15:59:06 14:02:22
1116 Standby 0 0 No No 96-09-12 05-07-30 05-07-30
11:24:12 14:00:06 14:02:13
;
```

The following example shows an abnormal situation. The active security log is full and has overflowed.

rept-stat-seculog

```
rlghncxa03w 05-07-29 16:40:40 EST EAGLE 28.1.0
-- SINCE LAST UPLOAD -- OLDEST NEWEST LAST
LOC ROLE ENTRIES %FULL OFLO FAIL RECORD RECORD UPLOAD
1114 Active 10000 100 Yes No 96-08-12 05-07-04 05-07-16
11:23:56 15:59:06 14:02:22

1116 Standby 0 0 No No 96-09-12 05-07-30 05-07-30
11:24:12 14:00:06 14:02:13

;
```

The following example shows what happens when both logs contain un-uploaded entries. The standby log on 1116 should be uploaded.

rept-stat-seculog

```
rlghncxa03w 05-07-29 16:40:40 EST EAGLE 28.1.0
-- SINCE LAST UPLOAD -- OLDEST NEWEST LAST
LOC ROLE ENTRIES %FULL OFLO FAIL RECORD RECORD UPLOAD
1114 Active 8312 84 No No 96-08-12 05-07-04 05-07-16
11:23:56 15:59:06 14:02:22

1116 Standby 693 7 No No 96-09-12 05-07-30 05-07-30
11:24:12 14:00:06 14:02:13

;
```

The following example shows how, if data cannot be retrieved from the standby OAM (for example, in simplex mode), blanks (-----) are displayed.

rept-stat-seculog

```
rlghncxa03w 05-07-29 16:40:40 EST EAGLE 28.1.0
-- SINCE LAST UPLOAD -- OLDEST NEWEST LAST
LOC ROLE ENTRIES %FULL OFLO FAIL RECORD RECORD UPLOAD
1114 Active 8312 83 No No 96-08-12 05-07-04 05-07-16
11:23:56 15:59:06 14:02:22

1116 Standby ----- --- --- --- -----
-----

;
```

Legend

LOC—The address of the TDM card (with the hard disk on it) that contains the log. It is always the card at location 1114 or 1116.

ROLE—The current role of the security log at that location. This value is always the same as the role of the OAM associated with the TDM card: **active** or **standby**.

-- SINCE LAST UPLOAD—This heading applies to the four columns directly below it on the output. It indicates that the fields below display information obtained since the last upload.

ENTRIES—Shows how many un-uploaded commands are currently recorded in the log. This value resets to 0 (zero) when the log is uploaded using **copy-seculog**.

%FULL—Shows, as a percentage, how much space in the log the ENTRIES field value occupies.

OFLO—The overflow indicator. Overflow is what happens if the log is not uploaded periodically: new entries start overwriting un-uploaded entries. This field displays **No** if no overflow has occurred and **Yes** if overflow has occurred.

FAIL—The failed indicator. This field displays **No** if no logging failure has occurred. It displays **Yes** to indicate that a logging failure has occurred that has prevented one or more entries from being recorded in the log successfully.

NOTE: Whether the system is able to set the logging failure flag in the security log header depends on the nature of the failure. If a copy-disk command is processing, the system sets the flag when the copy-disk command finishes processing. However, if the active fixed disk fails for some reason, or the security log happens to be in a bad sector that develops, the system is unable to set the logging failure flag.

OLDEST RECORD/NEWEST RECORD—The date and time recorded in the oldest and newest record in the log. Allows the administrator to know the time period that the log covers. The log records all commands that were issued between 6/3/96 at 13:45:03 up to 8/5/96 at 06:58:55. The **NEWEST RECORD** for the active log is the current date, because the log will have recorded the **rept-stat-secu**log command that was just entered to produce the report.

LAST UPLOAD—The date and time when the log was last uploaded successfully. That is, the **copy-secu**log command successfully copied the log to the FTA.

rept-stat-slan

Report Status of the STPLAN

Use this command to generate a summary report of the status of the ACMs that make up the STPLAN subsystem.

Keyword: **rept-stat-slan**

Related Commands: **rept-stat-alm**, **rept-stat-card**, **rept-stat-dlk**, **rept-stat-imt**, **rept-stat-sys**, **rept-stat-trbl**

Command Class: System Maintenance

Parameters

:mode= (optional)

Use this parameter to provide extended performance information, including group ticket voucher (TVG) message rates.

Range: **perf**

Default: No extended performance information is displayed

Example

```
rept-stat-slan
```

```
rept-stat-slan:mode=perf
```

Dependencies

No other **rept-stat-xxx** commands can be in progress when this command is entered.

A warning is issued if at least one ACM is not configured.

Notes

The HOST CAP. field value is obtained by averaging the usage percentages for the data links from each ACM to the host.

The EAGLE CAP. field value is obtained by averaging the usage percentages for the ACM traffic received from LIMs.

The system level usage for host capacity (the AVERAGE USAGE PER HOST CAPACITY field in the **rept-stat-slan** output) is obtained by averaging the usage percentages for the data links to the host from each ACM.

The EAGLE level usage for ACM capacity (the AVERAGE USAGE PER EAGLE CAPACITY field in the **rept-stat-slan** output) is obtained by averaging the usage percentages for the ACM traffic received from LIMs.

Output

rept-stat-slan

(Output with at least one ACM in an IS-NR state):

```
rlghncxa03w 04-02-27 16:53:22 EST EAGLE 31.3.0
SLAN Subsystem Report IS-NR Active -----
SLAN Cards Configured= 2 Cards IS-NR= 2
CARD VERSION PST SST AST HOST Cap. EAGLE Cap.
-----
1206 021-010-000 IS-NR Active ---- 42% 16%
1104 021-010-000 IS-NR Active ALMINH 36% 12%
-----
AVERAGE USAGE per HOST CAPACITY = 39%
AVERAGE USAGE per EAGLE CAPACITY = 14%
CARDS DENIED SLAN SEVICE:
1101, 1204
Command Completed.
```

rept-stat-slan:mode=perf

```
rlghncxa03w 04-02-04 13:36:07 EST EAGLE 31.3.0
SLAN Subsystem Report IS-NR Active -----
SLAN Cards Configured= 3 Cards IS-NR= 3
CARD HOST EAGLE TVG
CAP CAP RATE
-----
1101 50% 30% 140
1102 55% 33% 435
1103 47% 28% 435
-----
AVERAGE USAGE per HOST CAPACITY = 51%
AVERAGE USAGE per EAGLE CAPACITY = 30%
Command Completed.
```

Legend

SLAN SUBSYSTEM REPORT—The status of the STPLAN subsystem.

STPLAN CARDS CONFIGURED—The number of ACMs, used by the STPLAN, contained in the system.

CARDS IS_NR—The number of ACMs contained in the system whose status is in service normal (IS-NR).

CARD—The locations of the ACMs.

VERSION—The version number of the STPLAN GPL the cards are running.

PST—The primary state of the ACMs. The possible values are described in “Possible Values for PST/SST/AST” in Appendix A.

SST—The secondary state of the ACMs. The possible values are described in “Possible Values for PST/SST/AST” in Appendix A.

AST—The associated state of the ACMs. The possible values are described in “Possible Values for PST/SST/AST” in Appendix A.

HOST CAP—The amount of traffic being sent to the host from each ACM, expressed as a percentage of the total amount of traffic that can be sent to the host.

EAGLE CAP—The amount of traffic being sent to each ACM that is received from the LIMs, expressed as a percentage of the total amount of traffic that can be sent to the ACM.

AVERAGE USAGE PER HOST CAPACITY The amount of traffic being sent to all hosts from all ACMs, expressed as a percentage of the total amount of traffic that can be sent to all hosts from all ACMs.

AVERAGE USAGE PER EAGLE CAPACITY—The amount of traffic being sent to all ACMs that is received from the LIMs, expressed as a percentage of the total amount of traffic that can be sent to all ACMs.

CARDS DENIED SLAN SERVICE—The card locations that cannot use the STPLAN application.

CARDS DISABLED COPY SERVICE—The card locations that cannot use the stop and copy action of the gateway screening feature.

Instead of displaying the **VERSION**, **PST**, **SST**, **AST**, **HOST CAP**, **EAGLE CAP**, and **CARDS DENIED SLAN SERVICE** fields, the report displayed with the **rept-stat-slan:mode=perf** command shows these fields:

HOST CAP—The average of the usage percentages for the TCP/IP data links to the host from each ACM.

EAGLE CAP—The average of the usage percentages for the ACM traffic received from the LIMs.

TVG RATE—The number of messages per second received from all SS7 links, and any other group ticket voucher paced message source. It is obtained from statistics maintained by the ACM for the last 30-second period.

AVERAGE USAGE PER HOST CAPACITY—The amount of traffic being sent to all hosts from all ACMs, expressed as a percentage of the total amount of traffic that can be sent to all hosts from all ACMs.

AVERAGE USAGE PER EAGLE CAPACITY—The amount of traffic being sent to all ACMs that is received from the LIMs, expressed as a percentage of the total amount of traffic that can be sent to all ACMs.

rept-stat-slk**Report Status Signaling Link**

Use this command to generate a report of the MTP signaling links status. The secondary state (SST) indicates whether the link is available, unavailable, or manually removed from service.

Use this command to generate a separate report of status of the E1 associated with a signaling link. The status includes the **e1loc** parameter (card location of the E1 card) and the UAM text. If the E1 association is not provisioned, "E1 association unknown" is displayed. If the card is not type **lime1** or **limch**, no E1 output is generated.

Use this command to generate a separate report of status of the T1 associated with a signaling link. The status includes the **t1loc** parameter (card location of the T1 card) and the UAM text. If the card is not type **limt1** or **limch**, no T1 output is generated.

Keyword: **rept-stat-slk**

Related Commands: **act-slk, blk-slk, dact-slk, dlt-slk, ent-slk, inh-slk, rtrv-slk, tst-slk, ublk-slk, unhb-slk**

Command Class: System Maintenance

Parameters

:l2stats= (optional)

Report L2 status

Range: **align, both, brief, no, service**

align—Display alignment data only

both—Display alignment and service data

brief—Display up to 10 alignment events only

no—Do not display level 2 status information

service—Display service data only

Default: **no**

:loc= (optional)

The card location as stenciled on the shelf of the system.

Range: **1101-1108, 1111-1112, 1201-1208, 1211-1218, 1301-1308, 1311-1318, 2101-2108, 2111-2118, 2201-2208, 2211-2218, 2301-2308, 2311-2318, 3101-3108, 3111-3118, 3201-3208, 3211-3218, 3301-3308, 3311-3318, 4101-4108, 4111-4118, 4201-4208, 4211-4218, 4301-4308, 4311-4318, 5101-5108, 5111-5118, 5201-5208, 5211-5218, 5301-5308, 5311-5318, 6101-6108, 6111-6118**

Default: All cards containing signaling links are displayed.

:port= or :link= (optional)

The port on the card specified in the **loc** parameter. The ports can be specified in any sequence or pattern.

Range: **a, b, a1-a31, b1-b31**

Not all card types support all **link** parameter values.

See Table A-1 in Appendix A for valid **link** parameter range values for each type of card that can have assigned signaling links ports.

Default: Display all

:stat= (optional)

A report on cards whose status is the same as the state indicated by the parameter.

Range: **all, alminh, anr, dsbld, mt, nr**

all—All of the primary states

alminh—Alarms inhibited

anr—In service abnormal (IS-ANR)

dsbld—Out of service maintenance disabled (OOS-MT-DSBLD)

mt—Out of service maintenance (oos-mt)

nr—In service normal (IS-NR)

Default: Display all

Example

```
rept-stat-slk
```

```
rept-stat-slk:loc=1201:link=a
```

```
rept-stat-slk:stat=alminh
```

```
rept-stat-slk:loc=1203:link=b:L2stats=both
```

```
rept-stat-slk:loc=1203:link=b:L2stats=brief
```

Dependencies

No other **rept-stat-xxx** command can be in progress when this command is entered.

If the **loc** parameter or the **link** parameter is specified, the **stat** parameter cannot be specified.

When the **loc** parameter is specified, the **link** parameter must be specified.

The card must be equipped and must be one of the following cards:

- A LIM card running the **ss7ansi**, **ss7gx25**, **atmansi**, or **ccs7itu** application
- An E1 ATM card running the **atmitu** application.
- A DCM or SSEDCCM card running the **ss7ipgw**, **ipgwi**, **iplim**, or **iplimi** application
- An E1/T1 MIM card or HC-MIM card running the **ss7ansi** or **ccs7itu** application

The location specified by the **loc** parameter cannot be one of those reserved for non-LIM or non-DCM cards.

The signaling link must be an SS7 signaling link to display level 2 statistics (**l2stats**).

On TCP/IP point-to-multipoint links (DCM cards equipped as SS7IPGW or IPGWI links), **l2stats** output is not available.

The **link** parameter values **a1**, **b1**, **a2**, **b2**, **a3**, and **b3** can be specified only for the following cards:

- A multi-port LIM
- An SSEDCCM running the **iplim** or **iplimi** application that supports 8 points
- An E1/T1 MIM or HC-MIM.

The specified signaling link must be provisioned in the database.

A card location that is valid and defined in the database must be specified.

Notes

Not every card location represents a signaling link. Be sure to address a signaling link in this command.

This command can be canceled using the **F9** function key or the **canc-cmd** command. See **canc-cmd** for more information.

The *Installation Manual - EAGLE 5 SAS* provides an illustration of card locations.

Output

rept-stat-slk

rlghncxa03w 04-02-27 17:00:36 EST EAGLE 31.3.0

rept-stat-slk

SLK	LSN	CLLI	PST	SST	AST
1201,A	lsnssp2	-----	IS-NR	Avail	----
1201,B	lsnstpi	-----	IS-NR	Avail	----
1202,A	lsnstpn	-----	IS-NR	Avail	----
1202,B	lsnstpi	-----	IS-NR	Avail	----
1203,A	lsnstpa	-----	IS-NR	Avail	----
1203,B	lsnscpa	-----	IS-NR	Avail	----
1205,A	lsnscpi	-----	IS-NR	Avail	----
1205,B	lsnsspi1	-----	IS-NR	Avail	----
1207,A	lsnstpa	-----	IS-NR	Avail	----
1207,B	lsnsspa1	-----	IS-NR	Avail	----
1211,A	lsnstpn	-----	IS-NR	Avail	----
1211,B	lsnssp1	-----	IS-NR	Avail	----

Command Completed.

;

rept-stat-slk:loc=1201:link=a

rlghncxa03w 04-02-04 13:06:25 EST EAGLE 31.3.0

SLK	LSN	CLLI	PST	SST	AST
1201,A	lsnssp2	-----	OOS-MT	Unavail	----
ALARM STATUS = * 0213 REPT-LKF: received SIOS					
UNAVAIL REASON = PE NA					

Command Completed.

;

rept-stat-slk:loc=1213:link=a

rlghncxa03w 04-02-27 17:00:36 EST EAGLE 31.3.0

SLK	LSN	CLLI	PST	SST	AST
1201,A	lsnssp2	-----	OOS-MT-DSBLD	LPBK	LFS
ALARM STATUS = * 0236 REPT-LKS:not aligned					
UNAVAIL REASON = NA (can be any of those listed below)					

Command Completed.

;

rept-stat-slk:stat=alminh

rlghncxa03w 04-02-23 12:57:50 EST EAGLE 31.3.0

SLK	LSN	CLLI	PST	SST	AST
1205,A	lsnscpi	-----	IS-NR	Avail	ALMINH
1211,A	lsnstpn	-----	IS-NR	Avail	ALMINH

Command Completed.

;

The following example shows output that includes a multi-port LIM:

rept-stat-slk

```
rlghncxa03w 04-02-23 12:57:50 EST EAGLE 31.3.0
SLK      LSN      CLLI      PST      SST      AST
1201,A   lsnsspn2  -----  IS-NR    Avail    ----
1201,B   lsnstpi   -----  IS-NR    Avail    ----
1202,A   lsnstpn   -----  IS-NR    Avail    ----
1202,B   lsnstpi   -----  IS-NR    Avail    ----
1203,A   lsnstpa   -----  IS-NR    Avail    ----
1203,B   lsnscpa   -----  IS-NR    Avail    ----
1203,A1  lsnstpi   -----  IS-NR    Avail    ----
1203,B1  lsnscpi   -----  IS-NR    Avail    ----
1203,A2  lsnstpb   -----  IS-NR    Avail    ----
1203,B2  lsnscpb   -----  IS-NR    Avail    ----
1203,A3  lsnstpc   -----  IS-NR    Avail    ----
1203,B3  lsnscpc   -----  IS-NR    Avail    ----
1205,A   lsnscpi   -----  IS-NR    Avail    ALMINH
1205,B   lsnsspi1  -----  IS-NR    Avail    ----
1207,A   lsnstpa   -----  IS-NR    Avail    ----
1207,B   lsnsspa1  -----  IS-NR    Avail    ----
1211,A   lsnstpn   -----  OOS-MT   Unavail  ALMINH
1211,B   lsnsspn1  -----  OOS-MT   Unavail  ----
Command Completed.
;
```

rept-stat-slk:loc=1203:link=a:L2stats=both

```
rlghncxa03w 04-02-04 13:06:25 EST EAGLE 31.3.0
SLK      LSN      CLLI      PST      SST      AST
1203,A   lsnsspn2  -----  OOS-MT-DSBLD  Unavail  ----
  ALARM STATUS = ** 0236 REPT-LKS:not aligned
  UNAVAIL REASON = NA
Event Type      Event                                     Timestamp
SSCOP State     Idle                                     04-02-04 10:04:23.000
SSCOP State     Outgoing Conn. Pending                 04-02-04 10:04:23.000
SSCOP State     Incoming Conn. Pending                 04-02-04 10:05:31.100
SSCOP State     Outgoing Disc. Pending                 04-02-04 10:05:31.100
SSCOP State     Outgoing Resync Pending                04-02-04 10:05:31.105
SSCOP State     Incoming Resync Pending                04-02-04 10:05:31.105
SSCOP State     Outgoing Recovery Pending              04-02-04 10:05:46.425
SSCOP State     Recovery Response Pending              04-02-04 10:05:46.430
SSCOP State     Incoming Recovery Pending              04-02-04 10:05:46.430
SSCOP State     Data Transfer Ready                    04-02-04 10:06:02.110
SSCF State      OOS Idle                               04-02-04 10:06:02.120
SSCF State      OOS ODP                                04-02-04 10:06:02.885
SSCF State      Alignment Idle                          04-02-04 10:06:53.625
SSCF State      Alignment OCP                           04-02-04 10:07:14.000
SSCF State      Alignment ODP                           04-02-04 10:07:14.000
SSCF State      In Service/Data Transfer Ready          04-02-04 10:08:01.760
SSCF State      Proving Data Transfer Ready            04-02-04 10:08:01.760
SSCF State      Aligned/Ready Data Transfer Ready      04-02-04 10:04:23.000
MAAL State      OOS                                     04-02-04 10:04:23.000
MAAL State      Alignment                               04-02-04 10:05:31.100
MAAL State      Proving                                 04-02-04 10:05:31.100
MAAL State      Aligned/Ready                           04-02-04 10:05:31.105
MAAL State      In Service                              04-02-04 10:05:31.105
```

```

SSCOP Receive BGN 04-02-04 10:05:46.425
SSCOP Receive BGAk 04-02-04 10:05:46.430
SSCOP Receive END 04-02-04 10:05:46.430
SSCOP Receive ENDAk 04-02-04 10:06:02.110
SSCOP Receive RS 04-02-04 10:06:02.120
SSCOP Receive RSAk 04-02-04 10:06:02.885
SSCOP Receive BGREJ 04-02-04 10:06:53.625
SSCOP Receive SD 04-02-04 10:07:14.000
SSCOP Transmit ER 04-02-04 10:07:14.000
SSCOP Transmit POLL 04-02-04 10:08:01.760
SSCOP Transmit STAT 04-02-04 10:08:01.760
SSCOP Transmit USTAT 04-02-04 10:04:23.000
SSCOP Transmit UD 04-02-04 10:04:23.000
SSCOP Transmit MD 04-02-04 10:05:31.100
SSCOP Transmit ERAk 04-02-04 10:05:31.100
SSCF Receive Out of Service 04-02-04 10:05:31.105
SSCF Receive Processor Outage 04-02-04 10:05:31.105
SSCF Receive In Service 04-02-04 10:05:46.425
SSCF Receive Normal 04-02-04 10:05:46.430
SSCF Receive Emergency 04-02-04 10:05:46.430
SSCF Transmit Alignment Not Successful 04-02-04 10:06:02.110
SSCF Transmit Mgmt Initiated 04-02-04 10:06:02.120
SSCF Transmit Protocol Error 04-02-04 10:06:02.885
SSCF Transmit Proving Not Successful 04-02-04 10:06:53.625
Special Event LCD 04-02-04 10:05:46.425
Special Event LCD Cleared 04-02-04 10:05:46.430
Special Event LOF 04-02-04 10:05:46.430
Special Event LOF Cleared 04-02-04 10:06:02.110
Special Event LOS 04-02-04 10:06:02.120
Special Event LOS Cleared 04-02-04 10:06:02.885
Special Event Too Many Interrupts 04-02-04 10:06:53.625

Service Event
Timer_No_Credit expired 04-02-04 05:40:10.160
ERM link failure 04-02-04 10:02:02.125
Timer_No_Response expired 04-02-04 10:15:02.125
COO received 04-02-04 10:22:02.125
Stop Commanded 04-02-04 10:32:02.125
LPO 04-02-04 10:42:02.125
RPO 04-02-04 10:43:02.125
Remote OOS 04-02-04 10:44:02.125
Remote PE 04-02-04 10:45:02.125
Remote Mgmt Initiated 04-02-04 10:46:02.125
Failed SLT 04-02-04 10:47:02.125
LCD 04-02-04 10:48:02.125
LOS 04-02-04 10:49:02.125
LOF 04-02-04 10:52:02.125
Too many interrupts 04-02-04 10:53:02.125
In Service 04-02-04 10:54:01.760
Command Completed.
;

```

rept-stat-slk:loc=1203:link=b:L2stats=brief

```

rlghncxa03w 04-02-23 13:06:25 EST EAGLE 31.3.0
SLK      LSN      CLLI      PST      SST      AST
1203,B   lsnsspn2  -----  IS-NR      Avail    ----
        ALARM STATUS      = No Alarms
        UNAVAIL REASON    = --

Event Type      Event                      Timestamp
Transmit        SIOS                      97-10-31 10:04:23.000
State           Out of Service            97-10-31 10:04:23.000
State           Initial Align             97-10-31 10:05:31.100
State           Idle                      97-10-31 10:05:31.100
Transmit        SIO                       97-10-31 10:05:31.105
State           Not Aligned               97-10-31 10:05:31.105
State           T2 Expired               97-10-31 10:05:46.425
Command Completed.
;

```

The following example shows output for an E1 interface associated with a link:

rept-stat-slk:loc=1201:link=a

```

rlghncxa03w 04-02-23 13:06:25 EST EAGLE 31.3.0
SLK      LSN      CLLI      PST      SST      AST
1201,A   e5m6s4  -----  OOS-MT      Unavail    ----
        ALARM STATUS      = No Alarms
        UNAVAIL REASON    = --
        E1 STATUS        = 1201, REPT-E1F:FAC-E1 Port 1 LOS failure
Command Completed.
;

```

The following example shows output for when the E1 interface is not associated with a link:

rept-stat-slk:loc=1201:link=a

```

rlghncxa03w 04-02-23 13:06:25 EST EAGLE 31.3.0
SLK      LSN      CLLI      PST      SST      AST
1201,A   e5m6s4  -----  OOS-MT      Unavail    ----
        ALARM STATUS      = No Alarms
        UNAVAIL REASON    = --
        E1 status        = E1 association unknown
Command Completed.
;

```

This example shows output for a T1 interface associated with a link:

rept-stat-slk:loc=1201:link=a

```

rlghncxa03w 04-02-23 13:06:25 EST EAGLE 31.3.0
SLK      LSN      CLLI      PST      SST      AST
1201,A   e5m6s4  -----  OOS-MT      Unavail    ----
        ALARM STATUS      = No Alarms
        UNAVAIL REASON    = --
        T1 STATUS        = 1201, REPT-E1F:FAC-T1 Port 1 LOS failure
Command Completed.
;

```

This example shows output for an E1 ATM card:

rept-stat-slk:loc=1101:link=a

```
rlghncxa03w 04-02-23 13:06:25 EST EAGLE 31.3.0
SLK      LSN      CLLI      PST      SST      AST
1101,A  atmitul  -----  OOS-MT-DSBLD Manual  -----
  ALARM STATUS    = **  0236 REPT-LKF: not aligned
  UNAVAIL REASON  = NA
Command Completed.
```

;

This example shows output for an 8-point IPLIM card:

rept-stat-slk:loc=1301

```
rlghncxa03w 04-02-23 13:06:25 EST EAGLE 31.3.0
SLK      LSN      CLLI      PST      SST      AST
1301,A  lsnip    -----  OOS-MT-DSBLD Unavail  -----
1301,B  lsnip    -----  OOS-MT-DSBLD Unavail  -----
1301,A1 lsnip    -----  OOS-MT-DSBLD Unavail  -----
1301,B1 lsnip    -----  OOS-MT-DSBLD Unavail  -----
1301,A2 lsnip    -----  OOS-MT-DSBLD Unavail  -----
1301,B2 lsnip    -----  OOS-MT-DSBLD Unavail  -----
1301,A3 lsnip    -----  OOS-MT-DSBLD Unavail  -----
1301,B3 lsnip    -----  OOS-MT-DSBLD Unavail  -----

  ALARM STATUS    = **  0224 REPT-LKS: not aligned
  UNAVAIL REASON  = NA
Command Completed.
```

;

Legend

SLK—The card location and the signaling link.

LSN—The name of the linkset that contains the signaling link.

CLLI—The CLLI code of the destination STP of the signaling link.

PST—The primary state of the signaling link. The possible values are described in “Possible Values for PST/SST/AST” in Appendix A.

SST—The secondary state of the signaling link. The possible values are described in “Possible Values for PST/SST/AST” in Appendix A.

AST—The associated state of the signaling link. The possible values are described in “Possible Values for PST/SST/AST” in Appendix A.

ALARM STATUS—The trouble text alarm message that was generated for the specified signaling link.

UNAVAIL REASON—The reason that the signaling link is unavailable. More than one unavailable reason may be listed:

BSNR—The signaling link received 2 of 3 invalid BSNs.

CNGT—The signaling link has a remote congestion time-out.

COO—A changeover order was received.

FC—The signaling link is unavailable because of false congestion restart.

FE—The signaling link is in far end loopback mode.

FIBR—The signaling link received 2 of 3 invalid FIBs.

INTR—Too many link interrupts were received.

LB—The signaling link has been blocked locally.

LD—The signaling link received incomplete data.

LI—The signaling link has been inhibited locally.

NA—The signaling link is not aligned.

PF—The signaling link failed the proving period.

RB—The signaling link has been blocked remotely.

RD(xx.xxx)—The signaling link is unavailable because of a restart delay to prevent signaling link oscillation. The number in parentheses indicates the amount of time, in seconds, remaining in the restart delay period. The link is restarted automatically after this amount of time has elapsed.

RL—The signaling link is in remote near end loopback mode.

RMI—The signaling link has been inhibited remotely.

SIE—An unexpected SIE was received.

SIO—An unexpected SIO was received.

SIOS—An unexpected SIOS was received.

SIN—An unexpected SIN was received.

SLTF—Link test failed.

T1NR—The level-2 T1 (not ready) timer expired.

T1R—The level-2 T1 (ready) timer expired.

T2—The level-2 T2 timer expired.

T3—The level-2 T3 timer expired.

X25FL—An X25 link failed.

XDA—The signaling link did not receive an acknowledgment in time.

XER—The SUERM threshold was exceeded.—

--—The card is ISOLATED or the links are available.

The following are reasons that the ATM high-speed signaling link is unavailable:

TNC—Timer No Credit expired - The remote node has held the node in a no-credit state for too long. The far end office should be contacted to determine the cause of the link congestion.

TNR—Timer No Response expired - The far end is taking too long to acknowledge the messages sent to it by the near end. The far end office should be contacted to determine the cause for the excessive delay in acknowledging PDUs.

LPO—Local Processor Outage - Indicates a spontaneous or management-initiated processor outage. The user needs to determine whether the outage was spontaneous or management-initiated on the near end.

RPO—Remote Processor Outage - The far end has sent PDUs causing processor outage. The far end office should be contacted to determine the reason for the processor outage.

ROOS—Remote Out of Service - The far end has sent PDUs causing a link to become out of service. The far end office should be contacted to determine the reason for taking the link out of service.

RPE—Remote Protocol Error - The far end has sent PDUs declaring a protocol error. The far end office should be contacted to determine the details about the protocol error.

RMIR—Remote Management Initiated Release - The far end has sent PDUs releasing the link. The far end office should be contacted to determine the reason for releasing the link.

LCD—Level 1 facility outage: Loss of Cell Delineation

LOF—Level 1 facility outage: Loss of Frame

LOS—Level 1 facility outage: Loss of Signal

EVENT TYPE—The type of event being logged:

RECEIVE—When a signal unit is received.

TRANSMIT—When a signal unit is transmitted.

STATE—When an internal SS7 Level 2 state changes or a special event occurs that would either end alignment or cause the link to fail.

EVENT—The specific event being logged: (1) if a signal unit is being received or transmitted, the specific signal unit is displayed; (2) if the event being logged is a state change, the new state is displayed; (3) If neither (1) nor (2) is displayed, the link or alignment failure reason is displayed.

SERVICE EVENT—The service activity of the link; for example, In Service. Anything other than In Service is a description of a link failure.

TIMESTAMP—The time event processed by the system as follows:

YY-MM-DD HH:MM:SS.TTT, where

YY—The last 2 digits of the year (range 00–99)

MM—The month (range 01–12)

DD—The day of month (range 00–31)

HH—The hour of day (range 00–59)

MM—The minute of the hour (range 00–59)

SS—The seconds of the minute (range 00–59)

TTT—Milliseconds of the second (range 000–995 in increments of 5)

E1 STATUS—The status of the E1 interface associated with the link; the status includes the card location (**e1loc**) and the UAM text. If the E1 association is not provisioned, “E1 association unknown” is displayed. If the card is not type **lime1** or **limch**, no E1 output is displayed.

T1 STATUS—The status of the T1 interface associated with the link; the status includes the card location (**e1loc**) and the UAM text. If the card is not type **limt1** or **limch**, no T1 output is displayed.

rept-stat-sys

Report Status System

Use this command to display a summary report of the status of the main system entities. Use this display to determine where the troubles are in the system. The display shows the number of these items that are in service (IS-NR) and how many are in another state (IS-ANR, OOS-MT, OOS-MT-DSBLD).

NOTE: VSCCP cards are included in SCCP card status.

Keyword: rept-stat-sys

Related Commands: rept-stat-alm, rept-stat-applsock, rept-stat-card, rept-stat-clk, rept-stat-cluster, rept-stat-dstn, rept-stat-imt, rept-stat-ls, rept-stat-meas, rept-stat-mps, rept-stat-slk, rept-stat-seas, rept-stat-trbl, rept-stat-xlist

Command Class: System Maintenance

Parameters

This command has no parameters.

Example

rept-stat-sys

Dependencies

No other **rept-stat-xxx** command can be in progress when this command is entered.

Notes

None

Output

The following example shows the output when no features are turned on in the system and only the cards in locations 1109-1110 and 1113-1118 are installed.

rept-stat-sys

```
tekelecstp 04-03-31 15:30:42 EST EAGLE 31.6.0
MAINTENANCE STATUS REPORT
Maintenance Baseline established.
Routing Baseline established.
SCCP Baseline established.
ALARMS:      CRIT=    2    MAJR=    2    MINR=    0    INH=    0
OAM 1113     IS-NR      Active      INH=    0
OAM 1115     IS-NR      Standby     INH=    0
LIM        CARD IS-NR=    0    Other=    0    INH=    0
X25        CARD IS-NR=    0    Other=    0    INH=    0
SCCP        CARD IS-NR=    0    Other=    0    INH=    0
GLS        CARD IS-NR=    0    Other=    0    INH=    0
```

SLAN	CARD	IS-NR=	0	Other=	0	INH=	0
VXWSLAN	CARD	IS-NR=	0	Other=	0	INH=	0
EMDC	CARD	IS-NR=	0	Other=	0	INH=	0
SS7IPGW	CARD	IS-NR=	0	Other=	0	INH=	0
IPGWI	CARD	IS-NR=	0	Other=	0	INH=	0
IPLIM	CARD	IS-NR=	0	Other=	0	INH=	0
IPLIMI	CARD	IS-NR=	0	Other=	0	INH=	0
HMUX	CARD	IS-NR=	0	Other=	0	INH=	0
MCPM	CARD	IS-NR=	0	Other=	0	INH=	0
EROUTE	CARD	IS-NR=	0	Other=	0	INH=	0
CLOCK		IS-NR=	2	Other=	0	INH=	0
IMT		IS-NR=	2	Other=	0		
SLK		IS-NR=	0	Other=	0	INH=	0
DLK		IS-NR=	0	Other=	0	INH=	0
LINK	SET	IS-NR=	0	Other=	0	INH=	0
NDC	IP LK	IS-NR=	0	Other=	0	INH=	0
DSM	IP LK	IS-NR=	0	Other=	0	INH=	0
MCPM	IP LK	IS-NR=	0	Other=	0	INH=	0
APPLSOCK		IS-NR=	0	Other=	0	INH=	0
SCTP	ASSOC	IS-NR=	0	Other=	0	INH=	0
APPL	SERVER	IS-NR=	0	Other=	0	INH=	0
SS7	DPC	IS-NR=	0	Other=	0	INH=	0
X25	DPC	IS-NR=	0	Other=	0	INH=	0
CLUST	DPC	IS-NR=	0	Other=	0	INH=	0
XLIST	DPC	IS-NR=	0	Other=	0		
DPC	SS	Actv =	0	Other=	0		
SEAS	SS	IS-NR=	0	Other=	2		
SEAS	X25	IS-NR=	0	Other=	2	INH=	0
LSMS	SS	IS-NR=	0	Other=	2		
LSMS	Conn	IS-NR=	0	Other=	2	INH=	0
NDC	SS	IS-NR=	0	Other=	0		
NDC	Q.3	IS-NR=	0	Other=	0	INH=	0
TERMINAL		IS-NR=	16	Other=	0	INH=	0
MPS		IS-NR=	0	Other=	0		

;

The following example shows the output when various features are turned on in the system. (Your output will not show all of these entries; some features are mutually exclusive in the system).

Some entries appear as follows:

- When the Measurements Platform feature is not turned on and no MCPM cards are in the IS-NR state in the system, the MCPM and MCPM IP LK values are zero and the MEAS SS entry does not appear.
- When one or more MCPM cards have been installed and allowed, the MCPM CARD entry shows the number of MCPM cards that are in each state.
- When the Measurements Platform feature is turned on and the Measurements Platform collection option is enabled, the MEAS SS entry appears.
- When the Measurements Platform collection function has been enabled (**chg-measopts=platformenable=on**), the MCPM IP LK entry shows the number of links that are functioning for the MCPM cards, and the MEAS SS entry appears.
- When the OA&M IP Security Enhancement feature is turned on, the SECURITY SS entry appears.
- When the Equipment Identity Register (EIR) feature is turned on, the EIR SS entry appears.

rept-stat-sys

rlghncxa03w 05-03-27 16:53:22 EST EAGLE5 34.0.0
 MAINTENANCE STATUS REPORT

Maintenance Baseline established.
 Routing Baseline established.
 SCCP Baseline established.

ALARMS:	CRIT=	9	MAJR=	10	MINR=	3	INH=	2
OAM 1113	IS-NR		Active				INH=	0
OAM 1115	IS-NR		Standby				INH=	0
LIM	CARD IS-NR=	3	Other=		0		INH=	0
X25	CARD IS-NR=	0	Other=		0		INH=	0
SCCP	CARD IS-NR=	3	Other=		0		INH=	0
GLS	CARD IS-NR=	0	Other=		0		INH=	0
SLAN	CARD IS-NR=	0	Other=		0		INH=	0
VXWSLAN	CARD IS-NR=	0	Other=		0		INH=	0
EMDC	CARD IS-NR=	0	Other=		0		INH=	0
SS7IPGW	CARD IS-NR=	0	Other=		0		INH=	0
IPGWI	CARD IS-NR=	0	Other=		0		INH=	0
IPLIM	CARD IS-NR=	0	Other=		0		INH=	0
IPLIMI	CARD IS-NR=	0	Other=		0		INH=	0
HMUX	CARD IS-NR=	0	Other=		0		INH=	0
HIPR	IS-NR=	2	Other=		0		INH=	0
IMT	IS-NR=	2	Other=		0			
SLK	IS-NR=	0	Other=		6		INH=	0
DLK	IS-NR=	0	Other=		0		INH=	0
LINK SET	IS-NR=	0	Other=		4		INH=	0
NDC IP LK	IS-NR=	4	Other=		0		INH=	0
DSM IP LK	IS-NR=	0	Other=		0		INH=	0
MCPM	CARD IS-NR=	0	Other=		0		INH=	0
EROUTE	CARD IS-NR=	0	Other=		0		INH=	0
CLOCK	IS-NR=	2	Other=		0		INH=	0
HS CLOCK	IS-NR=	2	Other=		0		INH=	0
MCPM IP LK	IS-NR=	2	Other=		0		INH=	0
STC IP LK	IS-NR=	1	Other=		1		INH=	0
APPLSOCK	IS-NR=	0	Other=		0		INH=	0
SCTP ASSOC	IS-NR=	0	Other=		0		INH=	0
APPL SERVER	IS-NR=	0	Other=		0		INH=	0
SS7 DPC	IS-NR=	0	Other=		6		INH=	0
X25 DPC	IS-NR=	0	Other=		0		INH=	0
CLUST DPC	IS-NR=	0	Other=		1		INH=	0
XLIST DPC	IS-NR=	0	Other=		0			
DPC SS	Actv =	0	Other=		0			
SEAS SS	IS-NR=	0	Other=		2			
SEAS X25	IS-NR=	0	Other=		2		INH=	0
LSMS SS	IS-NR=	0	Other=		2			
LSMS Conn	IS-NR=	0	Other=		2		INH=	0
NDC SS	IS-NR=	1	Other=		0			
NDC Q.3	IS-NR=	0	Other=		0		INH=	1
TERMINAL	IS-NR=	2	Other=		14		INH=	0
MPS	IS-NR=	2	Other=		0			
SECURITY SS	IS-NR=	1	Other=		0			
EIR SS	IS-NR=	1	Other=		0			

;

Legend

INH—The number of devices within each device type that have their alarms inhibited.

ALARMS—The number of critical (**CRIT**), major (**MAJR**), and minor (**MINR**) alarms on the system when this command was executed and the count of alarm inhibited (**INH**) devices for cards, links, linksets, terminals, and SEAS X.25 links and terminals.

OAM—The status of each of the cards that are running the OAM (1113 and 1115).

LIM CARD—The status of the LIM cards.

X25 CARD—The status of the SS7GX25 cards.

SCCP CARD—The status of the SCCP subsystem cards. VSCCP cards are included in the SCCP card status.

GLS CARD—The status of the GLS subsystem cards.

SLAN CARD—The status of the STPLAN subsystem cards.

VXWSLAN CARD—The status of the VXW STPLAN subsystem cards.

EMDC CARD—The status of the EMDC cards.

SS7IPGW CARD—The status of the SS7IPGW cards.

IPGWI CARD—The status of the IPGWI cards.

IPLIM CARD—The status of the IPLIM cards.

IPLIMI CARD—The status of the IPLIMI cards.

HMUX CARD—The status of the HMUX cards.

HIPR CARD—The status of the HIPR cards.

MCPM CARD—The status of the MCPM cards.

EROUTE CARD—The status of the EROUTE cards.

CLOCK—The status of the system clocks.

HS CLOCK—The status of the high-speed clocks.

IMT—The status of the IMT system.

SLK—The status of the SS7, IPGWI, and X.25 signaling links in the system.

DLK—The status of the TCP/IP data links in the system.

LINK SET—The status of the linksets in the system.

NDC IP LK—The status of the NDC IP linksets.

DSM IP LK—The status of the DSM IP linksets.

MCPM IP LK—The status of the MCPM IP links.

APPLSOCK—The status of the application sockets.

SCTP ASSOC—The status of the SCTP associations.

APPL SERVER—The status of the Application Servers.

SS7 DPC—Summary information only for provisioned DPCs that are not in clusters.

X25 DPC—The status of the destination point codes in the X.25 domain.

CLUST DPC—Summary information for provisioned cluster DPCs only.

XLIST DPC—Summary information for X-LIST DPC entries only.

DPC SS—Summary information for the DPC subsystem.

SCCP SS—The status of the SCCP subsystem.

XLIST SS—Summary information for SEAS Subsystem X.25 Links to SEAC.

SEAS SS—The status of the SEAS subsystem.

LSMS SS—The status of the LSMS subsystem.

MEAS SS—The status of the Measurements subsystem (for Measurements Platform).

SEAS X25—The status of the SEAS X.25 signaling links.

LSMS CONN—Summary information on the communication link between the LSMS and the EMS.

NDC SS—The status of the NDC subsystem.

NDC Q3—Summary information on Q.3 association status.

MPS—Summary information on the MPS.

TERMINAL—The status of the terminals.

SECURITY SS—EAGLE OA&M IP Security subsystem status.

EIR SS—Equipment Identity Register subsystem status.

rept-stat-t1**Report Status T1**

Use this command to display the T1 port status and signaling link status for cards with provisioned T1 ports.

Keyword: **rept-stat-t1**

Related Commands: None

Command Class: System Maintenance

Parameters

:loc= (optional)

Card address. The unique identifier of a specific **limt1** card located in the STP.

Range: **1101-1108, 1111-1112, 1201-1208, 1211-1218, 1301-1308, 1311-1318, 2101-2108, 2111-2118, 2201-2208, 2211-2218, 2301-2308, 2311-2318, 3101-3108, 3111-3118, 3201-3208, 3211-3218, 3301-3308, 3311-3318, 4101-4108, 4111-4118, 4201-4208, 4211-4218, 4301-4308, 4311-4318, 5101-5108, 5111-5118, 5201-5208, 5211-5218, 5301-5308, 5311-5318, 6101-6108, 6111-6118**

Default: Information for all **limt1** cards is reported.

:t1port= (optional)

The T1 port number. When this parameter is specified, information is displayed only for the specified T1 port on the card in the specified card location.

Range: **1-8**

Ports 3 through 8 can be specified only for HC-MIM cards.

Example

```
rept-stat-t1
rept-stat-t1:loc=1203
rept-stat-t1:loc=1203:t1port=1
```

Dependencies

No other **rept-stat-xxx** command can be in progress when this command is entered.

The **loc** parameter must be specified when the **t1port** parameter is specified.

The active TDM location cannot be specified in the **loc** parameter.

Card locations 1117 and 1118 and the HMUX or HIPR card locations (xy09 and xy10 where *x* is the frame and *y* is the shelf) cannot be specified in the **loc** parameter.

Notes

Specifying the command without any parameters displays T1 port status for all cards with provisioned T1 ports.

If the **loc** parameter is specified, status is displayed for all T1 ports provisioned on the card in the specified location.

If the **loc** and **t1port** parameters are specified, the T1 port status summary is displayed for all T1 ports provisioned on the card in the specified location, followed by the status of all signaling links assigned to the specified T1 port on the card.

Output

When no parameters are specified in the command, T1 port status is displayed for all cards with provisioned T1 ports. Ports 3 through 8 are on HC-MIM cards only.

```
rept-stat-t1
rlghncxa03w 05-01-04 07:01:08 EST EAGLE5 33.0.0
LOC   T1PORT  PST           SST           AST
1203  1        IS-NR         Avail         BRGD MSTR
1203  2        IS-NR         Avail         BRGD SLAV
1203  3        IS-NR         Avail         -----
1203  7        OOS-MT        Unavail       -----
1207  1        IS-NR         Avail         -----
1207  2        IS-NR         Avail         -----
Command Completed.
```

When the **loc** parameter is specified, status is displayed for all T1 ports provisioned on the card in the specified location.

```
rept-stat-t1:loc=1203
rlghncxa03w 05-01-04 07:01:08 EST EAGLE5 33.0.0
LOC   T1PORT  PST           SST           AST
1203  1        IS-NR         Avail         BRGD MSTR
1203  2        IS-NR         Avail         BRGD SLAV
1203  3        IS-NR         Avail         -----
1203  7        OOS-MT        Unavail       -----
Command Completed.
```

When the **loc** and **t1port** parameters are specified, the T1 port status summary is displayed for all T1 ports provisioned on the card in the specified location, followed by the status of all signaling links assigned to the specified T1 port on the card.

rept-stat-t1:loc=1203:t1port=1

```
rlghncxa03w 05-01-04 07:01:08 EST EAGLE5 33.0.0
LOC   T1PORT   PST           SST           AST
1203  1         IS-NR        Avail        BRGD MSTR
ALARM STATUS      = No Alarms.
UNAVAIL REASON    = --
SLK   TS   PST           SST           AST
A     1   IS-NR        Avail        ---
A1    2   IS-NR        Avail        ---
Command Completed.
```

;

rept-stat-t1:loc=1203:t1port=2

```
rlghncxa03w 05-01-04 07:01:08 EST EAGLE5 33.0.0
LOC   T1PORT   PST           SST           AST
1203  2         IS-NR        Avail        BRGD SLAV
ALARM STATUS      = No Alarms.
UNAVAIL REASON    = --
Command Completed.
```

;

Legend

LOC—Card location

T1PORT—Number of the T1 port provisioned on the card in the specified location.

PST—The primary state of the card. The possible values are described in “Possible Values for PST/SST/AST” in Appendix A.

SST—The secondary state of the card. The possible values are described in “Possible Values for PST/SST/AST” in Appendix A.

AST—The associated state of the card. The possible values are described in “Possible Values for PST/SST/AST” in Appendix A. The values PARENT and PAIRED refer to odd and even adjacent ports on the card that are provisioned in channel bridging mode.

ALARM STATUS—Either "No Alarms" or current alarm number and text

UNAVAIL REASON—Reason for the T1 port being unavailable

SLK—Signaling link assigned to the T1 port

TS—Timeslot assigned to the signaling link

PST—The primary state of the signaling link. The possible values are described in “Possible Values for PST/SST/AST” in Appendix A.

SST—The secondary state of the signaling link. The possible values are described in “Possible Values for PST/SST/AST” in Appendix A.

AST—The associated state of the signaling link. The possible values are described in “Possible Values for PST/SST/AST” in Appendix A.

rept-stat-trbl

Report Status Trouble

Use this command to display a summary report of all the device trouble notifications that are logged currently in the OAM's RAM storage area.

Keyword: `rept-stat-trbl`

Related Commands: `act-alm-trns`, `dact-alm-trns`, `rept-stat-alm`, `rept-stat-clk`, `rls-alm`, `rtrv-obit`, `rtrv-trbl`

Command Class: System Maintenance

Parameters

:display= (optional)

Display type of alarms to be reported.

Range: `act`, `all`, `inhb`, `timestamp`

`act`—Display only active alarms

`all`—Display all alarms with no timestamps

`inhb`—Display only inhibited alarms

`timestamp`—Display all alarms with the date and time when the alarm was logged. Timestamps appear in the output only when the `display=timestamp` parameter is specified.

Default: `all`

:level= (optional)

The alarm level of the alarms to be displayed

Range: `crit`, `majr`, `minor`

Default: All alarms are displayed

Example

```
rept-stat-trbl
```

```
rept-stat-trbl:level=majr
```

```
rept-stat-trbl:display=inhb
```

```
rept-stat-trbl:display=timestamp
```

Dependencies

No other `rept-stat-xxx` command can be in progress when this command is entered.

Notes

This command can be canceled using the **F9** function key or the `canc-cmd` command. See `canc-cmd` for more information.

Output

The following example lists all devices that could appear. Your output will not be exactly the same; all devices and alarms cannot coexist in the system.

rept-stat-trbl

or

rept-stat-trbl:display=all

```

rlghncxa03w 02-03-07 09:50:17 EST EAGLE5 32.0.0
rlghncxa03w 02-03-07 09:50:17 EST EAGLE5 31.6.0
SEQN UAM AL DEVICE ELEMENT TROUBLE TEXT
0002.0143 * CARD 1113 OAM System release GPL(s) not approved
0003.0313 *C DPC s-010-010-003 DPC is prohibited
0004.0313 *C DPC 010-010-004 DPC is prohibited
0005.0313 *C DPC ps-010-010-005 DPC is prohibited
0006.0313 *C DPC s-252-010-003 DPC is prohibited
0008.0313 *C DPC 252-010-004 DPC is prohibited
0009.0313 *C DPC 252-011-* DPC is prohibited
0010.0318 ** LSN lsn4 REPT-LKSTO: link set prohibited
0011.0176 * SECULOG 1116 Stdb security log - upload required
0019.0236 *C T1PORT 1301,1 REPT-T1F:FAC-T1 LOS failure
0021.0318 ** LSN lsn1 REPT-LKSTO: link set prohibited
0022.0318 ** LSN lsn2 REPT-LKSTO: link set prohibited
0023.0318 ** LSN lsn3 REPT-LKSTO: link set prohibited
0024.0236 ** SLK 1315,A ls11234567 REPT-LKF: not aligned
0025.0236 ** SLK 1316,A ls11345678 REPT-LKF: not aligned
0028.0313 *C DPC 252-010-001 DPC is prohibited
0029.0308 *C SYSTEM Node isolated due to SLK failures
0036.0455 *C EIR SYSTEM EIR Subsystem is not available
3102.0435 *C LNP SYSTEM LNP Subsystem is disabled
3536.0084 ** EMAP B 7100 IP Connection Unavailable
3537.0084 ** DLK 1215, A MCP IP Connection Unavailable
3538.0179 * EMAP NDC Q.3 association is Unavailable
3539.0181 *C NDC SYSTEM NDC Subsystem is not available
3540.0203 ** SLK 1201,A lsn1 REPT-LKF: lost data
3541.0203 ** SLK 1201,B lsn4 REPT-LKF: lost data
3542.0203 ** SLK 1202,A lsn2 REPT-LKF: lost data
3543.0203 ** SLK 1202,B lsn4 REPT-LKF: lost data
3544.0202 ** SLK 1203,A lsn3 REPT-LKF: HWP - too many link interrupts
3545.0202 ** SLK 1203,B lsn4 REPT-LKF: HWP - too many link interrupts
SEQN UAM AL DEVICE ELEMENT TROUBLE TEXT
2353.0022 * CARD 1107 MCP Clock B for card failed, Clock A normal
3587.0048 * TERMINAL 1 Terminal failed
0007.0110 * IMT SYSTEM Failure detected on one IMT bus
2343.0002 * GPL SYSTEM BPDCM Card is not running approved GPL
4321.0321 * XLIST X-LIST occupancy threshold exceeded
0046.0344 * SEAS X25 Link A1 SEAS PVC unavailable
0045.0348 * SEAS SYSTEM SEAS is at min service limit
0011.0176 * SECULOG 1116 Stdb security log -- upload required
3538.0179 * EMAP NDC Q.3 association is Unavailable
4121.0398 * INP SYSTEM Local Subsystem normal,card(s) abnormal
2354.0516 * MEAS SYSTEM Degraded Mode - 1 card failed
3589.0013 ** CARD 1103 SS7ANSI Card is isolated from the system
2358.0013 ** CARD 1111 MCP Card is isolated from the system
3590.0013 ** CARD 1115 OAM Card is isolated from the system
3590.0514 ** CARD 1115 EOAM Standby MASP is inhibited
0006.0108 ** IMT BUS A Major IMT failure detected
Card 1105, 1113, 1115
0012.0390 ** CARD 1109 HMUX Illegal Address Error

```

```

0046.0155 * DLK 1104,A1 STPLAN connection unavailable
3591.0208 ** SLK 1101,A ls1 REPT-LKF: APF - lvl-2 T2 expired
3592.0208 ** SLK 1101,B ls2 REPT-LKF: APF - lvl-2 T2 expired
3593.0202 ** SLK 1102,B2 lsname489+ REPT-LKF: HWP -too many link interrupts
3594.0236 ** SLK 1103,A ls3 REPT-LKF: not aligned
3595.0236 ** SLK 1103,B ls4 REPT-LKF: not aligned
3596.0084 ** DLK 1111,A MCP IP Connection Unavailable
0024.0236 ** SLK 1315,A ls11234567 REPT-LKF: not aligned
0025.0236 ** SLK 1316,A ls11345678 REPT-LKF: not aligned
0943.0318 ** LSN ls1 REPT-LKSTO: link set prohibited
0945.0318 ** LSN ls2 REPT-LKSTO: link set prohibited
0948.0318 ** LSN ls4 REPT-LKSTO: link set prohibited
1234.0082 ** FUSE PANEL 11xx Alarm in Fuse Panel
0012.0341 ** OAP A OAP unavailable
0134.0084 ** IP7 LONGSOCKETNAME1 IP Connection Unavailable
3537.0084 ** DLK 1215,A MCP IP Connection Unavailable
3537.0084 ** DSM 1315,A IP Connection Unavailable
3536.0084 ** EMAP B 7100 IP Connection Unavailable
0133.0277 ** IP7 as1 AS Unavailable
0003.0313 *C DPC s-010-010-003 DPC is prohibited
0004.0313 *C DPC 010-010-004 DPC is prohibited
0005.0313 *C DPC ps-010-010-005 DPC is prohibited
0028.0313 *C DPC 252-010-001 DPC is prohibited
0006.0313 *C DPC s-252-010-003 DPC is prohibited
0008.0313 *C DPC 252-010-004 DPC is prohibited
0009.0313 *C DPC 252-011-* DPC is prohibited
2120.0058 *C CDT 1 Critical customer trouble detected
0029.0308 *C SYSTEM Node isolated due to SLK failures
0040.0128 *C CLOCK SYSTEM All clocks have failed
0050 1114 * HS CLOCK SYSTEM Clock selection mismatch
2109.0331 *C SCCP SYSTEM SCCP is not available
2110.0292 *C GLS SYSTEM GLS is not available
1234.0153 *C SLAN SYSTEM STPLAN not available
0009.0041 *C LSMS Connection A1 LNP DB Maintenance Required
0056.0356 *C LSMS SYSTEM LSMS unavailable
0041.0197 *C CLOCK SYSTEM All High Speed Clocks have failed
3102.0435 *C LNP SYSTEM LNP Subsystem is disabled
3539.0181 *C NDC SYSTEM NDC Subsystem is not available
0036.0455 *C EIR SYSTEM EIR Subsystem is not available
0019.0236 *C T1PORT 1301,1 REPT-T1F:FAC-T1 LOS failure
4521.0370 *C MPS A Critical Platform Failure(s)
0045.0469 *C EROUTE SYSTEM All STC cards Unavailable
5648.0382 ** E1PORT 1201,2 REPT-E1F:FAC-E1 LOF failure
0047.0392 ** SECURITY SYSTEM 1211 OA&M IP Security feature status is OFF
0036.0455 *C EIR SYSTEM EIR Subsystem is not available
1235 0114 ** IP TPS SYSTEM System IP TPS threshold exceeded
Command Completed.
;

```

rept-stat-trbl:display=act:level=majr

```

rlghncxa03w 02-03-07 09:50:17 EST EAGLE 30.0.0
Searching devices for alarms...
;

```

```

rlghncxa03w 02-03-07 09:50:17 EST EAGLE 30.0.0
SEQN UAM AL DEVICE ELEMENT TROUBLE TEXT
3540.0203 ** SLK 1201,A lsn1 REPT-LKF: lost data
3541.0203 ** SLK 1201,B lsn4 REPT-LKF: lost data
3542.0203 ** SLK 1202,A lsn2 REPT-LKF: lost data
3543.0203 ** SLK 1202,B lsn4 REPT-LKF: lost data
3544.0202 ** SLK 1203,A lsn3 REPT-LKF: HWP -too many link interrupts
3545.0202 ** SLK 1203,A1 lsn4 REPT-LKF: HWP -too many link interrupts

```

```

3545.0202 ** SLK 1203,B2 lsname489+ REPT-LKF: HWP -too many link interrupts
0022.0318 ** LSN lsn2 REPT-LKSTO: link set prohibited
0023.0318 ** LSN lsn3 REPT-LKSTO: link set prohibited
0010.0318 ** LSN lsn4 REPT-LKSTO: link set prohibited
Command Completed.

```

;

rept-stat-trbl:display=inhb:level=majr

```

rlghncxa03w 02-03-07 09:50:17 EST EAGLE 30.0.0
Searching devices for alarms...

```

;

```

rlghncxa03w 02-03-07 09:50:17 EST EAGLE 30.0.0
SEQN UAM AL DEVICE ELEMENT TROUBLE TEXT
0021.0318I** LSN lsn1 REPT-LKSTO: link set prohibited
Command Completed.

```

;

The following example shows output when the **display=timestamp** parameter is specified.

rept-stat-trbl:display=timestamp

```

rlghncxa03w 04-04-07 09:50:17 EST EAGLE 31.6.0
Searching devices for alarms...

```

;

```

tekelecstp 04-04-07 09:50:17 EST EAGLE 31.6.0
SEQN UAM AL DEVICE ELEMENT TROUBLE TEXT
0003.0048 * TERMINAL 1 Terminal failed
04-1-27 15:19:25
0004.0048 * TERMINAL 2 Terminal failed
04-1-27 15:19:25
0005.0048 * TERMINAL 4 Terminal failed
04-1-27 15:19:25
0006.0002 * GPL SYSTEM EOAM Card is not running approved GPL
04-1-27 15:19:25
0007.0176 * SECULOG 1116 Stdby security log -- upload required
04-1-27 15:19:25
0008.0013 ** CARD 1103 VSCCP Card is isolated from the system
04-15-27 15:19:25
0009.0438 *C SYSTEM Degraded Mode, Invalid OAM HW config
04-1-27 15:19:27
0010.0331 *C SCCP SYSTEM SCCP is not available
04-1-27 15:19:25
Command Completed.

```

;

Legend**In the AL column:**

*—Minor Alarm

**—Major Alarm

*C—Critical Alarm

I—Inhibited Alarm

rept-stat-trm**Report Status Terminal**

Use this command to display the status of the terminal ports. The device primary, secondary, and associated state information is displayed along with the terminal identification number.

Keyword: `rept-stat-trm`

Related Commands: `act-echo`, `alw-trm`, `chg-trm`, `dact-echo`, `inh-trm`, `rmv-trm`, `rst-trm`, `rtrv-trm`

Command Class: System Maintenance

Parameters

:trm= (optional)

The terminal ID. The ID of the terminal port that is to be reported.

Range: 1-40

Default: Display status of all terminal ports

Example

```
rept-stat-trm
```

```
rept-stat-trm:trm=5
```

Dependencies

No other **rept-stat-xxx** command can be in progress when this command is entered.

Notes

None

Output

The following example shows output when the IP User Interface is not turned on:

rept-stat-trm

```
tekelecstp 03-03-31 13:02:16 EST EAGLE 30.0.0
TRM  PST      SST      AST
 1  IS-NR     Active   -----
 2  IS-NR     Active   -----
 3  IS-NR     Active   -----
 4  IS-NR     Active   -----
 5  IS-NR     Active   -----
 6  IS-NR     Active   -----
 7  IS-NR     Active   -----
 8  IS-NR     Active   -----
 9  IS-NR     Active   -----
10  IS-NR     Active   -----
11  IS-NR     Active   -----
12  IS-NR     Active   -----
13  IS-NR     Active   -----
14  IS-NR     Active   -----
15  IS-NR     Active   -----
16  IS-NR     Active   -----
Command Completed.
```

```
;
```

The following example shows output when the IP User Interface is turned on and 3 IPSM cards are in the system:

rept-stat-trm

```
rlghncxa03w 04-01-07 09:50:17 EST EAGLE 31.3.0
```

TRM	PST	SST	AST
1	IS-NR	Active	-----
2	IS-NR	Active	-----
3	IS-NR	Active	ALMINH
4	IS-NR	Active	-----
5	OOS-MT-DSBLD	Manual	-----
6	IS-NR	Active	-----
7	IS-NR	Active	-----
8	IS-NR	Active	-----
9	IS-NR	Active	-----
10	IS-NR	Active	-----
11	IS-NR	Active	ALMINH
12	IS-NR	Active	-----
13	IS-NR	Active	-----
14	OOS-MT	Fault	-----
15	IS-NR	Active	-----
16	IS-NR	Active	-----
17	IS-NR	Active	-----
18	IS-NR	Active	-----
19	IS-NR	Active	-----
20	OOS-MT-DSBLD	Manual	-----
21	IS-NR	Idle	-----
22	IS-NR	Idle	-----
23	IS-NR	Idle	-----
24	IS-NR	Idle	-----
25	IS-NR	Active	-----
26	IS-NR	Active	-----
27	IS-NR	Active	-----
28	IS-NR	Active	-----
29	IS-NR	Active	-----
30	IS-NR	Active	-----
31	IS-NR	Active	-----
32	IS-NR	Active	-----
33	IS-NR	Active	-----
34	IS-NR	Active	-----
35	IS-NR	Active	-----
36	IS-NR	Active	-----
37	IS-NR	Active	-----
38	IS-NR	Active	-----
39	IS-NR	Active	-----
40	IS-NR	Active	-----

Command Completed.

;

rept-stat-trm:trm=5

```
rlghncxa03w 04-01-07 09:50:17 EST EAGLE 31.3.0
```

TRM	PST	SST	AST
5	IS-NR	Active	-----

Command Completed.

;

Legend

TRM—The ID of the terminal port.

PST—The primary state of the terminal ports. The possible values are described in “Possible Values for PST/SST/AST” in Appendix A.

SST—The secondary state of the terminal ports. The possible values are described in “Possible Values for PST/SST/AST” in Appendix A.

AST—The associated state of the terminal ports. The possible values are described in “Possible Values for PST/SST/AST” in Appendix A.

rept-stat-tstslk**Report Signaling Link Test Status**

Use this command to generate a report of the status of the MTP signaling links currently under test.

Keyword: `rept-stat-tstslk`

Related Commands: `tst-slk`

Command Class: Link Maintenance

Parameters

:loc= (optional)

The card location as stenciled on the shelf of the system.

Range: 1101–1108, 1111–1112, 1201–1208, 1211–1218, 1301–1308, 1311–1318, 2101–2108, 2111–2118, 2201–2208, 2211–2218, 2301–2308, 2311–2318, 3101–3108, 3111–3118, 3201–3208, 3211–3218, 3301–3308, 3311–3318, 4101–4108, 4111–4118, 4201–4208, 4211–4218, 4301–4308, 4311–4318, 5101–5108, 5111–5118, 5201–5208, 5211–5218, 5301–5308, 5311–5318, 6101–6108, 6111–6118

:loopback= (optional)

Loopback test type.

Range: `sltc`, `lxvr`, `oam`, `line`, `payload`

:port= or **:link=** (optional)

SS7 signaling links. The SS7 signaling link that is being tested.

Range: `a`, `b`, `a1-a31`, `b1-b31`

Not all card types support all **link** parameter values.

See Table A-1 in Appendix A for valid **link** parameter range values for each type of card that can have assigned signaling links.

Example

```
rept-stat-tstslk
rept-stat-tstslk:loc=1201
rept-stat-tstslk:loc=1203:link=a
rept-stat-tstslk:loopback=lxvr
```

Dependencies

The card in the location specified in the **loc** parameter must be equipped.

The signaling link specified by the **link** parameter must be equipped.

If the **link** parameter is specified, the **loc** parameter must be specified.

The specified signaling link must be an SS7 signaling link.

This command cannot be entered for cards with **ss7ipgw** and **ipgwi** signaling links.

Notes

None

Output

If no parameters are specified, all links in test are displayed.

If only the **loc** parameter is specified, all links in test on the specified card are displayed.

If the **loc** and **link** parameters are specified, the specified link on the specified card is displayed.

If the **loopback** parameter is specified, all links in the specified type of loopback test are displayed.

rept-stat-tstslk

```
tekelecstp 04-01-07 10:05:28 EST EAGLE 31.3.0
  SLK      LOOPBACK  MAX-TIME  TEST-TIME
  1102,A1  SLTC       01:00:00  00:04:01
  1201,A   OAM        02:00:00  01:04:11
  1203,A   LXVR      00:50:00  00:22:21
  1203,B   LXVR      24:00:00  20:04:01
  1208,A   PAYLOAD  01:10:00  01:05:22
  1211,A   LINE      21:30:00  00:14:01
;
```

Legend

SLK—Card and signaling link that are being tested.

LOOPBACK—Type of loopback test being run.

MAX-TIME—Maximum length of time for the test to run, as specified in the **tst-slk** command **time** parameter.

TEST-TIME—The length of time that the test has been running when this command was entered.

rept-stat-user**Report Status User**

Use this command to show which users are logged into the system. It shows user names, terminal identification numbers, when the last valid command was issued, and the current state of the last command entered.

Keyword: `rept-stat-user`

Related Commands: `act-user`, `chg-pid`, `chg-user`, `dact-user`, `dlt-user`, `ent-user`, `login`, `logout`, `rtrv-secu-user`, `rtrv-user`

Command Class: Basic

Parameters

This command has no parameters.

Example

```
rept-stat-user
```

Dependencies

None

Notes

None

Output**rept-stat-user**

```
rlghncxa03w 04-01-07 09:12:15 EST EAGLE 31.3.0
REPT-STAT-USER COMPLTD
USER ID      TERM#  IDLE SINCE      COMMAND          STATE
frodo        3     04-01-07 08:12:23  rept-stat-card  IDLE
jethro       5     04-01-07 09:15:14  rtrv-bip        IDLE
obadiah      7     04-01-07 10:06:22  rept-stat-user  PROCESSING
;
```

Legend

USER ID—The user ID of the users logged onto the system.

TERM #—The OAP terminal that the user's terminal is connected to.

IDLE SINCE—The date and time of day that the user last entered a command.

COMMAND—The last command the user entered.

STATE—The state of the command the user last entered.

rept-stat-xlist

Report Status X-List Storage Area Statistics

Use this command to report statistics related to the storage of x-list entries. X-list entries reside in the routing table and are dynamically created for individual members of clusters whenever one or more routes to that cluster member become more restrictive than the corresponding routes to the cluster.

The following information is reported:

- The number of routing table positions reserved for x-list entries
- The current number of x-list entries
- The percentage of space in the x-list reserved area currently in use
- The percentage of x-list space that must be in use before an alarm is issued

Keyword: `rept-stat-xlist`

Related Commands: `chg-stpopts`, `rept-stat-cluster`, `rtrv-stpopts`

Command Class: System Maintenance

Parameters

This command has no parameters.

Example

```
rept-stat-xlist
```

Dependencies

The Cluster Routing and Management Diversity (CRMD) feature must be turned on before using this command.

Notes

The statistics reported by this command are those gathered during periodic polling by the maintenance subsystem. They might differ slightly from the instantaneous values at the time the command was issued.

The following rules are used to compute the *Current X-LIST occupancy* percentage value that is displayed in the output report:

- The percentage value that is displayed is computed as follows:
$$[(\text{current x-list entries}) / (\text{allocated x-list space})] * 100$$
- Non-integer percentages will be rounded up to the next highest integer (for example, 23.5% becomes 24%), with the exception of the situation described in the next rule.
- 100% is not displayed until the current *X-LIST* entries value exactly equals the allocated X-LIST space (for example, 99.1% is not rounded up to 100%).

Output**rept-stat-xlist**

```

rlghncxa03w 04-02-18 03:32:42 EST   EAGLE 31.3.0
Allocated X-LIST space      = 500
Current X-LIST entries      = 156
Current X-LIST occupancy    = 31 % (see "Notes")
X-LIST occupancy threshold = 80 %
;

```

rept-x25-meas**Report X.25 Measurements**

Use this command to display the X.25 signaling link measurements. The X.25 signaling link is used in cellular networks to transport TCAP signaling messages from one mobile switching center (MSC) to another.

Keyword: rept-x25-meas

Related Commands: rept-stat-alm, rept-stat-dstn, rept-stat-imt, rept-stat-ls, rept-stat-slk, rept-stat-sys, rept-stat-trbl

Command Class: Link Maintenance

Parameters

:loc= (mandatory)

The card location as stenciled on the shelf of the system.

Range: 1101-1108, 1111-1112, 1201-1208, 1211-1218, 1301-1308, 1311-1318, 2101-2108, 2111-2118, 2201-2208, 2211-2218, 2301-2308, 2311-2318, 3101-3108, 3111-3118, 3201-3208, 3211-3218, 3301-3308, 3311-3318, 4101-4108, 4111-4118, 4201-4208, 4211-4218, 4301-4308, 4311-4318, 5101-5108, 5111-5118, 5201-5208, 5211-5218, 5301-5308, 5311-5318, 6101-6108, 6111-6118

(Refer to the *Installation Manual - EAGLE 5 SAS* for card location information).

:action= (optional)

This parameter is used to reset the measurements counters for an X25 link.

Range: reset, none

Default: none

:port= (optional)

The port on the card specified in the loc parameter

Range: a

Example

```
rept-x25-meas:loc=1211:port=a
```

```
rept-x25-meas:loc=1211:port=a:action=reset
```

Dependencies

No other action command can be in progress when this command is entered.

The specified signaling link must be equipped and assigned to a LIM configured with the ss7gx25 GPL.

Notes

None

Output**rept-x25-meas:loc=1211:port=a**

```
rlghncxa03w 04-02-18 03:32:42 EST EAGLE 31.3.0
X.25 MEASUREMENTS REPORT: CARD LOC: 1211; PORT:A
Time counters were last reset: 04-02-18; 02:32:78
```

Link counts:

```
Hardware errors = 0      CRC Errors= 150   Inits= 3
```

Level 2 counts:

```
Total recvd = 168321   FRMR recvd = 1   DISC recvd = 0
Total xmit = 171002    Re-xmit = 15000
```

Level 3 counts:

```
Total recvd = 101218   RESTART recvd = 5   DIAG/INT/REG recvd = 0
Total xmit = 122381    Re-xmit = 50   Discarded = 0
```

Logical Channel Status & Counts:

```
#SVC defined = 80      #SVC in use = 72   SVCs all in use =10
#PVC defined = 40      #PVC in use = 40
```

Number of times SVC Control Timers have expired:

```
T1 = 0   T2 = 0   T4 = 2   T5 = 0   T6 = 0   T7 = 0   T8 = 100
```

Command Completed.

;

Legend**Link Counts****HARDWARE ERRORS**—The number of signaling link hardware errors.**CRC ERRORS**—The number of signaling link CRC errors.**INITs**—The number of signaling link initializations.**Level 2 Counts****TOTAL RECVD**—The total number of frames received.**FRMR RECVD**—The number of frame reject frames received.**DISC RECVD**—The number of disconnect frames received.**TOTAL XMIT**—The total number of frames transmitted.**RE-XMIT**—The number of frames re-transmitted.**Level 3 Counts****TOTAL RECVD**—The total number of packets received.**RESTART RECVD**—The number of restarts received.**DIAG/INT/REJ RECVD**—The number of diagnostic, interrupt, or reject packets received.**TOTAL XMIT**—The total number of packets transmitted.

RE-XMIT—The number of packets retransmitted.

DISCARDED—The number of messages discarded because the transmit queue is full.

Logical Channel Status and Counts

#SVC DEFINED—The total number of switched virtual circuits (SVCs).

#SVC IN USE—The number of SVCs being used.

SVCs ALL IN USE—The number of times that all SVCs have been in use.

#PVC DEFINED—The total number of permanent virtual circuits (PVCs).

#PVC IN USE—The number of PVCs being used.

Number of times SVC control timers have expired

T1—SVC control timer T1

T2—SVC control timer T2

T4—SVC control timer T4

T5—SVC control timer T5

T6—SVC control timer T6

T7—SVC control timer T7

T8—SVC control timer T8

rls-alm

Release Alarm

Use this command to silence audible alarms. Entering this command also causes the alarm status on terminals to stop blinking (though they continue showing an alarm condition).

Keyword: rls-alm

Related Commands: act-alm-trns, dact-alm-trns, rept-stat-alm, rept-stat-clk, rept-stat-trbl, rtrv-obit, rtrv-trbl

Command Class: System Maintenance

Parameters

:lvl= (optional)

The alarm level

Range: crit, majr, minor

Default: All alarms are cleared

Example

rls-alm

rls-alm:lvl=crit

Dependencies

No other action command can be in progress when this command is entered.

Notes

This command has no effect on visual alarm indicators on the fuse and alarm panel (FAP) or on the cabinet side panel.

Any alarms that occur after the execution of this command activate audible alarms again.

Output**rls-alm**

```
rlghncxa03w 04-01-07 09:27:24 EST EAGLE 31.3.0
rls-alm
Command entered at terminal #8.
;
```

rmv-card**Remove Card**

Use this command to change the state of the card to out of service - maintenance disabled (OOS-MT-DSBLD), enabling a technician to test a LIM, TSM, or ACM, or physically remove it from the shelf.

Keyword: **rmv-card**

Related Commands: **dlt-card, ent-card, init-card, rept-stat-card, rst-card, rtrv-card**

Command Class: System Maintenance

Parameters

:loc= (mandatory)

The card location as stenciled on the shelf of the system.

Range: **1101-1108, 1111-1112, 1201-1208, 1211-1218, 1301-1308, 1311-1318, 2101-2108, 2111-2118, 2201-2208, 2211-2218, 2301-2308, 2311-2318, 3101-3108, 3111-3118, 3201-3208, 3211-3218, 3301-3308, 3311-3318, 4101-4108, 4111-4118, 4201-4208, 4211-4218, 4301-4308, 4311-4318, 5101-5108, 5111-5118, 5201-5208, 5211-5218, 5301-5308, 5311-5318, 6101-6108, 6111-6118**

(Refer to the *Installation Manual - EAGLE 5 SAS* for card location information).

:force= (optional)

Force inhibit

This parameter is required if the card is the last GLS or SCCP card.

Range: **yes, no**

Default: **no**

Example

```
rmv-card:loc=1101
```

```
rmv-card:loc=1201:force=yes
```

Dependencies

The following card locations are not valid for this command: 1113, 1114, 1115, 1116, 1117, 1118, and all xy09 and xy10 locations (where x is the frame and y is the shelf).

The shelf and card must be equipped.

If the card is a LIM, all signaling links assigned to it must be placed out of service.

The **force** parameter is required to force the last GLS or SCCP out of service.

If the card is an ACM, all TCP/IP data links assigned to it must be placed out of service.

Notes

The function of this command is the same as the **inh-card** command.

When this command is executed, the card boots and enters the OOS-MT-DSBLD state. It has no affect if the card is already OOS-MT-DSBLD.

The command is rejected if you attempt to inhibit a LIM that has active signaling links. The links must be cancelled, using the **dact-slk** command, before the command is accepted.

Inhibiting an TSM running the SCCP application affects GTT service. SCCP messages requiring global title translation are not routed, and an error message is returned to the originator.

Inhibiting an TSM running the GLS application has no immediate affect on the system. These cards are used only when loading gateway screening to the LIMs.

The command is rejected if you attempt to inhibit an ACM that has active TCP/IP data links. The TCP/IP data links must be cancelled, using the **canc-dlk** command, before the command is accepted.

Output

rmv-card:loc=1101

```
rlghncxa03w 04-01-07 11:11:28 EST EAGLE 31.3.0
Card has been inhibited.
```

;

rmv-imt

Remove IMT

The interprocessor message transport bus (IMT bus) is the main communications artery between all subsystems in the system. Use this command to remove the IMT bus from service.



CAUTION: Use this command only when directed by Tekelec Technical Services at (888) FOR-TKLC.

Keyword: `rmv-imt`

Related Commands: `clr-imt-stats`, `conn-imt`, `disc-imt`, `rept-imt-lvl1`, `rept-imt-lvl2`, `rept-stat-imt`, `rst-imt`

Command Class: System Maintenance

Parameters

:bus= (mandatory)

The IMT bus to be inhibited.

Range: a, b

Example

```
rmv-imt:bus=a
```

Dependencies

The function of this command is the same as the **inh-imt** command.

The alternate IMT bus must be in-service normal (IS-NR) in order for the specified bus to be inhibited.

This command cannot be entered during an IMT Fault Isolation Test.

Notes

Cards that are not connected to the other IMT bus will reinitialize.

All traffic is rerouted to the other IMT bus.

Output

rmv-imt:bus=a

```

rlghncxa03w 04-01-07 09:22:31 EST EAGLE 31.3.0
* 0014.0203 * SLK 1205,A nc00027 slk not aligned

rlghncxa03w 04-01-07 09:22:31 EST EAGLE 31.3.0
Inhibit IMT Bus A command issued

rlghncxa03w 04-01-07 09:22:31 EST EAGLE 31.3.0
* 00120.1203 * SLK 1205,B nc00027 slk not aligned

rlghncxa21w 04-01-07 09:22:31 EST EAGLE 31.3.0
0016.0096 CARD 1205 SS7ANSI card has been reloaded

rlghncxa21w 04-01-07 09:22:31 EST EAGLE 31.3.0
0017.0236 SLK 1205,A nc00027 slk is attempting to align

rlghncxa21w 04-01-07 09:22:31 EST EAGLE 31.3.0
0018.0236 SLK 1205,B nc00027 slk is attempting to align

rlghncxa21w 04-01-07 09:22:32 est EAGLE 31.3.0
0019.0098 imt bus a imt inhibited

rlghncxa21w 04-01-07 09:22:32 est EAGLE 31.3.0
* 0020.0107 * imt bus a minor imt failure detected

rlghncxa21w 04-01-07 09:22:32 EST EAGLE 31.3.0
** 0021.0108 ** IMT BUS A major imt failure detected

rlghncxa21w 04-01-07 09:22:33 EST EAGLE 31.3.0
0022.0026 CARD 1205 SS7ANSI clocks a and b for card normal
;

```

rmv-trm**Remove Terminal**

Use this command to set the primary state of a serial port to OOS-MT-DSBLD, and to set the secondary state to MANUAL. The serial port is not available to perform service functions. There is no outgoing traffic from the serial port; all incoming traffic is ignored.

Keyword: **rmv-trm**

Related Commands: **act-echo, alw-trm, canc-echo, chg-trm, dact-echo, inh-trm, rept-stat-trm, rst-trm, rtrv-trm**

Command Class: System Maintenance

Parameters

:trm= (mandatory)

The ID of the serial port to be inhibited.

Range: 1-40

:force= (optional)

Force the removal of this terminal, even if it is the last in-service OAP terminal available.

Range: yes, no

Default: no

Example

```
rmv-trm:port=5
```

```
rmv-trm:trm=1:force=yes
```

Dependencies

No other action command can be in progress when this command is entered.

The IP User Interface feature must be enabled before terminal ports 17 through 40 can be specified in the **trm** parameter.

The terminal specified by the **trm** parameter must be equipped.

To inhibit the last in-service OAP terminal, the **force=yes** parameter must be specified.

You cannot inhibit the terminal from which this command was entered.

Notes

When removing a terminal that has already been removed, a warning message is echoed to the scroll area but no action is taken.

Output**rmv-trm**

```
rlghncxa03w 04-01-07 11:11:28 EST EAGLE 31.3.0  
Inhibit message sent to terminal
```

```
;
```

rst-card**Reset Card**

Use this command to change the card from OOS-MT-DSBLD (out of service maintenance disabled) to IS-NR (in service normal) if the loading is successful. If the loading fails, the card status is OOS-MT (out of service maintenance).

Keyword: `rst-card`

Related Commands: `dlt-card`, `ent-card`, `init-card`, `rept-stat-card`, `rmv-card`, `rtrv-card`

Command Class: System Maintenance

Parameters

:loc= (mandatory)

The card location as stenciled on the shelf of the system.

Range: 1101-1108, 1111-1112, 1201-1208, 1211-1218, 1301-1308, 1311-1318, 2101-2108, 2111-2118, 2201-2208, 2211-2218, 2301-2308, 2311-2318, 3101-3108, 3111-3118, 3201-3208, 3211-3218, 3301-3308, 3311-3318, 4101-4108, 4111-4118, 4201-4208, 4211-4218, 4301-4308, 4311-4318, 5101-5108, 5111-5118, 5201-5208, 5211-5218, 5301-5308, 5311-5318, 6101-6108, 6111-6118

:code= (optional)

The GPL type to be loaded.

Range: `appr`, `trial`, or `utility`.

appr—Approved GPL

trial—Trial GPL

utility—Utility GPL, used primarily by the factory for loading special GPLs for testing purposes

Default: No GPL type is given.

:data= (optional)

High memory refresh. This parameter causes data to be reloaded to the specified card. This parameter is used to reload LNP data if the LNP feature is on. This parameter is applicable only to network cards containing the LNP database (SCCP, EBDABLM).

Range: `refresh`, `persist`

refresh—Causes data to be reloaded to the specified card.

persist—Indicates that the LNP database is not to be reloaded to the card. Used to request that the EAGLE 5 SAS perform a warm restart of the requested cards. The EAGLE 5 SAS performs various checks to ensure that all conditions necessary to initiate the warm restart are in place (for example, that the TSM/BLM card is present and ready and that the downloaded LNP database is coherent. The LNP database audit cannot be performed prior to the card reset). During the card initialization and loading sequence, a warm restart is performed if the card meets the warm restart conditions.

NOTE: Various conditions in the system may prevent the persistence of the LNP data on the SCCP/EBDABLM cards.

Default: `refresh`

Example

```
rst-card:loc=2301:code=trial
```

```
rst-card:loc=1101:data=persist
```

Dependencies

The following card locations are not valid for this command: 1113, 1114, 1115, 1116, 1117, 1118, and all xy09 and xy10 locations (where x is the frame and y is the shelf).

The shelf and card must be equipped.

If the card is a LIM, it must have a signaling link assigned to it before it can be allowed.

No other action command can be in progress when this command is entered.

The LNP feature must be turned on (see the **enable-ctrl-feat** command) before the **data** parameter can be specified.

The **data** parameter is valid ONLY for SCCP and EBDABLM card locations or GPLs.

Notes

The function of this command is the same as the **alw-card** command.

The *Installation Manual - EAGLE 5 SAS* provides an illustration of card locations.

The system previously supported the **data** parameter for reloading GTT data. The system does not support persistent GTT data loading, and the **data** parameter is now used in support of the warm restart feature.

When the OA&M IP Security feature is turned on, and an IPSM card is inserted and initialized for the first time or is removed, inserted, and initialized again, the "SSH Host Keys Regenerated" UIM is displayed. The UIM shows the generated SSH Host Key fingerprint that must be provided at the secure client in order for secure information transfer to occur. The SSH Host Key fingerprint is changed whenever power is lost and restored to an IPSM card.

```
rlghncxa03 03-07-11 07:05:00 EST EAGLE 30.2.0
0021.1493 CARD 1111 INFO SSH Host Keys Regenerated
DSA Server Host Key FTRA-formatted Fingerprint=
84 7c 92 8b c 7c ds 19 1c 6 4b de 5c 8f c5 4d
Report Date:03-07-11 Time:22:27:36
```

When the OA&M IP Security feature is turned on, and an IPSM card is restarted with this command, the "SSH Host Keys Loaded" UIM is displayed. The UIM shows the current SSH Host Key fingerprint. The SSH Host Key fingerprint is not changed if the IPSM card does not lose power.

```
rlghncxa03 03-07-11 07:05:00 EST EAGLE 30.2.0
0021.1493 CARD 1111 INFO SSH Host Keys Loaded
DSA Server Host Key FTRA-formatted Fingerprint=
84 7c 92 8b c 7c ds 19 1c 6 4b de 5c 8f c5 4d
Report Date:03-07-11 Time:22:27:36
```

Output

```
rst-card:loc=2301:code=trial
```

```
rlghncxa03w 04-01-07 11:11:28 EST EAGLE 31.3.0
Card has been allowed.
```

```
;
```

rst-dstn**Reset Destination Circular Routing Status**

Use this command to request that the circular routing status for the specified destination be reset (turned OFF). The destination that is specified can be a full point code (FPC), a cluster point code (for example, ni-nc-*), or an x-list point code. The system clears the circular routing status for the specified destination and then clears any outstanding circular routing alarm for the destination.

NOTE: This command does not support 24-bit ITU national point codes.

Keyword: rst-dstn

Related Commands: chg-stpopts, rept-stat-cluster, rept-stat-dstn, rtrv-stpopts

Command Class: System Maintenance

Parameters

NOTE: See “Point Code Formats and Conversion” in Appendix A for a detailed description of point code formats, rules for specification, and examples.

:dpc= or dpca= (mandatory)

ANSI destination point code with subfields *network indicator-network cluster-network cluster member (ni-nc-ncm)*. The *prefix* subfield indicates a private point code (*prefix-ni-nc-ncm*).

Range: p-, 000-255, *

Specify a valid value for each subfield of the point code, and separate the subfields with a dash (-).

prefix—p-

The asterisk (*) value is not valid for the *ni* subfield.

When **chg-sid:pctype=ansi** is specified, *ni* = 000 is not valid.

When **chg-sid:pctype=ansi** is specified, *nc* = 000 is not valid if *ni* = 001-005.

When **chg-sid:pctype=ansi** is specified, *nc* = 000 is valid if *ni* = 006-255.

When **chg-sid:pctype=ansi** is specified, *ni*-*-* is valid if *ni* = 006-255.

The point code 000-000-000 is not a valid point code.

Example

```
rst-dstn:dpc=1-2-*
```

```
rst-dstn:dpc=20-2-5
```

```
rst-dstn:dpc=p-20-2-5
```

Dependencies

The specified DPC must be either provisioned or an x-list entry.

The destination address must be a full point code or a cluster point code specified as *ni-nc*-.*. A DPC as *ni-nc*-.** or *ni-nc*-.*** cannot be specified for the **rst-dstn** command.

Notes

None

In this command, the point codes support only the private (internal) point code subtype prefix (p-).

Output**rst-dstn:dpc=1-2-***

```
rlghncxa03w 04-01-05 06:52:20 EST EAGLE 31.3.0
Destination reset command sent to SNM (scroll area)
```

```
rlghncxa03w 04-01-05 06:52:20 EST EAGLE 31.3.0
Command Completed.
```

```
;
```

rst-dstn:dpc=20-2-5

```
rlghncxa03w 04-02-29 16:40:40 EST EAGLE 31.3.0
Destination reset command sent to SNM (scroll area)
```

```
rlghncxa03w 04-01-05 16:40:40 EST EAGLE 31.3.0
Command Completed.
```

```
;
```

rst-imt**Reset IMT**

The interprocessor message transport bus (IMT bus) is the main communications artery between all subsystems in the system. Use this command to change the state of the specified IMT bus from OOS-MT-DSBLD (out of service maintenance disabled) to IS-NR (in service normal), if the command is successful. If the command fails, the status is IS-ANR (in service abnormal).

Keyword: rst-imt

Related Commands: clr-imt-stats, conn-imt, disc-imt, rept-imt-lvl1, rept-imt-lvl2, rept-stat-imt, rmv-imt

Command Class: System Maintenance

Parameters

:bus= (mandatory)

The IMT bus to be returned to service.

Range: a, b

Example

```
rst-imt:bus=a
```

Dependencies

None

Notes

The function of this command is the same as the **alw-imt** command.

This command returns an inhibited IMT bus to service.

Output

rst-imt:bus=a

```
rlghncxa03w 04-01-07 11:02:30 EST EAGLE 31.3.0
Allow IMT Bus A command issued.
```

```
rlghncxa03w 04-01-07 11:02:30 EST EAGLE 31.3.0
0100.0097 IMT BUS A IMT allowed
```

```
;
```

rst-trm

Reset Terminal

Use this command to return the specified serial port to the state IS-NR (in service normal) from the state OOS-MT-DSBLD (out of service maintenance disabled) if the command is successful. If the command is not successful, the terminal's state is OOS-MT (out of service maintenance).

Keyword: `rst-trm`

Related Commands: `act-echo`, `alw-trm`, `canc-echo`, `chg-trm`, `dact-echo`, `inh-trm`, `rept-stat-trm`, `rmv-trm`, `rtrv-trm`

Command Class: System Maintenance

Parameters

:trm= (mandatory)

ID of the serial port to be put into service.

Range: 1-40

Example

```
rst-trm:trm=5
```

```
rst-trm:trm=12
```

Dependencies

No other action command can be in progress when this command is entered.

The IP User Interface feature must be enabled before terminal ports 17 through 40 can be specified in the **trm** parameter.

The terminal specified by the **trm** parameter must be equipped.

Anyone logged in to the terminal specified by this command is logged off when this command is executed. For the user to continue working on the specified terminal, the user must log on to that terminal again.

Notes

The function of this command is the same as the **alw-trm** command.

When you attempt to return to service a terminal already in service, a warning message is echoed to the scroll area but no action is taken.

Output**rst-trm:trm=12**

```
rlghncxa03w 04-01-07 11:11:28 EST EAGLE 31.3.0
Allow message sent to terminal
```

```
rlghncxa03w 04-01-07 11:11:28 EST EAGLE 31.3.0
1062.0046     TERMINAL     12           Terminal Enabled
```

```
;
```

rtrv-acg-mic**Display ACG Manually Initiated Control**

Use this command to display the values of ACG controls assigned to certain queries. The control can apply to all queries or to specific query services and called party digits. A set of controls is selected to be displayed by specifying the type of controls (**type** parameter), the service (**serv** parameter), and the digits (**dgts** parameter).

Keyword: rtrv-acg-mic

Related Commands: chg-acg-mic, ent-acg-mic, dlt-acg-mic, rept-stat-lnp

Command Class: LNP Basic Administration

Parameters

:dgts= (optional)

Digits

Range: 000-999, 000000-999999999

:serv= (optional)

Query service

Range: ain, in

:type= (optional)

Type of control

Range: all, sd

Example

Display all MICs:

```
rtrv-acg-mic
```

Display the MIC(s) that apply to particular services and digits:

```
rtrv-acg-mic:type=sd
```

Display the MIC(s) that apply to AIN queries:

```
rtrv-acg-mic:serv=ain
```

Display the MIC(s) that apply to IN queries for 919-460-xxxx:

```
rtrv-acg-mic:serv=in:dgts=919460
```

Dependencies

If the **type=all** parameter is specified, optional parameters **serv** and **dgts** cannot be specified.

The **dgts** parameter value must be specified as 3 digits or 6-10 digits.

The LNP feature must be turned on (see the **enable-ctrl-feat** command) before the **rtrv-acg-mic** command can be entered.

Notes

None

Output

rtrv-acg-mic:type=sd

The following example shows how the memory space accounting command completion response is used for **type=sd**:

```
rlghncxa03w 04-01-28 08:50:12 EST EAGLE 31.3.0
TYPE=ALLND INTVL AINTVL DRTN
6 4 7 8
TYPE=SD
DGTS SERV INTVL AINTVL DRTN
704461 AIN - 8 7
919460 IN 6 - 7
9194602132 AIN - 7 8
9194602132 IN 4 - 8
919461 IN 6 - 7

ACG MIC table is (11 of 256) 4% full of type SD
RTRV-ACG-MIC: MASP A - COMPLTD
;
```

The following example shows how the memory space accounting command completion response is used for **type=all**:

rtrv-acg-mic:type=all

```
rlghncxa03w 04-01-28 08:50:12 EST EAGLE 31.3.0
TYPE=ALL
ND INTVL AINTVL DRTN
6 4 7 8
TYPE=SD
DGTS SERV INTVL AINTVL DRTN
919460 IN 6 - 7
9194602132 IN 4 - 8

ACG MIC table is (5 of 256) 2% full of type SD
RTRV-ACG-MIC: MASP A - COMPLTD
;
```

Legend

AINTVL—New AIN interval index

DGTS—Digits

DRTN—New duration index

INTVL—New IN interval index

ND—New number of digits

SERV—Query service

rtrv-acg-noc

Display ACG Node Overload Control

Use this command to display the definitions of node overload levels. The definition is comprised of the threshold LNP query rates for node overload levels and the values for the Automatic Call Gappings (ACG) to be sent when at the overload level.

Keyword: rtrv-acg-noc

Related Commands: chg-acg-noc, dlt-acg-noc, ent-acg-noc, rept-stat-lnp

Command Class: LNP Basic Administration

Parameters

:lvl= (optional)

Overload level

Range: 1-10

Example

```
rtrv-acg-noc
```

```
rtrv-acg-noc:lvl=3
```

Dependencies

The LNP feature must be turned on (see the enable-ctrl-feat command) before this command can be entered.

Notes

None

Output

The following example displays all defined overload levels:

```
rtrv-acg-noc
```

```
rlghncxa03w 04-01-28 08:50:12 EST EAGLE 31.3.0
LVL QR          AND  IND  INTVL DRTN
3   600000      10   6   3     6
4   750000      6    6   5     7
10  2147483647  10   10  15    13
RTRV-ACG-NOC: MASP A - COMPLTD
```

```
;
```

The following example displays overload level 3:

```
rtrv-acg-noc:lvl=3
```

```
rlghncxa03w 04-01-28 08:50:12 EST EAGLE 31.3.0
LVL QR          AND  IND  INTVL DRTN
3   600000      10   10  3     6
RTRV-ACG-NOC: MASP A - COMPLTD
```

```
;
```

Legend

LVL—Overload level

QR—Query rate

AND—AIN number of digits

IND—IN number of digits

INTVL—Interval index

DRTN—Duration index

rtrv-appl-rtkey**Retrieve Application Route Key Table**

Use this command to retrieve information from the Routing Key table. A routing key entry associates a routing key with up to 16 socket names with a limit of 1000 routing keys per system (if there are any dual-slot DCMs) or 2500 routing keys per system (if there are SSED CMs).

There are three types of routing keys, as follows:

- DPC, SI, SSN routing keys, which are used to route SCCP messages
- DPC, SI routing keys, which are used to route non-SCCP and non-ISUP messages
- DPC, SI, CIC routing keys, which are used to route ISUP messages

Keyword: rtrv-appl-rtkey

Related Commands: chg-appl-rtkey, dlt-appl-rtkey, ent-appl-rtkey

Command Class: Database Administration

Parameters

NOTE: See “Point Code Formats and Conversion” in Appendix A for a detailed description of point code formats, rules for specification, and examples.

:asname= (mandatory)

Application Server (AS) name assigned to this routing key.

Range: Up to 15 alphanumeric characters; the first character must be a letter

:cice= (optional)

The end range of circuit identification codes assigned to the routing key.

Range: See Table A-4 in Appendix A for valid CIC values for specified SI and MSU types.

:cics= (optional)

The start range of circuit identification codes assigned to the routing key.

Range: See Table A-4 in Appendix A for valid CIC values for specified SI and MSU types.

:display= (optional)

Indicates the scope of the display, whether it is a brief display or full display. The output includes the type and location of the card, the data collection being audited, and a message indicating the overall status. This parameter applies only to STP databases.

Range: **all, brief**

all—The KEY and the ATTRIBUTE sections of the routing key are displayed

brief—Only the KEY section of the routing key is displayed

Default: **brief**

:dpc/dpca/dpci/dpcn/dpcn24= (optional)

Destination point code.

:dpc or **:dpca=** (optional)

ANSI destination point code with subfields *network indicator-network cluster-network cluster member* (*ni-nc-ncm*).

Range: **000-255**

Specify a valid value for each subfield of the point code, and separate the subfields with a dash (-).

When **chg-sid:pctype=ansi** is specified, *ni* = **000** is not valid.

When **chg-sid:pctype=ansi** is specified, *nc* = **000** is not valid if *ni* = **001-005**.

When **chg-sid:pctype=ansi** is specified, *nc* = **000** is valid if *ni* = **006-255**.

The point code **000-000-000** is not a valid point code.

:dpci= (optional)

ITU international destination point code with subfields *zone-area-id*. The *prefix* subfield indicates a spare point code (*prefix-zone-area-id*)

Range: **s-, 0-255**

Specify a valid value for each subfield of the point code, and separate the subfields with a dash (-).

prefix—**s-**

zone—**0-7**

area—**000-255**

id—**0-7**

The point code **0-000-0** is not a valid point code.

:dpcn= (optional)

ITU national destination point code in the format of a 5-digit number (*nnnnn*); or 2, 3, or 4 numbers (members) separated by dashes (*m1-m2-m3-m4*) as defined by the

chg-stpopts:npcfnti flexible point code option. A group code must be specified when the ITUDUPPC feature is turned on (*nnnnn-gc*, *m1-m2-m3-m4-gc*). The *prefix* subfield indicates a spare point code (*prefix-nnnnn*, *prefix-nnnnn-gc*, *prefix-m1-m2-m3-m4*, *prefix-m1-m2-m3-m4-gc*).

Range: **s-, 0-16383, aa-zz**

Specify a valid value for each subfield of the point code, and separate the subfields with a dash (-).

prefix—**s-**

nnnnn—**0-16383**

gc—**aa - zz**

m1-m2-m3-m4—**0-14** for each member; values must sum to 14

:dpcn24= (optional)

24-bit ITU national destination point code with subfields *main signaling area-sub signaling area-signaling point* (*msa-ssa-sp*).

Range: 000-255

Specify a valid value for each subfield of the point code, and separate the subfields with a dash (-).

msa—000-255

ssa—000-255

sp—000-255

:loc= (optional)

Card location for retrieval of dynamic routing key entries.

Range: 1101-1108, 1111-1112, 1201-1208, 1211-1218, 1301-1308, 1311-1318, 2101-2108, 2111-2118, 2201-2208, 2211-2218, 2301-2308, 2311-2318, 3101-3108, 3111-3118, 3201-3208, 3211-3218, 3301-3308, 3311-3318, 4101-4108, 4111-4118, 4201-4208, 4211-4218, 4301-4308, 4311-4318, 5101-5108, 5111-5118, 5201-5208, 5211-5218, 5301-5308, 5311-5318, 6101-6108, 6111-6118

:mode= (optional)

Specifies whether to retrieve static keys only, dynamic keys only, or both static and dynamic keys.

Range: static, dynamic, both

Default: both

:norm= (optional)

Normalization process enabled/disabled indicator for MSUs using the routing key

Range: yes, no

:num= (optional)

The number of entries to display.

Range: 1-10000

Default: 50

:opc/opca/opci/opcn/opcn24= (optional)

Originating point code.

:opc or **:opca=** (optional)

ANSI originating point code with subfields *network indicator-network cluster-network cluster member* (*ni-nc-ncm*).

Range: 000-255

Specify a valid value for each subfield of the point code, and separate the subfields with a dash (-).

When **chg-sid:pctype=ansi** is specified, *ni* = 000 is not valid.

When **chg-sid:pctype=ansi** is specified, *nc* = 000 is not valid if *ni* = 001-005.

When **chg-sid:pctype=ansi** is specified, *nc* = 000 is valid if *ni* = 006-255.

The point code 000-000-000 is not a valid point code.

:opci= (optional)

ITU international originating point code with subfields *zone-area-id*. The *prefix* subfield indicates a spare point code (*prefix-zone-area-id*)

Range: **s-**, **0-255**
Specify a valid value for each subfield of the point code, and separate the subfields with a dash (-).

prefix—**s-**

zone—**0-7**

area—**000-255**

id—**0-7**

The point code **0-000-0** is not a valid point code.

:opcn= (optional)

ITU national originating point code in the format of a 5-digit number (*nnnnn*); or 2, 3, or 4 numbers (members) separated by dashes (*m1-m2-m3-m4*) as defined by the **chg-stpopts:npcfnti** flexible point code option. A group code must be specified when the ITUDUPPC feature is turned on (*nnnnn-gc*, *m1-m2-m3-m4-gc*). The *prefix* subfield indicates a spare point code (*prefix-nnnnn*, *prefix-nnnnn-gc*, *prefix-m1-m2-m3-m4*, *prefix-m1-m2-m3-m4-gc*).

Range: **s-**, **0-16383**, **aa-zz**

Specify a valid value for each subfield of the point code, and separate the subfields with a dash (-).

prefix—**s-**

nnnnn—**0-16383**

gc—**aa - zz**

m1-m2-m3-m4—**0-14** for each member; values must sum to 14

:opcn24= (optional)

24-bit ITU national originating point code with subfields *main signaling area-sub signaling area-signaling point* (*msa-ssa-sp*).

Range: **000-255**

Specify a valid value for each subfield of the point code, and separate the subfields with a dash (-).

msa—**000-255**

ssa—**000-255**

sp—**000-255**

:pstncat= (optional)

PSTN Category assigned to the routing key

Range: **065535**

:pstnid= (optional)

PSTN ID assigned to the routing key

Range: **065535**

:rcontext= (optional)

Routing Context. The **rcontext** parameter is used to display the routing key with the specified routing context.

Range: **0-4294967295**

:si= (optional)

Service indicator.

Range: 0-15 or equivalent text values:

Number = Text—Description

0 = snm—Signaling network management messages

1 = regtest—Signaling network testing and maintenance regular

2 = spltest—Signaling network testing and maintenance special

3 = sccp—SCCP

4 = tup—Telephone user part

5 = isup—ISDN user part

13 = qbicc

:sname= (optional)

Socket name as provisioned in the Socket table and associated with this routing key.

Range: Up to 15 alphanumeric characters; the first character must be a letter

:ssn= (optional)

Subsystem number.

Range: 0-255

:type= (optional)

The type of routing key.

Range: all, full, partial, default

Default: all

Example

```
rtrv-appl-rtkey
```

```
rtrv-appl-rtkey:dpc=123-234-255:si=3:ssn=123:sname=socket1
```

```
rtrv-appl-rtkey:sname=socket2
```

```
rtrv-appl-rtkey:dpc=123-234-255:si=3:mode=static
```

```
rtrv-appl-rtkey:dpc=123-234-255
```

```
rtrv-appl-rtkey:cics=1:cice=1000:num=3
```

```
rtrv-appl-rtkey:cice=19:mode=dynamic:loc=1107
```

```
rtrv-appl-rtkey:opc=122-124-125:mode=static
```

```
rtrv-appl-rtkey:type=partial:mode=both:loc=1107
```

```
rtrv-appl-rtkey:display=all
```

Dependencies

The subsystem number (**ssn**) is valid only when **si** is equal to **3** (or **sccp**); when **si** does not equal **3** (or **sccp**), **ssn** must not be specified.

The value specified for the starting circuit identification code (**cics**) must be less than or equal to the value entered for the ending circuit identification code (**cice**).

A circuit identification code range (**cics** to **cice**) that overlaps an existing routing key cannot be specified.

The **ssn** parameter cannot be specified when **opc**, **cics**, and **cice** are specified. See Table 5-8 on page 5-68 for valid parameter combinations.

When the DPC is ANSI and **si=4**, a DPC/SI routing key must be specified (TUP is used only in an ITU network).

The **opc**, **cics**, and **cice** parameters are allowed with the **si** parameter only when **si** equals **4**, **5**, or **13** (or **tup**, **isup**, or **qbicc**). Table A-4 in Appendix A shows valid CIC values for SI types 4, 5, and 13.

The following card locations (**loc** parameter) are not valid for this command: 1113, 1114, 1115, 1116, 1117, 1118, and all xy09 and xy10 locations (where x is the frame and y is the shelf). The card must be equipped and in service.

When **mode=static** is specified, the **loc** parameter cannot be specified.

Table A-4 in Appendix A shows valid CIC values for SI types 4, 5, and 13.

When a default routing key is specified, only the **sname** parameter is allowed.

The following types of partial routing keys are supported:

- The following types of partial routing keys are supported:
- DPC-SI-OPC (ignore CIC) can be used as a partial match key for CIC-based traffic.
- DPC-SI (ignore all other fields) can be used as a partial match key for CIC-based traffic or SCCP traffic.
- DPC only (ignore all other fields) can be used as a partial match for any type of traffic.
- SI only (ignore all other fields) can be used as a partial match for any type of traffic.

Notes

This command can be canceled using the **F9** function key or the **canc-cmd** command. See **canc-cmd** for more information.

Static routing keys are stored on disk and a copy of the table is loaded to each SS7IPGW card. Dynamic routing key entries are provisioned through IP requests and are unique to each SS7IPGW card. The type of routing key entries to be retrieved (static or dynamic) is controlled by the **loc** and **mode** parameters. Specifying a card location (**loc**) causes dynamic routing key entries to be retrieved from that location only. If **mode=both** is specified, specifying **loc** has no effect on the retrieval of static routing key entries.

Group codes are required for ITU-N point codes (DPCN/OPCN) when the Duplicate Point Code feature is turned on.

The **display=all** parameter must be specified to display the assigned routing context value for the routing key.

In this command, the point codes support only the spare point code subtype prefix (s-).

Output

NOTE: In the examples that follow the **DUP** column is meaningful only for dynamic routing keys and indicates whether or not a static routing key duplicate of the dynamic routing key exists (**DUP** column = Y) or does not exist (**DUP** column = N).

A duplicate routing key is defined as follows (note that socket associations are not considered when determining duplicate status):

- For SI=3, a static routing key exists with the same SI, DPC, and SSN values as the dynamic routing key.
- For SI=5, a static routing key exists with the same SI, DPC, and OPC values as the dynamic routing key and the static key's CIC range overlaps the dynamic key's CIC range (CIC ranges are not necessarily exact matches).
- For SI other than 3 or 5, a static routing key exists with the same SI and DPC values as the dynamic routing key.

rtrv-appl-rtkey: dpcn=2000-aa

```
rlghncxa03w 04-01-28 08:50:12 EST EAGLE 31.3.0
KEY:LOC      DPCN      SI SSN OPCN      CICS      CICE
      STATIC 02000-aa    5 --- 02001-aa    1         1000
      STATIC 02000-aa    5 --- 02003-aa    0         100
```

```
Static Route Key table is (50 of 250) 20% full
1107  Route Key table is (26 of 250) 10% full
```

```
Static Route Key Socket Association table is (80 of 4000) 2% full
1107  Route Key Socket Association table is (41 of 4000) 1% full
```

;

rtrv-appl-rtkey

```
rlghncxa03w 04-01-17 15:35:05 EST EAGLE 31.3.0
KEY:LOC      DPC      SI SSN OPC      CICS      CICE
      STATIC 001-006-003 ** *** ***** ***** *****
```

```
STATIC Route Key table is (1 of 500) 1% full
1305  Route Key table is (0 of 500) 0% full
```

```
STATIC Route Key Socket Association table is (3 of 8000) 1% full
1305  Route Key Socket Association table is (0 of 8000) 0% full
```

;

The following example shows output when the 2500 Routing Keys feature is enabled. The maximum number of routing keys allowed in the system is 2500. The maximum number of entries in the Static Route Key Socket Association table is 40,000.

rtrv-appl-rtkey

```
rlghncxa03w 04-01-17 15:35:05 EST EAGLE 31.3.0
KEY:LOC      DPC      SI SSN OPC      CICS      CICE
      STATIC 011-100-011 2 --- -----
      STATIC 011-100-011 5 --- 010-010-011 1         100
```

```
STATIC Route Key table is (2 of 2500) 1% full
```

```
STATIC Route Key Socket Association table is (2 of 40000) 1% full
```

;

The following example shows output for 24-bit ITU-N point codes:

rtrv-appl-rtkey

```
tekelecstp 02-03-21 16:20:07 EST EAGLE 31.0.0
KEY:LOC    DPCN24      SI SSN OPCN24      CICS      CICE
  STATIC 010-010-010  2 --- -----
  STATIC 010-010-010  5 --- 010-010-011 1          100

STATIC Route Key table is (2 of 1000) 1% full

STATIC Route Key Socket Association table is (2 of 16000) 1% full
```

;

The following example shows output for a routing key with routing context, assigned to a SUA Application Server.

rtrv-appl-rtkey:display=all:rcontext=7

```
tekelecstp 04-09-21 16:20:07 EST EAGLE 31.10.0
KEY:LOC    DPC      SI SSN OPC      CICS      CICE
  STATIC 001-006-003 ** *** *****
RCONTEXT:7
ASNAME:tsta1
ANAMES:tst1307a1      tst1307a2      tst1307a3

STATIC Route Key table is (1 of 500) 1% full
1305  Route Key table is (0 of 500) 0% full

STATIC Route Key Socket Association table is (3 of 8000) 1% full
1305  Route Key Socket Association table is (0 of 8000) 0% full
```

;

The following example shows output for a routing key without routing context, assigned to an M3UA Application Server:

rtrv-appl-rtkey:display=all

```
tekelecstp 04-09-21 16:20:07 EST EAGLE 31.10.0
KEY:LOC    DPC      SI SSN OPC      CICS      CICE
  STATIC 001-006-003 ** *** *****
RCONTEXT:-
ASNAME:tsta1
ANAMES:tst1307a1      tst1307a2      tst1307a3

STATIC Route Key table is (1 of 500) 1% full
1305  Route Key table is (0 of 500) 0% full

STATIC Route Key Socket Association table is (3 of 8000) 1% full
1305  Route Key Socket Association table is (0 of 8000) 0% full
```

;

The following example shows output for a routing key without routing context, assigned to a TALI connection. (Routing context is not valid for TALI connections).

rtrv-appl-rtkey:display=all

```
tekelecstp 04-09-21 16:20:07 EST EAGLE 31.10.0
KEY:LOC    DPC          SI SSN OPC          CICS          CICE
  STATIC 001-006-003 ** *** ***** ***** *****
  ATTR:PSTNCAT PSTNID NORM DUP
                0      0 N   -
  SNAMES:tst1307s1      tst1307s2      tst1307s3

STATIC Route Key table is (1 of 500) 1% full
1305  Route Key table is (0 of 500) 0% full

STATIC Route Key Socket Association table is (3 of 8000) 1% full
1305  Route Key Socket Association table is (0 of 8000) 0% full
;
```

The following examples show output with spare point codes:

rtrv-appl-rtkey

```
tekelecstp 05-01-07 16:20:07 EST EAGLE 31.12.0
KEY:LOC    DPCI          SI SSN   OPCI          CICS          CICE
  STATIC  s-1-015-1      3  5  -----
  STATIC  s-1-017-1      3 250 -----

STATIC Route Key table is (2 of 500) 1% full

STATIC Route Key Socket Association table is (2 of 8000) 1% full
;
```

rtrv-appl-rtkey:asname=ipg1315as1

```
tekelecstp 05-01-07 16:20:07 EST EAGLE 31.12.0
KEY:LOC    DPCI          SI SSN   OPCI          CICS          CICE
  STATIC  s-1-015-1      3  5  -----

STATIC Route Key table is (2 of 500) 1% full

STATIC Route Key Socket Association table is (2 of 8000) 1% full
;
```

The following example shows:

- A routing key without routing context that is assigned to an M3UA Application Server, with a spare point code
- A routing key with routing context that is assigned to an SUA Application Server, with a spare point code:

rtrv-appl-rtkey:display=all

```
tekelecstp 05-01-07 16:20:07 EST EAGLE 31.12.0
KEY:LOC      DPCI      SI SSN      OPCI      CICS      CICE
  STATIC  s-1-015-1      3  5  -----
  RCONTEXT:-
  ASNAME:ipg1315as1
  ANAMES:ipg1315a1      << spare pc M3ua example>>

KEY:LOC      DPCI      SI SSN      OPCI      CICS      CICE
  STATIC  s-1-017-1      3 250 -----
  RCONTEXT:17
  ASNAME:ipg1317as1
  ANAMES:ipg1317a1

STATIC Route Key table is (2 of 500) 1% full

STATIC Route Key Socket Association table is (2 of 8000) 1% full
;
```

The following example shows output for a routing key without routing context, assigned to an M3UA Application Server:

rtrv-appl-rtkey:display=all

```
tekelecstp 05-01-07 16:20:07 EST EAGLE 31.12.0
KEY:LOC      DPC      SI SSN OPC      CICS      CICE
  STATIC  001-006-003 ** ** ***** ***** *****
  RCONTEXT:-
  ASNAME:tsta1
  ANAMES:tst1307a1      tst1307a2      tst1307a3

STATIC Route Key table is (1 of 500) 1% full
1305  Route Key table is (0 of 500) 0% full

STATIC Route Key Socket Association table is (3 of 8000) 1% full
1305  Route Key Socket Association table is (0 of 8000) 0% full
;
```

The following example shows output for a routing key without routing context that is assigned to a TALI connection. (Routing context is not valid for TALI connections).

rtrv-appl-rtkey:display=all

```
tekelecstp 05-01-07 16:20:07 EST EAGLE 31.12.0
KEY:LOC      DPC      SI SSN OPC      CICS      CICE
  STATIC    001-006-003 ** *** ***** ***** *****
  ATTR:PSTNCAT PSTNID NORM DUP
                0      0 N      -
  SNAMES:tst1307s1      tst1307s2      tst1307s3

  STATIC Route Key table is (1 of 500) 1% full
  1305   Route Key table is (0 of 500) 0% full

  STATIC Route Key Socket Association table is (3 of 8000) 1% full
  1305   Route Key Socket Association table is (0 of 8000) 0% full
;
```

rtrv-appl-sock

Retrieve Application Socket

Use this command to retrieve the configuration data from the Socket table. The Socket table is used to associate the local host/local port to a remote host/remote port.

Keyword: rtrv-appl-sock

Related Commands: ent-appl-sock, dlt-appl-sock, chg-appl-sock

Command Class: Database Administration

Parameters

:lhost= (optional)

Local host name. The logical name assigned to the local host device.

Range: a-z, A-Z, 0-9, -, . (any string of characters beginning with a letter and comprising up to 60 characters in length)

Default: Retrieve all

:port= or :link= (optional)

The signaling link associated with this socket.

Range: a, b, a1, b1, a2, b2, a3, b3

Not all card types support all link parameter values.

See Table A-1 in Appendix A for valid link parameter range values for each type of card that can have signaling links.

Default: Retrieve all

:rhost= (optional)

Remote host name. The logical name assigned to the remote host device.

Range: a-z, A-Z, 0-9, -, .

Any string of characters beginning with a letter and comprising up to 60 characters in length.

Default: Retrieve all

:sname= (optional)

Name of socket. The routing key table and maintenance commands use these names to reference individual sockets.

Range: Up to 15 alphanumeric characters; the first character must be a letter.

Default: All information for all sockets is retrieved.

Example

rtrv-appl-sock:sname=swbel32

Dependencies

The **lhost**, **rhost**, and **sname** parameters must conform to the specified naming conventions.

Notes

This command can be canceled using the **F9** function key or the **canc-cmd** command. See **canc-cmd** for more information.

Output

rtrv-appl-sock:sname=swbel32

```
rlghncxa03w 05-05-17 15:35:05 EST EAGLE5 34.0.0
SNAME SWBEL32
LHOST GW105.NC.TEKELEC.COM
LPORT 1030
SERVER YES
RHOST GW100.NCD_ECONOMIC_DEVELOPMENT.SOUTHEASTERN_COORIDOR_ASH.GOV
RPORT 2345
OPEN YES
ALW YES
DCMPS 1
PORT A
REXMIT FIXED
RTT 60
IP Appl Sock table is (4 of 250) 1% full
;
```

rtrv-appl-sock:lhost=gw105.nc.tekelec.com

```
rlghncxa03w 05-05-17 15:35:05 EST EAGLE5 34.0.0
SNAME SOCKET2
LHOST GW105.NC.TEKELEC.COM
LPORT 1030
SERVER YES
RHOST GW100.NC.TEKELEC.COM
RPORT 2345
OPEN YES
ALW YES
DCMPS 1
PORT A
REXMIT MOD
RTT 250

SNAME SOCKET3
LHOST GW105.NC.TEKELEC.COM
LPORT 1030
SERVER YES
RHOST GW106.NC.TEKELEC.COM
RPORT 2346
OPEN YES
ALW YES
DCMPS 1
PORT A
```

```

REXMIT BSD
RTT     ----

```

IP Appl Sock table is (4 of 250) 1% full

;

rtrv-appl-sock

```

rlghncxa03w 05-05-17 15:35:05 EST  EAGLE5 34.0.0
SNAME SOCKET1
LHOST  GW105.NC.TEKELEC.COM
LPORT  1030
SERVER YES
RHOST  GW100.NC.TEKELEC.COM
RPORT  2345
OPEN   YES
ALW    YES
DCMPS  1
PORT   A
REXMIT FIXED
RTT    500

```

```

SNAME SOCKET2
LHOST  GW108.NC.TEKELEC.COM
LPORT  1035
SERVER YES
RHOST  GW102.NC.TEKELEC.COM
RPORT  2360
OPEN   YES
ALW    YES
DCMPS  1
PORT   B
REXMIT MOD
RTT    250

```

IP Appl Sock table is (4 of 250) 1% full;

rtrv-appl-sock

```

rlghncxa03w 04-07-17 15:35:05 EST  EAGLE 31.6.0
SNAME socket1
LINK    A
LHOST  GW105.NC.TEKELEC.COM
RHOST  GW100.NC.TEKELEC.COM
LPORT  1035          RPORT  2361
SERVER YES          DCMPS  1
REXMIT BSD          RTT    ----
OPEN   YES          ALW    YES

```

```

SNAME socket2
LINK    B
LHOST  GW108.NC.TEKELEC.COM
RHOST  GW102.NC.TEKELEC.COM
LPORT  1035          RPORT  2360
SERVER YES          DCMPS  1
REXMIT BSD          RTT    ----
OPEN   YES          ALW    YES

```

IP Appl Sock/Assoc table is (4 of 4000) 1% full

;

rtrv-appl-sock:link=b1

```

rlghncxa03w 05-05-17 15:35:05 EST EAGLE5 34.0.0
SNAME SOCKET2
LHOST GW108.NC.TEKELEC.COM
LPORT 1035
SERVER YES
RHOST GW102.NC.TEKELEC.COM
RPORT 2360
OPEN YES
ALW YES
DCMPS 1
PORT B
REXMIT MOD
RTT 250

```

IP Appl Sock table is (4 of 250) 1% full

;

Legend

ALW—Whether or not to the socket is allowed to carry SS7 traffic, **YES** or **NO**.

DCMPS—The parameter set used by this socket, **1** to **10**.

LHOST—The local host name.

LINK—The signaling link associated with this socket.

LPORT—The local port name.

OPEN—Whether or not the connection manager is to open this socket if the socket is operational, **YES** or **NO**.

REXMIT—Retransmission mode to use on socket when packet loss is detected; **BSD**, **FIXED** or **MOD**.

RHOST—The remote host name.

RPORT—The remote port name.

RTT—Expected Round Trip Time for socket when **REXMIT** is **FIXED** or **MOD**.

SERVER—The role of the local socket in the client/server relationship. If **YES**, the server is the local side. If **NO**, the client is the local side.

SNAME—The socket name.

rtrv-as**Retrieve Application Server**

Use this command to retrieve the characteristics of one or all Application Servers from the AS table.

Keyword: **rtrv-as**

Related Commands: **chg-as**, **dlt-as**, **ent-as**, **rept-stat-as**

Command Class: Database Administration

Parameters**:aname=** (optional)

Name of the Association.

Range: Up to 15 alphanumeric characters; the first character must be a letter.**Default:** Retrieve all**:asname=** (optional)

Name of the Application Server.

Range: Up to 15 alphanumeric characters; the first character must be a letter.**Default:** Retrieve all**Example****rtrv-as****rtrv-as:aname=as1****rtrv-as:asname=as1****Dependencies**

None

Notes

This command can be canceled using the **F9** function key or the **canc-cmd** command. See **canc-cmd** for more information.

Output**rtrv-as**

```

rlghncxa03w 05-06-05 08:40:18 EST EAGLE5 34.0.0
AS Name           Mode           Tr ms  Association Names
m3ua_as1          LOADSHARE     2000   m3ua_assoc1
                 m3ua_assoc1
sua_as1           OVERRIDE      200    sua_assoc1
                 sua_assoc2
AS Table is (2 of 250) 1% full
;

```

rtrv-asp**Retrieve Application Server Process****NOTE:** This command is obsolete.

Use this command to retrieve the characteristics of one or all Application Server Processes from the ASP table.

Keyword: rtrv-asp**Related Commands:** chg-asp, dlt-asp, ent-asp, rept-stat-aps**Command Class:** Database Administration**Parameters****:aspname=** (mandatory)

Name of the Application Server Process (ASP).

Range: Up to 15 alphanumeric characters; the first character must be a letter.

Example

rtrv-asp

Dependencies

None

Notes

This command can be canceled using the **F9** function key or the **canc-cmd** command. See **canc-cmd** for more information.

Output

rtrv-asp

```
rlghncxa03w 03-07-04 08:40:18 EST EAGLE 31.6.0
ASP          Association          UAPS
ASP1         sock1              1
ASP2         sock2              1
ASP3         sock3              1
```

ASP Table is (3 of 4000) 1% full

;

rtrv-asp

```
rlghncxa03w 03-07-04 08:40:18 EST EAGLE 31.6.0

ASP          Association          UAPS
asp01        asoc01              10
asp02        asoc02              10
```

ASP Table is (2 of 4000) 1% full

;

rtrv-assoc

Retrieve Association

Use this command to retrieve the configuration data from the IP Socket/Association (IPAPSOCK) table.

Keyword: **rtrv-assoc**

Related Commands: **chg-assoc, dlt-assoc, ent-assoc, rept-stat-assoc**

Command Class: Database Administration

Parameters

:adapter= (optional)

The adapter layer for this association.

Range: **m3ua, sua, m2pa**

Default: Retrieve all

:alhost= (optional)

Alternate local host name as defined in the IP Host table.

Range: a-z, A-Z, 0-9, -, . —any string of characters beginning with a letter and comprising up to 60 characters in length.

Default: Retrieve all

:aname= (optional)

Name assigned to this association (in IPAPSOCK table).

Range: Up to 15 alphanumeric characters; the first character must be a letter.

Default: Retrieve all

:lhost= (optional)

The local host name as defined in the IP Host table.

Range: a-z, A-Z, 0-9, -, . —any string of characters beginning with a letter and comprising up to 60 characters in length

Default: Retrieve all

:port= or link= (optional)

The signaling **link** for this association.

Range: a, b, a1, b1, a2, b2, a3, b3

Not all card types support all **link** parameter values.

See Table A-1 in Appendix A for valid **link** parameter range values for each type of card that can have assigned signaling links.

Default: Retrieve all

:rhost= (optional)

Name of Remote Host as defined in the IP Host table.

Range: a-z, A-Z, 0-9, -, . (any string of characters beginning with a letter and comprising up to 60 characters in length)

Default: Retrieve all

Example

```
rtrv-assoc
```

```
rtrv-assoc:aname=swbel32
```

```
rtrv-assoc:lhost=gw105.nc.tekelec.com:adapter=sua
```

Dependencies

None

Notes

This command can be canceled using the **F9** function key or the **canc-cmd** command. See **canc-cmd** for more information.

The IPAPSOCK table is used to associate the Local Host/Local Port to a Remote Host/Remote Port.

Output

rtrv-assoc:aname=swbel32

```

rlghncxa03w 04-07-04 08:40:18 EST EAGLE 34.0.0
  ANAME SWBEL32
    LINK      A
    ADAPTER   M3UA
    LHOST     GW105.NC.TEKELEC.COM
    ALHOST    ---
    RHOST     GW100.NCD_ECONOMIC_DEVELOPMENT.SOUTHEASTERN_COORIDOR_ASH.GOV
    LPORT     1030          RPORT     2345
    ISTRMS    2            OSTRMS    2
    RMODE     LIN          RMIN      120          RMAX      800
    RTIMES    10          CWMIN     3000
    OPEN      YES         ALW       YES
IP Appl Sock table is (4 of 4000) 1% full
;

```

rtrv-assoc:lhost=gw105.nc.tekelec.com:adapter=m3ua

```

rlghncxa03w 03-03-04 08:40:18 EST EAGLE 34.0.0
  ANAME A2
    LINK      A
    ADAPTER   M3UA
    LHOST     GW105.NC.TEKELEC.COM
    ALHOST    GW105B.NC.TEKELEC.COM
    RHOST     GW100.NC.TEKELEC.COM
    LPORT     1030          RPORT     2345
    ISTRMS    1            OSTRMS    1
    VER       M3UA DRAFT 8
    RMODE     RFC          RMIN      500          RMAX      1000
    RTIMES    12          CWMIN     1500
    OPEN      YES         ALW       YES

```

```

  ANAME A3
    LINK      A
    ADAPTER   M3UA
    LHOST     GW105.NC.TEKELEC.COM
    ALHOST    ---
    RHOST     GW106.NC.TEKELEC.COM
    LPORT     1030          RPORT     2346
    ISTRMS    2            OSTRMS    2
    VER       M3UA DRAFT 8
    RMODE     LIN          RMIN      10          RMAX      1000
    RTIMES    3            CWMIN     1500
    OPEN      YES         ALW       YES

```

IP Appl Sock table is (4 of 4000) 1% full

;

rtrv-assoc:alhost=gw105b.nc.tekelec.com

```

rlghncxa03w 04-01-04 08:40:18 EST EAGLE 34.0.0
  ANAME A2
    LINK      A
    ADAPTER   SUA
    LHOST     GW105.NC.TEKELEC.COM
    ALHOST    GW105B.NC.TEKELEC.COM
    RHOST     GW100.NC.TEKELEC.COM
    LPORT     1030          RPORT     2345
    ISTRMS    1            OSTRMS    1
    VER       SUA RFC
    RMODE     RFC          RMIN      500          RMAX      1000

```

```

RTIMES 6          CWMIN 1500
OPEN   YES        ALW   YES
IP Appl Sock table is (4 of 4000) 1% full

```

;

rtrv-assoc:link=a

```

rlghncxa03w 04-01-04 08:40:18 EST EAGLE 34.0.0
ANAME A1
LINK      A
ADAPTER  SUA
LHOST    GW105.NC.TEKELEC.COM
ALHOST   ---
RHOST    GW100.NC.TEKELEC.COM
LPORT    1030          RPORT  2345
ISTRMS   1            OSTRMS  1
VER      SUA RFC
RMODE    RFC          RMIN    70          RMAX    800
RTIMES   12          CWMIN    3000
OPEN     YES         ALW     YES

```

```

ANAME A2
LINK      A
ADAPTER  M2PA
LHOST    GW108.NC.TEKELEC.COM
ALHOST   ---
RHOST    GW102.NC.TEKELEC.COM
LPORT    1035          RPORT  2360
ISTRMS   1            OSTRMS  1
VER      SUA RFC
RMODE    LIN          RMIN    50          RMAX    1000
RTIMES   6            CWMIN    3000        M2PASET 1
OPEN     YES         ALW     YES

```

```

IP Appl Sock table is (4 of 4000) 1% full

```

;

rtrv-assoc

```

rlghncxa03w 04-07-04 08:40:18 EST EAGLE 34.0.0
ANAME a1
LINK      A
ADAPTER  M2PA
LHOST    e6p1301a
ALHOST   e6p1301b
RHOST    e5p1301a
LPORT    1301          RPORT  1301
ISTRMS   2            OSTRMS  2
RMODE    LIN          RMIN    120          RMAX    800
RTIMES   10          CWMIN    3000        M2PATSET 1
OPEN     YES         ALW     YES

```

```

ANAME a2
  LINK      B
  ADAPTER   M2PA
  LHOST     e6p1301a
  ALHOST    ---
  RHOST     ---
  LPORT     ---          RPORT     ---
  ISTRMS    2            OSTRMS    2
  RMODE     LIN          RMIN       120          RMAX       800
  RTIMES    10          CWMIN      3000         M2PATSET   1
  OPEN      NO          ALW        NO
    
```

IP Appl Sock/Assoc table is (3 of 4000) 1% full

;

rtrv-assoc

rlghncxa03w 05-07-04 08:40:18 EST EAGLE 34.3.0

rtrv-assoc

Command entered at terminal #4

```

ANAME ipl1301a
  LINK      A
  ADAPTER   M2PA          VER        M2PA DRAFT 6
  LHOST     e1021201.1301a
  ALHOST    ---
  RHOST     e1021301.1301a
  LPORT     1301          RPORT     1301
  ISTRMS    2            OSTRMS    2
  RMODE     LIN          RMIN       120          RMAX       800
  RTIMES    10          CWMIN      3000         M2PATSET   1
  OPEN      NO          ALW        NO
    
```

```

ANAME ipl1301b
  LINK      B
  ADAPTER   M2PA          VER        M2PA RFC
  LHOST     e1021201.1301a
  ALHOST    ---
  RHOST     e1021301.1301a
  LPORT     1302          RPORT     1302
  ISTRMS    2            OSTRMS    2
  RMODE     LIN          RMIN       120          RMAX       800
  RTIMES    10          CWMIN      3000         M2PATSET   1
  OPEN      YES         ALW        YES
    
```

```

ANAME ipgl305a1
  LINK      A
  ADAPTER   M3UA          VER        M3UA RFC
  LHOST     e1021201.1307a
  ALHOST    ---
  RHOST     e1021301.1305a
  LPORT     2050          RPORT     2050
  ISTRMS    2            OSTRMS    2
  RMODE     LIN          RMIN       120          RMAX       800
  RTIMES    10          CWMIN      3000         UAPS       10
  OPEN      NO          ALW        NO
    
```

```

ANAME ipgl307a1
LINK      A
ADAPTER  SUA          VER      SUA RFC
LHOST    e1021201.1307a
ALHOST   ---
RHOST    e1021301.1307a
LPORT    3050          RPORT    3050
ISTRMS   2            OSTRMS   2
RMODE    LIN          RMIN     120          RMAX     800
RTIMES   10          CWMIN    3000          UAPS     10
OPEN     NO           ALW      NO

```

IP Appl Sock/Assoc table is (4 of 4000) 1% full

;

rtrv-assoc:adapter=m2pa

rlghncxa03w 05-07-04 08:40:18 EST EAGLE 34.3.0

rtrv-assoc:adapter=m2pa

Command entered at terminal #4

```

ANAME ipl1301a
LINK      A
ADAPTER  M2PA          VER      M2PA DRAFT 6
LHOST    e1021201.1301a
ALHOST   ---
RHOST    e1021301.1301a
LPORT    1301          RPORT    1301
ISTRMS   2            OSTRMS   2
RMODE    LIN          RMIN     120          RMAX     800
RTIMES   10          CWMIN    3000          M2PATSET 1
OPEN     NO           ALW      NO

```

```

ANAME ipl1301b
LINK      B
ADAPTER  M2PA          VER      M2PA RFC
LHOST    e1021201.1301a
ALHOST   ---
RHOST    e1021301.1301a
LPORT    1302          RPORT    1302
ISTRMS   2            OSTRMS   2
RMODE    LIN          RMIN     120          RMAX     800
RTIMES   10          CWMIN    3000          M2PATSET 1
OPEN     YES          ALW      YES

```

IP Appl Sock/Assoc table is (4 of 4000) 1% full

;

rtrv-assoc:adapter=sua

```
rlghncxa03w 05-07-04 08:40:18 EST EAGLE 34.3.0>
rtrv-assoc:adapter=sua
Command entered at terminal #4
```

```
ANAME ipgl307a1
LINK A
ADAPTER SUA VER SUA RFC
LHOST e1021201.1307a
ALHOST ---
RHOST e1021301.1307a
LPORT 3050 RPORT 3050
ISTRMS 2 OSTRMS 2
RMODE LIN RMIN 120 RMAX 800
RTIMES 10 CWMIN 3000 UAPS 10
OPEN NO ALW NO
```

IP Appl Sock/Assoc table is (4 of 4000) 1% full

rtrv-atm-lps

Retrieve ATM Link Parameter Set

Use this command to display the parameter values for the ATM link parameter sets in the database configured with the **chg-atm-lps** command, along with the non-configurable ATM parameters.

Keyword: rtrv-atm-lps

Related Commands: chg-atm-lps

Command Class: Database Administration

Parameters

:lpset= (optional)

The ATM link parameter set to be displayed.

Range: 1-30

Default: All ATM link parameter sets are displayed

Example

```
rtrv-atm-lps:lpset=5
```

```
rtrv-atm-lps
```

Dependencies

None

Notes

None

Output

rtrv-atm-lps:lpset=5

rlghncxa03w 04-01-04 08:40:18 EST EAGLE 31.3.0
 ATM LINK PARAMETER SET TIMERS AND PARAMETERS (TIMERS IN SECONDS)

SSCOP PARAMETERS								
LPSET	MAXCC	MAXPD	MAXSTAT	TMR	TMR	TMR	TMR	TMR
				CC	KALIVE	NORSP	POLL	IDLE
5	4	500	67	0.2	0.125	1.5	0.150	0.125

SSCF-NNI PARAMETERS				
TMRT1	TMRT2	TMRT3	N1	
05.0	120.0	0.000925	64552	

SAAL PARAMETERS					
MAX	TMR	TNRNO	TMR	N	TMR
NRP	SREC	CRED	ERM	BLK	PROV
1	3600	1.5	0.125	3	0600.0

NONCONFIGURABLE PARAMETERS									
SDU	UU	FC		FC					
SIZE	SIZE	N	NR	BC	TSUP	TLOSS	ERMSM	THRES	
272	4	9	--	--	120	1.3	0.1	0.244	

;

NOTE: Dashes (--) in the FC NR and FC BC fields indicate that this implementation is not supported on ATM high-speed signaling links.

rtrv-atm-lps

rlghncxa03w 04-01-04 08:40:18 EST EAGLE 31.3.0

SSCOP PARAMETERS									
LPSET	MAXCC	MAXPD	MAXSTAT	TMR	TMR	TMR	TMR	TMR	
				CC	KALIVE	NORSP	POLL	IDLE	
1	4	500	67	0.2	0.125	1.5	0.150	0.125	
2	4	500	67	0.2	0.125	1.5	0.150	0.125	
3	4	500	67	0.2	0.125	1.5	0.150	0.125	
4	4	500	67	0.2	0.125	1.5	0.150	0.125	
5	4	500	67	0.2	0.125	1.5	0.150	0.125	
6	4	500	67	0.2	0.125	1.5	0.150	0.125	
7	4	500	67	0.2	0.125	1.5	0.150	0.125	
8	4	500	67	0.2	0.125	1.5	0.150	0.125	
9	4	500	67	0.2	0.125	1.5	0.150	0.125	
10	4	500	67	0.2	0.125	1.5	0.150	0.125	
11	4	500	67	0.2	0.125	1.5	0.150	0.125	
12	4	500	67	0.2	0.125	1.5	0.150	0.125	
13	4	500	67	0.2	0.125	1.5	0.150	0.125	
14	4	500	67	0.2	0.125	1.5	0.150	0.125	
15	4	500	67	0.2	0.125	1.5	0.150	0.125	
16	4	500	67	0.2	0.125	1.5	0.150	0.125	
17	4	500	67	0.2	0.125	1.5	0.150	0.125	
18	4	500	67	0.2	0.125	1.5	0.150	0.125	
19	4	500	67	0.2	0.125	1.5	0.150	0.125	
20	4	500	67	0.2	0.1	1.5	0.1	0.1	

SSCF-NNI PARAMETERS

LPSET	TMRT1	TMRT2	TMRT3	N1
1	05.0	015.0	0.000925	64552
2	05.0	120.0	0.000925	64552
3	05.0	120.0	0.000925	64552
4	15.0	010.0	0.000925	64552
5	05.0	120.0	0.000925	500
6	05.0	015.0	0.000925	64552
7	05.0	120.0	0.000925	64552
8	05.0	120.0	0.000925	64552
9	15.0	010.0	0.000925	64552
10	05.0	015.0	0.000925	64552
11	05.0	120.0	0.000925	64552
12	05.0	120.0	0.000925	64552
13	15.0	010.0	0.000925	64552
14	05.0	015.0	0.000925	64552
15	05.0	120.0	0.000925	64552
16	05.0	120.0	0.000925	64552
17	15.0	010.0	0.000925	64552
18	05.0	015.0	0.000925	64552
19	05.0	120.0	0.000925	64552
20	05.0	120.0	0.000925	64552

SAAL PARAMETERS

LPSET	MAX NRP	TMR SREC	TNRNO CRED	TMR ERM	N BLK	TMR PROV
1	1	3600	1.5	0.125	3	1200.0
2	1	3600	1.5	0.125	3	1000.0
3	1	60	1.5	0.125	3	0600.0
4	1	3600	1.5	0.125	3	0600.0
5	1	3600	1.5	0.125	3	0600.0
6	1	3600	1.5	0.125	3	1200.0
7	1	3600	1.5	0.125	3	1000.0
8	1	60	1.5	0.125	3	0600.0
9	1	3600	1.5	0.125	3	0600.0
10	1	3600	1.5	0.125	3	0600.0
11	1	3600	1.5	0.125	3	1200.0
12	1	3600	1.5	0.125	3	1000.0
13	1	60	1.5	0.125	3	0600.0
14	1	3600	1.5	0.125	3	0600.0
15	1	3600	1.5	0.125	3	0600.0
16	1	3600	1.5	0.125	3	1200.0
17	1	3600	1.5	0.125	3	1000.0
18	1	60	1.5	0.125	3	0600.0
19	1	3600	1.5	0.125	3	0600.0
20	1	3600	1.5	0.125	3	0600.0

NONCONFIGURABLE PARAMETERS

SDU SIZE	UU SIZE	N	FC NR	FC BC	TSUP	TLOSS	ERMSM	THRES
272	4	9	--	--	120	1.3	0.1	0.244

;

rtrv-atm-lps:lpset=25

tekelecstp 04-01-05 08:40:18 EST EAGLE 31.3.0
 ATM LINK PARAMETER SET TIMERS AND PARAMETERS (TIMERS IN SECONDS)

SSCOP PARAMETERS									
LPSET	MAXCC	MAXPD	MAXSTAT	CC	KALIVE	NORSP	POLL	IDLE	
25	4	500	67	0.2	0.125	1.5	0.150	0.125	

SSCF-NNI PARAMETERS				
TMRT1	TMRT2	TMRT3	N1	
05.0	120.0	0.000925	64552	

SAAL PARAMETERS					
MAX	TMR	TNRNO	TMR	N	TMR
0	3600	1.5	0.125	3	0600.0

NONCONFIGURABLE PARAMETERS									
SDU	UU	N	NR	BC	TSUP	TLOSS	ERMSM	THRES	
272	4	9	--	--	120	1.3	0.1	0.244	

;

rtrv-atm-lps

tekelecstp 04-01-05 08:40:18 EST EAGLE 31.3.0
 ATM LINK PARAMETER SET TIMERS AND PARAMETERS (TIMERS IN SECONDS)

SSCOP PARAMETERS									
LPSET	MAXCC	MAXPD	MAXSTAT	CC	KALIVE	NORSP	POLL	IDLE	
1	4	500	67	0.2	0.125	1.5	0.150	0.125	

.

20	4	500	67	0.2	0.1	1.5	0.1	0.1	
21	4	500	67	0.2	0.1	1.5	0.1	0.1	

.

30	4	500	67	0.2	0.1	1.5	0.1	0.1	
----	---	-----	----	-----	-----	-----	-----	-----	--

SSCF-NNI PARAMETERS				
LPSET	TMRT1	TMRT2	TMRT3	N1
1	05.0	015.0	0.000925	64552

.

20	5	30	0.000925	64552
21	5	120	0.000925	1000

.

30	5	120	0.000925	64552
----	---	-----	----------	-------

SAAL PARAMETERS									
LPSET	MAX	TMR	TNRNO	TMR	N	TMR			
	NRP	SREC	CRED	ERM	BLK	PROV			
1	1	3600	1.5	0.125	3	1200.0			
.									
20	1	3600	1.5	0.125	3	0600.0			
21	0	3600	1.5	0.125	3	1200.0			
.									
30	0	3600	1.5	0.125	3	0600.0			

NONCONFIGURABLE PARAMETERS									
SDU	UU	FC	FC						
SIZE	SIZE	N	NR	BC	TSUP	TLOSS	ERMSM	THRES	
272	4	9	--	--	120	1.3	0.1	0.244	

Legend

LPSET—The link parameter set being changed, **1** to **30**. The system default value for this parameter is **1** for ANSI and **21** for ITU.

ACTION—Copy a set of ATM signaling link parameters from one parameter set to another. The value of this parameter is **copy**. If this parameter is not specified, then the copy action cannot take place.

SCRLPSET—The ATM signaling link parameter set used as a source for the **action=copy** parameter. This parameter can only be specified with the **action=copy** parameter.

MAXCC—The maximum number of transmissions of a BGN, END, ER, or RS PDU. The value of this parameter can range from 1 to 10 PDUs. The system default value is 4 PDUs.

MAXPD—The maximum number of SD PDUs that can be sent before a POLL is sent. The value of this parameter can range from 5 to 2120 PDUs. The system default value is 500 PDUs.

MAXSTAT—The maximum number of list elements in a STAT PDU. The value of this parameter can range from 3 to 67 PDUs. The system default value is 67 PDUs.

TMRCC—The timer, in seconds, used during the connection phase to guard against unacknowledged BGN, END, ER or RS PDUs. The value of this parameter can range from .1 to 2 seconds. The system default value is .2 seconds.

TMRKALIVE—The timer, in seconds, used during the transient phase when no SD PDUs are being sent to keep connection up. The value of this parameter is from .025 to .5 seconds. The system default value is .1 seconds.

TMRNOSP—The timer, in seconds, used to check that STAT PDUs are arriving often enough. The value of this parameter can range from .5 to 2 seconds. The system default value is 1.5 seconds.

TMRPOLL—The timer, in seconds, used to guarantee that POLL PDUs are sent often enough. The value of this parameter can range from .025 to .5 seconds. The system default value is .1 seconds.

TMRIDLE—The timer, in seconds, used during the idle phase when no SD PDUs are being sent to limit time in the idle phase. The value of this parameter can range from .025 to 1 seconds. The system default value is .1 seconds.

TMRT1—The time, in seconds, between a link release action and the next link reestablish action during alignment. The value of this parameter can range from 1 to 15 seconds. The system default value is 5 seconds.

TMRT2—The total time, in seconds, that SSCF will attempt alignment. The value of this parameter can range from 15 to 180 seconds. The system default value is 120 seconds for ANSI and 30 seconds for ITU.

TMRT3—The time, in seconds, between proving PDUs. The value of this parameter can range from .00045 to .023 seconds. The system default value is .000925 seconds.

N1—The number of PDUs sent during proving. The value of this parameter can range from 500 to 64552 PDUs. The system default value is 64552 PDUs for ANSI and 1000 PDUs for ITU.

MAXNRP—The maximum number of retransmitted PDUs during proving. The value of this parameter can range from 1 to 10 PDUs. The system default value is 1 PDU for ANSI and 0 PDUs for ITU.

TMRSREC—The timer, in seconds, used to prohibit closely spaced SSCOP recoveries from occurring. The value of this parameter can range from 60 to 10800 seconds. The system default value is 3600 seconds.

TMRNOCRED—The timer, in seconds, used when the no credit exists and PDUs are available to be sent. The value of this parameter can range from 1 to 6 seconds. The system default value is 1.5 seconds.

TMRERM—The error rate monitor interval, in seconds. The value of this parameter can range from .025 to .5 seconds. The system default value is .1 seconds.

NBLK—The number of monitoring intervals per block. The value of this parameter can range from 1 to 10. The system default value is 3.

TMRPROV—The timer, in seconds, used to monitor the status of a link after it is placed into service. The value of this parameter can range from 60 to 1200 seconds. The system default value is 600 seconds.

SDU SIZE—The SSCOP SDU size (set to 272 octets).

UU SIZE—The SCOP UU size (set to 4 octets).

N—The monitoring intervals spanning a .4 second error event (set to 9).

FC NR—The fixed credit increment value.

FC BC—The fixed credit allocation frequency.

TSUP—The superblock timer for layer management, in seconds.

TLOSS—The loss timer for layer management, in seconds.

ERMSM—The error rate monitor smoothing factor.

THRES—The error rate monitor threshold.

rtrv-atm-prm**Retrieve ATM Parameters**

Use this command to display system-wide non-configurable ATM layer parameters for each ATM high-speed signaling link. The data displayed includes the ATM interface parameters and the ATM traffic descriptor values.

Keyword: rtrv-atm-prm

Related Commands: rtrv-atm-lps

Command Class: Database Administration

Parameters

This command has no parameters.

Example

```
rtrv-atm-prm
```

Dependencies

None

Notes

None

Output**rtrv-atm-prm**

```
tekelecstp 04-02-05 08:40:18 EST EAGLE 31.3.0
DS1 DS1 E1 E1 MAX MAX VCI VPI
PCR SCR PCR SCR BT CDVT QOS VPCs VCCs BITS BITS
3622 3622 4528 4528 210 100 3 0 1 16 12
;
```

Legend

The ATM traffic descriptors are displayed in the following fields:

BT—Burst tolerance. The number of consecutive cells on the VCL permitted on the ATM interface by the enforcement process, given the PCR and the line speed.

CDVT—The amount of cell delay variation for the VCL in the network ingress direction.

PCR—The maximum or peak cell rate for the VCL (virtual channel link) T1 is for ANSI and E1 is for ITU.

QOS—Quality of service. The performance objectives that must be met by the ATM VCL when it must discard cells during enforcement of the traffic parameters.

SCR—The average or sustainable cell rate supported on the VCL.
T1 is for ANSI and E1 is for ITU.

The ATM interface parameters are displayed in the following fields:

MAX VCCs—The maximum number of simultaneously active Virtual Circuit Connections (VCCs) supported.

MAX VPCs—The maximum number of simultaneously active Virtual Path Connections (VPCs) supported (by the ATM interface).

VCI BITS—The number of allocated VCI bits to be used in the VPIs in the ATM cells for the VCLs supported on the ATM interface.

VPI BITS—The number of bits to be used in the VPIs in the ATM cells for the VPLs terminated on the ATM interface.

rtrv-attr-seculog

Display Security Log Characteristic

Use this command to display security log attributes that were configured using the **chg-attr-seculog** command.

Keyword: rtrv-attr-seculog

Related Commands: chg-attr-seculog

Command Class: Security Administration

Parameters

This command has no parameters.

Example

```
rtrv-attr-seculog
```

Dependencies

None

Notes

None

Output

rtrv-attr-seculog

```
rlghncxa03w 04-01-07 08:16:17 EST EAGLE 31.3.0
Security log attributes
-----
UPLDALM      yes
UPSLG        80
;
```

rtrv-bip

Retrieve Board Identification PROMs

Use this command to show the board identification PROM (BIP) data for a specified card (main assembly or applique) and location.

The following information is displayed for both main assemblies and appliques: board part number, board revision, serial number (7, 8, 11, 12, or 14 digits), manufacturing location and date, and the software match ID.

For main assemblies, the port A ethernet address (if ENT01 record exists) and port B ethernet address (if ENT02 record exists) is also displayed.

For appliques, the applique type and ethernet address (if the applique type is ENET and ENT01 record exists) are also displayed.

Keyword: rtrv-bip

Related Commands: chg-bip-fld, chg-bip-rec, tst-bip

Command Class: System Maintenance

Parameters

:loc= (mandatory)

The card location as stenciled on the shelf of the system.

Range: (HMUX and HIPR locations xy09 and xy10 are not valid): **1101-1108, 1111-1113, 1115, 1201-1208, 1211-1218, 1301-1308, 1311-1318, 2101-2108, 2111-2118, 2201-2208, 2211-2218, 2301-2308, 2311-2318, 3101-3108, 3111-3118, 3201-3208, 3211-3218, 3301-3308, 3311-3318, 4101-4108, 4111-4118, 4201-4208, 4211-4218, 4301-4308, 4311-4318, 5101-5108, 5111-5118, 5201-5208, 5211-5218, 5301-5308, 5311-5318, 6101-6108, 6111-6118**

:type= (mandatory)

The type of board at the specified location whose BIP information is to be displayed.

Range: **mbd, dbd**

mbd—Main assembly

dbd—Applique

Example

```
rtrv-bip:loc=1201:type=mbd
```

```
rtrv-bip:loc=1201:type=dbd
```

Dependencies

The card location frame, shelf, and slot must be within the allowed range.

The card location must be valid for the command.

The board type **type=dbd** parameter is not valid for card type GSM-II, HCAP, ATM or DCM. HMUX and HIPR cards do not contain BIP information.

Notes

The **tst-bip** command verifies that the PROM is good by writing to and reading from the PROM. The **rtrv-bip** command shows the level of the BIP, as well as the board part number, the revision number, and the serial number. If the **rtrv-bip** command fails, this indicates that communication to the card has failed, and you might need to replace the card. Contact Tekelec Technical Service at (888) FOR-TKLC to find out if the card can be reprogrammed.

Output

rtrv-bip:type=mbd:loc=1201

(7-digit serial number of a main assembly card manufactured on the eleventh week of 1993)

```
rlghncxa03w 04-01-04 08:16:20 EST EAGLE 31.3.0
```

```
Location: 1201 MBD
```

```
Part Number: 850-0187-03      Manufactured at: Calabasas
Revision:     G2                Week/Year:      11/1993
Serial Number: 3110195
```

```
Software Match ID: EG 001
```

```
;END OF REPORT
```

```
;
```

rtrv-bip:loc=1201:type=dbd

(7-digit serial number of a DS0 applique manufactured on the tenth week of 1993)

```
rlghncxa03w 04-01-04 08:16:20 EST EAGLE 31.3.0
```

```
-----
Location: 1201 - DBD
```

```
Part Number: 850-0196-01      Manufactured at: Calabasas
Revision:     B1                Week/Year:      10/1993
Serial Number: 3100138
```

```
Software Match ID: EG - 001
```

```
Daughterboard Type: DS0
```

```
-----
END OF REPORT
```

```
;
```

rtrv-bip:loc=1201:type=mbd

(8-digit serial number of a main assembly card manufactured on the eleventh week of 1998)

```
rlghncxa03w 04-01-04 08:16:17 EST EAGLE 31.3.0
```

```
-----
Location: 1201 - MBD
```

```
Part Number: 850-0187-03      Manufactured at: Calabasas
Revision:     G2                Week/Year:      11/1998
Serial Number: 98110195
```

```
Software Match ID: EG - 001
```

```
-----
END OF REPORT
```

```
;
```

rtrv-bip:loc=1201:type=mbd

(11-digit serial number of a main assembly card manufactured on the eleventh week of 2002)

```
rlghncxa03w 04-01-04 08:16:17 EST EAGLE 31.3.0
-----
Location: 1201 MBD

Part Number:      850-0187-03           Manufactured at: Calabasas
Revision:         G2                   Week/Year:       11/2002
Serial Number:    10202110195

Software Match ID: EG 001
-----
END OF REPORT
```

;

rtrv-bip:loc=1201:type=mbd

(12-digit serial number of a main assembly card manufactured on the eleventh week of 1998)

```
rlghncxa03w 04-01-04 08:16:17 EST EAGLE 31.3.0
-----
Location: 1201 MBD

Part Number:      850-0187-03           Manufactured at: Calabasas
Revision:         G2                   Week/Year:       11/1998
Serial Number:    1029811a0195

Software Match ID: EG 001
-----
END OF REPORT
```

;

rtrv-bip:type=mbd:loc=1201

(14-digit serial number with ethernet port A and B records manufactured on the eleventh week of 2001)

```
rlghncxa03w 04-02-04 08:16:17 EST EAGLE 31.3.0
-----
Location: 1201 - MBD

Part Number:      850-0187-03           Manufactured at: Calabasas
Revision:         G2                   Week/Year:       11/2001
Serial Number:    102200111a0195

Software Match ID: EG - 001

Ethernet Port A Address: 00001704000C
Ethernet Port B Address: 000017040
-----
END OF REPORT
```

;

Legend

LOCATION—The card location and board type for the BIP information.

PART NUMBER—The part number of the card in the specified card location.

REVISION—The hardware version of the card.

SERIAL NUMBER—The serial number (7, 8, 11, 12, or 14 digits) of the card. Table 7-11 on page 7-292 shows the serial number formats.

Table 7-11. Serial Number Formats

Serial Numbers	Formats
7-digit serial number	ywwxxxx
8-digit serial number	yywwxxxx
11-digit serial number	nnnywwxxxx
12-digit serial number	nnnyww*xxxx
14-digit serial number	nnnyyyww*xxxx
Legend y = year digit (0-9) w = week digit (0-9) n = product identifier digit (0-9) x = serial number digit (0-F hexadecimal) * = special character (0-9, a-z, or A-Z, alphanumeric characters)	

SOFTWARE MATCH ID—This field is used to check hardware and software compatibility.

DAUGHTERBOARD TYPE—The type of applique.

MANUFACTURED AT—The factory location where the card was manufactured.

WEEK/YEAR—The week (1-52) and the year (4 digits) that the card was manufactured.

rtrv-card

Retrieve Card

Use this command to display the information about a card. The command displays the card type, the application the card is running, the linkset name, the signaling link code, and the ports. If no parameter is specified, the command displays information for all cards defined by the **ent-card** command. If the **loc** parameter is specified, the command displays information for the specified card only.

Keyword: rtrv-card

Related Commands: dlt-card, ent-card, init-card, rept-stat-card, rmv-card, rst-card

Command Class: Database Administration

Parameters

:loc= (mandatory)

The card location as stenciled on the shelf of the system.

Range: 1101-1108, 1111-1117, 1201-1208, 1211-1218, 1301-1308, 1311-1318, 2101-2108, 2111-2118, 2201-2208, 2211-2218, 2301-2308, 2311-2318, 3101-3108, 3111-3118, 3201-3208, 3211-3218, 3301-3308, 3311-3318, 4101-4108, 4111-4118, 4201-4208, 4211-4218, 4301-4308, 4311-4318, 5101-5108, 5111-5118, 5201-5208, 5211-5218, 5301-5308, 5311-5318, 6101-6108, 6111-6118

Default: Retrieve all

Example

```
rtrv-card
rtrv-card:loc=1205
```

Dependencies

The card location slot must be between 1 and 16 and not 9 or 10.

The card location cannot be 1114, 1116, 1117, or 1118.

The shelf location must be 11xx, 12xx, 13xx, 21xx, 22xx, 23xx, 31xx, 32xx, 33xx, 41xx, 42xx, 43xx, 51xx, 52xx, 53xx, or 61xx.

The specified card location must be equipped in the database.

Notes

The provisioning method of an MPL or MPL-T (multi-port LIM) and a two-port LIM running the **ss7ansi** application is the same, as is the function that the two cards perform. Both cards are provisioned with the **ss7ansi** application to allow the MPLs to replace a two-port LIM without having to re-provision the LIM in the database. The MPLs support only the LIMDS0 interface, and the **appl** value must be **ss7ansi**. The MPLs run the **ss7ml** GPL (see the **rept-stat-gpl** command), which allows the MPL cards to support eight signaling link ports. The **rtrv-card** command displays the status of all ports of the MPL card and displays its application as **ss7ansi**.

The provisioning method of an E1/T1 MIM (Multi-Channel Interface Module) and a two-port E1 card running the **ss7ansi** or **ccs7itu** application is the same, as is the function that the two cards perform. Both cards are provisioned with the **ss7ansi** or **ccs7itu** application to allow the E1/T1 MIM card to replace a two-port E1 card without having to re-provision the E1 card in the database. The **appl** value can be **ss7ansi** or **ccs7itu**. The E1/T1 MIM runs the **ss7ml** GPL (see the **rept-stat-gpl** command), which allows the card to support eight signaling link ports. The **rtrv-card** command displays the status of all ports of the E1/T1 card and displays its application as **ss7ansi** or **ccs7itu**.

Output

```
rtrv-card
rlghncxa03w 04-07-15 16:34:56 EST EAGLE 31.6.0
CARD  TYPE      APPL      LSET NAME      PORT SLC LSET NAME      PORT SLC
1101  TSM          SCCP      -----      A   -- -----      B   --
1102  TSM          GLS       -----      A   -- -----      B   --
1103  ACMENET     STPLAN   -----      A   -- -----      B   --
1104  ACMENET     STPLAN   -----      A   -- -----      B   --
1113  GPSM        OAM
1114  TDM-A
1115  GPSM        OAM
1116  TDM-B
1117  MDAL
```

```

1201 LIMV35 CCS7ITU lsn156 A 0 lsn1234 B 1
1205 LIME1 CCS7ITU e1lim1 A 0 ----- B --
----- A1 -- ----- B1 --
----- A2 -- ----- B2 --
----- A3 -- ----- B3 --
1206 LIMCH CCS7ITU e1lim1 A 1 ----- B --
----- A1 -- ----- B1 --
----- A2 -- ----- B2 --
----- A3 -- ----- B3 --
1207 LIME1 SS7ANSI e1lsn1 A 0 e1jwk4 B 1
e1lsn2 A1 2 e1jwk3 B1 2
e1lsn3 A2 4 e1jwk2 B2 15
----- A3 -- e1jwk1 B3 16
1208 LIMCH SS7ANSI e1jwk5 A 8 e1lsn1 B 1
e1jwk6 A1 9 e1lsn7 B1 13
e1jwk7 A2 10 e1lsn6 B2 14
e1jwk8 A3 10 e1lsn5 B3 15
1211 LIMT1 SS7ANSI t1lsn1 A 0 t1lsn1 B 1
----- A1 -- t1lsn1 B1 2
t1lsn5 A2 0 t1lsn6 B2 6
t1lsn7 A3 13 ----- B3 --
1212 LIMCH SS7ANSI t1lsn1 A 3 t1lsn13 B 10
t1lsn10 A1 16 t1lsn14 B1 10
t1lsn11 A2 1 t1lsn15 B2 4
t1lsn12 A3 8 ----- B3 --
;

```

The following example shows a retrieval by the specified card location:

rtrv-card:loc=1205

```

rlghncxa03w 04-01-15 16:34:56 EST EAGLE 31.3.0
CARD TYPE APPL LSET NAME PORT SLC LSET NAME PORT SLC
1205 LIMDS0 SS7ANSI LS1 A 0 LS1 B 1
LS1 A1 2 LS1 B1 3
LS1 A2 4 LS1 B2 5
LS1 A3 6 LS1 B3 7
;

```

The following examples show the output when 2-port E1 and Channel cards and E1/T1 MIM cards used as E1, T1, and Channel cards are provisioned on the system:

rtrv-card:loc=1205

```

rlghncxa03w 04-01-15 16:34:56 EST EAGLE 31.3.0
CARD TYPE APPL LSET NAME PORT SLC LSET NAME PORT SLC
1205 LIME1 CCS7ITU e1lim1 A 0 ----- B --
----- A1 -- ----- B1 --
----- A2 -- ----- B2 --
----- A3 -- ----- B3 --
;

```

rtrv-card:loc=1207

```

rlghncxa03w 04-01-15 16:34:56 EST EAGLE 31.3.0
CARD TYPE APPL LSET NAME PORT SLC LSET NAME PORT SLC
1207 LIME1 SS7ANSI e1lsn1 A 0 e1jwk4 B 1
e1lsn2 A1 2 e1jwk3 B1 2
e1lsn3 A2 4 e1jwk2 B2 15
----- A3 -- e1jwk1 B3 16
;

```

rtrv-card:loc=1211

```
rlghncxa03w 04-01-15 16:34:56 EST EAGLE 31.3.0
CARD  TYPE      APPL      LSET NAME      PORT SLC LSET NAME      PORT SLC
1211  LIMT1      SS7ANSI  t11sn1         A    0    t11sn1         B    1
----- A1    --    t11sn1         B1   2
      t11sn5     A2    0    t11sn6         B2   6
      t11sn7     A3    13  ----- B3   --
;
```

The following example shows the output when MPL or MPL-T (multi-port LIM) cards are provisioned on the system:

rtrv-card

```
rlghncxa03w 03-03-15 16:34:56 EST EAGLE 30.0.0
CARD  TYPE      APPL      LSET NAME      PORT SLC LSET NAME      PORT SLC
1201  LIMDS0      SS7ANSI  LS1            A    0    LS1            B    1
      LS1            A1   2    LS1            B1   3
      LS1            A2   4    LS1            B2   5
      LS1            A3   6    LS1            B3   7
1202  LIMDS0      SS7ANSI  LS2            A    0    LS3            B    0
      ----- A1   --    LS3            B1   1
      LS2            A2   1    LS2            B2   2
      ----- A3   --    ----- B3   --
1203  LIMDS0      SS7GX25  LS4            A    0    LS4            B    1
1204  LIMATM      ATMANSI  LS5            A    0    ----- B    --
1205  DCM          IPLIM    ----- A    --    LS6            B    0
1102  DSM          VSCCP    ----- A    --    ----- B    --
1113  GPSM         OAM
1114  TDM-A
1115  GPSM         OAM
1116  TDM-B
1117  MDAL
1303  DCM          IPGWI    ipgwitun      A    00  ----- B    --
;
```

The following example shows the output when an MCPM card for the Measurements Platform feature is provisioned on the system:

rtrv-card:loc=1205

```
rlghncxa03w 04-01-15 16:34:56 EST EAGLE 31.3.0
CARD  TYPE      APPL      LSET NAME      PORT SLC LSET NAME      PORT SLC
1205  MCPM        MCP      ----- A    00  ----- B    --
;
```

The following example shows the output when an IPGWI card is provisioned on the system:

rtrv-card:loc=1205

```
rlghncxa03w 04-01-15 16:34:56 EST EAGLE 31.3.0
CARD  TYPE      APPL      LSET NAME      PORT SLC LSET NAME      PORT SLC
1303  DCM          IPGWI    ipgwitun      A    00  ----- B    --
;
```

The following example shows the output when an STC card for the EAGLE Support for Integrated Sentinel feature is provisioned on the system:

rtrv-card:loc=1205

```
rlghncxa03w 04-01-15 16:34:56 EST EAGLE 31.3.0
CARD  TYPE      APPL      LSET NAME      PORT SLC LSET NAME      PORT SLC
1205  STC          EROUTE   lsntest1      A    00  lsntest2      B    01
;
```

The following examples show the output when SSED CM cards are used as IPLIM to 8 Points cards:

rtrv-card:loc=1205

```
rlghncxa03w 04-01-15 16:34:56 EST EAGLE 31.3.0
CARD  TYPE      APPL      LSET NAME      PORT SLC LSET NAME      PORT SLC
1205  DCM         IPLIM      LS6             A    0   LS6            B    1
                                     LS6             A1   2   LS6            B1   3
                                     LS6             A2   4   LS6            B2   5
                                     LS6             A3   6   LS6            B3   7
```

;

rtrv-card

```
rlghncxa03w 03-03-15 16:34:56 EST EAGLE 30.0.0
CARD  TYPE      APPL      LSET NAME      PORT SLC LSET NAME      PORT SLC
1201  LIMDS0      SS7ANSI    LS1             A    0   LS1            B    1
                                     LS1             A1   2   LS1            B1   3
                                     LS1             A2   4   LS1            B2   5
                                     LS1             A3   6   LS1            B3   7
1202  LIMDS0      SS7ANSI    LS2             A    0   LS3            B    0
                                     ----- A1   --  LS3            B1   1
                                     LS2             A2   1   LS2            B2   2
                                     ----- A3   --  ----- B3   --
1203  LIMDS0      SS7GX25    LS4             A    0   LS4            B    1
1204  LIMATM      ATMANSI    LS5             A    0   ----- B    --
1205  DCM         IPLIM      LS6             A    0   LS6            B    1
                                     LS6             A1   1   LS6            B1   2
                                     LS6             A2   4   LS6            B2   5
                                     LS6             A3   6   LS6            B3   7
1102  DSM         VSCCP      ----- A    --  ----- B    --
1113  GPSM        OAM
1114  TDM-A
1115  GPSM        OAM
1116  TDM-B
1117  MDAL
```

;

The following example includes an IPSM card:

rtrv-card

```
rlghncxa03w 04-01-15 16:34:56 EST EAGLE 31.3.0
CARD  TYPE      APPL      LSET NAME      PORT SLC LSET NAME      PORT SLC
1201  LIMDS0      SS7ANSI    LS1             A    0   LS1            B    1
1202  LIMDS0      SS7ANSI    LS2             A    0   LS3            B    0
                                     ----- A1   --  LS3            B1   1
                                     LS2             A2   1   LS2            B2   2
                                     ----- A3   --  ----- B3   --
1203  LIMDS0      SS7GX25    LS4             A    0   LS4            B    1
1204  LIMATM      ATMANSI    LS5             A    0   ----- B    --
1205  DCM         IPLIM      LS6             A    0   LS6            B    1
1103  IPSM        IPS
1113  GPSM        OAM
1114  TDM-A
1115  GPSM        OAM
1116  TDM-B
1117  MDAL
```

;

The following examples show the output when an E1 ATM card is provisioned on the system:

rtrv-card

```
tekelecstp 04-01-17 15:09:32 EST EAGLE 31.3.0
CARD  TYPE      APPL      LSET NAME      PORT SLC LSET NAME      PORT SLC
1201  LIMDS0      SS7ANSI  LS1             A    0   LS1             B    1
      LS1             A1   2   LS1             B1   3
      LS1             A2   4   LS1             B2   5
      LS1             A3   6   LS1             B3   7
1204  LIME1ATM    ATMITU   LS2             A    0   -----      --   --
1205  LIMATM      ATMANSI  LS5             A    0   -----      --   --
1113  GPSM        OAM
1114  TDM-A
1115  GPSM        OAM
1116  TDM-B
1117  MDAL
```

;

rtrv-card:loc=1204

```
tekelecstp 04-01-17 15:09:32 EST EAGLE 31.3.0
CARD  TYPE      APPL      LSET NAME      PORT SLC LSET NAME      PORT SLC
1204  LIME1ATM    ATMITU   LS2             A    0   -----      --   --
```

;

Legend

CARD—The card location as stenciled on the shelf of the system.

TYPE—The type of card. (The DCM and SSEDCCM cards are card type DCM).

APPL—The application associated with each card in the display.

LSET NAME—The linkset name associated with the cards in the display.

PORT—The port associated with the linkset. If the card is an MPL or MPL-T (**TYPE** is **limds0**, **APPL** is **ss7ansi**) or an E1/T1 MIM (**TYPE** can be **lime1**, **limt1**, or **limch**; **APPL** can be **ss7ansi** or **ccs7itu**), the card can support 8 ports (**a**, **a1**, **a2**, **a3**, **b**, **b1**, **b2**, and **b3**).

SLC—The signaling link code.

rtrv-cmd

Retrieve Command Attributes

Use this command to retrieve the list of command classes to which a command is assigned. You can retrieve output for one command, commands in one command class, or all commands.

Keyword: rtrv-cmd

Related Commands: chg-cmd

Command Class: Basic

Parameters

:cmd= (optional)

The command whose attributes are to be retrieved.

Range: One alphabetic character followed by up to 19 additional alphanumeric characters, enclosed in double quotes.

:class= (optional)

The command class whose attributes are to be retrieved.

Range: One alphabetic character followed by up to 5 additional alphanumeric characters.

Example

```
rtrv-cmd:cmd="ent-rte"
```

```
rtrv-cmd:class=dab
```

```
rtrv-cmd
```

Dependencies

The Command Class Management feature must be enabled before a configurable command class name can be specified in the **class** parameter.

The LNP feature must be turned on (see the **enable-ctrl-feat** command) before:

- A command from classes LNPBAS, LNPDB, and LNPSUB can be specified in the **cmd** parameter
- Command classes LNPBAS, LNPDB, and LNPSUB can be specified in the **class** parameter

The value of the **cmd** parameter must be a valid system command.

The value of the **class** parameter must be a valid configurable or non-configurable command class name.

Notes

This command can be canceled using the **F9** function key or the **canc-cmd** command. See **canc-cmd** for more information.

Output

The following example shows the command classes to which the **rept-stat-slk** command is assigned (non-configurable class **sys** and user-configured classes **u01**, **u02**, **krb**, and **u11**):

```
rtrv-cmd:cmd="rept-stat-slk"
```

```
eagle10404 04-01-22 16:30:56 EST EAGLE 31.3.0
cmd CLASS
rept-stat-slk sys, u01, u02, krb, u11
```

```
;
```

The following example shows the commands assigned to user-configured command class **krb**:

rtrv-cmd:class=krb

```
eagle10404 04-01-22 16:30:56 EST EAGLE 31.3.0
CMD CLASS
rept-stat-slk sys, u01, u02, krb, u11
act-slk link, u09, krb
ent-user sa, krb, abc, u23
alw-card sys, u09 dab, krb
```

;

rtrv-cmd:class=link

```
eagle10404 04-01-22 16:30:56 EST EAGLE 31.3.0
CMD CLASS
alw-slk link, u11
unhb-slk link
inh-slk link, abc
rtrv-meas-sched link, abc, def
act-lbp link
act-dlk link
act-slk link
act-lpo link
blk-slk link, abc, u23, u31
dact-lbp link
canc-dlk link
canc-lpo link, u01, u02, u03, u04, u05, u06, u07, u08, u09, u10,
u11, u12, u13
canc-slk link
ublk-slk link, u01, u02, u03, u04, u05, u06, u07, u08, u09, u10,
u11, u12, u13, u14, u15, u16, u17, u18, u19, u20, u21,
u22, u23, u24, u25, u26, u27, u28, u29, u30, u31, u32
rept-x25-meas link
rept-meas link
chg-meas link
tst-dlk link, krb
tst-slk link
```

;

rtrv-cmd

```
eagle10404 04-01-22 16:30:56 EST EAGLE 31.3.0
CMD CLASS
alw-slk link, u11
ent-user sa
unhb-slk link
rtrv-attr-seculog sa, u31
inh-slk link, abc
rtrv-meas-sched link, abc, def
act-lbp link
act-dlk link
act-slk link
```

```

rtrv-seculog      sa, abc, def, ghi
act-lpo           link
blk-slk           link, abc, u23, u31
dact-lbp          link
canc-dlk          link
inh-card          sys
canc-lpo          link, u01, u02, u03, u04, u05, u06, u07, u08, u09, u10,
                  u11, u12, u13
canc-slk          link
ublk-slk          link, u01, u02, u03, u04, u05, u06, u07, u08, u09, u10,
                  u11, u12, u13, u14, u15, u16, u17, u18, u19, u20, u21,
                  u22, u23, u24, u25, u26, u27, u28, u29, u30, u31, u32
rept-x25-meas    link
inh-trm           sys, krb
rept-meas         link
ent-lnp-sub       lnpsub, u22
.
.
.
chg-meas          link
tst-dlk           link, krb
tst-slk           link
;

```

rtrv-cmdclass**Retrieve Command Class**

Use this command to retrieve the name and description of one command class or all command classes.

Keyword: rtrv-cmdclass

Related Commands: chg-cmdclass

Command Class: Basic

Parameters

:class= (optional)

The command class whose name and description are to be retrieved.

Range: 1 alphabetic character followed by up to 5 alphanumeric characters

Example

```
rtrv-cmdclass:class=krb
```

```
rtrv-cmdclass
```

Dependencies

The Command Class Management feature must be enabled and turned on before a configurable command class name can be specified in the **class** parameter.

The LNP feature must be turned on (see the **enable-ctrl-feat** command) before command classes LNPBAS, LNPDB, and LNPSUB can be specified in the **class** parameter.

The value of the **class** parameter must be a valid configurable or non-configurable command class name.

Notes

The LNP feature must be turned on (see the **enable-ctrl-feat** command) before classes LNPBAS, LNPDB, and LNPSUB will appear in the command output.

The Command Class Management feature must be enabled and turned on before configurable command classes will appear in the command output.

Output

In the following examples, the classes u01, u03, u05, and u32 are default configurable command class names. The classes krb and dab are user-assigned configurable command class names; the user changed default configurable command class name u02 to krb and changed default configurable command class name u04 to dab. The descriptions of classes krb and dab were entered with the **descr** parameter when the class names were changed with the **chg-cmdclass** command.

rtrv-cmdclass:class=krb

```
eagle10404 04-01-22 16:30:56 EST EAGLE 31.3.0
class descr
krb my command class description
```

```
;
```

rtrv-cmdclass

```
eagle10404 04-01-22 16:30:56 EST EAGLE 31.3.0
class descr
link link maintenance commands
sa security administration commands
sys system maintenance commands
.
.
.
u01 configurable command class 1
krb my command class description
u03 configurable command class 3
dab your command class description
u05 configurable command class 5
.
.
.
u32 configurable command class 32
```

```
;
```

rtrv-csl**Retrieve Common Screening List**

Use this command to retrieve all Common Screening List (CSL) entries for a specified feature, a list of screening entries for the specified feature and screening list name, or a specific **ds** or **pc** value for a particular feature and screening list name. The Common Screening List commands are used to tailor certain types of general screening information to specific features.

Keyword: **rtrv-csl**

Related Commands: **chg-csl, dlt-csl, ent-csl, rtrv-ctrl-feat**

Command Class: Database Administration

Parameters

NOTE: See "Point Code Formats and Conversion" on page A-6 for a detailed description of point code formats, rules for specification, and examples.

:ds= (Optional)

Digit String. This parameter specifies a unique string of digits that is used by the specified screening feature.

NOTE: Either the **ds** or the **pc** parameter must be specified. Both parameters cannot be specified in the same command.

Range: 1 - 15 digits

Valid digits are **0-9, a-f, A-F**

1-15 digits—IDP Screening for Prepaid **insl** list

4 digits—IDP Screening for Prepaid **skts** list

1-15 digits—Prepaid IDP Query Relay **ccnc** list

1-5 digits—Prepaid IDP Query Relay **delpfx** list

1-6 digits—Prepaid IDP Query Relay **gta** list

1-4 digits—Prepaid IDP Query Relay **skbcsm** list

:feature= (Optional)

Feature Name. The name of the enabled screening feature for which the command is entered. Enter the entire feature name as it appears in the **rtrv-ctrl-feat** command description output example.

NOTE: Either the **pn** parameter or the **feature** parameter must be specified to identify the feature.

Range: *abcdefghijklmnopqrstuvwxyz*

1 alphabetic character and up to 24 optional alphanumeric characters, including spaces and special characters, enclosed in double quotation marks (" ").

The following feature names are valid for this command:

- IDP Screening for Prepaid
- Prepaid IDP Query Relay

:list= (Optional)

The name of Common Screening List that is associated with the feature.

NOTE: The **list** parameter must be specified when the feature uses more than one type of Common Screening List.

Range: **ccnc, delpfx, gt, insl, skbcsm, skts**

ccnc—CC+NC List

delpfx—Delete Prefix List

gt—Global Title List

insl—In Network Subscriber List

skbcsm—SK+BCSM List

skts—Service Key + TeleService List

The following screening lists are valid for the indicated features:

- **skts, insl**—IDP Screening for Prepaid
- **ccnc, delpfx, gt, skbcm**—Prepaid DP Query Relay feature

:pc= or :pca= (Optional)

ANSI point code with subfields *network indicator-network cluster-network cluster member* (*ni-nc-ncm*).

Range: **000-255**

Specify a valid value for each subfield of the point code, and separate the subfields with a dash (-).

When **chg-sid:pctype=ansi** is specified, *ni = 000* is not valid.

When **chg-sid:pctype=ansi** is specified, *nc = 000* is not valid if *ni = 001-005*.

When **chg-sid:pctype=ansi** is specified, *nc = 000* is valid if *ni = 006-255*.

The point code **000-000-000** is not a valid point code.

:pc/pca/pci/pcn/pcn24= (Optional)

Point code. Either the **ds** or **pc** parameter must be specified from this command.

Currently, there are no common screening list features that use point codes.

:pci= (Optional)

ITU international point code with subfields *zone-area-id*. The *prefix* subfield indicates a spare point code (*prefix-zone-area-id*).

Range: **s-, 0-255**

Specify a valid value for each subfield of the point code, and separate the subfields with a dash (-).

prefix—s-

zone—0-7

area—000-255

id—0-7

The point code **0-000-0** is not a valid point code.

:pcn= (Optional)

ITU national destination point code in the format of a 5-digit number (*nnnnn*); or 2, 3, or 4 numbers (members) separated by dashes (*m1-m2-m3-m4*) as defined by the

chg-stpopts:npcfmti flexible point code option. A group code must be specified when the ITUDUPPC feature is turned on (*nnnnn-gc, m1-m2-m3-m4-gc*). The *prefix* subfield indicates a spare point code (*prefix-nnnnn-gc, prefix-m1-m2-m3-m4-gc*).

Range: **s-, 0-16383, aa-zz**

Specify a valid value for each subfield of the point code, and separate the subfields with a dash (-).

prefix—s-

nnnnn—0-16383

gc—aa - zz

m1-m2-m3-m4—0-14 for each member; values must sum to 14

:pcn24= (Optional)

24-bit ITU national point code with subfields *main signaling area-sub signaling area-signaling point* (*msa-ssa-sp*).

Range: 000-255

Specify a valid value for each subfield of the point code, and separate the subfields with a dash (-).

msa—000-255

ssa—000-255

sp—000-255

Default: No change to current value.

:pn= (Optional)

Part Number. The 9-digit "893xxxxxx" part number of the feature for which the command is entered. The **rtrv-ctrl-feat** command description shows the part number in the command output example.

NOTE: Either the **pn** parameter or the **feature** parameter must be specified to identify the feature.

Range: 893000000-893999999

The first three digits are **893**. Do not separate the digits with dashes or spaces.

The following part numbers are valid for this command:

- 893015501—IDP Screening for Prepaid
- 893016001—Prepaid IDP Query Relay

Example

rtrv-csl

rtrv-csl:feature="IDP Screening for Prepaid":list=insl:ds=123456789bcdEF

rtrv-csl:feature="Prepaid IDP Query Relay":list=ccnc:ds=456789

rtrv-csl:feature="Prepaid IDP Query Relay":list=ccnc

Dependencies

The specified feature name must be for a feature that uses a Common Screening List.

The feature name must be specified as it appears in the **rtrv-ctrl-feat** command output example. The entire feature name must be specified.

The following features use a Common Screening List:

- IDP Screening for Prepaid
- Prepaid IDP Query Relay

The **list** parameter value must be valid for the specified screening feature.

The following **list** parameter values are valid for the indicated feature:

- **insl, skts**—IDP Screening for Prepaid feature
- **gt, ccnc, delpfx, skbcm**—Prepaid IDP Query Relay feature

The following parameters are allowed with the indicated common screening list type:

- **list=gt—ds** parameter
- **list=ccnc—ds** parameter
- **list=delpfx—ds** and **p1** parameters

- **list=skbcm—ds** parameter
- **list=insl—ds** parameter
- **list=skts—ds** parameter

Notes

None

Output

The following example retrieves all screening entries for all screening lists for all enabled screening list features:

rtrv-csl

```
tekelecstp 05-08-21 15:18:41 EST EAGLE 34.3.0
Prepaid IDP Query Relay
SK+BCSM List
DS
-----
3104
3212
4323
5434
6545
7566

SK+BCSM Screening List table is (6 of 25) 24% full

Prepaid IDP Query Relay
GT List
DS
-----
234
354
678
765
789
987

GT List table is (6 of 50) 12% full

Prepaid IDP Query Relay
Delete Prefix List
DS
-----
543
678
765
879
890

Delete Prefix List table is (5 of 10) 50% full

Prepaid IDP Query Relay
CC+NC List
DS
-----
7848
24574
67547
```

```

224723
656354
546535

```

CC+NC List table is (6 of 20) 30% full

```

IDP Screening for Prepaid
SK+TS List
DS
-----
1233
1234

```

SK+TS List table is (2 of 25) 8% full

```

IDP Screening for Prepaid
INSL List
DS
-----
1233
1235
123456789012345

```

INSL List table is (3 of 50) 6% full

;

The following example retrieves a specified screening entry for the specified feature and screening list:

rtrv-csl:feature="Prepaid IDP Query Relay":list=ccnc:ds=456789

```

tekelecstp 05-07-12 08:45:21 EST EAGLE 34.1.0
Prepaid IDP Query Relay
CC+NC List
DS
-----
456789

```

CC+NC List table is (1 of 20) 5% full

;

The following example retrieves all screening entries for the specified feature and screening list:

rtrv-csl:feature="Prepaid IDP Query Relay":list=ccnc

```

tekelecstp 05-07-12 08:44:50 EST EAGLE5 34.1.0
Prepaid IDP Query Relay
CC+NC Screening List
DS
-----
123
456789
754532

```

CC+NC List table is (3 of 20) 15% full

;

The following example retrieves all screening lists for the specified feature:

rtrv-csl:feature="Prepaid IDP Query Relay"

```
tekelecstp 05-07-12 08:44:50 EST EAGLE 34.1.0

Prepaid IDP Query Relay
CC+NC Screening List
DS
-----
123
456789
754532

CC+NC List table is (3 of 20) 15% full

Prepaid IDP Query Relay
Delete Prefix List
DS
-----
45678
75453

Delete Prefix List table is (2 of 10) 20% full

Prepaid IDP Query Relay
GT List
DS
-----
4567890123abcde

GT List table is (1 of 50) 2% full

Prepaid IDP Query Relay
SK+BCSM List
DS
-----
4321
8765

SK+BCSM List table is (2 of 25) 8% full
;
```

The following example retrieves list values for all screening lists for the IDP Screening for Prepaid feature.

rtrv-csl:feature="IDP Screening for Prepaid"

```
tekelecstp 06-03-01 08:44:50 EST EAGLE 34.3.0
rtrv-csl:pn=893015501
Command entered at terminal #4.

IDP Screening for Prepaid
SK+TS List
DS
-----
1233
1234

SK+TS List table is (2 of 25) 8% full
```

```

IDP Screening for Prepaid
INSL List
DS
-----
1233
1235
123456789012345

INSL List table is (3 of 50) 6% full

```

The following example retrieves all SKTS list entries for the IDP Screening for Prepaid feature.

rtrv-csl:pn=893015501:list=skts

```

tekelecstp 06-03-01 08:44:50 EST EAGLE 34.3.0
rtrv-csl:pn=893015501:list=skts
Command entered at terminal #4.

IDP Screening for Prepaid
SK+TS List
DS
-----
1233
1234

SK+TS List table is (2 of 25) 8% full

```

rtrv-cspc

Retrieve Concerned Signaling Point Code

Use this command to show one or more lists of concerned signaling point codes that are to be notified when subsystem-prohibited or subsystem-allowed messages are received for an associated mate application.

Keyword: rtrv-cspc

Related Commands: dlt-cspc, ent-cspc

Command Class: Database Administration

Parameters

:grp= (optional)

Group name

Range: 1 alphabetic character followed by up to 7 alphanumeric characters

Default: Retrieve all.

Example

```

rtrv-cspc
rtrv-cspc:grp=grp01

```

Dependencies

If specified, the group name must exist in the database.

Notes

If no group parameter is specified, a summary list of group names is displayed with an indication of network type and a percent full indication for each group.

Output

When the ANSI-ITU-China SCCP Conversion feature is on, point codes from mixed domains are allowed in a group.

When the Spare Point Code Support feature is on, groups can include spare point codes with the **s-** prefix.

rtrv-cspc

```
rlghncxa03w 04-01-07 11:43:02 EST EAGLE 31.3.0
CSPC GRP NETWORK PERCENT FULL
Grp01 ANSI 2%
Grp02 ANSI, ITU, ITU-N24 3%
Grp03 ITU 2%
;
```

rtrv-cspc:grp=grp02

```
rlghncxa03w 05-01-07 11:43:02 EST EAGLE 31.12.0
CSPC GRP PC Type
GRP02 001-012-123 A
001-012-124 A
7-089-0 I
s-2-021-4 I
s-00789 N
```

When the ANSI-ITU-China SCCP Conversion feature is not on, point codes from only one domain are allowed in a group.

When the Spare Point Code Support feature is on, groups can include spare point codes with the **s-** prefix.

rtrv-cspc:grp=grp02

```
tekelecstp 03-03-17 16:40:57 EST EAGKE 31.0.0
CSPC GRP PC Type
GRP02 001-012-123 A
001-012-124 A
001-012-007 I
023-012-126 N24
;
```

rtrv-cspc:grp=groupi

```
rlghncxa03w 05-01-07 11:43:02 EST EAGLE 31.12.0
CSPC GRP PCI
groupi 7-089-0
s-2-021-4
```

Legend

CSPC PC TABLE IS 15% FULL—The relative size of the CSPC point code tables.

CSPC GRP—The name of the CSPC broadcast group.

NETWORK—The network type or types associated with the point code or codes in the group. (When no parameters are specified in the command, only the groups are listed. The **grp** parameter must be specified to list the point codes in the specified group).

PERCENT FULL—The relative size of the CSPC broadcast group.

PC—The point codes that make up the CSPC broadcast group.

TYPE—The network type of the point code in the group. (The **grp** parameter is specified in the command to list the point codes in the specified group).

rtrv-ctrl-feat

Retrieve Controlled Feature

Use this command to retrieve the status of feature access key controlled features that are purchased and enabled in the system.

Keyword: rtrv-ctrl-feat

Related Commands: chg-ctrl-feat, enable-ctrl-feat

Command Class: Database Administration

Parameters

:enable= (optional)

Retrieve controlled features that are enabled with either temporary feature access keys or permanent feature access keys.

Range: temp, perm

Default: Retrieve controlled features for both temporary and permanent feature access keys

:expired= (optional)

Retrieve controlled features with expired temporary feature access keys.

Range: yes, no

Default: no

:partnum= (optional)

The Part Number to retrieve or the command.

Range: 893000000 - 893999999

Do not include dashes in the 9-digit number.

Default: Retrieve all controlled features

:status= (optional)

Retrieve features with the specified status (On or Off).

Range: on, off

Default: Retrieve features with On and Off status

Example

```
rtrv-ctrl-feat
```

```
rtrv-ctrl-feat:partnum=893000110
```

```
rtrv-ctrl-feat:enable=perm
```

Dependencies

None

Notes

When **enable=perm** is specified, the **expired** parameter value is understood to be **no**.

The product feature access keys (EAGLE5, EAGLE, and IP⁷) are not mutually exclusive. The hierarchy for product feature access keys is EAGLE5, then EAGLE, then IP⁷. This means that if the EAGLE5 feature access key is on, the product is EAGLE5 regardless of the setting of the other product feature access keys. Some features require that a specific product feature access key is enabled and turned on.

For systems being upgraded, the product feature access key for the specific product is turned on. For example, upgrading from IP⁷ Release 6.0 causes the IP⁷ product key to be enabled and turned on during the conversion.

For new installation, no product feature access keys are on. The appropriate key for the highest required product in the hierarchy must be enabled and turned on.

Output

NOTE: The following output examples will differ from the output shown at your terminal and might include features that are not supported in your system. A feature must be purchased before you can enable the feature and turn the feature on. If you are not sure whether you have purchased a feature, contact your Tekelec Sales Representative or Account Representative.

If a Part Number (**partnum** parameter) is entered that belongs to a feature associated with quantity, the output will show which quantity is currently enabled on the system, even if the specified Part Number is for a different quantity. The output will also include the temporary enabled information, if applicable.

rtrv-ctrl-feat

rlghncxa03w 05-01-29 16:40:40 EST EAGLE5 34.3.0

The following features have been permanently enabled:

Feature Name	Partnum	Status	Quantity
IPGWx Signaling TPS	893012805	on	2000
ISUP Normalization	893000201	on	----
Command Class Management	893005801	on	----
LNP Short Message Service	893006601	on	----
Prepaid SMS Intercept Ph1	893006701	on	----
Intermed GTT Load Sharing	893006901	on	----
G-Port Circ Route Prevent	893007001	on	----
XGTT Table Expansion	893006101	on	400000
XMAP Table Expansion	893007710	on	3000
Large System # Links	893005910	on	1500
Routesets	893006403	on	8000
EAGLE5 Product	893007101	on	----
EAGLE Product	893007201	off	----
IP7 Product	893007301	off	----
Network Security Enhance	893009101	off	----
Telnet	893005701	on	----
Port Chk for MO SMS	893009301	on	----
LNP ELAP Configuration	893010901	on	----
LNP ported TNs	893011014	on	192000000
LNP ported LRNs	893010501	on	150000
LNP ported NPANXXs	893009402	on	300000
HC-MIM SLK Capacity	893012707	on	64
15 Minute Measurements	893012101	off	----
EIR	893012301	on	----
EAGLE OA&M IP Security	893400001	off	----
SCCP Conversion	893012001	on	----
SE-HSL SLK Capacity	893013005	on	64
Flexible GTT Load Sharing	893015401	on	----
GSM Map Screening (GMS)	893013201	on	----
Enhanced GMS (EGMS)	893012401	on	----
MTP MAP Screening	893013501	on	----
Spare Point Code Support	893013601	on	----
GSM MAP SRI Redirect	893014001	on	----
ISUP NP with EPAP	893013801	on	----
Prepaid IDP Query Relay	893016001	on	----
IDP Screening for Prepaid	893015501	on	----

The following features have been temporarily enabled:

Feature Name	Partnum	Status	Quantity
Trial Period Left			
G-Port Circ Route Prevent	893007001	On	---- 20 days 8 hrs 57 mins

The following features have expired temporary keys:

Feature Name	Part Num
OnOffFeatV	

;

rtrv-ctrl-feat:partnum=893012805

rlghncxa03w 04-07-29 16:40:40 EST EAGLE 31.6.0

The following features have been permanently enabled:

Feature Name	Partnum	Status	Quantity
IPGWx Signaling TPS	893012805	on	2000

The following features have been temporarily enabled:

Feature Name	Partnum	Status	Quantity	Trial Period Left
Zero entries found.				

The following features have expired temporary keys:

Feature Name	Part Num
Zero entries found.	

;

rtrv-ctrl-feat:enable=perm

rlghncxa03w 05-06-29 16:40:40 EST EAGLE5 34.2.0

The following features have been permanently enabled:

Feature Name	Partnum	Status	Quantity
15 Minute Measurements	893012101	off	----
Command Class Management	893005801	on	----
EAGLE OA&M IP Security	893400001	off	----
EAGLE Product	893007201	on	----
EAGLE5 Product	893007101	off	----
EIR	893012301	on	----
Enhanced GMS (EGMS)	893012401	on	----
Flexible GTT Load Sharing	893015401	on	----
G-Port Circ Route Prevent	893007001	on	----
GSM Map Screening (GMS)	893013201	on	----
HC-MIM SLK Capacity	893012707	on	64
ICNP	893014801	on	----
Intermed GTT Load Sharing	893006901	on	----
IP7 Product	893007301	on	----
IPGWx Signaling TPS	893012805	on	2000
ISUP Normalization	893000201	on	----
Large System # Links	893005910	on	1500
LNP ELAP Configuration	893010901	on	----
LNP ported LRNs	893010501	on	150000
LNP ported NPANXXs	893009402	on	300000
LNP ported TNs	893011012	on	192000000
LNP Short Message Service	893006601	on	----
MTP MAP Screening	893013501	on	----
Network Security Enhance	893009101	on	----
Port Chk for MO SMS	893009301	on	----
Prepaid IDP Query Relay	893016001	on	----
Prepaid SMS Intercept Ph1	893006701	on	----
Routesets	893006401	on	6000
SCCP Conversion	893012001	on	----
SE-HSL SLK Capacity	893013005	on	32
Spare Point Code Support	893013601	on	----
Telnet	893005701	on	----
XGTT Table Expansion	893006101	on	400000
XMAP Table Expansion	893007710	on	3000

;

rtrv-ctrl-feat:enable=temp

```
rlghncxa03w 04-07-29 16:40:40 EST EAGLE 31.6.0
The following features have been temporarily enabled:
Feature Name          Partnum   Status   Quantity   Trial Period Left
G-Port Circ Route Prevent 893007001 On          ---- 20 days 8 hrs 57 mins
```

The following features have expired temporary keys:

```
Feature Name          Part Num
OnOffFeatV           893492401
```

;

rtrv-ctrl-feat:expired=yes

```
rlghncxa03w 04-02-29 16:40:40 EST EAGLE 31.3.0
The following features have expired temporary keys:
Feature Name          Part Num
OnOffFeatV           893492401
```

;

rtrv-dcmps**Retrieve Database Communication Module Parameter Set**

Use this command to retrieve the sets of generic timers and parameters that can be used by any system application.

Keyword: rtrv-dcmps

Related Commands: chg-dcmps

Command Class: Database Administration

Parameters

:set= (optional)

The set number.

Range: 1-10

Default: All parameter sets are displayed

Example

```
rtrv-dcmps:set=1
```

Dependencies

None

Notes

This command can be canceled using the **F9** function key or the **canc-cmd** command. See **canc-cmd** for more information.

Output

rtrv-dcmps:set=1

```
rlghncxa03w 04-02-17 15:35:05 EST EAGLE 31.3.0
SET  TIMER      TVALUE  PARM      PVALUE
  1      1         1200    1         1200
  1      2         1400    2         1200
  1      3         1400    3         4800
  1      4         1400    4         12000
  1      5         1600    5         1200
  1      6         1800    6         1200
  1      7         2000    7         1200
  1      8         4000    8         1200
  1      9  4294967295  9  4294967295
  1     10         6000   10        1200
```

TIMER 1: TALI T1 Timer, time (mS) between sending of TEST msgs by NE
TVALUE : Valid Range: 32-bits

TIMER 2: TALI T2 Timer, time (mS) to wait for response to TEST msg
TVALUE : Valid Range: 32-bits

TIMER 3: TALI T3 Timer, time (mS) to continue processing rcv'd service
msgs after NE is prohibited
TVALUE : Valid Range: 32-bits

TIMER 4: TALI T4 Timer, time (mS) between sending of MONI msgs by NE
TVALUE : Valid Range: 32-bits

PARAM 1: Type of Service (TOS), IP header socket option
PVALUE : Valid Range: lowest 8-bits

PARAM 2: Nagle's Algorithm, TCP socket option
PVALUE : Valid Range: lowest bit: 0 = Disable Nagle, 1 = Enable Nagle

PARAM 3: Default SORP Flags socket option. Each bit is used as an
enabled/disabled flag for a particular socket option.
PVALUE : Valid Range: 32-bits

BIT	BIT VALUE
0=Broadcast Phase MTPP Primitives;	0=Disabled , 1=Enabled
1=Response Method MTPP Primitives;	0=Disabled , 1=Enabled
2=SCCP with MTP;	0=Disabled , 1=Enabled
3=ISUP via MTP;	0=Disabled , 1=Enabled
4=Group Code in MTPP;	0=Disabled , 1=Enabled
5=Use XSRV;	0=Disabled , 1=Enabled
6-31=Reserved	

;

rtrv-dlk

Retrieve Data Link

Use this command to show the parameters of a TCP/IP data link.

Keyword: rtrv-dlk

Related Commands: act-dlk, canc-dlk, dlt-dlk, ent-dlk, rept-stat-dlk, tst-dlk

Command Class: Database Administration

Parameters

:ipaddr= (mandatory)

The TCP/IP data link's IP address. This is a TCP/IP address expressed in standard dot notation. IP addresses consist of the system's network number and the machine's unique host number. An example IP address is **192.126.100.5**, where **192.126.100** is the network number and **5** is the machine's host number.

Range: 1-223, 0-255

4 numbers separated by dots

1-223—first number

0-255—the other three numbers

Default: Display all.

:loc= (mandatory)

The card location as stenciled on the shelf of the system.

Range: 1101-1108, 1111-1112, 1201-1208, 1211-1218, 1301-1308, 1311-1318, 2101-2108, 2111-2118, 2201-2208, 2211-2218, 2301-2308, 2311-2318, 3101-3108, 3111-3118, 3201-3208, 3211-3218, 3301-3308, 3311-3318, 4101-4108, 4111-4118, 4201-4208, 4211-4218, 4301-4308, 4311-4318, 5101-5108, 5111-5118, 5201-5208, 5211-5218, 5301-5308, 5311-5318, 6101-6108, 6111-6118

Default: All TCP/IP data links are shown.

Example

```
rtrv-dlk
```

```
rtrv-dlk:loc=1201
```

```
rtrv-dlk:ipaddr=193.4.201.34
```

Dependencies

This command can be entered with no parameters or with one of the optional parameters **loc** or **ipaddr**; however, both **loc** and **ipaddr** cannot be specified in the same command.

The shelf and card must be equipped.

The specified card must have a TCP/IP data link assigned to it.

If the **ipaddr** parameter is specified, the IP address must be assigned to a TCP/IP data link.

Notes

None

Output

```
rtrv-dlk
```

```
eagle10110 05-07-29 14:14:14 EST EAGLE5 34.0.0
LOC IPADDR LINK SPEED
1107 10.254.113.33 10Mbit
1111 10.254.111.34 100Mbit
1108 10.254.112.33 10Mbit
1106 10.254.110.33 10Mbit
1105 10.254.111.33 10Mbit
1104 10.254.112.34 10Mbit
```

```

1103 10.254.113.34 10Mbit
;
rtrv-dlk:loc=1201
rlghncxa03w 05-07-29 14:14:14 EST EAGLE5 34.0.0
LOC IPADDR LINK SPEED
1201 193.4.201.34 10Mbit
;
rtrv-dlk:ipaddr=193.4.201.38
rlghncxa03w 05-07-29 14:14:14 EST EAGLE5 34.0.0
LOC IPADDR LINK SPEED
1205 193.4.201.38 10Mbit
;

```

The specified IP address is not assigned to a TCP/IP data link

```

rtrv-dlk:ipaddr=193.4.201.28
rlghncxa03w 04-02-19 21:16:48 EST EAGLE 31.3.0
LOC IPADDR
IPADDR not assigned to a TCP/IP Link.
;

```

There are no TCP/IP data links in the database.

```

rtrv-dlk
rlghncxa03w 04-02-19 21:16:48 EST EAGLE 31.3.0
LOC IPADDR
No TCP/IP Links are defined in the database.
;

```

The specified IP address is assigned to a TCP/IP node instead of a TCP/IP data link.

```

rtrv-dlk:ipaddr=193.4.201.63
rlghncxa03w 04-02-19 21:16:48 EST EAGLE 31.3.0
LOC IPADDR
IPADDR assigned to a TCP/IP Node.
;

```

Legend

IPADDR—The IP address associated with the interface on the data link.

LOC—The card location containing the data link.

LINK SPEED—The Ethernet link speed for the STPLAN cards.

rtrv-dstn

Retrieve Destination

Use this command to show the destination point code entries in the Destination point code table.

Keyword: rtrv-dstn

Related Commands: chg-dstn, chg-rte, dlt-dstn, dlt-rte, ent-dstn, ent-rte, rept-stat-dstn, rtrv-rte

Command Class: Database Administration

Parameters

NOTE: See “Point Code Formats and Conversion” in Appendix A for a detailed description of point code formats, rules for specification, and examples.

:aliasa/aliasi/aliasn/aliasn24= (optional)

Alias point code.

:aliasa= (optional)

ANSI alias point code with subfields *network indicator-network cluster-network cluster member* (*ni-nc-ncm*).

Range: **000-255, ***

Specify a valid value for each subfield of the point code, and separate the subfields with a dash (-).

The asterisk (*) value is not valid for the *ni* subfield.

When **chg-sid:pctype=ansi** is specified, *ni* = **000** is not valid.

When **chg-sid:pctype=ansi** is specified, *nc* = **000** is not valid if *ni* = **001-005**.

When **chg-sid:pctype=ansi** is specified, *nc* = **000** is valid if *ni* = **006-255**.

When **chg-sid:pctype=ansi** is specified, *ni*-*-* is valid if *ni* = **006-255**.

The point code **000-000-000** is not a valid point code.

:aliasi= (optional)

ITU international alias point code with subfields *zone-area-id*. This parameter is not valid if an ITU international (**dpci**) point code is entered. The *prefix* subfield indicates a spare point code (*prefix-zone-area-id*).

Range: **s-, 0-255**

Specify a valid value for each subfield of the point code, and separate the subfields with a dash (-).

prefix—s-

zone—0-7

area—000-255

id—0-7

The point code **0-000-0** is not a valid point code.

:aliasn= (optional)

ITU national alias point code in the format of a 5-digit number (*nnnnn*); or 2, 3, or 4 numbers (members) separated by dashes (*m1-m2-m3-m4*) as defined by the **chg-stpopts:npcfmti** flexible point code option. A group code must be specified when the ITUDUPPC feature is turned on (*nnnnn-gc*, *m1-m2-m3-m4-gc*). The *prefix* subfield indicates a spare point code (*prefix-nnnnn*, *prefix-nnnnn-gc*, *prefix-m1-m2-m3-m4*, *prefix-m1-m2-m3-m4-gc*).

Range: **s-, 0-16383, aa-zz**

Specify a valid value for each subfield of the point code, and separate the subfields with a dash (-).

prefix—s-

nnnnn—0-16383

gc—aa - zz

m1-m2-m3-m4—0-14 for each member; values must sum to 14

:aliasn24= (optional)

24-bit ITU national destination point code with subfields *main signaling area-sub signaling area-signaling point (msa-ssa-sp)*.

Range: 000-255

Specify a valid value for each subfield of the point code, and separate the subfields with a dash (-).

msa—000-255

ssa—000-255

sp—000-255

:cli= (optional)

The Common Language Location Identifier assigned to this link.

Range: 1 alphabetic character followed by 10 alphanumeric characters

Default: none

:dpc/dpca/dpci/dpcn/dpcn24= (optional)

Destination point code.

:dpc= or **:dpca=** (optional)

ANSI destination point code with subfields *network indicator-network cluster-network cluster member (ni-nc-ncm)*. The *prefix* subfield indicates a private point code (*prefix-ni-nc-ncm*).

Range: p-, 000-255, *

Specify a valid value for each subfield of the point code, and separate the subfields with a dash (-).

prefix—p-

The asterisk (*) value is not valid for the *ni* subfield.

When **chg-sid:pctype=ansi** is specified, *ni* = 000 is not valid.

When **chg-sid:pctype=ansi** is specified, *nc* = 000 is not valid if *ni* = 001-005.

When **chg-sid:pctype=ansi** is specified, *nc* = 000 is valid if *ni* = 006-255.

When **chg-sid:pctype=ansi** is specified, *ni*-*-* is valid if *ni* = 006-255.

The point code 000-000-000 is not a valid point code.

:dpci= (optional)

ITU international destination point code with subfields *zone-area-id*. The *prefix* subfield indicates a spare point code, private point code, or private and spare point code (*prefix-zone-area-id*).

Range: s-, p-, ps, 0-255

Specify a valid value for each subfield of the point code, and separate the subfields with a dash (-).

The point code 0-000-0 is not a valid point code.

prefix—s-, p-, ps-

zone—0-7

area—000-255

id—0-7

:dpcn= (optional)

ITU national destination point code in the format of a 5-digit number (*nnnnn*); or 2, 3, or 4 numbers (members) separated by dashes (*m1-m2-m3-m4*) as defined by the

chg-stpopts:npcfnti flexible point code option. A group code must be specified when the ITUDUPPC feature is turned on (*nnnnn-gc*, *m1-m2-m3-m4-gc*). The *prefix* subfield indicates a spare point code, private point code, or private and spare point code (*prefix-nnnnn*, *prefix-nnnnn-gc*, *prefix-m1-m2-m3-m4*, *prefix-m1-m2-m3-m4-gc*).

Range: **s-, p-, ps-, 0-16383, aa-zz**

Specify a valid value for each subfield of the point code, and separate the subfields with a dash (-).

prefix—**s-, p-, ps-**

nnnnn—**0-16383**

gc—**aa - zz**

m1-m2-m3-m4—**0-14** for each member; values must sum to 14

:dpcn24= (optional)

24-bit ITU national destination point code with subfields *main signaling area-sub signaling area-signaling point* (*msa-ssa-sp*). The *prefix* subfield indicates a private point code (*prefix-msa-ssa-sp*).

Range: **p-, 000-255**

Specify a valid value for each subfield of the point code, and separate the subfields with a dash (-).

prefix—**p-**

msa—**000-255**

ssa—**000-255**

sp—**000-255**

:msar= (optional)

Memory space accounting report. When the NRT feature or the CRMD feature, or both, is turned on, this parameter lets you choose whether summary or detail destination table memory space accounting information is displayed. The **summary** report or the **detail** report appears following the destination information that is requested by entering the command with or without other parameters. The **only** parameter value displays a detail destination table memory space accounting report without any other destination information. (If neither feature is on, only the summary report information is displayed; the detail report information cannot be displayed).

Range: **detail, only, summary**

Default: **detail**—if **rtrv-dstn** is entered with no parameters

summary—if **rtrv-dstn** is entered with parameters

:ncai= (optional)

Nested cluster allowed indicator. The NCAI specifies whether the route to the cluster point code can be different for provisioned members of the cluster. This parameter lets you choose whether you want to display clusters with nested cluster point codes (**ncai=yes**), or clusters that do not allow nested cluster point codes (**ncai=no**).

Range: **yes, no**

yes—Display clusters with the **ncai** set to **yes**

no—Display clusters with the **ncai** set to **no**

:pcst= (optional)

Point code subtype. The command displays only point codes with no subtype prefix or only point codes of the specified subtype.

Range: none, p, ps, s

none— Display only point codes without subtype prefixes

p—Display only private point codes (subtype prefix p-)

ps—Display only private and spare point codes (subtype prefix ps-)

s—Display only spare point codes (subtype prefix s-)

:pctype= (optional)

Point code network domain. The command displays only point codes of the specified type.

Range: ansi, itui, itun, itun24

ansi— Display only ANSI point codes

itui—Display only ITU International point codes

itun—Display only ITU National point codes

itun24—Display only 24-bit ITU National point codes

:spc/spca/spci/spcn/spcn24= (optional)

Secondary point code.

:spc or :spca= (optional)

ANSI secondary point code with subfields *network indicator-network cluster-network cluster member (ni-nc-ncm)*. The *prefix* subfield indicates a private point code (prefix-ni-nc-ncm).

Range: p-, 000-255

Specify a valid value for each subfield of the point code, and separate the subfields with a dash (-).

prefix—p-

When **chg-sid:pctype=ansi** is specified, *ni* = 000 is not valid.

When **chg-sid:pctype=ansi** is specified, *nc* = 000 is not valid if *ni* = 001-005.

When **chg-sid:pctype=ansi** is specified, *nc* = 000 is valid if *ni* = 006-255.

The point code 000-000-000 is not a valid point code.

:spci= (optional)

ITU international secondary point code with subfields *zone-area-id*. The *prefix* subfield indicates a spare point code, private point code, or private and spare point code (*prefix-zone-area-id*).

Range: s-, p-, ps-, 0-255

Specify a valid value for each subfield of the point code, and separate the subfields with a dash (-).

The point code 0-000-0 is not a valid point code.

prefix—s-, p-, ps-

zone—0-7

area—000-255

id—0-7

:spcn= (optional)

ITU national secondary point code in the format of a 5-digit number (*nnnnn*); or 2, 3, or 4 numbers (members) separated by dashes (*m1-m2-m3-m4*) as defined by the **chg-stpopts:npcfnti** flexible point code option. A group code must be specified when the ITUDUPPC feature is turned on (*nnnnn-gc*, *m1-m2-m3-m4-gc*). The *prefix* subfield indicates a spare point code, private point code, or private and spare point code (*prefix-nnnnn*, *prefix-nnnnn-gc*, *prefix-m1-m2-m3-m4*, *prefix-m1-m2-m3-m4-gc*).

Range: **s-**, **0-16383**, **aa-zz**

Specify a valid value for each subfield of the point code, and separate the subfields with a dash (-).

prefix—**s-**, **p-**, **ps-**

nnnnn—**0-16383**

gc—**aa - zz**

m1-m2-m3-m4—**0-14** for each member; values must sum to 14

:spcn24= (optional)

24-bit ITU national secondary point code with subfields *main signaling area-sub signaling area-signaling point* (*msa-ssa-sp*). The *prefix* subfield indicates a private point code (*prefix-msa-ssa-sp*).

Range: **p-**, **000-255**

Specify a valid value for each subfield of the point code, and separate the subfields with a dash (-).

prefix—**p-**

msa—**000-255**

ssa—**000-255**

sp—**000-255**

Example

The following example displays all encountered destination point codes that are members of network cluster **20-2** as well as the cluster address:

```
rtrv-dstn:dpca=20-2.***
```

The following example displays the destination with an ANSI alias of **222-200-200**:

```
rtrv-dstn:aliasa=222-200-200
```

The following example displays all encountered ANSI alias destination point codes that have a network indicator (**ni**) of **222** and a network cluster (**nc**) of **200**:

```
rtrv-dstn:aliasa=222-200.**
```

The following example displays the destination with a CLLI of **rlghncbb001**:

```
rtrv-dstn:clli=rlghncbb001
```

The following example displays the secondary point code **6-6-6**:

```
rtrv-dstn:spc=6-6-6
```

The following example displays the retrieval of clusters with **ncai** set to **yes**:

```
rtrv-dstn:ncai=yes
```

The following example displays a single cluster (the NRT feature must be turned on):

```
rtrv-dstn:dpc=010-*.*
```

The following example displays a single ITU national destination (the ITUDUPPC feature must be turned on):

```
rtrv-dstn:dpcn=3-15-15-15-fr:spc=1-15-15-15-fr
```

The following example displays all ITU national group codes by duplicate point code:

```
rtrv-dstn:dpcn=2050-*
```

The following example displays all ITU national point codes within a group code:

```
rtrv-dstn:dpcn=*-fr
```

The following example displays 24-bit ITU national point code **15-100-10**:

```
rtrv-dstn:dpcn24=15-100-10
```

The following example displays 24-bit ITU national secondary point code **99-99-99**:

```
rtrv-dstn:spcn24=99-99-99
```

The following example displays 24-bit ITU national alias point code **4-4-4**:

```
rtrv-dstn:aliasn24=4-4-4
```

The following example displays a private point code:

```
rtrv-dstn:dpcn=p-12-12-12
```

The following examples display a private and spare point code:

```
rtrv-dstn:dpcn=ps-123
```

```
rtrv-dstn:dpci=ps-1-234-1
```

The following example displays all ANSI private point codes:

```
rtrv-dstn:pctype=ansi:pcst=p
```

The following example displays all ITU international spare point codes:

```
rtrv-dstn:pctype=itui:pcst=s
```

The following example displays all ITU national private and spare point codes:

```
rtrv-dstn:pctype=itun:pcst=ps
```

The following example displays all 24-bit ITU national private point codes:

```
rtrv-dstn:pctype=itun24:pcst=p
```

The following example displays all ANSI point codes that do not have point code subtype prefixes:

```
rtrv-dstn:pctype=ansi
```

The following example displays all ITU international point codes that do not have point code subtype prefixes:

```
rtrv-dstn:pctype=itui
```

The following example displays all ITU national point codes that do not have point code subtype prefixes:

rtrv-dstn:pctype=itun

The following example displays all 24-bit ITU national point codes that do not have point code subtype prefixes:

rtrv-dstn:pctype=itun24

The following example displays all point codes that do not have point code subtype prefixes:

rtrv-dstn:pcst=none

The following example displays all private point codes:

rtrv-dstn:pcst=p

The following example displays all spare point codes:

rtrv-dstn:pcst=s

The following example displays all private and spare point codes:

rtrv-dstn:pcst=ps

Dependencies

NOTE: A *full point code* contains numerical values for all three segments of the point code.

Only one destination point code parameter, or one alias point code parameter, or one CLLI parameter can be specified in the command; these parameters cannot be specified together in the command.

The specified destination address must already be defined in the Destination point code table.

If the **dpcn** parameter or the **aliasn** parameter is specified, the format must match the format that was assigned with the **chg-stpopts:npcfmti** parameter.

If specified (except when **spc=none**), the secondary point code must be a full point code.

Cluster destinations are allowed only if the Cluster Routing Management and Diversity (CRMD) feature is turned on.

Alias point codes must be specified as full point codes.

If specified, the **cli** parameter value must already be defined in the Route table.

When the **msar=only** parameter is specified, no other parameters can be specified in the command.

Network routing is valid only if the Network Routing (NRT) feature is turned on.

When using network routing, if the destination point code has a value of * in the *nc* subfield, the *ncm* subfield must also be * (for example, **dpc=21-*.***).

The **pcst** parameter value **s** or **ps** cannot be specified when the **pctype** value **ansi** or **itun24** is specified.

The **pctype** and **pcst** parameters cannot be specified in the same command with the destination point code, alias point code, secondary point code, **cli**, **msar=only**, and **ncai** parameters.

Notes

This command can be canceled using the **F9** function key or the **canc-cmd** command. See **canc-cmd** for more information.

In this command, only ITU-international and ITU national point codes and aliases support the spare point code subtype prefix (**s-**). Only ITU-international and ITU national point codes support the private and spare point code subtype prefix (**ps-**). All of the point code types support the private (internal) point code subtype prefix (**p-**). Aliases do not support the private (internal) point code prefix.

Table 7-12 on page 7-325 provides a summary description of the reports that are produced by the various DPC parameter syntaxes.

Table 7-12. Summary of DPC Parameter Syntaxes

DPC format	Meaning
rtrv-dstn:dpc=ni-nc-ncm	Requests a report for fully provisioned destination <i>ni-nc-ncm</i> .
rtrv-dstn:dpc=ni-*-*	Requests a report for provisioned network destination with the specified network indicator. Note that if * is specified in the <i>nc</i> field, * must be specified in the <i>ncm</i> field.
rtrv-dstn:dpc=ni-**-*	Requests a report for the full network cluster for the specified <i>ni</i> .
rtrv-dstn:dpc=ni-***.*	Requests a report for the full network cluster and the network cluster address (if any) for the specified <i>ni</i> .
rtrv-dstn:dpc=ni-nc-*	Requests a report for provisioned cluster destination <i>ni-nc-*</i> .
rtrv-dstn:dpc=ni-nc-**	Requests a report showing all destinations whose network (<i>ni</i>) and cluster (<i>nc</i>) components match those specified. Note, however, that the network cluster address on <i>ni-nc-*</i> (if it exists) is not reported.
rtrv-dstn:dpc=ni-nc-***	Requests a report showing all destinations whose network (<i>ni</i>) and cluster (<i>nc</i>) components match those specified. The network cluster address <i>ni-nc-*</i> (if it exists) is also reported.
rtrv-dstn:dpcn24=msa-ssa-sp	Requests a report for fully provisioned 24-bit ITU-N destination <i>main signaling area-sub signaling area-signaling point</i> .

Output

Destination Table Memory Space Accounting Information

Each output example for this command shows the display of destination table memory space accounting information. The **msar** parameter value and the NCR, NRT, and CRMD feature bit settings determine whether a summary report or a detail report is displayed.

Summary Report

rtrv-dstn:msar=only

```
rlghncxa03w 04-09-17 16:02:05 EST  EAGLE 31.8.0
Destination table is (0 of 2000) 0% full
Alias table is (0 of 12000) 0% full
RTRV-DSTN: MASP A - COMPLTD
```

;

When the NCR, NRT, and CRMD features are off, the summary report is displayed when the command is entered with and without parameters specified and for all of the **msar** parameter values. The detail report cannot be displayed. The summary information appears at the end of the requested destination information, or appears without any other destination information when the **msar=only** parameter is specified.

When one or more of the NCR, NRT, and CRMD features are on, the summary report is displayed:

- When the command is entered with one or more parameters to select the specific destination information to be displayed. The summary information appears at the end of the requested destination information. (The **msar=summary** parameter value is the default in this case).
- When the command is entered with only the **msar=summary** parameter specified. The summary information appears at the end of the destination information.

The maximum number of destinations that can be provisioned depends on the Routes and Routesets quantity features that are on in the system (see the **rtrv-feat dstn5000** entry and the **rtrv-ctrl-feat Routesets** entry). The **chg-stpopts** command **mtpdpcq** parameter must be set to the value of the Routes or Routesets quantity feature to allow the maximum number of destinations to be provisioned.

The number currently provisioned is the value x, the allowed maximum is the value y, and the table percent full is the value z shown in the following first line of the summary report:

```
Destination table is (x of y) z% full
```

- When no Routes or Routesets quantity features are on in the system, a maximum of 2000 destinations can be provisioned.
- When the DSTN5000 (5000 Routes) feature bit is on, a maximum of 5000 destinations can be provisioned.
- When the 6000, 7000, or 8000 Routesets quantity feature is enabled, a maximum of the corresponding number of destinations can be provisioned.

The maximum number of aliases that can be provisioned depends on the quantity features that are on in the system (see the **rtrv-feat dstn5000** entry and the **rtrv-ctrl-feat Routesets** entry). The number currently provisioned is the x value, the allowed maximum is the y value, and the table percent full is the z value shown in the following second line of the summary report:

```
Alias table is (x of y) z% full
```

- When no Routes or Routesets quantity features are on in the system, a maximum of 12000 aliases can be provisioned.
- When the DSTN5000 feature bit is on, a maximum of 12000 aliases can be provisioned.
- When the 6000 Routesets feature quantity is enabled, a maximum of 12000 aliases can be provisioned.
- When the 7000, or 8000 Routesets quantity feature is enabled, a maximum of 8000 aliases can be provisioned.

Detail Report

rtrv-dstn:msar=only

```
rlghncxa03w 04-09-17 16:02:05 EST EAGLE 31.8.0
DESTINATION ENTRIES ALLOCATED: 2000
  FULL DPC(s): 0
  NETWORK DPC(s): 0
  CLUSTER DPC(s): 0
  TOTAL DPC(s): 0
  CAPACITY (% FULL): 0%
ALIASES ALLOCATED: 12000
  ALIASES USED: 0
  CAPACITY (% FULL): 0%
X-LIST ENTRIES ALLOCATED: 500
RTRV-DSTN: MASP A - COMPLTD
```

```
;
```

When the NCR, NRT, and CRMD features are off, the detail report cannot be displayed.

When one or more of the NCR, NRT, or CRMD features are on, the detail report is displayed:

- When the command is entered with no parameters. The detail report appears at the end of the destination information. (The **msar=detail** parameter value is the default in this case).
- When the **msar=detail** parameter is specified with one or more other parameters to select the specific destination information to be displayed. The detail report appears at the end of the requested destination information.
- When the **msar=only** parameter is specified. The detail report appears with no other destination information.

The maximum number of destinations that can be provisioned depends on the Routes and Routesets quantity features that are on in the system (see the **rtrv-feat dstn5000** entry and the **rtrv-ctrl-feat Routesets** entry). The **chg-stpopts mtpdpcq** parameter must be set to the value of the quantity feature to allow the maximum number of destinations to be provisioned. The possible maximum numbers of destinations are described in the *Summary Report* section.

In the example of the detail report, the allowed maximum number of destinations is the DESTINATION ENTRIES ALLOCATED value. The list of values under the allocated value includes the TOTAL DPCs currently provisioned and the Destination table CAPACITY (% FULL).

The allowed maximum number of aliases is the ALIASES ALLOCATED value. The list of values under the allocated value include the current number of ALIASES USED and the Aliases table CAPACITY (% FULL). The possible maximum numbers of aliases are described in the *Summary Report* section.

rtrv-dstn Output Examples

The following example shows the display of an empty Destination table when the NCR, NRT, and CRMD features are off and no Routes or Routesets quantity features are on.

rtrv-dstn

```
rlghncxa03w 04-09-17 16:02:05 EST EAGLE 31.8.0

DPCA          CLLI          BEI ELEI  ALIASI          ALIASN/N24  DOMAIN
DPCI          CLLI          BEI ELEI  ALIASA          ALIASN/N24  DOMAIN
DPCN          CLLI          BEI ELEI  ALIASA          ALIASI       DOMAIN
DPCN24        CLLI          BEI ELEI  ALIASA          ALIASI       DOMAIN

No destinations meeting the requested criteria were found

Destination table is (0 of 2000) 0% full
Alias table is (0 of 12000) 0% full
RTRV-DSTN: MASP A - COMPLTD
```

;

The following example shows the display of an empty Destination table when one or more of the NCR, NRT, or CRMD features are turned on and no Routes or Routesets features are on.

rtrv-dstn

```
rlghncxa03w 04-09-17 16:02:05 EST EAGLE 31.8.0

DPCA          CLLI          BEI ELEI  ALIASI          ALIASN/N24  DOMAIN
DPCI          CLLI          BEI ELEI  ALIASA          ALIASN/N24  DOMAIN
DPCN          CLLI          BEI ELEI  ALIASA          ALIASI       DOMAIN
DPCN24        CLLI          BEI ELEI  ALIASA          ALIASI       DOMAIN

No destinations meeting the requested criteria were found
```

```

DESTINATION ENTRIES ALLOCATED: 2000
  FULL DPC(s): 0
  NETWORK DPC(s): 0
  CLUSTER DPC(s): 0
  TOTAL DPC(s): 0
  CAPACITY (% FULL): 0%
ALIASES ALLOCATED: 12000
  ALIASES USED: 0
  CAPACITY (% FULL): 0%
X-LIST ENTRIES ALLOCATED: 500
RTRV-DSTN: MASP A - COMPLTD

```

;

The following example shows the display of all provisioned destinations.

rtrv-dstn

```

rlghncxa03w 04-09-17 16:02:05 EST EAGLE 31.8.0
DPCA          CLLI          BEI  ELEI  ALIASI          ALIASN/N24  DOMAIN
001-056-002  ----- no ---  1-056-2        16000      SS7
001-056-003  ----- no ---  -----        -----      SS7
001-056-004  ----- no ---  -----        -----      SS7
001-056-006  ----- no ---  -----        -----      SS7
002-056-000  ----- no ---  -----        00500      SS7
002-056-002  ----- no ---  -----        -----      SS7
002-056-003  ----- no ---  -----        -----      SS7
002-156-*    ----- no no  -----        -----      SS7
001-067-001  ----- no ---  -----        -----      X25

DPCI          CLLI          BEI  ELEI  ALIASA          ALIASN/N24  DOMAIN
1-056-5      ----- no ---  001-056-005    -----      SS7
1-067-0      ----- no ---  -----        -----      SS7

DPCN          CLLI          BEI  ELEI  ALIASA          ALIASI        DOMAIN
00600        tekmate       no ---  -----        -----      SS7

DPCN24        CLLI          BEI  ELEI  ALIASA          ALIASI        DOMAIN

Destination table is (12 of 2000) 1% full
Alias table is (4 of 12000) 1% full
RTRV-DSTN: MASP A - COMPLTD

```

;

The following example appears when the display of a specific ANSI destination point code is requested, and when the single SPC assigned to that ANSI destination point code is requested

rtrv-dstn:dpca=001-056-002

or

rtrv-dstn:spc=1-56-2

```

rlghncxa03w 04-09-17 16:02:05 EST EAGLE 31.8.0
DPCA          CLLI          BEI  ELEI  ALIASI          ALIASN/N24  DOMAIN
001-056-002  ----- no ---  1-056-2        16000      SS7
              SPC          NCAI
              001-056-005  no

Destination table is (12 of 2000) 1% full
Alias table is (4 of 12000) 1% full
RTRV-DSTN: MASP A - COMPLTD

```

;

The following example shows the display of a destination by SPC where multiple destinations are assigned to the specified SPC.

rtrv-dstn:spc=001-056-005

```
rlghncxa03w 04-09-17 16:02:05 EST EAGLE 31.8.0
DPCA          CLLI          BEI ELEI  ALIASI          ALIASN/N24  DOMAIN
001-056-002  ----- no   ---  1-056-2      16000      SS7

                SPC          NCAI
                001-056-005  ----

001-056-003  ----- no   ---  1-056-2      16000      SS7

                SPC          NCAI
                001-056-005  ----

Destination table is (11 of 2000) 1% full
Alias table is (4 of 12000) 1% full
RTRV-DSTN: MASP A - COMPLTD
```

;

The following example displays the retrieval of clusters with **ncai** set to **yes**.

rtrv-dstn:ncai=yes

```
rlghncxa03w 04-09-17 16:02:05 EST EAGLE 31.8.0
DPCI          CLLI          BEI ELEI  ALIASA          ALIASN/N24  DOMAIN
010-010-*    ----- no   no   -----          -----  SS7

                SPC          NCAI
                ----- yes

010-001-*    ----- yes yes -----          -----  SS7

                SPC          NCAI
                ----- yes

Destination table is (11 of 2000) 1% full
Alias table is (4 of 12000) 1% full
RTRV-DSTN: MASP A - COMPLTD
```

;

The following example displays the retrieval of a single cluster with **ncai** set to **yes**.

rtrv-dstn:dpc=010-010-*

```
rlghncxa03w 04-09-17 16:02:05 EST EAGLE 31.8.0
DPCI          CLLI          BEI ELEI  ALIASA          ALIASN/N24  DOMAIN
010-010-*    ----- no   no   -----          -----  SS7

                SPC          NCAI
                ----- yes

Destination table is (11 of 2000) 1% full
Alias table is (4 of 12000) 1% full
RTRV-DSTN: MASP A - COMPLTD
```

;

The following example displays the retrieval of clusters with **ncai** set to **no**.

rtrv-dstn:ncai=no

```
rlghncxa03w 04-09-17 16:02:05 EST EAGLE 31.8.0
DPCI          CLLI          BEI  ELEI  ALIASA          ALIASN/N24  DOMAIN
040-010-*    -----  no  no  -----  -----  SS7
              SPC          NCAI
              -----  no

040-001-*    -----  yes yes  -----  -----  SS7
              SPC          NCAI
              -----  no

Destination table is (11 of 2000) 1% full
Alias table is (4 of 12000) 1% full
RTRV-DSTN: MASP A - COMPLTD
```

;

The following example displays a single cluster with the NRT feature turned on.

rtrv-dstn:dpc=010-*-*

```
rlghncxa03w 04-09-17 16:02:05 EST EAGLE 31.8.0
DPCI          CLLI          BEI  ELEI  ALIASA          ALIASN/N24  DOMAIN
010-*-*      -----  no  no  -----  -----  SS7
              SPC          NCAI
              -----  no

Destination table is (11 of 2000) 1% full
Alias table is (4 of 12000) 1% full
RTRV-DSTN: MASP A - COMPLTD
```

;

The following example displays a single ITU national destination with the ITUDUPPC (ITU duplicate point code) feature turned on:

rtrv-dstn:dpcn=3-15-15-15-fr:spc=1-15-15-15-fr

```
rlghncxa03w 04-09-17 16:02:05 EST EAGLE 31.8.0
DPCN          CLLI          BEI  ELEI  ALIASA          ALIASI          DOMAIN
3-15-15-15-FR -----  no  ---  -----  -----  SS7
              SPC          NCAI
              1-15-15-15-FR ---

Destination table is (11 of 2000) 1% full
Alias table is (4 of 12000) 1% full
RTRV-DSTN: MASP A - COMPLTD
```

;

The following example displays all ITU national group codes by duplicate point code:

rtrv-dstn:dpcn=2050-*

```

rlghncxa03w 04-09-17 16:02:05 EST EAGLE 31.8.0
DPCN        CLLI        BEI    ELEI    ALIASA    ALIASI    DOMAIN
2050-AA     -----          no     ---     -----     -----     SS7
                SPC                NCAI
                -----          ----

2050-AF     -----          yes    ---     -----     -----     SS7
                SPC                NCAI
                4081-AF          ----

2050-FR     -----          no     ---     -----     -----     SS7
                SPC                NCAI
                4083-FR          ----

Destination table is (11 of 2000) 1% full
Alias table is (4 of 12000) 1% full
RTRV-DSTN: MASP A - COMPLTD

```

;

The following example displays all ITU national point codes within a group code:

rtrv-dstn:dpcn=*-fr

```

rlghncxa03w 04-09-17 16:02:05 EST EAGLE 31.8.0
DPCN        CLLI        BEI    ELEI    ALIASA    ALIASI    DOMAIN
2050-FR     -----          no     ---     -----     -----     SS7
                SPC                NCAI
                4082-FR          ----

DPCN        CLLI        BEI    ELEI    ALIASA    ALIASI    DOMAIN
4080-FR     -----          no     ---     -----     -----     SS7
                SPC                NCAI
                4082-FR          ----

DPCN        CLLI        BEI    ELEI    ALIASA    ALIASI    DOMAIN
7040-FR     -----          no     ---     -----     -----     SS7
                SPC                NCAI
                4082-FR          ----

Destination table is (11 of 2000) 1% full
Alias table is (4 of 12000) 1% full
RTRV-DSTN: MASP A - COMPLTD

```

;

The following example displays a single cluster with the NRT feature turned on and with the DSTN5000 feature turned on.

rtrv-dstn:dpc=010-*.*

```

rlghncxa03w 04-09-17 16:02:05 EST EAGLE 31.8.0
DPCI        CLLI        BEI  ELEI  ALIASA    ALIASN/N24  DOMAIN
010-*. *    -----          no   no     -----     -----     SS7

                SPC                NCAI
                -----          no

Destination table is (3 of 6000) 1% full
Alias table is (4 of 12000) 1% full
RTRV-DSTN: MASP A - COMPLTD

```

;

The following examples show output when the 6000 Routesets feature is turned on and the CRMD feature is on:

rtrv-dstn

```
rlghncxa03w 04-09-17 16:02:05 EST EAGLE 31.8.0
DPCI          CLLI          BEI ELEI  ALIASA          ALIASN/N24  DOMAIN
003-003-003  ----- no  ---  -----  -----  SS7
004-004-004  ----- no  ---  -----  -----  SS7
005-005-005  ----- no  ---  -----  -----  SS7
008-001-*    ----- no  no  -----  -----  SS7

DPCI          CLLI          BEI ELEI  ALIASA          ALIASN          DOMAIN
DPCN          CLLI          BEI ELEI  ALIASA          ALIASI          DOMAIN

DESTINATION ENTRIES ALLOCATED:  6000
  FULL DPC(s):                    3
  NETWORK DPC(s):                  0
  CLUSTER DPC(s):                  1
  TOTAL DPC(s):                    4
  CAPACITY (% FULL):               1%
ALIASES ALLOCATED:                 12000
  ALIASES USED:                    0
  CAPACITY (% FULL):               0%
X-LIST ENTRIES ALLOCATED:          500
RTRV-DSTN: MASP A - COMPLTD
```

;

rtrv-dstn:dpc=8-1-*

```
rlghncxa03w 04-09-17 16:02:05 EST EAGLE 31.8.0
DPCI          CLLI          BEI ELEI  ALIASA          ALIASN/N24  DOMAIN
008-001-*    ----- no  no  -----  -----  SS7

          SPC          NCAI
          ----- no

Destination table is (4 of 6000) 1% full
Alias table is (0 of 12000) 0% full
RTRV-DSTN: MASP A - COMPLTD
```

;

The following example displays a 24-bit ITU-N secondary point code assigned to a 24-bit ITU-N destination point code:

rtrv-dstn:spcn24=99-99-99

or

rtrv-dstn:dpcn24=12-12-12

```
rlghncxa03w 04-09-17 16:02:05 EST EAGLE 31.8.0
DPCN24        CLLI          BEI ELEI          ALIASI          DOMAIN
012-012-012  ----- no  ---  -----  -----  SS7

          SPC          NCAI
          099-099-099  ----

Destination table is (1 of 2000) 1% full
Alias table is (0 of 12000) 0% full
RTRV-DSTN: MASP A - COMPLTD
```

;

The following example displays a specific 24-bit ITU-N alias point code:

rtrv-dstn:aliasn24=4-4-4

```
rlghncxa03w 04-09-17 16:02:05 EST EAGLE 31.8.0
DPCI          CLLI          BEI ELEI  ALIASA          ALIASN/N24  DOMAIN
1-006-1      ----- no --- ----- 004-004-004  SS7

                SPC          NCAI
                ----- ----
```

```
Destination table is (1 of 2000) 1% full
Alias table is (1 of 12000) 1% full
RTRV-DSTN: MASP A - COMPLTD
```

;

The following example displays an ANSI destination point code with a 24-bit ITU-N alias point code:

rtrv-dstn:alias24=10-2-2

```
rlghncxa03w 04-09-17 16:02:05 EST EAGLE 31.8.0
DPCA          CLLI          BEI ELEI  ALIASI          ALIASN/N24  DOMAIN
010-002-002  ----- no --- ----- 016-123-031  SS7

                SPC          NCAI
                ----- ----
```

```
Destination table is (1 of 2000) 1% full
Alias table is (1 of 12000) 1% full
RTRV-DSTN: MASP A - COMPLTD
```

;

The following example displays all destinations in the database, including a 24-bit ITU-N destination:

rtrv-dstn

```
rlghncxa03w 04-09-17 16:02:05 EST EAGLE 31.8.0
DPCA          CLLI          BEI ELEI  ALIASI          ALIASN/N24  DOMAIN
101-006-231  ----- no --- ----- 209-113-045  SS7

DPCI          CLLI          BEI ELEI  ALIASA          ALIASN/N24  DOMAIN
1-006-1      ----- no --- ----- 009-009-009  SS7

DPCN          CLLI          BEI ELEI  ALIASA          ALIASI          DOMAIN
DPCN24        CLLI          BEI ELEI  ALIASA          ALIASI          DOMAIN
012-012-012  ----- no --- ----- 5-005-5      SS7
```

```
Destination table is (3 of 2000) 1% full
Alias table is (3 of 12000) 1% full
RTRV-DSTN: MASP A - COMPLTD
```

;

The following example includes output for linksets that contain spare, private, and spare point codes.

rtrv-dstn:dpci=ps-5-120-1

```

tekelecstp 05-01-20 21:22:04 EST EAGLE 31.12.0
  DPCI          CLLI          BEI  ELEI  ALIASA          ALIASN/N24  DOMAIN

ps-5-120-1    ----- no  --- -----  -----  SS7
              SPC          NCAI
              -----  ----
    
```

Destination table is (65 of 2000) 3% full

;

rtrv-dstn:pctype=ansi:pcst=none

```

tekelecstp 05-01-20 21:22:04 EST EAGLE 31.12.0
  DPCA          CLLI          BEI  ELEI  ALIASI          ALIASN/N24  DOMAIN

001-001-002   ----- no  --- -----  -----  SS7
008-001-001   systest1 no  --- -----  -----  SS7
020-001-*     systest2 no  no  -----  -----  SS7
100-101-001   ----- no  ---  1-190-1  -----  SS7
100-101-002   ----- no  ---  s-1-012-1  -----  SS7
100-101-003   ----- no  --- -----  0-0-0-0123-aa  SS7
100-101-004   ----- no  --- -----  s-0-0-0-0123-aa  SS7
012-230-001   ----- no  --- -----  -----  SS7
123-134-014   ----- no  --- -----  -----  SS7
    
```

```

DESTINATION ENTRIES ALLOCATED: 2000
  FULL DPC(s): 64
  NETWORK DPC(s): 0
  CLUSTER DPC(s): 1
  TOTAL DPC(s): 65
  CAPACITY (% FULL): 3%
X-LIST ENTRIES ALLOCATED: 500
    
```

;

rtrv-dstn:pctype=itui:pcst=s

```

tekelecstp 05-01-20 21:22:04 EST EAGLE 31.12.0
  DPCI          CLLI          BEI  ELEI  ALIASA          ALIASN/N24  DOMAIN

s-2-002-1     ----- no  --- -----  -----  SS7
s-2-002-2     ----- no  ---  001-001-003  -----  SS7
s-1-002-3     ----- no  --- -----  -----  SS7
s-2-100-1     ----- no  --- -----  -----  SS7
s-7-100-1     ----- no  --- -----  -----  SS7
s-2-012-1     ----- no  --- -----  -----  SS7
s-3-134-1     ----- no  --- -----  -----  SS7
s-5-120-1     ----- no  --- -----  -----  SS7
    
```

```

DESTINATION ENTRIES ALLOCATED: 2000
  FULL DPC(s): 64
  NETWORK DPC(s): 0
  CLUSTER DPC(s): 1
  TOTAL DPC(s): 65
  CAPACITY (% FULL): 3%
X-LIST ENTRIES ALLOCATED: 500
    
```

;

rtrv-dstn:pctype=ansi:pcst=p

```
tekelecstp 05-01-20 21:22:04 EST EAGLE 31.12.0
  DPCA          CLLI          BEI  ELEI  ALIASI          ALIASN/N24  DOMAIN
p-001-002-004 ----- no --- -----
p-002-200-001 ----- no --- -----
p-002-003-001 ----- no --- -----
p-001-002-005 ----- no --- -----
p-001-002-006 ----- no --- -----
p-001-002-007 ----- no --- -----
p-001-002-008 ----- no --- -----
p-012-230-001 ----- no --- -----
p-123-134-014 ----- no --- -----
p-129-234-001 ----- no --- -----
```

```
DESTINATION ENTRIES ALLOCATED: 2000
  FULL DPC(s) : 64
  NETWORK DPC(s) : 0
  CLUSTER DPC(s) : 1
  TOTAL DPC(s) : 65
  CAPACITY (% FULL) : 3%
X-LIST ENTRIES ALLOCATED: 500
```

;

rtrv-dstn:pctype=itun:pcst=p

```
tekelecstp 05-01-20 21:22:04 EST EAGLE 31.12.0
  DPCN          CLLI          BEI  ELEI  ALIASA          ALIASI          DOMAIN
p-0-0-0-0323-aa ----- no --- -----
p-0-0-0-1298-aa ----- no --- -----
p-1-1-0-0057-aa ----- no --- -----
p-1-1-1-0058-aa ----- no --- -----
p-1-1-1-0059-aa ----- no --- -----
p-1-1-1-0060-aa ----- no --- -----
p-1-1-1-0061-aa ----- no --- -----
p-1-1-1-0125-aa ----- no --- -----
p-1-1-1-0125-xy ----- no --- -----
p-1-1-1-0126-xy ----- no --- -----
p-1-1-1-0126-aa ----- no --- -----
p-1-1-1-0127-bb ----- no --- -----
```

```
DESTINATION ENTRIES ALLOCATED: 2000
  FULL DPC(s) : 64
  NETWORK DPC(s) : 0
  CLUSTER DPC(s) : 1
  TOTAL DPC(s) : 65
  CAPACITY (% FULL) : 3%
X-LIST ENTRIES ALLOCATED: 500
```

;

rtrv-dstn:pctype=itun:pcst=ps

```

tekelecstp 05-01-20 21:22:04 EST EAGLE 31.12.0
  DPCN          CLLI          BEI  ELEI  ALIASA          ALIASI          DOMAIN
ps-1-1-1-2047-aa ----- no  ---    100-120-120  s-1-123-1      SS7
ps-1-1-1-2046-aa ----- no  --- ----- ----- SS7
ps-1-1-1-2045-aa ----- no  --- ----- ----- SS7
ps-1-1-1-2044-aa ----- no  --- ----- ----- SS7
ps-0-0-0-0323-aa ----- no  --- ----- ----- SS7
ps-0-0-0-1298-aa ----- no  --- ----- ----- SS7
ps-1-1-1-0059-aa ----- no  --- ----- ----- SS7
ps-1-1-1-0234-aa wearehereto yes --- ----- ----- SS7
ps-1-1-1-0235-aa longcclinam yes --- ----- ----- SS7
    
```

```

DESTINATION ENTRIES ALLOCATED: 2000
  FULL DPC(s) : 64
  NETWORK DPC(s) : 0
  CLUSTER DPC(s) : 1
  TOTAL DPC(s) : 65
  CAPACITY (% FULL) : 3%
X-LIST ENTRIES ALLOCATED: 500
    
```

;

rtrv-dstn:pctype=ansi

```

tekelecstp 05-01-20 21:22:04 EST EAGLE 31.12.0
  DPCA          CLLI          BEI  ELEI  ALIASI          ALIASN/N24      DOMAIN
001-001-002 ----- no  --- ----- ----- SS7
p-001-002-004 ----- no  --- ----- ----- SS7
008-001-001 systest1 no  --- ----- ----- SS7
020-001-*   systest2 no  no  ----- ----- SS7
100-101-001 ----- no  ---    1-190-1 ----- SS7
100-101-002 ----- no  ---    s-1-012-1 ----- SS7
100-101-003 ----- no  --- ----- 0-0-0-0123-aa SS7
100-101-004 ----- no  --- ----- s-0-0-0-0123-aa SS7
p-002-200-001 ----- no  --- ----- ----- SS7
p-002-003-001 ----- no  --- ----- ----- SS7
p-001-002-005 ----- no  --- ----- ----- SS7
p-001-002-006 ----- no  --- ----- ----- SS7
p-001-002-007 ----- no  --- ----- ----- SS7
p-001-002-008 ----- no  --- ----- ----- SS7
p-012-230-001 ----- no  --- ----- ----- SS7
012-230-001 ----- no  --- ----- ----- SS7
p-123-134-014 ----- no  --- ----- ----- SS7
123-134-014 ----- no  --- ----- ----- SS7
p-129-234-001 ----- no  --- ----- ----- SS7
    
```

```

DESTINATION ENTRIES ALLOCATED: 2000
  FULL DPC(s) : 64
  NETWORK DPC(s) : 0
  CLUSTER DPC(s) : 1
  TOTAL DPC(s) : 65
  CAPACITY (% FULL) : 3%
X-LIST ENTRIES ALLOCATED: 500
    
```

;

rtrv-dstn:pctype=itui

tekelecstp 05-01-20 21:22:04 EST EAGLE 31.12.0		EST	ELEI	ALIASA	ALIASN/N24	DOMAIN
DPCI	CLLI	BEI	ELEI	ALIASA	ALIASN/N24	DOMAIN
s-2-002-1	-----	no	---	-----	-----	SS7
s-2-002-2	-----	no	---	001-001-003	-----	SS7
s-1-002-3	-----	no	---	-----	-----	SS7
ps-2-100-1	-----	no	---	-----	-----	SS7
s-2-100-1	-----	no	---	-----	-----	SS7
2-100-1	-----	no	---	-----	-----	SS7
p-2-120-1	-----	no	---	-----	-----	SS7
p-7-100-1	-----	no	---	-----	-----	SS7
s-7-100-1	-----	no	---	-----	-----	SS7
ps-7-129-2	-----	no	---	-----	-----	SS7
ps-4-012-1	-----	no	---	-----	-----	SS7
p-2-012-1	-----	no	---	-----	-----	SS7
s-2-012-1	-----	no	---	-----	-----	SS7
s-3-134-1	-----	no	---	-----	-----	SS7
p-3-134-1	-----	no	---	-----	-----	SS7
ps-3-134-1	-----	no	---	-----	-----	SS7
ps-5-120-1	-----	no	---	-----	-----	SS7
s-5-120-1	-----	no	---	-----	-----	SS7
p-5-120-1	-----	no	---	-----	-----	SS7

DESTINATION ENTRIES ALLOCATED: 2000
 FULL DPC(s): 64
 NETWORK DPC(s): 0
 CLUSTER DPC(s): 1
 TOTAL DPC(s): 65
 CAPACITY (% FULL): 3%
 X-LIST ENTRIES ALLOCATED: 500

;

rtrv-dstn:pctype=itun

tekelecstp 05-01-20 21:22:04 EST EAGLE 31.12.0							
DPCN	CLLI	BEI	ELEI	ALIASA	ALIASI	DOMAIN	
ps-1-1-1-2047-aa	-----	no	---	100-120-120	s-1-123-1	SS7	
ps-1-1-1-2046-aa	-----	no	---	-----	-----	SS7	
ps-1-1-1-2045-aa	-----	no	---	-----	-----	SS7	
ps-1-1-1-2044-aa	-----	no	---	-----	-----	SS7	
ps-0-0-0-0323-aa	-----	no	---	-----	-----	SS7	
s-0-0-0-0323-aa	-----	no	---	-----	-----	SS7	
p-0-0-0-0323-aa	-----	no	---	-----	-----	SS7	
0-0-0-0323-aa	-----	no	---	-----	-----	SS7	
0-0-0-1298-aa	-----	no	---	-----	-----	SS7	
p-0-0-0-1298-aa	-----	no	---	-----	-----	SS7	
s-0-0-0-1298-aa	-----	no	---	-----	-----	SS7	
ps-0-0-0-1298-aa	-----	no	---	-----	-----	SS7	
p-1-1-0-0057-aa	-----	no	---	-----	-----	SS7	
p-1-1-1-0058-aa	-----	no	---	-----	-----	SS7	
p-1-1-1-0059-aa	-----	no	---	-----	-----	SS7	
ps-1-1-1-0059-aa	-----	no	---	-----	-----	SS7	
p-1-1-1-0060-aa	-----	no	---	-----	-----	SS7	
p-1-1-1-0061-aa	-----	no	---	-----	-----	SS7	
p-1-1-1-0125-aa	-----	no	---	-----	-----	SS7	
p-1-1-1-0125-xy	-----	no	---	-----	-----	SS7	
p-1-1-1-0126-xy	-----	no	---	-----	-----	SS7	
p-1-1-1-0126-aa	-----	no	---	-----	-----	SS7	
p-1-1-1-0127-bb	-----	no	---	-----	-----	SS7	
ps-1-1-1-0234-aa	wearehereto	yes	---	-----	-----	SS7	
ps-1-1-1-0235-aa	longcclinam	yes	---	-----	-----	SS7	
1-1-1-0235-aa	-----	no	---	-----	-----	SS7	
s-1-1-1-0235-aa	-----	no	---	-----	-----	SS7	

DESTINATION ENTRIES ALLOCATED: 2000
 FULL DPC(s): 64
 NETWORK DPC(s): 0
 CLUSTER DPC(s): 1
 TOTAL DPC(s): 65
 CAPACITY (% FULL): 3%
 X-LIST ENTRIES ALLOCATED: 500

;

rtrv-dstn:pcst=none

```

tekelecstp 05-01-20 21:22:04 EST EAGLE 31.12.0
DPCA          CLLI          BEI  ELEI  ALIASI          ALIASN/N24  DOMAIN

001-001-002  ----- no  --- -----          -----  SS7
008-001-001  systest1  no  --- -----          -----  SS7
020-001-*    systest2  no  no  -----          -----  SS7
100-101-001  ----- no  ---  1-190-1          -----  SS7
100-101-002  ----- no  ---  s-1-012-1          -----  SS7
100-101-003  ----- no  --- -----          0-0-0-0123-aa  SS7
100-101-004  ----- no  --- -----          s-0-0-0-0123-aa  SS7
012-230-001  ----- no  --- -----          -----  SS7
123-134-014  ----- no  --- -----          -----  SS7

DPCI          CLLI          BEI  ELEI  ALIASA          ALIASN/N24  DOMAIN

2-100-1      ----- no  --- -----          -----  SS7

DPCN          CLLI          BEI  ELEI  ALIASA          ALIASI       DOMAIN

0-0-0-0323-aa ----- no  --- -----          -----  SS7
0-0-0-1298-aa ----- no  --- -----          -----  SS7
1-1-1-0235-aa ----- no  --- -----          -----  SS7

DPCN24        CLLI          BEI  ELEI  ALIASA          ALIASI       DOMAIN
    
```

```

DESTINATION ENTRIES ALLOCATED: 2000
FULL DPC(s) : 64
NETWORK DPC(s) : 0
CLUSTER DPC(s) : 1
TOTAL DPC(s) : 65
CAPACITY (% FULL) : 3%
X-LIST ENTRIES ALLOCATED: 500
    
```

;

rtrv-dstn:pcst=s

```

tekelecstp 05-01-20 21:22:04 EST EAGLE 31.12.0
  DPCA          CLLI          BEI  ELEI  ALIASI          ALIASN/N24  DOMAIN

  DPCI          CLLI          BEI  ELEI  ALIASA          ALIASN/N24  DOMAIN
s-2-002-1      ----- no  --- -----          -----          SS7
s-2-002-2      ----- no  --- 001-001-003 -----          SS7
s-1-002-3      ----- no  --- -----          -----          SS7
s-2-100-1      ----- no  --- -----          -----          SS7
s-7-100-1      ----- no  --- -----          -----          SS7
s-2-012-1      ----- no  --- -----          -----          SS7
s-3-134-1      ----- no  --- -----          -----          SS7
s-5-120-1      ----- no  --- -----          -----          SS7

  DPCN          CLLI          BEI  ELEI  ALIASA          ALIASI          DOMAIN
s-0-0-0-0323-aa ----- no  --- -----          -----          SS7
s-0-0-0-1298-aa ----- no  --- -----          -----          SS7
s-1-1-1-0235-aa ----- no  --- -----          -----          SS7

  DPCN24        CLLI          BEI  ELEI  ALIASA          ALIASI          DOMAIN

DESTINATION ENTRIES ALLOCATED: 2000
  FULL DPC(s) : 64
  NETWORK DPC(s) : 0
  CLUSTER DPC(s) : 1
  TOTAL DPC(s) : 65
  CAPACITY (% FULL) : 3%
X-LIST ENTRIES ALLOCATED: 500

```

;

rtrv-dstn:pcst=p

```

tekelecstp 05-01-20 21:22:04 EST EAGLE 31.12.0
  DPCA          CLLI          BEI  ELEI   ALIASI          ALIASN/N24  DOMAIN
  p-001-002-004 ----- no  --- -----          -----  SS7
  p-002-200-001 ----- no  --- -----          -----  SS7
  p-002-003-001 ----- no  --- -----          -----  SS7
  p-001-002-005 ----- no  --- -----          -----  SS7
  p-001-002-006 ----- no  --- -----          -----  SS7
  p-001-002-007 ----- no  --- -----          -----  SS7
  p-001-002-008 ----- no  --- -----          -----  SS7
  p-012-230-001 ----- no  --- -----          -----  SS7
  p-123-134-014 ----- no  --- -----          -----  SS7
  p-129-234-001 ----- no  --- -----          -----  SS7

  DPCI          CLLI          BEI  ELEI   ALIASA          ALIASN/N24  DOMAIN
  p-2-120-1     ----- no  --- -----          -----  SS7
  p-7-100-1     ----- no  --- -----          -----  SS7
  p-2-012-1     ----- no  --- -----          -----  SS7
  p-3-134-1     ----- no  --- -----          -----  SS7
  p-5-120-1     ----- no  --- -----          -----  SS7

  DPCN          CLLI          BEI  ELEI   ALIASA          ALIASI        DOMAIN
  p-0-0-0-0323-aa ----- no  --- -----          -----  SS7
  p-0-0-0-1298-aa ----- no  --- -----          -----  SS7
  p-1-1-0-0057-aa ----- no  --- -----          -----  SS7
  p-1-1-1-0058-aa ----- no  --- -----          -----  SS7
  p-1-1-1-0059-aa ----- no  --- -----          -----  SS7
  p-1-1-1-0060-aa ----- no  --- -----          -----  SS7
  p-1-1-1-0061-aa ----- no  --- -----          -----  SS7
  p-1-1-1-0125-aa ----- no  --- -----          -----  SS7
  p-1-1-1-0125-xy ----- no  --- -----          -----  SS7
  p-1-1-1-0126-xy ----- no  --- -----          -----  SS7
  p-1-1-1-0126-aa ----- no  --- -----          -----  SS7
  p-1-1-1-0127-bb ----- no  --- -----          -----  SS7

  DPCN24        CLLI          BEI  ELEI   ALIASA          ALIASI        DOMAIN
  
```

```

DESTINATION ENTRIES ALLOCATED: 2000
  FULL DPC(s) : 64
  NETWORK DPC(s) : 0
  CLUSTER DPC(s) : 1
  TOTAL DPC(s) : 65
  CAPACITY (% FULL) : 3%
X-LIST ENTRIES ALLOCATED: 500
  
```

;

rtrv-dstn:pcst=ps

```

tekelecstp 05-01-20 21:22:04 EST EAGLE 31.12.0
  DPCA          CLLI          BEI  ELEI  ALIASI          ALIASN/N24  DOMAIN

  DPCI          CLLI          BEI  ELEI  ALIASA          ALIASN/N24  DOMAIN

ps-2-100-1     ----- no  --- ----- ----- SS7
ps-7-129-2     ----- no  --- ----- ----- SS7
ps-4-012-1     ----- no  --- ----- ----- SS7
ps-3-134-1     ----- no  --- ----- ----- SS7
ps-5-120-1     ----- no  --- ----- ----- SS7

  DPCN          CLLI          BEI  ELEI  ALIASA          ALIASI          DOMAIN

ps-1-1-1-2047-aa ----- no  ---   100-120-120  s-1-123-1     SS7
ps-1-1-1-2046-aa ----- no  --- ----- ----- SS7
ps-1-1-1-2045-aa ----- no  --- ----- ----- SS7
ps-1-1-1-2044-aa ----- no  --- ----- ----- SS7
ps-0-0-0-0323-aa ----- no  --- ----- ----- SS7
ps-0-0-0-1298-aa ----- no  --- ----- ----- SS7
ps-1-1-1-0059-aa ----- no  --- ----- ----- SS7
ps-1-1-1-0234-aa wearehereto yes --- ----- ----- SS7
ps-1-1-1-0235-aa longcllinam yes --- ----- ----- SS7

  DPCN24        CLLI          BEI  ELEI  ALIASA          ALIASI          DOMAIN

DESTINATION ENTRIES ALLOCATED:  2000
  FULL DPC(s) :                   64
  NETWORK DPC(s) :                  0
  CLUSTER DPC(s) :                  1
  TOTAL DPC(s) :                   65
  CAPACITY (% FULL) :                3%
X-LIST ENTRIES ALLOCATED:         500
;

```

rtrv-dstn

```
tekelecstp 05-01-20 21:22:04 EST EAGLE 31.12.0
DPCA          CLLI          BEI  ELEI  ALIASI          ALIASN/N24  DOMAIN
001-001-002  ----- no  --- -----          ----- SS7
p-001-002-004 ----- no  --- -----          ----- SS7
008-001-001  systest1  no  --- -----          ----- SS7
020-001-*    systest2  no  no  -----          ----- SS7
100-101-001  ----- no  ---  1-190-1 ----- SS7
100-101-002  ----- no  ---  s-1-012-1 ----- SS7
100-101-003  ----- no  --- -----          0-0-0-0123-aa SS7
100-101-004  ----- no  --- -----          s-0-0-0-0123-aa SS7
```

```
DPCI          CLLI          BEI  ELEI  ALIASA          ALIASN/N24  DOMAIN
s-2-002-1    ----- no  --- -----          ----- SS7
s-2-002-2    ----- no  ---  001-001-003 ----- SS7
s-1-002-3    ----- no  --- -----          ----- SS7
ps-2-100-1   ----- no  --- -----          ----- SS7
s-2-100-1   ----- no  --- -----          ----- SS7
2-100-1     ----- no  --- -----          ----- SS7
```

```
DPCN          CLLI          BEI  ELEI  ALIASA          ALIASI          DOMAIN
ps-1-1-1-2047-aa ----- no  ---  100-120-120 s-1-123-1  SS7
s-0-0-0-0323-aa ----- no  --- -----          ----- SS7
p-0-0-0-0323-aa ----- no  --- -----          ----- SS7
0-0-0-0323-aa ----- no  --- -----          ----- SS7
ps-1-1-1-0234-aa wearehereto yes --- -----          ----- SS7
```

```
DPCN24        CLLI          BEI  ELEI  ALIASA          ALIASI          DOMAIN

DESTINATION ENTRIES ALLOCATED:  2000
FULL DPC(s) :                    64
NETWORK DPC(s) :                  0
CLUSTER DPC(s) :                  1
TOTAL DPC(s) :                    65
CAPACITY (% FULL) :                3%
X-LIST ENTRIES ALLOCATED:        500
```

;

Legend

DPC/DPCA/DPCI/DPCN/DPCN24—Destination point code.

CLLI—Command Language Location Indicator.

BEI—Broadcast Exception Indicator.

ELEI—Cluster Exception-List Exclusion Indicator.

NCAI—Nested Cluster Allowed Indicator.

ALIASA/ALIASI/ALIASN/ALIASN24—Alias point code.

SPC—Secondary point code.

DOMAIN—Destination Entity Domain.

rtrv-e1**Retrieve E1 Information**

Use this command to retrieve the following information for a specified E1 interface or for all E1 interfaces that have been defined by the **ent-e1** command: card location, E1 port number, CRC4, CAS/CCS, encoding/decoding, channel bridging, timing source, international NFAS data, and national NFAS data.

Keyword: **rtrv-e1**

Related Commands: **chg-e1, dlt-e1, ent-e1, tst-e1**

Command Class: Database Administration

Parameters

:e1port= (optional)

E1 port number. The value must be an E1 port that has already been configured with an E1 interface on the specified E1 card.

Range: **1-8**

Ports 3 through 8 can be specified only for HC-MIM cards.

Default: If not specified, all E1 ports are listed.

:loc= (mandatory)

The card location as stenciled on the shelf of the system.

Range: **1101-1108, 1111-1112, 1201-1208, 1211-1218, 1301-1308, 1311-1318, 2101-2108, 2111-2118, 2201-2208, 2211-2218, 2301-2308, 2311-2318, 3101-3108, 3111-3118, 3201-3208, 3211-3218, 3301-3308, 3311-3318, 4101-4108, 4111-4118, 4201-4208, 4211-4218, 4301-4308, 4311-4318, 5101-5108, 5111-5118, 5201-5208, 5211-5218, 5301-5308, 5311-5318, 6101-6108, 6111-6118**

Default: If not specified, all E1 card locations are listed.

Example

```
rtrv-e1
```

```
rtrv-e1:loc=1307:e1port=2
```

```
rtrv-e1:loc=1311:e1port=1
```

Dependencies

The **loc** and **e1port** parameters must both be specified if any parameters are specified for the command.

The specified card location (**loc** parameter) must be equipped.

The card in the specified card location (**loc** parameter) must be a **lime1** card type.

The port specified by the **e1port** parameter must be already equipped with an E1 interface.

Notes

None.

Output

In the following examples,

- Cards with E1 ports greater than 2 are HC-MIM cards used as E1 cards.
- Cards with LINKCLASS=UNCHAN are HC-MIM cards used as SE-HSL cards. All other E1 cards show LINKCLASS=CHAN.
- Cards with CHANBRDG=MASTER or CHANBRDG=SLAVE are HC-MIM cards used as E1 cards, with 2 ports configured in channel bridging mode to allow non-signaling data pass-through.

rtrv-e1

```
rlghncxa03w 05-01-20 09:07:58 EST EAGLE5 33.0.0
      E1
LOC  PORT  CRC4  CAS  ENCODE  E1TSEL  SI  SN  CHANBRDG  CLASS  MIMSU
1307  7      ON   OFF  HDB3    LINE     0  0  -----  CHAN   ----
1307  8      ON   OFF  HDB3    LINE     0  0  -----  CHAN   ----
1311  1      OFF  OFF  AMI     EXTERNAL 3  6  MASTER  CHAN   ----
1311  2      OFF  OFF  AMI     EXTERNAL 3  6  SLAVE   CHAN   ----
1311  5      OFF  OFF  AMI     RECOVERED 3  6  MASTER  CHAN   ----
1311  6      OFF  OFF  AMI     RECOVERED 3  6  SLAVE   CHAN   ----
;

```

rtrv-e1

```
rlghncxa03w 05-01-20 09:07:58 EST EAGLE5 34.0.0
      E1
LOC  PORT  CRC4  CAS  ENCODE  E1TSEL  SI  SN  CHANBRDG  CLASS  MINSU
1307  7      ON   ---  HDB3    LINE     -- --  -----  UNCHAN 1000
1307  8      ON   ---  HDB3    LINE     -- --  -----  UNCHAN 2000
1311  1      OFF  ON   AMI     LINE     1  1  -----  CHAN   ----
;

```

In the following examples, time slot entries (TSx) are not shown for SE-HSL cards (time slots are not configured for "unchannelized" cards). Time slot entries are shown for all other E1 cards.

rtrv-e1:loc=1307:e1port=7

```
rlghncxa03w 05-01-20 09:07:58 EST EAGLE5 33.0.0
      E1
LOC  PORT  CRC4  CAS  ENCODE  E1TSEL  SI  SN  CHANBRDG  CLASS  MIMSU
1307  7      ON   OFF  HDB3    LINE     0  0  -----  CHAN   ----

TS0  (N/A)      TS8  -----  TS16 -----  TS24 -----
TS1  -----  TS9  -----  TS17 -----  TS25 -----
TS2  -----  TS10 -----  TS18 -----  TS26 -----
TS3  -----  TS11 -----  TS19 -----  TS27 -----
TS4  -----  TS12 1307,A  TS20 -----  TS28 -----
TS5  -----  TS13 -----  TS21 -----  TS29 -----
TS6  -----  TS14 -----  TS22 -----  TS30 -----
TS7  -----  TS15 -----  TS23 -----  TS31 -----
;

```

Card 1311 port 8 is channel bridged with port 7 for non-signaling data pass through.

rtrv-e1:loc=1311:e1port=7

```

rlghncxa03w 05-01-20 09:07:58 EST EAGLE5 33.0.0
      E1
LOC  PORT  CRC4  CAS  ENCODE  E1TSEL  SI  SN  CHANBRDG  CLASS  RATE
1311  7      OFF  OFF  AMI      EXTERNAL  3  6  MASTER    CHAN   ----

      TS0  (N/A)      TS8  -----  TS16  -----  TS24  -----
      TS1  -----  TS9  -----  TS17  1311,B31  TS25  -----
      TS2  -----  TS10 -----  TS18  -----  TS26  -----
      TS3  -----  TS11 -----  TS19  -----  TS27  -----
      TS4  -----  TS12 1311,A  TS20  -----  TS28  -----
      TS5  -----  TS13 -----  TS21  1311,A24  TS29  -----
      TS6  -----  TS14 -----  TS22  -----  TS30  -----
      TS7  -----  TS15 -----  TS23  -----  TS31  -----
    
```

;

rtrv-e1:loc=1311:e1port=8

```

rlghncxa03w 05-01-20 09:07:58 EST EAGLE5 33.0.0
      E1
LOC  PORT  CRC4  CAS  ENCODE  E1TSEL  SI  SN  CHANBRDG  CLASS  RATE
1311  8      OFF  OFF  AMI      EXTERNAL  3  6  SLAVE     CHAN   ----
    
```

;

In the following example, the card in location 1307 is an SE-HSL card.

rtrv-e1:loc=1307:e1port=7

```

rlghncxa03w 05-05-20 09:07:58 EST EAGLE5 34.0.0
      E1
LOC  PORT  CRC4  CAS  ENCODE  E1TSEL  SI  SN  CHANBRDG  CLASS  RATE
1307  7      ON    ---  HDB3    LINE     --  --  -----  UNCHAN 1000
    
```

;

Legend

LOC—E1 card location in an EAGLE 5 SAS shelf.

E1PORT—E1 port number on an E1 card.

CRC4—CRC4 indicator.

CAS—CAS/CRC indicator (**on** = CAS is used; **off** = CRC is used).

ENCODE—Indicator for use of HDB3 or AMI encoding/decoding.

E1TSEL—E1 timing source indicator (**external** = master timing source; **line** = slave timing source; **RECOVERED** = the timing source for the even-numbered port in a channel bridged pair is recovered from the odd-numbered port of the pair).

SI—Value of two Spare International bits of NFAS data.

SN—Value of five Spare National bits of NFAS data

CHANBRDG—Indicates whether an HC-MIM odd numbered port is not channel bridged with its adjacent even numbered port for non-signaling data pass through (dashes), or the HC-MIM port is the odd-numbered channel bridged port on the card (MASTER), or the HC-MIM port is the even-numbered channel bridged port on the card (SLAVE).

LINKCHAN—Indicates whether an HC-MIM card is used as a "channelized" E1 Card (CHAN) or an "unchannelized" SE-HSL card (UNCHAN).

MINSURATE—Minimum number of signaling units present on a link uniformly distributed. A value appears in this field only when the LINKCHAN field value is UNCHAN.

TSx—Timeslot.

rtrv-eisopts

Retrieve EAGLE Support for Integrated Sentinel Options

Use this command to retrieve the status (on or off) of the copy function for the EAGLE Support for Integrated Sentinel (EIS) feature.

Keyword: rtrv-eisopts

Related Commands: chg-eisopts

Command Class: Security Administration

Parameters

This command has no parameters.

Example

rtrv-eisopts

Dependencies

The EAGLE Support for Integrated Sentinel (EIS) feature must be turned on before this command can be entered.

Notes

None

Output

rtrv-eisopts

```
rlghncxa03w 04-02-20 09:07:58 EST EAGLE 31.3.0
EISOPTION
-----
EISCOPY                ON
;
```

rtrv-feat

Retrieve Feature

Use this command to show the status of optional features in the system that are controlled with the **chg-feat** command.

Keyword: rtrv-feat

Related Commands: chg-feat

Command Class: Program Update

Parameters

This command has no parameters.

Example

```
rtrv-feat
```

Dependencies

The database and the MAS configuration table must be accessible.

Notes

None

Output

CAUTION: The following output example may differ from the output shown at your terminal and may include unsupported features. A feature must be purchased before you turn the feature on. If you are not sure whether you have purchased a feature, contact your Tekelec Sales Representative or Account Representative. After you turn on a feature with the `chg-feat` command, you cannot turn it off.

rtrv-feat

```
rlghncxa03w 04-01-28 11:34:04 EST EAGLE 31.3.0
EAGLE FEATURE LIST

GTT      = on      GWS      = off      NRT      = off
X25G     = off     LAN      = off     CRMD     = off
SEAS     = off     LFS      = off     MTPRS    = off
FAN      = off     DSTN5000 = off     WNP      = off
CNCF     = off     TLNP     = off     SCCPCNV  = off
TCAPCNV  = off     IPISUP   = off     DYNRTK   = off
X252000  = off     INP      = off     PLNP     = off
NCR      = off     ITUMTPRS = off     SLSOCB   = off
EGTT     = off     VGTT     = off     MGMTT    = off
MPC      = off     ITUDUPPC = off     GFLEX    = off
GPORT    = off     MEASPLAT = off     TSCSYNC  = off
E5IS     = off

;
```

Legend

GTT—The Global Title Translation feature

GWS—The Gateway Screening feature

NRT—Network Routing feature

X25G—The X.25/SS7 Gateway feature

LAN—The STPLAN feature

CRMD—The Cluster Routing and Management Diversity feature

SEAS—The Signaling Engineering Administration System feature

LFS—The Link Fault Sectionalization feature

MTPRS—The ANSI MTP Restart feature

FAN—The Cooling Fan feature
DSTN5000—The DSTN5000 (5000 Routes) feature
WNP—The Wireless Number Portability feature
CNCF—The Calling Name Conversion Facility with Redirect Capability feature
TLNP—The Triggerless Local Number Portability feature
IPISUP—The ISUP Routing over IP feature
DYNRTK—The Dynamic Routing Key feature
SCCPCNV—The SCCP Conversion feature
TCAPCNV—The TCAP Conversion feature
GFLEX—The GSM Flexible Numbering feature
X252000—The 2000 X.25 Routes and Destinations feature
PLNP—The PCS 1900 Number Portability feature
NCR—The Nested Cluster Routing feature
ITUMTPRS—ITU MTP Restart feature
SLSOCB—Other CIC Bit Used feature
EGTT—The Enhanced Global Title Translation feature
VGTT—Variable Length GTT feature
MGTT—The Global Title Modifications feature
MPC—The Multiple Point Code feature
INP—The INAP Number Portability feature
ITUDUPPC—The ITU National Duplicate Point Code feature
GPORT—The GSM Mobile Number Portability feature
TSCSYNC—The Time Slot Counter Synchronization (TSC) feature
EIS—The EAGLE Support for Integrated Sentinel feature
MEASPLAT—The Measurements Platform feature

rtrv-ftp-serv**Retrieve FTP Server Entry**

Use this command to retrieve an entry for an FTP server from the FTP Server table or all entries in the FTP Server table.

Keyword: rtrv-ftp-serv

Related Commands: chg-ftp-serv, dlt-ftp-serv, ent-ftp-serv

Command Class: Database Administration

Parameters

:app=. (optional)

The FTP Client application that interfaces with the FTP Server.

Range: **meas, user**

meas—the Measurements Platform application

user—the FTP-based Table Retrieve Application (FTRA)

:ipaddr= (optional)

IP Address of the FTP Server.

Range: 4 numbers separated by dots, with each number in the range of **000–255**.

:mode= (optional)

Full or brief report indicator.

Range: **full, brief**

Default: **brief**

Example

```
rtrv-ftp-serv
rtrv-ftp-serv:app=meas:ipaddr=1.255.0.100
rtrv-ftp-serv:mode=brief
rtrv-ftp-serv:app-meas
rtrv-ftp-serv:ipaddr=1.255.0.100
rtrv-ftp-serv:mode=full
```

Dependencies

The **app** parameter must specify an application that uses the FTP Support feature.

The **ipaddr** parameter must specify a valid IP address for the FTP server.

The **mode** parameter allows you to display either the full 100 characters of the path string for each entry (**mode=full**), or the first 29 characters of the path string for each entry (**mode=brief**). The default is **brief**.

Notes

The LOGIN and PATH are displayed in mixed case.

Output

The following examples show output when the EAGLE OA&M IP Security feature is not enabled:

```
rtrv-ftp-serv:app=meas:ipaddr=1.255.0.100
rlghncxa03w 04-02-28 11:34:04 EST EAGLE 31.3.0

APP          IPADDR          LOGIN          PRIO  PATH
-----
meas         1.255.0.100    ftpmeas3      3     ~ftpmeas3\files

FTP SERV table is (1 of 10) 10% full
;
```

rtrv-ftp-serv:mode=brief

rlghncxa03w 04-02-28 11:34:04 EST EAGLE 31.3.0

APP	IPADDR	LOGIN	PRIO	PATH
meas	1.255.0.100	ftpmeas3	3	~ftpmeas3\files
meas	1.255.0.101	ftpmeas2	2	\home\ftpmeas2\public
user	1.255.0.100	tekiperson1	1	\share

FTP SERV table is (3 of 10) 20% full

;

rtrv-ftp-serv:app=meas

rlghncxa03w 04-02-28 11:34:04 EST EAGLE 31.3.0.

APP	IPADDR	LOGIN	PRIO	PATH
meas	1.255.0.100	ftpmeas3	3	~ftpmeas3\files
meas	1.255.0.101	ftpmeas2	2	\home\ftpmeas2\public

FTP SERV table is (2 of 10) 20% full

;

rtrv-ftp-serv:ipaddr=1.255.0.100

rlghncxa03w 04-02-28 11:34:04 EST EAGLE 31.3.0.

APP	IPADDR	LOGIN	PRIO	PATH
meas	1.255.0.100	ftpmeas3	3	~ftpmeas3\files
user	1.255.0.100	tekiperson1	1	\share

FTP SERV table is (2 of 10) 20% full

;

rtrv-ftp-serv:mode=full

rlghncxa03w 04-02-28 11:34:04 EST EAGLE 31.3.0.

APP	IPADDR	LOGIN	PRIO	PATH
meas	1.255.0.100	ftpmeas3	3	Path: ~ftpmeas3\files
meas	1.255.0.101	ftpmeas2	5	Path: \tmp\measurements\backup\data\path\that\goes\on\and\on\and\on\and\keeps\on scrolling\to\new\line
user	1.255.0.100	tekiperson1	1	Path: \share

FTP SERV table is (3 of 10) 30% full

;

The following example shows output when the EAGLE OA&M IP Security feature is enabled and turned off:

rtrv-ftp-serv:mode=fulltekelecstp 04-07-15 12:41:58 EST EAGLE 31.6.0
FTP Client Security: OFF

APP	IPADDR	LOGIN	PRIO	PATH
meas	1.255.0.100	ftpmeas3	3	Path: ~ftpmeas3/files

```

meas      1.255.0.101      ftpmeas2      5
  Path:   /tmp/measurements/backup/data/path/that/goes/on/and/on/and/on/and/
         keeps/on/scrolling/to/new/line
user      1.255.0.100      tekperson1     1
  Path:   \share

FTP SERV table is (3 of 10) 30% full
;

```

The following example shows output when the EAGLE OA&M IP Security feature is turned on:

rtrv-ftp-serv:mode=full

```

tekelecstp 04-07-15 12:41:58 EST EAGLE 31.6.0
FTP Client Security: ON

APP          IPADDR          LOGIN          PRIO
-----
meas         1.255.0.100     ftpmeas3       3
  Path:      ~ftpmeas3/files
meas         1.255.0.101     ftpmeas2       5
  Path:      /tmp/measurements/backup/data/path/that/goes/on/and/on/and/on/and/
         keeps/on/scrolling/to/new/line
user         1.255.0.100     tekperson1     1
  Path:      \share

FTP SERV table is (3 of 10) 30% full
;

```

rtrv-gpl

Retrieve Generic Program Load

Use this command to show the version numbers of the GPLs stored on each fixed disk (TDM) or removable cartridge (MDAL, if available) and the system release table stored on each fixed disk.

Keyword: rtrv-gpl

Related Commands: act-gpl, alw-card, chg-gpl, copy-gpl, init-card, init-sys, rept-stat-gpl

Command Class: Program Update

Parameters

:appl= (obsolete)

This parameter is obsolete; use the **gpl** parameter.

The **appl** parameter has been replaced with the **gpl** parameter to more accurately indicate that a GPL, and not an application, is specified for the parameter value.

:gpl= (optional)

The type of GPL to report on.

- Range:** **atmans**, **atmitu**, **blbios**, **blcpld**, **bldiag**, **blvxw**, **bpdc**, **bphcap**, **bphcapt**, **bphmux**, **bpmp**, **bpmp**, **ccs7itu**, **cdu**, **ebdabl**, **ebdadcm**, **emdc**, **eroute**, **gls**, **hipr**, **imt**, **imtpci**, **ipgwi**, **iplim**, **iplimi**, **ips**, **mcp**, **plde1t1**, **pdp**, **sccp**, **ss7ansi**, **ss7gx25**, **ss7hc**, **ss7ipgw**, **ss7ml**, **stplan**, **vcdu**, **vsccp**, **vxwslan**
- atmans**—The GPL is used by the LIM cards to support the ATM high-speed signaling link feature.
- atmitu**—The GPL is used by the E1 ATM cards to support the E1 ATM high-speed signaling link feature.
- blbios** —A flash GPL containing the BIOS ROM image on HC-MIM cards that are used for E1 or T1 signaling links.
- blcpld** —A flash GPL containing the bit-files for the CPLD on HC-MIM cards that are used for E1 or T1 signaling links.
- bldiag** —A flash GPL containing the diagnostic code on HC-MIM cards that are used for E1 or T1 signaling links.
- blvxw** —A flash GPL containing the VxWorks operating system on HC-MIM cards that are used for E1 or T1 signaling links.
- bpdc**—This GPL is used in communications in the **init-flash** process.
- bphcap**—This GPL is used to support Board PROM for HCAP flash memory.
- bphcapt**—This GPL is used to support Board PROM for HCAP-T flash memory.
- bphmux**—This GPL is used to support Board PROM for HMUX flash memory.
- bpmp**—This GPL is used to support Board PROM for MPL flash memory.
- bpmp**—This GPL is used to support Board PROM for E1/T1 flash memory and Board Prom for the MPL-T flash memory.
- ccs7itu**—This GPL is used by the LIM cards for ITU-TSS MTP functionality.
- cdu**—This GPL is used in the card manufacturing process for testing, and when directed by Tekelec Technical Services.
- ebdabl**—This GPL is used by the TSM cards for enhanced bulk download.
- ebdadcm**—This GPL is used by the DCM card to transmit the LSMS LNP database to the EAGLE 5 SAS at high speed over an ethernet connection for enhanced bulk download.
- emap**—This GPL is the software that is running on the EOAP used for the GR-376 feature. This GPL transfers the System Release ID table from the removable cartridge to the fixed disk. This GPL is used to alert the technician when the EOAP GPLs are not compatible with an EAGLE 5 SAS release.
- emdc**—This GPL is used by the DCM card for CMIP/OSI measurement collection interface as defined by Telcordia GR-376.
- eroute**—This GPL is used by the STc cards for the EAGLE Support for Integrated Sentinel feature.
- gls**—This GPL is used by the TSM cards for downloading gateway screening to LIM cards.
- hipr** —The communication software used on the High Speed IMT Packet Router (HIPR) card.
- imt**—This GPL is the communication processor on the logical processing element (LPE).
- imtpci** —The communication software that operates the IMT bus on HC-MIM cards.

- ipgwi**—This GPL is used by the DCM card for TCP/IP point-to-point connectivity for ITU point codes.
- iplim**—This GPL is used by the DCM card for TCP/IP point-to-point connectivity for ANSI point codes.
- iplimi**—This GPL is used by the DCM card for TCP/IP point-to-point connectivity for ITU point codes.
- ips**—This GPL is used by the IPSM card for the IP User Interface feature.
- mcp**—This GPL is used by the MCPM card for the Measurements Platform feature.
- plde1t1** —This GPL is used to support Board PROM for HC-MIM flash memory.
- pldpmc1** —This GPL is used to support Board PROM for HC-MIM flash memory.
- sccp**—This GPL is used by the TSM cards for the global title translation application.
- ss7ansi**—This GPL is used by the LIM cards for the MTP functionality.
- ss7gx25**—This GPL is used by the LIM cards to support X.25 functionality.
- ss7hc**—This GPL is used to support the functionality for the HC-MIM (High Capacity Multi-Channel Interface Module) card. The HC-MIM card runs either the **ss7ansi** or **ccs7itu** application; the **ss7hc** GPL allows the card to support up to 64 signaling links for E1 and T1 functions.
- ss7ipgw**—This GPL is used by the DCM card to support TCP/IP point-to-multipoint connectivity.
- ss7ml**—This GPL is used to support the functionality for the multi-port LIM (MPL or MPL-T) card. The MPL cards run only the **ss7ansi** application on a LIMDS0 card (as specified with the **ent-card:type=limds0:appl=ss7ansi** command); the **ss7ml** GPL allows the card to support eight signaling link ports rather than the usual two ports for LIM cards. The MPL cards support only the DS0 interface.
- stplan**—This GPL is used by the ACM card to support the STPLAN application.
- vcd**—This GPL is used in the card manufacturing process for testing, and when directed by Tekelec Technical Services.
- vscpp**—This GPL is used by the DSM card to support the G-Flex, G-Port, LNP ELAP Configuration, and INP features. If the G-Flex, G-Port, LNP ELAP Configuration, or INP feature is not turned on, and a DSM card is present, the VSCCP GPL processes normal GTT traffic.
- vxwslan**—This GPL is used by the DCM card to support the STPLAN application.

Default: Display all

Example

```
rtrv-gpl
rtrv-gpl:gpl=glS
rtrv-gpl:gpl=ss7ansi
rtrv-gpl:gpl=atmansi
rtrv-gpl:gpl=vscpp
rtrv-gpl:gpl=bpmp1
```

rtrv-gpl:gpl=bphmux
rtrv-gpl:gpl=hipr
rtrv-gpl:gpl=ss7ml
rtrv-gpl:gpl=mcp
rtrv-gpl:gpl=bpmp1t
rtrv-gpl:gpl=atmitu
rtrv-gpl:gpl=bphcapt
rtrv-gpl:gpl=ss7hc
rtrv-gpl:gpl=blbios
rtrv-gpl:gpl=blcpld
rtrv-gpl:gpl=bldiag
rtrv-gpl:gpl=intpci
rtrv-gpl:gpl=pldeltl
rtrv-gpl:gpl=pldpmc1
rtrv-gpl:gpl=blvxw

Dependencies

No other activate, change, copy, or retrieve GPL command can be in progress when this command is entered.

A GPL audit cannot be in progress when this command is entered.

Notes

To check the version of the EPAP or ELAP application, use the **rept-stat-mps** command.

If no application is specified, the approved and trial versions for all GPLs are shown, as well as the release table and removable trial GPL.

The approved GPL is the GPL that resides on the fixed disk and was made the approved version by specifying the GPL version number while executing the **act-gpl** command.

The trial GPL is the version of the GPL that was downloaded from the removable cartridge, but not activated by the **act-gpl** command.

When the **act-gpl** command is executed, the version specified in the command becomes the approved GPL and the previously approved GPL becomes the trial GPL.

If a GPL is not found, a version of "-----" is shown. This should happen only for the utility and OAM GPL trial versions on the fixed disk and for all GPLs on the removable when the removable cartridge is not inserted

If the approved GPL version does not match the GPL version shown in the ACTIVE MASP RELEASE column, an alarm is activated.

A minor alarm is shown, and ALM is displayed for each APPROVED GPL (**rtrv-gpl**) and for each RUNNING GPL (**rept-stat-gpl**) that does not match the GPL in the RELEASE column of the **rtrv-gpl** command output. The minor alarm is not activated, but ALM is displayed for each GPL that does not match the GPL in the RELEASE column.

ALM is always displayed when the approved version does not match the release version. You cannot turn off *fixed disk auditing*. The auditing state shown here is for the **rept-stat-gpl** command. You can turn on and off *running version auditing*.

Output

rtrv-gpl

```
rlghncxa03w 05-01-02 11:34:04 EST EAGLE 33.0.0
```

GPL	CARD	RELEASE	APPROVED	TRIAL	REMOVE TRIAL
EOAM	1114	125-003-000	125-003-000	125-003-000	125-003-000
EOAM	1116	125-003-000	125-003-000	-----	-----
SS7ANSI	1114	125-002-000	125-002-000	125-002-000	125-002-000
SS7ANSI	1116	125-002-000	125-002-000	125-002-000	-----
SCCP	1114	125-002-000	125-002-000	125-002-000	125-002-000
SCCP	1116	125-002-000	125-002-000	125-002-000	-----
GLS	1114	125-002-000	125-002-000	125-002-000	125-002-000
GLS	1116	125-002-000	125-002-000	125-002-000	-----
CDU	1114	125-000-000	125-000-000	125-000-000	125-002-000
CDU	1116	125-000-000	125-000-000	125-002-000	-----
CCS7ITU	1114	125-002-000	125-002-000	125-002-000	125-002-000
CCS7ITU	1116	125-002-000	125-002-000	125-002-000	-----
SS7GX25	1114	125-001-000	125-001-000	125-001-000	125-001-000
SS7GX25	1116	125-001-000	125-001-000	125-001-000	-----
STPLAN	1114	125-001-000	125-001-000	125-001-000	125-001-000
STPLAN	1116	125-001-000	125-001-000	125-001-000	-----
IMT	1114	125-001-000	125-001-000	125-001-000	125-001-000
IMT	1116	125-001-000	125-001-000	125-001-000	-----
ATMANSI	1114	125-002-000	125-002-000	125-002-000	125-002-000
ATMANSI	1116	125-002-000	125-002-000	125-002-000	-----
BPHCAP	1114	125-001-000	125-001-000	125-001-000	125-001-000
BPHCAP	1116	125-001-000	125-001-000	125-001-000	-----
BPDCM	1114	125-001-000	125-001-000	125-001-000	125-001-000
BPDCM	1116	125-001-000	125-001-000	125-001-000	-----
EMDC	1114	125-001-000	125-001-000	125-001-000	125-001-000
EMDC	1116	125-001-000	125-001-000	125-001-000	-----
EBDABLM	1114	125-001-000	125-001-000	125-001-000	125-001-000
EBDABLM	1116	125-001-000	125-001-000	125-001-000	-----
EBDADCM	1114	125-001-000	125-001-000	125-001-000	125-001-000
EBDADCM	1116	125-001-000	125-001-000	125-001-000	-----
VXWSLAN	1114	125-001-000	125-001-000	125-001-000	125-001-000
VXWSLAN	1116	125-001-000	125-001-000	125-001-000	-----
IPLIM	1114	125-002-000	125-002-000	125-002-000	125-002-000
IPLIM	1116	125-002-000	125-002-000	125-002-000	-----
IPLIMI	1114	125-002-000	125-002-000	125-002-000	125-002-000
IPLIMI	1116	125-002-000	125-002-000	125-002-000	-----
SS7IPGW	1114	125-002-000	125-002-000	125-002-000	125-002-000
SS7IPGW	1116	125-002-000	125-002-000	125-002-000	-----
VSCCP	1114	125-002-000	125-002-000	125-002-000	125-002-000
VSCCP	1116	125-002-000	125-002-000	125-002-000	-----
ATMITU	1114	125-001-000	125-001-000	125-001-000	125-001-000
ATMITU	1116	125-001-000	125-001-000	125-001-000	-----
VCDU	1114	125-000-000	125-000-000	125-000-000	125-002-000
VCDU	1116	125-000-000	125-000-000	125-002-000	-----
BPMPPL	1114	125-001-000	125-001-000	125-001-000	125-001-000
BPMPPL	1116	125-001-000	125-001-000	125-001-000	-----
SS7ML	1114	125-001-000	125-001-000	125-001-000	125-001-000

```

SS7ML      1116  125-001-000  125-001-000      125-001-000  -----
BPHMUX     1114  125-001-000  125-005-000      125-005-000  125-005-000
BPHMUX     1116  125-001-000  125-005-000      125-005-000  -----
IPGWI      1114  125-001-000  125-001-000      125-001-000  125-001-000
IPGWI      1116  125-001-000  125-001-000      125-001-000  -----
IPS        1114  125-001-000  125-001-000      125-001-000  125-001-000
IPS        1116  125-001-000  125-001-000      125-001-000  -----
EROUTE     1114  125-001-000  125-001-000      125-001-000  125-001-000
EROUTE     1116  125-001-000  125-001-000      125-001-000  -----
BPMPLT     1114  002-103-001  002-103-001      002-103-001  125-001-000
BPMPLT     1116  002-103-001  002-103-001      002-103-001  -----
MCP        1114  125-001-000  125-001-000      125-001-000  125-001-000
MCP        1116  125-001-000  125-001-000      125-001-000  -----
BPHCAPT    1114  002-116-003  002-116-003      002-116-003  125-001-000
BPHCAPT    1116  002-116-003  002-116-003      002-116-003  -----
MPLG       1114  125-001-000  125-001-000      125-001-000  125-001-000
MPLG       1116  125-001-000  125-001-000      125-001-000  -----
HIPR       1114  125-001-000  125-005-000      125-005-000  125-005-000
HIPR       1116  125-001-000  125-005-000      125-005-000  -----
SS7HC      1114  125-001-000  125-001-000      125-001-000  125-001-000
SS7HC      1116  125-001-000  125-001-000      125-001-000  -----
BLCPLD     1114  125-001-000  125-001-000      125-001-000  125-001-000
BLCPLD     1116  125-001-000  125-001-000      125-001-000  -----
BLDIAG     1114  125-001-000  125-001-000      125-001-000  125-001-000
BLDIAG     1116  125-001-000  125-001-000      125-001-000  -----
PLDE1T1    1114  125-001-000  125-001-000      125-001-000  125-001-000
PLDE1T1    1116  125-001-000  125-001-000      125-001-000  -----
PLDPMC1    1114  125-001-000  125-001-000      125-001-000  125-001-000
PLDPMC1    1116  125-001-000  125-001-000      125-001-000  -----
BLBIOS     1114  125-001-000  125-001-000      125-001-000  125-001-000
BLBIOS     1116  125-001-000  125-001-000      125-001-000  -----
BLVXW      1114  125-001-000  125-001-000      125-001-000  125-001-000
BLVXW      1116  125-001-000  125-001-000      125-001-000  -----
IMTPCI     1114  125-001-000  125-001-000      125-001-000  125-001-000
IMTPCI     1116  125-001-000  125-001-000      125-001-000  -----
OAP*       A    125-001-000  125-001-000      -----      125-002-000
OAP*       B    125-001-000  125-002-000  ALM -----      -----
EMAP*      A    125-015-000  125-015-000      -----      125-015-000
EMAP      *  B    125-015-000  125-015-001  ALM -----      -----
;

```

*These entries only appear in the output if an OAP is provisioned and running. Systems that use two OAPs will show two entries for the OAP: OAP A and OAP B. The EMAP GPL should always be dual configuration because a single GR-376 EOAP is not a valid configuration.

rtrv-gpl:gpl=utility

(1115 active MASP, cartridge inserted)

```

rlghncxa03w 04-01-05 11:34:04 EST  EAGLE 31.3.0
GPL Auditing  ON

```

```

GPL      CARD  RELEASE      APPROVED      TRIAL      REMOVE TRIAL
UTILITY  1114  101-016-000  101-016-000  -----      -----
UTILITY  1116  101-016-000  101-016-000  -----      101-016-000
;

```

rtrv-gpl:gpl=vsccp

rlghncxa03w 04-01-05 11:34:04 EST EAGLE 31.3.0
 GPL Auditing ON

GPL	CARD	RELEASE	APPROVED	TRIAL	REMOVE TRIAL
VSCCP	1114	101-016-000	101-016-000	101-016-000	101-016-000
VSCCP	1116	101-016-000	101-016-000	101-016-000	-----

;

rtrv-gpl:gpl=ss7ansi (MASP A active)

rlghncxa03w 04-01-05 11:34:04 EST EAGLE 31.3.0
 GPL Auditing ON

GPL	CARD	RELEASE	APPROVED	TRIAL	REMOVE TRIAL
SS7ANSI	1114	101-016-000	101-016-000	101-016-000	-----
SS7ANSI	1116	101-016-000	101-016-000	101-016-000	101-016-000

;

rtrv-gpl:gpl=ss7gx25 (MASP B active)

rlghncxa03w 04-02-01 11:34:04 EST EAGLE 31.3.0
 GPL Auditing ON

GPL	CARD	RELEASE	APPROVED	TRIAL	REMOVE TRIAL
SS7GX25	1114	101-016-000	101-005-001 ALM	101-016-000	-----
SS7GX25	1116	101-016-000	101-005-001 ALM	101-016-000	101-016-000

;

rtrv-gpl:gpl=iplimi

rlghncxa03w 04-02-04 07:01:08 EST EAGLE 31.3.0
 GPL Auditing ON

GPL	CARD	RELEASE	APPROVED	TRIAL	REMOVE TRIAL
IPLIMI	1114	101-016-000	101-016-000	101-016-000	101-016-000
IPLIMI	1116	101-016-000	101-016-000	101-016-000	-----

;

rtrv-gpl:gpl=bphmux

rlghncxa03w 04-02-04 07:01:08 EST EAGLE 31.3.0
 GPL Auditing ON

GPL	CARD	RELEASE	APPROVED	TRIAL	REMOVE TRIAL
BPHMUX	1114	027-000-000	027-005-000	027-005-000	027-005-000
BPHMUX	1116	027-000-000	027-005-000	027-005-000	-----

;

rtrv-gpl:gpl=hipr

rlghncxa03w 05-01-04 07:01:08 EST EAGLE5 33.0.0
 GPL Auditing ON

GPL	CARD	RELEASE	APPROVED	TRIAL	REMOVE TRIAL
HIPR	1114	118-020-000	118-020-000	118-020-000	118-020-000
HIPR	1116	118-020-000	118-020-000	118-020-000	-----

;

rtrv-gpl:gpl=eoam

tekelecstp 04-02-10 06:51:36 EST EAGLE 31.3.0
 GPL Auditing ON

GPL	CARD	RELEASE	APPROVED	TRIAL	REMOVE TRIAL
EOAM	1114	028-000-000	028-001-000	028-000-000	028-000-000
EOAM	1116	028-000-000	028-001-000	028-000-000	-----

;

rtrv-gpl:gpl=ss7hc

```
rlghncxa03w 05-01-04 07:01:08 EST EAGLE5 33.0.0
GPL Auditing ON
```

GPL	CARD	RELEASE	APPROVED	TRIAL	REMOVE TRIAL
SS7HC	1114	125-001-000	125-001-000	125-001-000	-----
SS7HC	1116	125-001-000	125-001-000	125-001-000	125-001-000

;

Legend

GPL—The type of GPL associated with each card in the display.

APPROVED—The GPL version that is the approved GPL.

CARD—The card location.

RELEASE—The version number of each GPL that is required to be installed and approved for a specific release of software for the system.

REMOVE TRIAL—The GPL version that is on the removable cartridge.

TRIAL—The GPL version that is the trial GPL.

-----GPL is not present at the specified location.

ALM—An alarm indicator showing that the system has an approved GPL that is not the GPL required for this software release according to the active MASP system release table.

CORRUPTED—Data audit has determined that the GPL is corrupted.

rtrv-gsmmap-scrn**Retrieve GSM MAP Screening Entry**

Use this command to retrieve the GSM (Global System for Mobile Telecommunication) MAP (Mobile Application Part) Screening CgPA and CdPA entries and their attributes from the active system database.

Keyword: rtrv-gsmmap-scrn

Related Commands: chg-gsmmap-scrn, dlt-gsmmap-scrn, ent-gsmmap-scrn

Command Class: Database Administration

Parameters

:opname= (mandatory)

The user-defined name for the operation code. The **opname** value references the operation code (**opcode**) defined with the **ent-gsms-opcode** command.

Range: Up to 8 alphanumeric characters

:action= (optional)

The screening action to take if a message is forbidden as defined by the **forbid** parameter.

Range: **pass, discard, atierr, route, forward, duplicate, dupdisc**

pass—Route the message as normal to the destination.

discard—The MSU is to be discarded.

atierr—An ATI (Any Time Interrogation) reject message is generated. This option is only valid for ATI MAP operation codes.

route—Route the message as normal to the original destination node; no UIM will be generated. The original destination is the node to which normal GTT would be sent if no GSM MAP actions are taken.

forward—Route the original message to the forward node. The original message will not be sent to the original node. If, however, the forward node is not available for routing, the MSU is routed to the original node.

duplicate—Route the message as normal to the original destination and route a copy of the original message to the duplicate node. If the MSU fails to route to the duplicate node, a UIM is generated indicating the duplicate routing failure.

dupdisc—Route the original message to the duplicate node. The original message will not be sent to the original node. If, however, the duplicate node is not available for routing, the MSU is routed to the original node.

Default: Display all screening actions

:cdsr= (optional)

CdPA Screening Reference.

Range: 1 alphabetic character followed by up to 3 optional alphanumeric characters

:cgsr= (optional)

CgPA Screening Reference.

Range: 1 alphabetic character followed by up to 3 optional alphanumeric characters

:eaddr= (optional)

The ending origination address, in association with **npv** and **naiv** for the CGPA address to be screened.

Range: 1–15 hexadecimal digits, values 0–9, a-f, A-F

:forbid= (optional)

The forbidden parameter value. Indicates a forbidden parameter for the entered address. If a forbidden parameter is detected the message is rejected by the action defined by the **action** parameter.

Range: **all, location, none, state**

all—All parameters are forbidden. Take the specified screening action defined by the **action** parameter for messages arriving at the system.

location—Take the specified screening action defined by the **action** parameter for messages arriving at the system that contain **location** as the forbidden parameter value for the entered address/operation code combination. Note: The **location** value is valid only for GSM ATI messages.

none—None of the parameters are forbidden. Route the message to its destination.

state—Take the specified screening action defined by the **action** parameter for messages arriving at the system that contain **state** as the forbidden parameter value for the entered address/operation code combination. Note: The **state** value is valid only for GSM ATI messages.

Default: Display all forbidden parameter values

:naiv= (optional; must be specified together with **npv**)

Nature of Address value for the address or range of CgPA and CdPA addresses.

Range: 0–127, *

:npv= (optional must be specified together with **naiv**)

Numbering Plan value for the address or range of CgPA and CdPA addresses.

Range: 0–15, *

:saddr= (optional)

The starting origination address. in association with **npv** and **naiv** for the single entry or range of entries of the CGPA address to be screened.

Range: 1–15 hexadecimal digits, values 0–9, a-f, A-F; or *

Default: *

Example

The following example retrieves all CgPA entries for the specified **opname**:

```
rtrv-gsmmap-scrn:opname=ati
```

The following example retrieves the specified CgPA range entry for the specified **opname**:

```
rtrv-gsmmap-scrn:opname=ati:saddr=91946200000000:eaddr=91946300000000
```

The following example retrieves all CdPA entries for the specified **cgsr**:

```
rtrv-gsmmap-scrn:opname=xyz:cgsr=fela
```

The following example retrieves the specified **cdsr** entry for the specified **cgsr**:

```
rtrv-gsmmap-scrn:opname=xyz:cgsr=fela:cdsr=cal4
```

Dependencies

The GSM Map Screening feature (see the **enable-ctrl-feat** command) must be enabled before this command can be entered.

The Enhanced GSM Map Screening (EGMS) feature must be enabled before:

- The **cgsr** parameter can be specified
- The **cdsr** parameter can be specified
- The **saddr=*** parameter can be specified
- The **saddr** and **eaddr** parameters can contain hexadecimal digits

The specified **opname** parameter value must exist in the GSM Map Op-Code table.

If the **eaddr** parameter is specified, its value must contain the same number of digits as the **saddr** parameter value.

If the **eaddr** parameter is specified, its value must be greater than the **saddr** parameter value.

If the **eaddr** parameter is specified, the **saddr** parameter must be specified.

If **saddr=*** is specified, the **eaddr** parameter cannot be specified.

If the **saddr** parameter is specified, the **cgsr** and **cdsr** parameters cannot be specified.

The **saddr**, **npv**, and **naiv** parameters must be specified together in the command.

When any of the **saddr/eaddr/npv/naiv** and **cdsr** parameters are specified, the **forbid** and **action** parameters cannot be specified.

A value of **state** or **location** cannot be specified for the **forbid** parameter unless the operation code (**opcode**) referenced by **opname** is **71**. An operation code of **71** signifies an ATI MAP operation code.

A value of **atierr** cannot be specified for the **action** parameter unless the operation code (**opcode**) referenced by **opname** is **71**. The **atierr** option is only valid for ATI MAP operation codes; **opcode=71** signifies an ATI MAP operation code.

When the **cdsr** parameter is specified, the **cgsr** parameter must be specified.

The specified **cgsr** parameter value must exist in the database.

The specified **cdsr** parameter value must exist in the database.

Notes

None

Output

NOTE: GSM MAP Screening single entries and range entries are output in separate sections of the retrieval report. All single entries are output first in a summary report and then all range entries follow.

rtrv-gsmmap-scrn:opname=xyz

tekelecstp 03-10-30 10:33:28 EST EAGLE 31.3.0

Single CgPA Entries for OPNAME: xyz

```

-----
SADDR          NPV NAIV FORBID ACTION PCA          SSN CGSR
SADDR          NPV NAIV FORBID ACTION PCI          SSN CGSR
SADDR          NPV NAIV FORBID ACTION PCN          SSN CGSR
*              3   20   all   dup   1234          100 fall
SADDR          NPV NAIV FORBID ACTION PCN24         SSN CGSR
SADDR          NPV NAIV FORBID ACTION CGSR
abcdefabcdefabc * *   all   disc  cal3
*              2   20   all   disc  fal2
    
```

Range CgPA Entries for OPNAME: xyz

```

-----
SADDR          EADDR          NPV NAIV FORBID ACTION PCA          SSN CGSR
123456789012345 234567890123456 3   40   all   fwd   001-001-001 200 fela
123456789012345 234567890123456 5   60   all   fwd   001-001-001 200 fell
SADDR          EADDR          NPV NAIV FORBID ACTION PCI          SSN CGSR
SADDR          EADDR          NPV NAIV FORBID ACTION PCN          SSN CGSR
SADDR          EADDR          NPV NAIV FORBID ACTION PCN24         SSN CGSR
SADDR          EADDR          NPV NAIV FORBID ACTION CGSR
    
```

GSM MAP Screening Table (10 of 4000) is 1% full

;

rtrv-gsmmap-scrn:opname=test2

tekelecstp 05-01-07 10:33:28 EST EAGLE 31.12.0

Single CgPA Entries for OPNAME: test2

```

-----
SADDR          NP NAI FORBD ACT          PCA          SSN CGSR
434            * *   all   dupl   002-002-003 111 t8
SADDR          NP NAI FORBD ACT          PCI          SSN CGSR
123            * *   all   dupl   s-1-001-1   10  t1
456            * *   all   dupl   s-1-001-1   10  t2
*              * *   all   dupl   1-001-1     10  t3
SADDR          NP NAI FORBD ACT          PCN          SSN CGSR
234            * *   all   dupl   0-020-6-1-aa 255 t6
334            * *   all   dupl   s-0-020-6-1-aa 254 t7
991            * *   all   dupl   2-003-3-1-aa 255 t20
998            * *   all   dupl   s-2-003-3-1-aa 255 t12
999            * *   all   dupl   2-003-3-1-aa 255 t10
SADDR          NP NAI FORBD ACT          PCN24         SSN CGSR
    
```

```
SADDR      NP NAI FORBD ACT  CGSR
466        * *   none  disc  t9
```

Range CgPA Entries for OPNAME: test2

```
SADDR      EADDR      NP NAI FORBD ACT  PCA      SSN CGSR
623456789012345 643210987654321 * *   all   fwd    002-002-003  111 ansi
```

```
SADDR      EADDR      NP NAI FORBD ACT  PCI      SSN CGSR
123456      987654      * *   all   dupl   1-001-1      10  t4
1123456     1987654     * *   all   dupdc  s-1-001-1    10  t5
```

```
SADDR      EADDR      NP NAI FORBD ACT  PCN      SSN CGSR
782        783        1 127 all   dupl   2-003-3-1-aa 255 t22
777        779        * *   all   dupl   2-003-3-1-aa 255 t14
780        781        * *   all   dupl   2-003-3-1-aa 255 t21
800        801        * *   all   dupl   s-2-003-3-1-aa 255 t15
2123456    2987654    * *   all   dupdc  s-0-020-6-1-aa 254 pcn1
3123456    3987654    * *   all   dupdc  0-020-6-1-aa 255 pcn2
123456789012345 543210987654321 * *   all   fwd    s-0-020-6-1-aa 254 pcn3
```

```
SADDR      EADDR      NP NAI FORBD ACT  PCN24     SSN CSGR
```

```
SADDR      EADDR      NP NAI FORBD ACT  CGSR
623456     643210     3 17 all   disc  nopc
```

GSM MAP Screening Table (55 of 4000) is 1% full

;

Legend

SINGLE ENTRIES/RANGE ENTRIES—GSM MAP screening single entries and range entries are output in separate sections of the retrieval report. All single entries are output first during a summary report and then all range entries follow.

CGPA—Calling Party Address entry

CDPA—Called Party Address entry

OPNAME—User-defined MAP operation code name.

SADDR—Start origination address.

EADDR—End origination address. This column is displayed for range entries only.

NPV—Numbering plan value.

NAIV—Nature of address indicator value.

FORBID or **FORBD**—Indicates a forbidden parameter for the entered address. If a forbidden parameter is detected the message is rejected by the action defined by the **action** parameter. (Some values are abbreviated; for example, **locat** means **location**).

ACTION or **ACT**—Screening action, if forbidden. Possible actions are pass, discard (disc), atterr, route, forward, duplicate (dupl), and dupdisc.

PC or **PCA**—ANSI Point Code

PCI—ITU International Point Code

PCN—ITU National Point Code

PCN24—24-bit ITU National Point Code

SSN—Subsystem Number

CGSR—CgPA Screening Reference

CDSR—CdPA Screening Reference

rtrv-gsmopts

Retrieve GSM System Options

Use this command to display all GSM (Global System for Mobile Telecommunication) system options from the database.

Keyword: rtrv-gsmopts

Related Commands: chg-gsmopts

Command Class: Database Administration

Parameters

This command has no parameters.

Example

```
rtrv-gsmopts
```

Dependencies

The G-Flex feature or G-Port feature must be turned on, or the Equipment Identity Register (EIR) feature must be enabled, before this command can be entered.

Notes

None

Output

The following examples show the output if the G-Flex feature is turned on. The second example includes values for CCNC and MCCMNC.

```
rtrv-gsmopts
```

```
rlghncxa03w 04-04-20 09:04:14 EST EAGLE 31.6.0
```

```
GSM OPTIONS
```

```
-----
DEFMCC      = NONE
DEFMNC      = NONE
SRFADDR     = NONE
MSRNDIG     = RN
DEFMAPVR    = 1
IS412GSM    = NONE
```

```
;
```

rtrv-gsmopts

```
rlghncxa03w 04-04-20 09:04:14 EST EAGLE 31.6.0
```

```
GSM OPTIONS
```

```
-----
DEFMCC      = NONE
DEFMNC      = NONE
SRFADDR     = NONE
MSRNDIG     = RN
DEFMAPVR    = 1
CCNC=33322123   MCCMNC=21434
IS412GSM    = NONE
```

```
;
```

The following examples show the output if the G-Port feature is turned on. The second example includes the Server Prefix digits. The SERVERPFX field does not appear when the G-Port feature is not on and when the Server Prefix string is not provisioned (set to none).

rtrv-gsmopts

```
rlghncxa03w 04-04-20 09:04:14 EST EAGLE 31.6.0
```

```
GSM OPTIONS
```

```
-----
DEFMCC      = NONE
DEFMNC      = NONE
SRFADDR     = 123456789abcdef
MSRNDIG     = RN
DEFMAPVR    = 1
SRIDN       = TCAP
IS412GSM    = 0123456789abcde
```

```
;
```

rtrv-gsmopts

```
rlghncxa03w 04-09-02 09:04:14 EST EAGLE 31.6.3
```

```
GSM OPTIONS
```

```
-----
DEFMCC      = NONE
DEFMNC      = NONE
SRFADDR     = 123456789abcdef
MSRNDIG     = RN
DEFMAPVR    = 1
SRIDN       = TCAP
IS412GSM    = 0123456789abcde
MSISDNTRUNC = 3
SERVERPFX   = 0000
```

```
;
```

The following examples show the output if the Prepaid Short Message Service (PPSMS) feature is turned on. The second example includes spare points codes that can be defined when the ITU Spare Point Code Support feature is on.

rtrv-gsmopts

```
rlghncxa03w 03-08-20 09:04:14 EST EAGLE 31.6.0
GSM OPTIONS
-----
DEFMCC      = 214
DEFMNC      = 34
MSRNDIG     = RN
DEFMAPVR    = 1
SRIDN       = TCAP
PPSMSRI1    = SSN
PPSMSRI2    = GT
PPSMSPCI1   = 1-1-1
PPSMSPCN2   = -----
PPMSGTA     = 1112223333,
              2223334444,
              ABCDEF123456ABC
IS412GSM    = 0123456789abcde
```

;

rtrv-gsmopts

```
rlghncxa03w 05-01-07 09:04:14 EST EAGLE 31.12.0
GSM OPTIONS
-----
DEFMCC      = 214
DEFMNC      = 34
MSRNDIG     = RN
DEFMAPVR    = 1
SRIDN       = TCAP
PPSMSRI1    = SSN
PPSMSRI2    = GT
PPSMSPCI1   = s-1-104-0
PPSMSPCN2   = 1-101-1
PPMSGTA     = NONE
IS412GSM    = NONE
```

;

The following example shows the output if the Equipment Identity Register (EIR) feature is turned on.

rtrv-gsmopts

```
tekelecstp 03-07-08 14:53:59 EST EAGLE5 31.0.0
GSM OPTIONS
-----
DEFMCC      = NONE
DEFMNC      = NONE
SRFADDR     = NONE
MSRNDIG     = RN
IS412GSM    = NONE
DEFMAPVR    = 1
EIRGRSP     = BLKLST
EIRRSPTYPE  = TYPE2
EIRIMSCHK   = ON
```

;

The following example includes multiple country code entries and no MSISDN truncation digits.

rtrv-gsmopts

```
tekelecstp 04-04-08 14:53:59 EST EAGLE 31.6.0
GSM OPTIONS
-----
DEFMCC      = NONE
DEFMNC      = NONE
SRFADDR     = NONE
MSRNDIG     = RN
IS412GSM    = NONE
DEFMAPVR    = 1
IS412GSM    = NONE
MULTCC      = 2
MULTCC      = 4
MULTCC      = 5
MULTCC      = 20
MULTCC      = 119
MULTCC      = 121
MULTCC      = 123
MULTCC      = 124
MSISDNTRUNC = 0
```

;

Legend

DEFMCC—E212 default mobile country code.

DEFMNC—E212 default mobile network code.

CCNC—E214 country code and network code.

MCCMNC—E212 mobile country code and mobile network code.

SRFADDR—Entity address of the MNP_SRF node.

SRFNAI—The nature of address indicator value of the MNP_SRF.

SRFNP—The numbering plan value of the MNP_SRF.

MSRNDIG—The routing number to be used as is or to be concatenated with the MSISDN.

MSRNNAI—The nature of address indicator value for the MSRN.

MSRNNP—The numbering plan value for the MSRN.

SRIDN—Send Routing Information Dialed Number location.

PPSMSRI1—A routing indicator for an Intelligent Network (IN) platform used by Prepaid Short Message Service Intercept (PPSMS) for credit checking.

PPSMSRI2—A routing indicator for an Intelligent Network (IN) platform used by Prepaid Short Message Service Intercept (PPSMS).

PPSMSPCI1—An ITU international point code for an IN platform used by PPSMS.

PPSMSPCI2—An ITU international point code for an IN platform used by PPSMS.

PPSMSPCN1—An ITU national point code for an IN platform used by PPSMS.

PPSMSPCN2—An ITU national point code for an IN platform used by PPSMS.

PPSMSGTA—Entity addresses for up to 3 IN platforms used by PPSMS.

IS412GSM—IS-41 to GSM Migration prefix.

EIRGRSP—Equipment Identity Register Global Response status.

EIRRSPTYPE—Equipment Identity Register Global Response Type.

EIRIMSICHK—Equipment Identity Register IMSI Check status.

MULTCC—Multiple country code list entry.

MSISDNTRUNC—Number of digits to delete from the beginning of the National MSISDN (MSISDN without Country Code) before formulating the MSRN parameter of the SRI-ack response.

SERVERPFX—Server prefix for IS-41 to GSM Migration SRI Redirect.

rtrv-gsms-opcode

Retrieve GSM MAP Screening Operation Code

Use this command to retrieve the concerned GSM (Global System for Mobile Telecommunication) MAP (Mobile Application Part) screening operation codes and the default screening action for the operation code. This command allows the technician to verify a list of all operation codes or a single operation code that the system uses in performing GSM Map Screening.

Keyword: rtrv-gsms-opcode

Related Commands: dlt-gsms-opcode, chg-gsms-opcode, ent-gsms-opcode

Command Class: Database Administration

Parameters

:opcode= (optional)

MAP operation code.

Range: 0–255, *

Default: Display all MAP operation codes

:opname= (optional)

The user-defined name for the operation code. The **opname** value is defined with the **ent-gsms-opcode** command.

Range: Up to 8 alphanumeric characters

Default: Display all operation code names

Example

```
rtrv-gsms-opcode
```

```
rtrv-gsms-opcode:opname=ati
```

Dependencies

The GSM Map Screening feature (see the **enable-ctrl-feat** command) must be enabled before this command can be entered.

The Enhanced GSM Map Screening feature must be enabled and turned on before:

- **opcode=*** can be specified
- An **opname** can be specified that refers to an **opcode=*** entry

The **opcode** parameter and the **opname** parameter cannot be specified together in the same command.

The **opcode** parameter value must be specified as a number between **0** and **255**, or *****.

The specified **opname** must exist in the GSM MAP Op-Code table.

Notes

None

Output

rtrv-gsms-opcode

```
rlghncxa03w 04-02-10 11:43:04 EST EAGLE 31.3.0
OPCODE OPNAME DFLTACT PCA SSN
* xyz duplicate 009-009-009 3

OPCODE OPNAME DFLTACT PCI SSN

OPCODE OPNAME DFLTACT PCN SSN

OPCODE OPNAME DFLTACT PCN24 SSN

OPCODE OPNAME DFLTACT
```

```
GSMMS OPCODE Table (1 of 257) is 1% full
RTRV-GSMS-OPCODE: MASP A - COMPLTD
```

;

rtrv-gsms-opcode:opname=ati

```
rlghncxa03w 04-02-10 11:43:04 EST EAGLE 31.3.0
OPCODE OPNAME DFLTACT
71 ati atierr
```

```
GSM Map Op-Code Table is (1 of 257) 1% full
RTRV-GSMS-OPCODE: MASP A - COMPLTD
```

;

rtrv-gsms-opcode:opname=atl

```
rlghncxa03w 04-02-10 11:43:04 EST EAGLE 31.3.0
OPCODE OPNAME DFLTACT PCI SSN
71 atl forward 7-100-6 5
```

```
GSM Map Op-Code Table is (1 of 257) 1% full
RTRV-GSMS-OPCODE: MASP A - COMPLTD
```

;

rtrv-gsms-opcode:opname=atl

```
rlghncxa03w 04-02-10 11:43:04 EST EAGLE 31.3.0
```

OPCODE	OPNAME	DFLTACT	PCN	SSN
72	atl	forward	12345	5

GSM Map Op-Code Table is (1 of 257) 1% full

RTRV-GSMS-OPCODE: MASP A - COMPLTD

;

The following example shows output for a 24-bit ITU national point code:

rtrv-gsms-opcode:opname=ati

```
tekelecstp 04-01-07 11:50:25 EST EAGLE 31.3.0
```

OPCODE	OPNAME	DFLTACT	PCN24	SSN
2	ati	duplicate	008-008-008	20

GSMSMMS OPCODE Table (1 of 257) is 1% full

;

The following example includes a spare point code:

rtrv-gsms-opcode

```
tekelecstp 05-01-07 11:50:25 EST EAGLE 31.12.0
```

OPCODE	OPNAME	DFLTACT	PCA	SSN
6	test6	dupl	002-002-003	10

OPCODE	OPNAME	DFLTACT	PCI	SSN
2	test2	dupl	1-001-1	10
3	test3	dupl	s-1-001-1	10

OPCODE	OPNAME	DFLTACT	PCN	SSN
4	test4	dupl	003-003-003	10

OPCODE	OPNAME	DFLTACT	PCN24	SSN
4	test4	dupl	003-003-003	10

OPCODE	OPNAME	DFLTACT
7	test7	disc
8	test8	disc
9	test9	disc

GSMSMMS OPCODE Table (7 of 257) is 3% full

;

Legend

OPCODE—MAP operation code.

OPNAME—The user-defined name of operation code.

DFLTACT—The default screening action.

PCA—ANSI Point Code.

PCI—ITU International Point Code.

PCN—ITU National Point Code.

PCN24—24-bit ITU National Point Code.

SSN—Subsystem Number.

rtrv-gsmssn-scrn **Retrieve GSM Subsystem Number Screening Entry**

Use this command to retrieve all or single subsystem numbers in the GSM SSN screening table.

Keyword: rtrv-gsmssn-scrn

Related Commands: dlt-gsmssn-scrn, ent-gsmssn-scrn

Command Class: Database Administration

Parameters

:ssn= (optional)

Subsystem number.

Range: 000–255

Default: Display all

:type= (optional)

Subsystem type.

Range: orig, dest

orig—The origination SSN

dest—The destination SSN

Default: Display all

Example

```
rtrv-gsmssn-scrn
```

```
rtrv-gsmssn-scrn:ssn=0:type=dest
```

Dependencies

The GSM Map Screening feature must be enabled (see the **enable-ctrl-feat** command) before this command can be entered.

Notes

If specified, the **ssn/type** parameter combination must exist in the GSM SSN screening table. If the value does not exist, the following message is displayed:

```
SSN      ORIG      DEST
No matching entries with the specified criteria found.
```

Output

```
rtrv-gsmssn-scrn:ssn=2:type=dest
```

```
rlghncxa03w 04-02-20 09:07:58 EST EAGLE 31.3.0
SSN  ORIG  DEST
002  No    Yes
GSMMS SSN table is (2 of 512) 1% full
RTRV-GSMSSN-SCRN: MASP A - COMPLTD
```

```
;
```

rtrv-gsmssn-scrn:ssn=10:type=orig

```
rlghncxa03w 04-02-20 09:07:58 EST EAGLE 31.3.0
SSN ORIG DEST
010 Yes Yes
GSMMS SSN table is (256 of 512) 50% full
RTRV-GSMSSN-SCRN: MASP A - COMPLTD
```

;

rtrv-gsmssn-scrn

```
rlghncxa03w 04-02-20 09:07:58 EST EAGLE 31.3.0
SSN ORIG DEST
002 Yes No
010 Yes Yes
GSMMS SSN table is (2 of 512) 1% full
RTRV-GSMSSN-SCRN: MASP A - COMPLTD
```

;

Legend

SSN—Subsystem number.

ORIG—Specifies whether the subsystem type is origination (yes) or not (no).

DEST—Specifies whether the subsystem type is destination (yes) or not (no).

rtrv-gta**Retrieve Global Title Address Information**

Use this command to display a list of the GTA (global title address) information applicable to the specified GTT set. This list can be filtered using a number of parameters. The report that is displayed contains two records (the percentage full and number-of-cells-used field) that give the total entries in the GTT table without regard to the selector specified.

This command obtains the routing object (destination address and subsystem number), relative cost, and routing indicator assigned to that object for specified GTAs (global title addresses) or ranges of GTAs with a given GTT set.

NOTE: When the ANSI-ITU-China SCCP Conversion feature is enabled, entries that are provisioned with `xlat=dpc` where `ntt` has been specified are displayed with an `xlat` of `dpcngt`.

Keyword: `rtrv-gta`

Related Commands: `chg-gta`, `dlt-gta`, `ent-gta`, `rtrv-gtt`

Command Class: Database Administration

Parameters

:gttsn= (mandatory)

GTT set name. A GTT set is an entity to which global title addresses and selectors are assigned.

Range: 1 leading alphabetic character and up to 8 alphanumeric characters

:egta= (optional)

End Global Title Address.

Range: Maximum of 21 digits

Default: The first `gta` entry for the given GTT selector

:force= (optional)
Display more than 1000 entries.

Range: yes, no

Default: no

:gta= (optional)
Start global title address.

Range: Maximum of 21 digits

Default: The first **gta** entry for the given GTT selector

:num= (optional)
Number of entries to display.

Range: 1-65535

Default: 1—if **gta** is specified
20—if **gta** is not specified

NOTE: See “Point Code Formats and Conversion” in Appendix A for a detailed description of point code formats, rules for specification, and examples.

:pc/pca/pci/pcn/pcn24= (optional)
Translated point code.

:pc= or **:pca=** (optional)

ANSI point code in the form of *network indicator-network cluster-network cluster member (ni-nc-ncm)*. The *prefix* subfield indicates a private point code (*prefix-ni-nc-ncm*).

Range: p-, 000-255
Specify a valid value for each subfield of the point code, and separate the subfields with a dash (-).

prefix—p-

When **chg-sid:pctype=ansi** is specified, *ni* = 000 is not valid.

When **chg-sid:pctype=ansi** is specified, *nc* = 000 is not valid if *ni* = 001-005.

When **chg-sid:pctype=ansi** is specified, *nc* = 000 is valid if *ni* = 006-255.

The point code 000-000-000 is not a valid point code.

:pci= (optional)

ITU international point code in the form of *zone-area-id*. The *prefix* subfield indicates a spare point code, private point code, or private and spare point code (*prefix-zone-area-id*).

Range: s-, p-, ps-, 0-255
Specify a valid value for each subfield of the point code, and separate the subfields with a dash (-).

The point code 0-000-0 is not a valid point code.

prefix—s-, p-, ps-

zone—0-7

area—000-255

id—0-7

:pcn= (optional)

ITU national point code in the format of a 5-digit number (*nnnnn*); or 2, 3, or 4 numbers (members) separated by dashes (*m1-m2-m3-m4*) as defined by the **chg-stpopts:npfinti** flexible point code option. A group code must be specified when the ITUDUPPC feature is turned on (*nnnnn-gc*, *m1-m2-m3-m4-gc*). The *prefix* subfield indicates a spare point code, private point code, or private and spare point code (*prefix-nnnnn*, *prefix-nnnnn-gc*, *prefix-m1-m2-m3-m4*, *prefix-m1-m2-m3-m4-gc*).

Range: **s-**, **p-**, **ps-**, **0-16383**, **aa-zz**

Specify a valid value for each subfield of the point code, and separate the subfields with a dash (-).

prefix—**s-**, **p-**, **ps-**

nnnnn—**0-16383**

gc—**aa-zz**

m1-m2-m3-m4—**0-14** for each member; values must sum to 14

:pcn24= (optional)

24-bit ITU national point code with subfields *main signaling area-sub signaling area-signaling point* (*msa-ssa-sp*) The *prefix* subfield indicates a private point code (*prefix-ni-nc-ncm*).

Range: **p-**, **000-255**

Specify a valid value for each subfield of the point code, and separate the subfields with a dash (-).

prefix—**p-**

msa—**000-255**

ssa—**000-255**

sp—**000-255**

:pctype= (optional)

Point code type. This parameter can be specified only when the ANSI-ITU-China SCCP Conversion feature is enabled, to retrieve a single type of point code among mixed types of point code provisioned for a Translation Type.

Range: **ansi**, **itui**, **itun**, **itun24**

Default: Display all point code types

:ssn= (optional)

Translated subsystem number.

Range: **000-255**

Default: Display all

Example

```
rtrv-gta:gttsn=t800:num=65535:force=yes
```

```
rtrv-gta:gttsn=t800:pc=8-1-1:ssn=222:gta=9195551212
```

```
rtrv-gta:gttsn=t800:ssn=222:gta=9000000000:egta=9762429999:num=65535:force=yes
```

```
rtrv-gta:gttsn=ntoa23:pctype=ansi
```

```
rtrv-gta:gttsn=atoi22:pctype=itui
```

```
rtrv-gta:gttsn=aton21:pctype=itun
```

```
rtrv-gta:gttsn=ntin24:pctype=itun24
```

rtrv-gta:gttsn=setnat003:pcn=s-129-aa

rtrv-gta:gttsn=setnat003:gta=987658321198765432101:pcn=s-128-aa

Dependencies

The EGTT feature must be turned on before this command can be entered.

The ANSI-ITU-China SCCP Conversion feature must be enabled before the **pctype** parameter can be specified.

An asterisk cannot be specified for the **ssn** parameter value.

The **gttsn** parameter must be specified, cannot have a value of **none**, and must match an existing **gttsn**.

The **pc/pca/pci/pcn/pcn24** parameter cannot be out of range and must be a full point code.

When the ANSI-ITU-China SCCP Conversion feature is not on and the specified GTT set is an ANSI set, the **pc/pca** parameter must be a valid ANSI point code.

When the ANSI-ITU-China SCCP Conversion feature is not on and the specified GTT set is an ITU set, the **pci/pcn/pcn24** parameter must be a valid ITU point code.

If the **egta** parameter is specified, the **gta** parameter must be specified. The **gta** and **egta** parameters must be the same length, and the **egta** value must be greater than the **gta** value.

If the specified **num** parameter value is greater than **1000**, the **force=yes** parameter must be specified.

The number of digits in the specified **gta** parameter must be at least the number of digits provisioned for the specified GTT set (**gttsn**). If the VGTT (variable length GTT) feature is turned on, there can be up to 10 GTA lengths per GTT set. When the **ent-gta** command is entered to create entries, the software keeps track of the lengths and allows only 10 different lengths.

Notes

The percentage full and number of cells used report that is provided with a **rtrv-gta** command reflects the total entries in the GTA table without regard to the selector specified.

When the EGTT feature is turned on, the GTT Selector (**ent/chg/dlt/rtrv-gttset**), GTT Set (**ent/dlt/rtrv-gttset**), and GTA (**ent/chg/dlt/rtrv-gta**) commands replace the Translation Type (**ent/dlt/rtrv-tt**) and Global Title Translation (**ent/chg/dlt/rtrv-gtt**) commands. All data previously provisioned with these commands is maintained.

This command can be canceled using the **F9** function key or the **canc-cmd** command. See **canc-cmd** for more information.

If the **rtrv-gta** command is entered with only the **gta** parameter, a match would be an entry containing the same number of digits, or more digits, for the GTT set. For example, if **gta=8005556666** is specified, the six-digit GTT set **800555** would be a match. If the VGTT feature is turned on and the **egta** parameter is specified, all matching entries regardless of length are displayed.

In this command, only ITU-international and ITU national point codes support the spare point code subtype prefix (s-) and the private and spare point code subtype prefix (ps-). All of the point code types support the private (internal) point code subtype prefix (p-).

The point code domain translation types for EGTT are handled by the EAGLE protocol processing as either ANSI or ITU; therefore, ITU applies to ITU-I, ITU-I Spare, ITU-N, and ITU-N Spare. ITU-I includes ITU-I Spare, and ITU-N includes ITU-N Spare.

Output

NOTE: The Start GTA (gta) and End GTA (egta) fields are sized according to the ndgt parameter value. Because all GTAs for a GTT Set are the same size, this helps the appearance of the display. If all 21 digits are used, an entry will not fit on a single line. If two lines per entry are used, the size of the report would double, being inefficient for large reports. It is not anticipated that more than 15 digits will be used in the immediate future, but displaying GTAs longer than 19 digits will cause the line to wrap around to the next.

Retrieve all GTAs for the specified GTT Set:

rtrv-gta:gttsn=t800:num=65535:force=yes

```
rlghncxa03w 04-02-18 08:29:15 EST EAGLE 31.3.0
GTTSN      NETDOM  NDGT
t800      ansi    10
GTA TABLE IS 1 % FULL (17 of 269999)

START GTA  END GTA    XLAT  RI  PCA          SSN CCGT NTT
8005550000 8005551999 dpcssn ssn 001-254-255 255 no ---
8005552000 8005553999 dpc    gt  001-254-255 255 no ---
8005554000 8005555999 dpcngt gt  001-254-255 255 no 123
8005556000 8005557999 dpcssn ssn 001-254-255 255 no ---
8005558000 8005559999 dpcssn ssn 001-254-255 255 yes ---
9195551212          dpcssn ssn 008-001-001 222 no ---
9762428487          dpcssn ssn 001-254-255 222 no ---
9766423277          dpcssn ssn 001-254-255 222 no ---
9769388928          dpcssn ssn 001-254-255 222 no ---
```

;

Retrieve the specific GTAs containing the specified pc/ssn/gta combination for the specified GTT Set:

rtrv-gta:gttsn=t800:pc=8-1-1:ssn=222:gta=9195551212

```
rlghncxa03w 04-02-18 08:29:15 EST EAGLE 31.3.0
GTTSN      NETDOM  NDGT
t800      ansi    10
GTA TABLE IS 1 % FULL (17 of 269999)

START GTA  END GTA    XLAT  RI  PCA          SSN CCGT NTT
9195551212          dpcssn ssn 008-001-001 222 no ---
```

;

Retrieve all GTAs containing the specified **ssn** and within the specified **gta** range for the specified GTT Set:

rtrv-gta:gttsn=t800:ssn=222:gta=900000000:egta=9762429999:num=65535:force=yes

```
rlghncxa03w 04-02-18 08:29:15 EST EAGLE 31.3.0
GTTSN      NETDOM  NDGT
t800      ansi    10
GTA TABLE IS 1 % FULL (17 of 269999)

START GTA  END GTA  XLAT  RI  PCA          SSN CCGT NTT
9195551212          dpcssn ssn 008-001-001 222 no  ---
9762428487          dpcssn ssn 001-254-255 222 no  ---
```

;

Retrieve all GTAs for the specified GTT Set when the VGTT feature is turned on:

rtrv-gta:gttsn=t800:num=65535:force=yes

```
rlghncxa03w 04-02-18 08:29:15 EST EAGLE 31.3.0
GTTSN      NETDOM  NDGT
t800      ansi    3,10
GTA TABLE IS 1 % FULL (17 of 269999)

START GTA  END GTA  XLAT  RI  PCA          SSN CCGT NTT
800          dpcssn ssn 001-253-001 222 no  ---
9195551212          dpcssn ssn 008-001-001 222 no  ---
9762428487          dpcssn ssn 001-254-255 222 no  ---
9766423277          dpcssn ssn 001-254-255 222 no  ---
9769388928          dpcssn ssn 001-254-255 222 no  ---
8005550000 8005551999 dpcssn ssn 001-254-255 255 no  ---
8005552000 8005553999 dpc  gt  001-254-255 255 no  ---
8005554000 8005555999 dpcngt gt  001-254-255 255 no  123
8005556000 8005557999 dpcssn ssn 001-254-255 255 no  ---
8005558000 8005559999 dpcssn ssn 001-254-255 255 yes ---
```

;

The following example shows a retrieve with the MGTT **npn**, **nnai**, **npdd**, and **npds** parameter values:

rtrv-gta:gttsn=ansi

```
rlghncxa03w 04-02-18 08:29:15 EST EAGLE 31.3.0
GTTSN      NETDOM  NDGT
t800      ansi    10
GTA TABLE IS 1 % FULL (17 of 269999)

START GTA  END GTA  XLAT  RI  PCA          SSN CCGT NTT
8005550000 8005551999 dpcssn ssn 001-254-255 255 no  ---
8005552000 8005553999 dpc  gt  001-254-255 255 no  ---
                                NNP=3 NNAI=120 NPDD=3 NPDS=345
8005554000 8005555999 dpcngt gt  001-254-255 255 no  123
8005558000 8005559999 dpcssn ssn 001-254-255 255 yes  ---
9195551212          dpcssn ssn 008-001-001 222 no  ---
9762428487          dpcssn ssn 001-254-255 222 no  ---
                                NNP=3 NNAI=100 NPDD=3 NPDS=345
9766423277          dpcssn ssn 001-254-255 222 no  ---
```

;

The following example shows output when the GTT table can contain up to 1,000,000 entries:

rtrv-gta:gttsn=ansi

```
rlghncxa03w 04-02-18 08:29:15 EST EAGLE 31.3.0
GTTSN      NETDOM  NDGT
t800      ansi    10
GTA TABLE IS 1 % FULL (17 of 1000000)

START GTA  END GTA   XLAT  RI  PCA          SSN CCGT NTT
8005550000 8005551999 DPCSSN SSN 001-254-255 255 no  ---
8005552000 8005553999 DPCNGT GT  001-254-255 255 no  123
                    NNP=3  NNAI=120 NPDD=3  NPDS=345
8005554000 8005555999 DPCNGT GT  001-254-255 255 no  123
8005558000 8005559999 DPCSSN SSN 001-254-255 255 yes ---
9195551212                DPCSSN SSN 008-001-001 222 no  ---
9762428487                DPCNGT GT  001-254-255 222 no  123
                    NNP=3  NNAI=100 NPDD=3  NPDS=345
9766423277                DPCSSN SSN 001-254-255 222 no  ---
```

;

The following examples show output when the ANSI-ITU-China SCCP Conversion feature is enabled and the **pctype** parameter is specified.

rtrv-gta:gttsn=ntoa23:pctype=ansi

```
rlghncxa03w 04-02-18 08:29:15 EST EAGLE 31.3.0
GTTSN      NETDOM  NDGT
ntoa23     itu     4
GTT TABLE IS 1 % FULL (36 of 269999)

START GTA  END GTA   XLAT  RI  PC          SSN CCGT NTT
1899      1899      DPCNGT GT  010-002-002 --- no  37
          NNP=    NNAI=    NPDD=0  NPDS=
          NGTI=2
```

;

rtrv-gta:gttsn=atoi22:pctype=itui

```
rlghncxa03w 04-02-18 08:29:15 EST EAGLE 31.3.0
GTTSN      NETDOM  NDGT
atoi22     ansi    9
GTT TABLE IS 1 % FULL (36 of 269999)

START GTA  END GTA   XLAT  RI  ITUI PC          SSN CCGT NTT
991001200 991001300 DPCNGT GT  7-001-4      --- no  4
          NNP=    NNAI=    NPDD=0  NPDS=
          NGTI=2
```

;

rtrv-gta:gttsn=aton21:pctype=itun

```
rlghncxa03w 04-02-18 08:29:15 EST EAGLE 31.3.0
GTTSN      NETDOM  NDGT
aton21     ansi    2
GTT TABLE IS 1 % FULL (36 of 269999)

START GTA  END GTA   XLAT  RI  ITUN PC          SSN CCGT NTT
80         89         DPCSSN SSN 15441        45 no  ---
```

;

rtrv-gta:gttsn=ntin24:pctype=itun24

```
rlghncxa03w 04-02-18 08:29:15 EST EAGLE 31.3.0
GTTSN      NETDOM  NDGT
ntin24     itu      10
GTA TABLE IS 1 % FULL (36 of 269999)

START GTA  END GTA  XLAT  RI  ITUN24 PC  SSN CCGT NTT
8006550000 8006551999 DPCSSN SSN 100-120-003 255 no  ---
```

;

The following examples include spare point codes:

rtrv-gta:gttsn=setnat003

```
rlghncxa03w 05-01-18 08:29:15 EST EAGLE 31.12.0
GTTSN      NETDOM  NDGT
setnat003  itu      6,11,21
GTT TABLE IS 1 % FULL (10 of 269999)

START GTA          END GTA          XLAT  RI  PC
123456            123456            DPCSSN GT  s-00128-aa
SSN=10  CCGT=no  NTT=---
NNP=12  NNAI=125 NPDD=21 NPDS=125498679012426556356
NGTI=
234567            234567            DPCNGT GT  s-00124-aa
SSN=---  CCGT=no  NTT=255
234568            234568            DPC    GT  s-00124-aa
SSN=0    CCGT=no  NTT=---
234569            234569            DPC    GT  s-00124-aa
SSN=0    CCGT=no  NTT=---
NNP=13  NNAI=120 NPDD=21 NPDS=125498679012426556356
NGTI=
12345678901      23456789012      DPCSSN SSN  s-00124-aa
SSN=10  CCGT=no  NTT=---
NNP=14  NNAI=3   NPDD=0  NPDS=
NGTI=
334569467213456789012 334569478932012345678 DPC    GT  s-00124-aa
SSN=0    CCGT=no  NTT=---
NNP=13  NNAI=120 NPDD=21 NPDS=125498679012426556356
NGTI=
987656789012345678901 987657321098765432101 DPCNGT GT  s-00124-aa
SSN=---  CCGT=no  NTT=234
NNP=12  NNAI=26  NPDD=0  NPDS=
NGTI=
987658321198765432101 987658321198765432101 DPCNGT GT  s-00128-aa
SSN=---  CCGT=no  NTT=235
NNP=1    NNAI=127 NPDD=0  NPDS=987657878901234567891
NGTI=4
987658321198765432102 990123456789012345678 DPCNGT GT  s-00124-aa
SSN=---  CCGT=no  NTT=235
NNP=1    NNAI=127 NPDD=0  NPDS=987657878901234567891
NGTI=4
```

;

rtrv-gta:gttsn=setnat003:pcn=s-129-aa

```

rlghncxa03w 05-01-18 08:29:15 EST EAGLE 31.12.0
GTTSN      NETDOM  NDGT
setnat003  itu     6,11,21
GTT TABLE IS 1 % FULL (11 of 269999)

START GTA          END GTA          XLAT  RI    PC
987658321198765432102 987658321198765432102 DPCNGT GT  s-00129-aa
SSN=--- CCGT=no NTT=235
NNP=1  NNAI=127 NPDD=0  NPDS=987657878901234567891
NGTI=4

```

;

rtrv-gta:gttsn=setnat003:ssn=10

```

rlghncxa03w 05-01-18 08:29:15 EST EAGLE 31.12.0
GTTSN      NETDOM  NDGT
setnat003  itu     6,11,21
GTT TABLE IS 1 % FULL (11 of 269999)

START GTA          END GTA          XLAT  RI    PC
123456          123456          DPCSSN GT  s-00128-aa
SSN=10 CCGT=no NTT=---
NNP=12 NNAI=125 NPDD=21 NPDS=125498679012426556356
NGTI=
12345678901          23456789012          DPCSSN SSN  s-00124-aa
SSN=10 CCGT=no NTT=---
NNP=14 NNAI=3  NPDD=0  NPDS=
NGTI=

```

;

rtrv-gta:gttsn=setnat003:gta=987658321198765432101:pcn=s-128-aa

```

rlghncxa03w 05-01-18 08:29:15 EST EAGLE 31.12.0
GTTSN      NETDOM  NDGT
setnat003  itu     6,11,21
GTT TABLE IS 1 % FULL (11 of 269999)

START GTA          END GTA          XLAT  RI    PC
987658321198765432101 987658321198765432101 DPCNGT GT  s-00128-aa
SSN=--- CCGT=no NTT=235
NNP=1  NNAI=127 NPDD=0  NPDS=987657878901234567891
NGTI=4

```

;

rtrv-gta:gttsn=setssnn

```

tekelecstp 05-05-17 09:49:42 EST EAGLE5 34.2.0
GTTSN      NETDOM  NDGT
setssnn    ----   -
GTT TABLE IS 1 % FULL (1 of 269999)

START GTA  END GTA  XLAT  RI    PCA
1111111111 1111111111 DPC   GT    001-001-003
MRNSET=1   SSN=0   CCGT=no NTT=---

```

;

rtrv-gta:gttsn=seta

```
tekelecstp 05-05-17 09:49:42 EST EAGLE5 34.2.0
GTTSN      NETDOM  NDGT
setssnn    ----   -
GTT TABLE IS 1 % FULL (1 of 269999)
```

```
START GTA  END GTA   XLAT  RI    PCA
5555555556 5555555556 DPC   GT    001-001-002
          MRNSET=NONE SSN=0  CCGT=no NTT=---
```

;

Legend

GTTSN—The GTT set name. A GTT set is an entity to which global title addresses and selectors are assigned.

NETDOM—The network domain.

NDGT—The number of digits required for GTAs associated with this set.

START GTA—The start global title address.

END GTA—The end global title address.

MRNSET—The MRN set id.

XLAT—The translate indicator.

RI—The routing indicator.

PC, PCA, ITU PC, ITUI PC, ITUN PC, ITUN24 PC—Translated point code.

SSN—The translated subsystem number.

CCGT—The cancel called global title indicator.

NNP—New Numbering Plan.

NNAI—New Nature of Address Indicator.

NPDD—New Prefix Digits to be Deleted.

NPDS—New Prefix Digits String.

NTT—The new translation type.

rtrv-gtcnv**Retrieve Global Title Conversion**

Use this command to display entries in the Default Global Title Conversion table.

Keyword: rtrv-gtcnv

Related Commands: chg-gtcnv, dlt-gtcnv, ent-gtcnv

Command Class: Database Administration

Parameters

:dir=. (optional)

Direction of conversion.

Range: **atoi, itoa, both**

atoi—ANSI to ITU conversion

itoa—ITU to ANSI conversion

both—Conversion in both directions

:gtixlat= (optional)

Global Title Indicator conversion. This parameter is expressed in the form of the ANSI GTI and the ITU GTI.

Range: **22, 24**

22—Converts an incoming ANSI GTI 2 to an outgoing ITU GTI 2 or an incoming ITU GTI 2 to an outgoing ANSI GTI 2

24—Converts an incoming ANSI GTI 2 to an outgoing ITU GTI 4 or an incoming ITU GTI 4 to an outgoing ANSI GTI 2

:nai= (optional)

Nature of Address Indicator.

Range: **0-63, ***

:np= (optional)

Numbering Plan.

Range: **0-15, ***

:tta= (optional)

ANSI translation type.

Range: **0-255, ***

:tti= (optional)

ITU translation type.

Range: **0-255, ***

Example

```
rtrv-gtcnv
```

Dependencies

The ANSI-ITU-China SCCP Conversion feature must be enabled before the command can be entered.

Notes

None

Output

```

rtrv-gtcnv
rlghncxa03w 04-01-07 11:43:04 EST EAGLE 31.3.0
  TYPEA      TTN      NDGT
    3        c800      10
GTT TABLE IS 1 % FULL (9 of 269999)
START GTA          END GTA  XLAT  RI  PCA          SSN NGT
9195551212                DPCSSN SSN 008-001-001 222 ---
8005550000                8005551999 DPCSSN SSN 001-254-255 255 ---
8005552000                8005553999 DPC   GT   001-254-255 255 ---
8005554000                8005555999 NGT   GT   001-254-255 255 123
8005556000                8005557999 DPCSSN SSN 001-254-255 255 ---
8005558000                8005559999 DPCSSN SSN 001-254-255 255 ---
9762428487                DPCSSN SSN 001-254-255 222 ---
9766423277                DPCSSN SSN 001-254-255 222 ---
9769388928                DPCSSN SSN 001-254-255 222 ---
;

```

Legend

TYPE/TYPEA/TYPEI/TYPEN/TYPEN24—The translation type.

TTN—The translation name.

NDGT—The number of digits.

rtrv-gtt

Retrieve Global Title Translation

Use this command to show one or more entries from the GTT Data and the Translation Type tables. The report that is displayed contains two records (the percentage full and number-of-cells-used field) that give the total entries in the GTT table without regard to the **type** parameter specified.

NOTE: If the EGTT (Enhanced Global Title Translation) feature is turned on in the system, the system will no longer accept GTT (Global Title Translation) and TT (Translation Type) commands. Refer to the new command sets that replace the GTT and TT commands: GTT Selector commands (ent/chg/dlt/rtrv-gttset), GTT Set commands (ent/dlt/rtrv-gttset), and GTA commands (ent/chg/dlt/rtrv-gta).

Keyword: rtrv-gtt

Related Commands: chg-gtt, dlt-gtt, ent-gtt

Command Class: Database Administration

Parameters

† A least one of these parameters must be specified.

NOTE: See “Point Code Formats and Conversion” in Appendix A for a detailed description of point code formats, rules for specification, and examples.

:force= (optional)

This parameter allows the user to display more than 1000 entries. This parameter is used to prevent inadvertent displays of extremely large amounts of information, which could take many hours.

Range: yes, no

Default: no

:gta= (optional)

Global title start address.

Range: Maximum of 21 digits

Default: The first GTT entry for the given translation type.

:egta= (optional)

Global title end address.

Range: Maximum of 21 digits

Default: The first GTT entry for the given translation type.

:num= (optional)

Number of entries.

This parameter allows the user to specify the number of entries to be shown.

Range: 1-1000—If **force=yes** is not specified

1-65535—If **force=yes** is specified

Default: 1 (if **gta** is specified),

20 (if **gta** is not specified).

:pc/pca/pci/pcn/pcn24= (optional)

Point code.

:pc= or **:pca=** (optional)

ANSI point code with subfields *network indicator-network cluster-network cluster member* (*ni-nc-ncm*). The *prefix* subfield indicates a private point code (*prefix-ni-nc-ncm*).

Range: p-, 000-255

Specify a valid value for each subfield of the point code, and separate the subfields with a dash (-).

prefix—p-

When **chg-sid:pctype=ansi** is specified, *ni* = 000 is not valid.

When **chg-sid:pctype=ansi** is specified, *nc* = 000 is not valid if *ni* = 001-005.

When **chg-sid:pctype=ansi** is specified, *nc* = 000 is valid if *ni* = 006-255.

The point code 000-000-000 is not a valid point code.

Default: Display all

:pci= (optional)

ITU international point code with subfields *zone-area-id*. The *prefix* subfield indicates a spare point code, private point code, or private and spare point code (*prefix-zone-area-id*).

Range: s-, p-, ps-, 0-255

Specify a valid value for each subfield of the point code, and separate the subfields with a dash (-).

The point code 0-000-0 is not a valid point code.

prefix—s-, p-, ps-

zone—0-7

area—000-255

id—0-7

Default: Display all

:pcn= (optional)

ITU national point code in the format of a 5-digit number (*nnnnn*); or 2, 3, or 4 numbers (members) separated by dashes (*m1-m2-m3-m4*) as defined by the **chg-stpopts:npfinti** flexible point code option. A group code must be specified when the ITUDUPPC feature is turned on (*nnnnn-gc*, *m1-m2-m3-m4-gc*). The *prefix* subfield indicates a spare point code, private point code, or private and spare point code (*prefix-nnnnn*, *prefix-nnnnn-gc*, *prefix-m1-m2-m3-m4*, *prefix-m1-m2-m3-m4-gc*).

Range: **s-**, **p-**, **ps-**, **0-16383**, **aa-zz**

Specify a valid value for each subfield of the point code, and separate the subfields with a dash (-).

prefix—**s-**, **p-**, **ps-**

nnnnn—**0-16383**

gc—**aa-zz**

m1-m2-m3-m4—**0-14** for each member; values must sum to 14

Default: Display all

pcn24= (optional)

24-bit ITU national point code with subfields *main signaling area-sub signaling area-signaling point* (*msa-ssa-sp*) The *prefix* subfield indicates a private point code (*prefix-ni-nc-ncm*).

Range: **p-**, **000-255**

Specify a valid value for each subfield of the point code, and separate the subfields with a dash (-).

prefix—**p-**

msa—**000-255**

ssa—**000-255**

sp—**000-255**

Default: Display all

:pctype= (optional)

Point code type. This parameter can be specified, only when the ANSI-ITU-China SCCP Conversion feature is enabled, to retrieve a single type of point code among mixed types of point code provisioned for a Translation Type.

Range: **ansi**, **itui**, **itun**, **itun24**

Default: Display all

:ssn= (optional)

Subsystem number. This parameter identifies the subsystem address that is to receive the message.

Range: **001-255**

Default: Display all

:ttn= (optional)†

Translation name.

Range: 1 alphabetic character followed by up to 7 alphanumeric characters

Default: None given

:type/typea/typei/typen/typen24= (optional)†

Translation type identifies the translation type and network type. This parameter is the decimal representation of the 1-byte field used in SS7.

The **type** and **typea** parameters specify an ANSI network.

The **typei** parameter specifies an ITU-international network.

The **typen** parameter specifies an ITU-national network.

The **typen24** parameter specifies a 24-bit ITU-national network.

A translation type numeric value can be entered as ANSI type (**type** or **typea**) and also as an ITU type (**typei** or **typen**). However, they are separate entities.

The point code domain translation types for GTT are handled by the EAGLE protocol processing as either ANSI or ITU; therefore, ITU applies to ITU-I, ITU-I Spare, ITU-N, and ITU-N Spare. ITU-I includes ITU-I Spare, and ITU-N includes ITU-N Spare.

Range: 0–255

Default: None given

Example

```
rtrv-gtt:type=5:ttn=lidb1:gta=919555
```

```
rtrv-gtt:type=5:gta=919555
```

```
rtrv-gtt:type=5:gta=919555:num=2500:force=yes
```

```
rtrv-gtt:typen24=0
```

```
rtrv-gtt:typei=7:pctype=ansi
```

```
rtrv-gtt:typen=106:pctype=itui
```

```
rtrv-gtt:type=55:pctype=itun
```

```
rtrv-gtt:type=9:pctype=itun24
```

```
rtrv-gtt:typei=4:pci=s-1-24-1
```

```
rtrv-gtt:typen=3:pcn=s-124
```

Dependencies

This command cannot be entered when the EGTT feature is turned on.

The ANSI-ITU-China SCCP Conversion feature must be enabled before the **pctype** parameter can be specified.

If the **pcn** parameter is specified, its format must match the format that was assigned with the **chg-stpopts:npcfnti** parameter.

The first character of the translation name must be a letter.

If translation type was specified, it must already exist and cannot be an alias.

If the translation type name was specified, that name must correspond to a given type entry. If both translation type and translation type name were specified, the **ttn** must correspond to the given translation type.

If the **gta** parameter is not specified, the first entry in the global title translation table corresponding to the translation type is the first entry shown.

If the **gta** and **egta** parameters are specified, the entry that matches the **gta**, or is the nearest entry below the **gta**, is the first entry shown for the specified range.

The number of entries to be shown (**num**) can be specified for any valid combination of parameters.

If **num** is not specified, and **gta** is not specified, up to 20 entries are shown.

If **gta** is specified but **num** is not specified, only one entry is shown, if it is in the database.

If **num** is specified, the number of entries shown is the lesser of the number of entries in the table from the defined starting point to the end, or the value of the **num** parameter.

If the **num** parameter exceeds **1000**, the **force=yes** parameter must be entered.

Either the **type** parameter or the **tn** parameter must be specified.

An asterisk cannot be specified for the **ssn** parameter value.

The translated point code (**pc/pca/pci/pcn/pcn24** parameter) must be a full point code.

If the **egta** parameter is specified, the **gta** parameter must be specified.

If the system is defined as an ANSI system, the **pc/pca** parameter must be specified as a valid ANSI point code.

The network type (ANSI, ITU-I, ITU-N, or 24-bit ITU-N) of the Translation Type and the Translated Point Code must be the same.

The ANSI-ITU-China SCCP Conversion feature must be on before a translated point code and a translation type in different network types can be specified.

The number of digits in the specified **gta** parameter must be at least the number of digits provisioned for the given translation type. If the VGTT (variable length GTT) feature is turned on, there can be up to 10 GTA lengths per translation type. When the **ent-gtt** command is entered to create entries, the software keeps track of the lengths and allows only ten different lengths.

Notes

If the **rtrv-gtt** command is entered with only the **gta** parameter, a match would be an entry containing the same number of digits, or more digits, for the translation type. For example, if **gta=8005556666** is specified, the six-digit translation type **800555** would be a match. If the VGTT feature is turned on and the **egta** parameter is specified, all matching entries regardless of length are displayed.

This command can be canceled using the **F9** function key or the **canc-cmd** command. See **canc-cmd** for more information.

If you do not know either the translation type or the translation type name, use the **rtrv-tt** command to obtain type and name.

Due to the size of these tables (up to 270,000 possible entries), a limit (65,535) is placed on the number of entries that can be printed at one time.

In this command, only ITU-international and ITU national point codes support the spare point code subtype prefix (**s-**) and the private and spare point code subtype prefix (**ps-**). All of the point code types support the private (internal) point code subtype prefix (**p-**).

Output

rtrv-gtt:type=10:num=65535:force=yes

```

rlghncxa03w 04-01-07 11:43:04 EST EAGLE 31.3.0
  TYPEA   TTN       NDGT
    3     c800      10
GTT TABLE IS 1 % FULL (9 of 269999)
START GTA           END GTA   XLAT  RI  PCA          SSN NGT
9195551212                DPCSSN SSN 008-001-001 222 ---
8005550000            8005551999 DPCSSN SSN 001-254-255 255 ---
8005552000            8005553999 DPC   GT  001-254-255 255 ---
8005554000            8005555999 NGT   GT  001-254-255 255 123
8005556000            8005557999 DPCSSN SSN 001-254-255 255 ---
8005558000            8005559999 DPCSSN SSN 001-254-255 255 ---
9762428487                DPCSSN SSN 001-254-255 222 ---
9766423277                DPCSSN SSN 001-254-255 222 ---
9769388928                DPCSSN SSN 001-254-255 222 ---

```

;

rtrv-gtt:type=10:dpc=8-1-1:ssn=222:gta=9195551212

```

rlghncxa03w 04-01-07 11:43:04 EST EAGLE 31.3.0
  TYPEA   TTN       NDGT
    3     c800      10
GTT TABLE IS 1 % FULL (9 of 269999)
START GTA           END GTA   XLAT  RI  PCA          SSN NGT
9195551212                DPCSSN SSN 008-001-001 222 ---

```

;

rtrv-gtt:type=10:ssn=222:gta=9000000000:egta=9762429999:num=65535:force=yes

```

rlghncxa03w 04-01-07 11:43:04 EST EAGLE 31.3.0
  TYPEA   TTN       NDGT
    3     c800      10
GTT TABLE IS 1 % FULL (9 of 269999)
START GTA           END GTA   XLAT  RI  PCA          SSN NGT
9195551212                DPCSSN SSN 008-001-001 222 ---
9762428487                DPCSSN SSN 001-254-255 222 ---

```

;

rtrv-gtt:typen=10

```

rlghncxa03w 04-01-07 11:43:04 EST EAGLE 31.3.0
  TYPEA   TTN       NDGT
    10    - - - - - 6
GTT TABLE IS 1 % FULL (9 of 269999)
START GTA           END GTA   XLAT  RI  ITU PC        SSN NGT
123456             123456   DPC   GT  0500-1-0-1    --- ---

```

;

The following example shows a retrieval of all GTTs for a specified translation when the VGTT (variable length GTT) feature is turned on:

rtrv-gtt:type=10:num=65535:force=yes

```
rlghncxa03w 04-01-07 11:43:04 EST EAGLE 31.3.0
  TYPEA   TTN      NDGT
  10      c800     6, 8, 10
  GTT TABLE IS 1 % FULL (17 of 269999)

  START GTA          END GTA          XLAT  RI  PCA          SSN NGT
  976242             976242             DPCSSN SSN 001-254-255 222 ---
  976642             976642             DPCSSN SSN 001-254-255 222 ---
  976938             976938             DPCSSN SSN 001-254-255 222 ---
  80055500           80055519           DPCSSN SSN 001-254-255 255 ---
  80055520           80055539           DPC      GT  001-254-255 255 ---
  80055540           80055559           NGT      GT  001-254-255 255 123
  80055560           80055579           DPCSSN SSN 001-254-255 255 ---
  80055580           80055599           DPCSSN SSN 001-254-255 255 ---
  9195551212        9195551212        DPCSSN SSN 008-001-001 222 ---
  8005550000         8005551999        DPCSSN SSN 001-254-255 255 ---
  8005552000         8005553999        DPC      GT  001-254-255 255 ---
  8005554000         8005555999        NGT      GT  001-254-255 255 123
  8005556000         8005557999        DPCSSN SSN 001-254-255 255 ---
  8005558000         8005559999        DPCSSN SSN 001-254-255 255 ---
  9762428487        9762428487        DPCSSN SSN 001-254-255 222 ---
  9766423277        9766423277        DPCSSN SSN 001-254-255 222 ---
  9769388928        9769388928        DPCSSN SSN 001-254-255 222 ---
```

;

The following example shows output containing MGTT **nnp**, **nnai**, **npdd**, and **npds** parameter values:

rtrv-gtt:type=7

```
rlghncxa03w 04-01-07 11:43:04 EST EAGLE 31.3.0
  TYPEA   TTN      NDGT
  7       isvm     3,6,7,10
  GTT TABLE IS 1 % FULL (17 of 269999)

  START GTA          END GTA          XLAT  RI  PCA          SSN NGT
  564             564             DPCSSN SSN 248-006-015 245 ---
  NNP=3 NNAI=100 NPDD=3 NPDS=345
  641             641             DPCSSN SSN 248-006-015 245 ---
  589234          598744          DPCSSN SSN 248-006-015 245 ---
  NNP=10 NNAI=50 NPDD=3 NPDS=345
  648392          659832          DPCSSN SSN 248-006-015 245 ---
```

;

The following example shows output when the GTT table can contain up to 1,000,000 entries:

rtrv-gtt:type=7

```
rlghncxa03w 04-01-07 11:43:04 EST EAGLE 31.3.0
  TYPEA   TTN       NDGT
  7       isvm      3,6,7,10
  GTT TABLE IS 1 % FULL (17 of 1000000)

  START GTA           END GTA           XLAT  RI  PCA           SSN NGT
  564                 564                 DPCNGT GT 248-006-015 245 123
                                     NNP=3 NNAI=100 NPDD=3 NPDS=345
  641                 641                 DPCNGT GT 248-006-015 245 123
  589234             598744             DPCNGT GT 248-006-015 245 123
                                     NNP=10 NNAI=50 NPDD=3 NPDS=345
  648392             659832             DPCSSN SSN 248-006-015 245 ---
;

```

The following example shows output for a 24-bit ITU-N point code translation type of 4:

rtrv-gtt:typen24=4

```
rlghncxa03w 03-03-07 11:43:04 EST EAGLE 31.0.0
  TYPEN24 TTN       NDGT
  4       - - - - - 6
  GTT TABLE IS 1 % FULL (1 of 269999)

  START GTA           END GTA           XLAT  RI  ITU PC           SSN NGT
  919833             919833             DPCSSN SSN 008-008-008 20 ---
;

```

The following example shows output when the ANSI-ITU-China SCCP Conversion feature is enabled, with suffix digits and new GTI code parameter values.

NOTE: When the ANSI-ITU-China SCCP Conversion feature is enabled, entries that are provisioned with xlat=dpc where ngt has been specified are displayed with an xlat of dpcngt.

rtrv-gtt:type=7

```
rlghncxa03w 03-11-07 11:43:04 EST EAGLE 31.3.0
  TYPEI   TTN       NDGT
  7       isvm      3,6,7,10
  GTT TABLE IS 1 % FULL (17 of 1000000)

  START GTA           END GTA           XLAT  RI  PC           SSN NGT
  564                 564                 DPCNGT GT 002-136-005 245 123
                                     NNP=3 NNAI=100 NSDD=3 NSDS=345
                                     NGTI=4
  641                 641                 DPCNGT GT 23456           245 123
                                     NGTI=2
  589234             598744             DPCNGT GT 3-006-1           245 123
                                     NNP=10 NNAI=50 NPDD=3 NPDS=345
                                     NGTI=4
  648392             659832             DPCSSN SSN 007-006-005 245 ---
;

```

The following examples show output when the ANSI-ITU-China SCCP Conversion feature is enabled and the **pctype** parameter is specified.

rtrv-gtt:typei=7:pctype=ansi

```
rlghncxa03w 03-11-07 11:43:04 EST EAGLE 31.3.0
  TYPEI   TTN      NDGT
  7       isvm    3,6,7,10
  GTT TABLE IS 1 % FULL (17 of 1000000)

  START GTA          END GTA          XLAT  RI  PCA          SSN NGT
  564                564                DPCNGT GT 002-136-005 245 123
                                     NNP=3 NNAI=100 NSDD=3 NSDS=345
                                     NGTI=4
  648392            659832            DPCSSN SSN 007-006-005 245 ---
;

```

rtrv-gtt:typen=106:pctype=itui

```
rlghncxa03w 03-11-07 11:43:04 EST EAGLE 31.3.0
  TYPEN   TTN      NDGT
  106     ntoi43   6
  GTT TABLE IS 1 % FULL (17 of 1000000)

  START GTA          END GTA          XLAT  RI  ITUI PC          SSN NGT
  300006            300006            DPCNGT GT 6-002-3          --- 33
                                     NNP=6 NNAI=7 NPDD=0 NPDS=
                                     NGTI=4
;

```

rtrv-gtt:type=55:pctype=itun

```
rlghncxa03w 03-11-07 11:43:04 EST EAGLE 31.3.0
  TYPEA   TTN      NDGT
  55      aton44   7
  GTT TABLE IS 1 % FULL (17 of 1000000)

  START GTA          END GTA          XLAT  RI  ITUN PC          SSN NGT
  6543210            6543210            DPCNGT GT 12341          --- 42
                                     NNP=3 NNAI=1 NPDD=0 NPDS=
                                     NGTI=4
;

```

rtrv-gtt:type=9:pctype=itun24

```
rlghncxa03w 03-11-07 11:43:04 EST EAGLE 31.3.0
  TYPE   TTN      NDGT
  7       isvm    3,6,7,10
  GTT TABLE IS 1 % FULL (17 of 1000000)

  START GTA          END GTA          XLAT  RI  ITUN24 PC          SSN NGT
  764                864                DPCNGT GT 002-136-005 245 123
                                     NNP=3 NNAI=100 NSDD=3 NSDS=345
                                     NGTI=4
  668392            689832            DPCSSN SSN 007-006-005 245 ---
;

```

rtrv-gtt:typen=3

rlghncxa03w 05-01-07 11:43:04 EST EAGLE 31.12.0

TYPEN TTN NDGT

3 ----- 6,21

GTT TABLE IS 1 % FULL (6 of 269999)

START GTA	END GTA	XLAT	RI	ITU	PC
123456	123456	DPCSSN	GT	s-00124	aa
SSN=10 NGT=---					
NNP=12 NNAI=125 NPDD=21 NPDS=125498679012426556356					
NGTI=					
234567	234567	DPCNGT	GT	s-00124	aa
SSN=--- NGT=255					
234568	234568	DPC	GT	s-00124	aa
SSN=--- NGT=---					
234569	234569	DPC	GT	s-00124	aa
SSN=--- NGT=---					
NNP=13 NNAI=120 NPDD=21 NPDS=125498679012426556356					
NGTI=					
334569467213456789012	334569478932012345678	DPC	GT	s-00124	aa
SSN=--- NGT=---					
NNP=13 NNAI=120 NPDD=21 NPDS=125498679012426556356					
NGTI=					

;

rtrv-gtt:typen=3:pcn=s-124-aa

rlghncxa03w 05-01-07 11:43:04 EST EAGLE 31.12.0

TYPEN TTN NDGT

3 ----- 6,21

GTT TABLE IS 1 % FULL (6 of 269999)

START GTA	END GTA	XLAT	RI	ITU	PC
123456	123456	DPCSSN	GT	s-00124	aa
SSN=10 NGT=---					
NNP=12 NNAI=125 NPDD=21 NPDS=125498679012426556356					
NGTI=					
234567	234567	DPCNGT	GT	s-00124	aa
SSN=--- NGT=255					
234568	234568	DPC	GT	s-00124	aa
SSN=--- NGT=---					
234569	234569	DPC	GT	s-00124	aa
SSN=--- NGT=---					
NNP=13 NNAI=120 NPDD=21 NPDS=125498679012426556356					
NGTI=					
334569467213456789012	334569478932012345678	DPC	GT	s-00124	aa
SSN=--- NGT=---					
NNP=13 NNAI=120 NPDD=21 NPDS=125498679012426556356					
NGTI=					

;

rtrv-gtt:typen=3:ssn=104

```
rlghncxa03w 05-01-07 11:43:04 EST EAGLE 31.12.0
TYPEEN   TTN       NDGT
3         - - - - - 6
GTT TABLE IS 1 % FULL (5 of 269999)

START GTA           END GTA           XLAT  RI      ITU PC
123456             123456             DPCSSN GT  s-00124-aa
SSN=10  NGT=---
NNP=12  NNAI=125 NPDD=21 NPDS=125498679012426556356
NGTI=
```

;

rtrv-gtt:typen=3:gta=234569

```
rlghncxa03w 05-01-07 11:43:04 EST EAGLE 31.12.0
TYPEEN   TTN       NDGT
3         - - - - - 6
GTT TABLE IS 1 % FULL (5 of 269999)

START GTA           END GTA           XLAT  RI      ITU PC
234569             234569             DPC   GT   s-00124-aa
SSN=---  NGT=---
NNP=13  NNAI=120 NPDD=21 NPDS=125498679012426556356
NGTI=
```

;

rtrv-gtt:ttn= tbl1

```
tekelecstp 05-06-27 13:54:32 EST EAGLE5 34.2.0

TYPEA    TTN       NDGT
1        tbl1     10
GTT TABLE IS 1 % FULL (1 of 269999)

START GTA           END GTA           XLAT  RI      PCA
1234567890         1234567890         DPC   GT   001-001-002
MRNSET=NONE  SSN=---  NGT=---
```

;

rtrv-gtt:ttn= tbl2

```
tekelecstp 05-06-27 13:54:32 EST EAGLE5 34.2.0

TYPEA    TTN       NDGT
1        tbl2     10
GTT TABLE IS 1 % FULL (1 of 269999)

START GTA           END GTA           XLAT  RI      PCA
2345678901         2345678901         DPC   GT   001-001-001
MRNSET=1          SSN=---  NGT=---
```

;

Legend

TYPE/TYPEA/TYPEI/TYPEN/TYPEN24—The translation type.

TTN—The translation name.

NDGT—The number of digits.

GTT TABLE IS 10% FULL—The relative size of the GTT table.

X OF Y—Number of entries in the table (x) and the maximum number of entries configured for the table (y).

START GTA—Global title start address.

END GTA—Global title end address.

MRNSET—The MRN set id.

XLAT—Translate indicator.

RI—Route indicator.

PC, PCA, ITU PC, ITUI PC, ITUN PC, ITUN24 PC—Point code.

SSN—Subsystem number.

NGT—New global title translation type. This field identifies the type of global title translation that replaces the original type.

NNP—New Numbering Plan.

NNAI—New Nature of Address Indicator.

NPDD—New Prefix Digits to be Deleted.

NPDS—New Prefix Digits String.

NSDD—New Suffix Digits to be Deleted.

NSDS—New Suffix Digits String

NGTI—New GTI code. When the ANSI-ITU-China SCCP Conversion and MGTT features are on and the Translated Point Code is of a different network type, the *NGTI* value indicates whether the new GTI translation format is GTI type 2 or GTI type 4.

rtrv-gttssel

Retrieve GTT Selectors

Use this command to display a list of administered global title selector combinations required for a global title entry. The list can be filtered by using various parameter combinations.

Keyword: rtrv-gttssel

Related Commands: chg-gttssel, dlt-gttssel, ent-gttssel, rtrv-tt

Command Class: Database Administration

Parameters

:gti/gtia/gtii/gtin/gtin24= (mandatory)

Global title indicator. For all EGTT selector commands, the domain is defined as **gti** and **gtia** (ANSI), **gtii** (ITU international), **gtin** (ITU national), and **gtin24** (24-bit ITU national). For the selector commands, **gti** and **gtia** are equivalent; **gtii** and **gtin/gtin24** are mutually exclusive because the EGTT database does not distinguish between ITU national and ITU international translations. This means that while ITU-I and ITU-N selectors are stored separately, two separate ITU-I and ITU-N entries with the same selector values cannot exist. For example, if an entry with **gtii=2** and **tt=4** already exists, an entry of **gtin=2** and **tt=4** cannot be entered.

Range: Supported value for ANSI: **gti=2** and **gtia=2**

Supported values for ITU: **gtii=2, 4** and **gtin/gtin24=2, 4**

Default: Display all

:gttsn= (optional)

GTT set name. A GTT set is an entity to which global title addresses and selectors are assigned.

Range: 1 leading alphabetic character and up to 8 alphanumeric characters.

Default: Display all

:nai= (optional)

Nature of address indicator (see Table A-5 in Appendix A).

Range: **sub, rsvd, natl, intl, dflt**

Default: Display all

:naiv= (optional)

Nature of address indicator value (see Table A-5 in Appendix A).

Range: **0-127**

Default: Display all

NOTE: The nature of address indicator parameters can be specified by supplying either a mnemonic or an explicit value. At no time may both the mnemonic and the explicit value be specified at the same time for the same parameter. Either the **naiv** parameter or the **nai** parameter can be specified. Table A-5 in Appendix A shows the mapping between the **naiv** and the **nai** parameters.

:np= (optional)

Numbering plan (see Table A-6 in Appendix A).

Range: **e164, generic, x121, f69, e210, e212, e214, private, dflt**

Default: Display all

:npv= (optional)

Numbering plan value (see Table A-6 in Appendix A).

Range: **0-15**

Default: Display all

NOTE: The numbering plan parameter can be specified by supplying either a mnemonic or an explicit value. At no time may both the mnemonic and the explicit value be specified at the same time for the same parameter. Either the **npv** parameter or the **np** parameter can be specified. Table A-6 in Appendix A shows the mapping between the **npv** and the **np** parameters.

:tt= (optional)
 Translation type.
Range: 0-255
Default: Display all

Example

```
rtrv-gttset
rtrv-gttset:gtii=2
rtrv-gttset:tt=0:np=e164
rtrv-gttset:gti=2:tt=10
rtrv-gttset:gttsn=setint000
```

Dependencies

The EGTT feature must be turned on before this command can be entered.

An entry that matches exactly the specified combination of **gti**, **tt**, **np**/**npv**, **nai**/**naiv**, and **gttsn** must be specified. If no match is found, the following message is displayed in the scroll area of the terminal:

No GTT Selectors matching the specified criteria were found.

The specified **gttsn** value must exist for the specified **gtin24**, **tt**, **np**/**npv**/**nai**/**naiv** parameter combination.

The **np** and **npv** parameters cannot be specified together in the same command.

The **nai** and **naiv** parameters cannot be specified together in the same command.

The parameter values **gtia=4**, **gti/gtia/gtii/gtin/gtin24=1**, and **gti/gtia/gtii/gtin/gtin24=3** cannot be specified.

When the **gti/gtia/gtii/gtin/gtin24=2** parameter is specified, the **np**/**npv** and **nai**/**naiv** parameter combinations cannot be specified.

Notes

When the EGTT feature is turned on, the GTT Selector (**ent/chg/dlt/rtrv-gttset**), GTT Set (**ent/dlt/rtrv-gttset**), and GTA (**ent/chg/dlt/rtrv-gta**) commands replace the Translation Type (**ent/dlt/rtrv-tt**) and Global Title Translation (**ent/chg/dlt/rtrv-gtt**) commands. All data previously provisioned with these commands is maintained.

Output

Retrieve all GTT selectors:

```
rtrv-gttset
rlghncxa03w 04-02-18 08:29:15 EST EAGLE 31.3.0
GTIA  TT  NP      NAI    GTTSN
2      0    --      ---    setans000
2      9    --      ---    lidb
2     10    --      ---    t800
2     253  --      ---    t800
```

```

GTII  TT  NP      NAI  GTTSN
2     0   --      ---  setint000
2     9   --      ---  imsi
2    18   --      ---  imsi
4     0  e164    sub  setint000
4     0  dflt    dflt setint000
4     9  dflt    dflt imsi
4    18  dflt    dflt imsi
4    128 13      123  abcd12345
4    254 private rsvd  setint000

```

```

GTIN  TT  NP      NAI  GTTSN
2     2   --      ---  setnat002
4     2  dflt    dflt setnat002
4    223 f69     intl  setint000
;

```

Retrieve all GTT selectors containing the specified GTI value:

rtrv-gttset:gti=2

```

rlghncxa03w 04-02-18 08:29:15 EST EAGLE 31.3.0
GTII  TT  NP      NAI  GTTSN
2     0   --      ---  setint000
2     9   --      ---  imsi
2    18   --      ---  imsi
;

```

Retrieve all GTT selectors containing the specified TT and NP values:

rtrv-gttset:tt=0:np=e164

```

rlghncxa03w 04-02-18 08:29:15 EST EAGLE 31.3.0
GTII  TT  NP      NAI  GTTSN
4     0  e164    sub  setint000
4     0  dflt    dflt setint000
;

```

Retrieve a specific GTT selector:

rtrv-gttset:gti=2:tt=10

```

rlghncxa03w 04-02-18 08:29:15 EST EAGLE 31.3.0
GTIA  TT  NP      NAI  GTTSN
2     10  --      ---  t800
;

```

Retrieve all GTT selectors using a specified GTT set name:

rtrv-gttset:gtsn=setin000

```

rlghncxa03w 04-02-18 08:29:15 EST EAGLE 31.3.0
GTII  TT  NP      NAI  GTTSN
2     0   --      ---  setin000
4     0  e164    sub  setin000
4     0  dflt    dflt setin000
4    254 private rsvd  setin000

GTIN  TT  NP      NAI  GTTSN
4    223 f69     intl  setin000
;

```

rtrv-gttset

```
tekelecstp 03-03-31 15:09:45 EST EAGLE 31.0.0
```

```
GTIN24  TT      NP      NAI  GTTSN
  2      2      --      --- any
  2      4      --      --- set24n004
```

```
;
```

Legend

GTI/GTIA/GTII/GTIN/GTIN24—The global title indicator.

TT—The translation type.

NP—The number plan.

NAI—The nature of address indicator.

GTTSN—The GTT set name. A GTT set is an entity to which global title addresses and selectors are assigned.

rtrv-gttset**Retrieve GTT Set**

Use this command to display a list of administered GTT sets. The list can be filtered by using the parameters shown.

Keyword: rtrv-gttset

Related Commands: dlt-gttset, ent-gttset, rtrv-tt

Command Class: Database Administration

Parameters

:gttsn= (optional)

GTT set name. A GTT set is an entity to which global title addresses and selectors are assigned.

Range: 1 leading alphabetic character and up to 8 alphanumeric characters.

:netdom= (optional)

Network domain. Note the choices are for either ANSI or ITU. This command does not distinguish between ITU National or ITU International because the Enhanced Global Title Translation feature does not discriminate between the ITU-I and ITU-N translations.

Range: ansi, itu

Default: Display all

Example

```
rtrv-gttset
```

```
rtrv-gttset:netdom=ansi
```

```
rtrv-gttset:gttsn=t800
```

Dependencies

The EGTT feature must be turned on prior to using this command.

If the **gttsn** parameter is specified, it cannot have a value of **none**, and must match an existing **gttsn**.

If the **netdom** parameter is specified, at least one entry must exist that exactly matches the specified value. Otherwise, the following error message appears in the scroll area:

```
No GTT Sets matching the specified criteria were found.
```

Notes

When the EGTT feature is turned on, the GTT Selector (**ent/chg/dlt/rtrv-gttset**), GTT Set (**ent/dlt/rtrv-gttset**), and GTA (**ent/chg/dlt/rtrv-gta**) commands replace the Translation Type (**ent/dlt/rtrv-tt**) and Global Title Translation (**ent/chg/dlt/rtrv-gtt**) commands. All data previously provisioned with these commands is maintained.

Output

Retrieve all GTT sets:

rtrv-gttset

```
rlghncxa03w 04-02-19 08:16:15 EST EAGLE 31.3.0
GTTSN      NETDOM      NDGT
lidb       ansi          10
t800       ansi          6
s_i000     itu           15
imsi       itu           15
abcd1234   itu           12
;
```

Retrieve all GTT sets containing the specified **netdom** value:

rtrv-gttset:netdom=ansi

```
rlghncxa03w 04-02-19 08:16:15 EST EAGLE 31.3.0
GTTSN      NETDOM      NDGT
lidb       ansi          10
t800       ansi          6
;
```

Retrieve a specific GTT set:

rtrv-gttset:gttsn=t800

```
rlghncxa03w 04-02-19 08:16:15 EST EAGLE 31.3.0
GTTSN      NETDOM      NDGT
t800       ansi          6
;
```

Retrieve all GTT sets when the VGTT (variable length GTT) feature is turned on:

rtrv-gttset

```
rlghncxa03w 04-02-19 08:16:15 EST EAGLE 31.3.0
GTTSN      NETDOM      NDGT
lidb       ansi          3,7,10
t800       ansi          4,6
s_i000     itu           10,15
imsi       itu           10,15
abcd1234   itu           12
;
```

Legend

GTTSN—The GTT set name. A GTT set is an entity to which global title addresses and selectors are assigned.

NETDOM—The network domain.

NDGT—The number of digits required for GTAs associated with this set.

rtrv-gtw-stp**Retrieve Gateway STP Parameters**

Use this command to display the level 3 ANSI transfer control status (TFCSTAT) parameter. This value is the level 3 control status used on a TFC message received from an ITU node destined for an ANSI node.

Keyword: rtrv-gtw-stp

Related Commands: chg-gtw-stp

Command Class: Database Administration

Parameter

None

Example

```
rtrv-gtw-stp
```

Dependencies

None

Notes

None

Output

```
rtrv-gtw-stp
rlghncxa03w 03-03-11 11:34:04 EST EAGLE 31.3.0
TFCSTAT
1
;
```

rtrv-gtwy-acthresh**Retrieve the Gateway Screening Activity Threshold**

Use this command to display the current values for the SS7 message rejection thresholds occurring because of the gateway screening process.

Keyword: rtrv-gtwy-acthresh

Related Commands: set-gtwy-acthresh

Command Class: Database Administration

Parameters

:lsn=. (optional)

Linkset name.

Range: 1 alphabetic character followed by up to 9 alphanumeric characters

Default: Display all

Example

```
rtrv-gtwy-acthresh:lsn=wy644368
```

```
rtrv-gtwy-acthresh
```

Dependencies

The linkset specified must exist in the active database, and it must exist in the gateway linkset entity set of the requesting system.

Notes

None

Output

```
rtrv-gtwy-acthresh
```

The following example shows the display of the thresholds of all linksets:

```
rlghncxa03w 04-02-18 08:50:12 EST EAGLE 31.3.0
LSN      REJ      RECV      INTRVL
WY644368 10       1000     10
WY234456 25       2000     20
LN123445 -        -        -
LN123556 25       2500     30
OP239900 -        5        5
;
```

The following example shows the display of the linkset **wy644368** rejection thresholds:

```
rtrv-gtwy-acthresh:lsn=wy644368
```

```
rlghncxa03w 04-02-18 08:50:12 EST EAGLE 31.3.0
LSN      REJ      RECV      INTRVL
wy644368 10       1000     10
:
```

Legend

LSN—Linkset name.

REJ—Reject threshold.

RECV—Received message threshold.

INTRVL—Monitor interval.

rtrv-gtwy-prmtrs**Retrieve Gateway Parameters**

Use this command to display the STP values that limit the display of certain notification messages that could become excessive. Only the values set by the **set-screj-prmtrs** command are displayed.

Keyword: rtrv-gtwy-prmtrs

Related Commands: set-screj-prmtrs

Command Class: Database Administration

Parameters

This command has no parameters.

Example

```
rtrv-gtwy-prmtrs
```

Dependencies

None

Notes

None

Output

```
rtrv-gtwy-prmtrs
rlghncxa03w 04-02-18 08:50:12 EST EAGLE 31.3.0
LIMIT INTRVL
1000 15
;
```

Legend

LIMIT—The threshold not to be exceeded.

INTRVL—Monitor interval. The examination period, in minutes, during which the gateway screening activity thresholds are to be tested.

rtrv-gws-actset**Retrieve Gateway Screening Stop Action Sets**

Use this command to display the values defined for gateway screening stop actions.

Keyword: rtrv-gws-actset

Related Commands: chg-gws-actset

Command Class: Database Administration

Parameters

:actid= (optional)

The identification number of the gateway screening stop action.

Range: 4-16

Default: Display all

:actname= (optional)

The name of the gateway screening stop action set.

Range: One alphabetic character followed by up to five alphanumeric characters.

Default: Display all

Example

```
rtrv-gws-actset
rtrv-gws-actset:actname=cr
rtrv-gws-actset:actid=6
```

Dependencies

Either **actname** or **actid** can be specified, but not both.

Notes

If neither **actname** nor **actid** are specified with the **rtrv-gws-actset** command, all gateway screening stop actions are displayed.

Output

rtrv-gws-actset

(with 6 gateway screening stop action sets defined)

```
rlghncxa03w 03-03-07 00:57:31 EST EAGLE 31.3.0
ACT ACT ACT ACT ACT ACT ACT ACT ACT ACT ACT
ID NAME 1 2 3 4 5 6 7 8 9 10
-- -----
1 copy copy
2 rdct rdct
3 cr copy rdct
4 crcncf copy cncf rdct
5 cncf cncf
6 cfrd cncf rdct
```

GWS action set table is (6 of 16) 38% full
;

rtrv-gws-actset:actname=cr

```
rlghncxa03w 03-03-07 00:57:31 EST EAGLE 31.3.0
ACT ACT ACT ACT ACT ACT ACT ACT ACT ACT ACT
ID NAME 1 2 3 4 5 6 7 8 9 10
-- -----
3 cr copy rdct
```

GWS action set table is (6 of 16) 38% full
;

rtrv-gws-actset:actid=6

```
rlghncxa03w 03-03-07 00:57:31 EST EAGLE 31.3.0
ACT ACT ACT ACT ACT ACT ACT ACT ACT ACT ACT
ID NAME 1 2 3 4 5 6 7 8 9 10
-- -----
6 cfrd cncf rdct
```

GWS action set table is (6 of 16) 38% full
;

rtrv-gws-redirect**Retrieve Gateway Screening Redirect**

Use this command to display the provisioning data for the redirect function. The parameters and values that are retrieved using this command are stored in the Redirect table, and they are used to set the variable fields of the MSUs being redirected.

Keyword: rtrv-gws-redirect

Related Commands: chg-gws-redirect, dlt-gws-redirect, ent-gws-redirect

Command Class: Database Administration

Parameters

This command has no parameters.

Example

rtrv-gws-redirect

Dependencies

None

Notes

None

Output**rtrv-gws-redirect**

```
rlghncxa03w 03-11-10 11:43:04 EST EAGLE 31.6.0
ENABLED DPCA      RI  SSN  TT    GTA
on      001-030-001 SSN 10   25    1800833
```

;

rtrv-gws-redirect

```
rlghncxa03w 03-11-10 11:43:04 EST EAGLE 31.6.0
ENABLED DPCI      RI  SSN  TT    GTA
on      1-001-1     SSN 10   25    1800833
```

;

rtrv-gws-redirect

```
rlghncxa03w 03-11-10 11:43:04 EST EAGLE 31.6.0
ENABLED DPCN      RI  SSN  TT    GTA
on      10234       SSN 10   25    1800833
```

;

rtrv-gws-redirect

```
rlghncxa03w 03-11-10 11:43:04 EST EAGLE 31.6.0
ENABLED DPCN24    RI  SSN  TT    GTA
on      001-030-001 SSN 10   25    1800833
```

;

In the following example, the gateway screening redirect function is not enabled.

rtrv-gws-redirect

```
rlghncxa03w 03-11-10 11:43:04 EST EAGLE 31.6.0
ENABLED DPCA      RI  SSN  TT    GTA
Redirect function data is not provisioned.
```

;

Legend

ENABLED—Indicates whether the gateway screening redirect function is on or off

DPCA/DPCI/DPCN/DPCN24—The destination point code that the message is being redirected to.

RI—The routing indicator for the redirected message

SSN—The subsystem to which the redirected message is bound for.

TT—The translation type of the global title translation

GTA—The global title translation address

rtrv-home-smsc**Retrieve HOME SMSC Address**

Use this command to retrieve HOME SMSC specific addresses currently used to identify Short Message Service Centers in the database. This command reads the HOME SMSCADDR table.

Keyword: rtrv-home-smsc

Related Commands: dlt-home-smsc, ent-home-smsc

Command Class: Database Administration

Parameters

:force= (optional)

Display more than 50 entries.

Range: yes, no

Default: no

:num= (optional)

Number of entries to display. The **force** parameter must also be specified to display more than 50 entries.

Range: 0-500

Default: 50

:smc= (optional)

Short Message Service Center address.

Range: 1-21 hexadecimal digits

Example

```
rtrv-home-smsc
```

```
rtrv-home-smsc:smc=552611646
```

```
rtrv-home-smsc:num=100:force=yes
```

Dependencies

The Portability Check for Mobile Originated SMS (MNP SMS) feature must be enabled (see the **enable-ctrl-feat** command) before this command can be entered. (This controlled feature can be turned off with the **chg-ctrl-feat** command and the **rtrv-home-smsc** command will still execute).

When the specified **num** parameter value is greater than 50, the **force=yes** parameter must also be specified.

Notes

None

Output

rtrv-home-smsc

```
rlghncxa03w 03-03-28 08:50:12 EST EAGLE 31.3.0
SMSC ADDRESS

13214564894498
55231465465434
5465455655656456

HOME SMSC ADDRESS TABLE IS 1 % FULL (3 of 500)

;
```

rtrv-homern

Retrieve Home Routing Number Prefix List

Use this command to retrieve a list of routing number prefixes that belong to the operating network.

Keyword: rtrv-homern

Related Commands: dlt-homern, ent-homern

Command Class: Database Administration

Parameters

This command has no parameters.

Example

```
rtrv-homern
```

Dependencies

To enter the **rtrv-homern** command, the INP or G-Port feature must be turned on.

Notes

None

Output**rtrv-homern**

```

rlghncxa03w 03-03-28 08:50:12 EST  EAGLE 31.3.0
RN
-----
216780909087654
76345098
abc
abc1234
c10234567
cabade

HOMERN table is (6 of 100) 6% full
;

```

Legend

RN—Routing Number

rtrv-inpopts**Retrieve INP Options**

Use this command to retrieve INP-specific options.

Keyword: **rtrv-inpopts**

Related Commands: **chg-inpopts**

Command Class: Database Administration

Parameters

This command has no parameters.

Example

```
rtrv-inpopts
```

Dependencies

The INP feature must be turned on before this command can be entered.

Notes

The command output displays the DRANAI along with its associated mnemonic string whenever the stored value has an associated mnemonic string. If there is no associated mnemonic string, the output shows the DRANAIV along with its value.

The command output displays the DRANP along with its associated mnemonic string whenever the stored value has an associated mnemonic string. If there is no associated mnemonic string, the output shows the DRANPV along with its value.

The command output displays each CDPNPFx along with its associated DLTPFX setting.

The command output displays each CDPNNAI along with its associated SNAI.

Output**rtrv-inpopts**

```

rlghncxa03w 04-02-17 15:35:05 EST  EAGLE 31.3.0
dranai      = sub

```

```

dranpv      = 2
dra         = rn
sprestype   = connect

CDPNPFX          DLTPFX
-----          ---
1                yes
325ABCDEF12     yes
ABCDEF          no
0123456789ABCDE no

CDPNNAI          SNAI
---             ----
1                Sub
99              natl
85              intl
70              sub
50              intl
;

```

Legend

DRANAI—The nature of address indicator for the destination routing address.

DRANPV—The numbering plan value for the destination routing address.

DRA—The destination routing address.

CDPNPFX—The Called Party Number Prefix.

DLTPFX—The Delete Prefix

CDPNNAI—The Called Party Number Nature of Address Indicator.

SNAI—The Service Nature of Address Indicator

rtrv-ip-card**Retrieve Internet Protocol Card**

Use this command to retrieve IP networking parameters for a given card.

Keyword: rtrv-ip-card

Related Commands: chg-ip-card

Command Class: Database Administration

Parameters

:loc= (optional)

Card location. The unique identifier of a specific application subsystem located in the system.

Range: 1101–1108, 1111–1112, 1201–1208, 1211–1218, 1301–1308, 1311–1318, 2101–2108, 2111–2118, 2201–2208, 2211–2218, 2301–2308, 2311–2318, 3101–3108, 3111–3118, 3201–3208, 3211–3218, 3301–3308, 3311–3318, 4101–4108, 4111–4118, 4201–4208, 4211–4218, 4301–4308, 4311–4318, 5101–5108, 5111–5118, 5201–5208, 5211–5218, 5301–5308, 5311–5318, 6101–6108, 6111–6118

Example**rtrv-ip-card:loc=1211****rtrv-ip-card****Dependencies**

The **loc** parameter value must correspond to a DCM card in the card table.

Notes

None

Output**rtrv-ip-card:loc=1211**

```
rlghncxa03w 04-02-17 15:35:05 EST EAGLE 31.3.0
LOC 1211
  SRCHORDR LOCAL
  DNSA      150.123.123.123
  DNSB      -----
  DEFROUTER -----
  DOMAIN    NC.TEKELEC.COM
;
```

rtrv-ip-card

```
rlghncxa03w 04-02-17 15:35:05 EST EAGLE 31.3.0
LOC 1211
  SRCHORDR LOCAL
  DNSA      150.1.1.1
  DNSB      -----
  DEFROUTER -----
  DOMAIN    NC.TEKELEC.COM

LOC 1213
  SRCHORDR LOCAL
  DNSA      150.1.1.1
  DNSB      -----
  DEFROUTER 150.1.1.25
  DOMAIN    NC.TEKELEC.COM

LOC 1301
  SRCHORDR SRVROONLY
  DNSA      150.1.1.10
  DNSB      150.1.1.28
  DEFROUTER -----
  DOMAIN    NC.TEKELEC.COM
;
```

Legend

LOC—The card location.

SRCHORDR—The Host table search order.

LOCAL— Indicates that the Local Host table is searched first.

SRVR—Indicates that the Domain server is searched first.

SRVROONLY— Indicates that only the Domain server is searched.

DNSA—The IP address of Domain Server A.

DNSB—The IP address of Domain Server B.

DEFROUTER—The IP address for the default router.

DOMAIN—The Domain name of the Domain server.

rtrv-ip-host

Retrieve Internet Protocol Hostname

Use this command to retrieve the IP Host table. The Host table defines local host names for IP addresses.

Keyword: rtrv-ip-host

Related Commands: ent-ip-host, dlt-ip-host

Command Class: Database Administration

Parameters

:host= (optional)

Host name. The logical name of the device associated with the indicated IP address.

Range: a-z, A-Z, 0-9, -, . (any string of characters beginning with a letter and comprising up to 60 characters in length)

:ipaddr= (optional)

The IP address associated with the hostname. This is a TCP/IP address expressed in standard dot notation. IP addresses consist of the system's network number and the machine's unique host number. An example IP address is **192.126.100.5**, where **192.126.100** is the network number and **5** is the machine's host number.

Range: 4 numbers separated by dots with each number in the range of 0-255

Example

```
rtrv-ip-host:host=gw100-nc.tekelec.com:ipaddr=150.1.1.1
```

```
rtrv-ip-host:host=gw100.nc.tekelec.com
```

```
rtrv-ip-host:ipaddr=150.1.1.1
```

```
rtrv-ip-host
```

Dependencies

The host name, if entered, must exist.

The IP address, if entered, must exist.

Notes

If optional parameters are specified, only the entries that match the entered parameters are retrieved.

Output

```
rtrv-ip-host:host=gw100-nc.tekelec.com:ipaddr=150.1.1.1
```

```
rlghncxa03w 04-02-17 15:35:05 EST EAGLE 31.3.0
IPADDR          HOST
150.1.1.1      GW100.NC.TEKELEC.COM
;
```

rtrv-ip-host:host=gw100.nc.tekelec.com

```
rlghncxa03w 04-02-17 15:35:05 EST EAGLE 31.3.0
IPADDR          HOST
150.1.1.1       GW100.NC.TEKELEC.COM
;
```

rtrv-ip-host:ipaddr=150.1.1.1

```
rlghncxa03w 04-02-17 15:35:05 EST EAGLE 31.3.0
IPADDR          HOST
150.1.1.5       GW100.NCDECONOMIC_DEVELOPMENT.GOV
150.1.1.5       GW101.NCDECONOMIC_DEVELOPMENT.GOV
;
```

rtrv-ip-host

```
rlghncxa03w 04-02-17 15:35:05 EST EAGLE 31.3.0
IPADDR          HOST
150.1.1.1       GW100.NC.TEKELEC.COM
150.1.1.1       GW101.NC.TEKELEC.COM
150.1.1.2       GW102.NC.TEKELEC.COM
150.1.1.3       GW103.NC.TEKELEC.COM
;
```

rtrv-ip-lnk**Retrieve Internet Protocol Link**

Use this command to retrieve the IP link table.

Keyword: rtrv-ip-lnk

Related Commands: chg-ip-lnk

Command Class: Database Administration

Parameters

:loc= (optional)

Card location. The unique identifier of a specific application subsystem located in the system.

Range: 1101-1108, 1111-1112, 1201-1208, 1211-1218, 1301-1308, 1311-1318, 2101-2108, 2111-2118, 2201-2208, 2211-2218, 2301-2308, 2311-2318, 3101-3108, 3111-3118, 3201-3208, 3211-3218, 3301-3308, 3311-3318, 4101-4108, 4111-4118, 4201-4208, 4211-4218, 4301-4308, 4311-4318, 5101-5108, 5111-5118, 5201-5208, 5211-5218, 5301-5308, 5311-5318, 6101-6108, 6111-6118

Default: All card location link data are displayed.

:port= (optional)

Ethernet interface port ID.

Range: a, b

Default: All IP link port data associated with all ports on the card are displayed.

Example

```
rtrv-ip-lnk:loc=1211:port=a
```

```
rtrv-ip-lnk:loc=1211
```

```
rtrv-ip-lnk
```

Dependencies

The **loc** parameter value must correspond to a DCM card in the card table.

Notes

None

Output

rtrv-ip-lnk

```
rlghncxa03w 04-02-17 15:35:05 EST EAGLE 31.3.0
LOC  PORT  IPADDR          SUBMASK          DUPLEX  SPEED  MACTYPE  AUTO  MCAST
1211  A     150.123.123.123  255.255.255.0   HALF    10     DIX      NO    YES
1211  B     150.123.123.124  255.255.255.0   HALF    10     DIX      NO    NO
1213  A     150.123.123.125  255.255.255.0   ----    ---    DIX      YES   NO
1213  B     150.123.123.126  255.255.255.0   ----    ---    DIX      YES   NO
1215  A     150.123.123.127  255.255.255.0   FULL    100    DIX      NO    YES
1215  B     150.123.123.128  255.255.255.0   FULL    100    DIX      NO    NO
```

IP-Link table is (6 of 512) 1% full

;

rtrv-ip-lnk:loc=1211

```
rlghncxa03w 04-02-17 15:35:05 EST EAGLE 31.3.0
LOC  PORT  IPADDR          SUBMASK          DUPLEX  SPEED  MACTYPE  AUTO  MCAST
1211  A     150.123.123.123  255.255.255.0   HALF    10     DIX      NO    NO
1211  B     150.123.123.124  255.255.255.0   HALF    10     DIX      NO    NO
```

;

rtrv-ip-lnk:loc=1211:port=a

```
rlghncxa03w 04-02-17 15:35:05 EST EAGLE 31.3.0
LOC  PORT  IPADDR          SUBMASK          DUPLEX  SPEED  MACTYPE  AUTO  MCAST
1211  A     150.123.123.123  255.255.255.0   HALF    10     DIX      NO    NO
```

;

Legend

LOC—The card location.

PORT—The Ethernet interface port ID, **A** or **B**.

IPADDR—The IP address for the specified port.

SUBMASK—The subnet mask of the IP interface.

DUPLEX—The mode of operation of the interface, **HALF** or **FULL**.

SPEED—The bandwidth for the interface in megabits per second, **10** or **100**.

MACTYPE—The Media Access Control Type of the interface, **DIX** or **802.3**, where **DIX** indicates the Digital/Inter/Xerox **de facto** standard for ethernet and **802.3** indicates the IEEE standard number 802.3.

AUTO—Whether or not to automatically determine duplex and speed. If **YES**, duplex and speed are automatically determined. If **NO**, duplex and speed are not automatically determined.

MCAST—Multicast Control. Enables or disables multicast support for the interface. This parameter is necessary for INP, G-Port, and G-Flex to establish the connection from the DSM card to the MPS system.

rtrv-ip-node**Retrieve IP Node**

Use this command to display one or more nodes that are directly connected to a TCP/IP data link. A particular connection can be displayed, a particular application on a node can be displayed, or an entire node can be displayed. If an entire node is displayed, no parameters are required to perform this action. A particular application can be specified by giving either the application's name or its IP port on the node.

Keyword: **rtrv-ip-node**

Related Commands: **dlt-ip-node**, **ent-ip-node**

Command Class: Database Administration

Parameters

:ipaddr= (optional)

The remote host's IP address. This is a TCP/IP address expressed in standard dot notation. IP addresses consist of the system's network number and the machine's unique host number. An example IP address is **192.126.100.5**, where **192.126.100** is the network number and **5** is the machine's host number.

Range: **1-223, 0-255**

4 numbers separated by dots

1-223—first number

0-255—the other three numbers

Default: Display all

:ipappl= (optional)

The IP application supported by the node.

Range: **stplan**

:ippport= (optional)

The logical IP port that addresses the application on the node.

Range: **1024-5000**

Default: Display all

:iprte= (optional)

The default router's IP address. This is a TCP/IP address expressed in standard dot notation. IP addresses consist of the system's network number and the machine's unique host number. An example IP address is **192.126.100.5**, where **192.126.100** is the network number and **5** is the machine's host number.

Range: **1-223, 0-255**

4 numbers separated by dots

1-223—first number

0-255—the other three numbers

Default: Display all

:loc= (optional)

The card location as stenciled on the shelf of the system that contains the TCP/IP link that will be directly connected to the node.

Range: 1101–1108, 1111–1112, 1201–1208, 1211–1218, 1301–1308, 1311–1318, 2101–2108, 2111–2118, 2201–2208, 2211–2218, 2301–2308, 2311–2318, 3101–3108, 3111–3118, 3201–3208, 3211–3218, 3301–3308, 3311–3318, 4101–4108, 4111–4118, 4201–4208, 4211–4218, 4301–4308, 4311–4318, 5101–5108, 5111–5118, 5201–5208, 5211–5218, 5301–5308, 5311–5318, 6101–6108, 6111–6118

Default: Display all

Example

```
rtrv-ip-node
rtrv-ip-node:ipappl=stplan
rtrv-ip-node:ipaddr=193.4.201.50
rtrv-ip-node:ipaddr=193.4.201.50:ipport=1024
rtrv-ip-node:loc=1201
rtrv-ip-node:ipaddr=193.4.201.50:ipport=1022
rtrv-ip-node:ipaddr=193.4.111.55
```

Dependencies

If the **ipappl**, **ipport**, or **loc** parameter is specified, the others cannot be specified.

The **ipport** parameter can be specified only if the **ipaddr** parameter is specified.

The ACM is the only valid card type for this command.

The shelf and card must be equipped.

If the **loc** parameter is specified, the card location must be equipped with a TCP/IP data link.

If the **ipaddr** parameter is specified, that IP address must be in the TCP/IP data link table.

If the **ipappl** parameter is specified, that IP application must be in the TCP/IP data link table.

If the **iprte** parameter is not specified, then all TCP/IP nodes meeting the display criteria are displayed. If the TCP/IP node has no TCP/IP router assigned to it, dashes are displayed in the IPRTE field.

Notes

None

Output

```
rtrv-ip-node
rtrv-ip-node:ipappl=stplan
rlghncxa03w 04-02-04 21:16:43 EST EAGLE 31.3.0
IPADDR      IPPORT  IPAPPL  LOC    CAP  IPRTE
193.4.201.50 1024    stplan  1201  10%  --
193.4.201.50 1024    stplan  1202  10%  --
193.4.201.50 1024    stplan  1203  20%  --
193.4.202.30 2000    stplan  1204  40%  193.4.201.1
194.5.198.74 3000    stplan  1205  40%  193.4.201.1
197.4.217.39 4000    stplan  1206  40%  197.4.216.1
;
```

rtrv-ip-node:ipaddr=193.4.201.50**rtrv-ip-node:ipaddr=193.4.201.50:ippport=1024**

```
rlghncxa03w 04-02-04 21:16:43 EST EAGLE 31.3.0
IPADDR          IPPORT  IPAPPL  LOC   CAP  IPRTE
193.4.201.50    1024    stplan  1201  10%  --
193.4.201.50    1024    stplan  1202  10%  --
193.4.201.50    1024    stplan  1203  20%  --
;
```

rtrv-ip-node:loc=1201

```
rlghncxa03w 04-02-04 21:16:43 EST EAGLE 31.3.0
IPADDR          IPPORT  IPAPPL  LOC   CAP  IPRTE
193.4.201.50    1024    stplan  1201  10%  --
;
```

rtrv-ip-node:ipaddr=193.4.201.50:ippport=1022

```
rlghncxa03w 04-02-04 21:16:43 EST EAGLE 31.3.0
IPADDR          IPPORT  IPAPPL  LOC   CAP  IPRTE
IPPORT on Node not connected to any TCP/IP link.
;
```

rtrv-ip-node:ipaddr=193.4.111.55

```
rlghncxa03w 04-02-04 21:16:43 EST EAGLE 31.3.0
IPADDR          IPPORT  IPAPPL  LOC   CAP  IPRTE
IPADDR not connected to any TCP/IP Link.
;
```

Legend

IPADDR—The remote host's IP address.

IPPORT—The logical IP port to address the application on the node.

IPAPPL—The IP application supported by the node.

LOC—The card location as stenciled on the shelf of the system that contains the TCP/IP link that will be directly connected to the node.

CAP—The maximum percentage of ethernet capacity for this node connection.

IPRTE—The default router's IP address.

rtrv-ip-rte**Retrieve IP Route**

Use this command to display all static IP route entries in the Static IP Route table, or the entries for a specific card (destination IP addresses, subnet masks, and gateway IP addresses), or the entries for a specific destination IP address, or the entries for a specific gateway IP address.

Keyword: rtrv-ip-rte

Related Commands: dlt-ip-lnk, ent-ip-rte

Command Class: Database Administration

Parameters

:loc=, (optional)

Card location. The unique identifier of a specific IP card in the system.

Range: 1101–1108, 1111–1112, 1201–1208, 1211–1218, 1301–1308, 1311–1318, 2101–2108, 2111–2118, 2201–2208, 2211–2218, 2301–2308, 2311–2318, 3101–3108, 3111–3118, 3201–3208, 3211–3218, 3301–3308, 3311–3318, 4101–4108, 4111–4118, 4201–4208, 4211–4218, 4301–4308, 4311–4318, 5101–5108, 5111–5118, 5201–5208, 5211–5218, 5301–5308, 5311–5318, 6101–6108, 6111–6118

:dest= (optional)

Destination IP Address. The IP Address of a remote destination host or network.

Range: 4 numbers separated by dots, with each number in the range of 0–255

:gtwy= (optional)

Gateway IP Address. The IP address assigned to the gateway router that will properly forward IP datagrams with the destination IP address (**dest**) to the next-hop gateway router or final destination host.

Range: 4 numbers separated by dots, with each number in the range of 0–255

Example

```
rtrv-ip-rte
```

```
rtrv-ip-rte:loc=1301
```

```
rtrv-ip-rte:dest=128.252.10.5
```

```
rtrv-ip-rte:gtwy=140.190.15.3
```

Dependencies

Only one optional parameter can be specified in a single command.

The **loc** parameter value must correspond to a DCM card or SSEDCCM card in the card table that is running the **ss7ipgw**, **ipgwi**, **iplim**, or $\pi\lambda\mu\mu$ application. The B network is used only on SSEDCCM cards.

The specified destination IP address (**dest** parameter):

- Must not be the default route (**0.0.0.0**)
- Must not correspond to any loopback address (i.e. 127.X.X.X)

The specified gateway IP address (**gtwy** parameter):

- Must not be the default route (**0.0.0.0**)
- Must not correspond to any loopback address (i.e. 127.X.X.X)

Notes

None

Output**rtrv-ip-rte**

```

rlghncxa03w  04-01-07  09:50:17  EST  EAGLE 6.0.0
LOC  DEST          SUBMASK          GTWY
1301 128.252.10.5   255.255.255.255  140.188.13.33
1301 128.252.0.0     255.255.0.0      140.188.13.34
1301 150.10.1.1       255.255.255.255  140.190.15.3
1303 192.168.10.1    255.255.255.255  150.190.15.23
1303 192.168.0.0      255.255.0.0      150.190.15.24

```

```

IP Route table is (5 of 1024) 1% full
;

```

rtrv-ip-rte:loc=1301

```

rlghncxa03w  04-01-07  09:50:17  EST  EAGLE 6.0.0
LOC  DEST          SUBMASK          GTWY
1301 128.252.10.5   255.255.255.255  140.188.13.33
1301 128.252.0.0     255.255.0.0      140.188.13.34
1301 150.10.1.1       255.255.255.255  140.190.15.3

```

```

IP Route table is (5 of 1024) 1% full
;

```

rtrv-ip-rte:dest=128.252.10.5

```

rlghncxa03w  04-01-07  09:50:17  EST  EAGLE 6.0.0
LOC  DEST          SUBMASK          GTWY
1301 128.252.10.5   255.255.255.255  140.188.13.33

```

```

IP Route table is (5 of 1024) 1% full
;

```

rtrv-ip-rte:gtwy=140.190.15.3

```

rlghncxa03w  04-01-07  09:50:17  EST  EAGLE 6.0.0
LOC  DEST          SUBMASK          GTWY
1301 150.10.1.1       255.255.255.255  140.190.15.3

```

```

IP Route table is (5 of 1024) 1% full
;

```

rtrv-isupvar-attrb**Retrieve ISUP Variant Attribute**

Use this command to retrieve the attributes of ISUP variant table entries.

Keyword: rtrv-isupvar-attrb

Related Commands: copy-isupvar-attrb, chg-isupvar-attrb, rtrv-pstn-pres

Command Class: Database Administration

Parameters

:pstncat= (optional)

The PSTN category assigned to the variant entry being retrieved.

Range: 0-65535

:pstnid= (optional)

The PSTN ID that identifies the source variant table entry being copied.

Range: 0-65535

:display= (optional)

Display indicates which information in the variant entry will be displayed.

Range: **brief, full**

Default: **brief**

:msgcode= (optional)

The ISUP message type code entered to identify a specific ISUP message that is going to have its attributes changed.

Range: **0-255 or (h'00-h'ff)**

:parmcode= (optional)

The ISUP parameter code entered to identify a specific ISUP parameter that is going to have its attributes changed.

Range: **0-255 or (h'00-h'ff)**

Example

```
rtrv-isupvar-attrib:pstncat=65535:pstnid=65535:msgcode=4
```

```
rtrv-isupvar-attrib:pstncat=1:pstnid=5:parmcode=h'20
```

Dependencies

The **pstncat=1** and **pstnid=2** parameter combination is invalid.

Required controlled features must be enabled.

- ISUP Normalization controlled feature
- ON/OFF controlled feature for Tekelec-defined Variant

The Tekelec-defined Variants are listed in “Tekelec-defined ISUP Normalization Variants” in Appendix A.

- Quantity controlled feature for user-defined Variant

The **pstncat** and **pstnid** values must have been previously defined with **ent-pstn-pres**.

The **dpstncat** and **dpstnid** values must have been previously defined with **ent-pstn-pres**.

Notes

The **copy-isupvar-attrib** command provides the user with an easy way to provision a new ISUP variant table entry by copying all the data from another entry. Then the user changes the entry with the **chg-isupvar-attrib** command.

An ISUP variant table entry exists for each variant defined in the SG. Each entry contains ISUP message and parameter data specific to the ISUP protocol that variant uses. A variant is uniquely defined by its PSTN presentation value, consisting of a PSTN category and a PSTN ID.

The PSTN presentation is used to identify both the source and destination table entries. Both entries **must** be previously defined PSTN presentation values, such as either a Tekelec-defined PSTN or a user-defined PSTN by the **ent-pstn-pres** commands. Use the **rtrv-pstn-pres** command to display the **only** allowed values for the source and destination PSTNs.

If the source or destination variant is a Tekelec-defined PSTN value, then its associated ON/OFF control feature must be ENABLED.

The following is an example of a possible output displaying all supported parameters for a specified message in a variant.

PSTNCAT	PSTNID	MSGCODE	ATTRIB		ACTION
00001	00005	04h	DEFINED		CONVERT
	MSGCODE	PARMCODE	TYPE	ORDER	ACTION
	04h	---	---	-	CONVERT
		10h	MF	1	NONE
		08h	MF	2	NONE
		09h	MV	1	CONVERT
		FEh	MV	2	NONE
		00h	OPT	-	NONE
		01h	OPT	-	NONE
		04h	OPT	-	NONE
		0Fh	OPT	-	PASSTHRU

Output

The following example displays one message in the specified variant.

rtrv-isupvar-attrib:pstncat=65535:pstnid=65535:msgcode=4

PSTNCAT	PSTNID	MSGCODE	ATTRIB	ACTION
65535	65535	04h	DEFINED	PASSTHRU

ISUP variant table is (5 of 20) 25% full

;

Legend

PSTNCAT—The PSTN category that identifies the source variant table entry being copied.

PSTNID—The PSTN ID that identifies the source variant table entry being copied.

DPSTNCAT—The PSTN category that identifies the destination variant table entry where the source variant table is being copied.

DPSTNID—The PSTN ID that identifies the destination variant table entry where the source variant table is being copied.

rtrv-l2t

Retrieve Level 2 Timers

Use this command to display the values of the SS7 MTP Level 2 timers. The SS7 MTP level 2 timers are organized in 30 timer sets of 8 timer values each. The 30 timer sets have been grouped and system default values have been initialized by specification (ANSI, ITU, High Speed for China, and High Speed for Q.703 Annex A). Each timer set is administered individually by the **chg-l2t** command. The **ent-slk** command associates links with timer sets. Each assigned link is associated with one of the 30 timer sets.

Keyword: rtrv-l2t

Related Commands: chg-l2tent-slk, rtrv-slk

Command Class: Database Administration

Parameters**:l2set=** (optional)

Level 2 timer set identifier, or timer set number. Up to 30 different sets of SS7 MTP Level 2 timer sets can be defined. The **ent-slk** command can be used to assign an SS7 signaling link to any one of the 30 timer sets.

Range: 1–30**Default:** Display all timer sets**Example****rtrv-l2t****rtrv-l2t:l2set=3****Dependencies**

None

Notes

The timer values are shown in the output for this command in seconds, even though they were specified in milliseconds in the **chg-l2t** command.

Output**rtrv-l2t**

```

rlghncxa03w 05-02-07 09:50:17 EST EAGLE5 34.0.0
L2T TIMERS (IN SECONDS)
L2TSET      T1      T2      T3      T4NPP      T4EPP      T5      T6      T7
 1      13.0    11.5    11.5    2.3      0.60    0.10    4.0    1.5
 2      13.0    11.5    11.5    2.3      0.60    0.10    4.0    1.5
 3      13.0    11.5    11.5    2.3      0.60    0.10    4.0    1.5
 4      13.0    11.5    11.5    2.3      0.60    0.10    4.0    1.5
 5      13.0    11.5    11.5    2.3      0.60    0.10    4.0    1.5
 6      13.0    11.5    11.5    2.3      0.60    0.10    4.0    1.5
 7      13.0    11.5    11.5    2.3      0.60    0.10    4.0    1.5
 8      13.0    11.5    11.5    2.3      0.60    0.10    4.0    1.5
 9      13.0    11.5    11.5    2.3      0.60    0.10    4.0    1.5
10      13.0    11.5    11.5    2.3      0.60    0.10    4.0    1.5
11      40.0    30.0     2.0    8.2      0.50    0.10    4.0    1.5
12      40.0    30.0     2.0    8.2      0.50    0.10    4.0    1.5
13      40.0    30.0     2.0    8.2      0.50    0.10    4.0    1.5
14      40.0    30.0     2.0    8.2      0.50    0.10    4.0    1.5
15      40.0    30.0     2.0    8.2      0.50    0.10    4.0    1.5
16      40.0    30.0     2.0    8.2      0.50    0.10    4.0    1.5
17      40.0    30.0     2.0    8.2      0.50    0.10    4.0    1.5
18      40.0    30.0     2.0    8.2      0.50    0.10    4.0    1.5
19      40.0    30.0     2.0    8.2      0.50    0.10    4.0    1.5
20      40.0    30.0     2.0    8.2      0.50    0.10    4.0    1.5
21      150.0   130.0     1.0   30.0     0.50    0.10    5.0    0.8
22      150.0   130.0     1.0   30.0     0.50    0.10    5.0    0.8
23      150.0   130.0     1.0   30.0     0.50    0.10    5.0    0.8
24      150.0   130.0     1.0   30.0     0.50    0.10    5.0    0.8
25      150.0   130.0     1.0   30.0     0.50    0.10    5.0    0.8
26      300.0   130.0     1.0   30.0     0.50    0.10    5.0    0.8
27      300.0   130.0     1.0   30.0     0.50    0.10    5.0    0.8
28      300.0   130.0     1.0   30.0     0.50    0.10    5.0    0.8
29      300.0   130.0     1.0   30.0     0.50    0.10    5.0    0.8
30      300.0   130.0     1.0   30.0     0.50    0.10    5.0    0.8

```

;

If the **l2tset** parameter is specified (for example, **rtrv-l2t:l2tset=1**), the values for the specified timer are shown.

```

rlghncxa03w  04-01-07  09:50:17  EST  EAGLE 31.3.0
L2T TIMERS (IN SECONDS)
L2TSET T1    T2    T3    T4NPP  T4EPP  T5    T6    T7
1       13.0  11.5  11.5  3.3    1.0    0.5  10.0  1.5
;
    
```

Legend

L2TSET—The SS7 MTP Level 2 timer set identifier or number

T1—Aligned ready

T2—Not aligned

T3—Aligned

T4NPP—Proving period normal

T4EPP—Proving period Emergency

T5—Sending SIB

T6—Remote congestion

T7—Excessive delay of acknowledgment

rtrv-l3t

Retrieve Level 3 Timers

Use this command to show values of the SS7 level 3 timers. The timers are grouped into sets that are assigned to linksets.

Keyword: **rtrv-l3t**

Related Commands: **chg-l2t, chg-l3t, ent-ls, rtrv-l2t, rtrv-ls**

Command Class: Database Administration

Parameters

:l3set= (optional)

Level 3 timer set table. Only one level 3 timer set table can be defined. The timer set can then be assigned to a linkset using the **ent-ls** or **chg-l3t** command.

Range: 1

Default: Display table

Example

rtrv-l3t:l3tset=1

Dependencies

Only one timer set is supported in this release.

Notes

The timer output for this command is in seconds, even though it could have been entered in milliseconds on the **chg-l3t** command.

Output**rtrv-l3t****rtrv-l3t:l3tset=1**

```

rlghncxa03w 04-02-17 16:03:12 EST EAGLE 31.3.0
LEVEL 3 TIMERS (IN SECONDS)
  L3TSET    T1      T2      T3      T4      T5      T6      T7
           1      0.8    1.4    0.8    0.8    0.8    0.8    1.0
           T8      T9      T10     T11     T12     T13     T14
           0.8    --     30.0   30.0   0.8    0.8    2.0
           T15     T16     T17     T18     IT18     T19     IT19
           3.0    1.4    0.8    10.0   19.0   480.0  67.0
  T20/IT22  IT20    T21/IT23 IT21    T22     T23     T24
           90.0   59.0   90.0   63.0   10.0   10.0   10.0
           T25     T26     T27     T28     T29     T30     T31
           30.0   12.0   --     3.0    60.0   30.0   60.0
           T32
           60.0
;

```

Legend

L3TSET—The level 3 timer set table.

T1—The delay, in seconds, to avoid message missequencing on changeover. Also used as the ITU MTP restart isolation timer.

T2—The amount of time, in seconds, to wait for changeover acknowledgment.

T3—Time controlled diversion – the delay, in seconds, to avoid missequencing on changeback.

T4—The amount of time, in seconds, to wait for changeback acknowledgment, first attempt.

T5—The amount of time, in seconds, to wait for changeback acknowledgment, second attempt.

T6—The delay, in seconds, to avoid message missequencing on controlled rerouting.

T7—The amount of time, in seconds, to wait for signaling data link connection acknowledgment.

T8—The transfer-prohibited inhibited timer (transient solution).

T10—The amount of time, in seconds, to wait before repeating the signaling-route-set-test message.

T11—The transfer-restricted timer.

T12—The amount of time, in seconds, to wait for uninhibit acknowledgment.

T13—The amount of time, in seconds, to wait for force uninhibit.

T14—The amount of time, in seconds, to wait for inhibition acknowledgment.

- T15**—The amount of time, in seconds, to wait before repeating the signaling-route-set-congestion test.
- T16**—The amount of time, in seconds, to wait for route-set-congestion status update.
- T17**—The delay, in seconds, to avoid oscillation of initial alignment failure and link restart.
- T18**—The repeat TFR once by response method timers.
- IT18**—The timer within an STP whose MTP restarts to supervise the receipt of routing information and the activation of the link and link set. The amount of time, in seconds, to wait for links to align and to receive TRAs from all adjacent nodes.
- T19**—The failed link craft referral timer.
- IT19**—The amount of time, in seconds, for the supervision timer to wait during MTP restart to avoid ping-pong of TFP, TFR1, and TRA messages.
- T20/IT22**—The amount of time, in seconds, to wait before repeating the local inhibit test.
- IT20**—The amount of time, in seconds, to wait overall for the MTP restart at the signaling point whose MTP restarts.
- T21/IT23**—The amount of time, in seconds, to wait before repeating the remote inhibit test.
- IT21**—The overall MTP restart timer at a signaling point adjacent to one whose MTP restarts.
- T22**—The timer at the restarting STP. The amount of time, in seconds, to wait for signaling links to become available.
- T23**—The timer at the restarting STP. Starting after T22, the amount of time, in seconds, to wait to receive all TRA messages.
- T24**—The timer at the restarting STP with transfer function. Starting after T23, the amount of time, in seconds, to wait to broadcast all TRA messages.
- T25**—The timer at the adjacent and restarting STPs. The amount of time, in seconds, to wait for a TRA message (may be started at level 2).
- T26**—The timer at the restarting STP. The amount of time, in seconds, to wait to repeat a TRW message.
- T28**—The timer at the STP adjacent to the restarting STP. The amount of time, in seconds, to wait for a TRW message.
- T29**—The timer started when a TRA message is sent in response to an unexpected TRA or TRW. Also, the timer started when traffic is resumed without receipt of a TRA message.
- T30**—The timer used to limit the sending of TFPS/TFRs in response to an unexpected TRA or TRW message.
- T31**—The false link congestion detection timer.
- T32**—The link oscillation timer—Procedure A.

rtrv-lbp**Retrieve Loopback Point Attributes**

Use this command to retrieve the current value of a far-end loopback point maintained in the link fault sectionalization table.

Keyword: rtrv-lbp

Related Commands: act-lbp, ent-lbp, chg-lbp, dact-lbp, dlt-lbp

Command Class: Database Administration

Parameters

:lbp= (optional)

Loopback point ID. This parameter identifies a far-end loopback point that lies along an SS7 signaling link path between the STP and the target device (up to and including the target device).

Range: 1–32

Default: Display all

:loc= (optional)

Card location. The unique identifier of a specific application subsystem located in the STP.

Range: 1101–1108, 1111–1112, 1201–1208, 1211–1218, 1301–1308, 1311–1318, 2101–2108, 2111–2118, 2201–2208, 2211–2218, 2301–2308, 2311–2318, 3101–3108, 3111–3118, 3201–3208, 3211–3218, 3301–3308, 3311–3318, 4101–4108, 4111–4118, 4201–4208, 4211–4218, 4301–4308, 4311–4318, 5101–5108, 5111–5118, 5201–5208, 5211–5218, 5301–5308, 5311–5318, 6101–6108, 6111–6118

Default: All card locations.

:port= or :link= (optional)

SS7 signaling link. The SS7 signaling link that is to be tested.

Range: a, b, a1-a31, b1-b31

Not all card types support all **link** parameter values.

See Table A-1 in Appendix A for valid **link** parameter range values for each type of card that can have assigned signaling links.

Default: Display all

Example

```
rtrv-lbp
```

```
rtrv-lbp:loc=1202
```

```
rtrv-lbp:loc=1202:link=a
```

```
rtrv-lbp:loc=1202:link=a:lbp=3
```

Dependencies

The Link Fault Sectionalization (LFS) feature must be on before using this command.

The card location cannot be reserved by the system.

If the **lbp** parameter is specified, both the **loc** parameter and the **link** parameter must be specified.

If the **link** parameter is specified, the **loc** parameter must be specified.

The card location (**loc** parameter) must identify a provisioned **limds0**, **limt1**, or **limch** (associated to a **limt1**) card configured with either an **ss7ansi** or **ccs7itu** application.

Notes

This command can be canceled using the **F9** function key or the **canc-cmd** command. See **canc-cmd** for more information.

Output

The following example displays the attributes for all the loopback points for SS7 links assigned to the STP:

rtrv-lbp

```
rlghncxa03w 04-02-17 16:02:05 EST EAGLE 31.3.0
LOC LINK LBP RLE REP CLLI LFST
1101 A 1 DSO 0 ----- LLT
      7 OCU 0 ----- NLT
      9 NEI 0 ----- LLT

1102 A 2 DSO 0 ----- LLT
      3 DSO 4 ----- LLT
      4 NEI 0 ----- LLT

1102 B 1 DSO 0 ----- LLT
      6 NEI 0 ----- LLT

1215 A 1 DSO 0 ----- LLT
      3 DSO 4 ----- LLT
      5 DSO 5 ----- LLT
      7 DSO 8 ----- LLT
      9 NEI 0 ----- LLT

;
```

The following example displays the attributes for all the loopback points for the SS7 links A and B of the LIM card residing in the first frame, first shelf, and second slot of the STP:

rtrv-lbp:loc=1202

```
rlghncxa03w 04-02-17 16:02:05 EST EAGLE 31.3.0
LOC LINK LBP RLE REP CLLI LFST
1102 A 2 DSO 0 ----- LLT
      3 DSO 4 ----- LLT
      4 NEI 0 ----- LLT

1102 B 1 DSO 0 ----- LLT
      6 NEI 0 ----- LLT

;
```

The following example displays the attributes for all the loopback points for the SS7 link A of the LIM card residing in the first frame, first shelf, and second slot of the STP:

rtrv-lbp:loc=1202:link=a

```
rlghncxa03w 04-02-17 16:02:05 EST EAGLE 31.3.0
LOC LINK LBP RLE REP CLLI LFST
1102 A 2 DSO 0 ----- LLT
      3 DSO 4 ----- LLT
      4 NEI 0 ----- LLT

;
```

The following example displays the attributes for loopback point 3 for the SS7 link A of the LIM card residing in the first frame, first shelf, and second slot of the STP:

rtrv-lbp:loc=1202:link=a:lbp=3

```
rlghncxa03w 04-02-17 16:02:05 EST EAGLE 31.3.0
LOC  LINK  LBP  RLE  REP  CLLI                                LFST
1102  A    3    DSO  4    ----- LLT
;
```

The following example displays the attributes for all the loopback points for the SS7 link A of the LIM card residing in the first frame, first shelf, and second slot of the STP. However, no loopback points have been provisioned.

rtrv-lbp:loc=1202:link=a

```
rlghncxa03w 04-02-17 16:02:05 EST EAGLE 31.3.0
LOC  LINK  LBP  RLE  REP  CLLI                                LFST
```

```
No loopback points meeting the requested criteria were found
;
```

rtrv-lnp-dbts

Retrieve LNP Database Time Stamp

NOTE: This command is obsolete.

Use this command to retrieve the LNP database time stamp corresponding to the latest LNP Database update applied by the LSMS.

Keyword: rtrv-lnp-dbts

Related Commands: None

Command Class: LNP Database

Parameters

This command has no parameters.

Example

```
rtrv-lnp-dbts
```

Dependencies

The LNP feature must be turned on prior to using this command (see the **enable-ctrl-feat** and **chg-ctrl-feat** commands).

Notes

The timestamp that this command displays is updated during the importation of an LNP database created by the LSMS (using the command and parameter **chg-db:action=import**). It is also updated whenever the database is modified as a result of an **upd-lnp-10dt** command received from the LSMS. Note that not all LNP DB update commands received from the LSMS cause the timestamp to be updated (only **upd-lnp-10dt**). LNP database updates caused by commands issued from EAGLE terminals do not cause the timestamp to be updated.

ACTV (active) or STDBY (standby) is displayed for the 1114/1116 disks to indicate the role of the associated MASP. If the disk is not accessible, then NOACCS is displayed.

The timestamp that is displayed is the verbatim timestamp as provided by the LSMS. This timestamp is normally a 14-character date/time in the format: *yyyymmddhhmmss*. The timestamp is displayed exactly as received by the LSMS without additional reformatting.

Output

rtrv-lnp-dbts

```

TDM 1114 (ACTV)          TDM 1116 (STDBY)
  TIME LAST UPDATE      TIME LAST UPDATE
-----
FD BKUP    19971218114204  19971218114204
FD CRNT    19971218114204  19971218114204
MDAL 1117
-----
RD BKUP    19971218104204
;
    
```

rtrv-lnp-dbts

(with the standby MASP and removable cartridge not available)

```

TDM 1114 (ACTV)          TDM 1116 (NOACCS)
  TIME LAST UPDATE      TIME LAST UPDATE
-----
FD BKUP    19971218114204  -
FD CRNT    19971218114204  -
MDAL 1117
-----
RD BKUP    -
;
    
```

Legend

(ACTV)—The specified MASP is the active processor.

(STDBY)—The specified MASP is the standby processor.

(NOACCS)—The specified processor is not accessible.

RD BKUP—Removable cartridge backup partition.

FD BKUP—Fixed disk backup partition.

FD CRNT—Fixed disk current partition.

TIME LAST UPDATE—The date and time the last change was performed on the specified card and its associated database.

—The database is not available.

rtrv-lnp-dpcer

Retrieve LNP DPC Exception Report

NOTE: This command is obsolete.

Use this command to generate a report of LNP subscriptions in the database that have not been assigned to a route. If **tn** is specified, the generated report shows telephone number (TN) subscriptions accepted from the Local Service Management System (LSMS) which contain a translation type (TT) for which no destination point code (DPC) exists in the LNP database. If **tn** is not specified, the report shows a list of TT-DPCs that have not been assigned a route.

NOTE: If the LNP ELAP Configuration feature is turned on, this command is no longer available.

NOTE: This command does not support 24-bit ITU national point codes.

Keyword: rtrv-lnp-dpcer

Related Commands: canc-lnp-dpcer

Command Class: LNP Basic Administration

Parameters

:dpc= (optional)

The ANSI destination point code, in the form of *network indicator-network cluster-network cluster member* (*ni-nc-ncm*), associated with a **tn** that does not have a route assigned to it.

Range: *ni*—000–255

nc—000–255

ncm—000–255

Default: Information is displayed for all DPCs associated with the specified parameters.

:etn= (optional)

The end number of the range of telephone numbers on which to base the report.

Range: To specify a single TN subscription— 10 digits

To pool a block of 1000 TNs— 7 digits with 3 asterisks (***) appended

:force= (optional)

Allows for the report to be displayed when **num** is specified as greater than **50**, or when the range of numbers specified with **tn** and **etn** results in output of over 50 entries.

Range: yes, no

Default: no

:num= (optional)

The maximum number of database entries to display.

Range: 1–12000000

Default: 50

:tn= (optional)

The telephone number, or start number of the range of telephone numbers, on which to base the report.

Range: To specify a single TN subscription— 10 digits

To pool a block of 1000 TNs— 7 digits with 3 asterisks (***) appended

:tt= (optional)

The translation type on which to base the report.

Range: 0–255

Default: Information is displayed for all translation types associated with the specified parameters.

Example

```
rtrv-lnp-dpcer
```

```
rtrv-lnp-dpcer:tn=9191234567:tt=16:dpc=100-100-100
```

```
rtrv-lnp-dpcer:tn=111111000:etn=1999999999:num=250:force=yes
```

```
rtrv-lnp-dpcer:tn-9194605***
```

Dependencies

The LNP feature must be turned on prior to using this command (see the **enable-ctrl-feat** and **chg-ctrl-feat** commands).

If **tn** is specified, the generated report shows TN subscriptions accepted from the LSMS which contain a TT for which no DPC exists in the LNP database. If **tn** is not specified, the report shows a list of TT-DPCs that have not been assigned a route.

If translation type (**tt**) is specified along with **tn**, the TT value must not be associated with an AIN or IN query service.

If **tt** is specified, the TT value must not be a WNP or LNPQS query service, or an LNP alias.

If the **tt** and **dpc** parameters are both specified, output is reported only if both criteria are matched.

If a single subscription contains multiple TTs with a missing DPC, multiple entries are displayed in the report.

Notes

Specifying a **tn** or **tn/etn** range is not recommended when using the **rtrv-lnp-dpcer** command. When a **tn** or **tn/etn** range is not specified, a report is generated based on translation types. The execution time of a translation type based report is much shorter, and the data is more useful for identifying DPCs in the LNP entries that do not have routes assigned.

Because the processing time for this report can be extremely long, the **canc-lnp-dpcer** command can be entered to cancel the report.

The **REFCNT** field in the output indicates the number of DPCs being referenced or used in the database.

By specifying a **tn/etn** range, it is possible for the Numbering Plan Area (NPANXX) ranges to cross boundaries (for example, 9195551111–9605551111).

Output

rtrv-lnp-dpcer:tn=9191234567:tt=16:dpc=100-100-100

(shows a specific telephone number with a specific translation type whose destination point code is not assigned to a route)

```
rlghncxa03w 04-02-14:23:37 EDT EAGLE 31.3.0
TN          TT      DPC
9191234567  16      100-100-100
;
```

rtrv-lnp-dpcer:tn=1111111000:etn=1999999999:num=250:force=yes

(shows the first 250 telephone numbers found in the specified range which have translation types whose destination point codes are not assigned to a route)

```
rlghncxa03w 04-02-14:23:37 EDT EAGLE 31.3.0
TN          TT      DPC
1111111110  10      100-100-100
                25      100-130-105
1111111111  35      200-123-434
1111111***  10      100-100-100
                35      200-123-434
1111111200  13      001-001-002
. . .
1234567890  45      003-002-001
```

Report terminated - output length limitation (NUM=250) reached.
;

rtrv-lnp-dpcer:tt=15:num=20

(shows the first 20 entries of a specified translation type whose destination point code is not assigned to a route)

```
rlghncxa03w 04-02-14:23:37 EDT EAGLE 31.3.0
TT      DPC          REFCNT
15      001-001-001  4294
15      100-100-100  100
. . .
15      002-002-002  99
```

Report terminated - output length limitation (NUM=20) reached.
;

rtrv-lnp-dpcer:dpc=012-012-012

(shows the first 100 translation types containing a specific destination point code that is not assigned to a route. The report was then canceled with the **cancel-lnp-dpcer** command)

```
rlghncxa03w 04-02-14:23:37 EDT EAGLE 31.3.0
TT      DPC          REFCNT
15      012-012-012  299
20      012-012-012  10004
35      012-012-012  3
. . .
255    012-012-012  520597
```

Report terminated by the CANCEL-LNP-DPCER command.
;

rtrv-lnp-dpcer:tn=143-34-87:tt=30:dpc=255-255-255

(shows the command output when the search criteria was not found)

```
rlghncxa03w 04-02-14:23:37 EDT EAGLE 31.3.0
TN          TT    DPC
No entry exists matching the requested criteria
;
```

rtrv-lnp-dpcer

(shows the output when the command is specified with no parameters and all the destination point codes are assigned to routes)

```
rlghncxa03w 04-02-14:23:37 EDT EAGLE 31.3.0
TT    DPC          REF CNT
No entries found
;
```

rtrv-lnp-lrn**Retrieve LNP Location Routing Number**

NOTE: This command is obsolete.

Use this command to display all LRNs and their associated final overriding message relay global title translations from the database.

NOTE: If the LNP ELAP Configuration feature is turned on, this command is no longer available, and all LNP provisioning is performed at the LSMS or using the ELAP user interface.

Keyword: rtrv-lnp-lrn

Related Commands: chg-lnp-lrn, dlt-lnp-lrn, ent-lnp-lrn

Command Class: LNP Basic Administration

Parameters

:elrn= (optional)

End range location routing number.

Range: 10 digits

Default: Same value as the lrn parameter

:force= (optional)

This parameter is used to display more than 50 entries in the report.

Range: yes, no

Default: no

:lrn= (optional)

Location routing number.

Range: 10 digits

:num= (optional)

Number of entries to be displayed. This parameter specifies how many records you want to display (potentially within a given range). Use this parameter to prevent inadvertent displays of extremely large amounts of information.

Range: 1-100,000

Default: 1, 50

1—If the **lrn** parameter is specified and the **elrn** parameter is not specified.

50—In all other cases.

:sp= (optional)

Service provider. Use this parameter to limit the displays to LRN records found matching the specified value.

Range: Four alphanumeric characters.

Default: Display all LRNs in the database.

Example

```
rtrv-lnp-lrn:num=30
```

```
rtrv-lnp-lrn:lrn=9093350000
```

```
rtrv-lnp-lrn:lrn=9093350000:elrn=9093359999:num=80:force=yes
```

```
rtrv-lnp-lrn:lrn=1234567890:elrn=1234569999:num=80:force=yes:sp=1234
```

Dependencies

The LNP feature must be turned on (see the **enable-ctrl-feat** command) before this command can be entered.

The **num** parameter value defaults to **50** if not specified.

If the specified **num** parameter value is greater than 50, the **force=yes** parameter must be specified.

If the **elrn** parameter is specified, the **lrn** parameter value must be specified.

The **elrn** parameter value must be greater than the **lrn** parameter value.

The LNP database must be accessible.

Notes

None

Output

The following example shows how to display the first 30 LRNs in the database:

rtrv-lnp-lrn:num=30

```
rlghncxa03w 04-02-28 14:23:37 EST EAGLE 31.3.0
LRN      SP      TT      XLAT      RI      PCA      SSN
9093350000 a909 16      DPCSSN    SSN    001-001-001 20
          18      DPCSSN    SSN    002-002-002 30
          19      DPCSSN    SSN    002-002-004 20

9093350099 b123 --      -----  ---  -----  --
9193370000 a123 --      -----  ---  -----  --

LRN table is 1% full
;
```

The following example shows how to display a specific LRN:

rtrv-lnp-lrn:lrn=9093350000

```
rlghncxa03w 04-02-28 14:23:37 EST EAGLE 31.3.0
LRN      SP      TT      XLAT      RI      PCA      SSN
9093350000 a123 16      DPCSSN    SSN    001-001-001 20
          18      DPCSSN    SSN    002-002-002 30
          19      DPCSSN    SSN    002-002-004 20

9093350099 a243 --      -----  ---  -----  --

LRN table is 58% full
;
```

The following example shows how to display the first 80 records in the given LRN range:

rtrv-lnp-lrn:lrn=9093350000:elrn=9093359999:num=80:force=yes

```
rlghncxa03w 04-02-28 14:23:37 EST EAGLE 31.3.0
LRN      SP      TT      XLAT      RI      PCA      SSN
9093350000 90933599 16      DPCSSN    SSN    001-001-001 20
          18      DPCSSN    SSN    002-002-002 30
          19      DPCSSN    SSN    002-002-004 20

9093350099 90933500 --      -----  ---  -----  --

LRN TABLE IS 58% FULL
;
```

The following example shows how to display the first 80 records matching the specified SP and within the specified range:

rtrv-lnp-lrn:lrn=1234567890:elrn=1234569999:num=80:force=yes:sp=a123

```
rlghncxa03w 04-02-28 14:23:37 EST EAGLE 31.3.0
LRN      SP      TT      XLAT      RI      PCA      SSN
1234567899 a123 16      DPCSSN    SSN    001-001-001 20
          18      DPCSSN    SSN    002-002-002 30
          19      DPCSSN    SSN    002-002-004 20

LRN table is 58% full
;
```

Legend

LRN—Location routing number
SP—Service provider
TT—Translation type
XLAT—Translate
RI—Routing indicator
PCA—ANSI destination point code
SSN—Subsystem number

rtrv-lnp-npanxx**Retrieve LNP NPANXX**

NOTE: This command is obsolete.

Use this command to retrieve all ported LNP NPANXXs and their associated message relay and LNP query default global title translations from the database. Use the **num** parameter to prevent inadvertent displays of extremely large amounts of information, because this action can require several hours.

NOTE: If the LNP ELAP Configuration feature is turned on, this command is no longer available. This function can be performed using the ELAP user interface.

Keyword: rtrv-lnp-npanxx

Related Commands: chg-lnp-npanxx, dlt-lnp-npanxx, ent-lnp-npanxx

Command Class: LNP Basic Administration

Parameters

:enpanxx= (optional)

End range numbering plan area and exchange.

Range: 6 digits

Default: Display all npanxx entries

:force= (optional)

This parameter is used to display more than 50 entries.

Range: yes, no

Default: no

:npanxx= (optional)

Numbering plan area and exchange.

Range: 6 digits

Default: Display all npanxx entries

num= (optional)

Number of entries to be shown. This parameter determines how many records you want to display (potentially within a given range). Use this parameter to prevent inadvertent displays of extremely large amounts of information.

Range: 1–50, if **force=yes** is not specified

1–50000, if **force=yes** is specified

Default: 1—if **npanxx** is specified and **enpanxx** is not specified

50—all other cases

Example

rtrv-lnp-npanxx:npanxx=909335

Dependencies

The LNP feature must be turned on (see the **enable-ctrl-feat** command) before the **rtrv-lnp-npanxx** command can be entered.

If a value is specified for the **num** parameter that is greater than 50, the **force=yes** parameter must be specified.

If the **enpanxx** parameter is specified, the **npanxx** parameter must be specified.

The **enpanxx** parameter value must be greater than the **npanxx** parameter value.

Notes

Translation type values cannot be retrieved that are associated with AIN or IN LNP queries as NPANXX default message relay global title translations.

Output

To retrieve a single NPANXX:

rtrv-lnp-npanxx:npanxx=909335

```
rlghncxa03w 04-02-28 14:23:37 EST EAGLE 31.3.0
NPANXX MR LRN TT XLAT RI PCA SSN NGT
909335 yes yes 16 DPC GT 001-001-001 0 ---
                18 DPCNGT GT 002-002-002 0 10
                19 DPCSSN SSN 002-002-004 20 ---
```

NPANXX TABLE IS 58% FULL

;

To retrieve the first 50 NPANXXs:

rtrv-lnp-npanxx

```
rlghncxa03w 04-02-28 14:23:37 EST EAGLE 31.3.0
NPANXX MR LRN TT XLAT RI PCA SSN NGT
909335 yes yes 16 DPC GT 001-001-001 0 ---
                18 DPCNGT GT 002-002-002 0 10
                19 DPCSSN SSN 002-002-004 20 ---
```

```
909336 yes yes 16 DPC GT 001-001-001 0 ---
```

NPANXX TABLE IS 1% FULL

;

To retrieve the first 100 NPANXX:

rtrv-lnp-npanxx:num=100:force=yes

```
rlghncxa03w 04-02-28 14:23:37 EST EAGLE 31.3.0
NPANXX MR LRN TT XLAT RI PCA SSN NGT
909335 yes yes 16 DPC GT 001-001-001 0 ---
          18 DPCNGT GT 002-002-002 0 10
          19 DPCSSN SSN 002-002-004 20 ---

909336 yes yes 16 DPC GT 001-001-001 0 ---

NPANXX TABLE IS 1% FULL
;
```

To retrieve the first 50 records in a large range of NPANXX:

rtrv-lnp-npanxx:npanxx=555555:enpanxx=666666

```
rlghncxa03w 04-02-28 14:23:37 EST EAGLE 31.3.0
NPANXX MR LRN TT XLAT RI PCA SSN NGT
909335 Y Y 16 DPC GT 001-001-001 0 ---
          18 DPCNGT GT 002-002-002 0 10
          19 DPCSSN SSN 002-002-004 20 ---

909336 Y Y 16 DPC GT 001-001-001 0 ---

NPANXX TABLE IS 1% FULL
;
```

To retrieve the first 10000 records in a large range of NPANXX:

rtrv-lnp-npanxx:npanxx=555555:enpanxx=999999:num=10000:force=yes

```
rlghncxa03w 04-02-28 14:23:37 EST EAGLE 31.3.0
NPANXX MR LRN TT XLAT RI PCA SSN NGT
909335 Y Y 16 DPC GT 001-001-001 0 ---
          18 DPCNGT GT 002-002-002 0 10
          19 DPCSSN SSN 002-002-004 20 ---

909336 Y Y 16 SSN GT 001-001-001 0 ---

NPANXX TABLE IS 1% FULL
;
```

Legend

NPANXX—Numbering plan area and exchange

MR—Message relay 10-digit TN search indication

LRN—Location routing number

TT—Translation type

XLAT—Translate

RI—Routing indicator

PCA—ANSI point code

SSN—Subsystem number

NGT—New global title translation type

rtrv-lnp-serv**Retrieve LNP Service**

This command is obsolete.

Use this command to retrieve all LNP services. This command displays the assigned translation type, translation type name, service type, LNP digit validity indication, and TT aliases.

Keyword: rtrv-lnp-serv

Related Commands: chg-lnp-serv, dlt-lnp-serv, ent-lnp-serv

Command Class: LNP Basic Administration

Parameters

This command has no parameters.

Example

```
rtrv-lnp-serv
```

Dependencies

The LNP feature must be turned on (see the **enable-ctrl-feat** command) before this command can be entered.

Notes

None

Output**rtrv-lnp-serv**

```
rlghncxa03w 02-11-28 14:42:38 EST EAGLE 30.0.0
SERV  TT  TTN      DV  ALIAS
AIN   15  AINGTE  TCAP 235
      236
LIDB  20  LIDB    SCCP ---
WNP   22  WNP     TCAP ---
LNPQS 11  LNPQS   TCAP ---
PCS   12  PCS     TCAP ---
CLASS 25  CLASSGTE SCCP ---
UDF1  201  UDF1    SCCP ---

LNP-SERV TABLE IS 2% FULL (7 of 256)
;
```

If the LNP SMS feature is turned on and provisioned, the WSMSC entry is included:

```
rlghncxa03w 02-11-28 14:42:38 EST EAGLE 30.0.0
SERV  TT  TTN      DV  ALIAS
AIN   15  AINGTE   TCAP 235
      236
LIDB  20  LIDB     SCCP ---
WNP   22  WNP      TCAP ---
LNPQS 11  LNPQS    TCAP ---
PCS   12  PCS      TCAP ---
CLASS 25  CLASSGTE SCCP ---
WSMSC 55  WSMSC    SCCP ---
UDF1  201  UDF1     SCCP ---

LNP-SERV TABLE IS 2% FULL (8 of 256)
;
```

If the LNP SMS feature is not turned on but is provisioned, the output includes the WSMSC entry with an asterisk:

```
rlghncxa03w 02-11-28 14:42:38 EST EAGLE 30.0.0
SERV  TT  TTN      DV  ALIAS
AIN   15  AINGTE   TCAP 235
      236
LIDB  20  LIDB     SCCP ---
WNP   22  WNP      TCAP ---
LNPQS 11  LNPQS    TCAP ---
PCS   12  PCS      TCAP ---
CLASS 25  CLASSGTE SCCP ---
WSMSC* 55  WSMSC    SCCP ---
UDF1  201  UDF1     SCCP ---

LNP-SERV TABLE IS 2% FULL (8 of 256)
;
```

Legend

SERV—Reserved service type name.

TT—Translation type

TTN—Translation type name

DV—Digits valid

ALIAS—Alias translation type

rtrv-lnp-sp

Retrieve LNP Service Provider

NOTE: This command is obsolete.

Use this command to retrieve all LNP service provider information from the database.

NOTE: If the LNP ELAP Configuration feature is turned on, this command is no longer available. This function can be performed using the ELAP user interface.

Keyword: rtrv-lnp-sp

Related Commands: dlt-lnp-sp, ent-lnp-sp

Command Class: LNP Basic Administration

Parameters

:force= (optional)

Use this parameter to prevent display of extremely large amounts of data. This parameter is required if a value greater than **50** is specified for the **num** parameter.

Range: yes, no

Default: no

:num= (optional)

The number of records to be displayed.

Range 1–10000

Default: 1—if only the **sp** parameter is specified
50—if no parameters are specified

:sp= (optional)

The service provider ID.

Range: 1–4 alphanumeric characters.

Default: Display all

Example

```
rtrv-lnp-sp
```

```
rtrv-lnp-sp:sp=abjj
```

```
rtrv-lnp-sp:num=10:sp=a123
```

Dependencies

The LNP feature must be turned on (see the **enable-ctrl-feat** command) before the **rtrv-lnp-sp** command can be entered.

The LNP database must be accessible.

The LNP SP table must be accessible.

The **force=yes** parameter must be specified when the value of the **num** parameter is greater than **50**.

Notes

If the **num** and **sp** parameters are specified with the **rtrv-lnp-sp** command, the number of service provider IDs specified by the **num** parameter is displayed, with the service provider ID specified by the **sp** parameter displayed first.

Output

In the following examples, the Service Provider ID table contains 11 entries.

rtrv-lnp-sp

```
rlghncxa03w 04-01-07 00:57:31 EST EAGLE 31.3.0
SP
a123
b123
c123
d123
e123
f123
g123
h123
i123
j123
tklc
SP TABLE IS (11 of 10000) 1% FULL
;
```

rtrv-lnp-sp:sp=abjj

```
rlghncxa03w 04-01-07 00:57:31 EST EAGLE 31.3.0
SP
abjj
SP TABLE IS (11 of 10000) 1% FULL
;
```

In the following example, the Service Provider ID table contains 1000 entries; 10 entries are displayed.

rtrv-lnp-sp:num=10:sp=a123

```
rlghncxa03w 04-01-07 00:57:31 EST EAGLE 31.3.0
SP
a123
b123
c123
d123
e123
f123
g123
h123
i123
j123
SP TABLE IS (1000 of 10000) 10% FULL
;
```

rtrv-lnp-sub

Retrieve LNP 10-digit Subscription

NOTE: This command is obsolete.

Use this command to retrieve all LNP 10-digit ported telephone numbers (TN), and their assigned services, from the database. Subscriptions cannot be retrieved across NPANXX boundaries.

NOTE: If the LNP ELAP Configuration feature is turned on, this command is no longer available. This function can be performed using the ELAP user interface.



CAUTION: Using the `rtrv-lnp-sub` command to generate this report could affect the rate at which the LNP data can be updated in the EAGLE by two telephone numbers per second. To avoid the delay, use the `rtrv-lnp-tnrpt` command instead.

NOTE: This command displays the `ptype` value. For range or `ptype`-specific retrievals, use the `rtrv-lnp-tnrpt` command.

Keyword: `rtrv-lnp-sub`

Related Commands: `chg-lnp-sub`, `dlt-lnp-sub`, `ent-lnp-sub`

Command Class: LNP Basic Administration

Parameters

:tn= (mandatory)

Telephone number.

Range: 10 digits—To specify a single TN subscription

7 digits with 3 asterisks (***) appended—To pool a block of 1000 TNs

etn= (optional)

The end range telephone number.

Range: 10 digits—To specify a single TN subscription

7 digits with 3 asterisks (***) appended—To pool a block of 1000 TNs

Default: Display same parameter value as the `tn` parameter.

:force= (optional)

This parameter is used to display more than 50 entries.

Range: `yes`, `no`

Default: `no`

:lrn= (optional)

Location routing number.

Range: 10 digits

Default: Display all

:num= (optional)

The number of entries to be shown. This parameter determines how many records you want to display (potentially within a given TN range). Use this parameter to prevent inadvertent displays of extremely large amounts of information.

Range 1-10000

1-50, if the `force=yes` parameter is not specified

1-10000, if the `force=yes` parameter is specified

Default: 1—if only the `tn` parameter is specified and the `etn` parameter is not specified

50—if no parameters are specified

:ptype= (optional)

Local number portability type.

Range: `none`, `pool`

`none`—Displays entries of all non-pooled subscriptions

`pool`—Pooled block number port

Default: `none`

:sp= (optional)
 The service provider.
Range: 4 alphanumeric characters.
Default: Display all

:tt= (optional)
 The translation type.
Range: 0-255
Default: Display all

Example

```
rtrv-lnp-sub:tn=9093351111
rtrv-lnp-sub:tn=9093350000:etn=910933659999:num=60:force=yes
rtrv-lnp-sub:tn=1234567890:etn=1234569999:tt=16
rtrv-lnp-sub:tn=1234567890:etn=1234569999:sp=1234:num=20
rtrv-lnp-sub:tn=1234567890:etn=1234569999:lrn=1234567891:num=100:force=yes:ptype=pool
```

Dependencies

The LNP feature must be turned on (see the **enable-ctrl-feat** command) before this command can be entered.

The **num** parameter defaults to **50** if not specified.

When the specified **num** parameter value is greater than **50**, the **force=yes** parameter must be specified.

Translation type values associated with AIN, IN, LNPQS, PCS, or WNP LNP queries are not allowed for retrievals.

The **etn** parameter value must be greater than the **tn** parameter value.

The **tn** parameter range must not cross NPANXX boundaries.

The translation type and service provider must be in the LNP database.

The translation type value must be a reserved service for LNP.

The LRN must exist in the database.

Notes

The **tt**, **sp**, and **lrn** parameters are provided to limit the displays to subscription records found matching their specified values. Combinations of these parameters are allowed.

Output

Retrieve a single TN:

```
rtrv-lnp-sub:tn=9093351111
rlghncxa03w 04-02-28 14:23:37 EST EAGLE 31.3.0
TN          SP      LRN          PTYPE
9093351111 a123  1234567890  none
          TT  XLAT  RI    PCA          SSN  NGT  RGTA
```

```

16 DPC GT 001-001-001 0 0 yes
18 DPCNGT GT 002-002-002 0 10 no
SERVICE PROVIDER TABLE IS 5% FULL
LRN TABLE IS 60% FULL
MESSAGE RELAY TABLE IS 75% FULL
NPANXX TABLE IS 80% FULL
PORTED TN TABLE IS 90% FULL
SCCP CARDS CONFIGURED TO SUPPORT A MAXIMUM OF 500000 PORTED TNS
;

```

Retrieve first 60 records in the given TN range:

rtrv-lnp-sub:tn=9093350000:etn=910933659999:num=60:force=yes

```

rlghncxa03w 04-02-28 14:23:37 EST EAGLE 31.3.0
TN SP LRN PTYPE
9093351111 a123 1234567890 none
9093351*** abcd 4567890123 pool
9093352456 1234 9876543211 none
9093352555 4321 9877733333 none
9093354*** abcd 4567890123 pool

TT XLAT RI PCA SSN NGT RGTA
16 DPC GT 001-001-001 0 0 yes
18 DPCNGT GT 002-002-002 0 10 no

9193361111 a123 1234567891 pool

TT XLAT RI PCA SSN NGT RGTA
17 DPCNGT GT 001-001-002 0 10 yes

```

```

SERVICE PROVIDER TABLE IS 5% FULL
LRN TABLE IS 60% FULL
MESSAGE RELAY TABLE IS 75% FULL
NPANXX TABLE IS 80% FULL
PORTED TN TABLE IS 90% FULL
SCCP CARDS CONFIGURED TO SUPPORT A MAXIMUM OF 500000 PORTED TNS
;

```

Retrieve the first 50 TNs in the range which are assigned the specified TT value:

rtrv-lnp-sub:tn=1234567890:etn=1234569*:tt=16**

```

rlghncxa03w 04-02-28 14:23:37 EST EAGLE 31.3.0
TN SP LRN PTYPE
1234567*** a123 1234567890 pool

TT XLAT RI PCA SSN NGT RGTA
16 DPC GT 001-001-001 0 0 yes
18 DPCNGT GT 002-002-002 0 10 no

```

```

SERVICE PROVIDER TABLE IS 5% FULL
LRN TABLE IS 60% FULL
MESSAGE RELAY TABLE IS 75% FULL
NPANXX TABLE IS 80% FULL
PORTED TN TABLE IS 90% FULL
SCCP CARDS CONFIGURED TO SUPPORT A MAXIMUM OF 500000 PORTED TNS
;

```

Retrieve the first 20 subscriptions in the range which are assigned the specified SP value:

rtrv-lnp-sub:tn=1234567890:etn=1234569999:sp=12345678:num=20

```
rlghncxa03w 04-02-28 14:23:37 EST EAGLE 31.3.0
TN          SP      LRN          PTYPE
1234567***  a123   1234567891  pool
```

```
TT  XLAT  RI  PCA          SSN  NGT  RGTA
17  DPCNGT  GT  001-001-002  0    10   yes
```

```
SERVICE PROVIDER TABLE IS 5% FULL
LRN TABLE IS 60% FULL
MESSAGE RELAY TABLE IS 75% FULL
NPANXX TABLE IS 80% FULL
PORTED TN TABLE IS 90% FULL
SCCP CARDS CONFIGURED TO SUPPORT A MAXIMUM OF 500000 PORTED TNS
;
```

Retrieve the first 100 subscriptions in the range which are assigned the specified LRN value:

rtrv-lnp-sub:tn=1234567890:etn=1234569999:lrn=1234567891:num=100:force=yes

```
rlghncxa03w 04-02-28 14:23:37 EST EAGLE 31.3.0
TN          SP      LRN          PTYPE
1234567***  a123   1234567891  pool
```

```
TT  XLAT  RI  PCA          SSN  NGT  RGTA
16  DPC   GT  001-001-001  0    0    yes
18  DPCNGT  GT  002-002-002  0    10   no
```

NOTE: The following message is appended to the report to convey that further subscriptions exist for other portable TNs that meet the specified criteria, but were not reported due to the limit set by the num parameter:

Further subscriptions exist that remain to be reported.

```
SERVICE PROVIDER TABLE IS 5% FULL
LRN TABLE IS 60% FULL
MESSAGE RELAY TABLE IS 75% FULL
NPANXX TABLE IS 80% FULL
PORTED TN TABLE IS 90% FULL
SCCP CARDS CONFIGURED TO SUPPORT A MAXIMUM OF 500000 PORTED TNS
;
```

Retrieve by ptype:

NOTE: It is recommended that range or ptype-specific retrievals use the rtrv-lnp-tnrpt command.

rtrv-lnp-sub:ptype=pool:tn=9093351111:etn=9093352222:num=10

```
rlghncxa03w 04-02-28 14:23:37 EST EAGLE 31.3.0
TN          SP      LRN          PTYPE
9093351***  a123   1234567890  pool
```

```
TT  XLAT  RI  PCA          SSN  NGT  RGTA
16  DPC   GT  001-001-001  0    0    yes
18  DPCNGT  GT  002-002-002  0    10   no
```

```
SERVICE PROVIDER TABLE IS 5% FULL
LRN TABLE IS 60% FULL
MESSAGE RELAY TABLE IS 75% FULL
NPANXX TABLE IS 80% FULL
PORTED TN TABLE IS 90% FULL
SCCP CARDS CONFIGURED TO SUPPORT A MAXIMUM OF 500000 PORTED TNS
;
```

Legend

TN—Telephone number

ETN—The end range telephone number

SP—The service provider

LRN—The location routing number

PTYPE—The local number portability type

TT—The translation type

XLAT—Translate

RI—The routing indicator

PCA—The ANSI point code

SSN—The subsystem number

NGT—The new global title translation type

RGTA—The replacement global title address (TN) with an LRN

rtrv-lnp-tnrpt**Retrieve LNP Subscription Version Data**

NOTE: This command is obsolete.

Use this command to retrieve and display LNP subscription data based on the LNP type.

NOTE: If the LNP ELAP Configuration feature is turned on, this command is no longer available. Subscription data can be retrieved by TN using the ELAP user interface. The output indicates the LNP type.



CAUTION: The rtrv-lnp-sub command can also be used to generate this report, but doing so could impact updating the LNP data in the EAGLE at a rate of two telephone numbers per second. Using the rtrv-lnp-tnrpt command eliminates the impact on updating the LNP data.

Keyword: rtrv-lnp-tnrpt

Related Commands: canc-lnp-tnrpt

Command Class: LNP Basic Administration

Parameters

etn= (optional)

The end range telephone number.

Range: 10 digits—To specify a single TN subscription
7 digits with 3 asterisks (***) appended—To pool a block of 1000 TNs

Default: Display same parameter value as the **tn** parameter.

:force= (optional)

This parameter is used to display more than 50 entries.

Range: **yes, no**

Default: **no**

:num= (optional)

The number of entries to be shown. This parameter determines how many records you want to display (potentially within a given TN range). Use this parameter to prevent inadvertent displays of extremely large amounts of information.

Range **1-12,000,000**

1-50— if the **force=yes** parameter is not specified

1-12,000,000—if the **force=yes** parameter is specified

Default: **1**—if only the **tn** parameter is specified and the **etn** parameter is not specified

50—all other cases

:ptype= (optional)

Specifies the local number portability type to display.

Range: **none, pool**

none—Displays entries of all non-pooled subscriptions

pool—Pooled block number port

Default: Both pooled and non-pooled TNs are retrieved

:tn= (optional)

Telephone number.

Range: 10 digits—To specify a single TN subscription

7 digits with 3 asterisks (***) appended—To pool a block of 1000 TNs

Example

```
rtrv-lnp-tnrpt:ptype=pool
```

```
rtrv-lnp-tnrpt:tn=9093350000:etn=9193369***:num=60:force=yes:ptype=pool
```

Dependencies

The LNP feature must be turned on (see the **enable-ctrl-feat** command) before this command can be entered.

Another **rtrv-lnp-tnrpt** command cannot be in progress when this command is entered.

The **num** parameter defaults to **50** if not specified.

When the specified **num** parameter value is greater than **50**, the **force=yes** parameter must be specified.

The **etn** parameter value must be greater than the **tn** parameter value.

If the **etn** parameter is specified, then the **tn** parameter must be specified.

The LNP database must be accessible.

Notes

If a range of telephone numbers is specified, it is possible for the NPANXX ranges to cross boundaries.

Output

Retrieve by **ptype**:

rtrv-lnp-tnrpt:ptype=pool

```
rlghncxa03w 04-02-28 14:23:37 EST EAGLE 31.3.0
TN          PTYPE
9093351***  pool
;
```

Retrieve the first 60 records in the given range with **ptype=pool**:

rtrv-lnp-tnrpt:tn=9093350000:etn=9193369999:num=60:force=yes:ptype=pool

```
rlghncxa03w 04-02-28 14:23:37 EST EAGLE 31.3.0
TN          PTYPE
9093351***  pool
9193361***  pool
;
```

Retrieve first 60 records in the given TN range:

rtrv-lnp-tnrpt:tn=9093350000:etn=9193369999:num=60:force=yes

```
rlghncxa03w 04-02-28 14:23:37 EST EAGLE 31.3.0
TN          PTYPE
9093351***  pool
9093358123  none
9193361432  none
9193361***  pool
;
```

rtrv-lnp-ttmap**Retrieve LNP Translation Type Mapping**

Use this command to retrieve all LNP MRGTs or all LNP MRGTs for a given TT, TT-PC-SSN, or TT-DPC combination.

NOTE: This command does not support 24-bit ITU national point codes.

Keyword: rtrv-lnp-ttmap

Related Commands: chg-lnp-ttmap, ent-lnp-sub

Command Class: LNP Basic Administration

Parameters

:force= (optional)

Forcible value.

Range: yes, no

Default: no

:num= (optional)

Number of entries to be displayed. This parameter specifies how many records you want to display (potentially within a given range). Use this parameter to prevent inadvertent displays of extremely large amounts of information.

Range 1–52,000

Default: 50

:pc= or :pca= (optional)

ANSI destination point code in the form of *network indicator-network cluster-network cluster member (ni-nc-ncm)*.

Range: 000-255

Specify a valid value for each subfield of the point code, and separate the subfields with a dash (-).

When **chg-sid:pctype=ansi** is specified, *ni* = 000 is not valid.

When **chg-sid:pctype=ansi** is specified, *nc* = 000 is not valid if *ni* = 001–005.

When **chg-sid:pctype=ansi** is specified, *nc* = 000 is valid if *ni* = 006–255.

The point code 000-000-000 is not a valid point code.

Default: Display all

:tt= (optional)

The translation type.

Range 0-255

Default: Display all

Example

```
rtrv-lnp-ttmap:tt=16:pc=100-100-100
```

```
rtrv-lnp-ttmap
```

```
rtrv-lnp-ttmap:tt=15:num=20
```

```
rtrv-lnp-ttmap:dpc=1-1-1:num=100:force=yes
```

Dependencies

The LNP feature must be turned on (see the **enable-ctrl-feat** command) before this command can be entered.

If the **pc/pca** parameter is specified, the **tt** parameter must be specified.

The translation type must be in the LNP database.

The LNP database must be accessible.

If the specified **num** parameter value is greater than 50, the **force=yes** parameter must be specified.

Translation type values associated with AIN or IN LNP queries are not allowed for retrievals.

Notes

Use the **tt** and **dpc** parameters to limit the displays to LNP MRGT records found matching their specified values. Combinations of these parameters are allowed.

Output

The following example shows how to retrieve an LNP GT:

rtrv-lnp-ttmap:tt=16:pc=100-100-100

```
rlghncxa03w 04-02-14:23:37 EST EAGLE 31.3.0
TT PCA          NGT  RGTA
16 100-100-100 28   YES
```

Message Relay Table is 1% full

;

The following example shows how to retrieve the first 50 LNP GTs assigned to the specified TT value:

rtrv-lnp-ttmap

```
rlghncxa03w 04-02-28 14:23:37 EST EAGLE 31.3.0
TT PCA          NGT  RGTA
16 001-001-001 0    YES
16 100-100-100 28   YES
```

.

.

```
18 002-002-002 10   NO
```

Message Relay Table is 1% full

;

The following example shows how to retrieve the first 20 LNP GTs assigned to the specified TT value:

rtrv-lnp-ttmap:tt=15:num=20

```
rlghncxa03w 04-02-28 14:23:37 EST EAGLE 31.3.0
TT PCA          NGT  RGTA
15 001-001-002 10   NO
```

.

.

```
15 001-001-005 10   YES
```

Message Relay Table is 1% full

;

The following example shows how to retrieve the first 100 LNP GTs assigned to the specified DPC value:

rtrv-lnp-ttmap:dpc=1-1-1:num=100:force=yes

```
rlghncxa03w 04-02-28 14:23:37 EST EAGLE 31.3.0
TT PCA          NGT  RGTA
16 001-001-001 0    NO
18 001-001-001 10   NO
```

.

.

.

Message Relay Table is 75% full

;

Legend

TT—The translation type.

PCA—The ANSI point code.

NGT—The new global title translation type.

RGTA—The replacement GTA treatment.

rtrv-lnpopts

Retrieve LNP System Options

Use this command to display all the LNP-specific system options from the database.

Keyword: rtrv-lnpopts

Related Commands: chg-lnpopts

Command Class: LNP Basic

Parameters

This command has no parameters.

Example

rtrv-lnpopts

Dependencies

The LNP feature must be turned on (see the **enable-ctrl-feat** command) before this command can be entered.

The LNP database must be accessible.

Notes

None

Output

The following example shows the JIPPROV and JIPDIGITS fields that appear when the Triggerless LNP feature is turned on.

The WSMSC10DIG field appears when the LNP SMS feature is turned on.

rtrv-lnpopts

```

AMASLPID      = 123456789
INCSLP        = yes
AMATYPE       = 003
AMAFEATID     = 010
CIC           = 1369
AUD           = on
SP            = a123
FRCSMPLEX     = no
ADMHIPRI      = yes
GTWYSTP       = yes
JIPPROV       = yes
JIPDIGITS     = 919460
CCP           = no
SERVPORT      = no
WQREDRCT      = off
WSMSC10DIG    = yes
;

```

Legend**AMASLPID**—AMA slip ID**INCSLP**—Whether the AMA slip ID included in the response**AMATYPE**—AMA call type**AMAFEATID**—AMA feature ID**CIC**—Carrier identification code**AUD**—Audit indicator**SP**—Service provider ID**FRCSMPLX**—Allow simplex database updates indicator**ADMHIPRI**—Indicator that LNP database administration has the highest priority of all administration**GTWYSTP**—Indicator that LNP system is also configured as a Gateway STP**JIPPROV**—Indicator of whether a Jurisdictional Information Parameter (JIP) value is to be added to the IAM**JIPDIGITS**—The Jurisdictional Information Parameter value**CCP**—Copy Charge Parameters**SERVPORT**—Service Portability**WQREDRCT**—Wireless queries directed to default GTT**WSMS10DIG**—SCCP GTA length indicator for 10 or 11 digits**rtrv-log****Display Records from the Log**

Use this command to retrieve records from the active or standby Alarm and UIM logs generated by the Maintenance system. This command selects these records based on a span of time or a specific log file index.

Keyword: rtrv-log**Related Commands:** None**Command Class:** System Maintenance**Parameters****:dir=** (optional)

Direction in which to obtain entries from within the log (forward or backward) for displaying. See the Dependencies and Notes sections for usage information.

Range: fwd, bkwd

fwd—Display entries from nearer the beginning of the log toward entries at the end of the log

bkwd—Display entries from nearer the end of the log toward entries at the beginning of the log

Default: fwd

:edate= (optional)

End date. Report only log entries that were created on or *before* the specified date (when **dir=fwd**), or only log entries that were created on or *after* the specified date (when **dir=bkwd**). See the Notes section for usage information.

Range: 000101-991231

(in the form *yymmdd*, where *yy* is year, *mm* is month, and *dd* is day)

Default: Report log entries regardless of their creation date

:enum= (optional)

Ending Message Reference Number (MRN) for which to display entries. The ending Alarm or UIM number if specifying a range.

Range: 1-1499

1-999—Alarms (UAMs)

1000-1499—UIMs

Default: If **enum** is not specified and:

If **snum** is specified, the default **enum** value is the same as the specified **snum** value.

If **snum** is not specified and **type** is **alarm** or not specified, **enum= 999**.

If **snum** is not specified and **type** is **all** or **uim**, **enum= 1499**.

:etime= (optional)

End time. Report only log entries that were created on or *before* the specified time (when **dir=fwd**), or only log entries that were created on or *after* the specified time (when **dir=bkwd**). See the Notes section for usage information.

Range: 000000-235959

(in the form *yymmdd*, where *yy* is year, *mm* is month, and *dd* is day)

Default: Report log entries regardless of their creation time

:mode= (optional)

Log display mode; display all information or just summary information from each log entry.

Range: brief, full

brief—Display only the first “Summary” line of the log entry

full—Display all information available in the log entry

Default: full

:next= (optional)

Number of additional records to display using the same direction (**dir**) and filtering criteria of **outgrp**, **type**, **slog**, and **mode** that were used for the previous successful **rtrv-log** command at the same terminal. This parameter cannot be specified with any other parameters in the command. See the Dependencies and Notes sections for usage information.

Range: 1-65500

:num= (optional)

Number of records that can be displayed before the report is stopped.

Range: 1-65500

Default: 15

:outgrp= (optional)

Output Group to sort or filter the Alarms (UAMs) and/or UIMs on. This parameter cannot be specified when the **snum** parameter is specified.

Range: **all, appserv, appss, card, clk, db, dbg, gtt, gws, link, lnpdb, lnpsub, meas, mon, mps, pu, sa, seas, slan, sys, traf**

all—Retrieve information for all Output Groups

appserv—Application Server

appss—Application Subsystem

card—Card

clk—Clock

db—Database

dbg—Debug

gtt—GTT Maintenance

gws—GWS Maintenance

link—Link Maintenance

lnpdb—LNP Database

lnpsub—LNP Subsystem

meas—Measurements Maintenance

mon—Monitoring (Sentinel) Maintenance

mps—MPS Maintenance

pu—Program Update

sa—System Administration

seas—SEAS (Sentinel)

slan—SLAN Maintenance

sys—System Maintenance

traf—Traffic

Default: If the **next** parameter is not specified, the default is **all**.

If the **next** parameter is specified, the output is the same as the immediately previous successful **rtrv-log** command that was entered at the same terminal (and no **rtrv-log** command was entered at another terminal).

:sdate= (optional)

Start date. Report only log entries that were created on or *after* the specified date (when **dir=fwd**), or only log entries that were created on or *before* the specified date (when **dir=bkwd**). See the Notes section for usage information.

Range: **000101–991231**

(in the form *yymmdd*, where *yy* is year, *mm* is month, and *dd* is day)

Default: Report log entries regardless of their creation date

:slog= (optional)

Source of log. Which OAM's Maintenance log to access: active or standby.

Range: **act, stb**

act—Active OAM

stb—Standby OAM

Default: **act**

:snum= (optional)

A single Alarm or UIM Message Reference Number (MRN), or the starting Alarm or UIM MRN if specifying a range. This parameter cannot be specified when the **outgrp** parameter is specified.

Range: 1-1499

1-999—Alarms (UAMs)

1000-1499—UIMs

Default: All entries for the specified **type** are displayed.

If **type** is **all**, **alarm**, or not specified, **snum=1**.

If **type** is **uim**, **snum=1000**.

:stime= (optional)

Start time. Report only log entries that were created on or *after* the specified time (when **dir=fwd**), or only log entries that were created on or *before* the specified time (when **dir=bkwd**). See the Notes section for usage information.

Range: 000000-235959

hhmmss—*hh*=hours (00-23), *mm*=minutes (00-59), *ss*=seconds (00-59)

Default: Report log entries regardless of their creation time

:type= (optional)

Type of Maintenance log to access for the report: alarms (UAMs), UIMs, or both logs (**all**).

Range: all, alarm, uim

Default: alarm

Example

```
rtrv-log:sdate=960715:stime=220000:num=50
```

```
rtrv-log:sdate=960715:stime=220000:num=50:snum=106
```

```
rtrv-log:sdate=960715:stime=220000:num=50:snum=106:enum=350
```

```
rtrv-log:sdate=960715:stime=220000:num=50:outgrp=slan:type=all
```

```
rtrv-log:next=100
```

Dependencies

No other **rtrv-log** command can already be in progress on the same OAM.

The initialization of the ELOG and UIM logs must be complete in the system before the **rtrv-log** command can be entered.

If both the **sdate** and **edate** parameters are specified,

- In the forward direction, the **sdate** value must be less than or equal to the **edate** value.
- In the backward direction, the **sdate** value must be greater than or equal to the **edate** value.

The month component of the **sdate** and **edate** parameters must be in the range 1-12.

The day component of the **sdate** and **edate** parameters must be in the range 1-31 and must accurately reflect the number of days in the month and year indicated (see Notes section).

The seconds component of the **stime** and **etime** parameters must be in the range **00–59**.

The minutes component of the **stime** and **etime** parameters must be in the range **00–59**.

If the **sdate** parameter value is equal to the **edate** parameter value,

- In the forward direction, the **stime** value must be less than or equal to the **etime** value.
- In the backward direction, the **stime** value must be greater than or equal to the **etime** value.

The **sdate** parameter value plus the **stime** parameter value must be less than the current time and date combination.

If **dir=bkwd** is specified with a date and time range, **sdate/stime** must be greater than **edate/etime**.

When the **enum** parameter is specified, the **snum** parameter must be specified with a value less than or equal to the specified **enum** value.

The specified **enum** parameter value and the specified **snum** value must be within the same range: **1-999** for Alarms (UAMs) and **1000-1499** for UIMs.

The **type** parameter and the **snum/enum** parameters cannot be specified together in the command.

The **rtrv-log:next=** command must be entered on the same terminal where the previous successful **rtrv-log** command was entered in the system. No other parameters can be entered with the **next** parameter in the command.

The **rtrv-log:next=** command cannot be entered following a **rtrv-log** command that contained the **type=all** parameter. A **rtrv-log** command without the **type=all** parameter must be entered before the **rtrv-log::next=** command can be entered.

Because entries can be overwritten between the entry of a **rtrv-log** command without the **next** parameter and the entry of a **rtrv-log:next=** command, the **rtrv-log:next:** command might not execute successfully. Another **rtrv-log** command without the **next** parameter must be entered before the **rtrv-log:next:** command can be entered again,

Notes

This command can be canceled using the **F9** function key or the **canc-cmd** command. See **canc-cmd** for more information.

To accommodate the year 2000 and beyond, the two-digit year portion of dates is interpreted to be in the indicated century as follows:

years 95–99 = 1995 through 1999

years 00–94 = 2000 through 2094

This means that date 000101 (Jan. 1, 2000) is greater than 991231 (Dec. 31, 1999).

The day portion of any **sdate/edate** value entered must be in agreement with the month and year. The system issues error message E2252 if the day is found to be not valid (for example, 960631 is not a valid date). The system software and date/time hardware properly handle leap years and leap centuries. The year 2000 is a leap year.

When no date or time parameters are specified, the log display depends on the specified or default values of two other parameters: **num** and **dir**. The **num** parameter determines the maximum number of entries to display, and the **dir** parameter determines whether entries are displayed from the oldest end (**dir=fwd** or not specified) or the newest end (**dir=bkwd**).

When **sdate** is specified and **edate** is not specified in the forward direction, **edate** is defaulted to be the end of the log.

When **edate** is specified and **sdate** is not specified in the forward direction, **sdate** is defaulted to be the beginning of the log.

When **sdate** is specified and **edate** is not specified in the backward direction, **edate** is defaulted to be the beginning of the log.

When **edate** is specified and **sdate** is not specified in the backward direction, **sdate** is defaulted to be the end of the log.

When **stime** is specified and **etime** is not specified in the forward direction, **etime** is defaulted to **235959**.

When **etime** is specified and **stime** is not specified in the forward direction, **stime** is defaulted to **000000**.

When **stime** is specified and **etime** is not specified in the backward direction, **etime** is defaulted to **000000**.

When **etime** is specified and **stime** is not specified in the backward direction, **stime** is defaulted to **235959**.

When **stime** or **etime** is specified but neither the **sdate** or **edate** parameters are specified, **sdate** and **edate** are each defaulted to the value **today**.

The **num** parameter is used to control the maximum number of entries to be displayed by one command.

The **dir** parameter is used to control whether preceding (older) or following (newer) records are displayed. In either output format, records are displayed in time order regardless of the retrieval control of the **dir** parameter.

Because logging does not stop while records are displaying, old records that were displayed can be overwritten before they are accessed again.

After the date or time is changed in the system, output records can show anomalies in the date-time stamp. An example of this occurs when the time is changed back—in this case records may show that an earlier time follows a later time in the log.

When no Output Group (**outgrp**) is specified, no sorting based on Output Groups and no additional Alarm/UIM breakdown into Output Group categories is done for the report. The log entries will be shown only in the forward or reverse chronological ordering of the logs.

When a unique Output Group (**outgrp**) is specified, the report is separated into Alarm and UIM categories, and the entries for the specified Output Group are shown in each category.

When **outgrp=all** is specified, the report is separated into Alarm and UIM categories, and the available entries in each category are listed by Output Group.

The **next** parameter is used to display a specified number of additional log records after the previous **rtrv-log** entry at the terminal. New records that are logged after the previous **rtrv-log** command was entered will not be displayed when the **rtrv-log:next=** command is entered. The **next** parameter is valid only under the following conditions:

- The **rtrv-log:next=** command is entered at the same terminal from which the previous **rtrv-log** command was entered. The previous **rtrv-log** command must not include the **type=all** parameter.
- No other terminal has issued a **rtrv-log** command after the **rtrv-log** command entered at the terminal from which the **rtrv-log:next=** command is entered.
- The **next** parameter is the only parameter specified in the **rtrv-log** command.
- There are still logs present that match the conditions (except **time/date/num**) specified in the previous **rtrv-log** command.

When either a single **snum** or range of **snum/enum** is specified, only those Alarms or UIMs within the specified range are displayed.

When **snum** is specified and **enum** is not specified, the **enum** value defaults to the specified **snum** value.

When **enum** is specified, an **snum** value must be specified that is less than or equal to the specified **enum** value.

If an **snum** is specified within the range **1-999**, its corresponding **enum** must be greater than or equal to the **snum** and also within the range of **1-999**.

If an **snum** is specified within the range **1000-1499**, its corresponding **enum** must be greater than or equal to the **snum** and also within the range of **1000-1499**.

When **enum** is not specified and the specified **snum** Alarm or UIM does not exist (is not currently used in the system), a scroll area message indicates that the **snum** value is out of range.

If **snum** and **enum** are specified and one or both specified Alarms and/or UIMs do not exist (are not currently used in the system), the report lists all existing Alarms and/or UIMs that exist within the specified range.

Output

In the following example, the sequence numbers that are replaced by the dashes (- - -) represent the UIMs that were discarded due to the UIM thresholding feature.

rtrv-log:type=uim:sdate=960715:stime=220000:num=50

```
rlghncxa03w 04-02-16 10:15:29 EST EAGLE 31.3.0
Card 1113; SYS REL= Rel 31.3.0; STP CLLI= ncralstp0001; Timezone= EST
```

```
**** Logged 99-07-16 01:03:09****
0001.1005    CARD 1105,B  INFO  GWS rcvd OPC that is not allowed
              SIO=01   OPC=001-001-001  DPC=002-002-002
              HOH1=000  AFTPC=003-003-003
              TEST MODE
              SR=scrib  LSN=A1234567
```

```
Report Date: 99-07-16 Time: 01:00:01
**** Logged 99-07-16 01:03:34****
----.1004 CARD 1205,B INFO MTP rcvd unknown DPC
      SIO=07 OPC=001-001-001 DPC=002-002-002
      LSN=A1234567
```

```
Report Date: 99-07-16 Time: 01:01:00
**** Logged 99-07-16 01:03:55****
0014.1019 CARD 1103 INFO SCCP rcvd invalid UDTS msg
      SIO=03 OPC=001-001-001 DPC=002-002-002
      CDPA: SSN=005 TT=250
      CGPA: SSN=000 TT=000
      RETURN CAUSE=001
      DATA=26 80 03 09 0e 06 09 00 fe 08 50 55
      43 00
      LSN=A1234567
Report Date: 99-07-16 Time: 01:00:05
```

;

The following example shows the records in the log created after 15 July 2003 at 10 PM up to a maximum of 50 records.

rtrv-log:sdate=030715:stime=220000:num=50

```
ncralstp00001 03-07-16 10:15:29 EST EAGLE 31.3.0
Card 1113; SYS REL= 31.3.0; STP CLLI= ncralstp00001; Timezone= EST
****03-07-15 22:03:09****
3159.0013 ** CARD 1207 CCS7ITU Card is isolated from the system
****03-07-15 22:03:11****
3160.0046 TERMINAL 10 Terminal enabled
****03-07-16 00:23:55****
3161.0200 SLK 1103,B RCVRY-LKF: link available
****03-07-16 01:42:18****
3162.0155 * DLK 2117,A STPLAN Connection unavailable
****03-07-16 01:43:51****
3163.0317 LSET A123456789 RCVRY-LKSTO: linkset allowed
****03-07-16 02:35:16****
3164.0082 * FUSE PANEL 11xx Alarm in fuse panel
****03-07-16 03:00:23****
3165.0108 ** IMT BUS A Major IMT fault detected
****03-07-16 03:37:59****
3166.0292 *C GLS SYSTEM GLS is not available
****03-07-16 07:22:06****
3167.0313 *C DPC 021-005-000 DPC is prohibited
****03-07-16 09:33:17****
3168.0348 * SEAS SYSTEM SEAS is at minimum service
****03-07-16 09:34:01****
3169.0112 * IMT SYSTEM Major Failures detected on both
****03-07-16 09:35:07****
3170.0160 * CLOCK SYSTEM 1116-S clock failed
****03-07-16 09:36:34****
3171.0160 * CARD 1116 OAM 1116-S clock failed
****03-07-16 09:37:23****
3172.0065 * CLOCK Minor holdover clock trouble detected
****03-07-16 09:38:12****
3173.0308 *C SYSTEM Node isolated due to SLK failure
```

```

****03-07-16 09:39:56****
3174.0331 *C SCCP SYSTEM          SCCP is not available
****03-07-16 09:40:15****
3175.0002 * GPL SYSTEM OAM       Card is not running approved GP
****03-07-16 09:41:34****
3176.0153 *C SLAN SYSTEM         STPLAN not available
****03-07-16 09:42:45****
3177.0060 * CDT 9                Minor customer trouble detected
****03-07-16 09:43:52****
3178.0344 * SEAS X25 LINK A1     SEAS PVC unavailable
****03-07-16 09:44:18****
3179.0344 * SEAS OAP A          SEAS UAL unavailable
****03-07-16 09:45:29****
3180.0321 * XLIST                X-LIST occupancy threshold Exceeded
****03-07-16 09:48:48****
3181.0175 * SECURITY 1114        LOGBUFROVL-SECULOG - upload required
****03-07-16 10:23:47****
0259.0084 ** DSM 1101,B          IP Connection Unavailable
Failed Channels:  Prov Dnld TCP UDP
****03-07-16 10:25:41****
0069.0084 ** STC 1105,B          IP Connection Unavailable
ERROR STATUS: DHCP Lease. Physical Link.

```

;

Report terminated - end of log reached.
 END OF LOG REPORT.

The following example shows the records in the log created after 15 July 2003 at 10 PM for Alarm (UAM) 160.

rtrv-log:sdate=030715:stime=220000:num=50:snum=160

```

ncralstp00001 03-07-16 10:15:29 EST EAGLE 31.3.0

Card 1113; SYS REL= 31.3.0; STP CLLI= ncralstp00001; Timezone= EST
****03-07-16 09:35:07****
3170.0160 * CLOCK SYSTEM          1116-S clock failed
****03-07-16 09:36:34****
3171.0160 * CARD 1116 OAM         1116-S clock failed

```

;

Report terminated - end of log reached.
 END OF LOG REPORT.

;

The following example shows the records in the log created after 15 July 2003 at 10 PM that include Alarms (UAMs) 106 through 350.

rtrv-log:sdate=030715:stime=220000:num=50:snum=106:enum=350

```

ncralstp00001 03-07-16 10:15:29 EST EAGLE 31.3.0

Card 1113; SYS REL= 31.3.0; STP CLLI= ncralstp00001; Timezone= EST
****03-07-16 00:23:55****
3161.0200 SLK 1103,B             RCVRY-LKF: link available
****03-07-16 01:42:18****
3162.0155 * DLK 2117,A           STPLAN Exceededn unavailable
****03-07-16 01:43:51****
3163.0317 LSET A123456789        RCVRY-LKSTO: linkset allowed
****03-07-16 03:00:23****
3165.0108 ** IMT BUS A           Major IMT fault detected
****03-07-16 03:37:59****
3166.0292 *C GLS SYSTEM          GLS is not available

```

```

****03-07-16 07:22:06****
3167.0313 *C DPC 021-005-000      DPC is prohibited
****03-07-16 09:33:17****
3168.0348 * SEAS SYSTEM          SEAS is at minimum service
****03-07-16 09:34:01****
3169.0112 * IMT SYSTEM           Major Failures detected on both
****03-07-16 09:35:07****
3170.0160 * CLOCK SYSTEM         1116-S clock failed
****03-07-16 09:36:34****
3171.0160 * CARD 1116 OAM        1116-S clock failed
****03-07-16 09:38:12****
3173.0308 *C SYSTEM             Node isolated due to SLK failure
****03-07-16 09:39:56****
3174.0331 *C SCCP SYSTEM         SCCP is not available
****03-07-16 09:41:34****
3176.0153 *C SLAN SYSTEM         STPLAN not available
****03-07-16 09:43:52****
3178.0344 * SEAS X25 LINK A1     SEAS PVC unavailable
****03-07-16 09:44:18****
3179.0344 * SEAS OAP A           SEAS UAL unavailable
****03-07-16 09:45:29****
3180.0321 * XLIST                X-LIST occupancy threshold Exceeded
****03-07-16 09:48:48****
3181.0175 * SECURITY 1114        LOGBUFROVL-SECULOG - upload required
;

Report terminated - end of log reached.
END OF LOG REPORT.
;

```

The following example shows the records in the log created after 15 July 2003 at 10 PM for Alarms (UAMs) and UIMs in the SLAN Output Group.

rtrv-log:sdate=030715:stime=220000:num=50:outgrp=slan:type=all

```
ncralstp00001 03-07-16 10:15:29 EST EAGLE 31.3.0
```

```
Card 1113; SYS REL= 31.3.0; STP CLLI= ncralstp00001; Timezone= EST
```

```
Alarm Output Group - SLAN
```

```
****03-07-16 09:41:34****
3176.0153 *C SLAN SYSTEM         STPLAN not available
```

```
UIM Output Group - SLAN
```

```
**** Logged 03-07-16 01:03:09****
0001.1005   CARD 1105,B   INFO  GWS rcvd OPC that is not allowed
           SIO=01   OPC=001-001-001  DPC=002-002-002
           HOH1=000  AFTPC=003-003-003
           TEST MODE
           SR=scrib  LSN=A1234567
           Report Date: 03-07-16  Time: 01:00:01
```

```

;
Report terminated - end of log reached.
END OF LOG REPORT.
;

```

The following example shows the records in the log in the backwards direction that were created between 12 June 2003 at 4:48:27 PM and 11 June 2003 at 10:00:45 PM for Alarms (UAMs).

rtrv-log:dir=bkwd:stime=044827:sdate=030612:etime=100045:edate=030611

```
tekelecstp 03-06-23 04:10:12 EST EAGLE 31.3.0
Card 1115; SYS REL= 31.3.0. STP CLLI= tekelecstp; Timezone= EST

Report Initiated - extended processing time required

****03-06-12 04:48:27****
5001.0009 CARD 1115 EOAM MASP became active
****03-06-11 13:38:55****
5003.0002 * GPL SYSTEM BPHMUX Card is not running approved GPL
****03-06-11 13:38:55****
5002.0002 * GPL SYSTEM BPCDM Card is not running approved GPL
****03-06-11 13:36:04****
5001.0009 CARD 1115 EOAM MASP became active
****03-06-11 12:15:29****
5001.0009 CARD 1115 EOAM MASP became active
****03-06-11 11:19:51****
5001.0009 CARD 1115 EOAM MASP became active
****03-06-11 10:00:46****
5019.0109 IMT SYSTEM All IMT System level alarms cleared
****03-06-11 10:00:45****
5018.0106 IMT BUS B IMT Bus alarm cleared
****03-06-11 10:00:45****
5017.0106 IMT BUS A IMT Bus alarm cleared
****03-06-11 10:00:45****
5016.0014 CARD 1107 SS7ANSI Card is present
ASSY SN: 10200301518
****03-06-11 10:00:45****
5015.0111 ** IMT SYSTEM Failure on both IMT A and IMT B
Report terminated - 11 records displayed
END OF LOG REPORT.
```

;

rtrv-ls

Retrieve Linkset

Use this command to show the linkset information.

Keyword: rtrv-ls

Related Commands: chg-ls, chg-slt, dlt-ls, rtrv-ls

Command Class: Database Administration

Parameters

:itutfr= (optional)

ITU TFR (Transfer Restricted) procedure indicator. Display only the linksets that have the specified value of the **itutfr** parameter. This parameter is valid for ITU national linksets only.

Range: on, off

Default: Display all link sets

:lsn= (optional)

Linkset name

Range: 1 alphabetic character followed by up to 9 alphanumeric characters

Default: Display all link sets

:mtrse= (optional)

ANSI or ITU MTP Restart equipped. This parameter indicates whether the node adjacent to the linkset is equipped with MTP Restart.

Range: **yes, no**

yes—equipped

no—not equipped

Default: Display all link sets

:slsobit= (optional)

Other CIC (Circuit Identification Code) Bit. Display all the linksets that have the **slsobit** parameter set to value from **5** to **16**.

Range: *

(for all values **5–16**)

Default: Display all link sets

:slsrsb= (optional)

Rotated SLS (Signaling Link Selection) Bit. Display only the linksets with the specified rotated bit.

Range: **1–4**

Default: Display all link sets

Example

Display the attributes of all link sets:

```
rtrv-ls
```

Retrieve link set **ls1**:

```
rtrv-ls:lsn=ls1
```

Retrieve all link sets with the **mtrse** parameter set to **yes**:

```
rtrv-ls:mtrse=yes
```

Retrieve all link sets that use the **slsobit** parameter with a value from **5** to **16**:

```
rtrv-ls:slsobit=*
```

Display a specified ITU linkset to view the settings for the **slsrsb** or **slsobit** parameters:

```
rtrv-ls:lsn=lsitu
```

Retrieve all ITU national linksets that have the **itutfr** parameter set to **on**:

```
rtrv-ls:itutfr=on
```

Retrieve the specified ITU national linkset and display its setting for the **itutfr** parameter:

```
rtrv-ls:lsn=lsitun
```

Dependencies

The first character in the linkset name must be a letter.

The specified linkset must be in the database.

The **mtpkse** parameter cannot be specified with the **slsocbit** or **slsrsb** parameter.

If the **lsn** parameter or the **itutfr** parameter is specified, the linkset name must be an ITU national linkset.

Notes

This command can be canceled using the **F9** function key or the **canc-cmd** command. See **canc-cmd** for more information.

The CLLI, TFATCABMLQ, MTPRSE, and ASL8 fields are displayed only when a specific linkset is specified. The SLSOCBIT and SLSRSB fields are displayed only when a specific linkset is specified, and the linkset must be an ITU linkset.

If the **tfatcabmlq** parameter database value is **0** for a linkset, the value displayed is one-half the number of links assigned to the given linkset (or **1** if there are 3 or fewer links in the linkset).

When the **tfatcabmlq** parameter database value is **0**, the TFA/TCA broadcast minimum link quantity is calculated by the EAGLE to be either a minimum of **1** for linksets containing 3 or fewer links, or half of the number of links configured in the linkset for linksets containing more than 3 links. The calculated value is displayed in the **rtrv-ls** command output.

When the **tfatcabmlq** parameter value is set to a specific value greater than **0**, the EAGLE does not calculate a TFA/TCA broadcast minimum link quantity. The provisioned value is displayed in the **rtrv-ls** command output.

The EAGLE **ent-ls** command allows 10-character linkset names, but entering a linkset name through SEAS is still restricted to 8 characters. In SEAS, a specific linkset with a name greater than 8 characters (entered using the EAGLE command) cannot be retrieved by name. If an asterisk is used for the linkset name in the SEAS **vfy-ls** command, all linksets will be shown; however, the linkset names that are more than 8 characters will have only the first 8 characters shown. Therefore it may appear that there are duplicate linkset names in SEAS **vfy-ls** output, but all linkset names are actually unique.

In this command, only ITU-international and ITU national point codes support the spare point code subtype prefix (**s-**) and the private and spare point code subtype prefix (**ps-**). All of the point code types support the private (internal) point code subtype prefix (**p-**).

Output

The following example displays the attributes of all linksets.

rtrv-ls

```
tekelecstp 04-09-05 01:33:29 EST EAGLE 31.9.0

LSN          APCA  (SS7)  SCRN  L3T SLT          GWS GWS GWS
ls11234567   001-001-002 gws1  1  1  no  A  1  off off off no  off
ls11345678   001-001-003 none  1  1  no  A  1  off off off no  off
ls11345679   001-001-004 none  1  1  no  A  1  off off off no  off
ls1134567    001-001-005 none  1  1  no  A  1  off off off no  off
ls113456     001-001-006 none  1  1  no  A  1  off off off no  off
ls11345      001-001-007 none  1  1  no  A  1  off off off no  off
ls113467     001-001-008 none  1  1  no  A  1  off off off no  off
ls1134       001-001-009 none  1  1  no  A  1  off off off no  off

LSN          APCA  (X25)  SCRN  L3T SLT          GWS GWS GWS
ls11234567   001-001-002 gws1  1  1  no  A  1  off off off no  off
ls11345678   001-001-003 none  1  1  no  A  1  off off off no  off
ls11345679   001-001-004 none  1  1  no  A  1  off off off no  off
ls1134567    001-001-005 none  1  1  no  A  1  off off off no  off
ls113456     001-001-006 none  1  1  no  A  1  off off off no  off
ls11345      001-001-007 none  1  1  no  A  1  off off off no  off
ls113467     001-001-008 none  1  1  no  A  1  off off off no  off
ls1134       001-001-009 none  1  1  no  A  1  off off off no  off

LSN          APCI  (SS7)  SCRN  L3T SLT          GWS GWS GWS
lsintl       1-056-3      none  1  2  no  A  0  off off off --- off

LSN          APCN  (SS7)  SCRN  L3T SLT          GWS GWS GWS
lsnational   15-15-15-3-aa none  1  2  no  A  0  off off off --- off

LSN          APCN24 (SS7)  SCRN  L3T SLT          GWS GWS GWS
ls11234567   001-001-002 gws1  1  1  no  A  1  off off off no  off
ls11345678   001-001-003 none  1  1  no  A  1  off off off no  off
ls11345679   001-001-004 none  1  1  no  A  1  off off off no  off
ls1134567    001-001-005 none  1  1  no  A  1  off off off no  off
ls113456     001-001-006 none  1  1  no  A  1  off off off no  off
ls11345      001-001-007 none  1  1  no  A  1  off off off no  off
ls113467     001-001-008 none  1  1  no  A  1  off off off no  off
ls1134       001-001-009 none  1  1  no  A  1  off off off no  off
```

Link set table is (10 of 1024) 1% full.

;

The following examples show output for a specified linkset.

rtrv-ls:lsn=ls1

- The TFATCABMLQ and MTPRSE fields are displayed only when a specific link set is specified.
- The SLSOCBIT and SLRSRB fields are not displayed for ANSI link sets.

```
tekelecstp 04-09-05 01:33:29 EST EAGLE 31.9.0

LSN          APCA  (SS7)  SCRN  L3T SLT          GWS GWS GWS
ls1          003-003-003 gws1  1  1  no  A  15 on on on yes off

CLLI          TFATCABMLQ MTPRSE ASL8 IPGWAPC
----- 7          --- no no

IPGWAPC MATELSN IPTPS  LSUSEALM  SLKUSEALM
no          ----- --- ---

LOC  PORT  SLC  TYPE          L2T          L1          PCR  PCR
SET  BPS  MODE TSET  ECM  N1  N2
1101 A    0  LIMDS0  1  56000  --- --- BASIC ---
1201 A    5  IPLIM
```

LOC	PORT	SLC	TYPE	LP SET	BPS	ATM TSEL	VCI	VPI	LL
1102	A	2	LIMATM	1	1544000	EXTERNAL	5	0	0

LOC	PORT	SLC	TYPE	LP SET	BPS	ATM TSEL	VCI	VPI	CRC4	SI	SN
1205	A	6	LIME1	1	56000	BASIC	---	-----	1205	1	1

LOC	PORT	SLC	TYPE	L2T SET	BPS	ECM	PCR N1	PCR N2	E1 LOC	E1 PORT	TS
1205	A	6	LIME1	1	56000	BASIC	---	-----	1205	1	1

LOC	PORT	SLC	TYPE	L2T SET	BPS	ECM	PCR N1	PCR N2	T1 LOC	T1 PORT	TS
1206	A	10	LIMT1	1	56000	BASIC	---	-----	1206	1	1

Link set table is (7 of 1024) 1% full.

;

rtrv-ls:lsn=xz172261

- The TFATCABMLQ and MTPRSE fields are displayed only when a specific link set is specified. In this example, link set **XZ172261**'s TFACABMLQ and MTPRSE attribute values are "---" because these attributes are not supported for link sets terminating in the X.25 domain. The FE-PC of this link set has no CLLI; therefore the CLLI is shown as "-----".
- The SLSOCBIT and SLRSRB fields are not displayed for ANSI link sets.

tekelecstp 04-09-05 01:33:29 EST EAGLE 31.9.0

LSN	APCA	(SS7)	SCRN	L3T SET	SLT SET	BEI	LST	LNKS	GWS ACT	GWS MES	GWS DIS	SLSCI	NIS
xz172261	240-021-000		scr1	1	1	yes	a	1	off	off	off	---	off

CLLI	TFATCABMLQ	MTPRSE	ASL8
-----	--	---	----

IPGWAPC	MATELSN	IPTPS	LSUSEALM	SLKUSEALM
no	-----	---	---	---

LOC	PORT	SLC	TYPE	L2T SET	BPS	L1 MODE	TSET	ECM	PCR N1	PCR N2
1205	a	0	LIMV35	1	56000	---	---	BASIC	---	-----

Link set table is (114 of 1024) 12% full

;

rtrv-ls:lsn=ipgw1

- The MATELSN field is shown when a specific IP Gateway linkset is specified (IPGWAPC=yes).
- IPTPS, LSUSEALM, and SLKUSEALM values are shown when a specific IP Gateway linkset is specified (IPGWAPC=yes). The values shown are either the default values or the provisioned values if the default was changed.

tekelecstp 04-09-05 01:33:29 EST EAGLE 31.9.0

```

LSN          APCI  (SS7)  SCRN  SET SET BEI LST LNKS ACT MES DIS SLSCI NIS
ipgw1       1-202-0      none  1  1  no  A  1  off off off ---  on

          L3T SLT          GWS GWS GWS
          CLLI          TFATCABMLQ MTPRSE ASL8 SLRSRB ITUTFR
          -----  1          no      ---  1      off

IPGWAPC MATELSN IPTPS  LSUSEALM  SLKUSEALM
yes      ipgw2    2000    100      80

          L2T          L1          PCR PCR
          SET BPS      MODE TSET  ECM  N1  N2
LOC  LINK SLC TYPE

          LP          ATM
          SET BPS      TSEL        VCI  VPI  LL
LOC  LINK SLC TYPE

          LP          ATM          E1ATM
          SET BPS      TSEL        VCI  VPI  CRC4 SI SN
LOC  LINK SLC TYPE

          IPLIML2
LOC  LINK SLC TYPE
1301  A    0  SS7IPGW

          L2T          PCR PCR  E1  E1
          SET BPS      ECM  N1  N2  LOC  PORT TS
LOC  LINK SLC TYPE

          L2T          PCR PCR  T1  T1
          SET BPS      ECM  N1  N2  LOC  PORT TS
LOC  LINK SLC TYPE

```

Link set table is (10 of 1024) 1% full.

rtrv-ls:lsn=ipgw3

- The MATELSN field is shown when a specific IP Gateway linkset is specified (IPGWAPC=yes).
- IPTPS, LSUSEALM, and SLKUSEALM values are shown when a specific IP Gateway linkset is specified (IPGWAPC=yes). The values shown are either the default values or the provisioned values if the default was changed.

tekelecstp 04-09-05 01:33:29 EST EAGLE 31.9.0

```

LSN          APCA  (SS7)  SCRN  SET SET BEI LST LNKS ACT MES DIS SLSCI NIS
ipgw3       1-115-0      none  1  1  no  A  8  off off off ---  on

          L3T SLT          GWS GWS GWS
          CLLI          TFATCABMLQ MTPRSE ASL8 SLRSRB ITUTFR
          -----  5          no      ---  1      off

IPGWAPC MATELSN IPTPS  LSUSEALM  SLKUSEALM
yes      ---      2000    100      80

          L2T          L1          PCR PCR
          SET BPS      MODE TSET  ECM  N1  N2
LOC  LINK SLC TYPE

          LP          ATM
          SET BPS      TSEL        VCI  VPI  LL
LOC  LINK SLC TYPE

```

				LP	ATM		E1ATM				
LOC	LINK	SLC	TYPE	SET	BPS	TSEL	VCI	VPI	CRC4	SI	SN
				IPLIML2							
LOC	LINK	SLC	TYPE								
1301	A	0	SS7IPGW								
1302	A	1	SS7IPGW								
1303	A	2	SS7IPGW								
1304	A	3	SS7IPGW								
1305	A	4	SS7IPGW								
1306	A	5	SS7IPGW								
1307	A	6	SS7IPGW								
1308	A	7	SS7IPGW								

				L2T			PCR	PCR	E1	E1	
LOC	LINK	SLC	TYPE	SET	BPS	ECM	N1	N2	LOC	PORT	TS
				L2T							
LOC	LINK	SLC	TYPE	SET	BPS	ECM	N1	N2	LOC	PORT	TS

Link set table is (10 of 1024) 1% full.

The following example displays all the linksets with the **mtprse** parameter set to **yes**. The output appears the same as the **rtrv-ls** output, but the command filters the output to display only the link sets that have the specified value of the **mtprse** parameter.

rtrv-ls:mtprse=yes

tekelecstp 04-09-05 01:33:29 EST EAGLE 31.9.0

				L3T	SLT	GWS GWS GWS							
LSN	APCA	(SS7)	SCRN	SET	SET	BEI	LST	LNKS	ACT	MES	DIS	SLSCI	NIS
wy644368	240-020-000		SEAS	1	1	yes	a	4	off	off	off	no	off
wy644389	240-030-000		scr1	1	2	no	c	3	on	on	on	yes	

				L3T	SLT	GWS GWS GWS							
LSN	APCA	(SS7)	SCRN	SET	SET	BEI	LST	LNKS	ACT	MES	DIS	SLSCI	NIS
xz172261	240-021-000		scr1	1	1	yes	a	1	off	off	off	---	off

				L3T	SLT	GWS GWS GWS							
LSN	APCA	(SS7)	SCRN	SET	SET	BEI	LST	LNKS	ACT	MES	DIS	SLSCI	NIS
ia125167	1-111-1		scr1	1	1	yes	a	1	off	off	off	---	off
ib237261	1-111-2		scr2	1	2	no	c	3	on	on	on	---	off
ic383726	1-111-3		scr3	1	3	yes	c	5	off	off	off	---	off

				L3T	SLT	GWS GWS GWS							
LSN	APCA	(SS7)	SCRN	SET	SET	BEI	LST	LNKS	ACT	MES	DIS	SLSCI	NIS
nd147271	11111		scr1	1	1	yes	a	1	off	off	off	---	off
ne238271	11112		scr2	1	2	no	c	3	on	on	on	---	on
nf373762	11113		scr3	1	3	yes	c	5	off	off	off	---	off

Link set table is (114 of 1024) 12% full

The following example displays all the linksets with the **slsocbit** parameter set to a value from **5** to **16**. The output appears the same as the **rtrv-ls** output, but the command filters the output to display only the link sets that have the specified value of the **slsocbit** parameter.

rtrv-ls:slsocbit=*

```
tekelecstp 04-09-05 01:33:29 EST EAGLE 31.9.0

                                L3T SLT                                GWS GWS GWS
LSN          APCI   (SS7)  SCRN  SET SET BEI LST LNKS ACT MES DIS SLSCI NIS
lsitu        1-067-0      none  1   2  no  C   1   off off off ---  ---

Link set table is (114 of 1024) 12% full
;
```

The following example displays the specified ITU linkset that has the **slsrsb** and **slsobit** parameters.

rtrv-ls:lsn=lsitu

```
tekelecstp 04-09-05 01:33:29 EST EAGLE 31.9.0

                                L3T SLT                                GWS GWS GWS
LSN          APCN   (SS7)  SCRN  SET SET BEI LST LNKS ACT MES DIS SLSCI NIS
lsitu        1-067-0      none  1   2  no  C   1   off off off ---  ---

CLLI          TFATCABMLQ  MTPRSE  ASL8  SLSOCBIT  SLRSRB  GSMSCRN
----- 1          ---      ---      7          2          on

                                L2T          L1          PCR PCR
LOC  PORT SLC TYPE      SET  BPS      MODE TSET  ECM  N1  N2
1211 A    0  LIMDS0    11  56000  ---  ---  BASIC ---  -----

                                LP          ATM
LOC  PORT SLC TYPE      SET  BPS      TSEL          VCI  VPI  LL

Link set table is (6 of 1024) 1% full.
;
```

The following example displays an ITU-I linkset with the **multgc** parameter set to a value of **yes**, and no **SAPC**:

rtrv-ls:lsn=lsitui

```
tekelecstp 04-09-05 01:33:29 EST EAGLE 31.9.0

                                L3T  SLT
LSN          APCI (SS7)  SCRN  SET  SET BEI LST LNKS GWSA GWSM GWSL SLSCI NIS
lsitui       1-115-0      none  1   1  no  B   4   off off off ---  ---

CLLI          TFATCABMLQ  MTPRSE  ASL8  SLRSRB  MULTGC ITUTFR
----- 2          no      ---  1          yes  no

IPGWAPC
yes

                                L2T          L1          PCR PCR
LOC  PORT SLC TYPE      SET  BPS      MODE TSET  ECM  N1  N2
1311 A    0  IPLIMI     11  56000  ---  ---  BASIC ---  -----
1313 A    1  IPLIMI     11  56000  ---  ---  BASIC ---  -----
1311 B    2  IPLIMI     11  56000  ---  ---  BASIC ---  -----
1313 B    3  IPLIMI     11  56000  ---  ---  BASIC ---  -----

                                LP          ATM
LOC  PORT SLC TYPE      SET  BPS      TSEL          VCI  VPI  LL

Link set table is (51 of 1024) 5% full.
;
```

The following example shows the output when the **chg-stpopts** command **npcfnti** parameter is set to **1-1-1-11**:

```
tekelecstp 04-09-05 01:33:29 EST EAGLE 31.9.0
                                L3T SLT                                GWS GWS GWS
LSN          APCN   (SS7)  SCRN  SET SET BEI LST LNKS ACT MES DIS SLSCI NIS
lsitun00    1-1-1-2046  scr3  1   3   yes c   5   off off off ---  off

Link set table is (1 of 1024) 1% full
;
```

The following examples show IPGWAPC information for a specific ANSI and ITU linkset.

rtrv-ls:lsn=ls1105

```
tekelecstp 04-09-05 01:33:29 EST EAGLE 31.9.0
                                L3T SLT                                GWS GWS GWS
LSN          APCA   (SS7)  SCRN  SET SET BEI LST LNKS ACT MES DIS SLSCI NIS
ls1105      241-031-001  none  1   1   no  a   1   off off off no   off

CLLI          TFATCABMLQ MTPRSE ASL8 IPGWAPC
----- 1          no      no   yes

                                L2T          L1          PCR PCR
LOC  PORT SLC TYPE          SET  BPS          MODE TSET  ECM  N1  N2
1105 A    0  SS7IPGW

                                LP          ATM
LOC  PORT SLC TYPE          SET  BPS          TSEL          VCI  VPI  LL

Link set table is (114 of 1024) 12% full.
;
```

rtrv-ls:lsn=ls1105

```
tekelecstp 04-09-05 01:33:29 EST EAGLE 31.9.0
                                L3T SLT                                GWS GWS GWS
LSN          APCI   (SS7)  SCRN  SET SET BEI LST LNKS ACT MES DIS SLSCI NIS
ls1105      0-000-1          none  1   1   no  A   1   off off off ---  ---

CLLI          TFATCABMLQ MTPRSE ASL8 SLRSRB IPGWAPC
----- 1          no      ---  1          yes

                                L2T          L1          PCR PCR
LOC  PORT SLC TYPE          SET  BPS          MODE TSET  ECM  N1  N2
1105 A    0  IPGWI

                                LP          ATM
LOC  PORT SLC TYPE          SET  BPS          TSEL          VCI  VPI  LL

Link set table is (5 of 255) 2% full.
;
```

The following example shows a specified ITU international linkset and its **itutfr** parameter setting:

rtrv-ls:lsn=lsitun

```
tekelecstp 04-09-05 01:33:29 EST EAGLE 31.9.0
```

```

                                L3T SLT                                GWS GWS GWS
LSN          APCI  (SS7)  SCRN  SET SET BEI LST LNKS ACT MES DIS SLSCI NIS
lsitun      2340          none  1  2  no  C   1   off off off ---  ---

                                L3T SLT                                GWS GWS GWS
CLLI          TFATCABMLQ MTPRSE ASL8 SLSOCBIT SLRSRB ITUTFR
----- 1          ---  --- 7          2          on

GSMSCRN
On

                                L2T          L1          PCR  PCR
LOC  PORT SLC TYPE          SET  BPS  MODE TSET  ECM  N1  N2
1211 A    0  LIMDS0  11  56000  ---  ---  BASIC ---  -----

                                LP          ATM
LOC  PORT SLC TYPE          SET  BPS  TSEL          VCI  VPI  LL

```

Link set table is (6 of 1024) 1% full.

;

The following example shows all the linksets that have the **itutfr** parameter set to **on**:

rtrv-ls:itutfr=on

tekelecstp 04-09-05 01:33:29 EST EAGLE 31.9.0

```

                                L3T SLT                                GWS GWS GWS
LSN          APCI  (SS7)  SCRN  SET SET BEI LST LNKS ACT MES DIS SLSCI NIS
lsitun      2340          none  1  2  no  C   1   off off off ---  ---

```

Link set table is (114 of 1024) 12% full

;

The following example shows output that includes a multi-port LIM:

rtrv-ls:lsn=ls1

tekelecstp 04-09-05 01:33:29 EST EAGLE 31.9.0

```

                                L3T SLT                                GWS GWS GWS
LSN          APCA  (SS7)  SCRN  SET SET BEI LST LNKS ACT MES DIS SLSCI NIS
LS1         240-020-000  none  1  2  no  C   8   off off off no  off

```

```

CLLI          TFATCABMLQ MTPRSE ASL8 IPGWAPC
----- 4          no  no  no

```

```

                                L2T          L1          PCR  PCR
LOC  PORT SLC TYPE          SET  BPS  MODE TSET  ECM  N1  N2
1201 A    0  LIMDS0  1  56000  ---  ---  BASIC ---  -----
1201 A3   1  LIMDS0  2  56000  ---  ---  BASIC ---  -----
1202 A1   2  LIMDS0  3  56000  ---  ---  BASIC ---  -----
1202 B    3  LIMDS0  4  56000  ---  ---  BASIC ---  -----
1202 B1   4  LIMDS0  5  56000  ---  ---  BASIC ---  -----
1202 A2   5  LIMDS0  6  56000  ---  ---  BASIC ---  -----
1202 B2   6  LIMDS0  7  56000  ---  ---  BASIC ---  -----
1202 B3   7  LIMDS0  8  56000  ---  ---  BASIC ---  -----

```

```

                                LP          ATM
LOC  PORT SLC TYPE          SET  BPS  TSEL          VCI  VPI  LL

```

Link set table is (51 of 1024) 5% full.

;

The following example shows output that includes an E1 card:

rtrv-ls:lsn=ls1

```
tekelecstp 04-09-05 01:33:29 EST EAGLE 31.9.0

LSN          APCA (SS7)   SCRN   L3T SLT          GWS GWS GWS
ls1          003-003-003  none  1  1  no  A  4  off off off no  off

CLLI          TFATCABMLQ MTPRSE ASL8 IPGWAPC
----- 2          ---  no  no

LOC  PORT  SLC  TYPE          L2T          L1          PCR  PCR
      SET  BPS  MODE TSET  ECM  N1  N2
1101 B3   1  LIMDS0  1  56000  ---  ---  BASIC ---  -----
1201 A    5  IPLIM

LOC  PORT  SLC  TYPE          LP          ATM
      SET  BPS  TSEL          VCI  VPI  LL
1103 A    3  LIMATM  1  1544000  EXTERNAL 5    0    0

LOC  PORT  SLC  TYPE          L2T          PCR  PCR  E1  E1
      SET  BPS  ECM  N1  N2  LOC  PORT TS
1205 A1   7  LIME1  1  56000  BASIC ---  ----- 1205 1  2
```

Link set table is (7 of 1024) 1% full.

;

The following example shows output that includes E1/T1 MIM cards used as T1 cards:

rtrv-ls:lsn=ls1

```
tekelecstp 04-09-05 01:33:29 EST EAGLE 31.9.0

LSN          APCI (SS7)   SCRN   L3T SLT          GWS GWS GWS
ls1          1-001-1      none  1  2  no  A  3  off off off ---  ---

CLLI          TFATCABMLQ MTPRSE ASL8 SLRSRB
----- 1          ---  ---  1

LOC  PORT  SLC  TYPE          L2T          L1          PCR  PCR
      SET  BPS  MODE TSET  ECM  N1  N2
1201 A3   0  LIMT1  11 56000  BASIC ---  ----- 1201 1  1
1202 B2   1  LIMT1  11 56000  BASIC ---  ----- 1202 2  1
1204 B    2  LIMCH  11 56000  BASIC ---  ----- 1203 1  1

LOC  PORT  SLC  TYPE          LP          ATM
      SET  BPS  TSEL          VCI  VPI  LL

LOC  PORT  SLC  TYPE          L2T          PCR  PCR  E1  E1
      SET  BPS  ECM  N1  N2  LOC  PORT TS
1201 A3   0  LIMT1  11 56000  BASIC ---  ----- 1201 1  1
1202 B2   1  LIMT1  11 56000  BASIC ---  ----- 1202 2  1
1204 B    2  LIMCH  11 56000  BASIC ---  ----- 1203 1  1
```

Link set table is (51 of 1024) 5% full.

;

The following example shows information for an E1 ATM card link.

rtrv-ls:lsn=e1atm1

```
tekelecstp 04-09-05 01:33:29 EST EAGLE 31.9.0
```

```

LSN          APCI  (SS7)  SCRN  L3T SLT          GWS GWS GWS
elatm1      5-005-5      none  1  2  no  A  1  off off off --- off

CLLI          TFATCABMLQ MTPRSE ASL8 IPGWAPC
----- 1          ---  no  no

LOC  PORT  SLC  TYPE          L2T          L1          PCR  PCR
SET  BPS  MODE TSET  ECM  N1  N2

LOC  PORT  SLC  TYPE          LP          ATM          VCI  VPI  LL
SET  BPS  TSEL

LOC  PORT  SLC  TYPE          LP          ATM          E1ATM
SET  BPS  TSEL  VCI  VPI  CRC4 SI SN
1317 A      12 LIME1ATM 21  2.048M LINE  5  0  ON  3  0

LOC  PORT  SLC  TYPE          L2T          PCR  PCR  E1  E1
SET  BPS  ECM  N1  N2  LOC  PORT TS

LOC  PORT  SLC  TYPE          L2T          PCR  PCR  T1  T1
SET  BPS  ECM  N1  N2  LOC  PORT TS

```

Link set table is (1 of 1024) 1% full.

;

The following examples show output when the IPLIMx to 8 Point feature is installed.

rtrv-ls:lsn=ls1

tekelecstp 04-09-05 01:33:29 EST EAGLE 31.9.0

```

LSN          APCA  (SS7)  SCRN  L3T SLT          GWS GWS GWS
ls1         003-003-003  gws1  1  1  no  A  5  on on on yes off

CLLI          TFATCABMLQ MTPRSE ASL8 IPGWAPC
----- 5          ---  no  no

LOC  PORT  SLC  TYPE          L2T          L1          PCR  PCR
SET  BPS  MODE TSET  ECM  N1  N2
1101 A      0 LIMDS0  1  56000 --- --- BASIC --- -----

LOC  PORT  SLC  TYPE          LP          ATM          VCI  VPI  LL
SET  BPS  TSEL
1102 A      2 LIMATM  1  1544000 LINE  5  0  0

LOC  PORT  SLC  TYPE          LP          ATM          E1ATM
SET  BPS  TSEL  VCI  VPI  CRC4 SI SN

LOC  PORT  SLC  TYPE          IPLIML2
1201 A      5 IPLIM  SAALTALI

LOC  PORT  SLC  TYPE

```



```

                L2T          PCR PCR E1 E1
LOC  PORT  SLC  TYPE      SET  BPS   ECM  N1  N2  LOC  PORT  TS
1205 A    6  LIME1      1   56000 BASIC ---  ----- 1205 1    1

                L2T          PCR PCR T1 T1
LOC  PORT  SLC  TYPE      SET  BPS   ECM  N1  N2  LOC  PORT  TS
1206 A   10  LIMT1      1   56000 BASIC ---  ----- 1206 1    1
    
```

Link set table is (7 of 1024) 1% full.

;

rtrv-ls:lsn=elsli

tekelecstp 04-09-05 01:33:29 EST EAGLE 31.9.0

```

                L3T SLT          GWS GWS GWS
LSN          APCI  (SS7)  SCRN  SET SET BEI LST LNKS ACT MES DIS SLSCI NIS
ele2i        1-202-0      none  1  1  no  B  10  off off off ---  on
    
```

```

CLLI          TFATCABMLQ MTPRSE ASL8 SLSRSB ITUTFR IPGWAPC
----- 5          no    ---  1    off    no
    
```

```

                L2T          L1          PCR PCR
LOC  PORT  SLC  TYPE      SET  BPS   MODE TSET  ECM  N1  N2
    
```

```

                LP          ATM          VCI  VPI  LL
LOC  PORT  SLC  TYPE      SET  BPS   TSEL          VCI  VPI  LL
    
```

```

                LP          ATM          E1ATM
LOC  PORT  SLC  TYPE      SET  BPS   TSEL  VCI  VPI  CRC4 SI SN
    
```

```

LOC  PORT  SLC  TYPE      IPLIML2
1311 A    0  IPLIMI      SAALTALI
1313 A    1  IPLIMI      SAALTALI
1311 B    2  IPLIMI      SAALTALI
1313 B    3  IPLIMI      SAALTALI
1313 A1   4  IPLIMI      SAALTALI
1313 B1   5  IPLIMI      SAALTALI
1313 A2   6  IPLIMI      SAALTALI
1313 B2   7  IPLIMI      SAALTALI
1313 A3   8  IPLIMI      SAALTALI
1313 B3   9  IPLIMI      SAALTALI
    
```

```

LOC  PORT  SLC  TYPE
    
```

```

                L2T          PCR PCR E1 E1
LOC  PORT  SLC  TYPE      SET  BPS   ECM  N1  N2  LOC  PORT  TS
    
```

```

                L2T          PCR PCR T1 T1
LOC  PORT  SLC  TYPE      SET  BPS   ECM  N1  N2  LOC  PORT  TS
    
```

SAPCN
03664

Link set table is (10 of 1024) 1% full.

;

The following examples show information for linksets with an ITU-N 24-bit Adjacent Point Code.

rtrv-ls

```
tekelecstp 04-09-05 01:33:29 EST EAGLE 31.9.0

LSN          APCA   (SS7)  SCRN   L3T SLT          GWS GWS GWS
            SET SET BEI LST LNKS ACT MES DIS SLSCI NIS

LSN          APCA   (X25)  SCRN   L3T SLT          GWS GWS GWS
            SET SET BEI LST LNKS ACT MES DIS SLSCI NIS

LSN          APCI   (SS7)  SCRN   L3T SLT          GWS GWS GWS
            SET SET BEI LST LNKS ACT MES DIS SLSCI NIS

LSN          APCN   (SS7)  SCRN   L3T SLT          GWS GWS GWS
            SET SET BEI LST LNKS ACT MES DIS SLSCI NIS

LSN          APCN24 (SS7)  SCRN   L3T SLT          GWS GWS GWS
            SET SET BEI LST LNKS ACT MES DIS SLSCI NIS

ls1011      010-100-010 none 1 1 no A 2 off off off --- off
ls1012      010-100-012 none 1 1 no A 0 off off off --- off
```

Link set table is (7 of 1024) 1% full.

;

rtrv-ls:lsn=ls1011

```
tekelecstp 04-09-05 01:33:29 EST EAGLE 31.9.0
L3T SLT          GWS GWS GWS
LSN          APCN24 (SS7)  SCRN   SET SET BEI LST LNKS ACT MES DIS SLSCI NIS
ls1011      010-100-010 none 1 1 no A 2 off off off --- off
```

```
CLLI          TFATCABMLQ MTPRSE ASL8 SLSRSB ITUTFR IPGWAPC
----- 1          --- --- 1 off no
```

```
LOC PORT SLC TYPE          L2T          L1          PCR PCR
SET BPS MODE TSET ECM N1 N2
1101 A 1 LIMDS0 11 56000 --- --- BASIC --- -----
1101 B 2 LIMDS0 11 56000 --- --- BASIC --- -----
```

```
LOC PORT SLC TYPE          LP          ATM          VCI VPI LL
SET BPS TSEL
```

```
LOC PORT SLC TYPE          LP          ATM          VCI VPI CRC4 SI SN
SET BPS TSEL
```

```
LOC PORT SLC TYPE          L2T          PCR PCR E1 E1
SET BPS ECM N1 N2 LOC PORT TS
```

```
LOC PORT SLC TYPE          L2T          PCR PCR T1 T1
SET BPS ECM N1 N2 LOC PORT TS
```

Link set table is (7 of 1024) 1% full.

;

rtrv-ls:lsn=ls1311

```
tekelecstp 04-09-05 01:33:29 EST EAGLE 31.9.0
```

```

LSN          APCI  (SS7)  SCRN  L3T SLT          GWS GWS GWS
LS1311      1-202-0      none  1  1  no  B   16  off off off  ---  on

CLLI          TFATCABMLQ MTPRSE ASL8  SLSRSB  ITUTFR  IPGWAPC
----- 5          no    ---  1    off    no

LOC  LINK  SLC  TYPE          L2T          L1          PCR  PCR
SET  BPS          MODE TSET  ECM    N1  N2

LOC  LINK  SLC  TYPE          LP          ATM
SET  BPS          TSEL          VCI    VPI  LL

LOC  LINK  SLC  TYPE          LP          ATM          E1ATM
SET  BPS          TSEL          VCI    VPI  CRC4 SI SN

LOC  LINK  SLC  TYPE          IPLIML2

1311 A      0  IPLIMI  M3UA
1311 B      1  IPLIMI  M3UA

LOC  LINK  SLC  TYPE          L2T          PCR  PCR  E1  E1
SET  BPS          ECM    N1  N2  LOC  PORT TS

LOC  LINK  SLC  TYPE          L2T          PCR  PCR  T1  T1
SET  BPS          ECM    N1  N2  LOC  PORT TS

SAPCN24
1-110-0
    
```

Link set table is (10 of 1024) 1% full.

;

The following examples show the GSMSCRN parameter value for an ANSI linkset and an ITU linkset.

rtrv-ls:lsn=lsa

tekelecstp 04-09-05 01:33:29 EST EAGLE 31.9.0

```

LSN          APCA  (SS7)  SCRN  L3T SLT          GWS GWS GWS
lsa         003-003-003  none  1  1  no  A   0  off off off  no  off

CLLI          TFATCABMLQ MTPRSE ASL8  GSMSCRN  IPGWAPC
----- 1          ---  no  off    no

LOC  PORT  SLC  TYPE          L2T          L1          PCR  PCR
SET  BPS          MODE TSET  ECM    N1  N2

LOC  PORT  SLC  TYPE          LP          ATM
SET  BPS          TSEL          VCI    VPI  LL

LOC  PORT  SLC  TYPE          LP          ATM          E1ATM
SET  BPS          TSEL          VCI    VPI  CRC4 SI SN
    
```

```

LOC  PORT  SLC  TYPE          IPLIML2

LOC  PORT  SLC  TYPE

LOC  PORT  SLC  TYPE          L2T          PCR  PCR  E1  E1
                               SET  BPS    ECM   N1  N2   LOC  PORT  TS

LOC  PORT  SLC  TYPE          L2T          PCR  PCR  T1  T1
                               SET  BPS    ECM   N1  N2   LOC  PORT  TS

```

Link set table is (3 of 1024) 1% full.

;

rtrv-ls:lsn=lsi

```

tekelecstp 04-09-05 01:33:29 EST EAGLE 31.9.0
L3T SLT          GWS GWS GWS
LSN             APCI  (SS7)  SCRN  SET SET BEI LST LNKS ACT MES DIS SLSCI NIS
lsi             4-004-4      none  1  2  no  A  0   off off off ---  off

```

```

CLLI             TFATCABMLQ MTPRSE ASL8 SLSOCBIT SLSRSB MULTGC
----- 1          ---  ---  none      1      no

```

```

ITUTFR GSMSCRN IPGWAPC
off    on      no

```

```

LOC  PORT  SLC  TYPE          L2T          L1          PCR  PCR
                               SET  BPS    MODE TSET  ECM   N1  N2

LOC  PORT  SLC  TYPE          LP            ATM
                               SET  BPS    TSEL          VCI   VPI   LL

LOC  PORT  SLC  TYPE          LP            ATM          E1ATM
                               SET  BPS    TSEL          VCI   VPI   CRC4 SI SN

LOC  PORT  SLC  TYPE          IPLIML2

LOC  PORT  SLC  TYPE

LOC  PORT  SLC  TYPE          L2T          PCR  PCR  E1  E1
                               SET  BPS    ECM   N1  N2   LOC  PORT  TS

LOC  PORT  SLC  TYPE          L2T          PCR  PCR  T1  T1
                               SET  BPS    ECM   N1  N2   LOC  PORT  TS

```

Link set table is (3 of 1024) 1% full.

;

The APCI/APCN/SAPCI/SAPCN point code values shown in the following examples include adjacent and secondary adjacent spare point codes (prefix s-).

The adjacent (APC/APCA/APCI/APCN/APCN24) and secondary adjacent (SAPC/SAPCA/SAPCI/SAPCN/SAPCN24) point code values shown in the following examples include adjacent and secondary adjacent private point codes (prefix p-) and private and spare point code values (prefix ps-).

rtrv-ls

tekelecstp 05-01-07 10:12:31 EST EAGLE 31.12.0

LSN	APCA	(SS7)	SCRN	L3T SLT		BEI	LST	LNKS	GWS GWS GWS			SLSCI	NIS
				SET	SET				ACT	MES	DIS		
lsa1	001-001-002		none	1	1	no	A	0	off	off	off	no	off
lsa2	p-001-002-004		none	1	1	no	A	0	off	off	off	no	off
lsa3	p-001-002-005		none	1	1	no	A	0	off	off	off	no	off

LSN	APCA	(X25)	SCRN	L3T SLT		BEI	LST	LNKS	GWS GWS GWS			SLSCI	NIS
				SET	SET				ACT	MES	DIS		

LSN	APCI	(SS7)	SCRN	L3T SLT		BEI	LST	LNKS	GWS GWS GWS			SLSCI	NIS
				SET	SET				ACT	MES	DIS		
lsn1	s-1-002-3		none	1	2	no	A	1	off	off	off	---	off
lsn2	s-2-002-2		none	1	2	no	A	1	off	off	off	---	off
lsn3	s-2-100-1		none	1	2	no	A	1	off	off	off	---	off
lsn4	s-2-012-1		none	1	2	no	A	1	off	off	off	---	off
lsn5	2-100-1		none	1	2	no	A	1	off	off	off	---	off
lsn6	s-3-134-1		none	1	2	no	A	1	off	off	off	---	off

LSN	APCN	(SS7)	SCRN	L3T SLT		BEI	LST	LNKS	GWS GWS GWS			SLSCI	NIS
				SET	SET				ACT	MES	DIS		
lsn410234	ps-1-1-1-2047-aa		none	1	2	no	B	0	off	off	off	---	off
lsn410235	p-1-1-1-0059-aa		none	1	2	no	B	0	off	off	off	---	off
lsn4102356	ps-1-1-1-0234-aa		none	1	2	no	B	0	off	off	off	---	off

LSN	APCN24	(SS7)	SCRN	L3T SLT		BEI	LST	LNKS	GWS GWS GWS			SLSCI	NIS
				SET	SET				ACT	MES	DIS		

Link set table is (12 of 1024) 1% full.

;

rtrv-ls:lsn=lsn4102356

```
tekelecstp 05-01-07 10:12:31 EST EAGLE 31.12.0
                                L3T SLT                                GWS GWS GWS
LSN          APCN   (SS7)  SCRN SET SET BEI LST LNKS ACT MES DIS SLSCI NIS
lsn4102356 ps-1-1-1-0234-aa none 1  2  no  B  0  off off off ---  off
```

```
CLLI          TFATCABMLQ MTPRSE ASL8 SLSRSB MULTGC ITUTFR
wearehereto  1          ---  ---  1      no      off
```

```
IPGWAPC
no
```

```

                                L2T          L1          PCR  PCR
LOC  LINK SLC TYPE          SET  BPS          MODE TSET  ECM  N1  N2

                                LP          ATM
LOC  LINK SLC TYPE          SET  BPS          TSEL          VCI  VPI  LL

                                LP          ATM          E1ATM
LOC  LINK SLC TYPE          SET  BPS          TSEL          VCI  VPI  CRC4 SI SN

LOC  PORT SLC TYPE          IPLIML2

LOC  PORT SLC TYPE

                                L2T          PCR  PCR  E1  E1
LOC  LINK SLC TYPE          SET  BPS          ECM  N1  N2  LOC  PORT TS

                                L2T          PCR  PCR  T1  T1
LOC  LINK SLC TYPE          SET  BPS          ECM  N1  N2  LOC  PORT TS
```

Link set table is (12 of 1024) 1% full.

;

The following examples show linksets with **apctype=ituchina** specified.

rtrv-ls

```
tekelecstp 05-06-03 16:22:25 EST EAGLE 34.0.0
      L3T SLT          GWS GWS GWS
LSN      APCA  (SS7)  SCRN  SET SET BEI LST LNKS ACT MES DIS SLSCI NIS
apexls   240-012-003  none  1  1  no  A  0  off off off no  off
wilsonls 240-012-004  none  2  1  no  A  0  off off off no  off
bensonls 240-012-005  none  3  1  no  A  0  off off off no  off
caryls   240-012-006  none  4  1  no  A  0  off off off no  off

      L3T SLT          GWS GWS GWS
LSN      APCA  (X25)  SCRN  SET SET BEI LST LNKS ACT MES DIS SLSCI NIS

      L3T SLT          GWS GWS GWS
LSN      APCI  (SS7)  SCRN  SET SET BEI LST LNKS ACT MES DIS SLSCI NIS
londonls 1-012-2      none  1  2  no  D  1  off off off --- off

      L3T SLT          GWS GWS GWS
LSN      APCN  (SS7)  SCRN  SET SET BEI LST LNKS ACT MES DIS SLSCI NIS
ls2      15-15-15-3-aa none  1  2  no  A  0  off off off --- off
ls4      15-15-14-1-aa none 11  2  no  B  0  off off off --- off

      L3T SLT          GWS GWS GWS
LSN      APCN24 (SS7) SCRN  SET SET BEI LST LNKS ACT MES DIS SLSCI NIS
e2ls     255-255-251  none  1  2  no  C  0  off off off --- off
e3ls     255-255-252  none  1  2  no  D  0  off off off --- off

      L3T SLT          GWS GWS GWS
LSN (CHINA) APCN  (SS7) SCRN  SET SET BEI LST LNKS ACT MES DIS SLSCI NIS
ls1      15-15-15-4-aa none  1  2  no  A  0  off off off --- off
ls3      15-15-14-5-aa none  1  2  no  B  0  off off off --- off

      L3T SLT          GWS GWS GWS
LSN (CHINA) APCN24 (SS7) SCRN  SET SET BEI LST LNKS ACT MES DIS SLSCI NIS
e4ls     255-255-253  none  1  2  no  B  C  off off off --- off
e5ls     255-255-254  none  1  2  no  B  D  off off off --- off
```

Link set table is (11 of 1024) 1% full.

;

rtrv-ls:lsn=e4ls

```
tekelecstp 05-06-03 16:22:25 EST EAGLE 34.0.0
      L3T SLT          GWS GWS GWS
LSN (CHINA) APCN24 (SS7) SCRN  SET SET BEI LST LNKS ACT MES DIS SLSCI NIS
e4ls      255-255-253  none  1  2  no  B  C  off off off --- off
```

;

Legend

LSN—The name of the linkset. When CHINA appears after the LSN heading, each linkset that is listed under the heading was defined with the **apctype=ituchina** parameter specified.

APC/APCI/APCN/APCN24—The adjacent DPC of the linkset.

SCRN—The screen set assigned to the linkset.

- L3TSET**—The level 3 timer set value assigned to the linkset.
- SLTSET**—The SLTM record associated with the linkset.
- BEI**—The broadcast exception indicator. This field indicates whether TFP (transfer prohibited) messages are allowed to be broadcast on the linkset.
- LST**—The type of links in the linkset (access links, bridge links, etc.).
- LNKS**—The number of links in the linkset.
- GWSA**—Shows whether gateway screening is used on the specified linkset.
- GWSM**—Shows whether the display of messages generated for each screened message is turned on or off.
- GWSD**—Shows whether the gateway screening message discard function is turned on or off.
- SLSCI**—Shows whether the 5-to-8-bit SLS conversion feature is to be used to select links for outgoing messages directed to the given linkset.
- NIS**—Shows whether the Network Indicator Spare option is on or off for the specified linkset.
- CLLI**—The far end Common Language Location Identifier (CLLI).
- TFATCABMLQ**—Displays the minimum number of links in the given linkset (or in the combined linkset in which it resides) that must be available to user-part messages traffic in order for the STP to consider the first-choice ordered routes using that linkset as allowed rather than restricted.
- MTPRSE**—Shows whether the adjacent node is equipped with MTP restart.
- ASL8**—Shows whether the adjacent node is sending MSUs with 8-bit SLSs.
- MULTGC**—Shows whether multiple group codes are allowed.
- IPGWAPC**—Shows whether the adjacent point code is an IP Gateway adjacent point code.
- MATELSN**—The name of the mate IP Gateway linkset.
- IPTPS**—Provisioned or default TPS for the specified IPGWx linkset. This value is a user-defined or default portion of the total enabled system IP Signaling TPS.
- LSUSEALM**—The percent of the linkset TPS (**iptps**) at which an alarm is generated to indicate that the actual linkset TPS is approaching the configured **iptps** value for the linkset.
- SLKUSEALM**—The percent of the link "fair share" TPS at which an alarm is generated to indicate that the actual link TPS is approaching the link's "fair share" of its linkset's configured TPS (**iptps**). The "fair share" of the linkset TPS for a link is the configured linkset TPS divided by the number of in-service links in the linkset.
- LOC**—The location of the card containing the signaling links that make up the linkset.
- PORT**—The port on the card containing the signaling link.
- SLSOCBIT**—The setting of the Other CIC (Circuit Identification Code) Bit.
- SLSRSB**—The setting of the Rotated SLS (Signaling Link Selection) Bit.

GSMSCRN—Shows whether the GSM MAP screening indicator is turned on or off.

ITUTFR—Shows whether the ITU TFR procedure indicator is turned on or off.

L2TSET—The level 2 timer set value associated with the signaling link.

SLC—The signaling link code of the signaling link.

TYPE—The type of card.

BPS—The transmission rate for the link in bits per second.

L1MODE—The mode of operation used to select the link clocking source at layer 1.

TSET—An indicator of whether the transmitter signal element timing is on or off.

E1PORT—The E1 port with the E1 interface that services the link.

E1LOC—The card location of the E1 card with the E1 interface that services the link.

T1PORT—The T1 port with the T1 interface that services the link.

T1LOC—The card location of the T1 card with the T1 interface that services the link.

TS—The timeslot assigned to the link that is serviced by the E1 or T1 interface.

E1ATMCRC4—The indicator of whether CRC4 multi-frame structure is enabled or disabled.

E1ATMSI—Value of two Spare International bits of NFAS data.

E1ATMSN—Value of five Spare National bits of NFAS data.

rtrv-m2pa-tset

Retrieve M2PA Timer Set

Use this command to retrieve either one or all M2PA timer sets

Keyword: rtrv-m2pa-tset

Related Commands: chg-m2pa-tset

Command Class: Database Administration

Parameters

:tset= (optional)

The name of the M2PA timer set to be retrieved.

Range: 1-20

:ver= (optional)

The ver parameter indicates which M2PA timer set to retrieve.

Range: d6, rfc

Example

```
rtrv-m2pa-tset
```

```
rtrv-m2pa-tset:tset=1
```

```
rtrv-m2pa-tset:tset=1:ver=d6
```

```
rtrv-m2pa-tset:tset=1:ver=rfc
```

Dependencies

None

Notes

If a timer set is not specified in the command, all timer sets are retrieved.

Output

The following example retrieves M2PA Draft 6 Timer set 1.

rtrv-m2pa-tset:tset=1:ver=d6

Command Accepted - Processing

```
rlghncxa03w 06-02-18 08:16:14 EST EAGLE 34.3.0
rtrv-m2pa-tset:tset=1:ver=d6
Command entered at terminal #5.
M2PA Draft 6 Timers (in msec, T16 in microsec)
```

TSET	T1	T2	T3	T4N	T4E	T5	T6	T7	T16	T17	T18
1	10000	-----	10000	10000	500	1000	3000	1200	200000	250	1000

;

The following example retrieves M2PA RFC Timer set 1

rtrv-m2pa-tset:tset=1:ver=rfc

Command Accepted - Processing

```
rlghncxa03w 06-02-18 08:16:14 EST EAGLE 34.3.0
rtrv-m2pa-tset:tset=1:ver=rfc
Command entered at terminal #5.
M2PA RFC Timers (in msec, T16 in microsec)
```

TSET	T1	T2	T3	T4N	T4E	T5	T6	T7	T16	T17	T18
1	300000	20000	2000	15000	500	100	3000	1200	200000	250	1000

;

The following example retrieves M2PA Draft 6 and RFC Timer set 1.

rtrv-m2pa-tset:tset=1

Command Accepted - Processing

```
rlghncxa03w 06-02-18 08:16:14 EST EAGLE 34.3.0
rtrv-m2pa-tset:tset=1
Command entered at terminal #5.
M2PA Draft 6 Timers (in msec, T16 in microsec)
```

TSET	T1	T2	T3	T4N	T4E	T5	T6	T7	T16	T17	T18
1	10000	-----	10000	10000	500	1000	3000	1200	200000	250	1000

M2PA RFC Timers (in msec, T16 in microsec)

TSET	T1	T2	T3	T4N	T4E	T5	T6	T7	T16	T17	T18
1	300000	20000	2000	15000	500	100	3000	1200	200000	250	1000

;

The following example retrieves all M2PA Draft 6 Timer sets.

rtrv-m2pa-tset:ver=d6

Command Accepted - Processing

```
rlghncxa03w 06-02-18 08:16:14 EST EAGLE 34.3.0
rtrv-m2pa-tset:ver=d6
Command entered at terminal #5.
M2PA Draft 6 Timers (in msec, T16 in microsec)
```

TSET	T1	T2	T3	T4N	T4E	T5	T6	T7	T16	T17	T18
1	10000	-----	10000	10000	500	1000	3000	1200	200000	250	1000
2	10000	-----	10000	10000	500	1000	3000	1200	200000	250	1000
3	10000	-----	10000	10000	500	1000	3000	1200	200000	250	1000
4	10000	-----	10000	10000	500	1000	3000	1200	200000	250	1000
5	10000	-----	10000	10000	500	1000	3000	1200	200000	250	1000
6	10000	-----	10000	10000	500	1000	3000	1200	200000	250	1000
7	10000	-----	10000	10000	500	1000	3000	1200	200000	250	1000
8	10000	-----	10000	10000	500	1000	3000	1200	200000	250	1000
9	10000	-----	10000	10000	500	1000	3000	1200	200000	250	1000
10	10000	-----	10000	10000	500	1000	3000	1200	200000	250	1000
11	10000	-----	10000	10000	500	1000	3000	1200	200000	250	1000
12	10000	-----	10000	10000	500	1000	3000	1200	200000	250	1000
13	10000	-----	10000	10000	500	1000	3000	1200	200000	250	1000
14	10000	-----	10000	10000	500	1000	3000	1200	200000	250	1000
15	10000	-----	10000	10000	500	1000	3000	1200	200000	250	1000
16	10000	-----	10000	10000	500	1000	3000	1200	200000	250	1000
17	10000	-----	10000	10000	500	1000	3000	1200	200000	250	1000
18	10000	-----	10000	10000	500	1000	3000	1200	200000	250	1000
19	10000	-----	10000	10000	500	1000	3000	1200	200000	250	1000
20	10000	-----	10000	10000	500	1000	3000	1200	200000	250	1000

;

The following example retrieves all M2PA RFC Timer sets.

rtrv-m2pa-tset:ver=rfc

Command Accepted - Processing

```
rlghncxa03w 06-02-18 08:16:14 EST EAGLE 34.3.0
rtrv-m2pa-tset:ver=rfc
Command entered at terminal #5.
M2PA RFC Timers (in msec, T16 in microsec)
```

TSET	T1	T2	T3	T4N	T4E	T5	T6	T7	T16	T17	T18
1	300000	20000	2000	15000	500	100	3000	1200	200000	250	1000
2	300000	20000	2000	15000	500	100	3000	1200	200000	250	1000
3	300000	20000	2000	15000	500	100	3000	1200	200000	250	1000
4	300000	20000	2000	15000	500	100	3000	1200	200000	250	1000
5	300000	20000	2000	15000	500	100	3000	1200	200000	250	1000
6	300000	20000	2000	15000	500	100	3000	1200	200000	250	1000
7	300000	20000	2000	15000	500	100	3000	1200	200000	250	1000
8	300000	20000	2000	15000	500	100	3000	1200	200000	250	1000
9	300000	20000	2000	15000	500	100	3000	1200	200000	250	1000
10	300000	20000	2000	15000	500	100	3000	1200	200000	250	1000
11	300000	20000	2000	15000	500	100	3000	1200	200000	250	1000
12	300000	20000	2000	15000	500	100	3000	1200	200000	250	1000
13	300000	20000	2000	15000	500	100	3000	1200	200000	250	1000
14	300000	20000	2000	15000	500	100	3000	1200	200000	250	1000

```

15 300000 20000 2000 15000 500 100 3000 1200 200000 250 1000
16 300000 20000 2000 15000 500 100 3000 1200 200000 250 1000
17 300000 20000 2000 15000 500 100 3000 1200 200000 250 1000
18 300000 20000 2000 15000 500 100 3000 1200 200000 250 1000
19 300000 20000 2000 15000 500 100 3000 1200 200000 250 1000
20 300000 20000 2000 15000 500 100 3000 1200 200000 250 1000

```

;

The following example retrieves all M2PA Draft6 and RFC Timer sets.

rtrv-m2pa-tset

```

rlghncxa03w 06-02-18 08:16:14 EST EAGLE 34.3.0
Command entered at terminal #5.
M2PA Draft 6 Timers (in msec, T16 in microsec)

```

TSET	T1	T2	T3	T4N	T4E	T5	T6	T7	T16	T17	T18
1	10000	-----	10000	10000	500	1000	3000	1200	200000	250	1000
2	10000	-----	10000	10000	500	1000	3000	1200	200000	250	1000
3	10000	-----	10000	10000	500	1000	3000	1200	200000	250	1000
4	10000	-----	10000	10000	500	1000	3000	1200	200000	250	1000
5	10000	-----	10000	10000	500	1000	3000	1200	200000	250	1000
6	10000	-----	10000	10000	500	1000	3000	1200	200000	250	1000
7	10000	-----	10000	10000	500	1000	3000	1200	200000	250	1000
8	10000	-----	10000	10000	500	1000	3000	1200	200000	250	1000
9	10000	-----	10000	10000	500	1000	3000	1200	200000	250	1000
10	10000	-----	10000	10000	500	1000	3000	1200	200000	250	1000
11	10000	-----	10000	10000	500	1000	3000	1200	200000	250	1000
12	10000	-----	10000	10000	500	1000	3000	1200	200000	250	1000
13	10000	-----	10000	10000	500	1000	3000	1200	200000	250	1000
14	10000	-----	10000	10000	500	1000	3000	1200	200000	250	1000
15	10000	-----	10000	10000	500	1000	3000	1200	200000	250	1000
16	10000	-----	10000	10000	500	1000	3000	1200	200000	250	1000
17	10000	-----	10000	10000	500	1000	3000	1200	200000	250	1000
18	10000	-----	10000	10000	500	1000	3000	1200	200000	250	1000
19	10000	-----	10000	10000	500	1000	3000	1200	200000	250	1000
20	10000	-----	10000	10000	500	1000	3000	1200	200000	250	1000

M2PA RFC Timers (in msec, T16 in microsec)

TSET	T1	T2	T3	T4N	T4E	T5	T6	T7	T16	T17	T18
1	300000	20000	2000	30000	500	100	3000	1200	200000	250	1000
2	300000	20000	2000	30000	500	100	3000	1200	200000	250	1000
3	300000	20000	2000	30000	500	100	3000	1200	200000	250	1000
4	300000	20000	2000	30000	500	100	3000	1200	200000	250	1000
5	300000	20000	2000	30000	500	100	3000	1200	200000	250	1000
6	300000	20000	2000	30000	500	100	3000	1200	200000	250	1000
7	300000	20000	2000	30000	500	100	3000	1200	200000	250	1000
8	300000	20000	2000	30000	500	100	3000	1200	200000	250	1000
9	300000	20000	2000	30000	500	100	3000	1200	200000	250	1000
10	300000	20000	2000	30000	500	100	3000	1200	200000	250	1000
11	300000	20000	2000	30000	500	100	3000	1200	200000	250	1000
12	300000	20000	2000	30000	500	100	3000	1200	200000	250	1000
13	300000	20000	2000	30000	500	100	3000	1200	200000	250	1000
14	300000	20000	2000	30000	500	100	3000	1200	200000	250	1000
15	300000	20000	2000	30000	500	100	3000	1200	200000	250	1000
16	300000	20000	2000	30000	500	100	3000	1200	200000	250	1000
17	300000	20000	2000	30000	500	100	3000	1200	200000	250	1000
18	300000	20000	2000	30000	500	100	3000	1200	200000	250	1000
19	300000	20000	2000	30000	500	100	3000	1200	200000	250	1000
20	300000	20000	2000	30000	500	100	3000	1200	200000	250	1000

;

rtrv-map

Retrieve Mate Applications

Use this command to show the mated application relationship information maintained by the system. This information is used to support the routing of SCCP management SSP/SSA messages.

Keyword: rtrv-map

Related Commands: chg-map, dlt-map, ent-map

Command Class: Database Administration

Parameters

NOTE: See “Point Code Formats and Conversion” in Appendix A for a detailed description of point code formats, rules for specification, and examples.

:pc/pca/pci/pcn/pcn24= (optional)

Point code.

:pc= or :pca= (optional)

ANSI point code in the form of *network indicator-network cluster-network cluster member (ni-nc-ncm)*.

Range: 000-255

Specify a valid value for each subfield of the point code, and separate the subfields with a dash (-).

When **chg-sid:pctype=ansi** is specified, *ni* = 000 is not valid.

When **chg-sid:pctype=ansi** is specified, *nc* = 000 is not valid if *ni* = 001-005.

When **chg-sid:pctype=ansi** is specified, **nc = 000** is valid if **ni = 006-255**.
The point code **000-000-000** is not a valid point code.

:pci= (optional)

ITU international point code in the form of *zone-area-id*.

Range: **s-**, **0-255**

Specify a valid value for each subfield of the point code, and separate the subfields with a dash (-).

prefix—**s-**

zone—**0-7**

area—**000-255**

id—**0-7**

The point code **0-000-0** is not a valid point code.

:pcn= (optional)

ITU national point code in the format of a 5-digit number (*nnnnn*); or 2, 3, or 4 numbers (members) separated by dashes (*m1-m2-m3-m4*) as defined by the **chg-stpopts:npcfmti** flexible point code option. A group code must be specified when the ITUDUPPC feature is turned on (*nnnnn-gc*, *m1-m2-m3-m4-gc*). The *prefix* subfield indicates a spare point code (*prefix-nnnnn*, *prefix-nnnnn-gc*, *prefix-m1-m2-m3-m4*, *prefix-m1-m2-m3-m4-gc*).

Range: **s-**, **0-16383**, **aa-zz**

Specify a valid value for each subfield of the point code, and separate the subfields with a dash (-).

prefix—**s-**

nnnnn—**0-16383**

gc—**aa-zz**

m1-m2-m3-m4—**0-14** for each member; values must sum to 14

:pcn24= (optional)

24-bit ITU national point code in the form of *main signaling area-sub signaling area-signaling point*.

Range: **000-255**

Specify a valid value for each subfield of the point code, and separate the subfields with a dash (-).

msa—**000-255**

ssa—**000-255**

sp—**000-255**

:ssn= (optional)

Subsystem number

Range: **2-255**

Default: All subsystem numbers and their mates are shown for the given point code.

Example

rtrv-map:pc=10-10-10:ssn=10

rtrv-map:pcn=12345:ssn=5

rtrv-map:pc=10-10-10:ssn=10

rtrv-map:pcn=12345:ssn=5

rtrv-map:pcn24=12-12-12

Dependencies

The **pc/pca/pci/pcn/pcn24** parameter value must already exist in the Mate Application entity set. All subsystem numbers for the specified point code, and mate, are displayed.

The remote point code must be specified as a full point code.

Asterisk entries are not allowed.

If no parameters are entered, all defined remote point codes, up to 1024, are shown.

All subsystem numbers for the specified point code, and their mates, are shown.

If a subsystem number is specified, the point code/subsystem number pair must be in the Mate Applications (MAP) table. The point code/subsystem number entry and its mate are shown.

The destination point code of the primary subsystem must be a full point code.

If the subsystem number (**ssn**) is specified, the remote point code must be specified.

Notes

This command can be canceled using the **F9** function key or the **canc-cmd** command. See the **canc-cmd** command for more information.

In this command, only ITU-international and ITU national point codes support the spare point code subtype prefix (**s**).

Output

rtrv-map

```
rlghncxa03w 04-01-07 11:43:04 EST EAGLE 31.3.0
MAP TABLE IS 1 % FULL (1 of 3000)
```

PCA	SSN	RC	MPCA	MSSN	MATERC	SRM	MRC	GRP	NAME
001-001-001	5	10							

For the PCN, the **chg-stpopts** command **npcfnti** parameter is set to a one-part format.

rtrv-map

```
rlghncxa03w 04-01-07 11:43:04 EST EAGLE 31.3.0
MAP TABLE IS 1 % FULL (1 of 3000)
```

PCN	SSN	RC	MPCN	MSSN	MATERC	SRM	MRC	GRP	NAME
12345	5	10	12347	5	20				

In the following example, the ITU national duplicate point code and flexible ITU national point code features are enabled.

rtrv-map

```
rlghncxa03w 04-01-07 11:43:04 EST EAGLE 31.3.0
MAP TABLE IS 1 % FULL (2 of 3000)

PCI          SSN  RC  MPCI          MSSN  MATERC  SRM  MRC  GRP NAME
128-10-6-1-ab 5    0
128-10-6-1-ab 5    20 121-11-3-2-bb 250    99    ---  ---  xyz
                121-11-3-2-bb 50    99    ---  ---  abcdefgh
;
```

In the following example, the Subsystem Status Option (**sso**) is set to **on**, and the XMAP feature is enabled for a maximum of 3000 MAP table entries.

rtrv-map

```
rlghncxa03w 04-01-07 11:43:04 EST EAGLE 31.3.0
MAP TABLE IS 1 % FULL (1 of 3000)

PCA          SSN  RC  MPCA          SSN  MATERC  MULT  SRM  MRC  GRP NAME  SSO
002-002-002 10  10
                002-002-003 20    10  SHR  YES  YES  -----  ON
;
```

rtrv-map:pcn24=12-12-12

```
tekelecstp 03-03-11 11:11:34 EST EAGLE 31.0.0
MAP TABLE IS 1 % FULL (2 of 1024)

PCN24        SSN  RC  MULT  MPCN24          MSSN  MATERC  MULT  SRM  MRC  GRP NAME  SSO
012-012-012 10    5  DOM
                023-023-023 10    10  DOM  NO   NO  -----  OFF
;
```

The following example includes spare point codes:

rtrv-map

```

tekelecstp 05-01-11 11:11:34 EST EAGLE 31.12.0
MAP TABLE IS 1 % FULL (9 of 1024)

      PCA          SSN RC MULT |-----MATE-----| SRM MRC GRP NAME SSO
                                PCA          SSN RC MULT
001-102-001  110  5 SHR                YES YES ----- OFF
                                002-001-000  110  5 SHR YES YES ----- OFF
                                003-001-000  110  5 SHR YES YES ----- OFF
002-001-000   10 20 SOL                --- --- ----- OFF
003-101-001   10 30 DOM                YES YES abcdefgh OFF
                                003-001-000   10 40 DOM YES YES abcdefgh OFF
007-101-001  254 10 SOL                --- --- ----- OFF
007-101-001  255 10 COM                YES YES ----- OFF
                                007-001-000  251 10 COM YES YES ----- OFF
                                007-001-000  249 10 COM YES YES ----- OFF
                                007-001-000  253 15 COM YES YES ----- OFF

MAP TABLE IS 1 % FULL (9 of 1024)

      PCI          SSN RC MULT |-----MATE-----| SRM MRC GRP NAME SSO
                                PCI          SSN RC MULT
s-1-128-6     55 10 SOL                --- --- ----- OFF
MAP TABLE IS 1 % FULL (9 of 1024)

      PCN          SSN RC MULT |-----MATE-----| SRM MRC GRP NAME SSO
                                PCN          SSN RC MULT
03-00-01-2-aa 55 10 DOM                NO  NO  ----- OFF
                                s-09-14-05-3-ab 45 99 DOM NO  NO  ----- OFF
;

```

Legend

PC/PCA/PCI/PCN/PCN24—This field identifies the point code of the SCP where the primary application resides.

SSN—This field identifies the applications subsystem number.

RC—This field identifies the relative cost of the point code/subsystem.

MPC—This field identifies the point code of the SCP where the mate application resides.

MSSN—This field identifies the mate applications subsystem number.

MATERC—This field identifies the mate relative cost.

SRM—This field specifies whether subsystem routing messages are transmitted.

MRC—This field specifies whether message routing under congestion is on or off.

GRP NAME—This field identifies the name of a group of point codes (the broadcast list group name) that should be notified of the subsystem status.

SSO—Subsystem Status Option. Indicates the subsystem status (“prohibited” or “allowed”) for PC/SSN MAP entries.

rtrv-meas-sched

Retrieve Measurements Schedule

Use this command to retrieve the current scheduled measurement report(s) and collection settings.

Keyword: rtrv-meas-sched

Related Commands: chg-meas, rept-meas

Command Class: Link Maintenance

Parameters

This command has no parameters.

Example

```
rtrv-meas-sched
```

Dependencies

None

Notes

None

Output

Output with measurement collection on.

rtrv-meas-sched

```
rlghncxa03w 04-02-27 07:19:51 EST EAGLE 31.3.0
COLLECT      = on
GTWYLSFLTR   = both
-----
SYSTOT-STP   = on
SYSTOT-TT    = off
SYSTOT-STPLAN = off
COMP-LNKSET  = on
COMP-LINK    = on
GTWY-STP     = on
GTWY-LNKSET  = on
MTCD-STP     = on
MTCD-LINK    = on
MTCD-STPLAN  = on
MTCD-LNKSET  = on
;
```

Output with measurement collection off. The parentheses () indicate that a setting is not in effect because collection is turned off.

rtrv-meas-sched

```
rlghncxa03w 04-02-27 07:19:51 EST EAGLE 31.3.0
COLLECT      = off
GTWYLSFLTR   = (both)
-----
SYSTOT-STP   = (off)
SYSTOT-TT    = (off)
SYSTOT-STPLAN = (off)
COMP-LNKSET  = (off)
COMP-LINK    = (off)
GTWY-STP     = (off)
GTWY-LNKSET  = (off)
MTCD-STP     = (on)
MTCD-LINK    = (on)
MTCD-STPLAN  = (on)
MTCD-LNKSET  = (on)
;
```

Legend

COLLECT—Shows whether measurement collection is on or off.

GTWYLSFLTR—Shows the setting that filters the linksets included in the GTWY report.
The settings are as follows:

both—Only gateway linksets are included in the report to the terminal and SEAS.

stp—Only gateway linksets are included in the report to the terminal. All defined linksets are included in the report to SEAS.

seas—All defined linksets are included in the report to the terminal. Only gateway linksets are included in the report to SEAS.

none—All defined linksets are included in the report to the terminal and SEAS.

SYSTOT-STP—System total-STP measurement collection is on or off.

SYSTOT-TT—System total-translation type measurement collection is on or off.
SYSTOT-STPLAN—System total-STP LAN measurement collection is on or off.
COMP-LNKSET—Component-linkset measurement collection is on or off.
COMP-LINK—Component-link measurement collection is on or off.
GTWY-STP—Gateway administration-STP measurement report is on or off.
GTWY-LNKSET—Gateway administration-LNKSET measurement report is on or off.
MTCD-STP—Maintenance daily-STP measurement collection is on or off.
MTCD-LINK—Maintenance daily-link measurement collection is on or off.
MTCD-STPLAN—Maintenance daily-STP LAN measurement collection is on or off.
MTCD-LNKSET—Maintenance daily-LNKSET measurement report is on or off.

Refer to the *Maintenance Manual* for specific details on measurement reports.

rtrv-measopts

Retrieve Measurement Options

Use this command for the following functions:

- Show the enabled/disabled status of all FTP scheduled measurements reports
- Verify that the Measurements Platform has been enabled (PLATFORMENABLE setting)
- Verify that the 15 Minute Measurements collection option has been turned on (COLLECT15MIN setting)
- Verify that the CLI-based report file name option is turned on or off (CLLIBASEDNAME setting)

Keyword: rtrv-measopts

Related Commands: chg-measopts

Command Class: Link Maintenance

Parameters

This command has no parameters.

Example

rtrv-measopts

Dependencies

The Measurements Platform feature must be on before this command can be entered.

This command cannot be entered while in upgrade mode.

Notes

None

Output

rtrv-measopts

```
rlghncxa03w 03-03-07 00:57:31 EAGLE EAGLE 31.3.0
EAGLE MEASUREMENT OPTIONS LIST
```

```
PLATFORMENABLE =on
```

```
COLLECT15MIN = off
```

```
CLLIBASEDNAME = on
```

```
-----
SYSTOTSTP = on
SYSTOTTT = off
SYSTOTSTPLAN = on
COMPLINK = off
COMPLNKSET = on
GTWYSTP = on
GTWYLNKSET = on
GTWYORIGNI = on
GTWYORIGNINC = on
GTWYLSORIGNI = on
GTWYLSDESTNI = off
GTWYLSONISMT = off
```

```
MTCHLNP = on
MTCHNP = off
MTCHMAP = off
MTCHEIR = off
MTCNSTP = on
MTCNLINK = off
MTCNLINKSET = off
MTCNSTPLAN = on
MTCNLP = on
MTCNPN = on
MTCNMAP = on
MTCNDEIR = on
NMSTP = on
NMLINK = on
NMLNKSET = on
AVLLINK = on
AVLSTPLAN = on
AVLDLINK = on
```

```
;
```

Legend

PLATFORMENABLE—Indicator that measurements collection is enabled or disabled when the Measurements Platform feature is turned on. See the **chg-measopts** command.

COLLECT15MIN—Indicator that 15 Minute Measurements collection is enabled or disabled when the 15 Minute Measurements feature is turned on. See the **chg-measopts** command **collect15min** parameter.

CLLIBASEDNAME—Indicator that the CLI-based file name option is turned on or off.

SYSTOTSTP—System Total measurements report for the entire STP.

SYSTOTTT—System Total report for Translation Type measurements.

SYSTOTSTPLAN—System Total report STP LAN measurements.

COMPLINK—Component measurements report for a single link.

COMPLNKSET—Component measurements report for a link set.

GTWYORIGNI—Gateway Administration measurements report per originating network (large network uniquely identified by NI only).

GTWYORIGNINC—Gateway Administration measurements report per originating network (small network identified by NI-NC).

GTWYLSORIGNI—Gateway Administration measurements report per link set and originating network.

GTWYLSDESTNI—Gateway Administration measurements report per link set and destination network.

GTWYLSONISMT—Gateway Administration measurements report per link set, per originating network, per ISUP message type.

MTCHEIR—Maintenance Hourly (marginal) measurements report for Equipment Identity Register

MTCHNP—Maintenance Hourly (marginal) measurements report for INP or G-Port.

MTCHLNP—Maintenance Hourly (marginal) measurements report for LNP.

MTCHMAP—Maintenance Hourly (marginal) measurements report for GSM Map Screening.

MTCDEIR—Maintenance Daily measurements report for Equipment Identity Register

MTC DSTP—Maintenance Daily measurements report for STP.

MTC DLNK—Maintenance Daily measurements report for links.

MTC DLNKSET—Maintenance Daily measurements report for linksets.

MTC DSTPLAN—Maintenance Daily measurements report for STPLAN.

MTC DLNP—Maintenance Daily measurements report for LNP.

MTC DNP—Maintenance Daily measurements report for INP or G-Port.

MTC DMAP—Maintenance Daily measurements report for GSM Map Screening.

NMLINK—Network Management measurements report for a single link.

NMLNKSET—Network Management measurements report for a link set.

NMSTP—Network Management measurements report for the entire STP.

AVLINK—Hourly Availability report for a single link.

AVLSTPLAN—Hourly Availability report for STP LAN.

AVLDLINK—Daily Availability report for a single link.

rtrv-mem**Retrieve Allocated Memory**

NOTE: This command is obsolete.

Use this command to display the objects in the EAGLE database.

NOTE: If the LNP ELAP Configuration feature is turned on, this command is no longer available. This function can be performed from the ELAP user interface to View RTDB Status.

Keyword: rtrv-mem

Related Commands: alloc-mem

Command Class: System Maintenance

Parameters

:obj= (mandatory)

The type of database object to create.

Range: lnp4digit, all

Default: all

Example

```
rtrv-mem:obj=lnp4digit
```

Dependencies

The LNP feature must be on (see the “enable-ctrl-feat” command) before the **rtrv-mem** command can be executed.

Notes

None

Output**rtrv-mem**

```
rlghncxa03w 03-03-07 00:57:31 EST EAGLE 31.3.0
LNP 4DIGIT OBJECT %FULL
```

```
-----
LNP_4DIG.TBL          100
LNP4DIG1.TBL         100
LNP4DIG2.TBL         100
LNP4DIG3.TBL         100
LNP4DIG4.TBL         100
LNP4DIG5.TBL          50
```

```
LNP 4DIGIT database is (11000000 of 12000000) 92% full
```

```
rlghncxa03w 03-03-07 00:57:31 EST EAGLE 31.3.0
Memory retrieval complete.
;
```

Legend

LNP 4DIGIT OBJECT—The name of each LNP 4DIGIT database object.

%FULL—The capacity of each LNP 4DIGIT database object expressed as a percentage of the maximum number of ported telephone numbers each LNP 4DIGIT database object can contain.

rtrv-mrn

Retrieve Mated Relay Node

Use this command to display the Mated Relay Node application relationship information maintained by the EAGLE 5 SAS. This information is used to support the routing of SCCP management SSP/SSA messages.

Keyword: rtrv-mrn

Related Commands: chg-mrn, dlt-mrn, ent-mrn

Command Class: Database Administration

Parameters

NOTE: See “Point Code Formats and Conversion” in Appendix A for a detailed description of point code formats, rules for specification, and examples.

:mrnset= (optional)

The MRN set ID.

Range: 1-3000, dflt

dflt—The default mrnset.

:pc/pca/pci/pcn/pcn24= (optional)

Post-GTT-translated point code.

:pc= or :pca= (optional)

ANSI point code in the form of *network indicator-network cluster-network cluster member (ni-nc-ncm)*.

Range: 000-255

Specify a valid value for each subfield of the point code, and separate the subfields with a dash (-).

When **chg-sid:pctype=ansi** is specified, *ni = 000* is not valid.

When **chg-sid:pctype=ansi** is specified, *nc = 000* is not valid if *ni = 001-005*.

When **chg-sid:pctype=ansi** is specified, *nc = 000* is valid if *ni = 006-255*.

The point code **000-000-000** is not a valid point code.

:pci= (optional)

ITU international point code with subfields *zone-area-id*. The *prefix* subfield indicates a spare point code (*prefix-zone-area-id*).

Range: s-, 0-255

Specify a valid value for each subfield of the point code, and separate the subfields with a dash (-).

prefix—s-

zone—0-7

area—000-255

id—0-7

The point code **0-000-0** is not a valid point code.

:pcn= (optional)

ITU national point code in the format of a 5-digit number (*nnnnn*); or 2, 3, or 4 numbers (members) separated by dashes (*m1-m2-m3-m4*) as defined by the **chg-stpopts:npcfinti** flexible point code option. A group code must be specified when the ITUDUPPC feature is turned on (*nnnnn-gc*, *m1-m2-m3-m4-gc*). The *prefix* subfield indicates a spare point code (*prefix-nnnnn*, *prefix-nnnnn-gc*, *prefix-m1-m2-m3-m4*, *prefix-m1-m2-m3-m4-gc*).

Range: **s-**, **0-16383**, **aa-zz**

Specify a valid value for each subfield of the point code, and separate the subfields with a dash (-).

prefix—**s-**

nnnnn—**0-16383**

gc—**aa-zz**

m1-m2-m3-m4—**0-14** for each member; values must sum to 14

:pcn24= (optional)

24-bit ITU national point code with subfields *main signaling area-sub signaling area-signaling point* (*msa-ssa-sp*).

Range: **000-255**

Specify a valid value for each subfield of the point code, and separate the subfields with a dash (-).

msa—**000-255**

ssa—**000-255**

sp—**000-255**

Example

The following example retrieves the stored information for all point code groups in the MRN table.

```
rtrv-mrn
```

The following example retrieves the stored information for the point code group that contains the specified point code.

```
rtrv-mrn:pc=1-1-2
```

The following examples show spare point codes.

```
rtrv-mrn:pci=s-2-2-1
```

```
rtrv-mrn:pcn=s-1-1-1-123-aa
```

Dependencies

A point code that is specified in the command must already exist in the MRN table.

When Flexible GTT Load Sharing feature is enabled, the **pc** and **mrnset** must be specified together.

Notes

This command can be canceled using the **F9** function key or the **canc-cmd** command. See **canc-cmd** for more information.

In this command, only ITU-international and ITU national point codes support the spare point code subtype prefix (**s-**).

Output

rtrv-mrn

```
rlghncxa03w 03-03-20 09:07:58 EST EAGLE 31.3.0
```

PC	RC
1-1-0	05
1-1-1	10
1-1-2	20
1-1-3	20
1-1-4	40

PC	RC
1-2-1	20
1-1-7	25
1-1-8	30
1-3-2	30

;

rtrv-mrn

```
rlghncxa03w 05-01-07 09:07:58 EST EAGLE 31.12.0
```

PCI	RC
s-2-002-1	10
s-2-002-2	11
s-2-100-1	12

PC	RC
s-1-1-1-0123-aa	1
s-1-1-1-0235-aa	2
s-1-1-1-0235-aa	3

;

rtrv-mrn:pc=1-1-2

```
rlghncxa03w 03-03-20 09:07:58 EST EAGLE 31.3.0
```

PC	RC
1-1-0	05
1-1-1	10
1-1-2	20
1-1-3	20
1-1-4	40

;

rtrv-mrn:pci=s-2-2-1

```
rlghncxa03w 05-01-07 09:07:58 EST EAGLE 31.12.0
```

PCI	RC
s-2-002-1	10
s-2-002-2	11
s-2-100-1	12

;

rtrv-mrn:pcn=s-1-1-1-123-aa

rlghncxa03w 05-01-07 09:07:58 EST EAGLE 31.12.0

PCN	RC
s-1-1-1-0123-aa	1
s-1-1-1-0235-aa	2
s-1-1-1-0235-aa	3

;

rtrv-mrn

PCN24	RC
008-008-008	0

;

rtrv-mrn

MRNSET	PC	RC
DFLT	001-001-001	10
	001-001-002	20
	001-001-003	30

MRNSET	PC	RC
110	001-001-001	10
	001-001-005	20
	001-001-006	30
	001-001-003	40
	001-001-008	50

MRNSET	PC	RC
111	001-001-001	30
	001-001-005	30
	001-001-006	30
	001-001-003	30
	001-001-008	30

MRNSET	PC	RC
112	001-003-001	10
	001-003-002	10
	001-003-003	30
	001-003-004	30
	001-003-006	60
	001-003-007	60
	001-003-008	80
	001-003-009	80

MRNSET	PCN	RC
113	s-1-1-1-0123-aa	1
	s-1-1-1-0235-aa	2
	s-1-1-1-0235-aa	3

;

rtrv-mrn:pc=1-1-1:mrnset=111

```

tekelecstp 04-04-07 11:22:38 EST EAGLE5 Rel 34.2.0
rtrv-mrn:pc=1-1-1:mrnset=111
MRNSET   PC           RC
111      001-001-001      30
          001-001-005      30
          001-001-006      30
          001-001-003      30
          001-001-008      30
;

```

rtrv-na**Retrieve Network Appearance**

Use this command to display the configured network appearances.

Keyword: rtrv-na

Related Commands: dlt-na, ent-na

Command Class: Database Administration

Parameters

This command has no parameters.

Example

```
rtrv-na
```

Dependencies

None

Notes

None

Output**rtrv-na**

```

rlghncxa03w 05-01-20 09:07:58 EST EAGLE 31.12.0
TYPE      GC          NA
ANSI      --          0
ITUI      --          1
ITUN      aa          2
ITUN24    --          3
ITUIS     --          4
ITUNS     bb          5
;

```

rtrv-netopts**Retrieve Network Options**

Use this command to retrieve the user-specified options for the IP networks used by the EAGLE 5 SAS. This command displays the Private Virtual Network (PVN) IP address and PVN subnet mask.

Keyword: rtrv-netopts

Related Commands: chg-netopts

Command Class: Database Administration

Parameters

This command has no parameters.

Example

```
rtrv-netopts
```

Dependencies

None

Notes

None

Output**rtrv-netopts**

```
rlghncxa03w 03-03-20 09:07:58 EST EAGLE 31.3.0
NET OPTIONS
-----
PVN          172.20.50.0
PVNMASK     255.255.252.0
```

```
;
```

rtrv-oap-config**Retrieve OAP Configuration**

Use this command to display the OAP configuration information in the EAGLE database configured with the **chg-oap-config** command.

Keyword: rtrv-oap-config

Related Commands: chg-oap-config

Command Class: Database Administration

Parameters

This command has no parameters.

Example

```
rtrv-oap-config
```

Dependencies

The Local Number Portability feature or the SEAS feature must be on (an LNP ported TNs quantity of up to 12000000 in the **rtrv-ctrl-feat** command output or **seas=on** in the **rtrv-feat** command output) before the **rtrv-oap-config** command can be entered.

Notes

None

Output

The output of the **rtrv-oap-config** command displays different fields depending on whether the SEAS feature is on, the LNP feature is on, or both features are on as shown in the following output examples.

rtrv-oap-config (If both the SEAS and LNP features are on)

```
rlghncxa03w 03-03-07 00:57:31 EST EAGLE 31.3.0
OAP CONFIGURATION REPORT
DATA                OAP A                OAP B
Hostname            tekelec-8            tekelec-9
IP Address          128.132.064.015     128.132.064.016
IP Netmask          255.255.255.000     255.255.255.000
Default Router      128.132.064.001     128.132.064.001
Config              dual                 dual
SEAC CLLI           SEASNJPYRRC         SEASNJPYRRC
X25 Packet Size    7                    7
X25 Mode            DTE                  DTE
Active LSMS         main                 main
Main LSMS NSAP      198.089.039.022     198.089.039.022
Main LSMS SSEL      emss                 emss
Main LSMS PSEL      emsp                 emsp
Shadow LSMS NSAP    <Not configured>    <Not configured>
Shadow LSMS SSEL    <Not configured>    <Not configured>
Shadow LSMS PSEL    <Not configured>    <Not configured>
;
```

rtrv-oap-config (If only the SEAS feature is on)

```
rlghncxa03w 03-03-07 00:57:31 EST EAGLE 31.3.0
OAP CONFIGURATION REPORT
DATA                OAP A                OAP B
Hostname            tekelec-8            tekelec-9
IP Address          128.132.064.015     128.132.064.016
IP Netmask          255.255.255.000     255.255.255.000
Default Router      128.132.064.001     128.132.064.001
Config              dual                 dual
SEAC CLLI           SEASNJPYRRC         SEASNJPYRRC
X25 Packet Size    7                    7
X25 Mode            DTE                  DTE
;
```

rtrv-oap-config (If only the LNP feature is on)

```

rlghncxa03w 03-03-07 00:57:31 EST EAGLE 31.3.0
OAP CONFIGURATION REPORT
DATA                OAP A                OAP B
Hostname            tekelec-8            tekelec-9
IP Address          128.132.064.015     128.132.064.016
IP Netmask          255.255.255.000     255.255.255.000
Default Router      128.132.064.001     128.132.064.001
Config              dual                  dual
Active LSMS         main                  main
Main LSMS NSAP      198.089.039.022     198.089.039.022
Main LSMS SSEL      emss                  emss
Main LSMS PSEL      emsp                  emsp
Shadow LSMS NSAP    <Not configured>    <Not configured>
Shadow LSMS SSEL    <Not configured>    <Not configured>
Shadow LSMS PSEL    <Not configured>    <Not configured>
;

```

Legend

HOSTNAME—Host name of OAP A or OAP B.

IP ADDRESS—IP address of OAP A or OAP B.

IP NETMASK—The netmask for OAP A or OAP B.

DEFAULT ROUTER—The IP address of the default router assigned to OAP A or OAP B.

CONFIG—The number of OAPs configured (single or dual).

SEAC CLLI—The common language location identifier (CLLI) of the SEAC to which the OAP connects.

X25 PACKET SIZE—The X.25 package size for the link to the SEAC (7 or 8).

X25 MODE—The mode of the X.25 link to the SEAC (DTE or DTC).

ACTIVE LSMS—The LSMS associated with the OAP (main or shadow).

MAIN LSMS NSAP—The network service access point of the main LSMS.

MAIN LSMS SSEL—The session selector of the main LSMS.

MAIN LSMS PSEL—The presentation selector of the main LSMS.

SHADOW LSMS NSAP—The network service access point of the shadow LSMS.

SHADOW LSMS SSEL—The session selector of the shadow LSMS.

SHADOW LSMS PSEL—The presentation selector of the shadow LSMS.

rtrv-obit**Retrieve Obituary Report**

Use this command to show the obituaries that were most recently logged in the system. The report shows the obituaries from either the active or standby OAM, and the report indicates which card and processor generated the obituary.

An obituary is a set of data that describes the status of the system just before a processor restarted due to a fault in hardware or software. The data includes a register dump and a stack dump of the processor, card location, reporting module number, software code location, and class of the fault detected.

Keyword: rtrv-obit

Related Commands: act-alm-trns, dact-alm-trns, rept-stat-clk, rept-stat-trbl, rls-alm, rtrv-trbl

Command Class: System Maintenance

Parameters

:loc= (mandatory)

The address of the card that is running the OAM from which the obituary information is to be retrieved.

Range: 1113, 1115

:mode= (optional)

Display mode

Range: c, m

c—Continuous mode; shows obituaries already logged and new obituaries as they occur.

m—Manual mode; shows obituaries on demand only, when this command is entered.

Default: c

:num= (optional)

This parameter indicates how many obituaries to display.

Range: 1–150

Default: 150

Example

```
rtrv-obit:loc=1115:num=2
```

Dependencies

The obituary log on the specified OAM must contain at least one obituary; otherwise, the command is rejected.

If the **mode** parameter is specified without the **num** parameter, the entire log is displayed.

Only one **rtrv-obit** or **rtrv-trbl** command at a time can be in progress throughout the entire system.

The card location specified by the **loc** parameter must be either **1113** or **1115**.

If the **loc** parameter specifies the card that is running the standby OAM, that card must be available.

Notes

This command can be canceled using the **F9** function key or the **canc-cmd** command when the command is entered for the active OAM. See **canc-cmd** for more information.

In most situations, obituary reports are generated automatically when a card is reset. Automatic report generation can be turned off by selecting the **mode=m** parameter for manual mode.

The obituary from a 186 processor displays the register dump and a 16-word stack dump.

The obituary from a 486 processor is different from 186 because the register set is larger. Also, only 12 words of the stack are dumped for the 486.

The obituary from an IXP-based processor card (which include HIPR and HC-MIM cards) contains significantly more information than an obituary from an x86-based processor card. The data in an IXP obituary will be spread over multiple system buffers, where each buffer is logged and printed as an independent obituary. Sequence numbers are displayed in the output so that it is clear which buffers comprise a given obituary. There is an overall sequence number, and a sequence number within each class (such as IXP register set or user data) of information.

The obituary from an EP9312-based processor card (e.g. SIFB) contains different information than an obit from an IXP-based processor card. The data in an EP9312 obituary is spread over multiple system buffers, where each buffer is logged and printed as an independent obituary. Sequence numbers are displayed in the output so that it is clear which buffers comprise a given obituary. There is an overall sequence number, and a sequence number within each class (e.g. ARM register set) of information.

Output

The following example shows output for two obituaries from an x86-based card.

rtrv-obit:loc=1115:num=2

```
rlghncxa03w 03-03-30 08:43:14 EST EAGLE 31.3.0
-----
STH: Received a BOOT 286-obituary reply for 1 restart(s)
Primary: Card 1203 Module 4608 Mod_loc 1 Class 0080
Register Dump :
    FL=338e    CS=4a9c    IP=01c0
    AX=0000    CX=0100    DX=21c1    BX=078a
    SP=01a6    BP=01a6    SI=0fe4    DI=3ece
    DS=dce8    ES=21c1    SS=336b
Stack Dump :
[SP+1E]=3ece    [SP+16]=46cc    [SP+0E]=0001    [SP+06]=0246
[SP+1C]=078a    [SP+14]=dce8    [SP+0C]=4608    [SP+04]=338e
[SP+1A]=078a    [SP+12]=078a    [SP+0A]=0001    [SP+02]=4a9c
[SP+18]=0100    [SP+10]=336b    [SP+08]=0080    [SP+00]=01c0
```

```

STH: Received a BOOT 486-obituary reply for 1 restart(s)
Primary: Card 1213  Module 0047  Mod_loc 5  Class 0241
Register Dump :
  EFL=00000000  CS =0208      EIP=0003e75f  SS =0060
  EAX=0009a90b  ECX=0009a915  EDX=00000000  EBX=00000000
  ESP=000ddaf2  EBP=000ddb6c  ESI=00090241  EDI=00141df8
  DS =0060      ES =0060      FS =0060      GS =0060
Stack Dump :
[ESP+2E]=0009  [ESP+28]=1df8  [ESP+22]=0000  [ESP+1C]=a915
[ESP+2C]=a90b  [ESP+26]=0009  [ESP+20]=0000  [ESP+1A]=0009
[ESP+2A]=0014  [ESP+24]=a8c0  [ESP+1E]=0009  [ESP+18]=a90b
User Data Dump :
  0a 06 00 00 46 01 08 04 00 00 00      ....F.....
Report Date:03-03-04  Time:09:19:59
-----

```

The following example shows output for six obituaries from an IXP-based card.

rtrv-obit:loc=1113:num=6

```

rlghncxa03w 03-01-23 08:43:14 EST  EAGLE 30.0.0
-----
STH: Received a BOOT IMT-obituary reply for 1 restart(s)
Card 1209  Module TKS_SBFR.C  Line 728  Class 01cc
StrongARM Core Register Dump (1 of 1):  [Overall: 1 of 6]
  r0 =00008b22  r1 =00004e72  r2 =0003e75f  r3 =0060024a
  r4 =0004a92b  r5 =000019c5  r6 =0000a57c  r7 =00005521
  r8 =0000b1f7  r9 =0000836c  r10=0000e251  r11=00141d42
  r12=006055a3  sp =0000727c  lr =0000003f  pc =00006429
Report Date:03-01-23  Time:12:20:45
-----

rlghncxa03w 03-01-23 08:43:14 EST  EAGLE 30.0.0
-----
STH: Received a BOOT IMT-obituary reply for 1 restart(s)
Card 1209  Module TKS_SBFR.C  Line 728  Class 01cc
StrongARM Core Stack Dump (1 of 1):  [Overall: 2 of 6]
System Mode Stack:
  0000  15a3a816  0012be0a  06000046  01080400  .....
  0010  00a2342c  07f7b83a  15729dd2  05580601  .....
  0020  1a22a616  7072b91a  46304a44  06887400  .....
  0030  25a33b12  01a4ba22  17e03026  11483402  .....
  0040  00130811  0033a30a  14008149  0cab6130  .....
  0050  00000000  00000000  00000000  00000000  .....
  0060  15a3a816  0012be0a  06000046  01080400  .....
  0070  00a2342c  07f7b83a  15729dd2  05580601  .....
  0080  1a22a616  7072b91a  46304a44  06887400  .....
Abort Mode Stack:
  0000  25a33b12  01a4ba22  17e03026  11483402  .....
  0010  00130811  0033a30a  14008149  0cab6130  .....
  0020  1a22a616  7072b91a  46304a44  06887400  .....
  0030  25a33b12  01a4ba22  17e03026  11483402  .....
  0040  00130811  0033a30a  14008149  0cab6130  .....
  0050  00000000  00000000  00000000  00000000  .....
  0060  15a3a816  0012be0a  06000046  01080400  .....
Report Date:03-01-23  Time:12:20:45
-----

```

```

rlghncxa03w 03-01-23 08:43:14 EST EAGLE 30.0.0
-----
STH: Received a BOOT IMT-obituary reply for 1 restart(s)
Card 1209 Module TKS_SBFR.C Line 728 Class 01cc
IXP Register Dump (1 of 2): [Overall: 3 of 6]
***** FBI Registers: *****
IREG =00000000 SOP_SEQ1=00000000
SOP_SEQ2=0003e75f ENQUEUE_SEQ1=0060024a
ENQUEUE_SEQ2=0060024a THREAD_DONE_REG0=00600231
THREAD_DONE_REG1=00600231 RCV_RDY_CNT=000012d4
RCV_RDY_HI =0009a90b RCV_RDY_LO=00000000
RCV_RDY_CTL=0009a915 RCV_CNTL=00000000
REC_FASTPORT_CTL =000ddaf2 FLOWCTL_MASK =000ddb6c
RDYBUS_SYN_CNT_DEF=00090241 SELF_DESTRUCT=00141df8
HASH_MULTIPLIER_64_HI=006011a3 HASH_MULTIPLIER_64_LO=00000000
HASH_MULTIPLIER_48_HI=006011a3 HASH_MULTIPLIER_48_LO=00000000
GET_CMD=00000000 XMIT_RDY_LO=00000000
XMIT_RDY_HI=00000000 XMIT_RDY_CTL=00000000
XMIT_PTR =0003e75f

***** SDRAM Registers: *****
SDRAM_CSR=0060024a SDRAM_MEMCTL0=0060024a
SDRAM_MEMCTL1=00600231 DRAM_MEMINIT=00600231

***** StrongARM System Registers: *****
PLL_CFG=0060024a GPIO_EN=0060024a
GPIO_DATA=00600231 RTC_DIV=00600231
RTC_INIT=000012d4 RTC_TVAL=0009a90b
RTC_CNTR=00000000 RTC_ALM=0009a915
UART_SR=0009a915 UART_CR=00000000
UART_DR=00090241 TIMER_1_LOAD=000ddb6c
TIMER_2_LOAD=00090241 TIMER_3_LOAD=00141df8
TIMER_4_LOAD=00000000 TIMER_1_VALUE=00000000
TIMER_2_VALUE=006011a3 TIMER_3_VALUE=00000000
TIMER_4_VALUE=00090241 TIMER_1_CONTROL=00141df8
TIMER_2_CONTROL=00000000 TIMER_3_CONTROL=00000000
TIMER_4_CONTROL=006011a3 FIQ=00000000
IRQ=00000000

***** PCI Configuration Space Registers: *****
PCI_VEN_DEV_ID=0060024a PCI_CMD_STAT=0060024a
PCI_REV_CLASS=00600231 PCI_CACHE_LAT_HDR_BIST=00600231
PCI_MEM_BAR=000012d4 PCI_IO_BAR=0009a90b
PCI_DRAM_BAR=00000000 PCI_SUBSYS=0009a915
PCI_INT_LAT=0009a915

***** PCI Shared Control Registers: *****
CAP_PTR_EXT=00090241 PWR_MGMT=000ddb6c
IXP1200_RESET=00090241 PCI_OUT_INT_MASK=00141df8
I20_INB_FIFO=00000000 I20_OUTB_FIFO=00000000
MAILBOX_0=006011a3 MAILBOX_1=00000000
MAILBOX_2=006011a3 MAILBOX_3=00000000
DOORBELL=006011a3 DOORBELL_SETUP=00000000

***** PCI Control Registers: *****
CHAN_1_BYTE_COUNT=0060024a CHAN_2_BYTE_COUNT=0060024a
CHAN_1_PCI_BAR=00600231 CHAN_2_PCI_BAR=00600231
CHAN_1_DRAM_ADDR=000012d4 CHAN_2_DRAM_ADDR=0009a90b
CHAN_1_DESC_PTR=00000000 CHAN_2_DESC_PTR=0009a915
CHAN_1_CONTROL=0009a915 CHAN_2_CONTROL=00000000
DMA_INF_MODE=00090241 CSR_BASE_ADDR_MASK=000ddb6c
DRAM_BASE_ADDR_MASK=000ac14c I20_INB_FLIST_HPTR=00141df8
I20_INB_PLIST_TPTR=006011a3 I20_OUTB_PLIST_HPTR =00000000

```

```

I20_OUTB_FLIST_TPTR =00000000      I20_INB_FLIST_CNT=00000000
I20_OUTB_PLIST_CNT =006011a3      I20_INB_PLIST_CNT =00000000
SA_CONTROL=00090241              PCI_ADDR_EXT=000ddb6c
DBELL_PCI_MASK=00090241          DBELL_SA_MASK=00141df8
IRQ_STATUS=00000000              FIQ_STATUS=00000000
IRQ_RAW_STATUS=006011a3          FIQ_RAW_STATUS=00000000
IRQ_ENABLE=006011a3              FIQ_ENABLE=00000000
***** Coprocessor 15 Registers: *****
ID_CHIP=0060024a                  CONTROL_CP15=0060024a
TRANSLATION_TAB_BASE=00600231    DOMAIN_ACCESS_CONTROL=00600231
FAULT_STATUS=000012d4            FAULT_ADDRESS=0009a90b
CACHE_CONTROL_OPER=00000000      READ_BUFFER_OPER=0009a915
PROC_ID_VIRT_ADDR_MAP=00000000    DATA_BREAKPT_CONTROL_REG=0009a915
Report Date:03-01-23   Time:12:20:45
-----

```

rlghncxa03w 03-01-23 08:43:14 EST EAGLE 30.0.0

STH: Received a BOOT IMT-obituary reply for 1 restart(s)

Card 1209 Module TKS_SBFRC Line 728 Class 01cc

IXP Register Dump (2 of 2): [Overall: 4 of 6]

***** SRAM Registers: *****

```

SRAM_CSR=0060024a                SRAM_AUTO_BASE=0060024a
SRAM_AUTO_PTR=00600231            SRAM_AUTO_END=00600231
SRAM_TEST_MOD=000012d4            SRAM_SLOW_CONFIG=0009a90b
SRAM_BOOT_CONFIG=00000000         SRAM_SLOWPORT_CONFIG=0009a915

```

***** Microengine 0 Registers: *****

```

USTORE_DATA=0060024a             ALU_OUTPUT=0060024a
CTX_ENABLES=000012d4             CC_ENABLE=0009a90b
CTX_0_SIG_EVENTS=00090241         CTX_1_SIG_EVENTS=000ddb6c
CTX_2_SIG_EVENTS=00090241         CTX_3_SIG_EVENTS=00141df8
CTX_0_WAKEUP_EVENTS=00000000      CTX_1_WAKEUP_EVENTS=00000000
CTX_2_WAKEUP_EVENTS=006011a3      CTX_3_WAKEUP_EVENTS=00000000
CTX_ARB_CNTL=00600231
ACTIVE_CTX_STS:  SEG=1   ACNO=1   AB=0   ACTXPC: 38
CTX_0_STS:        SEG=1   ACNO=2   RR=0   CTX_PC: 245
CTX_1_STS:        SEG=0   ACNO=1   RR=1   CTX_PC: 15
CTX_2_STS:        SEG=0   ACNO=0   RR=0   CTX_PC: 75
CTX_3_STS:        SEG=1   ACNO=3   RR=1   CTX_PC: 132

```

***** Microengine 1 Registers: *****

```

USTORE_DATA=0060024a             ALU_OUTPUT=0060024a
CTX_ENABLES=000012d4             CC_ENABLE=0009a90b
CTX_0_SIG_EVENTS=00090241         CTX_1_SIG_EVENTS=000ddb6c
CTX_2_SIG_EVENTS=00090241         CTX_3_SIG_EVENTS=00141df8
CTX_0_WAKEUP_EVENTS=00000000      CTX_1_WAKEUP_EVENTS=00000000
CTX_2_WAKEUP_EVENTS=006011a3      CTX_3_WAKEUP_EVENTS=00000000
CTX_ARB_CNTL=00600231
ACTIVE_CTX_STS:  SEG=1   ACNO=1   AB=0   ACTXPC: 38
CTX_0_STS:        SEG=1   ACNO=2   RR=0   CTX_PC: 245
CTX_1_STS:        SEG=0   ACNO=1   RR=1   CTX_PC: 15
CTX_2_STS:        SEG=0   ACNO=0   RR=0   CTX_PC: 128
CTX_3_STS:        SEG=1   ACNO=3   RR=1   CTX_PC: 72

```

***** Microengine 2 Registers: *****

```

USTORE_DATA=0060024a             ALU_OUTPUT=0060024a
CTX_ENABLES=000012d4             CC_ENABLE=0009a90b
CTX_0_SIG_EVENTS=00090241         CTX_1_SIG_EVENTS=000ddb6c
CTX_2_SIG_EVENTS=00090241         CTX_3_SIG_EVENTS=00141df8
CTX_0_WAKEUP_EVENTS=00000000      CTX_1_WAKEUP_EVENTS=00000000
CTX_2_WAKEUP_EVENTS=006011a3      CTX_3_WAKEUP_EVENTS=00000000
CTX_ARB_CNTL=00600231
ACTIVE_CTX_STS:  SEG=1   ACNO=1   AB=0   ACTXPC: 38

```

```

CTX_0_STS:      SEG=1    ACNO=2    RR=0    CTX_PC: 245
CTX_1_STS:      SEG=0    ACNO=1    RR=1    CTX_PC: 125
CTX_2_STS:      SEG=0    ACNO=0    RR=0    CTX_PC: 75
CTX_3_STS:      SEG=1    ACNO=3    RR=1    CTX_PC: 62
***** Microengine 3 Registers: *****
USTORE_DATA=0060024a      ALU_OUTPUT=0060024a
CTX_ENABLES=000012d4      CC_ENABLE=0009a90b
CTX_0_SIG_EVENTS=00090241  CTX_1_SIG_EVENTS=000ddb6c
CTX_2_SIG_EVENTS=00090241  CTX_3_SIG_EVENTS=00141df8
CTX_0_WAKEUP_EVENTS=00000000  CTX_1_WAKEUP_EVENTS=00000000
CTX_2_WAKEUP_EVENTS=006011a3  CTX_3_WAKEUP_EVENTS=00000000
CTX_ARB_CNTL=00600231
ACTIVE_CTX_STS:  SEG=1    ACNO=1    AB=0    ACTXPC: 38
CTX_0_STS:      SEG=1    ACNO=2    RR=0    CTX_PC: 245
CTX_1_STS:      SEG=0    ACNO=1    RR=1    CTX_PC: 125
CTX_2_STS:      SEG=0    ACNO=0    RR=0    CTX_PC: 75
CTX_3_STS:      SEG=1    ACNO=3    RR=1    CTX_PC: 62
***** Microengine 4 Registers: *****
USTORE_DATA=0060024a      ALU_OUTPUT=0060024a
CTX_ENABLES=000012d4      CC_ENABLE=0009a90b
CTX_0_SIG_EVENTS=00090241  CTX_1_SIG_EVENTS=000ddb6c
CTX_2_SIG_EVENTS=00090241  CTX_3_SIG_EVENTS=00141df8
CTX_0_WAKEUP_EVENTS=00000000  CTX_1_WAKEUP_EVENTS=00000000
CTX_2_WAKEUP_EVENTS=006011a3  CTX_3_WAKEUP_EVENTS=00000000
CTX_ARB_CNTL=00600231
ACTIVE_CTX_STS:  SEG=1    ACNO=1    AB=0    ACTXPC: 38
CTX_0_STS:      SEG=1    ACNO=2    RR=0    CTX_PC: 245
CTX_1_STS:      SEG=0    ACNO=1    RR=1    CTX_PC: 15
CTX_2_STS:      SEG=0    ACNO=0    RR=0    CTX_PC: 75
CTX_3_STS:      SEG=1    ACNO=3    RR=1    CTX_PC: 132
***** Microengine 5 Registers: *****
USTORE_DATA=0060024a      ALU_OUTPUT=0060024a
CTX_ENABLES=000012d4      CC_ENABLE=0009a90b
CTX_0_SIG_EVENTS=00090241  CTX_1_SIG_EVENTS=000ddb6c
CTX_2_SIG_EVENTS=00090241  CTX_3_SIG_EVENTS=00141df8
CTX_0_WAKEUP_EVENTS=00000000  CTX_1_WAKEUP_EVENTS=00000000
CTX_2_WAKEUP_EVENTS=006011a3  CTX_3_WAKEUP_EVENTS=00000000
CTX_ARB_CNTL=00600231
ACTIVE_CTX_STS:  SEG=1    ACNO=1    AB=0    ACTXPC: 38
CTX_0_STS:      SEG=1    ACNO=2    RR=0    CTX_PC: 245
CTX_1_STS:      SEG=0    ACNO=1    RR=1    CTX_PC: 15
CTX_2_STS:      SEG=0    ACNO=0    RR=0    CTX_PC: 75
CTX_3_STS:      SEG=1    ACNO=3    RR=1    CTX_PC: 132

```

Report Date:03-01-23 Time:12:20:45

rlghncxa03w 03-01-23 08:43:14 EST EAGLE 30.0.0

```

STH: Received a BOOT IMT-obituary reply for 1 restart(s)
Card 1209  Module TKS_SBFR.C  Line 728  Class 01cc
User Data Dump (1 of 2):      [Overall: 5 of 6]
0000  15a3a816  0012be0a  06000046  01080400  .....
0010  00a2342c  07f7b83a  15729dd2  05580601  .....
0020  1a22a616  7072b91a  46304a44  06887400  .....
0030  25a33b12  01a4ba22  17e03026  11483402  .....
0040  00130811  0033a30a  14008149  0cab6130  .....
0050  00000000  00000000  00000000  00000000  .....
0060  15a3a816  0012be0a  06000046  01080400  .....
0070  00a2342c  07f7b83a  15729dd2  05580601  .....
0080  1a22a616  7072b91a  46304a44  06887400  .....
0090  25a33b12  01a4ba22  17e03026  11483402  .....

```

```

00a0 00130811 0033a30a 14008149 0cab6130 .....
00b0 1a22a616 7072b91a 46304a44 06887400 .....
00c0 25a33b12 01a4ba22 17e03026 11483402 .....
00d0 00130811 0033a30a 14008149 0cab6130 .....
00e0 00000000 00000000 00000000 00000000 .....
00f0 15a3a816 0012be0a 06000046 01080400 .....
0100 00a2342c 07f7b83a 15729dd2 05580601 .....
0110 1a22a616 7072b91a 46304a44 06887400 .....
0120 25a33b12 01a4ba22 17e03026 11483402 .....
0130 25a33b12 01a4ba22 17e03026 11483402 .....
0140 00130811 0033a30a 14008149 0cab6130 .....
0150 00000000 00000000 00000000 00000000 .....
0160 15a3a816 0012be0a 06000046 01080400 .....
0170 00a2342c 07f7b83a 15729dd2 05580601 .....
0180 1a22a616 7072b91a 46304a44 06887400 .....
0190 25a33b12 01a4ba22 17e03026 11483402 .....
01a0 00130811 0033a30a 14008149 0cab6130 .....
01b0 1a22a616 7072b91a 46304a44 06887400 .....
01c0 25a33b12 01a4ba22 17e03026 11483402 .....

```

Report Date:03-01-23 Time:12:20:45

```

rlghncxa03w 03-01-23 08:43:14 EST EAGLE 30.0.0

```

STH: Received a BOOT IMT-obituary reply for 1 restart(s)

Card 1209 Module TKS_SBFR.C Line 728 Class 01cc

User Data Dump (2 of 2): [Overall: 6 of 6]

```

0000 15a3a816 0012be0a 06000046 01080400 .....
0010 00a2342c 07f7b83a 15729dd2 05580601 .....
0020 1a22a616 7072b91a 46304a44 06887400 .....
0030 25a33b12 01a4ba22 17e03026 11483402 .....
0040 00130811 0033a30a 14008149 0cab6130 .....
0050 00000000 00000000 00000000 00000000 .....
0060 15a3a816 0012be0a 06000046 01080400 .....
0070 00a2342c 07f7b83a 15729dd2 05580601 .....
0080 1a22a616 7072b91a 46304a44 06887400 .....
0090 25a33b12 01a4ba22 17e03026 11483402 .....
00a0 00130811 0033a30a 14008149 0cab6130 .....
00b0 1a22a616 7072b91a 46304a44 06887400 .....
00c0 25a33b12 01a4ba22 17e03026 11483402 .....
00d0 00130811 0033a30a 14008149 0cab6130 .....
00e0 00000000 00000000 00000000 00000000 .....
00f0 15a3a816 0012be0a 06000046 01080400 .....
0100 00a2342c 07f7b83a 15729dd2 05580601 .....
0110 1a22a616 7072b91a 46304a44 06887400 .....
0120 25a33b12 01a4ba22 17e03026 11483402 .....

```

Report Date:03-01-23 Time:12:20:45

;

rtrv-obit:loc=1115

Command Accepted - Processing

```
stdcfg1b 05-06-13 16:32:30 EST EAGLE 34.0.0
NOTICE: Only 7 obit(s) to retrieve in the log.
```

;

```
stdcfg1b 05-06-13 16:32:30 EST EAGLE 34.0.0
```

```
-----
STH: Received a BOOT IMT-Obituary reply for restart
Card 1103 Module ATH_386A.ASM Line 988 Class 0400
Register Dump :
    EFL=00000246   CS =0058       EIP=0041cf03   SS =0060
    EAX=00000046   ECX=00000000   EDX=005245d9   EBX=00000001
    ESP=00483f80   EBP=00483f88   ESI=00000000   EDI=00000000
    DS =0060       ES =0060       FS =0060       GS =0060

Stack Dump :
[SP+1E]=0048   [SP+16]=0000   [SP+0E]=0041   [SP+06]=0000
[SP+1C]=3fd0   [SP+14]=0001   [SP+0C]=cecc   [SP+04]=0000
[SP+1A]=0048   [SP+12]=0000   [SP+0A]=0048   [SP+02]=0041
[SP+18]=3fbc   [SP+10]=0a0a   [SP+08]=3f9c   [SP+00]=e600
```

```
Report Date:05-06-10 Time:19:20:55
```

;

```
stdcfg1b 05-06-13 16:32:31 EST EAGLE 34.0.0
```

```
-----
STH: Received a BOOT IMT-Obituary reply for restart
Card 1209 Module sds_arm_send Line 356 Class 0001
StrongARM Core Register Dump (1 of 1): [Overall: 1 of 6]

SYSTEM MODE REGISTERS:
r0 = 00116bd4   r1 = 00000164   r2 = 00000001   r3 = 00000003
r4 = 00f5f3f0   r5 = 00000000   r6 = 0000001f   r7 = 001251a0
r8 = 00177be0   r9 = 10ffbfcc   r10= 00118b74   r11= 00000000
r12= 642b0002   sp = 000cffa8   lr = 00116b88   pc = 00102424
cpsr=400000df
```

Register Dump 2 is empty

```
Report Date:05-06-13 Time:16:30:42
```

;

```
stdcfg1b 05-06-13 16:32:33 EST EAGLE 34.0.0
```

```
-----
STH: Received a BOOT IMT-Obituary reply for restart
Card 1209 Module sds_arm_send Line 356 Class 0001
StrongARM Core Stack Dump (1 of 1): [Overall: 2 of 6]

SYSTEM MODE STACK (Length=192):
0000 00e00000 00000007 00e00000 00102ab0 .....*..
0010 00178698 00000000 000000f8 000cff08 .....
0020 00000001 00116bd4 00000164 00000001 ....k..d.....
0030 000cff68 00000000 00000000 0000001f h.....
0040 001251a0 00177be0 10ffbfcc 00118b74 .Q...{.....t...
0050 00000000 00102468 00000000 00000000 ....h$......
```

```
0060 000cffa8 00116bd4 00000164 00000001 .....k..d.....
0070 00000003 00f5f3f0 00000000 0000001f .....
0080 001251a0 00177be0 10ffbfcc 00118b74 .Q...{.....t...
0090 00000000 642b0002 00116b88 00102424 .....+d.k..$$..
00a0 00000000 00000000 0000001f 00115e10 .....^..
00b0 00177c4c 00177bf0 0000001f 00125268 L|...{.....hR..
```

;

```
stdcfg1b 05-06-13 16:32:34 EST EAGLE 34.0.0
Stack Dump 2 is empty
```

```
Report Date:05-06-13 Time:16:30:42
```

;

```
stdcfg1b 05-06-13 16:32:35 EST EAGLE 34.0.0
```

```
-----
STH: Received a BOOT IMT-Obituary reply for restart
Card 1209 Module sds_arm_send Line 356 Class 0001
User Data Dump (1 of 1): [Overall: 3 of 6]
```

User Data is empty

```
Report Date:05-06-13 Time:16:30:42
```

;

```
stdcfg1b 05-06-13 16:32:36 EST EAGLE 34.0.0
```

```
-----
STH: Received a BOOT IMT-Obituary reply for restart
Card 1209 Module sds_arm_send Line 356 Class 0001
EP9312 Register Dump (1 of 2): [Overall: 4 of 6]
```

***** DMA Registers *****

DMA_CTRL_M2M0=	0608d40c	DMA_INTR_STAT_M2M0=	00000000
DMA_STAT_M2M0=	00000000	DMA_BCR0_M2M0=	0608d40c
DMA_BASE_SRC0_M2M0=	00000000	DMA_CRNT_SRC0_M2M0=	00000000
DMA_BASE_DSTN0_M2M0=	00000000	DMA_CRNT_DSTN0_M2M0=	00000000
DMA_BCR1_M2M0=	000001fc	DMA_BASE_SRC1_M2M0=	00000000
DMA_CRNT_SRC1_M2M0=	00000000	DMA_BASE_DSTN1_M2M0=	00000000
DMA_CRNT_DSTN1_M2M0=	00000000		
DMA_CTRL_M2M1=	0608d40c	DMA_INTR_STAT_M2M1=	00000000
DMA_STAT_M2M1=	00000000	DMA_BCR0_M2M1=	00000000
DMA_BASE_SRC0_M2M1=	00000000	DMA_CRNT_SRC0_M2M1=	00000000
DMA_BASE_DSTN0_M2M1=	00000000	DMA_CRNT_DSTN0_M2M1=	00000000
DMA_BCR1_M2M1=	00000000	DMA_BASE_SRC1_M2M1=	00000000
DMA_CRNT_SRC1_M2M1=	00000000	DMA_BASE_DSTN1_M2M1=	00000000
DMA_CRNT_DSTN1_M2M1=	00000000		
DMA_ACTIVE_INTR=	00000000		

***** TIMER Registers *****

TMR1_CURR_VALUE=	00000000	TMR1_CTRL_REG=	00000000
TMR1_LOAD_REG=	00000000	TMR2_CURR_VALUE=	00000000
TMR2_CTRL_REG=	00000000	TMR2_LOAD_REG=	00000000
TMR3_CURR_VALUE=	00000001	TMR3_CTRL_REG=	000000d5
TMR3_LOAD_REG=	00000001	TMR4_VALUE_LOW=	413c60f3
TMR4_VALUE_HI=	0000015f		

***** SYSCON Registers *****

PWRSTS=	4320ace3	PWRCNT=	0c000000
CLKSET1=	00a5a127	CLKSET2=	0003c317

```

SCRATCH0=          00000040    SCRATCH1=          00000000
DEVCFG=            6902090e    CHIP_ID=           34009213
SYSCFG=            340000d6    APB_WAIT=          00000001
ARB_REG=           00000000    VID_REG=           00000000
MIR_REG=           00000000    I2S_REG=           00000000
TCH_REG=           00000000
    
```

***** GPIO Registers *****

```

PADR=              0000007f    PBDR=              000000e9
PCDR=              000000c0    PDDR=              000000c4
PEDR=              00000000    PFDR=              000000ff
PGDR=              00000002    PHDR=              0000007f
PADDR=             00000000    PBDDR=             00000009
PCDDR=             000000fb    PDDDR=             000000fb
PEDDR=             00000003    PFDDR=             00000000
PGDDR=             0000000c    PHDDR=             00000007
PA_TYPE1=          00000000    PB_TYPE1=          00000080
PF_TYPE1=          00000000    PA_TYPE2=          00000000
PB_TYPE2=          00000000    PF_TYPE2=          00000000
PA_INT_EN=         00000000    PB_INT_EN=         00000080
PF_INT_EN=         00000000    PA_RAW_STAT=       00000080
PB_RAW_STAT=       0000001f    PF_RAW_STAT=       00000000
PA_INT_STAT=       00000000    PB_INT_STAT=       00000000
PF_INT_STAT=       00000000    PA_DB=             00000000
PB_DB=             00000000    PF_DB=             00000000
EE_REG=            00000000
    
```

***** Coprocessor 15 Registers *

```

ID_CODE_CP15_0=    41129200    CACHE_CODE_CP15_0= 0d172172
CONTROL_CP15_1=    c000107d    TRANS_BASE_TBL_CP15_2=10ffc000
DOMAIN_ACCESS_CP15_3= ffffffff    FAULT_STATUS_CP15_5= 0000000d
FAULT_PREFETCH_CP15_5=000000fa    FAULT_ADDR_CP15_6=  d3b765e8
CACHE_OPER_CP15_7= 00000000    TLB_OPER_CP15_8=    00000000
DCACHE_LOCKDN_CP15_9= 00000000    ICACHE_LOCKDN_CP15_9= 00000000
D_TLB_LOCKDN_CP15_10= 00b00000    I_TLB_LOCKDN_CP15_10= 00200000
FCSE_PID_CP15_13= 00000000
    
```

Report Date:05-06-13 Time:16:30:42

;

stdcfg1b 05-06-13 16:32:40 EST EAGLE 34.0.0

STH: Received a BOOT IMT-Obituary reply for restart
 Card 1209 Module sds_arm_send Line 356 Class 0001
 EP9312 Register Dump (2 of 2): [Overall: 5 of 6]

***** VIC Registers *****

```

VIC_1_IRQ_STATUS= 00000000    VIC_1_FIQ_STATUS= 00000000
VIC_1_RAW_INTR=   25000008    VIC_1_INT_SELECT= 00000000
VIC_1_INT_ENABLE= 00060000    VIC_1_SOFT_INT=   00000000
VIC_1_SOFT_INT_CLEAR= 00000000
VIC_2_IRQ_STATUS= 00000000    VIC_2_FIQ_STATUS= 00000000
VIC_2_RAW_INTR=   0000021b    VIC_2_INT_SELECT= 00080000
VIC_2_INT_ENABLE= 08080004    VIC_2_SOFT_INT=   00000000
VIC_2_SOFT_INT_CLEAR= 00000000
    
```

***** SMC Registers *****

```

BANK_CONFIG0=      70001c80    BANK_CONFIG1=      70001420
BANK_CONFIG2=      40001480    BANK_CONFIG3=      70000400
    
```

```

BANK_CONFIG6=          70001440    BANK_CONFIG7=          70001440

***** UART3 Registers *****
LINE_CTRL_LOW=         00000003    LINE_CTRL_MID=         00000000
LINE_CTRL_HIGH=        00000074    CTRL_REG=              00000001
STATUS_REG=            00000000    FLAGS_REG=             00000090
DATA_REG=              00000020

***** Watchdog Registers *****
WDOG_REG=              00806c69

Report Date:05-06-13   Time:16:30:42
-----
;

stdcfg1b 05-06-13 16:32:42 EST  EAGLE  34.0.0
-----
STH: Received a BOOT IMT-Obituary reply for restart
Card 1209  Module sds_arm_send  Line 356  Class 0001
SIFB Register Dump (1 of 1):  [Overall: 6 of 6]

***** BCM5630 Switch0 Registers *****
Switch0 Port0 Status= 00c06c00    Switch0 Port1 Status= 00c06c00
Switch0 Port2 Status= 00806c00    Switch0 Port3 Status= 00806c00
Switch0 Port4 Status= 00806c00    Switch0 Port5 Status= 00806c00
Switch0 Port6 Status= 00806c00    Switch0 Port7 Status= 00800000
Switch0 Port12 Status=00806c00

***** BCM5630 Switch1 Registers *****
Switch1 Port0 Status= 00806c00    Switch1 Port1 Status= 00806c00
Switch1 Port2 Status= 00806c00    Switch1 Port3 Status= 00806c00
Switch1 Port4 Status= 00806c00    Switch1 Port5 Status= 00806c00
Switch1 Port6 Status= 00806c00    Switch1 Port7 Status= 00806c00
Switch1 Port8 Status= 00806c00    Switch1 Port9 Status= 00806c00
Switch1 Port10 Status=00806c00    Switch1 Port11 Status=00800000
Switch1 Port12 Status=aaaaaa00

Report Date:05-06-13   Time:16:30:43
-----
;

```

rtrv-prefix**Retrieve Prefix**

Use this command to retrieve provisioned prefix information for all supported features or for a specified feature.

Keyword: rtrv-prefix

Related Commands: chg-prefix, dlt-prefix, rtrv-ctrl-feat

Command Class: Database Administration

Parameters

:feature= (optional)

Feature Name. This parameter specifies the name of an enabled controlled feature that is supported by this command. The parameter value must match the feature name as it is displayed in the **rtrv-ctrl-feat** command output.

- Range:** 1 alphabetic character and up to 24 optional alphanumeric characters and spaces, enclosed in double quotation marks.
- The parameter value is not case-sensitive; upper case or lower case or both can be entered.
- Part or all of the feature name can be entered. If part of the feature name is specified, the entry must start with the first letter of the name, and must contain enough of the name to uniquely identify the feature. For example, there are two feature names that begin with "GSM MAP." Enough additional characters to identify which GSM MAP feature is being entered (at least "GSM MAP SR" to identify the "GSM MAP SRI Redirect" feature). This command supports the following controlled features:
- GSM MAP SRI Redirect
 - ISUP NP for EPAP
 - Prepaid IDP Query Relay

Example

Retrieve provisioned prefix information for all supported features.

rtrv-prefix

Retrieve prefix information for the GSM MAP SRI Redirect feature.

rtrv-prefix:feature="GSM MAP SRI Redirect"

Dependencies

The specified feature name must be the name of an enabled controlled feature as it is displayed in the **rtrv-ctrl-feat** command output; The specified feature must be one of the following features that are supported by this command:

- GSM MAP SRI Redirect
- ISUP NP for EPAP
- Prepaid IDP Query Relay

Notes

None

Output

The **rtrv-prefix** command retrieves the provisioned prefix information for all supported features. The Function column identifies the entries for prefix numbers 6 and 7 used by the ISUP NP with EPAP feature.

rtrv-prefix

```
rlghncxa03w 05-09-20 09:04:14 EST EAGLE 34.1.0
Feature                NUM  Prefix          Function
-----
GSM MAP SRI Redirect   1    1a1a
GSM MAP SRI Redirect   2    ffff
GSM MAP SRI Redirect   3    1234
ISUP NP with EPAP      1    3b4c
ISUP NP with EPAP      6    886              Insertion Country Code
ISUP NP with EPAP      7    0                Deletion Condition
Prepaid IDP Query Relay 1    123              Intl Insert Prefix
```

```

Prepaid IDP Query Relay 2 456          Natl Insert Prefix
Prepaid IDP Query Relay 3 1           CDPN NAI Incoming
Prepaid IDP Query Relay 4 1           CGPA DEF CC Check On

```

```
FEATPFX table is (10 of 256) 3% full
```

```
;
```

Retrieve provisioned prefix information for the GSM MAP SRI Redirect feature. The table capacity line reports the total number of entries in use and not just the number of entries displayed.

rtrv-prefix:feature="gsm map sri redirect"

```
rlghncxa03w 04-09-20 09:04:14 EST EAGLE 31.11.0
```

Feature	NUM	Prefix	Function
GSM MAP SRI Redirect	1	1a1a	
GSM MAP SRI Redirect	2	ffff	
GSM MAP SRI Redirect	3	1234	

```
FEATPFX table is (3 of 256) 1% full
```

```
;
```

rtrv-pstn-pres

Retrieve PSTN Presentation Parameters

Use this command to display PSTN Presentation parameters supported by the IP⁷ Secure Gateway. This command provides a summary of the available values for the PSTNCAT and PSTNID parameters used in SS7 routing key commands and ISUP Normalization Administration commands.

Keyword: rtrv-pstn-pres

Related Commands: chg-appl-rtkey, chg-isupvar-attrib, chg-pstn-pres, dlt-pstn-pres, ent-pstn-pres, rtrv-appl-rtkey

Command Class: Database Administration

Parameters

This command has no parameters.

Example

```
rtrv-pstn-pres
```

Dependencies

The ISUP Normalization controlled feature must be enabled.

Notes

All the *Tekelec-defined* and *user-defined* PSTNs will be displayed.

NOTE: An asterisk (*) will be displayed next to the PSTN Category for the following reasons:

- The ETSIV3 Variant before it has its controlled feature enabled
- Variants that are no longer usable. These are Variants that are disabled because their temporary feature key expired. The user should either get a permanent feature key for the Variant or use the **dlt-pstn-pres** command to remove the Variant.

Output

rtrv-pstn-pres

rlghncxa03w 03-03-07 12:05:33 EST EAGLE 31.3.0

PSTNCAT Value(s)	PSTNCAT Description	Valid PSTNID Value(s) in PSTNCAT
0	Default value	0 = Default Value
1	PSTN formats supported by Tekelec IP7 SG ISUP	0 = Reserved 1 = ITU Q.767
	Normalization function	2 = ETSI V3 3 = UK PNO-ISC7 4 = GERMAN ISUP
2-4095	Reserved	--
4096-65535	User Defined	0-65535 = User Defined

=====

;

rtrv-rmt-appl

Retrieve Remote Application

Use this command to retrieve a list of remote application assignments.

Keyword: rtrv-rmt-appl

Related Commands: ent-rmt-appl, dlt-rmt-appl

Command Class: Database Administration

Parameters

This command has no parameters.

Example

rtrv-rmt-appl

Dependencies

None

Notes

None

Output**rtrv-rmt-appl**

```

rlghncxa03w 05-01-07 12:05:33 EST EAGLE 31.12.0
IPCA          SI SSN
003-003-003   3 100, 110-119, 200
               5
IPCI          SI SSN
3-003-3       3 5, 50-100, 250
               5

IPCN          SI SSN
16380         3 250
               5

IPCN24        SI SSN
100-200-100   5

```

;

rtrv-rmt-appl

```

rlghncxa03w 05-01-07 12:05:33 EST EAGLE 31.12.0
IPCA          SI SSN
p-001-001-001 3 5-102

IPCI          SI SSN
ps-2-002-2    5

IPCN          SI SSN
s-16380       3 250

IPCN24        SI SSN

```

;

Legend

IPC/IPCA/IPCI/IPCN/IPCN24—End node's internal point code.

SI—Service indicator value that designates which user part is assigned to the IPC.

SSN—SCCP subsystem number.

Point code subtype prefixes—

s- Spare point code

p- Private point code

ps- Private and spare point code

rtrv-rte**Retrieve Route**

Use this command to show the parameter information for a route.

Keyword: rtrv-rte

Related Commands: dlt-rte, ent-rte, rept-stat-dstn

Command Class: Database Administration

Parameters

NOTE: See “Point Code Formats and Conversion” in Appendix A for a detailed description of point code formats, rules for specification, and examples.

:cli= (optional)

The Common Language Location Identifier assigned to this link.

Range: 1 alphabetic character followed by 10 alphanumeric characters

Default: No value given

:dpc/dpca/dpci/dpcn/dpcn24= (optional)

Destination point code.

:dpc= or **:dpca=** (optional)

ANSI destination point code with subfields network indicator-network cluster-network cluster member (*ni-nc-ncm*). The *prefix* subfield indicates a private point code (*prefix-ni-nc-ncm*).

Range: **p-**, **000-255**, *****

Specify a valid value for each subfield of the point code, and separate the subfields with a dash (-).

prefix—**p-**

The asterisk (*) value is not valid for the *ni* subfield.

When **chg-sid:pctype=ansi** is specified, *ni* = **000** is not valid.

When **chg-sid:pctype=ansi** is specified, *nc* = **000** is not valid if *ni* = **001-005**.

When **chg-sid:pctype=ansi** is specified, *nc* = **000** is valid if *ni* = **006-255**.

When **chg-sid:pctype=ansi** is specified, *ni*^{*}-* is valid if *ni* = **006-255**.

The point code **000-000-000** is not a valid point code.

:dpci= (optional)

ITU international point code with subfields *zone-area-id*. The *prefix* subfield indicates a spare point code, private point code, or private and spare point code (*prefix-zone-area-id*).

Range: **s-**, **p-**, **ps-**, **0-255**

Specify a valid value for each subfield of the point code, and separate the subfields with a dash (-).

prefix—**s-**, **p-**, **ps-**

zone—**0-7**

area—**000-255**

id—**0-7**

The point code **0-000-0** is not a valid point code.

:dpcn= (optional)

ITU national point code in the format of a 5-digit number (*nnnnn*); or 2, 3, or 4 numbers (members) separated by dashes (*m1-m2-m3-m4*) as defined by the **chg-stpopts:npcfmti** flexible point code option. A group code must be specified when the ITUDUPPC feature is turned on (*nnnnn-gc*, *m1-m2-m3-m4-gc*). The *prefix* subfield indicates a spare point code, private point code, or private and spare point code (*prefix-nnnnn*, *prefix-nnnnn-gc*, *prefix-m1-m2-m3-m4*, *prefix-m1-m2-m3-m4-gc*).

Range: **s-, p-, ps-, 0-16383, aa-zz**

Specify a valid value for each subfield of the point code, and separate the subfields with a dash (-).

prefix—**s-, p-, ps-**

nnnnn—**0-16383**

gc—**aa-zz**

m1-m2-m3-m4—**0-14** for each member; values must sum to 14

:dpcn24= (optional)

24-bit ITU national point code with subfields *main signaling area-sub signaling area-signaling point (msa-ssa-sp)*. The *prefix* indicates a private point code (*prefix-msa-ssa-sp*).

Range: **p-, 000-255**

Specify a valid value for each subfield of the point code, and separate the subfields with a dash (-).

prefix—**p-**

msa—**000-255**

ssa—**000-255**

sp—**000-255**

:lsn= (optional)

Linkset name

Range: 1 alphabetic character followed by up to 9 alphanumeric characters

Default: Display all

:pcst= (optional)

Point code subtype. Display only the point codes that have no subtype prefix, or display only the point codes that have the specified subtype prefix.

Range: **none, s, p, ps**

none—Display all point codes that do not have subtype prefixes

s—Display only spare point codes

p—Display only private point codes

ps—Display only private and spare point codes

:pctype= (optional)

Point code domain. Display only the point codes that are of the specified domain type (ANSI, ITU international, ITu national, or 24-bit ITU national).

Range: **ansi, itui, itun, itun24**

Example

```
rtrv-rte
```

```
rtrv-rte:lsn=ls000001
```

```
rtrv-rte:dpc=240-012-004:lsn=ls000001
```

```
rtrv-rte:cli=dp1:lsn=ls000001
```

```
rtrv-rte:dpc=140-012-008
```

```
rtrv-rte:cli=dp1rtrv-rte
```

```
rtrv-rte:dpcn=3-15-15-15-fr
```

```
rtrv-rte:lsn=e1m3itun
```



```
rtrv-rte:dpcn24=10-100-14
rtrv-rte:pcst=s
rtrv-rte:pcst=none
rtrv-rte:pcst=p
rtrv-rte:pcst=ps
rtrv-rte:pctype=ansi
rtrv-rte:pctype=itun
rtrv-rte:pctype=itui:pcst=ps
rtrv-rte:pctype=itun24:pcst=none
```

Dependencies

The DPC must be in the destination point code table.

If the **dpc** and **lsn** parameters are specified, the linkset name must be defined as a route.

The destination point code of a route must be a full point code (*ni-nc-ncm*), a cluster point code (*ni-nc-**), or a network point code (*ni-*-**).

If the **dpcn** parameter is specified, its format must match the format that was assigned with the **chg-stpopts** command **npcfmti** parameter.

The **pcst** parameter value **s** or **ps** cannot be specified when the **pctype** value **ansi** or **itun24** is specified.

The **pctype** and **pcst** parameters cannot be specified in the same command with the destination point code, alias point code, secondary point code, **cli**, **msar=only**, and **ncai** parameters.

Network routing is valid only if the NRT feature is on. The NRT feature is turned on with the **chg-feat** command.

When using network routing, if the destination point code has a value of * in the NC field, the NCM field must also be * (for example, **dpc=21-*-***).

Notes

This command can be canceled using the **F9** function key or the **canc-cmd** command. See **canc-cmd** for more information.

In this command, only ITU-international and ITU national point codes support the spare point code subtype prefix (**s-**) and the private and spare point code subtype prefix (**ps-**). All of the point code types support the private (internal) point code subtype prefix (**p-**).

Output

rtrv-rte

```

rlghncxa03w 03-11-07 12:05:33 EST EAGLE 31.3.0
DPCA      ALIASI  ALIASN/N24  CLLI      LSN      RC APCA
001-001-002 -----
001-001-003 -----
001-001-004 -----
001-001-005 -----
001-001-006 -----
001-001-007 -----
001-001-008 -----
001-001-009 -----
020-002-* -----
001-003-001 -----
009-008-007 -----
009-008-009 -----
008-008-008 -----
111-222-111 -----
DPCI      ALIASN/N24  ALIASA  CLLI      LSN      RC APC
1-001-4 -----
7-255-7 -----
1-222-1 -----

DPCN      ALIASA  ALIASI  CLLI      LSN      RC APC
02-00-02-2-aa -----
15-15-15-3-aa -----
01-15-15-3-aa -----
02-00-00-0-aa -----
13-04-02-3-aa -----
13-04-02-2-aa -----
04-15-11-1-aa -----
05-00-02-3-aa -----
04-15-11-1-dd -----

DPCN24    ALIASA  ALIASI  CLLI      LSN      RC APC

```

;

Output when the table is empty.

rtrv-rte

```

rlghncxa03w 03-11-07 12:05:33 EST EAGLE 31.3.0
DPCA      ALIASI  ALIASN/N24  CLLI      LSN      RC APCA
DPCI      ALIASN/N24  ALIASA  CLLI      LSN      RC APCI
DPCN      ALIASA  ALIASI  CLLI      LSN      RC APCN
DPCN24    ALIASA  ALIASI  CLLI      LSN      RC APC

```

;

rtrv-rte:lsn=1s2

```

rlghncxa03w 03-03-07 12:05:33 EST EAGLE 31.3.0
LSN      DPCA      RC
ls2      001-056-003 10

```

;

rtrv-rte:dpc=001-056-003:lsn=ls2

```

rlghncxa03w 03-03-07 12:05:33 EST EAGLE 31.3.0
LSN      DPCA      RC
ls2      001-056-003 10

```

;

In the following example, the NPCFMTI is set to 7-4-3.

rtrv-rte:dpcn=127-15-7 (where the chg-stpopts:npcfnti parameter is set to 7-4-3)

```
rlghncxa03w 02-03-07 12:05:33 EST EAGLE 30.0.0
DPCN          ALIASA          ALIASI          CLLI          LSN          RC APCN
127-15-7     -----          6-100-1        -----          ls1          10 100-10-2
;
```

In the following example, the NPCFMTI is set to 11-1-1-1 and ITUDUPPC is on.

rtrv-rte:lsn=ls3

```
rlghncxa03w 03-03-07 12:05:33 EST EAGLE 31.3.0
LSN          DPCN          RC
ls3          2000-1-1-1      10
;
```

In the following example, the NPCFMTI is set to 2-4-4-4 and ITUDUPPC is on.

rtrv-rte:dpcn=3-15-15-15-fr

```
rlghncxa03w 02-03-07 12:05:33 EST EAGLE 30.0.0
DPCN          ALIASA          ALIASI          CLLI          LSN          RC APCN
3-15-15-15-fr -----          -----          -----          elm2itun     10 3-15-15-15-fr
;
```

In the following example, the NPCFMTI is set to 11-1-1-1 and ITUDUPPC is on.

rtrv-rte:lsn=e1m3itun

```
LSN          DPCN          RC
e1m3itun     2047-1-1-1-pe 10
;
```

The following example contains 24-bit ITU-N DPC 010-100-014.

rtrv-rte:lsn=ls1013

```
rlghncxa03w 02-03-07 12:05:33 EST EAGLE 31.0.0

DPCN24          ALIASA          ALIASI          CLLI          LSN          RC APC
010-100-014     -----          -----          -----          ls1013       10 010-100-001
;
```

```
DPCA          ALIASI  ALIASN/N24          CLLI          LSN          RC APCA
001-001-002     -----          -----          -----          ls11234567  10 001-001-002
001-001-003     -----          -----          -----          ls11345678  10 001-001-003
001-001-004     -----          -----          -----          ls11345679  10 001-001-004
001-001-005     -----          -----          -----          -----          -- -----
001-001-006     -----          -----          -----          -----          -- -----
001-001-007     -----          -----          sillyseas7    ls11345     10 001-001-007
001-001-008     -----          -----          sillyseas8    ls113467   10 001-001-008
001-001-009     -----          -----          sillyseas9    ls1134     10 001-001-009
020-002-*       -----          -----          -----          -----          -- -----
001-003-001     -----          -----          -----          -----          -- -----
009-008-007     -----          -----          seas987       -----          -- -----
009-008-009     -----          -----          seas989       -----          -- -----
008-008-008     -----          -----          -----          -----          -- -----
111-222-111     -----          -----          -----          -----          -- -----
DPCI          ALIASN/N24          ALIASA          CLLI          LSN          RC APC
1-001-4         -----          -----          -----          -----          -- -----
7-255-7         -----          -----          -----          -----          -- -----
1-222-1         -----          -----          -----          -----          -- -----
```

The following examples contain spare, private, and private and spare point codes.

rtrv-rte:pctype=ansi

```

rlghncxa03w 05-01-07 12:05:33 EST EAGLE 31.12.0
  DPCA          ALIASI      ALIASN/N24    LSN          RC      APCA
001-001-002 -----
                                CLLI=-----
p-001-002-004 -----
                                CLLI=-----
008-001-001 -----
                                CLLI=systest1
020-001-* -----
                                CLLI=systest2
100-101-001   1-190-1 -----
                                CLLI=-----
100-101-002   s-1-012-1 -----
                                CLLI=-----
100-101-003 -----          0-0-0-0123-aa -----
                                CLLI=-----
100-101-004 -----          s-0-0-0-0123-aa -----
                                CLLI=-----
p-002-200-001 -----
                                CLLI=-----
p-002-003-001 -----
                                CLLI=-----
p-001-002-005 -----
                                CLLI=-----
p-001-002-006 -----
                                CLLI=-----
p-001-002-007 -----
                                CLLI=-----
p-001-002-008 -----
                                CLLI=-----
p-012-230-001 -----
                                CLLI=-----
012-230-001 -----
                                CLLI=-----
p-123-134-014 -----
                                CLLI=-----
123-134-014 -----
                                CLLI=-----
p-129-234-001 -----
                                CLLI=-----

```

;

rtrv-rte:pctype=itui

```

rlghncxa03w 05-01-07 12:05:33 EST EAGLE 31.12.0
  DPCI      ALIASN/N24      ALIASA      LSN      RC      APC
s-2-002-1 -----
                                     CLLI=-----
s-2-002-2 -----          001-001-003 -----
                                     CLLI=-----
s-1-002-3 -----          ----- lsn1      1      s-1-002-3
                                     lsn4      1      s-2-012-1
                                     lsn5      2      2-100-1
                                     lsn6      3      s-3-134-1
                                     lsn2     10      s-2-002-2
                                     lsn3     13      s-2-100-1
                                     CLLI=-----
ps-2-100-1 -----
                                     CLLI=-----
s-2-100-1 -----
                                     CLLI=-----
  2-100-1 -----
                                     CLLI=-----
p-2-120-1 -----
                                     CLLI=-----
p-7-100-1 -----
                                     CLLI=-----
s-7-100-1 -----
                                     CLLI=-----
ps-7-129-2 -----
                                     CLLI=-----
ps-4-012-1 -----
                                     CLLI=-----
p-2-012-1 -----
                                     CLLI=-----
s-2-012-1 -----
                                     CLLI=-----
s-3-134-1 -----
                                     CLLI=-----
p-3-134-1 -----
                                     CLLI=-----
ps-3-134-1 -----
                                     CLLI=-----
ps-5-120-1 -----
                                     CLLI=-----
s-5-120-1 -----
                                     CLLI=-----
p-5-120-1 -----
                                     CLLI=-----

```

;

rtrv-rte:pctype=itun

```

rlghncxa03w 05-01-07 12:05:33 EST EAGLE 31.12.0
  DPCN          ALIASA          ALIASI  LSN          RC      APC
ps-1-1-1-2047-aa    100-120-120  s-1-123-1  -----  --  -----
                                           CLLI=-----
ps-1-1-1-2046-aa  -----  -----  -----  --  -----
                                           CLLI=-----
ps-1-1-1-2045-aa  -----  -----  -----  --  -----
                                           CLLI=-----
ps-1-1-1-2044-aa  -----  -----  -----  --  -----
                                           CLLI=-----
ps-0-0-0-0323-aa  -----  -----  -----  --  -----
                                           CLLI=-----
s-0-0-0-0323-aa  -----  -----  -----  --  -----
                                           CLLI=-----
p-0-0-0-0323-aa  -----  -----  -----  --  -----
                                           CLLI=-----
  0-0-0-0323-aa  -----  -----  -----  --  -----
                                           CLLI=-----
  0-0-0-1298-aa  -----  -----  -----  --  -----
                                           CLLI=-----
p-0-0-0-1298-aa  -----  -----  -----  --  -----
                                           CLLI=-----
s-0-0-0-1298-aa  -----  -----  -----  --  -----
                                           CLLI=-----
ps-0-0-0-1298-aa  -----  -----  -----  --  -----
                                           CLLI=-----
p-1-1-0-0057-aa  -----  -----  -----  --  -----
                                           CLLI=-----
p-1-1-1-0058-aa  -----  -----  -----  --  -----
                                           CLLI=-----
p-1-1-1-0059-aa  -----  -----  -----  --  -----
                                           CLLI=-----
ps-1-1-1-0059-aa  -----  -----  -----  --  -----
                                           CLLI=-----
p-1-1-1-0060-aa  -----  -----  -----  --  -----
                                           CLLI=-----
p-1-1-1-0061-aa  -----  -----  -----  --  -----
                                           CLLI=-----
p-1-1-1-0125-aa  -----  -----  -----  --  -----
                                           CLLI=-----
p-1-1-1-0125-xy  -----  -----  -----  --  -----
                                           CLLI=-----
p-1-1-1-0126-xy  -----  -----  -----  --  -----
                                           CLLI=-----
p-1-1-1-0126-aa  -----  -----  -----  --  -----
                                           CLLI=-----
p-1-1-1-0127-bb  -----  -----  -----  --  -----
                                           CLLI=-----
ps-1-1-1-0234-aa  -----  -----  -----  --  -----
                                           CLLI=wearehereto
ps-1-1-1-0235-aa  -----  -----  -----  --  -----
                                           CLLI=longclinam
  1-1-1-0235-aa  -----  -----  -----  --  -----
                                           CLLI=-----
s-1-1-1-0235-aa  -----  -----  -----  --  -----
                                           CLLI=-----
ps-1-0-1-0123-aa  -----  -----  -----  --  -----
                                           CLLI=-----
p-1-1-1-0122-aa  -----  -----  -----  --  -----
                                           CLLI=-----

```

```

s-1-1-1-0122-aa -----
                                           CLLI=-----
ps-1-1-1-0122-aa -----
                                           CLLI=-----
ps-1-1-1-0123-aa -----
                                           CLLI=-----
s-1-1-1-0123-aa -----
                                           CLLI=-----
p-1-1-1-0123-aa -----
                                           CLLI=-----

```

;

rtrv-rte:pctype=ansi:pcst=p

```

rlghncxa03w 05-01-07 12:05:33 EST EAGLE 31.12.0
  DPCA          ALIASI      ALIASN/N24    LSN          RC      APCA
p-001-002-004 -----
                                           CLLI=-----
p-002-200-001 -----
                                           CLLI=-----
p-002-003-001 -----
                                           CLLI=-----
p-001-002-005 -----
                                           CLLI=-----
p-001-002-006 -----
                                           CLLI=-----
p-001-002-007 -----
                                           CLLI=-----
p-001-002-008 -----
                                           CLLI=-----
p-012-230-001 -----
                                           CLLI=-----
p-123-134-014 -----
                                           CLLI=-----
p-129-234-001 -----
                                           CLLI=-----

```

;

rtrv-rte:pctype=itui:pcst=ps

```

rlghncxa03w 05-01-07 12:05:33 EST EAGLE 31.12.0
  DPCI          ALIASN/N24    ALIASA      LSN          RC      APC
ps-2-100-1 -----
                                           CLLI=-----
ps-7-129-2 -----
                                           CLLI=-----
ps-4-012-1 -----
                                           CLLI=-----
ps-3-134-1 -----
                                           CLLI=-----
ps-5-120-1 -----
                                           CLLI=-----

```

;

rtrv-rte:pctype=itun:pcst=s

```

rlghncxa03w 05-01-07 12:05:33 EST EAGLE 31.12.0
  DPCN          ALIASA          ALIASI  LSN          RC          APC
s-0-0-0-0323-aa -----
                                           CLLI=-----
s-0-0-0-1298-aa -----
                                           CLLI=-----
s-1-1-1-0235-aa -----
                                           CLLI=-----
s-1-1-1-0122-aa -----
                                           CLLI=-----
s-1-1-1-0123-aa -----
                                           CLLI=-----

```

;

rtrv-rte:pcst=none

```

rlghncxa03w 05-01-07 12:05:33 EST EAGLE 31.12.0
  DPCA          ALIASI          ALIASN/N24  LSN          RC          APCA
001-001-002 -----
                                           CLLI=-----
008-001-001 -----
                                           CLLI=systest1
020-001-* -----
                                           CLLI=systest2
100-101-001  1-190-1 -----
                                           CLLI=-----
100-101-002  s-1-012-1 -----
                                           CLLI=-----
100-101-003 ----- 0-0-0-0123-aa -----
                                           CLLI=-----
100-101-004 ----- s-0-0-0-0123-aa -----
                                           CLLI=-----
012-230-001 -----
                                           CLLI=-----
123-134-014 -----
                                           CLLI=-----

  DPCI          ALIASN/N24          ALIASA      LSN          RC          APC
2-100-1 -----
                                           CLLI=-----

  DPCN          ALIASA          ALIASI  LSN          RC          APC
0-0-0-0323-aa -----
                                           CLLI=-----
0-0-0-1298-aa -----
                                           CLLI=-----
1-1-1-0235-aa -----
                                           CLLI=-----

```

;

rtrv-rte:pcst=p

```

rlghncxa03w 05-01-07 12:05:33 EST EAGLE 31.12.0
  DPCA          ALIASI      ALIASN/N24    LSN          RC      APCA
p-001-002-004 -----
                                CLLI=-----
p-002-200-001 -----
                                CLLI=-----
p-002-003-001 -----
                                CLLI=-----
p-001-002-005 -----
                                CLLI=-----
p-001-002-006 -----
                                CLLI=-----
p-001-002-007 -----
                                CLLI=-----
p-001-002-008 -----
                                CLLI=-----
p-012-230-001 -----
                                CLLI=-----
p-123-134-014 -----
                                CLLI=-----
p-129-234-001 -----
                                CLLI=-----

  DPCI          ALIASN/N24    ALIASA      LSN          RC      APC
p-2-120-1 -----
                                CLLI=-----
p-7-100-1 -----
                                CLLI=-----
p-2-012-1 -----
                                CLLI=-----
p-3-134-1 -----
                                CLLI=-----
p-5-120-1 -----
                                CLLI=-----

  DPCN          ALIASA      ALIASI      LSN          RC      APC
p-0-0-0-0323-aa -----
                                CLLI=-----
p-0-0-0-1298-aa -----
                                CLLI=-----
p-1-1-0-0057-aa -----
                                CLLI=-----
p-1-1-1-0058-aa -----
                                CLLI=-----
p-1-1-1-0059-aa -----
                                CLLI=-----
p-1-1-1-0060-aa -----
                                CLLI=-----
p-1-1-1-0061-aa -----
                                CLLI=-----
p-1-1-1-0125-aa -----
                                CLLI=-----
p-1-1-1-0125-xy -----
                                CLLI=-----
p-1-1-1-0126-xy -----
                                CLLI=-----
p-1-1-1-0126-aa -----
                                CLLI=-----
p-1-1-1-0127-bb -----
                                CLLI=-----

```

```

p-1-1-1-0122-aa -----
CLLI=-----
p-1-1-1-0123-aa -----
CLLI=-----

DPCN24          ALIASA          ALIASI  LSN          RC          APC

;

rtrv-rte:pcst=s
rlghncxa03w 05-01-07 12:05:33 EST EAGLE 31.12.0
DPCA          ALIASI          ALIASN/N24  LSN          RC          APCA

DPCI          ALIASN/N24          ALIASA      LSN          RC          APC
s-2-002-1 -----
CLLI=-----
s-2-002-2 -----          001-001-003 -----
CLLI=-----
s-1-002-3 -----          lsn1          1          s-1-002-3
          lsn4          1          s-2-012-1
          lsn5          2          2-100-1
          lsn6          3          s-3-134-1
          lsn2          10         s-2-002-2
          lsn3          13         s-2-100-1
CLLI=-----
s-2-100-1 -----
CLLI=-----
s-7-100-1 -----
CLLI=-----
s-2-012-1 -----
CLLI=-----
s-3-134-1 -----
CLLI=-----
s-5-120-1 -----
CLLI=-----

DPCN          ALIASA          ALIASI  LSN          RC          APC
s-0-0-0-0323-aa -----
CLLI=-----
s-0-0-0-1298-aa -----
CLLI=-----
s-1-1-1-0235-aa -----
CLLI=-----
s-1-1-1-0122-aa -----
CLLI=-----
s-1-1-1-0123-aa -----
CLLI=-----

DPCN24          ALIASA          ALIASI  LSN          RC          APC

;

```

rtrv-rte:pcst=ps

```

rlghncxa03w 05-01-07 12:05:33 EST EAGLE 31.12.0
  DPCA          ALIASI      ALIASN/N24    LSN          RC      APCA
  DPCI          ALIASN/N24    ALIASA      LSN          RC      APC
ps-2-100-1 -----
                                           CLLI=-----
ps-7-129-2 -----
                                           CLLI=-----
ps-4-012-1 -----
                                           CLLI=-----
ps-3-134-1 -----
                                           CLLI=-----
ps-5-120-1 -----
                                           CLLI=-----

  DPCN          ALIASA      ALIASI  LSN          RC      APC
ps-1-1-1-2047-aa 100-120-120 s-1-123-1 -----
                                           CLLI=-----
ps-1-1-1-2046-aa -----
                                           CLLI=-----
ps-1-1-1-2045-aa -----
                                           CLLI=-----
ps-1-1-1-2044-aa -----
                                           CLLI=-----
ps-0-0-0-0323-aa -----
                                           CLLI=-----
ps-0-0-0-1298-aa -----
                                           CLLI=-----
ps-1-1-1-0059-aa -----
                                           CLLI=-----
ps-1-1-1-0234-aa -----
                                           CLLI=wearehereto
ps-1-1-1-0235-aa -----
                                           CLLI=longcllinam
ps-1-0-1-0123-aa -----
                                           CLLI=-----
ps-1-1-1-0122-aa -----
                                           CLLI=-----
ps-1-1-1-0123-aa -----
                                           CLLI=-----

  DPCN24        ALIASA      ALIASI  LSN          RC      APC
;

```

Legend

DPC, DPCA, DPCI, DPCN, DPCN24—The destination point code to be reached through this route.

ALIAS, ALIASA, ALIASI, ALIASN/N24—The alias associated with the route.

CLLI—The CLI associated with the route.

LSN—The name of the linkset assigned to this route.

RC—The relative cost (priority) assigned to the route.

APC, APCA, APCI, APCN, APCN24—The point code of the STP or SSP that is directly adjacent to the linkset. The point code may or may not be the same as the destination point code assigned to this route.

rtrv-sccp-serv

Retrieve SCCP Service

Use this command to display the SCCP Service application relationship information.

Keyword: rtrv-sccp-serv

Related Commands: chg-sccp-serv, dlt-sccp-serv

Command Class: Database Administration

Parameters

NOTE: See “Point Code Formats and Conversion” in Appendix A for a detailed description of point code formats, rules for specification, and examples.

:serv= (mandatory)

Name of the service

Range: gflex, gport

Example

```
rtrv-sccp-serv
```

Dependencies

The feature associated with a **serv** must be ON or enabled.

Notes

None.

Output

The following example displays the output that results when no supporting features are turned on, and no alternate re-route PCs are defined for the SCCP Service Table:

rtrv-sccp-serv

```
tekelecstp 05-12-20 08:28:48 EST 34.3
rtrv-sccp-serv
Command entered at terminal #4.
```

```
No Entries Found.
```

```
;
```

The following example shows the output that results when the G-Port feature is turned on, and no alternate re-route PCs are defined for the SCCP Service Table:

rtrv-sccp-serv

```
tekelecstp 05-12-20 08:31:24 EST 34.3
rtrv-sccp-serv
Command entered at terminal #4.
```

```
-----
Service      : GPORT
State        : Offline
GTT Option   : Yes
-----
```

```
;
```

The following example shows the output that results when the G-Port and G-Flex features are turned on, and no alternate re-route PCs are defined for the SCCP Service Table:

rtrv-sccp-serv

```
tekelecstp 05-12-20 08:32:58 EST 34.3
rtrv-sccp-serv
Command entered at terminal #4.
```

```
-----
Service      : GFLEX
State        : Offline
GTT Option   : Yes
-----
```

```
-----
Service      : GPORT
State        : Offline
GTT Option   : Yes
-----
```

```
;
```

The following example shows the output that results when the G-Port service is ONLINE, and there are ANSI point codes in the service set:

rtrv-sccp-serv

```
tekelecstp 05-12-20 08:41:38 EST 34.3
rtrv-sccp-serv
Command entered at terminal #4.
```

```
-----
Service      : GFLEX
State        : Offline
GTT Option   : Yes
-----
```

```

-----
Service      : GPORT
State        : Online
GTT Option   : Yes
-----
ANSI PC      RC
001-001-001 10
002-002-002 20
003-003-003 30
004-004-004 40

```

;

The following example shows the output that results when the G-PORT service is ONLINE, and there are ANSI and ITU-I point codes in the service set:

rtrv-sccp-serv

```

tekelecstp 05-12-20 08:51:53 EST 34.3
rtrv-sccp-serv
Command entered at terminal #4.

```

```

-----
Service      : GFLEX
State        : Offline
GTT Option   : Yes
-----

```

```

-----
Service      : GPORT
State        : Online
GTT Option   : Yes
-----

```

```

ANSI PC      RC
001-001-001 10
002-002-002 20
003-003-003 30
004-004-004 40

```

```

ITUI PC      RC
2-002-2      10
3-003-3      10

```

;

The following example shows the output that results when retrieval is from an SCCP-SERV set that includes ITUN spare point codes.

rtrv-sccp-serv

```
tekelecstp 06-01-09 13:53:51 EST 34.3
rtrv-sccp-serv
Command entered at terminal #4.
```

```
-----
Service      : GFLEX
State        : Offline
GTT Option   : No
-----
```

```
ANSI PC      RC
001-003-004  01
```

```
ITUN SPARE   RC
s-00502      01
s-00503      01
```

```
-----
Service      : GPORT
State        : Offline
GTT Option   : Yes
-----
```

```
ANSI PC      RC
001-003-004  01
```

;

rtrv-sccpopts

Retrieve SCCP Options

Use this command to display the current value of one or more of the SCCP option indicators maintained in the STP options table.

Keyword: rtrv-sccpopts

Related Commands: chg-sccpopts

Command Class: Database Administration

Parameters

This command has no parameters.

Example

```
rtrv-sccpopts
```

Dependencies

None.

Notes

None.

Output**rtrv-sccpopts**

```

rlghncxa03w 04-08-29 16:40:40 EST  EAGLE 31.6.3
  SCCP OPTIONS
  -----
  class1se1 = on
  ;

```

rtrv-scr-aftpc**Retrieve Allowed Affected Point Code**

Use this command to show the allowed affected point code (AFTPC) screening references in the AFTPC entity set.

Keyword: **rtrv-scr-aftpc**

Related Commands: **chg-scr-aftpc**, **dlt-scr-aftpc**, **ent-scr-aftpc**

Command Class: Database Administration

Parameters

:actname= (optional)

The name of the gateway screening stop action set. Stop actions must be administered using the **actname** parameter in conjunction with the gateway screening stop action table (see **chg-gws-actset** and **rtrv-gws-actset**).

Range: 1 alphabetic character followed by up to 5 alphanumeric characters.

none—Display only those gateway screening rules that do not have a gateway screening stop action set assigned to them

:all= (optional)

Displays all AFTPC screening references.

Range: **yes, no**

Default: **no**

:area= (optional)

The ITU international area. The area is specified in the point code. The format of the point code is *zone-area-id*. An asterisk (*) indicates the full range of values from **000–255**.

Range: **000–255, *, c**

:id= (optional)

The ITU international ID. The parameter specifies the ID in the point code represented by format *zone-area-id*. An asterisk (*) indicates the full range of values from **0–7**.

Range: **0–7, ***

:msa= (optional)

The 24-bit ITU national main signaling area. The main signaling area is specified in the point code. The format of the point code is *msa-ssa-sp*. An asterisk (*) indicates the full range of values from **000–255**.

Range: **000–255, ***

:nc= (optional)

The network cluster identifier value. This parameter restricts display to those entries containing this specific cluster of the point code represented by *ni-nc-ncm*. A single value or a range of values can be specified. An asterisk (*) indicates the full range of values from **0-255**.

Range: 0-255, *, c

Default: Display all

:ncm= (optional)

The network cluster member identifier value. This parameter restricts display to those entries containing this specific cluster member of the point code represented by *ni-nc-ncm*. A single value or a range of values can be specified. An asterisk (*) indicates the full range of values from **0-255**.

Range: 0-255, *

Default: Display all

:ni= (optional)

The network identifier value. This parameter restricts display to those entries containing this specific network of the point code represented by *ni-nc-ncm*. A single value or a range of values can be specified. An asterisk (*) indicates the full range of values from **0-255**.

Range: 0-255, *, c

Default: Display all

:npc= (optional)

The ITU national point code. An asterisk (*) indicates the full range of values from **00000-16383**.

Range: 00000-16383, *

NOTE: Gateway screening allows the ITU national point code to be displayed and entered in the database only as a single number. If you are using multiple-part ITU national point codes, see Appendix A for information on converting the point code format.

:nsfi= (optional)

This parameter specifies the next screening category that is used in the gateway screening process, or it indicates that the gateway screening process should stop.

Range: stop

stop—The gateway screening process ends and the message proceeds through normal routing.

Default: Display all

:nsr= (optional)

The next screening reference parameter indicates which screening reference in the specified screening category (**nsfi**) is to be used in the screening process.

Range: 1 alphabetic character followed by up to 3 alphanumeric characters

Default: Display all

:pcst= (optional)

Point code subtype. This parameter indicates whether the specified ITU international or ITU national point code has no subtype prefix or has the spare point code prefix (**s-**).

Range: none, s

Default: none

:sp= (optional)

The 24-bit ITU national signaling point. This parameter specifies the signaling point (sp) in the point code represented by *msa-ssa-sp*. An asterisk (*) indicates the full range of values from **000-255**.

Range: **000-255, ***

:sr= (optional)

The AFTPC screening reference name

Range: 1 alphabetic character followed by up to 3 alphanumeric characters

Default: Display all

:ssa= (optional)

The 24-bit ITU national sub signaling area. The sub signaling area is specified in the point code. The format of the point code is *msa-ssa-sp*. An asterisk (*) indicates the full range of values from **000-255**.

Range: **0-255, ***

:ssn= (optional)

Subsystem number. An asterisk (*) indicates the full range of values from **0-255**.

Range: **1-255**

Default: Display all.

:zone= (optional)

The ITU international zone. The parameter specifies the zone in the point code represented by format *zone-area-id*. An asterisk (*) indicates the full range of values from **0-7**.

Range: **0-7, *, c**

Example

```
rtrv-scr-aftpc
```

```
rtrv-scr-aftpc:sr=iec:ni=240:nc=001:ncm=010&&014:ssn=012
```

```
rtrv-scr-aftpc:sr=iec
```

```
rtrv-scr-aftpc:all=yes
```

```
rtrv-scr-aftpc:sr=iec:ni=240:nc=001:ncm=010:ssn=012:actname=copy
```

```
rtrv-scr-aftpc:sr=aft1
```

```
rtrv-scr-aftpc:sr=aft1:zone=1:area=2:id=3:nsfi=stop:ssn=1:pcst=s
```

Dependencies

If the **nsfi** parameter is specified, the parameter value must be **stop**.

ANSI point code value **000-000-000** and ITU-International point code value **0-000-0** are not allowed.

If **zone=*** is specified, **area=*** and **id=*** must be specified.

If **area=*** is specified, **id=*** must be specified.

If **msa=*** is specified, **ssa=*** and **sp=*** must be specified.

If **ssa=*** is specified, **sp=*** must be specified.

The character **c** is not a valid value for the **ni**, **nc**, **ncm**, **zone**, **area**, **id**, **msa**, **ssa**, **sp**, and **npc** parameters.

The **nsr** parameter cannot be specified if the **actname** parameter is specified.

The **nsr** parameter cannot be specified if the **nsfi=stop** parameter is specified.

The value of the **actname** parameter must be defined in the gateway screening stop action table with the **chg-gws-actset** command. These values are shown in the ACT NAME field of the **rtrv-gws-actset** command output.

If the **actname** parameter is specified with the **sr** parameter, the specified value for the **actname** parameter must be assigned to that screening reference name.

If specified, the **sr** parameter value must exist in the AFTPC screen entity set.

The Spare Point Code Support feature must be enabled before the **pcst** parameter can be specified.

The spare point code subtype prefix (**s-**) is not supported for ANSI point codes (parameters **ni**, **nc**, **ncm**) or for 24-bit ITU national point codes (parameters **msa**, **ssa**, **sp**). The **pcst** parameter cannot be specified for ANSI and ITU-N24 point codes.

Any specified **ni**, **nc**, **ncm**, **zone**, **area**, **id**, **msa**, **ssa**, **sp**, **npc**, **nsfi**, and **nsr** parameters must already exist in the AFTPC entity for the screening reference.

If the **pcst** parameter is specified, point codes with the specified subtype prefix (no prefix or **s-**) must exist in the database.

If the **ni** parameter is specified as an asterisk (**ni=***) or as a range, the **nc** and **ncm** parameters must be specified as an asterisk or as the full range **000-255**.

If the **nc** parameter is specified as an asterisk (**nc=***), the **ncm** parameter must be specified as an asterisk or as the full range **000-255**.

If the **nc** parameter is specified as a single value or a range, a single value must be specified for the **ni** parameter.

If the **nc** parameter is specified as a range, the **ncm** parameter must be specified as an asterisk or as the full range **000-255**.

Notes

An asterisk as a parameter value in this command displays only entries that have an asterisk as the same parameter value in the entry.

A range of values by separating the values that define the range by two ampersands (**&&**); for example, **:ni=025&&100** specifies all network indicators for ANSI point codes from **25** to **100**.

If no parameters are specified, a list of allowed AFTPC references is produced indicating whether they are referenced or not.

If only the **all=yes** parameter is specified, detailed information for every rule in every allowed AFTPC screening table is displayed.

If the **all** parameter is specified and other parameters are also specified, the **all** parameter is ignored.

The spare point code subtype prefix **s-** is supported only for ITU international and ITU national point codes. The **pcst** parameter indicates whether the specified point code has no subtype prefix or has the spare point code prefix.

Output

rtrv-scr-aftpc

```
rlghncxa03w 03-03-13 13:12:38 EST EAGLE 31.3.0
SCREEN = ALLOWED AFTPC
SR   REF  RULES
IEC  YES   2
WRD2 YES   1
WRD3 NO    4
WRD4 YES   9
```

;

rtrv-scr-aftpc:sr=iec:ni=240:nc=001:ncm=010&&014:ssn=012:actname=copy

```
rlghncxa03w 03-03-14 15:23:18 EST EAGLE 31.3.0
SCREEN = ALLOWED AFTPC
SR   NI      NC      NCM      SSN      NSFI      NSR/ACT
IEC  240     001     010&&012 012      STOP      COPY
```

;

rtrv-scr-aftpc:nsfi=stop:sr=af01:ssn=1:msa=255:ssa=255:sp=255

```
tekelecstp 03-03-05 10:19:51 EST EAGLE 31.0.0
SCREEN = ALLOWED AFTPC
SR   MSA     SSA     SP      NSFI      NSR/ACT
af01 255     255     255     1         STOP      -----
```

;

rtrv-scr-aftpc:sr=aft1:zone=1:area=2:id=3:nsfi=stop:ssn=1:pcst=s

```
tekelecstp 05-01-05 10:19:51 EST EAGLE 31.12.0
SCREEN = ALLOWED AFTPC
SR   ZONE   AREA   ID      SSN      NSFI      NSR/ACT
aft1 s-1     002    3       1        STOP      -----
```

;

rtrv-scr-aftpc:sr=aft1

```
tekelecstp 05-01-05 10:19:51 EST EAGLE 31.12.0
SCREEN = ALLOWED AFTPC
SR   ZONE   AREA   ID      SSN      NSFI      NSR/ACT
aft1 s-2     002    3       1        STOP      -----

SR   NPC
aft1 s-00128      1        STOP      -----
```

;

Legend

For a summary report:

REF—This indicates whether a screen is referenced by another screen. If NO, the screen is not used. If you need a more detailed output, use the **rtrv-scr-blkdpc:all=yes** command, or specify the specific screening reference.

RULES—The number of screening rules in that screening table.

For a detailed report:

SCREEN = ALLOWED AFTPC—This is the screen type.

SR—This is used to identify the various screen sets being used. It can be up to four characters in length.

NI-NC-NCM—The point code referenced within the screen. For international point codes, these columns are ZONE - AREA - ID. For 24-bit ITU national point codes, these columns are MSA - SSA - SP. For national point codes, these columns become the single column NPC.

SSN—The subsystem number associated with the point code identified by *ni-nc-ncm*.

NSFI—The next screening category to be used.

NSR/ACT—The name of the next screening reference (NSR—up to four characters) or action to be taken (ACT—up to six characters), if the message passes this screen.

rtrv-scr-blkdpc**Retrieve Blocked DPC**

Use this command to show the blocked destination point code (BLKDPC) screening references in the BLKDPC entity set.

Keyword: **rtrv-scr-blkdpc**

Related Commands: **chg-scr-blkdpc, dlt-scr-blkdpc, ent-scr-blkdpc**

Command Class: Database Administration

Parameters

:actname= (optional)

The name of the gateway screening stop action set. Stop actions must be administered using the **actname** parameter in conjunction with the gateway screening stop action table (see **chg-gws-actset** and **rtrv-gws-actset**).

Range: 1 alphabetic character followed by up to 5 alphanumeric characters.

none—Display only those gateway screening rules that do not have a gateway screening stop action set assigned to them

:all= (optional)

Displays all blocked DPC screening references.

Range: **yes, no**

Default: **no**

:area= (optional)

The ITU international area. The area is specified in the point code. The format of the point code is *zone-area-id*. An asterisk (*) indicates the full range of values from **000–255**.

Range: 000–255, *, c

:id= (optional)

The ITU international ID. The parameter specifies the ID in the point code represented by format *zone-area-id*. An asterisk (*) indicates the full range of values from 0–7.

Range: 0–7, *

:msa= (optional)

The 24-bit ITU national main signaling area. The main signaling area is specified in the point code. The format of the point code is *msa-ssa-sp*. An asterisk (*) indicates the full range of values from 000–255.

Range: 000–255, *, c

:nc= (optional)

The network cluster identifier value. This parameter restricts display to those entries containing this specific cluster of the point code represented by *ni-nc-ncm*. A single value or a range of values can be specified. An asterisk (*) indicates the full range of values from 0–255.

Range: 0–255, *, c

Default: Display all

:ncm= (optional)

The network cluster member identifier value. This parameter restricts display to those entries containing this specific cluster member of the point code represented by *ni-nc-ncm*. A single value or a range of values can be specified. An asterisk (*) indicates the full range of values from 0–255.

Range: 0–255, *

Default: Display all

:ni= (optional)

The network identifier value. This parameter restricts display to those entries containing this specific network of the point code represented by *ni-nc-ncm*. A single value or a range of values can be specified. An asterisk (*) indicates the full range of values from 0–255.

Range: 0–255, *, c

Default: Display all

:npc= (optional)

The ITU national point code. An asterisk (*) indicates the full range of values from 00000–16383.

Range: 00000–16383, *, c

NOTE: Gateway screening allows the ITU national point code to be displayed and entered in the database only as a single number. If you are using multiple-part ITU national point codes, see Appendix A for information on converting the point code format.

:nsfi= (optional)

This parameter specifies the next screening category that is used in the gateway screening process, or it indicates that the gateway screening process should stop.

Range: cgpa, destfld, fail, isup, stop

cgpa—Allowed calling party address is the next screening category.

destfld—Allowed destination field (DESTFLD) is the next screening category.

fail—The received message should be discarded.

isup—ISUP message type (ISUP) is the next screening category.

stop—The gateway screening process ends and the message proceeds through normal routing.

Default: Display all

:nsr= (optional)

The next screening reference parameter indicates which screening reference in the specified screening category (**nsfi**) is to be used in the screening process. This parameter is mandatory if **nsfi** is other than **stop** or **fail**. The **nsr** parameter cannot be entered if **nsfi** is **stop** or **fail**, or the **copy=yes** parameter is specified.

Range: 1 alphabetic character followed by up to 3 alphanumeric characters

Default: Display all

:pcst= (optional)

Point code subtype. This parameter indicates whether the specified ITU international or ITU national point code has no subtype prefix or has the spare point code prefix (s-).

Range: none, s

Default: none

:sp= (optional)

The 24-bit ITU national signaling point. This parameter specifies the signaling point (sp) in the point code represented by *msa-ssa-sp*. An asterisk (*) indicates the full range of values from **000-255**.

Range: 000-255, *, c

:sr= (optional)

The BLKDPC screening reference name

Range: 1 alphabetic character followed by up to 3 alphanumeric characters

Default: Display all.

:ssa= (optional)

The 24-bit ITU national sub signaling area. The sub signaling area is specified in the point code. The format of the point code is *msa-ssa-sp*. An asterisk (*) indicates the full range of values from **000-255**.

Range: 0-255, *, c

:zone= (optional)

The ITU international zone. The parameter specifies the zone in the point code represented by format *zone-area-id*. An asterisk (*) indicates the full range of values from **0-7**.

Range: 0-7, *, c

Example

```
rtrv-scr-blkdpc
```

```
rtrv-scr-blkdpc:sr=ieci:ni=240:nc=001:ncm=010&&018:nsfi=stop:actname=rdct
```

```
rtrv-scr-blkdpc:sr=ieci
```

```
rtrv-scr-blkdpc:all=yes
```

```
rtrv-scr-blkdpc:sr=bdp1:npc=128:nsfi=fail:pcst=s
```

Dependencies

A complete point code must be specified, and must be one and only one of the four point code parameter combinations: **ni-nc-ncm**; **zone-area-id**; **msa-ssa-sp**; or **npc**, except in the special case of entering **c** for "continue".

If **ni=c** is specified, either the character **c** must also be specified for the **nc** and **ncm** parameters or the **nc** and **ncm** parameters must not be specified. If the **nc** and **ncm** parameters are not specified when **ni=c** is specified, the **nc** and **ncm** values default to the character **c** in the database.

If **zone=c** is specified, either the character **c** must also be specified for the **area** and **id** parameters or the **area** and **id** parameters must not be specified. If the **area** and **id** parameters are not specified when **ni=c** is specified, the **area** and **id** values default to the character **c** in the database.

If **msa=c** is specified, either the character **c** must also be specified for the **ssa** and **sp** parameters or the **ssa** and **sp** parameters must not be specified. If the **ssa** and **sp** parameters are not specified when **ni=c** is specified, the **ssa** and **sp** values default to the character **c** in the database.

ANSI point code value **000-000-000** and ITU-International point code value **0-000-0** are not allowed.

If **zone=*** is specified, **area=*** and **id=*** must be specified.

If **area=*** is specified, **id=*** must be specified.

If **msa=*** is specified, **ssa=*** and **sp=*** must be specified.

If **ssa=*** is specified, **sp=*** must be specified.

The **nsr** parameter cannot be specified if the specified **nsfi** parameter is **stop** or **fail**.

If the **actname** parameter is specified, the **nsr** parameter cannot be specified.

The **actname** parameter can be specified only when the **nsfi** parameter value is **stop**.

If the **actname** parameter is specified with the **sr** parameter, the specified value for the **actname** parameter must be assigned to that screening reference name.

The value of the **actname** parameter must already be defined in the Gateway Screening Stop Action table with the **chg-gws-actset** command. These values are shown in the ACT NAME field of the **rtrv-gws-actset** command output.

If the **ni** parameter is specified as an asterisk (**ni=***) or as a range, the **nc** and **ncm** parameters must be specified as an asterisk or as the full range **000-255**.

If the **nc** parameter is specified as an asterisk (**nc=***), the **ncm** parameter must be specified as an asterisk or as the full range **000-255**.

If the **nc** parameter is specified as a single value or a range, a single value must be specified for the **ni** parameter.

If the **nc** parameter is specified as a range, the **ncm** parameter must be specified as an asterisk or as the full range **000-255**.

If the **ncm** parameter is specified as a single value, or a range other than the full range of **000-255**, the **ni** and the **nc** parameters must be specified with a single value.

If specified, the **sr** must already exist in the BLKDPC entity set.

The Spare Point Code Support feature must be enabled before the **pcst** parameter can be specified.

The spare point code subtype prefix (**s-**) is not supported for ANSI point codes (parameters **ni**, **nc**, **ncm**) or for 24-bit ITU national point codes (parameters **msa**, **ssa**, **sp**). The **pcst** parameter cannot be specified for ANSI and ITU-N24 point codes.

Any specified **ni**, **nc**, **ncm**, **zone**, **area**, **id**, **msa**, **ssa**, **sp**, **nep**, **nsfi**, and **nsr** parameters must already exist in the database.

If the **pcst** parameter is specified, point codes with the specified subtype prefix (no prefix or **s-**) must exist in the database.

Notes

If no parameters are specified, a list of blocked DPC screening references is displayed indicating whether they are referenced or not.

If only the **all=yes** parameter is specified, detailed information for every rule in every blocked DPC screening table is output.

If the **all** parameter is specified and other parameters are also specified, the **all** parameter is ignored.

An asterisk as a parameter value in this command displays only entries that have an asterisk as the same parameter value in the entry.

A range of values is specified by separating the values that define the range by two ampersands (**&&**); for example, **:ni=025&&100** specifies all network indicators for ANSI point codes from **25** to **100**.

The character **c** is used in the blocked DPC screens to allow the screening process to continue for messages with point codes that do not match any point codes in the blocked DPC screens. When screening for a blocked DPC and the point code being screened does not match any of the point codes in the blocked DPC screens, the message is not rejected and the screening process continues. There must be an entry in the blocked DPC screens to allow the screening process to continue. This entry consists of a screening reference, point code, **nsfi**, and **nsr**. The point code has the value **c-c-c**.

If the character **c** is specified for any subfield of a three-subfield point code, all three subfields must have the value **c**. No other values can be used. For example, a point code **c-c-255** is not allowed. The point code must be **c-c-c**. The asterisk (*) value cannot be used with the character **c** (for example, a point code **c-c-*** is not allowed).

In all cases, if **c** for "continue" is entered for the first subfield in the point code, the other subfields default to **c** in the database.

When the point code does not match any entries in the blocked DPC screens, the screening process is directed to the screening reference with the point code **c-c-c**. The **nsfi** and **nsr** in this entry are examined to determine the next step in the screening process.

The spare point code subtype prefix **s-** is supported only for ITU international and ITU national point codes. The **pcst** parameter indicates whether the specified point code has no subtype prefix or has the spare point code prefix.

Output

rtrv-scr-blkdpc

```

rlghncxa03w 03-03-13 13:12:38 EST EAGLE 31.3.0
SCREEN = BLOCKED DPC
SR   REF  RULES
IEC  YES   2
WRD2 YES   1
WRD3 NO    4
WRD4 YES   9

```

;

rtrv-scr-blkdpc:sr=iec:ni=240:nc=001:ncm=010&&018

```

rlghncxa03w 03-03-13 13:13:21 EST EAGLE 31.3.0
SCREEN = BLOCKED DPC
SR   NI      NC      NCM      NSFI      NSR/ACT
IEC  240     001     010&&020 STOP     -----

```

;

rtrv-scr-blkdpc:actname=rdct

```

rlghncxa03w 03-03-13 13:13:21 EST EAGLE 31.3.0
SCREEN = BLOCKED DPC
SR   NI      NC      NCM      NSFI      NSR/ACT
IEC  C        C        C        STOP     RDCT

```

;

rtrv-scr-blkdpc:nsr=is02

```

tekelecstp 02-08-30 09:25:54 EST EAGLE 30.0.0
rtrv-scr-blkdpc:nsr=is02
Command entered at terminal #4.
SCREEN = BLOCKED DPC
SR   NI      NC      NCM      NSFI      NSR/ACT
bdp3 C        C        C        ISUP     is02

```

;

rtrv-scr-blkdpc:sr=bd01

```

tekelecstp 03-03-25 15:57:51 EST EAGLE 31.0.0
SCREEN = BLOCKED DPC
SR   MSA     SSA     SP      NSFI      NSR/ACT
bd01 255     255     255     FAIL     -----
bd01 C        C        C        ISUP     is01

```

;

rtrv-scr-blkdpc:sr=bdp1:ncp=128:nsfi=fail

```

tekelecstp 05-01-25 15:57:51 EST EAGLE 31.12.0
SCREEN = BLOCKED DPC
SR   NPC      NSFI      NSR/ACT
bdp1 s-00128    FAIL     -----

```

;

Legend

For a summary report:

REF—This indicates whether a screen is referenced by another screen. If NO, the screen is not used. If you need a more detailed output, use the **rtrv-scr-blkdpc:all=yes** command, or specify the specific screening reference.

RULES—The number of screening rules in that screening table.

For a detailed report:

SCREEN = BLOCKED DPC—This is the screen type.

SR—This is used to identify the various screen sets being used. It can be up to four characters in length.

NI - NC - NCM—The point code referenced within the screen. For international point codes, these columns are ZONE - AREA - ID. For 24-bit ITU national point codes, these columns are MSA-SSA-SP. For national point codes, these columns become the single column NPC.

NSFI—The next screening category to be used.

NSR/ACT—The name of the next screening reference (NSR - up to four characters) or action to be taken (ACT - up to six characters), if the message passes this screen.

rtrv-scr-blkopc

Retrieve Blocked OPC

Use this command to show the blocked originating point code (BLKOPC) screening references in the BLKOPC entity set.

Keyword: rtrv-scr-blkopc

Related Commands: chg-scr-blkopc, dlt-scr-blkopc, ent-scr-blkopc

Command Class: Database Administration

Parameters

:actname= (optional)

The name of the gateway screening stop action set. Stop actions must be administered using the **actname** parameter in conjunction with the gateway screening stop action table (see **chg-gws-actset** and **rtrv-gws-actset**).

Range: 1 alphabetic character followed by up to 5 alphanumeric characters.

none—Display only those gateway screening rules that do not have a gateway screening stop action set assigned to them

:all= (optional)

Displays all blocked OPC screening references.

Range: yes, no

Default: no

:area= (optional)

The ITU international area. The area is specified in the point code. The format of the point code is *zone-area-id*. An asterisk (*) indicates the full range of values from **000-255**.

Range: 000-255, *, c

:id= (optional)

The ITU international ID. The parameter specifies the ID in the point code represented by format *zone-area-id*. An asterisk (*) indicates the full range of values from **0-7**.

Range: 0-7, *, c

:msa= (optional)

The 24-bit ITU national main signaling area. The main signaling area is specified in the point code. The format of the point code is *msa-ssa-sp*. An asterisk (*) indicates the full range of values from **000-255**.

Range: **000-255, *, c**

:nc= (optional)

The network cluster identifier value. This parameter restricts display to those entries containing this specific cluster of the point code represented by *ni-nc-ncm*. A single value or a range of values can be specified. An asterisk (*) indicates the full range of values from **0-255**.

Range: **0-255, *, c**

Default: Display all

:ncm= (optional)

The network cluster member identifier value. This parameter restricts display to those entries containing this specific cluster member of the point code represented by *ni-nc-ncm*. A single value or a range of values can be specified. An asterisk (*) indicates the full range of values from **0-255**.

Range: **0-255, *, c**

Default: Display all

:ni= (optional)

The network identifier value. This parameter restricts display to those entries containing this specific network of the point code represented by *ni-nc-ncm*. A single value or a range of values can be specified. An asterisk (*) indicates the full range of values from **0-255**.

Range: **0-255, *, c**

Default: Display all

:npc= (optional)

The ITU national point code. An asterisk (*) indicates the full range of values from **00000-16383**.

Range: **00000-16383, *, c**

NOTE: Gateway screening allows the ITU national point code to be displayed and entered in the database only as a single number. If you are using multiple-part ITU national point codes, see Appendix A for information on converting the point code format.

:nsfi= (optional)

This parameter specifies the next screening category that is used in the gateway screening process, or it indicates that the gateway screening process should stop.

Range: **cgpa, stop, fail, sio, dpc, blkdpc**

cgpa—Allowed calling party address is the next screening category.

stop—The gateway screening process ends and the message proceeds through normal routing.

fail—The received message should be discarded.

sio—Allowed SIO is the next screening category.

dpc—Allowed DPC is the next screening category.

blkdpc—Blocked DPC is the next screening category.

Default: Display all

:nsr= (optional)

The next screening reference parameter indicates which screening reference in the specified screening category (**nsfi**) is to be used in the screening process. This parameter is mandatory if **nsfi** is other than **stop** or **fail**. The **nsr** parameter cannot be entered if **nsfi** is **stop** or **fail**, or the **copy=yes** parameter is specified.

Range: 1 alphabetic character followed by up to 3 alphanumeric characters

Default: Display all

:pcst= (optional)

Point code subtype. This parameter indicates whether the specified ITU international or ITU national point code has no subtype prefix or has the spare point code prefix (**s-**).

Range: none, s

Default: none

:sp= (optional)

The 24-bit ITU national signaling point. This parameter specifies the signaling point (**sp**) in the point code represented by *msa-ssa-sp*. An asterisk (*) indicates the full range of values from **000-255**.

Range: 000-255, *, c

:sr= (optional)

The BLKOPC screening reference name

Range: 1 alphabetic character followed by up to 3 alphanumeric characters

Default: Display all.

:ssa= (optional)

The 24-bit ITU national sub signaling area. The sub signaling area is specified in the point code. The format of the point code is *msa-ssa-sp*. An asterisk (*) indicates the full range of values from **000-255**.

Range: 0-255, *, c

:zone= (optional)

The ITU international zone. The parameter specifies the zone in the point code represented by format *zone-area-id*. An asterisk (*) indicates the full range of values from **0-7**.

Range: 0-7, *, c

Example

```
rtrv-scr-blkopc
```

```
rtrv-scr-blkopc:sr=iec:ni=240:nc=001:ncm=010&&018:actname=copy
```

```
rtrv-scr-blkopc:sr=iec
```

```
rtrv-scr-blkopc:all=yes
```

```
rtrv-scr-blkopc:sr=bop1:npc=128:nsfi=fail
```

```
rtrv-scr-blkopc:sr=bop1:zone=2:area=2:id=3:nsfi=fail:pcst=s
```

Dependencies

ANSI point code value **000-000-000** and ITU-International point code value **0-000-0** are not allowed.

Any specified **ni**, **nc**, **ncm**, **zone**, **area**, **id**, **msa**, **ssa**, **sp**, **nep**, **nsfi**, and **nsr** parameters must already exist in the database.

If the **pcst** parameter is specified, point codes with the specified subtype prefix (no prefix or **s-**) must exist in the database.

If **ni=*** is specified, **nc=*** and **ncm=*** must be specified.

If **nc=*** is specified, **ncm=*** must be specified.

If **zone=*** is specified, **area=*** and **id=*** must be specified.

If **area=*** is specified, **id=*** must be specified.

If **msa=*** is specified, **ssa=*** and **sp=*** must be specified.

If **ssa=*** is specified, **sp=*** must be specified.

The **nsr** parameter cannot be specified if the **actname** parameter is specified.

The **nsr** parameter cannot be specified if the specified **nsfi** parameter is **stop** or **fail**.

If the **actname** parameter is specified, the **nsfi=stop** parameter must be specified.

If the character **c** is specified for any subfield of a three-subfield point code, all three subfields must have the value **c**. No other values can be used. For example, a point code **c-c-255** is not allowed. The point code must be **c-c-c**. The asterisk (*) value cannot be used with the character **c** (for example, a point code **c-c-*** is not allowed).

- If **ni=c** is specified, **nc** and **ncm** values must either be **c** or not entered.
- If **zone=c** is specified, **area** and **id** values must either be **c** or not entered.
- If **msa=c** is specified, **ssa** and **sp** must either be **c** or not entered.

In all cases, if **c** for "continue" is entered for the first subfield in the point code, the other subfields default to **c** in the database.

The value of the **actname** parameter must already be defined in the Gateway Screening Stop Action table with the **chg-gws-actset** command. These values are shown in the ACT NAME field of the **rtrv-gws-actset** command output.

If the **actname** parameter is specified with the screening reference name parameter, the specified value for the **actname** parameter must be assigned to that screening reference name.

The Spare Point Code Support feature must be enabled before the **pcst** parameter can be specified.

The spare point code subtype prefix (**s-**) is not supported for ANSI point codes (parameters **ni**, **nc**, **ncm**) or for 24-bit ITU national point codes (parameters **msa**, **ssa**, **sp**). The **pcst** parameter cannot be specified for ANSI and ITU-N24 point codes.

Notes

An asterisk as a parameter value in this command displays only entries that have an asterisk as the same parameter value in the entry.

If no parameters are specified, a list of blocked OPC references is displayed indicating whether they are referenced or not.

If only the **all=yes** parameter is specified, detailed information for every rule in every blocked OPC screening table is displayed.

If the **all** parameter is specified and other parameters are also specified, the **all** parameter is ignored.

A range of values is specified by separating the values that define the range by two ampersands (&&); for example, **:ni=025&&100** specifies all network indicators for ANSI point codes from **25** to **100**.

For point codes with three subfields, the value **c** (continue) is used as a place holder. In the event the point code is not found in this screen set, the continue value points to the **nsfi** and **nsr** to be applied next.

The character **c** is used in the blocked OPC screens to allow the screening process to continue for messages with point codes that do not match any point codes in the blocked OPC screens. When screening for a blocked OPC and the point code being screened does not match any of the point codes in the blocked OPC screens, the message is not rejected and the screening process continues. There must be an entry in the blocked OPC screens to allow the screening process to continue. This entry consists of a screening reference, point code, **nsfi**, and **nsr**. The point code **c-c-c**.

When the point code does not match any entries in the blocked OPC screens, the screening process is directed to the screening reference with the point code **c-c-c**. The **nsfi** and **nsr** in this entry are examined to determine the next step in the screening process.

The spare point code subtype prefix **s-** is supported only for ITU international and ITU national point codes. The **pcst** parameter indicates whether the specified point code has no subtype prefix or has the spare point code prefix.

Output

rtrv-scr-blkopc

```
rlghncxa03w 03-03-13 13:12:38 EST EAGLE 31.3.0
SCREEN = BLOCKED OPC
SR   REF  RULES
IEC  YES   2
WRD2 YES   1
WRD3 NO    4
WRD4 YES   9
```

;

rtrv-scr-blkopc:sr=iec:ni=240:nc=001:ncm=010&&018

```
rlghncxa03w 03-03-13 13:13:21 EST EAGLE 31.3.0
SCREEN = BLOCKED OPC
SR   NI      NC      NCM      NSFI      NSR/ACT
IEC  240     001     010&&020 FAIL  -----
```

;

rtrv-scr-blkopc:actname=cncf

```
rlghncxa03w 03-03-13 10:34:07 EST EAGLE 31.3.0
SCREEN = BLOCKED OPC
SR   NI      NC      NCM      NSFI      NSR/ACT
IEC  C       C       C       STOP     CNCF
```

;

rtrv-scr-blkopc:all=yes

```

rlghncxa03w 03-03-13 10:34:07 EST EAGLE 31.3.0
SCREEN = BLOCKED OPC
SR      NI      NC      NCM      NSF1     NSR/ACT
IEC    240     001     010     FAIL     -----
IEC    241     010     *       FAIL     -----

SR      ZONE    AREA    ID      NSF1     NSR/ACT
IEC    1       003     4       FAIL     -----
IEC    1       003     5       FAIL     -----

SR      NI      NC      NCM      NSF1     NSR/ACT
IEC    C       C       C       STOP     CRNCF

SR      NI      NC      NCM      NSF1     NSR/ACT
WRD2   243     015     001     FAIL     -----
WRD2   243     105     002     FAIL     -----
WRD2   C       C       C       STOP     CNCF

```

;

rtrv-scr-blkopc:sr=bo01:nsfi=sio:nsr=si01:msa=c:ssa=c:sp=c

```

tekelecstp 03-03-25 15:57:07 EST EAGLE 31.0.0
SCREEN = BLOCKED OPC
SR      MSA     SSA     SP      NSF1     NSR/ACT
bo01   C       C       C       SIO     si01

```

;

rtrv-scr-aftpc:sr=aft1:zone=1:area=2:id=3:nsfi=stop:ssn=1:pcst=s

```

tekelecstp 05-01-25 15:57:07 EST EAGLE 31.12.0
SCREEN = ALLOWED AFTPC
SR      ZONE    AREA    ID      SSN      NSF1     NSR/ACT
aft1   s-2     002     3       1        STOP     -----

SR      NPC
aft1   s-00128          SSN      NSF1     NSR/ACT
                        1        STOP     -----

```

;

rtrv-scr-blkopc:sr=bop1

```

tekelecstp 05-01-25 15:57:07 EST EAGLE 31.12.0
SCREEN = BLOCKED OPC
SR      ZONE    AREA    ID      NSF1     NSR/ACT
bop1   s-2     002     3       FAIL     -----

SR      NPC
bop1   s-00128          NSF1     NSR/ACT
                        FAIL     -----

SR      ZONE    AREA    ID      NSF1     NSR/ACT
bop1   C       C       C       STOP     -----

```

;

Legend

For a summary report:

REF—This indicates whether a screen is referenced by another screen. If NO, the screen is not used. If you need a more detailed output, use the **rtrv-scr-blkopc:all=yes** command, or specify the specific screening reference.

RULES—The number of screening rules in that screening table.

For a detailed report:

SCREEN = BLOCKED OPC—This is the screen type.

SR—This is used to identify the various screen sets being used. It can be up to four characters in length.

NI - NC - NCM—The point code referenced within the screen. For international point codes, these columns are ZONE - AREA - ID. For 24-bit ITU national point codes, these columns are MSA-SSA-SP. For national point codes, these columns become the single column NPC.

NSFI—The next screening category to be used.

NSR/ACT—The name of the next screening reference (NSR - up to four characters) or action to be taken (ACT - up to six characters), if the message passes this screen.

rtrv-scr-cdpa**Retrieve Allowed Called Party Address**

Use this command to show the allowed called party address (CDPA) screening references in the CDPA entity set.

Keyword: **rtrv-scr-cdpa**

Related Commands: **chg-scr-cdpa, dlt-scr-cdpa, ent-scr-cdpa**

Command Class: Database Administration

Parameters

:actname= (optional)

The name of the gateway screening stop action set. Stop actions must be administered using the **actname** parameter in conjunction with the gateway screening stop action table (see **chg-gws-actset** and **rtrv-gws-actset**).

Range: 1 alphabetic character followed by up to 5 alphanumeric characters.

none—Display only those gateway screening rules that do not have a gateway screening stop action set assigned to them

:all= (optional)

Displays all allowed CDPA screening references.

Range: **yes, no**

Default: **no**

:area= (optional)

The ITU international area. The area is specified in the point code. The format of the point code is *zone-area-id*. An asterisk (*) indicates the full range of values from **000–255**.

Range: **000–255, *, c**

:id= (optional)

The ITU international ID. The parameter specifies the ID in the point code represented by format *zone-area-id*. An asterisk (*) indicates the full range of values from **0-7**.

Range: **0-7, ***

:msa= (optional)

The 24-bit ITU national main signaling area. The main signaling area is specified in the point code. The format of the point code is *msa-ssa-sp*. An asterisk (*) indicates the full range of values from **000-255**.

Range: **000-255, ***

:nc= (optional)

The network cluster identifier value. This parameter restricts display to those entries containing this specific cluster of the point code represented by *ni-nc-ncm*. A single value or a range of values can be specified. An asterisk (*) indicates the full range of values from **0-255**.

Range: **0-255, *, c**

Default: Display all

:ncm= (optional)

The network cluster member identifier value. This parameter restricts display to those entries containing this specific cluster member of the point code represented by *ni-nc-ncm*. A single value or a range of values can be specified. An asterisk (*) indicates the full range of values from **0-255**.

Range: **0-255, *, c**

Default: Display all

:ni= (optional)

The network identifier value. This parameter restricts display to those entries containing this specific network of the point code represented by *ni-nc-ncm*. A single value or a range of values can be specified. An asterisk (*) indicates the full range of values from **0-255**.

Range: **0-255, *, c**

Default: Display all

:npc= (optional)

The ITU national point code. An asterisk (*) indicates the full range of values from **00000-16383**.

Range: **00000-16383, *, c**

NOTE: Gateway screening allows the ITU national point code to be displayed and entered in the database only as a single number. If you are using multiple-part ITU national point codes, see Appendix A for information on converting the point code format.

:nsfi= (optional)

This parameter specifies the next screening category that is used in the gateway screening process, or it indicates that the gateway screening process should stop.

Range: **aftpc, stop**

aftpc—Allowed affected point code is the next screening category.

stop—The gateway screening process ends and the message proceeds through normal routing.

Default: Display all

:nsr= (optional)

The next screening reference parameter indicates which screening reference in the specified screening category (**nsfi**) is to be used in the screening process. This parameter is mandatory if **nsfi** is other than **stop** or **fail**. The **nsr** parameter cannot be entered if **nsfi** is **stop** or **fail**, or the **copy=yes** parameter is specified.

Range: 1 alphabetic character followed by up to 3 alphanumeric characters

Default: Display all

:scmgfid= (optional)

The SCCP management (SCMG) format ID, which consists of a 1-octet field and uniquely defines the function and format of each SCMG message. A single value or a range of values can be specified. An asterisk (*) indicates the full range of values from **1-255**. The following SCCP message types are screened against the Allowed CDPA table and all others are passed: UDT, UDTS, XUDT, XUDTS, LUDT, LUDTS

Range: 1-255, *

Default: All SCMG format IDs are shown.

:sp= (optional)

The 24-bit ITU national signaling point. This parameter specifies the signaling point (sp) in the point code represented by *msa-ssa-sp*. An asterisk (*) indicates the full range of values from **000-255**.

Range: 000-255, *

:sr= (optional)

Displays all allowed CDPA screening references.

Range: 1 alphabetic character followed by up to 3 alphanumeric characters

Default: Display all.

:ssa= (optional)

The 24-bit ITU national sub signaling area. The sub signaling area is specified in the point code. The format of the point code is *msa-ssa-sp*. An asterisk (*) indicates the full range of values from **000-255**.

Range: 0-255, *

:ssn= (optional)

Subsystem number. An asterisk (*) indicates the full range of values from **0-255**.

Range: 1-255

Default: Display all.

:zone= (optional)

The ITU international zone. The parameter specifies the zone in the point code represented by format *zone-area-id*. An asterisk (*) indicates the full range of values from **0-7**.

Range: 0-7, *, c

Example

```
rtrv-scr-cdpa
```

```
rtrv-scr-cdpa:sr=iec:ni=240:nc=001:ncm=010:ssn=001
```

```
rtrv-scr-cdpa:sr=iec:ni=240:nc=001:ssn=002&&005
```

```
rtrv-scr-cdpa:sr=iec
```

rtrv-scr-cdpa:sr=iec:actname=copy

rtrv-scr-cdpa:sr=cdp1:zone=1:area=2:id=3:ssn=1:nsfi=stop:scmgfid=1:pcst=s

rtrv-scr-cdpa:sr=cdp1

Dependencies

If the **actname** parameter is specified, the **nsr** parameter cannot be specified.

If the **actname** parameter is specified, the **nsfi=stop** parameter must be specified.

The **nsr** parameter cannot be specified when **nsfi=stop**.

If **zone=*** is specified, **area=*** and **id=*** must be specified.

If **area=*** is specified, **id=*** must be specified.

If **msa=*** is specified, **ssa=*** and **sp=*** must be specified.

If **ssa=*** is specified, **sp=*** must be specified.

If the **ni** parameter is specified as an asterisk (**ni=***) or as a range, the **nc** and **ncm** parameters must be specified as an asterisk or as the full range **000-255**.

If the **nc** parameter is specified as an asterisk (**nc=***), the **ncm** parameter must be specified as an asterisk or as the full range **000-255**.

If the **nc** parameter is specified as a single value or a range, a single value must be specified for the **ni** parameter.

If the **nc** parameter is specified as a range, the **ncm** parameter must be specified as an asterisk or as the full range **000-255**.

If the **ncm** parameter is specified as a single value, or a range other than the full range of **000-255**, the **ni** and the **nc** parameters must be specified with a single value.

ANSI point code value **000-000-000** and ITU-International point code value **0-000-0** are not allowed.

If the **actname** parameter is specified with the screening reference name parameter, the specified value for the **actname** parameter must be assigned to that screening reference name.

The value of the **actname** parameter must already be defined in the Gateway Screening Stop Action table with the **chg-gws-actset** command. These values are shown in the ACT NAME field of the **rtrv-gws-actset** command output.

The Spare Point Code Support feature must be enabled before the **pcst** parameter can be specified.

The spare point code subtype prefix (**s-**) is not supported for ANSI point codes (parameters **ni**, **nc**, **ncm**) or for 24-bit ITU national point codes (parameters **msa**, **ssa**, **sp**). The **pcst** parameter cannot be specified for ANSI and ITU-N24 point codes.

Any specified **ni**, **nc**, **ncm**, **zone**, **area**, **id**, **msa**, **ssa**, **sp**, **ncp**, **nsfi**, **ri**, **ssn**, and **nsr** parameters must already exist in the CGPA entity for the screening reference.

If the **pcst** parameter is specified, point codes with the specified subtype prefix (no prefix or **s-**) must exist in the database.

The specified screening reference (**sr**) must be in the allowed CDPA entity set.

Notes

If no parameters are specified, the system displays a summary output.

If only the **all=yes** parameter is specified, the system displays a detailed output.

If the **all** parameter and any point code parameter are specified, the **all** parameter is ignored.

The REF column of the output of this command displays **YES** when the screen is referenced by another screen; otherwise, it displays **NO**.

An asterisk as a parameter value in this command displays only entries that have an asterisk as the same parameter value in the entry.

A range of values is specified by separating the values that define the range by two ampersands (&&); for example, **:ni=025&&100** specifies all network indicators for ANSI point codes from **25** to **100**.

The spare point code subtype prefix **s-** is supported only for ITU international and ITU national point codes. The **pcst** parameter indicates whether the specified point code has no subtype prefix or has the spare point code prefix.

Output

rtrv-scr-cdpa:sr=iec:ni=240:nc=001:ncm=010:ssn=001

```
rlghncxa03w 03-03-07 12:05:33 EST EAGLE 31.3.0
SCREEN = ALLOWED CDPA
SR  NI      NC      NCM      SSN      SCMGFID  NSFI  NSR/ACT
IEC 240      001      010      001      002&&003 STOP  -----
;

```

rtrv-scr-cdpa:sr=iec:ni=240:nc=001:ssn=002&&005

```
rlghncxa03w 03-03-07 12:05:33 EST EAGLE 31.3.0
SCREEN = ALLOWED CDPA
SR  NI      NC      NCM      SSN      SCMGFID  NSFI  NSR/ACT
IEC 240      001      010      002      ----- STOP  -----
IEC 240      001      011      002&&003 ----- STOP  -----
;

```

rtrv-scr-cdpa:sr=iec

```
rlghncxa03w 03-03-07 12:05:33 EST EAGLE 31.3.0
SCREEN = ALLOWED CDPA
SR  NI      NC      NCM      SSN      SCMGFID  NSFI  NSR/ACT
IEC 240      001      010      12      ----- STOP  -----
IEC 241      010      *      *      ----- AFTPC IAFT
;

```

rtrv-scr-cdpa

```
rlghncxa03w 03-03-07 12:05:33 EST EAGLE 31.3.0
SCREEN = ALLOWED CDPA
SR  REF  RULES
IEC YES   2
WRD2 YES  1
WRD4 YES  4
;

```

rtrv-scr-cdpa:sr=iec:actname=copy

```

rlghncxa03w 03-03-07 12:05:33 EST EAGLE 31.3.0
SCREEN = ALLOWED CDPA
SR   NI       NC       NCM       SSN       SCMGFID   NSFI   NSR/ACT
IEC  245     001     010     001     002&&003 STOP   COPY
IEC  246     001     010     001     002&&003 STOP   COPY

U0 - CNCF
;

```

rtrv-scr-cdpa:sr=cd01

```

tekelecstp 03-03-05 14:41:36 EST EAGLE 31.0.0
SCREEN = ALLOWED CDPA
SR   MSA     SSA     SP       NSFI     NSR/ACT
cd01 002     003     004     1        1        AFTPC  af01
;

```

rtrv-scr-cdpa:sr=cdp1:zone=1:area=2:id=3:ssn=1:nsfi=stop:scmgfid=1:pcst=s

```

rlghncxa03w 05-01-07 12:05:33 EST EAGLE 31.12.0
SCREEN = ALLOWED CDPA
SR   ZONE   AREA   ID       SSN       SCMGFID   NSFI   NSR/ACT
cdp1 s-1     002    3        1         1         STOP   -----
;

```

rtrv-scr-cdpa:sr=cdp1

```

rlghncxa03w 05-01-07 12:05:33 EST EAGLE 31.12.0
SCREEN = ALLOWED CDPA
SR   ZONE   AREA   ID       SSN       SCMGFID   NSFI   NSR/ACT
cdp1 s-2     002    3        1         1         STOP   -----

SR   NPC
cdp1 s-00128          1         1         STOP   -----
;

```

Legend

For a summary report:

REF—This indicates whether a screen is referenced by another screen. If NO, the screen is not used. If you need a more detailed output, use the **rtrv-scr-cdpa:all=yes** command, or specify the specific screening reference.

RULES—The number of screening rules in that screening table.

For a detailed report:

SCREEN = ALLOWED CDPA—This is the screen type.

SR—This is used to identify the various screen sets being used. It can be up to four characters in length.

NI - NC - NCM—The point code referenced within the screen. For international point codes, these columns are ZONE - AREA - ID. For 24-bit national point codes, these columns are MSA - SSA - SP. For national point codes, these columns become the single column NPC.

SSN—The subsystem number associated with the point code identified by the **ni-nc-ncm**.

SCMGFID—The SCMGFID format ID.

NSFI—The next screening category to be used.

NSR/ACT—The name of the next screening reference (NSR - up to four characters) or action to be taken (ACT - up to six characters), if the message passes this screen.

rtrv-scr-cgpa

Retrieve Allowed Calling Party Address

Use this command to show the allowed calling party address (CGPA) screening references in the CGPA entity set.

Keyword: rtrv-scr-cgpa

Related Commands: chg-scr-cgpa, dlt-scr-cgpa, ent-scr-cgpa

Command Class: Database Administration

Parameters

:actname= (optional)

The name of the gateway screening stop action set. Stop actions must be administered using the **actname** parameter in conjunction with the gateway screening stop action table (see **chg-gws-actset** and **rtrv-gws-actset**).

Range: 1 alphabetic character followed by up to 5 alphanumeric characters.

none—Display only those gateway screening rules that do not have a gateway screening stop action set assigned to them

:all= (optional)

Displays all allowed CGPA screening references.

Range: yes, no

Default: no

:area= (optional)

The ITU international area. The area is specified in the point code. The format of the point code is *zone-area-id*. An asterisk (*) indicates the full range of values from **000-255**.

Range: 000-255, *, c

:id= (optional)

The ITU international ID. The parameter specifies the ID in the point code represented by format *zone-area-id*. An asterisk (*) indicates the full range of values from **0-7**.

Range: 0-7, *

:msa= (optional)

The 24-bit ITU national main signaling area. The main signaling area is specified in the point code. The format of the point code is *msa-ssa-sp*. An asterisk (*) indicates the full range of values from **000-255**.

Range: 000-255, *

:nc= (optional)

The network cluster identifier value. This parameter restricts display to those entries containing this specific cluster of the point code represented by *ni-nc-ncm*. A single value or a range of values can be specified. An asterisk (*) indicates the full range of values from **0-255**.

Range: 0-255, *, c

Default: Display all

:ncm= (optional)

The network cluster member identifier value. This parameter restricts display to those entries containing this specific cluster member of the point code represented by *ni-nc-ncm*. A single value or a range of values can be specified. An asterisk (*) indicates the full range of values from **0-255**.

Range: 0-255, *, c

Default: Display all

:ni= (optional)

The network identifier value. This parameter restricts display to those entries containing this specific network of the point code represented by *ni-nc-ncm*. A single value or a range of values can be specified. An asterisk (*) indicates the full range of values from **0-255**.

Range: 0-255, *, c

Default: Display all

:npc= (optional)

The ITU national point code. An asterisk (*) indicates the full range of values from **00000-16383**.

Range: 00000-16383, *, c

NOTE: Gateway screening allows the ITU national point code to be displayed and entered in the database only as a single number. If you are using multiple-part ITU national point codes, see Appendix A for information on converting the point code format.

:nsfi= (optional)

This parameter specifies the next screening category that is used in the gateway screening process, or it indicates that the gateway screening process should stop.

Range: **cdpa**, **stop**, **tt**

cdpa—Allowed called party address point code is the next screening category.

stop—The gateway screening process ends and the message proceeds through normal routing.

tt—Allowed translation type point code is the next screening category.

Default: Display all

:nsr= (optional)

The next screening reference parameter indicates which screening reference in the specified screening category (**nsfi**) is to be used in the screening process. This parameter is mandatory if **nsfi** is other than **stop** or **fail**. The **nsr** parameter cannot be entered if **nsfi** is **stop** or **fail**, or the **copy=yes** parameter is specified.

Range: 1 alphabetic character followed by up to 3 alphanumeric characters

Default: Display all

:ri= (optional)

The routing indicator provides routing instructions to the receiving signaling point. In gateway screening, messages may be screened based on the value of the routing indicator.

Range: **gt**, **dpc**, *

gt—Allow a called party address with a routing indicator value of "global title".

dpc—Allow a called party address with a routing indicator value of "DPC/SSN".

*—Allow both routing indicator values.

Default: Display all

:sccpmt= (optional)

The SCCP message type. An asterisk (*) indicates all possible allowed values; that is, **9, 10, 17, 18, 19, and 20** and **18**.

Range: **9, 10, 17, 18, 19, 20, ***

9—UDT

10—UDTS

17—XUDT

18—XUDTS

19—LUDT

20—LUDTS

Default: Display all SCCP message types

:sp= (optional)

The 24-bit ITU national signaling point. This parameter specifies the signaling point (sp) in the point code represented by *msa-ssa-sp*. An asterisk (*) indicates the full range of values from **000-255**.

Range: **000-255, ***

:sr= (optional)

The CGPA screening reference name

Range: 1 alphabetic character followed by up to 3 alphanumeric characters

Default: Display all.

:ssa= (optional)

The 24-bit ITU national sub signaling area. The sub signaling area is specified in the point code. The format of the point code is *msa-ssa-sp*. An asterisk (*) indicates the full range of values from **000-255**.

Range: **0-255, ***

:ssn= (optional)

Subsystem number. An asterisk (*) indicates the full range of values from **0-255**.

Range: **1-255**

Default: Display all.

:zone= (optional)

The ITU international zone. The parameter specifies the zone in the point code represented by format *zone-area-id*. An asterisk (*) indicates the full range of values from **0-7**.

Range: **0-7, *, c**

Example

```
rtrv-scr-cgpa:sr=iec:ni=240:nc=001:ncm=010:ssn=012
```

```
rtrv-scr-cgpa:sr=iec:ni=240:nc=001:ncm=010:actname=copy
```

```
rtrv-scr-cgpa:sr=cgp1
```

```
rtrv-scr-cgpa:sr=cgpa:zone=1:area=2:id=3:ssn=1:sccpmt=9:ri=*.nsfi=stop:pcst=s
```

Dependencies

If the **ni** parameter is specified as an asterisk (**ni=***) or as a range, the **nc** and **ncm** parameters must be specified as an asterisk or as the full range **000-255**.

If the **nc** parameter is specified as an asterisk (**nc=***), the **ncm** parameter must be specified as an asterisk or as the full range **000-255**.

If the **nc** parameter is specified as a single value or a range, a single value must be specified for the **ni** parameter.

If the **nc** parameter is specified as a range, the **ncm** parameter must be specified as an asterisk or as the full range **000-255**.

If the **ncm** parameter is specified as a single value, or a range other than the full range of **000-255**, the **ni** and the **nc** parameters must be specified with a single value.

If the **actname** parameter is specified, the **nsr** parameter cannot be specified.

If the **actname** parameter is specified, the **nsfi=stop** parameter must be specified.

If the **actname** parameter is specified with the screening reference name parameter, the specified value for the **actname** parameter must be assigned to that screening reference name.

The value of the **actname** parameter must already be defined in the Gateway Screening Stop Action table with the **chg-gws-actset** command. These values are shown in the ACT NAME field of the **rtrv-gws-actset** command output.

ANSI point code value **000-000-000** and ITU-International point code value **0-000-0** are not allowed.

If **zone=*** is specified, **area=*** and **id=*** must be specified.

If **area=*** is specified, **id=*** must be specified.

If **msa=*** is specified, **ssa=*** and **sp=*** must be specified.

If **ssa=*** is specified, **sp=*** must be specified.

The Spare Point Code Support feature must be enabled before the **pcst** parameter can be specified.

The spare point code subtype prefix (**s-**) is not supported for ANSI point codes (parameters **ni**, **nc**, **ncm**) or for 24-bit ITU national point codes (parameters **msa**, **ssa**, **sp**). The **pcst** parameter cannot be specified for ANSI and ITU-N24 point codes.

Any specified **ni**, **nc**, **ncm**, **zone**, **area**, **id**, **msa**, **ssa**, **sp**, **ncp**, **nsfi**, **ri**, **ssn**, and **nsr** parameters must already exist in the CGPA entity for the screening reference.

If the **pcst** parameter is specified, point codes with the specified subtype prefix (no prefix or **s-**) must exist in the database.

The specified screening reference (**sr**) must be in the allowed CGPA entity set.

Notes

If no parameters are specified, the system displays a summary output.

If only the **all=yes** parameter is specified, the system displays a detailed output.

If the **all** parameter and any point code parameter are specified, the **all** parameter is ignored.

An asterisk as a parameter value in this command displays only entries that have an asterisk as the same parameter value in the entry.

A range of values is specified by separating the values that define the range by two ampersands (&&); for example, **:ni=025&&100** specifies all network indicators for ANSI point codes from **25** to **100**.

The spare point code subtype prefix **s-** is supported only for ITU international and ITU national point codes. The **pcst** parameter indicates whether the specified point code has no subtype prefix or has the spare point code prefix.

Output

rtrv-scr-cgpa:sr=iec:ni=240:nc=001:ncm=010:ssn=012

```
rlghncxa03w 03-03-14 15:58:16 EST EAGLE 31.3.0
SCREEN = ALLOWED CGPA
SR  NI      NC      NCM      SSN      RI      SCCPMT  NSFI      NSR/ACT
IEC 240      001      010      012      DPC    009&&010 STOP      -----
```

;

rtrv-scr-cgpa:sr=iec:ni=240:nc=001-004:ri=dpc:sccpmt=000&&010

```
rlghncxa03w 03-03-14 15:58:16 EST EAGLE 31.3.0
SCREEN = ALLOWED CGPA
SR  NI      NC      NCM      SSN      RI      SCCPMT  NSFI      NSR/ACT
IEC 240      001      010      012      DPC    017&&018 STOP      -----
IEC 240      002&&003 *      004      DPC    009      STOP      -----
```

;

rtrv-scr-cgpa:actname=none

```
rlghncxa03w 03-03-14 15:58:16 EST EAGLE 31.3.0
SCREEN = ALLOWED CGPA
SR  NI      NC      NCM      SSN      RI      SCCPMT  NSFI      NSR/ACT
IEC 240      001      010      012      DPC    017      STOP      -----
IEC 240      001      010      014      GT     *      STOP      -----
IEC 241      002      011      014      GT     *      CDPA     CDP1
```

;

rtrv-scr-cgpa:sr=cg01:nsfi=tt:nsr=tt01:ri=gt:ssn=1:sccpmt=9:msa=255:ssa=255:sp=255

```
tekelecstp 03-03-05 14:41:37 EST EAGLE 31.0.0
SCREEN = ALLOWED CGPA
SR  MSA      SSA      SP      NSFI      NSR/ACT
cg01 255      255      255      1          GT     9          TT          tt01
```

;

rtrv-scr-cgpa:sr=cg01:nsfi=tt:nsr=tt01:ri=gt:ssn=1:sccpmt=19:msa=255:ssa=255:sp=255

```
tekelecstp 03-03-05 14:41:37 EST EAGLE 31.0.0
SCREEN = ALLOWED CGPA
SR  MSA      SSA      SP      NSFI      RI      SCCPMT  NSFI      NSR/ACT
cg01 255      255      255      1          GT     19      STOP      -----
```

;

rtrv-scr-cgpa:sr=cg01:nsfi=tt:nsr=tt01:ri=gt:ssn=1:sccpmt=9:msa=255:ssa=255:sp=255

```
tekelecstp 03-03-05 14:41:37 EST EAGLE 31.0.0
SCREEN = ALLOWED CGPA
SR  MSA      SSA      SP      NSFI      NSR/ACT
cg01 255      255      255      1          GT     9          TT          tt01
```

;

rtrv-scr-cgpa:sr=cg01:nsfi=tt:nsr=tt01:ri=gt:ssn=1:sccpmt=19:msa=255:ssa=255:sp=255

```
tekelecstp 03-03-05 14:41:37 EST EAGLE 31.0.0
SCREEN = ALLOWED CGPA
SR      MSA      SSA      SP      NSFI      RI      SCCPMT  NSFI      NSR/ACT
cg01   255      255      255      1         GT      19       STOP      -----
```

;

rtrv-scr-cgpa:sr=cgpa:zone=1:area=2:id=3:ssn=1:sccpmt=9:ri=*:nsfi=stop:pcst=s

```
tekelecstp 05-01-05 14:41:37 EST EAGLE 31.12.0
SCREEN = ALLOWED CGPA
SR      ZONE     AREA     ID      SSN      RI      SCCPMT  NSFI      NSR/ACT
cgpa   s-1       002      3       1        *       9       STOP      -----
```

;

rtrv-scr-cgpa:sr=cgp1

```
tekelecstp 05-01-05 14:41:37 EST EAGLE 31.12.0
SCREEN = ALLOWED CGPA
SR      ZONE     AREA     ID      SSN      RI      SCCPMT  NSFI      NSR/ACT
cgp1   s-2       002      3       1        *       *       STOP      -----

SR      NPC
cgp1   s-00128          1        *       *       STOP      -----
```

;

Legend

For a summary report:

REF—This indicates whether a screen is referenced by another screen. If NO, the screen is not used. If you need a more detailed output, use the **rtrv-scr-cgpa:all=yes** command, or specify the specific screening reference.

RULES—The number of screening rules in that screening table.

For a detailed report:

SCREEN = ALLOWED CGPA—This is the screen type.

SR —This is used to identify the various screen sets being used. It can be up to four characters in length.

NI - NC - NCM—The point code referenced within the screen. For international point codes, these columns are ZONE - AREA - ID. For 24-bit ITU national point codes, these columns are MSA-SSA-SP. For national point codes, these columns become the single column NPC.

SSN—The subsystem number associated with the point code identified by the *ni-nc-ncm*.

RI—The routing indicator in the called party address.

SCCPMT—The SCCP message type.

NSFI—The next screening category to be used.

NSR/ACT—The name of the next screening reference (NSR - up to four characters) or action to be taken (ACT - up to six characters), if the message passes this screen.

rtrv-scr-destfld**Retrieve Allowed DESTFLDs**

Use this command to show the attributes of one or more allowed affected destination field (DESTFLD) screening references and associated attributes (destination point code, next screening function identifier, next screening function reference) that are allowed to receive SS7 messages from another network.

Keyword: rtrv-scr-destfld

Related Commands: chg-scr-destfld, dlt-scr-destfld, ent-scr-destfld

Command Class: Database Administration

Parameters

:actname= (optional)

The name of the gateway screening stop action set. Stop actions must be administered using the **actname** parameter in conjunction with the gateway screening stop action table (see **chg-gws-actset** and **rtrv-gws-actset**).

Range: 1 alphabetic character followed by up to 5 alphanumeric characters.

none—Display only those gateway screening rules that do not have a gateway screening stop action set assigned to them

:all= (optional)

Displays all allowed DPC screening references.

Range: yes, no

Default: no

:area= (optional)

The ITU international area. The area is specified in the point code. The format of the point code is *zone-area-id*. An asterisk (*) indicates the full range of values from **000–255**.

Range: 000–255, *

Default: Display all

:id= (optional)

The ITU international ID. The parameter specifies the ID in the point code represented by format *zone-area-id*. An asterisk (*) indicates the full range of values from **0–7**.

Range: 0–7, *

Default: Display all

:msa= (optional)

The 24-bit ITU national main signaling area. The main signaling area is specified in the point code. The format of the point code is *msa-ssa-sp*. An asterisk (*) indicates the full range of values from **000–255**.

Range: 000–255, *

:nc= (optional)

The network cluster identifier value. This parameter restricts display to those entries containing this specific cluster of the point code represented by *ni-nc-ncm*. A single value or a range of values can be specified. An asterisk (*) indicates the full range of values from **0–255**.

Range: 0–255, *

Default: Display all

:ncm= (optional)

The network cluster member identifier value. This parameter restricts display to those entries containing this specific cluster member of the point code represented by *ni-nc-ncm*. A single value or a range of values can be specified. An asterisk (*) indicates the full range of values from **0-255**.

Range: 0-255, *

Default: Display all

:ni= (optional)

The network identifier value. This parameter restricts display to those entries containing this specific network of the point code represented by *ni-nc-ncm*. A single value or a range of values can be specified. An asterisk (*) indicates the full range of values from **0-255**.

Range: 0-255, *

Default: Display all

:npc= (optional)

The ITU national point code. An asterisk (*) indicates the full range of values from **0000-16383**.

Range: 0000-16383, *

NOTE: Gateway screening allows the ITU national point code to be displayed and entered in the database only as a single number. If you are using multiple-part ITU national point codes, see Appendix A for information on converting the point code format.

:nsfi= (optional)

This parameter indicates that the gateway screening process should stop. If specified for this command, the parameter must have the value of **stop**. The value of **stop** means that the gateway screening process ends and the message proceeds through normal routing.

Range: stop

Default: Display all screening references

:nsr= (optional)

The next screening reference parameter indicates which screening reference in the specified screening category (**nsfi**) is to be used in the screening process.

Range: 1 alphabetic character followed by up to 3 alphanumeric characters

Default: Display all

:pcst= (optional)

Point code subtype. This parameter indicates whether the specified ITU international or ITU national point code has no subtype prefix or has the spare point code prefix (s-).

Range: none, s

Default: none

:sp= (optional)

The 24-bit ITU national signaling point. This parameter specifies the signaling point (sp) in the point code represented by *msa-ssa-sp*. An asterisk (*) indicates the full range of values from **000-255**.

Range: 000-255, *

:sr= (optional)

The name of the individual DESTFLD screen to be displayed.

Range: 1 alphabetic character followed by up to 3 alphanumeric characters

Default: Display all.

:ssa= (optional)

The 24-bit ITU national sub signaling area. The sub signaling area is specified in the point code. The format of the point code is *msa-ssa-sp*. An asterisk (*) indicates the full range of values from **000-255**.

Range: 0-255, *, c

:zone= (optional)

The ITU international zone. The parameter specifies the zone in the point code represented by format *zone-area-id*. An asterisk (*) indicates the full range of values from **0-7**.

Range: 0-7, *, c

Example

```
rtrv-scr-destfld
```

```
rtrv-scr-destfld:sr=iec:ni=240:nc=001:ncm=010&&018
```

```
rtrv-scr-destfld:sr=iec:id=4:actname=cncf
```

```
rtrv-scr-destfld:all=yes
```

```
rtrv-scr-destfld:sr=dst1:zone=1:area=2:id=3:nsfi=stop:pcst=s
```

```
rtrv-scr-destfld:sr=dst1
```

Dependencies

If the **actname** parameter is specified, the **nsfi=stop** parameter must be specified.

If specified, the **nsfi** parameter value must equal **stop**.

The **nsr** parameter cannot be specified in the command.

If the **actname** parameter is specified, the **nsr** parameter cannot be specified.

The value of the **actname** parameter must already be defined in the Gateway Screening Stop Action table with the **chg-gws-actset** command. These values are shown in the ACT NAME field of the **rtrv-gws-actset** command output.

If the **actname** parameter is specified with the screening reference name parameter, the specified value for the **actname** parameter must be assigned to that screening reference name.

If the **ni** parameter is specified as an asterisk (**ni=***) or as a range, the **nc** and **ncm** parameters must be specified as an asterisk or as the full range **000-255**.

If the **nc** parameter is specified as an asterisk (**nc=***), the **ncm** parameter must be specified as an asterisk or as the full range **000-255**.

If the **nc** parameter is specified as a single value or a range, a single value must be specified for the **ni** parameter.

If the **nc** parameter is specified as a range, the **ncm** parameter must be specified as an asterisk or as the full range **000-255**.

If the **ncm** parameter is specified as a single value, or a range other than the full range of **000-255**, the **ni** and the **nc** parameters must be specified with a single value.

ANSI point code value **000-000-000** and ITU-International point code value **0-000-0** are not allowed.

If **zone=*** is specified, **area=*** and **id=*** must be specified.

If **area=*** is specified, **id=*** must be specified.

If **msa=*** is specified, **ssa=*** and **sp=*** must be specified.

If **ssa=*** is specified, **sp=*** must be specified.

The specified screening reference (**sr**) must be in the allowed DESTFLD entity set.

The Spare Point Code Support feature must be enabled before the **pcst** parameter can be specified.

The spare point code subtype prefix (**s-**) is not supported for ANSI point codes (parameters **ni**, **nc**, **ncm**) or for 24-bit ITU national point codes (parameters **msa**, **ssa**, **sp**). The **pcst** parameter cannot be specified for ANSI and ITU-N24 point codes.

If the **pcst** parameter is specified, point codes with the specified subtype prefix (no prefix or **s-**) must exist in the database.

Notes

If no parameters are specified, the system displays a summary output.

If only the **all=yes** parameter is specified, the system displays a detailed output.

If the **all** parameter and any point code parameter are specified, the **all** parameter is ignored.

The REF column of the output of this command displays **YES** when the screen is referenced by another screen; otherwise, it displays **NO**.

An asterisk as a parameter value in this command displays only entries that have an asterisk as the same parameter value in the entry.

A range of values is specified by separating the values that define the range by two ampersands (**&&**); for example, **:ni=025&&100** specifies all network indicators for ANSI point codes from **25** to **100**.

The spare point code subtype prefix **s-** is supported only for ITU international and ITU national point codes. The **pcst** parameter indicates whether the specified point code has no subtype prefix or has the spare point code prefix.

Output

rtrv-scr-destfld

```

rlghncxa03w 03-03-13 13:12:38 EST EAGLE 31.3.0
SCREEN = ALLOWED DESTFLD
SR      REF  RULES
IEC     YES   2
WRD2    YES   1
WRD3    NO    4
WRD4    YES   9
;

```

rtrv-scr-destfld:sr=iec:ni=240:nc=001:ncm=010&&018

rlghncxa03w 03-03-13 13:13:21 EST EAGLE 31.3.0
 SCREEN = ALLOWED DESTFLD

SR	NI	NC	NCM	NSFI	NSR/ACT
IEC	240	001	010&&020	STOP	-----

;

rtrv-scr-destfld:sr=iec:id=4:actname=cncf

rlghncxa03w 03-03-13 13:13:56 EST EAGLE 31.3.0
 SCREEN = ALLOWED DESTFLD

SR	ZONE	AREA	ID	NSFI	NSR/ACT
IEC	1	003	4	STOP	CNCF

;

rtrv-scr-destfld:all=yes

rlghncxa03w 03-03-13 13:14:18 EST EAGLE 31.3.0
 SCREEN = ALLOWED DESTFLD

SR	NI	NC	NCM	NSFI	NSR/ACT
IEC	240	001	010	STOP	CNCF
IEC	241	010	*	STOP	-----

SR	ZONE	AREA	ID	NSFI	NSR/ACT
IEC	1	003	4	STOP	-----
IEC	1	003	5	STOP	CR

SR	NPC	NSFI	NSR/ACT
IEC	00235	STOP	CNCF
IEC	00240	STOP	-----

;

rtrv-scr-destfld:sr=dst1

tekelecstp 03-03-06 11:40:26 EST EAGLE 31.0.0
 SCREEN = ALLOWED DESTFLD

SR	MSA	SSA	SP	NSFI	NSR/ACT
dst1	002	002	002	STOP	-----

;

rtrv-scr-destfld:sr=dst1:zone=1:area=2:id=3:nsfi=stop:pcst=s

tekelecstp 05-01-06 11:40:26 EST EAGLE 31.12.0
 SCREEN = ALLOWED DESTFLD

SR	ZONE	AREA	ID	NSFI	NSR/ACT
dst1	s-1	002	3	STOP	-----

;

rtrv-scr-destfld:sr=dst1

tekelecstp 05-01-06 11:40:26 EST EAGLE 31.12.0
 SCREEN = ALLOWED DESTFLD

SR	ZONE	AREA	ID	NSFI	NSR/ACT
dst1	s-1	002	3	STOP	-----

SR	NPC	NSFI	NSR/ACT
dst1	s-00128	STOP	-----

;

Legend

For a summary report:

REF—This indicates whether a screen is referenced by another screen. If NO, the screen is not used. If you need a more detailed output, use the **rtrv-scr-destfld:all=yes** command, or specify the specific screening reference.

RULES—The number of screening rules in that screening table.

For a detailed report:

SCREEN = ALLOWED DESTFLD—This is the screen type.

SR—This is used to identify the various screen sets being used. It can be up to four characters in length.

NI - NC - NCM—The point code referenced within the screen. For international point codes, these columns are ZONE - AREA - ID. For 24-bit ITU national point codes, these columns are MSA-SSA-SP. For national point codes, these columns become the single column NPC.

NSFI—The next screening category to be used.

NSR/ACT—The name of the next screening reference (NSR - up to four characters) or action to be taken (ACT - up to six characters), if the message passes this screen.

rtrv-scr-dpc**Retrieve Allowed DPC**

Use this command to show the attributes of one or more allowed DPC screening references and associated attributes (destination point code, next screening function identifier, next screening function reference) that are allowed to receive SS7 messages from another network.

Keyword: rtrv-scr-dpc

Related Commands: chg-scr-dpc, dlt-scr-dpc, ent-scr-dpc

Command Class: Database Administration

Parameters

:actname= (optional)

The name of the gateway screening stop action set. Stop actions must be administered using the **actname** parameter in conjunction with the gateway screening stop action table (see **chg-gws-actset** and **rtrv-gws-actset**).

Range: 1 alphabetic character followed by up to 5 alphanumeric characters.

none—Display only those gateway screening rules that do not have a gateway screening stop action set assigned to them.

:all= (optional)

Displays all allowed DPC screening references.

Range: yes, no

Default: no

:area= (optional)

The ITU international area. The area is specified in the point code. The format of the point code is *zone-area-id*. An asterisk (*) indicates the full range of values from **000-255**.

Range: 000-255, *

:id= (optional)

The ITU international ID. The parameter specifies the ID in the point code represented by format *zone-area-id*. An asterisk (*) indicates the full range of values from **0-7**.

Range: 0-7, *

:msa= (optional)

The 24-bit ITU national main signaling area. The main signaling area is specified in the point code. The format of the point code is *msa-ssa-sp*. An asterisk (*) indicates the full range of values from **000-255**.

Range: 000-255, *

:nc= (optional)

The network cluster identifier value. This parameter restricts display to those entries containing this specific cluster of the point code represented by *ni-nc-ncm*. A single value or a range of values can be specified. An asterisk (*) indicates the full range of values from **0-255**.

Range: 0-255, *, c

Default: Display all

:ncm= (optional)

The network cluster member identifier value. This parameter restricts display to those entries containing this specific cluster member of the point code represented by *ni-nc-ncm*. A single value or a range of values can be specified. An asterisk (*) indicates the full range of values from **0-255**.

Range: 0-255, *

Default: Display all

:ni= (optional)

The network identifier value. This parameter restricts display to those entries containing this specific network of the point code represented by *ni-nc-ncm*. A single value or a range of values can be specified. An asterisk (*) indicates the full range of values from **0-255**.

Range: 0-255, *

Default: Display all

:npc= (optional)

The ITU national point code. An asterisk (*) indicates the full range of values from **00000-16383**.

Range: 00000-16383, *

NOTE: Gateway screening allows the ITU national point code to be displayed and entered in the database only as a single number. If you are using multiple-part ITU national point codes, see Appendix A for information on converting the point code format.

:nsfi= (optional)

This parameter specifies the next screening category that is used in the gateway screening process, or it indicates that the gateway screening process should stop.

Range: **blkdpc**, **cgpa**, **destfld**, **isup**, **stop**
blkdpc—Blocked DPC is the next screening category.
cgpa—Allowed calling party address is the next screening category.
destfld—Allowed destination field (DESTFLD) is the next screening category.
isup—ISUP message type (ISUP) is the next screening category.
stop—The gateway screening process ends and the message proceeds through normal routing.

Default: Display all screen references

:nsr= (optional)

The next screening reference parameter indicates which screening reference in the specified screening category (**nsfi**) is to be used in the screening process. This parameter is mandatory if **nsfi** is other than **stop** or **fail**. The **nsr** parameter cannot be entered if **nsfi** is **stop** or **fail**, or the **copy=yes** parameter is specified.

Range: 1 alphabetic character followed by up to 3 alphanumeric characters.

Default: Display all

:pcst= (optional)

Point code subtype. This parameter indicates whether the specified ITU international or ITU national point code has no subtype prefix or has the spare point code prefix (s-).

Range: **none**, **s**

Default: **none**

:sp= (optional)

The 24-bit ITU national signaling point. This parameter specifies the signaling point (sp) in the point code represented by *msa-ssa-sp*. An asterisk (*) indicates the full range of values from **000-255**.

Range: **000-255**, *

:sr= (optional)

The allowed DPC screening reference name.

Range: 1 alphabetic character followed by up to 3 alphanumeric characters.

Default: Display all.

:ssa= (optional)

The 24-bit ITU national sub signaling area. The sub signaling area is specified in the point code. The format of the point code is *msa-ssa-sp*. An asterisk (*) indicates the full range of values from **000-255**.

Range: **0-255**, *

:zone= (optional)

The ITU international zone. The parameter specifies the zone in the point code represented by format *zone-area-id*. An asterisk (*) indicates the full range of values from **0-7**.

Range: **0-7**, *

Example

```
rtrv-scr-dpc
```

```
rtrv-scr-dpc:sr=iec:ni=240:nc=001:ncm=010&&018
```

```
rtrv-scr-dpc:sr=iec:id=4
```

rtrv-scr-dpc:all=yes

rtrv-scr-dpc:all=yes:actname=cncf

rtrv-scr-dpc:sr=dpc1:npc=128:nsfi=stop:pcst=s

Dependencies

ANSI point code value **000-000-000** and ITU-International point code value **0-000-0** are not allowed.

The specified screening reference (**sr**) must be in the allowed DPC entity set.

Any specified **ni**, **nc**, **ncm**, **zone**, **area**, **id**, **msa**, **ssa**, **sp**, **npc**, **nsfi**, and **nsr** parameters must already exist in the allowed DPC entity for the screening reference.

The Spare Point Code Support feature must be enabled before the **pcst** parameter can be specified.

The spare point code subtype prefix (**s-**) is not supported for ANSI point codes (parameters **ni**, **nc**, **ncm**) or for 24-bit ITU national point codes (parameters **msa**, **ssa**, **sp**). The **pcst** parameter cannot be specified for ANSI and ITU-N24 point codes.

If the **pcst** parameter is specified, point codes with the specified subtype prefix (no prefix or **s-**) must exist in the database.

If **ni=*** is specified, **nc=*** and **ncm=*** must be specified.

If **nc=*** is specified, **ncm=*** must be specified.

If **zone=*** is specified, **area=*** and **id=*** must be specified.

If **area=*** is specified, **id=*** must be specified.

If **msa=*** is specified, **ssa=*** and **sp=*** must be specified.

If **ssa=*** is specified, **sp=*** must be specified.

The **nsr** parameter cannot be specified if the specified **nsfi** parameter is **stop**.

The **nsr** parameter cannot be specified if the **actname** parameter is specified.

If the **actname** parameter is specified, the **nsfi=stop** parameter must be specified.

The value of the **actname** parameter must already be defined in the Gateway Screening Stop Action table with the **chg-gws-actset** command. These values are shown in the ACT NAME field of the **rtrv-gws-actset** command output.

If the **actname** parameter is specified with the screening reference name parameter, the specified value for the **actname** parameter must be assigned to that screening reference name.

Notes

If no parameters are specified, a list of allowed DPC references is displayed indicating whether they are referenced or not.

If a single allowed DPC screening reference is specified, the specified entity set requested is shown.

If **all=yes** and no other parameter is specified, detailed information for all of the screening reference entities in the allowed DPC entity set are shown.

If the **all** parameter is specified and other parameters are also specified, the **all** parameter is ignored.

An asterisk as a parameter value in this command displays only entries that have an asterisk as the same parameter value in the entry.

A range of values is specified by separating the values that define the range by two ampersands (&&); for example, **.ni=025&&100** specifies all network indicators for ANSI point codes from **25** to **100**.

The spare point code subtype prefix **s-** is supported only for ITU international and ITU national point codes. The **pcst** parameter indicates whether the specified point code has no subtype prefix or has the spare point code prefix.

Output

rtrv-scr-dpc

```
rlghncxa03w 03-03-13 13:12:38 EST EAGLE 31.3.0
SCREEN = ALLOWED DPC
SR    REF  RULES
IEC   YES   2
WRD2  YES   1
WRD3  NO    4
WRD4  YES   9
```

;

rtrv-scr-dpc:sr=iec:ni=240:nc=001:ncm=010&&018

```
rlghncxa03w 03-03-13 13:13:21 EST EAGLE 31.3.0
SCREEN = ALLOWED DPC
SR  NI      NC      NCM      NSFI      NSR/ACT
IEC 240     001     010&&020 STOP     -----
```

;

rtrv-scr-dpc:sr=iec:id=4

```
rlghncxa03w 03-03-13 13:13:56 EST EAGLE 31.3.0
SCREEN = ALLOWED DPC
SR  ZONE   AREA   ID      NSFI      NSR/ACT
IEC 1      003    4       BLKOPC   blk1
```

;

rtrv-scr-dpc:all=yes

```
rlghncxa03w 03-03-13 13:14:18 EST EAGLE 31.3.0
SCREEN = ALLOWED DPC
SR  NI      NC      NCM      NSFI      NSR/ACT
IEC 240     001     010     STOP     -----
IEC 241     010     *       CGPA     cg04

SR  ZONE   AREA   ID      NSFI      NSR/ACT
IEC 1      003    4       BLKDPC   blk1
IEC 1      003    5       STOP     -----

SR  NPC
IEC 00235
IEC 00240
NSFI      NSR/ACT
CGPA     cg04
CGPA     cg01
```

;

rtrv-scr-dpc:sr=dpc1:actname=copy

```
rlghncxa03w 03-03-13 13:16:13 EST EAGLE 31.3.0
SCREEN = ALLOWED DPC
SR      NI      NC      NCM      NSF1     NSR/ACT
dpc1   010     010     010     STOP    COPY
dpc1   010     010     012     STOP    COPY
```

;

rtrv-scr-dpc:sr=dp01

```
tekelecstp 03-03-06 11:29:11 EST EAGLE 31.0.0
SCREEN = ALLOWED DPC
SR      MSA     SSA     SP      NSF1     NSR/ACT
dp01   002     002     002     BLKDPC  bd01
dp01   255     002     003     CGPA    cg01
dp01   255     255     255     DESTFLD df01
```

;

rtrv-scr-dpc:sr=dpc1:npc=128:pcst=s

```
tekelecstp 05-01-06 11:29:11 EST EAGLE 31.12.0
SCREEN = ALLOWED DPC
SR      NPC                                NSF1     NSR/ACT
dpc1   s-00128                            STOP     -----
```

;

rtrv-scr-dpc:sr=dpc1

```
tekelecstp 05-01-06 11:29:11 EST EAGLE 31.12.0
SCREEN = ALLOWED DPC
SR      ZONE   AREA    ID      NSF1     NSR/ACT
dpc1   s-1     002     3       STOP     -----

SR      NPC                                NSF1     NSR/ACT
dpc1   s-00128                            STOP     -----
```

;

Legend

For a summary report:

REF—This indicates whether a screen is referenced by another screen. If NO, the screen is not used. If you need a more detailed output, use the **rtrv-scr-dpc:all=yes** command, or specify the specific screening reference.

RULES—The number of screening rules in that screening table.

For a detailed report:

SCREEN = ALLOWED DPC—This is the screen type.

SR—This is used to identify the various screen sets being used. It can be up to four characters in length.

NI - NC - NCM—The point code referenced within the screen. For international point codes, these columns are ZONE - AREA - ID. For 24-bit ITU national point codes, these columns are MSA-SSA-SP. For national point codes, these columns become the single column NPC.

NSFI—The next screening category to be used.

NSR/ACT—The name of the next screening reference (NSR - up to four characters) or action to be taken (ACT - up to six characters), if the message passes this screen.

rtrv-scr-isup

Retrieve Allowed ISUP Screening Reference

Use this command to display one allowed ISUP screening reference or all allowed ISUP screening references in the Allowed ISUP entity set.

Keyword: rtrv-scr-isup

Related Commands: chg-scr-isup, dlt-scr-isup, ent-scr-isup

Command Class: Database Administration

Parameters

:actname= (optional)

The name of the gateway screening stop action set. Stop actions must be administered using the **actname** parameter in conjunction with the gateway screening stop action table (see **chg-gws-actset** and **rtrv-gws-actset**).

Range: 1 alphabetic character followed by up to 5 alphanumeric characters.

:all= (optional)

This parameter is specified to display all allowed ISUP screening references in the Allowed ISUP entity set.

Range: yes, no

Default: no

:isupmt= or tupmt= (optional)

ISUP message type or TUP message type in the specified entry. The **tupmt** parameter is not valid for SEAS. A single value or range of values can be entered. An asterisk (*) indicates the entire range of 0-255.

Range: 000-255, *

:nsfi= (optional)

This parameter specifies the next screening category that is used in the gateway screening process. If specified, the parameter must have the value of **stop**.

Range: stop

stop—The gateway screening process ends and the message proceeds through normal routing.

:nsr= (optional)

Next screening reference. The **nsr** parameter cannot be specified if **nsfi=stop** is specified.

Range: 1 alphabetic character followed by up to 3 alphanumeric characters.

Default: No value given

:sr= (optional)

The individual ISUP screen to be displayed.

Range: 1 alphabetic character followed by up to 3 alphanumeric characters.

Examples

```
rtrv-scr-isup:sr=iec:isupmt=1:nisupmt=1&&2
```

```
rtrv-scr-isup:sr=tu01:tupmt=0&&255
```

Dependencies

If the **nsfi** parameter is specified, the value must be **stop**.

The **nsr** parameter cannot be specified if the **actname** parameter is specified.

The **nsr** parameter cannot be specified if the **nsfi=stop** parameter is specified.

If **sr** is specified, the value must exist in the database.

The value of the **actname** parameter must be defined in the gateway screening stop action table with the **chg-gws-actset** command. These values are shown in the ACT NAME field of the **rtrv-gws-actset** command output.

Notes

A range of values for the **isupmt** parameter or **tupmt** parameter can be specified by separating the values that define the range by two ampersands (&&); for example, **:isupmt=025&&100** specifies all ISUP message types from **25** to **100**. The value to the left of the && must be less than the value to the right of the && in the range.

An asterisk can be used for a parameter value in the **chg-scr-isup**, **rtrv-scr-isup**, and **rtrv-scr-isup** commands only if that parameter value was specified as an asterisk in the **ent-scr-isup** command to define the parameter value.

If no parameters are specified, a list of allowed ISUP references is produced indicating whether they are referenced or not.

Output

rtrv-scr-isup

```
tekelecstp 02-09-02 11:10:38 EST EAGLE 30.0.0
SCREEN = ALLOWED ISUP
SR      REF  RULES
iall   NO    1
ibig   NO    1
iec     NO    2
is01   YES    1
is02   YES    1
isu     NO    1
isu1   NO    1
isu2   NO    1
isw1   NO    1
```

;

rtrv-scr-isup:sr=iall

```
tekelecstp 02-09-02 11:13:25 EST EAGLE 30.0.0
SCREEN = ALLOWED ISUP
SR  ISUPMT  NSFI  NSR/ACT
iall *      STOP  -----
```

;

rtrv-scr-isup:sr=iec:isupmt=1&&9

```
tekelecstp 02-09-02 11:13:25 EST EAGLE 30.0.0
SCREEN = ALLOWED ISUP
SR  ISUPMT  NSFI  NSR/ACT
iec 001&&002 STOP  -----
iec 009      STOP  -----
```

;

rtrv-scr-isup:isupmt=*

```
tekelecstp 02-09-02 11:13:25 EST EAGLE 30.0.0
SCREEN = ALLOWED ISUP
SR  ISUPMT  NSFI  NSR/ACT
iall *      STOP  -----
isu2 *      STOP  -----
isw1 *      STOP  -----
```

;

rtrv-scr-isup:sr=tu01:tupmt=0&&255

```
tekelecstp 03-11-13 13:10:02 EST EAGLE 31.4.0
SCREEN = ALLOWED ISUP
SR  ISUPMT  NSFI  NSR/ACT
      TUPMT/
tu01 002      STOP  -----
```

;

rtrv-scr-isup:all=yes

```
tekelecstp 02-09-13 13:10:02 EST EAGLE 30.0.0
SCREEN = ALLOWED ISUP
SR  ISUPMT  NSFI  NSR/ACT
is01 001      STOP  -----
is02 001&&010 STOP  -----
is03 *      STOP  -----
```

;

Legend

REF—This indicates whether a screen is referenced by another screen. If NO, the screen is not used. If you need a more detailed output, use the **rtrv-scr-isup:all=yes** command, or specify the specific screening reference.

RULES—The number of screening rules in that screening table.

For a detailed report:

SCREEN = ALLOWED ISUP— This is the screen type.

SR—This is used to identify the various screen sets being used. It can be up to four characters in length.

ISUPMT/TUPMT—The ISUP message type or TUP Message type in the entry.

NSFI—The next screening category to be used.

NSR/ACT—The name of the next screening reference (NSR - up to four characters) or action to be taken (ACT - up to six characters), if the message passes this screen.

rtrv-scr-opc

Retrieve Allowed OPC

Use this command to show an allowed OPC screening reference and associated attributes (originating point code, next screening function identifier, next screening function reference).

Keyword: rtrv-scr-opc

Related Commands: chg-scr-opc, dlt-scr-opc, ent-scr-opc

Command Class: Database Administration

Parameters

:actname= (optional)

The name of the gateway screening stop action set. Stop actions must be administered using the **actname** parameter in conjunction with the gateway screening stop action table (see **chg-gws-actset** and **rtrv-gws-actset**).

Range: 1 alphabetic character followed by up to 5 alphanumeric characters.

none—Display only those gateway screening rules that do not have a gateway screening stop action set assigned to them.

:all= (optional)

Displays all allowed OPC screening references.

Range: yes, no

Default: Display all

:area= (optional)

The ITU international area. The area is specified in the point code. The format of the point code is *zone-area-id*. An asterisk (*) indicates the full range of values from **000-255**.

Range: 000-255, *

:id= (optional)

The ITU international ID. The parameter specifies the ID in the point code represented by format *zone-area-id*. An asterisk (*) indicates the full range of values from **0-7**.

Range: 0-7, *

:msa= (optional)

The 24-bit ITU national main signaling area. The main signaling area is specified in the point code. The format of the point code is *msa-ssa-sp*. An asterisk (*) indicates the full range of values from **000-255**.

Range: 000-255, *

:nc= (optional)

The network cluster identifier value. This parameter restricts display to those entries containing this specific cluster of the point code represented by *ni-nc-ncm*. A single value or a range of values can be specified. An asterisk (*) indicates the full range of values from **0-255**.

Range: 0–255, *

Default: Display all

:ncm= (optional)

The network cluster member identifier value. This parameter restricts display to those entries containing this specific cluster member of the point code represented by *ni-nc-ncm*. A single value or a range of values can be specified. An asterisk (*) indicates the full range of values from 0–255.

Range: 0–255, *

Default: Display all

:ni= (optional)

The network identifier value. This parameter restricts display to those entries containing this specific network of the point code represented by *ni-nc-ncm*. A single value or a range of values can be specified. An asterisk (*) indicates the full range of values from 0–255.

Range: 0–255, *

Default: Display all

:npc= (optional)

The ITU national point code. An asterisk (*) indicates the full range of values from 00000–16383.

Range: 00000–16383, *

NOTE: Gateway screening allows the ITU national point code to be displayed and entered in the database only as a single number. If you are using multiple-part ITU national point codes, see Appendix A for information on converting the point code format.

:nsfi= (optional)

This parameter specifies the next screening category that is used in the gateway screening process, or it indicates that the gateway screening process should stop.

Range: **blkopc**, **sio**, **dpc**, **blkdpc**, **cgpa**, **stop**

blkopc—Blocked OPC is the next screening category.

sio—Allowed SIO is the next screening category

dpc—Allowed DPC is the next screening category.

blkdpc—Blocked DPC is the next screening category.

cgpa—Allowed calling party address is the next screening category.

stop—The gateway screening process ends and the message proceeds through normal routing.

Default: Display all screening references

:nsr= (optional)

The next screening reference parameter indicates which screening reference in the specified screening category (**nsfi**) is to be used in the screening process. This parameter is mandatory if **nsfi** is other than **stop** or **fail**. The **nsr** parameter cannot be entered if **nsfi** is **stop** or **fail**, or the **copy=yes** parameter is specified.

Range: 1 alphabetic character followed by up to 3 alphanumeric characters

Default: Display all

:pcst= (optional)

Point code subtype. This parameter indicates whether the specified ITU international or ITU national point code has no subtype prefix or has the spare point code prefix (**s**).

Range: none, s

Default: none

:sp= (optional)

The 24-bit ITU national signaling point. This parameter specifies the signaling point (sp) in the point code represented by *msa-ssa-sp*. An asterisk (*) indicates the full range of values from **000-255**.

Range: 000-255, *

:sr= (optional)

The allowed OPC screening reference name

Range: 1 alphabetic character followed by up to 3 alphanumeric characters

Default: Display all.

:ssa= (optional)

The 24-bit ITU national sub signaling area. The sub signaling area is specified in the point code. The format of the point code is *msa-ssa-sp*. An asterisk (*) indicates the full range of values from **000-255**.

Range: 0-255, *

:zone= (optional)

The ITU international zone. The parameter specifies the zone in the point code represented by format *zone-area-id*. An asterisk (*) indicates the full range of values from **0-7**.

Range: 0-7, *, c

Example

```
rtrv-scr-opc
```

```
rtrv-scr-opc:sr=iec:ni=240:nc=001:ncm=010&&018
```

```
rtrv-scr-opc:sr=iec:id=4
```

```
rtrv-scr-opc:all=yes
```

```
rtrv-scr-opc:sr=opc1:actname=cr
```

```
rtrv-scr-opc:sr=opc1:npc=128:nsfi=fail:pcst=s
```

Dependencies

ANSI point code value **000-000-000** and ITU-International point code value **0-000-0** are not allowed.

If **ni=*** is specified, **nc=*** and **ncm=*** must be specified.

If **nc=*** is specified, **ncm=*** must be specified.

If **zone=*** is specified, **area=*** and **id=*** must be specified.

If **area=*** is specified, **id=*** must be specified.

If **msa=*** is specified, **ssa=*** and **sp=*** must be specified.

If **ssa=*** is specified, **sp=*** must be specified.

If the **ni** parameter is specified as an asterisk (**ni=***) or as a range, the **nc** and **ncm** parameters must be specified as an asterisk or as the full range **000-255**.

If the **nc** parameter is specified as an asterisk (**nc=***), the **ncm** parameter must be specified as an asterisk or as the full range **000-255**.

If the **nc** parameter is specified as a single value or a range, a single value must be specified for the **ni** parameter.

If the **nc** parameter is specified as a range, the **ncm** parameter must be specified as an asterisk or as the full range **000-255**.

If the **ncm** parameter is specified as a single value, or a range other than the full range of **000-255**, the **ni** and the **nc** parameters must be specified with a single value.

The **nsr** parameter cannot be specified if the **actname** parameter is specified.

If the **actname** parameter is specified, the **nsfi=stop** parameter must be specified.

The **nsr** parameter cannot be specified if the specified **nsfi** parameter is **stop**.

The value of the **actname** parameter must already be defined in the Gateway Screening Stop Action table with the **chg-gws-actset** command. These values are shown in the ACT NAME field of the **rtrv-gws-actset** command output.

If the **actname** parameter is specified with the screening reference name parameter, the specified value for the **actname** parameter must be assigned to that screening reference name.

The specified screening reference (**sr**) must be in the allowed OPC entity set.

The Spare Point Code Support feature must be enabled before the **pcst** parameter can be specified.

The spare point code subtype prefix (**s-**) is not supported for ANSI point codes (parameters **ni**, **nc**, **ncm**) or for 24-bit ITU national point codes (parameters **msa**, **ssa**, **sp**). The **pcst** parameter cannot be specified for ANSI and ITU-N24 point codes.

If the **pcst** parameter is specified, point codes with the specified subtype prefix (no prefix or **s-**) must exist in the database.

Any specified **ni**, **nc**, **ncm**, **zone**, **area**, **id**, **msa**, **ssa**, **sp**, **nep**, **nsfi**, and **nsr** parameters must already exist in the allowed OPC entity for the screening reference.

Notes

If no parameters are specified, a list of allowed OPC references is produced indicating whether they are referenced or not.

If a single allowed OPC screening reference is specified, the specified entity set requested is shown.

If **all=yes** and no other parameter is specified, detailed information for all of the screening reference entities in the allowed OPC entity set are shown.

If **all** is specified and other parameters are also specified, the **all** parameter is ignored.

An asterisk specified as a parameter value in this command displays only entries that have an asterisk as the same parameter value in the entry.

A range of values is specified by separating the values that define the range by two ampersands (&&); for example, **.ni=025&&100** specifies all network indicators for ANSI point codes from **25** to **100**.

The spare point code subtype prefix **s-** is supported only for ITU international and ITU national point codes. The **pcst** parameter indicates whether the specified point code has no subtype prefix or has the spare point code prefix.

Output

rtrv-scr-opc

```
rlghncxa03w 03-03-13 13:12:38 EST EAGLE 31.3.0
SCREEN = ALLOWED OPC
SR    REF  RULES
IEC   YES   2
WRD2  YES   1
WRD3  NO    4
WRD4  YES   9
```

;

rtrv-scr-opc:sr=iec:ni=240:nc=001:ncm=010&&018

```
rlghncxa03w 03-03-13 13:13:21 EST EAGLE 31.3.0
SCREEN = ALLOWED OPC
SR    NI      NC      NCM      NSF1     NSR/ACT
IEC   240     001     010&&020 STOP    -----
```

;

rtrv-scr-opc:sr=iec:id=4

```
rlghncxa03w 03-03-13 13:13:56 EST EAGLE 31.3.0
SCREEN = ALLOWED OPC
SR    ZONE   AREA   ID      NSF1     NSR/ACT
IEC   1      003    4       BLKOPC  blk1
```

;

rtrv-scr-opc:all=yes

```
rlghncxa03w 03-03-13 13:14:18 EST EAGLE 31.3.0
SCREEN = ALLOWED OPC
SR    NI      NC      NCM      NSF1     NSR/ACT
IEC   240     001     010     STOP    -----
IEC   241     010     *       CGPA    cg04

SR    ZONE   AREA   ID      NSF1     NSR/ACT
IEC   1      003    4       BLKOPC  blk1
IEC   1      003    5       STOP    -----

SR    NPC                    NSF1     NSR/ACT
IEC   00235                  CGPA    cg04
IEC   00240                  CGPA    cg01

SR    NI      NC      NCM      NSF1     NSR/ACT
WRD2  243     015     001     STOP    -----
WRD3  243     105     002     CGPA    WRD4
```

;

rtrv-scr-opc:sr=opc1:actname=cr

```
rlghncxa03w 03-03-13 13:16:13 EST EAGLE 31.3.0
SCREEN = ALLOWED OPC
SR    NI      NC      NCM      NSF1     NSR/ACT
opc1  010     010     010     STOP    CR
opc1  010     010     012     STOP    CR
```

;

rtrv-scr-opc:sr=op55

```
tekelecstp 03-03-06 11:30:42 EST EAGLE 31.0.0
SR      MSA      SSA      SP      NSF1      NSR/ACT
op55   007      077      007      BLKOPC   bo55
```

;

rtrv-scr-opc:sr=opc1:npc=128:nsfi=fail

```
tekelecstp 05-01-06 11:30:42 EST EAGLE 31.12.0
SR      NPC
opc1   s-00128
NSFI      FAIL
NSR/ACT   -----
```

;

Legend

For a summary report:

REF—This indicates whether a screen is referenced by another screen. If NO, the screen is not used. If you need a more detailed output, use the **rtrv-scr-opc:all=yes** command, or specify the specific screening reference.

RULES—The number of screening rules in that screening table.

For a detailed report:

SCREEN = ALLOWED OPC— This is the screen type.

SR—This is used to identify the various screen sets being used. It can be up to four characters in length.

NI - NC - NCM—The point code referenced within the screen. For international point codes, these columns are ZONE - AREA - ID. For 24-bit ITU national point codes, these columns are MSA-SSA-SP. For national point codes, these columns become the single column NPC.

NSFI—The next screening category to be used.

NSR/ACT—The name of the next screening reference (NSR - up to four characters) or action to be taken (ACT - up to six characters), if the message passes this screen.

rtrv-scr-sio**Retrieve Allowed SIO**

Use this command to show the attributes of one or more **nic/si/h0/h1** combinations that are allowed for SS7 messages from another network.

Keyword: rtrv-scr-sio

Related Commands: chg-scr-sio, dlt-scr-sio, ent-scr-sio

Command Class: Database Administration

Parameters

:actname= (optional)

The name of the gateway screening stop action set. Stop actions must be administered using the **actname** parameter in conjunction with the gateway screening stop action table (see **chg-gws-actset** and **rtrv-gws-actset**).

Range: 1 alphabetic character followed by up to 5 alphanumeric characters.
none—Display only those gateway screening rules that do not have a gateway screening stop action set assigned to them.

:all= (optional)

Displays all allowed SIO screening references.

Range: **yes, no**

Default: **no**

:h0= (optional)

H0 heading code. A single value or a range of values can be specified. An asterisk (*) indicates all possible values; that is, the entire range of **0-15**.

Range: **0-15, ***

Default: Display all

:h1= (optional)

H1 heading code. A single value or a range of values can be specified. An asterisk (*) indicates all possible values; that is, the entire range of **0-15**.

Range: **0-15, ***

Default: Display all

:nic= (optional)

The network indicator code. An asterisk (*) indicates all possible values; that is, the entire range of **0-3**.

Range: **0-3, ***

Default: Display all

:nsfi= (optional)

This parameter specifies the next screening category that is used in the gateway screening process, or it indicates that the gateway screening process should stop.

Range: **blkdpc, cgpa, cdpa, destfld, dpc, isup, stop**

blkdpc—Blocked DPC is the next screening category.

cgpa—Allowed calling party address is the next screening category.

cdpa—Allowed called party address is the next screening category.

destfld—Allowed destination field (DESTFLD) is the next screening category.

dpc—Allowed DPC is the next screening category.

isup—ISUP message type (ISUP) is the next screening category.

stop—The gateway screening process ends and the message proceeds through normal routing.

Default: Display all screening references

:nsr= (optional; mandatory if **nsfi** is other than **stop**; cannot be entered if **nsfi=stop**)

The next screening reference parameter indicates which screening reference in the specified screening category (**nsfi**) is to be used in the screening process.

Range: 1 alphabetic character followed by up to 3 alphanumeric characters.

Default: Display all

:pri= (optional)

Message priority. A single value or a range of values can be specified. An asterisk (*) indicates all possible values; that is, the entire range of **0-3**.

Range: 0-3, *

Default: Display all

:si= (optional)

The service indicator.

Range: 0-15, *

Default: Display all

:sr= (optional)

The allowed SIO screening reference name

Range: 1 alphabetic character followed by up to 3 alphanumeric characters.

Default: Display all

Example

```
rtrv-scr-sio
```

```
rtrv-scr-sio:sr=iec:nic=1:si=3:pri=2&&3
```

```
rtrv-scr-sio:sr=sio1:nic=1:si=1
```

```
rtrv-scr-sio:sr=sio1:nic=1:si=1:h0=1:h1=*
```

```
rtrv-scr-sio:sr=sio1:si=1:h0=1:h1=1
```

```
rtrv-scr-sio:all=yes
```

```
rtrv-scr-sio:sr=iec:nic=1:si=1:actname=crncf
```

Dependencies

If the **si** parameter is not equal to **00**, **01**, or **02**, the **h0** and **h1** parameters cannot be specified.

If the **sr**, **nic**, **si**, and **h0/h1** parameters are specified, the SIO screening reference must be in the allowed SIO entity set.

The network indicator code (**nic**) must be specified if the service indicator is specified.

The network indicator code (**nic**) and the service indicator (**si**) must be specified if the **h0** and **h1** parameters are specified.

If an asterisk value is specified for the **h0** parameter, the **h1** parameter cannot be specified.

If the **nsr** parameter is specified, **nsfi=stop** cannot be specified.

If the **actname** parameter is specified, **nsfi=stop** must be specified.

The **nsr** parameter cannot be specified if the **actname** parameter is specified.

If the **actname** parameter is specified with the screening reference name parameter, the specified value for the **actname** parameter must be assigned to that screening reference name.

The value of the **actname** parameter must be defined in the gateway screening stop action table with the **chg-gws-actset** command. These values are shown in the ACT NAME field of the **rtrv-gws-actset** command output.

Notes

An asterisk as a parameter value in this command displays only entries that have an asterisk as the same parameter value in the entry.

If no parameters are specified, a list of allowed SIO references is output indicating whether they are referenced or not.

If only the **all** parameter is specified and is **yes**, detailed information for every rule in every allowed SIO screening table is displayed.

If the **all** parameter is specified and other parameters are also specified, the **all** parameter is ignored.

Output

rtrv-scr-sio

```
SCREEN = ALLOWED SIO
SR   REF  RULES
s    NO    1
s999 NO    1
si   NO    1
si01 NO    1
si1  NO    1
sio1 NO    3
swl1 NO    1
swl2 NO    1
```

;

rtrv-scr-sio:sr=iec:nic=1:si=3:pri=2&&3

```
rlghncxa03w 03-03-15 08:36:43 EST EAGLE 31.3.0
SCREEN = ALLOWED SIO
SR   NIC PRI  SI  H0    H1    NSFI  NSR/ACT
IEC  1  0&&2  3  --    --    BLKDPC WDB2
IEC  1  3    3  --    --    DPC   ABC2
```

;

rtrv-scr-sio:sr=sio1:nic=1:si=1:h1=1:pri=1:h0=15:nsfi=blkdpc:nsr=bdp1

```
rlghncxa03w 03-03-07 12:05:33 EST EAGLE 31.3.0
SCREEN = ALLOWED SIO
SR   NIC PRI  SI  H0    H1    NSFI  NSR/ACT
sio1 1  1    1  15    01    BLKDPC bdp1
```

;

rtrv-scr-sio:sr=sio1:h0=1:h1=1

```
rlghncxa03w 03-03-07 12:05:33 EST EAGLE 31.3.0
SCREEN = ALLOWED SIO
SR   NIC PRI  SI  H0    H1    NSFI  NSR/ACT
sio1 1  1    1  01    *    STOP  -----
sio1 2  1    1  01    *    STOP  -----
```

;

rtrv-scr-sio:sr=sio1:nic=1:si=1

```
rlghncxa03w 03-03-07 12:05:33 EST EAGLE 31.3.0
SCREEN = ALLOWED SIO
SR   NIC PRI  SI  H0    H1    NSFI  NSR/ACT
sio1 1  1    1  01    *    STOP  -----
sio1 1  1    1  02    01    STOP  -----
```

;

rtrv-scr-sio:sr=sio1:nic=1:si=1:h0=1:h1=*

```
rlghncxa03w 03-03-07 12:05:33 EST EAGLE 31.3.0
SCREEN = ALLOWED SIO
SR   NIC  PRI   SI  H0    H1    NSFI   NSR/ACT
sio1 1    1    1   01    *    STOP   -----
```

;

rtrv-scr-sio:sr=iec:nic=1:si=1:actname=crncf

```
rlghncxa03w 03-03-19 21:16:37 EST EAGLE 31.3.0
SCREEN = ALLOWED SIO
SR   NIC  PRI   SI  H0    H1    NSFI   NSR/ACT
iec  1    1    1   15    01    STOP   CRNCF
```

;

rtrv-scr-sio:si=5

```
tekelecstp 02-08-28 16:47:06 EST EAGLE 30.0.0
SCREEN = ALLOWED SIO
SR   NIC  PRI   SI  H0    H1    NSFI   NSR/ACT
si01 1    1    5   --    --    STOP   -----
si02 1    1    5   --    --    ISUP   is01
```

;

Legend**For a summary report:**

SR—This is used to identify the various screen sets being used. It can be up to four characters in length.

REF—This indicates whether a screen is referenced by another screen. If NO, the screen is not used. If you need a more detailed output, use the **rtrv-scr-sio:all=yes** command, or specify the specific screening reference.

RULES—The number of screening rules in that screening table.

For a detailed report:

SCREEN = ALLOWED SIO—This is the screen type.

SR—This is used to identify the various screen sets being used. It can be up to four characters in length.

NIC—The network indicator code in the service information octet.

PRI—The priority of a single message or the beginning message priority in a range of priorities in the service information octet.

SI—The service indicator for the service information octet, which are the last two bits of the subservice field.

H0—The H0 heading code.

H1—The H1 heading code.

NSFI—The next screening category to be used.

NSR/ACT—The name of the next screening reference (NSR - up to four characters) or action to be taken (ACT - up to six characters), if the message passes this screen.

rtrv-scr-tt**Retrieve Allowed Translation Type**

Use this command to show the allowed translation type (TT) screening reference in the TT entity set.

Keyword: rtrv-scr-tt

Related Commands: chg-scr-tt, dlt-scr-tt, ent-scr-tt

Command Class: Database Administration

Parameters

:actname= (optional)

The name of the gateway screening stop action set. Stop actions must be administered using the **actname** parameter in conjunction with the gateway screening stop action table (see **chg-gws-actset** and **rtrv-gws-actset**).

Range: 1 alphabetic character followed by up to 5 alphanumeric characters.

none—Display only those gateway screening rules that do not have a gateway screening stop action set assigned to them.

:all= (optional)

Displays all allowed TT screening references.

Range: yes, no

Default: no

:nsfi= (optional)

This parameter specifies the next screening category that is used in the gateway screening process, or it indicates that the gateway screening process should stop.

Range: cdpa, stop

cdpa—Allowed called party address is the next screening category.

stop—The gateway screening process ends and the message proceeds through normal routing.

Default: Display all screening references

:nsr= (optional)

The next screening reference parameter indicates which screening reference in the specified screening category (**nsfi**) is to be used in the screening process. This parameter is mandatory if **nsfi** is other than **stop**. The **nsr** parameter cannot be entered if **nsfi** is **stop**, or the **copy=yes** parameter is specified.

Range: 1 alphabetic character followed by up to 3 alphanumeric characters

Default: Display all

:sr= (optional)

The TT screening reference name

Range: 1 alphabetic character followed by up to 3 alphanumeric characters

Default: Display all

:type= (optional)

The translation type. The translation type identifies the global title translation type value in the called party address. It is the decimal representation of the 1-byte field used in SS7. A single value or a range of values can be specified.

Range: 1–255, *

Default: Display all.

Example

rtrv-scr-tt

rtrv-scr-tt:sr=iec

rtrv-scr-tt:all=yes

rtrv-scr-tt:sr=iec:type=1&&15:actname=copy

Dependencies

If the **nsr** parameter is specified, **nsfi=stop** cannot be specified.

If the **actname** parameter is specified and **nsfi** is specified, the value specified for **nsfi** must be **stop**.

The value of the **actname** parameter must be defined in the gateway screening stop action table with the **chg-gws-actset** command. These values are shown in the ACT NAME field of the **rtrv-gws-actset** command output.

The **nsr** parameter cannot be specified if the **actname** parameter is specified.

If the **actname** parameter is specified with the screening reference name parameter, the specified value for the **actname** parameter must be assigned to that screening reference name.

The **copy** parameter is obsolete. Stop actions must be administered using the **actname** parameter in conjunction with the gateway screening stop action table (see **chg-gws-actset** and **rtrv-gws-actset**).

Notes

An asterisk as a parameter value in this command displays only entries that have an asterisk as the same parameter value in the entry.

If no parameters are specified, a list of allowed TT references is produced indicating whether they are referenced or not.

If only the **all** parameter is specified and is **yes**, detailed information for every rule in every allowed TT screening table is displayed.

If the **all** parameter is specified and other parameters are also specified, the **all** parameter is ignored.

Output

rtrv-scr-tt

```
rlghncxa03w 03-03-07 12:05:33 EST EAGLE 31.3.0
SCREEN = ALLOWED TT
SR    REF  RULES
IEC   YES   2
WRD2  YES   1
WRD4  YES   4
```

;

rtrv-scr-tt:sr=iec

```
rlghncxa03w 03-03-07 12:05:33 EST EAGLE 31.3.0
SCREEN = ALLOWED TT
SR      TYPE      NSFI      NSR/ACT
IEC     005&&010  STOP     -----
IEC     012        STOP     -----
IEC     016        CDPA     IEC
```

;

rtrv-scr-tt:all=yes

```
rlghncxa03w 03-03-07 12:05:33 EST EAGLE 31.3.0
SCREEN = ALLOWED TT
SR      TYPE      NSFI      NSR/ACT
IEC     005&&010  STOP     -----
IEC     012        STOP     -----
IEC     016        CDPA     IEC
WRD2    243        STOP     -----
WRD4    *          STOP     -----
```

;

rtrv-scr-tt:sr=iec:type=1&&15:actname=copy

```
rlghncxa03w 03-03-15 08:54:35 EST EAGLE 31.3.0
SCREEN = ALLOWED TT
SR      TYPE      NSFI      NSR/ACT
IEC     005&&010  STOP     COPY
IEC     012        STOP     COPY
```

;

Legend

SCREEN = ALLOWED TT—This is the screen type.

SR—This is used to identify the various screen sets being used. It can be up to four characters in length.

REF—This indicates whether a screen is referenced by another screen. If NO, the screen is not used. If a more detailed output is needed, the **rtrv-scr-tt:all=yes** command should be used, or specify the specific screening reference.

TYPE—The translation type of that is allowed for global title translation.

NSFI—The next screening category to be used.

NSR/ACT—The name of the next screening reference (NSR - up to four characters) or action to be taken (ACT - up to six characters), if the message passes this screen.

rtrv-scrset

Retrieve Screen Set

Use this command to show the attributes of one or more screen sets in the screen set entity set.

Keyword: rtrv-scrset

Related Commands: chg-scrset, dlt-scrset, ent-scrset

Command Class: Database Administration

Parameters

:actname= (optional)

The name of the gateway screening stop action set. Stop actions must be administered using the **actname** parameter in conjunction with the gateway screening stop action table (see **chg-gws-actset** and **rtrv-gws-actset**).

Range: 1 alphabetic character followed by up to 5 alphanumeric characters.

none—Display only those gateway screening rules that do not have a gateway screening stop action set assigned to them.

:all= (optional)

Displays all screen sets (except “placeholder” screen sets that contain only one rule with **nsfi=stop** specified in the rule).

Range: **yes, no**

Default: **no**

:destfld= (optional)

This parameter displays the indicator that specifies whether to apply the automatic allowed affected destination screening for network management messages against the routing table, self point codes, and capability point codes. When this parameter is on in the screen set rule, the automatic screening is applied at the end of the provisioned screen set.

Range: **yes, no**

Default: Display all

:nsfi= (optional)

The values of this parameter indicate in the screen set rules the next screening category that is used in the gateway screening process, or that the gateway screening process should stop. In this command, information is displayed for one or more screen sets containing rules with the specified **nsfi** parameter value.

NOTE: When **nsfi=stop** is specified for this command, the command displays only the “placeholder” screen sets that have only one rule, with **nsfi=stop** specified in the rule. This is a way to locate those “placeholder” screen sets, so that you can add or change the rules to accomplish appropriate screening.

Range: **opc, blkopc, sio, dpc, blkdpc, stop**

opc—Display rules with Allowed OPC as the next screening category.

blkopc—Display rules with Blocked OPC as the next screening category.

sio—Display rules with Allowed SIO as the next screening category.

dpc—Display rules with Allowed DPC as the next screening category.

blkdpc—Display rules with Blocked DPC as the next screening category.

stop—Display only “placeholder” screen sets that have only one rule in the screen set, with **nsfi=stop** specified as the next screening category.

Default: Display all

:nsr= (optional)

The next screening reference parameter indicates which screening reference in the specified screening category (**nsfi**) is to be used in the screening process. In this command, the **nsr** parameter is used to display information for one or more screen sets with rules that have the specified **nsr** parameter value.

Range: 1 alphabetic character followed by up to 3 alphanumeric characters

Default: Display all

:scrn= (optional)

The screen set name. When this parameter is specified, the information for only the specified screen set is displayed.

Range: 1 alphabetic character followed by up to 3 alphanumeric characters

Default: Display all

Example

```
rtrv-scrset
```

```
rtrv-scrset:scrn=scr1
```

```
rtrv-scrset:nsr=opc4
```

```
rtrv-scrset:nsfi=dpc
```

```
rtrv-scrset:actname=copy
```

Dependencies

The screen set name must already exist.

If the **actname** parameter is specified and the **nsfi** parameter is specified, the value specified for **nsfi** must be **stop**.

The value of the **actname** parameter must be defined in the gateway screening stop action table with the **chg-gws-actset** command. These values are shown in the ACT NAME field of the **rtrv-gws-actset** command output.

The **nsr** parameter cannot be specified if the **actname** parameter is specified.

If the **actname** parameter is specified with the screen set name parameter, the specified value for the **actname** parameter must be assigned to that screen set name.

Notes

If no parameters are specified for the **rtrv-scrset** command, the output shows all the screen sets, the screening function identifier of the root screening table, the screening reference of the root screening table, the memory usage (percentage), the number of entries in the screen set and the overall gateway screening statistics, followed by a summary of statistics for each screen set.

For the **rtrv-scrset:all=yes** command, the output consists of every screen set and every screening reference in each screen set (except “placeholder” screen sets that have only one rule with **nsfi=stop** specified in the rule). The **all=yes** and **nsfi=stop** parameters cannot be specified in the same command.

If the **scrn**, **nsfi**, or **nsr** parameter is entered, summary information for all screens that match the specified parameters is shown.

When the % FULL is over 100%, the screen is inaccessible. A screen set over 100% capacity size will not bind correctly. A screen set can become provisioned over capacity when linking one screen reference to another causes the size to become too large. To reduce a screen set that is over 100% capacity, screen rules must be deleted (see the **dlt-scr-xxx** commands).

Output

In the following example the % full is over 100% and the screen is inaccessible.

rtrv-scrset

```
rlghncxa03w 03-03-14 16:37:05 EST EAGLE 31.3.0
ENTIRE GWS DATABASE IS 1% FULL
CDPA + AFTPC TABLES ARE 0% FULL
SCREEN SET TABLE IS (2 OF 255) 2% FULL
THERE ARE 0 SEAS SCREEN SETS USED ( prefix 00nn )
THERE ARE 2 EAGLE SCREEN SETS USED

THE FOLLOWING ARE OVER 80% FULL:
SCRN  NSFI      NSR/ACT  FULL  RULES  TABLES  DESTFLD
scr1  OPC              101% 4093   2        Y

SCRN  NSFI      NSR/ACT  FULL  RULES  TABLES  DESTFLD
scr1  OPC      opc1     101% 4093   2        Y
scr2  OPC      opc2       1%   3      2        Y
;
```

rtrv-scrset:nsfi=opc

```
rlghncxa03w 03-03-14 16:37:54 EST EAGLE 31.3.0
SCRN  NSFI      NSR/ACT  RULES  DESTFLD
att1  OPC      att1     111    Y
atx1  OPC      atx1      2      Y
bam1  OPC      bam1      3      Y
ctt1  OPC      ctt1      1      Y
ctw1  OPC      ctw       39     Y
mci1  OPC      mci1      3      Y
wt11  OPC      wt11     339    Y
;
```

rtrv-scrset:nsr=dpc3

```
rlghncxa03w 03-03-14 16:38:28 EST EAGLE 31.3.0
SCRN  NSFI      NSR/ACT  RULES
ss01  DPC      dpc3      3
ss02  DPC      dpc3      3
ss03  DPC      dpc3      3
ss04  DPC      dpc3      3
ss05  DPC      dpc3      3
;
```

rtrv-scrset:scrn=ss53

```
rlghncxa03w 03-03-14 16:39:04 EST EAGLE 31.3.0
SCRN  NSFI      NSR/ACT  RULES  DESTFLD
ss53  BLKDPC  bkd2      2      Y
      CGPA    cgp1      3
      TT     tt1       3
      TT     tt2       3
      TT     tt3       4
      CDPA   cdp1      3
      CDPA   cdp2      3
      CDPA   cdp3      4
      AFTPC  end1      9
;
```

rtrv-scrset:scrn=gws1

```
e1070402 02-07-22 10:06:09 EST EAGLE 30.0.0
rtrv-scrset:scrn=gws1
Command entered at terminal #4.
SCRN  NSFI      NSR/ACT  RULES  DESTFLD
gws1  OPC       opc1     17     Y
      BLKOPC   bop1     1812
      SIO      sio1     80
      DPC      dpc1     17
      BLKDPC   bdp1     1812
      CGPA     cga1     34
      TT       tt01     256
      CDPA     cda1     17
      CDPA     cdb1     6
      AFTPC    apc1     17
      ISUP     isu1     17
```

;

Legend

SCRN—The name of the screen set.

NSFI—The next screening category to be used.

NSR/ACT—The name of the next screening reference (NSR - up to four characters) or action to be taken (ACT - up to six characters), if the message passes this screen.

FULL—The capacity of allowed memory a given screen set occupies, expressed as a percentage.

RULES—The number of entries in the screen set.

TABLES—The number of tables in the screen set.

DESTFLD—Displays whether to apply the automatic allowed affected destination screening for network management messages against the routing table, self point codes, and capability point codes. When this parameter is on, the automatic screening is applied at the end of the provisioned screen set.

rtrv-secu-dflt**Display System-Wide Security-Related Defaults**

Use this command to display the current values of the various security-related parameters that have been configured with the **chg-secu-dflt** command.

Keyword: **rtrv-secu-dflt**

Related Commands: **chg-pid, chg-secu-dflt**

Command Class: Security Administration

Parameters

:msg= (optional)

Use this parameter to specify whether the text of the login warning message is to be displayed also.

Range: **yes, no**

Default: **no**

Example

```
rtrv-secu-dflt
rtrv-secu-dflt:msg=yes
```

Dependencies

None

Notes

None

Output

rtrv-secu-dflt:msg=yes

```
rlghncxa03w 03-03-17 16:02:05 EST EAGLE 31.3.0
-----
PAGE             60
UOUT             90
MULTLOG         NO
MINLEN          8
ALPHA           1
NUM             1
PUNC            1
WARNING MESSAGE
-----
1:"*****"
2:"* NOTICE: This is a private computer system.   *"
3:"* Unauthorized Access or use may lead to        *"
4:"* prosecution.                                  *"
5:"* 05-03-01 Notice!! Eagle will be upgraded between *"
6:"*                the hours of 2am-3am on 05-03-02.  *"
7:"*                                               *"
8:"* Today's happy message: Go with Tekelec!!      *"
9:"*****"
10:" "
11:""
12:""
13:""
14:""
15:""
16:""
17:""
18:""
19:""
20:""
;
```

rtrv-secu-dflt

```
rlghncxa03w 03-03-17 16:02:05 EST EAGLE 31.3.0
-----
PAGE             60
UOUT             90
MULTLOG         NO
MINLEN          8
ALPHA           1
NUM             1
PUNC            1
;
```

Legend

PAGE—The default password aging interval for newly created user IDs

UOUT—The number of successive days a user ID can go unused (no successful login) before the system denies login.

MULTLOG—Indicates whether users can be logged on to multiple terminals at the same time

MINLEN—The minimum password length.

ALPHA—The minimum number of alphabetic characters (a–z) required in a new password.

NUM—The minimum number of numeric characters (0–9) required in a new password.

PUNC—The minimum number of punctuation characters required in a new password. A punctuation character is any character that is not an alphabetic or numeric character.

WARNING MESSAGE—The message displayed when a user has successfully logged in.

rtrv-secu-trm**Display Terminal Access Rights**

Use this command to display the access rights for a terminal. Only a user with system security administration authority can change a terminal's access rights. Access rights determine whether a terminal or port has command access to the system.

Keyword: rtrv-secu-trm

Related Commands: chg-secu-trm

Command Class: Security Administration

Parameters

:trm= (optional)

Specifies the port about which information will be displayed.

Range: 1-16

Default: Display all

Example

```
rtrv-secu-trm
```

```
rtrv-secu-trm:trm=9
```

Dependencies

None

Notes

None

Output

rtrv-secu-trm

```
rlghncxa03w 03-03-15 12:31:04 EST EAGLE 31.3.0
                                LNP LNP LNP
TRM  LINK SA  SYS  PU   DB   DBG  BAS  DB  SUB
1    NO  NO  YES  NO   YES  NO  YES  YES NO
2    NO  YES NO  NO   NO   NO  YES  NO  NO
3    YES *** YES  YES  YES  YES  YES  NO  NO
4    NO  NO  NO  NO   NO   NO  YES  NO  YES
5    YES *** YES  NO   YES  YES  YES  YES  YES
6    NO  NO  NO  NO   NO   NO  YES  YES  YES
.
.
.
16   NO  YES NO  NO   YES  YES  YES  YES  YES
;
```

In the following example, the Command Class Management feature is enabled.

rtrv-secu-trm

```
rlghncxa03w 03-03-15 12:30:07 EST EAGLE 31.3.0
                                lnp lnp lnp
trm  link sa  sys pu   db   dbg  bas  db  sub
1    NO  NO  YES NO   YES  NO  YES  YES NO
2    NO  YES NO  NO   NO   NO  YES  NO  NO
3    YES *** YES  YES  YES  YES  YES  NO  NO
4    NO  NO  NO  NO   NO   NO  YES  NO  YES
5    YES *** YES  NO   YES  YES  YES  YES  YES
6    NO  NO  NO  NO   NO   NO  YES  YES  YES
.
.
.
16   NO  YES NO  NO   YES  YES  YES  YES  YES

trm  U01 U02 U03 U04 U05 U06 U07 U08 U09 U10 U11 U12 U13 U14 U15 U16
1    NO  NO  YES NO   YES  NO  YES  YES NO  YES NO  NO  NO  NO  YES NO
2    NO  YES NO  NO   NO   NO  YES  NO  NO  NO  YES NO  YES NO  YES NO
3    YES NO  YES YES  YES  YES  YES  NO  NO  YES NO  NO  NO  YES NO  YES
4    NO  NO  NO  NO   NO   NO  YES  NO  YES  NO  YES NO  YES NO  YES NO
5    YES YES YES NO   YES  YES  YES  YES  YES  YES NO  NO  NO  YES NO  YES
6    NO  NO  NO  NO   NO   NO  YES  YES  YES  NO  YES NO  YES NO  YES NO
.
.
.
16   NO  YES NO  NO   YES  YES  YES  YES  YES  YES  YES  YES  YES NO  YES NO  YES

trm  U17 U18 U19 U20 U21 U22 U23 U24 U25 U26 U27 U28 U29 U30 U31 U32
1    NO  NO  YES NO   YES  NO  YES  YES NO  YES NO  NO  NO  YES NO  YES
2    NO  NO  NO  NO   NO   NO  YES  NO  YES  NO  YES NO  YES NO  YES NO
3    YES YES YES NO   YES  YES  YES  YES  YES  YES NO  NO  NO  YES NO  YES
4    NO  NO  NO  NO   NO   NO  YES  YES  YES  NO  YES NO  YES NO  YES NO
5    NO  NO  YES NO   YES  NO  YES  YES NO  YES  NO  NO  NO  NO  YES NO
6    NO  YES NO  NO   NO   NO  YES  NO  NO  NO  YES  NO  YES NO  YES NO
.
.
.
16   NO  YES NO  NO   YES  YES  YES  YES  NO  YES  NO  YES  NO  YES NO  YES
;
```

rtrv-secu-trm:trm=9

```
rlghncxa03w 03-03-15 12:30:07 EST EAGLE 31.3.0
                                LNP LNP LNP
TRM   LINK SA  SYS  PU   DB   DBG  BAS  DB  SUB
9     NO  NO  YES  NO   YES  NO   YES  YES  YES
;
```

In the following example, the Command Class Management feature is enabled.

rtrv-secu-trm:trm=9

```
rlghncxa03w 03-03-15 12:30:07 EST EAGLE 31.3.0
                                LNP LNP LNP
TRM   LINK SA  SYS  PU   DB   DBG  BAS  DB  SUB
9     NO  NO  YES  NO   YES  NO   YES  YES  YES

trm   U01 U02 U03 U04 U05 U06 U07 U08 U09 U10 U11 U12 U13 U14 U15 U16
9     NO  NO  YES NO   YES NO   YES YES YES YES NO  YES NO  YES NO  YES

trm   U17 U18 U19 U20 U21 U22 U23 U24 U25 U26 U27 U28 U29 U30 U31 U32
9     NO  NO  YES YES YES YES YES YES YES YES YES YES YES NO  YES NO  NO
;
```

Legend

TRM—The ID number of the terminal whose characteristics are to be changed.

LINK—Shows whether the Link Maintenance class of commands is allowed for this terminal.

SA—Shows whether the Security Administration class of commands is allowed for this terminal.

SYS—Shows whether the System Maintenance class of commands is allowed for this terminal.

PU—Shows whether the Program Update class of commands is allowed for this terminal.

DB—Shows whether the Database class of commands is allowed for this terminal.

DBG—Shows whether the Debug class of commands is allowed for this terminal.

*******—Denotes a Security Administration port whose port type has been configured with a value of **oap**, **none**, or **printer**. These terminal types do not allow you to enter commands.

LNPBAS—Shows whether the LNP BASIC class of commands is allowed for this terminal. (Appears only if LNP is turned on).

LNPDB—Shows whether the LNP Database class of commands is allowed for this terminal. (Appears only if LNP is turned on).

LNPSUB—Shows whether the LNP Subscription class of commands is allowed for this terminal. (Appears only if LNP is turned on).

U01 - U32—Configurable command class default names. (If configured with a user-specified name, that name appears).

rtrv-secu-user**Retrieve Security User**

Use this command to show the security information for all users in the system.

Keyword: rtrv-secu-user

Related Commands: act-user, chg-pid, chg-user, dact-user, dlt-user, ent-user, login, logout, rept-stat-user, rtrv-user

Command Class: Security Administration

Parameters

:uid= (optional)

User ID

Range: 1 alphabetic character followed by up to 15 alphanumeric characters

Default: Display all

Example

rtrv-secu-user:uid=rogers

Dependencies

If a user ID is specified, the user ID must exist in the UserID table.

Notes

Only the system administrator should have access to this command.

Passwords cannot be shown.

This command can be canceled using the **F9** function key or the **canc-cmd** command. See **canc-cmd** for more information.

Output

The following example shows a display when the LNP feature is turned on and the Command Class Management feature is not enabled:

rtrv-secu-user

```

rlghncxa03w 04-01-07 09:50:17 EST EAGLE 31.3.0
                                     lnp lnp lnp
user id          age page uout rev link sa  sys pu  db  dbg bas db  sub
eagle1longname16 750 0    0    NO  YES  YES  YES  YES  YES  YES  YES  YES  YES
                                     lnp lnp lnp
user id          age page uout rev link sa  sys pu  db  dbg bas db  sub
manny           36  60   60   NO  YES  YES  YES  YES  YES  YES  YES  YES  YES
                                     lnp lnp lnp
user id          age page uout rev link sa  sys pu  db  dbg bas db  sub
moe             100 30   60   YES YES  YES  YES  YES  YES  YES  YES  YES  YES
                                     lnp lnp lnp
user id          age page uout rev link sa  sys pu  db  dbg bas db  sub
jack            10  30   30   NO  YES  YES  YES  YES  YES  YES  YES  YES  YES
;

```

The following example shows a display when the LNP feature is turned on and the Command Class Management feature is enabled:

rtrv-secu-user

rlghncxa03w 04-01-07 09:50:17 EST EAGLE 31.3.0

user id	age	page	uout	rev	link	sa	sys	pu	db	dbg	bas	db	sub
eagle1longname16	750	0	0	NO	YES	YES	YES	YES	YES	YES	YES	YES	YES

u01	u02	u03	u04	u05	u06	u07	u08	u09	u10	u11	u12	u13	u14	u15	u16
YES	YES	YES	YES	YES	YES	YES	YES	YES	YES	YES	YES	YES	YES	YES	NO
u17	u18	u19	u20	u21	u22	u23	u24	u25	u26	u27	u28	u29	u30	u31	u32
YES	YES	YES	YES	YES	YES	YES	YES	YES	YES	YES	NO	NO	NO	NO	YES

user id	age	page	uout	rev	link	sa	sys	pu	db	dbg	bas	db	sub
manny	36	60	60	NO	YES	YES	YES	YES	YES	YES	YES	YES	YES

u01	u02	u03	u04	u05	u06	u07	u08	u09	u10	u11	u12	u13	u14	u15	u16
NO	NO	NO	NO	YES	YES	YES	YES	YES	YES	YES	YES	YES	YES	YES	YES
u17	u18	u19	u20	u21	u22	u23	u24	u25	u26	u27	u28	u29	u30	u31	u32
YES	YES	YES	YES	YES	YES	YES	YES	YES	YES	YES	NO	NO	NO	NO	YES

user id	age	page	uout	rev	link	sa	sys	pu	db	dbg	bas	db	sub
moe	100	30	60	YES	YES	YES	YES	YES	YES	YES	YES	YES	YES

u01	u02	u03	u04	u05	u06	u07	u08	u09	u10	u11	u12	u13	u14	u15	u16
YES	YES	YES	YES	YES	YES	YES	YES	YES	YES	YES	YES	YES	YES	YES	NO
u17	u18	u19	u20	u21	u22	u23	u24	u25	u26	u27	u28	u29	u30	u31	u32
YES	YES	YES	YES	YES	YES	YES	YES	YES	YES	YES	YES	YES	NO	NO	NO

user id	age	page	uout	rev	link	sa	sys	pu	db	dbg	bas	db	sub
jack	10	30	30	NO	YES	YES	YES	YES	YES	YES	YES	YES	YES

u01	u02	u03	u04	u05	u06	u07	u08	u09	u10	u11	u12	u13	u14	u15	u16
YES	YES	YES	YES	YES	YES	YES	YES	YES	YES	YES	YES	YES	YES	YES	YES
u17	u18	u19	u20	u21	u22	u23	u24	u25	u26	u27	u28	u29	u30	u31	u32
YES	YES	YES	YES	YES	YES	NO	NO	NO	NO	YES	YES	YES	YES	YES	NO

;

The following example shows a display when the LNP feature is not turned on and the Command Class Management feature is not enabled:

rtrv-secu-user

```
rlghncxa03w 03-03-07 09:50:17 EST EAGLE 31.3.0
user id          age page uout rev link sa  sys pu  db  dbg
eagle1longname16 750 0    0    NO  YES  YES YES YES YES YES

user id          age page uout rev link sa  sys pu  db  dbg
manny           36  60   60   NO  YES  YES YES YES YES YES

user id          age page uout rev link sa  sys pu  db  dbg
moe             100 30   60   YES YES YES YES YES YES

user id          age page uout rev link sa  sys pu  db  dbg
jack            10  30   30   NO  YES  YES YES YES YES YES
```

;

Legend

USER-ID—The name of the user

AGE—Shows the current age, in days, of the password associated with this user ID. If the password age is greater than 999 days, the value 999 is displayed.

PAGE—Shows the maximum password age established for this user ID. When AGE becomes greater than PAGE, the system forces the user to change the password at the next login. An asterisk (*) displayed after the value indicates that the system-wide default page parameter value, as configured on the **chg-secu-dflt** command, is in effect for the user ID.

UOUT—Shows the user ID aging interval, in days. If the user ID is not used (that is, no successful login) for longer than this interval, the system does not allow a login. An asterisk (*) displayed after the value indicates that the system-wide default **uout** parameter value, as configured on the **chg-secu-dflt** command, is in effect for the user ID.

REV—Shows whether the user ID is denied login (revoked). YES indicates that the user ID is revoked, NO indicates that the user ID is not revoked.

LINK—Shows whether the user has access to all commands in the command class “Link Maintenance.”

SA—Shows whether the user has access to all commands in the command class “Security Administration.”

SYS—Shows whether the user has access to all commands in the command class “System Maintenance.”

PU—Shows whether the user has access to all commands in the command class “Program Update.”

DB—Shows whether the user has access to all commands in the command class “Database Administration.”

DBG—Shows whether the user has access to all commands in the command class “Debug.”

If the Command Class Management feature is enabled, the following fields appear:

U01 - U32—Default configurable command class names. If user-defined names have been provisioned, they will appear instead of the default names.

If the LNP feature is turned on, the following fields are displayed:

LNPBAS—Shows whether the user has access to all commands in the command class “LNP Basic.”

LNPDB—Shows whether the user has access to all commands in the command class “LNP Database.”

LNPSUB—Shows whether the user has access to all commands in the command class “LNP Subscription.”

rtrv-seculog

Generate Report from Security Log Contents

Use this command to retrieve the contents of a security log and display it to the user in the scroll area. Various reports can be produced by varying the values of the command parameters. By default, the report is generated from the log on the active fixed disk, although the **slog** parameter can be used to generate the report from the log on the standby fixed disk.

Keyword: rtrv-seculog

Related Commands: None

Command Class: Security Administration

Parameters

:edate= (optional)

End date. Use this parameter to report log entries only if they were created on or before the specified date. If the **sdate** parameter is also specified, log entries are reported only if they were created for the date period specified by the **sdate** and **edate** combination.

Range: 000101–991231

(in the form *yymmdd*, where *yy* is year, *mm* is month, and *dd* is day)

The date must be specified with 6 digits. For example, enter 1/1/96 as **960101**.

Default: Report log entries regardless of their creation date

:etime= (optional)

End time. Use this parameter to report log entries only if they were created between midnight (00:00:00) and the time specified on this parameter. If the **stime** parameter is also specified, log entries are reported only if they were created in the time period specified by the **stime** and **etime** combination.

Range: 000000–235959

(in the form *yymmdd*, where *yy* is year, *mm* is month, and *dd* is day)

The time must be specified with 6 digits in a 24-hour format. For example, enter 1:05:03 P.M. as **130503**.

Default: Report log entries regardless of their creation time

:mode= (optional)

Use this parameter to produce a either full log report or an abbreviated log report.

Range: **brief, full**

brief—Causes only one line of output to be generated for each log entry reported. Some information in each reported log entry is not shown.

full—Produces a report showing multiple lines of output for each log record that is reported. This report displays more information from each log record (including the entire command) than the **mode=brief** report.

Default: **brief**

:num= (optional)

Maximum number of records to be displayed. This parameter specifies how many records are to be displayed before the report is terminated.

Range **1–50,000**

Default: **500**—if **mode=brief** is specified

250—if **mode=full** is not specified

:rectype= (optional)

Use this parameter to specify whether you want all records in the log to be considered for reporting or only new (that is, un-uploaded) records.

Range: **new, both**

new—The report generator scans only new (that is, un-uploaded) records when generating the report. Old records are not considered for reporting, even if they match the reporting criteria.

both—All records in the log are considered for reporting.

Default: **new**

:sdate= (optional)

Start date. Use this parameter to report log entries only if they were created on or after the specified date. If the **edate** parameter is also specified, log entries are reported only if they were created for the date period specified by the **sdate** and **edate** combination.

Range: **000101–991231**

(in the form **yymmdd**, where **yy** is year, **mm** is month, and **dd** is day)

The date must be specified with 6 digits. For example, enter 1/1/96 as **960101**.

Default: Report log entries regardless of their creation date

The date must be specified with 6 digits. For example, enter 1/1/96 as **960101**.

:slog= (optional)

Source log indicator. This parameter specifies which log is to be copied to the FTA.

Range: **act, stb**

act—Specify **act** to produce the report from the log on the active MASP

stb—Specify **stb** to produce the report from the log on the standby MASP

Default: **act**

:stime= (optional)

Start time. Use this parameter to report log entries only if they were created between the time specified on this parameter and the end of the day (23:59:59) inclusive. If the **etime** parameter is also specified, log entries are reported only if they were created in the time period specified by the **stime** and **etime** combination.

Range: 000000–235959

The time must be specified with 6 digits in a 24-hour format (*hhmmss*). For example, enter 1:05:03 P.M. as **130503**.

hhmmss—*hh*=hours (**00-23**), *mm*=minutes (**00-59**), *ss*=seconds (**00-59**)

Default: Report log entries regardless of their creation time

:trm= (optional)

Terminal ID. Use this parameter to report only those log entries created by the specified terminal.

Range: 1-16

Default: Report log entries regardless of the associated terminal

:uid= (optional)

User ID. Use this parameter to report only those log entries created by the specified user ID. Specify **uid=seas** to report only those commands received on a SEAS terminal. Specify **uid=none** to report only those commands not associated with a user ID. For example, commands issued prior to login.

Range: 1 alphabetic character followed by up to 15 alphanumeric characters

Default: Display all

Example

```
rtrv-seculog:sdate=021496:edate=021596:num=7
```

```
rtrv-seculog:mode=full:sdate=021496:edate=021496:stime=062900:etime=063200
```

Dependencies

If both the **sdate** and **edate** parameters are specified, the date that is specified for the **sdate** parameter must be earlier than or equal to the date specified for the **edate** parameter.

If both the **stime** and **etime** parameters are specified, the time that is specified for the **stime** parameter must be earlier than or equal to the time specified for the **etime** parameter.

The month component of the **sdate** and **edate** parameter combination must be specified in the range **1-12**.

The day component of **sdate** and **edate** parameter combination must be specified in the range **1-31**. This value must accurately reflect the number of days in the month and year indicated. For example, **sdate=960631** is not a valid parameter value because June has only 30 days.

The second component of the **stime** and **etime** parameter combination must be specified in the range **00-59**.

The minute component of the **stime** and **etime** parameter combination must be specified in the range **00-59**.

No other security log command can be in progress when this command is entered.

Notes

To accommodate the year 2000 and beyond, the two-digit year portion of dates is interpreted to be in the indicated century as follows:

years 95–99 = 1995 through 1999

years 00–36 = 2000 through 2036

A consequence of this is that date 000101 (January 1, 2000) is greater than 991231 (December 31, 1999).

If the **mode=brief** parameter is specified and the output report has a plus (+) symbol appearing at the end of the command, the plus symbol indicates that more command characters are available to be displayed. Specify the **mode=full** parameter to see these additional characters.

In the **mode=full** output report, a plus (+) symbol appearing at the end of the command indicates the command is longer than 150 characters. Note that even in the uploaded log, each record in the log has room to record only 150 characters of the entered command. If the command is longer than 150 characters, then only the first 149 characters of the command and the plus symbol (to indicate that truncation has occurred) are recorded.

Security log size is limited to 50,000 records. Data from a query that exceeds the size limit of the security log cannot be displayed.

The system checks to ensure that the day portion of any **sdate/edate** value entered is in agreement with the month and year. It issues error message E2252 if the day is found to be invalid (for example, **960631** is not a valid date). The system software and date/time hardware properly handle leap years and leap centuries. The year 2000 is a leap year.

The system uses the **sdate/edate** and **stime/etime** parameters to select log records for reporting as follows:

- If the date on which the log record was created is not in the date range specified by the **sdate/edate** parameters, the record is not reported. The default **sdate** is the date of the oldest record in the log, and the default **edate** is the current date.
- If the time of day at which the log record was created is not in the time range specified by the **stime/etime** parameters, the record is not reported. The default **stime** is 00:00:00 (midnight), and the default **etime** is 23:59:59.
- Otherwise, the log record is reported, unless it is disqualified by other parameters such as **uid** or **trm**.

As an example, if the following command is entered, records are displayed for October 10, 1996 from 2:00 p.m. until 4:00 p.m., for October 11, 1996, from 2:00 p.m. until 4:00 p.m., and for October 12, 1996, from 2:00 p.m. until 4:00 p.m.

```
rtrv-seculog:sdate=961010:edate=961012:stime=140000:etime=160000
```

It takes the system approximately one minute to display 500 lines of data in the scroll area. To output a complete **mode=full** report (150,000 lines maximum) takes approximately 300 minutes. For this reason, the **num** parameter defaults to either **125 (mode=full)** or **500 (mode=brief)**, to prevent an excessively long process time, unless you deliberately choose a longer report.

This command can be canceled using the **F9** function key or the **canc-cmd** command. See **canc-cmd** for more information.

The message Command Failed - unable to read security log message appears in the scroll area if the **slog=stb** parameter is specified (either explicitly or by default) and the standby fixed disk is not available (for example, simplex mode).

When the **rtrv-seculog** command is entered, one of the first things that the reporting function does is to examine the log overflowed and logging failure flags in the header of the specified log. Depending on the nature of the information found, one of the following notices is displayed in the output:

```
Notice: Log overflow has occurred -- report may be incomplete.
Notice: Logging failure -- report may be incomplete.
```

Output

The following example shows how all records in the log created between 2/14/96 and 2/15/96 are to be displayed, up to a maximum of 9 records.

rtrv-seculog:sdate=960214:edate=960215:num=9

```
rlghncxa03w 96-02-14 06:32:20 EST EAGLE 27.1
Notice: Log overflow has occurred -- report may be incomplete.
Reporting parameters:
  sdate   = 960214
  edate   = 960215
  num     = 9
```

uid	trm	date	time	st	cmd
NONE	03	960214	063000	OK	login:uid=johnlamb
SEAS	15	960214	063010	OK	CHG-SLK::LSN123-03:123456:50,RCH::S+
johnlamb	03	960214	063021	OK	rept-stat-trbl
SEAS	15	960214	063032	OK	CHG-RTE::LSNABC-001001001:123456:55+
johnlamb	05	960215	064524	RJ	ent-crad:loc=1201:type=limds0:appl=+
johnlamb	05	960215	064528	OK	ent-card:loc=1201:type=limds0:appl=+
johnlamb	03	960215	063030	AB	rept-stat-card
johnlamb	03	960215	063031	OK	canc-cmd
johnlamb	05	960215	064533	OK	logout

```
Report terminated -- output length limitation (NUM=) reached.
9 records reported of 5613 records scanned.
END OF SECURITY LOG REPORT.
;
```

The following example shows that all records in the log created between 2/14/96 and 2/15/96 between the hours of 06:29:00 and 06:32:00 are to be displayed.

rtrv-seculog:mode=full:sdate=960214:edate=960214:stime=062900:etime=063200

```
rlghncxa03w 96-02-14 06:32:20 EST EAGLE 27.1
Reporting parameters:
  sdate   = 960214
  edate   = 960214
  stime   = 062900
  etime   = 063200
```

uid	trm	date	time	result
NONE	05	960214	062912	E1234
Cmd: login:uid=eagle				
johnlamb	03	960214	063000	OK
Cmd: rept-stat-card				
SEAS	16	960214	063123	OK

```

Cmd:CHG-SLK::LSN12345-12:123456:50,RCH::OOS:::D,PRV123456-106-12,96-02-14-06-31
-22;
Johnlamb          03 960214 063128 OK
Cmd:chg-lnp-lrn:lrn=1234567890:nmrgt1=255-255-255-255-255-dpcssn-ssn-255-yes:nmr
gt2=255-255-255-255-dpcssn-ssn-255-yes:mrrgt3=255-255-255-255-255-dpcssn+

3 records reported of 50000 records scanned.
END OF SECURITY LOG REPORT.
;

```

Legend

UID—The user ID that issued the command. The value **SEAS** appears if the command was received on a SEAS port. The value **NONE** appears if no user ID was associated with the port at the time the command was logged.

TRM—The terminal ID of the terminal where the command was received.

DATE—The date when the log entry was made; that is, the date on which the command was received for execution.

TIME—The time when the log entry was made; that is, the time the command was received for execution. A 24-hour time format is used (for example, 1:00p.m. = 130000).

ST—The two-letter shorthand notation of the command's status. The complete status can be obtained by re-entering the **rtrv-seculog** command and specifying the **mode=full** parameter. The status abbreviations are as follows:

AB—Command aborted. Displayed when the **canc-cmd:trm** command is issued to abort the following commands: **rept-stat-card**, **rept-stat-dstn**, **rept-stat-ls**, **rept-stat-slk**, **rtrv-dstn**, **rtrv-gta**, **rtrv-gtt**, **rtrv-ls**, **rtrv-map**, **rtrv-rte**, **rtrv-seculog**, and **rtrv-slk**. An AB status indicates that processing and output of the command have been halted. This status is also displayed for SEAS flow-thru commands that are canceled with the **canc-cmd** (without the **trm** parameter).

RJ—Command rejected. Displayed whenever the results value that would be displayed in the **mode=full** report would be one of the following:

Edddd

FAILED

rrrrr/mmmm

RL—Retry later. The system is busy.

IP—In Progress

OK—Command successfully executed

TO—Timed out.

CMD—The command that was recorded. In the **mode=brief** report, if the length of the recorded command is greater than or equal to 35 characters (as this much as can be displayed on a single line of the output report), then only the first 34 characters of the command are displayed, and the 35th character is displayed as a plus symbol (+) to

indicate that more information is available in the log. Re-enter the **rtrv-seculog** command with the **mode=full** parameter to see the additional information. In the **mode=full** report, a plus symbol at the end of a command indicates that the command is longer than 150 characters.

rtrv-serial-num

Retrieve Serial Number

Use this command to retrieve the NT serial number for the system.

Keyword: rtrv-serial-num

Related Commands: ent-serial-num

Command Class: Database Administration

Parameters

This command has no parameters.

Example

rtrv-serial-num

Dependencies

None

Notes

None

Output

Dashes appear if the serial number has not yet been entered into the database.

rtrv-serial-num

```
rlghncxa03w 03-03-29 16:40:40 EST EAGLE 31.3.0
System serial number = nt00001231
```

```
System serial number is locked.
```

```
rlghncxa03w 03-03-29 16:40:40 EST EAGLE 31.3.0
Command Completed
```

```
;
```

rtrv-sg-opts

Retrieve IP⁷ Secure Gateway Options

Use this command to retrieve information about the currently chosen IP⁷ Secure Gateway protocol options.

Keyword: rtrv-sg-opts

Related Commands: chg-sg-opts, rtrv-appl-rtkey

Command Class: Database Administration

Parameters

This command has no parameters.

Example**rtrv-sg-opts****Dependencies**

None

Notes

None

Output**rtrv-sg-opts**

```

rlghncxa03w 03-07-07 09:50:17 EST EAGLE 31.6.0
SYNC:          TALI
SRKQ:          250
DRKQ:          750
SNMPCONT:     john doe 555-123-4567
GETCOMM:      public
SETCOMM:      private
TRAPCOMM:     public
INHFEPALM:    YES
SCTPCSUM:     adler32
IPGWABATE:    NO
IPLIMABATE:   NO
IPTPSALMTHRESH: 100%
;

```

Legend

SYNC—The synchronization opcode used for messages sent by SS7IPGW cards (TALI or SASSI).

SRKQ—The static routing key quantity. The maximum number of routing key entries in the Static Routing Key table.

DRKQ—The dynamic routing key quantity. The maximum number of routing key entries in the Dynamic Routing Key table of each SS7IPGW card.

SNMPCONT—The system contact information for each DCM and SSED CM SNMP agent.

GETCOMM—The community name used for SNMP Get and GetNext request validations. This value applies for each DCM and SSED CM SNMP agent in the system.

SETCOMM—The community name used for SNMP Set request validation. This value applies for each DCM and SSED CM SNMP agent in the system.

TRAPCOMM—The community name to use when SNMP traps are generated. This value applies for each DCM and SSED CM SNMP agent in the system.

SCTPCSUM—SCTP checksum algorithm type (adler32 or crc32c).

IPGWABATE—Enabled (YES) or disabled (NO) IPGWx SS7 congestion abatement procedures.

IPLIMABATE—Enabled (YES) or disabled (NO) IPLIMx SS7 congestion abatement procedures.

IPTPSALMTHRESH—Alarm threshold percent at which system IPTPS alarms are generated. Can be set below 100 percent if "early warning" is desired.

rtrv-shlf

Retrieve Shelf

Use this command to display the frames and shelves that are currently provisioned in the system. The type of shelf is also shown.

Keyword: rtrv-shlf

Related Commands: dlt-shlf, ent-shlf

Command Class: Database Administration

Parameters

:loc= (optional)

The shelf location.

Range: 1100, 1200, 1300, 2100, 2200, 2300, 3100, 3200, 3300, 4100, 4200, 4300, 5100, 5200, 5300, 6100

Default: Display all configured locations

Example

```
rtrv-shlf
rtrv-shlf:loc=1300
rtrv-shlf:loc=2100
```

Dependencies

The frame and shelf values of the shelf location parameter (**loc**) must be within the valid range (xyzz, where x=frame and y=shelf; zz is always 00 for this command).

Notes

None

Output

The following example displays all configured STP equipment shelves.

```
rtrv-shlf
rlghncxa03w 04-01-07 09:50:17 EST EAGLE 31.3.0
SHELF DISPLAY
FRAME SHELF      TYPE
   1     1      CONTROL
   1     2      EXTENSION
   1     3      EXTENSION
   2     3      EXTENSION
;
```

The following example displays a specific STP equipment shelf.

rtrv-shlf:loc=1300

```
rlghncxa03w 04-01-07 09:50:17 EST EAGLE 31.3.0
SHELF DISPLAY LOCATION=1300
FRAME SHELF      TYPE
 1      3      EXTENSION
CARD  TYPE      APPL  LSET NAME  PORT SLC  LSET NAME  PORT SLC
1301  LIMDS0    SS7ANSI  -----  --  --  -----  --  --
1302  LIMDS0    SS7ANSI  -----  --  --  -----  --  --
1303  LIMDS0    SS7ANSI  -----  --  --  -----  --  --
1304  LIMDS0    SS7ANSI  -----  --  --  -----  --  --
1305  LIMDS0    SS7ANSI  -----  --  --  -----  --  --
;
```

The following example displays a specific STP equipment shelf that is not configured (unequipped).

rtrv-shlf:loc=2100

```
rlghncxa03w 04-01-07 09:50:17 EST EAGLE 31.3.0
SHELF DISPLAY LOCATION=2100
FRAME SHELF      TYPE

This shelf is UNEQUIPPED in the database.
;
```

Legend

FRAME—The frame location of the shelf.

SHELF—The location of the shelf within the frame.

TYPE—The type of shelf.

CARD—Card location in the specified shelf.

TYPE—Card type

APPL—Application running on the card.

LSET NAME—Linkset name defined for the port on the card.

PORT—Port used by the linkset defined on the card.

SLC—Signaling link code for the linkset.

rtrv-sid

Retrieve Self Identification

Use this command to retrieve site identification characteristics of the system. It shows the point code assigned to this system, the CLI code of the system, the capability code of the STP, and the type of point codes supported by the system.

Keyword: rtrv-sid

Related Commands: chg-sid

Command Class: Security Administration

Parameters

:cpc/cpca/cpci/cpcn/cpcn24= (optional)

Capability point code. The code used by the SS7 protocol to identify a group of functionally related STPs in the signaling network to which the STP belongs.

NOTE: See “Point Code Formats and Conversion” in Appendix A for a detailed description of point code formats, rules for specification, and examples.

:cpc= or **:cpca=** (optional)

ANSI capability point code in the form of *network indicator-network cluster-network cluster member (ni-nc-ncm)*.

Range: **000-255**

Specify a valid value for each subfield of the point code, and separate the subfields with a dash (-).

When **chg-sid:pctype=ansi** is specified, *ni = 000* is not valid.

When **chg-sid:pctype=ansi** is specified, *nc = 000* is not valid if *ni = 001-005*.

When **chg-sid:pctype=ansi** is specified, *nc = 000* is valid if *ni = 006-255*.

The point code **000-000-000** is not a valid point code.

Default: Display all

:cpci= (optional)

ITU international point code with subfields *zone-area-id*. The *prefix* subfield indicates a spare point code (*prefix-zone-area-id*).

Range: **s-, 0-255**

Specify a valid value for each subfield of the point code, and separate the subfields with a dash (-).

prefix—s-

zone—0-7

area—000-255

id—0-7

The point code **0-000-0** is not a valid point code.

Default: Display all

:cpcn= (optional)

ITU national point code in the format of a 5-digit number (*nnnnn*); or 2, 3, or 4 numbers (members) separated by dashes (*m1-m2-m3-m4*) as defined by the **chg-stpopts:npcfinti** flexible point code option. A group code must be specified when the ITUDUPPC feature is turned on (*nnnnn-gc, m1-m2-m3-m4-gc*). The *prefix* subfield indicates a spare point code (*prefix-nnnnn, prefix-nnnnn-gc, prefix-m1-m2-m3-m4, prefix-m1-m2-m3-m4-gc*).

Range: **s-, 0-16383, aa-zz**

Specify a valid value for each subfield of the point code, and separate the subfields with a dash (-).

prefix—s-

nnnnn—0-16383

gc—aa - zz

m1-m2-m3-m4—0-14 for each member; values must sum to 14

Default: Display all

:cpcn24= (optional)

24-bit ITU national point code with subfields *main signaling area-sub signaling area-signaling point (msa-ssa-sp)*.

Range: 000-255

Specify a valid value for each subfield of the point code, and separate the subfields with a dash (-).

msa—000-255

ssa—000-255

sp—000-255

Default: Display all

:cpctype= (optional)

Capability point code type. Specify whether the point code is for the STP or for LNP, INP, or Equipment Identity Register (EIR).

Range: stp, lnp, inp, eir

Default: stp

Example

rtrv-sid

rtrv-sid:cpcn24=002-002-007

rtrv-sid:cpc=3-3-3

rtrv-sid:cpcn=001-001-001

rtrv-sid:cpctype=inp

rtrv-sid:cpci=2-100-4

rtrv-sid:cpcn24=33-33-33

rtrv-sid:cpcn=s-00456

Dependencies

The STP destination point codes and capability point codes can be specified only as full point codes.

The ANSI point code **0-0-0** and the ITU-I point code **0-000-0** are invalid for STP capability point codes.

If **cpctype** is **lnp**, the LNP feature must be turned on (see the “**enable-ctrl-feat**” command).

If **cpctype** is **inp**, the INP feature must be turned on.

If **cpctype** is **eir**, the Equipment Identity Register (EIR) feature must be enabled.

The Spare Point Code Support feature must be enabled before an ITU-I or ITU-N spare point code can be retrieved.

If the **cpcn** parameter is specified, the format of the specified point code must match the format that was assigned with the **chg-stpopts** command **npcfmti** parameter.

Notes

If the **cpc/cpca/cpci/cpcn/cpcn24** parameter is not specified, all site identification characteristics are displayed.

If the STP capability point code is specified and not provisioned, the report contains only the PCA, PCI, PCN or PCN24, CLLI, and PCTYPE fields, with the message:

Compatibility Point Code specified is not provisioned.

In this command, only ITU-international and ITU national point codes support the spare point code subtype prefix (s-).

Output

In the following output examples:

- When a 24-bit ITU-N site identification STP point code is configured, the PCN header is changed to PCN24.
- The s- point code prefix indicates an ITU national or international spare point code or spare capability point code.
- INP, LNP, and EIR capability point codes are indicated in parentheses after the capability point code header. STP capability point codes have no parentheses after the header.

The following examples show all site identification characteristics provisioned in the system at the time the command was entered.

rtrv-sid

```
tekelecstp 04-06-14 15:18:11 EST EAGLE 31.12.0
PCA          PCI          PCN          CLLI          PCTYPE
008-013-008  -----          -----          tklcstn14     OTHER

CPCA
005-005-002      005-005-004      005-005-005

CPCA (LNP)
005-005-002      005-005-004      005-005-005
;
```

rtrv-sid

```
tekelecstp 04-06-14 15:18:11 EST EAGLE 31.12.0
PCA          PCI          PCN24        CLLI          PCTYPE
001-001-001  -----          011-011-011  tekelecstp   ANSI

CPCN24
022-022-022
;
```

rtrv-sid

```
tekelecstp 04-06-14 15:18:11 EST EAGLE 31.12.0
PCA          PCI          PCN          CLLI          PCTYPE
005-067-000      1-023-4      01234          tekelecstp   ANSI
                   s-1-023-4      s-01234

CPCI
s-4-056-0

CPCN
s-00456
;
```

The following example shows a display of a particular STP capability point code.

rtrv-sid:cpc=5-5-4

```
rlghncxa03w 03-03-18 09:33:58 EST EAGLE 31.3.0
PCA          PCI          PCN          CLLI          PCTYPE
008-013-008  -----          -----          tklcstn14     OTHER

CPCA
005-005-004
;
```

The following example shows a particular LNP capability point code.

rtrv-sid:cpc=3-3-3

```
rlghncxa03w 03-03-10 09:33:58 EST EAGLE 31.3.0
PCA          PCI          PCN          CLLI          PCTYPE
008-013-008  -----          -----          tklcstn14     OTHER

CPCA (LNP)
003-003-003
;
```

The following example shows the message that appears when no match for the specified capability point code is found in the site ID table.

rtrv-sid:cpc=100-100-100

```
rlghncxa03w 03-03-18 09:33:58 EST EAGLE 31.3.0
PCA          PCI          PCN          CLLI          PCTYPE
008-013-008  -----          -----          tklcstn14     OTHER

Capability Point Code specified is not provisioned
;
```

The following example shows a display of a site identification STP point code with a group code (the ITUDUPPC feature must be on).

rtrv-sid

```
rlghncxa03w 03-03-18 09:33:58 EST EAGLE 31.3.0
PCA          PCI          PCN          CLLI          PCTYPE
008-013-008  -----          128-15-1-1-SI tklcstn14     OTHER
;
```

The following example shows all provisioned INP capability point codes.

rtrv-sid:cptype=inp

```
rlghncxa03w 03-03-18 09:33:58 EST EAGLE 31.3.0
PCA          PCI          PCN          CLLI          PCTYPE
-----          2-150-4          12345          tklcstn14     OTHER

CPCN (INP)
1234 34567

CPCI (INP)
3-050-2          4-100-3
;
```

The following example shows a specific INP capability point code.

rtrv-sid:pci=2-100-4

```
rlghncxa03w 03-03-18 09:33:58 EST EAGLE 31.3.0
PCA          PCI          PCN          CLLI          PCTYPE
-----          1-200-3          -----          tklcstn14          OTHER

CPCI (INP)
2-100-4
```

;

The following example retrieves a specific spare ITU-N capability point code.

rtrv-sid:pcpn=s-00456

```
rlghncxa03w 05-01-07-18 09:33:58 EST EAGLE 31.12.0
PCA          PCI          PCN          CLLI          PCTYPE
005-067-000  1-023-4          01234          tekelecstp          ANSI
                s-1-023-4          s-01234
```

```
CPCN
s-00456
```

;

```
CPCN (EIR)
s-123
```

;

The following example shows a specific 24-bit ITU-N capability point code.

rtrv-sid:pcpn24=33-33-33

```
rlghncxa03w 02-03-18 09:33:58 EST EAGLE 31.0.0
PCA          PCI          PCN24          CLLI          PCTYPE
001-001-001  -----          011-011-011          tekelecstp          ANSI
```

```
CPCN24
033-033-033
```

;

The following examples retrieve all capability point codes with CPCTYPE of EIR. The second example includes spare point codes.

rtrv-sid:cpctype=eir

```
rlghncxa03w 03-03-18 09:33:58 EST EAGLE 31.0.0
PCA          PCI          PCN24          CLLI          PCTYPE
001-001-001  2-020-1          PCN24          tekelecstp          ANSI
```

```
CPCI (EIR)
2-020-2
```

```
CPCN (EIR)
123
```

rtrv-sid:cpctype=eir

```

rlghncxa03w 05-01-07 09:33:58 EST EAGLE 31.12.0
PCA          PCI          PCN          CLLI          PCTYPE
005-067-000  1-023-4      01234       tekelecstp   ANSI
                s-1-023-4    s-01234

```

```

CPCI (EIR)
s-1-024-5

```

```

CPCN (EIR)
12346

```

;

Legend

PCA—The ANSI point code of the STP.

PCI—The ITU-TSS international point code of the STP.

PCN—The ITU-TSS national point code of the STP.

PCN24—The 24-bit ITU national point code of the STP.

CPCA—The ANSI capability point code used by the SS7 protocol to identify a group of functionally related STPs in the signaling network.

CPCN—The ITU-TSS national capability point code used by the SS7 protocol to identify a group of functionally related STPs in the signaling network.

CPCI—The ITU-TSS international capability point code used by the SS7 protocol to identify a group of functionally related STPs in the signaling network.

CPCN24—The ITU-TSS 24-bit national capability point code used by the SS7 protocol to identify a group of functionally related STPs in the signaling network.

(EIR)—The identified point code is an Equipment Identity Register (EIR) point code.

(INP)—The identified point code is an INAP Number Portability (INP) point code.

(LNP)—The identified point code is a local number portability (LNP) point code.

CLLI—The common language location identifier of the STP

PCTYPE—The type of point code used by the STP. There are two types of point codes that the EAGLE STP can use, ANSI and OTHER. The value ANSI means the EAGLE STP supports point codes that meet the ANSI standard. The value OTHER means that the EAGLE STP supports point codes that do not meet the ANSI standard.

rtrv-slk**Retrieve Signaling Link**

Use this command to show the parameters for low-speed signaling links, ATM high-speed signaling links, or both.

Keyword: rtrv-slk

Related Commands: act-slk, blk-slk, dact-slk, dlt-slk, ent-slk, inh-slk, rept-stat-slk, tst-slk, ublk-slk, unhb-slk

Command Class: Database Administration

Parameters

:class= (optional)

The class of links to be displayed.

Range: **mtp2, saal, e1, t1**

mtp2—Displays low-speed signaling link information only.

saal—Displays ATM high-speed signaling link information only.

e1—Displays signaling link information only for 2-port E1 cards, and E1/T1 cards and HC-MIM cards used as E1 cards or as SE-HSL cards.

t1—Displays signaling link information only for E1/T1 MIM cards and HC-MIM cards used as T1 cards.

Default: Display all signaling links

:loc= (optional)

The card location as stenciled on the shelf of the system.

Range: **1101–1108, 1111–1112, 1201–1208, 1211–1218, 1301–1308, 1311–1318, 2101–2108, 2111–2118, 2201–2208, 2211–2218, 2301–2308, 2311–2318, 3101–3108, 3111–3118, 3201–3208, 3211–3218, 3301–3308, 3311–3318, 4101–4108, 4111–4118, 4201–4208, 4211–4218, 4301–4308, 4311–4318, 5101–5108, 5111–5118, 5201–5208, 5211–5218, 5301–5308, 5311–5318, 6101–6108, 6111–6118**

Default: All signaling links are shown.

:port= or :link= (optional)

The signaling link on the card specified in the **loc** parameter. The links can be specified in any sequence or pattern.

Range: **a, b, a1-a31, b1-b31**

Not all card types support all **link** parameter values.

See Table A-1 in Appendix A for valid **link** parameter range values for each type of card that can have assigned signaling links.

Default: Display all

Example

```
rtrv-slk
```

```
rtrv-slk:loc=1202:link=a
```

```
rtrv-slk:class=saal
```

```
rtrv-slk:loc=1302:link=a
```

```
rtrv-slk:class=e1
```

```
rtrv-slk:loc=1302:link=b2
```

```
rtrv-slk:class=mtp2
```

```
rtrv-slk:class=t1
```

```
rtrv-slk:loc=1303:link=a31
```

Dependencies

If the **link** parameter is specified, the **loc** parameter must be specified. The **loc** parameter can be specified without the **link** parameter.

The **loc** parameter or the **class** parameter, but not both, can be specified in the command.

The slot portion of the specified **loc** parameter must be **01** through **18**, except **09** and **10** cannot be specified (**loc=xyss**, where *x* is the frame, *y* is the shelf, and *ss* is the slot).

Card locations **1113** through **1118** cannot be specified for the **loc** parameter.

The frame and shelf portion of the specified **loc** parameter must be **11, 12, 13, 21, 22, 23, 31, 32, 33, 41, 42, 43, 51, 52, 53, or 61** (**loc=xyss**, where *x* is the frame, *y* is the shelf, and *ss* is the slot).

The **limatm, lime1atm, limds0, limocu, limv35, lime1, limt1, limch, and dcm** card types are the only valid card types for this command.

The card must be a LIM, an E1/T1 MIM, or an HC-MIM.

The specified card location must be equipped.

The **link** parameter values **a1, b1, a2, b2, a3, and b3** can be specified only for the following cards:

- A multi-port LIM
- An SSEDCCM running the **iplim** or **iplimi** application that supports 8 points
- An E1/T1 MIM or an HC-MIM.

The link parameter values **a4-a31** and **b4-b31** can be specified only for the HC-MIM card that is used as an E1 card or a T1 card. The link parameter values **a4-a31** and **b4-b31** cannot be specified for Channel cards.

The link parameter values **a4-a31** and **b4-b31** cannot be specified for even-numbered card locations.

If the card application is **ss7gx25**, **link=a** must be specified.

If the card application is **atmansi** or **atmitu**, **link=a** must be specified.

Notes

This command can be canceled using the **F9** function key or the **canc-cmd** command. See **canc-cmd** for more information.

Not every card location represents a signaling link. Be sure to address a signaling link in this command.

The *Installation Manual - EAGLE 5 SAS* provides an illustration of the card locations.

Output

rtrv-slk

```
tekelecstp 05-04-21 08:40:18 EST EAGLE5 33.0.0
      L2T      L1      PCR PCR
LOC  LINK LSN      SLC TYPE  SET BPS  MODE TSET  ECM  N1  N2
1201 A  lsn1201a    0  LIMDS0  1  56000 --- --- BASIC ---
1201 B  lsn1201b    1  LIMDS0  1  56000 --- --- BASIC ---

      LP      ATM
LOC  LINK LSN      SLC TYPE  SET BPS  TSEL  VCI  VPI  LL
1302 A  atm1302a    5  LIMATM  3  1544000 EXTERNAL 35  15  0
1305 A  atm1305a    5  LIMATM  5  1544000 LINE 5  0  0
1306 A  lsetC      0  LIMATM  5  1544000 LINE 5  0  0

      LP      ATM      E1ATM
LOC  LINK LSN      SLC TYPE  SET BPS  TSEL  VCI  VPI  CRC4 SI SN
1101 A  LS1      0  LIME1ATM 21  2.048M LINE 5  0  ON  3  0
1102 A  LS1      1  LIME1ATM 23  2.048M EXTERNAL 65535 4095 OFF 3  31
```

LOC	LINK	LSN	SLC	TYPE	L2T		ECM	PCR		PCR	E1	E1
					SET	BPS		N1	N2			
1307	A	e11307a	0	LIME1	1	64000	PCR	76	3800	1307	2	12
1311	A	e11311a	0	LIME1	1	56000	BASIC	---	-----	1311	1	1
1311	B	e11311b	0	LIME1	1	56000	BASIC	---	-----	1311	1	2

LOC	LINK	LSN	SLC	TYPE	L2T		ECM	PCR		PCR	T1	T1
					SET	BPS		N1	N2			
1308	A	t11308a	0	LIMT1	1	56000	PCR	76	3800	1307	2	12
1312	A	t11312a	1	LIMT1	1	56000	BASIC	---	-----	1311	1	1
1312	B	t11312b	0	LIMT1	1	56000	BASIC	---	-----	1311	1	2

SLK table is (13 of 1200) 1% full
;

The following example shows output for a specific card location, which contains an SSEDCEM with 8 IPLIM links.

rtrv-slk:loc=1307

```
tekelecstp 05-04-21 08:40:18 EST EAGLE5 33.0.0
```

LOC	LINK	LSN	SLC	TYPE	IPLIML2
1307	A	lsetC	0	IPLIM	SAALTALI
1307	B	lsetC	1	IPLIM	SAALTALI
1307	A1	lsetC	2	IPLIM	SAALTALI
1307	B1	lsetC	3	IPLIM	SAALTALI
1307	A2	lsetC	4	IPLIM	SAALTALI
1307	B2	lsetC	5	IPLIM	SAALTALI
1307	A3	lsetC	6	IPLIM	SAALTALI
1307	B3	lsetC	7	IPLIM	SAALTALI

;

The following example shows output for a specific card location, which contains an SSEDCEM with 4 SAALTALI IPLIM links and 4 M2PA IPLIM links.

rtrv-slk:loc=1307

```
tekelecstp 05-04-21 08:40:18 EST EAGLE5 33.0.0
```

LOC	LINK	LSN	SLC	TYPE	IPLIML2
1307	A	lsetC	0	IPLIM	SAALTALI
1307	B	lsetC	1	IPLIM	SAALTALI
1307	A1	lsetC	2	IPLIM	SAALTALI
1307	B1	lsetC	3	IPLIM	SAALTALI
1307	A2	lsetC	4	IPLIM	M2PA
1307	B2	lsetC	5	IPLIM	M2PA
1307	A3	lsetC	6	IPLIM	M2PA
1307	B3	lsetC	7	IPLIM	M2PA

;

The following examples include signaling links assigned to HC-MIM cards used as E1 cards or T1 cards.

rtrv-slk:loc=1311

```
tekelecstp 05-04-08 16:22:25 EST EAGLE5 33.0.0
      L2T          PCR PCR  E1  E1
LOC  LINK LSN      SLC TYPE SET  BPS  ECM  N1  N2  LOC  PORT TS
1311 A   e11311a    0  LIME1  1   56000 BASIC --- 1311 1  1
1311 B   e11311b    0  LIME1  1   56000 BASIC --- 1311 1  2
1311 A1  e11311a    1  LIME1  1   56000 BASIC --- 1311 1  3
1311 B1  e11311b    1  LIME1  1   56000 BASIC --- 1311 2  4
1311 A2  e11311a    2  LIME1  1   56000 BASIC --- 1311 2  5
1311 B2  e11311b    3  LIME1  1   56000 BASIC --- 1311 3  6
1311 B3  e11311b    2  LIME1  1   56000 BASIC --- 1311 3  7
1311 A4  e11311b    4  LIME1  1   56000 BASIC --- 1311 4  14
1311 B6  e11311a    3  LIME1  1   56000 BASIC --- 1311 5  13
1311 A11 e11311b    5  LIME1  1   56000 BASIC --- 1311 5  12
1311 B17 e11311a    4  LIME1  1   56000 BASIC --- 1311 6  11
1311 A29 e11311b    6  LIME1  1   56000 BASIC --- 1311 7  10
1311 B31 e11311a    5  LIME1  1   56000 BASIC --- 1311 8  9
```

;

rtrv-slk:loc=1307

```
tekelecstp 05-04-08 16:22:25 EST EAGLE5 33.0.0
      L2T          PCR PCR  T1  T1
LOC  LINK LSN      SLC TYPE SET  BPS  ECM  N1  N2  LOC  PORT TS
1307 A   t11307    0  LIMT1  1   56000 BASIC --- 1307 2  12
1307 B   t11307    1  LIMT1  1   56000 BASIC --- 1307 1  1
1307 B1  t11307    2  LIMT1  1   56000 BASIC --- 1307 1  2
1307 A2  t11307    3  LIMT1  1   56000 BASIC --- 1307 1  3
1307 B3  t11307    4  LIMT1  1   56000 BASIC --- 1307 1  4
1307 A5  t11307    5  LIMT1  1   56000 BASIC --- 1307 1  5
1307 B8  t11307    6  LIMT1  1   56000 BASIC --- 1307 1  6
1307 B11 t11307    7  LIMT1  1   56000 BASIC --- 1307 1  7
1307 A21 t11307    8  LIMT1  1   56000 BASIC --- 1307 3  16
1307 B24 t11307    9  LIMT1  1   56000 BASIC --- 1307 4  17
1307 A25 t11307   10  LIMT1  1   56000 BASIC --- 1307 6  18
1307 B25 t11307   11  LIMT1  1   56000 BASIC --- 1307 6  19
1307 A27 t11307   12  LIMT1  1   56000 BASIC --- 1307 7  20
1307 B29 t11307   13  LIMT1  1   56000 BASIC --- 1307 8  21
1307 A31 t11307   14  LIMT1  1   56000 BASIC --- 1307 2  22
1307 B31 t11307   15  LIMT1  1   56000 BASIC --- 1307 1  23
```

;

rtrv-slk:loc=1307:link=a31

```
tekelecstp 05-04-08 16:22:25 EST EAGLE5 33.0.0
      L2T          PCR PCR  T1  T1
LOC  LINK LSN      SLC TYPE SET  BPS  ECM  N1  N2  LOC  PORT TS
1307 A31 t11307   14  LIMT1  1   64000 BASIC --- 1307 2  22
```

;

The following examples include signaling links assigned to HC-MIM cards used as SE-HSL cards (the BPS value is 1984000 for SE-HSL cards).

rtrv-slk

```
tekelecstp 05-04-08 16:22:25 EST EAGLE5 34.0.0
      L2T      L1      PCR PCR
      SET BPS  MODE TSET  ECM N1  N2
LOC  PORT LSN      SLC TYPE
No Links Set up.

      LP      ATM
      SET BPS  TSEL      VCI      VPI      LL
LOC  PORT LSN      SLC TYPE
No Links Set up.

      LP      ATM      E1ATM
      SET BPS  TSEL      VCI      VPI  CRC4 SI SN
LOC  PORT LSN      SLC TYPE
No Links Set up.

LOC  PORT LSN      SLC TYPE  IPLIML2
No Links Set up.

LOC  PORT LSN      SLC TYPE
No Links Set up.

      L2T      PCR PCR  E1  E1
      SET BPS  ECM N1  N2  LOC PORT TS
1101 B  e1ls      0 LIME1  11 56000 BASIC --- ----- 1101 2 1
1102 A  e2ls      0 LIME1  21 1984000 BASIC --- ----- 1102 1  --

No Links Set up.

      L2T      PCR PCR  T1  T1
      SET BPS  ECM N1  N2  LOC PORT TS
LOC  PORT LSN      SLC TYPE
No Links Set up.

SLK table is (2 of 1200) 0% full.
```

;

rtrv-slk:class=e1

```
tekelecstp 05-04-08 16:22:25 EST EAGLE5 34.0.0
      L2T      PCR PCR  E1  E1
      SET BPS  ECM N1  N2  LOC PORT TS
1101 B  e1ls      0 LIME1  11 56000 BASIC --- ----- 1101 2 1
1102 A  e2ls      0 LIME1  21 1984000 BASIC --- ----- 1102 1  --
```

;

Legend

LOC—The location of the card containing the signaling link.

LINK—The signaling link assigned to the card.

LSN—The name of the linkset containing the signaling link.

SLC—The signaling link code of the signaling link.

TYPE—The type of card.

L2TSET—The number of the level 2 timer set associated with the signaling link.

BPS—The transmission rate of the signaling link in bits per second.

L1MODE—The mode of operation used to select the link clocking source at layer 1.

TSET—An indicator of whether the transmitter signal element timing is on or off.

ECM—The basic of PC for transmission.

PCRN1—The MSU number.

PCRN2—The octet number.

LPSET—The ATM link parameter set identifier.

ATMTSEL—The ATM timing selector. Possible values are as follows:

INTERNAL—Derived from an internal clock source operating at 1.544 MHz \pm 200 Hz (ANSI) or 2.048 MHz \pm 103 Hz (ITU).

EXTERNAL—Derived from the High-Speed Master Clock (T1 or E1).

LINE—Derived from its received data stream, if present.

VCI—The ATM virtual channel identifier.

VPI—The ATM virtual path identifier.

LL—The ATM line length.

E1PORT—The E1 card port that has an E1 interface assigned to it.

E1LOC—The card location of an E1 card with an E1 interface assigned to it.

T1PORT—The T1 card port that has a T1 interface assigned to it.

T1LOC—The card location of a T1 card with a T1 interface assigned to it.

TS—The timeslot associated with the signaling link that is serviced by the E1 or T1 interface.

E1ATMCRC4—E1 ATM card CRC4 multi-frame structure enable/disable indicator.

E1ATMSI—Value of two Spare International bits of NFAS data for the E1 ATM card.

E1ATMSN—Value of five Spare National bits of NFAS data for the E1 ATM card.

IPLIML2—IPLIM Level 2 stack (SAALTALI, M2PA, or M3UA)

rtrv-slt**Retrieve Signaling Link Test Message**

Use this command to display the fields of an SLTM (signaling link test message) record in the SLTM table.

Keyword: rtrv-slt

Related Commands: chg-l3t, chg-slt, ent-ls, rtrv-ls

Command Class: Database Administration

Parameters

:enabled= (optional)

Displays the SLTM records that are either enabled (**on**) or disabled (**off**).

Range: on, off

Default: All SLTM records with the specified value for the enabled parameter are shown.

:sltset= (optional)

The signaling link test message (SLTM) record number in the SLTM table.

Range: 1-20

Default: Display all

Example

```
rtrv-slt
```

```
rtrv-slt:sltset=1
```

```
rtrv-slt:enabled=off
```

Dependencies

None

Notes

None

Output**rtrv-slt**

```

rlghncxa03w 03-03-07 00:21:24 EST EAGLE 31.3.0
SLTM PARAMETERS
SLTSET  T1  T2  MODE  ENABLED  PATTERN
1       9.0 60.0 SPECIAL ON      AA2233445566778899AABBCCDDEEFF
2       12.0 30.0 SPECIAL OFF     F01234BCDE
3       4.0 50.0 REGULAR ON      CC2233445566778899AABBCCDDEEFF
4       6.0 90.0 SPECIAL OFF     BB23446789BCABEFG
5       6.0 90.0 SPECIAL OFF     BB23446789BCABEFG
6       6.0 90.0 SPECIAL OFF     BB23446789BCABEFG
7       6.0 90.0 SPECIAL OFF     BB23446789BCABEFG
8       6.0 90.0 SPECIAL OFF     BB23446789BCABEFG
9       6.0 90.0 REGULAR OFF     BB23446789BCABEFG
10      6.0 90.0 REGULAR OFF     BB23446789BCABEFG
11      6.0 90.0 REGULAR OFF     BB23446789BCABEFG
12      4.0 50.0 SPECIAL ON      FFEEDDCCBAA998877665544332211
13      4.0 50.0 SPECIAL ON      EE22334455
14      6.0 90.0 SPECIAL ON      AABBCCDD
15      6.0 90.0 REGULAR ON      AABBCCDD
16      6.0 90.0 REGULAR ON      AABBCCDD
17      6.0 90.0 REGULAR ON      AABBCCDD
18      6.0 90.0 SPECIAL ON      AABBCCDD
19      6.0 90.0 SPECIAL ON      AABBCCDD
20      6.0 90.0 SPECIAL ON      AABBCCDD
;

```

rtrv-slt:sltset=1

```

rlghncxa03w 03-03-07 00:21:24 EST EAGLE 31.3.0
SLTM PARAMETERS
SLTSET  T1  T2  MODE  ENABLED  PATTERN
1       9.0 60.0 SPECIAL ON      112233445566778899AABBCCDDEEFF
;

```

rtrv-slt:enabled=off

```

rlghncxa03w 03-03-07 00:21:24 EST EAGLE 31.3.0
SLTM PARAMETERS
SLTSET  T1  T2  MODE  ENABLED  PATTERN
2       12.0 30.0 SPECIAL OFF     F01234BCDE
4       6.0 90.0 SPECIAL OFF     0123446789BCABEFG
5       6.0 90.0 SPECIAL OFF     0123446789BCABEFG
6       6.0 90.0 SPECIAL OFF     0123446789BCABEFG
7       6.0 90.0 SPECIAL OFF     0123446789BCABEFG
8       6.0 90.0 SPECIAL OFF     0123446789BCABEFG
9       6.0 90.0 REGULAR OFF     0123446789BCABEFG
10      6.0 90.0 REGULAR OFF     0123446789BCABEFG
11      6.0 90.0 REGULAR OFF     0123446789BCABEFG
;

```

Legend

SLTSET—The signaling link test message record number in the SLTM table.

T1—The T1 timer value for the SLTM record.

T2—The T2 timer value for the SLTM record.

MODE—The SLTM mode to be used when sending test messages.

ENABLED—Indicates whether the signaling link test message is enabled.

PATTERN—The test pattern to be sent with a signaling link test message.

rtrv-spc

Retrieve Secondary Point Code

Use this command to retrieve an SPC (secondary point code) from the active database.

Keyword: rtrv-spc

Related Commands: dlt-spc, ent-spc

Command Class: Database Administration

Parameters

:spc/spca/spci/spcn/spcn24= (optional)

The secondary point code.

NOTE: See “Point Code Formats and Conversion” in Appendix A for a detailed description of point code formats, rules for specification, and examples.

:spc= or **:spca=** (optional)

ANSI point code in the form of *network indicator-network cluster-network cluster member (ni-nc-ncm)*.

Range: 000-255

Specify a valid value for each subfield of the point code, and separate the subfields with a dash (-).

When **chg-sid:pctype=ansi** is specified, *ni* = 000 is not valid.

When **chg-sid:pctype=ansi** is specified, *nc* = 000 is not valid if *ni* = 001-005.

When **chg-sid:pctype=ansi** is specified, *nc* = 000 is valid if *ni* = 006-255.

The point code 000-000-000 is not a valid point code.

:spci= (optional)

ITU international secondary point code with subfields *zone-area-id*. The *prefix* subfield indicates a spare point code (*prefix-zone-area-id*).

Range: s-, 0-255

Specify a valid value for each subfield of the point code, and separate the subfields with a dash (-).

The point code 0-000-0 is not a valid point code.

prefix—s-

zone—0-7

area—000-255

id—0-7

:spcn= (optional)

ITU national point code in the format of a 5-digit number (*nnnnn*); or 2, 3, or 4 numbers (members) separated by dashes (*m1-m2-m3-m4*) as defined by the **chg-stpopts:npcfinti** flexible point code option. A group code must be specified when the ITUDUPPC feature is turned on (*nnnnn-gc*, *m1-m2-m3-m4-gc*). The *prefix* subfield indicates a spare point code (*prefix-nnnnn*, *prefix-nnnnn-gc*, *prefix-m1-m2-m3-m4*, *prefix-m1-m2-m3-m4-gc*).

Range: **s-**, **0-16383**, **aa-zz**
Specify a valid value for each subfield of the point code, and separate the subfields with a dash (-).

prefix—**s-**

nnnnn—**0-16383**

gc—**aa-zz**

m1-m2-m3-m4—**0-14** for each member; values must sum to 14

:spcn24= (optional)

24-bit ITU national point code with subfields *main signaling area-sub signaling area-signaling point (msa-ssa-sp)*.

Range: **000-255**
Specify a valid value for each subfield of the point code, and separate the subfields with a dash (-).

msa—**000-255**

ssa—**000-255**

sp—**000-255**

Example

rtrv-spc

rtrv-spc:spc=5-3-3

rtrv-spc:spcn24=98-98-98

rtrv-spc:spcn=s-00345

Dependencies

The MPC feature must be turned on before this command can be entered.

The Spare Point Code Support feature must be enabled before a spare point code (prefix **s-**) can be specified in the command.

Notes

In this command, only ITU-international and ITU national point codes support the spare point code subtype prefix (**s-**).

Output

The following examples show the command to retrieve all secondary point codes. The second example includes spare point codes.

(SPC-N is a flexible point code value as defined with the **chg-stpopts:npcfnti** command).

rtrv-spc

```
rlghncxa03w 03-03-18 08:50:12 EST EAGLE 31.0.0
SPC (Secondary Point Codes)
```

```
SPCA
001-010-010
002-010-010
003-010-010
```

```
SPC-I
01-253-05
02-254-06
03-255-07
```

```
SPC-N
120-01-0-1
100-02-1-0
```

```
SPC-N24
099-099-099
```

```
;
Secondary Point Code table is (9 of 40) 25% full
```

```
;
```

rtrv-spc

```
rlghncxa03w 05-01-18 08:50:12 EST EAGLE 31.12.0
SPC (Secondary Point Codes)
```

```
SPCA
001-001-001
001-123-003
```

```
SPC-I
1-001-1
s-1-001-1
2-003-4
s-4-003-4
```

```
SPC-N
00234
s-00345
```

```
SPC-N24
011-011-011
```

```
Secondary Point Code table is (9 of 40) 22% full.1
```

```
;
```

The following example shows the command to retrieve all 24-bit ITU-N secondary point codes.

rtrv-spc

```
rlghncxa03w 03-03-18 08:50:12 EST EAGLE 31.0.0
```

```
SPC (Secondary Point Codes)
```

```
SPCA
none
```

```
SPC-I
none
```

```
SPC-N
none
```

```
SPC-N24
099-099-099
```

```
Secondary Point Code table is (1 of 40) 2% full.
```

```
;
```

The following examples show commands to retrieve a specific secondary point code. In the second example, the specified point code is not provisioned in the database. The third example shows a spare point code.

rtrv-spc: spc=5-3-3

```
rlghncxa03w 03-03-18 08:50:12 EST EAGLE 31.3.0
```

```
SPC (Secondary Point Codes)
```

```
005-003-003
```

```
Secondary Point Code table is (8 of 40) 25% full
```

```
;
```

rtrv-spc: spc=5-3-1

```
rlghncxa03w 03-03-18 08:50:12 EST EAGLE 31.3.0
```

```
Secondary Point Code specified is not provisioned
```

```
;
```

rtrv-spc:spcn=s-00345

```
rlghncxa03w 03-03-18 08:50:12 EST EAGLE 31.12.0
```

```
SPC (Secondary Point Codes)
```

```
s-00345
```

```
Secondary Point Code table is (2 of 40) 5% full.
```

```
;
```

The following example shows the command to retrieve a specific 24-bit ITU-N secondary point code.

rtrv-spc:spcn24=98-98-98

```
rlghncxa03w 03-03-18 08:50:12 EST EAGLE 31.0.0
```

```
SPC (Secondary Point Codes)
```

```
098-098-098
```

```
Secondary Point Code table is (2 of 40) 5% full.
```

```
;
```

Legend

SPC—The ANSI secondary point code

SPCA—The ANSI secondary point code

SPCI—The ITU international point code

SPCN—The ITU national point code

SPCN24—The 24-bit ITU national point code

rtrv-split-npa**Retrieve Split NPANXX**

NOTE: This command is obsolete.

Use this command to display all NPANXXs existing in a split mode in the database.

NOTE: If the LNP ELAP Configuration feature is turned on, this command is no longer available. This function can be performed at the LSMS or using the ELAP user interface.

Keyword: rtrv-split-npa

Related Commands: dlt-split-npa, ent-split-npa

Command Class: LNP Basic Administration

Parameters

:enpanxx= (optional)

End range numbering plan area and exchange.

Range: 6 digits

Default: Display all npanxx existing in a split mode in the database

force= (optional)

Force command execution. The **force=yes** parameter must be specified when a value greater than **50** is specified for the **num** parameter, to display more than 50 entries in the command output.

Range: yes, no

Default: no

:npanxx= (optional)

Numbering plan area and exchange.

Range: 6 digits

Default: Display all npanxx existing in a split mode in the database

:num= (optional)

Number of entries to be shown.

Range 1–50,000

Default: 1—if the **npanxx** parameter is specified

50—all other cases

Example

```
rtrv-split-npa
rtrv-split-npa:npanxx=909335
```

Dependencies

The LNP feature must be turned on (see the “**enable-ctrl-feat**” command) before this command can be entered.

When the **enpanxx** parameter is specified, the **npanxx** parameter must be specified.

The **enpanxx** parameter value must be greater than the **npanxx** parameter value.

The **force=yes** parameter must be specified when the specified **num** parameter value is greater than **50**.

The LNP database must be accessible.

Notes

None

Output

```
rtrv-split-npa
rlghncxa03w 03-03-28 14:23:37 EST EAGLE 31.3.0
NPANXX  NNPANXX
909335  919336
919321  920461
```

```
rtrv-split-npa:npanxx=9093355
rlghncxa03w 03-03-28 14:23:37 EST EAGLE 31.3.0
NPANXX  NEW NPANXX
9093355 9193366
;
```

Legend

NPANXX—The NPANXXs currently in the database.

NEW NPANXX—The new NPANXXs in the database.

rtrv-srvsel**Retrieve Service Selector**

Use this command to display a list of administered service selector combinations. The list can be filtered using various parameter combinations.

NOTE: The **rtrv-srvsel** operation may be lengthy because the service selector table can contain over 1,000 entries.

Keyword: rtrv-srvsel

Related Commands: chg-srvsel, dlt-srvsel, ent-srvsel

Command Class: Database Administration

Parameters

:force= (optional)

The **force=yes** parameter must be specified when a **num** parameter value greater than 50 is specified to display more than 50 entries.

Range: yes, no

Default: no

:gti/gtia/gtii/gtin/gtin24= (optional)

Global title indicator. For all service selector commands, the domain is defined as **gti** and **gtia** (ANSI), **gtii** (ITU international), **gtin** (ITU national) and **gtin24** (24-bit ITU national). For the service selector commands, **gti** and **gtia** are equivalent.

Range: Supported value for ANSI: **gti=2** and **gtia=2**

Supported values for ITU: **gtii=2, 4; gtin=2, 4, gtin24=2, 4**

Default: Display all

:nai= (optional)

Nature of address indicator (see Table A-5 in Appendix A).

Range: sub, rsvd, natl, intl

Default: Display all

:naiv= (optional)

Nature of address indicator value (see Table A-5 in Appendix A).

Range: 0-127

Default: Display all

NOTE: The nature of address indicator parameters (**naiv** or **nai**) can be specified by supplying either a mnemonic or an explicit value. At no time may both the mnemonic and the explicit value be specified at the same time for the same parameter. Either the **naiv** or **nai** parameter can be specified. Table A-5 in Appendix A shows the mapping between the **naiv** and the **nai** parameters.

:np= (optional)

Numbering plan (see Table A-6 in Appendix A).

Range: e164, generic, x121, f69, e210, e212, e214, private

Default: Display all

:npv= (optional)

Numbering plan value (see Table A-6 in Appendix A).

Range: 0-15

Default: Display all

NOTE: The numbering plan parameters (**npv** or **np**) can be specified by supplying either a mnemonic or an explicit value. At no time may both the mnemonic and the explicit value be specified at the same time for the same parameter. Either the **npv** or **np** parameter can be specified. Table A-6 in Appendix A shows the mapping between the **npv** and the **np** parameters.

:num= (optional)

Number of entries to display. The **force=yes** parameter is required when this parameter value is specified greater than 50 entries.

Range 0–20,992

Default: 50

:serv= (optional)

The DSM service.

Range: eir, gflex, gport, idpr, idps, inpq, inpmr, mnpsms, smsmr,

eir—Equipment Identity Register

gflex—GSM flexible numbering

idpr—Prepaid IDP Query Relay

idps—IDP Screening for Prepaid

inpq—INP query

inpmr—INP message relay

gport—GSM number portability

mnpsms—Portability Check for Mobile Originated SMS

smsmr—Prepaid SMS Intercept

Default: Display all

:snai= (optional)

The service nature of address indicator.

Range: sub, natl, intl, rnidn, rnrndn, rnsdn, ccrndn

sub—Subscriber number

natl—National significant number

intl—International number

rnidn—Routing number prefix and international dialed/directory number

rnrndn—Routing number prefix and national dialed/directory number

rnsdn—Routing number prefix and subscriber dialed/directory number

ccrndn—Country code, routing number, and national directory number

Default: Display all

:snp= (optional)

The service numbering plan.

Range: e164, e212, e214,

e164—E.164 numbering plan

e212—E.212 numbering plan

e214—E.214 numbering plan

Default: Display all

:ssn= (optional)

Subsystem number.

Range: 0–255, *

:tt= (optional)

Translation type.

Range: 0–255

Default: Display all

Example

```
rtrv-srvsel
rtrv-srvsel:gtii=2
rtrv-srvsel:tt=0:np=e164
```

Dependencies

The G-Flex, G-Port, or INP feature must be turned on, or the Equipment Identity Register (EIR) feature must be enabled before this command can be entered.

The INP feature must be turned on before the **serv=inp_{pmr}** or **serv=inp_q** parameter can be specified.

The G-Flex feature must be turned on before the **serv=gflex** parameter can be specified.

The G-Port feature must be turned on before the **serv=gport** parameter can be specified.

The **np** and **npv** parameters cannot be specified together in the command.

The **nai** and **naiv** parameters cannot be specified together in the command.

The values **1** and **3** are not valid for the **gti/gtia/gtii/gtin/gtin24** parameters.

The value **4** is not valid for the **gti/gtia** parameters.

When the **gti/gtia/gtii/gtin/gtin24=2** parameter is specified, no **np(v)** and **nai(v)** parameter combinations can be specified.

When a **serv** parameter value of **inp_{pmr}**, **inp_q**, **gport**, **eir**, **smsmr**, or **mnpsms** is specified, the **gtia** and **gti** parameters cannot be specified.

When the **serv=inp_{pmr}** parameter is specified, the **snp** parameter must be **e164** if it is specified.

When an **snai** parameter value of **rnidn**, **rnndn**, or **rnsdn** is specified, the **serv** parameter value must be **inp_{pmr}**, **gport**, **smsmr**, or **mnpsms** if it is specified.

When the **serv=inp_q** parameter is specified, the **gtii** parameter cannot be specified.

When an **snai** parameter value of **rnidn**, **rnndn**, or **rnsdn** is specified, the **serv=gflex** parameter cannot be specified.

When a **serv** parameter value of **inp_q** or **eir** is specified, the **snp** and **snai** parameters cannot be specified.

When the **snai=ccr_{ndn}** parameter is specified, a **serv** parameter value of **gport**, **smsmr**, or **mnpsms** must be specified.

When the specified **num** parameter value is greater than **50**, the **force=yes** parameter must be specified.

When the **serv=id_{pr}** parameter is specified, the Prepaid IDP Query Relay feature must be on.

When the **serv=id_{pr}** parameter is specified, the only valid mandatory service parameters are **tt**, **serv**, **ssn** and **gti(n/i/a)**.

When the **serv=id_{pr}** parameter is specified, the only valid optional parameters are **np** and **nai**.

When the **serv=inpq/eir/idpr** parameter is specified, the **snai** and **snp** parameters must not be specified.

When the **serv=idps** parameter is specified, the IDP Screening for Prepaid feature must be on.

Notes

None

Output

The following example displays all provisioned service selectors:

rtrv-srvsel

```
rlghncxa03w 00-03-29 16:40:40 EST EAGLE 31.3.0
GTIA TT NP NAI NPV NAIV SSN SNP SNAI SERV
2 9 -- --- --- --- --- e212 intl gflex
2 10 -- --- --- --- --- e164 intl gflex
2 253 -- --- --- --- --- e214 natl gflex

GTII TT NP NAI NPV NAIV SSN SNP SNAI SERV
2 0 -- --- --- --- --- e164 intl gflex
2 18 -- --- --- --- --- e164 rnsdn inpmr
4 0 e214 sub --- --- --- e214 sub gflex

GTIN TT NP NAI NPV NAIV SSN SNP SNAI SERV
2 2 -- --- --- --- --- e164 intl gflex
2 9 -- -- --- --- --- --- inpq
4 2 e164 natl --- --- --- e164 rnndn inpmr
4 9 --- --- 10 128 --- --- --- inpq
;
```

The following example displays all service selectors containing the specified GTI value:

rtrv-srvsel:gtii=2

```
rlghncxa03w 00-03-29 16:40:40 EST EAGLE 31.3.0
GTII TT NP NAI NPV NAIV SSN SNP SNAI SERV
2 0 -- --- --- --- --- e164 intl gflex
2 18 -- --- --- --- --- e164 rnsdn inpmr
;
```

The following example displays all service selectors containing the specified **tt** and **np** values:

rtrv-srvsel:tt=0:np=e164

```
rlghncxa03w 00-03-29 16:40:40 EST EAGLE 31.3.0
GTII TT NP NAI NPV NAIV SSN SNP SNAI SERV
4 0 e164 sub --- --- --- e164 sub gflex
;
```

The following example displays all service selectors containing the specified service:

rtrv-srvsel:serv=inpq

```
rlghncxa03w 00-03-29 16:40:40 EST EAGLE 31.3.0
GTIN TT NP NAI NPV NAIV SSN SNP SNAI SERV
2 9 -- -- --- --- --- --- inpq
4 9 --- --- 10 128 --- --- --- inpq
;
```

The following example displays all service selectors containing the **gport** service:

rtrv-srvsel:serv=gport

```
rlghncxa03w 00-03-29 16:40:40 EST EAGLE 31.3.0
GTIN TT NP NAI NPV NAIV SSN SNP SNAI SERV
4 0 e164 128 --- --- --- e164 ccrndn gport
;
```

The following example includes a **gtin24** entry:

rtrv-srvsel

```
rlghncxa03w 03-05-29 16:40:40 EST EAGLE 31.0.0
GTIN TT NP NAI NPV NAIV SSN SNP SNAI SERV
4 4 e164 intl --- --- --- e164 intl gport

GTIN24 TT NP NAI NPV NAIV SSN SNP SNAI SERV
4 4 e164 intl --- --- --- e164 intl gport

SRV SELECTOR table is (2 of 20992) 1 % full
;
```

The following examples display service selectors containing the **eir**, **smsmr**, and **mnpmsms** services:

rtrv-srvsel

```
tekelecstp 03-03-28 15:43:22 EST EAGLE5 31.0.0
GTII TT NP NAI NPV NAIV SSN SNP SNAI SERV
4 1 e214 intl --- --- 3 --- --- eir
4 1 e214 intl --- --- 4 e164 intl gport
4 1 e214 intl --- --- 5 e164 intl smsmr
4 2 e214 intl --- --- 5 e164 intl mnpmsms
4 2 e214 intl --- --- * --- --- eir

GTIN TT NP NAI NPV NAIV SSN SNP SNAI SERV
4 4 e214 natl --- --- --- e164 intl gflex
4 9 e214 natl --- --- --- e164 intl gflex

SRV SELECTOR table is (7 of 20992) 1 % full
;
```

rtrv-srvsel:ssn=3

```
tekelecstp 03-03-28 15:43:22 EST EAGLE5 31.0.0
GTII TT NP NAI NPV NAIV SSN SNP SNAI SERV
4 1 e214 intl --- --- 3 --- --- eir

SRV SELECTOR table is (4 of 20992) 1 % full
;
```

rtrv-srvsel:serv=eir

```
tekelecstp 03-03-28 15:43:22 EST EAGLE5 31.0.0
GTII TT NP NAI NPV NAIV SSN SNP SNAI SERV
4 1 e214 intl --- --- 3 --- --- eir
4 2 e214 intl --- --- * --- --- eir

SRV SELECTOR table is (4 of 20992) 1 % full
;
```

rtrv-srvsel

```
tekelecstp 05-08-17 17:05:51 EST 33.1.0
```

GTII	TT	NP	NAI	NPV	NAIV	SSN	SNP	SNAI	SERV
4	20	e164	intl	---	---	123	----	-----	idpr

```
SRV SELECTOR table is (1 of 20992) 1 % full
```

```
;
```

The following example displays service selectors containing the **eir**, **gport**, **idps**, **mnpsms**, and **smsmr** services:

rtrv-srvsel

```
tekelecstp 05-03-28 15:43:22 EST EAGLE5 34.3.0
```

GTII	TT	NP	NAI	NPV	NAIV	SSN	SNP	SNAI	SERV
4	1	e214	intl	---	---	3	---	---	eir
4	1	e214	intl	---	---	4	e164	intl	gport
4	1	e214	intl	---	---	5	e164	intl	smsmr
4	2	e214	intl	---	---	5	e164	intl	mnpsms
4	2	e214	intl	---	---	*	---	---	eir
4	20	e164	intl	---	---	6	---	----	idps

GTIN	TT	NP	NAI	NPV	NAIV	SSN	SNP	SNAI	SERV
4	4	e214	natl	---	---	---	e164	intl	gflex
4	9	e214	natl	---	---	---	e164	intl	gflex

```
SRV SELECTOR table is (7 of 20992) 1 % full
```

```
;
```

Legend

GTI/GTIA/GTII/GTIN/GTIN24—Global title indicator.

TT—Translation type.

NP—Numbering plan.

NAI—Nature of address indicator.

NPV—Numbering plan value.

NAIV—Nature of address indicator value.

SNP—Service numbering plan.

SNAI—Service nature of address indicator.

SERV—DSM service.

rtrv-ss-appl**Retrieve Subsystem Application**

Use this command to retrieve all applications from the database. The command displays the application type, subsystem number, and application status.

Keyword: **rtrv-ss-appl**

Related Commands: **chg-ss-appl**, **dlt-ss-appl**, **ent-ss-appl**

Command Class: Database Administration

Parameters

This command has no parameters.

Example

```
rtrv-ss-appl
```

Dependencies

The LNP feature (see the “**enable-ctrl-feat**” command) or the INP feature must be turned on, or the Equipment Identity Register (EIR) feature must be enabled, before this command can be entered.

The LNP database must be accessible.

Notes

None

Output

rtrv-ss-appl

```
rlghncxa03w 03-03-17 16:02:05 EST EAGLE 31.3.0
APPL SSN STAT
LNP 15 online
SS-APPL table is (1 of 1) 100% full
```

;

rtrv-ss-appl

```
rlghncxa03w 03-03-17 16:02:05 EST EAGLE 31.3.0
APPL SSN STAT
INP 15 online

SS-APPL table is (1 of 1) 100% full
```

;

rtrv-ss-appl

```
tekelecstp 03-06-28 14:42:38 EST EAGLE 31.0.0
APPL SSN STAT
EIR 11 online

SS-APPL table is (1 of 1) 100% full
```

;

Legend

APPL—Application type

SSN—Subsystem number

STAT—Status

rtrv-ss7opts**Retrieve SS7 Options**

This command retrieves the current values of the SS7 option indicators maintained in the STP options table. SS7 options can modify normal handling of SS7 traffic.

Keyword: rtrv-ss7opts

Related Commands: chg-ss7opts

Command Class: Database Administration

Parameters

None

Example

rtrv-ss7opts

Dependencies

None

Notes

None

Output

NOTE: The LSRESTRICT field is always off; the Linkset Restrict function is not available at this time.

rtrv-ss7opts

```
tekelecstp 05-06-28 14:42:38 EST EAGLE 31.11.0
SS7 OPTIONS
-----
LSRESTRICT          off
DISCARDTFCI        off
DISCARDTFCN        off
;
```

rtrv-stpopts**Retrieve STP Options**

Use this command to retrieve the current value of the system's node-level processing option indicators maintained in the system's options table.

Keyword: rtrv-stpopts

Related Commands: chg-stpopts

Command Class: Database Administration

Parameters

This command has no parameters.

Example

```
rtrv-stpopts
```

Dependencies

None

Notes

The timer output for this command is in milliseconds, even though the timer could have been entered in seconds on the **chg-stpopts** command.

Output

The following example displays MTP STP options with no affecting features on. Certain features that are shown in other examples control changes and additional options in this option list:

rtrv-stpopts

```
rlghncxa03w 04-04-17 16:02:05 EST EAGLE 31.6.0
STP OPTIONS
-----
MTP31CTL            1
MTP31CTI            yes
MTP31CTDPCQ        3
MTP31TST            10000
MTP31DPCQ           2000
MTP31FRPR           1000
MTP31PRST           yes
MTP310ALT           30000
```

UIMRD	yes
SLSCNV	perls
CRITALMINH	yes
DISPACTALMS	no
NPCFMTI	14-0-0-0
RPTLNPMRSS	yes
RANDSLS	off
GR2878RGLBL	yes
RSTRDEV	on
HSCLKSRC	RS422
HSCLKGAIN	LONGHAUL

;

The following example displays all MTP STP options. The following list indicates which options appear in the output when the associated features are on:

NOTE: All options will not appear in actual output, because all features that cause these options to appear cannot be on in the system at the same time.

- Cluster Routing and Management Diversity (CRMD) feature—MTPXLQ, MTPXLET, MTPXLOT
- MTP Restart (MTPRS or ITUMTPRS) feature—MTPRSI, MTPRSIT
- 6000, 7000, or 8000 Routesets feature—MTPDPCQ=6000 or 7000 or 8000
- GSM MAP Screening (GSMSCRN) feature—GSMDFLT, GSMDECERR
- GSM Mobile Number Portability (G-Port) feature, INAP Number Portability (INP) feature, or GSM Flexible Numbering (G-Flex) feature—DEFCC, DEFNDC, DSMAUD
- GSM Flexible Numbering (G-Flex) feature—ANSIGFLEX
- Network Security (NSE) feature—SECMTPMATE, SECMTPSID, SECMTPSNM, SECSCCPSCMG
- ANSI-ITU-China SCCP Conversion (SCCP Conversion) feature—CNVCGDA, CNVCGDI, CNVCGDN, CNVCGDN24, GTCNVDFLT

rtrv-stpopts

```
rlghncxa03w 04-04-17 16:02:05 EST EAGLE 31.8.0
STP OPTIONS
```

```
-----
MTPT31CTL          1
MTPLTI             yes
MTPLTCTDPCQ       3
MTPLTST           10000
MTPXLQ            500
MTPXLET           0100
MTPXLOT           90%
MTPDPCQ           8000
TFATFRPR          1000
MTPRSI            yes
MTPRSIT           5000
MTPLRST           yes
MTPT10ALT         30000
UIMRD             yes
SLSCNV            perls
CRITALMINH        yes
DISPACTALMS       no
NPCFMTI           14-0-0-0
GSMDFLT           PASS
GSMDECERR         PASS
DEFCC             49
DEFNDC            177
DSMAUD            no
RPTLNPMRSS       yes
RANDSLS           all
GR2878RGLBL      no
RSTRDEV           on
SECMPMATE         off
SECMTPSID         off
SECMTPSNM         notify
SECSCCPSCMG       notify
CNVCGDA           yes
CNVCGDI           yes
CNVCGDN           yes
CNVCGDN24        yes
GTCNVDFLT        yes
ANSIGFLEX         yes
HSCLKSRC          RS422
HSCLKLL           LONGHAUL
```

;

Legend

MTPT31CTL—MTP T31 congestion trigger level. The signaling link congestion level at which the system starts the level 3 t31 timer. When the level 3 t31 timer expires, the associated signaling link is removed from service for realignment.

MTPLTI—MTP loop test indicator. Specifies whether the MTP loop detection procedures are enabled or disabled at the system.

MTPLTCTDPCQ—MTP loop test congestion trigger DPC quantity. The number of most frequently occurring DPCs to which the MTP loop test messages are to be sent when the MTP loop test is triggered by congestion.

MTPLTST—MTP loop test supervision timer. The amount of time, in milliseconds, that the MTP loop test detection procedures run when started.

- MTPXLQ**—MTP x-list quantity. The number of dynamic status exception list (x-list) entries the system maintains.
- MTPXLET**—MTP x-list expiration time. The maximum amount of time the system maintains an unreferenced dynamic status exception list (x-list) entry.
- MTPXLOT**—MTP x-list occupancy threshold. The dynamic status exception list (x-list) occupancy threshold at which the system raises a minor alarm. The threshold is expressed as a percentage of space available.
- MTPDPCQ**—MTP destination point code quantity. The maximum number of DPCs that can be provisioned in the system.
- TFATFRPR**—TFA/TFR pacing rate. The amount of time, in milliseconds, between partial broadcasts of up to 20 percent increments of the number of TFAs/TCAs or TFRs/TCRs to be broadcast by the STP when an affected destination becomes accessible using its primary route rather than an alternate route. The STP uses this pacing to prevent congestion on the newly-recovered linksets.
- MTPRSIT**—MTP Restart isolation timer. The minimum duration of node isolation, in milliseconds, before the MTP Restart procedure is deemed necessary.
- MTPRSI**—MTP Restart indicator. Specifies whether ANSI or ITU MTP Restart procedures are enabled or disabled at the STP.
- MTPLPRST**—MTP low priority route set test. Specifies whether low priority route set polling is enabled or disabled at the STP.
- MTPT10ALT**—MTP T10 alternate timer. Specifies the interval at which the STP performs a route set test on low priority routes.
- SLSCNV**—Per node SLS conversion indicator. Specifies whether SLS conversion is on, off, or performed per linkset (perls).
- UIMRD**—Unsolicited Information Message (UIM) redirect. Specifies whether specific UIMs are redirected to this output group.
- CRITALMINH**—Indicates whether the option that allows the inhibiting of critical alarms is enabled (*yes*) or disabled (*no*).
- DISPACTALMS**—Indicates whether to display active or total alarms in the alarm status area of the VT320 screen.
- NPCFMTI**—Defines how the ITU national point code is entered into the database and how it is displayed in any outputs from the system.
- GSMDFLT**—Indicates whether the GSM MAP screening default action is set to pass or discard.
- GSMDECERR**—Indicates whether the GSM MAP screening decode error action is set to pass or discard.
- DEFCC**—Defines the default country code.
- DEFNDC**—Defines the default network destination code.
- DSMAUD**—Indicates whether the DSM audit is running (*on*) or disabled (*off*).
- RANDSLS**—Displays the Random SLS setting.

RTPLNPMRSS—Displays the setting for reporting or suppressing UIM 1049 for LNP MR with missing subsystems.

GR2878RGLBL—Yes = use GR-2878-CORE HSL labels and data in SEAS output. No = HSL labels and data are not supported to SEAS.

RSTRDEV—Allow or disable restoration of device states when an **init-sys** command is executed, an OAM role changes, or a card reload occurs.

SECMTPMATE—Indicates Network Security screening for MTP messages received by an STP on a non-C-Link, with an OPC equal to the SID (True, Adjacent, or Capability) point code of its mate.

SECMTPSID—Indicates Network Security screening for MTP messages received at MTP3 containing an OPC equal to its own SID (OPC that is the True, Secondary, or Capability point code entered in the **chg-sid** command) that is not a route-set-congestion-message. The EAGLE should not receive a message with its own OPC unless the message is a result of a circular route test or is an SLTM when the far end is in loopback. (SLTM messages are not checked).

SECMTPSNM—Indicates Network Security screening for MTP SNM messages. The EAGLE should not receive an MTP network management message unless:

- The OPC is an adjacent point code. (For all link types, this rule does not apply to UPU, TFC, and RCT messages).
- The EAGLE has a route to the OPC of the MTP network management message on the linkset which the message was received.
- The EAGLE has a route to the destination field in the message (if applicable to the concerned message) on the linkset which the message was received. (For all link types, this rule is not applicable to RST messages).

SECSCCPSCMG—Indicates Network Security screening for SCCP SCMG messages. This value applies only to SSP and SOR messages. SSA, SST, SOG, SBR, SNR and SRT messages are not affected. The EAGLE should not receive an SCCP network management message unless:

- The EAGLE has a route to the OPC of the SCMG message on the linkset on which the message was received.
- The EAGLE has a route to the Affected Point Code (also called the Concerned Point Code in EAGLE) in the message on the linkset on which the message was received.

CNVCGDA—Indicates whether or not to discard the CGPA PC in ANSI SCCP messages if the PC or ALIAS PC of the destination network type is not defined.

CNVCGDI—Indicates whether or not to discard the CGPA PC in ITU-I SCCP messages if the PC or ALIAS PC of the destination network type is not defined.

CNVCGDN—Indicates whether or not to discard the CGPA PC in ITU-N SCCP messages if the PC or ALIAS PC of the destination network type is not defined.

CNVCGDN24—Indicates whether or not to discard the CGPA PC in 24-bit ITU-N SCCP messages if the PC or ALIAS PC of the destination network type is not defined.

ANSIGFLEX—Indicates enable or disable of ANSI G-Flex to execute at 1700 TPS per DSM card

GTCNVDFLT—Indicates enable or disable of routing of SCCP messages using system defaults when an appropriate entry is not found in the Default GT Conversion table.

HSCLKLL—High speed master clock line length option (SHORTHAUL, LONGHAUL)

HSCLKSRC—High speed master clock source

rtrv-subnetid

Retrieve Subnet ID

Use this command to retrieve a list of Subnet ID entries from the SUBNETID table, for the ISUP NP with EPAP feature.

Keyword: rtrv-subnetid

Related Commands: ent-subnetid, dlt-subnetid

Command Class: Database Administration

Parameters

:subnetnum= (optional)

Subnet Number

Range: 1-5

Example

```
rtrv-subnetid
```

```
rtrv-subnetid:subnetnum=1
```

Dependencies

The ISUP NP with EPAP feature must be enabled before this command can be entered.

Notes

None.

Output

When the command is entered with no parameter, the Subnet IDs for Subnet number 1 are listed in numerical order, followed by the Subnet IDs for Subnet number 2 in numerical order., and so on.

rtrv-subnetid

```
tekelecstp 04-09-21 16:11:21 EST EAGLE 31.11.0
```

```
Subnet
ID      Number
-----
```

```
886932      1
886936      1
886935      2
886938      2
886939      2
```

```
Subnetidlen = 6
```

```
SUBNETID table is (5 of 50) 3% full
```

```
;
```

When a Subnet number is specified, the Subnet IDs for the specified Subnet number are listed in numerical order. The table capacity line shows the total number of entries in use, not just the number of entries displayed.

rtrv-subnetid:subnetnum=2

```
tekelecstp 04-09-21 16:13:54 EST EAGLE 31.11.0
      Subnet
ID      Number
-----
886935      2
886938      2
886939      2

Subnetidlen = 6

SUBNETID table is (5 of 50) 3% full
```

;

rtrv-t1

Retrieve T1 Information

Use this command to retrieve information for a specified T1 interface, or for all T1 interfaces that have been defined by the **ent-t1** command for an E1/T1 card or an HC MIM card that is used as a T1 card: card location. The following information can be retrieved: T1 port number, encoding/decoding, timing source, framing, channel bridging, and line length.

Keyword: rtrv-t1

Related Commands: chg-t1, dlt-t1, ent-t1, tst-t1

Command Class: Database Administration

Parameters

:t1port (optional)

T1 port number. The value must be a T1 port that has already been configured on the T1 card specified in the **loc** parameter.

Range: 1, 8

Ports 3-8 are valid only for HC-MIM cards.

Default: If not specified, all T1 ports are listed.

:loc= (optional)

The card location of a T1 card, as stenciled on the shelf of the system.

Range: 1101-1108, 1111-1112, 1201-1208, 1211-1218, 1301-1308, 1311-1318, 2101-2108, 2111-2118, 2201-2208, 2211-2218, 2301-2308, 2311-2318, 3101-3108, 3111-3118, 3201-3208, 3211-3218, 3301-3308, 3311-3318, 4101-4108, 4111-4118, 4201-4208, 4211-4218, 4301-4308, 4311-4318, 5101-5108, 5111-5118, 5201-5208, 5211-5218, 5301-5308, 5311-5318, 6101-6108, 6111-6118

Default: If not specified, all T1 card locations are listed.

Example

```
rtrv-t1
rtrv-t1:loc=1307:t1port=2
rtrv-t1:loc=1311:t1port=1
```

Dependencies

The **loc** and **t1port** parameters must be specified together, if any parameters are specified for the command.

The specified card location (**loc** parameter) must be equipped.

The card specified by the **loc** parameter must be a **limt1** card type.

The specified port (**t1port** parameter) on the card in the specified card location (**loc** parameter) must already have a defined T1 interface.

Notes

None.

Output**rtrv-t1**

```
rlghncxa03w 03-03-20 09:07:58 EST EAGLE 31.3.0
LOC  T1PORT ENCODE  T1TSEL  FRAMING  LL
1211  1      ami     external  esf       10
1307  2      b8zs   line     sf        133
1311  1      ami     external  esf       500
```

;

rtrv-t1:loc=1211:t1port=1

```
rlghncxa03w 03-03-20 09:07:58 EST EAGLE 31.3.0
LOC  T1PORT ENCODE  T1TSEL  FRAMING  LL
1211  1      ami     external  esf       133

TS1  1211,B2  TS9   -----  TS17  -----
TS2  1211,B   TS10  -----  TS18  -----
TS3  -----  TS11  -----  TS19  -----
TS4  -----  TS12  -----  TS20  -----
TS5  -----  TS13  -----  TS21  -----
TS6  -----  TS14  -----  TS22  -----
TS7  -----  TS15  -----  TS23  -----
TS8  -----  TS16  -----  TS24  -----
```

;

rtrv-t1:loc=1311:t1port=1

```
rlghncxa03w 03-03-20 09:07:58 EST EAGLE 31.3.0
LOC  T1PORT ENCODE  T1TSEL  FRAMING  LL
1211  1      ami     external  esf       100

TS1  1311,A   TS9   1313,B   TS17  -----
TS2  1311,A1  TS10  -----  TS18  -----
TS3  1311,B1  TS11  -----  TS19  -----
TS4  1311,B3  TS12  1313,B3  TS20  -----
TS5  1312,A   TS13  -----  TS21  -----
TS6  -----  TS14  -----  TS22  -----
TS7  1313.A   TS15  -----  TS23  -----
TS8  1313.A   TS16  -----  TS24  -----
```

;

The following examples include information for HC-MIM T1 cards (8 ports and up to 64 links per card):

rtrv-t1

```
rlghncxa03w 05-04-20 09:07:58 EST EAGLE5 33.0.0
LOC  T1PORT ENCODE  T1TSEL  FRAMING  LL  CHANBRDG
1211 1      ami      external esf      10  -----
1307 2      b8zs     line      sf       133  -----
1307 6      b8zs     line      sf       133  -----
1311 1      ami      external esf      500  -----
1311 2      ami      external esf      500  -----
1311 3      ami      external esf      500  MASTER
1311 4      ami      external esf      500  SLAVE
1311 5      ami      RECOVERED esf     500  MASTER
1311 6      ami      RECOVERED esf     500  SLAVE
1311 7      ami      recovered sf      500  MASTER
1311 8      ami      recovered sf      500  SLAVE
```

;

rtrv-t1:loc=1307:t1port=7

```
rlghncxa03w 03-03-20 09:07:58 EST EAGLE 31.3.0
LOC  T1PORT ENCODE  T1TSEL  FRAMING  LL  CHANBRDG
1307 6      b8zs     line      sf       133  -----

TS1  1307,A  TS9   1307,B18  TS17  -----
TS2  1307,A1 TS10  -----   TS18  -----
TS3  1307,B1 TS11  -----   TS19  -----
TS4  1307,B3 TS12  1307,B31  TS20  -----
TS5  1307,A12 TS13  -----   TS21  -----
TS6  -----  TS14  -----   TS22  -----
TS7  1307,A21 TS15  -----   TS23  -----
TS8  1307,A31 TS16  -----   TS24  -----
```

;

rtrv-t1:loc=1311:t1port=5

```
rlghncxa03w 05-04-20 09:07:58 EST EAGLE5 33.0.0
LOC  T1PORT ENCODE  T1TSEL  FRAMING  LL  CHANBRDG
1311 5      ami      RECOVERED esf     500  MASTER

TS1  1311,A  TS9   1311,B18  TS17  -----
TS2  1311,A1 TS10  -----   TS18  -----
TS3  1311,B1 TS11  -----   TS19  -----
TS4  1311,B3 TS12  1311,B31  TS20  -----
TS5  1311,A12 TS13  -----   TS21  -----
TS6  -----  TS14  -----   TS22  -----
TS7  1311,A21 TS15  -----   TS23  -----
TS8  1311,A31 TS16  -----   TS24  -----
```

;

rtrv-t1:loc=1311:t1port=6

```
rlghncxa03w 05-04-20 09:07:58 EST EAGLE5 33.0.0
LOC  T1PORT ENCODE  T1TSEL  FRAMING  LL  CHANBRDG
1311 6      B8ZS    recovered SF      135  SLAVE
```

Card 1311, port 6 is channel bridged with port 5 for data pass through.

;

Legend

LOC—E1/T1 MIM card or HC-MIM card location in an EAGLE shelf.

T1PORT—T1 port number for the T1 interface on an E1/T1 MIM card or HC-MIM card.

ENCODE—Indicator for use of B8ZS or AMI encoding/decoding.

T1TSEL—T1 timing source indicator (**external** = master timing source; **line** = slave timing source; **RECOVERED** = the timing source for the even-numbered port in a channel bridged pair is recovered from the odd-numbered port of the pair).

FRAMING—Framing format (SF or ESF).

LL—Line length; T1 cable length in feet between the EAGLE and the connecting node

CHANBRDG—Indicates whether an HC-MIM odd numbered port is not channel bridged with its adjacent even numbered port for non-signaling data pass through (dashes), or the HC-MIM port is the odd-numbered channel bridged port on the card (MASTER), or the HC-MIM port is the even-numbered channel bridged port on the card (SLAVE).

TSx—Timeslot.

rtrv-tbl-capacity

Retrieve Table Capacity

Use this command to retrieve table use capacity summary information. For each table listed, the number of table entry elements in use and the total allowed number of table elements is presented, along with a percent (%) full value.

Keyword: rtrv-tbl-capacity

Related Commands: rept-stat-xlist, rtrv-appl-rtkey, rtrv-appl-sock, rtrv-as, rtrv-assoc, rtrv-dstn, rtrv-gta, rtrv-gtt, rtrv-ip-lnk, rtrv-ls, rtrv-map, rtrv-scrset, rtrv-slk, rtrv-spc, rtrv-x25-dstn, rtrv-x25-slk

Command Class: Database Administration

Parameters

This command has no parameters.

Example

```
rtrv-tbl-capacity
```

Dependencies

None

Notes

This command can be canceled using the **F9** function key or the **canc-cmd** command. See **canc-cmd** for more information.

XLIST table information is shown only if the CRMD feature is ON.

Secondary Point Code (SPC) table information is shown only if the MPC feature is ON.

If the EGTT feature is ON then table name is GTA instead of GTT.

Additional information for each listed table can be displayed using the commands listed in Table 7-13 on page 7-653.

Though the ASP table entries are now part of the IPAPSOCK table, EAGLE command entry and output still appear as though they are separate tables. The **rtrv-tbl-capacity** command shows the number of ASPs in the 4000-entry IPAPSOCK table.

Table 7-13. Retrieve Commands for Additional Table Information

Command	Table name	Description of table
rept-stat-xlist	XLIST	Destination - Routeset Extension
rtrv-appl-sock	IPAPSOCK	IP Socket/Association
rtrv-appl-rtkey	IPRTKEY	IP Routing Key
rtrv-as	AS	Application Server
rtrv-assoc	IPAPSOCK	IP Socket/Association
rtrv-dstn	DSTN	Destination Routeset
rtrv-gta	GTA	Global Title Address
rtrv-gtt	GTT	Global Title Translation
rtrv-ip-lnk	IP-LNK	Internet Process Link
rtrv-ls	LS	Link Set
rtrv-map	MAP	Mated Application
rtrv-scrset	SCRSET	Gateway Screening Screen Set
rtrv-slk	SLK	Signal Link
rtrv-spc	SPC	Secondary Point Code
rtrv-x25-dstn	X25-DSTN	X.25 Destination
rtrv-x25-slk	X25-SLK	X.25 Signal Link

Output

The following example shows the output for the minimum table sizes in the system:

rtrv-tbl-capacity

```
tekelecstp 04-04-02 07:35:33 EST EAGLE 31.6.0

DSTN      table is (   200 of   2000) 10% full
XLIST     table is (    0 of    500) 0% full
X25-DSTN  table is (    0 of   1024) 0% full
SPC       table is (    0 of    40) 0% full
LS        table is (   512 of   1024) 50% full
SLK       table is (    48 of   1200) 4% full
X25-SLK   table is (    0 of    256) 0% full
IP-LNK    table is (    10 of    500) 2% full
MAP       table is (   256 of   1025) 25% full
GTT       table is (  2700 of 270000) 1% full
SCRSET    table is (    50 of    255) 20% full
AS        table is (    5 of    250) 2% full
ASP       table is (    5 of   4000) 2% full
RTEKEY    table is (    2 of    2500) 1% full
IPAPSOCK  table is (   324 of   4000) 8% full
```

;

The following example shows the output for the maximum table sizes in the system. For the DSTN, SLK, GTT, and MAP tables, maximum values depend on the enabled feature quantity value applicable to the table in the system.

rtrv-tbl-capacity

```
tekelecstp 04-04-02 07:35:33 EST EAGLE 31.8.0

DSTN      table is (   600 of   8000) 10% full
XLIST     table is (    0 of    500) 0% full
X25-DSTN  table is (    0 of   1024) 0% full
SPC       table is (    0 of    40) 0% full
LS        table is (   512 of   1024) 50% full
SLK       table is (  1501 of   1500) 75% full
X25-SLK   table is (    0 of    256) 0% full
IP-LNK    table is (    10 of    500) 2% full
MAP       table is (  1500 of   3000) 50% full
GTT       table is (1000000 of 1000000) 100% full
SCRSET    table is (    25 of    255) 10% full
AS        table is (    5 of    250) 2% full
ASP       table is (    5 of   4000) 2% full
RTEKEY    table is (    2 of    2500) 1% full
IPAPSOCK  table is (   324 of   4000) 8% full
```

;

rtrv-th-alm

Retrieve Alarm Thresholds

Use this command to retrieve the values used for the System SCCP and LNP TPS threshold alarms, the DB threshold alarm levels for database, and the SCCP GTT and Non-GTT Service threshold alarms.

Keyword: rtrv-th-alm

Related Commands: chg-th-alm, rept-stat-sccp

Command Class: Database Administration

Parameters

This command has no parameters.

Example

```
rtrv-th-alm
```

Dependencies

Level 1 thresholds must be less than their corresponding level 2 thresholds.

Notes

None

Output**rtrv-th-alm**

```
rlghncxa03w 05-03-07 11:43:13 EST EAGLE5 34.0.0
SCCP TPS Threshold: 80 %
RTRV-TH-SCCP: MASP A - COMPLTD.
```

```
;
```

rtrv-th-alm

```
rlghncxa03w 05-03-07 11:43:13 EST EAGLE5 34.0.0
Thermal Alarm Level 1: 75 Degrees Celcius
Thermal Alarm Level 2: 82 Degrees Celcius
SCCP TPS Threshold: 80%
SCCP Calculation Method: N
LNP TN DB Alarm Level 1: 80%
LNP TN DB Alarm Level 2: 90%
GTT SCCP Service Alarm Level 1: 50%
GTT SCCP Service Alarm Level 2: 60%
Non-GTT SCCP Service Alarm Level 1: 10%
Non-GTT SCCP Service Alarm Level 2: 20%
Command Executed
```

```
;
```

rtrv-th-sccp**Retrieve SCCP Alarm Thresholds**

NOTE: This command is obsolete. The functions have been updated and moved to the **rtrv-th-alm** command.

Use this command to retrieve the value used for the system SCCP TPS (transactions-per-second) threshold alarm. An alarm triggers when the TPS for the EAGLE system is greater than the value set by the **chg-th-sccp** command.

Keyword: **rtrv-th-sccp**

Related Commands: **chg-th-sccp**, **rept-stat-sccp**

Command Class: Database Administration

Parameters

This command has no parameters.

Example

```
rtrv-th-sccp
```

Dependencies

None

Notes

None

Output**rtrv-th-sccp**

```

rlghncxa03w 03-03-07 11:43:13 EST  EAGLE 31.3.0
Command entered at terminal #4.
SCCP TPS Threshold: 80 %
RTRV-TH-SCCP: MASP A - COMPLTD.
;

```

rtrv-trbl**Retrieve Trouble**

Use this command to display detailed information for one or more troubles that are currently logged into the system.

Keyword: rtrv-trbl

Related Commands: act-alm-trns, dact-alm-trns, rept-stat-alm, rept-stat-clk, rept-stat-trbl, rls-alm, rtrv-obit

Command Class: System Maintenance

Parameters

:loc= (mandatory)

The address of the card that is running the OAM from which logged trouble reports are to be displayed.

Range: 1113, 1115

:mode= (optional)

Display mode

Range: c, m

c—Continuous mode; shows troubles already logged and new troubles as they occur.

m—Manual mode; shows troubles on demand only

Default: c

:num= (optional)

The number of entries to be shown. This parameter determines how many records you want to display (potentially within a given TN range). Use this parameter to prevent inadvertent displays of extremely large amounts of information.

Range 1-12,000,000

1-50, if the **force=yes** parameter is not specified

1-12,000,000, if the **force=yes** parameter is specified

Default: 1—if only the **tn** parameter is specified and the **etn** parameter is not specified

50—all other cases

:num= (optional)
Indicates how many troubles to display.
Range 1-99
Default: 99

Example

```
rtrv-trbl:loc=1113:num=2
```

Dependencies

At least one trouble must be in the trouble log, or the command is rejected.

Only one **rtrv-trbl** or **rtrv-obit** command can be in progress at a time.

If the **mode** parameter is specified without the **num** parameter, the entire log is displayed.

The card specified by the **loc** parameter must be **1113** or **1115**.

If the **loc** parameter specifies the card that is running the standby OAM, that card must be available.

Notes

When a trouble is generated in the system, it is logged into the RAM storage area of the active OAM. Each OAM can store up to 99 troubles in a queue. If the OAM resets, logged troubles are lost.

Output

NOTE: The output from this command should be reviewed with a member of the Tekelec Technical Services Team. You can contact Tekelec Technical Services at (888) FOR-TKLC.

```
rtrv-trbl:loc=1113:num=2
```

```
rlghncxa03w 03-03-07 08:47:43 EST EAGLE 31.3.0  
Card 1113 Module 0000 Mod_loc 0 Class 0000 Severity 0  
Report Date:00-00-00 Time:00:00:00
```

```
rlghncxa03w 03-03-07 08:47:43 EST EAGLE 31.3.0  
Card 1108 Module 8001 Mod_loc 6 Class 100A Severity 1  
Report Date:03-03-04 Time:09:19:59
```

```
;
```

rtrv-trbltx**Retrieve Trouble Text Table Entries**

Use this command to retrieve Alarm and UIM message information including MRN (message reference number), level (for Alarms), Output Group, and text.

The default report displays all Alarms (in numerical order) and then all UIMs.

The optional parameters can be used to:

- Display a range of Alarms or UIMs (ranges spanning both Alarms and UIMs are not supported)
- Search for Alarms, UIMs, or both message types matching a specific Output Group
- Sort all entries by Output Group

Keyword: rtrv-trbltx

Related Commands: None

Command Class: Database Administration

Parameters

:enum= (optional)

The ending Message Reference Number (MRN) when specifying a range.

Range: 1-999 for Alarms, 1000-1499 for UIMs

Default: when **enum** is not specified,

If **snum** is specified, the **enum** value defaults to the specified **snum** value.

If **snum** is not specified and **type=all**, **type=uim**, or **type** not specified, the **enum** value defaults to 1499

If **snum** is not specified and **type=alarm**, the **enum** value defaults to 999

:outgrp= (optional)

The Output Group to sort or filter the Alarm/UIMs on.

Range: appserv, appss, card, clk, db, dbg, gtt, gws, link, lnpdb, lnpsub, meas, mon, mps, pu, sa, seas, slan, sys, traf

all—retrieve information for all Output Groups

appserv—Application Server

appss—Application Subsystem

card—Card

clk—Clock

db—Database

dbg—Debug

gtt—GTT Maintenance

gws—GWS Maintenance

link—Link Maintenance

lnpdb—LNP Database

lnpsub—LNP Subsystem

meas—Measurements Maintenance

mon—Monitoring (Sentinel) Maintenance

mps—MPS Maintenance

pu—Program Update
sa—System Administration
seas—SEAS (Sentinel)
slan—SLAN Maintenance
sys—System Maintenance
traf—Traffic

Default: No sorting or filtering is done on Output Groups.

:snum= (optional)

A single Message Reference Number (MRN), or the starting MRN when specifying a range.

Range: 1-999 for Alarms, 1000-1499 for UIMs.

Default: All message entries for the specified **type** are displayed.

For **type=all**, **type=alarm**, or **type** not specified—**snum** Default: 1

For **type=uim**—**snum** Default: 1000

:type= (optional)

The type of trouble text entry—Alarm, UIM, or both types—to display.

Range: all, alarm, uim

all—Both types are displayed

alarm—Only Alarm entries are displayed

uim—Only UIM entries are displayed

Default: all

Example

```
rtrv-trbltx
rtrv-trbltx:type=alarm
rtrv-trbltx:type=uim
rtrv-trbltx:outgrp=sys
rtrv-trbltx:type=alarm:outgrp=all
rtrv-trbltx:snum=3
rtrv-trbltx:snum=1002
```

Dependencies

If **enum** is specified, **snum** must be specified in the command.

The specified **enum** value must be greater than the specified **snum** value.

The specified **enum** value must be in the same range as the specified **snum** value (1-999 for Alarms and 1000-1499 for UIMs). The range cannot span both types.

The specified **snum** and **enum** values must be in the range of the specified **type** (1-999 for Alarms and 1000-1499 for UIMs).

When the **outgrp** parameter is specified, the **snum** and **enum** parameters cannot be specified.

Notes

This command can be canceled using the **F9** function key or the **canc-cmd** command. See **canc-cmd** for more information.

To display a single Alarm or UIM, enter the Alarm or UIM MRN as the value of the **snum** parameter. Either do not specify the **enum** parameter or specify the **enum** parameter with the same value as the **snum** value.

If an unused MRN is specified as an **snum** parameter value, the header information is displayed without any Output Group header or MRN information.

If an **snum/enum** range is specified, and there are unused MRNs within that range, only the used MRNs are displayed.

Output

The following example shows output when the command has no parameters. All entries are not shown; the list is long:

rtrv-trbltx

```
ncralstp00001 03-07-16 10:15:29 EST EAGLE 31.3.0
```

Alarm Report

MRN	LEVEL	OUTPUT GROUP	TEXT
0001	MAJR	SYS	Card has reset
0002	MINR	SYS	Card is not running approved GPL
0003	NONE	SYS	Alarm cleared for GPL
.			
.			
.			
0912	NONE	SYS	Dynamic database is now consistent

UIM Report

MRN	OUTPUT GROUP	TEXT
1000	SYS	MTP rcvd UPU - user part is not SCCP
1001	SYS	MTP rcvd Transfer Controlled (TFC)
1002	SYS	MTP rcvd invalid TFC - status 0
.		
.		
.		
1499	SYS	Invalid MRN detected

```
END OF RTRV-TRBLTX REPORT.
```

```
;
```

The following example shows the display with **type=alarm**. All entries are not shown; the list is long:

rtrv-trbltx:type=alarm

ncralstp00001 03-07-16 10:15:29 EST EAGLE 31.3.0

Alarm Report

MRN	LEVEL	OUTPUT GROUP	TEXT
0001	MAJR	SYS	Card has reset
0002	MINR	SYS	Card is not running approved GPL
0003	NONE	SYS	Alarm cleared for GPL
.	.	.	.
.	.	.	.
.	.	.	.
0912	NONE	SYS	Dynamic database is now consistent

END OF RTRV-TRBLTX REPORT.

;

The following example shows the display with **type=uim**. All entries are not shown; the list is long:

rtrv-trbltx:type=uim

ncralstp00001 03-07-16 10:15:29 EST EAGLE 31.3.0

UIM Report

MRN	OUTPUT GROUP	TEXT
1000	SYS	MTP rcvd UPU - user part is not SCCP
1001	SYS	MTP rcvd Transfer Controlled (TFC)
1002	SYS	MTP rcvd invalid TFC - status 0
.	.	.
.	.	.
.	.	.
1499	SYS	Invalid MRN detected

END OF RTRV-TRBLTX REPORT.

;

The following example shows the display with **outgrp=all**. The complete list of Alarms and UIMs is not shown; it is a long list; examples from each type and several Output Groups are shown.

NOTE: The output for outgrp=all:type=alarm includes all Output Groups in the Alarm Report only; the output for outgrp=all:type=uim includes all Output Groups in the UIM Report only.

rtrv-trbltx:outgrp=all

ncralstp00001 03-07-16 10:15:29 EST EAGLE 31.3.0

Alarm Report

MRN	LEVEL	OUTPUT GROUP	TEXT

Output Group - SYS			
0001	MAJR	SYS	Card has reset
0002	MINR	SYS	Card is not running approved GPL
.			
.			
.			
0912	NONE	SYS	Dynamic database is now consistent
.			
.			
.			
Output Group - LINK			
0155	MINR	LINK	STPLAN connection unavailable
0156	NONE	LINK	STPLAN connection available
		:	
0479	NONE	LINK	Link not Monitored

UIM Report

MRN	OUTPUT GROUP	TEXT

Output Group - SYS		
1000	SYS	MTP rcvd UPU - user part is not SCCP
1001	SYS	MTP rcvd Transfer Controlled (TFC)
.		
.		
.		
1499	SYS	Invalid MRN detected
.		
.		
.		
Output Group - LINK		
13nn	LINK	Example text

END OF RTRV-TRBLTX REPORT.

;

The following example shows the display for **outgrp=sys**. All entries are not shown; the list is long:

rtrv-trbltx:type=alarm:outgrp=sys

ncralstp00001 03-07-16 10:15:29 EST EAGLE 31.3.0

Alarm Report

MRN	LEVEL	OUTPUT	GROUP	TEXT

Output Group - SYS				
0001	MAJR	SYS		Card has reset
0002	MINR	SYS		Card is not running approved GPL
.				
.				
.				
0912	NONE	SYS		Dynamic database is now consistent

END OF RTRV-TRBLTX REPORT.

;

The following example shows the display for only Alarm MRN 3:

rtrv-trbltx:snum=3

ncralstp00001 03-07-16 10:15:29 EST EAGLE 31.3.0

Card 1113; SYS REL= 31.3.0; STP CLLI= ncralstp00001; Timezone= EST

Alarm Report

MRN	LEVEL	OUTPUT	GROUP	TEXT

0003	NONE	SYS		Alarm cleared for GPL

END OF RTRV-TRBLTX REPORT.

;

The following example shows the display for only UIM MRN 1002:

rtrv-trbltx:snum=1002

ncralstp00001 03-07-16 10:15:29 EST EAGLE 31.3.0

UIM Report

MRN	OUTPUT	GROUP	TEXT

1002	SYS		MTP rcvd invalid TFC - status 0

END OF RTRV-TRBLTX REPORT.

;

rtrv-trm**Retrieve Terminal**

Use this command to show the port configuration for all TDM terminals or a specified terminal. These ports are used to connect modems, printers, and terminals to the system. This command displays the following information: device type, data transmission rate, parity, type of flow control used, number of stop bits, number of data bits, and the type of unsolicited messages to be received.

Keyword: rtrv-trm

Related Commands: act-echo, canc-echo, chg-trm, dact-echo, inh-trm, rept-stat-trm, rmv-trm, rst-trm

Command Class: Database Administration

Parameters

:trm= (optional)

Specifies the ID number of the terminal whose characteristics are to be retrieved and displayed.

Range: 1-40

Default: Display all

Example

```
rtrv-trm:trm=3
```

```
rtrv-trm
```

Dependencies

The IP User Interface feature must be enabled and turned on, and at least one IPSM card must be equipped, before **telnet** or **emsalm** type terminals with IDs 17 - 40 can be specified.

The specified terminal must be equipped.

Notes

The LNPDB and LNPSUP columns in the output report will be displayed only if the LNP feature has been turned on (see the “**enable-ctrl-feat**” command).

Output

The following example, with the LNP feature turned on, shows the display of the terminal settings for terminal port 3, which is configured for a terminal:

```
rtrv-trm:trm=3
```

```
rlghncxa03w 03-11-01 16:02:08 EST EAGLE 31.3.0
TRM  TYPE      COMM          FC      TMOUT  MXINV  DURAL
3    KSR        9600-7-E-1 SW    60      0      00:00:00

                                     LNP LNP
TRM  TRAF  LINK  SA   SYS  PU  DB  DB  SUB  UIMRD
3    YES  YES  YES YES YES YES YES YES YES YES

      APP  APP
TRM  SERV  SS   CARD  CLK  DBG  GTT  GWS  MEAS  MON  MPS  SEAS  SLAN
3    YES  YES YES   YES YES YES YES YES YES YES NO   NO
```

```
;
```

The following example, with the LNP feature turned off, shows the display of the terminal settings for terminal port 3, which is configured for a terminal:

rtrv-trm:trm=3

```
rlghncxa03w 03-11-01 16:02:08 EST EAGLE 31.3.0
TRM TYPE COMM FC TMOUT MXINV DURAL
3 KSR 9600-7-E-1 SW 60 0 00:00:00

TRM TRAF LINK SA SYS PU DB UIMRD
3 YES YES YES YES YES YES YES

APP APP
TRM SERV SS CARD CLK DBG GTT GWS MEAS MON MPS SEAS SLAN
3 YES YES YES YES YES YES YES YES YES YES NO NO
```

The following example, with the LNP feature turned on, shows the display of the terminal settings for 16 terminal ports (no IPSM cards are equipped):

rtrv-trm

```
rlghncxa03w 03-11-01 16:02:08 EST EAGLE 31.3.0
TRM TYPE COMM FC TMOUT MXINV DURAL
1 VT320 9600-7-E-1 SW 60 5 99:59:59
2 VT320 9600-7-E-1 BOTH 60 5 INDEF
3 KSR 9600-7-E-1 SW 60 0 00:00:00
4 NONE 9600-7-E-1 SW 60 5 00:30:00
5 NONE 9600-7-E-1 SW 60 5 00:00:30
6 OAP 19200-7-E-1 SW 0 5 INDEF
7 VT320 9600-7-E-1 SW 60 5 99:59:59
8 VT320 9600-7-E-1 SW 60 5 INDEF
9 VT320 9600-7-E-1 SW 60 0 00:00:00
10 VT320 9600-7-E-1 SW 60 5 00:30:00
11 VT320 9600-7-E-1 NONE 60 5 00:00:30
12 NONE 19200-7-E-1 SW 0 5 INDEF
13 VT320 9600-7-E-1 SW 60 5 99:59:59
14 VT320 9600-7-E-1 SW 60 5 INDEF
15 VT320 9600-7-E-1 SW 60 0 00:00:00
16 VT320 9600-7-E-1 SW 60 5 00:30:00

LNP LNP
TRM TRAF LINK SA SYS PU DB DB SUB UIMRD
1 YES YES YES YES YES YES YES YES YES
2 YES YES YES YES YES YES YES YES YES
3 YES YES YES YES YES YES YES YES YES
4 YES YES YES YES NO YES YES YES YES
5 YES YES YES YES YES YES YES YES YES
6 YES YES YES YES YES YES YES YES YES
7 NO YES YES YES YES YES YES YES YES
8 YES YES YES YES YES YES YES YES YES
9 YES YES YES YES YES YES YES YES YES
10 NO NO NO NO NO NO NO NO NO
11 NO NO NO NO NO NO NO NO NO
12 NO NO NO NO NO NO NO NO NO
13 NO NO NO NO NO NO NO NO NO
14 NO NO NO NO NO NO NO NO NO
15 NO NO NO NO NO NO NO NO NO
16 NO NO NO NO NO NO NO NO NO
```

TRM	SERV	SS	CARD	CLK	DBG	GTT	GWS	MEAS	MON	MPS	SEAS	SLAN
1	YES	YES	YES	YES	YES	YES	YES	YES	YES	YES	NO	NO
2	YES	YES	YES	YES	YES	YES	YES	YES	YES	YES	NO	NO
3	YES	YES	YES	YES	YES	YES	YES	YES	YES	YES	NO	NO
4	YES	YES	YES	YES	YES	NO	YES	YES	YES	YES	NO	NO
5	YES	YES	YES	YES	YES	YES	YES	YES	YES	YES	NO	NO
6	YES	YES	YES	YES	YES	YES	YES	YES	YES	YES	NO	NO
7	NO	YES	YES	YES	YES	YES	YES	YES	YES	YES	NO	NO
8	YES	YES	YES	YES	YES	YES	YES	YES	YES	YES	YES	YES
9	YES	YES	YES	YES	YES	YES	YES	YES	YES	YES	YES	YES
10	NO	NO	NO	NO	NO	NO	NO	NO	NO	NO	NO	NO
11	NO	NO	NO	NO	NO	NO	NO	NO	NO	NO	NO	NO
12	NO	NO	NO	NO	NO	NO	NO	NO	NO	NO	NO	NO
13	NO	NO	NO	NO	NO	NO	NO	NO	NO	NO	NO	NO
14	NO	NO	NO	NO	NO	NO	NO	NO	NO	NO	NO	NO
15	NO	NO	NO	NO	NO	NO	NO	NO	NO	NO	NO	NO
16	NO	NO	NO	NO	NO	NO	NO	NO	NO	NO	NO	NO

;

The following example, with the LNP feature turned off, shows the display of the terminal settings for 16 terminal ports (no IPSM cards are equipped):

rtrv-trm

```

rlghncxa03w 03-11-01 16:02:08 EST EAGLE 31.3.0
TRM TYPE COMM FC TMOUT MXINV DURAL
1 VT320 9600-7-E-1 SW 60 5 99:59:59
2 VT320 9600-7-E-1 BOTH 60 5 INDEF
3 KSR 9600-7-E-1 SW 60 0 00:00:00
4 NONE 9600-7-E-1 SW 60 5 00:30:00
5 NONE 9600-7-E-1 SW 60 5 00:00:30
6 OAP 19200-7-E-1 SW 0 5 INDEF
7 VT320 9600-7-E-1 SW 60 5 99:59:59
8 VT320 9600-7-E-1 SW 60 5 INDEF
9 VT320 9600-7-E-1 SW 60 0 00:00:00
10 VT320 9600-7-E-1 SW 60 5 00:30:00
11 VT320 9600-7-E-1 NONE 60 5 00:00:30
12 NONE 19200-7-E-1 SW 0 5 INDEF
13 VT320 9600-7-E-1 SW 60 5 99:59:59
14 VT320 9600-7-E-1 SW 60 5 INDEF
15 VT320 9600-7-E-1 SW 60 0 00:00:00
16 VT320 9600-7-E-1 SW 60 5 00:30:00
    
```

TRM	TRAF	LINK	SA	SYS	PU	DB	UIMRD
1	YES	YES	YES	YES	YES	YES	YES
2	YES	YES	YES	YES	YES	YES	YES
3	YES	YES	YES	YES	YES	YES	YES
4	YES	YES	YES	YES	YES	YES	YES
5	YES	YES	YES	YES	NO	YES	YES
6	YES	YES	YES	YES	YES	YES	YES
7	NO	YES	YES	YES	YES	YES	YES
8	YES	YES	YES	YES	YES	YES	YES
9	YES	YES	YES	YES	YES	YES	YES
10	NO	NO	NO	NO	NO	NO	NO
11	NO	NO	NO	NO	NO	NO	NO
12	NO	NO	NO	NO	NO	NO	NO
13	NO	NO	NO	NO	NO	NO	NO
14	NO	NO	NO	NO	NO	NO	NO
15	NO	NO	NO	NO	NO	NO	NO
16	NO	NO	NO	NO	NO	NO	NO

```

APP APP
TRM  SERV  SS  CARD  CLK  DBG  GTT  GWS  MEAS  MON  MPS  SEAS  SLAN
1     YES  YES  YES   YES  YES  YES  YES  YES   YES  YES  NO   NO
2     YES  YES  YES   YES  YES  YES  YES  YES   YES  YES  NO   NO
3     YES  YES  YES   YES  YES  YES  YES  YES   YES  YES  NO   NO
4     YES  YES  YES   YES  YES  NO   YES  YES   YES  YES  NO   NO
5     YES  YES  YES   YES  YES  YES  YES  YES   YES  YES  NO   NO
6     YES  YES  YES   YES  YES  YES  YES  YES   YES  YES  NO   NO
7     NO   YES  YES   YES  YES  YES  YES  YES   YES  YES  NO   NO
8     YES  YES  YES   YES  YES  YES  YES  YES   YES  YES  YES  YES
9     YES  YES  YES   YES  YES  YES  YES  YES   YES  YES  YES  YES
10    NO   NO  NO   NO   NO  NO  NO  NO   NO  NO  NO   NO
11    NO   NO  NO   NO   NO  NO  NO  NO   NO  NO  NO   NO
12    NO   NO  NO   NO   NO  NO  NO  NO   NO  NO  NO   NO
13    NO   NO  NO   NO   NO  NO  NO  NO   NO  NO  NO   NO
14    NO   NO  NO   NO   NO  NO  NO  NO   NO  NO  NO   NO
15    NO   NO  NO   NO   NO  NO  NO  NO   NO  NO  NO   NO
16    NO   NO  NO   NO   NO  NO  NO  NO   NO  NO  NO   NO

```

;

The following example shows the display of the terminal settings for a **mgmt** terminal used for Network Surveillance:

rtrv-trm:trm=3

```

rlghncxa03w 03-11-01 16:02:08 EST EAGLE 31.3.0
TRM  TYPE      COMM          FC      TMOUT  MXINV  DURAL
3     MGMT      9600-7-E-1 SW    60     0      00:00:00

```

```

LNP LNP

```

```

TRM  TRAF  LINK  SA  SYS  PU  DB  DB  SUB  UIMRD
3     YES  YES   YES  YES  YES  YES  YES  YES  YES

```

```

APP APP

```

```

TRM  SERV  SS  CARD  CLK  DBG  GTT  GWS  MEAS  MON  MPS  SEAS  SLAN
3     YES  YES  YES   YES  YES  YES  YES  YES   YES  YES  NO   NO

```

;

The following example shows the display of the terminal settings with the IP User Interface feature enabled and one IPSM card equipped:

rtrv-trm

```

rlghncxa03w 03-11-01 16:02:08 EST EAGLE 31.3.0
TRM  TYPE      COMM          FC      TMOUT  MXINV  DURAL
1     VT320      9600 -7-E-1 SW    0       5      00:01:00
2     VT320      9600 -7-E-1 SW    0       5      00:01:00
3     VT320      9600 -7-E-1 SW    0       5      00:01:00
4     KSR       9600 -7-E-1 SW    0       5      00:01:00
5     NONE      9600 -7-E-1 SW    30      5      00:01:00
6     NONE      9600 -7-E-1 SW    30      5      00:01:00
7     NONE      9600 -7-E-1 SW    30      5      00:01:00
8     NONE      9600 -7-E-1 SW    30      5      00:01:00
9     VT320      9600 -7-E-1 SW    0       5      00:01:00
10    VT320      9600 -7-E-1 SW    0       5      00:01:00
11    VT320      9600 -7-E-1 SW    0       5      00:01:00
12    KSR       9600 -7-E-1 SW    0       5      00:01:00
13    NONE      9600 -7-E-1 SW    30      5      00:01:00
14    NONE      9600 -7-E-1 SW    30      5      00:01:00
15    NONE      9600 -7-E-1 SW    30      5      00:01:00
16    NONE      9600 -7-E-1 SW    30      5      00:01:00

```

TRM	TYPE	LOC	TMOUT	MXINV	DURAL
17	TELNET	1201	60	5	00:30:00
18	TELNET	1201	60	5	00:30:00
19	TELNET	1201	60	5	00:30:00
20	TELNET	1201	60	5	00:30:00
21	TELNET	1201	60	5	00:30:00
22	TELNET	1201	60	5	00:30:00
23	TELNET	1201	60	5	00:30:00
24	TELNET	1201	60	5	00:30:00

;

TRM	TRAF	LINK	SA	SYS	PU	DB	LNP		UIMRD
							DB	SUB	
1	YES	YES	YES	YES	YES	YES	YES	YES	YES
2	YES	YES	YES	YES	YES	YES	YES	YES	YES
3	YES	YES	YES	YES	YES	YES	YES	YES	YES
4	YES	YES	YES	YES	NO	YES	YES	YES	YES
5	YES	YES	YES	YES	YES	YES	YES	YES	YES
6	YES	YES	YES	YES	YES	YES	YES	YES	YES
7	NO	YES	YES	YES	YES	YES	YES	YES	YES
8	YES	YES	YES	YES	YES	YES	YES	YES	YES
9	YES	YES	YES	YES	YES	YES	YES	YES	YES
10	NO	NO	NO	NO	NO	NO	NO	NO	NO
11	NO	NO	NO	NO	NO	NO	NO	NO	NO
12	NO	NO	NO	NO	NO	NO	NO	NO	NO
13	NO	NO	NO	NO	NO	NO	NO	NO	NO
14	NO	NO	NO	NO	NO	NO	NO	NO	NO
15	NO	NO	NO	NO	NO	NO	NO	NO	NO
16	NO	NO	NO	NO	NO	NO	NO	NO	NO
17	NO	NO	NO	NO	NO	NO	NO	NO	NO
18	NO	NO	NO	NO	NO	NO	NO	NO	NO
19	NO	NO	NO	NO	NO	NO	NO	NO	NO
20	NO	NO	NO	NO	NO	NO	NO	NO	NO
21	NO	NO	NO	NO	NO	NO	NO	NO	NO
22	NO	NO	NO	NO	NO	NO	NO	NO	NO
23	NO	NO	NO	NO	NO	NO	NO	NO	NO
24	NO	NO	NO	NO	NO	NO	NO	NO	NO

TRM	APP		CARD	CLK	DBG	GTT	GWS	MEAS	MON	MPS	SEAS	SLAN
	SERV	SS										
1	YES	YES	YES	YES	YES	YES	YES	YES	YES	YES	NO	NO
2	YES	YES	YES	YES	YES	YES	YES	YES	YES	YES	NO	NO
3	YES	YES	YES	YES	YES	YES	YES	YES	YES	YES	NO	NO
4	YES	YES	YES	YES	YES	NO	YES	YES	YES	YES	NO	NO
5	YES	YES	YES	YES	YES	YES	YES	YES	YES	YES	NO	NO
6	YES	YES	YES	YES	YES	YES	YES	YES	YES	YES	NO	NO
7	NO	YES	YES	YES	YES	YES	YES	YES	YES	YES	NO	NO
8	YES	YES	YES	YES	YES	YES	YES	YES	YES	YES	YES	YES
9	YES	YES	YES	YES	YES	YES	YES	YES	YES	YES	YES	YES
10	NO	NO	NO	NO	NO	NO	NO	NO	NO	NO	NO	NO
11	NO	NO	NO	NO	NO	NO	NO	NO	NO	NO	NO	NO
12	NO	NO	NO	NO	NO	NO	NO	NO	NO	NO	NO	NO
13	NO	NO	NO	NO	NO	NO	NO	NO	NO	NO	NO	NO
14	NO	NO	NO	NO	NO	NO	NO	NO	NO	NO	NO	NO
15	NO	NO	NO	NO	NO	NO	NO	NO	NO	NO	NO	NO
16	NO	NO	NO	NO	NO	NO	NO	NO	NO	NO	NO	NO
17	NO	NO	NO	NO	NO	NO	NO	NO	NO	NO	NO	NO

```

18 NO NO NO NO NO NO NO NO NO NO NO NO
19 NO NO NO NO NO NO NO NO NO NO NO NO
20 NO NO NO NO NO NO NO NO NO NO NO NO
21 NO NO NO NO NO NO NO NO NO NO NO NO
22 NO NO NO NO NO NO NO NO NO NO NO NO
23 NO NO NO NO NO NO NO NO NO NO NO NO
24 NO NO NO NO NO NO NO NO NO NO NO NO
    
```

;

The following example shows the display of the terminal settings with the IP User Interface feature enabled and three IPSM cards equipped:

rtrv-trm

```

rlghncxa03w 03-11-01 16:02:08 EST EAGLE 31.3.0
TRM  TYPE      COMM      FC      TMOUT  MXINV  DURAL
1    VT320     9600 -7-E-1 SW    0      5      00:01:00
2    VT320     9600 -7-E-1 SW    0      5      00:01:00
3    VT320     9600 -7-E-1 SW    0      5      00:01:00
4    KSR       9600 -7-E-1 SW    0      5      00:01:00
5    NONE      9600 -7-E-1 SW   30     5      00:01:00
6    NONE      9600 -7-E-1 SW   30     5      00:01:00
7    NONE      9600 -7-E-1 SW   30     5      00:01:00
8    NONE      9600 -7-E-1 SW   30     5      00:01:00
9    VT320     9600 -7-E-1 SW    0      5      00:01:00
10   VT320     9600 -7-E-1 SW    0      5      00:01:00
11   VT320     9600 -7-E-1 SW    0      5      00:01:00
12   KSR       9600 -7-E-1 SW    0      5      00:01:00
13   NONE      9600 -7-E-1 SW   30     5      00:01:00
14   NONE      9600 -7-E-1 SW   30     5      00:01:00
15   NONE      9600 -7-E-1 SW   30     5      00:01:00
16   NONE      9600 -7-E-1 SW   30     5      00:01:00
    
```

```

TRM  TYPE      LOC      TMOUT  MXINV  DURAL
17   TELNET    1201     60     5      00:30:00
18   TELNET    1201     60     5      00:30:00
19   TELNET    1201     60     5      00:30:00
20   TELNET    1201     60     5      00:30:00
21   TELNET    1201     60     5      00:30:00
22   TELNET    1201     60     5      00:30:00
23   TELNET    1201     60     5      00:30:00
24   TELNET    1201     60     5      00:30:00
25   TELNET    1203     60     5      00:30:00
26   TELNET    1203     60     5      00:30:00
27   TELNET    1203     60     5      00:30:00
28   TELNET    1203     60     5      00:30:00
29   TELNET    1203     60     5      00:30:00
30   TELNET    1203     60     5      00:30:00
31   TELNET    1203     60     5      00:30:00
32   TELNET    1203     60     5      00:30:00
33   TELNET    1208     60     5      00:30:00
34   TELNET    1208     60     5      00:30:00
35   TELNET    1208     60     5      00:30:00
36   TELNET    1208     60     5      00:30:00
37   TELNET    1208     60     5      00:30:00
38   TELNET    1208     60     5      00:30:00
39   TELNET    1208     60     5      00:30:00
40   TELNET    1208     60     5      00:30:00
    
```

;

TRM	TRAF	LINK	SA	SYS	PU	LNP		SUB	UIMRD
						DB	DB		
1	YES	YES	YES	YES	YES	YES	YES	YES	YES
2	YES	YES	YES	YES	YES	YES	YES	YES	YES
3	YES	YES	YES	YES	YES	YES	YES	YES	YES
4	YES	YES	YES	YES	NO	YES	YES	YES	YES
5	YES	YES	YES	YES	YES	YES	YES	YES	YES
6	YES	YES	YES	YES	YES	YES	YES	YES	YES
7	NO	YES	YES	YES	YES	YES	YES	YES	YES
8	YES	YES	YES	YES	YES	YES	YES	YES	YES
9	YES	YES	YES	YES	YES	YES	YES	YES	YES
10	NO	NO	NO	NO	NO	NO	NO	NO	NO
11	NO	NO	NO	NO	NO	NO	NO	NO	NO
12	NO	NO	NO	NO	NO	NO	NO	NO	NO
13	NO	NO	NO	NO	NO	NO	NO	NO	NO
14	NO	NO	NO	NO	NO	NO	NO	NO	NO
15	NO	NO	NO	NO	NO	NO	NO	NO	NO
16	NO	NO	NO	NO	NO	NO	NO	NO	NO
17	NO	NO	NO	NO	NO	NO	NO	NO	NO
18	NO	NO	NO	NO	NO	NO	NO	NO	NO
19	NO	NO	NO	NO	NO	NO	NO	NO	NO
20	NO	NO	NO	NO	NO	NO	NO	NO	NO
21	NO	NO	NO	NO	NO	NO	NO	NO	NO
22	NO	NO	NO	NO	NO	NO	NO	NO	NO
23	NO	NO	NO	NO	NO	NO	NO	NO	NO
24	NO	NO	NO	NO	NO	NO	NO	NO	NO
25	NO	NO	NO	NO	NO	NO	NO	NO	NO
26	NO	NO	NO	NO	NO	NO	NO	NO	NO
27	NO	NO	NO	NO	NO	NO	NO	NO	NO
28	NO	NO	NO	NO	NO	NO	NO	NO	NO
29	NO	NO	NO	NO	NO	NO	NO	NO	NO
30	NO	NO	NO	NO	NO	NO	NO	NO	NO
31	NO	NO	NO	NO	NO	NO	NO	NO	NO
32	NO	NO	NO	NO	NO	NO	NO	NO	NO
33	NO	NO	NO	NO	NO	NO	NO	NO	NO
34	NO	NO	NO	NO	NO	NO	NO	NO	NO
35	NO	NO	NO	NO	NO	NO	NO	NO	NO
36	NO	NO	NO	NO	NO	NO	NO	NO	NO
37	NO	NO	NO	NO	NO	NO	NO	NO	NO
38	NO	NO	NO	NO	NO	NO	NO	NO	NO
39	NO	NO	NO	NO	NO	NO	NO	NO	NO
40	NO	NO	NO	NO	NO	NO	NO	NO	NO

TRM	APP		CARD	CLK	DBG	GTT	GWS	MEAS	MON	MPS	SEAS	SLAN
	SERV	SS										
1	YES	YES	YES	YES	YES	YES	YES	YES	YES	YES	NO	NO
2	YES	YES	YES	YES	YES	YES	YES	YES	YES	YES	NO	NO
3	YES	YES	YES	YES	YES	YES	YES	YES	YES	YES	NO	NO
4	YES	YES	YES	YES	YES	NO	YES	YES	YES	YES	NO	NO
5	YES	YES	YES	YES	YES	YES	YES	YES	YES	YES	NO	NO
6	YES	YES	YES	YES	YES	YES	YES	YES	YES	YES	NO	NO
7	NO	YES	YES	YES	YES	YES	YES	YES	YES	YES	NO	NO
8	YES	YES	YES	YES	YES	YES	YES	YES	YES	YES	YES	YES
9	YES	YES	YES	YES	YES	YES	YES	YES	YES	YES	YES	YES
10	NO	NO	NO	NO	NO	NO	NO	NO	NO	NO	NO	NO

```

11 NO NO NO NO NO NO NO NO NO NO NO NO NO
12 NO NO NO NO NO NO NO NO NO NO NO NO NO
13 NO NO NO NO NO NO NO NO NO NO NO NO NO
14 NO NO NO NO NO NO NO NO NO NO NO NO NO
15 NO NO NO NO NO NO NO NO NO NO NO NO NO
16 NO NO NO NO NO NO NO NO NO NO NO NO NO
17 NO NO NO NO NO NO NO NO NO NO NO NO NO
18 NO NO NO NO NO NO NO NO NO NO NO NO NO
19 NO NO NO NO NO NO NO NO NO NO NO NO NO
20 NO NO NO NO NO NO NO NO NO NO NO NO NO
21 NO NO NO NO NO NO NO NO NO NO NO NO NO
22 NO NO NO NO NO NO NO NO NO NO NO NO NO
23 NO NO NO NO NO NO NO NO NO NO NO NO NO
24 NO NO NO NO NO NO NO NO NO NO NO NO NO
25 NO NO NO NO NO NO NO NO NO NO NO NO NO
26 NO NO NO NO NO NO NO NO NO NO NO NO NO
27 NO NO NO NO NO NO NO NO NO NO NO NO NO
28 NO NO NO NO NO NO NO NO NO NO NO NO NO
29 NO NO NO NO NO NO NO NO NO NO NO NO NO
30 NO NO NO NO NO NO NO NO NO NO NO NO NO
31 NO NO NO NO NO NO NO NO NO NO NO NO NO
32 NO NO NO NO NO NO NO NO NO NO NO NO NO
33 NO NO NO NO NO NO NO NO NO NO NO NO NO
34 NO NO NO NO NO NO NO NO NO NO NO NO NO
35 NO NO NO NO NO NO NO NO NO NO NO NO NO
36 NO NO NO NO NO NO NO NO NO NO NO NO NO
37 NO NO NO NO NO NO NO NO NO NO NO NO NO
38 NO NO NO NO NO NO NO NO NO NO NO NO NO
39 NO NO NO NO NO NO NO NO NO NO NO NO NO
40 NO NO NO NO NO NO NO NO NO NO NO NO NO

```

;

The following example shows the display of the terminal settings with the IP User Interface feature enabled and two IPSM cards equipped (the second IPSM card was removed):

rtrv-trm

```

rlghncxa03w 03-11-01 16:02:08 EST EAGLE 31.3.0
TRM TYPE COMM FC TMOUT MXINV DURAL
1 VT320 9600 -7-E-1 SW 0 5 00:01:00
2 VT320 9600 -7-E-1 SW 0 5 00:01:00
3 VT320 9600 -7-E-1 SW 0 5 00:01:00
4 KSR 9600 -7-E-1 SW 0 5 00:01:00
5 NONE 9600 -7-E-1 SW 30 5 00:01:00
6 NONE 9600 -7-E-1 SW 30 5 00:01:00
7 NONE 9600 -7-E-1 SW 30 5 00:01:00
8 NONE 9600 -7-E-1 SW 30 5 00:01:00
9 VT320 9600 -7-E-1 SW 0 5 00:01:00
10 VT320 9600 -7-E-1 SW 0 5 00:01:00
11 VT320 9600 -7-E-1 SW 0 5 00:01:00
12 KSR 9600 -7-E-1 SW 0 5 00:01:00
13 NONE 9600 -7-E-1 SW 30 5 00:01:00
14 NONE 9600 -7-E-1 SW 30 5 00:01:00
15 NONE 9600 -7-E-1 SW 30 5 00:01:00
16 NONE 9600 -7-E-1 SW 30 5 00:01:00

```

TRM	TYPE	LOC	TMOUT	MXINV	DURAL
17	TELNET	1201	60	5	00:30:00
18	TELNET	1201	60	5	00:30:00
19	TELNET	1201	60	5	00:30:00
20	TELNET	1201	60	5	00:30:00
21	TELNET	1201	60	5	00:30:00
22	TELNET	1201	60	5	00:30:00
23	TELNET	1201	60	5	00:30:00
24	TELNET	1201	60	5	00:30:00
33	TELNET	1208	60	5	00:30:00
34	TELNET	1208	60	5	00:30:00
35	TELNET	1208	60	5	00:30:00
36	TELNET	1208	60	5	00:30:00
37	TELNET	1208	60	5	00:30:00
38	TELNET	1208	60	5	00:30:00
39	TELNET	1208	60	5	00:30:00
40	TELNET	1208	60	5	00:30:00

;

TRM	TRAF	LINK	LNP LNP						UIMRD
			SA	SYS	PU	DB	DB	SUB	
1	YES	YES	YES	YES	YES	YES	YES	YES	YES
2	YES	YES	YES	YES	YES	YES	YES	YES	YES
3	YES	YES	YES	YES	YES	YES	YES	YES	YES
4	YES	YES	YES	YES	NO	YES	YES	YES	YES
5	YES	YES	YES	YES	YES	YES	YES	YES	YES
6	YES	YES	YES	YES	YES	YES	YES	YES	YES
7	NO	YES	YES	YES	YES	YES	YES	YES	YES
8	YES	YES	YES	YES	YES	YES	YES	YES	YES
9	YES	YES	YES	YES	YES	YES	YES	YES	YES
10	NO	NO	NO	NO	NO	NO	NO	NO	NO
11	NO	NO	NO	NO	NO	NO	NO	NO	NO
12	NO	NO	NO	NO	NO	NO	NO	NO	NO
13	NO	NO	NO	NO	NO	NO	NO	NO	NO
14	NO	NO	NO	NO	NO	NO	NO	NO	NO
15	NO	NO	NO	NO	NO	NO	NO	NO	NO
16	NO	NO	NO	NO	NO	NO	NO	NO	NO
17	NO	NO	NO	NO	NO	NO	NO	NO	NO
18	NO	NO	NO	NO	NO	NO	NO	NO	NO
19	NO	NO	NO	NO	NO	NO	NO	NO	NO
20	NO	NO	NO	NO	NO	NO	NO	NO	NO
21	NO	NO	NO	NO	NO	NO	NO	NO	NO
22	NO	NO	NO	NO	NO	NO	NO	NO	NO
23	NO	NO	NO	NO	NO	NO	NO	NO	NO
24	NO	NO	NO	NO	NO	NO	NO	NO	NO
33	NO	NO	NO	NO	NO	NO	NO	NO	NO
34	NO	NO	NO	NO	NO	NO	NO	NO	NO
35	NO	NO	NO	NO	NO	NO	NO	NO	NO
36	NO	NO	NO	NO	NO	NO	NO	NO	NO
37	NO	NO	NO	NO	NO	NO	NO	NO	NO
38	NO	NO	NO	NO	NO	NO	NO	NO	NO
39	NO	NO	NO	NO	NO	NO	NO	NO	NO
40	NO	NO	NO	NO	NO	NO	NO	NO	NO

TRM	APP APP											
	SERV	SS	CARD	CLK	DBG	GTT	GWS	MEAS	MON	MPS	SEAS	SLAN
1	YES	YES	YES	YES	YES	YES	YES	YES	YES	YES	NO	NO
2	YES	YES	YES	YES	YES	YES	YES	YES	YES	YES	NO	NO
3	YES	YES	YES	YES	YES	YES	YES	YES	YES	YES	NO	NO
4	YES	YES	YES	YES	YES	NO	YES	YES	YES	YES	NO	NO
5	YES	YES	YES	YES	YES	YES	YES	YES	YES	YES	NO	NO
6	YES	YES	YES	YES	YES	YES	YES	YES	YES	YES	NO	NO
7	NO	YES	YES	YES	YES	YES	YES	YES	YES	YES	NO	NO
8	YES	YES	YES	YES	YES	YES	YES	YES	YES	YES	YES	YES
9	YES	YES	YES	YES	YES	YES	YES	YES	YES	YES	YES	YES
10	NO	NO	NO	NO	NO	NO	NO	NO	NO	NO	NO	NO
11	NO	NO	NO	NO	NO	NO	NO	NO	NO	NO	NO	NO
12	NO	NO	NO	NO	NO	NO	NO	NO	NO	NO	NO	NO
13	NO	NO	NO	NO	NO	NO	NO	NO	NO	NO	NO	NO
14	NO	NO	NO	NO	NO	NO	NO	NO	NO	NO	NO	NO
15	NO	NO	NO	NO	NO	NO	NO	NO	NO	NO	NO	NO
16	NO	NO	NO	NO	NO	NO	NO	NO	NO	NO	NO	NO
17	NO	NO	NO	NO	NO	NO	NO	NO	NO	NO	NO	NO
18	NO	NO	NO	NO	NO	NO	NO	NO	NO	NO	NO	NO
19	NO	NO	NO	NO	NO	NO	NO	NO	NO	NO	NO	NO
20	NO	NO	NO	NO	NO	NO	NO	NO	NO	NO	NO	NO
21	NO	NO	NO	NO	NO	NO	NO	NO	NO	NO	NO	NO
22	NO	NO	NO	NO	NO	NO	NO	NO	NO	NO	NO	NO
23	NO	NO	NO	NO	NO	NO	NO	NO	NO	NO	NO	NO
24	NO	NO	NO	NO	NO	NO	NO	NO	NO	NO	NO	NO
33	NO	NO	NO	NO	NO	NO	NO	NO	NO	NO	NO	NO
34	NO	NO	NO	NO	NO	NO	NO	NO	NO	NO	NO	NO
35	NO	NO	NO	NO	NO	NO	NO	NO	NO	NO	NO	NO
36	NO	NO	NO	NO	NO	NO	NO	NO	NO	NO	NO	NO
37	NO	NO	NO	NO	NO	NO	NO	NO	NO	NO	NO	NO
38	NO	NO	NO	NO	NO	NO	NO	NO	NO	NO	NO	NO
39	NO	NO	NO	NO	NO	NO	NO	NO	NO	NO	NO	NO
40	NO	NO	NO	NO	NO	NO	NO	NO	NO	NO	NO	NO

;

The following example shows the display of the terminal settings for telnet terminal 30:

rtrv-trm:trm=30

```

rlghncxa03w 03-11-01 16:02:08 EST EAGLE 31.3.0
TRM TYPE LOC TMOUT MXINV DURAL
30 TELNET 1204 60 0 00:00:00

TRM TRAF LINK SA SYS PU DB UIMRD
30 YES YES YES YES YES YES YES

APP APP
TRM SERV SS CARD CLK DBG GTT GWS MEAS MON MPS SEAS SLAN
3 YES YES YES YES YES YES YES YES YES YES YES NO NO
    
```

;

The following example shows the display of the terminal settings with the IP User Interface feature enabled, one IPSM card equipped, and the OA&M IP Security Enhancements feature turned off:

rtrv-trm

```

rlghncxa03w 03-11-01 16:02:08 EST EAGLE 31.3.0
TRM  TYPE      COMM      FC      TMOUT  MXINV  DURAL
1    VT320     9600 -7-E-1 SW    0      5      00:01:00
2    VT320     9600 -7-E-1 SW    0      5      00:01:00
3    VT320     9600 -7-E-1 SW    0      5      00:01:00
4    KSR       9600 -7-E-1 SW    0      5      00:01:00
5    NONE      9600 -7-E-1 SW   30     5      00:01:00
6    NONE      9600 -7-E-1 SW   30     5      00:01:00
7    NONE      9600 -7-E-1 SW   30     5      00:01:00
8    NONE      9600 -7-E-1 SW   30     5      00:01:00
9    VT320     9600 -7-E-1 SW    0      5      00:01:00
10   VT320     9600 -7-E-1 SW    0      5      00:01:00
11   VT320     9600 -7-E-1 SW    0      5      00:01:00
12   KSR       9600 -7-E-1 SW    0      5      00:01:00
13   NONE      9600 -7-E-1 SW   30     5      00:01:00
14   NONE      9600 -7-E-1 SW   30     5      00:01:00
15   NONE      9600 -7-E-1 SW   30     5      00:01:00
16   NONE      9600 -7-E-1 SW   30     5      00:01:00

TRM  TYPE      LOC              TMOUT  MXINV  DURAL      SECURE
17   TELNET    1201             60     5      00:30:00   no
18   TELNET    1201             60     5      00:30:00   no
19   TELNET    1201             60     5      00:30:00   no
20   TELNET    1201             60     5      00:30:00   no
21   TELNET    1201             60     5      00:30:00   no
22   TELNET    1201             60     5      00:30:00   no
23   TELNET    1201             60     5      00:30:00   no
24   TELNET    1201             60     5      00:30:00   no

                                LNP LNP
TRM  TRAF  LINK  SA  SYS  PU  DB  DB  SUB  UIMRD
1    YES  YES  YES  YES  YES  YES  YES  YES  YES
2    YES  YES  YES  YES  YES  YES  YES  YES  YES
3    YES  YES  YES  YES  YES  YES  YES  YES  YES
4    YES  YES  YES  YES  NO  YES  YES  YES  YES
5    YES  YES  YES  YES  YES  YES  YES  YES  YES
6    YES  YES  YES  YES  YES  YES  YES  YES  YES
7    NO  YES  YES  YES  YES  YES  YES  YES  YES
8    YES  YES  YES  YES  YES  YES  YES  YES  YES
9    YES  YES  YES  YES  YES  YES  YES  YES  YES
10   NO  NO  NO  NO  NO  NO  NO  NO  NO
11   NO  NO  NO  NO  NO  NO  NO  NO  NO
12   NO  NO  NO  NO  NO  NO  NO  NO  NO
13   NO  NO  NO  NO  NO  NO  NO  NO  NO
14   NO  NO  NO  NO  NO  NO  NO  NO  NO
15   NO  NO  NO  NO  NO  NO  NO  NO  NO
16   NO  NO  NO  NO  NO  NO  NO  NO  NO
17   NO  NO  NO  NO  NO  NO  NO  NO  NO
18   NO  NO  NO  NO  NO  NO  NO  NO  NO
19   NO  NO  NO  NO  NO  NO  NO  NO  NO
20   NO  NO  NO  NO  NO  NO  NO  NO  NO
21   NO  NO  NO  NO  NO  NO  NO  NO  NO
22   NO  NO  NO  NO  NO  NO  NO  NO  NO
23   NO  NO  NO  NO  NO  NO  NO  NO  NO
24   NO  NO  NO  NO  NO  NO  NO  NO  NO
    
```

TRM	APP											
	SERV	SS	CARD	CLK	DBG	GTT	GWS	MEAS	MON	MPS	SEAS	SLAN
1	YES	YES	YES	YES	YES	YES	YES	YES	YES	YES	NO	NO
2	YES	YES	YES	YES	YES	YES	YES	YES	YES	YES	NO	NO
3	YES	YES	YES	YES	YES	YES	YES	YES	YES	YES	NO	NO
4	YES	YES	YES	YES	YES	NO	YES	YES	YES	YES	NO	NO
5	YES	YES	YES	YES	YES	YES	YES	YES	YES	YES	NO	NO
6	YES	YES	YES	YES	YES	YES	YES	YES	YES	YES	NO	NO
7	NO	YES	YES	YES	YES	YES	YES	YES	YES	YES	NO	NO
8	YES	YES	YES	YES	YES	YES	YES	YES	YES	YES	YES	YES
9	YES	YES	YES	YES	YES	YES	YES	YES	YES	YES	YES	YES
10	NO	NO	NO	NO	NO	NO	NO	NO	NO	NO	NO	NO
11	NO	NO	NO	NO	NO	NO	NO	NO	NO	NO	NO	NO
12	NO	NO	NO	NO	NO	NO	NO	NO	NO	NO	NO	NO
13	NO	NO	NO	NO	NO	NO	NO	NO	NO	NO	NO	NO
14	NO	NO	NO	NO	NO	NO	NO	NO	NO	NO	NO	NO
15	NO	NO	NO	NO	NO	NO	NO	NO	NO	NO	NO	NO
16	NO	NO	NO	NO	NO	NO	NO	NO	NO	NO	NO	NO
17	NO	NO	NO	NO	NO	NO	NO	NO	NO	NO	NO	NO
18	NO	NO	NO	NO	NO	NO	NO	NO	NO	NO	NO	NO
19	NO	NO	NO	NO	NO	NO	NO	NO	NO	NO	NO	NO
20	NO	NO	NO	NO	NO	NO	NO	NO	NO	NO	NO	NO
21	NO	NO	NO	NO	NO	NO	NO	NO	NO	NO	NO	NO
22	NO	NO	NO	NO	NO	NO	NO	NO	NO	NO	NO	NO
23	NO	NO	NO	NO	NO	NO	NO	NO	NO	NO	NO	NO
24	NO	NO	NO	NO	NO	NO	NO	NO	NO	NO	NO	NO

;

The following example shows the display of the terminal settings with the IP User Interface feature enabled, one IPSM card equipped, and the OA&M IP Security Enhancements feature turned on:

rtrv-trm

```
rlghncxa03w 03-11-01 16:02:08 EST EAGLE 31.3.0
```

TRM	TYPE	COMM	FC	TMOUT	MXINV	DURAL
1	VT320	9600	-7-E-1 SW	0	5	00:01:00
2	VT320	9600	-7-E-1 SW	0	5	00:01:00
3	VT320	9600	-7-E-1 SW	0	5	00:01:00
4	KSR	9600	-7-E-1 SW	0	5	00:01:00
5	NONE	9600	-7-E-1 SW	30	5	00:01:00
6	NONE	9600	-7-E-1 SW	30	5	00:01:00
7	NONE	9600	-7-E-1 SW	30	5	00:01:00
8	NONE	9600	-7-E-1 SW	30	5	00:01:00
9	VT320	9600	-7-E-1 SW	0	5	00:01:00
10	VT320	9600	-7-E-1 SW	0	5	00:01:00
11	VT320	9600	-7-E-1 SW	0	5	00:01:00
12	KSR	9600	-7-E-1 SW	0	5	00:01:00
13	NONE	9600	-7-E-1 SW	30	5	00:01:00
14	NONE	9600	-7-E-1 SW	30	5	00:01:00
15	NONE	9600	-7-E-1 SW	30	5	00:01:00
16	NONE	9600	-7-E-1 SW	30	5	00:01:00

TRM	TYPE	LOC	TMOUT	MXINV	DURAL	SECURE
17	TELNET	1201	60	5	00:30:00	yes
18	TELNET	1201	60	5	00:30:00	yes
19	TELNET	1201	60	5	00:30:00	yes
20	TELNET	1201	60	5	00:30:00	yes
21	TELNET	1201	60	5	00:30:00	yes
22	TELNET	1201	60	5	00:30:00	yes
23	TELNET	1201	60	5	00:30:00	yes
24	TELNET	1201	60	5	00:30:00	yes

TRM	LNP LNP								
	TRAF	LINK	SA	SYS	PU	DB	DB	SUB	UIMRD
1	YES	YES	YES	YES	YES	YES	YES	YES	YES
2	YES	YES	YES	YES	YES	YES	YES	YES	YES
3	YES	YES	YES	YES	YES	YES	YES	YES	YES
4	YES	YES	YES	YES	NO	YES	YES	YES	YES
5	YES	YES	YES	YES	YES	YES	YES	YES	YES
6	YES	YES	YES	YES	YES	YES	YES	YES	YES
7	NO	YES	YES	YES	YES	YES	YES	YES	YES
8	YES	YES	YES	YES	YES	YES	YES	YES	YES
9	YES	YES	YES	YES	YES	YES	YES	YES	YES
10	NO	NO	NO	NO	NO	NO	NO	NO	NO
11	NO	NO	NO	NO	NO	NO	NO	NO	NO
12	NO	NO	NO	NO	NO	NO	NO	NO	NO
13	NO	NO	NO	NO	NO	NO	NO	NO	NO
14	NO	NO	NO	NO	NO	NO	NO	NO	NO
15	NO	NO	NO	NO	NO	NO	NO	NO	NO
16	NO	NO	NO	NO	NO	NO	NO	NO	NO
17	NO	NO	NO	NO	NO	NO	NO	NO	NO
18	NO	NO	NO	NO	NO	NO	NO	NO	NO
19	NO	NO	NO	NO	NO	NO	NO	NO	NO
20	NO	NO	NO	NO	NO	NO	NO	NO	NO
21	NO	NO	NO	NO	NO	NO	NO	NO	NO
22	NO	NO	NO	NO	NO	NO	NO	NO	NO
23	NO	NO	NO	NO	NO	NO	NO	NO	NO
24	NO	NO	NO	NO	NO	NO	NO	NO	NO

TRM	APP APP											
	SERV	SS	CARD	CLK	DBG	GTT	GWS	MEAS	MON	MPS	SEAS	SLAN
1	YES	YES	YES	YES	YES	YES	YES	YES	YES	YES	NO	NO
2	YES	YES	YES	YES	YES	YES	YES	YES	YES	YES	NO	NO
3	YES	YES	YES	YES	YES	YES	YES	YES	YES	YES	NO	NO
4	YES	YES	YES	YES	YES	NO	YES	YES	YES	YES	NO	NO
5	YES	YES	YES	YES	YES	YES	YES	YES	YES	YES	NO	NO
6	YES	YES	YES	YES	YES	YES	YES	YES	YES	YES	NO	NO
7	NO	YES	YES	YES	YES	YES	YES	YES	YES	YES	NO	NO
8	YES	YES	YES	YES	YES	YES	YES	YES	YES	YES	YES	YES
9	YES	YES	YES	YES	YES	YES	YES	YES	YES	YES	YES	YES
10	NO	NO	NO	NO	NO	NO	NO	NO	NO	NO	NO	NO
11	NO	NO	NO	NO	NO	NO	NO	NO	NO	NO	NO	NO
12	NO	NO	NO	NO	NO	NO	NO	NO	NO	NO	NO	NO
13	NO	NO	NO	NO	NO	NO	NO	NO	NO	NO	NO	NO
14	NO	NO	NO	NO	NO	NO	NO	NO	NO	NO	NO	NO
15	NO	NO	NO	NO	NO	NO	NO	NO	NO	NO	NO	NO
16	NO	NO	NO	NO	NO	NO	NO	NO	NO	NO	NO	NO
17	NO	NO	NO	NO	NO	NO	NO	NO	NO	NO	NO	NO
18	NO	NO	NO	NO	NO	NO	NO	NO	NO	NO	NO	NO
19	NO	NO	NO	NO	NO	NO	NO	NO	NO	NO	NO	NO
20	NO	NO	NO	NO	NO	NO	NO	NO	NO	NO	NO	NO

```

21 NO NO NO NO NO NO NO NO NO NO NO NO
22 NO NO NO NO NO NO NO NO NO NO NO NO
23 NO NO NO NO NO NO NO NO NO NO NO NO
24 NO NO NO NO NO NO NO NO NO NO NO NO

```

;

The following example shows the display of the terminal settings with an EMSALM type terminal on a serial terminal port. All output group settings default to YES when a terminal is set to type EMSALM.

rtrv-trm:trm=11

```

rlghncxa03w 04-03-01 16:02:08 EST EAGLE 31.5.0
TRM  TYPE      COMM          FC      TMOUT MXINV DURAL
11   EMSALM  9600 -7-E-1 SW      0       5      00:01:00

                                LNP LNP
TRM  TRAF LINK SA  SYS PU  DB  DB  SUB  UIMRD
11   YES  YES  YES  YES YES YES YES  YES YES  YES

                                APP APP
TRM  SRV SS  CARD CLK DBG GTT GWS MEAS MON MPS SEAS SLAN
11   YES YES YES  YES YES YES YES YES  YES YES YES  YES

```

;

Legend

Part one of the **rtrv-trm** report contains these fields:

TRM—The TDM terminal port number associated with the output device.

TYPE—The type of output device that is connected.

COMM—This field is composed of four communication attributes in the format *baud-dbts-prty-sb*. The parts are:

BAUD—The serial port baud rate of the output device

DBTS—The number of data bits used by the output device

PRTY—The parity of the output device

SB—The number of stop bits used in communications with the output device

FC—The type of protocol used between the system and the output devices.

TMOUT—Shows the maximum amount of time (in minutes) that a login session can remain idle.

MXINV—Shows the login/unlock failure threshold.

DURAL—Shows the length of time (in seconds, minutes, and hours) the terminal is disabled after each failed login/unlock attempt in excess of the threshold configured with the **mxinv** parameter.

SECURE—Indicates whether the OA&M IP Security Enhancements feature is turned on or off for Telnet terminals.

Part two of the **rtrv-trm** report contains these fields:

TRM—The TDM terminal associated with the output device.

TRAF—Shows whether traffic-related unsolicited messages are received by the output device.

LINK—Shows whether link-related unsolicited messages are received by the output device.

SA—Shows whether security administration-related unsolicited messages are received by the output device.

SYS—Shows whether system maintenance-related unsolicited messages are received by the output device.

PU—Shows whether program update-related unsolicited messages are received by the output device.

DB—Shows whether database-related unsolicited messages are received by the output device.

UIMRD—Shows whether Unsolicited Information Messages (UIMs) specific to the group are received by the output device.

If the LNP feature is turned on, the following fields are displayed:

LNPDB—Shows whether LNP database-related unsolicited messages are received by the output device.

LNPSUB—Shows whether LNP subscription-related unsolicited messages are received by the output device.

Part three of the **rtrv-trm** report contains these fields:

APP SERV—Shows whether Application Server unsolicited messages are received by the output device.

APP SS—Shows whether Application Subsystem unsolicited messages are received by the output device.

CARD—Shows whether Card unsolicited messages are received by the output device.

CLK—Shows whether Clock unsolicited messages are received by the output device.

DBG—Shows whether Debug unsolicited messages are received by the output device.

GTT—Shows whether GTT unsolicited messages are received by the output device.

GWS—Shows whether GWS unsolicited messages are received by the output device.

MEAS—Shows whether Measurements Maintenance unsolicited messages are received by the output device.

MON—Shows whether Monitor unsolicited messages are received by the output device.

MPS—Shows whether MPS unsolicited messages are received by the output device.

SEAS—Shows whether SEAS Maintenance unsolicited messages are received by the output device.

SLAN—Shows whether STP LAN unsolicited messages are received by the output device.

rtrv-tt

Retrieve Translation Type

Use this command to show the translation types that are currently defined in the system database for global title translations.

NOTE: If the EGTT (Enhanced Global Title Translation) feature is turned on in your system, the system will no longer accept GTT (Global Title Translation) and TT (Translation Type) commands. Refer to the new command sets that replace the GTT and TT commands: GTT Selector commands (ent/chg/dlt/rtrv-gttset), GTT Set commands (ent/dlt/rtrv-gttset), and GTA commands (ent/chg/dlt/rtrv-gta).

Keyword: rtrv-tt

Related Commands: dlt-tt, ent-tt

Command Class: Database Administration

Parameters

:alias= (optional)

The alias of the global title translation type

Range: 0-255

Default: Display all

:ttn= (optional)

Translation type name.

Range: 1 alphabetic character followed by up to 7 alphanumeric characters

Default: Display all

:type/typea/typei/typen/typen24= (optional)

Translation type identifies the translation type and network type. This parameter is the decimal representation of the 1-byte field used in SS7.

The **type** and **typea** parameters specify an ANSI network.

The **typei** parameter specifies an ITU-international network.

The **typen** parameter specifies an ITU-national network.

The **typen24** parameter specifies a 24-bit ITU-national network.

A translation type numeric value may be entered as ANSI type (**type** or **typea**) and also as an ITU type (**typei** or **typen**). However, they are separate entities.

Range: 0-255

Default: No translation type is specified

Example

```
rtrv-tt
```

```
rtrv-tt:type=230
```

```
rtrv-tt:ttn=lidb
```

rtrv-tt:type=230:ttn=lidb

rtrv-tt:type=230:ttn=lidb:alias=012

Dependencies

This command is not valid when the EGTT feature is turned on.

Asterisk (*) parameter values are not allowed for this command.

The translation type must exist in the translation table. If either or both parameters are given, they must be the same as the values entered with the **ent-tt** command. If the translation name is specified, it must be associated with a translation type.

If a translation type is specified, it must already exist in the database for the network type and cannot be an alias.

If both translation type and translation type name are specified, the translation type name must correspond to the specified translation type.

If an alias is specified with a translation type and/or translation type name, the alias must exist in the database for the specified network type, and it cannot be a translation type.

If an alias is specified without a translation type or translation type name, the alias must exist in the database for at least one of the network types. If it exists, the entries and the mapped translation type entries that exist in the database for all network types are displayed.

Notes

If a translation type, translation type name, or both, are specified, the translation type entry and all aliases mapped to that translation type are displayed.

Output

rtrv-tt

```
tekelecstp 03-05-02 09:03:09 EST EAGLE 31.0.0
TYPEA      TTN      NDGT
130        lidb     5
180        ansi180 9

ALIAS      TYPEA
1          130
7          130
10         180

TYPEI      TTN      NDGT
105        intlabc  15
119        intl119 18

ALIAS      TYPEI
29         119
33         105

TYPEN      TTN      NDGT
204        natlxyz  8
210        nat1210 21

ALIAS      TYPEN
7          204
```

```

TYPEN24  TTN          NDGT

;
rtrv-tt:type=130:tt=LIDB
tekelecstp 03-11-02 09:06:38 EST  EAGLE 30.0.0
TYPEA      TTN          NDGT
130        lidb        5

ALIAS      TYPEA
1          130
7          130

;
rtrv-tt:tt=intlabc
tekelecstp 03-11-02 09:19:34 EST  EAGLE 30.0.0
TYPEI      TTN          NDGT
105        intlabc    15

ALIAS      TYPEI
33         105

;
rtrv-tt:alias=7
tekelecstp 03-11-02 09:19:34 EST  EAGLE 30.0.0
ALIAS      TYPEA
7          130

ALIAS      TYPEN
7          204

;
rtrv-tt
tekelecstp 03-05-02 09:19:34 EST  EAGLE 31.0.0
TYPEA      TTN          NDGT

TYPEI      TTN          NDGT

TYPEN      TTN          NDGT

TYPEN24    TTN          NDGT
2          -----    6
4          first       6

;

```

Legend

- TYPEA/TYPEI/TYPEN/TYPEN24**—The global title translation type.
- TTN**—The name of the global title translation type.
- NDGT**—The number of digits in the global title translation type
- ALIAS**—The alias global title translation type.

rtrv-ttmap

Display Translation Type Mapping

Use this command to display a mapped SS7 message translation type (TT) for a given gateway linkset name. This command can be used to display the identification of the type of allowed global title translation in the SS7 message before and after translation type mapping, see which linkset the mapping applies to, and see whether the mapping applies to incoming or outgoing messages.

Keyword: rtrv-ttmap

Related Commands: chg-ttmap, dlt-ttmap, ent-ttmap

Command Class: Database Administration

Parameters

:ett= (optional)

Translation type before mapping. The identification of the type of allowed global title translation in the SS7 message *prior to* translation type mapping. This attribute is the decimal representation of the 1-octet binary field used by the SS7 protocol to identify the translation type.

Range: 0–255

Default: Display all types allowed

:io= optional)

Incoming or outgoing. The system uses this parameter to indicate whether the translation type mapping data provisioned for the gateway linkset is for SS7 messages *received* or *sent* on the linkset.

Range: i, o

i—incoming

o—outgoing

Default: Both incoming and outgoing

:lsn= (optional)

Linkset name

Range: 1 alphabetic character followed by up to 9 alphanumeric characters

Default: Display all

Example

```
rtrv-ttmap
```

```
rtrv-ttmap:lsn=nc001
```

```
rtrv-ttmap:lsn=nc001:io=i:ett=128
```

```
rtrv-ttmap:io=i:ett=128
```

```
rtrv-ttmap:ett=128
```

```
rtrv-ttmap:ett=40
```

Dependencies

The linkset must be defined.

The memory space accounting report (MSAR) is not produced when the **io** parameter, **ett** parameter, or both are specified, because the statistics presented may be misleading.

Notes

The order of display is by linkset index + I/O + ETT.

Output**rtrv-ttmap**

```
rlghncxa03w 03-11-22 11:39:44 EST EAGLE 30.0.0
LSN      IO  ETT  MTT
nc001    I   047  032
nc001    I   128  055
nc001    I   238  128
nc001    I   254  016
nc001    O   016  254
nc001    O   128  238
```

TTMAP table for nc001 is (6 of 64) 9% full

```
nc002    I   128  055
nc002    I   238  128
nc002    O   128  238
```

TTMAP table for nc002 is (3 of 64) 5% full

```
lsi1     I   001  142
lsi1     O   142  001
```

TTMAP table for lsi1 is (2 of 64) 3% full

```
lsi2     I   238  128
```

TTMAP table for lsi2 is (1 of 64) 2% full

```
lsi3     I   254  016
```

TTMAP table for lsi3 is (1 of 64) 2% full

```
lsn1     O   016  254
lsn1     O   128  238
```

TTMAP table for lsn1 is (2 of 64) 3% full

```
lsn2     I   128  055
lsn2     I   238  128
lsn2     O   128  238
```

TTMAP table for lsn2 is (3 of 64) 5% full

;

rtrv-ttmap:lsn=nc001

```
rlghncxa03w 03-11-22 12:02:36 EST EAGLE 30.0.0
LSN      IO  ETT  MTT
nc001    I   047  032
nc001    I   128  055
nc001    I   238  128
nc001    I   254  016
nc001    O   016  254
nc001    O   128  238
```

TTMAP table for nc001 is (6 of 64) 9% full

;

rtrv-ttmap:lsn=nc001:io=i:ett=128

```
rlghncxa03w 03-11-22 12:04:21 EST EAGLE 30.0.0
LSN      IO  ETT  MTT
nc001    I   128  055
```

;

rtrv-ttmap:io=i:ett=128

```
rlghncxa03w 03-11-22 12:06:13 EST EAGLE 30.0.0
LSN          IO   ETT  MTT
nc001       I    128  055
nc002       I    128  055
lsn2        I    128  055
;
```

rtrv-ttmap:ett=128

```
rlghncxa03w 03-11-22 12:41:21 EST EAGLE 30.0.0
LSN          IO   ETT  MTT
nc001       I    128  055
nc001       O    128  238
nc002       I    128  055
nc002       O    128  238
lsn1        O    128  238
lsn2        I    128  055
lsn2        O    128  238
;
```

rtrv-ttmap:ett=40

```
rlghncxa03w 03-11-07 16:12:38 EST EAGLE 30.0.0
LSN          IO   ETT  MTT
No mapped translation types defined for ETT specified.
;
```

Legend

LSN—Linkset name

IO—Incoming or outgoing linkset

ETT—Translation type before mapping

MTT—Mapped translation type

rtrv-uaps**Retrieve UA Parameter Set**

Use this command to retrieve one UA parameter set or all UA parameter sets.

Keyword: rtrv-uaps

Related Commands: chg-uaps

Command Class: Database Administration

Parameters

:set= (optional)

UA parameter set to be displayed.

Range: 1-10

Default: Display all

Example

```
rtrv-uaps
```

```
rtrv-uaps:set=1
```

Dependencies

None

Notes

This command can be canceled using the F9 function key or the **canc-cmd** command. See **canc-cmd** for more information.

Output

rtrv-uaps:set=1

```
rlghncxa03w 05-05-05 08:50:12 EST EAGLE5 34.0.0
SET  TIMER      TVALUE  PARM      PVALUE
1     1          0        1          255
1     2          3000     2          0
1     3          0        3          0
1     4          0        4          0
1     5          0        5          0
1     6          0        6          0
1     7          0        7          0
1     8          0        8          0
1     9          0        9          0
1    10          0       10          0
```

TIMER 2: False IP Connection Congestion Timer (ms), max time an association can be congested before failing due to false congestion. SS7IPGW and IPGWI applications enforce 0-30000(ms).

TVALUE : Valid range = 32-bits

PARAM 1: ASP SNM options. Each bit is used as an enabled/disabled flag for a particular ASP SNM option.

PVALUE : Valid range = 32-bits

BIT	BIT VALUE
0=Broadcast	0=Disabled , 1=Enabled
1=Response Method	0=Disabled , 1=Enabled
2-5=Reserved	
6=Broadcast Congestion Status Change	0=Disabled , 1=Enabled
7-31=Reserved	

PARAM 2: ASP/AS Notification options. Each bit is used an enabled/disabled flag for a particular ASP/AS Notification option.

PVALUE : Valid range = 32-bits

BIT	BIT VALUE
0=ASP Active Notifications	0=Disabled , 1=Enabled
1=ASP Inactive Notifications	0=Disabled , 1=Enabled
2=ASP AS State Query	0=Disabled , 1=Enabled
3-31=Reserved	

;

rtrv-uaps

Rlghncxa03w 05-05-05 08:50:12 EST EAGLE 34.0.0

SET	TIMER	TVALUE	PARM	PVALUE
1	1	0	1	3
1	2	3000	2	0
1	3	0	3	0
1	4	0	4	0
1	5	0	5	0
1	6	0	6	0
1	7	0	7	0
1	8	0	8	0
1	9	0	9	0
1	10	0	10	0
SET	TIMER	TVALUE	PARM	PVALUE
2	1	0	1	3
2	2	3000	2	0
2	3	0	3	0
2	4	0	4	0
2	5	0	5	0
2	6	0	6	0
2	7	0	7	0
2	8	0	8	0
2	9	0	9	0
2	10	0	10	0
SET	TIMER	TVALUE	PARM	PVALUE
3	1	0	1	3
3	2	3000	2	0
3	3	0	3	0
3	4	0	4	0
3	5	0	5	0
3	6	0	6	0
3	7	0	7	0
3	8	0	8	0
3	9	0	9	0
3	10	0	10	0
SET	TIMER	TVALUE	PARM	PVALUE
4	1	0	1	3
4	2	3000	2	0
4	3	0	3	0
4	4	0	4	0
4	5	0	5	0
4	6	0	6	0
4	7	0	7	0
4	8	0	8	0
4	9	0	9	0
4	10	0	10	0

SET	TIMER	TVALUE	PARM	PVALUE
5	1	0	1	3
5	2	3000	2	0
5	3	0	3	0
5	4	0	4	0
5	5	0	5	0
5	6	0	6	0
5	7	0	7	0
5	8	0	8	0
5	9	0	9	0
5	10	0	10	0
SET	TIMER	TVALUE	PARM	PVALUE
6	1	0	1	3
6	2	3000	2	0
6	3	0	3	1
6	4	0	4	0
6	5	0	5	0
6	6	0	6	0
6	7	0	7	0
6	8	0	8	0
6	9	0	9	0
6	10	0	10	0
SET	TIMER	TVALUE	PARM	PVALUE
7	1	0	1	3
7	2	3000	2	0
7	3	0	3	0
7	4	0	4	0
7	5	0	5	0
7	6	0	6	0
7	7	0	7	0
7	8	0	8	0
7	9	0	9	0
7	10	0	10	0
SET	TIMER	TVALUE	PARM	PVALUE
8	1	0	1	3
8	2	3000	2	0
8	3	0	3	0
8	4	0	4	0
8	5	0	5	0
8	6	0	6	0
8	7	0	7	0
8	8	0	8	0
8	9	0	9	0
8	10	0	10	0
SET	TIMER	TVALUE	PARM	PVALUE
9	1	0	1	2
9	2	3000	2	0
9	3	0	3	0
9	4	0	4	0
9	5	0	5	0
9	6	0	6	0
9	7	0	7	0
9	8	0	8	0
9	9	0	9	0
9	10	0	10	0

SET	TIMER	TVALUE	PARM	PVALUE
10	1	0	1	3
10	2	3000	2	0
10	3	0	3	0
10	4	0	4	0
10	5	0	5	0
10	6	0	6	0
10	7	0	7	0
10	8	0	8	0
10	9	0	9	0
10	10	0	10	0

TIMER 2: False IP Connection Congestion Timer (ms), max time an association can be congested before failing due to false congestion. SS7IPGW and IPGWI applications enforce 0-30000(ms).

TVALUE : Valid range = 32-bits

PARM 1: ASP SNM options. Each bit is used as an enabled/disabled flag for a particular ASP SNM option.

PVALUE : Valid range = 32-bits

BIT	BIT VALUE
0=Broadcast	0=Disabled , 1=Enabled
1=Response Method	0=Disabled , 1=Enabled
2-5=Reserved	
6=Broadcast Congestion Status Change	0=Disabled , 1=Enabled
7-31=Reserved	

PARM 2: ASP/AS Notification options. Each bit is used an enabled/disabled flag for a particular ASP/AS Notification option.

PVALUE : Valid range = 32-bits

BIT	BIT VALUE
0=ASP Active Notifications	0=Disabled , 1=Enabled
1=ASP Inactive Notifications	0=Disabled , 1=Enabled
2=ASP AS State Query	0=Disabled , 1=Enabled
3-31=Reserved	

rtrv-uim-acthresh

Retrieve Activity Level Threshold for STP UIM Activity Reporting

Use this command to query the UIM number, limit, and interval period parameters that are used to report the thresholding of UIM messages.

Keyword: rtrv-uim-acthresh

Related Commands: set-uim-acthresh, dlt-uim-acthresh

Command Class: Database Administration

Parameters

:uimn= (optional)

The UIM number.

Range: 1000-1499

Default: Display all

Example

Display UIM number 1333 threshold:

```
rtrv-uim-acthresh:uimn=1333
```

Display the threshold for all UIMs that have been set:

```
rtrv-uim-acthresh
```

Dependencies

If specified, the **uimn** parameter value must be four numeric characters in the range **1000–1499**.

The **uimn** parameter value, if specified, must exist in the system Trouble Text Table.

Notes

None

Output

```
rtrv-uim-acthresh"uimn=1333
```

```
rlghncxa03w 03-11-01 08:50:12 EST EAGLE 31.3.0
UIMN      LIMIT      INTRVL
1333      100         5
The UIM Threshold Table is (1 of 499) 1% full.
```

```
rtrv-uim-acthresh
```

```
rlghncxa03w 03-11-01 08:50:12 EST EAGLE 31.3.0
UIMN      LIMIT      INTRVL
1333      100         5
1444      200         15
1155      50          30
The UIM Threshold Table is (3 of 499) 1% full.
```

rtrv-user**Retrieve User**

Use this command to show the information about the user currently logged on to the terminal from which this command was entered.

Keyword: **rtrv-user**

Related Commands: **act-user, chg-pid, chg-user, dact-user, dlt-user, ent-user, login, logout, rept-stat-user, rtrv-secu-user**

Command Class: Basic

Parameters

This command has no parameters.

Example

```
rtrv-user
```

Dependencies

This command cannot be entered from a SEAS terminal, because a SEAS terminal has no user ID associated with it.

Notes

The password is not shown.

This command shows the command class privileges for the user logged onto the system. No other users are shown.

All users have access to this command.

Output

The following example shows the display when the LNP feature is turned on and the Command Class Management feature is turned on:

rtrv-user

```
rlghncxca03w 03-11-07 09:50:17 EST EAGLE 31.3.0
user id          age page uout rev link sa  sys pu  db  dbg
manny           36  60   60  NO  YES  YES  YES  YES  YES  YES  YES

      u01 u02 u03 u04 u05 u06 u07 u08 u09 u10 u11 u12 u13 u14 u15 u16
      NO  NO  NO  NO  YES YES YES YES YES YES YES YES YES YES YES YES

      u17 u18 u19 u20 u21 u22 u23 u24 u25 u26 u27 u28 u29 u30 u31 u32
      YES YES YES YES YES YES YES YES YES YES YES YES NO  NO  NO  NO  YES
```

;

The following example shows the display when the LNP feature is not turned on and the Command Class Management feature is not turned on:

rtrv-user

```
rlghncxca03w 03-11-07 09:50:17 EST EAGLE 31.3.0
USER ID          LINK SA SYS  PU  DB DBG
eagle            YES YES YES YES YES YES

      USER ID          AGE PAGE UOUT REV
      eagle            750 0   0   NO
```

;

Legend

USER ID—The name of the user.

AGE—Shows the current age, in days, of the password associated with this user ID. If the password age is greater than 999 days, the value 999 is displayed.

PAGE—Shows the maximum password age established for this user ID. When AGE becomes greater than PAGE, the system forces the user to change the password at the next login. An asterisk (*) displayed after the value indicates that the system-wide default page parameter value, as configured on the **chg-secu-dflt** command, is in effect for the user ID.

UOUT—Shows the user ID aging interval, in days. If the user ID is not used (that is, no successful login) for longer than this interval, the system does not allow a login. An asterisk (*) displayed after the value indicates that the system-wide default **uout** parameter value, as configured on the **chg-secu-dflt** command, is in effect for the user ID.

REV—Shows whether the user ID is denied login (revoked). **YES** indicates that the user ID is revoked, **NO** indicates that the user ID is not revoked.

LINK—Shows whether the user has access to all commands in the command class “Link Maintenance.”

SA—Shows whether the user has access to all commands in the command class “Security Administration.”

SYS—Shows whether the user has access to all commands in the command class “System Maintenance.”

PU—Shows whether the user has access to all commands in the command class “Program Update.”

DB—Shows whether the user has access to all commands in the command class “Database Administration.”

DBG—Shows whether the user has access to all commands in the command class “Debug.”

If the Command Class Management feature is enabled and turned on, the following fields are displayed:

U01 - U32—Default configurable command class names. If user-defined names have been provisioned, they will appear instead of the default names.

If the LNP feature is turned on, the following fields are displayed:

LNPBAS—Shows whether the user has access to all commands in the command class “LNP Basic.”

LNPDB—Shows whether the user has access to all commands in the command class “LNP Database.”

LNPSUB—Shows whether the user has access to all commands in the command class “LNP Subscription.”

rtrv-vendid

Retrieve Vendor ID

Use this command to retrieve a list of Vendor ID entries from the VENDID table, for the GSM MAP SRI Redirect to Serving HLR feature.

Keyword: rtrv-vendid

Related Commands: ent-venid, dlt-venid

Command Class: Database Administration

Parameters

:vendnum= (optional)
Vendor Number
Range: 1-3

Example

```
rtrv-vendid
rtrv-vendid:vendnum=1
```

Dependencies

The GSM MAP SRI Redirect feature must be enabled before this command can be entered.

Notes

None.

Output

When the command is entered with no parameter, the Vendor Types are listed in numerical order. The Vendor Numbers for each Vendor Type are listed in numerical order, followed by the Vendor ID for each Vendor Number.

rtrv-vendid

```
tekelecstp 04-09-21 16:11:21 EST EAGLE 31.11.0
Vendor  Vendor  Vendor
Type    Number  ID
-----
1       1       123123123456789
1       1       1234567890abcde
1       2       112233445566778
1       2       214365870912543
2       3       098765432112345
2       3       098767890143251

VENDID table is (5 of 200) 3% full
```

;

When a Vendor number is specified, the Vendor Type and Vendor IDs for the specified Vendor number are listed in numerical order. The table capacity line shows the total number of entries in use, not just the number of entries displayed.

rtrv-vendid:vendnum=2

```
tekelecstp 04-09-21 16:13:54 EST EAGLE 31.11.0
Vendor  Vendor  Vendor
Type    Number  ID
-----
1       2       112233445566778
1       2       214365870912543

VENDID table is (5 of 200) 3% full
```

;

rtrv-x25-dstn**Retrieve X.25 Destination**

Use this command to show the associations between X.25 network addresses and SS7 point codes. If the node is actually in the X.25 domain, the X.25 address is a real network address and the point code is a dummy point code. If the node is in the SS7 domain, the point code is a real SS7 point code and the X.25 address is a dummy address. X.25 destinations are shown in order of entry.

NOTE: This command does not support 24-bit ITU national point codes.

Keyword: rtrv-x25-dstn

Related Commands: chg-x25-dstn, dlt-x25-dstn, ent-x25-dstn

Command Class: Database Administration

Parameters

:dpc= or :dpca= (optional)

Specifies the value used to set the destination point code field in the routing label of the MSU. The point code is an ANSI point code in the format of *network indicator-network cluster-network cluster member (ni-nc-ncm)*.

Range: 000-255

Specify a valid value for each subfield of the point code, and separate the subfields with a dash (-).

When **chg-sid:pctype=ansi** is specified, *ni = 000* is not valid.

When **chg-sid:pctype=ansi** is specified, *nc = 000* is not valid if *ni = 001-005*.

When **chg-sid:pctype=ansi** is specified, *nc = 000* is valid if *ni = 006-255*.

The point code **000-000-000** is not a valid point code.

:xaddr= (optional)

The X.25 network address of the X.25 destination entity or the SS7 node

Range: A number consisting of 4–15 digits.

Default: Display all

Example

```
rtrv-x25-dstn
```

```
rtrv-x25-dstn:xaddr=220525586456772
```

```
rtrv-x25-dstn:dpc=133-13-1
```

Dependencies

If an X.25 address is specified, it must contain a minimum of four digits and must be in the X.25 destination table.

If a destination point code is specified, it must be assigned to at least one X.25 address.

The X.25 SS7 ANSI destination point code must be a full point code (ni-nc-ncm).

Notes

None

Output**rtrv-x25-dstn**

```
tekelecstp 02-06-19 21:16:37 EST EAGLE 31.3.0
X25 ADDR      SS7 DPC      SSN  DOMAIN
220525586456772 133-013-001 002 X25
2342342325    251-001-004 236 SS7
23423423      251-001-001 112 SS7
423423045656767 251-001-003 112 X25
9342          251-001-004 234 X25
```

X.25 DSTN TABLE IS (5 of 1024) 1 % FULL

;

rtrv-x25-dstn:xaddr=220525586456772

```
tekelecstp 02-06-19 21:17:37 EST EAGLE 31.3.0
X25 ADDR      SS7 DPC      SSN  DOMAIN
220525586456772 133-013-001 002 X25
```

X.25 DSTN TABLE IS (5 of 1024) 1 % FULL

;

Legend

X25 ADDR—The X.25 address of the X.25 destination or the SS7 node

SS7 DPC—The SS7 destination point code.

SSN—The subsystem number associated with the SS7 DPC.

rtrv-x25-rte**Retrieve X.25 Route**

Use this command to show the routing parameters needed by the gateway portion of the LIMs with the **ss7gx25** application for establishing a virtual circuit that is permanently maintained by the system.

Keyword: **rtrv-x25-rte**

Related Commands: **chg-x25-rte, dlt-x25-rte, ent-x25-rte**

Command Class: Database Administration

Parameters

lc= (optional)

The number of the logical channel on the X.25 signaling link that the PVC connection is assigned to. For automatic virtual circuits and remote virtual circuits, the logical channel number is arbitrary and cannot be specified.

Range: 1-255

Default: Display all

lc2nm= (optional)

Generates network management for failures and recoveries of logical channels. When the logical channel being used to carry data fails, the Database Transport Access (DTA) feature requires that traffic be diverted to alternate routes. The Logical Channel to Network Management Mapping (LC2NM) feature handles this process.

Range: yes, no

Default: Display all

:loc= (optional)

The card location containing the X.25 signaling link that will sustain the connection. For an automatic virtual circuit, this link is the link on which the system initially attempts the connection. However, if this attempt fails, the connection may be established by the X.25 destination entity on any other link in this link's linkset.

Range: 1101–1108, 1111–1112, 1201–1208, 1211–1218, 1301–1308, 1311–1318, 2101–2108, 2111–2118, 2201–2208, 2211–2218, 2301–2308, 2311–2318, 3101–3108, 3111–3118, 3201–3208, 3211–3218, 3301–3308, 3311–3318, 4101–4108, 4111–4118, 4201–4208, 4211–4218, 4301–4308, 4311–4318, 5101–5108, 5111–5118, 5201–5208, 5211–5218, 5301–5308, 5311–5318, 6101–6108, 6111–6118

Default: All card locations are shown.

:port= (optional)

The port on the card containing the X.25 signaling link.

Range: a

Default: a

:rt= (optional)

The type of routing to perform for messages originating in the SS7 domain and destined for the X.25 domain. Two types of routing are available: (1) route on X.25 destination point code (XPC), and (2) route using X.25 origination and destination point code combinations (PC).

Range: xpc, pc

Default: Display al

:saddr= (optional)

The alias X.25 address assigned to the SS7 destination entity on the SS7 side of the circuit.

Range: A number consisting of 4–15 digits

Default: All X.25 addresses assigned to the SS7 destination entity are shown.

:type= (optional)

The type of X.25 connection that the link is expected to maintain.

Range: pvc, svca, svcr

pvc—Permanent virtual circuit

svca—automatic virtual circuit

svcr—remote virtual circuit

Default: Display al

:xaddr= (optional)

The X.25 address assigned to the X.25 destination entity on the X.25 side of the circuit.

Range: A number consisting of 4–15 digits

Default: All X.25 addresses assigned to the SS7 destination entity are shown.

Example

```
rtrv-x25-rte
```

```
rtrv-x25-rte:xaddr=345454
```

```
rtrv-x25-rte:saddr=4545434
```

rtrv-x25-rte:xaddr=345454:saddr=4545434

rtrv-x25-rte:loc=1201:port=a:lc=2

rtrv-x25-rte:loc=1201:port=a

rtrv-x25-rte:type=avc

rtrv-x25-rte:rt=xpc

rtrv-x25-rte:lc2nm=no

Dependencies

Each X.25 address must have at least four digits.

If the **port** parameter is specified, the **loc** parameter must be specified.

If the **lc** parameter is specified, both the **loc** and **port** parameters must be specified.

The **limds0**, **limocu**, and **limv35** card types are the only valid card types for this command. These card types must be running the ss7gx25 GPL type.

The shelf and card must be equipped.

If **lc2nm=yes** is specified, **rt=pc** cannot be specified.

Notes

None

Output

rtrv-x25-rte

```
rlghncxa03w 03-11-19 21:16:37 EST EAGLE 31.3.0
X25 ADDR          SS7 ADDR          TYPE LOC  PORT  LC  RT   LC2NM
2510010011234567 342342341234567 pvc  1201  a    02  XPC  YES
251001002         234234231         pvc  1201  a    04  PC   NO
51200105          34223422845       svca 1202  a    --  PC   NO
2510103           232330            pvc  1201  a    06  XPC  YES
2510103           232330            svcr  ----  -    --  PC   NO
2516019002        24247235          svca 3205  a    --  PC   NO
345454             4545434           svca 1201  a    --  PC   NO
X.25 ROUTE TABLE IS 30 % FULL
;
```

rtrv-x25-rte:xaddr=345454

```
rlghncxa03w 03-11-19 21:16:37 EST EAGLE 31.3.0
X25 ADDR          SS7 ADDR          TYPE LOC  PORT  LC  RT   LC2NM
345454             4545434           svca 1201  a    --  PC   NO
X.25 ROUTE TABLE IS 30 % FULL
;
```

rtrv-x25-rte:saddr=4545434

```
rlghncxa03w 03-11-19 21:16:37 EST EAGLE 31.3.0
X25 ADDR          SS7 ADDR          TYPE LOC  PORT  LC  RT   LC2NM
345454             4545434           svca 1201  a    --  PC   NO
X.25 ROUTE TABLE IS 30 % FULL
;
```

rtrv-x25-rte:xaddr=345454:saddr=4545434

```
rlghncxa03w 03-11-19 21:17:04 EST EAGLE 31.3.0
X25 ADDR          SS7 ADDR          TYPE LOC   PORT   LC   RT   LC2NM
345454            4545434          svca 1201   a     --   PC   NO
X.25 ROUTE TABLE IS 30 % FULL
;
```

rtrv-x25-rte:loc=1201:port=a:lc=2

```
rlghncxa03w 03-11-19 21:17:04 EST EAGLE 31.3.0
X25 ADDR          SS7 ADDR          TYPE LOC   PORT   LC   RT   LC2NM
2510010011234567 342342341234567 pvc 1201   a     02   PC   NO
X.25 ROUTE TABLE IS 30 % FULL
;
```

rtrv-x25-rte:loc=1201:port=a

```
rlghncxa03w 03-11-19 21:17:04 EST EAGLE 31.3.0
X25 ADDR          SS7 ADDR          TYPE LOC   PORT   LC   RT   LC2NM
2510010011234567 342342341234567 pvc 1201   a     02   PC   NO
251001002         234234231        pvc 1201   a     04   XPC  YES
345454            4545434          svca 1201   a     --   PC   NO
X.25 ROUTE TABLE IS 30 % FULL
;
```

rtrv-x25-rte:type=svca

```
rlghncxa03w 03-11-19 21:16:37 EST EAGLE 31.3.0
X25 ADDR          SS7 ADDR          TYPE LOC   PORT   LC   RT   LC2NM
51200105          34223422845      svca 1202   a     --   PC   NO
2516019002        24247235         svca 3205   a     --   PC   NO
345454            4545434          svca 1201   a     --   PC   NO
X.25 ROUTE TABLE IS 30 % FULL
;
```

rtrv-x25-rte:type=svcr

```
rlghncxa03w 03-11-19 21:16:37 EST EAGLE 31.3.0
X25 ADDR          SS7 ADDR          TYPE LOC   PORT   LC   RT   LC2NM
2510103           232330           svcr ----   -     --   PC   NO
X.25 ROUTE TABLE IS 30 % FULL
;
```

Legend

X25 ADDR—The X.25 address assigned to the X.25 destination entity on the X.25 side of the circuit.

SS7 ADDR—The dummy X.25 address assigned to the SS7 destination entity on the SS7 side of the circuit.

TYPE—The X.25 connection type.

LOC—The card location of the X.25 signaling link.

PORT—The signaling link port on the card.

LC—The number of the logical channel on the X.25 signaling link that the PVC connection is assigned to.

RT—The type of routing to perform for messages originating in the SS7 domain and destined for the X.25 domain.

LC2NM—Whether the logical channel-to-network management function is enabled (YES) or disabled (NO).

rtrv-x25-slk**Retrieve X.25 Signaling Link Parameters**

Use this command to display the X.25 signaling link parameters.

Keyword: rtrv-x25-slk

Related Commands: chg-x25-slk

Command Class: Database Administration

Parameters

:loc= (optional)

The card location containing the X.25 signaling link.

Range: 1101–1108, 1111–1112, 1201–1208, 1211–1218, 1301–1308, 1311–1318, 2101–2108, 2111–2118, 2201–2208, 2211–2218, 2301–2308, 2311–2318, 3101–3108, 3111–3118, 3201–3208, 3211–3218, 3301–3308, 3311–3318, 4101–4108, 4111–4118, 4201–4208, 4211–4218, 4301–4308, 4311–4318, 5101–5108, 5111–5118, 5201–5208, 5211–5218, 5301–5308, 5311–5318, 6101–6108, 6111–6118

Default: All card locations are displayed.

:port= (optional)

The port on the card containing the X.25 signaling link.

Range: a

Example

```
rtrv-x25-slk
```

```
rtrv-x25-slk:loc=1204
```

```
rtrv-x25-slk:loc=1204:port=a
```

Dependencies

The **limds0**, **limocu**, and **limv35** card types are the only valid card types for this command. These card types must be running the **ss7gx25** GPL.

The shelf and card must be equipped.

The **port** parameter cannot be specified without the **loc** parameter.

Notes

None

Output

rtrv-x25-slk

```
rlghncxa03w 02-06-10 11:43:04 EST EAGLE 29.0
LOC  PORT  T1  N1    N2  K  L3MODE  PVC  SVC  WIN  MPS
1201  A     10  2104  15  7  DCE     25  205  1   256
1202  A     9   1080  13  6  DTE    255  0    2   256
1203  A     8   2104  11  5  DCE    10   10   3   128
1204  A     7   1080  9   4  DTE     0   255  4   128
1205  A     6   2104  7   3  DCE    100  0    5   256
1206  A     5   1080  5   2  DTE     0   100  6   256
1207  A     4   2104  3   1  DCE    100  100  7   128
1208  A     3   1080  5   2  DTE     1    1   6   128
```

```
x25-slk table is (8 of 256) 3% full
```

```
;
```

rtrv-x25-slk:loc=1204

```
rlghncxa03w 03-11-19 21:16:37 EST EAGLE 31.3.0
LOC  PORT  T1  N1    N2  K  L3MODE  PVC  SVC  WIN  MPS
1204  A     7   1080  9   4  DTE     0   255  4   128
```

```
;
```

rtrv-x25-slk:loc=1201:port=a

```
rlghncxa03w 03-11-19 21:16:37 EST EAGLE 31.3.0
LOC  PORT  T1  N1    N2  K  L3MODE  PVC  SVC  WIN  MPS
1201  A     10  2104  15  7  DCE     25  205  1   256
```

```
;
```

Legend

LOC—The card location containing the X.25 signaling link.

PORT—The port on the card containing the X.25 signaling link.

T1—The amount of time to wait before retransmitting a frame.

N1—The maximum number of bits in a frame.

N2—The maximum number of retransmission attempts to complete a transmission.

K—The maximum number of outstanding I frames.

L3MODE—The logical layer 3 address of the connection

PVC—The total number of permanent virtual circuits (PVCs) available on this X.25 signaling link.

SVC—The total number of switched virtual circuits (automatic virtual circuits and remote virtual circuits) available on this X.25 signaling link.

WIN—The number of packets allowed for a window on this X.25 signaling link.

MPS—The maximum packet size (in bytes) allowed on this X.25 signaling link.

set-date**Set Date**

Use this command to set the date in the system.

Keyword: set-date

Related Commands: set-time

Command Class: Security Administration

Parameters

:date= (mandatory)

The system date, to be reflected on all reports and output messages.

Range: 000101–991231

(in the form *yymmdd*, where *yy*=year, *mm*=month, *dd*=day)

Example

```
set-date:date=010307
```

Dependencies

None

Notes

None

Output

```
set-date:date=010307
```

```
rlghncxa03w 03-11-07 11:11:28 EST EAGLE 31.3.0  
Date set complete.
```

```
;
```

set-gtwy-acthresh**Set Gateway Thresholds**

Use this command to set or change the level of activity thresholds to be used when reporting gateway screening activity. The STP reports screening activity only if the threshold is set and only if the threshold is reached. The thresholds are set on a linkset basis.

Keyword: set-gtwy-acthresh

Related Commands: rtrv-gtwy-acthresh

Command Class: Database Administration

Parameters

:intrvl= (mandatory)

Monitor interval. The examination period, in minutes, during which the gateway screening activity thresholds are to be tested.

Range: 5, 10, 15, 20, 30

System Default: 0; (this value indicates that thresholds are not set)

:lsn= (mandatory)

Linkset name

Range: 1 alphabetic character followed by up to 9 alphanumeric characters

:rcv= (optional)

Received message threshold. The threshold for MSUs received on the gateway linkset.

Range: 0-999999

Default: The current value
System Default: 0

:rej= (optional)

Reject threshold. The threshold for MSUs rejected on the gateway linkset because of screening.

Range: 0-999999

Default: The current value
System Default: 0

Example

The following example shows how to set the linkset **wy644368** rejection threshold to 100, with a 15 minute interval.

```
set-gtwy-acthresh:lsn=wy644368:rej=100:intrvl=15
```

The following example shows how to set the linkset **wy644368** message threshold to 1000 and the rejection threshold to 300, with an interval of 20 minutes.

```
set-gtwy-acthresh:lsn=wy644368:intrv=20:rej=300:rcv=1000
```

The following example shows how to set the linkset **wy644368** so that no activity messages are produced.

```
set-gtwy-acthresh:lsn=wy644368:intrv=5:rej=0:rcv=0
```

Dependencies

One or more optional parameters must be specified.

The linkset specified must exist in the active database, and it must exist in the gateway linkset entity set of the requesting system.

Notes

None

Output

```
set-gtwy-acthresh:lsn=wy644368:rej=100:intrvl=15
```

```
rlghncxa03w 03-11-18 08:50:12 EST EAGLE 31.3.0
SET-GTWY-TRSHLD: MASP A - COMPLTD
```

```
;
```

set-scrrej-prmtrs Set Parameters for SS7 Message-Rejection Reporting

Use this command to change the STP values that limit the display of MSUs rejected because of gateway screening notification messages that could become excessive. The new values overwrite the existing values.

Keyword: set-scrrej-prmtrs

Related Commands: rtrv-gtwy-acthresh, rtrv-gtwy-prmtrs, set-gtwy-acthresh

Command Class: Database Administration

Parameters

:intrvl= (mandatory)

Monitor interval. The examination period, in minutes, during which the gateway screening activity thresholds are to be tested.

Range: 5, 10, 15, 20, 30

Default: System Default: 5

:limit= (mandatory)

Threshold not to be exceeded.

Range: 0-999999

Default: System Default: 9999

Example

```
set-scrrej-prmtrs:limit=200:intrvl=10
```

Dependencies

None

Notes

None

Output

```
set-scrrej-prmtrs:limit=200:intrvl=10
rlghncxa03w 03-11-18 08:50:12 EST EAGLE 31.3.0
SET-SCRREJ-PRMTRS: MASP A - COMPLTD
;
```

set-time

Set Time

Use this command to set the system clock. The clock is used to determine when measurements collection takes place as well as several other time-driven events.

Keyword: set-time

Related Commands: set-date

Command Class: Security Administration

Parameters

:time= (mandatory)

The system time that is to be reflected on all reports and output messages.

Range: 0000-2359

hhmm where *hh* = 00-23 (hour) and *mm* = 00-59 (minute)

:tz= (optional)

The time zone

Range: acdt, acst, adt, aedt, aest, akdt, akst, ast, awdt, awst, bra, bst, cct, cdt, cest, cet, cst, edt, eest, eet, est, fst, fwt, gmt, hdt, hst, idt, ist, mdt, mest, met, msd, msk, mst, ndt, nst, nzdt, nzst, pdt, pst, rok, sast, utc, west, wet

The time zones are described in Table 7-14 on page 7-703.

Default: Current value

Table 7-14. Time Zones Set by the **set-time** command

Abbreviation	Time Zone	Abbreviation	Time Zone
akdt	Alaska Daylight Time	gmt	Greenwich Mean Time
akst	Alaska Standard Time	hdt	Hawaiian Daylight Time
adt	Atlantic Daylight Time	hst	Hawaiian Standard Time
ast	Atlantic Standard Time	idt	India Daylight Time
acdt	Australian Central Daylight Time	ist	India Standard Time
acst	Australian Central Standard Time	mest	Middle European Summer Time
aedt	Australian Eastern Daylight Time	met	Middle European Time
aest	Australian Eastern Standard Time	msd	Moscow Summer Time
awdt	Australian Western Daylight Time	msk	Moscow Time
awt	Australian Western Standard Time	mdt	Mountain Daylight Time
bra	Brazil Standard Time	mst	Mountain Standard Time
bst	British Summer Time	nzdt	New Zealand Daylight Time
cdt	Central Daylight Time	nzst	New Zealand Standard Time
cest	Central European Summer Time	ndt	Newfoundland Daylight Time
cet	Central European Time	nst	Newfoundland Standard Time
cst	Central Standard Time	pdt	Pacific Daylight Time
cct	China Coast Time	pst	Pacific Standard Time
edt	Eastern Daylight Time	rok	Republic of Korea
eest	Eastern European Summer Time	sast	South African Standard Time
eet	Eastern European Time	utc	Universal Time Coordinated
est	Eastern Standard Time	west	Western European Summer Time
fst	French Summer Time	wet	Western European Time
fwt	French Winter Time		

Example

set-time:time = 1432:tz = est

Dependencies

None

Notes

None

Output

```

set-time:time=1432:tz=est
    rlgncxa03w 02-11-07 14:32:28 EST EAGLE 30.0.0
    Time set complete.
;

```

set-uim-acthresh **Set Activity Level Thresholds for STP UIM Activity Reporting**

Use this command to set or change the level-of-activity threshold for reporting UIM messages. The system suppresses the generation of UIM messages when message generation exceeds the threshold that was defined for the interval period. The values are set within five seconds after the command was entered. Any previous count is cleared and the new or changed threshold and limit is enforced. Refer to “Configuring the UIM Threshold” in the *Database Administration—System Management Manual* for more information about UIM threshold configuration.

Keyword: set-uim-acthresh**Related Commands:** rtrv-uim-acthresh, dlt-uim-acthresh**Command Class:** Database Administration**Parameters****:uimn=** (mandatory)

The UIM number.

Range: 1000–1499**:force=** (optional)Required to set the **limit** parameter to **0** for a given interval.

CAUTION: Setting the **limit** to **0** turns off all occurrences of the specified UIM. Use this manner of creating thresholds only if you are certain you have specified the correct UIM.

Range: yes, no**Default:** no force specified**:intrvl=** (mandatory)

The monitor interval in minutes.

Range: 5, 10, 15, 20, 25, 30**Default:** Current value**:limit=** (optional)

The message threshold.



CAUTION: Setting the limit to 0 will turn off all occurrences of the specified UIM. This can be dangerous if the wrong UIM number is specified by mistake. It is highly recommended that thresholds for UIMs are not set in this manner, but the ability is provided for certain extreme cases. The force parameter must be specified to set the limit to 0, and an additional scroll area message is issued.

Range: 0–9999

Default: Current value

Example

Sets UIM number 1333 threshold to 100 in a 5-minute interval:

```
set-uim-acthresh:uimn=1333:limit=100:intrvl=5
```

Sets UIM number 1444 threshold to 200 in a 15-minute interval:

```
set-uim-acthresh:uimn=1444:limit=200:intrvl=15
```

Dependencies

At least one optional parameter must be specified.

The **uimn** parameter value must be a numeric value in the range **1000–1499**.

The **limit** parameter value must be a numeric value in the range **0–9999**.

The **intrvl** parameter value must be one or two numeric characters with the following values: **5, 10, 15, 20, 25, 30**.

Force=yes is required to set the **limit** parameter to **0** for a given interval. Setting the **limit** to **0** turns off all occurrences of the specified UIM. See the cautions under the **force** and **limit** parameters.

When creating a new UIM threshold, both the **limit** and **intrvl** parameters must be specified.

The specified **uimn** parameter value must exist in the system Trouble Text Table.

Notes

None

Output

```
set-uim-acthresh:uimn=1333:limit=100:intrvl=5
```

```
rlghncxa03w 03-11-01 08:50:12 EST EAGLE 31.3.0
SET-UIM-ACTHRESH: MASP A - COMPLTD
```

```
;
```

tst-bip

Test Board Identification PROM

Use this command to test each byte of the specified board identification PROM (BIP) by reading and writing to the PROM. The test is performed for both the main assembly and applique BIPs.

Keyword: **tst-bip**

Related Commands: **chg-bip-fld, chg-bip-rec, rtrv-bip**

Command Class: System Maintenance

Parameters

:loc= (mandatory)

The card location as stenciled on the shelf of the system.

Range: (HMUX and HIPR locations are not valid): **1101–1108, 1111–1113, 1115, 1201–1208, 1211–1218, 1301–1308, 1311–1318, 2101–2108, 2111–2118, 2201–2208, 2211–2218, 2301–2308, 2311–2318, 3101–3108, 3111–3118, 3201–3208, 3211–3218, 3301–3308, 3311–3318, 4101–4108, 4111–4118, 4201–4208, 4211–4218, 4301–4308, 4311–4318, 5101–5108, 5111–5118, 5201–5208, 5211–5218, 5301–5308, 5311–5318, 6101–6108, 6111–6118**

Example

```
tst-bip:loc=1211
```

Dependencies

The card location, frame, shelf, or slot must be within the allowed range.

The card location must be valid for the command.

The board type **type=dbd** parameter is not valid for card type GPSM-II, HCAP, ATM or DCM. HMUX and HIPR cards do not contain BIP information.

The card specified by the **loc** parameter must be equipped in the database.

The card specified by the **loc** parameter must be in the OOS-MT-DSBLD state prior to BIP testing.

Notes

The specified card must be inhibited.

The **tst-bip** command verifies that the PROM is good by writing and reading to the PROM. The **rtrv-bip** command show the level of the BIP, as well as the board part number, the revision number, and the serial number. If the **rtrv-bip** command fails, this indicates that communications to the card has failed, and the card should be replaced.

Output**tst-bip:loc=1211**

```
rlghncxa03w 03-11-07 16:19:08 EST EAGLE 31.3.0
Test Board Identification PROM Location: 1211 - MBD Packet: 1
```

```
-----
BIP Passed
```

```
rlghncxa03w 03-11-07 16:19:08 EST EAGLE 31.3.0
Test Board Identification PROM Location: 1211 - DBD Packet: 1
```

```
-----
BIP Passed
```

```
;
```

tst-disk**Test Disk**

Use this command prior to an upgrade, or as a diagnostic tool, to test the integrity of an EAGLE disk, fixed (TDM) or removable (MDAL), at the specified location. The test is non-intrusive and non-destructive to the disk. A read-only test is executed for all logical blocks (LBAs) of the specified target disk and a report that identifies any bad or questionable LBAs is output.

Keyword: **tst-disk**

Related Commands: **copy-disk**

Command Class: System Maintenance

Parameters

:loc= (mandatory)

The location of the disk to be tested.

Range: **1114, 1116, 1117**

:partition= (optional)

Portion of disk to be tested. This parameter specifies the individual physical disk partition (1, 2, 3, or 4), all defined partitions for a given disk size up to a maximum of 4 partitions, or the entire physical disk to be tested.

Range: **1, 2, 3, 4, all, disk**

1, 2, 3, 4—Tests the specified existing partition on the disk.

Only the number or numbers for the partition or partitions that exist on the disk are valid. (For example, if the disk size allows only 2 partitions, **partition=3** and **partition=4** are invalid for that disk).

all—Tests all existing partitions on the fixed disk or on one side of the removable disk

disk—Tests the ENTIRE physical disk

NOTE: The **partition=disk** value is for Tekelec engineering debug use only.

Default: **all**

Example

```
tst-disk:loc=1116
```

Dependencies

The card in the specified location (**loc**) must be a TDM or MDAL card.

The disk to be tested must be in service.

If a TDM location is specified, the TDM cannot be reserved (as when a copy-disk command is running).

The target drive must have low level format.

The **tst-disk** command can be run simultaneously on both TDMs, if entered from different terminals.

The removable disk can be tested simultaneously with the standby TDM but not with the active TDM.

To test the removable disk when **loc=1117** is specified, the disk must be inserted in the removable cartridge drive on the MDAL card.

The **partition=3** and **partition=4** values are invalid for a 4GB fixed drive. The only valid value for the 2.3 GB and 4.1 GB removable disks is **partition=1**

An error message will be generated for a disk that has been Formatted (**format-disk** command) but does not yet contain a DOS directory structure (created with the **copy-disk** command) when **partition= 1, 2, 3, 4, or all** is specified. (The **partition=disk** parameter can be specified in this case; it will test the ENTIRE disk).

Notes

A physical fixed (TDM) or removable (MDAL) disk is formatted and given a DOS directory structure to define the number of physical partitions that the disk size can accommodate. (The logical partitions that contain database, backup, GPL, and measurements files are placed in these physical partitions, with no correlation between the physical numbers and the logical contents).

For a fixed TDM disk, the **partition** parameter specifies the individual partition (1, 2, 3, or 4), all existing partitions, or the entire physical disk to be tested.

- One partition = 2 GB.
- The 4 GB drive contains two 2 GB partitions.
- The 9 GB drive and the 18 GB drive each contain four 2 GB partitions.
- The 9 GB drive contains four 2 GB partitions.
- Any disk space beyond the four 2 GB partitions is unused disk space (and always has been due to EAGLE DISK FAT structure used).

For a removable MDAL disk, each side of the disk will contain the maximum number of partitions (up to 4) that the disk size can accommodate. Only one side of the disk is tested with one **tst-disk** command. For example, a 2.3 GB removable disk has one partition on each side that is slightly larger than 1 GB. A 4.1 GB removable disk has one 2 GB partition on each side. Only **tst-disk:partition=1** is valid for either of these disks.

The **partition=all** value implies that testing starts with the first partition, then second, and so on, until the last existing disk partition is detected without skipping any non-existing or defined partitions.

Table 7-15 outlines execution time estimates based on disk capacity.

Table 7-15. Test Disk Execution Times

Capacity	Nominal Execution Time	Maximum Execution Time for 100% Errors
4.0 GB	40 minutes	27.5 hours
9.0 GB	1 hour 45 minutes	(Not determined)
18 GB	30 minutes (partition=1) 5 hours (partition=disk) depending on amount of disk tested and EAGLE provisioning/activity	(Not determined)
2.3 GB Magneto Optical Removable	18 minutes	7.4 hours
4.1 GB Magneto Optical Removable	25 minutes (requires 806 MDAL)	7.4 hours
507 MB	5 minutes	3.4 hours
2.0 GB	20 minutes	13.5 hours
4.0 GB	40 minutes	27.5 hours
Magneto Optical Removable	20 minutes	7.4 hours
SyQuest Removable	10 minutes	2 hours

Nominal times for **tst-disk** command execution depend on the capacity of the disk being tested and assume that few or no errors are found. Maximum execution times are based on disk capacity, retry count, and retry delay. Each read error and retry may cause a delay of up to three seconds. If a TDM has 100% error sectors, the MASP will likely reset, terminating the disk test. A termination and reset will not occur, however, when testing the removable cartridge.

Because of the intense, sustained disk activity created when **tst-disk** is executed, concurrently performing other disk-based activities, such as prolonged LNP command entry or database backups, will result in performance degradation up to twice the usual execution time.

Because of the extended processing time required for large disks, a progress message is displayed every five minutes providing the current LBA and the total LBA count for the partition.

Specific errors are reported for the first 10 error occurrences. Thereafter, only the error count is tracked and summary results are reported upon completion.

Output**tst-disk:loc=1116**

```
rlghncxa03w 03-11-27 11:40:02 EST EAGLE 31.3.0
TST-DISK of all partitions initiated for TDM 1116
```

;

```
rlghncxa03w 03-11-27 11:40:02 EST EAGLE 31.3.0
TST-DISK: TDM 1116 in progress 868680 of 4124735 LBA read
```

;

```
rlghncxa03w 03-11-27 11:40:02 EST EAGLE 31.3.0
TST-DISK Error: TDM 1116 LBA range 4124706 - 4124960
Check Condition: DISK_NOT_READY
TST-DISK results for TDM 1116
Total LBAs = 4124735    LBA size = 512
Retries    = 1    Errors    = 1
Command Completed
```

;

tst-disk:loc=1116:partition=2

```
rlghncxa03w 03-11-27 11:40:02 EST EAGLE 31.3.0
TST-DISK on Partition 2 initiated for TDM 1116
```

;

```
rlghncxa03w 03-11-27 11:40:02 EST EAGLE 31.3.0
TST-DISK: TDM 1116 in progress 1234567 of 4194304 LBA read
```

;

```
rlghncxa03w 03-11-27 11:40:02 EST EAGLE 31.3.0
TST-DISK Error: TDM 1116 LBA range 4194304 - 4194558
                (NOTE: w/i 2nd disk partition)
Check Condition: DISK_NOT_READY
TST-DISK results for TDM 1116
Total LBAs = 4194304    LBA size = 512
Retries    = 1    Errors    = 1
Command Completed
```

;

tst-dlk**Test Data Link**

Use this command to test the specified TCP/IP data link. The TCP/IP data link is tested with an ethernet test that is an echo test type called ping.

Keyword: **tst-dlk**

Related Commands: **act-dlk, canc-dlk, dlt-dlk, ent-dlk, rept-stat-dlk, rtrv-dlk**

Command Class: Link Maintenance

Parameters

:loc= (mandatory)

The card location as stenciled on the shelf of the system.

Range: 1101–1108, 1111–1112, 1201–1208, 1211–1218, 1301–1308, 1311–1318, 2101–2108, 2111–2118, 2201–2208, 2211–2218, 2301–2308, 2311–2318, 3101–3108, 3111–3118, 3201–3208, 3211–3218, 3301–3308, 3311–3318, 4101–4108, 4111–4118, 4201–4208, 4211–4218, 4301–4308, 4311–4318, 5101–5108, 5111–5118, 5201–5208, 5211–5218, 5301–5308, 5311–5318, 6101–6108, 6111–6118

:type= (mandatory)

The type of test to run.

Range: ping

:ipaddr= (optional)

The IP address of the remote host. This is a TCP/IP address expressed in standard dot notation. IP addresses consist of the system's network number and the machine's unique host number. An example IP address is **192.126.100.5**, where **192.126.100** is the network number and **5** is the machine's host number.

Range: 1-223, 0-255

4 numbers separated by dots

1-223—first number

0-255—the other three numbers

Default: Host IP

:rc= (optional)

The number of times the test is repeated.

Range: 1-15

Default: 1

Example

tst-dlk: loc=1206:type=ping

Dependencies

No other action command can be in progress when this command is entered.

The card location must contain an ACM.

The shelf and card must be equipped.

The specified card must have a TCP/IP data link assigned to it.

If a test repeat count (**rc**) is not entered, the test is not repeated.

If a data link test is in progress, another data link test cannot be started.

Notes

None

Output

tst-dlk:loc=1206:type=ping

```
rlghncxa03w 03-11-27 17:00:36 EST    EAGLE 31.3.0
Command Accepted: Test Link message is sent.

rlghncxa03w 03-11-27 17:00:36 EST    EAGLE 31.3.0
Command Completed.

rlghncxa03w 03-11-27 17:00:36 EST    EAGLE 31.3.0
1310.1132   CARD 1206   INFO  STPLAN DLK ping test completed
           TESTS REQUESTED= 1   PASSED COUNT= 1   FAILED COUNT= 0
           AVR RND TRIP=   10   MAX RND TRIP=10   MIN RND TRIP=10
           HOST IPADDR=198.089.040.069
;
```

tst-e1

Test E1 Port

Use this command to test HC-MIM E1 ports. The **loopback** parameter provides the ability to select local transceiver (**lxvr**) and line loopback tests.

The **tst-e1** command is rejected if a loopback test is not compatible with the port type.

Keyword: **tst-e1**

Related Commands: **chg-e1, dlt-e1, ent-e1, rtrv-e1**

Command Class: System Maintenance

Parameters

:e1port= (mandatory)

E1 port number. The value must be an E1 port that has already been configured with an E1 interface on the specified HC-MIM E1 card.

Range: **1-8**

Ports 3 through 8 can be specified only for HC-MIM cards.

:loc= (mandatory)

Card location. The HC-MIM card location as stenciled on the shelf of the system.

Range: **1101-1108, 1111-1112, 1201-1208, 1211-1218, 1301-1308, 1311-1318, 2101-2108, 2111-2118, 2201-2208, 2211-2218, 2301-2308, 2311-2318, 3101-3108, 3111-3118, 3201-3208, 3211-3218, 3301-3308, 3311-3318, 4101-4108, 4111-4118, 4201-4208, 4211-4218, 4301-4308, 4311-4318, 5101-5108, 5111-5118, 5201-5208, 5211-5218, 5301-5308, 5311-5318, 6101-6108, 6111-6118**

:action= (optional)

Indicator of command action to stop or start a test.

Range: **start, stop**

Default: **start**

:loopback= (optional)

Select loopback test type.

Range: **line, lxvr**

Default: **lxvr**

Example

```
tst-e1:e1port=1:loc=1203:loopback=lxvr
```

```
tst-e1:e1port=1:loc=1203:action=stop
```

Dependencies

This command cannot be entered during upgrade.

A valid card location for an HC-MIM E1 card must be specified.

The card in the specified card location (**loc** parameter) must be an HC-MIM card with card type **lime1**.

The card in the specified card location (**loc** parameter) must be equipped.

The card in the specified card location (**loc** parameter) must be in service.

The specified E1 port on the card must have a defined E1 interface.

All signaling links that provide timeslots serviced by E1 interfaces on the specified card must be deactivated before this command can be entered. None of the signaling links can be running link diagnostic tests (**tst-slk** and **act-cdl**) when this command is entered.

Only one port test can be running on an E1 port at one time.

When the **action=stop** parameter is specified, the **loopback** parameter cannot be specified.

The **action=stop** parameter can be specified only when a port test is running.

Notes

This command can be used only for HC-MIM card ports.

Only one port test can be performed at a time on an E1 port. When a port test is in progress on an E1 port, subsequent test requests are rejected.

Output

```
tst-e1:e1port=1:loc=1203:loopback=lxvr
```

```
rlghncxa03w 05-01-07 16:19:08 EST EAGLE5 33.0.0
Command Accepted: Test Port message is sent.
```

```
;
```

```
rlghncxa03w 05-01-07 16:19:08 EST EAGLE5 33.0.0
Command Completed.
```

```
;
```

```
tst-e1:e1port=1:loc=1203:action=stop
```

```
rlghncxa03w 05-01-07 16:19:08 EST EAGLE5 33.0.0
Command Accepted: Stop Port test message is sent.
```

```
;
```

```
rlghncxa03w 05-01-07 16:19:08 EST EAGLE5 33.0.0
Command Completed.
```

```
;
```

tst-imt**Test IMT Bus**

The interprocessor message transport bus (IMT bus) is the main communications artery between all subsystems in the system. Use this command to determine the location of faults on a failed or abnormal IMT bus. The alternate bus state must be IS-NR. The target bus state must be OOS-MT-DSBLD.

NOTE: At least one card must be populated in each EAGLE shelf to allow **tst-imt** the opportunity to successfully execute. The card does not need to be a provisioned card; the card must be in IS-NR state on both IMT busses before the **tst-imt** command is entered. If an empty shelf does exist in the EAGLE, the following text is displayed when you try to run **tst-imt**:

Notice: IMT Fault test terminated.

Non-Standard cabling or IMT Bus-X state change detected.

Keyword: **tst-imt**

Related Commands: **clr-imt-stats, init-imt-gpl, rept-imt-lvl1, rept-imt-lvl2**

Command Class: System Maintenance

Parameters

:bus= (mandatory)

The IMT bus to test.

Range: a, b

Example

```
tst-imt:bus=a
```

```
tst-imt:bus=b
```

Dependencies

A related IMT command must not be in progress. Only one fault isolation test can be active at a time.

This command cannot be entered if the alternate bus is other than in service - normal (IS-NR).

This command cannot be entered if the target bus is other than out of service - maintenance disabled (OOS-MT-DSBLD).

This command cannot be entered during the IMT statistics collection period following an hourly boundary (IMT performance monitoring).

Notes

Probable causes are listed in order of most probable to least probable. The listed components should be replaced in order listed by the output of the **tst-imt** command.

Multiple, masking points of failure can occur in the same bus segment. Such faults are reported as a single bus segment fault. Because running this command on a system with no IMT bus faults prints an indication that no faults were found, you can iteratively replace components and run this test until all components in the segment are ruled out.

A detection of an IMT address mismatch indicates a faulty backplane or card.

A detection of an inconsistency with a particular card's IMT card list indicates an error of unknown origin, probably due to one or more lost messages.

When the **tst-imt** command completes, either through normal termination of the command or because the command was ended for another reason, you must administratively enable the target bus. If all faults have meanwhile been isolated and corrected, the target bus becomes operational.

When a fault is detected, the possible error sources are listed in order from the most likely to the least likely. This ordering is based on operational experience.

Output

Connectivity test fails

tst-imt:bus=a

```
rlghncxa03w 03-11-27 12:47:07 EST EAGLE 31.3.0
IMT Fault Isolation Bus A
Fault Location    Probable Cause  Failure(s)
Bus 1218-1301    HIPR 1209
                  HIPR 1309
                  Card 1218
                  Card 1301
                  Cable connecting Shelves 1200 and 1300 on Bus A
                  Backplane 1200
                  Backplane 1300
                                     Connectivity Test Failed
Bus 1304-1305    HIPR 1309
                  Card 1304
                  Card 1305
                  Backplane 1300
                                     Connectivity Test Failed
;
```

Pass-through test fails.

tst-imt:bus=a

```
rlghncxa03w 03-11-27 12:47:07 EST EAGLE 31.3.0
IMT Fault Isolation Bus B
Fault Location    Probable Cause  Failure(s)
Card 1201         Card 1201
                                     Pass-through Test Failed
Card 1301         Card 1301
                                     Pass-through Test Failed
;
```

All tests pass.

tst-imt:bus=b

```
rlghncxa03w 03-11-27 12:47:07 EST EAGLE 31.3.0
IMT Fault Isolation Bus B
Fault Location    Probable Cause  Failure(s)
No Faults Found
                                     All Tests Passed.
;
```

tst-slk**Test Signaling Link**

Use this command for testing signaling links. The **loopback** parameter on the **tst-slk** command provides the ability to select from among the following loopback tests: local transceiver (**lxvr**), **oam**, **line**, **payload**, and either low-speed signaling links or ATM high-speed signaling links (**sltc**).

The **tst-slk** command is rejected if the loopback test is not compatible with the link type.

- The **tst-slk** command is not valid on TCP/IP point-to-multipoint links (DCM cards equipped as SS7IPGW and IPGWI links).
- For low-speed links, the **lxvr** and **sltc** tests are allowed.
- On LIM-ATMs, the **lxvr**, **sltc**, **payload**, **line**, and **oam** tests are allowed.
- On TCP/IP point-to-point links (DCM cards equipped as IPLIM or IPLIMI links), **sltc** is the only supported test. The **sltc** test is allowed only for links configured with **ipliml2=saaltali** or **ipliml2-m2pa**.
- On E1/T1 MIM cards, the **sltc** test is the only supported test.
- On E1 ATM card (**atmitu** application), the **lxvr**, **oam**, and **sltc** tests are allowed.

See Appendix A for information about loopback testing commands and functions.

Keyword: **tst-slk**

Related Commands: **act-lpo**, **act-slk**, **blk-slk**, **canc-lpo**, **canc-slk**, **dact-slk**, **inh-slk**, **rept-stat-tstslk**, **rtrv-slk**, **ublk-slk**, **unhb-slk**

Command Class: Link Maintenance

Parameters

:loc= (mandatory)

The card location as stenciled on the shelf of the system.

Range: **1101-1108, 1111-1112, 1201-1208, 1211-1218, 1301-1308, 1311-1318, 2101-2108, 2111-2118, 2201-2208, 2211-2218, 2301-2308, 2311-2318, 3101-3108, 3111-3118, 3201-3208, 3211-3218, 3301-3308, 3311-3318, 4101-4108, 4111-4118, 4201-4208, 4211-4218, 4301-4308, 4311-4318, 5101-5108, 5111-5118, 5201-5208, 5211-5218, 5301-5308, 5311-5318, 6101-6108, 6111-6118**

:port= or **:link=** (mandatory)

The signaling link on the card specified in the **loc** parameter. The links can be specified in any sequence or pattern.

Range: **a, b, a1-a31, b1-b31**

Not all card types support all **link** parameter values.

See Table A-1 in Appendix A for valid **link** parameter range values for each type of card that can have a location specified in the **loc** parameter.

:action= (optional)

Indicator of command action to stop or start a test.

Range: **start, stop**

Default: **start**

:force= (optional)

The **force=yes** parameter must be specified to start a test when there are 256 or more tests already running.

Range: **yes, no**

Default: **no**

:loopback= (optional)

Specifies the type of loopback test to run.

Range: **line, lxvr, oam, payload, sltc**

line—This test is similar to the payload loopback test, but the data transmitted to the remote system is received by the remote system's ATM driver. This test is prohibited for the E1 ATM card.

lxvr—Loopback at the local transceiver without involving the remote STP. For the ADS0, AINF, AOCU, and AV35 appliques, the MTP-2 protocol stack and ISCC hardware are tested. For AATM applique and DS1 interface, the AATM hardware, ATM level 2 protocol stack, and AAL5CP portion of ATM driver are tested,

oam—Messages are passed between local and remote systems to guarantee that the ATMM portion of ATM driver is functioning.

payload—This test is similar to the local transceiver loopback test. The wire is also tested because the loopback is at the remote's DS1 interface instead of the local's DS1 interface. This test is prohibited for the E1 ATM card.

sltc—This test can be run on either the low-speed signaling links or the ATM high-speed signaling links. This is the only test that is supported for links on the E1/T1 MIM card, and for **saaltali** and **m2pa** links on IPLIMx cards.

Default: **sltc**

:time= (optional)

The time duration for testing the link.

Range: **1-240000**

hhmmss—*hh*=hours (00-24), *mm*=minutes (00-59), *ss*=seconds (00-59)

For example, **time=1** or **time=000001** is one second; **time=240000** is 24 hours; **time=200** or **time=000200** is 2 minutes.

Default: **1**

Example

```
tst-slk:loc=1203:link=a
```

```
tst-slk:loc=1203:link=a:loopback=lxvr
```

```
tst-slk:loc=1205:link=b:time=000200:force=yes:action=start
```

```
tst-slk:loc=1205:link=b:action=stop
```

```
tst-slk:loc=1205:link=b:time=200
```

Dependencies

A card location that is valid and defined in the database must be specified.

The card must be equipped and in service, and must be one of the following cards:

- A LIM card running the **ss7ansi**, **ss7gx25**, **atmansi**, or **ccs7itu** application
- An E1 ATM card running the **atmitu** application
- A dual-slot DCM or EDCM card running the **iplim** or **iplimi** application with links having **ipliml2=saaltali**
- An SSEDCM card running the **iplim** or **iplimi** application with links having **ipliml2=m2pa** or **ipliml2=saaltali**
- An E1/T1 MIM card or an HC-MIM card running the **ss7ansi** or **ccs7itu** application

The **link** parameter values **a1**, **b1**, **a2**, **b2**, **a3**, and **b3** can be specified only for the following cards:

- A multi-port LIM
- An SSEDCM running the **iplim** or **iplimi** application that supports 8 points
- An E1/T1 MIM or an HC-MIM.

If the signaling link is an ATM HSL signaling link, only the **link=a** parameter can be specified.

This command is not supported for cards running the **ss7ipgw** and **ipgwi** applications.

This command cannot be entered for an IPLIMx signaling link that has an **ipliml2** parameter setting of **m3ua**.

For IPLIMx signaling links having an **ipliml2** parameter setting of **saaltali** or **m2pa**, only the **loopback=sltc** test is allowed.

The **payload** and **line** values are not valid for the **loopback** parameter when the card is an E1 ATM.

Only the **sltc** test can be run on card types **lime1**, **limt1**, and **limch**.

The card must contain the specified signaling link.

The specified signaling link must be provisioned in the database.

The specified signaling link must be an SS7 signaling link.

The signaling link that is used for LFS (Link Fault Sectionalization) testing cannot be active.

The previously entered command for a link test must be accepted before another link test command can be entered.

This command cannot be entered if the LFS test is running on the specified link.

The specified link cannot in Command Driven Loopback (CDL) when this command is entered. The link must be removed from CDL before this command can be entered for the link. (See the "**act-cdl**" and "**dact-cdl**" commands).

The **force=yes** parameter must be specified to start a test when 256 or more tests are already running in the system.

This command cannot be entered if the maximum number of LFS or link tests are already running in the system. At least one active test must complete before the command can be entered again.

Only one link test can be running on a signaling link at one time.

The **action=stop** parameter cannot be specified when there is no active link test running on the specified link.

When the **action=stop** parameter is specified, the **loopback**, **time**, and **force** parameters cannot be specified.

Notes

The **lxvr** and **sltc** loopback tests can be run on low-speed signaling links. All the loopback tests can be run on the ATM high-speed signaling links.

This command cannot be used with X.25 signaling links.

Output

If the card is inhibited, not in service, the following message appears when you try to test the links on the card:

tst-slk:loc=1203:link=a

```
rlghncxa03w 03-11-07 16:19:08 EST EAGLE 31.3.0
Command Rejected : Card is not in service.
```

;

tst-slk:loc=1205:link=b:time=000200:force=yes:action=start

```
tekelecstp 03-11-27 16:15:20 EST EAGLE 31.3.0
tst-slk:loc=1205:link=b:time=000200:force=yes:action=start
Command Accepted: Test Link message is sent.
```

;

```
tekelecstp 03-11-27 16:15:22 EST EAGLE 31.3.0
Command Completed.
```

;

```
tekelecstp 03-11-27 16:22:25 EST EAGLE 31.3.0
LOC = 1205 Link = B LSN = ls12345678 Start time = 16:22:25
LOOPBACK = SLTC TIME = 00:02:00
TEST STATUS = Loopback success
```

;

tst-slk:loc=1205:link=b:action=stop

```
tekelecstp 03-11-27 16:15:20 EST EAGLE 31.3.0
tst-slk:l oc=1205:link=b:action=stop
Command Accepted: Stop Test Link message is sent.
```

;

```
tekelecstp 03-11-27 16:15:22 EST EAGLE 31.3.0
Command Completed.
```

;

```
tekelecstp 03-11-27 16:22:25 EST EAGLE 31.3.0
LOC = 1205 = B LSN = ls12345678 Start time = 16:22:25
LOOPBACK = LXVR TIME = 00:01:00
TEST STATUS = Loopback cleared
```

;

tst-slk:loc=1205:link=b:time=200

```
tekelecstp 03-11-27 16:15:20 EST EAGLE 31.3.0
tst-slk:loc=1205:link=b:time=200
Command Accepted: Stop Test Link message is sent.
```

;

```
tekelecstp 03-11-27 16:15:22 EST EAGLE 31.3.0
Command Completed.
```

;

```
tekelecstp 03-11-27 16:22:25 EST EAGLE 31.3.0
LOC = 1205 Link = B LSN = ls12345678 Start time = 16:22:25
LOOPBACK = SLTC TIME = 00:00:53
TEST STATUS = Loopback failed
```

;

Legend

LOC—Card location that contains the signaling being tested.

LINK—Signaling link being tested on the card.

LSN—Name of the linkset that contains the link being tested.

START TIME—Time that the test started.

LOOPBACK—Type of loopback test being run.

TIME—Length of time that the test ran. This value can exceed the value that was specified in the **time** parameter if the test requires more than the specified time to complete.

TEST STATUS—

- When a **tst-slk** command with **action=start** (specified or default) is entered, any one of the following *TEST STATUS* values can appear:
 - Loopback success
 - Loopback failed
 - Loopback aborted
 - Loopback in-progress

- Loopback prevented
- Loopback invalid
- When a **tst-slk** command with **action=stop** is entered, any one of the following *TEST STATUS* values can appear:
 - Loopback cleared
 - Loopback could not be cleared

tst-t1**Test T1 Port**

Use this command to test HC-MIM T1 Ports. The **loopback** parameter provides the ability to select local transceiver (**lxvr**) and line loopback tests.

The **tst-t1** command is rejected if a loopback test is not compatible with the port type.

Keyword: **tst-t1**

Related Commands: **chg-t1, dlt-t1, ent-t1, rtrv-t1**

Command Class: System Maintenance

Parameters

:t1port= (mandatory)

T1 port number. The value must be an T1 port that has already been configured with a T1 interface on the specified HC-MIM T1 card.

Range: **1-8**

Ports 3 through 8 can be specified only for HC-MIM cards.

:loc= (mandatory)

Card location. The HC-MIM card location as stenciled on the shelf of the system.

Range: **1101-1108, 1111-1112, 1201-1208, 1211-1218, 1301-1308, 1311-1318, 2101-2108, 2111-2118, 2201-2208, 2211-2218, 2301-2308, 2311-2318, 3101-3108, 3111-3118, 3201-3208, 3211-3218, 3301-3308, 3311-3318, 4101-4108, 4111-4118, 4201-4208, 4211-4218, 4301-4308, 4311-4318, 5101-5108, 5111-5118, 5201-5208, 5211-5218, 5301-5308, 5311-5318, 6101-6108, 6111-6118**

:action= (optional)

Indicator of command action to stop or start a test.

Range: **start, stop**

Default: **start**

:loopback= (optional)

Select loopback test type.

Range: **line, lxvr**

Default: **lxvr**

Example

```
tst-t1:t1port=1:loc=1203:loopback=lxvr
```

```
tst-t1:t1port=1:loc=1203:action=stop
```

Dependencies

This command cannot be entered during upgrade.

A valid card location for an HC-MIM T1 card must be specified.

The card in the specified card location (**loc** parameter) must be an HC-MIM card with card type **lime1**.

The card in the specified card location (**loc** parameter) must be equipped.

The card in the specified card location (**loc** parameter) must be in service.

The specified T1 port on the card must have a defined T1 interface.

All signaling links that provide timeslots serviced by T1 interfaces on the specified card must be deactivated before this command can be entered. None of the signaling links can be running link diagnostic tests (**tst-slk** and **act-cdl** commands) when this command is entered.

Only one port test can be running on a T1 port at one time.

When the **action=stop** parameter is specified, the **loopback** parameter cannot be specified.

The **action=stop** parameter can be specified only when a port test is running.

Notes

This command can be used only for HC-MIM card ports.

Only one port test can be performed at a time on a T1 port. When a port test is in progress on a T1 port, subsequent test requests are rejected.

Output

tst-t1:t1port=1:loc=1203:loopback=lxvr

```
rlghncxa03w 05-01-07 16:19:08 EST EAGLE5 33.0.0
Command Accepted: Test Port message is sent.
```

```
;
```

```
rlghncxa03w 05-01-07 16:19:08 EST EAGLE5 33.0.0
Command Completed.
```

```
;
```

tst-t1:t1port=1:loc=1203:action=stop

```
rlghncxa03w 05-01-07 16:19:08 EST EAGLE5 33.0.0
Command Accepted: Stop Port test message is sent.
```

```
;
```

```
tekelecstp 03-12-16 14:31:23 EST EAGLE5 33.0.0
Command Completed.
```

```
;
```

ublk-slk

Unblock Signaling Link

Use this command to cancel a local processor outage (LPO) and restore the link to its previous state. Link status signal units (LSSU) with status of processor outage are stopped, and the link begins sending MSUs again.

NOTE: The signaling link's blocked status is not preserved across a LIM reboot.

Keyword: ublk-slk

Related Commands: act-lpo, blk-slk, canc-lpo

Command Class: Link Maintenance

Parameters

:loc= (mandatory)

The card location as stenciled on the shelf of the system.

Range: 1101–1108, 1111–1112, 1201–1208, 1211–1218, 1301–1308, 1311–1318, 2101–2108, 2111–2118, 2201–2208, 2211–2218, 2301–2308, 2311–2318, 3101–3108, 3111–3118, 3201–3208, 3211–3218, 3301–3308, 3311–3318, 4101–4108, 4111–4118, 4201–4208, 4211–4218, 4301–4308, 4311–4318, 5101–5108, 5111–5118, 5201–5208, 5211–5218, 5301–5308, 5311–5318, 6101–6108, 6111–6118

:port= or :link= (mandatory)

The signaling link on the card specified in the **loc** parameter. The signaling links can be specified in any sequence or pattern.

Range: a, b, a1-a31, b1-b31

Not all card types support all **link** parameter values.

See Table A-1 in Appendix A for valid **link** parameter range values for each type of card that can have a location specified in the **loc** parameter.

Example

ublk-slk:loc=2311:link=b

Dependencies

A card location that is valid and defined in the database must be specified.

No other action command can be in progress when this command is entered.

The card must be equipped and must be one of the following cards:

- A LIM card running the **ss7ansi**, **ss7gx25**, **atmansi**, or **ccs7itu** application
- An E1 ATM card running the **atmitu** application
- An SSEDCCM card running the **iplim** or **iplimi** application with links having **ipliml2=m2pa**
- An E1/T1 MIM card or an HC-MIM card running the **ss7ansi** or **ccs7itu** application

This command can be entered only for IPLIMx signaling links that have an **ipliml2** parameter setting of **m2pa**.

The **ublk-slk** command is not valid for DCM cards with **ss7ipgw** or **ipgwi** TCP/IP links.

The card must contain signaling links.

The signaling link must be equipped in the database.

The **link** parameter values **a1**, **b1**, **a2**, **b2**, **a3**, and **b3** can be specified only for the following cards:

- A multi-port LIM
- An E1/T1 MIM or an HC-MIM.

Notes

Unblocking a signaling link removes a Level 2 failure resulting from a **blk-slk** of an ATM high-speed signaling link.

The function of this command is the same as the **canc-lpo** command.

The *Installation Manual - EAGLE 5 SAS* provides an illustration of card locations.

Output

ublk-slk:loc=2311:link=b

```
rlghncxa03w 03-03-07 11:11:28 EST EAGLE 31.3.0
Local processor outage being cleared.
;
```

ublk-slk:loc=1113:link=a

```
rlghncxa03w 03-03-07 11:11:28 EST EAGLE 31.3.0
Command Rejected : Location is not valid for command.
;
```

unhb-alm

Restore Alarm Reporting

Use this command to restore the reporting of alarms for the given device.

Keyword: unhb-alm

Related Commands: inh-alm, rept-stat-alm, rept-stat-card, rept-stat-cdt, rept-stat-dlk, rept-stat-dstn, rept-stat-ls, rept-stat-rte, rept-stat-seas, rept-stat-slk, rept-stat-sys, rept-stat-trbl, rept-stat-trm, rtrv-log

Command Class: System Maintenance

Parameters

NOTE: See “Point Code Formats and Conversion” in Appendix A for a detailed description of point code formats, rules for specification, and examples.

:dev= (mandatory)

The device for which you want to restore the reporting of alarms.

Range: applsock, as, card, cdt, clock, dlk, e1port, ls, lsmsconn, ndclk, ndcq3, route, seax25, slk, t1port, trm

applsock—IP gateway application socket

as—IP gateway application Application Server

card—Cards in the database

cdt—Customer defined troubles

clock—System clock

dlk—The IP ports on the VSCCP, EROUTE, SLAN, VXWSLAN and MCP application cards.

e1port—E1 port on E1/T1 MIM or HC-MIM cards
ls—Linksets
lsmconn—Communication link between the LSMS and the EMS
ndclk—Network Data Collection links
ndcq3—Q.3 association for the Network Data Collection
route—Route
seasx25—SEAS X.25 links
slk—Signaling links
t1port—T1 port on E1/T1 MIM or HC-MIM cards
trm—Terminals

:asname= (optional)

Gateway Application Server name. When used with the **dev=as** parameter, this parameter can be used to inhibit alarms for the named Application Server.

Range: Up to 15 alphanumeric characters; the first character must be a letter

:dpc/dpca/dpci/dpcn/dpcn24= (optional)

Destination point code for inhibiting alarms for routes.

:dpc= or :dpca= (optional)

ANSI destination point code with subfields network indicator-network cluster-network cluster member (*ni-nc-ncm*). The *prefix* subfield indicates a private point code (*prefix-ni-nc-ncm*).

Range: **p-, 000-255, ***

Specify a valid value for each subfield of the point code, and separate the subfields with a dash (-).

prefix—**p-**

The asterisk value (*) is not valid for the *ni* subfield.

When **chg-sid:pctype=ansi** is specified, *ni* = **000** is not valid.

When **chg-sid:pctype=ansi** is specified, *nc* = **000** is not valid if *ni* = **001-005**.

When **chg-sid:pctype=ansi** is specified, *nc* = **000** is valid if *ni* = **006-255**.

When **chg-sid:pctype=ansi** is specified, *ni*-*- is valid if *ni* = **006-255**.

The point code **000-000-000** is not a valid point code.

:dpci= (optional)

ITU international destination point code with subfields *zone-area-id*. The *prefix* subfield indicates a spare point code, private point code, or private and spare point code (*prefix-zone-area-id*).

Range: **s-, p-, ps-, 0-255**

Specify a valid value for each subfield of the point code, and separate the subfields with a dash (-).

The point code **0-000-0** is not a valid point code.

prefix—**s-, p-, ps-**

zone—**0-7**

area—**000-255**

id—**0-7**

:dpcn= (optional)

ITU national destination point code in the format of a 5-digit number (*nnnnn*); or 2, 3, or 4 numbers (members) separated by dashes (*m1-m2-m3-m4*) as defined by the

chg-stpopts:npcfnti flexible point code option. A group code must be specified when the ITUDUPPC feature is turned on (*nnnnn-gc*, *m1-m2-m3-m4-gc*). The *prefix* subfield indicates a spare point code, private point code, or private and spare point code (*prefix-nnnnn*, *prefix-nnnnn-gc*, *prefix-m1-m2-m3-m4*, *prefix-m1-m2-m3-m4-gc*).

Range: **s-, p-, ps-, 0-16383, aa-zz**

Specify a valid value for each subfield of the point code, and separate the subfields with a dash (-).

prefix—**s-, p-, ps-**

nnnnn—**0-16383**

gc—**aa-zz**

m1-m2-m3-m4—**0-14** for each member; values must sum to 14

:dpcn24= (optional)

24-bit ITU national destination point code with subfields *main signaling area-sub signaling area-signaling point*. The *prefix* subfield indicates a private point code.

Range: **p-, 000-255**

Specify a valid value for each subfield of the point code, and separate the subfields with a dash (-).

prefix—**p-**

msa—**000-255**

ssa—**000-255**

sp—**000-255**

:e1port= (optional)

Port ID. E1 port on the specified HC-MIM card.

This parameter is mandatory if **dev=e1port** is specified.

Range: **1-8**

Ports 3 through 8 can be specified only for HC-MIM cards.

:id= (optional)

Customer Defined Trouble (CDT) ID.

Customer Defined Trouble IDs 1 through 4 are generated critical alarms. Because critical alarms cannot be turned off, Customer Defined Trouble IDs 1 through 4 cannot be specified as values for the **id** parameter.

This parameter is mandatory if **dev=cdt** is specified.

Range: **5-16**

:loc= (optional)

The card location as stenciled on the shelf of the system.

Range: **1101-1113, 1115, 1201-1218, 1301-1318, 2101-2118, 2201-2218, 2301-2318, 3101-3118, 3201-3218, 3301-3318, 4101-4118, 4201-4218, 4301-4318, 5101-5118, 5201-5218, 5301-5318, 6101-6118**

:lsn= (optional)

Linkset name

Range: 1 alphabetic character followed by up to 9 alphanumeric characters

:port= or :link= (optional)

Signaling link on the card specified in the **loc** parameter.

Range: **a, b, a1-a31, b1-b31**

a, b—For **dev=dlk, dev=slk** for a two-port LIM

a1, a2, b1, b2—For **dev=ndclk/seasx25/lmsconn**

a, b, a1, b1, a2, b2, a3, b3—For **dev=slk** for a multi-port LIM

a, b, a1-a31, b1-b31—For **dev=slk** for an HC-MIM

:sname= (optional)

Gateway application socket. When used with the **dev=applsock** parameter, this parameter can be used to uninhibit alarms for the named IP⁷ application socket.

Range: 1 to 15 alphanumeric characters

:t1port= (optional)

Port ID. T1 port on the specified HC-MIM card.

This parameter is mandatory if **dev=t1port** is specified.

Range: **1-8**

Ports 3 through 8 can be specified only for HC-MIM cards.

:trm= (optional)

Specifies the ID number of the terminal whose characteristics are to be retrieved and displayed.

Range: **1-40**

Default: Report displays on the terminal where the command was issued.

Example

```
unhb-alm:dev=route:dpc=1-1-1
```

Dependencies

This command is not allowed in upgrade mode.

No other action command can be in progress when this command is entered.

When the **dev=card** parameter is specified, the **loc** parameter must be specified.

When the **dev=dlk** parameter is specified, the **loc** parameter must be specified.

When the **dev=slk** parameter is specified, the **loc** parameter and the **link** parameter must be specified.

When the **dev=ndclk** parameter is specified, the **link** parameter must be specified. The range of values for the **link** parameter is as follows:

a1—EMDC A to EMAP A link

a2—EMAP A to NDC OS link

b1—EMDC B to EMAP B link

b2—EMAP B to NDC OS link

When the **dev=e1port** parameter is specified, the **loc** parameter and the **e1port** parameter must be specified.

When the **dev=t1port** parameter is specified, the **loc** parameter and the **t1port** parameter must be specified.

When the **dev=ls** parameter is specified, the **lsn** parameter must be specified.

When the **dev=trm** parameter is specified, the **trm** parameter must be specified.

When the **dev=cdt** parameter is specified, the **id** parameter must be specified.

When the **dev=seasx25** parameter is specified, the **link** parameter must be specified.

When the **dev=lsmsconn** parameter is specified, the **link** parameter must be specified.

When the **dev=route** parameter is specified, a **dpc/dpca/dpci/dpcn/dpcn24** parameter must be specified.

When the **dev=applsock** parameter is specified, the **sname** parameter must be specified.

When the **dev=as** parameter is specified, the **asname** parameter must be specified.

The linkset specified by the **lsn** parameter must be equipped in the database.

If the **dpcn** parameter is specified, its format must match the format that was assigned with the **chg-stpopts:npcfmti** parameter.

If the **dev=slk** parameter or **dev=dlk** parameter is specified, the specified **link** must exist in the database.

Table 7-16 shows the valid parameter combinations for the **unhb-alm** command.

Table 7-16. Parameter Combinations for the **unhb-alm** command

Value (:dev)	a								l									
Device Parameter	k	s	d	t	k	k	t	s	n	k	3	e	5	k	t	r	m	
No Parameters					x													
:asname		x																
:dpc/dpca/dpci/dpcn/dpcn24													x					
:id				x														
:loc			x			x	x								x	x		
:lsn								x										
:e1port=1-8							x											
:link=a, b						x									x			
:link=a, b, a1, a2, b1, b2, a3, a3															x			
:link=a1, a2, b1, b2									x	x			x					

Table 7-16. Parameter Combinations for the **unhb-alm** command (Continued)

Value (:dev)	a								l								
Device Parameter	p								s								
	l								m								
	s								c	n	n	r	a				
	o	c							d	d	o	s					
	c	a	r	d	c	l	r	l	o	c	c	u	x	s			
	k	s	d	t	k	k	t	s	n	k	3	e	5	k	t	r	m
:link=a, b, a1-a31, b1-b31							x									x	
:sname	x																
:t1port=1-8																x	
:trm																	x

If the **sname** parameter is specified, the socket name must exist in the IPASOCK table.
 If a point code parameter is specified, the point code must exist in the Routing table.
 The card location that is specified in the **loc** parameter must be equipped.
 The specified device type must be supported by the card in the specified card location.

Notes

In this command, only ITU-international and ITU national point codes support the spare point code subtype prefix (**s-**) and the private and spare point code subtype prefix (**ps-**). All of the point code types support the private (internal) point code subtype prefix (**p-**).

Output

```
unhb-alm:dev=route:dpc=1-1-1
rlghncxa03w 03-03-23 13:20:59 EST EAGLE 31.3.0
Alarms are inhibited.

rlghncxa03w 03-03-23 13:20:59 EST EAGLE 31.3.0
Command Completed.
;
```

unhb-slkl

Uninhibit Signaling Link

Use this command to return an inhibited signaling link to service. If the link was aligned when it was inhibited, a changeover occurred. This command causes a changeback on the specified link. MSUs are transmitted on the link after the changeback is issued.

NOTE: The signaling link's inhibited status is not preserved across a LIM reboot.

Keyword: unhb-slkl

Related Commands: act-slkl, blk-slkl, dact-slkl, dlt-slkl, ent-slkl, inh-slkl, rept-stat-slkl, rtrv-slkl, tst-slkl, ublk-slkl

Command Class: Link Maintenance

Parameters

:loc= (mandatory)

The card location as stenciled on the shelf of the system.

Range: 1101–1108, 1111–1112, 1201–1208, 1211–1218, 1301–1308, 1311–1318, 2101–2108, 2111–2118, 2201–2208, 2211–2218, 2301–2308, 2311–2318, 3101–3108, 3111–3118, 3201–3208, 3211–3218, 3301–3308, 3311–3318, 4101–4108, 4111–4118, 4201–4208, 4211–4218, 4301–4308, 4311–4318, 5101–5108, 5111–5118, 5201–5208, 5211–5218, 5301–5308, 5311–5318, 6101–6108, 6111–6118

:port= or :link= (mandatory)

The signaling link on the card specified in the **loc** parameter. The signaling links can be specified in any sequence or pattern.

Range: a, b, a1-a31, b1-b31

Not all card types support all **link** parameter values.

See Table A-1 in Appendix A for valid **link** parameter range values for each type of card that can have a location specified in the **loc** parameter.

Example

```
unhb-slk:loc=1301:link=a
```

Dependencies

A card location that is valid and defined in the database must be specified.

No other action command can be in progress when this command is entered.

The card must be equipped and must be one of the following cards:

- A LIM card running the **ss7ansi**, **ss7gx25**, **atmansi**, or **ccs7itu** application
- An E1 ATM card running the **atmitu** application
- A DCM or SSEDCCM card running the **iplim** or **iplimi** application
- An E1/T1 MIM card or an HC-MIM card running the **ss7ansi** or **ccs7itu** application

The card must contain signaling links.

The signaling link must be equipped in the database.

The **link** parameter values **a1**, **b1**, **a2**, **b2**, **a3**, and **b3** can be specified only for the following cards:

- A multi-port LIM
- An SSEDCCM running the **iplim** or **iplimi** application that supports 8 points
- An E1/T1 MIM or an HC-MIM.

The inhibit and uninhibit actions are valid for links on IPLIMx SSEDCCMs that have **ipliml2=m2pa** or **ipliml2=saaltali**, and for links on IPLIMx EDCMs and DCMs that have **ipliml2=saaltali**.

Notes

This command is not valid on TCP/IP point to multipoint links (DCM cards equipped as SS7IPGW or IPGWI links). TCP/IP point to point links (IPLIM and IPLIMI) can be uninhibited.

The function of this command is the same as the **canc-lpo** command.

The *Installation Manual - EAGLE 5 SAS* provides an illustration of card locations.

Output

unhb-slk:loc=1301:link=a

```
rlghncxa03w 03-03-23 13:20:59 EST EAGLE 31.3.0
Allow Link message sent to card
;
```

unlock

Unlock Keyboard

Use this command to unlock a previously locked terminal keyboard. Anyone attempting to use the keyboard is prompted to enter the password of the currently logged-in user.

Keyword: unlock

Related Commands: lock

Command Class: Basic

Parameters

This command has no parameters.

Example

```
unlock
```

Dependencies

This command is not supported on telnet terminals (terminal IDs 17-40).

You must enter the password of the logged in user to unlock the keyboard.

This command is valid only if the keyboard is locked.

The port must not be in an unlock disabled state because of excessive successive unlock failures.

Notes

None

Output

unlock

```
Enter LOGIN password to unlock keyboard :
```

Debug Commands

Introduction

This chapter contains information about debug commands used in troubleshooting and debugging the system. These commands are intended only for Tekelec Technical Services personnel and authorized engineering personnel in the operating companies. The use of these commands is restricted to personnel who have access to the command class Debug.



CAUTION: These commands are to be used precisely as they are described in this chapter and only under the direction of Tekelec Technical Services personnel. Any other use of these commands can result in a system failure.

This chapter contains the debug commands in alphabetical order starting on page 8-2.

act-upgrade**Activate Upgrade**

Use this command to perform a software upgrade on an in-service system from a source release to the target release.

It is strongly recommended that this command be used only in conjunction with the *system* Upgrade Procedure for your target release. The Upgrade Procedure provides step-by-step information on performing an upgrade.

Keyword: act-upgrade

Related Commands: rept-stat-db

Command Class: Debug

Parameters

:action= (mandatory)

The kind of action to be performed for the upgrade process.

Range: **convertoam, convertnet, convertstp, dbstatus, netcomplete, oamcomplete**

convertoam—Converts the standby OAM database. Sets the disk's upgrade phase number to 1.

convertnet—Performs an inhibit/allow sequence for each network card. This sequence effects the controlled loading of the new release generic program load (GPL) and of the converted database. Requires upgrade phase indicator of 3.

convertstp—Performs all OAM and network conversions necessary for an upgrade. This command transitions through all of the upgrade phases to upgrade completion. If measurement collection is turned on, this command automatically inhibits measurements during the upgrade. Upon completion of the upgrade, this command returns the MASPs to full-function mode with measurement collection turned back on.

dbstatus—Reports the status of all database partitions on the TDM fixed disks and the MDAL removable disk (similar to **rept-stat-db:display=version**).

netcomplete—Indicates upgrade completion and places system in a fully functional mode.

oamcomplete—Sets the upgrade phase number to 3, enables the beginning of controlled card loading, and allows OAP terminals to be attached.

:appl= (optional)

The name of the GPL on which to perform the network upgrade.

Range: **atmansi, bpdcm, bphcap, ccs7itu, ebdatsm, emdc, gls, imt, sccp, ss7ansi, ss7gx25, stplan, utility, all**

Default: all

:disk= (optional)

Specifies which disk is to be used as the work area required for the conversion of the database.

Range: **fixed, remove**

fixed—The TDM fixed disk

remove—The removable disk

Default: **fixed**—if the TDM has available partitions

remove—if the TDM does not have available partitions

:force= (optional)

Force a command with the **convertnet** action specified to be executed. The **force** parameter is ignored for actions other than **convertnet**.

For **action=convertnet**, if all cards of the specified GPL type are not in the In-Service Normal state or Out-Of-Service Maintenance-Disabled state, the **force** parameter is required. In this case, minimum service may not be maintained when the command is executed with the force parameter.

Range: yes, no

Default: no

:thres= (optional)

Network Threshold value. Specifies the percentage of signaling links that are to remain in service (IS) during the network conversion phase. Use of this parameter also enables SCCP thresholding and flashing on non-provisioned cards during the upgrade.

Range: 50 - 90

Default: The network cards are updated serially.

Example

act-upgrade:action=convertstp

act-upgrade:action=convertoam

act-upgrade:action=oamcomplete

act-upgrade:action=convertnet:appl=gl:force=yes

act-upgrade:action=convertnet:appl=sccp

act-upgrade:action=netcomplete

act-upgrade:action=dbstatus

act-upgrade:action=convertstp:disk=remove

act-upgrade:action=convertstp:thres=75

Dependencies

Upgrade conversion cannot be initiated from a telnet-type terminal (terminal IDs 17-40).

Table 8-1 lists the actions (**action** parameter values) that correspond to a given upgrade mode. An action is accepted only when the system is in the corresponding upgrade mode.

Table 8-1. Actions with Corresponding Upgrade Phase

Action	Corresponding Upgrade Phase
action=convertoam	0 and 1
action=oamcomplete	2
action=convertnet	3
action=netcomplete	3
action=convertstp	0 through 3

If measurement collection is enabled, the **act-upgrade:action=convertstp** command automatically inhibits measurement collection during the upgrade. Before returning to full function mode, measurements are turned back on. The following actions require that you manually inhibit measurements: **converttoam**, **oamcomplete**, **convertnet**, and **netcomplete**.

The valid release upgrade disk must be inserted in the MDAL drive.

The standby OAM database must be the source release.

The current OAM database must be the source release.

The database partition must be coherent.

The database partition must be in the correct functional mode.

The **appl** parameter is valid only with **action=convertnet**. The **appl** parameter is required with **action=convertnet**.

The **force** parameter is valid only with **action=convertnet**.

For **action=convertnet**, if all cards of the specified GPL type are not in the In-Service Normal state or Out-Of-Service Maintenance-Disabled state, the **force** parameter is required. In such cases, minimum service may not be maintained.

The MTP Restart Indicator STP option must be set to **no** (see the **chg-stpopts** command) before the **act-upgrade** command can be entered.

The **thres** parameter is valid only with **action=convertnet** and **action=convertstp**.

IP references cannot be configured to entities in the IP database that do not exist.

Notes

For the **appl** parameter, the list of valid GPLs varies from release to release. The **rtvr-gpl** command can be used (when in full function mode) to obtain a list of the GPLs currently resident on the TDMs. The **rept-stat-gpl** command can be used to obtain a list of the GPLs currently active on provisioned network cards.

The **disk** parameter is to be used to override the decision logic of the upgrade processing that selects the disk to be used in the database conversion. The parameter is intended to be used in the command re-issue scenario where a problem was encountered using the disk chosen by the upgrade process and you want to attempt to execute the upgrade using the alternate disk.

Each upgrade phase will only accept the next upgrade phase command. There are four phases. For example, the command **act-upgrade:action=converttoam** (phases 0 and 1) can be followed only by the command **act-upgrade:action=oamcomplete** (phase 2). The **act-upgrade:action=oamcomplete** command can be followed only by **act-upgrade:action=netcomplete** (phase 3).

The **act-upgrade:action=convertstp** command executes all four upgrade phases consecutively.

If the **act-upgrade:action=convertstp** command is entered following a command abort, the upgrade processing determines the last upgrade phase that was successfully completed. The upgrade processing then attempts to restart from that point to successful completion. Re-entering the **act-upgrade:action=convertstp** command following a command abort is the recommended method for recovery.

The TDMs and removable cartridge have upgrade phase indicators. The upgrade command expects the disks to be in certain phases before executing a specific action. If the disks are not in the correct phases, an error is generated.

The command **act-upgrade:action=dbstatus** generates output similar to that provided by the command **rept-stat-db:display=version**.

The parameter **action=convertnet** results in the following actions:

- The sequential canceling of any assigned links.
- The inhibiting of each card.
- The allowing of each card.
- The activating of the canceled links.

The **convertnet** action proceeds to the next card after the current card has returned to the in-service normal (IS-NR) state or a timeout is reached. If 10% of the cards initially IS-NR are in an abnormal state, the command is aborted. Cards that do not return to the IS-NR state are left inhibited (OOS-MT-DSBLD). Cards that are not in the IS-NR or OOS-MT-DSBLD state when the **convertnet** action is issued are allowed during execution of the command. If such cards do not return to the IS-NR state, they are inhibited and left in the OOS-MT-DSBLD state when **force=yes** is specified.

For the **convertnet** action, if all cards of the specified GPL type are not in the IS-NR or OOS-MT-DSBLD state, the **force** parameter is required. In such case minimum service may not be maintained, and execution of the command must be forced by the technician. The **force** parameter is ignored for actions other than **convertnet**.

The **convertnet** action completes with no action performed if there are no cards of the specified GPL type defined in the database.

The **thres** parameter is used for the following purposes:

- Allows for multiple cards to be upgraded together, as long as the specified percentage of links remain in service. If no **thres** parameter is specified, the cards are upgraded serially. The value is applied to groups of links based upon the link-supporting GPL being upgraded.
- Enables SCCP thresholding, which allows multiple SCCP or VSCCP cards to be upgraded together. The specified **thres** parameter value is not used to determine the number of SCCP cards to upgrade. The peak SCCP load since the last OAM boot is used to determine the number of cards that must remain in service (at least half of the cards must remain in service).
- Enables the non-provisioned flash function, which flash-downloads any boot-prom type card if the card is in the system but not provisioned.

The **appl=all** parameter initiates the **action=convertnet** sequence on all GPL types in the order defined in Table 8-2 on page 8-6. The actions performed are subject to the conditions of the above notes.

Controlled Card Loading: During upgrade phase 3 (after **action=oamcomplete** and before **action=netcomplete**), card loading is controlled by a card's GPL type to prevent service interruption of the node. Table 8-2 shows the dependencies in card loading.

Table 8-2. Dependencies in Card Loading

Prior to Loading This Card . . .	These Cards Must Be Loaded
GLS	None
SCCP	All GLS cards
SS7	All GLS and SCCP cards
CCS7ITU	All GLS, SCCP, and SS7 cards
ATMANSI	All GLS, SCCP, SS7, and CCS7ITU cards
GX25	All GLS, SCCP, SS7, CCS7ITU, and ATMANSI cards
STPLAN	All other card types

Output

act-upgrade:action=convertstp

The **act-upgrade:action=convertstp** command performs the OAM conversion and the network conversion. During the conversion, it broadcasts the current activity in the scroll area. This example shows some, but not all, of the messages that might appear.

```

rlghncxa03w 01-03-22 16:18:00 EST Rel 26.1.0 Upgrade Phase 0
act-upgrade:action=convertstp
Command entered at terminal #3.
ACT-UPGRADE: MASP A - IMT GPL uploaded.
ACT-UPGRADE: MASP A - IMT GPL activated.
ACT-UPGRADE: MASP A - IMT GPL uploaded.
Conversion of Removable Cartridge has started...
NOTICE: Converting X25RTE.TBL
NOTICE: Converting X25DSTN.TBL
NOTICE: Converting DEVFILT.TBL
Conversion of Removable Cartridge complete
Marking Removable Upgrade Phase = 2...
Starting to format the Standby TDM...
Format disk in progress
Format-disk of standby fixed disk complete.
Starting Standby TDM restoration from removable...
Starting to backup Standby TDM...
Starting to copy GPLs to Standby TDM from removable...
Marking Standby TDM Upgrade Phase = 2...
Conversion of Standby TDM has completed
Booting the Standby...
Standby MASP has not finished initializing - please wait...
rlghncxa03w 01-03-22 16:35:06 EST Rel 26.1.0 Upgrade Phase 0
ACT-UPGRADE:MASP A - Active MASP will reboot and be converted for upgrade
rlghncxa03w 01-03-22 16:35:17 EST Rel 28.1.0
** 5001.0008 ** CARD 1113 OAM Active MASP has become isolated
5003.0009 CARD 1115 OAM MASP became active
rlghncxa03w 01-03-22 16:36:17 EST Rel 28.1.0 Upgrade Phase 2
Standby MASP has not finished initializing - please wait...
Starting to format the Standby TDM...
Format disk in progress
Format-disk of standby fixed disk complete.
Starting Standby TDM restoration from removable...
Starting to backup Standby TDM...
Starting to copy GPLs to Standby TDM from removable...
Marking Standby TDM Upgrade Phase = 2...
Conversion of Standby TDM has completed

```



```

Booting the Standby...
Standby MASP has not finished initializing - please wait...
rlghncxa03w 01-03-22 16:46:49 EST Rel 28.1.0 Upgrade Phase 3
ACT-UPGRADE: OAM upgrade complete
ACT-UPGRADE: prepare to initialize network cards
Starting network conversion...
Upgrading <x> of <y> <appl> cards [<card loc>]
Command in Progress : Network conversion in progress
ACT-UPGRADE: Network conversion complete
ACT-UPGRADE: Network upgrade complete
Command Complete : Upgrade action completed successfully
    
```

act-upgrade:action=converttoam

The action **converttoam** converts the database on the active and the standby TDMs and changes the upgrade phase.

```

rlghncxa03w 01-03-13 08:15:45 Rel 28.1.0 Upgrade Phase 1
Conversion of Removable Cartridge has started...
NOTICE: Converting XXXXXXXX.XXX
NOTICE: Converting XXX entries
Marking Removable Upgrade Phase = 2...
Starting to format the Standby TDM...
Starting Standby TDM restoration from removable...
Starting to backup Standby TDM...
Starting to copy GPLs to Standby TDM from removable...
Marking Standby TDM Upgrade Phase = 2...
Conversion of Standby TDM has completed
Booting the Standby...
    
```

act-upgrade:action=dbstatus

The action **dbstatus** reports the current database status.

```

tekelecstp 03-08-01 08:30:00 EST Rel 31.3.0 Upg Phase 2

DATABASE STATUS: >> OK <<
      TDM 1114 (STDBY)          TDM 1116 ( ACTV )
      C  LEVEL    TIME LAST BACKUP  C  LEVEL    TIME LAST BACKUP
      -----
FD BKUP Y    1    03-08-01 08:30:00 EST Y    1    03-08-01 08:30:00EST
FD CRNT Y    1
      MDAL 1117
      -----
RD BKUP Y    1    -----

CARD/APPL  LOC  C  T  LEVEL    TIME LAST UPDATE    VERSION STATUS
-----
TDM-CRNT  1114 Y  N  1    03-08-01 08:30:00    123-001123-000-000 UPG 2
TDM-BKUP  1114 Y  -  1    03-08-01 08:30:00    123-001123-000-000 UPG 2
TDM-CRNT  1116 Y  N  1    03-08-01 08:30:00    123-001123-000-000 UPG 2
TDM-BKUP  1116 Y  -  1    03-08-01 08:30:00    123-001123-000-000 UPG 2
MDAL      1117 Y  -  1    -----

INACTIVE PARTITION GROUP
CARD/APPL  LOC  C  T  LEVEL    TIME LAST UPDATE    VERSION STATUS
-----
TDM-CRNT  1114 Y  N  1    03-08-01 08:30:00    118-000-000 NORMAL
TDM-BKUP  1114 Y  -  1    03-08-01 08:30:00    118-000-000 NORMAL
TDM-CRNT  1116 Y  N  1    03-08-01 08:30:00    118-000-000 NORMAL
TDM-BKUP  1116 Y  -  1    03-08-01 08:30:00    118-000-000 NORMAL
;
    
```

act-upgrade:action=oamcomplete

The action **oamcomplete** marks the end of the OAM upgrade and changes the upgrade phase. The system is now ready for network initialization.

```
rlghncxa03w 01-03-13 12:38:04 Rel 28.1.0 Upgrade Phase 3
Command complete: OAM upgrade complete
Command Complete : prepare to initialize network cards
```

act-upgrade:action=convertnet:appl=sccp

The action **convertnet** sequentially cancels, inhibits, allows, and activates the link(s) for network cards for a given GPL type.

```
rlghncxa03w 01-03-01 18:32:05 EST Rel 28.1.0 Upgrade Phase 3
Starting network conversion...
;
rlghncxa03w 01-03-01 18:37:05 EST Rel 28.1.0 Upgrade Phase 3
Command in progress: Network conversion in progress.
;
rlghncxa03w 01-03-01 18:37:10 EST Rel 28.1.0 Upgrade Phase 3
Command complete: Network conversion complete.
;
```

act-upgrade:action=netcomplete

The action **netcomplete** marks the end of the upgrade and returns the system to full functional mode.

```
rlghncxa03w 01-03-13 08:15:45 Rel 28.1.0 Upgrade Phase 3
Command complete: Network upgrade complete
;
```

cdu**CAP Downloadable Utility (CDU)**

The CAP Downloadable Utility (CDU) is a diagnostic program that can be downloaded to any card including the DSM/DCM cards on the system by entering the **alw/rst-card:loc=xxxx:code=utility** command.

This command is used to enter commands to perform diagnostic functions. The command syntax is as follows:

cdu:loc=xxxx:cmd="command string"

where the **loc** and **cmd** parameters are mandatory parameters for the **cdu** command. The command string, which is enclosed in double quotes (" "), specifies the diagnostic function to perform and includes any optional or mandatory parameters for the specified **cmd** keyword.

The **cdu** command uses the VCDU or CDU GPL. The DSM board can hold up to 4 GB of memory. The CDU or the VCDU utility is downloaded automatically depending on the type of the board. For the DSM the VCDU utility is downloaded; for the TSM the CDU utility is downloaded.

Keyword: **cdu**

Related Commands: None

Command Class: Debug

Parameters

:loc= (mandatory)

The card location of the card as stenciled on the shelf of the system.

Range: 1101–1108, 1111–1113, 1115, 1201–1208, 1211–1218, 1301–1308, 1311–1318, 2101–2108, 2111–2118, 2201–2208, 2211–2218, 2301–2308, 2311–2318, 3101–3108, 3111–3118, 3201–3208, 3211–3218, 3301–3308, 3311–3318, 4101–4108, 4111–4118, 4201–4208, 4211–4218, 4301–4308, 4311–4318, 5101–5108, 5111–5118, 5201–5208, 5211–5218, 5301–5308, 5311–5318, 6101–6108, 6111–6118

:cmd = (mandatory)

The commands that are used to perform diagnostic functions. The command string contains a keyword (listed in the following Range section) and one or more parameters (listed in the Subrange section that follows the Range section). The command string must be enclosed in double quotes (“ ”).

Range: The keywords used in the command strings are:

act-memtst—Starts the memory test.

canc-memtst—Stops the memory test. This command has no parameters.

dump-memtst—Displays the memory test results continuously without any other output messages. This command has no parameters.

rtrv-memtst—Displays the memory test results. This command can be entered while the test is still running or as soon as a failure occurs. This command has no parameters.

act-qcktst—Implements a quick go/no-go test to check the basic integrity of the memory within ten minutes. The VDCU utility verifies the address, the data lines to memory, and the accessibility of each memory chip of 4 GB. This command applies to the DSM card only.

canc-qcktst—Aborts the quick test. This command applies to the DSM card only and has no parameters.

rtrv-qcktst—Displays the quick test results. This command applies to the DSM card only and has no parameters.

fill-mempat—Fills a section of memory with a specific data pattern.

tst-mempat—Tests the memory pattern that was initialized by the fill-mempat command.

dump-mempat—Displays the memory pattern test results continuously without any other output messages. This command has no parameters.

rtrv-mempat—Displays the memory pattern test results. This command can be entered while the test is still running or as soon as a failure occurs. This command has no parameters.

act-checkbit—Tests the M256 checkbit DRAM.

rtrv-checkbit—Displays the M256 checkbit test results. This command has no parameters.

act-memflt—Tests M256 error detection and correction capabilities (fault insertion test).

rtrv-memflt—Displays the fault insertion test results. This command has no parameters.

act-cachetst—Starts the cache test on the specified memory range.

dump-cachetst—Displays the results of the cache test. This command has no parameters.

act-pingtst—Implements a network test in the VCDU utility only. The ping test is applicable to DCM/DSM cards only and will not work in the other cards.

canc-pingtst—Aborts the ping test. This command has no parameters.

rtrv-pingtst—Displays the results of the ping test. This command has no parameters.

Subrange: The keywords used in the command strings use the following parameters.

:beg= (mandatory)

The start address of the physical memory range to be tested. The value is a hexadecimal number. This parameter is used with the keywords **act-cachetst**, **act-checkbit**, **act-memtst**, **fill-mempat**, and **tst-mempat**.

Range: For cards other than the DSM—**h'00100000–h'bfffffff**
 For **act-checkbit** only—**h'80000000–h'bfffffff**
 For **act-cachetst** only—**h'01400000–h'ffd40000**
 For **1GB DSM card** only—**h'01400000–h'3fffffff**
 For **2GB DSM card** only—**h'01400000–h'7fffffff**
 For **3GB DSM card** only—**h'01400000–h'bfffffff**
 For **4GB DSM card** only—**h'01400000–h'ffdffff**

:end= (mandatory)

The first address beyond the last address of the physical memory range to be tested. The value is a hexadecimal number. This parameter is used with the following keywords: **act-checkbit**, **act-cachetst**, **act-memtst**, **fill-mempat**, and **tst-mempat**.

Range: For cards other than the DSM—**h'00100002–h'c0000000**
 For **act-checkbit** only—**h'80000004–h'c0000000**
 For **act-cachetst** only—**h'01440000–h'ffdffff**
 For **act-memtst** on 1GB DSM card only—**h'01400000–h'40000000**
 For **act-memtst** on 2GB DSM card only—**h'01400000–h'80000000**
 For **act-memtst** on 3GB DSM card only—**h'01400000–h'c0000000**
 For **act-memtst** on 4GB DSM card only—**h'01400000–h'ffe00000**

:loop= (optional)

The number of times a test is performed. The value is a hexadecimal or a decimal number. This parameter is used with the following keywords: **act-memtst**, **act-cachetst**, **act-memflt**, **act-checkbit**, **act-qcktst**, and **act-pingtst**.

Range: **h'0–h'ffff**

The value **h'0** indicates that an infinite number of tests is performed.

Default: **h'1**

:data= (mandatory)

The hexadecimal of the data pattern.

This parameter is used only with the keywords **act-cachetst**, **fill-mempat**, and **tst-mempat**.

Range: **h'0000–h'ffff**

:port= (mandatory)

The port address from which to start the ping. This parameter is used **only** with the keyword **act-pingtst**.

Range: **a, b**

:dest= (mandatory)

The destination IP address to be pinged. This is a TCP/IP address expressed in standard dot notation. IP addresses consist of the system's network number and the machine's unique host number. An example IP address is 192.126.100.5, where 192.126.100 is the network number and 5 is the machine's host number. This parameter is used **only** with the keyword **act-pingtst**.

Range: 4 numbers separated by dots, with each number in the range of **0-255**.

:router= (optional)

The router through which the network interface can be tested. This is a TCP/IP address expressed in standard dot notation. IP addresses consist of the system's network number and the machine's unique host number. An example IP address is 192.126.100.5, where 192.126.100 is the network number and 5 is the machine's host number. This parameter is used **only** with the keyword **act-pingtst**.

Range: 4 numbers separated by dots, with each number in the range of **0-255**.

:type= (optional)

Indicates the type of memory test to perform: a comprehensive high-memory test or a fast high-memory test. The fast test performs two tests: the Write/Read block and the Address Write/Read. The comprehensive test performs the fast test as well as a Write/Read Walking 1/0s.

This parameter is used **only** with the **act-memtst** keyword.

Range: **full, fast**

Default: **full**

:addr= (mandatory)

Indicates the physical address to test. This parameter must be dword aligned and must not be the first or last dword of the installed M256 expansion DRAM.

This parameter is used **only** with the **act-memflt** keyword.

Range: **h'80000004-h'bffffff8**

Example

```
cdu:loc=1215:cmd="act-memtst:beg=h'00100000:end=h'00100002:loop=3:type=fast"
```

```
cdu:loc=1215:cmd="canc-memtst"
```

```
cdu:loc=1215:cmd="rtrv-memtst"
```

```
cdu:loc=1215:cmd="fill-mempat:beg=h'00100000:end=h'c0000000:data=h'ffff"
```

```
cdu:loc=1215:cmd="tst-mempat:beg=h'00100000:end=h'c0000000:data=h'ffff"
```

```
cdu:loc=1215:cmd="act-qcktst:loop=h'2"
```

```
cdu:loc=1215:cmd="canc-qcktst"
```

```
cdu:loc=1215:cmd="rtrv-qcktst"
```

```
cdu:loc=1215:cmd="act-pingtst:port=a:dest=215:200:100.6:router=150.1.1.105:loop=h'2"
```

```
cdu:loc=1215:cmd="canc-pingtst"
```

```
cdu:loc=1215:cmd="rtrv-pingtst"
```

```
cdu:loc=1107:cmd="act-cachetst:beg=h'01400000:end=h'01440000: data=h'ffff"
```

```
cdu:loc=1107:cmd="dump-cachetst"
```

```

cdu:loc=1215:cmd="act-checkbit:beg=h'80000000:end=h'80000004:loop=h'2"
cdu:loc=1215:cmd="rtrv-checkbit"
cdu:loc=1215:cmd="act-memflt:addr=h'80000004:loop=h'3"
cdu:loc=1215:cmd="rtrv-memflt"

```

Dependencies

If the **act-cachetst** keyword is entered, the address range should not be less than 256 KB.

The **fill-mempat** keyword must be entered before the **act-cachetst** keyword can be entered.

The quick memory test commands can be entered only on DSM cards.

The ping test commands can be entered only on DSM or DCM cards.

Notes

The **act-memtst:type=full** test takes approximately 21 hours to run on a 1GB TSM. The **act-memtst:type=fast** test takes approximately 1 hour. The VCDU utility has the capability to test the 4 GB of memory in 4 hours if the **act-memtst** command is entered with the **type** parameter set to **fast**.

Output

```
cdu:loc=1107:cmd="dump-memtst"
```

```
cdu: paced memtst output begins
```

address	written	read	address	written	read
bad: h'01400000,	h'5a5a,	h'ffff	h'01400002,	h'5a5a,	h'ffff
bad: h'01400004,	h'5a5a,	h'ffff	h'01400006,	h'5a5a,	h'ffff
bad: h'01400008,	h'5a5a,	h'ffff	h'0140000a,	h'5a5a,	h'ffff
bad: h'0140000c,	h'5a5a,	h'ffff	h'0140000e,	h'5a5a,	h'ffff
bad: h'01400010,	h'5a5a,	h'ffff	h'01400012,	h'5a5a,	h'ffff
bad: h'01400014,	h'5a5a,	h'ffff	h'01400016,	h'5a5a,	h'ffff
bad: h'01400018,	h'5a5a,	h'ffff	h'0140001a,	h'5a5a,	h'ffff

```
cdu:loc=1107:cmd="dump-mempat"
```

```
cdu: paced mempat output begins
```

address	written	read	address	written	read
bad: h'01400000,	h'1234,	h'ffff	h'01400002,	h'1234,	h'ffff
bad: h'01400004,	h'1234,	h'ffff	h'01400006,	h'1234,	h'ffff
bad: h'01400008,	h'1234,	h'ffff	h'0140000a,	h'1234,	h'ffff
bad: h'0140000c,	h'1234,	h'ffff	h'0140000e,	h'1234,	h'ffff
bad: h'01400010,	h'1234,	h'ffff	h'01400012,	h'1234,	h'ffff
bad: h'01400014,	h'1234,	h'ffff	h'01400016,	h'1234,	h'ffff
bad: h'01400018,	h'1234,	h'ffff	h'0140001a,	h'1234,	h'ffff
bad: h'0140001c,	h'1234,	h'ffff	h'0140001e,	h'1234,	h'ffff
bad: h'01400020,	h'1234,	h'ffff	h'01400022,	h'1234,	h'ffff
bad: h'01400024,	h'1234,	h'ffff	h'01400026,	h'1234,	h'ffff
bad: h'01400028,	h'1234,	h'ffff	h'0140002a,	h'1234,	h'ffff

NOTE: The **fill-mempat** keyword must be specified before the **act-cachetst** keyword is specified:

```
cdu:loc=1107:cmd="fill-mempat:beg=h'11000000:end=h'11001000:data=h'1234"
```

```
cdu:loc=1107:cmd="act-cachetst:beg=h'11000000:end=h'11001000:data=h'1234"
```

```

CARD : 1107          CDU: Cache Test Strt    Loop 0x1
CARD : 1107          CDU: Cache Test Pass    Loop 0x1

```

or

```
CARD : 1107      CDU: Cache Test Strt      Loop 0x2
CARD : 1107      CDU: Cache Test Fail      Loop 0x2
```

or

```
CARD : 1107      CDU: Cache write back may not occur w/ address range less than
256KB
```

or

```
CARD : 1107      CDU: Cache Test Already Running
```

cdu:loc=1107:cmd="dump-cachetst"

```
CARD 1107      CDU: PACED CACHETST OUTPUT BEGINS
CARD 1107      B:11000004,1234,55aa
```

cdu:loc=1107:cmd="act-qcktst"

```
CARD: 1107     CDU: Quick Test Started: Loop 0x1
CARD: 1107     CDU: Quick Test Passed: Loop 0x1
```

or

```
CARD: 1107     CDU: Quick Test Already In progress
```

or

```
CARD: 1107     CDU: Quick Test Started: Loop 0x1
CARD: 1107     CDU: Quick Test Failed: Loop 0x1
```

cdu:loc=1107:cmd="rtrv-qcktst"

```
Location: 1107 Loop: 0x1
Memory Range : 0x01400000 - 0xFFDFFFFFF Number of D1G = 4
Number of Failures: 15
Data Lines Test
Fault detected in data line D12 for chip xx
Fault detected in data line D20 for chip yy
:
Address Lines Test
Fault detected in address line A14 for chip xx
Fault detected in address line A26 for chip yy
:
Memory Device Test
Address: 0x01410000 Write: 0xaaaa Read: 0xaaa5
Address: 0x01410100 Write: 0xaaaa Read: 0xaa5a
```

cdu:loc=1107:cmd="act-pingtst:port=a:dest=128.113.14.95: loop=2"

```
CARD: 1107     CDU: PING Test Started: PORT A: Loop 0x1
CARD: 1107     CDU: PING Test Passed: PORT A: Loop 0x1
```

or

```
CARD: 1107     CDU:PING Test Already In Progress
```

cdu:loc=1107:cmd="rtrv-pingtst"

```
CARD: 1107 CDU: Ping Test: PORT A: Loop: 0x1
Total Attempts: 10 # of Successful Attempts: 2 # of Failed Attempts: 8
```

chg-bip-fld**Change Board Identification Field**

Initial programming of the board identification PROMs is done at the time of manufacturing. Field upgrades may require a technician to use this command to manually update the data on a prom.

Keyword: **chg-bip-fld**

Related Commands: **chg-bip-rec, disp-bip, rtrv-bip**

Command Class: Debug

Parameters

:data= (mandatory)

Board identification data.

Range: Patterned character string.

:fld= (mandatory)

Board identification field.

Range: **rev, sm**

rev—Revision

sm—Software match

:loc = (mandatory)

The card location as stenciled on the shelf of the system.

Range: (HMUX and HIPR locations are not valid): **1101–1108, 1111–1113, 1115, 1201–1208, 1211–1218, 1301–1308, 1311–1318, 2101–2108, 2111–2118, 2201–2208, 2211–2218, 2301–2308, 2311–2318, 3101–3108, 3111–3118, 3201–3208, 3211–3218, 3301–3308, 3311–3318, 4101–4108, 4111–4118, 4201–4208, 4211–4218, 4301–4308, 4311–4318, 5101–5108, 5111–5118, 5201–5208, 5211–5218, 5301–5308, 5311–5318, 6101–6108, 6111–6118**

:type = (mandatory)

The type of board.

Range: **mbd, dbd, gbd**

mbd—Main assembly

dbd—Applique

gbd—Guest card BIP

Example

```
chg-bip-fld:loc=1202:type=gbd:fld=rev:data="B"
```

```
chg-bip-fld:loc=1201:type=dbd:fld=sm:data="001"
```

Dependencies

The card location must be valid for the command.

The specified card location must be equipped.

The **type=dbd** parameter is not valid for card type GPSM-II, HCAP, ATM or DCM. HMUX and HIPR cards do not contain BIP information.

Notes

The card in the specified card location must be inhibited.

For accessing a guest card BIP (**type=gbd**), specify the location of the host card (see the “Example” section for this command).

Output

```
chg-bip-fld:loc=1202:type=gbd:fld=rev:data="B"
rlghncxa03w 04-04-31 12:05:44 EST EAGLE 31.6.0
Board ID Prom updated.
;
```

chg-bip-rec**Change Board Identification PROMs Record**

Even though initial programming of the board identification PROMs is done at manufacturing, field upgrades may require a technician to use the **chg-bip-rec** command to update the data on a PROM manually.

Keyword: **chg-bip-rec**

Related Commands: **chg-bip-fld**, **disp-bip**, **rtrv-bip**

Command Class: Debug

Parameters

:data= (mandatory)

Board identification data.

Range: A patterned character string (7, 8, 11, 12, or 14 digits).

:loc= (mandatory)

The card location as stenciled on the shelf of the system.

Range: (HMUX and HIPR locations are not valid): **1101–1108, 1111–1113, 1115, 1201–1208, 1211–1218, 1301–1308, 1311–1318, 2101–2108, 2111–2118, 2201–2208, 2211–2218, 2301–2308, 2311–2318, 3101–3108, 3111–3118, 3201–3208, 3211–3218, 3301–3308, 3311–3318, 4101–4108, 4111–4118, 4201–4208, 4211–4218, 4301–4308, 4311–4318, 5101–5108, 5111–5118, 5201–5208, 5211–5218, 5301–5308, 5311–5318, 6101–6108, 6111–6118**

:type = (mandatory)

The type of board.

Range: **mbd, dbd**

mbd—Main assembly

dbd—Applique

:init= (optional)

This parameter initializes the contents of a PROM to contain only the record specified in the **data** parameter, if that record is a board identification record.

Range: **yes, no**

Default: **no**

Example

```
chg-bip-rec:loc=1107:type=mbd:data=xxx:init=yes
```

Dependencies

To program the applique (**type=dbd**), the card must be inhibited.

The card location must be valid for the command.

The board type **type=dbd** parameter is not valid for card type GPSM-II, HCAP, ATM or DCM. HMUX and HIPR cards do not contain BIP information.

Notes

The card in the specified card location must be inhibited.

Output

```
chg-bip-rec:loc=1107:type=mbd:data=xxx:init=yes
rlghncxa03w 04-04-31 12:05:44 EST EAGLE 31.6.0
Board ID Prom updated.
;
```

chg-lnp-refnum**LNP Change Reference Number**

NOTE: This command is obsolete.

This command is used to change the table entry reference number. The change is updated on both OAMs and on all equipped TSM cards.

NOTE: If the LNP ELAP Configuration feature is enabled, this command is no longer available, and all LNP provisioning is performed at the LSMS.

Keyword: chg-lnp-refnum

Related Commands: vfy-lnp-refnum

Command Class: Debug

Parameters

:ref= (mandatory)

Reference number

Range: 0-4294967280

:gtt= (optional)

Global title translation value with the following mandatory arguments: **tt**, **pc**, **ssn**.

When the **gtt** parameter is specified, the constituent values must *all* be entered and separated by a comma (,) or a dash (-) in the order **tt-pc-ssn**.

tt-

Translation type

Range= 000-255

pc-

ANSI point code in the form of *network indicator-network cluster-network cluster member (ni-nc-ncm)*.

Range: 000-255

Specify a valid value for each subfield of the point code, and separate the subfields with a dash (-).

When **chg-sid:pctype=ansi** is specified, *ni = 000* is not valid.

When **chg-sid:pctype=ansi** is specified, *nc = 000* is not valid if *ni = 001-005*.

When **chg-sid:pctype=ansi** is specified, *nc = 000* is valid if *ni = 006-255*.

The point code **000-000-000** is not a valid point code.

ssn-

Subsystem number

Range: 000-255

:lrn= (optional)

Location routing number

Range: 10 digits

:npanxx= (optional)

Numbering plan area and exchange

Range: 6 digits

:sp= (optional)

Service provider

Range: 4 alphanumeric characters

:tt= (optional)

Translation type

Range: 0-255

Example

chg-lnp-refnum:ref=12:npanxx=919223:tt=20

Dependencies

Only one optional parameter can be specified, with the exception that when **npanxx** is specified, **tt** must also be specified.

The LNP feature must be turned on (see the **enable-ctrl-feat** commands) before the **chg-lnp-refnum** command can be entered.

The translation type (**tt**) value must be a reserved service for LNP and must be a true translation type, not an LNP alias.

A translation type cannot be associated with WNP or PCS query services.

Notes

None

Output**chg-lnp-refnum:ref=12:npanxx=919223:tt=20**

```
rlghncxa03w 01-03-22 21:14:41 EST Rel 28.1.0
CHH-LNP-REFNUM: MASP A - COMPLTD
```

;

chg-tbl**Change Table**

This command is used to create, rename, or reset any table on a fixed disk or removable cartridge.

Keyword: chg-tbl

Related Commands: disp-disk-dir

Command Class: Debug

Parameters

:action= (mandatory)

The desired action to perform on the table.

Range: create, rename, reset

create—Creates a DOS entry in the FAT table and updates the DOS directory table.

rename—Changes the name of an existing system table to a new DOS file name (does not update the **dms.cfg** file).

reset—Initializes an existing table to the value designated by the **resetchar** parameter.

:disk= (mandatory)

The disk that contains the file.

Range: remove, fixed

:ext = (optional)

The three character DOS filename extension.

Range: 0-3 ASCII characters

Default: No file name extension is specified

:filelength= (optional)

The amount of space the file occupies on the disk, in bytes.

Range: 1-7.75 (removable cartridge)

1-31 (fixed disk)

Default: The file length is not specified

:id= (optional)

The table identification number.

Range: 0-499

Default: No table identification number is specified

:name= (optional)

The name of the file.

Range: 1–8 ASCII characters.

Default: No file name is specified

:prtngrp= (optional)

The disk partition group to be displayed.

Range active, inactive

Default active

:resetchar= (optional)

The table reset character that is written to every byte of the table.

Range: 0–255

Example

```
chg-tbl:action=create:disk=remove:name=test:ext=sys:filelength=150000
```

```
chg-tbl:action=reset:disk=remove:id=0
```

```
chg-tbl:action=rename:disk=remove:id=0:name=dms:ext=old
```

Dependencies

If **action=create** is specified, the following parameters must be specified: **name**, **ext**, **filelength**. All other parameters are ignored or defaulted.

If the file type is a directory, the **filelength** parameter is not required. The directory entry file length is always 1 cluster in length.

The attributes used during file creation are: current date and time of the active MASP, readable/writable, files are allocated contiguously from the last free FAT cluster.

If **action=reset** is specified, the **id** parameter must be specified. All other parameters are ignored or defaulted.

If **action=rename** is requested the following parameters must be entered: **id**, **name**, **ext**. All other parameters are ignored or defaulted.

This command cannot be used to modify the security log.

Notes

None

Output

```
chg-tbl:action=create:disk=remove:name=test:ext=sys:filelength=150000
```

```
chg-tbl: CREATE OK : filename = test.sys, byte length = 150000
```

```
chg-tbl: command complete
```

```
;
```

```
chg-tbl:action=reset:disk=remove:id=0
```

```
chg-tbl: RESET OK : Table 0, DMS.CFG
```

```
chg-tbl: command complete
```

```
;
```

```
chg-tbl:action=rename:disk=remove:id=0:name=dms:ext=old
```

```
chg-tbl: RENAME OK : Table 0, DMS.CFG to DMS.OLD
```

```
chg-tbl: command complete
```

```
;
```

clr-disk-stats**Clear Disk Statistics**

This command clears the disk performance statistics. All associated disk statistics are zeroed.

Keyword: clr-disk-stats

Related Commands: disp-disk-state

Command Class: Debug

Parameters

:loc= (mandatory)

The location of the card.

Range: 1113, 1115

Default: None

Example

```
clr-disk-stats:loc=1113
```

Dependencies

The specified card location must contain a card that is running an OAM (1113 or 1115).

A related command must not be in progress.

Notes

None

Output

```
clr-disk-stats:loc=1113
```

```
rlghncxa03w 01-03-01 14:14:05 EST Rel 28.1.0  
Disk performance statistics cleared.  
;
```

copy-tbl**Copy Table**

This command allows a single table to be copied from one source to another. A table can be copied to any verifiable location in the system but the source and destination tables must have identical configurations (same number of entries, same entry size, both 1-dimensional and 2-dimensional). Also, a table cannot be copied onto itself.

Keyword: copy-tbl

Related Commands: None

Command Class: Debug

Parameters

:dloc= (mandatory)

The fixed disk or removable cartridge card location of the destination table.

Range: 1114, 1116 (TDM), 1117 (MDAL)

:sloc= (mandatory)

The fixed disk or removable cartridge card location of the source table.

Range: 1114, 1116 (TDM), 1117 (MDAL)

:stbl= (mandatory)

The identifying number of the source table.

Range: 0-511

:ddrv = (optional)

The disk drive that contains the destination table.

Range: fixed, remove

Default: fixed

:dprtnggrp= (optional)

The disk partition group of the destination table.

Range active, inactive

Default active

:dtbl = (optional)

The identifying number of the destination table.

Range: 0-511

Default: The **stbl** parameter value

:sdrv= (optional)

The disk drive that contains the source table.

Range: fixed, remove

Default: fixed

:sprtnggrp= (optional)

The disk partition group of the source table.

Range active, inactive

Default active

Example

copy-tbl:stbl=25:dtbl=24:sloc=1114:dloc=1116:sdrv=fixed

Dependencies

Only one table copy command can be executed at a time.

The source and destination tables must exist and be compatible.

The specified card locations must be valid disk locations.

This command cannot be used to modify the security log.

Notes

None

Output

```
copy-tbl:stbl=25:dtbl=24:sloc=1114:dloc=1116:sdrv=fixed
rlghncxa03w 01-03-04 16:11:53 EST Rel 28.1.0
Table copy command complete.
;
```

disp-bip**Display Board Identification PROM**

This command displays the board identification PROM (BIP) data (hex and ASCII) in its entirety for the specified card type and location. The PROM data consists of the board ID, part number, revision, date of manufacture, the location where the board was manufactured, serial number, software match ID, and check sums.

Keyword: disp-bip

Related Commands: chg-bip-fld, chg-bip-rec, rtrv-bip

Command Class: Debug

Parameters

:loc= (mandatory)

The card location as stenciled on the shelf of the system.

Range: (HMUX and HIPR locations are not valid): **1101–1108, 1111–1113, 1115, 1201–1208, 1211–1218, 1301–1308, 1311–1318, 2101–2108, 2111–2118, 2201–2208, 2211–2218, 2301–2308, 2311–2318, 3101–3108, 3111–3118, 3201–3208, 3211–3218, 3301–3308, 3311–3318, 4101–4108, 4111–4118, 4201–4208, 4211–4218, 4301–4308, 4311–4318, 5101–5108, 5111–5118, 5201–5208, 5211–5218, 5301–5308, 5311–5318, 6101–6108, 6111–6118**

:type = (optional)

The board type to be displayed.

Range: **mbd, dbd, both**
mbd—Main assembly
dbd—Applique
both—The main assembly and the applique

Default: **both**

Example

```
disp-bip:loc=1101:type=mbd
```

Dependencies

The card location frame, shelf, and slot must be within the allowed range.

The card location must be valid for the command.

The board type **type=dbd** parameter is not valid for card type GPSM-II, HCAP, ATM or DCM. HMUX and HIPR cards do not contain BIP information.

The specified card location must be equipped.

Notes

None

Output

disp-bp:loc=1105:type=mbd

```
rlghncxa03w 01-03-30 02:05:10 EST Rel 28.1.0
Board Identification PROM Dump Location: 1105 - Motherboard Packet: 1
```

```
-----
0000 42 49 44 30 31 2c 50 4e 38 35 30 2d 30 31 34 35 BID01,PN850-0145
0010 2d 30 31 2e 31 41 42 2c 53 4d 45 47 2e 30 30 31 -01.1AB,SMEG.001
0020 2c 44 53 39 32 2e 31 30 2e 43 2e 32 31 30 30 31 ,DS92.10.C.21001
0030 38 32 2c 43 53 32 32 35 00 00 00 00 00 00 00 82,CS225.....
0040 00 00 00 00 00 00 00 00 00 00 00 00 00 00 00 .....
0050 00 00 00 00 00 00 00 00 00 00 00 00 00 00 00 .....
0060 00 00 00 00 00 00 00 00 00 00 00 00 00 00 00 .....
0070 00 00 00 00 00 00 00 00 00 00 00 00 00 00 00
```

```
;
```

disp-bp**Display Breakpoint**

This command displays currently active breakpoints in the communication and application processors.

Keyword: disp-bp

Related Commands: dlt-bp, ent-bp

Command Class: Debug

Parameters

:card= (optional)

Card location, in the form of *GPLID-Subsystem ID*.

Range: *GPLID*—atmansi, atmitu, bpdcm, bphcap, bphcapt, bpmpl, bpmplt, ccs7itu, ebdablm, ebdadcm, emdc, eroute, gls, hipr, imt, ipgwi, iplim, iplimi, ips, mcp, oam, sccp, ss7ansi, ss7gx25, ss7ipgw, stplan, utility, vsccp, vxutil, vxwslan

Subsystem ID—a, b, act, stby, all

The **oam** GPL can be specified with any of the subsystem IDs.

For all other GPLs, only the **all** subsystem ID is valid.

:imt= (optional)

IMT address of the card.

Range: 0-255

:loc = (optional)

The card location as stenciled on the shelf of the system.

Range: 1101-1113, 1115, 1201-1218, 1301-1318, 2101-2118, 2201-2218, 2301-2318, 3101-3118, 3201-3218, 3301-3318, 4101-4118, 4201-4218, 4301-4318, 5101-5118, 5201-5218, 5301-5318, 6101-6118

Locations xy09 and xy10 (x = the frame, y = the shelf) are valid only for IXP-based cards (such as HIPR cards).

:proc= (optional)

Processor type.

Range: **appl, com**
appl—Application processor
com—Communication processor

Default: **appl**

:ueng= (optional)

Microengine number. This parameter is valid only on IXP-based cards. If this parameter is not specified, the card processor type is assumed to be ARM.

Range: **0–5**

Example

disp-bp:card=ss7ansi-all

disp-bp:loc=1214

disp-bp:loc=1109

disp-bp:loc=1109:ueng=3

Dependencies

The **loc**, **imt**, or **card** parameter must be specified.

Only one of the **loc**, **imt**, and **card** parameters can be specified in the command.

The **imt** parameter allows this command to be entered for a card that has not been configured in the system.

The **ueng** parameter can be specified only for IXP-based cards (such as HIPR cards).

The **eoam** GPLID accepts all subsystem values; all other GPLIDs accept only the **all** subsystem value.

The card location specified by the **loc** parameter must be in the database.

Card locations (**loc** parameter) **1114**, **1116**, **1117**, **1118**, and the HMUX locations (**xy09** and **xy10** where *x* is the frame and *y* is the shelf) are not valid for break point commands.

Notes

Card locations (**loc** parameter) **xy09** and **xy10** (*x* is the frame and *y* is the shelf) for HMUX cards are not valid for break point commands.

Output

The following examples are for x86-based cards:

disp-bp:card=ss7ansi-all

```

rlghncxa03w 01-03-22 21:14:58 EST EAGLE5 31.3.0
SDS Installed Breakpoint Report from IMT Address H'00f4
Brkpoint-Addr  Memory-Dump-Addr  Condition-1  Condition-2  Repeat-Count
-----
H'003a-H'0001  ANY  ANY  0

rlghncxa03w 01-03-22 21:14:58 EST EAGLE5 31.3.0
SDS Installed Breakpoint Report from IMT Address H'000a
BP Address  Memory-Dump Address  Conditions  Rpt Ct  Ind
-----
H'0000a974  H'000c030c  1- ANY  3  1
      Code Breakpoint  2- ANY
H'0000a975  1- ANY  PERM  0
      Data Write - WORD  2- ANY
H'0000a976  1- ANY  15  0
      Any Access - DWORD  2- ANY
H'0000a977  1- ANY  PERM  0
      Data Read - BYTE  2- ANY

rlghncxa03w 01-03-22 21:14:58 EST EAGLE5 31.3.0
80386/80486 Debug Registers in Use: DR0 DR2 DR3
;
    
```

disp-bp:card=vsccp-all:

```

rlghncxa03w 01-03-22 21:14:58 EST EAGLE5 31.3.0
SDS Installed Breakpoint Report from IMT Address H'0005
BP Address  Memory-Dump Address  Conditions  Rpt Ct  Ind
-----
H'0000a974  1- ANY  1  0
      Code Breakpoint  2- ANY
;
    
```

The following output examples are for IXP-based cards.

disp-bp:loc=1109

```

tekelecstp 05-01-10 13:58:45 GMT EAGLE5 33.0.0
SDS Installed Breakpoint Report from IMT Address H'00ff

BP Address  Memory-Dump Address  Conditions  Rep  Ind CPU
-----
H'000401000  R11+H'0000ffff  1- R15 > H'ffffffff  2  0  ARM
      Any Access - 2- R0 <= H'0000ffff
      Data value: H'00000000  Data Mask: H'ffffffff
    
```

disp-bp:loc=1109:ueng=3

```

tekelecstp 05-01-10 13:58:45 GMT EAGLE 33.0.0
SDS Installed Breakpoint Report from IMT Address H'00ff

BP Address  Memory-Dump Address  Conditions  Rep  Ind CPU
-----
H'00235000  H'00020044  1- ANY  PERM  1  UENG 3
      CODESW Breakpoint  2- ANY  CTX 2
;
    
```

disp-disk-dir**Display Disk Directory**

This command displays the DOS directory on the specified disk. It can be used to see the creation date for each file, or for selected files. This command allows a user to verify that the correct version of files are on the disk. This command applies to the fixed disks and removable cartridges.

Keyword: disp-disk-dir

Related Commands: act-gpl, chg-db, chg-gpl, copy-gpl, copy-meas, init-sys, rept-stat-db

Command Class: Debug

Parameters

:file= (optional)

The name of the file to be displayed.

Range: 1-12 ASCII characters

Default: All files are displayed

:loc= (optional)

The card location in the system. A fixed disk or removable cartridge location must be specified.

Range: 1114, 1116 (TDM), 1117 (MDAL)

Default: The active fixed disk

:prtnggrp= (optional)

The disk partition group to be displayed.

Range: active, inactive

Default: active

:src= (optional)

The identification of the disk containing the files to be displayed.

Range: fixed, remove

fixed—The fixed disk

remove—The removable cartridge

Default: The fixed disk

Example

```
disp-disk-dir:loc=1117:file="dms.cfg"
```

```
disp-disk-dir:src=remove:file="fta"
```

```
disp-disk-dir:src=remove:file="*.*"
```

Dependencies

Valid filenames must be in the format, *filename.extension*, with the following requirements:

File name—1-8 ASCII Characters

Extension—0-3 ASCII Characters

Wildcards (asterisks) are also allowed when the wildcard pattern is enclosed in parentheses.

*—Matches all characters in either filename or extension

?—Matches one character in either filename or extension

file="*.*"—Matches all files on disk

file="*.tbl"—Matches all files on disk with **.tbl** as a extension

Notes

None

Output

disp-disk-dir

```
lnpstp 01-03-30 15:52:04 EST Rel 28.1.0
DISP-DISK-DIR, Loc=1116, Device = FIXED, Dir = :\
Filename Ext          Length  Last Modified      Cluster      LBA
DMS      CFG          16384   00-08-01 18:45         2            573
:
```

```
File(s) : 175  Bytes : 457956761
Volume : FIXED DISK
Bytes free : 73654887
Disk Size (MB) : 2014
;
```

disp-disk-dir:loc=1117

```
lnpstp 01-03-30 15:52:46 EST Rel 28.1.0
DISP-DISK-DIR, Loc=1117, Device = REMOVE, Dir = :\
Filename Ext          Length  Last Modified      Cluster      LBA
DMS      CFG          16384   00-08-01 15:48         2            339
:
```

```
File(s) : 72  Bytes : 192883124
Volume : SYSTEM DISK
Bytes free : 956339788
Disk Size (MB) : 1096
;
```

disp-disk-dir:file=ttserv.tbl

```
lnpstp 01-03-30 15:53:09 EST Rel 28.1.0
DISP-DISK-DIR, Loc=1116, Device = FIXED, Dir = :\
Filename Ext          Length  Last Modified      Cluster      LBA
TTSERV   TBL           8192   00-08-01 18:45        2731         44237
```

```
File(s) : 1  Bytes : 8192
Volume : FIXED DISK
Bytes free : 73654887
Disk Size (MB): 2014
;
```

disp-disk-dir:loc=1116

```

eaglestp 05-03-30 15:53:09 EST TTTT PPP  EAGLE5 34.0.0
DISP-DISK-DIR, Loc=1116, Device = FIXED, Dir = :\
Filename Ext      Length  Last Modified      Cluster      LBA
DMS      CFG      16384  08-07-97 11:00      2            573
OAM      ELF      3145728 08-07-97 11:00      4            605
TOAM     ELF      3145728 08-07-97 11:00     388          6749
SS7      ELF      1048576 08-07-97 11:00     772          12893
TSS7     ELF      1048576 08-07-97 11:00     900          14941
GX25     ELF      1048576 08-07-97 11:00    1028         16989
TGX25    ELF      1048576 08-07-97 11:00    1156         19037
CCS7ITU  ELF      1048576 08-07-97 11:00    1284         21085
.
.
.
LNP_LRN  BKP      3072096 08-07-97 11:00    38963        623949
LNP_MR   BKP      1679392 08-07-97 11:00    39339        629965
LNP_NPA  BKP      5120096 08-07-97 11:00    39545        633261
LNP_4DIG BKP     128000064 08-07-97 11:00    40171        643277
ACG_MIC  BKP      187712  08-07-97 11:00    55797        893293
LNP_CHK  BKP      197378  08-07-97 11:00    55820        893661
LNP_DBMM BKP      801600  08-07-97 11:00    55845        894061
TRBLTX   BKP      63980   08-07-97 11:00    55943        895629
MTT      BKP     384000  08-07-97 11:00    55951        895757
2201800  REL      2048   08-07-97 11:00    55998        896509

File(s) : 175  Bytes : 457956761
Volume : FIXED DISK
Bytes free : 73654887
Disk Size (MB) : 507
Largest Free Space : 73654887

```

Legend

FILENAME—The name of the file in the directory

EXT—The extension of the file name (for example, for the file MFC.BIN, MFC is the file name and BIN is the extension of the file name).

LENGTH—The amount of space, in bytes, the file occupies on the disk.

LAST MODIFIED—The data and time the file was changed.

CLUSTER—A 2-byte, 16-digit binary number that represents the first section of the disk occupied by the file.

LBA—The starting logical block address that corresponds to the **CLUSTER**.

FILE(S)—The number of files on the disk that match the search criteria.

BYTES—The amount of space, in bytes, the displayed files occupy on the disk

VOLUME—An 11-character name for the disk.

BYTES FREE—The number of bytes that are available on the disk for file storage.

DISK SIZE—The total capacity of the specified disk.

disp-disk-stats**Display Disk Performance Statistics**

This command displays the disk performance statistics. The OAMs maintain disk read/writer access times as well as per table and per application statistics on the number of disk accesses and cache accesses. Per application and per table statistics that have zero values are not output if an application ID or table ID is not specified; only nonzero statistics are displayed in the default report.

Keyword: disp-disk-stats

Related Commands: None

Command Class: Debug

Parameters

:loc= (mandatory)

The card location in the system.

Range: 1113, 1115

:applid = (optional)

Application IDs used system wide to define tasks within system.

Range: 0-255

Default: all

:tblid = (optional)

Table IDs used system wide to define tables within system.

Range: 0-511

Default: all

Example

```
disp-disk-stats:loc=1113:applid=29
```

```
disp-disk-stats:loc=1113:applid=29
```

```
disp-disk-stats:loc=1113
```

Dependencies

The specified card location must contain a card that is running an OAM (1113 or 1115).

Notes

None

Output

disp-disk-stats:loc=1113:applid=29

rlghncxa03w 01-03-01 14:14:05 EST Rel 28.1.0

Disk Performance Statistics Report:

Appl Id	Cache Read Hits	Disk Read Accesses	Cache Write Hits	Disk Write Accesses
29	113	23	25	40

Command Completed.

;

disp-disk-stat:loc=1113

rlghncxa03w 01-03-01 14:14:05 EST Rel 28.1.0

Disk Performance Statistics Report:

Appl Id	Cache Read Hits	Disk Read Accesses	Cache Write Hits	Disk Write Accesses
29	113	23	25	40
120	12	223	225	361

Table Id	Cache Read Hits	Disk Read Accesses	Cache Write Hits	Disk Write Accesses
185	12	223	225	361
201	113	23	25	40
	Total Cache Read Hits	Total Disk Reads	Total Cache Write Hits	Total Disk Writes
	125	246	250	401

Disk Access Times (microseconds)

Minimum	Maximum	Average	Access Type
1260	31121	6380	Read
1215	31090	6350	Write

Command Completed.

;

disp-lba**Display Logical Block Access**

This command displays the contents of a logical block of data at a specified logical block address of a fixed disk or removable cartridge.

Keyword: disp-lba**Related Commands:** None**Command Class:** Debug**Parameters****:lba=** (mandatory)

Logical block address.

Range: 0–1953125

:loc= (mandatory)

The card location in the system. A fixed disk or removable cartridge location must be specified.

Range: 1114, 1116 (TDM), 1117 (MDAL)

Default: Active fixed disk

Example

disp-lba:lba=676:loc=1117

Dependencies

The requested disk must be available.

The logical block address specified must be within the valid range for the disk specified.

Notes

None

Output

disp-lba:lba=676:loc=1117

```
rlghncxa03w 01-03-02 16:21:12 EST Rel 28.1.0
0504 DISP-LBA DEVICE ID=H'0021, LBA=H'000002a4, LOC=1117
0000 ff 44 4d 53 2e 43 46 47 00 00 00 00 00 00 00 00 .DMS.CFG.....
0010 20 00 01 00 00 02 00 00 00 00 00 00 03 00 00 00 .....
0020 00 55 4e 55 53 45 44 54 41 42 4c 45 00 00 00 00 .UNUSEDTABLE....
0030 00 00 00 00 00 00 00 00 00 00 00 00 00 00 00 00 .....
0040 ff 64 62 73 74 61 74 2e 62 6b 70 00 00 00 02 00 .dbstat.bkp.....
0050 2e 00 01 00 01 00 00 00 00 00 00 00 00 01 00 00 .....
0060 ff 64 62 73 74 61 74 2e 74 62 6c 00 00 00 03 00 .dbstat.tbl.....
0070 2e 00 01 00 01 00 00 00 00 00 00 00 03 00 00 00 .....
0080 00 55 4e 55 53 45 44 54 41 42 4c 45 00 00 00 00 .UNUSEDTABLE....
0090 00 00 00 00 00 00 00 00 00 00 00 00 00 00 00 00 .....
00a0 ff 6d 63 66 67 2e 62 6b 70 00 00 00 00 05 00 .mcfg.bkp.....
00b0 9c 00 01 00 01 00 00 00 00 00 00 00 01 00 00 00 .....
00c0 ff 6d 63 66 67 2e 74 62 6c 00 00 00 00 00 06 00 .mcfg.tbl.....
00d0 9c 00 01 00 01 00 00 00 00 00 00 00 03 00 00 00 .....
00e0 ff 69 6d 74 61 2e 62 6b 70 00 00 00 00 07 00 .imta.bkp.....
00f0 28 00 01 00 00 01 00 00 00 00 00 00 01 00 00 00 (.
0100 ff 69 6d 74 61 2e 74 62 6c 00 00 00 00 08 00 .imta.tbl.....
0110 28 00 01 00 00 01 00 00 00 00 00 00 03 00 00 00 (.
0120 00 55 4e 55 53 45 44 54 41 42 4c 45 00 00 00 00 .UNUSEDTABLE....
0130 00 00 00 00 00 00 00 00 00 00 00 00 00 00 00 00 .....
0140 ff 6c 64 74 62 6c 2e 73 79 73 00 00 00 00 0a 00 .ldtbl.sys.....
0150 b8 00 01 00 14 00 00 00 00 00 00 00 03 00 00 00 .....
0160 ff 73 68 65 6c 66 2e 62 6b 70 00 00 00 00 0b 00 .shelf.bkp.....
0170 03 00 02 00 03 00 00 00 03 00 00 00 01 00 00 00 .....
0180 ff 73 68 65 6c 66 2e 74 62 6c 00 00 00 00 0c 00 .shelf.tbl.....
0190 03 00 02 00 03 00 00 00 03 00 00 00 03 00 00 00 .....
01a0 ff 6c 69 6e 6b 2e 62 6b 70 00 00 00 00 0d 00 .link.bkp.....
01b0 10 00 01 00 00 02 00 00 00 00 00 00 01 00 00 00 .....
01c0 ff 6c 69 6e 6b 2e 74 62 6c 00 00 00 00 0e 00 .link.tbl.....
01d0 10 00 01 00 00 02 00 00 00 00 00 00 03 00 00 00 .....
01e0 00 55 4e 55 53 45 44 54 41 42 4c 45 00 00 00 00 .UNUSEDTABLE....
01f0 00 00 00 00 00 00 00 00 00 00 00 00 00 00 00 00 .....
;
```

disp-mem**Display Memory**

This command is used to display memory in communication and application processors. This display is in byte format.

Keyword: disp-mem

Related Commands: set-mem

Command Class: Debug

Parameters

:addr= (optional)

The address, in the form of *segment–offset*.

Range: *segment—h'00–h'ffff*
offset—h'00–h'ffff

:bc= (optional)

The number of data bytes to display.

Range: 0–65535

Default: 96

:card= (optional)

Card location, in the form of *GPLID–Subsystem ID*.

Range: *GPLID—atmansi, atmitu, bphcap, bpdcm, ccs7itu, ebdablm, ebdadcm, emdc, gls, imt, iplim, iplimi, oam, sccp, ss7ansi, ss7gx25, ss7ipgw, stplan, utility, vxwslan*
Subsystem ID—a, b, act, stby, all

The **oam** GPL can be specified with any of the subsystem IDs. For all other GPLs, only the **all** subsystem ID is valid.

:dformat= (optional)

Memory dump format.

Range: byte, word, dword

Default: byte

:imt= (optional)

IMT address.

Range: 0–255

:loc= (optional)

The card location as stenciled on the shelf of the system.

Range: 1101–1108, 1111–1113, 1115, 1201–1208, 1211–1218, 1301–1308, 1311–1318, 2101–2108, 2111–2118, 2201–2208, 2211–2218, 2301–2308, 2311–2318, 3101–3108, 3111–3118, 3201–3208, 3211–3218, 3301–3308, 3311–3318, 4101–4108, 4111–4118, 4201–4208, 4211–4218, 4301–4308, 4311–4318, 5101–5108, 5111–5118, 5201–5208, 5211–5218, 5301–5308, 5311–5318, 6101–6108, 6111–6118

:paddr= (optional)

The physical offset of the memory address.

Range: h'00–h'ffffff

:proc= (optional)
 Processor type.

Range: **appl, com**
appl—Application processor)
com—Communication processor)

Default: **appl**

Example

```
disp-mem:card=ss7ansi-all:addr=h'03a-h'001:bc=8
disp-mem:loc=1204:paddr=h'103abc:bc=8:dformat=word
disp-mem:loc=1204:paddr=h'103abc:bc=8:dformat=dword
```

Dependencies

Either the **loc**, **imt**, or **card** parameter must be specified.

Only one of the **loc**, **imt**, and **card** parameters can be specified in the command.

Either the **addr** or **paddr** parameter can be specified, but not both, in the command.

The **bc** parameter value must not exceed **2000**.

The card location specified by the **loc** parameter must be in the database.

All of the *subsystem* values can be specified with the **oam GPLID**. The other *GPLID* values can be specified only with the **all subsystem** value.

Card locations (**loc** parameter) **1114**, **1116**, **1117**, **1118**, and the HMUX and HIPR locations (**xy09** and **xy10** where *x* is the frame and *y* is shelf) are not valid for memory commands.

Notes

The **imt** parameter allows this command to be entered for a card that has not been configured in the system.

Output

```
disp-mem:card=psm-a:addr=h'03a-h'001:bc=8
rlghncxa03w 01-03-22 21:13:50 EST Rel 28.1.0
SDS Memory Dump from IMT Address H'00f6
Source-Address = H'003a0001          Length = 8 bytes
0000 04 0d 3d 1c 04 0d 3d 1c          ..=...=
;

disp-mem:loc=1204:paddr=h'103abc:bc=8:dformat=word
rlghncxa03w 01-03-22 21:13:50 EST Rel 28.1.0
SDS Memory Dump from IMT Address H'000a
Source-Address = H'00103abc          Length = 8 bytes
0000 ffff 00ff 00ff 0000             .....
;

disp-mem:loc=1204:paddr=h'103abc:bc=8:dformat=dword
rlghncxa03w 01-03-22 21:13:50 EST Rel 28.1.0
SDS Memory Dump from IMT Address H'000a
Source-Address = H'00103abc          Length = 8 bytes
0000 00ffffff 000000ff             .....
;
```

dlt-bp**Delete Breakpoint**

This command deletes breakpoints in the communication or application processors.

Keyword: **dlt-bp**

Related Commands: **disp-bp, ent-bp**

Command Class: Debug

Parameters

:addr= (optional)

The address, in the form of *segment–offset*.

Range: *segment—h'00–h'ffff*
offset—h'00–h'ffff

:card= (optional)

Card location, in the form of *GPLID–Subsystem ID*.

Range: *GPLID—atmansi, atmitu, bphcap, bpdcm, ccs7itu, ebdablm, ebdadcm, emdc, gls, hipr, imt, iplim, iplimi, oam, sccp, ss7ansi, ss7gx25, ss7ipgw, stplan, utility, vxwslan*
Subsystem ID—a, b, act, stby, all
The **oam** GPL can be specified with any of the subsystem IDs.
For all other GPLs, only the **all** subsystem ID is valid.

:imt= (optional)

The card's IMT address.

Range: **0–255**

:loc = (optional)

The card location as stenciled on the shelf of the system.

Range: **1101–1113, 1115, 1201–1218, 1301–1318, 2101–2118, 2201–2218, 2301–2318, 3101–3118, 3201–3218, 3301–3318, 4101–4118, 4201–4218, 4301–4318, 5101–5118, 5201–5218, 5301–5318, 6101–6118**

Locations *xy09* and *xy10* (*x* = the frame, *y* = the shelf) are valid only for IXP-based cards (such as HIPR cards).

:paddr= (optional)

The physical offset of the memory address.

Range: **h'00–h'ffffff**

:proc= (optional)

Card's processor type.

Range: **appl, com**
appl—Application processor)
com—Communication processor)

Default: **appl**

:ueng= (optional)

Microengine number. This parameter is valid only on IXP-based cards. If this parameter is not specified, the card processor type is assumed to be ARM.

Range: 0–5

Example

dlt-bp:card=ss7gx25-all

dlt-bp:loc=1109

dlt-bp:loc=1209:ueng=2

dlt-bp:card=hipr-all

Dependencies

Either the **loc**, **imt**, or **card** parameter must be specified.

Only one of the **loc**, **imt**, and **card** parameters can be specified in the command.

Either the **addr** or **paddr** parameter, but not both, must be specified in the command.

The **ueng** parameter can be specified only on an IXP-based card (such as a HIPR card).

The card location specified by the **loc** parameter must be in the database.

All of the *subsystem* values can be specified with the **oam GPLID**. The other *GPLID* values can be specified only with the **all subsystem** value.

Card locations (**loc** parameter) **1114**, **1116**, **1117**, and **1118** are not valid for break point commands.

Notes

The **imt** parameter allows this command to be entered for a card that has not been configured in the system.

Card locations **xy09** and **xy10** (*x* is the frame and *y* is the shelf) are valid only for IXP-based cards (such as HIPR cards).

ent-bp

Enter Breakpoint

This command is used to add breakpoints in communications and application processors in the system.

Keyword: ent-bp

Related Commands: disp-bp, dlt-bp

Command Class: Debug

Parameters

:access= (optional)

The access type, in the form of *access type-format*.

NOTE: Use the **data** parameter to set the format on IXP-based cards (such as HIPR cards).

Range: *access type*—**r, w, rw**
format—**byte, word, dword, any**
 The *access type* is read, write, read-write.
 The *format* is byte, word, doubleword, any.

Default: For x86-based cards—**rw-byte**
 For IXP-based cards—**rw-any**

:addr= (optional)

The memory location in the form of *segment–offset*.

Range: *segment*—**h'00–h'ffff**
offset—**h'00–h'ffff**

:bc= (optional)

The number of data bytes to display.

For x86-based cards, the maximum number of bytes is 96.

For IXP-based cards, the maximum number of bytes is 256.

For IXP-based cards, **bc** represents the number of bytes of memory. The number of bytes of stack to be displayed will be 256 – **bc**. For example, if **bc=128**, 128 bytes of memory and 128 bytes of stack will be displayed. If **bc=0**, 0 bytes of memory and 256 bytes of stack will be displayed. The exception to this rule is that 1 byte of stack will never be displayed.

Range: For x86-based cards—**0–96**
 For IXP-based cards—**0–255**

:ca= (optional)

Condition “a” in the form of *register–condition–integer*.

Range: *register*—**sp, bp, ds, ss, es, cs, fl, ax, ah, al, bx, bh, bl, cx, ch, cl, dx, dh, dl, di, si, ip, fs, gs, esi, edi, ebp, esp, eip, efl, eax, ebx, ecx, edx, lr, pc, r1-r15**
condition—**eq, neq, gt, lt, gte, lte**
integer—**h'00–h'ffffff**

The value *register* is the CPU internal register.

The value *condition* is the comparison condition (equal, not equal, less than, greater than, greater than or equal, less than or equal).

The value *integer* is the value for comparison.

:card= (optional)

Card location, in the form of *GPLID–Subsystem ID*.

Range: *GPLID*—**atmansi, atmitu, bpdcm, bphcap, bphcapt, bpmpl, bpmplt, ccs7itu, ebdablm, ebdadcm, emdc, eroute, gls, hipr, imt, ipgwi, iplim, iplimi, ips, mcp, oam, sccp, ss7ansi, ss7gx25, ss7ipgw, stplan, utility, vsccp, vxutil, vxwslan**

Subsystem ID—**a, b, act, stby, all**

The **oam** GPL can be specified with any of the subsystem IDs.

For all other GPLs, only the **all** subsystem ID is valid.

:cb= (optional)

Condition “b” in the form of *register–condition–integer*.

Range: *register*—**sp, bp, ds, ss, es, cs, fl, ax, ah, al, bx, bh, bl, cx, ch, cl, dx, dh, dl, di, si, ip, fs, gs, esi, edi, ebp, esp, eip, efl, eax, ebx, ecx, edx, lr, pc, r0-r15**
condition—**eq, neq, gt, lt, gte, lte**

integer—h'00–h'ffffff

The value *register* is the CPU internal register.

The value *condition* is the comparison condition (equal, not equal, less than, greater than, greater than or equal, less than or equal).

The value *integer* is the value for comparison.

:ctx= (optional)

Bit-mapped microengine context mask.

Range: 1-15

:da= (optional)

Dump address, in the form of *segment–offset*.

Range: *segment*—h'00–h'fff

offset—h'00–h'fff

:data= (optional)

Instructs a data breakpoint to qualify on a match of the data. This parameter is valid only on IXP-based cards (such as HIPR cards).

Range: *value-mask*

value—0-0xFFFFFFFF

mask—0-0xFFFFFFFF

Default: 0-0

:dformat= (optional)

Memory dump format (byte, doubleword, word).

Range: byte, dword, word

Default: byte

:dpaddr = (optional)

Memory dump address (physical offset).

Range: h'00–h'ffffff

:dr= (optional)

The data register indirect memory dump, in the form *register-register-integer*.

The *register-register* value is the CPU internal register.

The *integer* value is the offset value.

Range: *register*—sp, bp, ss, ds, es, cs, fl, ax, ah, al, bx, bh, bl, cx, ch, cl, dx, dh, dl, di, si,

ip, fs, gs, esi, edi, ebp, esp, eip, efl, eax, ebx, ecx, edx

register—sp, bp, ds, ss, es, cs, fl, ax, ah, al, bx, bh, bl, cx, ch, cl, dx, dh, dl, di, si,

ip, fs, gs, esi, edi, ebp, esp, eip, efl, eax, ebx, ecx, edx

integer—h'00–h'ffffff

:drarm= (optional)

ARM register indirect memory dump.

Range: *ARM register-integer*
ARM register—r0-r15, sp, lr, pc
mask—0-65535
 The value *ARM register* is the CPU internal register.
 The value *integer* is the offset value.

Default: 0-0

:dur (optional)

Breakpoint duration.

Range: temp, perm

Default: temp

:imt (optional)

Card's IMT address.

Range: 0-255

:ind (optional)

Indirection count.

Range: 0-3

Default: 0

:loc = (optional)

The card location as stenciled on the shelf of the system.

Range: 1101-1113, 1115, 1201-1218, 1301-1318, 2101-2118, 2201-2218, 2301-2318,
 3101-3118, 3201-3218, 3301-3318, 4101-4118, 4201-4218, 4301-4318, 5101-5118,
 5201-5218, 5301-5318, 6101-6118

Locations *xy09* and *xy10* (*x* = the frame, *y* = the shelf) are valid only for
 IXP-based cards (such as HIPR cards).

:paddr = (optional)

The physical offset of the memory address.

Range: h'00-h'ffffff

:proc = (optional)

Card's processor type.

Range: appl, com

appl—Application processor

com—Communication processor

Default: appl

:rep= (optional)

Repetitions for this break point.

Range: 0-255

Default: 0

:type = (optional)

Breakpoint type in the form of *processor type-breakpoint type*

Range: *processor type—p186, p286, p486, arm, ixp*
breakpoint type—code, codehw, codesw, data

Default: For x46-based cards—**p486-code**
 For IXP-based cards—**arm-codesw**

:ueng= (optional)

Microengine number. This parameter is valid only on IXP-based cards. If this parameter is not specified, the card processor type is assumed to be ARM.

Range: 0–5

Example

```
ent-bp:loc=1113:addr=h'03a-0001
ent-bp:loc=1204:paddr=h'27c3c:type=p486-data:access=rw-word
ent-bp:loc=1109:paddr=h'401000:type=arm-codesw:access=rw-any:ca=r7-eq-0
ent-bp:loc=1209:paddr=h'402000:type=arm-data:access=w-any:data=h'1111-h'ff
ent-bp:loc=1309:paddr=h'403000:type=ixp-codesw:ueng=2:ctx=1
ent-bp:card=hipr-all:paddr=h'404000:type=arm-codehw:drarm=r3-0:bc=64
```

Dependencies

All of the *subsystem* values can be specified with the **oam** *GPLID*. The other *GPLID* values can be specified only with the **all** *subsystem* value.

Card locations (**loc** parameter) **1114**, **1116**, **1117**, and **1118** are not valid for break point commands.

The **loc** parameter, the **imt** parameter, or the **card** parameter must be specified.

Only one of the **loc**, **imt**, and **card** parameters can be specified in the command.

The **dr** parameter and the **da** parameter cannot be specified together in the command.

The **dur=perm** parameter and the **rep** parameter cannot be specified together in the command.

The **dur=perm** parameter cannot be specified when the value of the *processor type* portion of the **type** parameter is **p186** or **p286**.

Either the **addr** parameter or the **paddr** parameter, but not both, must be specified in the command.

When the **da** parameter, the **dr** parameter, or the **drarm** parameter is specified, the **dpaddr** parameter cannot be specified

When the **paddr** parameter and the **bc** parameter are specified, either the **dpaddr** or **dr** parameter must be specified in the command.

The **access** parameter can be specified only when the **type** parameter value is **p486-data** or **arm-data**.

The **bc** parameter value cannot be greater than **96** for x86-based cards.

The **ind** parameter value cannot be greater than **3**.

The specified card must be in use.

For 80286 processors, registers for 80386 processors cannot be specified.

For 80286 processors, *integer* values for *registers* and *conditions* must be less than 65535.

The **ueng** parameter is valid only on IXP-based cards (the value **ixp** is specified for the *processor type* portion of the **type** parameter).

The **cts** parameter is valid only on IXP-based cards (the value **ixp** is specified for the *processor type* portion of the **type** parameter).

The **data** parameter is valid only on IXP-based cards.

The **data** parameter is valid only when the value is **data** for the *breakpoint type* portion of the **type** parameter.

The *register* values **sp**, **lr**, **pc**, and **r0-r15** for the **ca**, **cb**, and **drarm** parameters are valid on an IXP-based card ARM processor. An ARM register value must be specified for an IXP-based card with an ARM processor.

The **ca** and **cb** parameters cannot be specified when the value **ixp** is specified for the *processor type* portion of the **type** parameter.

The **drarm** parameter can be specified only on IXP-based cards.

The **drarm** parameter can be specified only when the value **arm** is specified for the *processor type* portion of the **type** parameter.

The **dr** parameter and the **da** parameter cannot be specified for IXP-based cards.

The **data** and **codesw** values for the *breakpoint type* portion of the **type** parameter cannot be specified when the value **ixp** is specified for the *processor type* portion of the **type** parameter.

The **arm** and **ixp** values for the *processor type* portion of the **type** parameter are valid only on IXP-based cards.

The value **any** for the *format* portion of the **access** parameter can be specified only on IXP-based cards. The *format* value must be set to **any** on IXP-based cards.

When the value **ixp** is specified for the *processor type* portion of the **type** parameter, the **ueng** and **cts** parameters must be specified.

The **addr** parameter can be specified only when the **proc=com** parameter is specified for DS0 cards with PROM-based COM processors (such as TSMs).

When the **ca**, **cb**, and **dr** parameters are used with 80186 and 80286 processors, the *register* values **ip**, **fs**, **gs**, **esi**, **edi**, **ebp**, **esp**, **eip**, **efl**, **eax**, **ebx**, **ecx**, and **edx** cannot be specified. These registers can be used only with 80486 processors. The *integer* values for these parameters when used with 80186 and 80286 processors must be less than **h'ffff** (65535).

The **data** value for the *breakpoint type* portion of the **type** parameter cannot be specified with the values **p186**, **p286**, and **ixp** for the *processor type* portion of the **type** parameter.

Notes

The **imt** parameter allows this command to be entered for a card that has not been configured in the system.

Card locations **xy09** and **xy10** (*x* is the frame and *y* is the shelf) are valid only for IXP-based cards (such as HIPR cards).

Output

ent-bp:loc=1113:addr=h'03a-0001

```
rlghncxa03w 04-08-22 21:14:41 EST EAGLE 33.0.0
SDS Response Code 22 from IMT Address H'00f6 - command complete.
```

```
rlghncxa03w 04-08-22 21:14:41 EST EAGLE 33.0.0
SDS Response from IMT Address H'000a - command complete.
;
```

ent-trace

Enter Trace

This debug command is used to trace MSUs sent to SCCP, VSCCP, or SS7 cards running the following GPLs: **ss7ansi**, **ccs7itu**, **sccp**, **vsccp**, **atmitu**, **atmansi**, **iplim**, **iplimi** or **ss7ipgw**.

Table 8-3 lists by card type the parameters that can be used to filter an MSU.

Table 8-3. Parameter/Card Type Filters for MSUs

An MSU for this card type...	Can be filtered using one or more of the following parameters...
SCCP (running GPL sccp)	error , gt , lrn , tn , ssp , and sspa
VSCCP (running GPL vsccp)	error , gt , lrn , tn , ssp/sspa/sspi/sspn/sspn24 , dn , entityid , imei , and imsi
ANSI SS7 (running the ss7ansi , atmansi , iplim , or ss7ipgw GPL)	error , ssp/sspa , opc/opca , dpc/dpca , and tlnpisuptype
ITU SS7 (running the atmitu , ccs7itu or iplimi GPL)	error , sspi/sspn/sspn24 , opci/opcn/opcn24 , and dpci/dpcn/opcn24

For all cards supported by **ent-trace**, the **error** parameter can be provisioned as the only optional parameter or in addition to any other optional parameter to trace any messages that fail verification or processing. If not specified, the default is **error=yes**.

Invalid MSUs can be filtered using repetition (**rep**) as the only optional parameter.

INP messages are traced based on the triggers **gt**, **sspi**, **sspn**, **dn** and/or **entityid**.



CAUTION: If your system's configuration approaches the maximum number of 25 provisioned SCCP cards, entering this command might cause an OAM to reset because of the amount of information that may be returned.

Keyword: ent-trace

Related Commands: None

Command Class: Debug

Parameters

NOTE: See "Point Code Formats and Conversion" in Appendix A for a detailed description of point code formats, rules for specification, and examples.

:card= (mandatory)

Card location in the form of *APPL CLASS-Subsystem ID*

Range: *APPL CLASS*—*atmansi, atmitu, ccs7itu, iplim, iplimi, sccp, ss7ansi, ssripw, vsccp*
Subsystem ID—*all*

:dn= (optional)

Directory Number. The **dn** parameter is used for INP, G-Port, and G-Flex, and the **tn** parameter is used for LNP.

Range: **00000–fffffffffffff**
 5–15 characters; allowed characters are **0–9, A–F, a–f**.

:dpc/dpca/dpci/dpcn/dpcn24= (optional)

Destination point code.

:dpc= or **:dpca=** (optional)

ANSI destination point code with subfields *network indicator-network cluster-network cluster member* (*ni-nc-ncm*).

Range: **000-255**
 Specify a valid value for each subfield of the point code, and separate the subfields with a dash (-).
 When **chg-sid:pctype=ansi** is specified, *ni* = **000** is not valid.
 When **chg-sid:pctype=ansi** is specified, *nc* = **000** is not valid if *ni* = **001–005**.
 When **chg-sid:pctype=ansi** is specified, *nc* = **000** is valid if *ni* = **006–255**.
 The point code **000-000-000** is not a valid point code.

:dpci= (optional)

ITU international destination point code with subfields *zone-area-id*. The *prefix* subfield indicates a spare point code (*prefix-zone-area-id*)

Range: **s-, 0-255**
 Specify a valid value for each subfield of the point code, and separate the subfields with a dash (-).
prefix—**s-**
zone—**0–7**
area—**000–255**
id—**0–7**
 The point code **0-000-0** is not a valid point code.

:dpcn= (optional)

ITU national destination point code in the format of a 5-digit number (*nnnnn*); or 2, 3, or 4 numbers (members) separated by dashes (*m1-m2-m3-m4*) as defined by the **chg-stpopts:npcfmti** flexible point code option. A group code must be specified when the ITUDUPPC feature is turned on (*nnnnn-gc, m1-m2-m3-m4-gc*). The *prefix* subfield indicates a spare point code (*prefix-nnnnn, prefix-nnnnn-gc, prefix-m1-m2-m3-m4, prefix-m1-m2-m3-m4-gc*).

Range: **s-, 0-16383, aa-zz**
 Specify a valid value for each subfield of the point code, and separate the subfields with a dash (-).
prefix—**s-**
nnnnn—**0–16383**
gc—**aa - zz**
m1-m2-m3-m4—**0–14** for each member; values must sum to 14

:dpcn24= (optional)

24-bit ITU national destination point code with subfields *main signaling area-sub signaling area-signaling point* (*msa-ssa-sp*).

Range: 000-255

Specify a valid value for each subfield of the point code, and separate the subfields with a dash (-).

msa—000–255

ssa—000–255

sp—000–255

:entityid= (optional)

The entity ID.

Range: 0-ffffffffffffff

1 to 15 characters. Allowed characters are 0-9, a-f, A-F.

:error= (optional)

Trace on any message verification error and message processing error.

Range: yes, no

Default: yes

:gt= (optional)

The global title digits.

Range: 0-ffffffffffffff

1 to 15 characters. Allowed characters are 0-9, a-f, A-F.

:imei= (optional)

The International Mobile Equipment Identifier.

Range: 0000000000000-ffffffffffff

Exactly 14 digits. Allowed characters are 0-9, a-f, A-F.

:imsi= (optional)

The International Mobile Station Identifier.

Range: 0000-ffffffffffff

5 to 15 characters. Allowed characters are 0-9, a-f, A-F.

:lrn= (optional)

The location routing number.

Range: 000000000-999999999

:opc/opca/opci/opcn/opcn24= (optional)

The originating point code.

:opc= or **:opca=** (optional)

ANSI destination point code with subfields *network indicator-network cluster-network cluster member* (*ni-nc-ncm*).

Range: 000-255

Specify a valid value for each subfield of the point code, and separate the subfields with a dash (-).

When **chg-sid:pctype=ansi** is specified, *ni* = 000 is not valid.

When **chg-sid:pctype=ansi** is specified, *nc* = 000 is not valid if *ni* = 001-005.

When **chg-sid:pctype=ansi** is specified, **nc = 000** is valid if **ni = 006-255**.
The point code **000-000-000** is not a valid point code.

:opcn= (optional)

ITU national destination point code in the format of a 5-digit number (*nnnnn*); or 2, 3, or 4 numbers (members) separated by dashes (*m1-m2-m3-m4*) as defined by the **chg-stpopts:npcfnti** flexible point code option. A group code must be specified when the ITUDUPPC feature is turned on (*nnnnn-gc*, *m1-m2-m3-m4-gc*). The *prefix* subfield indicates a spare point code (*prefix-nnnnn*, *prefix-nnnnn-gc*, *prefix-m1-m2-m3-m4*, *prefix-m1-m2-m3-m4-gc*).

Range: **s-**, **0-16383**, **aa-zz**

Specify a valid value for each subfield of the point code, and separate the subfields with a dash (-).

prefix—**s-**

nnnnn—**0-16383**

gc—**aa - zz**

m1-m2-m3-m4—**0-14** for each member; values must sum to 14

:opcn24= (optional)

24-bit ITU national destination point code with subfields *main signaling area-sub signaling area-signaling point* (*msa-ssa-sp*).

Range: **000-255**

Specify a valid value for each subfield of the point code, and separate the subfields with a dash (-).

msa—**000-255**

ssa—**000-255**

sp—**000-255**

:rep= (optional)

The number of MSUs to trap.

A number greater than 1 includes multiple traps on the same message and traps on different messages, until the specified number is reached or the card reboots or another command is entered to change the parameter values.

To trap incoming and outgoing messages, the value of the **rep** parameter must be **2** or greater. For example, specifying **rep=10** could mean that for EIR queries the command displays 5 incoming MAP_CHECK_IMEI messages and the 5 outbound MAP_CHECK_IMEI_ack messages that the EAGLE sends back to the querying node.

For Message Relay and Query Service Response messages, the parameter that was traced on is not always contained in the outbound message (such as **dn**, **imei**, or **imsi**), but the trace parameter does appear in the inbound message. When the **rep** parameter value is **2** or greater, the outbound message is included in the trace output.

Range: **0-255**

Default: **1**

:ssp/sspa/sspi/sspn/sspn24= (optional)

The SSP point code.

:ssp= or **:sspa=** (optional)

ANSI destination point code with subfields *network indicator-network cluster-network cluster member* (*ni-nc-ncm*).

Range: 000-255

Specify a valid value for each subfield of the point code, and separate the subfields with a dash (-).

When **chg-sid:pctype=ansi** is specified, *ni* = **000** is not valid.

When **chg-sid:pctype=ansi** is specified, *nc* = **000** is not valid if *ni* = **001-005**.

When **chg-sid:pctype=ansi** is specified, *nc* = **000** is valid if *ni* = **006-255**.

The point code **000-000-000** is not a valid point code.

:sspi= (optional)

ITU international destination point code with subfields *zone-area-id*. The *prefix* subfield indicates a spare point code (*prefix-zone-area-id*)

Range: s-, 0-255

Specify a valid value for each subfield of the point code, and separate the subfields with a dash (-).

prefix—s-

zone—0-7

area—000-255

id—0-7

The point code **0-000-0** is not a valid point code.

:sspn= (optional)

ITU national destination point code in the format of a 5-digit number (*nnnnn*); or 2, 3, or 4 numbers (members) separated by dashes (*m1-m2-m3-m4*) as defined by the

chg-stpopts:npcfmti flexible point code option. A group code must be specified when the ITUDUPPC feature is turned on (*nnnnn-gc*, *m1-m2-m3-m4-gc*). The *prefix* subfield indicates a spare point code (*prefix-nnnnn*, *prefix-nnnnn-gc*, *prefix-m1-m2-m3-m4*, *prefix-m1-m2-m3-m4-gc*).

Range: s-, 0-16383, aa-zz

Specify a valid value for each subfield of the point code, and separate the subfields with a dash (-).

prefix—s-

nnnnn—0-16383

gc—aa - zz

m1-m2-m3-m4—0-14 for each member; values must sum to 14

:sspn24= (optional)

24-bit ITU national destination point code with subfields *main signaling area-sub signaling area-signaling point* (*msa-ssa-sp*).

Range: 000-255

Specify a valid value for each subfield of the point code, and separate the subfields with a dash (-).

msa—000-255

ssa—000-255

sp—000-255

:tlnpisuptype= (optional)

The ISUP message type.

Range: 0-255

:tn= (optional)

The directory number. The **tn** parameter is used for LNP, and the **dn** parameter is used for INP, G-Port, and G-Flex.

Range: 000000000-999999999

Example

```
ent-trace:gt=919460:card=sccp-all
```

```
ent-trace:gt=919460:lrn=9105551234:ssp=10-10-10:card=sccp-all:rep=2
```

```
ent-trace:opc=1-1-1:card=ss7ansi-all:rep=2
```

```
ent-trace:tlnpisuptype=01:card=ss7ansi-all
```

```
ent-trace:dn=12345:entityid=c123:card=vsccp-all
```

```
ent-trace:dn=abcde:imsi=c122d:card=vsccp-all
```

```
ent-trace:card=ccs7itu-all:dpc=2-7-5:error=no
```

```
ent-trace:card=vsccp-all:error=yes
```

```
ent-trace:card=ccs7itu-all:sspn24=10-11-12:opc24=10-10-10:dpc24=10-101-11
```

```
ent-trace:dn=abcde:imei=123456789101234:card=vsccp-all
```

```
ent-trace:card=ccs7itu-all:opci=s-1-17-3:dpci=s-1-23-4:rep=10
```

Dependencies

At least one optional parameter must be specified. The **error** parameter can be specified as the only optional parameter or with any other optional parameters in the command.

A value of **none** cannot be specified for the following parameters: **gt**, **entityid**, **dn**, **imei**, or **imsi**.

For the **card** parameter, only the following values are allowed: **sccp**, **vsccp**, **ss7ansi**, **atmitu**, **atmansi**, **iplim**, **iplimi**, **ss7ipgw**, or **ccs7itu**.

The only qualifier allowed for the **card** parameter is **-all**.

The following parameters are invalid for SCCP cards: **entityid**, **dn**, **imei**, **imsi**, **opc**, **dpc**, **tlnpisuptype**, **sspi**, **sspn**, and **sspn24**.

The following parameters are invalid for ANSI SS7 cards running the **ss7ansi**, **atmansi**, **iplim**, or **ss7ipgw** GPLs: **gt**, **entityid**, **dn**, **imei**, **imsi**, **lrn**, and **tn**.

The following ITU point code parameters are invalid for ANSI SS7 cards running the **ss7ansi**, **atmansi**, **iplim**, or **ss7ipgw** GPLs: **opci**, **open**, **opc24**, **dpci**, **dpcn**, **dpcn24**, **sspi**, **sspn**, and **sspn24**.

The following parameters are invalid for ITU SS7 cards running the **ccs7itu**, **atmitu**, or **iplimi** GPLs: **gt**, **entityid**, **dn**, **imei**, **imsi**, **lrn**, **tn**, and **tlnpisuptype**.

The following ANSI point code parameters are invalid for ITU SS7 cards running the **ccs7itu** or **iplimi** GPLs: **opc**, **opca**, **dpc**, **dpcn**, **ssp**, and **sspa**.

The following parameters are invalid for VSCCP cards: **opc**, **dpc**, and **tlnpisuptype**.

The G-Flex, G-Port, or INP feature must be turned on before the **dn** and **entityid** parameters can be specified.

The G-Flex feature or the Equipment Identity Register feature must be turned on before the **imsi** parameter can be specified.

If the ITU Duplicate Point Code (ITUDUPPC) feature is turned on, the ITU national point code must be specified as a full point code.

The Equipment Identity Register (EIR) feature must be turned on before the **imei** parameter can be specified.

Notes

The **card** parameter is input as two fields separated by a dash '-'

Output

ent-trace:gt=919460:card=sccp-all

```

rlghncxa03w 01-03-18 13:35:28 EST Rel 28.1.0
MSU TRACE DUMP: Version=01 Card=1102
Trace Condition: GT=919460
  0 1 2 3 4 5 6 7 8 9
MTP: 93 00 2d 01 0a 02 2d 0c

SCCP: 09 80 03 09 0e 06 89 10 0f 19
      49 06 05 c3 0a 0a 02 2d

TCAP: 2b e2 29 c7 04 ae 11 ba e3 e8
      21 e9 1f cf 01 0a d1 02 64 03
      30 16 bf 35 07 81 05 03 33 53
      10 00 8d 01 04 8f 07 03 14 19
      49 06 55 00
TRACE COMPLETE.
;
rlghncxa03w 01-03-18 13:35:28 EST Rel 28.1.0
MSU TRACE DUMP: Version=01 Card=1102
Trace Condition: GT=919460 LRN=9105551234 SSP=010-010-010
  0 1 2 3 4 5 6 7 8 9
MTP: 93 00 2d 01 0a 02 2d 0e

SCCP: 09 80 03 09 0e 06 89 10 0f 19
      49 06 05 c3 0a 0a 02 2d

TCAP: 2b e2 29 c7 04 5a 11 64 e5 e8
      21 e9 1f cf 01 0a d1 02 64 03
      30 16 bf 35 07 81 05 03 33 53
      10 00 8d 01 04 8f 07 03 14 19
      49 06 55 00
TRACE COMPLETE.
;
rlghncxa03w 01-03-18 13:35:28 EST Rel 28.1.0
MSU TRACE DUMP: Version=01 Card=1102
Trace Condition: TLNPISUPTYPE=001
  0 1 2 3 4 5 6 7 8 9
MTP: 93 00 2d 01 0a 02 2d 0e

DATA: 05 00 01 00 20 00 00 03 05 0c
      02 80 80 07 03 10 19 49 06 55
      00 0a 07 01 10 19 49 76 21 43
      00
TRACE COMPLETE.
;

```

```

rlghncxa03w 01-03-18 13:35:28 EST Rel 28.1.0
MSU TRACE DUMP: Version=01 Card=1102
Trace Condition: DN=12345
                ENTITYID=c123
      0  1  2  3  4  5  6  7  8  9
MTP:  93 00 2d 01 0a 02 2d 1c

SCCP: 09 80 03 0e 13 0b cb 19 0a 02
      2d 64 19 49 06 55 43 05 c3 10
      0a 02 2d

TCAP: 2e e2 2c c7 04 d9 04 10 c5 e8
      24 e9 22 cf 01 0a d1 02 64 03
      30 19 bf 35 07 81 05 19 49 06
      11 11 8d 01 04 8f 07 03 14 19
      49 06 55 43 94 01 02
TRACE COMPLETE.
;

rlghncxa03w 01-03-18 13:35:28 EST Rel 28.1.0
MSU TRACE DUMP: Version=01 Card=1102
Trace Condition: DN=abcde
                IMSI=c122d
      0  1  2  3  4  5  6  7  8  9
MTP:  93 00 2d 01 0a 02 2d 1c

SCCP: 09 80 03 0e 13 0b cb 19 0a 02
      2d 64 19 49 06 55 43 05 c3 10
      0a 02 2d

TCAP: 2e e2 2c c7 04 d9 04 10 c5 e8
      24 e9 22 cf 01 0a d1 02 64 03
      30 19 bf 35 07 81 05 19 49 06
      11 11 8d 01 04 8f 07 03 14 19
      49 06 55 43 94 01 02
TRACE COMPLETE.
;

rlghncxa03w 05-01-18 13:35:28 EST EAGLE 31.12.0
MSU TRACE DUMP: Version=01 Card=1303
Trace Condition: OPC=s-5-166-1
      0  1  2  3  4  5  6  7  8  9
MTP:  45 bc c8 22 02

DATA: 00 00 0c 02 04 02 80 22 13 02
      00 01 0c 0a 00 00 00 00 00 00
      00 00 00 00 1e 02 41 0e 03 01
      00 20 03 7e 01 00 27 01 00 00
TRACE COMPLETE.

```

rtrv-data-rtdb**Retrieve Network Card Data**

Use this command to retrieve IMSI and/or DN and/or Entity and/or IMEI data from RTDB on an active DSM card. If the card specified in the **loc** parameter is an active DSM card, the RTDB data is retrieved from that card. If the **loc** parameter is not specified, the data will be retrieved from an active DSM card having the lowest IMT address.

Keyword: rtrv-data-rtdb

Related Commands: None

Command Class: Database Administration

Parameters

:dn= (optional)

Dialed Number

Range: 5-15 hexadecimal digits; valid digits are A-F, a-f, 0-9

:entity= (optional)

Network Entity

Range: 1-15 hexadecimal digits; valid digits are A-F, a-f, 0-9

:entitytype= (optional)

Range: sp, rn

sp—Service Provider

rn—Routing Number

Default: sp

:force= (optional)

The **force** parameter must be used (**force=yes**) whenever the desired output, specified by the **num** parameter, exceeds 50 entries.

Range: yes, no

Default: no

:imei= (optional)

International Mobile Equipment Identity

Range: 14 hexadecimal digits; valid digits are A-F, a-f, 0-9

:imsi= (optional)

International Mobile Subscriber Identity

Range: 5-15 hexadecimal digits; valid digits are A-F, a-f, 0-9

:loc= (optional)

Card location

Range: 1101–1108, 1111–1112, 1201–1208, 1211–1218, 1301–1308, 1311–1318, 2101–2108, 2111–2118, 2201–2208, 2211–2218, 2301–2308, 2311–2318, 3101–3108, 3111–3118, 3201–3208, 3211–3218, 3301–3308, 3311–3318, 4101–4108, 4111–4118, 4201–4208, 4211–4218, 4301–4308, 4311–4318, 5101–5108, 5111–5118, 5201–5208, 5211–5218, 5301–5308, 5311–5318, 6101–6108, 6111–6118

:lrn= (optional)

Location Routing Number

Range: 10 digits

:npanxx= (optional)

Number Planning Area and Exchange

Range: 10 digits

:num= (optional)

The number of entries to display.

Range: 1-10000

:tn= (optional)

Telephone Number

Range: 10 digits—To specify a single TN subscription

7 digits with 3 asterisks (***) appended—To pool a block of 1000 TNs

Example

```
rtrv-data-rtdb:imsi=12345
```

```
rtrv-data-rtdb:dn=12345
```

```
rtrv-data-rtdb:entity=abcdefghijklm
```

```
rtrv-data-rtdb:entity=abcdefghijklm
```

```
rtrv-data-rtdb:imei=123456789012
```

```
rtrv-data-rtdb:entity=abcdefghijklm:entitytype=sp
```

Dependencies

At least one optional parameter must be specified.

At least one active DSM card must be active in the system before this command can be entered.

The G-Flex feature must be turned on or the Equipment Identity Register (EIR) feature must be enabled and turned on before the **imsi** parameter can be specified.

The G-Flex feature or the G-Port feature must be turned on before the **dn** parameter or the **entity** parameter can be specified.

The EIR feature must be enabled and turned on before the **imei** parameter can be specified.

If the **loc** parameter is not specified and any of the **npanxx**, **lrn**, or **tn** parameters are specified,

- The matching entry for the respective parameter is retrieved from the lowest numeric value card location in the STP DSM card list that is in service normal and the SCCP subsystem is in the active state.
- The existence of that entry is checked on all other in service normal DSM cards.

If the **loc** parameter is not specified, the **rtrv-data-rtdb** command sequentially accesses all provisioned DSM cards.

When the **loc** parameter is specified, at least one of the following parameters must be specified: **imsi**, **dn**, **entity**, **imei**.

When the **entitytype** parameter is specified, the **entity** parameter must be specified.

The card location specified in the **loc** parameter must be provisioned in the database, and must contain a provisioned DSM card that is running the **vsccp** application and that is currently active.

Notes

The RTDB status on the active DSM card can be coherent or incoherent.

If the specified **imsi** is found in the RTDB, the IMSI data and any associated ENTITY data and IMEI data are also displayed.

If the specified **dn** is found in the RTDB, the DN data and any associated ENTITY data is also displayed.

If the specified **entity** is found in the RTDB, only ENTITY data is displayed.

If the specified **imei** is found in the RTDB, only the IMEI data is displayed.

Output**rtrv-data-rtdb:dn=12345**

```
tekelecstp 05-07-11 07:43:36 EST EAGLE5 31.12.0
```

```
Card Loc      : 1105   Status : Coherent
```

```
DN              Portability Type ( 5)   Entity Index
12345           Migrated with 1 HS     H'00000004
```

```
Entity Address Type   PC(ANSI  ) RI  SSN TT  NP NAI DA
abcdefabcdefabc RN   003-003-003 GT  000 000 00 000 none
```

```
SRFIMSI        NSSN  CCGT  NTT  NNP  NNAI
abcdefabcdefabc no   no   no   no   no
```

```
;
```

rtrv-data-rtdb:entity=abcdef123456abc

```
tekelecstp 05-01-11 07:53:00 EST EAGLE5 31.12.0
```

```
INFO: Default value of Entity Type is : SP
```

```
;
```

```
tekelecstp 05-01-11 07:53:00 EST EAGLE5 31.12.0
```

```
Card Loc      : 1105   Status : Coherent
```

```
Entity Address Type   PC(NATL-gg) RI  SSN TT  NP NAI DA
abcdef123456abc SP   s-02000      SSN 122 000 00 000 prefix
```

```
SRFIMSI        NSSN  CCGT  NTT  NNP  NNAI
1234567890abcde yes  no   no   no   no
```

```
;
```

rtrv-data-rtdb:entity=abcdef123456abc:entitytype=sp

```
tekelecstp 05-01-11 07:56:48 EST EAGLE5 31.12.0
```

```
Card Loc      : 1105   Status : Coherent
```

```
Entity Address Type   PC(NATL-gg) RI  SSN TT  NP NAI DA
abcdef123456abc SP   p-02000      SSN 122 000 00 000 prefix
```

```
SRFIMSI        NSSN  CCGT  NTT  NNP  NNAI
1234567890abcde yes  no   no   no   no
```

```
;
```

rtrv-data-rtdb:imsi=12345

tekelecstp 03-09-11 07:55:28 EST EAGLE5 31.0.0

Card Loc : 1105 Status : Coherent

IMSI	Entity Index	IMEI Index
12345	H'00000002	H'00000006

Entity Address	Type	PC (NATL-gg)	RI	SSN	TT	NP	NAI	DA	SRFIMSI
abcdef123456abc	SP	02000		SSN 122	000	00	000	prefix	1234567890abcde

NSSN	CCGT	NTT	NNP	NNAI
yes	no	no	no	no

IMEI	VERSION	BLACK	GRAY	WHITE
12345678901234	0	yes	yes	yes

;

rtrv-data-rtdb:imei=12345678abcdef

tekelecstp 05-01-11 07:54:55 EST EAGLE5 31.12.0

Card Loc : 1105 Status : Coherent

IMEI	VERSION	BLACK	GRAY	WHITE
12345678abcdef	0	yes	no	yes

;

Legend**CARD LOC**—Location of the card that contains the retrieved information.**STATUS**—RTDB database status; Coherent or Incoherent.**IMSI**—International Mobile Subscriber Identity.**ENTITY INDEX**—The hexadecimal index at which the Network Entity data is stored in the Entity Bucket on the DSM card.**IMEI INDEX**—The hexadecimal index at which the IMEI data is stored in the IMEI Bucket on the DSM card.**ENTITY ADDRESS**—Hexadecimal Network Entity address.**TYPE**—Network Entity type; Service Provider (SP) or Routing Number (RN).**PC (type of PC)**—Point code and type of point code (ANSI; NATL - ITU National with or without group code (-gg)).**RI**—Routing Indicator**SSN**—Subsystem Number.**TT**—Translation Type.**NP**—Numbering Plan**DA**—Digits action (Prefix, Suffix, or none)**SRFIMSI**—Signaling Relay Function IMSI.**NSSN**—New Subsystem Number (yes or no)**CCGT**—Cancel GT (yes or no)

NTT—New Translation Type

NNP—New Numbering Plan

NNAI—New Nature of Address Indicator

IMEI—International Mobile Equipment Identity.

VERSION—IMEI data version

BLACK, WHITE, GRAY—Equipment Identity Register search lists

DN—Dialed Number

PORTABILITY TYPE (*number*)—

- 0—Not known to be ported
- 1—Own number ported out
- 2—Foreign number ported to Foreign network
- 3—Prepaid Short Message Service (PPSMS) subscriber on server #1
- 4—Prepaid Short Message Service (PPSMS) subscriber on server #2
- 5—IS-41 to GSM migrated subscriber with only GSM handset active
- 255—No portability type

send-msg

Send Message

This debug command is used to manually simulate a system generated message from a user terminal. The parameters (not entered by the user) are defaulted to:

- Origination subsystem = **cam_active**
- Destination subsystem = **orig application ID=appl_ID_ui**
- Violation= **no report**
- Bus = **imt choice**
- Message length = **computed**

Keyword: send-msg

Related Commands: None

Command Class: Debug

Parameters

:da= (mandatory)

Destination application ID

Range: 0–255

:ds= (mandatory)

Destination subsystem.

Range: 0–255

:f= (mandatory)

Function ID.

Range: 0-255

:loc= (mandatory)

The card location as stenciled on the shelf of the system.

Range: 1101-1108, 1111-1113, 1115, 1201-1208, 1211-1218, 1301-1308, 1311-1318, 2101-2108, 2111-2118, 2201-2208, 2211-2218, 2301-2308, 2311-2318, 3101-3108, 3111-3118, 3201-3208, 3211-3218, 3301-3308, 3311-3318, 4101-4108, 4111-4118, 4201-4208, 4211-4218, 4301-4308, 4311-4318, 5101-5108, 5111-5118, 5201-5208, 5211-5218, 5301-5308, 5311-5318, 6101-6108, 6111-6118

:alt= (optional)

Use the alternate bus bit.

Range: on, off

Default: on

:bus= (optional)

The IMT bus.

Range: a, b

Default: a

:oa= (optional)

Originating application ID.

Range: 0-255

Default: 2

:os= (optional)

Originating subsystem.

Range: 0-255

Default: 0

:d0= (optional)

Application Data.

Range: 0-255

:d1= (optional)

Application Data.

Range: 0-255

:d2= (optional)

Application Data.

Range: 0-255

:d3= (optional)

Application Data.

Range: 0-255

:d4= (optional)
Application Data.
Range: 0-255

:d5= (optional)
Application Data.
Range: 0-255

:d6= (optional)
Application Data.
Range: 0-255

:d7= (optional)
Application Data.
Range: 0-255

:d8= (optional)
Application Data.
Range: 0-255

:d9= (optional)
Application Data.
Range: 0-255

:len= (optional)
Message length in bytes.
Range: 0-65535
Default: Calculated

Example

```
send-msg:loc=1113:os=2:oa=h'28:ds=2:da=h'28:f=7
send-msg:loc=1113:ds=2:oa=h'17:da=h'30:f=11
```

Dependencies

The destination application ID and subsystem must be valid.
The destination location must be equipped to receive messages.

Notes

None

Output

```
send-msg:loc=1113:os=2:oa=h'28:ds=2:da=h'28:f=7
rlghncxa03w 01-03-13 15:01:02 EST
0061.0019 CARD 1113 PSM ADMIN PSM became active
;
```

```

send-msg:loc=1113:ds=2:oa=h'17:da=h'30:f=11
rlghncxa03w 01-03-13 15:02:34 EST
System Buffer sent has following attributes :
  Msg Length = H'0006
  Dest Card = H'00f4
  Orig Subsys = H'0002      Dest Subsys = H'0002
  Orig Appl ID = H'0017    Dest Appl ID = H'0030
  Func ID = H'000b        Bus/Alt/SUT = H'000b
  Violation Ind = H'0000
User Message sent to location 1113.
;

```

set-mem**Set Memory**

This command sets values in memory in the communication and application processors. If a card is reloaded, these memory changes are lost.

Keyword: set-mem

Related Commands: disp-mem

Command Class: Debug

Parameters

:addr= (optional)

The address, in the form of *segment–offset*

Range: *segment*—h'00–h'ffff
offset—h'00–h'ffff

:byte= (optional)

The number of data bytes to display.

Range: 0–h'00–h'ff

:card= (optional)

Card location, in the form of *GPLID–Subsystem ID*.

Range: *GPLID*—atmansi, atmitu, bphcap, bpdcm, ccs7itu, ebdablm, ebdadcm, emdc,
gls, hipr, imt, iplim, iplimi, oam, sccp, ss7ansi, ss7gx25, ss7ipgw, stplan,
utility, vsccp, vxwslan

Subsystem ID—a, b, act, stby, all

The **oam** GPL can be specified with any of the subsystem IDs.

For all other GPLs, only the **all** subsystem ID is valid.

:dword= (optional)

A double word value.

Range: 0–h'00–h'ffffff

:fill= (optional)

The number of times that the value is to be written to successive addresses.

Range: 0–65535

Default: 1

:imt= (optional)

IMT address.

Range: 0–254

:loc= (optional)

The card location as stenciled on the shelf of the system.

Range: 1101–1108, 1111–1113, 1115, 1201–1208, 1211–1218, 1301–1308, 1311–1318,
2101–2108, 2111–2118, 2201–2208, 2211–2218, 2301–2308, 2311–2318, 3101–3108,
3111–3118, 3201–3208, 3211–3218, 3301–3308, 3311–3318, 4101–4108, 4111–4118,
4201–4208, 4211–4218, 4301–4308, 4311–4318, 5101–5108, 5111–5118, 5201–5208,
5211–5218, 5301–5308, 5311–5318, 6101–6108, 6111–6118

:mask= (optional)

The mask that selects the bits that are to be included in the operation (**op**).

Range: 0–0xFFFFFFFF

Default: 0xFFFFFFFF

:op= (optional)

The operation that is performed in order to arrive at the final value in the memory location.

Range: replace, and, or, xor

Default: replace

:paddr= (optional)

The physical offset of the memory address.

Range: 0–h'00–h'ffffff

:proc= (optional)

Processor type.

Range: appl, com
appl—Application processor)
com—Communication processor)

Default: appl

:word= (optional)

A word value.

Range: h'00–h'ffff

Example

```
set-mem:card=ss7ansi-all:addr=h'03a-h'001:byte=4
```

```
set-mem:loc=1109:paddr=h'201000:byte=0:fill=1024
```

```
set-mem:card=hipr-all:paddr=h'202000:word=h'2a:op=and:mask=h'fff
```

Dependencies

The **loc**, **imt**, or **card** parameter must be specified.

Only one of the **loc**, **imt**, and **card** parameters can be specified in the command.

The **byte**, **word**, or **dword** parameter must be specified.

Only one of the **byte**, **word**, and **dword** parameter can be specified.

Either the **addr** parameter or the **paddr** parameter, but not both, can be specified.

The **paddr** parameter cannot be specified for an SS7 LIM card.

The card location specified by the **loc** parameter must be in the database.

All of the *subsystem* values can be specified with the **oam GPLID**. The other *GPLID* values can be specified only with the **all subsystem** value.

Card locations (**loc** parameter) **1114**, **1116**, **1117**, and **1118** are not valid for break point commands.

Notes

The **imt** parameter allows this command to be entered for a card that has not been configured in the system.

Output

```
set-mem:card=ss7ansi-all:addr=h'03a-h'001:byte=4
rlghncxa03w 01-03-22 21:14:03 EST Rel 28.1.0
SDS Response Code 22 from IMT Address H'00f6 - command complete.
;
```

vfy-lnp-refnum

LNP Verify Reference Number

NOTE: This command is obsolete.

This command is used for automated test purposes only to compare the entered reference number to the table entry reference number. No output is provided by this command.

NOTE: If the LNP ELAP Configuration feature is turned on, this command is no longer available, and all LNP provisioning is performed at the LSMS.

Keyword: vfy-lnp-refnum

Related Commands: chg-lnp-refnum

Command Class: Debug

Parameters

:ref= (mandatory)

Reference number

Range: 0-4294967280

:gtt= (optional)

Global title translation value with the following mandatory arguments: **tt**, **pc**, **ssn**.

When the **gtt** parameter is specified, the constituent values must *all* be entered and separated by a comma (,) or a dash (-) in the order **tt-pc-ssn**.

tt-

Translation type

Range: 000-255

pc-

ANSI point code in the form of *network indicator-network cluster-network cluster member* (*ni-nc-ncm*).

Range: 000-255

Specify a valid value for each subfield of the point code, and separate the subfields with a dash (-).

ni = 000 is not valid.

nc = 000 is not valid if *ni* = 001-005.

nc = 000 is valid if *ni* = 006-255.

The point code 000-000-000 is not a valid point code.

ssn-

Subsystem number

Range: 000-255

:lrn= (optional)

Location routing number

Range: 10 digits

:npanxx= (optional)

Numbering plan area and exchange

Range: 6 digits

:sp= (optional)

Service provider

Range: 4 alphanumeric characters

:tt= (optional)

Translation type

Range: 0-255

Example

vfy-lnp-refnum:ref=12:npanxx=919223:tt=20

Dependencies

Only one optional parameter can be specified, with the following exception: when **npanxx** is specified, **tt** must also be specified.

The LNP feature must be turned on (see the **enable-ctrl-feat** command) before the **vfy-lnp-refnum** command can be entered

The translation type (**tt**) value must be a reserved service for LNP and must be a true translation type, not an LNP alias.

A translation type cannot be specified that is associated with WNP or PCS query services.

Notes

None

Output

vfy-lnp-refnum:ref=12:npanxx=919223:tt=20

rlghncxa03w 03-01-18 08:50:12 EST Rel 30.0.0
VFY-REFNUM: MASP A - COMPLTD

;

Pass-Through Commands

This chapter introduces the pass-through commands and describes the command conventions. The pass-through commands are listed in alphabetical order starting on page 9-2.

Introduction

The pass-through commands are used within the **pass** command (see Chapter 7). Pass-through commands are passed through the OAM and sent to individual cards for processing. Pass-through commands reduce the need to add card-specific and application-specific code to the OAM build.

Command Conventions

The following is an example of a **pass** command:

```
pass:loc=1201:cmd="connmgr -c"
```

The **cmd** parameter contains the pass-through command (**connmgr -c**) within the double quotes.

Pass-through commands consist of two types of tokens: command name and command options. Tokens are whitespace-delimited and null-terminated. The generalized format of a pass-through command is:

```
command_name option1 option2....option n-1.... option n
```

In the example, the **command_name** is '**connmgr**' and the option is '-c'.

Options and option parameters are made up of a specific character string or a variable. The variable is to be replaced with a value selected from a range of values.

Option variables and option parameter variables are underlined. For example, the **arp** command option **-d** has the parameter variable IP address. Specify the IP address as in the command **arp -d 192.9.200.44**. Do not enter the underlined text; enter a value instead.

Help information for each pass-through command can be obtained by using the option **-h** on any command.

arp**Address Resolution Protocol**

This command is used to display and modify the internet to ethernet address translation tables used by the address resolution protocol.

Command Name: arp

Command Class: IP Stack Maintenance

Options

Options and option parameters that are underlined indicate that a value must be specified for that option or parameter. For example, the arp command option **-d** has the parameter **IP address**. The IP address must be specified for which an ARP entry will be deleted, as in the command **arp -d 192.9.200.44**. Do not enter the underlined option or parameter; enter a value for the information represented by the underlined option or parameter.

-a

This option displays all entries in the ARP table.

-d IP address

This option deletes an ARP entry for the specified IP address.

The IP address is a TCP/IP address expressed in standard “dot notation.” IP addresses consist of the system’s network number and the machine’s unique host number. An example IP address is **192.9.200.44**, where **192.9.200** is the network number and **44** is the machine’s host number.

Range: 4 numbers separated by dots, with each number in the range of **0-255**.

-f

This option flushes all entries from the ARP table.

-h

This option displays help (usage) information for the command.

-s IP address MAC address

This option creates an ARP entry for the specified IP address and ethernet address.

Range: 4 numbers separated by dots, with each number in the range of **0-255**.

The IP address is a TCP/IP address expressed in standard “dot notation.” IP addresses consist of the system’s network number and the machine’s unique host number. For example, **192.9.200.44**, where **192.9.200** is the network number and **44** is the machine’s host number.

Range: 6 hexadecimal numbers separated by colons; each number in the range **0 - FF**.

The MAC (media access control) address is an ethernet address with the format **x:x:x:x:x:x**, where **x** is a hexadecimal integer from **0** to **FF**. For example, **08:00:20:1b:0f:f2**.

Example

```
arp -a
```

```
arp -s 192.9.200.44 08:00:20:1b:0f:f2
```

```
arp -d 192.9.200.44
```

```
arp -f
```

Dependencies

Only one of the options can be specified at a time.

The **arp** command with no options displays all of the current ARP cache entries.

Notes

The **arp** command is executed through the **pass** command.

Output

pass:loc=1105:cmd="arp" or

pass:loc=1105:cmd="arp -h"

Command Accepted - Processing

```
rlghncxa03w 04-07-27 08:10:00 EST EAGLE5 31.6.0
  pass: loc=1105: cmd="arp"
  Command entered at terminal #1.
```

;

```
rlghncxa03w 04-07-27 08:10:00 EST EAGLE5 31.6.0
  PASS: Command sent to card
```

;

```
rlghncxa03w 04-07-27 08:10:00 EST EAGLE5 31.6.0
```

```
Usage: arp [-a] [-d ipaddr] [-f] [-h] [-s ipaddr enetaddr]
```

Options:

```
-a      Display All entries in ARP table
-d      Delete specified entry (ipaddr) from ARP table
-f      Flush all entries from ARP table
-h      Displays this message
-s      Set ARP table entry to associate ipaddr with enetaddr
enetaddr x:x:x:x:x:x
ipaddr   d.d.d.d
```

;

```
rlghncxa03w 04-07-27 08:10:01 EST EAGLE5 31.6.0
```

```
ARP command complete
```

;

pass:loc=1105:cmd="arp -s 192.168.100.234 11:22:33:44:55:66"

Command Accepted - Processing

```
rlghncxa03w 04-07-27 08:11:08 EST EAGLE5 31.6.0
  pass: loc=1105: cmd="arp -s 192.168.100.234 11:22:33:44:55:66"
  Command entered at terminal #1.
```

;

```
rlghncxa03w 04-07-27 08:11:08 EST EAGLE5 31.6.0
  PASS: Command sent to card
```

;

```
rlghncxa03w 04-07-27 08:11:08 EST EAGLE5 31.6.0
```

```
ARP: 192.168.100.234 (11:22:33:44:55:66) added
```

;

```
rlghncxa03w 04-07-27 08:11:09 EST EAGLE5 31.6.0
```

```
ARP command complete
```

;

pass:loc=1105:cmd="arp -a"

Command Accepted - Processing

```

rlghncxa03w 04-07-27 08:11:18 EST  EAGLE5 31.6.0
  pass: loc=1105: cmd="arp -a"
  Command entered at terminal #1.
;
rlghncxa03w 04-07-27 08:11:18 EST  EAGLE5 31.6.0
  PASS: Command sent to card
;
RLGHNCXA03WRLGHNCXA03W 04-07-27 08:11:18 EST  EAGLE5 31.6.0

  LINK LEVEL ARP TABLE
destination      gateway                flags  Refcnt  Use      Interface
-----
192.168.55.250   00:e0:16:9b:0d:86     405    1       0       seeq1
192.168.100.234 11:22:33:44:55:66    c05    0       0       seeq0
-----
;
rlghncxa03w 04-07-27 08:11:19 EST  EAGLE5 31.6.0
  ARP command complete
;

```

pass:loc=1105:cmd="arp -f"

Command Accepted - Processing

```

rlghncxa03w 04-07-27 08:11:38 EST  EAGLE5 31.6.0
  pass: loc=1105: cmd="arp -f"
  Command entered at terminal #1.
;
rlghncxa03w 04-07-27 08:11:38 EST  EAGLE5 31.6.0
  PASS: Command sent to card
;
rlghncxa03w 04-07-27 08:11:38 EST  EAGLE5 31.6.0
  ARP: ARP table flushed
;
rlghncxa03w 04-07-27 08:11:38 EST  EAGLE5 31.6.0

  ARP command complete
;

```

pass: loc=1105: cmd="arp -d 192.111.111.222"

E3780 Cmd Rej: Syntax Error Found

```

rlghncxa03w 04-07-27 08:26:37 EST  EAGLE5 31.6.0
  pass: loc=1105: cmd="arp -d 192.111.111.222"
  Command entered at terminal #1.
;
rlghncxa03w 04-07-27 08:26:37 EST  EAGLE5 31.6.0
  PASS: Command sent to card
;
rlghncxa03w 04-07-27 08:26:37 EST  EAGLE5 31.6.0
  ARP: entry not deleted
;
rlghncxa03w 04-07-27 08:26:37 EST  EAGLE5 31.6.0

  ARP command complete
;

```

aslog

SCTP Application Server Log

This command is used to display the state changes for a specified Application Server (AS).

Command Name: aslog

Command Class: Application Maintenance

Options

Options and option parameters that are underlined indicate that a value must be specified for that option or parameter. For example, the **aslog** command has the parameter asname. The Application Server name must be specified for which the log will be displayed, as in the command **asloc as1**. Do not enter the underlined option or parameter; enter a value for the information represented by the underlined option or parameter.

asname

This option specifies the Association Server name for the display.

-h

This option displays help (usage) information for the command.

Example

```
aslog as1
```

Dependencies

None

Notes

None

Output

```
pass:loc=1105:cmd="aslog as1"
```

```
Command Accepted - Processing
```

```
rlghncxa03w 00-01-27 08:10:00 EST EAGLE5 31.6.0  
pass: loc=1105: cmd="aslog as1"  
Command entered at terminal #3.
```

```
;
```

```
rlghncxa03w 00-01-27 08:10:00 EST EAGLE5 31.6.0  
PASS: Command sent to card
```

```
;
```

```
rlghncxa03w 00-01-27 08:10:00 EST EAGLE5 31.6.0  
ASLOG command in progress
```

```
;
```

```

rlghncxa03w 00-01-27 08:10:00 EST  EAGLE5 31.6.0

ASLOG: AS history log

ASLOG: AS state history log

Date          Time          AS Event
-----
65-05-31  22:27:29.075  Transition to AS-Down
65-05-31  22:27:29.080  Transition to AS-Active Override
65-05-31  22:38:24.050  Transition to AS-Active Override

ASLOG command complete
;

```

asplog**SCTP Application Server Process Log**

NOTE: This command is obsolete. The functions have been updated and moved to the ualog command.

This command is used to display the UA state history for a specified Application Server Process (ASP).

Command Name: asplog

Command Class: Application Maintenance

Options

Options and option parameters that are underlined indicate that a value must be specified for that option or parameter. For example, the **asplog** command has the parameter **asp name**. The Application Server Process must be specified for which the log will be displayed, as in the command **asplog s7000**. Do not enter the underlined option or parameter; enter a value for the information represented by the underlined option or parameter.

asp name

This option specifies the Application Server Process name for the display.

-h

This option displays help (usage) information for the command.

-i event group

This option includes groups of events in the state machine history.

Range: service, ua

-x event group

This option excludes groups of events from the state machine history.

Range: service, ua

Example

```
asplog s7000
```

Dependencies

None

Notes

None

Output

In this example, transmitted notification, ASP Inactivation (RFC Extension) , ASP Activation (RFC Extension) and ASP Failure Notification events are shown.

pass:loc=1105:cmd="asplog s7000"

```

Command entered at terminal #3.
;
rlghncxa03w 02-09-27 08:10:00 EST  EAGLE5 31.6.0
PASS: Command sent to card
;
rlghncxa03w 02-09-27 08:10:00 EST  EAGLE5 31.6.0
ASPLOG command in progress
;
rlghncxa03w 02-09-27 08:10:00 EST  EAGLE5 31.6.0

ASPLOG: ASP history log

ASPLOG: ASP state history log
        UA version: 01
        ASP ID:0x00000002
        UA Adapter Implemented: M3UA RFC
        Current settings: -i service ua

Date      Time      ASP Event
-----
02-08-01  17:17:46.700  ASP Created
02-08-01  17:17:46.780  AS Created
02-08-01  17:17:46.820  Transition to OOS
02-08-01  17:17:46.940  Management Socket Open
02-08-01  17:17:46.940  Transition to Connecting
02-08-01  17:17:47.500  Socket Allowed for Traffic
02-08-01  17:17:49.375  Socket Connection Established
02-08-01  17:17:49.375  Transition to ASP-DOWN
02-08-01  17:17:49.390  ASPUP PDU Received (ASP ID = 0x00000002)
02-08-01  17:17:49.390  ASPUPACK PDU Transmitted
02-08-01  17:17:49.390  Transition to ASP-INACTIVE LOADSHARE
02-08-01  17:17:49.390  AS INACTIVE NTFY PDU Transmitted
02-08-01  17:17:49.405  ASPACTIVE PDU Received
02-08-01  17:17:49.405  ASPACTIVEACK PDU Transmitted
02-08-01  17:17:49.405  Transition to ASP-ACTIVE LOADSHARE
02-08-01  17:17:49.405  AS ACTIVE NTFY PDU Transmitted
02-08-01  17:17:50.405  ASP INACT NTFY PDU Transmitted (ASP ID =0x00000005)
02-08-01  17:17:50.405  ASP ACT NTFY PDU Transmitted (ASP ID =0x00000005)
02-08-01  17:17:52.730  ASP FAILURE NFY PDU Transmitted (ASP ID =0x00000003)

ASPLOG command complete
;

```

The following output example shows output when User Adapter SUA RFC is implemented:

pass:loc=1303:cmd="asplog s7000"

```

rlghncxa03w 04-10-19 08:10:00 EST  EAGLE5 31.10.0
PASS: Command sent to card
;

rlghncxa03w 04-10-19 08:10:00 EST  EAGLE5 31.10.0

ASPLOG command in progress

;

rlghncxa03w 04-10-19 08:10:00 EST  EAGLE5 31.10.0
ASPLOG: ASP state history log
      UA Version: 01
      ASP ID: 0x00000007
      User Adapter Implemented: SUA RFC
      Current settings: -i service ua

Date          Time          Event
-----
04-11-09  18:56:06.515  IP Conn Established
04-11-09  18:56:06.515  Transition to ASP-DOWN
04-11-09  18:56:41.595  ASPUP PDU Received (ASP ID=0x00000007)
04-11-09  18:56:41.595  ASPUPACK PDU Transmitted
04-11-09  18:56:41.595  Transition to ASP-INACTIVE LOADSHARE
04-11-09  18:56:41.595  AS INACTIVE NTFY PDU Transmitted (RC=000000023)
04-11-09  18:56:41.595  ASPACTIVE PDU Received (RC=none)
04-11-09  18:56:41.595  ASPACTIVEACK PDU Transmitted (RC=000000023)
04-11-09  18:56:41.595  Transition to ASP-ACTIVE LOADSHARE
04-11-09  18:56:41.595  AS ACTIVE NTFY PDU Transmitted (RC=000000023)

ASPLOG: command complete
;

```

When a received M3UA or SUA PDU contains errors, a response error message is transmitted containing an error code. Error codes are recorded to and displayed in the **asplog** output only when the UA peer-to-peer message logging option (**-i ua**) is enabled.

The following output example shows error code 0x0000015:

pass:loc=1303:cmd="asplog asp1303a"

```

rlghncxa03w 00-01-27 08:10:00 EST  EAGLE5 31.6.0
PASS: Command sent to card
;

rlghncxa03w 00-01-27 08:10:00 EST  EAGLE5 31.6.0

ASPLOG command in progress

;

rlghncxa03w 00-01-27 08:10:00 EST  EAGLE5 31.6.0

ASPLOG: ASP state history log
      UA Version: 01
      ASP ID:undefined
      UA Adapter Implemented: M3UA_RFC
      Current settings: -i service ua

```

Date	Time	Socket Event
02-08-01	17:17:46.940	Management Socket Open
02-08-01	17:17:46.940	Transition to Connecting
02-08-01	17:17:49.375	Socket Connection Established
02-08-01	17:17:49.375	Transition to ASP-DOWN
02-08-01	17:17:49.390	ASPUP PDU Received (ASP ID = undefined)
02-08-01	17:17:49.390	ASPUPACK PDU Transmitted
02-08-01	17:17:49.390	Transition to ASP-INACTIVE LOADSHARE
02-08-01	17:17:49.390	AS INACTIVE NTFY PDU Transmitted
02-08-01	17:17:49.405	ASPACTIVE PDU Received
02-08-01	17:17:49.405	ASPACTIVEACK PDU Transmitted
02-08-01	17:17:49.405	Transition to ASP-ACTIVE LOADSHARE
02-08-01	17:17:49.405	AS ACTIVE NTFY PDU Transmitted
02-08-01	17:17:49.450	DAUD PDU Received
02-08-01	17:17:49.480	ERR PDU Transmitted (0x00000015)

ASPLOG command complete

;

Error Codes

NOTE: The following error codes are not used in M3UA: 0x02, 0x08, 0x1a, 0x1b, 0x1c, 0x10, 0x17, and 0x18

The following error codes can appear in the error messages:

0x01—Invalid Version

A message was received with an invalid or unsupported version. The error message contains the supported version in the Common Header.

0x03—Unsupported Message Class

A message was received with an unexpected or unsupported Message Class.

0x04—Unsupported Message Type

A message was received with an unexpected or unsupported Message Type.

0x05—Unsupported Traffic Handling Mode

This error is sent by a Signaling Gateway Process (SGP) if an Application Server Process (ASP) sends an ASP Active message with an unsupported Traffic Mode Type or a Traffic Mode Type that is inconsistent with the currently configured mode for the Application Server (AS).

0x06—Unexpected Message

This error message can be sent if a defined and recognized message is received that is not expected in the current state. In some cases the ASP might silently discard the message and not send an error message. Silent discard is used by an ASP if it received a DATA message from a signaling point while the ASP is in the ASP-INACTIVE state. If the unexpected message contains Routing Context, the Routing Context can be included in the error message.

0x07—Protocol Error

This error message is sent for any protocol anomaly, such as reception of a parameter that is syntactically correct but unexpected in the current situation.

0x09—Invalid Stream Identifier

A message is received on an unexpected SCTP stream (for example, a Management message was received on a stream other than 0).

0x0d—Refused - Management Blocking

An ASP Up or ASP Active message is received and the request is refused for management reasons (such as management lockout). If this error is in response to an ASP Active message, the Routing Context in the ASP Active message can be included in the error message.

0x0e—ASP Identifier Required

This error message is sent by an SGP in response to an ASP Up message that does not contain an ASP Identifier parameter when the SGP requires one. The ASP should resend the ASP Up message with an ASP Identifier.

0x0f—Invalid ASP Identifier

This error message is sent by an SGP in response to an ASP Up message with an invalid (for example, non-unique) ASP Identifier

0x11—Invalid Parameter Value

A message is received with an invalid parameter value (for example, a DUPU message was received with a Mask value other than 0).

0x12—Parameter Field Error

A message is received with a parameter that has a wrong length field.

0x13—Unexpected Parameter

A message contains an invalid parameter.

0x14—Destination Status Unknown

This error message can be sent if a DAUD is received at a Signaling Gateway (SG) asking for the availability/congestion status of a destination, and the SG does not provide the status (as in the case when the sender is not authorized to know the status). For this error, each invalid or unauthorized Point Code is included along with the Network Appearance and/or Routing Context associated with the Point Code.

0x15—Invalid Network Appearance

This error message is sent by an SGP if an ASP sends a message with an invalid (unconfigured) Network Appearance value. For this error, the invalid (unconfigured) Network Appearance is included in the Network Appearance parameter.

0x16—Missing Parameter

A message is received, and a mandatory parameter is not included in the message.

0x19—Invalid Routing Context

A message is received from a peer with an invalid (unconfigured) Routing Context value. The invalid Routing Context is included in the error message.

0x1a—No Configured AS for ASP

A message is received from a peer without a Routing Context parameter, and it is not known by configuration data which Application Servers are referenced.

assocrtt**SCTP Association Round Trip Time**

This command is used to display the SCTP round trip times for a specified association. Minimum, maximum, and average times are kept for each open association. The Retransmission Mode (RFC or LIN) and the configured Minimum and Maximum Retransmission Timeout limits are also displayed.

Command Name: `assocrtt`

Command Class: Application Maintenance

Options

Options and option parameters that are underlined indicate that a value must be specified for that option or parameter. For example, the `assocrtt` command has the parameter `aname`. The association name must be specified for which the information will be displayed, as in the command `assocrtt c7000`. Do not enter the underlined option or parameter; enter a value for the information represented by the underlined option or parameter.

aname

This option specifies the association name for the display.

-r

This option resets all statistics for the specified association name.

Example

```
assocrtt c7000
```

```
assocrtt c7000 -r
```

Dependencies

None

Notes

This command does not indicate whether or not the socket is congested.

Output

```

pass:loc=1105:cmd="assocrtt" or
pass:loc=1105:cmd="assocrtt -h"
  Command entered at terminal #1.
;
  rlghncxa03w 00-01-27 08:10:00 EST  EAGLE5 31.6.0
  PASS: Command sent to card
;
  rlghncxa03w 00-01-27 08:10:00 EST  EAGLE5 31.6.0

  Usage: ASOVRTT sockname [-r] [-h]
  Options:
    -r          Resets rtt data for specified association
    -h          Displays this message
;
  rlghncxa03w 00-01-27 08:10:00 EST  EAGLE5 31.6.0
  ASSocrtt command complete
;
pass:loc=1105:cmd="assocrtt c7000"
  Command Accepted - Processing

  rlghncxa03w 00-01-27 08:10:00 EST  EAGLE5 31.6.0
  pass: loc=1105: cmd="assocrtt c7000"
  Command entered at terminal #1.
;
  rlghncxa03w 00-01-27 08:10:00 EST  EAGLE5 31.6.0
  PASS: Command sent to card
;
  rlghncxa03w 00-01-27 08:10:00 EST  EAGLE5 31.6.0

  ASSOVRTT: Association round trip time report (in milliseconds)

  Retransmission Configuration
    Retransmission Mode          : LIN
    Minimum RTO      : 120
    Maximum RTO      : 800

  Traffic Round-Trip Times

    Minimum round-trip time      : 5
    Maximum round-trip time      : 120
    Weighted Average round-trip time : 10
    Last recorded round-trip time  : 10
;
  Measured Congested Traffic Round-Trip Times

    Minimum round-trip time      : 0
    Maximum round-trip time      : 0
    Weighted Average round-trip time : 0
    Last recorded round-trip time  : 0
;
  rlghncxa03w 00-01-27 08:10:01 EST  EAGLE5 31.6.0
  ASSOVRTT command complete
;

```

```

pass:loc=1105:cmd="assocrtt c7000 -r"
  Command entered at terminal #1.
;
  rlghncxa03w 00-01-27 08:10:01 EST  EAGLE5 31.6.0
  PASS: Command sent to card
;
  rlghncxa03w 00-01-27 08:10:01 EST  EAGLE5 31.6.0

  ASSocrtt: Association round-trip time report (in milliseconds)

  Retransmission Configuration
    Retransmission Mode           : RFC
    Minimum RTO      : 120
    Maximum RTO      : 800

  Traffic Round-Trip Times

    Minimum round-trip time       : 5
    Maximum round-trip time       : 120
    Weighted Average round-trip time : 10
    Last recorded round-trip time  : 10

  Measured Congested Traffic Round-Trip Times

    Minimum round-trip time       : 0
    Maximum round-trip time       : 0
    Weighted Average round-trip time : 0
    Last recorded round-trip time  : 0
;
  rlghncxa03w 00-01-27 08:10:01 EST  EAGLE5 31.6.0
  ASSocrtt command complete
;

```

connmgr**Connection Manager**

This command is used to generate reports about the status of the connection manager.

Command Name: connmgr

Command Class: Application Maintenance

Options

-c

This option displays client information for all client connections.

-d

This option displays a connection manager data summary.

-h

This option displays help (usage) information for the command.

-i

This option displays SCTP instance and association data.

-l

This option displays the connection manager event log.

-n

This option displays the SCTP notification log.

-r

This option resets the connection manager event log.

-s

This option displays information for all server sockets.

Example**connmgr -r****connmgr -c****connmgr -s****Dependencies**

Only one of the options can be specified at a time.

If no options are specified, usage information is displayed.

NotesThe **connmgr** command is executed through the **pass** command.**Output****pass:loc=1107:cmd="connmgr" or****pass:loc=1107:cmd="connmgr -h"**

Command Accepted - Processing

rlghncxa03w 04-07-02 15:29:46 EST EAGLE5 31.6.0

pass:loc=1107:cmd="connmgr -h"

Command entered at terminal #1.

;

rlghncxa03w 04-07-02 15:29:46 EST EAGLE5 31.6.0

PASS: Command sent to card

;

rlghncxa03w 04-07-02 15:29:46 EST EAGLE5 31.6.0

Usage: CONNMGR [-c] [-d] [-h] [-i] [-l] [-n] [-r] [-s]

Options:

```

-c   Display socket client data
-d   Display connection manager data summary
-h   Displays this message
-i   Displays SCTP instance and association data
-l   Display the connection manager event log
-n   Displays the SCTP notification log
-r   Reset the connection manager event log
-s   Display socket server data

```

;

pass:loc=1107:cmd="connmgr -c"

Command Accepted - Processing

```

rlghncxa03w 04-07-02 15:30:50 EST  EAGLE5 31.6.0
pass:loc=1107:cmd="connmgr -c"
Command entered at terminal #1.
;
rlghncxa03w 04-07-02 15:30:50 EST  EAGLE5 31.6.0
PASS: Command sent to card
;
rlghncxa03w 04-07-02 15:30:50 EST  EAGLE5 31.6.0
CONNMGR: command being processed
;
rlghncxa03w 04-07-02 15:30:50 EST  EAGLE5 31.6.0
CONNMGR: Connection Manager Client Data
task_id  client state lport  cfg  opn  cn_atmpt  cn_made
-----
0113D2C0 lnk-dact      5026   1   0       0         0
0113C118 lnk-dact      5027   1   0       0         0
0113AF70 lnk-dact      5028   1   0       0         0
01139DC8 lnk-dact      5029   1   0       0         0
01138C20 lnk-dact      5030   1   0       0         0

CONNMGR command complete
;

```

pass:loc=1103:cmd="connmgr -c"

The following example includes the `slk` column, which can show signaling link port B only for for IPLIMx cards.

Command Accepted - Processing

```

rlghncxa03w 04-07-02 15:30:50 EST  EAGLE5 31.6.0
pass:loc=1103:cmd="connmgr -c"
Command entered at terminal #4.
;
rlghncxa03w 04-07-02 15:30:50 EST  EAGLE5 31.6.0
PASS: Command sent to card
;
rlghncxa03w 04-07-02 15:30:50 EST  EAGLE5 31.6.0
CONNMGR: command being processed
;
rlghncxa03w 04-07-02 15:30:50 EST  EAGLE5 31.6.0
task_id  client state slk lport  cfg  opn  cn_atmpt  cn_made
CONNMGR: Connection Manager Client Data
-----
01024E78 connected  A  1103   1   1       1         1

CONNMGR command complete
;

```

pass:loc=1107:cmd="connmgr -d"

The Connection Manager Data Summary displays all provisioned signaling link ports.

In the following example, signaling link port (slk) B is valid only for IPLIMx cards.

Command Accepted - Processing

```

rlghncxa03w 04-07-02 15:37:12 EST  EAGLE5 31.6.0
pass:loc=1107:cmd="connmgr -d"
Command entered at terminal #1.
;
rlghncxa03w 04-07-02 15:37:12 EST  EAGLE5 31.6.0
PASS: Command sent to card
;
rlghncxa03w 04-07-02 15:37:12 EST  EAGLE5 31.6.0
CONNMGR: command being processed
;
rlghncxa03w 04-07-02 15:37:12 EST  EAGLE5 31.6.0
CONNMGR: Connection Manager Data Summary
slk link state  srv  cli  opn sock  inst  opn assoc
---  -
A   active      1   0      1   0      0
B   active      0   0      0   1      1

CONNMGR command complete
;

```

pass:loc=1301:cmd="connmgr -i"

Command Accepted - Processing

```

eagle10213 04-07-22 08:49:37 GMT  EAGLE5 31.6.0
pass:loc=1301:cmd="connmgr -i"
Command entered at terminal #4.
;
eagle10213 04-07-22 08:49:37 GMT  EAGLE5 31.6.0
PASS: Command sent to card
;
eagle10213 04-07-22 08:49:37 GMT  EAGLE5 31.6.0

CONNMGR command being processed
;
eagle10213 04-07-22 08:49:37 GMT  EAGLE5 31.6.0
CONNMGR: Connection Manager Instance Data
inst id  lport  cfg  est  tot grntd  tot rfsd
-----  -
021B7880  1301   2   2      0      0

CONNMGR command complete
;

```

pass:loc=1107:cmd="connmgr -l"

Command Accepted - Processing

```

rlghncxa03w 04-07-02 15:35:28 EST EAGLE5 31.6.0
pass:loc=1107:cmd="connmgr -l"
Command entered at terminal #1.
;
rlghncxa03w 04-07-02 15:35:28 EST EAGLE5 31.6.0
PASS: Command sent to card
;
rlghncxa03w 04-07-02 15:35:28 EST EAGLE5 31.6.0
CONNMGR: command being processed
;
rlghncxa03w 04-07-02 15:35:28 EST EAGLE5 31.6.0
CONNMGR: Connection Manager Event Log
04-07-03 13:17:40.730 conn-rcvd 5005 from 192.168.100.174:5005
04-07-03 13:17:40.735 conn-rfsd lnk-not-actv 5005 192.168.100.174
04-07-03 13:17:40.850 conn-rcvd 5006 from 192.168.100.174:5006
04-07-03 13:17:40.855 conn-rfsd lnk-not-actv 5006 192.168.100.174
04-07-03 13:17:40.910 conn-rcvd 5002 from 192.168.100.174:5002
04-07-03 13:17:40.915 conn-rfsd lnk-not-actv 5002 192.168.100.174
04-07-03 13:17:40.950 conn-rcvd 5004 from 192.168.100.174:5004
04-07-03 13:17:40.955 conn-rfsd lnk-not-actv 5004 192.168.100.174

CONNMGR command complete
;

```

pass:loc=1103:cmd="connmgr -l"

Command Accepted - Processing

```

rlghncxa03w 04-07-02 15:35:28 EST EAGLE5 31.6.0
pass:loc=1103:cmd="connmgr -l"
Command entered at terminal #4.
;
rlghncxa03w 04-07-02 15:35:28 EST EAGLE5 31.6.0
PASS: Command sent to card
;
rlghncxa03w 04-07-02 15:35:28 EST EAGLE5 31.6.0
CONNMGR: command being processed
;
rlghncxa03w 04-07-02 15:35:28 EST EAGLE5 31.6.0
CONNMGR: Connection Manager Event Log
00-01-13 13:17:40.170 sock-add ipl1103
00-01-13 13:17:40.885 lnk-act Port A
00-01-13 13:17:40.080 conn-made ipl1101

CONNMGR command complete
;

```

pass:loc=1301:cmd="connmgr -n"

Command Accepted - Processing

```

eagle10213 04-07-22 08:50:04 GMT EAGLE5 31.6.0
pass:loc=1301:cmd="connmgr -n"
Command entered at terminal #4.
;

```

```

eagle10213 04-07-22 08:50:04 GMT EAGLE5 31.6.0
PASS: Command sent to card
;

eagle10213 04-07-22 08:50:04 GMT EAGLE5 31.6.0

CONNMGR command being processed

;

eagle10213 04-07-22 08:50:04 GMT EAGLE5 31.6.0
CONNMGR: Connection Manager SCTP Notification Log
04-07-21 18:06:34.860 assoc-up   ipl1301a from 192.168.110.17:1301
04-07-21 18:06:49.620 assoc-up   ipl1301b from 192.168.110.18:1303
04-07-21 18:07:54.185 assoc-down ipl1301b from 192.168.110.18:1303
04-07-21 18:09:21.990 assoc-up   ipl1301b from 192.168.110.18:1303

CONNMGR command complete

;

pass:loc=1107:cmd="connmgr -r"
Command Accepted - Processing

    rlghncxa03w 04-07-02 15:36:18 EST  EAGLE5 31.6.0
    pass:loc=1107:cmd="connmgr -r"
    Command entered at terminal #1.
;

    rlghncxa03w 04-07-02 15:36:18 EST  EAGLE5 31.6.0
    PASS: Command sent to card
;

    rlghncxa03w 04-07-02 15:36:18 EST  EAGLE5 31.6.0
    CONNMGR: command being processed
;

    rlghncxa03w 04-07-02 15:36:18 EST  EAGLE5 31.6.0
    CONNMGR command complete
;

pass:loc=1107:cmd="connmgr -s"
Command Accepted - Processing

    rlghncxa03w 04-07-02 15:39:54 EST  EAGLE5 31.6.0
    pass:loc=1107:cmd="connmgr -s"
    Command entered at terminal #1.
;

    rlghncxa03w 04-07-02 15:39:54 EST  EAGLE5 31.6.0
    PASS: Command sent to card
;

    rlghncxa03w 04-07-02 15:40:02 EST  EAGLE5 31.6.0
    CONNMGR: command being processed
;

```



```

rlghncxa03w 04-07-02 15:40:03 EST  EAGLE5 31.6.0
CONNMGR: Connection Manager Server Data
task_id  server state lport  cfg  opn  cn_grntd  cn_rfsd
-----  -----  -----  -----  -----  -----  -----
0114FEE8  listening    5001   1   1       2       546
0114ED40  listening    5002   1   1       2       434
0114DB98  listening    5003   1   1       2       539
0114C9F0  listening    5004   1   1       2       542
0114B848  listening    5005   1   1       2       539
0114A6A0  listening    5006   1   1       2       549
011494F8  listening    5007   1   0       0       548
01148350  listening    5008   1   1       2       560
011471A8  listening    5009   1   1       2       523
01146000  listening    5010   1   1       2       532
01144E58  listening    5011   1   1       2       534
01143CB0  listening    5012   1   1       2       481
01142B08  listening    5013   1   1       2       474
01141960  listening    5014   1   1       2       521
011407B8  listening    5015   1   0       2       515
0113F610  listening    5016   5   0      14      2741
0113E468  listening    5017   5   0      11      2723

CONNMGR command complete
;
pass:loc=1103:cmd="connmgr -s"
Command Accepted - Processing

rlghncxa03w 04-07-02 15:39:54 EST  EAGLE5 31.6.0
pass:loc=1103:cmd="connmgr -s"
Command entered at terminal #4.
;
rlghncxa03w 04-07-02 15:39:54 EST  EAGLE5 31.6.0
PASS: Command sent to card
;
rlghncxa03w 04-07-02 15:40:02 EST  EAGLE5 31.6.0
CONNMGR: command being processed
;
rlghncxa03w 04-07-02 15:40:03 EST  EAGLE5 31.6.0
CONNMGR: Connection Manager Server Data
task_id  server state slk lport  cfg  opn  cn_grntd  cn_rfsd
-----  -----  -----  -----  -----  -----  -----

CONNMGR command complete
;

```

drklog

Dynamic Routing Key History Log

Use this command to report the dynamic routing key provisioning history. The most recent 100 dynamic routing key provisioning events are kept in a log.

The default mode of operation for this command, with no options specified, is to print all available entries in the log (up to 100 entries) regardless of the sockets and routing keys involved. The **-n**, **-k**, and **-s** options can act as filters that affect which entries are displayed as output.

NOTE: The **drklog** command is supported only on DCM cards running the **ss7ipgw** or **ipgwi** application.

NOTE: The **drklog** command does not support spare point codes.

Command Name: drklog

Command Class: Application Maintenance

Options

Options and option parameters that are underlined indicate that a value must be specified for that option or parameter. For example, the **drklog** command option **-c** has the parameter point code type. Specify the point code type of the routing key that follows the **-k** option, as in the command **drklog -c 192.9.200.44**. Do not enter the underlined option or parameter; enter a value for the information represented by the underlined option or parameter.

-h

This option provides help information for the command.

-c point code type

This option modifier can be specified preceding the **-k** option to identify the point code type in the routing key that follows the **-k** option in the command.

Range: ansi, itui, itun, itun24

-d

This option can be specified instead of the **-k** option to indicate the default routing key. The **-d** option and the **-k** option cannot be used in the same command.

-k routing key

This option is used to display only entries pertaining to a specified routing key.

The routing key is specified as a single parameter with up to five colon-separated fields. The subsystem is not specified when SI is not equal to 3.

The **-c point code type** or **-p** modifier, or both, can be specified to identify the format of the routing key that follows the **-k** option in the command.

The **-d** option can be specified in place of the **-k** option to indicate a default routing key in the command.

The following are valid formats for the routing key that follows the **-k** option in the command:

n-c-m:s:n - For DPC, SI, SSN type routing keys. The network, cluster and member (*n-c-m*) are in the range **0-255**. The service indicator (*s*) is **3** or **sccp**. The subsystem (*n*) is in the range **0-255**.

n-c-m:s - For DPC, SI, type routing keys. The network, cluster and member (*n-c-m*) are in the range **0-255**. The service indicator (*s*) is in the range **0-2**, **4**, or **6-15**. There is no subsystem. As a default, counts for all routing keys within the option combination are displayed.

n-c-m:s:no-co-mo:cs:ce - For DPC, SI, CIC type routing keys. The DPC network, cluster and member (*n-c-m*) are in the range **0-255**. The service indicator (*s*) is **5** or **isup**. There is no subsystem. The OPC network, cluster and member (*no-co-mo*) are in the range **0-255**. The starting circuit identification code (*cs*) and ending circuit identification code (*ce*) are in the range **0** to **16363**.

NOTE: ISUP routing keys can be specified using the same CIC value for CICS and CICE. All entries in the log for the specified CIC value (or any portion of the CIC range) will be displayed.

-n number

This option is used to display a specific number of the most recent entries.

-p

This option modifies the **-k** option to specify a partial routing key.

-s socket name

This option is used to display entries for the specified socket name only.

Range: Up to 15 alphanumeric characters

Default: Counts for all IP application sockets within the option combination

Example

```
drklog
```

```
drklog -s socyellow
```

```
drklog -k 3:5-5-5:4
```

```
drklog -n 3
```

```
drklog -k 5:7-7-7:8-8-8:175:200 -s socket25 -n 1
```

```
drklog -c itun24 -k 12-145-10:5:12-145-12:100:300 -n 2
```

Dependencies

At least one option must be specified.

Notes

The **drklog** command is executed through the **pass** command.

The **drklog** command is valid for **ss7ipgw** and **ipgwi** cards; it is not valid for **iplim** and **iplimi** cards.

Combinations of the **-k**, **-n**, and **-s** options provide log information based on the entered combination. These options do not affect the contents of the log; they affect only what is displayed by the command.

TALI routing key registration and deregistration requests that are discarded because of a full request queue are not stored in the log. The total number of discards can be reported using the **msucount** command.

Output

The output for each **drklog** entry consists of the following components:

- Date and time: when the registration or deregistration event occurred
- Type of operation (including Enter, Delete, Resize, and Split)
- Socket involved
- Success/Failure Indication
- Routing key involved (with indication of the point code type - ANSI/ITUI/ITUN/ITUN24, and the type of key - full/partial/default)

- Other pertinent routing key information (such as split CIC value or resize CIC values)
- Routing key attribute values (PSTN Category, PSTN ID, Norm flag) specified in the registration request. Only values that are specified in the registration request are shown in the **drklog** entry. No value is shown if the registration does not specify a change to these routing key attribute values.

Example of the help information for using the command:

pass:loc=1105:cmd="drklog -h"

Command Accepted - Processing

```

;

rlghncxa03w 04-07-29 11:31:09 EST  EAGLE5 31.6.0
pass:loc=1105:cmd="drklog -h"
;

rlghncxa03w 04-07-29 11:31:09 EST  EAGLE5 31.6.0
PASS: Command sent to card
;

rlghncxa03w 04-07-29 11:31:09 EST  EAGLE5 31.6.0
Usage: DRKLOG [-h] [-c PointCodetype] [-p] [-k route key] [-d] [-n number]
[-s socket name]
Options:
  -h                Displays this message
  -c                PointCode type
  -p                Partial routing key
  -k routing key   Displays entries affecting specified routing key
  -d                Default routing key
  -n number        Displays most recent 'number' of entries
  -s socket name   Displays entries affecting specified socket name
;

rlghncxa03w 04-07-29 11:31:09 EST  EAGLE5 31.6.0
DRKLOG command complete
;

```

Example of basic **drklog** with no filtering options, including entries for ANSI fully specified routing keys, partial keys, and default keys:

pass:loc=1105:cmd="drklog"

Command Accepted - Processing

```

;

rlghncxa03w 04-07-29 11:31:09 EST  EAGLE5 31.6.0
pass:loc=1105:cmd="drklog"
Command entered at terminal #1.
;

rlghncxa03w 04-07-29 11:31:09 EST  EAGLE5 31.6.0
PASS: Command sent to card
;

rlghncxa03w 04-07-29 11:31:09 EST  EAGLE5 31.6.0
DRKLOG command in progress
;

```

```
rlghncxa03w 04-07-29 11:31:09 EST EAGLE5 31.6.0
```

```
DRKLOG: Dynamic route key history log
```

```
99-11-27 10:01:33.570 SOCKET000000025:Enter full ANSI key      Success
      key=5-5-5:3:4
99-11-27 10:04:21.765 SOCKET000000026:Enter full ANSI key      Success
      key=7-7-7:5:8-8-8:100:200
99-11-27 10:04:55.405 SOCKET000000012:Enter full ANSI key      Error(4)
      key=0-0-0:0
      pstncat=4096  pstnid=1      norm=0
99-11-27 10:06:45.860 SOCKET000000010:Override Partial ANSI key  Success
      key=5-5-5:5:*:*:*
99-11-27 10:07:15.020 SOCKET000000011:Override Partial ANSI key  Success
      key=5-5-5:3:*
99-11-27 10:07:15.022 SOCKET000000011:Enter Partial SI-only key  Success
      key=*:3:*
      pstncat=4097  pstnid=1      norm=0
99-11-27 10:07:15.320 SOCKET000000011:Enter Partial ANSI key      Success
      key=7-7-7:*
      pstncat=4098  pstnid=1      norm=0
99-11-27 10:07:15.622 SOCKET000000011:Enter Default key      Success
      Default Key
      pstncat=4099  pstnid=1      norm=0
```

```
DRKLOG command complete
```

```
;
```

Example of basic **drklog** with no filtering options, including entries for ITUI and ITUN fully specified routing keys, partial keys, and default keys:

```
pass:loc=1107:cmd="drklog"
```

```
Command Accepted - Processing
```

```
rlghncxa03w 04-07-29 11:31:09 EST EAGLE5 31.6.0
pass:loc=1107:cmd="drklog"
Command entered at terminal #1.
```

```
;
```

```
rlghncxa03w 04-07-29 11:31:09 EST EAGLE5 31.6.0
PASS: Command sent to card
```

```
;
```

```

rlghncxa03w 04-07-29 11:31:09 EST EAGLE5 31.6.0
DRKLOG command in progress

;

rlghncxa03w 04-07-29 11:31:09 EST EAGLE5 31.6.0

DRKLOG: Dynamic route key history log

99-11-27 10:06:12.030 SOCKET00000026:Delete Full ITUI key      Success
                        key=2-145-5:3:4
99-11-27 10:06:13.030 SOCKET00000025:Resize Full ITUI key      Success
                        key=2-78-1:5:3-87-3:100:200
                        ncics=100:ncice=150
99-11-27 10:06:17.860 SOCKET00000025:Split Full ITUI key      Success
                        key=2345-gr:5:3456:100:150
                        split=125
99-11-27 10:06:53.860 SOCKET00000110:Override Partial ITUI key  Success
                        key=1-151-69:5:2-141-3:*:*
99-11-27 10:07:54.020 SOCKET00000111:Enter Partial ITUI key      Success
                        key=6-132-5:3:*
99-11-27 10:07:55.022 SOCKET00000111:Enter Partial ITUI key      Success
                        key=*:5
                        pstncat=1      pstnid=1      norm=0
99-11-27 10:07:57.320 SOCKET00000111:Enter Partial ITUI key      Success
                        key=4-231-7:*
99-11-27 10:07:59.622 SOCKET00000121:Enter Default key      Success
                        Default Key
                        pstncat=4099  pstnid=1      norm=0
99-11-27 11:06:45.860 SOCKET00000210:Enter Partial ITUN key      Success
                        key=555-uk:5:666:*:*
                        pstncat=1      pstnid=3      norm=1
99-11-27 11:07:15.020 SOCKET00000211:Enter Partial ITUN key      Success
                        key=555-gr:5:*:*:*
                        pstncat=1      pstnid=4      norm=1
99-11-27 11:07:15.022 SOCKET00000211:Enter Partial SI-only key  Success
                        key=*:13
                        pstncat=0      pstnid=0      norm=0
99-11-27 11:07:15.320 SOCKET00000211:Enter Partial ITUN key      Success
                        key=8888-uk:*
                        pstncat=0      pstnid=0      norm=0
99-11-27 11:07:15.622 SOCKET00000271:Enter Default key      Success
                        Default Key
                        pstncat=4099  pstnid=0      norm=0

DRKLOG command complete

;

```

Example of **drklog** with socket filter (only entries with SOCKET11):

pass:loc=1105:cmd="drklog -s socket11"

Command Accepted - Processing

```

rlghncxa03w 04-07-29 11:31:09 EST EAGLE5 31.6.0
pass:loc=1105:cmd="drklog"
Command entered at terminal #1.

;

rlghncxa03w 04-07-29 11:31:09 EST EAGLE5 31.6.0
PASS: Command sent to card

;

rlghncxa03w 04-07-29 11:31:09 EST EAGLE5 31.6.0
DRKLOG command in progress

;

```

```
rlghncxa03w 04-07-29 11:31:09 EST EAGLE5 31.6.0
```

```
DRKLOG: Dynamic route key history log
```

```
99-11-27 10:07:15.020 SOCKET000000011:Enter Partial ANSI key      Success
                    key=5-5-5:3:*
99-11-27 10:07:15.022 SOCKET000000011:Enter Partial SI-only key  Success
                    key=*:3
99-11-27 10:07:15.320 SOCKET000000011:Enter Partial ANSI key      Success
                    key=7-7-7:*
99-11-27 10:07:15.622 SOCKET000000011:Enter Default key          Success
                    Default Key
                    pstncat=4099  pstnid=1      norm=0
```

```
DRKLOG command complete
```

```
;
```

Example of **drklog** with routing key filtering option (only entries with ITUI full key **2-45-1:5:4-223-2:123:345**):

```
pass:loc=1107:cmd="drklog -c ITUI -k 2-45-1:5:4-223-2:123:345"
```

```
Command Accepted - Processing
```

```
rlghncxa03w 04-07-29 11:31:09 EST EAGLE5 31.6.0
pass:loc=1107:cmd="drklog -c ITUI -k 2-45-1:5:4-223-2:123:345"
Command entered at terminal #1.
```

```
;
```

```
rlghncxa03w 04-07-29 11:31:09 EST EAGLE5 31.6.0
PASS: Command sent to card
```

```
;
```

```
rlghncxa03w 04-07-29 11:31:09 EST EAGLE5 31.6.0
DRKLOG command in progress
```

```
;
```

```
rlghncxa03w 04-07-29 11:31:09 EST EAGLE5 31.6.0
```

```
DRKLOG: Dynamic route key history log
```

```
99-11-27 10:06:12.030 SOCKET000000026:Enter Full ITUI key      Success
                    key=2-45-1:5:4-223-2:123:345
                    pstncat=1  pstnid=2      norm=1
99-11-27 10:06:31.530 SOCKET000000028:Enter Full ITUI key      Success
                    key=2-45-1:5:4-223-2:123:345
                    pstncat=1  pstnid=2      norm=1
99-11-27 10:06:12.030 SOCKET000000044:Enter full ITUI key      Success
                    key=2-45-1:5:4-223-2:123:345
                    pstncat=1  pstnid=2      norm=0
99-11-27 11:33:21.550 SOCKET000000026:Override Full ITUI key  Success
                    key=2-45-1:5:4-223-2:123:345
```

```
DRKLOG command complete
```

```
;
```

Example of **drklog** with same routing key filter as the previous example, and with a request to display only the 2 most recent events:

pass:loc=1107:cmd="drklog -c ITUI -k 2-45-1:5:4-223-2:123:345 -n 2"

Command Accepted - Processing

```

rlghncxa03w 04-07-29 11:31:09 EST  EAGLE5 31.6.0
pass:loc=1107:cmd="drklog -c ITUI -k 2-45-1:5:4-223-2:123:345 -n 2"
Command entered at terminal #1.
;

rlghncxa03w 04-07-29 11:31:09 EST  EAGLE5 31.6.0
PASS: Command sent to card
;

rlghncxa03w 04-07-29 11:31:09 EST  EAGLE5 31.6.0
DRKLOG command in progress
;

rlghncxa03w 04-07-29 11:31:09 EST  EAGLE5 31.6.0

DRKLOG: Dynamic route key history log
99-11-27  10:06:12.030 SOCKET000000044:Enter Full ITUI key          Success
                    key=2-45-1:5:4-223-2:123:345
                    pstncat=1      pstnid=2      norm=1
99-11-27  11:33:21.550 SOCKET000000026:Override Full ITUI key      Success
                    key=2-45-1:5:4-223-2:123:345
                    pstncat=1      pstnid=2      norm=1

DRKLOG command complete
;

```

Example of **drklog** with routing key filtering option for a partial routing key (only entries with ANSI partial key 5-5-5:*.*. ; ignore CIC and OPC for ISUP traffic):

pass:loc=1107:cmd="drklog -c ANSI -p -k 5-5-5:5"

Command Accepted - Processing

```

rlghncxa03w 04-07-29 11:31:09 EST  EAGLE5 31.6.0
pass:loc=1107:cmd="drklog -c ANSI -p -k 5-5-5:5"
Command entered at terminal #1.
;

rlghncxa03w 04-07-29 11:31:09 EST  EAGLE5 31.6.0
PASS: Command sent to card
;

rlghncxa03w 04-07-29 11:31:09 EST  EAGLE5 31.6.0
DRKLOG command in progress
;

```



```
rlghncxa03w 04-07-29 11:31:09 EST EAGLE5 31.6.0
```

```
DRKLOG: Dynamic route key history log
```

```
99-11-27 10:06:12.030 SOCKET000000026:Delete Partial ANSI key Success
      key=5-5-5:5:*.:*
99-11-27 10:06:31.530 SOCKET000000028:Enter Partial ANSI key Success
      key=5-5-5:5:*.:*
99-11-27 10:06:12.030 SOCKET000000044:Enter Partial ANSI key Success
      key=5-5-5:5:*.:*
      pstncat=0      pstnid=0      norm=0
99-11-27 11:33:21.550 SOCKET000000026:Override Partial ANSI key Success
      key=5-5-5:5:*.:*
```

```
DRKLOG command complete
```

```
;
```

Example of *drklog* with a full ITUN24 routing key filter with a request to display only the 2 most recent events.

```
:pass:loc=1101:cmd="drklog -c ITUN24 -k 12-145-10:5:12-145-12:100:300 -n 2"
```

```
Command Accepted - Processing
```

```
rlghncxa03w 04-07-29 11:31:09 EST EAGLE5 31.6.0
```

```
pass:loc=1101:cmd="drklog -c ITUN24 -k 12-145-10:5:12-145-12:100:300 -n 2"
Command entered at terminal #1.
```

```
;
```

```
rlghncxa03w 04-07-29 11:31:09 EST EAGLE5 31.6.0
```

```
PASS: Command sent to card
```

```
;
```

```
rlghncxa03w 04-07-29 11:31:09 EST EAGLE5 31.6.0
```

```
DRKLOG command in progress
```

```
;
```

```
rlghncxa03w 04-07-29 11:31:09 EST EAGLE5 31.6.0
```

```
DRKLOG: Dynamic route key history log
```

```
99-11-27 10:06:12.030 SOCKET000000044:Enter Full ITUN24 key Success
      key=12-145-10:5:12-145-12:100:300
      pstncat=0      pstnid=0      norm=0
99-11-27 11:33:21.550 SOCKET000000026:Override Full ITUN24 key Success
      key=12-145-10:5:12-145-12:100:300
      pstncat=0      pstnid=0      norm=0
```

```
DRKLOG command complete
```

```
;
```

Other drklog output examples:**pass:loc=1105:cmd="drklog -k 3:5-5-5:4"**

Command Accepted - Processing

```

    rlghncxa03w 04-07-29 11:31:09 EST  EAGLE5 31.6.0
    pass:loc=1105:cmd="drklog -k 3:5-5-5:4"
    Command entered at terminal #1.
;
    rlghncxa03w 04-07-29 11:31:09 EST  EAGLE5 31.6.0
    PASS: Command sent to card
;
    rlghncxa03w 04-07-29 11:31:09 EST  EAGLE5 31.6.0
    DRKLOG command in progress
;
    rlghncxa03w 04-07-29 11:31:09 EST  EAGLE5 31.6.0

    DRKLOG: Dynamic route key history log
99-11-27  10:01:33.570  Enter      SOCKET25      Success
                    key=3:5-5-5:4
99-11-27  10:06:45.860  Override   SOCKET10      Success
                    key=3:5-5-5:4
99-11-27  10:07:15.020  Enter      SOCKET11      Success
                    key=3:5-5-5:4

```

DRKLOG command complete

pass:loc=1105:cmd="drklog -k 5:7-7-7:8-8-8:100:200"

Command Accepted - Processing

```

    rlghncxa03w 05-07-29 11:31:09 EST  EAGLE5 31.6.0
    pass:loc=1105:cmd="drklog -k 5:7-7-7:8-8-8:100:200"
    Command entered at terminal #1.
;
    rlghncxa03w 05-07-29 11:31:09 EST  EAGLE5 31.6.0
    PASS: Command sent to card
;
    rlghncxa03w 05-07-29 11:31:09 EST  EAGLE5 31.6.0
    DRKLOG command in progress
;
    rlghncxa03w 05-07-29 11:31:09 EST  EAGLE5 31.6.0

    DRKLOG: Dynamic route key history log
99-11-27  10:04:21.765  Enter      SOCKET26      Success
                    key=5:7-7-7:8-8-8:100:200
99-11-27  10:06:13.030  Resize     SOCKET25      Success
                    key=5:7-7-7:8-8-8:100:200
                    ncics=100:ncice=150
99-11-27  10:06:17.860  Split      SOCKET25      Success
                    key=5:7-7-7:8-8-8:100:150
                    split=125

```

DRKLOG command complete

```
pass:loc=1105:cmd="drklog -k 5:7-7-7:8-8-8:175:200 -s socket25 -n 1"
```

```
Command Accepted - Processing
```

```

rlghncxa03w 04-07-29 11:31:09 EST  EAGLE5 31.6.0
pass:loc=1105:cmd="drklog -k 5:7-7-7:8-8-8:175:200 -s socket25 -n 1"
Command entered at terminal #1.
;
rlghncxa03w 04-07-29 11:31:09 EST  EAGLE5 31.6.0
PASS: Command sent to card
;
rlghncxa03w 04-07-29 11:31:09 EST  EAGLE5 31.6.0
DRKLOG command in progress
;
rlghncxa03w 04-07-29 11:31:09 EST  EAGLE5 31.6.0

DRKLOG: Dynamic route key history log

99-11-27  10:06:13.030  Resize      SOCKET25      Success
                        key=5:7-7-7:8-8-8:100:200
                        ncics=100:ncice=150

DRKLOG command complete
;
```

ftptest

FTP Test

Use this command to send a test file to a configured FTP server that is used for the Measurements Platform feature

Command Name: ftptest

Command Class: System Maintenance

Options

Options and option parameters that are underlined indicate that a value must be specified for that option or parameter. For example, the **ftptest** command option **-a** has the parameter appl. The FTP registered application to be tested can be specified, as in the command **ftptest -a meas**. Do not enter the underlined option or parameter; enter a value for the information represented by the underlined option or parameter.

-h

This option provides help information for the command.

-a appl

This option specifies the FTP registered application to be tested.

Range: **meas**

meas—The Measurements Platform application

Example

```
ftptest
```

```
ftptest -h
```

```
ftptest -a meas
```

Dependencies

None

Notes

The **ftptest** command is executed through the **pass** command.

The specified card location must have an IP port configured to an FTP server using the **ent-ftp-serv** command, and the card must have its IP port configured using the **chg-ip-lnk** command.

Output

```
pass:loc=1105:cmd="ftptest-h"
```

or

```
pass:loc=1105:cmd="ftptest"
```

```
Command Accepted - Processing
```

```
rlghncxa03w 04-07-29 11:31:09 EST EAGLE5 31.6.0  
pass:loc=1215:cmd="ftptest -h"  
Command entered at terminal #3.
```

;

```
rlghncxa03w 04-07-29 11:31:09 EST EAGLE5 31.6.0  
PASS: Command sent to card
```

;

```
rlghncxa03w 04-07-29 11:31:09 EST EAGLE5 31.6.0
```

```
Usage: ftptest -a appl [-h]
```

```
Options:
```

```
  -a appl  FTP client application name  
  -h      Displays this message
```

;

```
rlghncxa03w 04-07-29 11:31:09 EST EAGLE5 31.6.0
```

```
FTPTEST: Command Complete
```

;

```

pass:loc=1105:cmd="ftptest -a meas"
PASS: Command sent to card
;

rlghncxa03w 04-07-29 11:31:09 EST EAGLE5 31.6.0

FTPTEST: Command In Progress
;

rlghncxa03w 04-07-29 11:31:09 EST EAGLE5 31.6.0
FTP Interface Test
  Test Results: PASS
  Server IP:    10.25.61.71
  FTP Error:    0
  File Error:   0
  Segment:     190004a2
  Diag Msg:
FTPTEST: Command Complete
;

```

The following example shows the error occurs if the wrong password is specified in the **ent-ftp-serv** command for the application specified in the **ftptest** command.

```

pass:loc=1215:cmd="ftptest -a meas"
rlghncxa03w 04-07-29 11:31:09 EST EAGLE5 31.6.0
PASS: Command sent to card
;

rlghncxa03w 04-07-29 11:31:09 EST EAGLE5 31.6.0

FTPTEST: Command In Progress
;

rlghncxa03w 04-07-29 11:31:09 EST EAGLE5 31.6.0
FTP Interface Test
  Test Results: FAIL
  Server IP:    0.0.0.0
  FTP Error:    530
  Segment:     190004dd
  Diag Msg:    Server Connection Error
FTPTEST: Command Complete
;

```

linkinfo

Link State and Event Log

This command is used to display the state of a signaling link and to retrieve/clear a specified event log for a signaling link. The signaling link is any valid signaling link provisioned for the card, and can be any one of the following: **a**, **a1**, **a2**, **a3**, **b**, **b1**, **b2**, or **b3**. This command is supported only for the IPLIMx GPLs.

Command Name: linkinfo

Command Class: Application Maintenance

Options

Options and option parameters that are underlined indicate that a value must be specified for that option or parameter. For example, the **linkinfo** command option **-i** has the parameter **event**. The event to be included in the report can be specified, as in the command **linkinfo a -a -i m2pa**. Do not enter the underlined option or parameter; enter a value for the information represented by the underlined option or parameter.

-h

This option provides help information for the command.

port

This option specifies the signaling link port.

Range: a, b, a1, b1, a2, b2, a3, b3

-a

This option displays the adapter layer interface (ALI) log for the specified signaling link.

-i event

This option includes (does not filter) a link event in the log.

Range: ali, all, data, l2l3, l3l2, m2pa, state
all—include all events

-l

This option displays the IPLIM ALI event log for the specified signaling link

-m

This option displays acknowledgment times on an M2PA connection (minimum, maximum, weighted average, last recorded).

-r

This option resets (clears) the event log for the specified signaling link. This option is valid only with the **-a** option or **-l** option.

-s

This option displays the state information for the specified signaling link

-v

This option displays the link event filter configuration.

-x event

This option excludes (filters) a link event in the log.

Range: ali, all, data, l2l3, l3l2, m2pa, state
all—exclude all events

Example

Provide help information for the command.

```
pass:loc=1301:cmd="linkinfo -h"
```

Display the ALI event log for signaling link a1.

```
pass:loc=1301:cmd="linkinfo a1 -a"
```

Display the IPLIM application event log for signaling link **a1**.

pass:loc=1301:cmd="linkinfo a1 -l"

Reset/clear the link event log for signaling link **a1**.

pass:loc=1301:cmd="linkinfo a1 -l -r"

Display the state information for signaling link **a1**.

pass:loc=1301:cmd="linkinfo a1 -s"

Display acknowledgement times for an M2PA connection on signaling link **b1**.

pass:loc=3315:cmd="linkinfo b1 -m"

Dependencies

None

Notes

The size of the signaling link event log is increased, redundant link status events are filtered, and new M2PA RFC state and timer events are included in the log.

Table 9-4. M2PA Link States

M2PA Link State	M2PA Version (Draft 6/RFC)	Description
IDLE	Both	The application is initializing.
NO-ASSOC	Both	Out of service. Power-up initialization is complete. The link's association is open=no .
CONNECTING	Both	Out of service. Power-up initialization is complete. The link's association is attempting to connect to the peer.
CONNECTED	Both	Out of service. Power-up initialization is complete. The link's association is established, but MTP3 has not yet issued the START primitive to start link alignment.
NOT ALIGNED	RFC	The link's association is established and MTP3 has issued the START primitive. M2PA has sent a Link Status Alignment message to its peer.
ALIGNED	RFC	A Link Status Alignment or Link Status Proving message was received in the NOT ALIGNED state, and M2PA has sent a Link Status Proving message to its peer.
AIP	Draft 6	Alignment in Progress.
PROVING	Both	RFC – Proving in Progress. Draft 6 - M2PA has sent and received a Link Status Alignment message. Proving is in Process.
ALIGNED READY	Both	Proving is Complete. M2PA is waiting for the peer to complete proving.
INS	Both	In Service. M2PA has completed alignment, proving, and has sent and received a Link Status Ready message.

Table 9-4. M2PA Link States

M2PA Link State	M2PA Version (Draft 6/RFC)	Description
RETRIEVAL	Draft 6	Link is no longer in service and is waiting for retrieval or MTP3 START.
ALIGNED NOT READY	RFC	Link is aligned but in local processor outage, therefore will not carry traffic. This state only occurs if the link has not yet gone in service.
PROCESSOR OUTAGE	RFC	One or both ends is in processor outage.

Output

Example of help for using the command:

pass:loc=1301:cmd="linkinfo" or

pass:loc=1301:cmd="linkinfo -h"

```

rlghncxa03w 04-07-29 11:31:09 EST  EAGLE5 31.6.0
PASS: Command sent to card
;

rlghncxa03w 04-07-29 11:31:09 EST  EAGLE5 31.6.0

Usage: LINKINFO port [-a [-r]] [-h] [-l [-r]] [-m [-r]] [-s] [-v]
Options:
  port      Signaling link port: a, b, a1, b1, a2, b2, a3, b3
  -a        Display the ALI event log for a signaling link
  -h        Displays this message
  -i event  Include (do not filter) a link event type in the log
            where 'event' is: ali, all, data, l2l3, l3l2,
            m2pa, state
  -l        Displays the event log for a signaling link
  -m        Display Link Measurements
  -r        Resets the specified event log for a signaling link
  -s        Displays the state information for a signaling link
  -v        View the link event filter configuration
  -x event  Exclude (filter) a link event type from the log
            where 'event' is: ali, all, data, l2l3, l3l2,
            m2pa, state
;

rlghncxa03w 04-07-29 11:31:09 EST  EAGLE5 31.6.0

LINKINFO command complete
;

```

The following example illustrates a request to display the adapter layer interface (ALI) event log for signaling link **a1** and association **ipl1301a** that has been provisioned with signaling link **a1**.

pass:loc=1301:cmd="linkinfo a1 -a"

```
rlghncxa03w 04-07-29 11:31:09 EST EAGLE5 31.6.0
PASS: Command sent to card
```

;

```
rlghncxa03w 04-07-29 11:31:09 EST EAGLE5 31.6.0
```

```
LINKINFO command being processed
```

;

```
rlghncxa03w 04-07-29 11:31:09 EST EAGLE5 31.6.0
IPLIM Adapter Layer Events for Port a1:
04-07-29 10:23:48.525 IP_CONN_OPENED
04-07-29 10:36:09.465 IP_CONN_CONNECTED
04-07-29 10:36:09.465 IP_CONN_ALLOWED
```

```
end of report
```

;

The following example illustrates a request to display the **iplim** ALI event log for signaling link **a1** and the association **ipl1301a** that has been provisioned with signaling link **a1**.

pass:loc=1301:cmd="linkinfo a1 -l"

```
rlghncxa03w 04-07-29 11:31:09 EST EAGLE5 31.6.0
PASS: Command sent to card
```

;

```
rlghncxa03w 04-07-29 11:31:09 EST EAGLE5 31.6.0
```

```
LINKINFO command being processed
```

;

```
rlghncxa03w 04-07-29 11:31:09 EST EAGLE5 31.6.0
IPLIM Adapter Layer Events for Port a1:
04-07-29 10:36:40.240 IP_CONN_ALLOWED
04-07-29 10:36:40.240 IP_CONN_OPENED
04-07-29 10:36:40.240 LINK_STATE_OOS
04-07-29 10:36:50.935 L3_L2_START
04-07-29 10:37:18.890 IP_CONN_CONNECTED
04-07-29 10:37:18.900 LINK_STATE_AIP
04-07-29 10:37:18.900 M2PA_LSA_RCVD
04-07-29 10:37:18.915 LINK_STATE_PROVING
04-07-29 10:37:18.915 M2PA_LSPN_RCVD
04-07-29 10:37:19.453 M2PA_T4_EXPD
04-07-29 10:37:20.565 M2PA_LSPN_RCVD
04-07-29 10:37:21.785 M2PA_T4_EXPD
04-07-29 10:37:22.565 M2PA_LSPN_RCVD
04-07-29 10:37:23.785 M2PA_T4_EXPD
04-07-29 10:37:24.565 M2PA_LSPN_RCVD
04-07-29 10:37:25.785 M2PA_T4_EXPD
04-07-29 10:37:26.385 M2PA_LSPN_RCVD
04-07-29 10:37:27.576 M2PA_T2_EXPD
```

```
04-07-29 10:37:27.585 LINK_STATE_READY
04-07-29 10:37:30.123 M2PA_LSR_RCVD
04-07-29 10:36:32.095 LINK_STATE_INS
```

end of report

;

The following example illustrates a **linkinfo** request to reset/clear the link event log for signaling link **a1**.

pass:loc=1301:cmd="linkinfo a1 -l -r"

```
rlghncxa03w 04-07-29 11:31:09 EST EAGLE5 31.6.0
PASS: Command sent to card
```

;

```
rlghncxa03w 04-07-29 11:31:09 EST EAGLE5 31.6.0
```

LINKINFO command being processed

;

```
rlghncxa03w 04-07-29 11:31:09 EST EAGLE5 31.6.0
LINKINFO command complete
```

;

The following example illustrates a **linkinfo** request to display acknowledgement times for an IPLIMx M2PA connection on signaling link **b1**.

pass:loc=1301:cmd="linkinfo b1 -m"

```
rlghncxa03w 04-07-29 11:31:09 EST EAGLE5 31.6.0
PASS: Command sent to card
```

;

```
rlghncxa03w 04-07-29 11:31:09 EST EAGLE5 31.6.0
```

LINKINFO: Command In Progress

;

```
rlghncxa03w 04-07-29 11:31:09 EST EAGLE5 31.6.0
IPLIMx M2PA Measurements Information for Port B1
```

Measured M2PA Traffic Acknowledgement Times

```
Minimum acknowledge time      : 14
Maximum acknowledge time      : 35
Weighted Average acknowledge time: 17
Last recorded acknowledge time : 20
```

end of report

;

```
rlghncxa03w 04-07-29 11:31:09 EST EAGLE5 31.6.0
```

;

The following example illustrates a **linkinfo** request to display the state information for signaling link **a1**.

```

pass:loc=1301:cmd="linkinfo a1 -s"
rlghncxa03w 03-07-29 11:31:09 EST  EAGLE5 30.0.0
PASS: Command sent to card
;

rlghncxa03w 03-07-29 11:31:09 EST  EAGLE5 30.0.0

LINKINFO command being processed
;

rlghncxa03w 03-07-29 11:31:09 EST  EAGLE5 30.0.0
SLK      LINKINFO STATE
1301,A1  OOS          CONNECTING

end of report
;

rlghncxa03w 03-07-29 11:31:09 EST  EAGLE5 30.0.0
LINKINFO command complete
;

```

The following example illustrates requests to display the state information for signaling link **a**. This example displays M2PA RFC signaling link states.

```

pass:loc=1301:cmd="linkinfo a -s "
Command Accepted - Processing

rlghncxa03w 06-01-17 10:47:02 EST  EAGLE5 34.3.0
pass:loc=1301:cmd="linkinfo a -s "
Command entered at terminal #1.
;

rlghncxa03w 06-01-17 10:47:02 EST  EAGLE5 34.3.0
PASS: Command sent to card
;

rlghncxa03w 06-01-17 10:47:02 EST  EAGLE5 34.3.0

LINKINFO: Command In Progress
;

rlghncxa03w 06-01-17 10:47:02 EST  EAGLE5 34.3.0

IPLIMx Layer 2 Link State Information for Link A

LINK_STATE_NOT_ALIGNED          IP_CONN_STATE_ESTABLISHED

end of report
;

```

The following output illustrates a request to display the IPLIMx signaling link event log for signaling link a. This is an example of a successful normal link alignment, proving, activation and deactivation for M2PA Draft 6.

pass:loc=1303:cmd="linkinfo a -l "

Command Accepted - Processing

```

rlghncxa03w 06-01-17 10:47:02 EST  EAGLE5 34.3.0
pass:loc=1303:cmd="linkinfo a -l "
Command entered at terminal #1.
;

rlghncxa03w 06-01-17 10:47:02 EST  EAGLE5 34.3.0
PASS: Command sent to card
;

rlghncxa03w 06-01-17 10:47:02 EST  EAGLE5 34.3.0

LINKINFO: Command In Progress
;

rlghncxa03w 06-01-17 10:47:02 EST  EAGLE5 34.3.0

IPLIMx Layer 2 Link Events for Link A

eagle10212 06-01-17 10:47:02 EST  EAGLE5 34.3.0

LINKINFO: Command In Progress
;

eagle10212 06-01-17 10:47:02 EST  EAGLE5 34.3.0

IPLIMx Layer 2 Link Events for Link A

06-01-17 15:11:22.810 IP_CONN_OPENED
06-01-17 15:11:22.810 LINK_STATE_CONNECTING
06-01-17 15:11:22.810 IP_CONN_ALLOWED
06-01-17 15:11:22.830 IP_CONN_CONNECTED
06-01-17 15:11:22.830 LINK_STATE_CONNECTED
06-01-17 15:11:22.830 M2PA_LSO_TRANSMITTED
06-01-17 15:11:22.830 M2PA_LSO_RECEIVED
06-01-17 15:11:22.955 M2PA_LSA_RECEIVED
06-01-17 15:11:32.955 M2PA_LSO_RECEIVED
06-01-17 15:11:33.200 L3_L2_EMERGENCY
06-01-17 15:11:33.200 L3_L2_START
06-01-17 15:11:33.200 LINK_STATE_AIP
06-01-17 15:11:33.200 M2PA_LSA_TRANSMITTED
06-01-17 15:11:33.775 M2PA_LSA_RECEIVED
06-01-17 15:11:33.775 LINK_STATE_PROVING
06-01-17 15:11:33.775 M2PA_LSPN_TRANSMITTED
06-01-17 15:11:33.775 M2PA_LSPN_RECEIVED
06-01-17 15:11:33.980 M2PA_T16_EXPIRED
06-01-17 15:11:34.175 M2PA_T16_EXPIRED
06-01-17 15:11:34.375 M2PA_T16_EXPIRED
06-01-17 15:11:34.575 M2PA_T16_EXPIRED
06-01-17 15:11:34.770 M2PA_LSR_RECEIVED
06-01-17 15:11:34.775 M2PA_T4_EXPIRED
06-01-17 15:11:34.775 LINK_STATE_ALIGNED_READY

```

```

06-01-17 15:11:34.775 M2PA_LSR_TRANSMITTED
06-01-17 15:11:34.775 LINK_STATE_INS
06-01-17 15:11:34.775 L2_L3_IN_SERVICE
06-01-17 15:12:36.200 L3_L2_STOP
06-01-17 15:12:36.200 LINK_STATE_RETRIEVAL
06-01-17 15:12:36.200 M2PA_LSO_TRANSMITTED
06-01-17 15:12:36.200 L2_L3_OUT_OF_SERVICE
06-01-17 15:12:36.215 M2PA_LSO_RECEIVED
06-01-17 15:12:36.270 RETRIEVAL_COMPLETE
06-01-17 15:12:36.270 LINK_STATE_CONNECTED
06-01-17 15:12:36.270 M2PA_LSO_TRANSMITTED

```

end of report

;

The following output illustrates a request to display the IPLIMx signaling link event log for signaling link a. This is an example of a successful normal link alignment, proving, activation and deactivation for M2PA RFC.

pass:loc=1301:cmd="linkinfo a -l "

Command Accepted - Processing

```

rlghncxa03w 06-01-17 10:47:02 EST EAGLE5 34.3.0
pass:loc=1301:cmd="linkinfo a -l "
Command entered at terminal #1.

```

;

```

rlghncxa03w 06-01-17 10:47:02 EST EAGLE5 34.3.0
PASS: Command sent to card

```

;

```

rlghncxa03w 06-01-17 10:47:02 EST EAGLE5 34.3.0

LINKINFO: Command In Progress

```

;

```

rlghncxa03w 06-01-17 10:47:02 EST EAGLE5 34.3.0

```

IPLIMx Layer 2 Link Events for Link A

```

06-01-17 14:53:18.160 IP_CONN_OPENED
06-01-17 14:53:18.160 LINK_STATE_CONNECTING
06-01-17 14:53:18.160 IP_CONN_ALLOWED
06-01-17 14:53:18.180 IP_CONN_CONNECTED
06-01-17 14:53:18.180 M2PA_LSO_TRANSMITTED
06-01-17 14:53:18.180 LINK_STATE_CONNECTED
06-01-17 14:53:18.180 M2PA_LSO_RECEIVED
06-01-17 14:54:18.390 L3_L2_EMERGENCY_CEASE
06-01-17 14:54:18.390 L3_L2_START
06-01-17 14:54:18.390 M2PA_LSA_TRANSMITTED
06-01-17 14:54:18.390 LINK_STATE_NOT_ALIGNED
06-01-17 14:54:38.390 M2PA_T2_EXPIRED
06-01-17 14:54:38.390 L2_L3_OUT_OF_SERVICE
06-01-17 14:54:38.390 M2PA_LSO_TRANSMITTED
06-01-17 14:54:38.390 LINK_STATE_CONNECTED
06-01-17 14:54:39.205 L3_L2_EMERGENCY_CEASE
06-01-17 14:54:39.205 L3_L2_START
06-01-17 14:54:39.205 M2PA_LSA_TRANSMITTED
06-01-17 14:54:39.205 LINK_STATE_NOT_ALIGNED
06-01-17 14:54:45.650 M2PA_LSA_RECEIVED

```

```

06-01-17 14:54:45.650 M2PA_LSPN_TRANSMITTED
06-01-17 14:54:45.650 LINK_STATE_ALIGNED
06-01-17 14:54:45.665 M2PA_LSPN_RECEIVED
06-01-17 14:54:45.665 LINK_STATE_PROVING
06-01-17 14:54:45.865 M2PA_T16_EXPIRED
06-01-17 14:54:46.070 M2PA_T16_EXPIRED
06-01-17 14:54:46.270 M2PA_T16_EXPIRED
06-01-17 14:54:46.470 M2PA_T16_EXPIRED
06-01-17 14:54:46.665 M2PA_T4_EXPIRED
06-01-17 14:54:46.665 M2PA_LSR_TRANSMITTED
06-01-17 14:54:46.665 LINK_STATE_ALIGNED_READY
06-01-17 14:54:46.680 M2PA_LSR_RECEIVED
06-01-17 14:54:46.680 L2_L3_IN_SERVICE
06-01-17 14:54:46.680 M2PA_LSR_TRANSMITTED
06-01-17 14:54:46.680 LINK_STATE_INS
06-01-17 14:54:46.680 M2PA_LSR_RECEIVED
06-01-17 14:55:07.380 L3_L2_STOP
06-01-17 14:55:07.380 M2PA_LSO_TRANSMITTED
06-01-17 14:55:07.380 LINK_STATE_CONNECTED
06-01-17 14:55:07.395 M2PA_LSO_RECEIVED

```

end of report

msucount

Message Signaling Unit (MSU) Count

This command is used to report the count of SS7 MSUs and bytes that pass through links, routing keys, and IP connections. These counts can be reported and reset at the same time to get accurate counts for longer periods of time. In addition to MSUs transmitted and received, the **msucount** command also reports statistics on packets related to MTP Primitives and on discarded transmit and receive data.

Command Name: **msucount**

Command Class: Application Maintenance

Options

Options and option parameters that are underlined indicate that a value must be specified for that option or parameter. For example, the **msucount** command option **-l** has the parameter port. The link for which counts will be displayed can be specified, as in the command **msucount -l a1**. Do not enter the underlined option or parameter; enter a value for the information represented by the underlined option or parameter.

-h

This option provides help information for the command.

-c point code type

This option modifier can be specified preceding the **-k** option to identify the point code type (ANSI, ITU international, ITU-national, 24-bit ITU national, ITU international spare, and ITU national spare) in the routing key that follows the **-k** option in the command.

Range: **ansi, itui, itun, itun24, ituis, ituns**

-d

This option can be specified instead of the **-k** option to indicate that the specified routing key in the command is a default routing key. The **-d** option and the **-k** option cannot be used in the same command.

-k routing key

This option specifies the routing key for which the counts will be displayed. The routing key is specified as a single parameter with up to five colon-separated fields. The subsystem is not specified when SI is not equal to 3.

The **-c point code type** or **-p** modifier, or both, can be specified to identify the format of the routing key that follows the **-k** option in the command.

Routing context is an index that uniquely defines a routing key associated with an SUA or M3UA AS. The **-x** option can be used with the **-k** option in the command as an alternate way to identify the routing key, by specifying its routing context in the **routing key** portion of the **-k** option.

The **-d** option can be specified in place of the **-k** option to indicate a default routing key in the command.

If the same routing key exists as both a static and dynamic routing key, the **-k** option will report the counts associated with the dynamic entry in the Routing Key table only. The **-t** static option can be used with the **-k** option to report the counts associated with the static entry in the Routing Key table.

The following formats are valid for the routing key that follows the **-k** option in the command:

- **n-c-m:s:n**—For DPC, SI, SSN type routing keys. The network, cluster and member (*n-c-m*) are in the range **0-255**. The service indicator (*s*) is **3** or **sccp**. The subsystem (*n*) is in the range **0-255**.
- **n-c-m:s**—For DPC, SI, type routing keys. The network, cluster and member (*n-c-m*) are in the range **0-255**. The service indicator (*s*) is in the range **0-2, 4, or 6-15**. There is no subsystem. As a default, counts for all routing keys within the option combination are displayed.
- **n-c-m:s:no-co-mo:cs:ce**—For DPC, SI, CIC type routing keys. The DPC network, cluster and member (*n-c-m*) are in the range **0-255**. The service indicator (*s*) is **5** or **isup**. There is no subsystem. The OPC network, cluster and member (*no-co-mo*) are in the range **0-255**. The starting circuit identification code (*cs*) and ending circuit identification code (*ce*) are in the range **0** to **16363**.

-l port

This option is used to display counts for links. The link report optionally allows display of link statistics for a specified port number.

The link report contains data, per link, for MSUs (tx/rcv), MSU bytes (tx/rcv), MGMT msgs (tx/rcv), and discarded data (tx/rcv).

Range: **a, b, a1, b1, a2, b2, a3, b3**

Ports **a1, b1, a2, b2, a3,** and **b3** are allowed only on SSEDICM IPLIMx cards.

If a port is not specified, **msucount** displays link statistics for port **a** for IPGWx links, and port **a** and port **b** for IPLIMx links.

The **msucount** link statistics report contains all zeros for a port that is valid for the card and application type but is unequipped.

-p

This option can be specified preceding the **-k** option to indicate that the routing key following the **-k** option in the command is a partial routing key.

-r

This option is used with other options to reset counts at the same time of reporting them.

-s name

This option is used to display counts for the specified IP connection only.

Range: Up to 15 alphanumeric characters

Default: Counts for all IP connections within the option combination

-t static

This option is used to force the report to use the counts associated with static entries in the Routing Key table.

-x

This option is used with the **-k** option as an alternate way to identify the routing key to display the routing context (routing key) MSU count report. The routing context value is specified as the **routing key** portion of the **-k** option,.

Example

Link counts only

msucount -l

Link counts only, for signaling link port **a1**

msucount -l a1

Counts for IP connection only

msucount -s socyellow

Counts for first matching routing key

msucount -k 10-10-10:3:16

Counts for matching static routing key

msucount -k 10-10-10:3:16 -t static

Counts for link and IP connection

msucount -l -s socyellow

Counts for link and first matching routing key

msucount -l -k 10-10-10:3:16

Counts for link and static matching routing key

msucount -l -k 10-10-10:3:16 -t static

Counts for first matching routing key and an associated IP connection

msucount -s socyellow -k 10-10-10:3:16

Counts for matching static routing key and an associated IP connection

msucount -s socyellow -k 10-10-10:3:16 -t static

Counts for link, first matching routing key and an associated IP connection

msucount -l -s socyellow -k 10-10-10:3:16

Counts for link, matching static routing key, and an associated IP connection

msucount -l -s socyellow -k 10-10-10:3:16 -t static

(Use with other parameters to display and reset counts. Valid with all of the above combinations).

msucount -r ...

The following examples show correct syntax to specify partial or default keys;

DPC-SI-OPC; ignore CIC; ANSI

msucount -p -k 5-5-1:5:6-6-6

DPC-SI; ignore OPC and CIC; ANSI

msucount -p -k 5-5-1:5

DPC-SI; ignore SSN; ANSI

msucount -p -k 5-5-1:3

DPC only; ITUI point code

msucount -c itui -p -k 1-235-1

DPC only; ITUN point code when ITUDUPPC feature is off

msucount -c itun -p -k 2351

DPC only; ITUN point code must specify group code when ITUDUPPC feature is on

msucount -c itun -p -k 2351-gr

DPC only, ITUN24 point code

msucount -c itun24 -p -k 10-235-1

SI only; ignore DPC (there is no DPC before SI of 2)

msucount -p -k :2

Default routing key

msucount -d

Default routing key; look only in static table

msucount -d -t static

Routing key specified by routing context

msucount -x -k 5

ITU-I spare point code MSU with SI of 5

msuroute -c ituis -k 3-11-1:5:4-11-1:5:5

Other examples of valid command syntax:

msucount -r -l -k 5-5-6:isup:5-5-7:1:1000

msucount -r -l -c itui -k 5-5-6:tup:5-5-7:1:1000

msucount -r -l -c itui -k 5-5-6:isup:5-5-7:1:1000

```
msucount -r -l -c itun -k 2860:3:5 -t static
msucount -c itui -k 5-5-1:3:5 -s c7000 -r
msucount -r -s c7050 -c itun -k 2860:3:5 -l
msucount -k 5-5-1:3:5 -s c7000
msucount -c itun -k 3838:sccp:5 -s c7000
msucount -c itui -k 1-34-4:sccp:105 -s c7001
msucount -r -l -c itun24 -k 15-105-16:5:15-105-17:1:1000
msucount -c ituis -k 3-11-1:isup:4-11-1 -s ipg1315a1
msucount -c ituns -k 6344:sccp:5 -s ipg1317a1
```

Dependencies

At least one option must be specified.

Notes

The **msucount** command is executed through the **pass** command.

Combinations of the **-l**, **-s**, **-k** and **-t** options provide count information based on the entered combination.

For the SS7IPGW and IPGWI GPLs, 3 types of reports can be generated: the link report, the routing key report, and the IP connection statistics report. For the IPLIM/IPLIMI card, the routing key report is not supported.

A single command line can request one or two types of reports, in the following combinations:

- Link statistics only
- Routing key statistics only
- IP connection statistics only
- Link statistics and routing key statistics
- Link statistics and IP connection statistics

The 3 reports are the following:

1. The link report (**-l** option) contains statistics per link—data about MSUs (transmit/receive), MSU bytes (transmit/receive), MGMT messages (transmit/receive), and discarded data (transmit/receive).
2. The routing key report (**-k** option) contains statistics for a specific routing key—data about MSUs (transmit), MSU bytes (transmit), and discards on the transmit path for the routing key.

A list of one or more IP connections associated with the routing key, with the MSU and MSU bytes counts for each connection, is also displayed. If the **-s name** option is specified with the **-k** option, only the connection association data for the specified connection is shown. When the **-s name** option is not specified with the **-k** option, all connection assignment slots are shown.

The **-c point code type** and **-p** (partial routing key) modifier options can be used with the **-k** option to specify the format of the routing key that follows the **-k** option in the command. The **-d** option can be used in place of the **-k** option to request information for a default routing key (the **-d** and **-k** options cannot be used in the same command).

For the **-k** options, the routing key must be an exact match of a routing key that exists in the static or dynamic Routing Key tables. If the same routing key exists in both the static and dynamic Routing Key tables, the **-k** option displays the counts associated with the entry in the dynamic Routing Key table only. The **-t static** option can be specified with the **-k** option to display the entry in the static Routing Key table.

3. The IP connection statistic report (**-s name** option) contains statistics for a specified IP connection—data about MSUs (transmit/receive), MSU bytes (transmit/receive), and discarded data (transmit/receive).

When the **-s name** option is specified in the command with the **-k** option, the output type is assumed to be routing key output.

When the **-s name** option is specified in the command without the **-k** option, the IP connection statistic report is generated.

All 3 report types can display individual transmit MSUs that were discarded at layer 2. The first 32 bytes of the MSU transmit data that is discarded is stored beginning at the SIO bytes. If the MSU is not 32 bytes long, the remaining bytes are set to 0.

The link and IP connection statistics reports can display individual receive packets that were discarded at layer 2. Portions of the TALI packets for the receive MSUs that the SS7IPGW application discards are stored beginning with the 12 bytes of the TALI header, and followed by the service data. If the storage space is larger than the service data, the extra bytes are set to 0. The TALI packet is stored instead of the MSU so that it is not necessary to construct an MTP3 header for packets that are discarded for reasons such as bad link state, bad SCCP message type, no calling or called party, or bad SIO for an ISUP message.

The reset option (**-r**) has no effect on the command output. The displayed counts are reset to 0 after the command is completed. The **-r** option can be added to any command.

Output

In the examples that follow, the hexadecimal output for discarded *transmit* data represents data stored beginning at the SIO bytes through the first 32 bytes of the MSU. If the MSU was less than 32 bytes, the remaining bytes are represented by zeros.

Hexadecimal output for discarded *receive* data represents data stored beginning at the TALI header. (A TALI header can have a sync code of either TALI or SASI). This data is used to store portions of the TALI packets for received MSUs that the SS7IPGW APPL layer decides to discard.

Stored *receive* data takes the following format:

First 12 bytes = TALI header.

Bytes 13-x = Service data, beginning with the first byte of service data based on the received TALI operations code. If the storage space is greater than the size of the service data, the remaining bytes are zeroed.

Output Specific to SS7IPGW and IPGWI

Example of help for using the command:

pass:loc=1105:cmd="msucount -h"

Command Accepted - Processing

```

rlghncxa03w 05-01-29 11:31:09 EST  EAGLE5 31.12.0
pass:loc=1105:cmd="msucount -h"
Command entered at terminal #1.
;

rlghncxa03w 05-01-29 11:31:09 EST  EAGLE5 31.12.0
PASS: Command sent to card
;

rlghncxa03w 05-01-29 11:31:09 EST  EAGLE5 31.12.0
Usage: msucount [-l] [-k routing key] [-s name] [-t static]
               [-k routing key -s name]
               [-l -k routing key] [-l -s name]
               [-l -k routing key -s name]
               [-r *] [-h] [-x]

Options:
-h Display this help message
-c pointCode type specifier
  -c ANSI, -c ITUI, -c ITUN, -c ITUN24. -c ITUIS, -c ITUNS
-p partial routing key msu count report
-d default routing key msu count report
-k Routing Key msu count report
-l Link msu count report
-r Reset msu counts (* used with above options)
-s Connection Name msu report
-t Use routing key from static route key table
-x Routing context (routing key) msu count report
;

rlghncxa03w 05-01-29 11:31:09 EST  EAGLE5 31.12.0
MSUCOUNT command complete
;

```

Example of link report only:

pass:loc=1105:cmd="msucount -l"

Command Accepted - Processing

```

rlghncxa03w 04-09-29 11:31:09 EST EAGLE5 31.10.0
pass:loc=1105:cmd="msucount -l"
Command entered at terminal #1.
;
rlghncxa03w 04-09-29 11:31:09 EST EAGLE5 31.10.0
PASS: Command sent to card
;
rlghncxa03w 04-09-29 11:31:09 EST EAGLE5 31.10.0
MSUCOUNT: Command In Progress
;
rlghncxa03w 04-09-29 11:31:09 EST EAGLE5 31.10.0

MSUCOUNT: MSU Count Report

-----
Link Measurements (Port A)
-----

Transmit Counts
-----
tx bytes:                927186
tx msus:                  35661
tx average rate (msus/second): 00441

Receive Counts
-----
rcv bytes:                775302
rcv msus:                  29826
rcv average rate (msus/second): 00342

Reroute Counts
-----
msus sent to mate cards: 00000
msus received from mate cards: 00000

MGMT Primitive Totals
-----
MTPP primitives received 00000
MTPP primitives discarded 00000
MTPP primitives transmitted 00000
RKRK requests received 00000
RKRK requests discarded 00000
RKRK dynamic route key table updates 00000

Transmit Discard Counts
-----
discarded tx due to special adjpc msu: 00000
discarded tx due to discard all adjpc msu: 00000
discarded tx due to no ss7 rtbl entry: 00000
discarded tx due to no ss7 rtkey: 00001
discarded tx due to no conn avail to pc: 00000
discarded tx due to no conn avail to rtkey: 00001
discarded tx due to congested connection 00000
discarded tx due to sccp msg type: 00000
discarded tx due to sccp class: 00001
discarded tx due to circular rte: 00000

```

```
discarded tx due to normalization error: 00000
discarded tx due to invalid traffic type: 00000
discarded tx due to M3UA conversion error: 00001
discarded tx due to SUA conversion error: 00000
discarded tx due to AS-Pending overflow: 00000
discarded tx due to AS timer Tr expiry: 00000
discarded tx due to reroute failure: 00000
```

Receive Discard Counts

```
-----
discarded rcv due to link state: 00000
discarded rcv due to sccp msg type: 00001
discarded rcv due to sccp class: 00003
discarded rcv due to sccp called party: 00004
discarded rcv due to sccp calling party: 00021
discarded rcv due to isup sio: 00011
discarded rcv due to normalization error: 00000
discarded rcv due to error in XSRV packet: 00000
discarded rcv due to M3UA PDU error: 00001
discarded rcv due to SUA PDU error: 00000
discarded rcv due to invalid rcontext 00000
```

Stored Transmit Discard Data

```
-----
83 01 05 05 0a 01 03 bf 09 80 03 08 0d 05 c3 07
01 05 05 05 c3 07 0a 01 03 08 e2 06 c7 04 13 10
```

Stored Receive Discard Data

```
-----
53 41 53 49 73 63 63 70 1a 00 09 01 03 08 0d 05
c3 05 0a 01 03 05 c3 05 01 05 05 08 e2 06 c7 04
```

END of Report

;

Routing Key Report Output Examples

The routing key report contains data about MSUs (tx), MSU bytes (tx), and discards on the transmit path for the routing key. A list of one or more connections associated with the routing key, with the MSU and MSU bytes counts for each connection, is also presented. If **-s name** is in the same input command with **-k routekey**, only the connection association data for the specified connection is displayed. When **-s name** is not specified with **-k routekey**, all connection associations are listed.

The report output itself does not display the routing key that was entered, other than an exact copy of the command line being generated as part of the output. The only indication in the output as to which key was found is the indication as to whether the key was in the dynamic Routing Key table or the static Routing Key table.

Partial routing keys (where some fields in the MSU are ignored with respect to finding a routing key to use for the MSU) and default keys can be specified in the command. The output does not change for these key types; the only difference is the routing key syntax (**-p**, **-d**) that must be processed as part of identifying the partial and default keys. (See the Example section of this command description for syntax examples).

Example of a routing key report for an ANSI routing key (from the dynamic Routing Key table):

pass:loc=1105:cmd="msucount -k 5-5-1:3:5"

or

pass:loc=1105:cmd="msucount -x -k 5"

Command Accepted - Processing

```

rlghncxa03w 04-04-29 11:31:09 EST  EAGLE5 31.6.0
pass:loc=1105:cmd="msucount -k 5-5-1:3:5"
Command entered at terminal #1.
;
rlghncxa03w 04-04-29 11:31:09 EST  EAGLE5 31.6.0
PASS: Command sent to card
;
rlghncxa03w 04-04-29 11:31:09 EST  EAGLE5 31.6.0
MSUCOUNT: Command In Progress
;
rlghncxa03w 04-04-29 11:31:09 EST  EAGLE5 31.6.0

MSUCOUNT: MSU Count Report

-----
Routing Key Measurements for Dynamic Routing Key
-----

Transmit Counts
-----
tx bytes:                971646
tx msus:                  37371

Transmit Discard Counts
-----
discarded tx due to sccp msg type:    00000
discarded tx due to sccp class:       00001
discarded tx due to normalization error: 00000
discarded tx due to invalid traffic type: 00000

Associated IP Connection          tx bytes          tx msus
-----
c7000                            00000000          00000000
c7050                            00326378          00012553
c7052                            00322660          00012410
c7054                            00322608          00012408

Stored Transmit Discard Data
-----
83 01 05 05 0a 01 03 94 09 01 03 08 0d 05 c3 05
01 05 05 05 c3 05 0a 01 03 08 e2 06 c7 04 28 10

END of Report
;

```

Example of a routing key report for an ANSI routing key (from the static Routing Key table):

pass:loc=1105:cmd="msucount -k 5-5-1:3:5 -t static"

Command Accepted - Processing

```

rlghncxa03w 04-04-29 11:33:40 EST  EAGLE5 31.6.0
pass:loc=1105:cmd="msucount -k 5-5-1:3:5 -t static"
Command entered at terminal #1.
;
rlghncxa03w 04-04-29 11:33:40 EST  EAGLE5 31.6.0
PASS: Command sent to card
;
rlghncxa03w 04-04-29 11:33:40 EST  EAGLE5 31.6.0
MSUCOUNT: Command In Progress
;
rlghncxa03w 04-04-29 11:33:40 EST  EAGLE5 31.6.0

MSUCOUNT: MSU Count Report

-----
Routing Key Measurements for Static Routing Key
-----

Transmit Counts
-----
tx bytes:                               00000
tx msus:                                 00000

Transmit Discard Counts
-----
discarded tx due to sccp msg type:      00000
discarded tx due to sccp class:         00000
discarded tx due to normalization error: 00000
discarded tx due to invalid traffic type: 00000

Associated IP Connection          tx bytes      tx  msus
-----          -----          -----
c7000                      00000000      00000000
c7050                      00000000      00000000
c7052                      00000000      00000000
c7054                      00000000      00000000

Stored Transmit Discard Data
-----
no stored transmit discard data

END of Report
;

```

Example of routing key report for an ANSI routing key, with one specified socket association displayed:

pass:loc=1105:cmd="msucount -k 5-5-1:3:5 -s c7000"

Command Accepted - Processing

```

rlghncxa03w 04-04-29 11:33:40 EST EAGLE5 31.6.0
pass:loc=1105:cmd="msucount -k 5-5-1:3:5 -s c7000"
Command entered at terminal #1.
;
rlghncxa03w 04-04-29 11:33:40 EST EAGLE5 31.6.0
PASS: Command sent to card
;
rlghncxa03w 04-04-29 11:33:40 EST EAGLE5 31.6.0
MSUCOUNT: Command In Progress
;
rlghncxa03w 04-04-29 11:33:40 EST EAGLE5 31.6.0

MSUCOUNT: MSU Count Report

-----
Routing Key Measurements for Dynamic Routing Key
-----

Transmit Counts
-----
tx bytes:                1132794
tx msus:                  43569

Transmit Discard Counts
-----
discarded tx due to sccp msg type:    00000
discarded tx due to sccp class:      00001
discarded tx due to normalization error: 00000
discarded tx due to invalid traffic type: 00000

Associated IP Connection          tx bytes          tx msus
-----
c7000                            00000000         00000000

Stored Transmit Discard Data
-----
83 01 05 05 0a 01 03 94 09 01 03 08 0d 05 c3 05
01 05 05 05 c3 05 0a 01 03 08 e2 06 c7 04 28 10

END of Report
;

```

Example of an ITU-I routing key report:

pass:loc=1105:cmd="msucount -c ITUI -k 5-5-1:3:5"

Command Accepted - Processing

```
rlghncxa03w 04-04-29 11:33:40 EST EAGLE5 31.6.0
pass:loc=1105:cmd="msucount -c ITUI -k 5-5-1:3:5"
Command entered at terminal #1.
```

;

```
rlghncxa03w 04-04-29 11:33:40 EST EAGLE5 31.6.0
PASS: Command sent to card
```

;

```
rlghncxa03w 04-04-29 11:33:40 EST EAGLE5 31.6.0
MSUCOUNT: Command In Progress
```

;

```
rlghncxa03w 04-04-29 11:33:40 EST EAGLE5 31.6.0

MSUCOUNT: MSU Count Report
```

```
-----
Routing Key Measurements for Dynamic Routing Key
-----
```

Transmit Counts

```
-----
tx bytes:                971646
tx msus:                  37371
```

Transmit Discard Counts

```
-----
discarded tx due to sccp msg type:    00000
discarded tx due to sccp class:       00001
discarded tx due to normalization error: 00000
discarded tx due to invalid traffic type: 00000
```

Associated IP Connection	tx bytes	tx msus
-----	-----	-----
c7000	00000000	00000000
c7050	00326378	00012553
c7052	00322660	00012410
c7054	00322608	00012408

Stored Transmit Discard Data

```
-----
83 01 05 05 0a 01 03 94 09 01 03 08 0d 05 c3 05
01 05 05 05 c3 05 0a 01 03 08 e2 06 c7 04 28 10
```

END of Report

;

Example of an ITU-N routing key report:

- Command when the ITUDUPPC feature is OFF (default)

pass:loc=1105:cmd="msucount -c ITUN -k 2860:3:5 -t static"

Command Accepted - Processing

```
rlghncxa03w 05-07-29 11:33:40 EST EAGLE5 31.6.0
pass:loc=1105:cmd="msucount -c ITUN -k 2860-aa:3:5 -t static"
Command entered at terminal #1.
```

;

- Command when the ITUDUPPC feature is ON (a 2-letter group code must be specified)

pass:loc=1105:cmd="msucount -c ITUN -k 2860-gr:3:5 -t static"

Command Accepted - Processing

```
rlghncxa03w 05-07-29 11:33:40 EST EAGLE5 31.6.0
pass:loc=1105:cmd="msucount -c ITUN -k 2860-gr:3:5 -t static"
Command entered at terminal #1.
```

;

- The remainder of the ITUN routing key report is the same for both the on and off settings of the ITUDUPPC feature:

```
rlghncxa03w 05-07-29 11:33:40 EST EAGLE5 31.6.0
PASS: Command sent to card
```

;

```
rlghncxa03w 05-07-29 11:33:40 EST EAGLE5 31.6.0
MSUCOUNT: Command In Progress
```

;

```
rlghncxa03w 05-07-29 11:33:40 EST EAGLE5 31.6.0
```

MSUCOUNT: MSU Count Report

```
-----
Routing Key Measurements for Static Routing Key
-----
```

Transmit Counts

```
tx bytes:                00000
tx msus:                  00000
```

Transmit Discard Counts

```
discarded tx due to sccp msg type:    00000
discarded tx due to sccp class:       00000
discarded tx due to normalization error: 00000
discarded tx due to invalid traffic type: 00000
```

Associated IP Connection	tx bytes	tx msus
-----	-----	-----
c7000	00000000	00000000
c7050	00000000	00000000
c7052	00000000	00000000
c7054	00000000	00000000

```

Stored Transmit Discard Data
-----
no stored transmit discard data

```

```

END of Report

```

```

;

```

Example of IP connection statistics report only, for a specific connection:

pass:loc=1105:cmd="msucount -s c7050"

Command Accepted - Processing

```

rlghncxa03w 04-09-29 11:31:09 EST EAGLE5 31.10.0
pass:loc=1105:cmd="msucount -s c7050"
Command entered at terminal #1.
;
rlghncxa03w 04-09-29 11:31:09 EST EAGLE5 31.10.0
PASS: Command sent to card
;
rlghncxa03w 04-09-29 11:31:09 EST EAGLE5 31.10.0
MSUCOUNT: Command In Progress
;
rlghncxa03w 04-09-29 11:31:09 EST EAGLE5 31.10.0

```

MSUCOUNT: MSU Count Report

```

-----
IP Connection Measurements
-----

```

Transmit Counts

```

-----
tx bytes:                320294
tx msus:                  12319

```

Receive Counts

```

-----
rcv bytes:                167681
rcv msus:                  06451

```

Transmit Discard Counts

```

-----
discarded tx due to sccp msg type:      00000
discarded tx due to sccp class:         00000
discarded tx due to normalization error: 00000
discarded tx due to invalid traffic type: 00000
discarded tx due to M3UA conversion error: 00000
discarded tx due to SUA conversion error: 00001

```

Receive Discard Counts

```

-----
discarded rcv due to link state:         00000
discarded rcv due to sccp msg type:      00000
discarded rcv due to sccp class:         00000
discarded rcv due to sccp called party:  00000
discarded rcv due to sccp calling party: 00003
discarded rcv due to isup sio:          00004

```

```

discarded rcv due to normalization error: 00000
discarded rcv due to error in XSRV packet: 00000
discarded rcv due to M3UA PDU error:      00000
discarded rcv due to SUA PDU error:      00001  discarded rcv due to
invalid rcontext      00000

```

Stored Transmit Discard Data

no stored transmit discard data

Stored Receive Discard Data

```

53 41 53 49 69 73 6f 74 11 00 87 0a 01 03 01 05
05 00 01 02 03 04 05 06 07 08 09 00 00 00 00 00

```

```

53 41 53 49 69 73 6f 74 11 00 87 0a 01 03 01 05
05 00 01 02 03 04 05 06 07 08 09 00 00 00 00 00

```

```

53 41 53 49 69 73 6f 74 11 00 87 0a 01 03 01 05
05 00 01 02 03 04 05 06 07 08 09 00 00 00 00 00

```

```

53 41 53 49 69 73 6f 74 11 00 87 0a 01 03 01 05
05 00 01 02 03 04 05 06 07 08 09 00 00 00 00 00

```

```

53 41 53 49 73 63 63 70 17 00 09 80 03 08 0a 05
c3 05 0a 01 03 02 c1 05 08 e2 06 c7 04 00 00 00

```

```

53 41 53 49 73 63 63 70 17 00 09 80 03 08 0a 05
c3 05 0a 01 03 02 c1 05 08 e2 06 c7 04 00 00 00

```

```

53 41 53 49 73 63 63 70 17 00 09 80 03 08 0a 05
c3 05 0a 01 03 02 c1 05 08 e2 06 c7 04 00 00 00

```

END of Report

;

Output Examples for Two Reports in the Same Command

The output for each report, as shown in the previous examples, is generated and concatenated into a single report before the END of Report line.

Example of a link report followed by a routing key report:

pass:loc=1105:cmd="msucount -k 5-5-1:3:5 -1"

Command Accepted - Processing

```
rlghncxa03w 04-09-29 11:31:09 EST EAGLE5 31.10.0
pass:loc=1105:cmd="msucount -k 5-5-1:3:5 -1"
Command entered at terminal #1.
```

;

```
rlghncxa03w 04-09-29 11:31:09 EST EAGLE5 31.10.0
PASS: Command sent to card
```

;

```
rlghncxa03w 04-09-29 11:31:09 EST EAGLE5 31.10.0
MSUCOUNT: Command In Progress
```

;

```
rlghncxa03w 04-09-29 11:31:09 EST EAGLE5 31.10.0
```

MSUCOUNT: MSU Count Report

```
-----
Link Measurements (Port A)
-----
```

Transmit Counts

```
tx bytes:                990132
tx msus:                  38082
tx average rate (msus/second): 00251
```

Receive Counts

```
rcv bytes:                838248
rcv msus:                  32247
rcv average rate (msus/second): 00198
```

Reroute Counts

```
msus sent to mate cards: 00000
msus received from mate cards: 00000
```

Transmit Discard Counts

```

-----
discarded tx due to special adjpc msu:      00000
discarded tx due to discard all adjpc msu: 00000
discarded tx due to no ss7 rtbl entry:      00000
discarded tx due to no ss7 rtkey:          00001
discarded tx due to no conn avail to pc:    00000
discarded tx due to no conn avail to rtkey:00001
discarded tx due to congested connection:  00000
discarded tx due to sccp msg type:          00000
discarded tx due to sccp class:            00001
discarded tx due to circular rte:           00000
discarded tx due to normalization error:    00000
discarded tx due to invalid traffic type:   00000
discarded tx due to M3UA conversion error:  00001
discarded tx due to SUA conversion error:   00000
discarded tx due to AS-Pending overflow:    00000
discarded tx due to AS timer Tr expiry:    00000
discarded tx due to reroute failure:        00000

```

Receive Discard Counts

```

-----
discarded rcv due to link state:            00000
discarded rcv due to sccp msg type:        00001
discarded rcv due to sccp class:           00003
discarded rcv due to sccp called party:    00004
discarded rcv due to sccp calling party:   00021
discarded rcv due to isup sio:             00011
discarded rcv due to normalization error:  00000
discarded rcv due to error in XSRV packet: 00000
discarded rcv due to M3UA PDU error:       00001
discarded rcv due to SUA PDU error:        00000
discarded rcv due to invalid rcontext      00000

```

MGMT Primitive Totals

```

-----
MTPP primitives received                    00000
MTPP primitives discarded                   00000
MTPP primitives transmitted                 00000
RKRK primitives received                    00000
RKRK primitives discarded                   00000
RKRK dynamic route key table updates       00000

```

Stored Transmit Discard Data

```

-----
83 01 05 05 0a 01 03 bf 09 80 03 08 0d 05 c3 07
01 05 05 05 c3 07 0a 01 03 08 e2 06 c7 04 13 10

83 01 05 05 0a 01 03 94 09 01 03 08 0d 05 c3 05
01 05 05 05 c3 05 0a 01 03 08 e2 06 c7 04 28 10

83 01 05 05 0a 01 03 ec 10 00 00 00 00 00 00 00
02 00 00 00 00 00 00 00 00 00 00 00 00 00 00 00

```

Stored Receive Discard Data

```

-----
53 41 53 49 73 63 63 70 1a 00 09 01 03 08 0d 05
c3 05 0a 01 03 05 c3 05 01 05 05 08 e2 06 c7 04

53 41 53 49 69 73 6f 74 11 00 87 0a 01 03 01 05
05 00 01 02 03 04 05 06 07 08 09 00 00 00 00 00

53 41 53 49 69 73 6f 74 11 00 87 0a 01 03 01 05
05 00 01 02 03 04 05 06 07 08 09 00 00 00 00 00

53 41 53 49 69 73 6f 74 11 00 87 0a 01 03 01 05
05 00 01 02 03 04 05 06 07 08 09 00 00 00 00 00

53 41 53 49 69 73 6f 74 11 00 87 0a 01 03 01 05
05 00 01 02 03 04 05 06 07 08 09 00 00 00 00 00

53 41 53 49 73 63 63 70 17 00 09 80 03 08 0a 05
c3 05 0a 01 03 02 c1 05 08 e2 06 c7 04 00 00 00

53 41 53 49 73 63 63 70 17 00 09 80 03 08 0a 05
c3 05 0a 01 03 02 c1 05 08 e2 06 c7 04 00 00 00

53 41 53 49 73 63 63 70 17 00 09 80 03 08 0a 05
c3 05 0a 01 03 02 c1 05 08 e2 06 c7 04 00 00 00

53 41 53 49 73 63 63 70 17 00 09 80 03 05 0a 02
c1 05 05 c3 05 01 05 05 08 e2 06 c7 04 00 00 00

53 41 53 49 73 63 63 70 17 00 09 80 03 05 0a 02
c1 05 05 c3 05 01 05 05 08 e2 06 c7 04 00 00 00
    
```

Routing Key Measurements for Dynamic Routing Key

Transmit Counts

```

-----
tx bytes:                991146
tx msus:                  38121
    
```

Transmit Discard Counts

```

-----
discarded tx due to sccp msg type:    00000
discarded tx due to sccp class:      00001
discarded tx due to normalization error: 00000
discarded tx due to invalid traffic type: 00000
    
```

Associated IP Connection	tx bytes	tx msus
-----	-----	-----
c7000	00000000	00000000
c7050	00332930	00012805
c7052	00329134	00012659
c7054	00329082	00012657

```

Stored Transmit Discard Data
-----
83 01 05 05 0a 01 03 94 09 01 03 08 0d 05 c3 05
01 05 05 05 c3 05 0a 01 03 08 e2 06 c7 04 28 10
    
```

END of Report

;

Example of a link report followed by a routing key report that shows an IP connections statistics report for one specified socket:

pass:loc=1105:cmd="msucount -r -s c7050 -k 5-5-1:3:5 -l"

Command Accepted - Processing

```

rlghncxa03w 04-09-29 11:31:09 EST EAGLE5 31.10.0
pass:loc=1105:cmd="msucount -r -s c7050 -k 5-5-1:3:5 -l"
Command entered at terminal #1.
    
```

;

```

rlghncxa03w 04-09-29 11:31:09 EST EAGLE5 31.10.0
PASS: Command sent to card
    
```

;

```

rlghncxa03w 04-09-29 11:31:09 EST EAGLE5 31.10.0
MSUCOUNT: Command In Progress
    
```

;

```

rlghncxa03w 04-09-29 11:31:09 EST EAGLE5 31.10.0
    
```

MSUCOUNT: MSU Count Report

```

-----
Link Measurements (Port A)
-----
    
```

Transmit Counts

```

-----
tx bytes:                00000
tx msus:                 00000
tx average rate (msus/second): 00000
    
```

Receive Counts

```

-----
rcv bytes:               00000
rcv msus:                00000
rcv average rate (msus/second): 00000
    
```

Reroute Counts

```

-----
msus sent to mate cards: 00000
msus received from mate cards: 00000
    
```

```

Transmit Discard Counts
-----
discarded tx due to special adjpc msu:      00000
discarded tx due to discard all adjpc msu:  00000
discarded tx due to no ss7 rtbl entry:      00000
discarded tx due to no ss7 rtkey:          00000
discarded tx due to no conn avail to pc:    00000
discarded tx due to no conn avail to rtkey: 00001
discarded tx due to congested connection:   00000
discarded tx due to sccp msg type:          00000
discarded tx due to sccp class:             00000
discarded tx due to circular rte:           00000
discarded tx due to normalization error:    00000
discarded tx due to invalid traffic type:   00000
discarded tx due to M3UA conversion error:  00001
discarded tx due to SUA conversion error:   00000
discarded tx due to AS-Pending overflow:    00000
discarded tx due to AS timer Tr expiry:    00000
discarded tx due to reroute failure:        00000

```

```

Receive Discard Counts
-----
discarded rcv due to link state:            00000
discarded rcv due to sccp msg type:         00000
discarded rcv due to sccp class:            00000
discarded rcv due to sccp called party:     00000
discarded rcv due to sccp calling party:    00000
discarded rcv due to isup sio:              00000
discarded rcv due to normalization error:   00000
discarded rcv due to error in XSRV packet:  00000
discarded rcv due to M3UA PDU error:        00001
discarded rcv due to SUA PDU error:         00000
discarded rcv due to invalid rcontext:      00000

```

```

MGMT Primitive Totals
-----
MTPP primitives received                    00000
MTPP primitives discarded                   00000
MTPP primitives transmitted                 00000
RKRPR primitives received                   00000
RKRPR primitives discarded                  00000
RKRPR dynamic route key table updates      00000

```

```

Stored Transmit Discard Data
-----
no stored transmit discard data

```

```

Stored Receive Discard Data
-----
no stored receive discard data

```

```

-----
Routing Key Measurements for Dynamic Routing Key
-----

```

```

Transmit Counts
-----
tx bytes:                                  00000
tx msus:                                    00000

```

```

Transmit Discard Counts
-----
discarded tx due to sccp msg type:      00000
discarded tx due to sccp class:         00000
discarded tx due to normalization error: 00000
discarded tx due to invalid traffic type: 00000

Associated IP Connection          tx bytes      tx  msus
-----
c7050                            00000000     00000000

Stored Transmit Discard Data
-----
no stored transmit discard data

END of Report

```

;

Example of a link report followed by an IP connection statistics report:

pass:loc=1105:cmd="msucount -l -s c7050"

Command Accepted - Processing

```

rlghncxa03w 04-09-29 11:31:09 EST  EAGLE5 31.10.0
pass:loc=1105:cmd="msucount -l -s c7050"
Command entered at terminal #1.

```

;

```

rlghncxa03w 04-09-29 11:31:09 EST  EAGLE5 31.10.0
PASS: Command sent to card

```

;

```

rlghncxa03w 04-09-29 11:31:09 EST  EAGLE5 31.10.0
MSUCOUNT: Command In Progress

```

;

```

rlghncxa03w 04-09-29 11:31:09 EST  EAGLE5 31.10.0

```

MSUCOUNT: MSU Count Report

```

-----
Link Measurements (Port A)
-----

```

```

Transmit Counts
-----
tx bytes:                1099384
tx msus:                  42284
tx average rate (msus/second): 00156

```

```

Receive Counts
-----
rcv bytes:                947500
rcv msus:                  36449
rcv average rate (msus/second): 00134

```

```

Transmit Discard Counts
-----
discarded tx due to special adjpc msu:      00000
discarded tx due to discard all adjpc msu: 00000
discarded tx due to no ss7 rtbl entry:      00000
discarded tx due to no ss7 rtkey:          00001
discarded tx due to no conn avail to pc:    00000
discarded tx due to no conn avail to rtkey:00001
discarded tx due to congested connection:  00000
discarded tx due to sccp msg type:          00000
discarded tx due to sccp class:            00001
discarded tx due to normalization error:    00000
discarded tx due to invalid traffic type:   00000
discarded tx due to M3UA conversion error:  00000
discarded tx due to SUA conversion error:   00001
discarded tx due to AS-Pending overflow:    00000
discarded tx due to AS timer Tr expiry:    00000
discarded tx due to reroute failure:        00000

```

```

Receive Discard Counts
-----
discarded rcv due to link state:            00000
discarded rcv due to sccp msg type:         00001
discarded rcv due to sccp class:           00003
discarded rcv due to sccp called party:     00004
discarded rcv due to sccp calling party:    00021
discarded rcv due to isup sio:             00011
discarded rcv due to normalization error:   00000
discarded rcv due to error in XSRV packet:  00000
discarded rcv due to M3UA PDU error:        00000
discarded rcv due to SUA PDU error:         00001
discarded rcv due to invalid rcontext:      00000

```

```

MGMT Primitive Totals
-----
MTPP primitives received                    00000
MTPP primitives discarded                   00000
MTPP primitives transmitted                 00000
RKRPrimitives received                     00000
RKRPrimitives discarded                    00000
RKRPrimitives dynamic route key table updates 00000

```

```

Stored Transmit Discard Data
-----
83 01 05 05 0a 01 03 bf 09 80 03 08 0d 05 c3 07
01 05 05 05 c3 07 0a 01 03 08 e2 06 c7 04 13 10

83 01 05 05 0a 01 03 94 09 01 03 08 0d 05 c3 05
01 05 05 05 c3 05 0a 01 03 08 e2 06 c7 04 28 10

83 01 05 05 0a 01 03 ec 10 00 00 00 00 00 00 00
02 00 00 00 00 00 00 00 00 00 00 00 00 00 00 00

```

Stored Receive Discard Data

```

-----
53 41 53 49 73 63 63 70 1a 00 09 01 03 08 0d 05
c3 05 0a 01 03 05 c3 05 01 05 05 08 e2 06 c7 04

53 41 53 49 69 73 6f 74 11 00 87 0a 01 03 01 05
05 00 01 02 03 04 05 06 07 08 09 00 00 00 00 00

53 41 53 49 69 73 6f 74 11 00 87 0a 01 03 01 05
05 00 01 02 03 04 05 06 07 08 09 00 00 00 00 00

53 41 53 49 69 73 6f 74 11 00 87 0a 01 03 01 05
05 00 01 02 03 04 05 06 07 08 09 00 00 00 00 00

53 41 53 49 69 73 6f 74 11 00 87 0a 01 03 01 05
05 00 01 02 03 04 05 06 07 08 09 00 00 00 00 00

53 41 53 49 73 63 63 70 17 00 09 80 03 08 0a 05
c3 05 0a 01 03 02 c1 05 08 e2 06 c7 04 00 00 00

53 41 53 49 73 63 63 70 17 00 09 80 03 08 0a 05
c3 05 0a 01 03 02 c1 05 08 e2 06 c7 04 00 00 00

53 41 53 49 73 63 63 70 17 00 09 80 03 08 0a 05
c3 05 0a 01 03 02 c1 05 08 e2 06 c7 04 00 00 00

53 41 53 49 73 63 63 70 17 00 09 80 03 05 0a 02
c1 05 05 c3 05 01 05 05 08 e2 06 c7 04 00 00 00

53 41 53 49 73 63 63 70 17 00 09 80 03 05 0a 02
c1 05 05 c3 05 01 05 05 08 e2 06 c7 04 00 00 00

```

IP Connection Measurements

Transmit Counts

```

-----
tx bytes:                               369694
tx msus:                                 14219

```

Receive Counts

```

-----
rcv bytes:                               217081
rcv msus:                                 08351

```

Transmit Discard Counts

```

-----
discarded tx due to sccp msg type:       00000
discarded tx due to sccp class:          00000
discarded tx due to normalization error: 00000
discarded tx due to invalid traffic type: 00000
discarded tx due to M3UA conversion error: 00000
discarded tx due to M3UA conversion error: 00000

```

```

Receive Discard Counts
-----
discarded rcv due to link state:          00000
discarded rcv due to sccp msg type:       00000
discarded rcv due to sccp class:          00000
discarded rcv due to sccp called party:   00000
discarded rcv due to sccp calling party:  00003
discarded rcv due to isup sio:            00004
discarded rcv due to normalization error: 00000
discarded rcv due to error in XSRV packet: 00000
discarded rcv due to M3UA PDU error:      00000
discarded rcv due to SUA PDU error:       00001
discarded rcv due to invalid rcontext:    00000

```

```

Stored Transmit Discard Data
-----
no stored transmit discard data

```

```

Stored Receive Discard Data
-----
53 41 53 49 69 73 6f 74 11 00 87 0a 01 03 01 05
05 00 01 02 03 04 05 06 07 08 09 00 00 00 00 00

53 41 53 49 69 73 6f 74 11 00 87 0a 01 03 01 05
05 00 01 02 03 04 05 06 07 08 09 00 00 00 00 00

53 41 53 49 69 73 6f 74 11 00 87 0a 01 03 01 05
05 00 01 02 03 04 05 06 07 08 09 00 00 00 00 00

53 41 53 49 69 73 6f 74 11 00 87 0a 01 03 01 05
05 00 01 02 03 04 05 06 07 08 09 00 00 00 00 00

53 41 53 49 73 63 63 70 17 00 09 80 03 08 0a 05
c3 05 0a 01 03 02 c1 05 08 e2 06 c7 04 00 00 00

53 41 53 49 73 63 63 70 17 00 09 80 03 08 0a 05
c3 05 0a 01 03 02 c1 05 08 e2 06 c7 04 00 00 00

53 41 53 49 73 63 63 70 17 00 09 80 03 08 0a 05
c3 05 0a 01 03 02 c1 05 08 e2 06 c7 04 00 00 00

```

END of Report

Output Specific to IPLIM and IPLIMI

NOTE: The routing key report is not supported for IPLIMx applications. The -c, -k, -t, -p, -d, -x options are not supported because the IPLIMx card does not use routing keys and does not support dynamic routing key registration.

Example of help for using the command:

pass:loc=1103:cmd="msucount -h" or

pass:loc=1103:cmd="msucount"

Command Accepted - Processing

```

rlghncxa03w 04-04-29 11:31:09 EST EAGLE5 31.6.0
pass:loc=1103:cmd="msucount -h"
Command entered at terminal #2.
;

rlghncxa03w 04-04-29 11:31:09 EST EAGLE5 31.6.0
PASS: Command sent to card
;

rlghncxa03w 04-04-29 11:31:09 EST EAGLE5 31.6.0

Usage: msucount [-l [port]] [-s name]
              [-l [port]-s name]
              [-r *] [-h]

Options:      -h Display this help message
              -l Link msu count report
              -l port Link msu count report for specified port
              -r Reset msu counts (* used with above options)
              -s IP Connection msu report
;

rlghncxa03w 04-04-29 11:31:09 EST EAGLE5 31.6.0
MSUCOUNT command complete
;

```

Example of a link report for an IPLIMx card with 2 SAALTALI or M2PA links:

The report does not contain MTPP or RKRPMGMT statistics, because those capabilities are not supported on the IPLIMx applications. The report also does not contain tx/rcv discard data, because there are no discards performed at layer 2 of the IPLIMx applications. The IPLIMx card can also contain 2 links per card; the output contains link data for each link.

pass:loc=1201:cmd="msucount -l"

Command Accepted - Processing

```

rlghncxa03w 05-07-29 16:30:51 EST EAGLE5 31.6.0
pass:loc=1201:cmd="msucount -l"
Command entered at terminal #1.

rlghncxa03w 05-07-29 16:30:51 EST EAGLE5 31.6.0
PASS: Command sent to card
;

rlghncxa03w 05-07-29 16:30:51 EST EAGLE5 31.6.0
MSUCOUNT: Command In Progress
;

rlghncxa03w 05-07-29 16:30:51 EST EAGLE5 31.6.0

MSUCOUNT: MSU Count Report

```

```

-----
Link Measurements (A port)
-----

Transmit Counts
-----
tx bytes:                927186
tx msus:                 35661
tx average rate (msus/second): 00167

Receive Counts
-----
rcv bytes:              775302
rcv msus:              29826
rcv average rate (msus/second): 00125

-----
Link Measurements (B port)
-----

Transmit Counts
-----
tx bytes:                927186
tx msus:                 35661
tx average rate (msus/second): 00167

Receive Counts
-----
rcv bytes:              775302
rcv msus:              29826
rcv average rate (msus/second): 00125

END of Report
;

```

Example if there is only an A port defined for the IPLIMx card at card location 1103:

pass:loc=1103:cmd="msucount -l"

Command Accepted - Processing

```

rlghncxa03w 05-07-29 16:30:51 EST EAGLE5 31.6.0
pass:loc=1103:cmd="msucount -l"
Command entered at terminal #1.
;
rlghncxa03w 05-07-29 16:30:51 EST EAGLE5 31.6.0
PASS: Command sent to card
;
rlghncxa03w 05-07-29 16:30:51 EST EAGLE5 31.6.0
MSUCOUNT: Command In Progress
;
rlghncxa03w 05-07-29 16:30:51 EST EAGLE5 31.6.0
MSUCOUNT: MSU Count Report

```



```

-----
Link Measurements (A port)
-----

Transmit Counts
-----
tx bytes:                927186
tx msus:                 35661
tx average rate (msus/second): 00167

Receive Counts
-----
rcv bytes:              775302
rcv msus:              29826
rcv average rate (msus/second): 00125

END of Report

```

;

Example of a link status report for an IPLIM card having 2 M3UA links:

pass:loc=1301:cmd="msucount -l"

Command Accepted - Processing

```

eagle10213 02-01-22 08:55:06 GMT EAGLE5 31.6.0
pass:loc=1301:cmd="msucount -l"
Command entered at terminal #4.

```

;

```

eagle10213 02-01-22 08:55:06 GMT EAGLE5 31.6.0
PASS: Command sent to card

```

;

```

eagle10213 02-01-22 08:55:06 GMT EAGLE5 31.6.0

MSUCOUNT: Command In Progress

```

;

```

eagle10213 02-01-22 08:55:06 GMT EAGLE5 31.6.0

MSUCOUNT: MSU Count Report

```

```

-----
Link Measurements (Port 0)
-----

Transmit Counts
-----
tx bytes:                00368
tx msus:                 00023
tx average rate (msus/sec): 00000

Transmit Discard Counts
-----
discarded tx due to M3UA conversion error: 00000

```

```

Receive Counts
-----
rcv bytes:                00000
rcv msus:                 00000
rcv average rate (msus/sec): 00000

Receive Discard Counts
-----
discarded rcv due to link state: 00000

Stored Transmit Discard Data
-----
b0 00 d4 01 00 d5 01 00 51 02 00 00 00 00 00 00
00 00 00 00 00 00 00 00 00 00 00 00 00 00 00 00

b0 00 d4 01 00 d5 01 00 51 03 00 75 00 00 00 00
00 00 00 00 00 00 00 00 00 00 00 00 00 00 00 00

b0 00 d4 01 00 d5 01 00 51 01 00 7f fb 00 00 00
00 00 00 00 00 00 00 00 00 00 00 00 00 00 00 00

b0 00 d4 01 00 d5 01 00 31 01 00 00 00 00 00 00
00 00 00 00 00 00 00 00 00 00 00 00 00 00 00 00

b0 00 d4 01 00 d5 01 00 31 02 00 00 00 5a 5a 5a
00 00 00 00 00 00 00 00 00 00 00 00 00 00 00 00

b0 00 d4 01 00 d5 01 00 51 02 00 6f 5a 5a 00 00
00 00 00 00 00 00 00 00 00 00 00 00 00 00 00 00

b0 00 d4 01 00 d5 01 00 51 01 00 49 00 00 00 00
00 00 00 00 00 00 00 00 00 00 00 00 00 00 00 00

Stored Receive Discard Data
-----
no stored receive discard data

-----

Link Measurements (Port 1)
-----

Transmit Counts
-----
tx bytes:                00112
tx msus:                 00007
tx average rate (msus/sec): 00000

Transmit Discard Counts
-----
discarded tx due to no M3UA conversion: 00003

Receive Counts
-----
rcv bytes:                00000
rcv msus:                 00000
rcv average rate (msus/sec): 00000

Receive Discard Counts
-----
discarded rcv due to link state: 00000

```

```

Stored Transmit Discard Data
-----
b0 00 d4 01 00 d5 01 00 51 13 00 02 5a 5a 00 00
00 00 00 00 00 00 00 00 00 00 00 00 00 00 00 00

b0 00 d4 01 00 d5 01 00 51 11 00 bc 5a 5a 00 00
00 00 00 00 00 00 00 00 00 00 00 00 00 00 00 00

b0 00 d4 01 00 d5 01 00 51 11 00 0f 00 00 00 00
00 00 00 00 00 00 00 00 00 00 00 00 00 00 00 00

Stored Receive Discard Data
-----
no stored receive discard data

```

END of Report

;

Example for port a1 on IPLIM card:

pass:loc=1103:cmd="msucount -l a1"

Command Accepted - Processing

```

eagle10213 02-01-22 08:55:06 GMT EAGLE5 31.6.0
pass:loc=1103:cmd="msucount -l a1"
Command entered at terminal #1.

```

;

```

eagle10213 02-01-22 08:55:06 GMT EAGLE5 31.6.0
PASS: Command sent to card

```

;

```

eagle10213 02-01-22 08:55:06 GMT EAGLE5 31.6.0
MSUCOUNT: Command In Progress

```

;

```

eagle10213 02-01-22 08:55:06 GMT EAGLE5 31.6.0
MSUCOUNT: MSU Count Report

```

```

-----
Link Measurements (Port A1)
-----

```

Transmit Counts

```

-----
tx bytes:                               927186
tx msus:                                 35661
tx average rate (msus/second):          00244

```

Receive Counts

```

-----
rcv bytes:                               775302
rcv msus:                                 29826
rcv average rate (msus/second):          00201

```

END of Report

;

Example of an IP connection statistics report. The IPLIMx IP connection report does not contain tx/rcv discard data, because there are no discards performed at layer 2 of the IPLIMx applications.

pass:loc=1103:cmd="msucount -s ipl1103"

Command Accepted - Processing

```

rlghncxa03w 04-04-29 11:31:09 EST  EAGLE5 31.6.0
pass:loc=1103:cmd="msucount -s ipl1103"
Command entered at terminal #1.
;

rlghncxa03w 04-04-29 11:31:09 EST  EAGLE5 31.6.0
PASS: Command sent to card
;

rlghncxa03w 04-04-29 11:31:09 EST  EAGLE5 31.6.0

MSUCOUNT: Command In Progress
;

rlghncxa03w 04-04-29 11:31:09 EST  EAGLE5 31.6.0

MSUCOUNT: MSU Count Report

-----
IP Connection Measurements
-----

Transmit Counts
-----
tx bytes:                696670920
tx msus:                  4996264

Receive Counts
-----
rcv bytes:                696774676
rcv msus:                  4997113

END of Report
;

```

Example of the link report and the IP connection report requested in one command:

pass:loc=1103:cmd="msucount -l -s ipl1103"

Command Accepted - Processing

```

rlghncxa03w 04-04-29 11:31:09 EST  EAGLE5 31.6.0
pass:loc=1103:cmd="msucount -l -s ipl1103"
Command entered at terminal #1.
;

rlghncxa03w 04-04-29 11:31:09 EST  EAGLE5 31.6.0
PASS: Command sent to card
;

```

```
rlghncxa03w 04-04-29 11:31:09 EST EAGLE5 31.6.0

MSUCOUNT: Command In Progress

;

rlghncxa03w 04-04-29 11:31:09 EST EAGLE5 31.6.0

MSUCOUNT: MSU Count Report

-----
Link Measurements (Port A)
-----

Transmit Counts
-----
tx bytes:                707541396
tx msus:                 5074039
tx average rate (msus/second): 01125

Receive Counts
-----
rcv bytes:              707645252
rcv msus:              5074889
rcv average rate (msus/second): 01127

-----
Link Measurements (Port B)
-----

Transmit Counts
-----
tx bytes:                00000
tx msus:                 00000
tx average rate (msus/second): 00000

Receive Counts
-----
rcv bytes:              00000
rcv msus:              00000
rcv average rate (msus/second): 00000

-----
IP Connection Measurements
-----

Transmit Counts
-----
tx bytes:                707541396
tx msus:                 5074039

Receive Counts
-----
rcv bytes:              707645252
rcv msus:              5074889

END of Report

;
```

msuroute**Message Signaling Unit (MSU) Routing Information**

This command is used to provide a list of all routing keys currently configured on an SS7IPGW/IPGWI card that could be used to route a particular MSU. With 3 types of routing keys (fully specified, partial and default) and 2 types of routing key tables (static and dynamic) the complexity associated with figuring out how a particular MSU would be routed at any point in time is not trivial. This command provides output to help determine how MSUs will be routed based on current conditions.

Command Name: `msuroute`

Command Class: Application Maintenance

Options

Options and option parameters that are underlined indicate that a value must be specified for that option or parameter. For example, the `msuroute` command option `-k` has the parameter routing key. The *full routing key* must be specified for the MSU for which the summary will be displayed, as in the command `msuroute -k 5-5-5:5:6-6-6:1100`. Do not enter the underlined option or parameter; enter a value for the information represented by the underlined option or parameter.

-h

This option provides help information for the command.

-c point code type

This option modifier can be specified preceding the `-k` option to identify the point code type (ANSI, ITU international, ITU national, ITU international spare, ITU national spare) in the routing key that follows the `-k` option in the command.

Range: `ansi, itui, itun, itun24, ituis, ituns`

Default: `ansi`

-k routing key

This option is required in the command to specify the full routing key for the MSU for which the summary will be displayed. The routing key is specified as a single parameter with up to five colon-separated fields. The subsystem is not specified when SI is not equal to 3.

The `-c point code type` modifier can be specified to identify the format of the routing key that follows the `-k` option in the command.

The following are valid formats for the routing key that follows the `-k` option in the command:

- `n-c-m:s:n`—For DPC, SI, SSN type routing keys. The network, cluster and member (`n-c-m`) are in the range **0-255**. The service indicator (`s`) is **3** or **sccp**. The subsystem (`n`) is in the range **0-255**.
- `n-c-m:s`—For DPC, SI, type routing keys. The network, cluster and member (`n-c-m`) are in the range **0-255**. The service indicator (`s`) is in the range **0-2**, **4**, or **6-15**. There is no subsystem.
- `n-c-m:s:no-co-mo:cs:ce`—For DPC, SI, CIC type routing keys. The DPC network, cluster and member (`n-c-m`) are in the range **0-255**. The service indicator (`s`) is **5** or **isup**. There is no subsystem. The OPC network, cluster and member (`no-co-mo`) are in the range **0-255**. The starting circuit identification code (`cs`) and ending circuit identification code (`ce`) are in the range **0** to **16363**.

Example

```

msuroute -h
msuroute -c ansi -k 5-5-5:5:6-6-6:1100
msuroute -c ansi -k 5-5-5:5:6-6-6:1100:1100
msuroute -k 5-5-5:5:6-6-6:1100
msuroute -k 5-5-5:5:6-6-6:1100:1100
msuroute -c ansi -k 5-5-5:8
msuroute -c itun -k 345:5:678:100:200
msuroute -c itun -k 345-gr:5:678-gr:100:200
msuroute -c itun24 -k 10-200-10:5:10-200-1:1:100

```

Dependencies

The **-k** option must be specified in the command, and must specify a full routing key. This command is not supported for IPLIM/IPLIMI cards.

Notes

The **msuroute** command is executed through the pass command.

The **-c point code type** modifier option can be used with the **-k** option to specify the format of the routing key that follows the **-k** option in the command.

Output

The output for each **msuroute** command consists of a list of all of the routing keys that exist on the IPGWx card that could be used to route the MSU. The list of routing keys is presented in the hierarchical search order in which the keys would be used. The list of routing keys indicates keys that have IP connections available for traffic, and indicates which routing key would currently be used to route the MSU (marked with ***).

For the routing key that is selected to route the MSU, the list of IP connections associated with the key is also displayed.

NOTE: Most of the following output examples show command entries for ANSI MSUs. Because, other than echoing the input command back to the screen, there is nothing in the output that contains specific fields from any configured keys. The output would not be different if the user entered ITUI MSUs instead of ANSI MSUs.

Example of help for using the command:

```

pass:loc=1105:cmd="msuroute -h"
Command Accepted - Processing

;

rlghncxa03w 05-07-29 16:30:51 EST  EAGLE5 31.12.0
pass:loc=1105:cmd="msuroute -h"
Command entered at terminal #1.

;

rlghncxa03w 05-07-29 16:30:51 EST  EAGLE5 31.12.0
PASS: Command sent to card

;

```

```

rlghncxa03w 05-07-29 16:30:51 EST  EAGLE5 31.12.0
Usage: MSURROUTE [-h] [-c point code] [-k route key]
Options:
  -h                Displays this message
  -c point code     ANSI | ITUI | ITUN | ITUN24 | ITUIS | ITUNS
  -k routing key    Displays entries affecting specified routing key
;

rlghncxa03w 05-07-29 16:30:51 EST  EAGLE5 31.12.0
MSURROUTE command complete
;

```

Example of **msuroute** output for an ANSI CIC-based MSU, showing at least 1 routing key of every key type in the search hierarchy configured on the 1105 card. Only key types that are configured on the card will be listed in the display.

pass:loc=1105:cmd="msuroute -c ANSI -k 5-5-5:5:6-6-6:1100"

```

Command Accepted - Processing

rlghncxa03w 04-04-29 11:31:09 EST  EAGLE5 31.6.0
pass:loc=1105:cmd="msuroute -c ANSI -k 5-5-5:5:6-6-6:1100"
Command entered at terminal #1.
;

rlghncxa03w 04-04-29 11:31:09 EST  EAGLE5 31.6.0
PASS: Command sent to card
;

rlghncxa03w 04-04-29 11:31:09 EST  EAGLE5 31.6.0
MSURROUTE command in progress
;

rlghncxa03w 04-04-29 11:31:09 EST  EAGLE5 31.6.0

TABLE  KEYTYPE                #ConnCfgd  #ConnAvail  RTKEY USED
DYN    FULL                    1          0           no
DYN    PARTIAL: IGNORE-CIC     2          0           no
DYN    PARTIAL: IGNORE-CIC+OPC 1          0           no
DYN    PARTIAL: DPC-SI ONLY    3          3           yes
DYN    PARTIAL: DPC ONLY       2          2           no
DYN    PARTIAL: SI ONLY       4          0           no
DYN    DEFAULT                 4          4           no
STATIC FULL                    12         4           no
STATIC PARTIAL: IGNORE-CIC     3          0           no
STATIC PARTIAL: IGNORE-CIC+OPC 2          0           no
STATIC PARTIAL: DPC-SI ONLY    3          2           no
STATIC PARTIAL: DPC ONLY       2          2           no
STATIC PARTIAL: SI ONLY       1          0           no
STATIC DEFAULT                 2          0           no

```



```

IP Connections Associated with the RTKEY USED
Name                               Avail?
Vox1                               yes
Mgc2                               yes
Mgc24                             yes

```

```
MSURROUTE command complete
```

```
;
```

Example of **msuroute** output for an ANSI SCCP MSU. Several of the key types in the search hierarchy are not configured on the 1105 card, and therefore are not part of the output (for example, dynamic or static full key and dynamic or static partial SI only). Only key types that are configured on the card will be listed in the display.

pass:loc=1105:cmd="msuroute -c ANSI -k 5-5-5:3:34"

```
Command Accepted - Processing
```

```

rlghncxa03w 04-04-29 11:31:09 EST  EAGLE5 31.6.0
pass:loc=1105:cmd="msuroute -c ANSI -k 5-5-5:3:34"
Command entered at terminal #1.

```

```
;
```

```

rlghncxa03w 04-04-29 11:31:09 EST  EAGLE5 31.6.0
PASS: Command sent to card

```

```
;
```

```

rlghncxa03w 04-04-29 11:31:09 EST  EAGLE5 31.6.0
MSURROUTE command in progress

```

```
;
```

```

rlghncxa03w 04-04-29 11:31:09 EST  EAGLE5 31.6.0
TABLE  KEYTYPE                #ConnCfgd  #ConnAvail  RTKEY USED
DYN    PARTIAL: DPC-SI ONLY    3          2           yes
DYN    PARTIAL: DPC ONLY      2          2           no
DYN    DEFAULT                4          4           no
STATIC PARTIAL: DPC-SI ONLY    3          2           no
STATIC PARTIAL: DPC ONLY      2          2           no
STATIC DEFAULT                2          0           no

```

```

SocketsIP Connections Associated with the RTKEY USED
Name                               Avail?
Scpsandiego                       no
scpdenver                          yes
scpkansascity                      yes

```

```
MSURROUTE command complete
```

```
;
```

Example of **msuroute** output for an ANSI MSU with SI=8:

pass:loc=1105:cmd="msuroute -c ANSI -k 5-5-5:8"

Command Accepted - Processing

```

rlghncxa03w 04-04-29 11:31:09 EST  EAGLE5 31.6.0
pass:loc=1105:cmd="msuroute -c ANSI -k 5-5-5:8"
Command entered at terminal #1.
;

rlghncxa03w 04-04-29 11:31:09 EST  EAGLE5 31.6.0
PASS: Command sent to card
;

rlghncxa03w 04-04-29 11:31:09 EST  EAGLE5 31.6.0
MSURROUTE command in progress
;

rlghncxa03w 04-04-29 11:31:09 EST  EAGLE5 31.6.0

TABLE   KEYTYPE                               #ConnCfgd  #ConnAvail  RTKEY USED
DYN     FULL                                  7           0            no
DYN     PARTIAL: DPC ONLY                     2           2            yes
DYN     PARTIAL: SI ONLY                       2           0            no
DYN     DEFAULT                               4           4            no
STATIC  FULL                                  11          0            no
STATIC  PARTIAL: DPC ONLY                      2           2            no
STATIC  PARTIAL: SI ONLY                       1           0            no
STATIC  DEFAULT                               2           0            no

IP Connections Associated with the RTKEY USED
Name                               Avail?
SI8sock1                           yes
SI8sock2                           yes

MSURROUTE command complete
;

```

Examples of **msuroute** output for an ITUN and an ITUN24 MSU with SI=5. The output format is the same for all four commands.

The ITUDUPPC feature is OFF (default):

pass:loc=1105:cmd="msuroute -c itun -k 345:5:678:100:200"

The ITUDUPPC feature is ON (the 2-letter group code must be specified with the DPC and OPC)

pass:loc=1105:cmd="msuroute -c itun -k 345-gr:5:678-gr:100:200"

An ITUN24 MSU with SI=5:

pass:loc=1105:cmd="msuroute -c itun24 -k 10-200-10:5:10-200-1:1:100"

An ITU-I Spare MSU with SI=5:

msuroute -c ituis -k 3-11-1:5:4-11-1:5:5

Command Accepted - Processing

```

rlghncxa03w 04-04-29 11:31:09 EST  EAGLE5 31.6.0

```

```

pass:loc=1105:cmd="msuroute -c ITUN -k 345:678:100:200"
Command entered at terminal #1.
;

rlghncxa03w 04-04-29 11:31:09 EST EAGLE5 31.6.0
PASS: Command sent to card
;

rlghncxa03w 04-04-29 11:31:09 EST EAGLE5 31.6.0
MSURROUTE command in progress
;

rlghncxa03w 04-04-29 11:31:09 EST EAGLE5 31.6.0
TABLE  KEYTYPE                #ConnCfgd  #ConnAvail  RTKEY USED
DYN     FULL                    1           0           no
DYN     PARTIAL: IGNORE CIC      2           0           no
DYN     PARTIAL: IGNORE CIC+OPC  1           0           no
DYN     PARTIAL: DPC-SI ONLY     3           3           yes
DYN     PARTIAL: DPC ONLY        2           2           no
DYN     PARTIAL: SI ONLY         4           0           no
DYN     DEFAULT                  4           4           no
STATIC  FULL                    12          4           no
STATIC  PARTIAL: IGNORE-CIC      3           0           no
STATIC  PARTIAL: IGNORE-CIC+OPC  2           0           no
STATIC  PARTIAL: DPC-SI ONLY     3           2           no
STATIC  PARTIAL: DPC ONLY        2           2           no
STATIC  PARTIAL: SI ONLY         1           0           no
STATIC  DEFAULT                  2           0           no

IP Connections Associated with the RTKEY USED
Name                               Avail?
Vox1                                yes
Mgc2                                yes
Mgc24                               yes

MSURROUTE command complete
;

```

msutrace**MSU Trace**

This command provides filter and trace capability for MSUs passing through the IP⁷ GPLs. This command provides a view of MSU data as it exists in the PSTN network and its corresponding format as it exists in the IP network.

Command Name: msutrace

Command Class: Application Maintenance

Options

Options and option parameters that are underlined indicate that a value must be specified for that option or parameter. For example, the **msutrace** command option **-a** has the parameter action. The action that the command is to take can be specified, as in the command **msutrace -a acttrace**. Do not enter the underlined option or parameter; enter a value for the information represented by the underlined option or parameter.

-a action

Action option.

Range: **acttrace, clrtrace, dacttrace, chgfilter**

acttrace—Activate (turn on) MSU tracing

clrtrace—Clear all data from trace buffers

dacttrace—Deactivate (turn off) MSU tracing

chgfilter—Change filter used to indicate which MSUs are placed in the trace buffers

-c point code type

This option specifies which type of point code (ANSI, ITU international, ITU national, 24-bit ITU national, ITU-I spare, or ITU-N spare) is contained in the filter key, when the key contains a DPC or OPC.

Range: **ansi, itui, itun, itun24, ituis, ituns**

Default: **ansi**

-d

This option can be specified instead of the **-k** option to indicate the default routing key. The **-d** option and the **-k** option cannot be used in the same command.

-g get option

The get option.

Range: **config, trace**

config—Displays the current **msutrace** settings: trace ON/OFF status, filter settings, and trace buffers used/available

trace—Displays contents of trace buffers containing captured MSU data

-h help

This option displays help information about this command.

Range: **full**

If **full** is specified, the detailed version of the help information is displayed.

If **full** is not specified (just **-h**), the simple version of the help information is displayed.

-m mode

The mode for indicating which MSUs are captured.

Range: **normerr, all**

normerr—trace only MSUs with normalization errors

all—trace all MSUs regardless of MSU contents

-p

This option indicates that the filter key is a partial routing key.

-k filter key

The **-k**, **-c**, **-p**, **-d** options specify the filter key used to determine which MSUs will have data placed in the trace buffers.

Range: **-k filter key [-p] [-c pcType], -d**

The syntax for the **filter key** portion of the **-k filter key** option is specified as a single string parameter with up to five colon-separated fields. The **filter key** can contain one or more of the following fields:

n-c-m—represents an ANSI DPC in the format *network-cluster-member*

no-co-mo—represents an ANSI OPC in the format *network-cluster-member*

z-a-i—represents an ITU-I DPC in the format *zone-area-id*

zo-ao-iozone-area-id—represents an ITU-I OPC in the format
msa-ssa-sp—represents a 24-bit ITU-N DPC in the format *main signaling area-sub signaling area-signaling point*
nnnnn—represents an ITU-N DPC
nnnnn-gc—represents an ITU-N DPC with Group Code when the Duplicate Point Code feature is ON
no—represents an ITU-N OPC
no-gc—represents an ITU-N OPC with Group Code when the Duplicate Point Code feature is ON
s—represents an SI (Service Indicator)
cs—represents a CIC Start value (start of the CIC range)
ce—represents a CIC End value (end of the CIC range)
n—represents an SSN (Subsystem Number)

The following examples show valid formats:

- ***n-c-m:s:n***—For DPC, SI, SSN type routing keys. The network, cluster and member (*n-c-m*) are in the range **0-255**. The service indicator (*s*) is **3** or **sccp**. The subsystem (*n*) is in the range **0-255**.
- ***n-c-m:s***—For DPC, SI type routing keys. The network, cluster and member (*n-c-m*) are in the range **0-255**. The service indicator (*s*) is in the range **0-2, 4, or 6-15**. There is no subsystem number. As a default, counts for all routing keys within the option combination are displayed.
- ***n-c-m:s:no-co-mo:cs:ce***—For DPC, SI, CIC type routing keys. The DPC network, cluster and member (*n-c-m*) are in the range **0-255**. The service indicator (*s*) is **5** or **isup**. There is no subsystem. The OPC network, cluster and member (*no-co-mo*) are in the range **0-255**. The starting circuit identification code (*cs*) and ending circuit identification code (*ce*) are in the range **0** to **16363**.
- ***z-a-i***—For DPCN and DPCI routing keys, the zone, area and ID (*z-a-i*) are in the range of **000-007** (zone and ID) and **000-255** (area).
- ***msa-ssa-sp***—For 24-bit DPCN routing keys, the main signaling area, sub signaling area and signaling point (*msa-ssa-sp*) are in the range of **000-255**.

Example

```
pass:loc=1105:cmd="msutrace -h"
pass:loc=1105:cmd="msutrace -h full"
pass:loc=1105:cmd="msutrace -g config"
pass:loc=1315:cmd="msutrace -g trace"
pass:loc=1105:cmd="msutrace -a clrtrace"
pass:loc=1105:cmd="msutrace -a acttrace"
pass:loc=1105:cmd="msutrace -a chgfilter -c ansi -k 3-3-3:5:4-4-4:10:1000"
pass:loc=1105:cmd="msutrace -a chgfilter -c itui -p -k 1-3-3:5:2-4-4"
pass:loc=1105:cmd="msutrace -a chgfilter -c itun -p -k 1536:5"
pass:loc=1105:cmd="msutrace -a chgfilter -m normerr"
pass:loc=1105:cmd="msutrace -a chgfilter -d -m all"
```

Dependencies

If no options are specified, the simple version of the help information is displayed.

The point code type defaults to ANSI when the `-c` option is not specified.

The `-c` option is allowed only on key types that contain a DPC or OPC.

Notes

The **msutrace** command is executed through the **pass** command.

The **mustrace** command captures the data portion of the PSTN packet, starting at the SIO bytes.

The **msutrace** command captures the entire TALI, M3UA, or SUA packet. This includes the TALI, M3UA, or SUA header and additional data stored inside system buffer chain elements.

The **msutrace** command currently does not support the trace and capture of TALI MTP Primitives or M3UA / SUA SSNM (Class 2) messages.

The **msutrace** command captures data in trace buffers. If the set of trace buffers becomes full with captured MSU data after MSU tracing is activated, no more data capturing will take place. The **-a clrtrace** option must be specified to reset (clear) the content of the trace buffers. After the trace buffers are empty again, **msutrace** will restart capturing qualified MSUs.

If MSU tracing is activated with the **-a acttrace** option before a properly formatted filter key is entered, **msutrace** will not capture any data due to lack of a proper filter. When the **-a chgfilter** option is specified to enter a properly formatted filter, **msutrace** will start capturing qualified MSUs.

Output

NOTE: The msutrace pass command exists on the IPLIM/IPLIMI cards as a debug-only pass command. All command syntax and output are identical to the SS7IPGW and IPGWI commands described in this section.

The simple version of the help information:

```
pass:loc=1105:cmd="msutrace -h"
Command Accepted - Processing

;
  eagle20003 05-01-27 10:16:03 EST  EAGLE5 31.12.0
  pass:loc=1105:cmd="msutrace -h"
  Command entered at terminal #1.
;
  eagle20003 05-01-27 10:16:03 EST  EAGLE5 31.12.0
  PASS: Command sent to card
;
  eagle20003 99-11-27 10:16:03 EST  EAGLE5 31.6.0
  eagle20003 04-09-27 10:16:03 EST  EAGLE5 31.10.0
  eagle20003 05-01-27 10:16:03 EST  EAGLE5 31.12.0
  Usage: msutrace [-a action_cmd] [-g get_cmd]
                [-h [full]] [-c pcType] [-p] [-d]
                [-k key] [-m mode]
```

```

Options:
-a  action_cmd: an Action Command
-c  pcType: Point Code type = [ANSI | ITUI | ITUN | ITUIS | ITUNS | ITUN24]
-d  indicates a default filter key
-g  get_cmd: a Get Command
-h  displays this message
-k  fltrkey: key for qualifying MSUs captured
-m  mode: mode for qualifying MSUs captured = [normerr | all]
-p  indicates a partial filter key

get_cmd:          [config | trace]
  config          config
  trace          trace
action_cmd:       [acttrace | chgfilter | clrtrace | dacttrace]
  acttrace       acttrace
  chgfilter      chgfilter [<fltrkey>] | [-m mode] (at least 1 required)
  clrtrace       clrtrace
  dacttrace      dacttrace
<fltrkey>:       -k key [-p] [-c pcType] | -d
                  (see "msutrace -h full" for complete description)
;

```

The full version of the help information:

pass:loc=1105:cmd="msutrace -h full"

Command Accepted - Processing

```

;
eagle20003 05-01-27 10:16:03 EST EAGLE5 31.12.0
pass:loc=1105:cmd="msutrace -h full"
Command entered at terminal #1.
;
eagle20003 05-01-27 10:16:03 EST EAGLE5 31.12.0
PASS: Command sent to card
;
eagle20003 05-01-27 10:16:03 EST EAGLE5 31.12.0
Usage: msutrace [-a action_cmd] [-g get_cmd]
               [-h [full]] [-c pcType] [-p] [-d]
               [-k key] [-m mode]

Options:
-a  action_cmd: an Action Command
-c  pcType: Point Code type = [ANSI | ITUI | ITUN | ITUIS | ITUNS | ITUN24]
-d  indicates a default filter key
-g  get_cmd: a Get Command
-h  displays this message
-k  fltrkey: key for qualifying MSUs captured
-m  mode: mode for qualifying MSUs captured = [normerr | all]
-p  indicates a partial filter key

get_cmd:          [config | trace]
  config          Display the current MSUTRACE settings:
                  trace ON/OFF status, filter settings, and
                  trace buffers used/available.
                  Ex: msutrace -g config

  trace          Display contents of trace buffers containing captured
                  MSU data.
                  ex: msutrace -g trace

action_cmd:       [acttrace | clrtrace | dacttrace | chgfilter ]
  acttrace       Activate (turn-on) MSU-tracing.
                  ex: msutrace -a acttrace

  clrtrace       Clear all data from trace buffers.
                  ex: msutrace -a clrtrace

  dacttrace      Deactivate (turn-off) MSU-tracing.
                  ex: msutrace -a dacttrace
;

```

```

chgfilter      Change filter used to qualify which MSUs are placed in
               trace buffer.
ex: To only trace MSUs with Normalization errors:
    msutrace -a chgfilter -m normerr
ex: To trace all MSUs regardless of error conditions:
    msutrace -a chgfilter -m all
ex: To trace MSUs based on MSU content:
    msutrace -a chgfilter <fltrkey>

<fltrkey>:    -k key [-p] [-c pcType] | -d
               The -k, -c, -p, and -d options together specify the
               filter key used to qualify which MSUs are placed
               in the trace buffers.
ex: To trace all ANSI MSUs with DPC=3-3-3 AND SI=3 AND
    SSN=4:
    <fltrkey> = "-c ANSI -k 3-3-3:3:4"
ex: To exclude SSN from filter in previous example:
    <fltrkey> = "-c ANSI -p -k 3-3-3:3"
ex: To trace all ANSI MSUs with DPC=3-3-3 AND SI=5 AND
    OPC=4-4-4 AND CIC value between 10-1000:
    <fltrkey> = "-c ANSI -k 3-3-3:5:4-4-4:10:1000"
ex: To trace all ITUI MSUs with DPC=3-3-3 AND SI=5 AND
    OPC=2-4-4:
    <fltrkey> = "-c ITUI -p -k 3-3-3:5:2-4-4"
Ex: To trace all ITUI Spare MSUs with DPCI=3-11-1 AND SI=5 AND
    OPCI=4-11-1:
    <fltrkey> = "-c ITUIS -p -k 3-11-1:5:3-11-2"
ex: To trace all ITUN MSUs with DPC=1536 AND SI=5:
    <fltrkey> = "-c ITUN -p -k 1536:5"
Ex: To trace all ITUN Spare MSUs with DPCN=6344 AND SI=5:
    <fltrkey> = "-c ITUNS -p -k 6344:5"
ex: To trace all MSUs with SI=5:
    <fltrkey> = "-p -k :5"
ex: To trace all ITUN MSUs with DPC=1536:
    <fltrkey> = "-p -k 1536:"
ex: To trace all MSUs regardless of MSU content:
    <fltrkey> = "-d"
ex: To trace all ITUN24 MSUs with DPC=13-103-3 AND SI=5
    AND OPC=12-104-4:
    <fltrkey> = "-c ITUN24 -p -k 13-103-3:5:12-104-4"

```

Get the current settings of the **msutrace** command options: trace ON/OFF status, filter settings, and trace buffers that are used and available.

pass:loc=1105:cmd="msutrace -g config"

Command Accepted - Processing

```

eagle20003 99-11-27 10:16:57 EST  EAGLE5 31.6.0
pass:loc=1105:cmd="msutrace -g config"
Command entered at terminal #1.

```

;

```

eagle20003 99-11-27 10:16:57 EST  EAGLE5 31.6.0
PASS: Command sent to card

```

;

```

eagle20003 99-11-27 10:16:57 EST  EAGLE5 31.6.0
MSUTRACE command in progress

```

;

```

eagle20003 99-11-27 10:16:57 EST  EAGLE5 31.6.0
MSUTRACE configurations

```

Trace = On

Trace buffers: 2 of 3 contain captured MSU data

MSUTRACE: filter settings

DPCA	SI	SSN	OPCA	CICS	CICE	MODE
055-055-055	13	***	016-006-006	1234567890	1234567890	normerr

```

;
  eagle20003 99-11-27 10:16:57 EST  EAGLE5 31.6.0
  MSUTRACE command complete
;

```

Get the current settings of the **msutrace** command options: trace ON/OFF status, filter settings, and trace buffers that are used and available, when the filter key specifies an ITU-I spare point code.

pass:loc=1105:cmd="msutrace -g config"

Command Accepted - Processing

```

  eagle20003 05-01-27 10:16:03 EST  EAGLE5 31.12.0
  pass:loc=1105:cmd="msutrace -g config"
  Command entered at terminal #1.
;
  eagle20003 05-01-27 10:16:03 EST  EAGLE5 31.12.0
  PASS: Command sent to card
;
  eagle20003 05-01-27 10:16:03 EST  EAGLE5 31.12.0
  MSUTRACE command in progress
;
  eagle20003 05-01-27 10:16:03 EST  EAGLE5 31.12.0
  MSUTRACE configurations

  Trace = On

  Trace buffers: 3 of 3 USED

  MSUTRACE: filter settings
    DPCI      SI SSN      OPCI      CICS      CICE      MODE
  s-2-011-1   2   ***      ****      ****      ****      all
;
  eagle20003 05-01-27 10:16:03 EST  EAGLE5 31.12.0
  MSUTRACE command complete
;

```

Retrieve contents of the trace buffers. In this TALI example, there are 2 stored trace buffers:

pass:loc=1315:cmd="msutrace -g trace"

Command Accepted - Processing

```

  eagle10202 01-01-19 10:20:56 GMT  EAGLE5 31.6.0
  pass:loc=1315:cmd="msutrace -g trace"
  Command entered at terminal #4.
;
  eagle10202 01-01-19 10:20:56 GMT  EAGLE5 31.6.0
  PASS: Command sent to card
;
  eagle10202 01-01-19 10:20:56 GMT  EAGLE5 31.6.0

  MSUTRACE command in progress
;

```

eagle10202 01-01-19 10:20:56 GMT EAGLE5 31.6.0

BUFFER: 0

Filter used:

DPCN	SI	SSN	OPCN	CICS	CICE	MODE
02137	**	***	****	****	****	any

Timestamp: 01-01-19 10:19:14.520
Direction: Rx
Error Code: 19

PSTN DATA

IP DATA

54 41 4c 49 78 73 72 76 ac 00 78 6e 72 6d 00 00	TALIXsrv..xnm..
02 61 61 04 00 01 00 00 00 00 00 00 00 00 02	.aa.....
85 00 85 59 48 16 a4 00 00 41 00 00 00 00 02	...YH...A.....
0e 0c 00 00 00 00 00 00 00 00 00 00 00 0a 0a
00 00 00 00 00 00 00 00 00 00 08 01 00 1a 04 00
00 00 00 0b 0a 00 00 00 00 00 00 00 00 00 13
02 00 01 28 0a 00 00 00 00 00 00 00 00 00 2a	...(.....*
01 00 20 03 7e 01 00 03 01 00 1d 02 00 80 c0 0b	...~.....
00 00 00 00 00 00 00 00 00 00 00 c1 09 00 00 00
00 00 00 00 00 00 39 02 00 00 3f 0a 00 00 00 009...?.....
00 00 00 00 00 00 00 03 0c 00 04 00 01 00 fc 00
04 00 0e 02 00 00

BUFFER: 1

Filter used:

DPCN	SI	SSN	OPCN	CICS	CICE	MODE
02137	05	***	04185	0	100	any

Timestamp: 01-01-19 10:19:32.470
Direction: Rx
Error Code: 0

PSTN DATA

85 59 48 16 64 00 00 01 00 00 00 00 00 02 0e 0c	.YH.d.....
00 00 00 00 00 00 00 00 00 00 00 00 0a 0a 00 00
00 00 00 00 00 00 00 00 08 01 00 1a 04 00 00 00
00 0b 0a 00 00 00 00 00 00 00 00 00 13 02 00
01 28 0a 00 00 00 00 00 00 00 00 00 00 2a 01 00	...(.....*
20 03 7e 01 00 03 01 00 1d 02 00 80 c0 0b 00 00	...~.....
00 00 00 00 00 00 00 00 00 c1 09 00 00 00 00 00
00 00 00 00 39 02 00 00 3f 0a 00 00 00 00 00 009...?.....
00 00 00 00 fc 02 00 00 00

IP DATA

```

-----
54 41 4c 49 78 73 72 76 ac 00 78 6e 72 6d 00 00    TALIXsrv..xnm..
02 61 61 04 00 01 00 00 00 00 00 00 00 00 02    .aa.....
85 00 85 59 48 16 64 00 00 01 00 00 00 00 02    ...YH.d.....
0e 0c 00 00 00 00 00 00 00 00 00 00 00 0a 0a    .....
00 00 00 00 00 00 00 00 00 00 08 01 00 1a 04 00    .....
00 00 00 0b 0a 00 00 00 00 00 00 00 00 00 13    .....
02 00 01 28 0a 00 00 00 00 00 00 00 00 00 2a    ...(.*****
01 00 20 03 7e 01 00 03 01 00 1d 02 00 80 c0 0b    ...~.....
00 00 00 00 00 00 00 00 00 00 00 c1 09 00 00 00    .....
00 00 00 00 00 00 39 02 00 00 3f 0a 00 00 00 00    .....9...?....
00 00 00 00 00 00 00 03 0c 00 04 00 01 00 fc 00    .....
04 00 0e 02 00 00

```

```

-----
BUFFER: 2
-----

```

Filter used:

DPCN	SI	SSN	OPCN	CICS	CICE	MODE
02137	05	***	04185	0	100	normerr

```

Timestamp: 01-01-19 10:20:53.305
Direction: Rx
Error Code: 19

```

PSTN DATA

IP DATA

```

54 41 4c 49 78 73 72 76 ac 00 78 6e 72 6d 00 00    TALIXsrv..xnm..
02 61 61 04 00 01 00 00 00 00 00 00 00 00 02    .aa.....
85 00 85 59 48 16 a4 00 00 41 00 00 00 00 02    ...YH....A.....
0e 0c 00 00 00 00 00 00 00 00 00 00 00 0a 0a    .....
00 00 00 00 00 00 00 00 00 00 08 01 00 1a 04 00    .....
00 00 00 0b 0a 00 00 00 00 00 00 00 00 00 13    .....
02 00 01 28 0a 00 00 00 00 00 00 00 00 00 2a    ...(.*****
01 00 20 03 7e 01 00 03 01 00 1d 02 00 80 c0 0b    ...~.....
00 00 00 00 00 00 00 00 00 00 00 c1 09 00 00 00    .....
00 00 00 00 00 00 39 02 00 00 3f 0a 00 00 00 00    .....9...?....
00 00 00 00 00 00 00 03 0c 00 04 00 01 00 fc 00    .....
04 00 0e 02 00 00

```

MSUTRACE command complete

;

Retrieve contents of the trace buffers. The following example contains 1 stored trace buffer for a transmitted M3UA PDU.

pass:loc=1303:cmd="msutrace -g trace "

Command Accepted - Processing

```

eagle10202 01-01-19 10:20:56 GMT EAGLE5 31.6.0
pass:loc=1303:cmd="msutrace -g trace "
Command entered at terminal #4.
;

eagle10202 01-01-19 10:20:56 GMT EAGLE5 31.6.0
PASS: Command sent to card
;

eagle10202 01-01-19 10:20:56 GMT EAGLE5 31.6.0

MSUTRACE command in progress
;

eagle10202 01-01-19 10:20:56 GMT EAGLE5 31.6.0

-----
BUFFER:  0
-----
Filter used:

DPCA      SI SSN OPCA      CICS      CICE      MODE
001-001-001 5  *** 001-001-002 0      100      all

Timestamp: 02-06-07 08:40:29.435
Direction: Tx
Error Code: 0

PSTN DATA
-----
85 01 01 01 02 01 01 b2 00 00 01 00 00 00 03      .....
05 00 02 80 80 0d 00 00 21 43 65 87 09 21 43 65      .....!Ce..!Ce
87 09 01      ...

IP DATA
-----
01 00 01 01 00 00 00 3c 02 00 00 08 00 00 00 01      .....<.....
02 10 00 2b 00 01 01 02 00 01 01 01 05 02 00 b2      ...+.....
00 00 01 00 00 00 00 03 05 00 02 80 80 0d 00 00      .....
21 43 65 87 09 21 43 65 87 09 01 00      !Ce..!Ce....

MSUTRACE command complete
;

```

Retrieve contents of the trace buffers with ITU-I spare point codes. The following example contains 3 stored trace buffers.

pass:loc=1317:cmd="msutrace -g trace "

Command Accepted - Processing

```

eagle20003 05-01-27 10:16:03 EST EAGLE5 31.12.0
pass:loc=1317:cmd="msutrace -g trace "
Command entered at terminal #4.
;

eagle20003 05-01-27 10:16:03 EST EAGLE5 31.12.0
PASS: Command sent to card
;

eagle20003 05-01-27 10:16:03 EST EAGLE5 31.12.0

MSUTRACE command in progress
;

eagle20003 05-01-27 10:16:03 EST EAGLE5 31.12.0

-----
BUFFER: 0
-----
Filter used:

      DPCI      SI SSN      OPCI      CICS      CICE      MODE
s-2-011-1      2   ***      ****      ****      ****      all

Timestamp: 05-01-26 10:33:14.330
Direction: Tx
Error Code: 0

PSTN DATA
-----
02 59 50 16 a2 80 03 83 ce 46 0a 00 00 00      .YP.....F....

IP DATA
-----
54 41 4c 49 6d 74 70 33 0e 00 02 59 50 16 a2 80      TALImtp3...YP...
03 83 ce 46 0a 00 00 00      ...F....

-----
BUFFER: 1
-----
Filter used:

      DPCI      SI SSN      OPCI      CICS      CICE      MODE
s-2-011-1      2   ***      ****      ****      ****      all

Timestamp: 05-01-26 10:33:14.335
Direction: Tx
Error Code: 0

```

```
PSTN DATA
-----
02 59 50 16 a2 80 84 04 c8 46 0a 00 00 00      .YP.....F....

IP DATA
-----
54 41 4c 49 6d 74 70 33 0e 00 02 59 50 16 a2 80  TALImtp3...YP...
84 04 c8 46 0a 00 00 00                          ...F....
```

```
-----
BUFFER:  2
-----
Filter used:
```

DPCI	SI	SSN	OPCI	CICS	CICE	MODE
s-2-011-1	2	***	****	****	****	all

```
Timestamp: 05-01-26 10:33:14.340
Direction: Tx
Error Code: 0
```

```
PSTN DATA
-----
02 59 50 16 f2 80 01 81 c1 46 0f 00 00 00      .YP.....F....

IP DATA
-----
54 41 4c 49 6d 74 70 33 0e 00 02 59 50 16 f2 80  TALImtp3...YP...
01 81 c1 46 0f 00 00 00                          ...F....
```

MSUTRACE command complete

;

Clear the contents of the trace buffers:

pass:loc=1105:cmd="msutrace -a clrtrace"

Command Accepted - Processing

```
eagle20003 99-11-27 10:16:57 EST EAGLE5 31.6.0
pass:loc=1105:cmd="msutrace -a clrtrace"
Command entered at terminal #1.
```

;

```
eagle20003 99-11-27 10:16:57 EST EAGLE5 31.6.0
PASS: Command sent to card
```

;

```
eagle20003 99-11-27 10:16:57 EST EAGLE5 31.6.0
MSUTRACE command in progress
```

;

```
eagle20003 99-11-27 10:16:57 EST EAGLE5 31.6.0
MSUTRACE command completed
```

;

Activate MSU tracing:

pass:loc=1105:cmd="msutrace -a acttrace"

Command Accepted - Processing

```

eagle20003 99-11-27 10:16:57 EST EAGLE5 31.6.0
pass:loc=1105:cmd="msutrace -a acttrace"
Command entered at terminal #1.
;
eagle20003 99-11-27 10:16:57 EST EAGLE5 31.6.0
PASS: Command sent to card
;
eagle20003 99-11-27 10:16:57 EST EAGLE5 31.6.0
MSUTRACE command in progress
;
eagle20003 99-11-27 10:16:57 EST EAGLE5 31.6.0
MSUTRACE command completed
;

```

Deactivate MSU tracing:

pass:loc=1105:cmd="msutrace -a dacttrace"

Command Accepted - Processing

```

eagle20003 99-11-27 10:16:57 EST EAGLE5 31.6.0
pass:loc=1105:cmd="msutrace -a dacttrace"
Command entered at terminal #1.
;
eagle20003 99-11-27 10:16:57 EST EAGLE5 31.6.0
PASS: Command sent to card
;
eagle20003 99-11-27 10:16:57 EST EAGLE5 31.6.0
MSUTRACE command in progress
;4.0.0
eagle20003 99-11-27 10:16:57 EST EAGLE5 31.6.0
MSUTRACE command completed
;

```

Examples for Entering a Filter Key

The output shown at the end of the following command examples is the same for each example, except for the echo of the entered command.

Command with the **-a chgfilter** option to insert a fully specified ANSI PC CIC filter key.

This filter key qualifies for capture MSUs with the following properties:

- DPC = 3-3-3 (ANSI)
- SI = 5
- OPC = 4-4-4 (ANSI)
- CIC = [10..1000]

pass:loc=1105:cmd="msutrace -a chgfilter -c ansi -k 3-3-3:5:4-4-4:10:1000"

Command with the **-a chgfilter** option to insert a fully specified ANSI SCCP filter.

This filter key qualifies for capture MSUs with the following properties:

- DPC = 3-3-3 (ANSI)
- SI = 3
- SSN = 230

pass:loc=1105:cmd="msutrace -a chgfilter -k 3-3-3:3:230"

Command with the **-a chgfilter** option to insert a fully specified ANSI DPC SI filter key.

This filter key qualifies for capture MSUs with the following properties:

- DPC = 3-3-3 (ANSI)
- SI = 6

pass:loc=1105:cmd="msutrace -a chgfilter -k 3-3-3:6"

Command with the **-a chgfilter** option to insert a fully specified ITUN24 PC CIC filter key.

This filter key qualifies for capture MSUs with the following properties:

- DPC = 13-103-3 (ITUN24)
- SI = 5
- OPC = 14-104-4 (ITUN24)
- CIC = [10..1000]

pass:loc=1105:cmd="msutrace -a chgfilter -c itun24 -k 13-103-3:5:14-104-4:10:1000"

Command with the **-a chgfilter** option to insert a partial ITUI DPC SI OPC filter key.

This filter key qualifies for capture MSUs with the following properties:

- DPC = 1-3-3 (ITUI)
- SI = 5
- OPC = 2-4-4 (ITUI)

pass:loc=1105:cmd="msutrace -a chgfilter -c itui -p -k 1-3-3:5:2-4-4"

Command with the **-a chgfilter** option to insert a partial DPC SI ITUN PC filter key, with the Duplicate Point Code feature turned off.

This filter key qualifies for capture MSUs with the following properties:

- DPC = 1536 (ITUN)
- SI = 5

pass:loc=1105:cmd="msutrace -a chgfilter -c itun -p -k 1536:5"

Command with the **-a chgfilter** option to insert a partial DPC SI ITUN PC filter key, with the Duplicate Point Code feature turned on:

This filter key qualifies for capture MSUs with the following properties:

- DPC = 1536-bb (ITUN)
- SI = 5

pass:loc=1105:cmd="msutrace -a chgfilter -c itun -p -k 1536-bb:5"

Command with the **-a chgfilter** option to insert a partial ANSI DPC filter key.

This filter key qualifies for capture MSUs with the following properties:

- DPC = 3-3-3 (ANSI)

pass:loc=1105:cmd="msutrace -a chgfilter -k 3-3-3 -p"

Command with the **-a chgfilter** option to insert a partial SI filter key. Because no DPC or OPC field is specified, point code type does not have to be indicated.

This filter key qualifies for capture MSUs with the following properties:

- SI = 5

pass:loc=1105:cmd="msutrace -a chgfilter -p -k :5"

Command with the **-a chgfilter** option to insert a partial ITUN24 DPC filter key.

This filter key qualifies for capture MSUs with the following properties:

- DPC = 13-113-3 (ITUN24)

pass:loc=1105:cmd="msutrace -a chgfilter -c itun24 -k 13-113-3 -p"

Command Accepted - Processing

```
eagle20003 99-11-27 10:16:57 EST EAGLE5 31.6.0
pass:loc=1105:cmd="msutrace -a chgfilter -c ansi -k 3-3-3:5:4-4-4:10:1000"
Command entered at terminal #1.
;
eagle20003 99-11-27 10:16:57 EST EAGLE5 31.6.0
PASS: Command sent to card
;
eagle20003 99-11-27 10:16:57 EST EAGLE5 31.6.0
MSUTRACE command in progress
;
eagle20003 99-11-27 10:16:57 EST EAGLE5 31.6.0
MSUTRACE command completed
;
```

The following commands include the **-m mode** option to change the trace capture mode.

Mode to have a 'capture-on-normalization error' property such that only MSUs with normalization processing errors are traced:

pass:loc=1105:cmd="msutrace -a chgfilter -m normerr"

Set a default filter key and the filter's mode at the same time:

pass:loc=1105:cmd="msutrace -a chgfilter -d -m all"

```
Command Accepted - Processing
  eagle20003 99-11-27 10:16:57 EST  EAGLE5 31.6.0
  pass:loc=1105:cmd="msutrace -a chgfilter -d -m all"
  Command entered at terminal #1.
;
  eagle20003 99-11-27 10:16:57 EST  EAGLE5 31.6.0
  PASS: Command sent to card
;
  eagle20003 99-11-27 10:16:57 EST  EAGLE5 31.6.0
  MSUTRACE command in progress
;
  eagle20003 99-11-27 10:16:57 EST  EAGLE5 31.6.0
  MSUTRACE command completed
;
```

The following commands insert a partial DPC-SI filter key with ITU-I spare point code and show the **msutrace getfilter** command output with the filter key after the **chgfilter** command is processed to completion.

This filter key will qualify MSUs with at least the following properties:

- DPCI = (ITU-I Spare) 2-11-1
- SI=5

pass:loc=1317:cmd="msutrace -a chgfilter -c ituis -p -k 2-11-1:5"

```
Command Accepted - Processing

  eagle20003 05-01-27 10:16:03 EST  EAGLE5 31.12.0
  pass:loc=1317:cmd="msutrace -a chgfilter -c ituis -p -k 2-11-1:5"
  Command entered at terminal #1.
;
  eagle20003 05-01-27 10:16:03 EST  EAGLE5 31.12.0
  PASS: Command sent to card
;
  eagle20003 05-01-27 10:16:03 EST  EAGLE5 31.12.0
  MSUTRACE command in progress
;
  eagle20003 05-01-27 10:16:03 EST  EAGLE5 31.12.0
  MSUTRACE command completed
;
```

pass:loc=1317:cmd="msutrace -g config"

```
Command Accepted - Processing

  eagle20003 05-01-27 10:16:03 EST  EAGLE5 31.12.0
  pass:loc=1317:cmd="msutrace -g config"
  Command entered at terminal #1.
;
```

```

eagle20003 05-01-27 10:16:03 EST EAGLE5 31.12.0
PASS: Command sent to card
;
eagle20003 05-01-27 10:16:03 EST EAGLE5 31.12.0
MSUTRACE command in progress
;
eagle20003 05-01-27 10:16:03 EST EAGLE5 31.12.0
MSUTRACE configurations

Trace = On

Trace buffers: 3 of 3 USED

MSUTRACE: filter settings
   DPCI      SI SSN   OPCI      CICS      CICE      MODE
s-2-011-1    5  ***     ****     ****     ****     all
;
eagle20003 05-01-27 10:16:03 EST EAGLE5 31.12.0
MSUTRACE command complete
;

```

The following commands insert a full DPC-SI-OPC filter key with an ITU-N spare point code when the Duplicate Point Code feature is on, and show the **msutrace getfilter** command output with the filter key after the **chgfilter** command is processed to completion.

This filter key will qualify MSUs with at least the following properties:

- DPC = (ITU-N Spare) 6234-aa
- SI=5
- OPC=(ITU-N Spare) 6233-aa
- CICS=1
- CICE=200

pass:loc=1315:cmd="msutrace -a chgfilter -c ITUNS -p -k 6234-aa:5:6233-aa:1:200"

```

Command Accepted - Processing

eagle20003 05-01-27 10:16:03 EST EAGLE5 31.12.0
pass:loc=1315:cmd="msutrace -a chgfilter -c ITUNS -p -k 6234-aa:5:6233-aa:1:200"
Command entered at terminal #1.
;
eagle20003 05-01-27 10:16:03 EST EAGLE5 31.12.0
PASS: Command sent to card
;
eagle20003 05-01-27 10:16:03 EST EAGLE5 31.12.0
MSUTRACE command in progress
;
eagle20003 05-01-27 10:16:03 EST EAGLE5 31.12.0
MSUTRACE command completed
;

```

pass:loc=1317:cmd="msutrace -g config"

Command Accepted - Processing

```

eagle20003 05-01-27 10:16:03 EST EAGLE5 31.12.0
pass:loc=1317:cmd="msutrace -g config"
Command entered at terminal #1.
;
eagle20003 05-01-27 10:16:03 EST EAGLE5 31.12.0
PASS: Command sent to card
;
eagle20003 05-01-27 10:16:03 EST EAGLE5 31.12.0
MSUTRACE command in progress
;
eagle20003 05-01-27 10:16:03 EST EAGLE5 31.12.0
MSUTRACE configurations

Trace = On

Trace buffers: 0 of 3 USED

MSUTRACE: filter settings
  DPCN      SI SSN   OPCI      CICS      CICE      MODE
s-6234-aa   5  ***   s-6233-aa  ****     ****     all
;
eagle20003 05-01-27 10:16:03 EST EAGLE5 31.12.0
MSUTRACE command complete
;

```

netstat**Network Statistics**

This command is used to display network statistics from the TCP/IP stack. This command allows troubleshooting of network interface and routing configuration problems within the private EPAP-DSM IP network.

Command Name: netstat

Command Class: IP Stack Maintenance

Options

Options and option parameters that are underlined indicate that a value must be specified for that option or parameter. For example, the **netstat** command option **-m** has the parameter **buffer pool**. The pool for which information will be displayed can be specified, as in the command **netstat -m sys**. Do not enter the underlined option or parameter; enter a value for the information represented by the underlined option or parameter.

-a

This option displays socket information for all protocols.

-h

This options provides help information for the command.

-i

This option displays interface information for all interfaces.

-m buffer pool

This option displays buffer pool information for the specified pool.

Range: **data, sys, dd**
data—SENS protocol stack data buffer pool
sys—system buffer pool
dd—Ethernet device driver buffer pool
Default: All three buffer pools are displayed.

-p protocol

This option displays information for the specified protocol.

Range: **tcp, udp, ip, icmp, sctp**
tcp—transmission control protocol
udp—user datagram protocol
ip—internet protocol
icmp—internet control message protocol
sctp—stream control transmission protocol

Default: None

-r

This option displays the Route table.

Example

```
netstat -i
netstat -a
netstat -p tcp
netstat -m
netstat -m sys
netstat -r
```

Dependencies

Only one of the options can be specified at a time.

Notes

The **netstat** command is executed through the **pass** command.

Output

```
pass: loc=1105: cmd="netstat"      or
pass: loc=1105: cmd="netstat -h"
Command Accepted - Processing

rlghncxa03w 03-07-27 07:58:52 EST  EAGLE5 30.0.0
pass: loc=1105: cmd="netstat"
Command entered at terminal #1.
;
rlghncxa03w 03-07-27 07:58:52 EST  EAGLE5 30.0.0
PASS: Command sent to card
;
```

```
rlghncxa03w 03-07-27 07:58:52 EST EAGLE5 30.0.0
Usage: netstat [-a] [-i] [-h] [-m data|sys|dd] [-p icmp|ip|tcp|udp|sctp] [-r]
```

Options:

```
-a      display socket information for all protocols
-h      Displays this message
-i      display interface information for all interfaces
-m      display buffer pool information for 1 of the system pools
-p      display socket information for 1 of the protocols
-r      display the route table information
```

```
;
rlghncxa03w 03-07-27 07:58:54 EST EAGLE5 30.0.0
```

```
NETSTAT command complete
```

```
;
```

pass: loc=1105: cmd="netstat -a"

```
Command Accepted - Processing
```

```
rlghncxa03w 04-07-27 07:59:12 EST EAGLE5 31.6.0
pass: loc=1105: cmd="netstat -a"
Command entered at terminal #1.
```

```
;
```

```
rlghncxa03w 04-07-27 07:59:12 EST EAGLE5 31.6.0
PASS: Command sent to card
```

```
;
```

```
rlghncxa03w 04-07-27 07:59:12 EST EAGLE5 31.6.0
Active Internet connections (including servers)
                Local Address
PCB          Proto Recv-Q Send-Q Foreign Address      (state)
-----
11df510     TCP          0      0      0.0.0.0.111 LISTEN
                0.0.0.0.0
11df384     UDP          0      0      0.0.0.0.1008
                0.0.0.0.0
11df48c     UDP          0      0      0.0.0.0.111
                0.0.0.0.0
```

```
;
```

```
rlghncxa03w 04-07-27 07:59:14 EST EAGLE5 31.6.0
```

```
NETSTAT command complete
```

```
;
```

pass: loc=1105: cmd="netstat -i"

```
rlghncxa03w 04-07-27 07:59:20 EST EAGLE5 31.6.0
pass: loc=1105: cmd="netstat -i"
Command entered at terminal #1.
```

```
;
```

```
rlghncxa03w 04-07-27 07:59:20 EST EAGLE5 31.6.0
PASS: Command sent to card
```

```
;
```

```

rlghncxa03w 04-07-27 07:59:20 EST EAGLE5 31.6.0
lo (unit number 0):
  Flags: (0x8069) UP LOOPBACK MULTICAST ARP RUNNING 10MB HDX DIX
  Type: SOFTWARE_LOOPBACK
  Internet address: 127.0.0.1
  Netmask 0xff000000 Subnetmask 0xff000000
  Metric is 0
  Maximum Transfer Unit size is 32768
  6 packets received; 6 packets sent
  0 multicast packets received
  0 multicast packets sent
  0 input errors; 0 output errors
  0 collisions; 0 dropped
seeq (unit number 0):
  Flags: (0x63) UP BROADCAST ARP RUNNING 10MB HDX DIX
  Type: ETHERNET_CSMACD
  Internet address: 192.168.100.112
  Broadcast address: 192.168.100.255
  Netmask 0xffffffff00 Subnetmask 0xffffffff00
  Ethernet address is 00:00:17:04:00:61
  Metric is 0
  Maximum Transfer Unit size is 1500
  5 packets received; 1 packets sent
  5 multicast packets received
  0 multicast packets sent
  0 input errors; 0 output errors
  0 collisions; 0 dropped
seeq (unit number 1):
  Flags: (0x63) UP BROADCAST ARP RUNNING 10MB HDX DIX
  Type: ETHERNET_CSMACD
  Internet address: 192.168.55.112
  Broadcast address: 192.168.55.255
  Netmask 0xffffffff00 Subnetmask 0xffffffff00
  Ethernet address is 00:00:17:04:00:62
  Metric is 0
  Maximum Transfer Unit size is 1500
  28 packets received; 16 packets sent
  13 multicast packets received
  0 multicast packets sent
  0 input errors; 0 output errors
  0 collisions; 0 dropped
;
rlghncxa03w 04-07-27 07:59:25 EST EAGLE5 31.6.0

NETSTAT command complete
;
pass: loc=1105: cmd="netstat -m data"
Command Accepted - Processing

rlghncxa03w 04-07-27 07:59:56 EST EAGLE5 31.6.0
  pass: loc=1105: cmd="netstat -m data"
  Command entered at terminal #1.
;
rlghncxa03w 04-07-27 07:59:56 EST EAGLE5 31.6.0
PASS: Command sent to card
;

```

```

rlghncxa03w 04-07-27 07:59:56 EST  EAGLE5 31.6.0
type          number
-----
FREE   :    9553
DATA   :      0
HEADER :      0
SOCKET :      0
PCB    :      0
RTABLE :      0
HTABLE :      0
ATABLE :      0
SONAME :      0
ZOMBIE :      0
SOOPTS :      0
FTABLE :      0
RIGHTS :      0
IFADDR :      0
CONTROL :     0
OOBDATA :     0
IPMOPTS :     0
IPMADDR :     0
IFMADDR :     0
MRTABLE :     0
TOTAL  :    9553
number of mbufs: 9553
number of times failed to find space: 0
number of times waited for space: 0
number of times drained protocols for space: 0
-----
CLUSTER POOL TABLE
-----
size      clusters  free      usage
-----
64        1000      1000      41
128       1250      1250      848
256       1250      1250      0
512       200        200       0
1024      100        100       0
2048      20         20        0
-----
;
rlghncxa03w 04-07-27 08:00:01 EST  EAGLE5 31.6.0

NETSTAT command complete
;
pass: loc=1105: cmd="netstat -m sys"
Command Accepted - Processing

rlghncxa03w 04-07-27 08:00:14 EST  EAGLE5 31.6.0
pass: loc=1105: cmd="netstat -m sys"
Command entered at terminal #1.
;
rlghncxa03w 04-07-27 08:00:14 EST  EAGLE5 31.6.0
PASS: Command sent to card
;

```



```

rlghncxa03w 04-07-27 08:00:14 EST  EAGLE5 31.6.0
type          number
-----
FREE         :    3069
DATA         :         0
HEADER       :         0
SOCKET       :         3
PCB          :         4
RTABLE       :        17
HTABLE       :         0
ATABLE       :         0
SONAME       :         0
ZOMBIE       :         0
SOOPTS       :         0
FTABLE       :         0
RIGHTS       :         0
IFADDR       :         6
CONTROL      :         0
OOBDATA      :         0
IPMOPTS      :         0
IPMADDR      :         1
IFMADDR      :         0
MRTABLE      :         0
TOTAL        :    3100
number of mbufs: 3100
number of times failed to find space: 0
number of times waited for space: 0
number of times drained protocols for space: 0
-----
CLUSTER POOL TABLE
-----
size         clusters  free      usage
-----
64           650        640       12
128          200        188       33
256          500        494        6
512          200        197       24
-----
;
rlghncxa03w 04-07-27 08:00:19 EST  EAGLE5 31.6.0
NETSTAT command complete
;
pass: loc=1105: cmd="netstat -m dd"
Command Accepted - Processing
;
rlghncxa03w 04-07-27 08:00:24 EST  EAGLE5 31.6.0
  pass: loc=1105: cmd="netstat -m dd"
  Command entered at terminal #1.
;
rlghncxa03w 04-07-27 08:00:24 EST  EAGLE5 31.6.0
  PASS: Command sent to card
;

```

```

rlghncxa03w 04-07-27 08:00:24 EST  EAGLE5 31.6.0

END-0 Buffer Pool
-----
CLUSTER POOL TABLE
-----
size      clusters  free      usage
-----
1528      80         77        10
-----

END-1 Buffer Pool
-----
CLUSTER POOL TABLE
-----
size      clusters  free      usage
-----
1528      80         72        58
-----

;
rlghncxa03w 04-07-27 08:00:27 EST  EAGLE5 31.6.0

NETSTAT command complete

;
pass: loc=1105: cmd="netstat -p icmp"
Command Accepted - Processing
;
rlghncxa03w 04-07-27 08:00:29 EST  EAGLE5 31.6.0
0966.1083   SYSTEM      INFO      REPT COND: system alive
           Report Date:05-07-27  Time:08:00:29
;
rlghncxa03w 04-07-27 08:00:37 EST  EAGLE5 31.6.0
PASS: Command sent to card
;
rlghncxa03w 04-07-27 08:00:38 EST  EAGLE5 31.6.0
ICMP:
  1 call to icmp_error
  0 error not generated because old message was icmp
  Output histogram:
    destination unreachable: 1
  0 message with bad code fields
  0 message < minimum length
  0 bad checksum
  0 message with bad length
  Input histogram:
    echo reply: 6
    destination unreachable: 1
  0 message response generated
;
rlghncxa03w 05-07-27 08:00:39 EST  EAGLE5 31.6.0

NETSTAT command complete

;

```

pass: loc=1105: cmd="netstat -p ip"

Command Accepted - Processing

```
rlghncxa03w 04-07-27 08:00:44 EST EAGLE5 31.6.0
  pass: loc=1105: cmd="netstat -p ip"
  Command entered at terminal #1.
;
rlghncxa03w 04-07-27 08:00:44 EST EAGLE5 31.6.0
  PASS: Command sent to card
;
rlghncxa03w 04-07-27 08:00:44 EST EAGLE5 31.6.0
  IP:
      48 total
      0 badsum
      0 tooshort
      0 toosmall
      0 badhlen
      0 badlen
      0 infragments
      0 fragdropped
      0 fragtimeout
      0 forward
      14 cantforward
      0 redirectsent
      1 unknownprotocol
      0 nobuffers
      0 reassembled
      0 outfragments
      0 noroute
;
rlghncxa03w 04-07-27 08:00:46 EST EAGLE5 31.6.0
  NETSTAT command complete
;
```

pass: loc=1105: cmd="netstat -p tcp"

Command Accepted - Processing

```
rlghncxa03w 04-07-27 08:00:54 EST EAGLE5 31.6.0
  pass: loc=1105: cmd="netstat -p tcp"
  Command entered at terminal #1.
;
rlghncxa03w 04-07-27 08:00:54 EST EAGLE5 31.6.0
  PASS: Command sent to card
;
rlghncxa03w 04-07-27 08:00:54 EST EAGLE5 31.6.0
  TCP:
      0 packet sent
          0 data packet (0 byte)
          0 data packet (0 byte) retransmitted
          0 ack-only packet (0 delayed)
          0 URG only packet
          0 window probe packet
          0 window update packet
          0 control packet
```

```

0 packet received
    0 ack (for 0 byte)
    0 duplicate ack
    0 ack for unsend data
    0 packet (0 byte) received in-sequence
    0 completely duplicate packet (0 byte)
    0 packet with some dup. data (0 byte duped)
    0 out-of-order packet (0 byte)
    0 packet (0 byte) of data after window
    0 window probe
    0 window update packet
    0 packet received after close
    0 discarded for bad checksum
    0 discarded for bad header offset field
    0 discarded because packet too short
0 connection request
0 connection accept
0 connection established (including accepts)
0 connection closed (including 0 drop)
0 embryonic connection dropped
0 segment updated rtt (of 0 attempt)
0 retransmit timeout
    0 connection dropped by rexmit timeout
0 persist timeout
0 keepalive timeout
    0 keepalive probe sent
    0 connection dropped by keepalive
0 pcb cache lookup failed
;
rlghncxa03w 05-07-27 08:00:58 EST  EAGLE5 31.6.0

NETSTAT command complete
;
pass: loc=1105: cmd="netstat -p udp"
Command Accepted - Processing
rlghncxa03w 05-07-27 08:01:05 EST  EAGLE5 31.6.0
  pass: loc=1105: cmd="netstat -p udp"
  Command entered at terminal #1.
;
rlghncxa03w 05-07-27 08:01:05 EST  EAGLE5 31.6.0
PASS: Command sent to card
;
rlghncxa03w 05-07-27 08:01:05 EST  EAGLE5 31.6.0
UDP:
  42 total packets
  29 input packets
  13 output packets
  0 incomplete header
  0 bad data length field
  0 bad checksum
  16 broadcasts received with no ports
  0 full socket
  13 pcb cache lookups failed
  1 pcb hash lookup failed
;
rlghncxa03w 05-07-27 08:01:07 EST  EAGLE5 31.6.0
NETSTAT command complete
;

```

pass:loc=1305:cmd="netstat -p sctp"

Command Accepted - Processing

```
eagle10110 03-08-30 14:18:27 EDT EAGLE5 30.0.0
pass:loc=1305:cmd="netstat -p sctp"
Command entered at terminal #4.
```

;

```
eagle10110 03-08-30 14:18:27 EDT EAGLE5 30.0.0
PASS: Command sent to card
```

;

```
eagle10110 03-08-30 14:18:27 EDT EAGLE5 30.0.0
```

SCTP:

```
ip packets sent..... 1474882
  ip packets sent with data chunk..... 306354
  control chunks (excluding retransmissions)..... 1172759
  ordered data chunks (excluding retransmissions).. 1534350
  unordered data chunks (excluding retransmissions) 0
  user messages fragmented due to MTU..... 0
  retransmit data chunks sent..... 4
  sacks sent..... 496302
  send failed..... 0
ip packets received..... 1816035
  ip packets received with data chunk..... 989957
  control chunks (excluding duplicates)..... 833141
  ordered data chunks (excluding duplicates)..... 989968
  unordered data chunks (excluding duplicates).... 0
  user messages reassembled..... 0
  data chunks read..... 988601
  duplicate tsns received..... 0
  sacks received..... 153763
  gap ack blocks received..... 0
  out of the blue..... 4
  with invalid checksum..... 0
connections established..... 2954
  by upper layer..... 0
  by remote endpoint..... 2958
connections terminated..... 4
  ungracefully..... 2952
  gracefully..... 0
associations dropped due to retransmits..... 0
consecutive retransmit timeouts..... 4
retransmit timer count..... 6
fast retransmit count..... 0
heartbeat requests received..... 330275
heartbeat acks received..... 340239
heartbeat requests sent..... 340258
associations supported..... 50
milliseconds cookie life at 4-way start-up handshake. 5000
retransmission attempts allowed at start-up phase.... 8
```

;

```
eagle10110 03-08-30 14:18:32 EDT EAGLE5 30.0.0
```

NETSTAT command complete

pass:loc=1105:cmd="netstat -r"

```
Command Accepted - Processing
  rlghncxa03w 04-07-27 08:01:14 EST  EAGLE5 31.6.0
    pass: loc=1105: cmd="netstat -r"
  Command entered at terminal #1.
```

```
;
  rlghncxa03w 04-07-27 08:01:14 EST  EAGLE5 31.6.0
    PASS: Command sent to card
;
  rlghncxa03w 04-07-27 08:01:14 EST  EAGLE5 31.6.0
```

ROUTE NET TABLE

destination	gateway	flags	Refcnt	Use	Interface
0.0.0.0	192.168.55.250	3	0	14	seeq1
192.168.55.0	192.168.55.112	101	0	0	seeq1
192.168.100.0	192.168.100.112	101	0	0	seeq0

ROUTE HOST TABLE

destination	gateway	flags	Refcnt	Use	Interface
127.0.0.1	127.0.0.1	5	1	6	lo0

```
;
  rlghncxa03w 04-07-27 08:01:15 EST  EAGLE5 31.6.0

  NETSTAT command complete
;
```

pass:loc=1105:cmd="netstat -f"

```
Command Accepted - Processing
```

```
;
  rlghncxa03w 04-07-27 08:01:38 EST  EAGLE5 31.6.0
    pass: loc=1105: cmd="netstat -f"
  Command entered at terminal #1.
```

```
;
  rlghncxa03w 04-07-27 08:01:38 EST  EAGLE5 31.6.0
    PASS: Command sent to card
```

```
;
  rlghncxa03w 04-07-27 08:01:38 EST  EAGLE5 31.6.0
```

```
Usage: netstat [-a] [-i] [-h] [-m data|sys|dd] [-p icmp|ip|tcp|udp] [-r]
```

Options:

```
-a      display socket information for all protocols
-h      Displays this message
-i      display interface information for all interfaces
-m      display buffer pool information for 1 of the system pools
-p      display socket information for 1 of the protocols
-r      display the route table information
```

```
;
  rlghncxa03w 04-07-27 08:01:39 EST  EAGLE5 31.6.0

  NETSTAT command complete
;
```

nslookup

Nameserver Lookup

This command returns the IP address for a given hostname, or returns a hostname for a given IP address.

Command Name: nslookup

Command Class: IP Stack Maintenance

Options

Options and option parameters that are underlined indicate that a value must be specified for that option or parameter. For example, the **nslookup** command has the option destination. An IP address or hostname can be specified for the destination, as in the commands **nslookup 192.168.100.3** and **nslookup dcm1107a**. Do not enter the underlined option or parameter; enter a value for the information represented by the underlined option or parameter.

destination

The destination can be either an IP address or hostname.

IP address

The IP address is a TCP/IP address expressed in standard “dot notation.” IP addresses consist of the system’s network number and the machine’s unique host number. An example IP address is **192.9.200.44**, where **192.9.200** is the network number and **44** is the machine’s host number.

Range: 4 numbers separated by dots, with each number in the range of **0-255**.

hostname

Hostname. This parameter identifies the logical name assigned to the device with the IP address indicated.

Range: a-z, A-Z, 0-9, -, . (any string of characters beginning with a letter and comprising up to 60 characters in length)

-h

This options provides help information for the command.

Example

```
nslookup 192.9.200.44
```

```
nslookup nc.tekelec.com
```

Dependencies

The actual **nslookup** text string must be followed by a destination (either a hostname or IP address).

Whether a host is found depends on the configuration of the host table and domain name servers.

Notes

The **nslookup** command is executed through the **pass** command.

Output**pass: loc=1105: cmd="nslookup"**

or

pass: loc=1105: cmd="nslookup -h"

```

Command Accepted - Processing
  rlghncxa03w 04-07-27 08:43:21 EST  EAGLE5 31.6.0
  pass: loc=1105: cmd="nslookup"
  Command entered at terminal #1.
;
  rlghncxa03w 04-07-27 08:43:21 EST  EAGLE5 31.6.0
  PASS: Command sent to card
;
  rlghncxa03w 04-07-27 08:43:21 EST  EAGLE5 31.6.0

Usage: nslookup [hostname|ipaddr]
Options:
  hostname  String name
  ipaddr    d.d.d.d
;
  rlghncxa03w 04-07-27 08:43:22 EST  EAGLE5 31.6.0
  NSLOOKUP command complete
;

```

pass: loc=1105: cmd="nslookup dcm1107a"

```

Command Accepted - Processing
  rlghncxa03w 04-07-27 08:43:46 EST  EAGLE5 31.6.0
  pass: loc=1105: cmd="nslookup dcm1107a"
  Command entered at terminal #1.
;
  rlghncxa03w 04-07-27 08:43:46 EST  EAGLE5 31.6.0
  PASS: Command sent to card
;
  rlghncxa03w 04-07-27 08:43:46 EST  EAGLE5 31.6.0

NSLOOKUP command in progress
;
  rlghncxa03w 04-07-27 08:43:46 EST  EAGLE5 31.6.0

Configured Domain Name Data

DNSA = 192.168.100.3
DNSB = 0.0.0.0
Domain Name = nc.tekelec.com
Search Order = LOCAL First

Resolving host name - dcm1107a

Host Table entry
  dcm1107a - 192.168.100.113
DNS Server - No entry exists

Currently using Host Table entry

NSLOOKUP command complete
;

```

pass: loc=1105: cmd="nslookup 192.168.100.3"

```
Command Accepted - Processing

    rlghncxa03w 04-07-27 13:21:49 EST  EAGLE5 31.6.0
    pass: loc=1105: cmd="nslookup 192.168.100.3"
    Command entered at terminal #1.
;
    rlghncxa03w 04-07-27 13:21:49 EST  EAGLE5 31.6.0
    PASS: Command sent to card
;
    rlghncxa03w 04-07-27 13:21:49 EST  EAGLE5 31.6.0

    NSLOOKUP command in progress
;
    rlghncxa03w 04-07-27 13:21:49 EST  EAGLE5 31.6.0

    Configured Domain Name Data

    DNSA = 192.168.100.3
    DNSB = 0.0.0.0
    Domain Name = nc.tekelec.com
    Search Order = LOCAL First

    Resolving IP address - 192.168.100.3

    Host Table - No entry exists
    DNS Server
        tekral.nc.tekelec.com - 192.168.100.3

    Currently using DNS Server entry

    NSLOOKUP command complete
;
```

ping

Packet Internetwork Groper

This command is used to test for the presence of hosts on the network. This command is invoked with a destination (either a hostname or IP address).

Command Name: ping

Command Class: IP Stack Maintenance

Options

Options and option parameters that are underlined indicate that a value must be specified for that option or parameter. For example, the **ping** command has the option destination. An IP address or hostname can be specified for the destination, as in the commands **ping 192.9.200.44** and **ping nc.tekelec.com**. Do not enter the underlined option or parameter; enter a value for the information represented by the underlined option or parameter.

destination

The destination can be either an IP address or hostname.

IP address

The IP address is a TCP/IP address expressed in standard “dot notation.” IP addresses consist of the system’s network number and the machine’s unique host number. An example IP address is **192.9.200.44**, where **192.9.200** is the network number and **44** is the machine’s host number.

Range: 4 numbers separated by dots, with each number in the range of **0-255**.

hostname

Hostname. This parameter identifies the logical name assigned to the device with the IP address indicated.

Range: any string of characters beginning with a letter and comprising ('a'..'z', 'A'..'Z', '0'..'9', '-', '.') up to 120 characters in length.

-i

This option specifies the number of ping requests to send.

Range: 1 - 5

Default: 3

-n

This option specifies the size of message to use in test.

Range: 12 - 2048

Default: 64

-h

This options provides help information for the command.

Example

ping 192.9.200.44

ping nc.tekelec.com

ping 192.9.200.44 -i 5 -n 2048

Dependencies

The actual **ping** text string must be followed by a destination (either a hostname or IP address) prior to the options.

Notes

The **ping** command is executed through the **pass** command.

Output

pass: loc=1105: cmd="ping" or

pass: loc=1105: cmd="ping -h"

Command Accepted - Processing

```
rlghncxa03w 04-07-27 08:29:35 EST EAGLE5 31.6.0
pass: loc=1105: cmd="ping"
Command entered at terminal #1.
```

;

```
rlghncxa03w 04-07-27 08:29:35 EST EAGLE5 31.6.0
PASS: Command sent to card
```

;

```

rlghncxa03w 04-07-27 08:29:35 EST  EAGLE5 31.6.0

Usage: ping <hostname | ipaddr> [-h] [-i size] [-n count]
Options:
  -h          Displays this message
  -i count    Number of pings to send. Range=1..5. Default=3.
  -n size     Sets size of ICMP echo packet. Range=12..2048. Default=64.
  hostname    Name of machine to ping
  ipaddr      IP Address of machine to ping (d.d.d.d)
;
rlghncxa03w 04-07-27 08:29:36 EST  EAGLE5 31.6.0

PING command complete
;

pass: loc=1105: cmd="ping tekral"
Command Accepted - Processing

rlghncxa03w 04-07-27 08:30:16 EST  EAGLE5 31.6.0
pass: loc=1105: cmd="ping tekral"
Command entered at terminal #1.
;
rlghncxa03w 04-07-27 08:30:16 EST  EAGLE5 31.6.0
PASS: Command sent to card
;
rlghncxa03w 04-07-27 08:30:16 EST  EAGLE5 31.6.0
PING command in progress
;
rlghncxa03w 04-07-27 08:30:18 EST  EAGLE5 31.6.0
PING tekral (192.168.100.3): 56 data bytes
64 bytes from tekral.nc.tekelec.com (192.168.100.3):icmp_seq=0.time=5. ms
64 bytes from tekral.nc.tekelec.com (192.168.100.3):icmp_seq=1.time=0. ms
64 bytes from tekral.nc.tekelec.com (192.168.100.3):icmp_seq=2.time=0. ms
----tekral PING Statistics----
  3 packets transmitted, 3 packets received, 0% packet loss
  round-trip (ms)  min/avg/max = 0/1/5
  PING command complete
;

pass: loc=1105: cmd="ping 192.168.100.3"
Command Accepted - Processing

rlghncxa03w 04-07-27 08:30:44 EST  EAGLE5 31.6.0
pass: loc=1105: cmd="ping 192.168.100.3"
Command entered at terminal #1.
;
rlghncxa03w 04-07-27 08:30:44 EST  EAGLE5 31.6.0
PASS: Command sent to card
;
rlghncxa03w 04-07-27 08:30:44 EST  EAGLE5 31.6.0

PING command in progress
;

```

```

rlghncxa03w 04-07-27 08:30:46 EST EAGLE5 31.6.0
PING 192.168.100.3: 56 data bytes
64 bytes from tekral.nc.tekelec.com (192.168.100.3):icmp_seq=0.time=5. ms
64 bytes from tekral.nc.tekelec.com (192.168.100.3):icmp_seq=1.time=0. ms
64 bytes from tekral.nc.tekelec.com (192.168.100.3):icmp_seq=2.time=0. ms
----192.168.100.3 PING Statistics----
 3 packets transmitted, 3 packets received, 0% packet loss
round-trip (ms)  min/avg/max = 0/1/5

```

PING command complete

;

pass: loc=1105: cmd="ping tekral -i 2"

Command Accepted - Processing

```

rlghncxa03w 04-07-27 08:31:46 EST EAGLE5 31.6.0
pass: loc=1105: cmd="ping tekral -i 2"
Command entered at terminal #1.

```

;

```

rlghncxa03w 04-07-27 08:31:46 EST EAGLE5 31.6.0
PASS: Command sent to card

```

;

```

rlghncxa03w 04-07-27 08:31:46 EST EAGLE5 31.6.0

```

PING command in progress

;

```

rlghncxa03w 04-07-27 08:31:47 EST EAGLE5 31.6.0
PING tekral (192.168.100.3): 56 data bytes
64 bytes from tekral.nc.tekelec.com(192.168.100.3):icmp_seq=0.time=10. ms
64 bytes from tekral.nc.tekelec.com(192.168.100.3):icmp_seq=1.time=0. ms
----tekral PING Statistics----
 2 packets transmitted, 2 packets received, 0% packet loss
round-trip (ms)  min/avg/max = 0/5/10

```

PING command complete

;

pass: loc=1105: cmd="ping tekral -i 1"

Command Accepted - Processing

```

rlghncxa03w 04-07-27 08:31:55 EST EAGLE5 31.6.0
pass: loc=1105: cmd="ping tekral -i 1"
Command entered at terminal #1.

```

;

```

rlghncxa03w 04-07-27 08:31:55 EST EAGLE5 31.6.0
PASS: Command sent to card

```

;

```

rlghncxa03w 04-07-27 08:31:55 EST EAGLE5 31.6.0

```

PING command in progress

;

```

rlghncxa03w 04-07-27 08:31:55 EST EAGLE5 31.6.0

```

PING: tekral is alive

PING command complete

;

```
pass: loc=1105: cmd="ping tekral -i 2 -n 200"
```

```
E3780 Cmd Rej: Syntax Error Found
```

```

rlghncxa03w 04-07-27 08:32:09 EST EAGLE5 31.6.0
pass: loc=1105: cmd="ping tekral -i 2 -n 200"
Command entered at terminal #1.
;
rlghncxa03w 04-07-27 08:32:09 EST EAGLE5 31.6.0
PASS: Command sent to card
;
rlghncxa03w 04-07-27 08:32:09 EST EAGLE5 31.6.0

PING command in progress
;
rlghncxa03w 04-07-27 08:32:10 EST EAGLE5 31.6.0
PING tekral (192.168.100.3): 192 data bytes
200 bytes from tekral.nc.tekelec.com(192.168.100.3):icmp_seq=0.time=5. ms
200 bytes from tekral.nc.tekelec.com(192.168.100.3):icmp_seq=1.time=0. ms
----tekral PING Statistics----
 2 packets transmitted, 2 packets received, 0% packet loss
round-trip (ms)  min/avg/max = 0/2/5

PING command complete
;

```

NOTE: In the above example, the response shows eight bytes less than the entry (192 as opposed to 200) because the ping command may use eight bytes automatically.

sctp

Stream Control Transmission Protocol

Use this command to provide a view of SCTP instance and associations information.

Command Name: sctp

Command Class: SCTP Stack Maintenance

Options

Options and option parameters that are underlined indicate that a value must be specified for that option or parameter. For example, the **scstp** command option **-g** has the parameter command flag **pegs -p port**. The local port can be specified for the association for which peg counts are retrieved, as in the command **sctp -g pegs -p 200 -i 1**. Do not enter the underlined option or parameter; enter a value for the information represented by the underlined option or parameter.

-g

The get option.

Range: **pegs, sctp, csum**

pegs—Retrieves the peg counts for a specific association. An association is specified using the **-p** and **-i** command flags.

-p port—local port

-i id—association ID

sctp—Summary list of all SCTP instances, or the detailed information for a specified SCTP instance, or the detailed information for a specified

association. An SCTP instance is specified using the **-p** command flag. An association is specified using the **-i** command flag.

-p port—local port

-i id—association ID

csum—Retrieves the SCTP checksum algorithm currently being used.

-a

The action option.

Range: **clrpegs**

clrpegs—Clears all the pegs for a specific association. An association is specified using the **-p** and **-i** command flags.

-p port—local port

-i id—association ID

-h

This option displays help information for the command.

Range: **full**

When **full** is not specified or when the entered command contains a syntax error, the simple version of the help information is displayed.

When **full** is specified, the detailed version of the help information is displayed.

Example

```
sctp -g pegs -p 200 -i 1
```

```
sctp -g sctp -p port
```

```
sctp -g sctp -p port -i id
```

```
sctp -g sctp -p 200 -i 1
```

```
sctp -a clrpegs -p 300 -i 2
```

Dependencies

Only one of the options can be specified at a time.

Notes

None

Output

This simple version of the help output is displayed when is specified the **-h** option without the **full** parameter, or when the **sctp** pass command that was entered contains a syntax error.

pass:loc=1307:cmd="sctp -h"

Command Accepted - Processing

```
eagle10207 01-07-02 12:41:43 EDT EAGLE5 30.0.0
pass:loc=1307:cmd="sctp -h"
Command entered at terminal #1.
```

;

```
eagle10207 01-07-02 12:41:43 EDT EAGLE5 30.0.0
PASS: Command sent to card
```

;

```
eagle10207 01-07-02 12:41:43 EDT EAGLE5 30.0.0
```

```
Usage: sctp [-a action_cmd] [-g get_cmd] [-h [full]] [-p port] [-i id]
```

Options:

```
-a          action command
-g          get command
-h          displays this message
-i          id: association id of an sctp instance = [0..65535]
-p          port: local port number [0..65535]
```

```
action_cmd: [clrpegs]
clrpegs:   clrpegs -p port -i id
```

```
get_cmd:   [pegs | sctp]
pegs:      pegs -p port -i id
sctp:      sctp [-p port] [-i id]
csum:      csum
```

;

```
eagle10207 01-07-02 12:41:45 EDT EAGLE5 30.0.0
```

```
SCTP command complete
```

;

The full version of the help output is displayed only when the **-h full** option is specified.

pass:loc=1307:cmd="sctp -h full"

Command Accepted - Processing

```
eagle10207 04-07-29 14:31:28 EDT EAGLE5 31.6.0
pass: loc=1307: cmd="sctp -h full"
Command entered at terminal #1.
```

;

```
eagle10207 04-07-29 14:31:28 EDT EAGLE5 31.6.0
PASS: Command sent to card
```

;

eagle10207 04-07-29 14:31:28 EDT EAGLE5 31.6.0

Usage: sctp [-a action_cmd] [-g get_cmd] [-h [full]] [-p port] [-i id]

Options:

```
-a          action command
-g          get command
-h          Displays this message
-i          id: association id of a sctp instance = [0..65535]
-p          port: local port number [0..65535]
```

```
action_cmd: [clrpegs]
  clrpegs:  clrpegs -p port -i id
```

```
get_cmd:    [pegs | sctp]
  pegs:     pegs -p port -i id
  sctp:     sctp [-p port] [-i id]
  csum:     csum
```

```
action_cmd: [clrpegs]
  clrpegs:  clrpegs -p port -i id
            Clears all the pegs for a specific association.
            A specific association is specified using the -p and -i
            command flags. For example the following Sctp command will
            clear the peg counts for the association with
            association id 2 and local port of 300.
            sctp -a clearpegs -p 300 -i 2
```

```
get_cmd:    [pegs | sctp]
  pegs:     pegs -p <port> -i <id>
            Retrieves the pegs for a specific association.
            A specific association is specified using the -p and -i
            command flags. For example the following Sctp command
            will get the peg counts for the association with
            association id 1 and local port 200.
            sctp -g pegs -p 200 -i 1
```

```
sctp:      sctp
            Summary list of all Sctp instances. To list all the Sctp
            instances issue the following command:
            sctp -g sctp

            sctp -g sctp -p port
            Retrieves detailed information for a
            specified Sctp instance.
            For example the following Sctp command will get the detailed
            information for the Sctp instance with a local port of 200.
            sctp -g sctp -p 200
```

```
sctp -p port -i id
            Retrieves detailed information for a specific association.
            For example the following Sctp command will get the detailed
            information for the association with association id 1 and
            local port of 200.
            sctp -g sctp -p 200 -i 1
```



```

csum:      csum
           Retrieves the active SCTP checksum algorithm on the
IPLIMx/IPGWx card

```

```

;
eagle10207 04-07-29 14:31:35 EDT  EAGLE5 31.6.0

SCTP command complete

```

```
;
```

The following example shows the **sctp get** command output when the command is entered to retrieve the pegs associated with the fully specified SCTP association.

pass: loc=1307: cmd="sctp -g pegs -p 2222 -i 2"

Command Accepted - Processing

```

eagle10207 04-07-29 12:44:02 EDT  EAGLE5 31.6.0
4545.1083  SYSTEM          INFO  REPT COND: system alive
           Report Date:01-07-02  Time:12:44:02

```

```
;
```

```

eagle10207 04-07-29 12:44:29 EDT  EAGLE5 31.6.0
pass:loc=1307:cmd="sctp -g pegs -p 2222 -i 2"
Command entered at terminal #1.

```

```
;
```

```

eagle10207 04-07-29 12:44:29 EDT  EAGLE5 31.6.0
PASS: Command sent to card

```

```
;
```

```

eagle10207 04-07-29 12:44:29 EDT  EAGLE5 31.6.0
           ip datagrams rcvd = 155402
           ip datagrams with data chunks rcvd = 120844
           data chunks rcvd = 367908
           data chunks read = 367900
           dup tsns rcvd = 8
           sacks rcvd = 38734
           gap ack blocks rcvd = 3
           heartbeat requests rcvd = 135
           heartbeat acks rcvd = 52
           heartbeat requests sent = 52
           ip datagrams sent = 129254
           ip datagrams with data chunks sent = 73084
           data chunks sent = 396330
           retransmit data chunks sent = 135
           sacks sent = 64872
           Send Failed = 0
           retransmit timer count = 0
           consecutive retransmit timeouts = 0

```

```

RTT between RMIN and RMAX inclusive = 6
    RTT greater than RMAX = 0
    retransmit timer count = 0
    consecutive retransmit timeouts = 0
    fast retransmit count = 135
    rcv timer count = 0
    heartbeat timer count = 244
    none left tosend = 0
    none left rwnd gate = 5
    none left cwnd gate = 8
;

eagle10207 04-07-29 12:44:32 EDT  EAGLE5 31.6.0

SCTP command complete
;

```

The following example shows the **sctp get** command output when the command is entered to retrieve a list of all SCTP instances and number of associations associated with each instance. In this example, there are 2 SCTP instances.

pass: loc=1307: cmd="sctp -g sctp"

```

Command Accepted - Processing

eagle10207 04-07-29 12:45:43 EDT  EAGLE5 31.6.0
pass:loc=1307:cmd="sctp -g sctp"
Command entered at terminal #1.
;

eagle10207 04-07-29 12:45:43 EDT  EAGLE5 31.6.0
PASS: Command sent to card
;

eagle10207 04-07-29 12:45:43 EDT  EAGLE5 31.6.0
Local   Local IP      Num of
Port    Address         Assoc
7001    192.168.110.35  1
2222    192.168.110.12  3
        192.168.112.12
;

eagle10207 04-07-29 12:45:43 EDT  EAGLE5 31.6.0

SCTP command complete
;

```

The following example shows the **sctp get** output when the port number is specified in the command, to retrieve the detailed information and the associations for the specific Sctp instance. In this example, there are 3 Sctp associations for the Sctp instance number 2222.

pass: loc=1307: cmd="sctp -g sctp -p 2222"

Command Accepted - Processing

```

eagle10207 04-07-29 12:46:55 EDT EAGLE5 31.6.0
pass:loc=1307:cmd="sctp -g sctp -p 2222"
Command entered at terminal #1.
;

eagle10207 04-07-29 12:46:55 EDT EAGLE5 31.6.0
PASS: Command sent to card
;

eagle10207 04-07-29 12:46:55 EDT EAGLE5 31.6.0
Local   Local IP      Num of
Port    Address       Assoc
2222    192.168.110.12  3
        192.168.112.12

Assoc   Loca          Local   Primary      Remote
ID      IP Address    Port    Address      Port
1       192.168.110.12 2222    192.168.112.4 5555
        192.168.112.12
2       192.168.110.12 2222    192.168.112.4 6666
        192.168.112.12
3       192.168.110.12 2222    192.168.112.4 7777
        192.168.112.12

        no.of inqueued msgs = 0
                max mtu = 1500
                max init times = 8
                max send times = 10
        max size reassembly = 1048576
        default rwnd value = 16384
        pre-open streams = 1
        ip datagram counter = 2781

Timer Values:          seconds          millisecs
        INIT              1              0
        RECV              0              200
        SEND              1              0
        SHUTDOWN          0              300
        HEARTBEAT         0              500
        PMTU              600            0
;

eagle10207 04-07-29 12:46:59 EDT EAGLE5 31.6.0

SCTP command complete
;

```

The following example shows the **sctp get vommsnf** output when the the port number and association ID are specified in the command, to retrieve detailed association information for a specific SCTP association. In this example, the information about association ID 2 in SCTP instance number 2222 is displayed.

pass: loc=1307: cmd="sctp -g sctp -p 2222 -i 2"

Command Accepted - Processing

```

eagle10207 04-07-29 12:49:02 EDT EAGLE5 31.6.0
4546.1083 SYSTEM INFO REPT COND: system alive
Report Date:01-07-02 Time:12:49:02
;

eagle10207 04-07-29 12:49:19 EDT EAGLE5 31.6.0
pass:loc=1307:cmd="sctp -g sctp -p 2222 -i 2"
Command entered at terminal #1.
;

eagle10207 04-07-29 12:49:19 EDT EAGLE5 31.6.0
PASS: Command sent to card
;

eagle10207 04-07-29 12:49:19 EDT EAGLE5 31.6.0
Assoc Local Local Primary Remote
ID IP Address Port Address Port
2 192.168.110.12 2222 192.168.112.4 6666
192.168.112.12

Configuration State
Retransmission Mode = Linear State = OPEN
Min. Retransmission Timeout = 10 ULP association id = 18
Max. Retransmission Timeout = 800 Number of nets = 1
Max. Number of Retries = 10
Min. Congestion Window = 3000
Inbound Streams config/actual = 2/1
Outbound Streams config/actual = 2/2

Nets Data

IP Address 192.168.112.4 State Reachable
Port 6666 Primary YES
MTU 1500 cwnd 16384
ssthresh 16384 RTO 120

IP Address 192.168.112.5 Reachable
Port 7777 Primary NO
MTU 1500 cwnd 16384
ssthresh 16384 RTO 120

Last Net Sent To = 1
Last Net Rcvd From = 1
Over All Error Count = 0
Peers Rwnd = 13880
My Rwnd = 16384
Max Window = 16384
Initial Seq Number = 24130
Next Sending Seq Number = 124686
Last Acked Seq Number = 124669

```

```

Maximum Outbound Char Count = 16384
Current Outbound Char Count = 2112
  Number Unsent Char Count = 0
Outbound Data Chunk Count = 16
  Number Unsent = 0
  Number To Retransmit = 0
;

eagle10207 04-07-29 12:49:22 EDT EAGLE5 31.6.0

SCTP command complete

```

The following example shows the **sctp** output when the command is entered to clear the pegs associated with the fully specified SCTP association.

pass: loc=1307: cmd="sctp -a clrpegs -p 7001 -i 1"

```

Command Accepted - Processing

eagle10207 04-07-29 14:45:53 EDT EAGLE5 31.6.0
pass:loc=1307:cmd="sctp -a clrpegs -p 7001 -i 1"
Command entered at terminal #1.
;

eagle10207 04-07-29 14:45:53 EDT EAGLE5 31.6.0
PASS: Command sent to card
;

eagle10207 04-07-29 14:45:53 EDT EAGLE5 31.6.0
      ip datagrams rcvd = 167591
ip datagrams with data chunks rcvd = 131462
      data chunks rcvd = 400386
      data chunks read = 400378
      dup tsns rcvd = 8
      sacks rcvd = 40704
      gap ack blocks rcvd = 3
      heartbeat requests rcvd = 135
      heartbeat acks rcvd = 52
      heartbeat requests sent = 52
      ip datagrams sent = 137701
ip datagrams with data chunks sent = 76627
      data chunks sent = 414197
      retransmit data chunks sent = 135
      sacks sent = 70587
      Send Failed = 0
      retransmit timer count = 0
      consecutive retransmit timeouts = 0
RTT between RMIN and RMAX inclusive = 6
      RTT greater than RMAX = 0
      rcv timer count = 0
      heartbeat timer count = 252
      fast retransmit count = 135
      none left tosend = 0
      none left rwnd gate = 5
      none left cwnd gate = 8
;

eagle10207 04-07-29 14:45:55 EDT EAGLE5 31.6.0
SCTP command complete
;

```

The following command displays the active SCTP checksum algorithm being used on the IPLIMx or IPGWx card.

pass: loc=1107: cmd="sctp -g csum"

Command Accepted - Processing

```

eagle10207 01-07-02 12:41:43 EDT  EAGLE5 30.0.0
pass:loc=1305:cmd="sctp -g csum"
Command entered at terminal #4.
;

eagle10207 01-07-02 12:41:43 EDT  EAGLE5 30.0.0
PASS: Command sent to card
;

eagle10207 01-07-02 12:41:43 EDT  EAGLE5 30.0.0

Checksum Algorithm is crc32c
;

eagle10207 01-07-02 12:41:43 EDT  EAGLE5 30.0.0

SCTP command complete
;

```

sockrft

Socket Round Trip Time

This command is used to report and reset the round-trip time statistics for application sockets. Minimum, maximum, and average times are kept for each open socket. The Retransmission Mode (BSD, FIXED, or MOD) and the Fixed Round Trip Time are also displayed.

Command Name: sockrft

Command Class: Application Maintenance

Options

Options and option parameters that are underlined indicate that a value must be specified for that option or parameter. For example, the **sockrft** command has the option socket name. The socket name must be specified for which statistics will be displayed, as in the command **sockrft socyellow**. Do not enter the underlined option or parameter; enter a value for the information represented by the underlined option or parameter.

socket name

This option is **mandatory** and specifies the socket name for which statistics are to be displayed.

Range: up to 15 alphanumeric characters.

-r

This option resets all statistics for the given socket name.

-h

This option provides help information for the command.

Example

```

sockrtrt
sockrtrt -h
sockrtrt socyellow
sockrtrt socyellow -r

```

Dependencies

None

Notes

The **sockrtrt** command is executed through the **pass** command.

Output

```

pass:loc=1105:cmd="sockrtrt" or
pass:loc=1105:cmd="sockrtrt -h"
Command Accepted - Processing

    rlghncxa03w 04-07-27 08:32:34 EST  EAGLE5 31.6.0
    pass:loc=1105:cmd="sockrtrt"
    Command entered at terminal #1.
;
    rlghncxa03w 04-07-27 08:32:34 EST  EAGLE5 31.6.0
    PASS: Command sent to card
;
    rlghncxa03w 04-07-27 08:32:34 EST  EAGLE5 31.6.0
    Usage: SOCKRTRT sockname [-r] [-h]
    Options:
        -r          Resets rtt data for specified socket
        -h          Displays this message
;
    rlghncxa03w 04-07-27 08:32:34 EST  EAGLE5 31.6.0

    SOCKRTRT command complete
;
pass:loc=1105:cmd="sockrtrt c7000"
Command Accepted - Processing
    rlghncxa03w 04-07-27 08:32:34 EST  EAGLE5 31.6.0
    pass:loc=1105:cmd="sockrtrt c7000"
    Command entered at terminal #1.
;
    rlghncxa03w 04-07-27 08:32:34 EST  EAGLE5 31.6.0
    PASS: Command sent to card
;
    rlghncxa03w 04-07-27 08:32:34 EST  EAGLE5 31.6.0

    SOCKRTRT: Socket round-trip time report (in milliseconds)

    Configured Traffic Round-Trip Time
        Retransmission Mode          : FIXED
        Fixed Round Trip Time        : 250

```

```

Measured Normal Traffic Round-Trip Times

    Minimum round-trip time      : 5
    Maximum round-trip time      : 195
    Weighted Average round-trip time : 10
    Last recorded round-trip time  : 10

Measured Congested Traffic Round-Trip Times

    Minimum round-trip time      : 0
    Maximum round-trip time      : 0
    Weighted Average round-trip time : 0
    Last recorded round-trip time  : 0
;
rlghncxa03w 04-07-27 08:32:34 EST  EAGLE5 31.6.0
SOCKRTT command complete
;
pass:loc=1105:cmd="sockrtt c7000 -r"
Command Accepted - Processing

    rlghncxa03w 04-07-27 08:32:34 EST  EAGLE5 31.6.0
    pass:loc=1105:cmd="sockrtt c7000 -r"
    Command entered at terminal #1.
;
    rlghncxa03w 04-07-27 08:32:34 EST  EAGLE5 31.6.0
    PASS: Command sent to card
;
    rlghncxa03w 04-07-27 08:32:34 EST  EAGLE5 31.6.0

SOCKRTT: Socket round-trip time report (in milliseconds)

Configured Traffic Round-Trip Time
    Retransmission Mode          : FIXED
    Fixed Round Trip Time        : 250

Measured Normal Traffic Round-Trip Times

    Minimum round-trip time      : 0
    Maximum round-trip time      : 0
    Weighted Average round-trip time : 0
    Last recorded round-trip time  : 0

Measured Congested Traffic Round-Trip Times

    Minimum round-trip time      : 0
    Maximum round-trip time      : 0
    Weighted Average round-trip time : 0
    Last recorded round-trip time  : 0
;
rlghncxa03w 04-07-27 08:32:34 EST  EAGLE5 31.6.0
SOCKRTT command complete
;

```

sockstate**Socket State**

This command is used to report the TALI state machine history for the specified socket name.

Command Name: sockstate

Command Class: Application Maintenance

Options

Options and option parameters that are underlined indicate that a value must be specified for that option or parameter. For example, the **sockstate** command has the option socket name. The socket name must be specified for which history will be displayed, as in the command **sockstate c7000**. Do not enter the underlined option or parameter; enter a value for the information represented by the underlined option or parameter.

socket name

This **mandatory** option specifies the socket name for which the history is to be displayed.

Range: Up to 15 alphanumeric characters

-i service

This option is used to include SS7 service messages in the display of the TALI state machine history.

-i tali

This option is used to include TALI peer-to-peer messages in the display of the TALI state machine history.

-x service

This option is used to exclude SS7 service messages in the display of the TALI state machine history.

-x tali

This option is used to exclude TALI peer-to-peer messages in the display of the TALI state machine history.

-h

This option provides help information for the command.

Example

```
sockstate
```

```
sockstate c7000
```

```
sockstate c7000 -i tali
```

Dependencies

None

Notes

The **sockstate** command is executed through the **pass** command.

State machine history is kept in a circular buffer in memory.

Output

pass:loc=1105:cmd="sockstate" or

pass:loc=1105:cmd="sockstate -h"

Command Accepted - Processing

```

    rlghncxa03w 04-07-27 08:32:34 EST  EAGLE5 31.6.0
    pass:loc=1105:cmd="sockstate"
    Command entered at terminal #1.
;
    rlghncxa03w 04-07-27 08:32:34 EST  EAGLE5 31.6.0
    PASS: Command sent to card
;
    rlghncxa03w 04-07-27 08:32:34 EST  EAGLE5 31.6.0
    Usage: SOCKSTATE sockname [-h] [-i service tali] [-x service tali]
    Options:
-h          Displays this message
-i service  Include SS7 service messages in sockstate log
-i tali     Include TALI peer-to-peer messages in sockstate log
-x service  Exclude SS7 service messages from sockstate log (default)
-x tali     Exclude TALI peer-to-peer messages from sockstate log (default)
;
    rlghncxa03w 04-07-27 08:32:34 EST  EAGLE5 31.6.0

    SOCKSTATE command complete
;

```

pass:loc=1105:cmd="sockstate c7000 -i tali"

Command Accepted - Processing

```

    rlghncxa03w 04-07-27 08:32:34 EST  EAGLE5 31.6.0
    pass:loc=1105:cmd="sockstate c7000 -i tali"
    Command entered at terminal #1.
;
    rlghncxa03w 04-07-27 08:32:34 EST  EAGLE5 31.6.0
    PASS: Command sent to card
;
    rlghncxa03w 04-07-27 08:32:34 EST  EAGLE5 31.6.0
    SOCKSTATE command in progress
;
    rlghncxa03w 04-07-27 08:32:34 EST  EAGLE5 31.6.0

    SOCKSTATE: Socket state history log
                Current settings: -i tali
                                   -x service

    SOCKSTATE command complete
;

```

pass:loc=1105:cmd="sockstate c7000 -i service"

Command Accepted - Processing

```

    rlghncxa03w 04-07-27 08:32:34 EST  EAGLE5 31.6.0
    pass:loc=1105:cmd="sockstate c7000 -i service"
    Command entered at terminal #1.
;
    rlghncxa03w 04-07-27 08:32:34 EST  EAGLE5 31.6.0
    PASS: Command sent to card
;

```

```

rlghncxa03w 04-07-27 08:32:34 EST  EAGLE5 31.6.0
SOCKSTATE command in progress
;
rlghncxa03w 04-07-27 08:32:34 EST  EAGLE5 31.6.0

SOCKSTATE: Socket state history log
           Current settings: -i service tali

SOCKSTATE command complete
;

```

pass:loc=1105:cmd="sockstate c7000"

Command Accepted - Processing

```

rlghncxa03w 04-07-27 08:32:34 EST  EAGLE5 31.6.0
pass:loc=1105:cmd="sockstate c7000"
Command entered at terminal #1.
;
rlghncxa03w 04-07-27 08:32:34 EST  EAGLE5 31.6.0
PASS: Command sent to card
;
rlghncxa03w 04-07-27 08:32:34 EST  EAGLE5 31.6.0
SOCKSTATE command in progress
;
rlghncxa03w 04-07-27 08:32:34 EST  EAGLE5 31.6.0

SOCKSTATE: Socket state history log
           Current settings: -i service tali
           MTP Primitives broadcast phase: enabled
           MTP Primitives response method: enabled
           SCCP with MTP3: disabled
           ISUP via MTP3: disabled
           XSRV Framing: enabled
           MTPP with Group Code: enabled
           Near End TALI version: 3.0
           Far End TALI version: 3.0
           Negotiated TALI version: 3.0

Date      Time          Socket Event
=====
05-07-27  10:01:33.570   Socket Created
05-07-27  10:04:21.765   Socket Allowed for Traffic
05-07-27  10:04:55.405   Management Socket Open
05-07-27  10:06:12.030   Link Activated
05-07-27  10:06:12.030   Transition to Connecting
05-07-27  10:06:17.860   Socket Connection Established
05-07-27  10:06:17.860   Transition to NEA-FEP
05-07-27  10:06:17.865   Transition to NEA-FEA
05-07-27  10:16:57.190   Monitor Message Transmitted
05-07-27  10:16:57.200   Monitor-Ack Message Received
05-07-27  10:16:58.170   Test Message Transmitted
05-07-27  10:16:58.180   Allow Message Received

           . . . .

05-07-27  10:20:55.285   SCCP MSU Transmitted
05-07-27  10:20:55.290   SCCP MSU Received
05-07-27  10:20:55.480   Test Message Transmitted
05-07-27  10:20:55.480   Allow Message Received
05-07-27  10:20:55.890   SCCP MSU Transmitted

SOCKSTATE command complete

```

tracert

IP Tracing Utility

This command is used to determine the path taken by a UDP message to a specified remote host. The command can be invoked with either a hostname or IP address.

Command Name: tracert

Command Class: IP Stack Maintenance

Options

Options and option parameters that are underlined indicate that a value must be specified for that option or parameter. For example, the **tracert** command has the option **IP address**. The IP address can be specified for the remote host to which the UDP message is sent, as in the command **tracert 208.55.20.177**. Do not enter the underlined option or parameter; enter a value for the information represented by the underlined option or parameter.

IP address

The IP address is a TCP/IP address expressed in standard “dot notation.” IP addresses consist of the system’s network number and the machine’s unique host number. An example IP address is **192.9.200.44**, where **192.9.200** is the network number and **44** is the machine’s host number.

Range: 4 numbers separated by dots, with each number in the range of **0-255**.

hostname

Hostname. This parameter identifies the logical name assigned to the device with the IP address indicated.

Range: String of characters, beginning with a letter, up to 120 characters in length. Valid characters are **a-z, A-Z, 0-9, -** (hyphen), **.** (period)

-h

This option provides help information for the command.

-m maximum hops

This option specifies the maximum number of hops before the trace is terminated.

Range: 1-30

Default: 10

-n

This option specifies that only the IP Address of each host will be displayed (not the hostname).

-p port

This option provides the user port number.

Range: 1-65535

Default: 33434

Example

```
tracert
```

```
tracert www.remotedest.com
```

```
tracert www.remotedest.com -m 20
```

```
tracert www.remotedest.com -m 20 -n
```

```
traceroute 208.55.20.177
```

```
traceroute 208.55.20.177 -m 20 -p 40000
```

Dependencies

If a Domain Name is specified, either the Domain Name must exist in the IP Host table or the Domain Name Server A or B must be provisioned.

Notes

The **traceroute** command is executed through the **pass** command.

Output

The following example illustrates the help information for the command.

```
pass:loc=1103:cmd="traceroute"      or
```

```
pass:loc=1103:cmd="traceroute -h"
```

```
Command entered at terminal #1.
;

  rlghncxa03w 04-07-27 08:32:34 EST  EAGLE5 31.6.0
PASS: Command sent to card
;

  rlghncxa03w 04-07-27 08:32:34 EST  EAGLE5 31.6.0

Usage: traceroute <hostname | ipaddr> [-h] [-m maxhops] [-n] [-p port]
Options:
  -h           Displays this message
  -m maxhops  Maximum number of hops to destination.  Range=1..30. Default=
10.
  -n names    Inhibits the display of intermediate host names
  -p port     Port number. Range=1..65535. Default=33434.
hostname     Name of machine to trace
ipaddr       IP Address of machine to trace (d.d.d.d)
Errors:
  *           Timeout
  !N         Unreachable Network
  !H         Unreachable Host
  !?nn       Unknown Failure (nn = ICMP Code)
;

  rlghncxa03w 04-07-27 08:32:34 EST  EAGLE5 31.6.0

TRACEROUTE command complete
```

The following example illustrates a **tracert** request to host **www.remotedest.com**. A maximum of 20 hops has been specified. Three packets are sent to each hop, with the time for each sample displayed. Intermediate host names are also displayed.

pass:loc=1103:cmd="tracert www.remotedest.com -m 20"

```

Command entered at terminal #1.
;

  rlghncxa03w 04-07-27 08:32:34 EST  EAGLE5 31.6.0
PASS: Command sent to card
;

  rlghncxa03w 04-07-27 08:32:34 EST  EAGLE5 31.6.0

TRACEROUTE command in progress
;

  rlghncxa03w 04-07-27 08:32:34 EST  EAGLE5 31.6.0
;

  rlghncxa03w 04-07-27 08:32:34 EST  EAGLE5 31.6.0
Traceroute to www.remotedest.com (208.55.20.177),
      20 hops max, 100 byte packets
 1    5ms    5ms    5ms  216-187-242-57.ded.bttelecom.net (216.187.242.57)
 2   25ms   25ms   85ms  216-187-251-74.ded.bttelecom.net (216.187.251.74)
 3   25ms   25ms   25ms  bti-rdu-c1-rtr.bttelecom.net (208.216.228.254)
 4   30ms   25ms   25ms  Serial4-1-0.GW2.RDU1.ALTER.NET (157.130.34.93)
 5   35ms   35ms   40ms  178.ATM2-0.XR1.DCA1.ALTER.NET (146.188.162.50)
 6   40ms   40ms   35ms  195.at-2-0-0.XR1.DCA6.ALTER.NET (152.63.33.22)
 7   40ms   40ms   40ms  0.so-1-3-0.XL1.DCA6.ALTER.NET (152.63.35.114)
 8   40ms   40ms   40ms  POS6-0.BR3.DCA6.ALTER.NET (152.63.38.117)
 9   40ms   40ms   40ms  a3-0.uunet.mclnva02.us.bb.verio.net (204.255.169.90)
10   75ms   75ms   75ms  p16-0-0-0.r00.atlna03.us.bb.verio.net
(129.250.2.49)
11   95ms   95ms   95ms  p4-0-2-0.r01.bcrtfl01.us.bb.verio.net (129.250.4.54)
12   95ms   95ms   95ms  ge-1-1.r01.border.boca.verio.net (129.250.28.52)
13   95ms   95ms   95ms  ge-8-1.r01.edge.boca.verio.net (208.55.254.9)
14   95ms   95ms   95ms  www.remotedest.com (208.55.20.177)

TRACEROUTE command complete
;

```

The following example illustrates a **traceroute** request to host **www.remotedest.com**. No maximum number of hops has been specified. Intermediate host names are displayed. The display terminates after 10 hops.

pass:loc=1103:cmd="traceroute www.remotedest.com"

```

Command entered at terminal #1.
;

  rlghncxa03w 04-07-27 08:32:34 EST  EAGLE5 31.6.0
PASS: Command sent to card
;

  rlghncxa03w 04-07-27 08:32:34 EST  EAGLE5 31.6.0

TRACEROUTE command in progress
;

  rlghncxa03w 04-07-27 08:32:34 EST  EAGLE5 31.6.0
;

  rlghncxa03w 04-07-27 08:32:34 EST  EAGLE5 31.6.0
Traceroute to www.remotedest.com (208.55.20.177),
  10 hops max, 100 byte packets
 1   5ms   5ms   5ms 216-187-242-57.ded.btitelecom.net (216.187.242.57)
 2  25ms  25ms  25ms 216-187-251-74.ded.btitelecom.net (216.187.251.74)
 3  25ms  25ms  25ms bti-rdu-cl-rtr.btitelecom.net (208.216.228.254)
 4  25ms  25ms  25ms 157.130.34.93 (157.130.34.93)
 5  35ms  40ms  40ms 178.ATM2-0.XR1.DCA1.ALTER.NET (146.188.162.50)
 6  40ms  35ms  45ms 195.at-2-0-0.XR1.DCA6.ALTER.NET (152.63.33.22)
 7  45ms  40ms  40ms 0.so-1-3-0.XL1.DCA6.ALTER.NET (152.63.35.114)
 8  40ms  35ms  35ms POS6-0.BR3.DCA6.ALTER.NET (152.63.38.117)
 9  40ms  40ms  40ms a3-0.uunet.mclnva02.us.bb.verio.net (204.255.169.90)
10  75ms  75ms  80ms p16-0-0-0.r00.atlnga03.us.bb.verio.net (129.250.2.49)
Maximum number of hops reached

TRACEROUTE command complete
;

```

The following example illustrates a **traceroute** request to host IP address **208.55.20.177**. No maximum number of hops has been specified. Intermediate host names are displayed. The display terminates after 10 hops.

pass:loc=1103:cmd="traceroute 208.55.20.177"

```

Command entered at terminal #1.
;

  rlghncxa03w 04-07-27 08:32:34 EST  EAGLE5 31.6.0
PASS: Command sent to card
;

  rlghncxa03w 04-07-27 08:32:34 EST  EAGLE5 31.6.0

TRACEROUTE command in progress
;

```

```

rlghncxa03w 04-07-27 08:32:34 EST EAGLE5 31.6.0
Traceroute to www.remotedest.com (208.55.20.177),
  10 hops max, 100 byte packets
 1   5ms   5ms   5ms 216-187-242-57.ded.btitelecom.net (216.187.242.57)
 2  55ms  260ms 300ms 216-187-251-74.ded.btitelecom.net (216.187.251.74)
 3  25ms  25ms  25ms bti-rdu-cl-rtr.btitelecom.net (208.216.228.254)
 4  25ms  25ms  25ms Serial4-1-0.GW2.RDU1.ALTER.NET (157.130.34.93)
 5  40ms  35ms  35ms 178.ATM2-0.XR1.DCA1.ALTER.NET (146.188.162.50)
 6  40ms  35ms  40ms 195.at-2-0-0.XR1.DCA6.ALTER.NET (152.63.33.22)
 7  35ms  40ms  40ms 0.so-1-3-0.XL1.DCA6.ALTER.NET (152.63.35.114)
 8  40ms  35ms  40ms POS6-0.BR3.DCA6.ALTER.NET (152.63.38.117)
 9  40ms  40ms  40ms a3-0.uunet.mclnva02.us.bb.verio.net (204.255.169.90)
10  75ms  75ms  75ms p16-0-0-0.r00.atlna03.us.bb.verio.net (129.250.2.49)
)
Maximum number of hops reached

TRACEROUTE command complete
;

```

The following example illustrates a **tracert** request to host IP address **208.55.20.177**. A maximum of 20 hops has been specified. Intermediate host names are displayed.

pass:loc=1103:cmd="tracert 208.55.20.177 -m 20"

```

Command entered at terminal #1.
;

rlghncxa03w 04-07-27 08:32:34 EST EAGLE5 31.6.0
PASS: Command sent to card
;

rlghncxa03w 04-07-27 08:32:34 EST EAGLE5 31.6.0

TRACEROUTE command in progress
;

rlghncxa03w 04-07-27 08:32:34 EST EAGLE5 31.6.0
;

rlghncxa03w 05-07-27 08:32:34 EST EAGLE5 31.6.0
Traceroute to www.remotedest.com (208.55.20.177),
  20 hops max, 100 byte packets
 1   5ms   5ms   5ms 216-187-242-57.ded.btitelecom.net (216.187.242.57)
 2  25ms  25ms  25ms 216-187-251-74.ded.btitelecom.net (216.187.251.74)
 3  25ms  25ms  25ms bti-rdu-cl-rtr.btitelecom.net (208.216.228.254)
 4  25ms  25ms  25ms Serial4-1-0.GW2.RDU1.ALTER.NET (157.130.34.93)
 5  35ms  35ms  35ms 178.ATM2-0.XR1.DCA1.ALTER.NET (146.188.162.50)
 6  35ms  40ms  35ms 195.at-2-0-0.XR1.DCA6.ALTER.NET (152.63.33.22)
 7  35ms  35ms  35ms 0.so-1-3-0.XL1.DCA6.ALTER.NET (152.63.35.114)
 8  40ms  35ms  35ms POS6-0.BR3.DCA6.ALTER.NET (152.63.38.117)
 9  40ms  40ms  40ms a3-0.uunet.mclnva02.us.bb.verio.net (204.255.169.90)
10  75ms  75ms  75ms p16-0-0-0.r00.atlna03.us.bb.verio.net (129.250.2.49)
11  95ms  95ms  95ms p4-0-2-0.r01.bcrtf101.us.bb.verio.net (129.250.4.54)
12  95ms  95ms  95ms ge-1-1.r01.border.boca.verio.net (129.250.28.52)
13  95ms  95ms  95ms ge-8-1.r01.edge.boca.verio.net (208.55.254.9)
14  95ms  95ms  95ms www.remotedest.com (208.55.20.177)

TRACEROUTE command complete
;

```

The following example illustrates a **traceroute** request to host IP address **208.55.20.177**. A maximum of 20 hops has been specified. Intermediate host names are not displayed because the **-n** option is specified.

pass:loc=1103:cmd="traceroute 208.55.20.177 -m 20 -n"

```
Command entered at terminal #1.
;
  rlghncxa03w 04-07-27 08:32:34 EST  EAGLE5 31.6.0
PASS: Command sent to card
;

  rlghncxa03w 04-07-27 08:32:34 EST  EAGLE5 31.6.0

TRACEROUTE command in progress
;

  rlghncxa03w 04-07-27 08:32:34 EST  EAGLE5 31.6.0

;

  rlghncxa03w 04-07-27 08:32:34 EST  EAGLE5 31.6.0
Traceroute to www.remotedest.com (208.55.20.177),
  20 hops max, 100 byte packets
 1   5ms   5ms   5ms 216.187.242.57
 2  25ms  25ms  25ms 216.187.251.74
 3  25ms  25ms  25ms 208.216.228.254
 4  30ms  30ms  30ms 157.130.34.93
 5  35ms  40ms  40ms 146.188.162.50
 6  40ms  40ms  40ms 152.63.33.22
 7  40ms  45ms  40ms 152.63.35.114
 8  40ms  40ms  35ms 152.63.38.117
 9  40ms  40ms  40ms 204.255.169.90
10  75ms  75ms  75ms 129.250.2.49
11  95ms  95ms  95ms 129.250.4.54
12  95ms  95ms  95ms 129.250.28.52
13  95ms  95ms  95ms 208.55.254.9
14 110ms 100ms  95ms 208.55.20.177

TRACEROUTE command complete
;
```

The following example illustrates a **traceroute** request to host IP address **www.remotedest.com**. A maximum of 20 hops has been specified. Intermediate host names are not displayed because the **-n** option is specified.

pass:loc=1103:cmd="traceroute www.remotedest.com -m 20 -n"

```
Command entered at terminal #1.
;
  rlghncxa03w 04-07-27 08:32:34 EST  EAGLE5 31.6.0
PASS: Command sent to card
;

  rlghncxa03w 04-07-27 08:32:34 EST  EAGLE5 31.6.0

TRACEROUTE command in progress
;

  rlghncxa03w 04-07-27 08:32:34 EST  EAGLE5 31.6.0

;
```

```

rlghncxa03w 05-07-27 08:32:34 EST EAGLE5 31.6.0
Traceroute to www.remotedest.com (208.55.20.177),
  20 hops max, 100 byte packets
 1   5ms   5ms   5ms 216.187.242.57
 2  25ms  25ms  25ms 216.187.251.74
 3  25ms  25ms  25ms 208.216.228.254
 4  30ms  30ms  30ms 157.130.34.93
 5  35ms  40ms  40ms 146.188.162.50
 6  40ms  40ms  40ms 152.63.33.22
 7  40ms  45ms  40ms 152.63.35.114
 8  40ms  40ms  35ms 152.63.38.117
 9  40ms  40ms  40ms 204.255.169.90
10  75ms  75ms  75ms 129.250.2.49
11  95ms  95ms  95ms 129.250.4.54
12  95ms  95ms  95ms 129.250.28.52
13  95ms  95ms  95ms 208.55.254.9
14 110ms 100ms  95ms 208.55.20.177

```

TRACEROUTE command complete

The following example illustrates a **tracert** request to host IP address **208.55.20.177**. A maximum of 20 hops has been specified. Intermediate host names are displayed. Application Port 40000 is used.

pass:loc=1103:cmd="tracert 208.55.20.177 -m 20 -p 40000"

```

Command entered at terminal #1.
;

rlghncxa03w 04-07-27 08:32:34 EST EAGLE5 31.6.0
PASS: Command sent to card
;

rlghncxa03w 04-07-27 08:32:34 EST EAGLE5 31.6.0

TRACEROUTE command in progress
;

rlghncxa03w 04-07-27 08:32:34 EST EAGLE5 31.6.0
;

rlghncxa03w 04-07-27 08:32:34 EST EAGLE5 31.6.0
Traceroute to www.remotedest.com (208.55.20.177),
  20 hops max, 100 byte packets
 1   5ms   5ms   5ms 216-187-242-57.ded.btitelecom.net (216.187.242.57)
 2  25ms  25ms  25ms 216-187-251-74.ded.btitelecom.net (216.187.251.74)
 3  25ms  25ms  25ms 208.216.228.254 (208.216.228.254)
 4  25ms  25ms  25ms 157.130.34.93 (157.130.34.93)
 5  35ms  40ms  40ms 178.ATM2-0.XR1.DCA1.ALTER.NET (146.188.162.50)
 6  45ms  35ms  40ms 195.at-2-0-0.XR1.DCA6.ALTER.NET (152.63.33.22)
 7  35ms  40ms  40ms 0.so-1-3-0.XL1.DCA6.ALTER.NET (152.63.35.114)
 8  40ms  35ms  40ms POS6-0.BR3.DCA6.ALTER.NET (152.63.38.117)
 9  40ms  40ms  40ms a3-0.uunet.mclnva02.us.bb.verio.net (204.255.169.90)
10  75ms  75ms  75ms p16-0-0-0.r00.atlnga03.us.bb.verio.net (129.250.2.49)
11  95ms  95ms  95ms p4-0-2-0.r01.bcrftl01.us.bb.verio.net (129.250.4.54)
12  95ms  95ms  95ms ge-1-1.r01.border.boca.verio.net (129.250.28.52)
13  95ms  95ms  95ms ge-8-1.r01.edge.boca.verio.net (208.55.254.9)
14  95ms  95ms  95ms www.remotedest.com (208.55.20.177)

TRACEROUTE command complete
;

```

The following example illustrates a traceroute request to host IP address 204.202.136.31. A maximum of 20 hops has been specified. Intermediate host names are displayed. Several timeouts occur. Finally, an ICMP error is received (in this case, an unknown response with an ICMP code = 13), and the command is terminated immediately.

pass:loc=1103:cmd="traceroute 204.202.136.31 -m 20"

```

Command entered at terminal #1.
;

  rlghncxa03w 04-07-27 08:32:34 EST  EAGLE5 31.6.0
PASS: Command sent to card
;

  rlghncxa03w 04-07-27 08:32:34 EST  EAGLE5 31.6.0

TRACEROUTE command in progress
;

  rlghncxa03w 04-07-27 08:32:34 EST  EAGLE5 31.6.0
;

  rlghncxa03w 04-07-27 08:32:34 EST  EAGLE 31.6.0
Traceroute to 204.202.136.31 (204.202.136.31),
  20 hops max, 100 byte packets
 1   5ms   5ms   5ms 216-187-242-57.ded.btitelecom.net (216.187.242.57)
 2  25ms  25ms  25ms 216-187-251-74.ded.btitelecom.net (216.187.251.74)
 3  25ms  25ms  25ms bti-rdu-c1-rtr.btitelecom.net (208.216.228.254)
 4  25ms  25ms  25ms Serial4-1-0.GW2.RDU1.ALTER.NET (157.130.34.93)
 5  35ms  40ms  35ms 178.ATM2-0.XR1.DCA1.ALTER.NET (146.188.162.50)
 6  40ms  35ms  35ms 195.at-1-0-0.TR1.DCA6.ALTER.NET (152.63.33.206)
 7  110ms 115ms 115ms 121.at-1-1-0.TR1.SEA1.ALTER.NET (146.188.140.74)
 8  110ms 115ms 115ms 299.ATM7-0.XR1.SEA1.ALTER.NET (146.188.200.109)
 9  115ms 115ms 115ms 195.ATM5-0.GW5.SEA1.ALTER.NET (146.188.201.57)
10  110ms 110ms 110ms waltdisney1-OC12-gw.customer.alter.net (157.130.182.30)
11  110ms 115ms 110ms 204.202.138.71 (204.202.138.71)
12  *      *      *      Request timed out
13  !?13          Unreachable

TRACEROUTE command complete
;

```

ualog

User Adapter Log

Use this command to report on the user adapter (UA) state machine history for a specified association name. State machine history is kept in a circular buffer in memory. The **-i** and **-x** options are used to include or exclude groups of events from the state machine history.

Command Name: ualog

Command Class: Application Maintenance

Options

Options and option parameters that are underlined indicate that a value must be specified for that option or parameter. For example, the **ualog** command has the parameter aname. The association name must be specified for which the user adapter log will be displayed, as in the command **ualog s7000**. Do not enter the underlined option or parameter; enter a value for the information represented by the underlined option or parameter.

aname

This option specifies the association name for the display.

-h

This option displays help (usage) information for the command.

-i event group

This option includes groups of events in the state machine history.

Range: service, ua

-x event group

This option excludes groups of events from the state machine history.

Range: service, ua

Example

```
pass:loc=1105:cmd="ualog s7000"
```

Dependencies

None

Notes

None

Output

```
pass:loc=1105:cmd="ualog s7000"
```

```

    rlgncxa03w 05-07-27 08:10:00 EST  EAGLE5 34.0.0
    PASS: Command sent to card
;
    rlgncxa03w 05-07-27 08:10:00 EST  EAGLE5 34.0.0
    UALOG command in progress
;
    rlgncxa03w 05-07-27 08:10:00 EST  EAGLE5 34.0.0
    Date      Time      ASP Event
    -----
    05-07-27  17:17:46.940  Management Socket Open
    05-07-27  17:17:46.940  Transition to Connecting
    05-07-27  17:17:47.500  Socket Allowed for Traffic
    05-07-27  17:17:49.375  Socket Connection Established
    05-07-27  17:17:49.375  Transition to ASP-DOWN
    05-07-27  17:17:49.390  ASPUP PDU Received (ASP ID = 0x00000002)
    05-07-27  17:17:49.390  ASPUPACK PDU Transmitted
    05-07-27  17:17:49.390  Transition to ASP-INACTIVE LOADSHARE (RC=none)
    05-07-27  17:17:49.390  AS INACTIVE NTFY PDU Transmitted (RC=none)
    05-07-27  17:17:49.405  ASPACTIVE PDU Received (RC=none)
    05-07-27  17:17:49.405  ASPACTIVEACK PDU Transmitted (RC=none)
    05-07-27  17:17:49.405  Transition to ASP-ACTIVE LOADSHARE (RC=none)
    05-07-27  17:17:49.405  AS ACTIVE NTFY PDU Transmitted (RC=none)
    05-07-27  17:17:50.405  ASP INACT NTFY PDU Transmitted (ASP ID = 0x00000005)
    05-07-27  17:17:50.405  ASP ACT NTFY PDU Transmitted (ASP ID = 0x00000005)
    05-07-27  17:17:52.730  ASP FAILURE NFY PDU Transmitted (ASP ID = 0x00000003)

    UALOG command complete
;
pass:loc=1105:cmd="ualog s7000"
Command Accepted - Processing

    rlgncxa03w 05-07-27 08:10:00 EST  EAGLE5 34.0.0
    pass:loc=1105:cmd="ualog s7000"
```

```

;

rlghncxa03w 05-07-27 08:10:00 EST EAGLE5 34.0.0
PASS: Command sent to card
;

rlghncxa03w 05-07-27 08:10:00 EST EAGLE5 34.0.0

UALOG command in progress

;

rlghncxa03w 05-07-27 08:10:00 EST EAGLE5 34.0.0

UALOG: User Adapter state history log
      UA Version: 01
      ASP ID: 0x00000007
      User Adapter Implemented: SUA RFC
      Current settings: -i service ua

Date       Time           Event
-----
05-07-27  19:45:33.265    CLDT PDU Transmitted(RC=0000000001)
05-07-27  19:48:07.490    ASPINACTIVE PDU Received(RC=none)
05-07-27  19:48:07.490    ASPINACTIVEACK PDU Transmitted(RC=0000000002)
05-07-27  19:48:07.490    Transition to ASP-INACTIVE LOADSHARE(RC=0000000002)
05-07-27  19:48:07.490    AS PENDING NTFY PDU Transmitted(RC=0000000002)
05-07-27  19:48:07.500    AS INACTIVE NTFY PDU Transmitted(RC=0000000002)
05-07-27  19:48:19.730    ASPACTIVE PDU Received(RC=0000000001)
05-07-27  19:48:19.730    ASPACTIVEACK PDU Transmitted(RC=0000000001)
05-07-27  19:48:19.730    Transition to ASP-ACTIVE LOADSHARE(RC=0000000001)
05-07-27  19:48:19.730    AS ACTIVE NTFY PDU Transmitted(RC=0000000001)

UALOG: command complete

;

```

When a M3UA or SUA PDU is received that contains one or more errors, a response error message is transmitted containing an error code. Error codes are recorded to and displayed in the UALOG only when the UA peer-to-peer message logging option is enabled (-i ua), as shown in the following example.:

pass:loc=1315:cmd="ualog assoc1315a1"

Command Accepted - Processing

```

rlghncxa03w 05-07-27 08:10:00 EST  EAGLE5 34.0.0
pass:loc=1315:cmd="ualog assoc1315a1"
Command entered at terminal #3.
;

rlghncxa03w 05-07-27 08:10:00 EST  EAGLE5 34.0.0
PASS: Command sent to card
;

rlghncxa03w 05-07-27 08:10:00 EST  EAGLE5 34.0.0

UALOG command in progress
;

rlghncxa03w 05-07-27 08:10:00 EST  EAGLE5 34.0.0

UALOG: User Adapter state history log
      UA Version: 01
      ASP ID:undefined
      User Adapter Implemented: M3UA RFC
      Current settings: -i service ua

Date          Time          Socket Event
-----
05-07-27 17:17:46.940  Management Socket Open
05-07-27 17:17:46.940  Transition to Connecting
05-07-27 17:17:49.375  Socket Connection Established
05-07-27 17:17:49.375  Transition to ASP-DOWN
05-07-27 17:17:49.390  ASPUP PDU Received (ASP ID = undefined)
05-07-27 17:17:49.390  ASPUPACK PDU Transmitted
05-07-27 17:17:49.390  Transition to ASP-INACTIVE LOADSHARE
05-07-27 17:17:49.390  AS INACTIVE NTFY PDU Transmitted
05-07-27 17:17:49.405  ASPACTIVE PDU Received
05-07-27 17:17:49.405  ASPACTIVEACK PDU Transmitted
05-07-27 17:17:49.405  Transition to ASP-ACTIVE LOADSHARE
05-07-27 17:17:49.405  AS ACTIVE NTFY PDU Transmitted
05-07-27 17:17:49.450  DAUD PDU Received
05-07-27 17:17:49.480  ERR PDU Transmitted (0x00000015)

UALOG command complete
;

```

Error Codes

NOTE: The following error codes are not used in M3UA: 0x02, 0x08, 0x1a, 0x1b, 0x1c, 0x10, 0x17, and 0x18

The following error codes can appear in the error messages:

0x01—Invalid Version

A message was received with an invalid or unsupported version. The error message contains the supported version in the Common Header.

0x03—Unsupported Message Class

A message was received with an unexpected or unsupported Message Class.

0x04—Unsupported Message Type

A message was received with an unexpected or unsupported Message Type.

0x05—Unsupported Traffic Handling Mode

This error is sent by a Signaling Gateway Process (SGP) if an Application Server Process (ASP) sends an ASP Active message with an unsupported Traffic Mode Type or a Traffic Mode Type that is inconsistent with the currently configured mode for the Application Server (AS).

0x06—Unexpected Message

This error message can be sent if a defined and recognized message is received that is not expected in the current state. In some cases the ASP might silently discard the message and not send an error message. Silent discard is used by an ASP if it received a DATA message from a signaling point while the ASP is in the ASP-INACTIVE state. If the unexpected message contains Routing Context, the Routing Context can be included in the error message.

0x07—Protocol Error

This error message is sent for any protocol anomaly, such as reception of a parameter that is syntactically correct but unexpected in the current situation.

0x09—Invalid Stream Identifier

A message is received on an unexpected SCTP stream (for example, a Management message was received on a stream other than 0).

0x0d—Refused - Management Blocking

An ASP Up or ASP Active message is received and the request is refused for management reasons (such as management lockout). If this error is in response to an ASP Active message, the Routing Context in the ASP Active message can be included in the error message.

0x0e—ASP Identifier Required

This error message is sent by an SGP in response to an ASP Up message that does not contain an ASP Identifier parameter when the SGP requires one. The ASP should resend the ASP Up message with an ASP Identifier.

0x0f—Invalid ASP Identifier

This error message is sent by an SGP in response to an ASP Up message with an invalid (for example, non-unique) ASP Identifier

0x11—Invalid Parameter Value

A message is received with an invalid parameter value (for example, a DUPU message was received with a Mask value other than 0).

0x12—Parameter Field Error

A message is received with a parameter that has a wrong length field.

0x13—Unexpected Parameter

A message contains an invalid parameter.

0x14—Destination Status Unknown

This error message can be sent if a DAUD is received at a Signaling Gateway (SG) asking for the availability/congestion status of a destination, and the SG does not provide the status (as in the case when the sender is not authorized to know the status). For this error, each invalid or unauthorized Point Code is included along with the Network Appearance and/or Routing Context associated with the Point Code.

0x15—Invalid Network Appearance

This error message is sent by an SGP if an ASP sends a message with an invalid (unconfigured) Network Appearance value. For this error, the invalid (unconfigured) Network Appearance is included in the Network Appearance parameter.

0x16—Missing Parameter

A message is received, and a mandatory parameter is not included in the message.

0x19—Invalid Routing Context

A message is received from a peer with an invalid (unconfigured) Routing Context value. The invalid Routing Context is included in the error message.

0x1a—No Configured AS for ASP

A message is received from a peer without a Routing Context parameter, and it is not known by configuration data which Application Servers are referenced.

A

Reference Information

Summary of Range Values for :link Parameter	A-2
Possible Values for PST/SST/AST	A-3
Point Code Formats and Conversion	A-6
ANSI Point Codes	A-6
ITU International Point Codes	A-9
ITU National Point Codes	A-9
Converting ITU National Point Code Formats	A-10
24-bit ITU-National Point Codes	A-12
Valid CIC Ranges for SI and MSU Types	A-15
NAIV/NAI Mapping	A-15
NPV/NP Mapping	A-16
Summary of Loopback Testing Commands and Functions	A-17
Tekelec-defined ISUP Normalization Variants	A-22

Summary of Range Values for :link Parameter

Table A-1 lists the valid **link** parameter range values signaling links assigned to each type of card for which a location can be specified in the command **loc** parameter. The commands that use these values refer to this table in their **link** parameter description.

NOTE: The link parameter is a synonym for the port parameter in signaling link definitions for a few EAGLE 5 SAS releases. Then the port parameter will be removed.

Table A-1. Summary of Ranges for **link** Parameter

Card	Link	Supported Application
Two-port LIM	A	All supported link applications. The two-port LIM supports the DS0 , OCU , V35 , ATM , E1 ATM , or E1 interface.
Two-port LIM	B	All supported link applications except ss7gx25 (X.25 signaling link), atmansi (ATM high-speed signaling link), atmitu (E1 ATM high-speed signaling link), or ss7ipgw and ipgwi (IP signaling link). The iplim and iplimi applications support sockets, M3UA/SCTP associations, or M2PA/SCTP associations on ports on dual-slot DCMs.
Multi-port LIM	A, B, A1, B1, A2, B2, A3, B3	The ss7ml GPL with DS0 interface at 56 Kb running the ss7ansi application only.
E1/T1 MIM	A, B, A1, B1, A2, B2, A3, B3	The ss7ml GPL running the ss7ansi or ccs7itu application.
IPLIMx with 8 Points (SSEDCM)	A, B, A1, B1, A2, B2, A3, B3	The iplim and iplimi GPLs running the iplim and iplimi applications with sockets, M2PA/SCTP associations, or M3UA/SCTP associations.
HC-MIM	A, B, A1-A31, B1-B31	Runs the ss7ansi or ccs7itu application. A maximum of 64 links can be assigned to each HC-MIM card.
HC-MIM for SE-HSL	A, B	Runs the ss7ansi or ccs7itu application.

Possible Values for PST/SST/AST

This section lists the possible values for the primary state (PST), secondary state (SST), and associated state (AST) shown in the output of Report Status (rept-stat-) and Retrieve (rtrv-) commands.

Status can apply to the following types of entities (not all values are possible for every entity type):

card	terminal port
clock	serial port
cluster	but
TCP/IP data link	signaling link
subsystem	linkset
EPAP/ELAP	ACM

PST

Primary state possible values are the following:

IS-ANR—(In Service - Abnormal) The entity is in service but only able to perform a limited subset of its normal service functions.

IS-NR—(In Service - Normal) The entity is in service and handling all its normal service functions.

OOS-MA—(Out Of Service - Memory Administration) The entity is out of service because it has not been equipped.

OOS-MT—(Out Of Service - Maintenance) The entity is out of service and is not available to perform its normal service function. The maintenance system is actively working to restore the entity to service.

OOS-MT-DSBLD—(Out Of Service - Maintenance -Disabled) The entity is out of service and the maintenance system is preventing the entity from performing its normal service function.

SST

Secondary state possible values are the following:

ACTIVE—(Active) The entity is currently in use and is handling its normal service function as the primary service provider.

(Master) The entity is currently in a master state in relation to its redundant unit.

ALLOWED—(Allowed) The entity is handling its normal service function.

AVAIL—(Available) Entity service is available to another entity.

BLOCKED—(Blocked) The entity has been manually prohibited from handling traffic.

BUSY—(Busy) The entity is handling the maximum traffic capacity and has no spare capacity for new service requests.

- CONN**—(Connect) The card's entity status is in connected state.
- DISC**—(Disconnect) The card's entity status is in disconnected state.
- FAULT**—(Fault) The entity has failed.
- IDLE**—(Idle) The entity is in use and has spare capacity for service.
For a telnet terminal, this indicates a "ready for connection" status.
- INHIBITED**—(Inhibited) The entity has been manually prevented from performing its normal service function.
- ISOLATED**—(Isolated) The entity cannot be detected through software or hardware.
- MANUAL**—(Manual) The entity has manually been removed from service and is not carrying any traffic.
- OVFLW-1**—(Overflow) One entity cannot provide service to another entity due to service denial.
- PROHIBIT**—(Prohibited) The entity is not handling traffic because of a failure in the network.
- RESTRICT**—(Restricted) The traffic the entity is handling is restricted. The normal capacity or configuration is not being used because of a failure in the network. The normal capacity, functionality or configuration of an entity may be restricted during loading or synching of data. This can occur when the Measurements Platform has not yet been enabled.
- STANDBY**—(Standby) The entity is currently in use and is handling its normal service function as an alternate service provider if the primary service provider failed. For an IPSM card, Standby is the state just prior to Ready, while the card completes initializations.
- STANDBY**—(Slave) The entity is currently in a slave state in relation to its redundant unit.
- TEST**—(Test) The entity is currently in a test state.
- UNAVAIL**—(Unavailable) Entity service is unavailable to another entity.
- UEQ**—(Unequipped) The entity is not equipped.
- UNBLOCKED**—(Unblocked) The entity is handling its normal service function.

AST

Associated state possible values are the following:

- (Blank)—The field may be left blank.
- ACCESS**—(Accessible) Traffic is being carried between the local entity and an adjacent, or remote, service provider. A full connection has been completed.
- ACTIVE**—(Active) The entity is currently in use and is handling its normal service function as the primary service provider. (This appears as an AST for the MPS when there is an alarm on it).
- ALMINH**—(Alarm Inhibited) The alarm has been inhibited.
- BIP ERROR**—(Board Identity Prom) The entity has both daughterboard and motherboard prom error.

- DB DIFF**—(Database Different) The entity has a database difference.
- D BIP ERR**—(Daughterboard Identity Prom) The entity has a daughterboard prom error.
- ENET FLT**—(Ethernet fault) An Ethernet fault exists.
- GWS**—(Gateway Screening) Linkset has gateway screening. See the “**rept-stat-ls**” command.
- INACCESS**—(Inaccessible) Traffic is not being carried from the local entity to another service provider. A breakdown in a complete circuit has been detected.
- LOCAL**—(Local) Entity has become locally isolated.
- M BIP ERR**—(Motherboard Identity Prom) The entity has a motherboard prom error.
- MPS UNAVL**—The DSM card cannot communicate to an MPS.
- STANDBY**—(Standby) The entity is currently in use and is handling its normal service function as an alternate service provider if the primary service provider failed. (This appears as an AST for the MPS when there is an alarm on it).
- XX%**—(Progress indicator for cards that are performing a warm restart and are currently data loading. Shows the percentage of tables that have been downloaded for GPLs that support a persistent LNP database (**sccp, ebdablm**)).

Point Code Formats and Conversion

Many of the commands used for database configuration use point codes. This section describes the point code formats that the system supports. If you need additional information or procedural information, refer to the *Database Administration Manual - SS7*.

The system supports four different point code formats:

- ANSI point codes
- ITU International point codes
- ITU National point codes
- ITU National 24-bit point codes

Each format is described in further detail in the following sections.

ANSI Point Codes

ANSI point codes are made up of three groups of digits called the network indicator (*ni*), network cluster (*nc*), and network cluster member (*ncm*). The values for ANSI point codes depend on the value of the **pctype** parameter of the **chg-sid** command, either **ansi** or **other**.

If the **chg-sid:pctype** parameter is set to **ansi**, the range of values for an ANSI point code is as follows:

ni—**001-255**
nc—**001-255** (if *ni* = **001-005**)
 —**000-255, *** (if *ni* = **006-255**)
ncm—**000-255**

The following rules apply to provisioning ANSI point codes if the **chg-sid:pctype=ansi** parameter is specified:

- An *ni* value of **0** is not allowed (for example, **dpc=0-1-1** and **dpc=0-0-0** are not valid point codes).
- If the *ni* value is **1, 2, 3, 4, or 5**, then the *nc* value cannot be **0** (for example, **dpc=5-0-1** is rejected).
- If the *ni* value is **1, 2, 3, 4, or 5**, then network routing point codes are not allowed (for example, **dpc=4-**-*** is rejected).

If the **chg-sid:pctype** parameter is set to **other**, the ANSI point codes do not meet ANSI standards. The range of values for these ANSI point codes is as follows:

ni—**000-255**
nc—**000-255, ***
ncm—**000-255, ***

The following rules apply to provisioning ANSI point code if the **chg-sid:pctype=other** parameter is specified:

- An *ni* value of **0** is allowed, however **dpc=0-0-0** is rejected (for example, **dpc=0-1-1** is accepted).
- The *nc* value can be **0** for all values of *ni* (for example, **dpc=5-0-1** is accepted).
- Network routing point codes are allowed for all values of *ni* (for example, **dpc=4-*-*** is accepted).

An ANSI point code containing all zeros (**0-0-0**) is not a valid point code and cannot be entered into the database.

ANSI point codes support the Private (Internal) Point Code subtype prefix (**p-**). The prefix can be specified before the point code subfield values to indicate a Private Point Code (**p-5-0-1**, for example). See “Spare and Private Point Code Subtype Prefixes” on page A-12.

NOTE: Point codes specified by many commands, including those for site identification, routing keys, and LNP, are required to be full point codes. The asterisk values are not valid in the commands that specify these point codes. The command Dependencies sections identify the point codes that must be full point codes in the commands.

A range of values for a subfield is specified by separating the values that define the range by two ampersands (**&&**); for example, **ni=025&&100** specifies all network indicators for ANSI point codes from **25** through **100**.

The asterisk (*) point code value indicates a single cluster address for a cluster point code (for example, **20-2-***) or a network routing destination (**21-*-***). If * is used for the *nc* subfield, then * must be also be used for the *ncm* subfield.

A double asterisk (**) and triple asterisk (***) can also be used for the *nc* and *ncm* subfields of the ANSI point code, but only for the **rtrv-dstn**, **rept-stat-dstn**, and **rept-stat-rte** commands. If *, **, or *** is used for the *nc* subfield, then *, **, or *** must be also be used for the *ncm* field

A double asterisk in the *nc* subfield of a network routing point code produces a summary report that shows all point code destinations that are members of the given network (**21**-***). This does not include the specified network routing point code. The following example shows a report generated using two asterisks in the *nc* field of a network routing point code.

```
rtrv-dstn:dPCA=21**-*
rlghncxa03w 04-02-30 21:16:37 GMT EAGLE5 31.8.0
DPCI          CLLI          BEI  ELEI  ALIASA          ALIASN/N24          DOMAIN
021-002-045   rlghncbb101 no   ---  -----  -----  SS7
021-002-050   rlghncbb101 no   ---  -----  -----  SS7

          SPC          NCAI
          -----  no

Destination table is (11 of 2000) 1% full
Alias table is (4 of 12000) 1% full
RTRV-DSTN: MASP A - COMPLTD
;
```

A double asterisk in the *ncm* subfield of a cluster point code produces a summary report that shows all point code destinations residing in the given cluster (20-2-**). This does not include the specified cluster point code. The following example shows a report generated using two asterisks in the *ncm* subfield of a cluster point code.

rtrv-dstn:dpca=20-2-**

```
rlghncxa03w 04-02-30 21:16:37 GMT EAGLE5 31.8.0
DPCI          CLLI          BEI  ELEI  ALIASA          ALIASN/N24  DOMAIN
020-002-045   rlghncbb100 no   ---  -----  -----  SS7
020-002-050   rlghncbb100 no   ---  -----  -----  SS7
```

```
SPC          NCAI
-----  no
```

```
Destination table is (11 of 2000) 1% full
Alias table is (4 of 12000) 1% full
RTRV-DSTN: MASP A - COMPLTD
```

;

Three asterisks in the *ncm* subfield of a cluster point code produces a summary report that shows all point code destinations residing in the given network cluster along with the specified cluster point code. The following example shows a report generated using three asterisks in the *ncm* subfield of a cluster point code.

rtrv-dstn:dpca=20-2-***

```
rlghncxa03w 04-02-30 21:16:37 GMT EAGLE5 31.8.0
DPCI          CLLI          BEI  ELEI  ALIASA          ALIASN/N24  DOMAIN
020-002-*     rlghncbb000 no   ---  -----  -----  SS7
020-002-045   rlghncbb100 no   ---  -----  -----  SS7
020-002-050   rlghncbb100 no   ---  -----  -----  SS7
```

```
SPC          NCAI
-----  no
```

```
Destination table is (11 of 2000) 1% full
Alias table is (4 of 12000) 1% full
RTRV-DSTN: MASP A - COMPLTD
```

;

Three asterisks in the *nc* subfield of the point code produces a summary report that shows all point code destinations residing in the given network along with the specified network routing point code. The following example shows a report generated using three asterisks in the *nc* subfield of a network routing point code.

rtrv-dstn:dpca=21-*-***

```
rlghncxa03w 04-02-30 21:16:37 GMT EAGLE5 31.8.0
DPCA          CLLI          BEI  ELEI  ALIASI  ALIASN  DOMAIN
021-*-*      rlghncbb001 yes  yes  -----  -----  SS7
021-002-045  rlghncbb101 no   ---  -----  -----  SS7
021-002-050  rlghncbb101 no   ---  -----  -----  SS7
```

```
SPC          NCAI
-----  no
```

```
Destination table is (11 of 2000) 1% full
Alias table is (4 of 12000) 1% full
RTRV-DSTN: MASP A - COMPLTD
```

;

ITU International Point Codes

The ITU international point codes are made up of three groups of digits called *zone*, *area*, and *id*. The range of values for ITU International point codes are:

zone—0-7

area—000-255

id—0-7

An ITU international point code containing all zeros (**0-000-0**) is not a valid point code and cannot be entered into the database.

ITU international point codes support the Spare Point Code subtype prefix (s-). The prefix can be specified before the point code subfield values to indicate a Spare Point Code (**s-5-222-1**, for example). See “Spare and Private Point Code Subtype Prefixes” on page A-12.

ITU National Point Codes

The ITU national point code is a 14-bit integer. The point codes can be a single number up to five digits, or two, three, or four numbers separated by dashes.

npcfnti=7-7-0-0, npcfnti=0-6-8-0

The following ranges of values are valid:

nnnnn—0-16383

nnnnn-gc—0-16363; group code is *aa-zz* (the ITUDUPPC feature must be on)

m1-m2-m3-m4—Each member represents the number of bits allowed in the corresponding position for a flexible ITU national point code. The range of each member is from **0** to **14**. Each member must be specified; the member value of **0** indicates that the position is not specified in the flexible point code. The sum of the member values must equal 14.

m1-m2-m3-m4-gc—Each member represents the number of bits allowed in the corresponding position for a flexible ITU national point code. The range of each member is from **0** to **14**. Each member must be specified; the member value of **0** indicates that the position is not specified in the flexible point code. The sum of the member values must equal 14. Group code is *aa-zz* (the ITUDUPPC feature must be on).

If the ITU National Duplicate Point Code (ITUDUPPC) feature is on, ITU national point codes can have group codes assigned to them. The point code is a 1- to 5-digit number. The group code is a two-character field ranging from **aa** to **zz** that is entered as the last subfield of the point code and is separated by a dash from the rest of the point code. An example is **12345-az**.

If the flexible point codes option is enabled (see the “chg-stpopts” command, **:npcfnti** parameter), an ITU national point code format consists of 2, 3, or 4 numbers separated by dashes (formatted as *m1-m2-m3-m4*). When the ITUDUPPC feature is also on, the format is *m1-m2-m3-m4-gc* with a group code. If one of the *m1*, *m2*, *m3*, *m4* members is set to zero bits, no value is entered for that position in the point code. For example, if the **npcfnti** parameter value is set to **3-8-3-0**, valid point codes would be **1-100-1-aa** with a group code, or **7-255-7** with no group code. See the tables in the **chg-stpopts** command description for valid member values and additional examples.

ITU national point codes support the Spare Point Code subtype prefix (s-). The prefix can be specified before the point code subfield values to indicate a Spare Point Code (s-12345 or s-1-3-5-5-gc, for example). See “Spare and Private Point Code Subtype Prefixes” on page A-12.

Converting ITU National Point Code Formats

Introduction

Gateway screening only allows ITU national point codes to be provisioned in the database by the enter, delete, or change gateway screening commands, and displayed by the gateway screening retrieve commands as a single number. If a format other than a single number (14-0-0-0) for the ITU national point code has been defined by the **npcfnti** parameter of the **chg-stpopts** command, the ITU national point code must be converted into a single number so that it can be used by gateway screening.

For example, the format of the ITU national point code is 4-4-4-2 and you would like to add point code 7-7-7-1 into the allowed OPC screen. The point code 7-7-7-1 would have to be converted to a single number so that the point code can be added to the allowed OPC screen. To determine what multiple-part ITU national point code is represented by the single number ITU national point code in the gateway screening table, the single number point code must be converted to a multiple-part point code.

To convert a single number ITU national point code to a multiple-part point code, go to “Converting Single Number ITU National Point Codes” on page A-10.

To convert a multiple-part ITU national point code to a single number point code, go to “Converting Multiple-Part ITU National Point Codes” on page A-11.

For a definition of the different formats that can be used for ITU national point codes, see “ITU National Point Codes” on page A-9.

Converting Single Number ITU National Point Codes

To convert a single number ITU national point code to a multiple-part ITU national point code, perform these steps.

To make this conversion, you will need to know the format of the ITU national point code. This can be verified in the NPCFMTI field of the **rtrv-stpopts** command output. For this example, the ITU national point codes **14781** and **695** are converted to point codes using the **3-8-3-0** format.

1. Convert the point code to a binary number. This can be done with most scientific calculators.

The number 14781 converts to the binary number 11100110111101.

The number 695 converts to the binary number 1010110111.

NOTE: Make sure the binary number contains 14 digits. If it does not, add leading zeros to the binary number to bring the total number of digits in the number to 14.

In this example, the binary equivalent for the decimal number 695 (1010110111) contains 10 digits; four zeros must be added to the beginning of the binary number. The resulting binary number is now 00001010110111.

2. Divide the binary number into the number of parts required by the format of the ITU national point code. For this example, the format is **3-8-3-0**. Because the last part of the point code format is **0**, the point code format contains only three parts. Divide the point code into three parts, the first part of the point code contains the first three digits of the 14-digit binary number, the second part of the point code contains the next eight digits of the 14-digit binary number, and the third part of the point code contains the last three digits of the 14-digit binary number.

For this example, the binary numbers would be divided like this:

11100110111101 = 111 00110111 101

00001010110111 = 000 01010110 111

3. Convert each part of the point code into a decimal number using the same scientific calculator used in step 1 and separate each part of the point code with dashes. The results are as follows.

111 00110111 101 = 7-55-5

000 01010110 111 = 0-86-7

When the ITU national point codes are converted from single numbers to multiple-part point codes, the resulting value of the multiple-part point code depends on the point code format specified by the **npcfmti** parameter of the **chg-stpopts** command. When converting the single number point code **14781** to the point code format **3-8-3-0**, the resulting point code value is **7-55-5**. If point code **14781** is converted to the point code format **4-4-4-2**, the resulting point code value is **14-6-15-1**.

Converting Multiple-Part ITU National Point Codes

To convert multiple-part ITU national point codes to a single number, perform these steps. To make this conversion, you will need to know the format of the ITU national point code. This can be verified in the **npcfmti** field of the **rtrv-stpopts** command output. For this example, the ITU national point codes **7-55-5** and **0-86-7**, using the **3-8-3-0** point code format, are converted into a single number.

1. Convert each part of the point code into a binary number using a scientific calculator. The results are as follows.

7-55-5 = 111 00110111 101

0-86-7 = 000 01010110 111

2. Combine each part of the point code into a single binary number as follows.

111 00110111 101 = 11100110111101

000 01010110 111 = 00001010110111

NOTE: If the binary number has any zeros at the beginning of the number, remove these zeros as they are not necessary.

In this example, the binary equivalent for the point code **0-86-7** (00001010110111) contains four zeros at the beginning of the binary number. When the leading zeros are removed from the binary number, the resulting binary number is now 1010110111.

3. Convert the binary number to a decimal number using the same scientific calculator used in step 1.

The binary number 1110011011101 converts to the decimal number **14781**.

The binary number 1010110111 converts to the decimal number **695**.

24-bit ITU-National Point Codes

The 24-bit ITU national point codes are made up of three groups of digits called *main signaling area*, *sub signaling area*, and *signaling point*. The valid values for 24-bit ITU national point codes are:

main signaling area—**000-255**

sub signaling area—**000-255**

signaling point—**000-255**

24-bit ITU national point codes support the Private (Internal) Point Code subtype prefix (**p-**). The prefix can be specified before the point code field values to indicate a Private Point Code (**p-2055-222-2011**, for example). See “Spare and Private Point Code Subtype Prefixes” on page A-12.

Spare and Private Point Code Subtype Prefixes

The Spare Point Code Support feature and the Internal Point Code Support feature provide optional point code subtype prefixes. The Spare Point Code feature must be enabled before a point code subtype prefix can be specified for a point code.

NOTE: The SEAS interface does not support point code subtype prefixes.

The values **p-**, **s-**, and **ps-** are valid point code subtype prefixes. The dash “-” separates the point code subtype prefix from the remainder of the point code. The prefixes are displayed in lower case. The syntax for the remainder of the point code remains the same.

The Spare Point Code prefix (**s-**) applies only to ITU-I and ITU-N point code domains (ITU-N24 point codes do not support the Spare Point Code prefix), to allow the EAGLE 5 SAS to fully support ITU National and International Spare Point Codes. Table A-2 lists the commands that support the Spare Point Code subtype prefix.

The Private (Internal) Point Code prefix (**p-**) applies to all point code domain types (including ITU-N24 point codes), to allow messages destined to the End Office Node to be routed from the inbound LIM to the outbound IPGWx. Table A-3 on page A-14 lists the commands that support the Private Point Code subtype prefix.

The subtype prefix **ps-** can be specified when the point code parameter supports both the spare and private point code prefixes.

Table A-2. Commands that Support the Spare Point Code Prefix

Command	Description	Applicable Point Code Parameters
sid	Site ID	True pci and pcn ; cpci and cpn ; ncpci and ncpn .
spc	Secondary Point Code	spci and spcn

Table A-2. Commands that Support the Spare Point Code Prefix (Continued)

Command	Description	Applicable Point Code Parameters
dstn	Destination	spci and spcn ; dpci and dpcn ; and to Alias combinations, as shown in Figure 1.
ls	Linkset	apci and apcn
rte	Route	dpci and dpcn
appl-rtkey	Application Route Key	dpci and dpcn ; opci and opcn
rmt-appl	Remote Application	ipci and ipcn
na	Network Appearance	type=ituis , type=ituns
scr-blkopc	Gateway Screening Blocked Origination Point Code	Parameters pctst and pctype
scr-blkdpc	Gateway Screening Blocked Destination Point Code	Parameters pctst and pctype
scr-opc	Gateway Screening Origination Point Code	Parameters pctst and pctype
scr-dpc	Gateway Screening Destination Point Code	Parameters pctst and pctype
scr-destfld	Gateway Screening Affected Destination (Concerned) Point Code	Parameters pctst and pctype
scr-cgpa	Gateway Screening Calling Party (Origination) Point Code	Parameters pctst and pctype
scr-aftpc	Gateway Screening Allowed Affected Point Code	Parameters pctst and pctype
scr-cdpa	Gateway Screening Called Party (CDPA PC Destination) Point Code	Parameters pctst and pctype
gtt/gta	Global Title Translation/Global Title Address	pci and pcn
map	Mated Application	pci and pcn ; mpci and mpcn
cspc	Concerned Signaling Point Code	pci and pcn
mrn	Mated Relay Node	pci and pcn ; pci1 and pcn1 ; pci2 and pcn2 ; pci3 and pcn3 ; pci4 and pcn4
gsmopts	Global System for Mobile communication (GSM) Options	ppsmspci1 , ppsmspci2 , ppsmspcn1 , ppsmspcn2
gsmmap-scrn	Global System for Mobile communication (GSM) Mobile Application Part (MAP) Screening	npci and npcn
gsms-opcode	GSM Short Message Services OP-Code	pci and pcn
alm	Alarm	dpci and dpcn

Table A-2. Commands that Support the Spare Point Code Prefix (Continued)

Command	Description	Applicable Point Code Parameters
ent-trace	Enter Trace	dpci and dpcn ; opci and opcn
pass	Pass Commands	Syntax for routing keys

Table A-3. Commands that Support the Private Point Code Prefix

Command	Description	Applicable Point Code Parameters
dstn	Destination	spci and spcn ; dpc , dpca , dpci , and dpcn Does not apply to Aliases
ls	Linkset	If ipgwpc=yes , apc , apca , apci and apcn
gtt/gta	Global Title Translation	pc , pca , pci , and pcn
inh/unhb-alm	Destination alarm inhibit	dpc , dpca , dpci , and dpcn
rte	Route	dpc , dpca , dpci , and dpcn
rmt-appl	Remote Application	ipc , ipca , ipci , and ipcn
rept-stat-cluster	Report Cluster Status	dpc and dpca
rept-stat-dstn	Report Destination Status	dpc , dpca , dpci , and dpcn
rst-dstn	Restore Destination	dpc and dpca

Valid CIC Ranges for SI and MSU Types in Routing Key Static Entries

Table A-4 lists the valid CIC ranges for use with SI and MSU types in Routing Key table static entries.

Table A-4. Valid CIC Ranges for SI and MSU Types

SI	MSU for ANSI DPC	MSU for ITU DPC	Comments
4 (TUP)	N/A	CIC is 12 bits. Range is 0-4095.	The TUP protocol is used only in ITU networks.
5 (ISUP)	CIC is 14 bits. Range is 0-16383.	CIC is 12 bits. Range is 0-4095.	
13 (QBICC)	CIC is 32 bits. Range is 0-4294967295.		

NAIV/NAI Mapping

Table A-5 shows the mapping between the **naiv** and the **nai** parameters.

Table A-5. NAIV/NAI Mapping

NAIV	NAI	Description
0	–	Unknown
1	Sub	Subscriber Number
2	Rsvd	Reserved for national use
3	Natl	National significant number
4	Intl	International number
5-127	–	Spare

NPV/NP Mapping

Table A-6 shows the mapping between the **npv** and the **np** parameters.

Table A-6. NPV/NP Mapping

NPV	NP	Description
0	–	Unknown
1	E164	ISDN/telephony numbering plan
2	Generic	Generic numbering plan
3	X121	Data numbering plan
4	F69	Telex numbering plan
5	E210	Maritime mobile numbering plan
6	E212	Land mobile numbering plan
7	E214	ISDN/mobile numbering plan
8	Private	Private network or network-specific numbering plan
9–15	–	Spare

Summary of Loopback Testing Commands and Functions

The following section, Table A-7 on page A-17, and Figure A-1 on page A-21 summarize the loopback testing commands and functions in the system.

The **tst-slk** command provides several methods for testing signaling links.

The **loopback** parameter on the **tst-slk** command provides the ability to select **lxvr** (local transceiver), **oam**, **line**, **payload**, and **sltc** loopback tests. The **tst-slk** command will be rejected if a loopback test is not compatible with the link type.

- For low-speed links, the **lxvr** and **sltc** tests are allowed.
- For high-speed links (ATM), the **lxvr**, **oam**, **line**, **payload**, and **sltc** tests are allowed.
- For SS7IPGW and IPGWI DCMs, the **tst-slk** command is not supported.
- For IPLIMx DCMs, only the **loopback=sltc** test is allowed, and is allowed only for links having IPLIML2 types of SAALTALI or M2PA.
- For LIME1, LIMT1 and LIMCH cards, only the **loopback=sltc** test is allowed.

The **act-lbp** command activates test on one or more loopback points for testing data signaling link elements in one CCS7 transmission path. The maximum number of loopback points is 32.

For a single loopback point test, the parameters can be entered on the command line. If the parameters are not entered at the command line, the LFS database is used. For multiple loopback point tests, the LFS database must be used.

The **ent-lbp** command is used to create the loopback points in the LFS database. The LBP's may be entered in any order.

See the command descriptions in this manual for details on entering parameters and using the commands.

Table A-7. Loopback Testing Commands and Functions
Per Card Type

Command/Function	DS0 MPL	OCU	V.35	LIME1 (within a channel)	E1-AT M	T1-AT M	T1 MIM (within a channel)	E1 MIM (within a channel)	IPLIM	IPGTWY	Testing Limits
ent-lbp OAM Database for Multiple LFS points per LFS tests No impact on actual link behavior other than allowing multiple points.	Yes	No	No	n/a	n/a	n/a	No	n/a	n/a	n/a	32 points per card no limit on # of cards
act/dact-lbp EAGLE initiated Level 1 DS0 LFS tests Link State—Link is down Equipment tested—Level 1 element(s) in a signaling path Purpose—Test the error rates of a signaling path Description—Sends loopback code to establish loopback, then performs BERT test for a specified period of time. Typical use—To validate signaling path has acceptable error rate.	Yes	No	No	n/a	n/a	n/a	Yes	n/a	n/a	n/a	16 concurrent tests per system 1 test per card

Table A-7. Loopback Testing Commands and Functions Per Card Type (Continued)

Command/Function	DS0 MPL	OCU	V.35	LIME1 (within a channel)	E1-AT M	T1-AT M	T1 MIM (within a channel)	E1 MIM (within a channel)	IPLIM	IPGTWY	Testing Limits
<p>Remote Loopback FAR END initiated DS0 LFS Test Link State—Link can be up or down Equipment tested—Near end hardware up to level 2 (LXVR) and far end hardware level 1 interface Purpose—Auto—loopback a BERT test to the far end Description—When receiving a loopback code, deactivate the link and go into loopback Typical use—used to remotely test the far end with standard DS0 BERT tests</p>	Yes	Yes	No	n/a	n/a	n/a	Yes	n/a	n/a	n/a	no limit on # of cards
<p>tst-slk SLTC EAGLE initiated Level 3 SS7 SLT Link State—Link is up Equipment tested—Near and far end up to Level 3 Purpose—Test the entire path to the far end at Level 3 Description—This will send an SLTM out and expects an SLTA back. Typical use—To validate connectivity of a signaling path.</p>	Yes	Yes	Yes	Yes	Yes	Yes	Yes	Yes	Yes (not M3UA)	n/a	no limit on # of cards
<p>tst-slk OAM EAGLE initiated Level 1 ATM test Link State—Link is down Equipment tested—Near and far end level 1 software and hardware including all hardware on the cards Purpose—Test the entire near and far end level 1 hardware by exchanging ATM cells Description—Sends OAM cells out to far end for 60 seconds if no errors, or 2 minutes when errors are received. Typical use—Verifies ATM cells can be exchanged between 2 signaling points</p>	n/a	n/a	n/a	Yes	Yes	n/a	n/a	n/a	n/a	n/a	no limit on # of cards

Table A-7. Loopback Testing Commands and Functions
Per Card Type (Continued)

Command/Function	DS0 MPL	OCU	V.35	LIME1 (within a channel)	E1-AT M	T1-AT M	T1 MIM (within a channel)	E1 MIM (within a channel)	IPLIM	IPGTWY	Testing Limits
tst-slk LINE <i>EAGLE</i> <i>initiated Level 1-2 ATM test</i> Link State—Link is down Equipment tested—Near end hardware up to level 2 (LXVR) and far end hardware level 1 interface Purpose—Hardware continuity check between near and far end Description—The following steps occur: <ol style="list-style-type: none"> 1. Device under test (DUT) sends T1 bit-oriented code (BOC) to remote device 2. Remote device receives BOC and programs hardware 3. DUT attempts level 2 alignment 4. If link aligns (level 2), test passes, else test fails 5. DUT sends BOC to remote device to remove loopback 6. Remote device receives BOC and re-programs hardware 	n/a	n/a	n/a	n/a	n/a	Yes	n/a	n/a	n/a	n/a	no limit on # of cards
Note: If the DUT boots in the middle of sequence, the remote device just needs to have the link activated or de-activated and it returns to the original programming. Typical use—Used for a link in line timing to check continuity from the near end level 2 hardware to the level 1 interface at the far end											

Table A-7. Loopback Testing Commands and Functions
Per Card Type (Continued)

Command/Function	DS0 MPL	OCU	V.35	LIME1 (within a channel)	E1-AT M	T1-AT M	T1 MIM (within a channel)	E1 MIM (within a channel)	IPLIM	IPGTWY	Testing Limits
<p>tst-slk PAYLOAD EAGLE initiated Level 1-2 ATM test Link State—Link is down Equipment tested—Near end hardware up to level 2 (LXVR) and far end hardware level 1 interface Purpose—Hardware continuity check between near and far end Description—The following steps occur:</p> <ol style="list-style-type: none"> 1. Device under test (DUT) sends T1 bit oriented code (BOC) to remote device 2. Remote device receives BOC and programs hardware 3. DUT attempts level 2 alignment 4. If link aligns (level 2), test passes, else test fails 5. DUT sends BOC to remote device to remove loopback 6. Remote device receives BOC and re-programs hardware <p>Note: If the DUT boots in the middle of sequence, the remote device just needs to have the link activated or de-activated and it returns to the original programming Typical use—used for a link in master timing to check continuity from the near end level 2 hardware to the level 1 interface at the far end</p>	n/a	n/a	n/a	n/a	n/a	Yes	n/a	n/a	n/a	n/a	no limit on # of cards
<p>tst-slk LXVR EAGLE initiated Level 1 Internal card loopback Link State—Link is down Equipment tested—Local card Purpose—Test the near end card only Description—This will test the near end card up through level 2. Typical use—To validate the card on the EAGLE 5 SAS as good</p>	Yes	Yes	Yes	Yes	Yes	Yes	Yes	Yes	No	No	no limit on # of cards

Figure A-1. ATM Loopback Tests

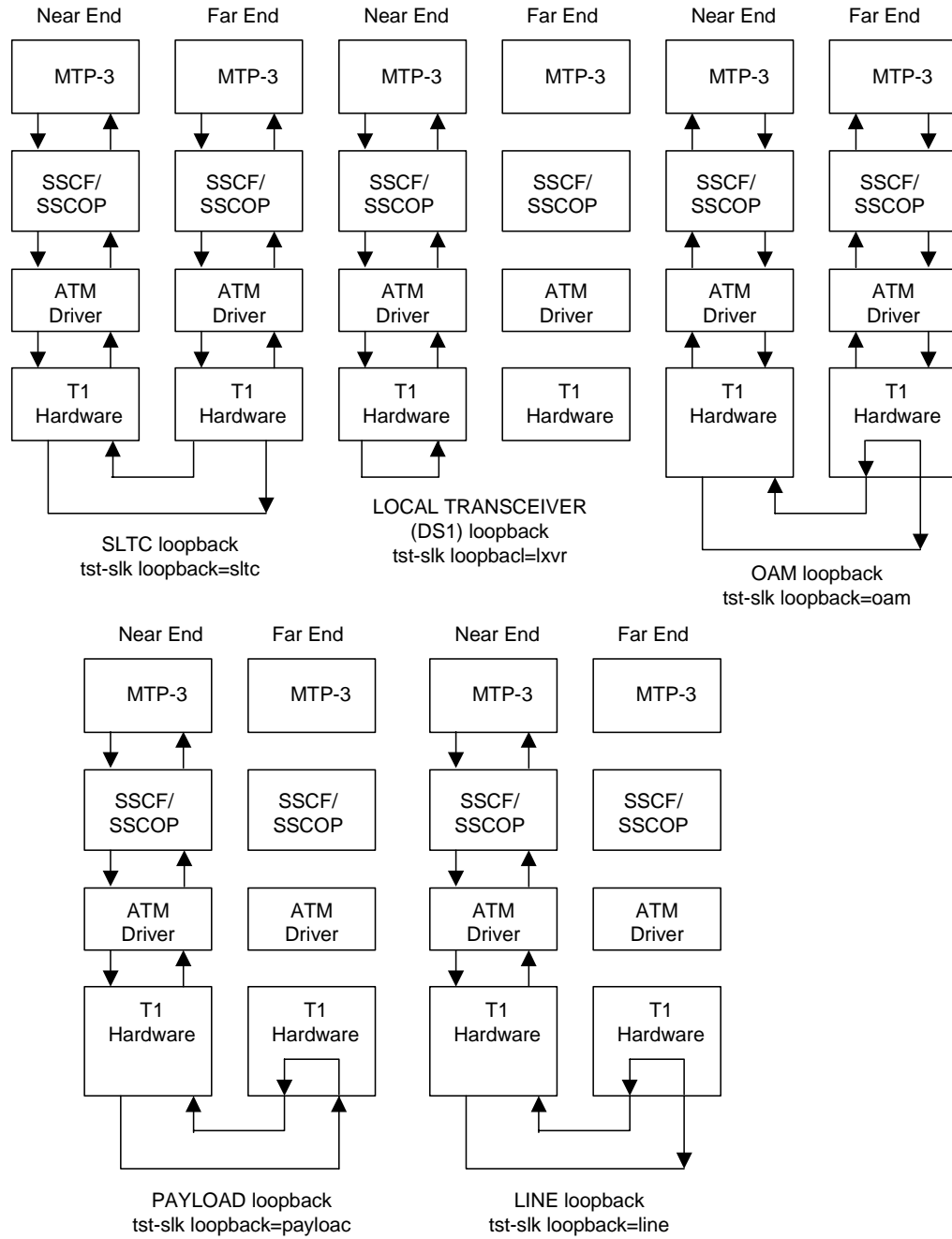

Tekelec-defined ISUP Normalization Variants

Table A-8 lists the available Tekelec-defined ISUP Normalization Variants, Feature Part Numbers, PSTN Categories, and PSTN IDs.

Table A-8. Tekelec-defined ISUP Normalization Variants

ISUP Variant	Part No.	PSTN Category	PSTN ID
ISUP Normalization	893000201	1	*
ITU Q.767 Normalization	893000501	1	1
ESTI V3 Normalization	893000601	1	2
UK PNO-ISC7 Normalization	893000401	1	3
German ISUP Normalization	893000301	1	4
French ISUP Normalization	893-0007-01	1	5
Sweden ISUP Normalization	893-0008-01	1	6
Belgium ISUP Normalization	893-0009-01	1	7
Netherlands ISUP Normalization	893-0010-01	1	8
Switzerland ISUP Normalization	893-0011-01	1	9
Austria ISUP Normalization	893-0012-01	1	10
Italy ISUP Normalization	893-0013-01	1	11
Ireland ISUP Normalization	893-0014-01	1	12
India ISUP Normalization	893-0015-01	1	13
Malaysia ISUP Normalization	893-0016-01	1	14
Vietnam ISUP Normalization	893-0017-01	1	15
South Africa ISUP Normalization	893-0018-01	1	16
Argentina ISUP Normalization	893-0019-01	1	17
Chile ISUP Normalization	893-0020-01	1	18
Venezuela ISUP Normalization	893-0021-01	1	19
Mexico ISUP Normalization	893-0022-01	1	20
Brazil ISUP Normalization	893-0023-01	1	21
Spain ISUP Normalization	893-0024-01	1	22
Colombia ISUP Normalization	893-0025-01	1	23
Peru ISUP Normalization	893-0026-01	1	24
Hong Kong ISUP Normalization	893-0027-01	1	25
China ISUP Normalization	893-0028-01	1	26
Japan ISUP Normalization	893-0029-01	1	27
Korea ISUP Normalization	893-0030-01	1	28
Taiwan ISUP Normalization	893-0031-01	1	29

Table A-8. Tekelec-defined ISUP Normalization Variants (Continued)

ISUP Variant	Part No.	PSTN Category	PSTN ID
Philippines ISUP Normalization	893-0032-01	1	30
Singapore ISUP Normalization	893-0033-01	1	31
Australia ISUP Normalization	893-0034-01	1	32
Reserved for future definition by Tekelec		2 through 4095	
Available for user-defined categories		4095 through 65535	

B

Acronyms and Abbreviations

AAL	ATM Adaptation Layer
AAL5	ATM Adaptation Layer 5
AAL5CP	ATM Adaptation Layer 5 Common Port
AATM	ATM Applique
ACG	Automatic Call Gapping
ACM	Application Communications Module
ADJ DPC	Adjacent Destination Point Code
AI	Address Indicator
AIN	Advanced Intelligent Network
AINF	Application Interface Applique
ANSI	American National Standards Institute
AP	Application Processor
ARP	Address Resolution Protocol
AS	Application Server; a logical entity serving a specific Routing Key
ASP	Application Server Process
ATI	Any Time Interrogation
ATM	Asynchronous Transfer Mode
ATMANSI	The application software for the ATM (high-speed) SS7 signaling links
ATM HSL	Asynchronous Transfer Mode High Speed Link

ATMM	ATM Layer Management
AVL	Availability Measurements report
AVLD	Daily Availability measurements report
AVLDTH	Day-to-Hour Availability measurements report
BIP	Board Identification PROM
BITS	Building Integrated Timing System
BLM	Bulk Load Module
BPHCAP	The application software used by the application processor and the IMT processor of the LIMATM
BPDCM	The application software for flash memory management on the DCM card.
BSD	Berkeley Software Distribution
BSN	Backward Sequence Number
CAS	Channel Associated Signaling
CCM	Command Class Management
CCS	Common Channel Signaling
CCS7	Common Channel Signaling System #7
CCS7ITU	The application software for the ITU SS7 signaling links
CDPA	Called Party Address
CGPA	Calling Party Address
CF	Control Frame
CIC	Circuit Identification Code
CLLI	Common Language Location Identifier
CLU	Network Cluster
CM	Cluster Management
CNCF	Calling Name Conversion Facility
CP	Communication Processor
CPU	Central Processing Unit
CRC	Cyclic Redundancy Check
CRMD	Cluster Routing and Management Diversity
CRP	Circular Route Prevention

CSPC	Concerned Signaling Point Code Group
CSU	Channel Service Unit
DB	Database
DCM	Database Communications Module
DIP	Dual In-Line Package
DIX	Digital/Intel/Xerox de facto standard for Ethernet Media Access Control Type
DN	Dialed or Directory Number
DPC	Destination Point Code
DRAM	Dynamic Random Access Memory
DS0	Digital Signal Level - 0
DSM	Database Services Module
DSU	Data Service Unit
DTA	Database Transport Access
EBDA	Enhanced Bulk Download and Audit
EDR	Efficient Data Representation
EF	Extension Frame
EGTT	Enhanced Global Title Translation
EIA	Electronic Industries Association
EILA	Enhanced Integrated LIM Applique
EIR	Equipment Identity Register
EIS	Eagle Integrated Sentinel
ELAP	Eagle LNP Application Processor
EMDC	Element Measurement & Data Collection Application
EMAP	Eagle Measurements Application Processor
EMP	Eagle Monitoring Protocol
EMSALM	Element Management System Alarm Monitor
ENET	Ethernet
EOAM	Enhanced Operations, Administration, and Maintenance
EOAP	Enhanced OSS Application Process

EPAP	Eagle Provisioning Application Processor
EPROM	Erasable PROM
ESP	Extended Services Platform
FAK	Feature Access Key
FAP	Fuse and Alarm Panel
FAS	Frame Alignment Signal
FGTLLS	Flexible Global Title Translation Load Sharing
FIGTLLS	Flexible Intermediate Global Title Translation Load Sharing
FISU	Fill In Signal Unit
FPCR	Full Point Code Routing
FSN	Forward Sequence Number
FTA	File Transfer Area
FTP	File Transfer Protocol
FTRA	FTP-based Table Retrieve Application
GDB	GSM Real-Time Database
G-Flex	GSM Flexible Numbering
G-Port	GSM Mobile Number Portability
GLS	Generic Loading Service
GMSC	Gateway MSC
GPL	Generic Program Load
GPSM	General Purpose Service Module
GSL	Generic Software Load
GSM	Global System for Mobile Communications
GTA	Global Title Address
GTI	Global Title Indicator
GTT	Global Title Translation
GTWY	Gateway Administration measurements report
GWS	Gateway Screening
GWSA	Gateway Screening Application
GWSM	Gateway Screening Messages

HC-MIM	High Capacity Multi-Channel Interface Module
HDB3	High Density Bipolar 3 encoding
HIPR	High Speed IMT Packet Router
HLR	Home Location Register
HOMERN	Home Network Routing Number Prefix
HMUX	High-Speed Multiplexer
HRN	Home Routing Number
HSL	High-Speed Links
IAM	Initial Address Message
IC	Integrated Circuit
ICMP	Internet Control Message Protocol
ID	Identity
IDCA	ISUP Digit Collection Application
IETF	Internet Engineering Task Force
IGTTLS	Intermediate Global Title Translation Load Sharing
IL	Incremental loading
ILA	Integrated LIM Applique
IMEI	International Mobile Equipment Identifier
IMSI	International Mobile Station Identifier
IMT	Inter-processor Message Transport
IN	Intelligent Network
INAP	Intelligent Network Application Part
INP	INAP-based Number Portability
INET	Internet
INH	Inhibit
IP	Internet Protocol
IP7SG	IP ⁷ Secure Gateway
IPGWI	An ITU version of SS7IPGW
IPGWx	Point to multi-point IP Transport GPL, referring to SS7IPGW (ANSI) and IPGWI (ITU).ÆE

IPLIM	The application software used by the DCM card for TCP/IP point-to-point connectivity for ANSI point codes.
IPLIMI	The application software used by the DCM card for TCP/IP point-to-point connectivity for ITU point codes.
IPLIMx	Point to point IP Transport GPL, referring to IPLIM (ANSI) and IPLIMI (ITU)
IPMX	IMT Power and Multiplexer
IPS	Internet Protocol Services
IPSM	Internet Protocol Services Module
IS-41	Interim Standard 41, same as and interchangeable with ASNI-41
IS-ANR	In Service - Abnormal
ISDN	Integrated Services Digital Network
IS-NR	In Service - Normal
ISUP	ISDN User Part
ITU	International Telecommunications Union
ITUDUPPC	ITU National Duplicate Point Code
JIP	Jurisdiction Indicator Parameter
LAN	Local Area Network
LB	Load Balancing
LBP	Loop Back Point
LC	Logical channel
LED	Light Emitting Diode
LFS	Link Fault Sectionalization
LIM	Link Interface Module
LIM-AINF	Link Interface Module with the AINF interface
LIM-ATM	LIM with ATM interface
LIM-DS0	LIM with DS0 Applique
LIM-E1	LIM with E1 Applique
LIM-OCU	LIM with Office Channel Unit Applique
LIM-V35	LIM with V35 Interface
LNP	Local Number Portability
LNPMR	LNP Message Relay

LNPQS	LNP Query Service
LNP SMS	LNP Short Message Service
LPE	Logical Processing Element
LRN	Location Routing Number
LS	Link Set
LSB	Least Significant Bit (bit 1)
LSL	Low-Speed Link
LSMS	Local Service Management System
LSN	Link Set Name
LSSU	Link Status Signal Unit
M2PA	SS7 MTP2-User Peer-to-Peer Adaptation Layer
M3UA	SS7 MTP3-User Adaptation Layer
MAAL	Management ATM Adaptation Layer
MAP	Mobile Application Part
MAPSCRN	GSM MAP Screening measurements report
MCAP	MAS Communication Application Processor Card
MCC	Mobile Country Code
MCM	Maintenance Communication Module
MCP	Measurement Collection Processor
MCPM	Measurement Collection and Polling Module
MDAL	Maintenance Disk and Alarm (card)
MDN	Mobile Dialed Number
MGT	Mobile Global Title
MGTT	Modified Global Title Translation
MF	Miscellaneous Frame
MIM	Multi-Channel Interface Module
MIN	Mobile Identification Number
MNP	Mobile Number Portability
MNP SMS	Portability Check for Mobile Originated SMS
MNP-SRF	Signaling Relay Function for support of Mobile Number Portability

MPC	Multiple Point Code feature
MPL	Multi-port LIM
MPS	Multi-Purpose Server
MR	Message Relay
MRN	Message Reference Number Mated Relay Node
MS	Mobile Station
MSB	Most Significant Bit
MSC	Mobile Switching Center
MSAR	Memory space accounting reporting
MSISDN	Mobile Station ISDN Number Mobile Switching ISDNNumber
MSRN	Mobile Station Roaming Number
MSU	Message Signal Unit
MTCD	Maintenance Daily measurements report
MTCDTH	Maintenance Day-to-Hour measurements report
MTCH	Maintenance Hourly (marginal) measurements report
MTCS	Maintenance Status (link/link set) measurements report
MTP	Message Transfer Part
MTP2	Message Transfer Part, Level 2
NAI	Nature of Address Indicator
NCAI	Nested Cluster Allowed Indicator
NCR	Nested Cluster Routing
NDC	Network Data Collection
NFAS	Non-Frame Alignment Signal
NI	Network Indicator
NIC	Network Information Center
NID	Network Identification
NM	Network Management
NP	Number Plan
NPA	Numbering Plan Area

NPAC	Number Portability Administration Center
NPANXX	Numbering Plan Area and Exchange
NRT	Network Routing
NSAP	Network Service Access Point
NSE	Network Security Enhancement
NSFI	Next Screening Function Indicator
NSP	Network Services Part
NSPC	New Secondary Point Code
OAM	Operations, Administration, and Maintenance
OAP	Operation System Support Application Processor
OAMP	Operations, Administration and Maintenance Part
OCU	Office Channel Unit
OOS-MA	Out of Service - Memory Administration
OOS-MT	Out of Service - Maintenance
OOS-MT-DSBLD	Out of Service - Maintenance Disabled
OPC	Origination Point Code
OSI	Open Systems Interconnection
OSS	Operations Systems Support
PC	Point Code
PCR	Preventive Cyclic Retransmission
PCS	Personal Communications Service (North American GSM)
PDBA	Provisioning Database Application
PDBI	Provisioning Database Interface
PDN	Packet Data Network
PDS	Persistent Device States
PLNP	PCS 1900 LNP
PLNPQS	LNPQS support provided for PLNP
PPSMS	Prepaid Short Message Service Intercept
PROM	Programmable Read-Only Memory
PSEL	Presentation Selector

PST	Primary State for Maintenance
PSTN	Public Switched Telephone Network
PVC	Permanent Virtual Circuit
PVN	Private Virtual Network
Q3	Q.3 Protocol
RAM	Random Access Memory
RBASE	Record Base measurements report
RI	Routing Indicator
RFC	Request for Comments
RMC	Remote Maintenance Center
RMTP	Reliable Multicast Transport Protocol
RN	Routing Number
RTDB	DSM Real-time database
RTT	Round Trip Time
SAAL	Signaling ATM Adaptation Layer
SAM	Subsequent Address Message
SCCP	Signaling Connection Control Part
SCMG	SCCP Management
SCP	Service Control Point
SCRSET	Screen Set
SCSI	Small Computer System Interface
SCTP	Stream Control Transmission Protocol
SE-HSL	Synchronous E1 High Speed Link
SEAS	Signaling Engineering and Administration System
SIB	Status Indication "Busy"
SIE	Status Indication "Emergency" Alignment
SIN	Status Indication "Normal Alignment"
SIO	Service Information Octet
SIO	Status Indication "Out of Alignment"
SIOS	Status Indication "Out of Service"

SLK	Signaling Link
SLS	Signaling Link Selection
SLSCI	Signaling Link Conversion Indicator
SLTA	Signaling Link Test Acknowledgement
SLTM	Signaling Link Test Message
SMS	Short Message Service
SMSC	Short Message Service Center
SMSMR	Prepaid Short Message Service
SNAI	Service Nature of Address Indicator
SNM	Signaling Network Management
SNR	Subsystem Normal Routing
SOR	Support for Optimal Routing
SORP	Socket Option Registration Primitive
SPC	Secondary Point Code Signaling Point Code
SRF	Signaling Relay Function
SRI	Send Routing Information
SS7	Signaling System #7
SS7ANSI	The application software for the ANSI SS7 signaling links
SS7GX25	The application software for the X.25/SS7 gateway feature
SS7IPGW	The application software used by the DCM card for TCP/IP point-to-multipoint capability
SSA	Subsystem Allowed (An SCCP management message)
SSEL	Session Selector
SSN	SS7 Subsystem Number
SSP	Service Switching Point
SSU	Status Signal Unit
ST	Stop Digit—BCD value 15 (0xF)—used to indicate the end of dialing in some applications
STC	Sentinel Transport Card
STP	Signal Transfer Point

STP LAN	The application software for the STP LAN feature
SUA	SS7 SCCP-User Adaptation Layer
SVC	Switched Virtual Circuit
TALI	Transport Adapter Layer Interface (RFC 3094)
TCP	Transmission Control Protocol
TCAP	Transaction Capabilities Application Part
TDM	Terminal Disk Module
TFC	Transfer Congested (traffic)
TFP	Transfer Prohibited
TFR	Transfer Restricted
TLNP	Triggerless LNP
TOS	Type of Service
TPS	Transactions Per Second
TRA	Traffic Restarting Allowed
TRBL	Trouble
TRW	Traffic Restarting Waiting
TSC	Time Slot Counter Synchronization
TSM	Translation Services Module
TT	Translation Type
TUP	Telephone User Part
TV	Ticket Voucher
TVG	Group Ticket Voucher
UA	IETF User Adaptation Layers
UAM	Unsolicited Alarm Message
UART	Universal Asynchronous Receiver - Transmit
UDP	User Datagram Protocol
UDTS	Unit Data Transfer Service
UI	User Interface
UID	User ID
UIM	Unsolicited Informational Message

UPD	Update
VGTT	Variable Length GTT
VLR	Visitor Location Register
VMSC	Voice Mail Service Center Visited Mobile Switching Center
VSCCP	VxWorks Signaling Connection Control Part
WNP	Wireless Number Portability
WNPQS	Wireless Number Portability Query Service
X.25 DE	X.25 Destination Entity
XGTT	Expanded GTT (GTT Table Expansion)
XMAP	Expanded MAP Table

Index

A

- act-alm-trns 5-2
- act-cdl 5-2
- act-dlk 5-4, 6-2
- act-echo 5-5
- act-file-trns 5-6
- act-flash 5-9
- act-ftp-trns 5-12
- act-gpl 5-13
- action commands 4-9
- Activate 5-5
- act-lpo 5-23
- act-oap-config 5-25
- act-slk 5-28
- act-upgrade 8-2
- act-user 5-30
- administration of User IDs and passwords 4-17
- alarm levels 4-3
- alloc-mem 5-31
- alw-imt 5-36
- alw-map-ss 5-37
- alw-slk 5-38
- alw-trm 5-39
- arp 9-2
- arrow key operations, terminal 4-12
- aslog 9-5
- asplog 9-6
- assocrtt 9-11
- AST possible values A-3
- aud-data 5-40

B

- banner format, output 4-15
- blk-slk 5-45

C

- canc-cmd 5-48
- canc-echo 5-51
- canc-lnp-dpcer 5-51

- canc-lnp-trnprt 5-52
- canc-lpo 5-53
- canc-slk 5-54
- canc-user 5-56
- Card(s) cannot warm restart - FORCE parameter required 6-419
- cdu 8-8
- chg-acg-mic 5-56
- chg-acg-noc 5-58
- chg-appl-rtkey 5-60
- chg-as 5-73
- chg-asp 5-74
- chg-assoc 5-69
- chg-atm-lps 5-80
- chg-attr-seculog 5-83
- chg-bip-fld 8-14
- chg-bip-rec 8-15
- chg-cmdclass 5-86
- chg-csl 5-87
- chg-ctrl-feat 5-92
- chg-db 5-96
- chg-dcmpps 5-94
- chg-dstn 5-106
- chg-e1 5-116
- chg-feat 5-120
- chg-ftp-serv 5-130
- chg-gpl 5-132
- chg-gsmmap-scrn 5-136
- chg-gsmopts 5-141
- chg-gsms-opcode 5-150
- chg-gta 5-153
- chg-gtcnv 5-161
- chg-gtt 5-164
- chg-gttset 5-172
- chg-gtw-stp 5-174
- chg-gws-actset 5-175
- chg-gws-redirect 5-179
- chg-inpopts 5-181
- chg-ip-card 5-185
- chg-ip-lnk 5-187
- chg-isupvar-attrb 5-190

Index

- chg-l2t 5-195
 - chg-l3t 5-199
 - chg-lbp 5-204
 - chg-lnp-lrn 5-206
 - chg-lnp-npanxx 5-209
 - chg-lnpopts 5-219
 - chg-lnp-refnum 8-16
 - chg-lnp-serv 5-212
 - chg-lnp-sub 5-214
 - chg-lnp-ttmap 5-217
 - chg-ls 5-222
 - chg-m2pa-tset 5-235
 - chg-map 5-238
 - chg-meas 5-244
 - chg-measopts 5-246
 - chg-mrn 5-254
 - chg-netopts 5-262
 - chg-oap-config 5-263
 - chg-pid 5-268
 - chg-prefix 5-269
 - chg-pstn-pres 5-272
 - chg-rte 5-273
 - chg-sccp-serv 5-277
 - chg-scr-blkdpc 5-289
 - chg-scr-blkopc 5-297
 - chg-scr-cdpa 5-304
 - chg-scr-cgpa 5-310
 - chg-scr-destfld 5-317
 - chg-scr-isup 5-328
 - chg-scr-opc 5-331
 - chg-scr-sio 5-337
 - chg-secu-dflt 5-346
 - chg-secu-trm 5-351
 - chg-sg-opts 5-354
 - chg-sid 5-360
 - chg-slt 5-369
 - chg-ss7opts 5-376
 - chg-stpopts 5-377
 - chg-t1 5-391
 - chg-tbl 8-18
 - chg-th-alm 5-393
 - chg-th-sccp 5-395
 - chg-trm 5-396
 - chg-ttmap 5-406
 - chg-uaps 5-407
 - chg-user 5-411
 - chg-x25-dstn 5-415
 - chg-x25-rte 5-417
 - chg-x25-slk 5-418
 - chk-unref-ent 5-421
 - classes, command 4-17
 - clr-disk-stats 8-20
 - clr-imt-stats 5-424
 - Command Aborted messages 4-15
 - Command Accepted messages 4-14
 - command classes, configuration of 4-17
 - Command Completed messages 4-14
 - Command Executed messages 4-14
 - Command Failed messages 4-14
 - Command Rejected messages, summary 4-14
 - Command Response messages 4-15
 - commands
 - about 4-9
 - command classes 4-17
 - duplicate parameters in 4-10
 - keywords 4-9
 - output banner format 4-15
 - parameters 4-9
 - reports and output message types generated by 4-14
 - commands, action 4-9
 - commands, entering 4-9
 - commands, functions performed by 4-9
 - configuration
 - of command classes 4-17
 - of terminals and printers 4-3
 - conn-imt 5-426
 - connmgr 9-13
 - controlled features
 - turn on and off 5-92
 - Converting ITU National Point Code Formats A-10
 - copy-disk 5-427
 - copy-fta 5-429
 - copy-gpl 5-431
 - copy-meas 5-434
 - copy-seculog 5-435
 - copy-tbl 8-20
 - critical alarms 4-3
 - Customer Assistance 1-8
- D**
- dact-alm-trns 6-2
 - dact-cdl 6-2

- dact-cmd 6-3
 - dact-echo 6-5
 - dact-rstst 6-8
 - dact-slk 6-9
 - dact-user 6-10
 - Debug Commands 8-1
 - disc-imt 6-11
 - disk drives, removable cartridge 4-2
 - disp-bip 8-22
 - disp-bp 8-23
 - disp-disk-dir 8-26
 - disp-disk-stats 8-29
 - disp-fta-dir 6-12
 - disp-lba 8-30
 - disp-mem 8-32
 - dlt-acg-mic 6-12
 - dlt-acg-noc 6-13
 - dlt-appl-rtkey 6-14
 - dlt-appl-sock 6-19
 - dlt-asp 6-21
 - dlt-assoc 6-22
 - dlt-bp 8-34
 - dlt-card 6-22
 - dlt-csl 6-23
 - dlt-cspc 6-27
 - dlt-dstn 6-30
 - dlt-e1 6-35
 - dlt-fta 6-36
 - dlt-ftp-serv 6-37
 - dlt-gsmmap-scrn 6-38
 - dlt-gsms-opcode 6-39
 - dlt-gsmssn-scrn 6-40
 - dlt-gta 6-41
 - dlt-gtcnv 6-43
 - dlt-gtt 6-45
 - dlt-gttset 6-47
 - dlt-gttset 6-49
 - dlt-gws-redirect 6-50
 - dlt-homern 6-51
 - dlt-home-smisc 6-51
 - dlt-ip-host 6-52
 - dlt-ip-node 6-53
 - dlt-ip-rte 6-55
 - dlt-lbp 6-56
 - dlt-lnp-lrn 6-58
 - dlt-lnp-npanxx 6-59
 - dlt-lnp-serv 6-60
 - dlt-lnp-sp 6-62
 - dlt-lnp-sub 6-62
 - dlt-ls 6-64
 - dlt-map 6-65
 - dlt-mrn 6-67
 - dlt-prefix 6-75
 - dlt-pstn-pres 6-77
 - dlt-rmt-appl 6-78
 - dlt-rte 6-80
 - dlt-sccp-serv 6-84
 - dlt-scr-aftpc 6-89
 - dlt-scr-blkdpc 6-93
 - dlt-scr-blkopc 6-97
 - dlt-scr-cdpa 6-101
 - dlt-scr-cgpa 6-104
 - dlt-scr-destfld 6-108
 - dlt-scr-dpc 6-112
 - dlt-scr-isup 6-115
 - dlt-scr-opc 6-116
 - dlt-scrset 6-123
 - dlt-scr-sio 6-120
 - dlt-scr-tt 6-122
 - dlt-slk 6-125
 - dlt-spc 6-127
 - dlt-split-npa 6-129
 - dlt-srvsel 6-130
 - dlt-ss-appl 6-131
 - dlt-subnetid 6-132
 - dlt-t1 6-133
 - dlt-tt 6-134
 - dlt-uim-acthresh 6-137
 - dlt-user 6-138
 - dlt-vendid 6-138
 - dlt-x25-dstn 6-139
 - dlt-x25-rte 6-140
 - documentation
 - admonishments 1-9
 - drklog 9-20
 - duplicate parameters in command 4-10
- E**
- Element Management System Alarm
 - Monitor (EMSALM) 4-8
 - EMSALM terminals 4-8
 - enable-ctrl-feat 6-140
 - ent-acg-mic 6-147
 - ent-acg-noc 6-149
 - ent-appl-rtkey 6-150

Index

ent-appl-sock 6-156
ent-as 6-159
ent-asp 6-160
ent-assoc 6-161
ent-bp 8-35
ent-card 6-165
ent-cspc 6-176
ent-dlk 6-179
ent-dstn 6-181
ent-e1 6-193
entering commands 4-9
ent-ftp-serv 6-197
ent-gsmmap-scrn 6-199
ent-gsms-opcode 6-205
ent-gsmssn-scrn 6-209
ent-gta 6-210
ent-gtcnv 6-217
ent-gtt 6-220
ent-gttset 6-228
ent-gttset 6-230
ent-gws-redirect 6-232
ent-homern 6-235
ent-home-smsc 6-234
ent-ip-host 6-236
ent-ip-node 6-237
ent-ip-rte 6-239
ent-lbp 6-241
ent-lnp-lrn 6-243
ent-lnp-npanxx 6-246
ent-lnp-serv 6-249
ent-lnp-sp 6-251
ent-lnp-sub 6-252
ent-ls 6-255
ent-map 6-265
ent-mrn 6-271
ent-na 6-279
ent-pstn-pres 6-280
ent-rmt-appl 6-282
ent-rte 6-284
ent-scr-aftpc 6-288
ent-scr-blkdpc 6-293
ent-scr-blkopc 6-298
ent-scr-cdpa 6-304
ent-scr-cgpa 6-308
ent-scr-destfld 6-313
ent-scr-dpc 6-316
ent-scr-isup 6-321
ent-scr-opc 6-323

ent-scrset 6-334
ent-scr-sio 6-328
ent-scr-tt 6-332
ent-serial-num 6-336
ent-shlf 6-337
ent-sid 6-338
ent-slk 6-340
ent-spc 6-354
ent-split-npa 6-356
ent-srvsel 6-357
ent-ss-appl 6-361
ent-subnetid 6-362
ent-t1 6-364
ent-trace 8-41
ent-tt 6-367
ent-ttmap 6-368
ent-user 6-370
ent-vendid 6-374, 7-691
ent-x25-dstn 6-375
ent-x25-rte 6-377
expired password procedure 4-21

F

flash-card 6-380
format, output banner 4-15
format-disk 6-383
FTA, wxtracting LNP measurements from
5-8
ftptest 9-29

G

GPSM-II card (IMASP) 4-2

I

I/O devices 4-2
inh-alm 6-387
inh-card 6-393
inhibited alarms 4-3
inh-imt 6-394
inh-map-ss 6-395
inh-slk 6-397
inh-trm 6-399
init-card 6-400
init-flash 6-406
init-imt-gpl 6-411
init-mux 6-412

init-network 6-413
 init-oap 6-416
 init-sys 6-417
 intrusion alert 4-18

K

key sequences
 KSR terminal 4-10
 VT320 terminal 4-10
 keyboard functions 4-10
 keywords, command 4-9
 KSR function on VT320 terminals 4-5
 KSR terminals
 function on VT320 devices 4-5
 key sequences 4-10

L

linkinfo 9-31
 LNP ELAP Configuration feature
 enable 6-143
 turn off 5-93
 LNP feature, how to turn on 6-140
 LNP measurements, extracting from FTA 5-8
 lock 6-422
 login 6-423
 procedure for password expired 4-21
 procedure for User ID-password already
 being used 4-22
 procedure for User ID-password not
 accepted 4-20
 procedure to change password at first
 login 4-20
 procedure to log into system 4-19
 security checks 4-17
 logout 6-424
 logout procedure 4-23

M

Maintenance and Administration Subsystem
 Processors See MASP cards 4-2
 Maintenance Disk and Alarm card See
 MDAL card 4-2
 major alarms 4-3
 manual
 related publications 1-3

MASP cards 4-2
 MDAL card
 function of 4-2
 removable cartridge drive 4-2
 measurements, extracting LNP from FTA 5-8
 minor alarms 4-3
 msucount 9-40
 msuroute 9-72
 msutrace 9-77

N

netstat 9-94
 nslookup 9-105

O

output banner format 4-15
 output groups, unsolicited messages 4-15
 output messages, types of 4-14

P

parameters, command 4-9
 pass 6-425
 Pass-Through Commands 2-9, 9-1
 password
 change at first login 4-20
 change expired at login 4-21
 passwords, rules for administering 4-17
 Permanently On controlled features, list of
 5-92
 ping 9-107
 point code subtype prefixes A-12
 port Parameter, Summary of Range Values
 for A-2
 prefixes, point code subtype A-12
 printers
 configuration of 4-3
 connection to TDM 4-5
 directing 4-15
 procedures
 Extracting LNP Measurements from the
 FTA 5-8
 log into system 4-19
 logout 4-23
 procedures, login
 change password at first login 4-20

Index

password expired 4-21
User ID-password already being used 4-22
User ID-password not accepted 4-20
PST/AST/SST possible values A-3

R

removable cartridge disk drives 4-2

rept-ftp-meas 7-2

rept-imt-info 7-6

rept-imt-lvl1 7-27

rept-imt-lvl2 7-39

rept-meas 7-43

rept-stat-alm 7-57

rept-stat-applsock 7-63

rept-stat-as 7-64

rept-stat-asp 7-66

rept-stat-assoc 7-67

rept-stat-card 7-69

rept-stat-cdl 7-91

rept-stat-cdt 7-92

rept-stat-clk 7-93

rept-stat-cluster 7-98

rept-stat-db 7-105

rept-stat-dlk 7-122

rept-stat-dstn 7-123

rept-stat-eroute 7-132, 7-135, 7-232

rept-stat-gpl 7-140

rept-stat-imt 7-150

rept-stat-iptps 7-152

rept-stat-lfs 7-156

rept-stat-lnp 7-158

rept-stat-ls 7-164

rept-stat-lsms 7-167

rept-stat-meas 7-168

rept-stat-mps 7-170

rept-stat-mux 7-182

rept-stat-ndc 7-183

rept-stat-rte 7-184

rept-stat-rtkey 7-193

rept-stat-sccp 7-194

rept-stat-seas 7-212

rept-stat-seculog 7-213

rept-stat-slan 7-216

rept-stat-slk 7-219

rept-stat-sys 7-228

rept-stat-trbl 7-235

rept-stat-trm 7-239

rept-stat-trstslk 7-241

rept-stat-user 7-243

rept-stat-xlist 7-244

rept-x25-meas 7-245

Response Messages 4-15

rls-alm 7-247

rmv-card 7-248

rmv-imt 7-249

rmv-trm 7-251

rst-card 7-252

rst-dstn 7-254

rst-imt 7-255

rst-trm 7-256

rtrv 7-534

rtrv-acg-mic 7-257

rtrv-acg-noc 7-259

rtrv-appl-rtkey 7-260

rtrv-appl-sock 7-270

rtrv-as 7-273

rtrv-asp 7-274

rtrv-assoc 7-275

rtrv-atm-lps 7-281

rtrv-atm-prm 7-287

rtrv-attr-seculog 7-288

rtrv-bip 7-288

rtrv-card 7-292

rtrv-cmd 7-297

rtrv-cmdclass 7-300

rtrv-csl 7-301

rtrv-cspc 7-308

rtrv-ctrl-feat 7-310

rtrv-data-rtdb 8-48

rtrv-dcmps 7-314

rtrv-dlk 7-315

rtrv-dstn 7-317

rtrv-e1 7-345

rtrv-eisopts 7-348

rtrv-feat 7-348

rtrv-ftp-serv 7-350

rtrv-gpl 7-353

rtrv-gsmmap-scrn 7-361

rtrv-gsmopts 7-366

rtrv-gsms-opcode 7-370

rtrv-gsmssn-scrn 7-373

rtrv-gta 7-374

rtrv-gtt 7-383, 7-385

rtrv-gttsel 7-396

rtrv-gttset 7-400
 rtrv-gtw-stp 7-402
 rtrv-gtwy-acthresh 7-402
 rtrv-gtwy-prmtrs 7-404
 rtrv-gws-actset 7-404
 rtrv-gws-redirect 7-406
 rtrv-homern 7-408
 rtrv-home-smisc 7-407
 rtrv-inpopts 7-409
 rtrv-ip-card 7-410
 rtrv-ip-host 7-412
 rtrv-ip-lnk 7-413
 rtrv-ip-node 7-415, 7-419
 rtrv-ip-rte 7-417
 rtrv-isupvar-attrib 7-419
 rtrv-l2t 7-421
 rtrv-l3t 7-423
 rtrv-lbp 7-426
 rtrv-lnp-dbts 7-428
 rtrv-lnp-dpcer 7-429
 rtrv-lnp-lrn 7-433
 rtrv-lnp-npanxx 7-436
 rtrv-lnpopts 7-452
 rtrv-lnp-serv 7-439
 rtrv-lnp-sp 7-440
 rtrv-lnp-sub 7-442
 rtrv-lnp-trrpt 7-447
 rtrv-lnp-ttmap 7-449
 rtrv-log 7-453
 rtrv-ls 7-463
 rtrv-m2pa-tset 7-483
 rtrv-map 7-487
 rtrv-measopts 7-494
 rtrv-meas-sched 7-492
 rtrv-mem 7-497
 rtrv-mrn 7-498
 rtrv-na 7-502
 rtrv-netopts 7-503
 rtrv-oap-config 7-503
 rtrv-prefix 7-516
 rtrv-pstn-pres 7-518
 rtrv-rmt-appl 7-519
 rtrv-rte 7-520
 rtrv-sccp-serv 7-534
 rtrv-scr-aftpc 7-538
 rtrv-scr-blkdpc 7-543
 rtrv-scr-blkopc 7-549
 rtrv-scr-cdpa 7-555
 rtrv-scr-cgpa 7-561
 rtrv-scr-destfld 7-567
 rtrv-scr-dpc 7-572
 rtrv-scr-isup 7-578
 rtrv-scr-opc 7-581
 rtrv-scrset 7-593
 rtrv-scr-sio 7-586
 rtrv-scr-tt 7-591
 rtrv-secu-dflt 7-597
 rtrv-seculog 7-605
 rtrv-secu-trm 7-599
 rtrv-secu-user 7-602
 rtrv-serial-num 7-611
 rtrv-sg-opts 7-611
 rtrv-shlf 7-613
 rtrv-sid 7-614
 rtrv-slt 7-627
 rtrv-spc 7-629
 rtrv-split-npa 7-633
 rtrv-srvsel 7-634
 rtrv-ss7opts 7-642
 rtrv-ss-appl 7-640
 rtrv-stpopts 7-643
 rtrv-subnetid 7-648
 rtrv-t1 7-649
 rtrv-tbl-capacity 7-652
 rtrv-th-sccp 7-654, 7-655
 rtrv-trbl 7-656
 rtrv-trbltx 7-658
 rtrv-trm 7-664
 rtrv-tt 7-679
 rtrv-ttmap 7-682
 rtrv-uaps 7-684
 rtrv-uim-acthresh 7-688
 rtrv-user 7-689
 rtrv-x25-dstn 7-693
 rtrv-x25-rte 7-694
 rtrv-x25-slk 7-698

S

sctp 9-111
 send-msg 8-53
 set-date 7-700
 set-gtwy-acthresh 7-700
 set-mem 8-56
 set-scrrej-prmtrs 7-702
 set-time 7-702

Index

set-uim-acthresh 7-704
sockrtrt 9-120
sockstate 9-123
SST possible values A-3
system security
 command classes 4-17
 intrusion alert 4-18
 login security checks 4-17

T

TDM card
 as part of MASP 4-2
 connection of terminals and printers to 4-5
telnet terminals 4-6
terminal disk module See TDM card 4-2
terminals
 arrow key operations 4-12
 configuration of 4-3
 connection to TDM 4-5
 directing unsolicited messages to 4-15
 EMSALM 4-8
 telnet 4-6
 VT320 4-3
traceroute 9-126
tst-bip 7-706
tst-disk 7-707
tst-dlk 7-710
tst-e1 7-712, 7-721
tst-imt 7-714
tst-slk 7-716
turn off
 controlled features 5-92
 LNP ELAP Configuration feature 5-93
turn on
 controlled features 5-92
 LNP ELAP Configuration feature 5-93
 LNP feature 6-140

U

ualog 9-133
ublk-slk 7-722
unhb-alm 7-724
unhb-slk 7-729
unlock 7-731
unsolicited messages
 definition 4-15

output groups 4-15
User IDs
 already in use at login 4-22
 not accepted at login 4-20
 rules for administering 4-17
User Names See User IDs 4-16
user session, log into system for 4-19

V

vfy-lnp-refnum 8-58
VT320 terminals 4-3
 key sequences 4-10
 KSR function on 4-5