



Siebel Pricing Administration Guide

Siebel Innovation Pack 2014
November 2014

ORACLE®

Copyright © 2005, 2014 Oracle and/or its affiliates. All rights reserved.

This software and related documentation are provided under a license agreement containing restrictions on use and disclosure and are protected by intellectual property laws. Except as expressly permitted in your license agreement or allowed by law, you may not use, copy, reproduce, translate, broadcast, modify, license, transmit, distribute, exhibit, perform, publish, or display any part, in any form, or by any means. Reverse engineering, disassembly, or decompilation of this software, unless required by law for interoperability, is prohibited.

The information contained herein is subject to change without notice and is not warranted to be error-free. If you find any errors, please report them to us in writing.

If this is software or related documentation that is delivered to the U.S. Government or anyone licensing it on behalf of the U.S. Government, the following notice is applicable:

U.S. GOVERNMENT END USERS: Oracle programs, including any operating system, integrated software, any programs installed on the hardware, and/or documentation, delivered to U.S. Government end users are "commercial computer software" pursuant to the applicable Federal Acquisition Regulation and agency-specific supplemental regulations. As such, use, duplication, disclosure, modification, and adaptation of the programs, including any operating system, integrated software, any programs installed on the hardware, and/or documentation, shall be subject to license terms and license restrictions applicable to the programs. No other rights are granted to the U.S. Government.

This software or hardware is developed for general use in a variety of information management applications. It is not developed or intended for use in any inherently dangerous applications, including applications that may create a risk of personal injury. If you use this software or hardware in dangerous applications, then you shall be responsible to take all appropriate fail-safe, backup, redundancy, and other measures to ensure its safe use. Oracle Corporation and its affiliates disclaim any liability for any damages caused by use of this software or hardware in dangerous applications.

Oracle and Java are registered trademarks of Oracle and/or its affiliates. Other names may be trademarks of their respective owners.

Intel and Intel Xeon are trademarks or registered trademarks of Intel Corporation. All SPARC trademarks are used under license and are trademarks or registered trademarks of SPARC International, Inc. AMD, Opteron, the AMD logo, and the AMD Opteron logo are trademarks or registered trademarks of Advanced Micro Devices. UNIX is a registered trademark of The Open Group.

This software or hardware and documentation may provide access to or information on content, products, and services from third parties. Oracle Corporation and its affiliates are not responsible for and expressly disclaim all warranties of any kind with respect to third-party content, products, and services. Oracle Corporation and its affiliates will not be responsible for any loss, costs, or damages incurred due to your access to or use of third-party content, products, or services.

Documentation Accessibility

For information about Oracle's commitment to accessibility, visit the Oracle Accessibility Program website at <http://www.oracle.com/pls/topic/lookup?ctx=acc&id=docacc>.

Access to Oracle Support

Oracle customers have access to electronic support through My Oracle Support. For information, visit <http://www.oracle.com/pls/topic/lookup?ctx=acc&id=info> or visit <http://www.oracle.com/pls/topic/lookup?ctx=acc&id=trs> if you are hearing impaired.

Contents

Chapter 1: What's New in This Release

Chapter 2: Overview of Pricing Administration

- About Pricing Administration 13
- Activating Pricing Workflows 14
- Enhancements Introduced in Siebel Pricer Version 7.8 14
- About the Processing Order of Price Adjustments 15
- Clearing Pricing Data from the Cache 16
- Which Type of Promotion Pricing to Use 16

Chapter 3: Creating and Assigning Price Lists

- About Price Lists 17
- About Sales Products and Service Products 18
- Price List Prerequisites 18
- Process of Creating a Price List 19
 - Defining a Price List Header 19
 - Adding Price List Line Items for Products 21
 - Adding Price List Line Items for Service Products 24
- About Setting Up Service Pricing 25
 - Setting Up Service Pricing as a Percentage of a Covered Product 26
 - Setting Up Service Pricing with Adjustments Based on a Covered Product 27
- About Effective Dates for Pricing Line Items 29
- Giving a Product Multiple Prices with Different Effective Dates 32
- Creating a Price List Line Item for a Simple Product Bundle 32
- Copying and Modifying a Price List 33
- Copying and Transforming a Price List 33
- Importing Price Lists 34
- Assigning Price Lists to Users 35
- Enabling Price List-Specific and Line Item-Specific Pricing Logic 35

Chapter 4: Creating and Assigning Rate Lists

- About Rate Lists 37
- Process of Creating Rate Lists 38
 - Creating Resources as Products 38
 - Creating a Rate List Record 38
 - Creating Rate List Line Items 39
- Copying and Modifying a Rate List 40
- Copying and Transforming a Rate List 41
- Assigning a Rate List to a User 42

Chapter 5: Creating and Using Cost Lists

- About Cost Lists 43
- Process of Creating Cost Lists 44
 - Creating the Price List or Rate List the Cost List Will Reference 44
 - Creating the Cost List Record 44
 - Creating the Cost List Line Item Records 45
 - Entering the Indirect Costs 46
 - Associating the Cost List with a Price List or Rate List 47
 - Updating a Price List's Costs 48
 - Viewing the Product Cost and Margin 48
- Using Asset Mapping to Value Assets 49

Chapter 6: Creating Volume Discounts

- About Volume Discounts 51
 - About Reusing Volume Discounts for Multiple Currencies 52
 - Volume Discounts and Products with Components 52
 - Volume Discounts Across Line Items 52
- Process of Setting Up a Volume Discount 53
 - Creating a Volume Discount Record 53
 - Creating Volume Discount Line Items 54
 - Linking the Volume Discount to a Price List or Discount Matrix 55

Chapter 7: Creating Aggregate Discounts

- About Aggregate Discounts 57
- Buy and Receive Products for Aggregate Discounts 58
- Process of Creating Aggregate Discounts 58
 - Adding an Aggregate Discount Record 59

Defining Aggregate Discount Sequence	60
Attaching an Aggregate Discount Sequence to a Price List	62
Aggregate Discounts for Buy One, Get One Free Discounts	63
Aggregate Discounts for Products with Components	63

Chapter 8: Creating Product Promotions

About Product Promotions	65
Process of Creating Product Promotions	66
Setting Up Image Files for Product Promotions	66
Creating the Product Promotion Record	67
Specifying Products for Product Promotions	69
Specifying Pricing for Product Promotions	71
Defining Eligibility Rules for Product Promotions	75
Defining Compatibility Rules for Product Promotions	75
Customizing Recommendation Messages for Product Promotions	76
Creating Translations of Recommendation Messages for Product Promotions	76
Specifying Terms and Conditions of Product Promotions	77
Releasing the Product Promotion	81
Creating Product Promotions That Upgrade Existing Promotions	82
Viewing a Summary of a Product Promotion	83
Managing Versions of Product Promotions	83
Viewing the Schedules of All Product Promotions	84
About Product Promotions for Customizable Products	84
Changing the Cardinality of Components of Product Promotions	85
Constraining the Products Available for a Component of a Product Promotion	86
Constraining the Attributes Available for a Product in a Product Promotion	86
Activating Workflows for Product Promotion	87

Chapter 9: Creating Product Offers

About Product Offers	89
About Versions of Product Offers	90
About Actions for Responses to Product Offers	91
Process of Creating Product Offers	94
Creating Product Offers	94
Creating Responses for Product Offers	95
Creating Actions for Responses to Product Offers	96
Creating Eligibility and Compatibility Rules for Product Offers	100

- Creating Product Offer Recommendations 101
- Creating Translations for Product Offer Messages 102
- Releasing Product Offers 103
- Product Offers with Named Parameters 104
 - Scenario for Setting Up Product Offers with Named Parameters 104
 - Creating Product Offers with Named Parameters 105
- Example of Creating Product Offers with Parent Actions 107
- Modifying Product Offers 108
- Viewing Product Offers for an Account 109
- Tasks for Suppressing Product Offer Recommendations 109
 - Suppressing Product Offer Recommendations that Have Been Accepted or Rejected 110
 - Suppressing Component Product Recommendations 110
- Migrating Product Offers Using Workspace Projects 111
- Workflow Reference for Product Offers 112
 - RAF Create Document Workflow 114
 - RAF Update Recommendation Workflow 117
 - RAF Update Recommendation SubProcess Workflow 118
 - RAF Submit Order Process Workflow 118
 - RAF Create Activity Workflow 119
 - RAF Product Offer Recommendation For Asset Workflow 119
 - RAF Recommendation Driver Workflow 120
 - RAF Prepare Header Sub Process Workflow 121
 -RAF Prepare Actions Sub Process Workflow 122
 - RAF Check Prepaid Balance Workflow 125
 - RAF Get Active Document Workflow 126
 - RAF Consolidate Actions Sub Process Workflow 126
 - RAF Check For Promotion Sub Process Workflow 127
 - RAF Ensure New Line Item Workflow 129
 - RAF RunProcess Driver Workflow 130
 - RAF Get Named Parameter Workflow 131
 - RAF Get Named Parameter For Web Call Workflow 132
 - RAF Apply Offer To Create Order Web Workflow 134
 - RAF Apply Offer To Create Quote Web Service Workflow 135
 - Product Offer GetProductOffer Workflow 137
 - Product Offer GetProductOfferStructure Workflow 138
 - Product Offer GetRecommendedProductOffers Workflow 138

Chapter 10: Creating Discount Matrices

- About Discount Matrices 141
- About Discount Matrix Dimensions 142

About Discount Matrix Types	143
Product-Based Adjustment Discount Matrices	143
Entitlement-Based Adjustment Discount Matrices	144
Training-Based Adjustment Discount Matrices	145
Defining a Discount Matrix	146
Entering Discount Matrix Details	147
Discount Matrix Integration	147
About Configuring Discount Matrices	148
Adding New Dimensions to Existing Discount Matrix Types	149
Creating New Discount Matrix Types for Custom Tables	150

Chapter 11: Creating Attribute Adjustments

About Attribute Pricing	153
Attribute Adjustments Design	154
About the Attribute Adjustments View	154
Variable Maps in Attribute Adjustments	156
Using System Preferences to Set Up Variable Maps for Pricing Adjustments	157
Using the Variable Maps View to Set Up Variable Maps for Pricing Adjustments	157
How Attribute Adjustments Apply Rules	158
Single and Multiple Type Attribute Adjustments	159
Order of Conditions in Multiple-Condition Pricing Tables	160
About Wildcards in Attribute Adjustments	161
Preventing Users from Selecting Invalid Combinations of Attributes	162
Process of Creating an Attribute Adjustment	165
Adding an Attribute Adjustment Record	165
Specifying Attribute Adjustment Dimensions and Domains	166
Adding Attribute Adjustment Conditions	170
Associating Attribute Adjustments with Price List Line Items	170
Example of Creating an Attribute Adjustment Based on Product Attributes	171
Example of Creating an Attribute Adjustment with Nonproduct Attributes	175
Guidelines for Creating Attribute Adjustments	182
How the Pricing Procedure Uses Attribute Adjustments	183
Upgrade Considerations for Attribute Adjustments	183

Chapter 12: Setting Up Pricing for Products with Components

- About Component-Based Pricing 185
- Impact of Product Versions and Price List Line Item Effectivity on Component-Based Pricing 186
- Viewing a Product's Components in the Pricing Designer 187
- About Setting Up Component-Based Pricing 188
 - Setting Up Base Pricing for Products With Components 188
 - Setting Up Summation or Rollup Pricing for Products With Components 189
- Viewing and Changing the Reference Price 191
 - Viewing the Reference Price 192
 - Exposing the Starting Price At in the Product Catalog 192
- Defining a Relationship-Based Price Adjustment 195
- Verifying Component Prices Across Time Intervals 196

Chapter 13: Creating Pricing Reports

- About Pricing Reports 199
- Running Reports 199
- About Creating and Modifying Reports 200

Chapter 14: Pricing in the Run-Time Application

- Pricing Waterfalls 201
 - Configuring Pricing Waterfalls 202
- Contract-Based Pricing 204
 - About Hierarchical Contract-Based Pricing 204
 - Defining Contract Pricing in the Agreements Screen 204
 - Defining Contract Pricing in the Discount Matrices View 205
 - Giving the Customer the Best Entitlement Price 206
- Multiple Price Types and Totals 206
- About Configuring Pricing Fields in Catalog, eSales, and Configurator 207
- Multiple Currencies in a Quote, Order, or Agreement 207
- Spread Discount Pricing 208
 - About the Spread Discount Algorithm 208
 - About Use of the Spread Discount Service with Pricing Procedures 209
 - About Configuring the Spread Discount Source Field 209
- Totaling and Rollups of Pricing 210

Appendix A: Siebel Pricer Technical Reference

Siebel Pricer Architecture	211
Pricing Procedures and Workflow References	213
PSP Driver Workflow Process Workflow	213
Basic Pricing Procedure Workflow	214
Dynamic Pricing Procedure Workflow	223
Pricing Procedure - Calculate Net Price Workflow	227
Pricing Procedure - Aggregate Discounts Workflow	230
Pricing Procedure - Service Workflow	231
Switching from Basic to Dynamic Pricing Procedure	232
Modifying Signals from Basic Pricing Procedure to Dynamic Pricing Procedure	234
Manually Enabling the Dynamic Pricing Procedure	235
Manual Signal Modifications for Siebel Business Applications and Industry Applications	235
Manual Signal Modifications for Communications, Media and Energy Applications	246
Miscellaneous Pricing Workflows	248
PSP Dynamic Matrix - Refresh Matrix Cache Workflow	248
PSP Waterfall Synch to DB Workflow	249
Spread Discount Driver Workflow	249

Appendix B: Siebel Pricer Deployment and Integration

About Pricing Integration	251
Integration Methods for Siebel Pricer	253
Internal Integration of Siebel Pricer	253
Changing the Base Class of the Business Component to User CSSBCOrderMgmtBase	254
Setting Up the Context Service Variable Map Integration Object and Mode	254
Triggering CalculatePriceForOpportunity	254
Designing the CalculatePriceForOpportunity Signal	255
Creating an Integration Object	256
Creating the Variable Map	257
Creating the Pricing Procedure	259
Sample Pricing Procedure for Internal Integration	259
External Integration of Siebel Pricer Using Pricer as a Service	274
Sample XML Input Property Set for External Integration	276
Sample XML Output Property Set for External Integration	280
Siebel Pricing Manager API Reference	287
Workflows for External Pricing API	290
CalculatePriceExternal Workflow	290

Get Config Item Price Workflow	291
Get Product List Price Workflow	292
Cache Configuration Settings	293

Index

1

What's New in This Release

What's New in Siebel Pricing Administration Guide, Siebel Innovation Pack 2014

No new features have been added to this guide for this release. This guide has been updated to reflect only product name changes.

NOTE: Siebel Innovation Pack 2014 is a continuation of the Siebel 8.1/8.2 release.

What's New in Siebel Pricing Administration Guide, Version 8.1/8.2

No new features have been added to this guide for this release. This guide has been updated to reflect only product name changes.

2

Overview of Pricing Administration

This chapter gives a general overview of pricing administration for Oracle's Siebel Pricer application, and it describes how you log on as Siebel Administrator. It also describes the processing order of price adjustments. This chapter covers the following topics:

- ["About Pricing Administration" on page 13](#)
- ["Activating Pricing Workflows" on page 14](#)
- ["Enhancements Introduced in Siebel Pricer Version 7.8" on page 14](#)
- ["About the Processing Order of Price Adjustments" on page 15](#)
- ["Clearing Pricing Data from the Cache" on page 16](#)
- ["Which Type of Promotion Pricing to Use" on page 16](#)

About Pricing Administration

Siebel Pricer allows you to work with the following:

- **Price lists, rate lists, and cost lists.** Create price lists, rate lists, and cost lists. For more information, see the following chapters:
 - [Chapter 3, "Creating and Assigning Price Lists"](#)
 - [Chapter 4, "Creating and Assigning Rate Lists"](#)
 - [Chapter 5, "Creating and Using Cost Lists"](#)
- **Volume discounts.** Give customers a discount if they buy in volume. For example, if a customer buys more than one hundred units, then the customer can get a 10 percent discount. For more information, see [Chapter 6, "Creating Volume Discounts."](#)
- Promotion pricing. There are two types as follows:
 - **Aggregate discounts.** Give customers a discount if they buy a group of products. For more information, see [Chapter 7, "Creating Aggregate Discounts."](#)
 - **Product promotions.** Create promotions that can be selected in quotes, orders, and catalogs, can be tracked as assets, can have commitments tied to them, and can have rules and penalties defined for future changes. For more information, see [Chapter 8, "Creating Product Promotions."](#)
- **Discount matrices.** Create a matrix of rules to define price adjustments. For more information, see [Chapter 10, "Creating Discount Matrices."](#)
- **Attribute adjustments.** Create a matrix of rules to define attribute-based pricing. Attribute adjustment provides flexibility to map rules to attributes or fields in any business component. For more information, see [Chapter 11, "Creating Attribute Adjustments."](#)

- **Products with components.** Define pricing for products whose components customers can choose. For example, when a customer buys a computer, the customer can choose to add peripherals such as a CD-ROM drive. For more information, see [Chapter 12, "Setting Up Pricing for Products with Components."](#)
- **Pricing reports.** Create a variety of reports to track your pricing policies. For more information, see [Chapter 13, "Creating Pricing Reports."](#)
- **Customizing pricing logic.** Pricing logic is based on pricing procedures, so it is fully configurable. For more information, see [Appendix A, "Siebel Pricer Technical Reference."](#)

Activating Pricing Workflows

To make pricing functionality available to users, you must activate the pricing workflows. For a complete list of these workflows, see [Appendix A, "Siebel Pricer Technical Reference."](#) For information about how to activate workflows, see *Siebel Business Process Framework: Workflow Guide*.

Enhancements Introduced in Siebel Pricer Version 7.8

The most important enhancements introduced in Siebel Pricer 7.8 are summarized in this topic.

Pricing Is Based on Pricing Procedures

Pricing logic is defined using pricing procedures. These procedures are based on the Product Selection and Pricing (PSP) engine. The advantage of using the PSP engine is that pricing is fully configurable. For more information about the PSP engine, see *Siebel Order Management Infrastructure Guide*. For information about the procedures used for pricing, see [Appendix A, "Siebel Pricer Technical Reference."](#)

Because you can use pricing procedures to define pricing logic, pricing models and pricing factors are no longer used in Siebel Pricer version 7.8 or later.

Effective Dates for Line Items

You can set the effective dates for the line items of price lists, cost lists, discount matrices, component product price adjustments, or service prices. For more information, see ["Giving a Product Multiple Prices with Different Effective Dates" on page 32](#).

Discount Matrices

Matrix-based administration of price adjustments using discount matrices is allowed. For more information, see [Chapter 10, "Creating Discount Matrices."](#)

Attribute Adjustments

You use attribute adjustments view to specify pricing for products with attributes. For more information, see [Chapter 11, "Creating Attribute Adjustments."](#)

Price Waterfalls

Call center agents and sales representatives can view a price waterfall that shows the calculations that were used to arrive at the net price that is displayed in a quote, order, or agreement. For more information, see [“Pricing Waterfalls” on page 201](#).

Enhancements in Pricing for Component Products

The following pricing enhancements for component products are available:

- Product versions allow you to create multiple future release versions for products.
- Line item effective dates in a price list allow you to create multiple line items in a price list for a product, with different effective dates and different prices.
- Every component adjustment can have an effective start and end date.

For more information, see [Chapter 12, “Setting Up Pricing for Products with Components.”](#)

Volume Discount Enhancements

Volume discounts provide multiple types of price adjustments, such as percentage markup and markup amount. For more information, see [Chapter 6, “Creating Volume Discounts.”](#)

Enhancements Across the Application

In addition to the features used to set up pricing, there are also many enhancements to pricing behavior in quotes and orders. For example, there is support for multiple price types and multiple currencies. For more information, see [Chapter 14, “Pricing in the Run-Time Application.”](#)

About the Processing Order of Price Adjustments

The order in which price adjustments are processed can affect the final price. For example, a product costs \$100 and you give a \$10 promotional discount plus a 10 percent volume discount if the customer buys more than ten. If the customer qualifies for both discounts, then you can calculate the final price in two ways:

- The unit cost would be \$81 if the promotional discount is applied first ($\$100 - \$10 = \$90$, and 10 percent off \$90 is \$81).
- The unit cost would be \$80 if the volume discount is applied first (10 percent off \$100 is \$90, and $\$90 - \$10 = \$80$).

The pricing procedure determines the processing order of discounts, but you can customize it. For information about the default processing order, see [“Pricing Procedures and Workflow References” on page 213](#).

Clearing Pricing Data from the Cache

After price list data is read from the database, it is cached in memory to improve performance. If a price list is modified, then the cached pricing data may no longer be valid.

When modified or newly developed pricing data is added to the database, the user clicks the Clear Cache button to remove cached data that may be obsolete.

The Clear Cache button is available in the Price Lists view, Volume Discount view, and many other views. In any view, it clears only the selected price list, volume discount, or other pricing data from the cache. Other pricing data remains in the cache to improve performance. For information about setting up caching, see *Siebel Order Management Infrastructure Guide*.

To clear pricing data from the cache

- 1 Navigate to the Administration - Pricing screen, then Price Lists view, Volume Discount view, or other appropriate view.
- 2 Select one or more Price List records, Volume Discount records, or other pricing records whose cached data may be obsolete.
- 3 Click Clear Cache.

Which Type of Promotion Pricing to Use

Siebel Pricer provides two types of promotions:

- **Aggregate discount promotions.** These promotions allow you to give discounts to customers who buy a combination of products, as described in [Chapter 7, "Creating Aggregate Discounts."](#) You use this type of promotion to maintain promotions that were defined using bundle pricing factors in earlier versions of Siebel Pricer.
- **Product promotions.** These promotions allow you to create many types of promotions, including bundle promotions, as described in [Chapter 8, "Creating Product Promotions."](#) This type of promotion has features such as the ability to display promotions in product catalogs and quote line items. It is recommended that you use product promotions for most new promotions.

3

Creating and Assigning Price Lists

This chapter begins with an overview of price lists, and then describes the most common way of creating a new price list. It also instructs you on assigning price lists to users. This chapter covers the following topics:

- ["About Price Lists"](#)
- ["About Sales Products and Service Products"](#)
- ["Price List Prerequisites" on page 18](#)
- ["Process of Creating a Price List" on page 19](#)
- ["About Setting Up Service Pricing" on page 25](#)
- ["About Effective Dates for Pricing Line Items" on page 29](#)
- ["Giving a Product Multiple Prices with Different Effective Dates" on page 32](#)
- ["Creating a Price List Line Item for a Simple Product Bundle" on page 32](#)
- ["Copying and Modifying a Price List" on page 33](#)
- ["Copying and Transforming a Price List" on page 33](#)
- ["Importing Price Lists" on page 34](#)
- ["Assigning Price Lists to Users" on page 35](#)
- ["Enabling Price List-Specific and Line Item-Specific Pricing Logic" on page 35](#)

About Price Lists

A *price list* is a set of standard prices for products or services.

A product must exist in a price list so that it appears in a catalog. So, the price list is one of the requirements for a product's visibility.

A product price defined in a price list is commonly used as the starting price for other prices generated by Siebel Pricer. Test the price list thoroughly before applying more advanced price adjustments.

This chapter describes the four common ways of creating a price list:

- Create a new price list
- Copy and modify an existing price list
- Copy and transform an existing price list
- Import price lists from other applications using Siebel Enterprise Integration Manager (EIM)

After you create a price list, you must assign it to customers so that it controls the prices available to customers.

A product can appear in many different price lists. For example, you can create:

- One price list with the wholesale prices for all of your products.
- One price list with the retail prices for all of your products.

The line item records of these two price lists will have different prices for the same products. You assign these price lists to the appropriate customers.

About Sales Products and Service Products

Price lists can include prices for two different types of products:

- **Sales products.** This is any product that is sold to a customer.
- **Service products.** This is a specialized type of sales product consisting of a service that covers another sales product, such as a warranty service.

Price List Prerequisites

Before you create any price list, you must create the products to which the prices will apply. You must define products. For more information, see *Siebel Product Administration Guide*.

Optional Prerequisites

The price list includes optional fields that let you associate it with other data in the Siebel application. You must define the other data before you can use these optional fields.

For example, if you want a price list to use volume discounts, then you must define volume discount information before you can associate it with line items in a price list.

You do not have to define this data before creating the price list. You can skip these optional fields when you create the price list, and go back to the price list to fill them in later, after defining the data that is needed.

The types of data that can optionally be associated with price lists include:

- **Pricing procedure.** You can create a custom pricing procedure with pricing logic specific to a price list or to line items. For more information, see [“Enabling Price List-Specific and Line Item-Specific Pricing Logic” on page 35](#).
- **Rate lists.** For more information, see [Chapter 4, “Creating and Assigning Rate Lists.”](#)
- **Cost lists.** For more information, see [Chapter 5, “Creating and Using Cost Lists.”](#)
- **Volume discounts.** For more information, see [Chapter 6, “Creating Volume Discounts.”](#)

- **Aggregate discount sequences.** For more information, see [Chapter 7, “Creating Aggregate Discounts.”](#)
- **Attribute adjustments.** For more information, see [Chapter 11, “Creating Attribute Adjustments.”](#)
- **Component-based pricing adjustments.** For more information, see [Chapter 12, “Setting Up Pricing for Products with Components.”](#)

Process of Creating a Price List

A price list consists of one price list header record that is associated with multiple line item records. The header record contains general information about the price list as a whole. The line item records contain prices for specific products.

There are two types of line items:

- **Sales products.** Enter line items for sales products in the Price List Line Items view.
- **Service products.** Enter line items for service products in the Service Pricing view.

A single price list can contain one or both of these types of line items. For more information about sales and service products, see [“About Sales Products and Service Products” on page 18.](#)

To create a new price list, perform the following tasks:

- 1 [“Defining a Price List Header” on page 19](#)
- 2 [“Adding Price List Line Items for Products” on page 21](#)
- 3 [“Adding Price List Line Items for Service Products” on page 24](#)

NOTE: Creating a price list line item for a product with components is more complex than creating a line item for a simple product. Consult with a Siebel Administrator before creating price lists for products with components. For more information about products with components, see [Chapter 12, “Setting Up Pricing for Products with Components.”](#)

Defining a Price List Header

This task is a step in [“Process of Creating a Price List” on page 19.](#)

Each price list is defined by the data in its header, which includes its name, describes its purpose, and specifies the time period when it will be effective.

The price list header does not hold the actual prices for products. Prices are in the associated price list line items.

To define a price list header

- 1 Navigate to the Administration - Pricing screen, then Price Lists view.
- 2 In the Price Lists list, add a new record and complete the necessary fields.

Some fields are described in the following table:

Field	Comments
Name	<p>Enter a meaningful name for this price list. Overwrite any Siebel-Pricer-generated name.</p> <p>If many price lists appear in your Siebel application, then use a consistent naming convention to name all your price lists.</p>
Cost List	Select the cost list you want to associate with this price list.
Currency	Enter the default currency for this price list.
Shipping Method	Select one default shipping method you want to associate with this price list. This appears as the default Shipping Method when a run-time user creates a quote or order that specifies this price list.
Payment Terms	Select one default set of payment terms to be associated with this price list. This selection appears as the default data for Payment Terms when a run-time user creates a Quote or Order that specifies this price list.
Organization	Select all the organizations that may have prices controlled by this price list. For more information, see "Assigning Price Lists to Users" on page 35 .
Ship Method	Enter the mode used for shipping such as air, ground, and so on.
Shipping Terms	Select one default shipping charge protocol that you want to associate with this price list. This appears as the default Shipping Terms data when a run-time user creates a quote or order that specifies this price list.
Effective From	Enter the date and time when this price list will become effective. By default, Siebel Pricer assigns the current system date and time when you first create the Price List record.
Effective To	Enter the date and time when this price list will become ineffective. After this time, Siebel applications will not be able to use this price list.
Updated By	By default, Siebel Pricer assigns the user name used to log in to the current session in which this Price List record is created.
Last Updated	By default, Siebel Pricer assigns the current system date and time when you most recently saved this Price List record.
Integration ID	If this Siebel-Pricer-generated ID appears, then you can use it as a unique identifier for this price list to assist with integration tasks. The Integration ID field is used for integration with external applications. This field is populated by Siebel EAI connectors.

Field	Comments
Pricing Procedure	Select a custom pricing procedure. The pricing logic in this procedure will be applied to all the line items in the price list. Before this field is available, you must do the setup work described in “Enabling Price List-Specific and Line Item-Specific Pricing Logic” on page 35.
Aggregate Discount Sequence	Select an aggregate discount sequence in order to apply aggregate discounts to the price list. For more information, see Chapter 7, “Creating Aggregate Discounts.”

Adding Price List Line Items for Products

This task is a step in [“Process of Creating a Price List” on page 19.](#)

A price list line item for a product includes the product name, the product price, and related information. Adding a line item is equivalent to adding a product to the price list.

A line item for a product can appear in multiple price lists. For example, your United States price list might have a line item for the product’s retail price in the United States, your Canadian price list may have the product’s retail price in Canada, and so on.

NOTE: Creating a price list line item for a product with components is more complex than creating a line item for a simple product, and it requires additional steps that are not included in this procedure. For more information about products with components, see [Chapter 12, “Setting Up Pricing for Products with Components.”](#)

To add a new price list line item for a product

- 1 Navigate to the Administration - Pricing screen, then Price Lists view.
- 2 In the Price List form, select the price list to which you want to add a line item.
- 3 Click the Price List Line Items view tab.
- 4 In the Price List Line Items list, click New.
The Add Products dialog box appears.
- 5 Use the Add Products dialog box to add the product to the price list.
- 6 If the product is a product with components, then see the instructions in [Chapter 12, “Setting Up Pricing for Products with Components.”](#)
- 7 Complete the fields in the Price List Item record, and the Price List Line Item Detail form, as described in the following table:

CAUTION: If you do not specify a price for a product in its price list line item, then that product may appear in a quote or order without a price, effectively making it free to a run-time user who is buying it. If you depend on other pricing mechanisms to supply a missing price, then be sure to test the results in the run-time environment.

Field	Comments
Product	Select a product name using the Add Products dialog box.
Price Type	This field is read-only and displays the price type for this product. Options are One-Time, Recurring, and Usage. The value is based on the product definition. For more information about multiple price types, see “Multiple Price Types and Totals” on page 206 .
Customizable	When this check box is selected, it means that the product has components. This value is based on the product definition and is read-only.
List Price	<p>Enter a list price, the standard price used for most transactions and the most commonly used target price for price adjustments.</p> <p>If you enter a promotional price, then it is used instead of this list price.</p> <p>The list price is not checked against the Minimum Price and Maximum Price fields when it is first entered, because these fields are usually entered after the list price. When the minimum and maximum prices are entered, the list price is validated against them.</p> <p>NOTE: If the list price, promotional price, and price override are all omitted, then the product may be offered with no price, the equivalent of a zero price.</p>
Promotional Price	If you enter a promotional price, then it will be used instead of the list price in all functions that do not explicitly identify the list price as the target price.
Volume Discount	Select the volume discount that applies to this line item, if any. More than one volume discount may be available for a given product, and all the volume discounts that can apply to this product are displayed in the drop-down list. For more information, see Chapter 6, “Creating Volume Discounts.”
Attribute Adjustments	This field specifies the attribute adjustments record that provides attribute-based pricing adjustments for this line item, if any. For more information, see Chapter 11, “Creating Attribute Adjustments.”
Start Date and End Date	If this line item has different effective dates from the price list, then enter the start date when the pricing becomes effective and the end date when it is no longer effective. To enter values in these fields, use the method described in “Giving a Product Multiple Prices with Different Effective Dates” on page 32 .
Product Line	This field displays the product line to which this line item product belongs. This value is taken from the product information.

Field	Comments
Part Number (Part #)	This field displays the part number assigned to the line item product. This value is derived from the product information.
Cost	Enter the cost of the line item product. You can use this as the target price for some price adjustment calculations.
MSRP	Enter the manufacturer's suggested retail price (MSRP) for reference purposes. In some cases, you can use this as the target price for price adjustment calculations.
Purchase Price	Enter the purchase price of the line item product. You can use this as the target price for some price adjustment calculations.
Unit of Measure	This field displays the unit of measure for the product item. This value comes from the product definition.
Minimum Price	<p>If a minimum price value is provided, then Siebel Pricer does not offer a lower price for this line item, unless a run-time user (such as an agent) manually overrides this price.</p> <p>As a default, specify a minimum price of zero to prevent amount discounts from resulting in negative number prices.</p> <p>The minimum price does not apply to components of products with components.</p>
Maximum Price	<p>If a maximum price value is provided, then Siebel Pricer does not offer a higher price for this line item, unless a run-time user (such as an agent) manually overrides this price.</p> <p>If a maximum price is provided for a price list line item product and if that product appears as a component in a product with components, then this maximum price will apply to that component product as well.</p>
% Margin	<p>Read-only. This is a calculated field that calculates the margin based on the following formula:</p> $((\text{List or promotional price}) - \text{cost}) / \text{List} * 100$
Pricing Procedure	Select a custom pricing procedure. The pricing logic in this procedure will be applied to this line item. Before this field is available, you must do the setup work described in "Enabling Price List-Specific and Line Item-Specific Pricing Logic" on page 35.

Adding Price List Line Items for Service Products

This task is a step in [“Process of Creating a Price List” on page 19](#).

A price list line item for a specific service product includes the product name, the product price, and related information, such as the time when the service price is effective. Adding a record to the Service Pricing view is equivalent to adding a service product to the price list.

As a shortcut, if you are adding the same service product with different time intervals, then you can click the New Effective Date button to add another record for the same service product, so you have to enter only the new start date, end date, and price. The time interval is the period when the service is delivered.

You can also base service pricing on the covered asset, as described in [“About Setting Up Service Pricing” on page 25](#).

To add a new price list line item for a service product

- 1 Navigate to the Administration - Pricing screen, then Price Lists view.
The Price Lists view appears, displaying the currently defined price lists.
- 2 In the Price List form, select the price list to which you want to add a line item.
- 3 Click the Service Pricing view tab.
- 4 In the Service Pricing list, click New.
The Add Products dialog box appears.
- 5 Use the Add Products dialog box to add the product to the price list.
- 6 If the product is a product with components, then see the instructions in [Chapter 12, “Setting Up Pricing for Products with Components.”](#)
- 7 Complete the fields in the Service Pricing record and the Service Pricing Details form, as described in the following table:

Field	Comments
Product	Select a product name using the Add Products dialog box.
Customizable	When this check box is selected, it means that the product has components. This value is based on the product definition and is read-only in this screen.
Service Product	This check box is selected if this is a service product. This information depends on the product definition.
List Price	Enter a list price, the standard price used for most transactions and the most commonly used target price for price adjustments. NOTE: If the list price and price override are both omitted, then the product may be offered with no price, the equivalent of a zero price.

Field	Comments
Start Date and End Date	If this line item has different effective dates from the price list, then enter the start date when the pricing becomes effective, and the end date when it is no longer effective. To enter values in these fields, use the method described in “Giving a Product Multiple Prices with Different Effective Dates” on page 32.
Service Price Method	Specify the basis used for calculating the price markup of the service product from the covered product. The options are the list price and net price of the covered product. The percentage entered in the Service Price % field is applied to the price you specify in this field, and the resulting amount is added to the list price of the service to calculate the price.
Service Price %	Enter a percentage that is used to mark up the price of the service product. The price for this service product is the list price of the service product plus this percentage of the net or list price of the covered product, depending on whether you selected net price or list price in the Service Price Method field.

About Setting Up Service Pricing

You can set up service pricing in two ways:

- Price the service as a percentage of the covered product. For example, a one-year warranty can be priced at 10% of the price of the computer system that it covers. For information about how to do this, see [“Setting Up Service Pricing as a Percentage of a Covered Product”](#) on page 26.
- Price the service with adjustments based on a primary covered product. The price of the service can be equal to the list price of the service with a price adjustment based on the product that is covered. For information about how to do this, see [“Setting Up Service Pricing with Adjustments Based on a Covered Product”](#) on page 27.

In either case, the service pricing is triggered when the end user creates a quote or order and associates the service to the covered product.

NOTE: You must enable the [Dynamic Pricing Procedure](#) to use service pricing. For information about enabling the [Dynamic Pricing Procedure](#), see [“Switching from Basic to Dynamic Pricing Procedure”](#) on page 232.

Setting Up Service Pricing as a Percentage of a Covered Product

The price of the service is equal to the list price of the service plus a percentage of the price of the covered product.

This method of pricing is available without configuration.

To set up service pricing as a percentage of a covered product, perform the following tasks:

- ["Pricing a Service as a Percentage of a Covered Product" on page 26](#)
- ["Associating a Service with a Covered Product" on page 26](#)

Pricing a Service as a Percentage of a Covered Product

A service can be priced as a percentage of the covered product. Alternatively, there can be a list price for the service, and a percentage of the covered product is added to this list price.

To set up service pricing as a percentage of the covered product

- 1 Add the service price line item, as described in ["Adding Price List Line Items for Service Products" on page 24](#).
- 2 Complete the fields in the Service Pricing Details form described in the following table:

Field	Comments
Service Pricing Method	Select Net Price of List Price to determine whether the service price is a percentage of the net of list price of the covered product.
Service Price %	Enter the percentage of the covered product's price to use as the service price.
List Price	Enter a list price for the service product.

Associating a Service with a Covered Product

When the end user creates a quote or order for a service whose price is based on a product, the end user must associate the service with the product. For more information about how an end user creates a quote or order, see *Siebel Order Management Guide*.

To associate a service with a covered product

- 1 Create a quote or order as described in *Siebel Order Management Guide*.
- 2 Add the covered product as a line item.
- 3 From the Line Items applet menu, choose Service.

A dialog box appears that includes only service products.

- 4 Select the appropriate service product from the dialog box, and click OK.

The service product is added as a line item to the quote or order, and it is associated with the covered product. This association appears in the Covered Product field of the service product line item.

NOTE: As an alternative to choosing Service from the menu, you can directly populate the Covered Product field of the service line item to create an association between the service and the covered product.

Setting Up Service Pricing with Adjustments Based on a Covered Product

The price of the service equals the list price of the service plus a price adjustment that depends on the primary product that it covers.

NOTE: This method of pricing requires configuration of the pricing procedure. You must enable the Dynamic Pricing Procedure to use service pricing. For information about enabling the Dynamic Pricing Procedure, see [“Switching from Basic to Dynamic Pricing Procedure” on page 232](#).

To set up service pricing with adjustments based on a product, perform the following tasks:

- [“Pricing a Service with Adjustments Based On a Primary Covered Product” on page 27](#)
- [“Associating the Service Product with Covered Products” on page 28](#)

Pricing a Service with Adjustments Based On a Primary Covered Product

Pricing administrators can set up service pricing with an adjustment based on the primary product that is covered. For example, there can be a list price for a one-year service agreement, with a 10 percent discount if the agreement covers computer system A and a 15 percent discount if it covers computer system B.

To price a service with adjustments based on a product

- 1 Add the service price line item, as described in [“Adding Price List Line Items for Service Products” on page 24](#).
- 2 Add a record to the Service Pricing Details list for each product that the service covers and complete the necessary fields, as described in the following table:

Field	Comments
Product	Select the product to which this discount applies.
Adjustment Type	Select the type of the adjustment that the discount will apply. Options are Discount Amount, % Discount, Markup Amount, % Markup, and Price Override.
Target Price	Select the price to which the discount applies.

Field	Comments
Adjustment Value	<p>The value in the Adjustment Type field determines how the adjustment value is applied, as follows:</p> <ul style="list-style-type: none"> ■ If the Adjustment Type is Discount Amount, then the amount in the Adjustment Value field is subtracted from the price. ■ If the Adjustment Type is % Discount, then the amount in the Adjustment Value field is treated as a percentage and is subtracted from the price. For example, if the Adjustment Amount is 10, then 10 percent is subtracted from the price. ■ If the Adjustment Type is Markup Amount, then the amount in the Adjustment Value field is added to the price. ■ If the Adjustment Type is % Markup, then the amount in the Adjustment Value field is treated as a percentage and added to the price. ■ If the Adjustment Type is Price Override, then the amount in the Adjustment Amount field is used instead of the price.

Associating the Service Product with Covered Products

When the end user creates a quote or order for products that are covered by this service, the end user must associate the service with one or more products. The price adjustment for the service depends on the primary product. For more information about how an end user creates a quote or order, see *Siebel Order Management Guide*.

To associate a service with covered products

- 1 Create a quote or order as described in *Siebel Order Management Guide*.
 - 2 Add the service product as a line item of the quote or order.
 - 3 Click the Assets view tab.
 - 4 In the Assets list, add records and in the Asset # field, select the products covered by this service.
 - 5 In the Asset record of the primary product covered by this service, select the Primary check box.
- The price adjustment for the service depends on the primary product.

About Effective Dates for Pricing Line Items

You can create effective dates for individual line items in a price list, cost list, discount matrix, or component-product price adjustment. The application prevents you from entering overlapping effective dates for the same line item when you enter effective dates using the New Effective Date button, as described in [“Giving a Product Multiple Prices with Different Effective Dates”](#) on page 32.

For example, if a price list has a line item for Product X with a price that is effective from January 2005 through June 2005, then do not enter another line item for Product X with a price that is effective from March, 2005 through December 2005, because the product would have two different prices during several months.

This topic describes several scenarios that show how the application resolves overlapping dates.

The New Time Interval Overlaps with One Existing Time Interval

This topic describes several possible scenarios where a new time interval overlaps with an existing time interval.

If the effective dates in the new record overlap with the existing record’s start date, as shown in [Figure 1](#), or with the existing record’s end date, as shown in [Figure 2](#), then the application displays an error message and does not enter the new effective dates.

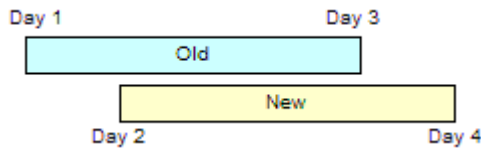

Figure 1. New Time Interval Overlaps with an Existing Start Date

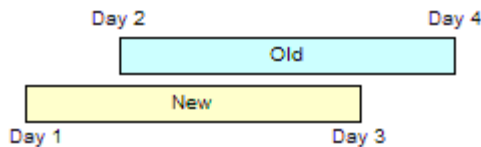

Figure 2. New Time Interval Overlaps with an Existing End Date

However, if the new time interval is entirely within an existing time interval and does not overlap with the start or end date, as shown in [Figure 3](#), then the application creates three time intervals, as shown in [Figure 4](#).

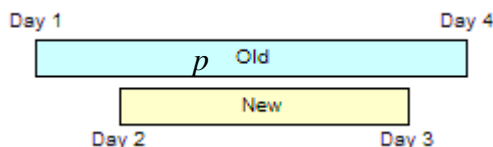

Figure 3. New Time Interval Is Within an Existing Time Interval

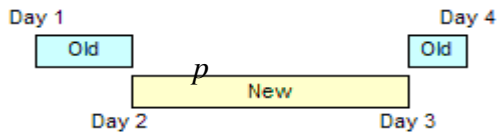

Figure 4. The Application Creates Three Time Intervals

Likewise, if the new time interval is entirely within an existing time interval but its end date is the same as the end date of the existing interval, as shown in [Figure 5](#), then the application creates two time intervals, as shown in [Figure 6](#).

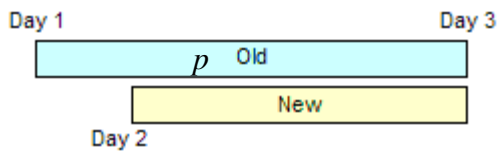

Figure 5. New Time Interval Is Within an Existing Time Interval and Has the Same End Date

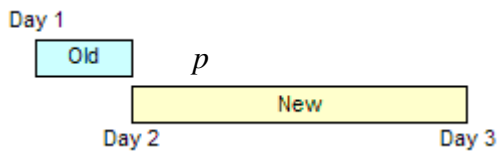

Figure 6. The Application Creates Two Time Intervals

However, if the new time interval is entirely within an existing time interval but its start date is the same as the start date of the existing interval, as shown in [Figure 7](#), then the application displays an error message and does not create the new time interval.

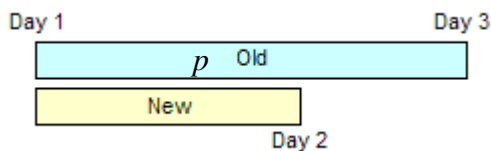

Figure 7. New Time Interval Is Within an Existing Time Interval and Has the Same End Date

However, if the new time interval extends beyond the existing time interval, as shown in [Figure 8](#), then the application displays an error message and does not create the new time interval.

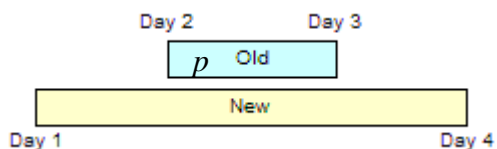

Figure 8. New Time Interval Extends Beyond an Existing Time Interval

The New Time Interval Overlaps with Two Existing Time Interval

This topic describes the possible scenarios where a new time interval overlaps with two existing time intervals. The effective dates in the new record may overlap with the effective dates in two existing records, as shown in [Figure 9](#), [Figure 10](#), [Figure 11](#), or [Figure 12](#). In all of these cases, the application displays an error message and does not enter the new effective dates.

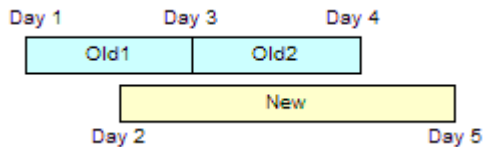

Figure 9. New Time Interval Covers One Record and Overlaps with Another’s End Date

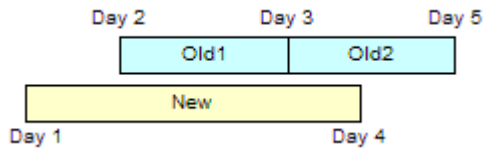

Figure 10. New Time Interval Covers One Record and Overlaps with Another’s Start Date

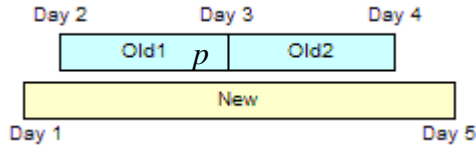

Figure 11. New Time Interval Covers Two Existing Records

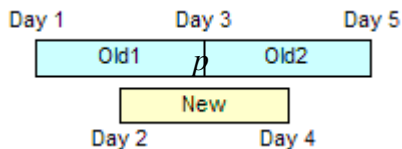

Figure 12. New Time Interval Overlaps with One Record’s Start Date and One’s End Date

Giving a Product Multiple Prices with Different Effective Dates

Price lists, cost lists, discount matrices, and component-product price adjustments have effective dates for the list or group as a whole. You can also enter effective dates for individual line items.

Effective dates for individual line items allow you to change prices rapidly and track changes to a product's prices. For example, if you have different prices for certain products during different seasons, then you can include prices for all the seasons in one price list, so prices change automatically when the season changes.

As a best practice, do not delete line items from a price list or directly modify the value of prices at a line level. In order to make price changes, create multiple line item records with different effective dates, as described below.

This topic describes how to create effective dates for line items in price lists. Use the same methods for cost lists, discount matrices, or component-product price adjustments.

When you use the method described here to add multiple line items for the same product with different effective dates, the application does not create line items with overlapping effective dates. For information about how the application resolves this issue, see ["About Effective Dates for Pricing Line Items"](#) on page 29.

To create multiple prices with different effective dates

- 1 Create one pricing line item for the product as described in ["Adding Price List Line Items for Products"](#) on page 21.
- 2 Select the pricing line item for the product, and then click New Effective Date.
A new line item is created for the same product.
- 3 In the new line item, enter the Start Date and End Date for the new time interval.
- 4 If necessary, repeat [Step 2](#) and [Step 3](#) to continue adding more line items with different effective dates for the product.

Creating a Price List Line Item for a Simple Product Bundle

A product bundle allows you to give customers a discount if they buy a combination of products. For example, you can give customers a price for a dining room table and four chairs that is less than the price they would pay if they bought the table and chairs individually.

You do this by creating a product of type bundle. You assign a price to the bundle product in the same way that you assign a price to an individual product. For information about creating simple bundle products, see *Siebel Product Administration Guide*. Before performing the following procedure, follow the instructions in ["Adding Price List Line Items for Products"](#) on page 21.

To create a price list line item for a simple product bundle

- 1 Create a new product line item, as described in [“Adding Price List Line Items for Products” on page 21](#).
- 2 In the Name field, select a product bundle that has been defined in the Product Administration screen.

Copying and Modifying a Price List

After building a price list, you can copy and modify it to create a new price list for different types of customers or markets. For example, you might use a price list named United States Price List as the basis for creating new price lists for different countries, locations, organizations, currencies, accounts, or demographics.

To modify the data in more elaborate ways, you use the Transform functionality, described in [“Copying and Transforming a Price List” on page 33](#), instead of modifying the data manually.

NOTE: Do not edit the Currency field when you copy and modify a price list. To modify this field, use the Transform function, described in [“Copying and Transforming a Price List” on page 33](#).

To copy and modify a price list

- 1 Navigate to the Administration - Pricing screen, then Price Lists view.
- 2 In the Price Lists list, select the price list you want to copy.
- 3 In the Price Lists list, click the menu button, and then click Copy Record.

A new Price List record appears with all of the data from the original price list, except for the original price list name.

- 4 Modify the information in the fields of the price list header and the price list line items.

Either edit the fields directly or click the menu button, click Change Records, and then use the Change Records dialog box to modify the record.

Copying and Transforming a Price List

The Transform function allows you to transform a copy of an existing price list by making sweeping price changes to product prices. It lets you change every list price without modifying each individual line item separately. Using the Transform options, you can:

- Change all list prices by the percentage you specify. For example, you can increase all list prices to 130 percent of their previous value.
- Convert all list prices to a different currency. You specify the currency and the conversion date, and the prices are converted automatically.
- Apply a pricing procedure to a price list, changing some or all product prices depending on the design of the procedure. To do this, you must create the pricing procedure before you do the transformation. For more information about creating pricing procedures, see *Siebel Order Management Infrastructure Guide*.

The Transform function transforms the list price as well as the promotional price fields.

To transform a price list

- 1 Select the price list you want to use as a basis for the new price list.
- 2 From the Price List menu, select Transform.
The Transform Price List form appears.
- 3 Enter information in the Transform Price List form, as described in the following table, and then click Transform.

Field	Comments
Source Price List Name	Enter the name of the price list to be transformed.
Destination Price List	Enter the name of the price list resulting from transforming the Source Price List.
Currency Code	Select the currency you want to use for prices in the transformed price list. The default value is the currency of the copied price list. If you are not changing currencies, then keep the default.
Exchange Date	If you are converting currencies, then enter the date for the currency exchange rate. The Siebel application will use the exchange rate on that day to convert currency.
Markup or Discount %	Enter a percentage to be applied to the list price for each product in the price list. For example, to increase all list prices by 30 percent, you would enter 130. To decrease all list prices by 20 percent, you would enter 80. The default value is 100 percent. If you do not want to change prices, then keep this default.
Pricing Procedure	If you are using a pricing procedure to transform the prices, then select the Workflow that calls the pricing procedure.

NOTE: After clicking the Transform button to change the data, be sure to validate your results.

Importing Price Lists

It is common to use Siebel Enterprise Integration Manager (EIM) to import price lists into the Siebel application to handle large numbers of price lists that were created in other applications.

Price lists are defined by organization. By default, the column ENTERPRISE_FLG of a manually entered price list is set to N, which enables organizational visibility of price lists and associated price list items.

If you use Siebel EIM to import price lists and price list items, then set ENTERPRISE_FLG to N to retain organizational visibility. If ENTERPRISE_FLG is set to Y, then the price lists and associated price list items are become visible across the enterprise, and are routed to all users regardless of organization. For more information about using Siebel EIM, see *Siebel Enterprise Integration Manager Administration Guide*.

Assigning Price Lists to Users

The price list that controls a user's prices depends on both organization and account:

- **Organization.** This option limits visibility. The user cannot see a price list unless it was assigned to the user's organization in the Organization field of the price list record. One price list can be assigned to many organizations, and many price lists can be assigned to a single organization.
- **Account.** This option controls which price list is active for the user. The active price list is the price list associated with the user's account record.

When you associate a price list with an account, that price list is automatically defaulted in the quote or order when the account is entered for the quote or order, and the price list's currency is set as the header-level currency for the quote or order.

NOTE: If you use Siebel Sales to sell to the public through the Web, then customers may not have accounts. The default price list is for customers without accounts. For information about setting a default price list, see the topic about setup tasks in *Siebel eSales Administration Guide*.

To assign a price list to a user

- 1 Navigate to the Administration - Pricing screen, then Price Lists view.
- 2 In the Price Lists list, select the price list you want to assign to the user.
- 3 In the price list's Organization field, click the select icon.
The Organization's dialog box appears.
- 4 If the user's organization is not already listed in this dialog box, then click New, add it, and then click OK.
- 5 Navigate to the Accounts screen, then Accounts List view.
- 6 In the Accounts list, click the name of the user's account.
- 7 Click the More Info view tab.
- 8 In the More Info view, go to the Price List field list and select the price list for this account.

Enabling Price List-Specific and Line Item-Specific Pricing Logic

You can associate a custom pricing procedure with either an entire price list or an individual line item in a price list. To associate a custom pricing procedure with an entire price list, select it in the Pricing Procedure field of the Price List record, as described in ["Defining a Price List Header" on page 19](#).

To associate a custom pricing procedure with a line item, select it in the Pricing Procedure field of the Line Item record, as described in ["Adding Price List Line Items for Products" on page 21](#).

Before you select the custom pricing procedure in these fields, you must create the custom pricing procedure and integrate it with the default pricing procedure. For more information about creating pricing procedures, see *Siebel Order Management Infrastructure Guide*.

To create price list-specific or line item-specific pricing logic, follow this general process:

- Create a custom pricing subprocedure with the pricing logic that you want to add to the price list or line item.
- Add a dynamic subprocedure step to the default pricing procedure.
- Modify the default pricing procedure to retrieve this subprocedure during Price List Lookup.
- Associate the custom subprocedure with the price list or line item as follows:
 - To associate it with the price list, select it in the Pricing Procedure field of the Price List record.
 - To associate it with a line item, select it in the Pricing Procedure field of the Line Item record.

4

Creating and Assigning Rate Lists

This chapter begins with an overview of rate lists, and then describes the most common ways of creating a new rate list. It also instructs you on assigning rate lists to users. This chapter covers the following topics:

- ["About Rate Lists"](#)
- ["Process of Creating Rate Lists" on page 38](#)
- ["Copying and Modifying a Rate List" on page 40](#)
- ["Copying and Transforming a Rate List" on page 41](#)
- ["Assigning a Rate List to a User" on page 42](#)

About Rate Lists

A rate list is a set of standard rates for resources that bill by the hour. For example, if you run a temporary employment agency, then you might charge your customers different standard hourly rates for employees who do word processing, who do data entry, who do secretarial work, and who answer the phone at a call center. These hourly rates for these different types of resources would be included on your rate list.

After you have set up rate lists administratively, they are used by service orders and time sheets to calculate the cost of resources.

If you assign a product price in a rate list, then it can appear in catalogs. Rate lists control the visibility of products, just as price lists do.

This chapter covers the general process of creating rate lists. More detailed processes for using rate lists with specific features of Siebel applications are covered in other books. Common uses of rate lists include:

- **Project Management for Professional Services.** Rate lists let you manage projects that use professional services to determine the billing rates for professional services for that project. For more information, see *Siebel Project and Resource Management Administration Guide*.
- **Field Service.** Rate lists determine the rates that customers pay for the time of field service representatives. For more information, see *Siebel Field Service Guide*.
- **Pricing Screen.** After the pricing administrator sets up rate lists using the Administration - Pricing screen, employees can view rate lists using the Pricing screen.

This chapter looks at three common ways of creating a rate list:

- Create a new rate list
- Copy and modify an existing rate list
- Copy and transform an existing rate list

After you create a rate list, you must assign it to users to make it control the rates they pay. For example, if you run a temporary help agency, then you may charge different rates to customers who need help for short-term projects and long-term projects, or you may charge different rates to larger and smaller customers. You would create and assign different rate lists to these customers to make their rates visible to them.

Process of Creating Rate Lists

A rate list consists of one rate list record and multiple rate list line item records. The rate list record contains general information about the rate list as a whole. The line item records contain rates for specific resources.

To create a new rate list, you go through the following process:

- 1 ["Creating Resources as Products" on page 38](#)
- 2 ["Creating a Rate List Record" on page 38](#)
- 3 ["Creating Rate List Line Items" on page 39](#)

Creating Resources as Products

This task is a step in ["Process of Creating Rate Lists" on page 38](#).

Before you create any rate list, you must create the resources that the rates apply to as products in the Product Administration screen. For example, if you run a temporary help agency, then you might create products named word processing operator, data entry clerk, secretary, and so on.

You must:

- Create the products.
- Associate each product with its product lines.

NOTE: To use these products as resources in the rate list, you must select the Project Resource check box when you create the product in the Product Administration screen.

For more information about creating products, see *Siebel Product Administration Guide*.

Creating a Rate List Record

This task is a step in ["Process of Creating Rate Lists" on page 38](#).

The Rate List record includes general information about the rate list as a whole, such as its name, description, and effective time period.

To create a rate list record

- 1 Navigate to the Administration - Pricing screen, then Rate Lists view.
- 2 In the Rate Lists list, add a new record and complete the necessary fields, as described in the following table:

Field	Comments
Name	Enter a unique, meaningful name for this rate list.
Description	Enter a description of the rate list for your own use.
Cost List	Select the cost list you want to associate with this rate list.
Currency	Select the currency for this rate list.
Effective From	Enter the date and time when this rate list will become effective. By default, the application assigns the current system date and time when you first create the Rate List record.
Effective To	Enter the date and time when this rate list will become ineffective. After this time, Siebel applications will not use this rate list. If no value is entered here, then the rate list remains in effect indefinitely.
Updated By	By default, the application assigns the user name used to log in to the current session in which this Rate List record is created.
Last Updated	By default, the application assigns the current system date and time when you most recently saved this Rate List record.
Organization	Select all the organization that may have rates controlled by this rate list. For more information, see "Assigning a Rate List to a User" on page 42 .

Creating Rate List Line Items

This task is a step in ["Process of Creating Rate Lists" on page 38](#).

A rate list line item contains rate data for a specific resource. It includes the resource name and information about the rates charged for that resource.

A rate list may have multiple line items for a resource, with different start and end dates. Effective dates for rate lists work in the same way as price lists, as described in ["Giving a Product Multiple Prices with Different Effective Dates" on page 32](#).

If you have multiple rate lists, then the same resource can have a line item in each rate list. For example, your United States rate list might have a line item for the rate charged for a resource in the United States. The Canadian rate list may have the rate charged for the resource in Canada, and so on.

NOTE: Alternatively, you can add a resource to multiple rate lists using the Administration - Product screen, then Rate List view.

To create a rate list line item

- 1 Navigate to the Administration - Pricing screen, then Rate Lists view.
- 2 In the Rate List, select the rate list for which you want to add a line item.
- 3 Click the Rate List Line Items view tab.
- 4 In the Rate List Line Items list, click New.
The Add Position Types dialog box appears.
- 5 Use the Add Position Types dialog box to add the type of resource to the rate list.
- 6 Complete the fields of the Rate List Item record, as described in the following table:

Field	Comments
Resource	This field displays the type of resource that you selected from the Add Position Types dialog box. A rate list line item uses this product name as its unique ID.
Rate Per Hour	Enter the standard hourly rate you charge for this resource.
Overtime Rate Per Hour	Enter the hourly overtime rate you charge for this resource.
Extended Overtime Rate Per Hour	Enter the hourly extended overtime rate you charge for this employee, if applicable.
Material Mark-Up	Enter the percentage of markup charged for materials used by this resource.
Expense Mark-Up	Enter the percentage mark-up charged for expenses incurred by this resource.
Description	Enter a description of this resource for your own use.

Copying and Modifying a Rate List

After creating a rate list, you can copy and modify it to create a new rate list for different types of customers or markets. For example, you might use a rate list named United States Rate List as the starting basis for creating new rate lists for different countries.

First, copy the rate list. This retains the original rate list and creates a new rate list with the same data. Then, modify the data in the copy as necessary.

To modify the data in more elaborate ways, use the transform feature described in [“Copying and Transforming a Rate List” on page 41](#), instead of modifying the data manually. For example, you can use the transform feature to convert all the currencies in a rate list to a different currency.

NOTE: Do not edit the Currency field when you copy and modify a rate list. To modify this field, use the Transform function described in [“Copying and Transforming a Rate List” on page 41](#).

To copy and modify a rate list

- 1 Navigate to the Administration - Pricing screen, then Rate Lists view.
- 2 In the Rate Lists list, select the rate list you want to copy.
- 3 In the Rate Lists list, click the menu button, and then click Copy Record.

A new Rate List record appears, with all of the data from the original rate list, except for the original rate list name.

- 4 Modify the information in the fields of the rate list record and the rate list line items.

Either edit the fields directly or click the menu button, and then click Change Records, using the Change Records dialog box to modify the record.

NOTE: Do not edit the Currency field directly. To modify this field, use the Transform function, described in the “Copying and Transforming a Rate List” on page 41.

Copying and Transforming a Rate List

The Transform function allows you to transform a copy of an existing rate list by making sweeping changes to rates. It lets you change every rate without modifying each individual line item separately. Using the Transform options, you can:

- Change all list prices by the percentage you specify. For example, you can increase all list prices to 130 percent of their previous value.
- Convert all list prices to a different currency. You specify the currency and the conversion date, and the prices are converted automatically.
- Apply a pricing procedure to a rate list, changing some or all rates depending on the design of the procedure. To do this, you must create the pricing procedure and the workflow that calls it before you do the following procedure. For more information, see *Siebel Order Management Infrastructure Guide*.

To transform a rate list

- 1 Select the rate list you want to transform.
- 2 From the Rate Lists list menu, select Transform.

The Transform Rate List form appears.

- 3 Enter information in the Transform Rate List form, as described in the following table, and then click Transform.

Field	Comments
Transformed Rate List Name	Enter the name of the rate list to be transformed.
Destination Rate List	Enter the name of the rate list resulting from the transformation.

Field	Comments
Currency Code	Select the currency you want to use for prices in the transformed rate list. The default value is the currency of the copied rate list. If you are not changing currencies, then keep the default.
Exchange Date	Enter the date for the currency exchange rate. The Siebel application will use the exchange rate on that day to convert currency. You must enter the date if you are converting currencies.
Markup or Discount %	Enter a percentage to be applied to the list price for each product in the rate list. For example, to increase all list prices by 30 percent, you would enter 130. To decrease all list prices by 20 percent, you would enter 80. The default value is 100 percent. If you do not want to change prices, then keep this default.
Pricing Procedure	If you are using a pricing procedure to transform the prices, then select the workflow that calls the pricing procedure.

Assigning a Rate List to a User

The rate list that an employee sees depends on that employee's organization. The employee cannot see a rate list unless it was assigned to the user's organization in the Organization field of the rate list record.

One rate list can be assigned to many organizations. Each organization can have multiple rate lists.

You can configure your application using Siebel Tools to make multiple rate lists available to one organization. For more information about Siebel Tools, see *Using Siebel Tools*.

To assign a rate list to a user

- 1 Navigate to the Administration - Pricing screen, then Rate Lists view.
- 2 In the Rate Lists list, select the rate list you want to assign to the user.
- 3 In the rate list's Organization field, click the select icon.
The Organizations dialog box appears.
- 4 If the user's organization is not already listed in this dialog box, then click New, add it, and then click OK.

5

Creating and Using Cost Lists

This chapter describes how to create and use cost lists, and covers the following topics:

- ["About Cost Lists" on page 43](#)
- ["Process of Creating Cost Lists" on page 44](#)
- ["Using Asset Mapping to Value Assets" on page 49](#)

About Cost Lists

A cost list is a set of costs for products or services. You can attach a cost list to either a rate list or a price list to determine the profit margin.

There are four cost methods that you can use to determine the cost of a product or service:

- **Standard Cost.** This is a predetermined operating cost that is compared with the actual cost to measure the performance of a given department or operation.
- **Last Cost.** This is a cost metric used in the LIFO (Last-In, First Out) costing method. LIFO calculates cost by assuming the last goods purchased are the first goods sold, so the ending inventory consists of the earliest goods purchased.
- **Next Cost.** This is a costing method that allows the user to maintain the cost manually.
- **Average Cost.** This is a costing method that calculates product cost as the average (arithmetic mean) of all the purchase costs of an inventoried product.

You can enter all four of these costs for each product or service that is a line item in the cost list. You use the Cost List record to choose which of these cost methods is used for all the line items in the list.

You can attach the same cost list to multiple price lists. For example, you may have two price lists with different prices for the same products, one with the prices for customers and the other with the prices for resellers. Although the products may have the same cost, regardless of the price you charge for them, you can attach the same cost list to both of these price lists.

Process of Creating Cost Lists

To create costs lists, perform the following tasks:

- 1 [“Creating the Price List or Rate List the Cost List Will Reference” on page 44](#)
- 2 [“Creating the Cost List Record” on page 44](#)
- 3 [“Creating the Cost List Line Item Records” on page 45](#)
- 4 [“Entering the Indirect Costs” on page 46](#)
- 5 [“Associating the Cost List with a Price List or Rate List” on page 47](#)
- 6 [“Updating a Price List’s Costs” on page 48](#)
- 7 [“Viewing the Product Cost and Margin” on page 48](#)

Creating the Price List or Rate List the Cost List Will Reference

This task is as step in [“Process of Creating Cost Lists” on page 44](#).

As a prerequisite for creating a cost list, create the price list or the rate list with which the cost list will be associated. The cost list will include the cost of products included in the price list or the hourly cost of the services included in the rate list. For more information about creating price lists, see [Chapter 3, “Creating and Assigning Price Lists.”](#) For more information about creating rate lists, see [Chapter 4, “Creating and Assigning Rate Lists.”](#)

Creating the Cost List Record

This task is as step in [“Process of Creating Cost Lists” on page 44](#).

The cost list record includes general information about the cost list as a whole, such as its name, the organizations that can use it, and its cost method.

To create the cost list record

- 1 Navigate to the Administration - Pricing screen, then Cost Lists view.
- 2 In the Cost Lists list, add a new record and complete the necessary fields, as described in the following table:

Field	Comments
Cost List	Enter a unique name for this cost list. If you have many cost lists, then it is important to use meaningful names and a consistent naming convention for them all.
Description	Enter a description of this cost list for your own use.

Field	Comments
Effective From	Enter the date and time when this cost list will become effective. By default, the application assigns the current system date and time when you first create the Cost List record.
Effective To	Enter the date and time when this cost list will become ineffective. After this time, Siebel applications will not use this cost list.
Cost Method	Select one of the four cost methods: Standard, Average, Next, or Last. These cost methods are described in “About Cost Lists” on page 43 .
Created By	This field displays the user name of the person creating this record.
Created	This field displays the date and time when the record was created.
Organization	Select the organizations that will use this cost list.
Updated By	This field displays the user name of the last person who updated this record.
Updated	This field displays the date and time when the record was last updated.

Creating the Cost List Line Item Records

This task is as step in [“Process of Creating Cost Lists” on page 44](#).

You must add a line item to the cost list for each product or service in the cost list. The cost list line item has specific information about the cost of that product or service.

You can enter four costs for each product, using the four cost methods described in [“About Cost Lists” on page 43](#). The cost method used depends on the cost method you choose in the Cost List record.

This record is used only for the direct cost you pay for the product. Indirect costs associated with the product are entered later.

NOTE: Alternatively, you can add a product to multiple cost lists using the Administration - Product screen, then Cost List view.

To create a cost list line item

- 1 Navigate to the Administration - Pricing screen, then Cost Lists view.
- 2 In the Cost Lists list, select the cost list to which you want to add a line item.
- 3 Click the Cost List Line Items view tab.
- 4 In the Cost List Line Items list, click New.
The Add Internal Products dialog box appears.
- 5 In the Add Internal Products dialog box, select the product you want to add to the price list, and click Add.

- 6 Complete the fields in the Cost List Line Item record, as described in the following table:

Field	Comments
Product	The name of the product or service that you selected from the Add Products dialog box is entered here.
Part #	The part number of the product or service that you selected from the Add Products dialog box is entered here. This number uniquely identifies the product or service.
Standard Cost	Enter the standard cost, as described in “About Cost Lists” on page 43.
Last Cost	Enter the last cost, as described in “About Cost Lists” on page 43.
Next Cost	Enter the next cost, as described in “About Cost Lists” on page 43.
Average Cost	Enter the average cost, as described in “About Cost Lists” on page 43.
Start Date and End Date	If the line item has different effective dates from the cost list, then enter the start date when the costing becomes effective and the end date when it is no longer effective. These fields work in the same way as the start and end date fields of price list line items, as described in “Giving a Product Multiple Prices with Different Effective Dates” on page 32.

Entering the Indirect Costs

This task is as step in [“Process of Creating Cost Lists” on page 44.](#)

After entering the direct cost of the product, you can also enter indirect costs associated with the product, such as your cost of ordering products, receiving products, and shipping products to customers. These indirect costs apply to all the products in the cost list. Enter an average cost for a unit for all your products.

To enter indirect costs

- 1 Navigate to the Administration - Pricing screen, then Cost Lists view.
- 2 In the Cost Lists list, select the cost list to which you want to add indirect costs.
- 3 Click the Cost List Indirect Costs view tab.
- 4 In the Cost List Indirect Costs Items list, click New.
- 5 Complete the fields in the Cost List Indirect Costs record, as described in the following table, and continue to add these records until you have entered all indirect costs.

Field	Comments
Expense Object	Select the type of indirect cost, such as shipment, receipt, or demonstration.
Cost Per Unit	Enter the cost for each unit of this indirect cost, spreading the total indirect cost across all the products or services in the cost list.
Comments	Enter a comment for your own use.

Associating the Cost List with a Price List or Rate List

This task is as step in [“Process of Creating Cost Lists” on page 44.](#)

After creating the cost list, you can associate it with either a price list or a rate list. You can associate the same cost list with more than one price list or rate list.

Associating a Cost List with a Price List

Use the following procedure to associate a cost list with a price list.

To associate a cost list with a price list

- 1 Navigate to the Administration - Pricing screen, then Price Lists view.
- 2 In the Price Lists list, select the price list with which you want to associate the cost list.
- 3 In the More Info form, go to the Cost List field and select the cost list.

Associating a Cost List with a Rate List

Use the following procedure to associate a cost list with a rate list.

To associate a cost list with a rate list

- 1 Navigate to the Administration - Pricing screen, then Rate Lists view.
- 2 In the Rate Lists list, select the rate list with which you want to associate the cost list.
- 3 In the More Info form, go to the Cost List field and select the cost list.

Updating a Price List's Costs

This task is as step in ["Process of Creating Cost Lists" on page 44](#).

If the cost list is associated with a price list, then you must update the cost for that price list to make the new cost list take effect.

This is not necessary if the cost list is associated with a rate list.

To update a price list's costs

- 1 Navigate to Administration - Pricing screen, then Price Lists view.
- 2 In the Price Lists list, select the price list whose cost you want to update.
- 3 In the Price Lists list, from the applet level menu, select Update Cost from the menu.

Viewing the Product Cost and Margin

This task is as step in ["Process of Creating Cost Lists" on page 44](#).

Now that cost lists have been set up and associated with a price list or rate list, any user can view the cost and the profit margin of products on that price list. The margin is displayed as a percentage.

NOTE: Before viewing the cost and margin for a rate list, you must configure the product using Siebel Tools to expose those fields. For more information about using Siebel Tools, see *Using Siebel Tools*.

Viewing a Product Cost and Margin in a Price List

Use the following procedure to view a product cost and margin in a price list.

To view a product cost and margin in a price list

- 1 Navigate to the Administration - Pricing screen, then Price Lists view.
- 2 In the Price Lists list, select the price list for the product whose cost you want to view.
- 3 Click the Price List Line Items view tab.
- 4 In the Price List Line Items list, select the product whose cost you want to view.
- 5 Navigate down to view the Price List Line Item Detail form.
- 6 If necessary, click the Show More button in the Price List Line Item Detail form.

The product cost is in the Cost field and the profit margin is in the % Margin field of the Price List Line Item Detail form.

Viewing a Product Cost and Margin in a Rate List

Use the following procedure to view a product cost and margin in a rate list.

To view a product cost and margin in a rate list

- 1 Navigate to the Administration - Pricing screen, then Rate Lists view.
- 2 In the Rate Lists list, select the rate list for the product whose cost you want to view.
- 3 Click the Rate List Line Items view tab.
- 4 In the Rate List Line Items list, select the product whose cost you want to view.

Using Asset Mapping to Value Assets

When you use asset mapping, an asset is valued as a percentage of its value on the cost list. The percentage can be based on the current condition of the asset. For example, a new asset in excellent condition would be 100% of the cost list value, while a used asset in average condition would be 40% of the cost list value.

Adjustments depend on the Condition, Value Basis, Cost List, and Cost Method fields for each asset. These factors are used to calculate the Asset Values and the Replacement Costs on the Assets screen, Value view.

If there are no asset mapping records and a cost list is specified, then the Assets screen, Value view uses the asset cost from the Cost List Line Items view. For more information about assets, see *Siebel Field Service Guide*.

NOTE: Asset mapping applies to product lines and to all assets that belong to the same product line and cost list.

To map the cost of assets for specific product lines

- 1 Navigate to the Administration - Pricing screen, then Cost List screen.
- 2 In the Cost Lists list, select a cost list.
- 3 Click the Asset Mapping view tab.
- 4 In the Asset Mapping form, add a new record and complete the necessary fields. Some fields are described in the following table:

Field	Comments
Cost Field	<p>Select the value that is used as the basis of the cost calculation. options are as follows:</p> <ul style="list-style-type: none"> ■ Asset Value. This calculation is based on the original cost of the product. ■ Replacement. This calculation is based on the cost list value of the product.

Field	Comments
Condition	Select the condition of the asset.
Value Basis	<p>Select the value basis of the asset. The value of the asset is adjusted based on your selection. options are as follows:</p> <ul style="list-style-type: none"> ■ Scrap. This is the value of the asset as scrap. In many cases, this involves depreciating to zero. ■ Original. This is the original basis for the value of the asset. ■ Adjusted. This is an adjustment based on a one-time event. For example, you could use this if you drop the asset and the damage reduces its value. ■ New. This is an adjustment for a new product. For example, a new car drops in value as soon as you drive it off the car lot. ■ Refurbished. This is the value of the asset when it is refurbished. ■ Used. This is the value of the asset when it is sold as used.
Cost Method	This is the same cost method used in the Cost List Line Items view.
Factor	<p>You can leave the Condition and Value Basis fields blank and instead enter a value in the Factor field, which specifies the percentage of its cost at which this asset is valued.</p> <p>If Condition or Value Basis are entered, then they override the Factor field.</p>

6

Creating Volume Discounts

This chapter describes the two different types of volume discounts and the process of setting up a volume discount. It also covers special features of volume discounts for products with components. This chapter covers the following topics:

- [“About Volume Discounts” on page 51](#)
- [“Process of Setting Up a Volume Discount” on page 53](#)

About Volume Discounts

A volume discount is an adjustment to the price of a product based on the quantity of that product in the quote line or order line item.

When you define a volume discount, you select one of two discount methods:

- **Simple.** This method applies the same discount to every line item. The discount for all items depends on the total quantity of that item purchased.
- **Tiered.** This method applies the discount defined by each Volume Discount Line Item record to the quantity of items defined in that Volume Discount Line Item record.

For example, you create a volume discount with line items that:

- Apply a 10 percent discount when the quantity is five to 10 items
- Apply a 20 percent discount when the quantity is 11 to 20 items
- Apply a 30 percent discount when the quantity is 21 items or more

If this is a simple volume discount, and if the customer buys 23 items, then the customer gets a discount of 30 percent on all 23 items.

If this is a tiered volume discount, and if the customer buys 23 items, then the customer gets no discount on items one to four, a 10 percent discount on items five to 10, a 20 percent discount on items 11 to 20, and a 30 percent discount on items 21 to 23.

Volume discounts apply to the quantity in the quote line or order line, not the total quantity in the entire quote or in an entire order. If a user splits an order for a product into two or more lines on a quote, then the volume discount calculation for that product is not based on the total of the two lines. However, you can configure the application to base volume discounts on multiple line items, as described in [“Volume Discounts Across Line Items” on page 52](#).

The volume discount applies to the start price after attribute pricing and customizable product pricing adjustments have been applied.

NOTE: If you use volume discounts with other types of price adjustments, then the final price depends on the order in which Siebel Pricer applies the pricing adjustments. For more information, see [“About the Processing Order of Price Adjustments” on page 15](#).

For more information about volume discounts, see the following information:

- [“About Reusing Volume Discounts for Multiple Currencies” on page 52](#)
- [“Volume Discounts and Products with Components” on page 52](#)
- [“Volume Discounts Across Line Items” on page 52](#)
- [“Process of Setting Up a Volume Discount” on page 53](#)

About Reusing Volume Discounts for Multiple Currencies

You can use the same volume discount schedule for price lists in different currencies.

You can create the volume discount schedule in one currency. When the salesperson creates a quote, the salesperson uses this volume discount schedule but specifies other currencies for the line items. While calculating the volume discounts, the pricing procedure automatically converts the currency of price adjustments in the volume discount to the currency of the quote or order line item.

Volume Discounts and Products with Components

Products with component are discussed in [Chapter 12, “Setting Up Pricing for Products with Components.”](#) This topic explains how volume discounts apply to component products.

The pricing procedure completes the pricing for the product with components before applying any volume discounts. For more information, see [“About the Processing Order of Price Adjustments” on page 15.](#)

Volume discounts can apply to the components of a customizable product. For example, if disk drives are one component of a computer, then you can give volume discounts based on the number of disk drives within a single instance of a disk drive in the customizable product. The volume discount applies to an individual line item within a customizable product, and takes into account the existence of multiple instances of the disk drive within the customizable product or quote. However, you can configure the product so it applies discounts based on the quantity in multiple line items of an order, as described in [“Volume Discounts Across Line Items” on page 52.](#)

Volume Discounts Across Line Items

You can modify the pricing procedure to create volume discounts that work across line items.

The pricing procedure is a PSP procedure. For more information about PSP procedures and about the Aggregate Transform, see *Siebel Order Management Infrastructure Guide*.

Process of Setting Up a Volume Discount

To set up a volume discount, perform the following tasks:

- 1 "Creating a Volume Discount Record" on page 53
- 2 "Creating Volume Discount Line Items" on page 54
- 3 "Linking the Volume Discount to a Price List or Discount Matrix" on page 55

Creating a Volume Discount Record

This task is a step in "Process of Setting Up a Volume Discount" on page 53.

A volume discount record provides the top-level information about a volume discount, including its name, whether it is a simple or tiered volume discount, its start and end dates, and its currency.

CAUTION: If you delete a volume discount record, then all references to this discount become invalid. Any price list line items that used this discount will no longer have a volume discount.

To create a volume discount record

- 1 Navigate to the Administration - Pricing screen, then Volume Discount view.
- 2 Add a new record to the Volume Discounts list and complete the necessary fields. Some fields are described in the following table:

Field	Comments
Name	Enter a name for this volume discount.
Discount Method	Select a method from the picklist. The options are Simple and Tiered, as described in "About Volume Discounts" on page 51.
Start Date	Enter the date when this volume discount becomes effective.
End Date	Enter the date when this volume discount becomes ineffective. If the volume discount will not expire, then leave this field blank.
Currency	Enter the currency in which the volume discount is applied.
Exchange Date	If you are converting currencies, then enter the date for the currency exchange rate. The Siebel application will use the exchange rate on that day to convert currency.

Creating Volume Discount Line Items

This task is a step in [“Process of Setting Up a Volume Discount” on page 53](#).

Volume discount line items include information about quantity range and the corresponding price adjustments.

Add a volume discount line item for each quantity range in the volume discount. For example, if you want to apply a 10 percent discount when the quantity is between five and ten, and a 20 percent discount when the quantity is 11 or more, then you must add two volume discount line items.

When you add volume discount line items, be careful not to create gaps or overlapping quantities, which result in the following errors:

- If you leave a gap in a simple discount, then quantities that fall within the range of the gap receive no discount at all.
- If you leave a gap in a tiered discount, then quantities that fall within the range of the gap default to the lower tier.
- If you create overlapping discount items and quantity ranges, then the discounting behavior is not predictable.

How the discounts in the line items are applied depends on whether this is a simple or tiered volume discount, as described in [“About Volume Discounts” on page 51](#).

To create a volume discount line item

- 1 Navigate to the Administration - Pricing screen, then Volume Discount view.
- 2 Select the volume discount for which you want to create line items.
- 3 Click the Volume Discounts Line Items view tab.
- 4 In the Volume Discounts Line Items list, add a new record and complete the necessary fields. Some fields are described in the following table:

Field	Comments
Name	Enter a name for this volume discount line item. This name appears in the quotes that your sales representatives create for customers, so use a name that describes the discount, such as “10 percent Discount for Buying 5 to 10.” The value in this field is also used to create an upsell message about the additional quantity to purchase in order to get a bigger discount.
Min Qty	Enter the minimum quantity that must be purchased to get this discount rate.
Max Qty	Enter the maximum quantity that gets this discount rate. If this field is blank, then this discount rate applies to all quantities above the minimum quantity.

Field	Comments
Adjustment Type	Select the type of the adjustment that the discount will apply. Options are Discount Amount, % Discount, Markup Amount, % Markup, Price Override.
Adjustment Amount	<p>The value in the Adjustment Type field determines how the adjustment amount is applied, as follows:</p> <ul style="list-style-type: none"> ■ If the Adjustment Type is Discount Amount, then the value in the Adjustment Amount field is subtracted from the price. ■ If the Adjustment Type is % Discount, then the value in the Adjustment Amount field is treated as a percentage and is subtracted from the price. For example, if the Adjustment Amount is 10, then 10 percent is subtracted from the price. ■ If the Adjustment Type is Markup Amount, then the value in the Adjustment Amount field is added to the price. ■ If the Adjustment Type is % Markup, then the value in the Adjustment Amount field is treated as a percentage, and is added to the price. ■ If the Adjustment Type is Price Override, then the value in the Adjustment Amount field is used instead of the price.

Linking the Volume Discount to a Price List or Discount Matrix

To apply the volume discount, you have to link it to a price list line item or a discount matrix line item. This task is a step in [“Process of Setting Up a Volume Discount” on page 53](#).

Linking a Volume Discount to a Product in a Price List

Use the following procedure to link a volume discount to a product in a price list.

To link a volume discount to a product in a price list

- 1 Navigate to the Administration - Pricing screen, then Price Lists view.
- 2 In the Price Lists list, select the price list to which you want the volume discount to apply.
- 3 Click the Price List Line Items view tab.
- 4 Select the line item you want.
- 5 In the Price List Line Items Detail form, in the Volume Discount field, select the volume discount you want to apply to that line item.

Linking a Volume Discount to a Line Item in a Matrix

Use the following procedure to link a volume discount to a line item in a discount matrix.

To link an volume discount to a line item in a discount matrix

- 1 Navigate to the Administration - Pricing screen, Discount Matrices, and then Discount Details view.
- 2 In the Discount Details form, in the Volume Discount field, select the volume discount.

7

Creating Aggregate Discounts

This chapter covers aggregate discounts and includes the following topics:

- [“About Aggregate Discounts” on page 57](#)
- [“Buy and Receive Products for Aggregate Discounts” on page 58](#)
- [“Process of Creating Aggregate Discounts” on page 58](#)
- [“Aggregate Discounts for Buy One, Get One Free Discounts” on page 63](#)
- [“Aggregate Discounts for Products with Components” on page 63](#)

NOTE: As an alternative to the methods described in this chapter, you can create aggregate discounts using a discount matrix, as described in [Chapter 10, “Creating Discount Matrices.”](#)

About Aggregate Discounts

When you define aggregate discounts, you specify a bundle of items and the discount that applies to specific items if the user buys the entire bundle.

For example, you might specify that customers who buy a dining room table and four chairs would get 10 percent off on the price of the chairs.

In addition to the method described in this chapter, there are two other ways to create aggregate discounts:

- **Simple Product Bundles.** In simple cases, you can create a simple product bundle with all the products in the promotion and create a special price for the bundle. For example, create a product bundle with a dining room table and four chairs, and set a price for this bundle that is less than the total of the individual prices of these items. For more information about simple bundle pricing, see [“Creating a Price List Line Item for a Simple Product Bundle” on page 32](#).
- **Product Promotions.** Product promotions allow you to create bundled promotions, to show these promotions in quotes, orders, and catalogs, and to recommend these promotions to customers who buy products in the bundle. This is usually the preferred method of creating bundle discounts. For more information, see [Chapter 8, “Creating Product Promotions.”](#)

NOTE: If you use an aggregate discount with other types of price adjustments, then the final price depends on the order in which Siebel Pricer applies the pricing adjustments. For more information, see [“About the Processing Order of Price Adjustments” on page 15](#).

Buy and Receive Products for Aggregate Discounts

When you add the components to an aggregate discount, you specify whether items are *buy* or *receive* products:

- **Buy products.** To qualify for the aggregate discount, the customer must buy at least the specified quantity of all the Buy products in the list. The Buy products themselves may be discounted if the customer qualifies for the aggregate discount.
- **Receive products.** The Receive products are discounted if the customer qualifies for an aggregate discount. There is no requirement to buy a specific number of Receive products.

Some examples of Buy and Receive products in aggregate discounts are as follows:

- If you buy a certain model of desk, then you get 50 percent off on a certain model of ergonomic chair. (The desk is a Buy product with a quantity of 1 and no price adjustment. The chair is a Receive product with a quantity of 1 and a price adjustment of 50 percent discount.)
- If you buy 10 desks, then you get 10 percent off on the desks and 50 percent off on the ergonomic chairs for them. (The desk is a Buy product with a quantity of 10 and a price adjustment of 10 percent discount. The chair is a Receive product with a quantity of 10 and a price adjustment of 50 percent discount.)
- If you buy 10 desks, then you get 10 percent off on the desks and 50 percent off on any model of desk chair for them. (The desk is a Buy product with a quantity of 10 and a price adjustment of 10 percent discount. Each model of desk chair is a Receive product with a quantity of 10 and a price adjustment of 50 percent discount.)
- If you buy 10 desks, then you get 10 percent off on the desks. (The desk is a Buy product with a quantity of 10 and a price adjustment of 10 percent discount. There is no Receive product.)

NOTE: The Buy product quantity is a minimum and the Receive product quantity is a maximum. For example, the bundling discount says that if you buy 10 desks, then you get 50 percent off on 10 ergonomic chairs for them. You must then buy a minimum of 10 desks to get the discount, and you can get a discount on a maximum of 10 chairs. This prevents a customer from buying 10 desks in order to get a discount on thousands of chairs.

Process of Creating Aggregate Discounts

By default, aggregate discount functionality is not designed to be used with promotions that include customizable products. If you want to use aggregate discount functionality with promotions that include customizable products, then it is recommended that you redesign the workflow with regard to the specific business scenario. For more information about the aggregate discount workflow, see [“Pricing Procedure - Aggregate Discounts Workflow” on page 230](#).

To create aggregate discounts, perform the following tasks:

- 1 [“Adding an Aggregate Discount Record” on page 59](#)
- 2 [“Defining Aggregate Discount Sequence” on page 60](#)
- 3 [“Attaching an Aggregate Discount Sequence to a Price List” on page 62](#)

Adding an Aggregate Discount Record

This task is a step in [“Process of Creating Aggregate Discounts”](#) on page 58.

To define an aggregate discount, you enter general information about the group of products in the Aggregate Discount record and add all the products in the group to the Discount Details list.

To define an aggregate discount

- 1 Navigate to the Administration - Pricing screen, then Aggregate Discounts view.
- 2 Add a record to the Aggregate Discounts list, and complete the necessary fields in the record and the More Info form.

Some fields are described in the following table:

Field	Comments
Name	Enter a name for the aggregate discount.
Currency	Select the currency for the aggregate discount.
Exchange Date	If multiple currencies are used for the products in the bundle, then enter the date of the exchange rate that will be used for currency conversion.
Effective From	Enter the start date when this discount becomes active.
Effective To	Enter the end date when this discount is no longer active.
Active	Select this check box to activate the aggregate discount. The discount is active only if the date of an order is between the Effective From and Effective To dates, and you have selected this check box so the aggregate discount is active.

- 3 Click the Discount Details view tab.
- 4 For each product in the bundle, add a record to the Discount Details list and complete the necessary fields. Some fields are described in the following table:

Field	Comments
Product Name	Select the product.
Buy	If it is a Buy product, then select this check box. For more information, see “Buy and Receive Products for Aggregate Discounts” on page 58.
Receive	If it is a Receive product, then select this check box. NOTE: You cannot select both the Buy and Receive check box in a single record. If you want to make a product both a Buy and a Receive product, then add two records for that product, and select Buy in one and Receive in the other.

Field	Comments
Qty	Enter the quantity of the product. For Buy products, this is the minimum quantity that you must buy to receive the aggregate discount. For Receive products, this is the maximum quantity that can receive a discount. For more information, see "Buy and Receive Products for Aggregate Discounts" on page 58.
Adjustment Type	Select the type of price adjustment applied to this product. Options are Discount Amount, % Discount, Markup Amount, % Markup, and Price Override.
Adjustment Amount	<p>Enter the amount of the Adjustment. How this value is used depends on the selection in the Adjustment Type field:</p> <ul style="list-style-type: none"> ■ Discount Amount. The adjustment amount is subtracted from the product price. ■ % Discount. The adjustment amount is treated as a percentage of the product price, which is subtracted from the product price. ■ Markup Amount. The adjustment amount is added to the product price. ■ % Markup. The adjustment amount is treated as a percentage of the product price, which is added to the product price. ■ Price Override. The adjustment amount is used as the product price, overriding the original price.

Defining Aggregate Discount Sequence

Aggregate discount sequences are used to define the stacking logic for aggregate discounts. This logic can define:

- The order in which aggregate discounts are applied.
- Which aggregate discounts are mutually exclusive.
- Which aggregate discounts can be "stacked," or applied in conjunction with one another.

You can use aggregate discounts within a quote or an order only if they are part of an aggregate discount sequence. Therefore, you must define an aggregate discount sequence even if you have only one aggregate discount. An aggregate discount can be a part of many aggregate discount sequences.

Aggregate discount sequences are linked with price list and discount matrix line items (like volume discounts and attribute adjustments). At run time, the pricing procedure picks the aggregate discount sequence to be used and evaluates the aggregate discounts to be applied.

The order in which aggregate discounts are applied within an aggregate discount sequence can affect the resulting price. For example, if aggregate discount (a) gives a discount of \$100, and aggregate discount (b) gives you 10% off the price of the product, the resulting price would be lower if aggregate discount (b) is applied before aggregate discount (a).

To apply all the aggregate discounts in a sequence, you attach the sequence to either a price list or a product with component line items. A sequence includes all the aggregate discounts that apply to one price list or to one product with components in a price list.

Use the following procedure to define the aggregate discount sequence. This task is a step in [“Process of Creating Aggregate Discounts” on page 58](#).

To define the aggregate discount sequence

- 1 Navigate to the Administration - Pricing screen, then Aggregate Discount Sequences view.
- 2 Add a record to the Aggregate Discount Sequence list and complete the necessary fields.

Some fields are described in the following table:

Field	Comments
Name	Enter a name for the aggregate discount sequence.
Effective From	Enter the date when the aggregate discount sequence becomes effective.
Effective To	Enter the date when the aggregate discount sequence is no longer effective.
Active	Select this check box to activate the aggregate discount sequence.

- 3 Click the Aggregate Discounts view tab.
- 4 Add records to the Aggregate Discounts list for every aggregate discount that you want in this sequence and complete the necessary fields, described in the following table:

Field	Comments
Sequence	Enter the sequence in which this aggregate discount is applied.
Name	Select the aggregate discount.
Next Discount if Used	Select the next aggregate discount in the sequence to be used if this discount is applied.
Next Discount if not Used	Select the next aggregate discount in the sequence to be used if this discount is not applied.

Attaching an Aggregate Discount Sequence to a Price List

This task is a step in [“Process of Creating Aggregate Discounts”](#) on page 58.

You can attach the aggregate discount sequence to a price list and, with some restrictions, also to price list line items. In the case of price list line items, you can attach an aggregate discount sequence to a product with components.

For example, with a computer system, you might want to attach the aggregate discount sequence to a product with components to give discounts to customers who buy a specific CD-ROM drive, monitor, and keyboard.

Attaching an Aggregate Discount Sequence to a Price List

Use the following procedure to attach an aggregate discount sequence to a price list.

To attach an aggregate discount sequence to a price list

- 1 Navigate to the Administration - Pricing screen, then Price Lists view.
- 2 In the Price Lists list, select the price list to which you will attach the sequence.
- 3 In the More Info form, in the Aggregate Discount Sequence field, select the sequence to attach to this price list.

The aggregate discounts in this sequence apply to all prices in this price list.

Attaching an Aggregate Discount Sequence to a Price List Line Item

Use the following procedure to attach an aggregate discount sequence to a price list line item.

To attach an aggregate discount sequence to a price list line item

- 1 Navigate to the Administration - Pricing screen, then Price Lists view.
- 2 Click the Price List Line Item view tab.
- 3 In the Price List Item Detail form, in the Aggregate Discount Sequence field, select the aggregate discount sequence.

You can modify this field only if the product is a product with components.

Aggregate Discounts for Buy One, Get One Free Discounts

Aggregate discounts are generally used to reduce the price of one product when it is sold with one or more different products. For example, a customer could buy a dining room table at full price and receive a discount on dining room chairs.

Aggregate discounts can also be used where you buy a product and receive a discount on the same product. This is commonly called a *Buy One, Get One Free* discount.

To set up this sort of discount, combine them in one aggregate discount with a Buy quantity equal to the total number of products a customer must buy, and the discount set to give the appropriate result. For example, if customers can buy one dining room chair and get one chair for free:

- Set the Buy quantity to two.
- Set the price Adjustment Type to % Discount and the Adjustment Amount to 50 to create a Receive rule that gives 50 percent off the List price for each product.

Similarly, if customers can buy three dining room chairs and get one chair for free:

- Set the Buy Quantity to four.
- Set the price Adjustment Type to % Discount and Adjustment Amount to 25 to create a receive rule that gives 25 percent off the List price for each product.

Aggregate Discounts for Products with Components

Aggregate discounts can be associated with component-based products. For example, for customers buying personal computers, you might create an aggregate discount so that if they buy both a CD-ROM drive and a floppy disk drive, then they get a 10 percent discount on both drives.

Aggregate discounts for product components work in the same general way as other aggregate discounts, but there are several additional constraints:

- Aggregate discounts for product components must include only components of the product. Do not create an aggregate discount that mixes components of one component-based product with components of other component-based products.
- The aggregate discount is applied once the product with component has the required quantity of the Buy and the Receive products.

- If you are defining the required quantities for a component-based product component in a bundling discount, then be aware of the constraints defined for the product, especially the Max Cardinality limit. Do not define aggregate discounts that require the user to buy more products than the cardinality limits. If the pricing rule exceeds cardinality, then it will not be applied.

NOTE: If the same product appears multiple times as a component, then the different instances of the product may have different prices after all adjustments. In this case, the aggregate discount uses as its target price the instance of the product with the highest net price. For example, if a specific memory chip appears multiple places within a customizable computer system product, then the highest calculated price for that memory chip will be used as the target price for all bundling discounts on that chip.

8

Creating Product Promotions

This chapter covers product promotions and includes the following topics:

- ["About Product Promotions" on page 65](#)
- ["Process of Creating Product Promotions" on page 66](#)
- ["Creating Product Promotions That Upgrade Existing Promotions" on page 82](#)
- ["Viewing a Summary of a Product Promotion" on page 83](#)
- ["Managing Versions of Product Promotions" on page 83](#)
- ["Viewing the Schedules of All Product Promotions" on page 84](#)
- ["About Product Promotions for Customizable Products" on page 84](#)

About Product Promotions

Product promotions are created in the Administration - Product screen. They represent the marketing definition of a product. Product promotions are time-sensitive, and they state discounted prices and contractual terms.

Product promotions may be broadly classified to belong to either of these two types:

- **Coupons.** This promotion includes a single product or service. This sort of promotion is used primarily for retail sales and is also called a retail promotion.
- **Bundled promotions.** This promotion includes a group of products or services.

End users can select product promotions in two ways:

- **Top-down selection.** If the customer receives an offer or sees an advertisement for the promotion, then the customer can order the promotion. The customer or sales representative adds the promotion to the order, and all of the products in the promotion are added as line items to the quote or order. This selection method usually applies to bundled promotions.
- **Bottom-up selection.** If the customer adds products to a quote or order that have product promotions available, then the sales representative or the application can recommend the promotion. When a customer is purchasing some products in a bundle promotion, the application can automatically recommend the bundle promotion. There can be an auto-recommendation if the customer has these products in a quote or order as new items, and if they are not already covered by another promotion.

For more information about how end users work with product promotions, see *Siebel Order Management Guide*.

Process of Creating Product Promotions

When you create a new Product Promotion record, a version named Work Space is automatically created and the Locked check box is automatically selected in the Product Promotions screen, Versions view. This check box must be selected to change the Effective Dates of the promotion. You do not have to lock the version to change any other information about a promotion, but to see the changes at run time, the user must select Refresh Cache from an applet-level menu item of the promotion header form. For more information, see [“Managing Versions of Product Promotions” on page 83](#).

To create a product promotion, perform the following tasks:

- 1 [“Setting Up Image Files for Product Promotions” on page 66](#)
- 2 [“Creating the Product Promotion Record” on page 67](#)
- 3 [“Specifying Products for Product Promotions” on page 69](#)
- 4 [“Specifying Pricing for Product Promotions” on page 71](#)
- 5 [“Defining Eligibility Rules for Product Promotions” on page 75](#)
- 6 [“Defining Compatibility Rules for Product Promotions” on page 75](#)
- 7 [“Customizing Recommendation Messages for Product Promotions” on page 76](#)
- 8 [“Creating Translations of Recommendation Messages for Product Promotions” on page 76](#)
- 9 [“Specifying Terms and Conditions of Product Promotions” on page 77](#)
- 10 [“Releasing the Product Promotion” on page 81](#)
- 11 [“Activating Workflows for Product Promotion” on page 87](#)

Setting Up Image Files for Product Promotions

This task is a step in [“Process of Creating Product Promotions” on page 66](#).

When you create a product promotion, you can associate an image file with it. This image will be displayed next to the promotion in catalogs. If you want to show the image in catalogs, then you must create the image and import it into the Siebel application in the Administration - Document screen. This makes it available to associate with the product promotion record.

To set up image files for product promotions

- 1 Create the images in either JPG or GIF format.
- 2 Navigate to the Administration - Document screen, then Literature view.
- 3 In the Literature list, click New File.
- 4 In the Choose File dialog box, select the image file.

Creating the Product Promotion Record

This task is a step in [“Process of Creating Product Promotions” on page 66](#).

Create the Product Promotion record, which contains general information about the entire product promotion.

NOTE: When you create a Product Promotion record, you specify the effective dates for the promotion. Before you do this, it can be useful to view a schedule of all your product promotions. For more information, see [“Viewing the Schedules of All Product Promotions” on page 84](#).

To create a product promotion record

- 1 Navigate to the Administration - Product screen, then Product Promotions view.
- 2 Add a new record to the promotions list and complete the necessary fields. Some fields are described in the following table:

Field	Comments
Name	Enter a name for the promotion.
Type	Select the type of the promotion. The options are coupon and bundled promotion. For more information about these types, see “About Product Promotions” on page 65 .
Instances	Select a value that specifies how many times a customer is allowed to use this promotion. The options are One Per Customer, One Per Order, and No Limit.
Effective Dates	This field displays the start date and end date of the period when this promotion is effective. Users can edit these dates in the Versions view.
Track as Asset	Select this check box to track the promotion as an asset. This is necessary if you provide ongoing service to the buyer of the promotion, or have some other reason to keep a record of which buyers have purchased the promotion. For more information, see the topic about asset-based ordering in <i>Siebel Order Management Guide</i> . NOTE: This check box applies only to the promotion, not to the products in it. To track products within the promotion as assets, you must select the Track as Asset check box for these products in the Administration - Products screen, Products view.

Field	Comments
Show in Catalog	<p>Select this check box to display the promotion in the product catalogs, so the end user can choose it in quotes and orders the same way the end user chooses a product.</p> <p>If you select the check box for bundle promotions, then end users can select the bundle promotion in a catalog to add all the products in the promotion to a quote or order.</p> <p>You generally do not select this check box for coupon promotions. For coupon promotions, end users generally add the product, and then select a coupon promotion that is available for that product.</p>
Promotion ID	<p>This field displays a unique, Siebel-Pricer-generated ID for the promotion.</p>
Image	<p>Select an image file that will display if this promotion is shown in a catalog. Before you can select this, you must set up the image, as described in “Setting Up Image Files for Product Promotions” on page 66.</p>
Organization	<p>Select one or more organizations to give them visibility to this promotion. Users who are not in these organizations cannot see this promotion in the Siebel application. For more information about organizations, see <i>Siebel Security Guide</i>.</p>
Campaign	<p>If the promotion is part of a marketing campaign, then select the campaign. For more information about campaigns, see <i>Siebel Marketing Installation and Administration Guide</i>.</p>
Score	<p>Enter the ranking that determines where on the list of product promotion recommendations this promotion will appear when the end user displays recommendations. Promotions with higher scores appear higher on the list. For more information, see the topic about recommendations in <i>Siebel Order Management Guide</i>.</p>
Message	<p>Enter a message for the promotion.</p>
Track as Agreement	<p>Select this check box to track the promotion as an agreement. This is necessary if the agreement involves some ongoing commitment to the customer that you must refer to in the future. For more information about agreements, see <i>Siebel Project and Resource Management Administration Guide</i>.</p>

Specifying Products for Product Promotions

This task is a step in [“Process of Creating Product Promotions” on page 66](#).

Every promotion applies to specific products. The promotion may apply to one product, such as a particular model of table and chair, or it may apply to many products, such as all of your dining room tables.

If you are creating a bundle product promotion, then list all the products in the bundle in the Products list. The customer must buy all these products to get a discount.

If you are creating a coupon product promotion, then you do not have to list the product here. Add the product and the price discount for it in the Product Promotion screen, Pricing view.

You can add the products covered by a promotion using the Product Promotions, Products, and then Components view. For example, if you give customers a discount if they buy a specific model of table and four chairs, then add that table to the Products view with a minimum quantity of 1, and add the chair with a minimum quantity of 4.

You can also add product lines or product classes to a promotion using the Product Promotions, Products, and then Aggregate view. For example, if you have a product line named Dining Room Tables, then you can add it to the promotion so that the promotion applies to all dining room tables. You specify the default dining room table that is included in the promotion, but the customer can select any product in the Dining Room Table product line to get the bundle discount.

Specifying Individual Products for a Product Promotion

Use the following procedure to specify individual products for a product promotion.

To specify individual products for a product promotion

- 1 Navigate to the Administration - Product screen, then Product Promotions view.
- 2 In the Product Promotions list, select the promotion for which you are specifying products.
- 3 Click the Products view tab.

If necessary, in the link bar of the Products view, click Components.

- 4 For each product that is covered by the promotion, add a new record to the Product Components list and complete the necessary fields. Some fields are described in the following table:

Field	Comments
Product Name	Select a product that is covered by the promotion. Products are available in the dialog box if they are released and have a currently active version. If this is a product with components, then you can click the product name to display the explorer view used to define products with components.
Description	Enter a description of the product.
Min	Enter the minimum number of this product that the customer must buy to qualify for this promotion, if there is a minimum requirement.

Field	Comments
Max	Enter the maximum number of this product that the customer may buy to get the discount for this promotion, if there is a maximum limit.
Default	<p>Enter the default quantity of this product that is included in the promotion, if you want to display a default quantity. If the customer selects this promotion in a quote or order, then the default quantity of all products in the promotion will be added as line items to the quote or order.</p> <p>This field is optional. If you do not enter a value here, then the application uses the value entered in the Min field as the default value.</p>
Customizable	<p>This check box is selected if the product selected in the Product Name field is customizable.</p> <p>The promotion can also be used to constrain the selections for the customizable product. For more information, see “About Product Promotions for Customizable Products” on page 84.</p>
Recommendable	Select this check box to allow the Siebel application to recommend this product promotion to end users when the product exists in a quote or order and is not associated with any other product promotion.
Commitment	<p>Select this check box if the product involves a commitment. For more information, see “Specifying Terms and Conditions of Product Promotions” on page 77.</p> <p>NOTE: Only bundled promotions have commitments. Coupon promotions do not have commitments.</p>

- To enter translations of descriptions of the product to be shown in catalogs that are not in the default language, add a new record to the Translations list for each language you support and complete the necessary fields, described in the following table:

Field	Comments
Language Name	This field displays the name of the language after you select the language code.
Language Code	Select the language code. For example, select ENU for American English.
Description	Enter the description of the promotion to be shown in catalogs and promotion recommendations using this language.

NOTE: The catalog in the default language shows the description that you entered in the Description field of the Product Component record, as described in [Step 4.](#)

Specifying Product Lines or Product Classes for a Product Promotion

Use the following procedure to specify product lines or product classes for a product promotion.

To specify product lines or product classes for a product promotion

- 1 Navigate to the Administration - Product screen, then Product Promotions view.
- 2 In the Product Promotions list, select the promotion for which you are specifying products.
- 3 Click the Products view tab, and in the link bar, click Aggregate.
- 4 For each product that is covered by the promotion, add a new record to the Product Aggregate list and complete the necessary fields. Some fields are described in the following table:

Field	Comments
Product Line	Select a product line that is covered by the promotion. Select either a product line or a product class, but not both.
Product Class	Select a product class that is covered by the promotion.

Complete the other fields in the same way as in the Components view.

- 5 In the Default Product view, click the Default check box for each product that is a default product for the promotion and enter the default quantity for each.
- 6 To enter descriptions of the promotion to be displayed in Edit Promotion view, add a new record to the Translations list for each language you support and complete the necessary fields in the same way as in the Components view.

Specifying Pricing for Product Promotions

This task is a step in [“Process of Creating Product Promotions” on page 66](#).

All promotions involve giving customers price adjustments on some or all products. For example, a promotion may offer a discount on a table if the customer buys a set that includes the table and four chairs.

Use the Pricing view to define the price adjustments for this promotion. You can define two types of price adjustments:

- **Component.** Define price adjustments for individual products.
- **Aggregate.** Define price adjustments for multiple products. There are two types of aggregate rules:
 - **Aggregate Conditional Rules.** Define rules for all the products in a product class or product line. For example, you could give a 10 percent discount on all digital cameras and a 15 percent discount on all film cameras, if these are two product lines with products that have been included in the promotion.
 - **Aggregate Default Rules.** Define rules that are applied by default if the line item product does not match any individual product pricing rule or any conditional aggregate pricing rule.

Specifying Price Adjustments for Individual Products in a Product Promotion

Use the following procedure to specify price adjustments for individual products in a product promotion.

To specify price adjustments for individual products in a product promotion

- 1 Navigate to the Administration - Product screen, then Product Promotions view.
- 2 In the Product Promotions list, select the promotion for which you are specifying pricing.
- 3 Click the Pricing view tab.
- 4 Click Components on the link bar in Pricing view.
- 5 In the Pricing Components list, add a record for each product whose price will be changed by the promotion and complete the necessary fields. Some fields are described in the following table:

Field	Comments
Product Name	Select a product.
Adjustment Type	Select the type of price adjustment applied to this product. The options are Discount Amount, % Discount, Markup Amount, % Markup, and Price Override.
Adjustment Value	<p>Enter the value of the Adjustment. How this value is used depends on the selection in the Adjustment Type field:</p> <ul style="list-style-type: none"> ■ Discount Amount. The adjustment value is subtracted from the product price. ■ % Discount. The adjustment value is a percentage of the product price, which is then subtracted from the product price. ■ Markup Amount. The adjustment value is added to the product price. ■ % Markup. The adjustment value is a percentage of the product price, which is then added to the product price. ■ Price Override. The adjustment value is used as the product price, overriding the original price.

Specifying Price Adjustments Applied to a Product Class or a Product Line in a Product Promotion

Use the following procedure to specify price adjustments applied to a product class or product line in a product promotion.

To specify price adjustments applied to a product class or product line in a product promotion

- 1 Navigate to the Administration - Product screen, then Product Promotions view.
- 2 In the Product Promotions list, select the promotion for which you are specifying the pricing.
- 3 Click the Pricing view tab.
- 4 Click Aggregate on the link bar in the Pricing view.
- 5 In the Pricing Aggregate list, add a new record and complete the necessary fields. Some fields are described in the following table:

Field	Comments
Type	<p>Select the type of aggregate adjustment. The options are as follows:</p> <ul style="list-style-type: none"> ■ Aggregate – Default. This is a default pricing rule. If the line item product does not match any individual product pricing rule or any conditional aggregate pricing rule, then the line item price is adjusted using this default rule. ■ Aggregate – Conditional. The adjustment is applied to product classes or product lines. When this value is selected a user must define the Group Field and Group Value fields.
Product Line	If you selected Aggregate - Conditional as the type, then you can select a product line to which the adjustment applies.
Class	If you selected Aggregate - Conditional as the type, then you can select a class to which the adjustment applies.
Adjustment Type and Adjustment Value	Enter the price adjustment. These fields are used in the same way as in the Pricing Components view, which was described in the previous procedure.

- 6 If you selected Aggregate - Conditional as the type, then you can add more records to define adjustments for additional product lines and classes.

Setting Up Promotion Price Adjustments for Components

Administrators can set up adjustments to prices for components that are part of a customizable product in a promotion. When a user creates an order or quote for that customizable product in the promotion, the user can view the adjusted prices for the components. You can add promotion components to price lists in the same way that you add other components to price lists. The prices for components in a promotion supersede any other prices for those components.

For example, if a promotion includes a bundle that allows for free voice mail for wire line service or a 50% discount for wireless service, then the administrator can set up the voice mail component for the wire line service with no price and the voice mail component for the wireless service with a 50% discount. When a user creates an order that includes this bundle, the user can view the \$0 price for voice mail if the customer wants the wire line service and the 50% discount price for voice mail if the customer wants the wireless service. If voice mail is priced at \$10 for each month when it is not part of a promotion, then the user does not see this \$10 monthly price.

Use the following procedure to set up promotion price adjustments for components.

NOTE: Setting up promotion price adjustments for components applies to Industry Applications only.

To set up promotion price adjustments for components

- 1 Navigate to the Administration - Product screen, then the Product Promotions view.
- 2 In the Promotions list, select the promotion for which you want to set up adjustments to component prices.
- 3 Click the Pricing tab.
- 4 In the Pricing Components list, select a customizable product for which you want to set up adjustments to component prices.

NOTE: A check mark displays in the Customizable field for the products that you can customize.

- 5 Click the Product Name field to display the components for the customizable product.
- 6 For each component for which you want to set up a price adjustment, select the component, and add a price adjustment record to the Adjustments list. Some fields are described in the following table:

Field	Comments
Adjustment Type	Select the type of price adjustment applicable to the component. Options include: Discount Amount, % Discount, Markup Amount, % Markup, and Price Override.
Adjustment Value	Enter the value of the adjustment. How this value is used depends on the value in the Adjustment Type field: <ul style="list-style-type: none"> ■ Discount Amount. The adjustment value is subtracted from the component price. ■ % Discount. The adjustment value is a percentage of the component price and is subtracted from the component price. ■ Markup Amount. The adjustment value is added to the component price. ■ % Markup. The adjustment value is a percentage of the component price and is added to the component price. ■ Price Override. The adjustment value is used as the component price and overrides the original component price.

Field	Comments
Maximum Price	Enter the price that the adjusted price cannot exceed.

- (Optional) Click Verify Adjustments to view the component prices in time intervals after adjustments.

Defining Eligibility Rules for Product Promotions

This task is a step in [“Process of Creating Product Promotions” on page 66](#).

Promotions may be restricted to only some of your customers. For example, a promotion may be offered only to customers in certain states. You can define rules that specify which customers are eligible for the promotion. For more information, see the topic about eligibility rules in *Siebel Order Management Guide*.

NOTE: Effective in the 7.8.2 version, the Check Eligibility flag and Inclusive Eligibility flag have been moved to the promotion header from the Versions view.

To define eligibility rules for a product promotion

- Navigate to the Administration - Product screen, then Product Promotions view.
- In the Product Promotions list, select the promotion for which you are defining the eligibility rules.
- Click the More Info view tab, select the Check Eligibility and Compatibility check box.
- Click the Eligibility and Compatibility view tab and in the Rules link bar, click Eligibility.
- Add new records to the Rules list and complete the necessary fields, as described in *Siebel Order Management Guide*.

Defining Compatibility Rules for Product Promotions

This task is a step in [“Process of Creating Product Promotions” on page 66](#).

You might have policies that keep customers from using more than one product promotion at the same time. For example, you might say that a coupon for a product may not be used with other coupons for the same product, but that the coupon may be used with bundle promotions for the same product.

You can define compatibility rules for a product promotion to specify the other product promotions with which it may and may not be used. For more information, see the topic about compatibility rules in *Siebel Order Management Guide*.

To define compatibility rules for a product promotion

- Navigate to the Administration - Product screen, then Product Promotions view.

- 2 In the Product Promotions list, select the promotion for which you are defining compatibility rules.
- 3 Click the Eligibility and Compatibility Rules view tab and then in the link bar, click Compatibility.
- 4 Add new records to the Rules list and complete the necessary fields, as described in the topic about compatibility in *Siebel Order Management Guide*.

Customizing Recommendation Messages for Product Promotions

This task is a step in [“Process of Creating Product Promotions” on page 66](#).

By default, if the application recommends a promotion, then it displays a message in the following form:

Recommend promotion '[Prod Prom Name]': [Promotion Description]

You can customize the form of this message.

To customize the recommendation message for product promotions

- 1 Navigate to the Administration - Application screen and in the link bar, click Message Types.
- 2 In the All Message Types list, query to find the record with the name *Promotion - Bottomup Recommendation*.
- 3 In the Message Type view, enter the desired message in the Full Text field.

Creating Translations of Recommendation Messages for Product Promotions

This task is a step in [“Process of Creating Product Promotions” on page 66](#).

You can translate the recommendation message in multiple languages. The language that is displayed depends on the language of the user's application.

To create translations of recommendation messages for a product promotion

- 1 Navigate to the Administration - Product screen, then Product Promotions view.
- 2 In the Product Promotions list, select the promotion.
- 3 Click the Messaging view tab.

- 4 For each language in which the message will be displayed, add a record to the Messaging list and complete the necessary fields. Some fields are described in the following table:

Field	Comments
Language Name	This field displays the name of the language after you select the language code.
Language Code	Select the language code. For example, select ENU for American English or ENG for British English.
Description	Enter the text of the recommendation message in the appropriate language.

Specifying Terms and Conditions of Product Promotions

This task is a step in ["Process of Creating Product Promotions"](#) on page 66.

Some promotions require customers to accept certain terms and conditions. In some industries, these are called commitments. If your promotion includes terms and conditions, then you must specify them.

For example, if a customer accepts a promotion offering a free cell phone to sign up for a certain wireless plan, then the customer may have to keep that wireless service for at least a year. If the customer cancels the service before the year has ended, then there may be a penalty.

When a customer disconnects an asset, the Siebel application checks to see whether the customer is breaking the terms and conditions of a promotion. If so, it displays a warning message telling the customer how much the penalty is. You can set up the product recommendation engine to recommend changes that will avoid the penalty, as described in the topic about recommendations in *Siebel Order Management Guide*. If there is a penalty, then the application calculates the amount. The Siebel application is integrated with the billing application, so the penalty is automatically applied.

You may want to prorate the penalty. For example, if customers get a free satellite dish when they sign up for twelve months of service, then they may have to pay the full penalty if they cancel before one month has elapsed, but pay only one-half of the penalty if they cancel after six months.

A commitment may include recurring credit and cancellation charges. The cancellation charge and credits may need to be prorated for partial periods.

The penalty may be a nonrecurring charge paid once, or it may be a recurring charge paid periodically during a specified time period.

You can use the Commitments view to give customers ongoing benefits that they receive with a promotion, in addition to using it for penalties. For example, if the promotion gives the customer a credit every month for a year, which reduces the customer's monthly bill, then the Commitments view can record this credit.

Entering the Customer's Commitment

In the Charge Plan view of the Commitment applet, enter the charges for customers' ongoing commitment. Enter negative amounts if it is a credit. To do this, you must first create schedules and plans for any recurring, nonrecurring, and usage charges that the customer must pay. For more information, see the topic about contracts and agreements in *Siebel Field Service Guide*.

After you have created the necessary recurring and nonrecurring charge plans, you can enter the amounts that customers are committed to pay.

To enter the customer's commitment

- 1 In the Product Promotions, Commitment view, click Charge Plan in the link bar.
- 2 In the Charge Plan form, complete the necessary fields.

Some fields are described in the following table:

Field	Comments
NRC Schedule	Select a schedule for the nonrecurring charge. For example, a schedule may specify that the customer pays the recurring charge by the fifteenth of each month.
Nonrecurring	Enter the total amount of the nonrecurring charge.
NRC Plan	Select a nonrecurring charge plan. For example, the plan may allow the customer to pay off the nonrecurring charge in three monthly payments.
NRC Quantity	<p>If the user does not select a value in the NRC Plan field, then the user can enter a specific number of payments. The charge calculation engine then divides the charge into equal payments of the quantity specified.</p> <p>If the user does select a value in the NRC Plan field, then this field displays the number of payments in the plan and is read-only.</p>
RC Schedule	Select a schedule for the recurring charge. For example, a schedule may specify that the customer pays the recurring charge by the fifteenth of each month.
Recurring	Enter the amount of the recurring charges.
RC Adjust	<p>Specify an adjustment for a recurring charge if the usage period is less than the entire billing period.</p> <p>For example, if the customer starts cable TV service on June 16, then the customer is charged for only 15 days in the month of June. In this case, enter the charge for the day in the RC Adjust field, and select Per Day in the RC Adjust U/M field. The application calculates the adjustment for the 15 days in June.</p>
RC Adjust U/M	Enter the time period to which the RC adjustment applies. The options are Per Day and Per Week.

Field	Comments
Adjust Charge	Enter a special adjustment to the amount the customer is charged. For example, if a customer calls to complain that cell phone service has not been working well for the last few days, then the company can agree to give the customer a one-time adjustment. The company enters the adjustment in this field.
Adjust Reason	Enter the reason for the special adjustment.
Commit	Select this check box when you are done making changes to the record.
Charge Basis	Specify when the charge for a period is generated. The options are as follows: <ul style="list-style-type: none"> ■ Schedule. Charges are generated after the usage period. For example, June charges are generated on July 1. ■ Advance. Charges are generated in advance of the usage period. For example, June charges are generated on June 1.
Use Plan	Select the usage payment plan for this promotion. For example, there may be different usage payment plans for regular, gold, and platinum customers.
Usage Schedule	Select a schedule for the usage charge. For example, a schedule may specify that the customer pays the usage charge by the fifteenth of each month.

Entering Penalties for Canceling the Commitment

In the Charges and Credits view of the Commitment applet, enter the penalties that the customer must pay for canceling this commitment. You can also use this view to enter credits that the customer receives.

Before you enter penalties, you may have to create a plan used to prorate the penalty charge, if the penalty depends on the amount of time that the customer used the service before canceling. Create the prorate plan as a nonrecurring charge plan, described in the topic about contracts and agreements in *Siebel Field Service Guide*.

To enter the penalty that customers pay for canceling the commitment

- 1 In the Product Promotions, Commitment view, click Charges and Credits in the link bar.

- 2 In the Charges and Credits list, add a record for each penalty that the customer must pay, and complete the necessary fields.

Some fields are described in the following table:

Field	Comments
Type	Select the penalty.
Amount	Enter the amount of the penalty. If you enter a negative amount, then the customer will receive a credit instead of paying a penalty.
Plan	Select the nonrecurring charge plan used to prorate the penalty.

Entering Terms Displayed to the Customer

In the Terms view of the Commitment applet, enter the list of terms that will be displayed and included in the contract that the customer accepts.

The user can select a term template instead of entering terms manually, if you first define term templates using the Administration - Contract screen, Term Templates view. For more information about defining term templates, see *Siebel Life Sciences Guide*.

To enter terms displayed to the customer

- 1 In the Product Promotion, Commitment view, click Terms in the link bar.
- 2 For each term that will be displayed to the customer, do the following:
 - To select a term template, click Pick from Template.
 - To enter terms manually, add a record to the Terms list and complete the necessary fields.

Some fields are described in the following table:

Field	Comments
Number	Enter a number to control what order this text will be displayed in within the list of terms.
Type	Select the Type of the Term. The options are Standard, Non-Standard, and Special. When you design screens and reports, you may decide to display only terms of certain types.
Section	Enter the text that will be displayed to the customer.

Releasing the Product Promotion

This task is a step in [“Process of Creating Product Promotions” on page 66](#).

When you created the new Product Promotion record, a version of it named Work Space was automatically created and the Locked check box was automatically selected in Product Promotions, Versions view.

When you have finished the entire process of defining the product promotion, you must release this version and refresh the cache to make the new version available to users.

Promotion versions work differently from product versions. Promotion versions only impact the Start Date, End Date, and Active fields of the promotion. Every other aspect of product promotions is uniform across all active versions of the promotion. The user must refresh the cache after making any changes to the promotion definition.

To release the product promotion

- 1 In the Product Promotions, Versions view, in the Work Space record, complete the necessary fields, as described in the following table:

Field	Comments
Required Start Date	Enter the date when the promotion becomes available.
Active	Select this check box to make the promotion available.

- 2 Click Release New Version.
- 3 From the Versions form menu, select Refresh Cache.

Creating Product Promotions That Upgrade Existing Promotions

You can design promotions that offer an upgrade to customers who have existing commitments because they have accepted earlier promotions.

For example, if customers have already signed up for a promotion to subscribe to a wireless telephone plan and have commitments to pay \$29.95 a month for the next year, then you can create a promotion that offers them a wireless plan with no roaming charges for \$39.95 a month. This involves breaking their existing commitment, but they do not have to pay the usual cancellation charge.

You can also offer the new promotion to customers who have accepted any one of many earlier promotions.

To create a promotion that is an upgrade to earlier promotions, define the new promotion as usual, and also use the Upgrade view to enter information about the existing promotions that customers can break without penalty.

By default, the Upgrade Promotion functionality is not feasible for both customizable and non-customizable products. In any case, selecting Upgrade Promotion from Menu in the Upgrade view triggers the workflow functionality by calling the pricing workflow. But if the functionality that is triggered is not exactly what you want, then as a workaround, it is recommended that you change the workflow to get the behavior that you want. For more information about pricing workflows, see [“Pricing Procedures and Workflow References” on page 213](#).

To create a product promotion that upgrades existing promotions

- 1 Navigate to the Administration - Product screen, then Product Promotions view.
- 2 In the Product Promotions list, select the promotion.
- 3 Click the Upgrade view tab.
- 4 Add a record for each earlier promotion that can be broken without penalty and complete the necessary fields, as described in the following table:

Field	Comments
Original Promotion	Select the earlier promotion that customers can break without penalty.
Commitment Start	Specify when the commitment starts for the new promotion. The options are as follows: <ul style="list-style-type: none">■ Original Start. The commitment starts at the same time the commitment for the earlier promotion started.■ Now. The commitment starts when the customer accepts the new promotion.■ Original End. The commitment starts when the commitment for the earlier promotion ends.

Field	Comments
Duration	<p>Specify the duration of the new promotion. The options are as follows:</p> <ul style="list-style-type: none"> ■ Original Duration. The duration of the new promotion is the same as the duration of the original promotion. ■ New Duration. The duration of the new promotion is different from the duration of the original promotion. If you select this, then you must enter the new duration in the Commitments view.
Penalty	Enter the penalty for upgrading from the old to the new promotion, if any.
Prorate Plan	If there is a penalty for upgrading from the old to the new promotion, then select the prorate plan used to prorate this penalty.

Viewing a Summary of a Product Promotion

At any time, you can view a summary of the most important features of a product promotion in a single screen.

This is a read-only view. You use it to look at a summary of the product promotion while you are creating it, and also to provide summary information about the promotion to sales representatives.

To view a summary of a product promotion

- 1 Navigate to the Administration - Product screen, then Product Promotions view.
- 2 In the Product Promotions list, select the promotion.
- 3 Click the Summary view tab.

Managing Versions of Product Promotions

You manage versions of product promotions using the Product Promotions, Versions view.

Managing versions of product promotions is not the same as managing versions of customizable products and product classes.

Versions are mainly used to schedule product promotions with different effective dates.

NOTE: Apart from the effective date fields, changes to the header of the product promotion, the More Info view, and the other views are not versioned. These changes take effect when the user selects Refresh Cache from the menu of the Promotion Header form, or when the user logs out and logs in again.

Creating Product Promotion Versions with Different Effective Dates

If you are running a product promotion now and you want to run the same promotion a second time later in the year, then you can do this by creating promotion versions with different effective dates.

For example, if you are running a promotion during the month of April, 2005, and you want to run the same promotion again during the month of June, 2005, then complete the steps in the following procedure.

To create product promotion versions with different effective dates

- 1 Create the promotion with April 1, 2005 in the Required Start Date field and the Active check box selected. Release this version of the promotion.
- 2 Create a new version of the promotion with May 1, 2005 in the Required Start Date field and the Active check box deselected. Release this version of the promotion. Because Active is deselected, this version will not be visible to customers.
- 3 Create a new version of the promotion with June 1, 2005 in the Required Start Date field, and the Active check box selected to make the promotion visible to customers beginning June 1.
- 4 Create a new version of the promotion with July 1, 2005 in the Required Start Date field and the Active check box deselected, so the promotion is not visible to customers beginning July 1.

Viewing the Schedules of All Product Promotions

When you are planning new promotions, you can view a schedule of all existing product promotions to help you decide on the best effective dates for the new promotion. The Product Promotions Schedule view shows you a schedule of the effective dates for all product promotions.

To view the schedules of all product promotions

- 1 Navigate to the Administration - Product screen, then Product Promotions Schedule view.
- 2 Click 1, 7, or 30 to view the schedules for a day, week, or month.
- 3 From the Date drop-down, select the start date of the schedules you want to view, and click Go.
Red bars are displayed to show the dates that the promotions are active.

About Product Promotions for Customizable Products

If the end user selects a promotion with a special configuration, and then displays Siebel Configurator to configure the product, then the rules defined for a promotion are enforced within the Configurator session.

For example, a specific model of computer may have hundreds of possible configurations, but a promotional offer may allow only a few of these configurations. The promotion may require you to get a specific processor and either a 20 GB or 30 GB hard drive, even though many other possible hard drives are allowed by the configuration rules.

In this example, the user must display Configurator to choose the amount of RAM, the computer monitor, and other features besides the processor and hard drive. Configurator allows you to choose any one of the features that the configuration rules allow. However, Configurator lets you choose only the processor required by the promotion, and it lets you choose between only the 20 GB and 30 GB hard drive that the promotion allows, even though other processors and other hard drives may be allowed by the general configuration rules.

When you create a promotion for customizable products, you can define additional constraints beyond the constraints defined in Configurator. You can create additional constraints in the following ways:

- [“Changing the Cardinality of Components of Product Promotions” on page 85](#)
- [“Constraining the Products Available for a Component of a Product Promotion” on page 86](#)
- [“Constraining the Attributes Available for a Product in a Product Promotion” on page 86](#)

Changing the Cardinality of Components of Product Promotions

You can change the cardinality of a component of a customizable product used in product promotions. For example, the product promotion can allow the user to select a smaller number of one component than the configurator constraints allow.

To change the cardinality of a component of a product promotion

- 1 Navigate to the Administration - Product screen, then Product Promotions view.
- 2 In the Product Promotions list, select the desired promotion.
- 3 Click the Products view tab.
- 4 In the Products link bar, click Components.
- 5 In the Components list, in Min or Max field for the component, enter the new cardinality constraints.

The new Min and Max values have to fall within the cardinality constraints defined in the Customizable product definition, which are displayed in the Lower Limit and Upper Limit fields.

Constraining the Products Available for a Component of a Product Promotion

By default, a component of a customizable product in a product promotion has the products available that are defined in Configurator. However, you can modify the products that are available for the component so that the promotion offers only a subset of the products defined in Configurator.

For example, as defined in Configurator, a computer may be available with five different monitors. For the promotion, you may want to offer only two of those monitors.

To constrain the products available as a component of a product promotion

- 1 Navigate to the Administration - Product screen, then Product Promotions view.
- 2 In the Product Promotions list, select the desired promotion.
- 3 Click the Products view tab.
- 4 In the Products list, click the Product Name field of the customizable product.
The structure of that product is displayed.
- 5 In the Relationships list, select the Component you want to change.
- 6 In the Relationship Domain list, click Modify.
This deletes all the products in the Relationship Domain list.
NOTE: You must now manually add all the products that you want to make available for the component in the promotion, as described in the following step.
- 7 In the Relationship Domain list, click Add Item, and in the Domain Product field, select a product.
- 8 Repeat [Step 7](#) until you have added all the products that are available for that component in the promotion.

Constraining the Attributes Available for a Product in a Product Promotion

If a product promotion includes a product with attributes, then you can constrain the domain of values allowed for an attribute. For example, if a shirt comes in ten different colors, then the promotion can be available for all the colors except red and blue.

You can create an exclude rule and list the attributes you do not want to make available, or you can create an include rule and list the attributes you do want to make available.

To constrain the attribute domain for a product in a product promotion

- 1 Navigate to the Administration - Product screen, then Product Promotions view.
- 2 In the Product Promotions list, select the desired promotion.
- 3 Click the Products view tab.

- 4 In the Products list, click the Product Name field of the customizable product.
The structure of that product is displayed.
- 5 Click the Attributes view tab.
- 6 In the Attributes list, go to the Condition field for the attribute whose domain you want to constrain, and select Exclude to create an exclude rule or select Include to create an include rule.
- 7 In the Values list:
 - a To create an exclude rule, add records for all the values of the attribute that you do not want to make available within the promotion.
 - b To create an include, add records for all the values of the attribute that you do want to make available within the promotion.

Activating Workflows for Product Promotion

This task is a step in ["Process of Creating Product Promotions"](#) on page 66.

Product promotions are based on Siebel Workflows. You must activate these workflows before using the product. For information about activating workflows, see *Siebel Business Process Framework: Workflow Guide*.

The following is a list of the workflows you need to activate:

- ISS Promotion Agreement Covered Assets Subprocess
- ISS Promotion Agreement Management Subprocess
- ISS Promotion Commitment Compliance Check Subprocess
- ISS Promotion Create Agreement Details
- ISS Promotion Disconnect Integration Subprocess
- ISS Promotion Disconnect Process
- ISS Promotion Disconnect Process - for Verify
- ISS Promotion Edit Integration Subprocess
- ISS Promotion Recommendation Subprocess
- ISS Promotion Upgrade Process
- ISS Promotion Verify Subprocess

9

Creating Product Offers

This chapter covers product offers. It includes the following topics:

- "About Product Offers" on page 89
- "About Versions of Product Offers" on page 90
- "About Actions for Responses to Product Offers" on page 91
- "Process of Creating Product Offers" on page 94
- "Product Offers with Named Parameters" on page 104
- "Example of Creating Product Offers with Parent Actions" on page 107
- "Modifying Product Offers" on page 108
- "Viewing Product Offers for an Account" on page 109
- "Tasks for Suppressing Product Offer Recommendations" on page 109
- "Migrating Product Offers Using Workspace Projects" on page 111
- "Workflow Reference for Product Offers" on page 112

About Product Offers

A *product offer* is an offer to sell a product that allows a customer to respond with a single click. For example, you can add product offers to a Web site and display them in an area with the label *Hot Offers*. One hot offer might say: *Do you want to upgrade to our extra value plan: 1,000 long distance minutes for \$33.85 a month?* This hot offer might have three buttons for the customer to click: Yes, No, and More Information. It is displayed only to customers who already have the standard plan for long-distance minutes. If the customer clicks Yes, then the order is placed automatically. If the customer clicks More Information, then an activity is created and assigned to a customer service representative, who contacts the customer.

To support one-click ordering, product offers have the following features:

- They enable you to define the possible user responses for a given offer.
- They enable you to specify ordering tasks that the Siebel application performs, such as:
 - Adding or deleting asset components, for example, changing a rate plan
 - Updating asset attributes, for example, changing bandwidth
 - Upgrading a promotion, for example, upgrading from the promotion named *double play* to the promotion named *triple play*
 - Editing or applying a promotion, for example, changing handset
 - Updating line item fields, for example, changing the value of a manual discount

- They enable you to specify preordering tasks and postordering tasks that the Siebel application performs, such as address validation and order validation.

Product Offers on Low-Interactivity Channels

Product offers are particularly useful for channels that are unassisted or have limited user interactivity, such as short messaging service (SMS), Interactive Voice Response (IVR), and the hot offers bin on a Web site. When the user accepts the order, some exceptions might occur. You must configure exception handling, which is typically channel-specific:

- **Web.** For this channel, display the exception on the Web site.
- **SMS.** For this channel, create an activity and assign it to a customer service representative.
- **IVR.** For this channel, route the exception to a customer service representative.

Because product offers are also available in the Siebel application, they provide customers with a consistent experience on all sales channels. For example, a customer might view the offer on the Web and phone the call center. Then the customer service representative at the call center can view the same product offer in the Siebel application and accept the offer on behalf of the customer. For more information on how customer service representatives can access product offers, see [“Viewing Product Offers for an Account” on page 109](#).

Product Offers and Promotions

Both product offers and Siebel promotions give customers the opportunity to buy products or bundles of products at a promotional price. The main differences are:

- Siebel promotions enable customers to buy a single product or a group of products and services at a promotional price. Each product or service within a promotion can have its own configurable options, contractual commitments, and early termination fees.
- Siebel product offers enable customers to buy products or services (including Siebel promotions) through nonassisted channels with limited, user interactivity. Product offers enable one-click ordering. Permitted user responses are clearly defined, as are the actions that the Siebel application performs for each user response. Customers are typically prequalified for product offers.

Upgrading a promotion often requires user interactivity to resolve product selections. Users typically must select the products or services that they want to upgrade or disconnect. Product offers do not support this level of user interactivity, but they can be used to give customers a quick start for creating orders when they are upgrading promotions.

About Versions of Product Offers

Product offer versions work differently from product versions. Product offer versions affect only the Start Date, End Date, and Active fields of the product. Every other aspect of a product offer is uniform for all active versions of the product offer. The user must refresh the cache after making any changes to the product offer definition, using the Clear Cache or Refresh Cache menu option.

These menu options are available for all the views that show versioned objects in the Administration - Product Offer screen: Versions view, Response-Actions view, Recommendations view, Compatibility view, Eligibility view, and Product Line Compatibility view.

If you choose the Clear Cache option, then the application refreshes the cache for all the child objects of the product offer, such as recommendations, compatibility rules, eligibility rules, and so on. The application calls the RefreshBC method of the Row Set Transformation Toolkit.

About Actions for Responses to Product Offers

When you define user responses to product offers, you can also define actions for each response.

The actions create sales orders or quotes, which can be used to:

- Create a new asset.
- Modify an existing asset by doing one of the following:
 - Add, replace, or delete products and services for an asset
 - Update asset line item fields
 - Upgrade products and services for an asset
 - Edit or apply a promotion to products and services in the asset

You can also perform other actions by invoking a Siebel workflow process.

NOTE: Actions that invoke workflows can be used for preorder tasks and postorder tasks, but they cannot be interspersed among actions that create orders. If an action invokes a workflow process, then create the workflow before you define responses. For more information about creating workflows, see *Siebel Business Process Framework: Workflow Guide*.

You generally create actions that map to common order processes such as:

- **Modify order.** Creates actions modifying an order, adding or deleting products, and providing manual discounts
- **Apply promotion.** Creates actions that include bundled products with promotional pricing

For example, you have a product offer for customers who have pay-as-you-go text messaging that says: *Get unlimited text messaging for \$10 per month.* For the response Accept, you create the following actions:

- To specify the product, create actions that modify the asset Wireless Service so that it has the component product Unlimited Text Messaging.
- To specify the pricing, create an action that updates the Discount Amount field of the component product Unlimited Text Messaging, so it has the value of 10.

This is one example of how product and pricing can be specified using the actions of product offers. Different product offers require other methods.

Some responses do not require actions. For example, if the user rejects the offer, then an action is not required usually. In that case, you do not have to define the actions for the Reject response.

You specify an action by selecting in both the Action Type field and the Action Code field. The selection in the Action Type field limits the available selections in the Action Code field. Depending on your selections in these two fields, you might have to specify a value in another field. For example:

- If you select Modify as the Action Type and Update as the Action Code, then you must also make entries in the Field Name and Field Value fields. The action updates that field with that field value.
- If you select Run Process as the Action and Workflow as the Action Code, then you must also select a workflow in the Service Name field. The action runs that workflow.

Table 1 shows the actions that can be performed by product offers, with the Action Type and Action Code of each. This table includes actions that you specify in the Action record, with no user input. You can also use named parameters to base some of these values on user input, rather than specifying them explicitly in the Action record. For more information, see [“Product Offers with Named Parameters” on page 104](#).

Table 1. Actions Performed by Product Offers

Action Type	Action Code	Description
New	Add	Generates an order or quote to create a new asset. Specify the product by selecting it in the Base Product field.
	Update	Modify a field or attribute value of a new asset. To do this requires two actions: <ul style="list-style-type: none"> ■ An action with the action type New and the action code Add to add the new asset ■ An action with the action type New and the action code Update to modify the new asset

Table 1. Actions Performed by Product Offers

Action Type	Action Code	Description
Modify	Add	<p>Modifies an existing asset by adding a product or service.</p> <p>Specify the product by selecting it in the Base Product field, and specify the product or service you are adding to it by selecting it in the Component Product field.</p>
	Update	<p>Modifies an existing asset by updating a product or service.</p> <p>Specify the product by selecting it in the Base Product field. Specify the product or service you are updating by selecting it in the Component Product field. Specify how the product or service is being updated by entering values in the Field Name and Field Value fields, or in the Attribute Name and Attribute Value fields</p>
	Delete	<p>Modifies an existing asset by deleting a product or service.</p> <p>Specify the product by selecting it in the Base Product field. Specify the product or service you are deleting by selecting it in the Component Product field.</p>
	Replace	<p>Modifies an existing asset by replacing a product or service that is an existing component with a new component under the same relationship.</p> <p>Specify the product by selecting it in the Base Product field. Specify the product or service with which you are replacing an existing component of the asset by selecting it in the Component Product field.</p> <p>The replace action deletes the item that was previously selected and adds the item that was specified in the actions. If there is no existing component, then it simply adds the new item.</p> <p>NOTE: The Replace action applies to relationships with a maximum cardinality of 1. If more than one item is selected in the asset, then the replace action randomly deletes one of the selected items.</p>
Upgrade	Upgrade	<p>Upgrades products and services for an existing asset.</p> <p>Specify the Upgrade From product in the Base Product field, and specify the Upgrade To product in the Upgrade Product field.</p>
Run Process	Workflow	<p>Runs a workflow.</p> <p>Select the workflow in the Workflow Name field.</p>

Process of Creating Product Offers

In addition to the tasks for defining product offers in this process, you must create the Web site and possibly other channels that present the offer to customers, and you must integrate them with the Siebel application.

To define a product offer, perform the following tasks:

- [“Creating Product Offers” on page 94](#)
- [“Creating Responses for Product Offers” on page 95](#)
- [“Creating Actions for Responses to Product Offers” on page 96](#)
- [“Creating Eligibility and Compatibility Rules for Product Offers” on page 100](#)
- [“Creating Product Offer Recommendations” on page 101](#)
- [“Creating Translations for Product Offer Messages” on page 102](#)
- [“Releasing Product Offers” on page 103](#)

Creating Product Offers

The first step in defining a product offer is to create a Product Offer record, which includes general information about the product offer. The view tabs under the Product Offer record hold the detailed definition of the product offer.

This task is a step in [“Process of Creating Product Offers” on page 94](#).

To create a product offer

- 1 Navigate to the Administration - Product screen, then Product Offers view.
- 2 Add a new record to the Product Offers list, and complete the necessary fields in the new record and in the More Info form. Some fields are described in the following table.

Field	Comments
Name	Enter a name for the product offer.
Product Offer ID	This field displays a unique ID for the product offer. Siebel CRM generates the ID.
Organization	Select one or more organizations to enable users to see this product offer. Users who are not in these organizations cannot see this product offer in the Siebel application.
Description	Enter a description of the product offer.
Effective Dates	This field displays the start date and end date of the period when this product offer is effective. Users can enter or edit these dates in the Versions view.

Field	Comments
Message Type	<p>The default value for the Unified Message Framework (UMF) message type is Product Offer Recommendation. This message type is part of the seed data and contains the responses Accept and Reject.</p> <p>If you want to create new responses, such as Enroll and Decline, then you must create a new message type, such as Loyalty Recommendation, using the Unified Message Framework, and associate it with the Product Offer Message Group. For more information about the Unified Messaging Framework, see <i>Siebel Order Management Infrastructure Guide</i>.</p>
Message	Enter a message for the product offer.
Thumbnail	Select the small thumbnail version of the image associated with the product offer.
Image	Select a larger version of the image associated with the product offer.
Check Eligibility	<p>Select this check box to make the Siebel application check customers' eligibility to get this product offer.</p> <p>If you select this check box, then you can define rules in the Eligibility and Compatibility Rules view for the product offer.</p>
Inclusive Eligibility	<p>Select this check box to specify inclusive eligibility. If this check box is not selected, then the Siebel application uses exclusive eligibility.</p> <p>With exclusive eligibility, customers are eligible to buy the product if they are not excluded by the eligibility or compatibility rule. With inclusive eligibility, customers are eligible to buy the product only if they are explicitly included by the eligibility rule.</p>

- From the More Info menu, select Clear Cache.

For more information about refreshing the cache, see [“About Versions of Product Offers” on page 90](#).

Creating Responses for Product Offers

Because product offers accept a one-click response, you must specify the different responses offered to the user. Examples of responses are:

- For the offer, *Get 500 points when you enroll in online billing*, the responses might be *Enroll* and *Decline*.
- For the offer, *Upgrade your handset to Daytech 500*, the responses might be *Accept*, *Decline* and *Learn More*.

If you keep the default value (Product Offer Recommendation) in the Message Type field of the Product Offer record, then the default responses, Accept and Reject, are displayed in the Responses list. You do not have to change them.

This task is a step in [“Process of Creating Product Offers” on page 94](#).

To create responses to product offers

- 1 Navigate to the Administration - Product screen, then Product Offers view.
- 2 Select the Product Offer that you want.
- 3 Click the Responses view tab.
- 4 Add a new record to the Responses list for each response that will be displayed to the user, and complete the necessary fields. Some fields are described in the following table.

Field	Comments
Sequence	Enter the order in which the responses are displayed to users.
Response	Select the response. The options can be the following: <ul style="list-style-type: none"> ■ The default values: Accept and Reject. ■ The messages that you created in the Unified Messaging Framework and associated with the Message Type of this product offer in “Creating Product Offers” on page 94.
Comments	Enter comments for your own use.
Inactive	Select this check box to make this response inactive, so it is not displayed as a possible response for the product offer. To use this field, you must select Columns Displayed from the menu.

Creating Actions for Responses to Product Offers

For each response that you created, you can define one or more actions that the Siebel application performs if the user selects that response. For more information about actions, see [“About Actions for Responses to Product Offers” on page 91](#).

In most cases, you define the action using only fields in the Action record, but there are two cases where you can define more complex actions:

- **Workflow parameters.** If the action runs a workflow, then you can also specify parameters that are passed to the workflow. For more information, see [“Creating Parameters for Actions That Invoke Workflows” on page 99](#).
- **Named parameters.** Rather than specifying certain values in the Action record, you can use named parameters to enable the user to select from a range of values. For more information, see [“Product Offers with Named Parameters” on page 104](#).

This task is a step in [“Process of Creating Product Offers” on page 94](#).

To create actions for a response to a product offer

- 1 Navigate to the Administration - Product screen, then Product Offers view.

- 2 Select the Product Offer that you want.
- 3 Click the Responses view tab.
- 4 Select the response that you want.
- 5 Add one or more new records to the Responses - Actions list, and complete the necessary fields. Some fields are described in the following table.

Field	Comments
Sequence	<p>Displays the order in which the actions are executed. The sequence number is generated automatically, and you cannot change it.</p> <p>NOTE: The sequence number is important when there is more than one action for the same product. For example, because a product must exist before you can change its attributes, the sequence number for an action that adds a product must be lower than the sequence number for an action that updates an attribute for that product.</p>
Action Name	<p>When you step off the action record, the Action Name field is automatically populated with a unique number. You can change it to give it a meaningful name that helps you to identify the action.</p>
Action Type	<p>Select the type of action. The options are as follows:</p> <ul style="list-style-type: none"> ■ New. Select this value to create a new sales order (if the customer is residential) or quote (if the customer is not residential). ■ Modify. Select this value to modify an existing asset by adding, updating or deleting products and services. ■ Upgrade. Select this value to upgrade products and services for an asset. Also, select this value to upgrade an existing asset. ■ RunProcess. Select this value to run preorder or postorder tasks by invoking a workflow.

Field	Comments
Action Code	<p>Select an action code to specify the action. The options are limited depending on your selection in the Action field. The options include:</p> <ul style="list-style-type: none"> ■ Add. Select this code to add new products and services for an asset. ■ Update. Select this code to modify products and services for an asset. ■ Replace. Select this code to delete the currently selected item and add the new product for a specific product path. <p>NOTE: The Replace action code applies to product paths that have a maximum cardinality of 1. You cannot have more than one product selected in the product path.</p> <ul style="list-style-type: none"> ■ Delete. Select this code to delete obsolete products and services for an asset. ■ Upgrade. Select this code to upgrade products and services for an asset. ■ Workflow. Select this code to invoke a workflow.
Base Product	Select a base product.
Component Product	You can enter a component in the Component Product field if you select an action code of Add, Replace, Update, or Delete and if the base product has components. You cannot enter a component in this field when the action code is Upgrade or Workflow.
User Input	Select this check box if the action requires user input. This field is used only with named parameters. For more information, see “Product Offers with Named Parameters” on page 104.
Workflow Name	If you selected workflow as the action code, then use this field to select the workflow process. If you invoke a workflow, then you can also pass parameters to this workflow if necessary. For more information, see “Creating Parameters for Actions That Invoke Workflows” on page 99.
Field Name and Field Value	<p>If the action code is Update, then you can select a field name and field value to update the field with the specified value.</p> <p>If you select a component product, then only the attributes and fields applicable to that component product are available for selection. If you do not select a component product, then only the fields applicable to the base product are available for selection.</p>
Attribute Name and Attribute Value	<p>If the action code is Update, then you can select an attribute name and attribute value to update the attribute with the specified value.</p> <p>If you select a component product, then only the attributes and fields applicable to that component product are available for selection. If you do not select a component product, then only the attributes and fields applicable to the base product are available for selection.</p>

Field	Comments
Upgrade Product	If the action code is Upgrade, then select the product that you want to upgrade.
Named Parameter	<p>If you are using a named parameter, then select one of the following options to specify what type of object the named parameter applies to:</p> <ul style="list-style-type: none"> ■ Base Product ■ Component Product ■ Upgrade Product ■ Attribute Value ■ Field Value <p>Do not enter a value in the equivalent fields of the Action record if you are specifying those values using named parameters. For example:</p> <ul style="list-style-type: none"> ■ Do not enter a value in the Base Product field when you select Base Product in the Named Parameter field. ■ Do not enter a value in the Attribute Value field when you select Attribute Value in the Named Parameter field. <p>You can either enter these values directly in the fields of the Action record, or you can specify these values using named parameters. For more information about how to specify values using named parameters, see “Product Offers with Named Parameters” on page 104.</p>
Parent Action	<p>Enter a parent action when the user input for this action is dependent on a user selection for an earlier action.</p> <p>This field can be used with named parameters. For more information, see “Product Offers with Named Parameters” on page 104.</p> <p>This field can also be used for other purposes. For more information, see “Example of Creating Product Offers with Parent Actions” on page 107.</p>

Creating Parameters for Actions That Invoke Workflows

If you defined an action for the product offer that invokes a workflow, then you can define parameters that are passed to the workflow.

For example, you have a number of product offers that require customers to have a minimum, prepaid balance, with different balances required for the different product offers. You create a workflow that checks an external application to determine the customer’s prepaid balance and that generates an order only if the customer has more than the required balance. Different product offers pass different parameters to the workflow, depending on the minimum balance that the offer requires. When you create a new product offer that requires a minimum balance of \$50, you call this workflow, and enter 50 as the workflow parameter.

For this product offer, you would enter the name of this workflow that checks minimum balance in the Workflow field, and you would enter 50 in the Value field in the procedure below. For a different product offer that requires a minimum balance of \$200, you would enter the name of this workflow in the Workflow field, and you would enter 200 in the Value field.

If you want to provide inputs from the current context, such as an order ID generated by earlier actions or custom fields on the account header, then you must extend the Default Product Offer Recommendation variable maps unless you have configured custom variable maps

To specify parameters for actions that invoke workflows

- 1 Create the action, as described earlier in this topic, with the values shown in the following table.

Field	Value
Action	RunProcess
Action Code	Workflow
Workflow	<i>The name of the workflow that is invoked</i>

- 2 Click the Workflow Parameter view tab.
- 3 Add one or more new records to the Workflow Parameter list, and complete the necessary fields. Some fields are described in the following table.

Field	Comments
Name	Enter a workflow parameter name.
Value	Enter the workflow parameter value.

Creating Eligibility and Compatibility Rules for Product Offers

You can define eligibility rules and compatibility rules for product offers. For more information, see the topics about eligibility rules and compatibility rules in *Siebel Product Administration Guide*.

An *eligibility rule* is a rule that restricts product offers to only some of your customers. For example, a product offer might be offered only to customers in certain states.

A *compatibility rule* is a rule that specifies other products or services with which product offers can and cannot be used. For example, the product offer, Free Unlimited Text Messages, requires customers to have the plan, Pay-As-You-Go Text Messages.

This task is a step in ["Process of Creating Product Offers" on page 94](#).

To create eligibility and compatibility rules for product offers

- 1 Navigate to the Administration - Product screen, then Product Offers view.

- 2 Select the Product Offer that you want.
- 3 In the More Info view tab, make sure that the Check Eligibility check box is selected and that the Inclusive Eligibility check box is selected if you want to create inclusive rules or that it is deselected if you want to create exclusive rules.
- 4 Click the Eligibility and Compatibility view tab.
- 5 Display the appropriate view as follows:
 - If you are checking eligibility, then click the Eligibility link.
 - If you are checking compatibility, then click the Compatibility link.
 - If you are checking compatibility based on product line, then click the Product Line Compatibility link.
- 6 Define the eligibility and compatibility rule in the same way that you define these rules for products.

For more information, see *Siebel Product Administration Guide*.

Creating Product Offer Recommendations

You can define upsell and cross-sell recommendations for product offers. You can recommend the product offer to customers who have a specific installed asset or to customers who add a specific item to a quote or order.

You can define translations of the recommendations so they are displayed in the customer service representative's language. For information about how the customer service representative can view the recommendations, see ["Viewing Product Offers for an Account" on page 109](#).

For example, you are creating a product offer for unlimited text messaging for \$10 for a month. You want to present this product offer as an upsell recommendation to wireless service customers who already have the pay-as-you-go text message plan. To accomplish this, you do the following:

- You create a recommendation when you define this product offer, and you select Wireless Service as the subject product. This product offer is the default value of the object product.
- You set up a compatibility rule that states that this product offer requires customers to have the pay-as-you-go text message plan.

When customer service representatives view the installed assets of wireless services customers, they can select Recommendations from the menu to display this product offer. The compatibility rule ensures that the product offer is displayed only for customers who have the pay-as-you-go text message plan. For more information about recommendations, see the chapter about product recommendations in *Siebel Order Management Guide*.

This task is a step in ["Process of Creating Product Offers" on page 94](#).

To create product offer recommendations

- 1 Navigate to the Administration - Product screen, then Product Offers view.
- 2 Select the Product Offer that you want.

- 3 Click the Recommendations view tab.
- 4 Add a new record to the Recommendations list, and complete the necessary fields. Some fields are described in the following table.

Field	Comments
Subject Product	Select the product that the customer must own or be interested in buying to get this recommendation.
Object Product	This field displays the product offer, which is the upsell or cross-sell product recommended to the customer.
Reason	Enter the message to be displayed in the Messages list. The message is used by customer service representatives to tell customers the reason that they should purchase the upsell or cross-sell product.
Effective From and Effective To	Enter the start date and end date of the period when this recommendation is active.

- 5 To specify translations for the text message that you entered in the Reason field, do the following:
 - a Select the record that you want to translate in the Recommendations list.
 - b In the Translations list that is below the Product Recommendations list, add a new record for each translation, and complete the necessary fields. Some fields are described in the following table.

Field	Comments
Language	Enter the language code for the translation. For example, if this record contains the French translation of the message text, then enter the code FRA.
Reason	Enter the translation of the message text. This translation is displayed in implementations in the language that you specified. For example, if the company has a Siebel implementation or a Web site in French, then this French translation is displayed in that implementation.

Creating Translations for Product Offer Messages

You can use the Messaging view to enter translations for the product offer description and message that you entered in the product offer header.

NOTE: In addition to translating the product offer description and message, you can also translate the names of the products using the Administration Products screen, Translations view. For more information, see *Siebel Product Administration Guide*.

The translations are displayed on both Web sites and in Siebel applications, depending on the language of each channel.

This task is a step in ["Process of Creating Product Offers" on page 94](#).

To create translations for product offer messages

- 1 Navigate to the Administration - Product screen, then Product Offers view.
- 2 Select the Product Offer that you want.
- 3 Click the Messaging view tab.
- 4 For each language in which the description is displayed, add a new record to the Messages list, and complete the necessary fields. Some fields are described in the following table.

Field	Comments
Language Name	After you select the language code, this field displays the name of the language.
Language Code	Select the language code. For example, select ENU for U.S. English or ENG for British English
Description	Enter the translation of the Description field.
Message	Enter the translation of the Message field.

Releasing Product Offers

When you created the new Product Offer record, a version of it named *Work Space* was automatically created, and the Locked check box was automatically selected in Product Offer, Versions view. When you have finished the entire process of defining the product offer, you must release this version and refresh the cache to make the new version available to users. For more information about refreshing the cache, see [“About Versions of Product Offers” on page 90](#).

This task is a step in [“Process of Creating Product Offers” on page 94](#).

To release product offers

- 1 Navigate to the Administration - Product screen, then Product Offers view.
- 2 Select the Product Offer that you want.
- 3 Click the Versions view tab.
- 4 If you have not cleared the cache since modifying information in this view, from the Versions menu, select Refresh Cache.

For more information about refreshing the cache, see [“About Versions of Product Offers” on page 90](#).

- 5 Click Release New Version.
- 6 Click the More Info view tab.

Product Offers with Named Parameters

Named parameters enable you to create a generic product offer to serve as a template for a number of similar offers. The named parameter is a variable that can take a number of different values, based on the user's input during run time. After accepting the product offer, the user selects an option from a list of possible values.

A product offer can include only one action that takes user input in the Siebel application. Although product offers are aimed at unassisted channels, named parameters provide some user interactivity: they enable a two-click order instead of a one-click order. Only one named parameter is allowed for a product offer to limit user interactivity. After the user accepts the product offer, the user is allowed to select from only one more prompt.

This limited user interactivity is allowed to make it easier to set up product offers. The administrator can create one product offer that uses a named parameter to let the user choose from 20 options, instead of having to create 20 different product offers that are almost identical.

The following topics cover product offers with named parameters:

- [“Scenario for Setting Up Product Offers with Named Parameters” on page 104](#)
- [“Creating Product Offers with Named Parameters” on page 105](#)

Scenario for Setting Up Product Offers with Named Parameters

This scenario shows one way that you can set up product offers using named parameters. You might use named parameters differently, depending on your business model.

A telecommunications company wants to set up a product offer that allows customers to get a 20% discount on all of its Short Messaging Service (SMS) options, 50 messages, 200 messages, 500 messages, or unlimited messages. Rather than setting up a separate product offer for each option, the company sets up one product offer with named parameters, which allows the customer to choose an option. The product offer says: *Get 20% off SMS*. If the customer clicks Accept, then the product offer displays a list that gives the customer the choice of selecting 50, 200, 500, or unlimited messages.

If you do not have named parameters, then you have to create four different offers, all with the same set of actions:

- Action Type is set to Modify.
- Action Code is set to Add.
- Base Product is set to Wireless Service.
- Component Product is set to 50 SMS, 200 SMS, 500 SMS, or Unlimited SMS.

Using named parameters, you create one product offer, with the following actions:

- Action Type is set to Modify.
- Action Code is set to Add.

- Base Product is set to Wireless Service.
- Component Product. (Leave this field blank.)
- Named Parameter is set to Component Product.

In this case, all of the options for SMS are set up as possible component products of the base product that is used to provide customers with their telecommunications package.

If the customer accepts the product offer, then the Siebel application displays a list SMS options for the user to choose from. You define the domain of the named parameter to specify which items are in this list. For more information on named parameters, see [“Creating Product Offers with Named Parameters.”](#)

Creating Product Offers with Named Parameters

To create product offers with named parameters, create the product offers in the usual way, described in [“Process of Creating Product Offers” on page 94](#), and enter the values described in the following procedure.

The following procedure shows you how to define a named parameter where the Siebel application gets the user input. You select the User Input check box, and you use the named parameter to present the user with a list of choices. If you are using some other application as the user interface that receives input, then you do not have to use these fields.

To create product offers with named parameters

- 1 When you create the action, as described in “Creating Actions for Responses to Product Offers” on page 96, enter the values described in the following table in the Action record.

Field	Comments
User Input	Select this check box to specify that the value of the named parameter is determined by the user’s input.
Named Parameter	<p>Select an option to specify which value will be determined using a named parameter. The options are as follows:</p> <ul style="list-style-type: none"> ■ Base Product. The named parameter sets the value of the base product in the product offer. ■ Component Product. If you select Component Product in the Named Parameter field, then you must also enter a value in the Base Product field to specify which base product has a component product set by the named parameter. ■ Upgrade Product. The named parameter sets the value of the upgrade product. ■ Attribute Value. If you select Attribute Value in the Named Parameter field, then you must also enter a value in the Attribute Name field to specify which attribute has its value set by this named parameter. ■ Field Value. If you select Field Value in the Named Parameter field, then you must also enter a value in the Field Name field to specify which field has its value set by this named parameter.
Parent Action	<p>Enter a parent action if the input for this action depends on a user selection for an earlier action. For example, a product offer allows the customer to get a 20% discount on any accessory for a particular brand of smartphone. You must create two actions:</p> <ul style="list-style-type: none"> ■ The first action adds the accessory selected by the user to the order. The named parameter is the base product. The user is prompted to select any product in the product line that includes all accessories for this smartphone. ■ The second action applies a 20% discount to the product that the user selected in the first action. You must select the first action as the parent action for the second action, so the Siebel application can determine that it applies the discount to the product that was selected in the first action.

- 2 Click the Named Parameters view tab.

The domain of the named parameter is the list of values that the user can choose from. You can specify a component domain, which allows you to define the products in the domain by explicitly selecting all of the individual products, attribute values, or field values that are available.

- 3 Add a record to the Component Domain list for each allowed value in the domain, and complete the necessary fields. Some fields are described in the following table.

Field	Comments
Sequence	Enter the sequence in which this value is listed when the allowed values are displayed to the user.
Base Product/ Component Product/ Upgrade Product/ Attribute Value/ Field Value.	Enter an allowed value for this parameter. The name of this field is dynamic and depends on what you select in the Named Parameter field of the Action record. For example, if you select Base Product in the Named Parameter field of the Action record, then this field displays the field name Base Product, indicating that you enter one allowed value for the base product in this field.

When the user accepts the product offer, the Siebel application displays a list of all the products in the domain that you defined, so that the user can choose one product.

Example of Creating Product Offers with Parent Actions

This topic gives one example of using parent actions in product offers. You might use this feature differently, depending on your business model.

The Parent Action field is in the Action record. For more information, see [“Creating Actions for Responses to Product Offers” on page 96](#).

You use the Parent Action field when you create products offers with named parameters. For more information, see [“Creating Product Offers with Named Parameters” on page 105](#).

You can also use the Parent Action field for other purposes. This example describes one possible use of parent actions for other purposes.

You have a product offer that gives 50% discount on an accessory, a product named Bluetooth Headset. The first action adds this product, and the second action gives a 50% discount to the product added in the first action. The second action has the first action as its parent action, because it uses a value from the first action.

To create this product offer with a parent action, create the product offers in the usual way, described in [“Process of Creating Product Offers” on page 94](#), and when you add the Action records, enter the values described in the following procedure.

To create actions for a response to a product offer

- 1 Navigate to the Administration - Product screen, then Product Offers view.
- 2 Select the Product Offer that you want.
- 3 Click the Responses view tab.

- 4 Select the response that you want.
- 5 To add the headset to the order, add a record to the Responses - Actions list, and complete the necessary fields with the values shown in the following table.

Field	Value
Sequence	1
Action Name	Add Headset
Action Type	New
Action Code	Add
Base Product	Bluetooth Headset

- 6 To give a 50% discount for the product that was added in the first action, add a second record to the Responses - Actions list, and complete the necessary fields with the values shown in the following table.

Field	Value
Sequence	2
Action Name	Give 50% Discount
Action Type	New
Action Code	Update
Base Product	<i>no value</i>
Field Name	Discount Percent
Field Value	50
Parent Action	Add Headset

Modifying Product Offers

Because product offers are versioned, you modify them by modifying the Workspace version in the Versions view. Whenever you release a product offer, the product offer that you release is given a version number, and a new version named *Work Space* is automatically created.

Versions of product offers are different from versions of products and promotions because only the Start Date, End Date, and Active fields of the product offer can be different in different versions. Apart from these three fields, every other field of a product offer is uniform for all versions of the product offer. You must refresh the cache after making any changes to the product offer definition, so these fields remain uniform. For more information, see ["About Versions of Product Offers" on page 90](#).

NOTE: If you change the data in any other field except the Start Date, End Date, and Active Field, then the change populates all of the older versions of the product offer as well as the new version.

To modify product offers

- 1 Navigate to the Administration - Product screen, then Product Offers view.
- 2 Select the Product Offer that you want.
- 3 Click the Versions view tab.
- 4 Make sure that the Work Space version is selected.
- 5 Select the Locked Flag check box.
- 6 Modify the Work Space version of the product offer by clicking the other view tabs and modifying the information.
For more information about the information in each view, see ["Process of Creating Product Offers" on page 94](#).
- 7 When it is time for customer service representatives and customers to view the modified product offer, click Release New Version.
- 8 From the Versions menu, select Clear Cache.

Viewing Product Offers for an Account

Customer service representatives can view all product offers for an account's installed assets.

This procedure displays all upsell or cross-sell recommendations for the account's installed assets that are either promotions or product offers.

NOTE: Product offers are not displayed in the Catalog or Product Pick applet of the Siebel application.

To view product offers for an account

- 1 Navigate to the Accounts screen, then the Accounts List view.
- 2 In the accounts list, drill down on the name of the Account that you want.
The Account Summary view appears, with the Installed Assets list on the left and the Billing Items list on the right.
- 3 In the menu for the Installed Assets list, select Recommendations.
A dialog box appears containing a list of all recommendations for this account.
- 4 In the dialog box, select recommendations in the list, and click the buttons to accept or reject the product offer.

Tasks for Suppressing Product Offer Recommendations

The following topics describe how to suppress product offer recommendations:

- [“Suppressing Product Offer Recommendations that Have Been Accepted or Rejected” on page 110.](#) You must suppress product offer recommendations so that product offers are not displayed after customers have already accepted or rejected them.
- [“Suppressing Component Product Recommendations” on page 110.](#) You can suppress product offer recommendations for component products to improve performance.

Suppressing Product Offer Recommendations that Have Been Accepted or Rejected

You suppress recommendations so that the same recommendation is not shown to the same customer or for the same asset after it has already been accepted or rejected.

For example, a customer has two wireless service subscriptions, one for himself and one for his wife. There is a product offer giving a 20% discount on any SMS to wireless service subscribers. This customer is presented with two offers, one for each of the wireless subscriptions. The customer is not interested in the SMS option for his wife, so he rejects the offer. The next time the customer calls, the offer for his wife is not displayed because it has already been rejected, but the offer for him is displayed. The customer accepts the offer for himself, and this offer will not be shown again because it has already been accepted.

This procedure assumes you are using the default Product Offer Recommendation message type and default responses. If you have created other message types or responses, you can turn suppression on and off in the same way.

To suppress recommendations that have been accepted or rejected

- 1 Navigate to the Administration - Order Management screen, then the Message Types view.
- 2 In the Message Types list, query for *Product Offer Recommendation*.
- 3 Click the Responses view tab.
- 4 For the Accept and Reject responses, select the Suppress Repetition check box to turn suppression on, or deselect this check box to turn suppression off.

Suppressing Component Product Recommendations

Product offer recommendation can be set at either the component product or root product level. By default, the product displays all recommendations for the assets of a given account. To improve performance, you might want to show recommendations for only the root products, not component products.

To suppress component product recommendations, you set a search specification for the variable map that controls the recommendation, which is Default Product Offer Recommendation Variable Map - Row Set, unless you have configured product offers by creating custom variable maps.

To configure product offers to suppress recommendations

- 1 Navigate to the Administration - Order Management screen, then the Variable Maps view.
- 2 In the Variable Maps list, query for the variable map you want.
 If you are using the default variable maps shipped with the product, query for Default Product Offer Recommendation Variable Map - Row Set
- 3 Drill down on the Work Space version.
- 4 Lock the Work Space version.
- 5 Click the Modes view tab.
- 6 In the row for the mode Any, in the SearchSpec field, to filter out the recommendations that you want to suppress, enter the search specification
 [Asset Id]=[Root Asset Id] .
- 7 Release the Work Space version, and refresh the cache.

Migrating Product Offers Using Workspace Projects

You can migrate product offers from one Siebel CRM environment to another by using workspace projects.

You can export just the product offer header or the full structure of the product offer, including all its child objects. If you export the full structure, then all the objects that the product offer refers to must exist in the target environment, including products, promotions, and eligibility and compatibility matrixes. For example, if you migrate a product offer that includes the product named Wireless Service and the component product named SMS Unlimited, then the product offer import fails if the products Wireless Service and SMS do not exist in the target environment.

To migrate product offers using workspace projects

- 1 Export the product offer from the source environment:
 - a Navigate to the Administration - Product screen, then the Workspace Projects view.
 - b In the Workspace Projects list, add a new record and complete the necessary fields. Some fields are described in the following table.

Field	Comments
Name	Enter a name for the workspace project.
Effective Start Date	Enter the date that the application uses to determine what versions must be exported for dependent items. When you import a workspace, this field is also used to set the start date of the versions released from the workspace project.

- c Click the Contents view tab.
 - d In the Contents list, click Add to add a new record.
 - e In the Select Versioned Object dialog box, select the product offer that you want.
 - f Continue to add new records and to select new product offers until you have selected all the product offers you want to migrate.
 - g From the Workspace Project menu, select Export Contents.
 - h In the Export Contents dialog box, choose one of the export options and click OK. Options are as follows:
 - **Object(s) only export.** Exports the product offer header information only.
 - **Full structure export.** Exports the product offer header and all of its child objects, including Responses, Actions, Recommendations and Messages. Full structure does not include product or promotion definitions.
 - i Use the dialog box to save the contents in an XML file in a location that you can access from the target environment.
- 2 Import the product offer to the target environment:
- a Navigate to the Administration - Product screen, then the Workspace Projects view.
 - b In the Workspace Projects list, add a new record and complete the necessary fields. Some fields are described in the following table.

Field	Comments
Name	Enter a name for the workspace project.
Effective Start Date	Enter the date that is used to set the Start Date of the versions released from the workspace project.

- c From the Workspace Project menu, select Import Contents.
- d In the dialog box, select the XML file with the content you want, and click on OK
The product offers from the XML file appear in the Contents view, and are all locked.
- e Click Release All.

Workflow Reference for Product Offers

Product offers use the following workflows:

- ["RAF Create Document Workflow" on page 114](#)
- ["RAF Update Recommendation Workflow" on page 117](#)
- ["RAF Update Recommendation SubProcess Workflow" on page 118](#)
- ["RAF Submit Order Process Workflow" on page 118](#)
- ["RAF Create Activity Workflow" on page 119](#)

- "RAF Product Offer Recommendation For Asset Workflow" on page 119
- "RAF Recommendation Driver Workflow" on page 120
- "RAF Prepare Header Sub Process Workflow" on page 121
- "RAF Prepare Actions Sub Process Workflow" on page 122
- "RAF Check Prepaid Balance Workflow" on page 125
- "RAF Get Active Document Workflow" on page 126
- "RAF Consolidate Actions Sub Process Workflow" on page 126
- "RAF Check For Promotion Sub Process Workflow" on page 127
- "RAF Ensure New Line Item Workflow" on page 129
- "RAF RunProcess Driver Workflow" on page 130
- "RAF Get Named Parameter Workflow" on page 131
- "RAF Get Named Parameter For Web Call Workflow" on page 132
- "RAF Apply Offer To Create Order Web Workflow" on page 134
- "RAF Apply Offer To Create Quote Web Service Workflow" on page 135
- "Product Offer GetProductOffer Workflow" on page 137
- "Product Offer GetProductOfferStructure Workflow" on page 138
- "Product Offer GetRecommendedProductOffers Workflow" on page 138

RAF Create Document Workflow

RAF Create Document Workflow, shown in Figure 13, is a wrapper workflow to carry out all actions in the product offer. It is invoked through the signal RAF Create Offer Document when the user accepts or rejects a product offer in the recommendation window.

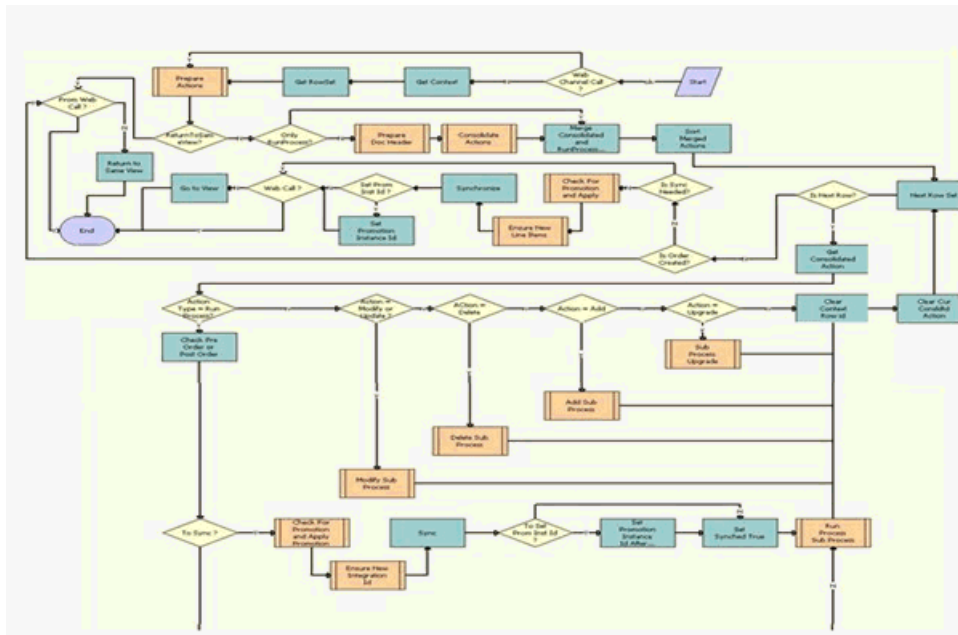

Figure 13. RAF Create Document Workflow

Workflow Description. This workflow performs the following actions:

- **Web Channel Call?** This decision step routes the flow to the Prepare Actions step if the process property Web Channel Call is Y or to the Get Context step if it is not Y. If the workflow is invoked through the Web channel, the context and the rowset information are prepopulated, and the flow can go directly to the Prepare Actions step because it is not necessary to get the context or the rowset.
- **Get Context.** This step calls the method GetRowSetData of the Context Service business service. It uses the variable map Default Product Offer Recommendation Variable Map - Context to get the account header information.
- **Get Rowset.** This step calls the method GetRowSetData of Context Service business service. It uses the variable map Default Product Offer Recommendation Variable Map - Row Set to get all asset information for the account.
- **Prepare Actions.** This step calls the subprocess RAF Prepare Actions Sub Process which queries for all the actions defined for the particular product offer and sorts them into different property sets depending on Action type. Outputs of this step are property sets such as Modify Action Set, New Action Set, RunProcess Action Set and so on.

- **Return to same view.** This decision step determines if the user should be navigated to a different view or remain in the same view. If the product offer has no actions specified, then the Return to same view flag is set to Y. If this Flag is Y the flow goes to business service step Return to Same View. If not, the flow goes to the step Only RunProcess?
- **Only Run Process?** This decision step routes flow to Merge Consolidated and RunProcess Actions if all the actions defined for Product Offer are of Type Run Process. If not, it routes the flow to Prepare Doc Header.
- **Prepare Doc Header.** This step calls the subprocess RAF Prepare Header Sub Process, which creates an Order or Quote header depending on account type and active doc Id.
- **Consolidate Actions.** This step calls the subprocess RAF Consolidate Actions Sub Process, which consolidates all actions based on Action type (other than Run Process) and groups them under one Base product.
- **Merge Consolidated and RunProcess Actions.** This step merges the consolidated property set from Consolidate Actions and Run Process property set.
- **Sort Merged Actions.** This business service step calls the method SortRowSet of business service RAF Product Offers Service which sorts the merged action property set according to sequence.
- **Next Row Set.** This step picks the next rowset from context property set.
- **Is Next Row?** This decision step routes the flow to the step Get Consolidated Action if Cur Row Id is not Null. Otherwise, it routes the flow to the step Is Order Created.
- **Get Consolidated Action.** This step gets the current consolidated actions and, depending on account type, builds an order or quote context rowset.
- **Action Type = Run Process?** This decision step routes the flow to Check Pre Order or Post Order if the Action Set Type is Run Process. Otherwise, it routes the flow to Action = Modify or Update?
- **Action = Modify or Update?** This decision step routes the flow to Modify Sub Process if the Action Code is - or Modified. Otherwise, it routes the flow to Action = Delete?
- **Action = Delete.** This decision step routes the flow to Delete Sub Process if the Action Code is Deleted. Otherwise, it routes the flow to Action = Add.
- **Action = Add.** This decision step routes the flow to Add Sub Process if the Action Code is New. Otherwise, it routes the flow to Action = Upgrade.
- **Action = Upgrade.** This decision step routes the flow to Sub Process Upgrade if the Action Code is Upgrade. Otherwise, it routes the flow to Clear Context Row id.
- **Check Pre Order or Post Order.** This step checks whether Run Process is the first action to be processed and whether or not an order has been created.
- **To Sync?** This decision step routes the flow to Check For Promotion and Apply Promotion if the response is not reject and the order has not been synchronized already. Otherwise, it routes the flow to Run Process Sub Process.
- **Check For Promotion and Apply Promotion.** This step calls the subprocess RAF Check For Promotion Sub Process which checks whether the Promotion Name is correct and does Apply, Disconnect, Modify or Upgrade promotion.

- **Ensure New Integration Id.** This step calls the subprocess RAF Ensure New Line Item, which ensures that all line items have unique integration ids.
- **Sync.** This step calls the business service method Synchronize of the ABO Bulk Request Processing Service, which synchronizes order and quote line items in the database.
- **To Set Prom Inst Id?** This decision step routes the flow to Set Promotion Instance Id After Sync if promotion has been added, deleted, modified or disconnected. Otherwise, it routes the flow to Set Synched True.
- **Set Promotion Instance Id After Sync.** This step stamps the promotion name and promotion instance Id on line items modified because of the promotion.
- **Set Synched True.** This step sets the Synched flag to Y.
- **Run Process Sub Process.** This step calls the subprocess RAF RunProcess Driver Workflow, which fetches workflow parameters and executes the specified workflow.
- **Modify Sub Process.** This step calls the subprocess ABO Bulk Request - Modify Sub-Process Workflow to carry out the actions in the product offer of the action type Modify. Instance information is not passed, as it is in bulk request flows. The Is RAF flag is passed to handle exceptions.
- **Delete Sub Process.** This step calls the subprocess ABO Bulk Request - Delete Sub-Process Workflow to carry out actions in the product offer of the action code Delete. Instance information is not passed, as it is in bulk request flows. The Is RAF flag is passed to handle exceptions.
- **Add Sub Process.** This step calls the subprocess ABO Bulk Request - Add Sub-Process Workflow to carry out actions in the product offer of the action type New. Instance information is not passed, as it is in bulk request flows. The Is RAF flag is passed to handle exceptions.
- **Sub Process Upgrade.** This step calls the subprocess ABO Bulk Request - Upgrade Sub-Process Workflow to carry out actions in the product offer of the action type Upgrade. Instance information is not passed, as it is in bulk request flows. The Is RAF flag is passed to handle exceptions.
- **Clear Context Row id.** This step clears the details of already processed actions from the context header.
- **Clear Cur Consldtd Action.** This step clears the details of already processed actions from the context rowset.
- **Is Order Created?** This decision step routes the flow to Is Sync Needed? if an order is created. Otherwise, it routes the flow to Return to same view.
- **Is Sync Needed?** This decision step routes the flow to Web Call? if the synched flag is Y. Otherwise, it routes the flow to Check For Promotion and Apply.
- **Check For Promotion and Apply.** This step calls the subprocess RAF Check For Promotion Sub Process, which checks whether the promotion name is correct and does Apply, Disconnect, Modify or Upgrade promotion.
- **Ensure New Line Items.** This step calls the subprocess RAF Ensure New Line Item, which ensures that all Line items have unique integration ids.
- **Synchronize.** This step calls the business service method Synchronize of ABO Bulk Request Processing Service, which synchronizes order and quote line items in the database.

- **Set Prom Inst Id?** This step checks whether the line item is added, deleted, modified because of the promotion. If so, it routes the flow to Set Promotion Instance Id.
- **Set Promotion Instance Id.** This step stamps the promotion name and promotion instance Id on line items modified because of the promotion.
- **Web Call?** This decision step routes the flow to End if it is a Web service call. Otherwise, it routes the flow to Go to View.
- **Go to View.** This step navigates the user to Order Entry - Line Items View (Sales) or Order Entry - Network Line Items Detail View (Sales) or Quote Item Detail View or Quote Network Detail View, depending on the account type and the field Compound Product Number.
- **Return to Same View.** This step navigates the user back to SIS OM Customer Account Portal view.

RAF Update Recommendation Workflow

RAF Update Recommendation Workflow, shown in [Figure 14](#), is invoked when the user updates the Message Type field of the product offer header. It updates the Message Type field in the Recommendation business component to the same value.

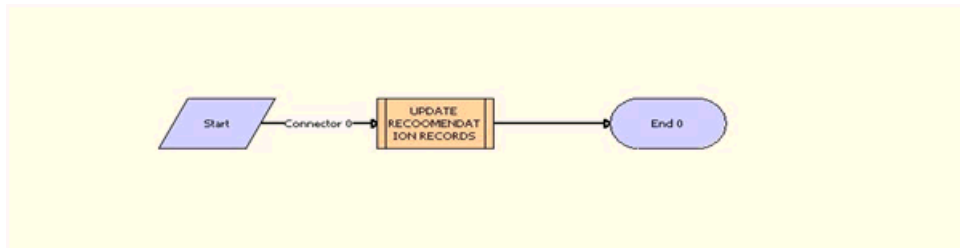

Figure 14. RAF Update Recommendation Workflow

Workflow Description. This workflow performs the following action:

- **UPDATE RECOMMENDATION RECORDS.** This step calls the subprocess RAF Update Recommendation SubProcess Workflow for all the recommendation records in the Product Offer.

RAF Update Recommendation SubProcess Workflow

RAF Update Recommendation SubProcess Workflow, shown in [Figure 15](#), is called as a subprocess by the parent workflow RAF Update Recommendation Workflow. It updates the Message Type field of all records in Recommendation business component to match that of Product Header Message Type.

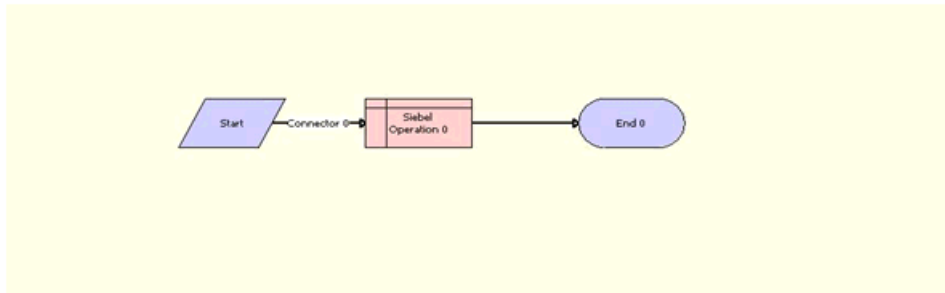

Figure 15. RAF Update Recommendation SubProcess Workflow

Workflow Description. This workflow performs the following action:

- **Siebel Operation:0.** This step performs an update operation on Recommendation records, updating the UMS Type Id and UMS Type fields.

RAF Submit Order Process Workflow

RAF Submit Order Process Workflow, shown in [Figure 16](#), a wrapper workflow called when the action type is Run Process and the workflow name is SIS OM Submit Order Process.

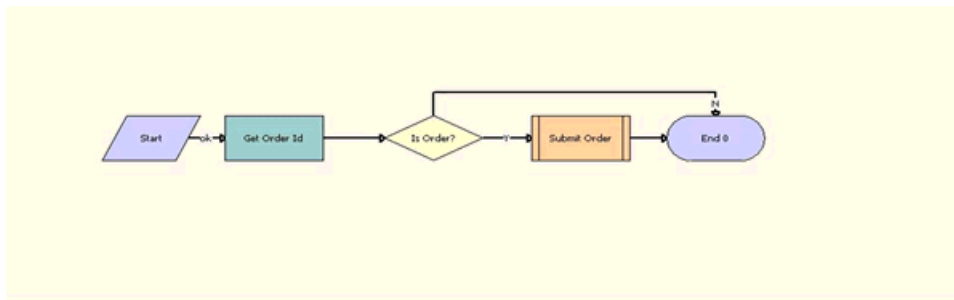

Figure 16. RAF Submit Order Process Workflow

Workflow Description. This workflow performs the following actions:

- **Get Order Id.** This step calls the method GetFieldValue of the business service CMU External Integration Service to get the active order Id for which submit order needs to be called.
- **Is Order.** This decision step routes flow to Submit Order if the Account Type is Residential. Otherwise, it routes the flow to End.

- **Submit Order.** This step calls the workflow SIS OM Submit Order Process, passing the order Id.

RAF Create Activity Workflow

RAF Create Activity Workflow, shown in [Figure 17](#), creates a record in activity applet which has details of the rejected product offer. It is called if the action is the type Run Process, and the workflow name is RAF Create Activity.

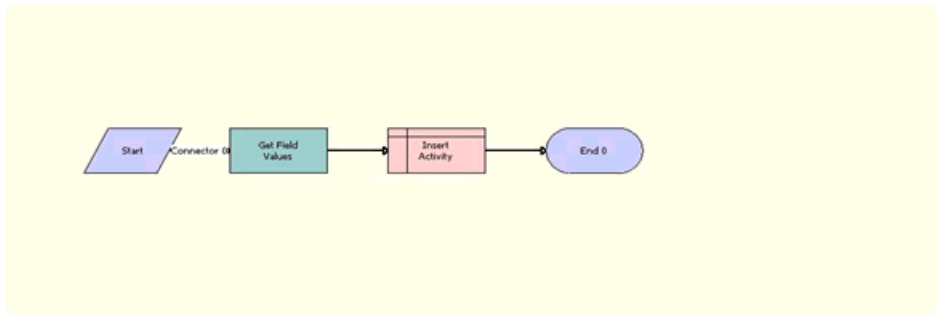

Figure 17. RAF Create Activity Workflow

Workflow Description. This workflow performs the following actions:

- **Get Field Values.** This step calls the method GetFieldValue of the business service CMU External Integration Service to get values for the fields Activity Description, Activity Type and Account Id from workflow parameters defined in Product Offer.
- **Insert Activity.** This step inserts a record in the Action business component with the details from previous step.

RAF Product Offer Recommendation For Asset Workflow

RAF Product Offer Recommendation For Asset Workflow, shown in [Figure 18](#), is called when the user clicks the Recommendation menu item for assets in SIS OM Customer Account Portal view.

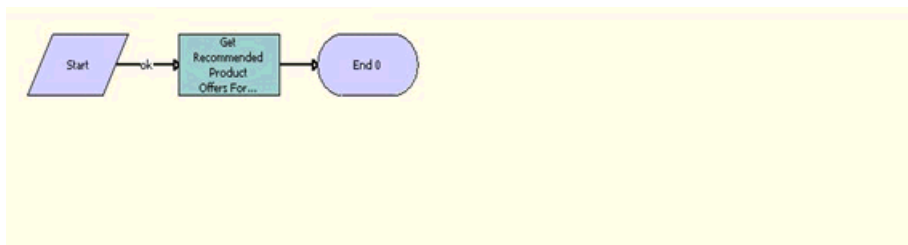

Figure 18. RAF Product Offer Recommendation For Asset Workflow

Workflow Description. This workflow performs the following action:

- **Get Recommended Product Offers For Assets.** This step calls the method RAFRaiseSignal of the business service RAF Product Offers Service, which raises the signal Product Recommendation Signal, which in turn calls RAF Recommendation Driver Workflow or Product Recommendation Driver Workflow, depending on instance type.

RAF Recommendation Driver Workflow

RAF Recommendation Driver Workflow, shown in [Figure 19](#), is called by the Product Recommendation signal when the instance type is AssetLineItem.

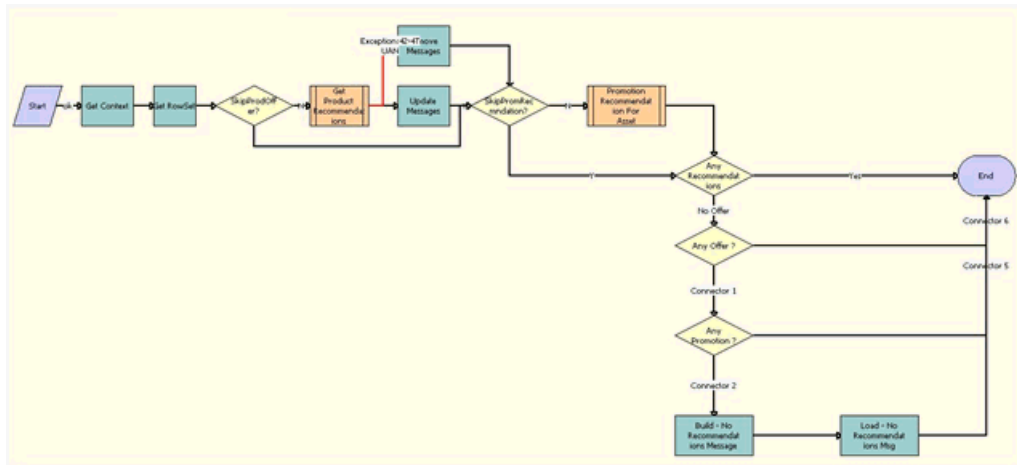

Figure 19. RAF Recommendation Driver Workflow

Workflow Description. This workflow performs the following actions:

- **Get Context.** This step calls the method GetRowSetData of the Context Service business service. It uses the variable map Default Product Offer Recommendation Variable Map - Context to get the account header information.
- **Get Rowset.** This step calls the method GetRowSetData of the Context Service business service. It uses the variable map Default Product Offer Recommendation Variable Map - Row Set to get all asset information for the account.
- **SkipProdOffer?** This decision step routes flow to SkipPromRecmndation? if the SkipProdOffer flag is Y. Otherwise, it routes the flow to Get Product Recommendations.
- **Get Product Recommendations.** This step calls the subprocess Product Recommendation Get Recommended Products, which returns all product offers recommendations for all the assets in the account, and which also performs eligibility and compatibility checks.
- **Remove Messages.** If there is an exception, this step calls the method DeleteMessages of the business service Unified Messaging Service and sets the source to Product Recommendation.

- **Update Messages.** This step calls the method UpdateMessages of the business service Unified Messaging Service and sets the source to Product Recommendation.
- **SkipPromRecmndation?** This decision step routes flow to Any Recommendations if SkipPromRecmndation flag is Y. Otherwise, it routes the flow to Promotion Recommendation For Asset.
- **Promotion Recommendation For Asset.** This step calls the subprocess ISS Promotion Recommendation For Assets to get all promotion recommendations.
- **Any Recommendations.** This decision step routes flow to Any Offer? if there are no recommendations. Otherwise, it routes the flow to End.
- **Any Offer?** This decision step routes flow to Any Promotion? if there are no product Offer recommendations. Otherwise, it routes the flow to End.
- **Any Promotion?** This decision step routes flow to Build - No Recommendations Message if there are no promotion recommendations. Otherwise, it routes the flow to End.
- **Build - No Recommendations Message.** This step calls the method Echo of the business service Workflow Utilities to get the display message if there are no promotion and product offer recommendations.
- **Load - No Recommendations Msg.** This step calls the method UpdateMessages of the business service Unified Messaging Service and sets the source to Zero Recommendation.

RAF Prepare Header Sub Process Workflow

RAF Prepare Header Sub Process Workflow, shown in [Figure 20](#), creates an order or quote header, depending on the account type and the Id of the active document. It is called as a subprocess from the Prepare Doc Header step of the parent workflow RAF Create Document Workflow.

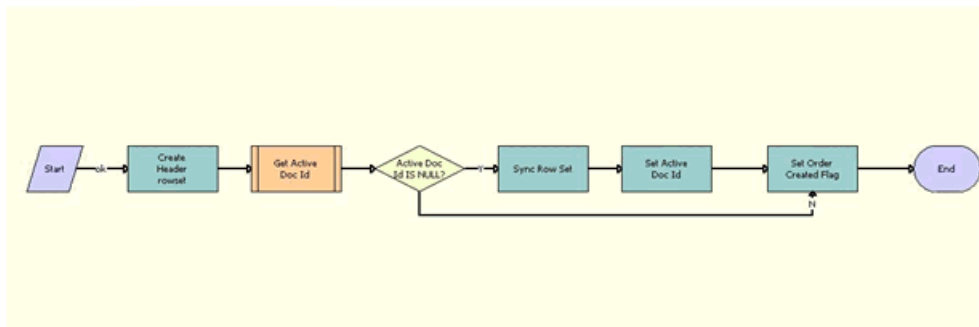

Figure 20. RAF Prepare Header Sub Process Workflow

Workflow Description. This workflow performs the following actions:

- **Create Header rowset.** This step calls the method Conditional Action Transform of the business service Row Set Transformation Toolkit to prepare an order or quote header property set, depending on account type.

- **Get Active Doc Id.** This step calls the subprocess RAF Get Active Document Workflow to get the Active Doc Id (the row_id of the latest pending order or latest open quote).
- **Active Doc Id IS NULL?** This decision step routes the flow to Sync Row Set if Active Doc Id is null. Otherwise, it routes the flow to Set Order Created Flag.
- **Sync Row Set.** This step calls the method SynchronizeRowSet of the business service RAF Product Offers Service to prepare an Order or Quote context property set by getting the asset context from Default Product Recommendation Variable Map - Context.
- **Set Active Doc Id.** This step calls the method Set Profile Attribute of the business service SIS OM PMT Service to set the value of the Order Profile Attribute Name or Quote Profile Attribute Name to Active Doc Id.
- **Set Order Created Flag.** This step calls the method Echo of the business service Workflow Utilities to set the Order Created flag to Y.

RAF Prepare Actions Sub Process Workflow

RAF Prepare Actions Sub Process Workflow, shown in Figure 21, queries for all the actions defined for the particular product offer and sorts them into different property sets depending on the action type. It is called as a subprocess from the Prepare Actions step of the parent workflow RAF Create Document Workflow.

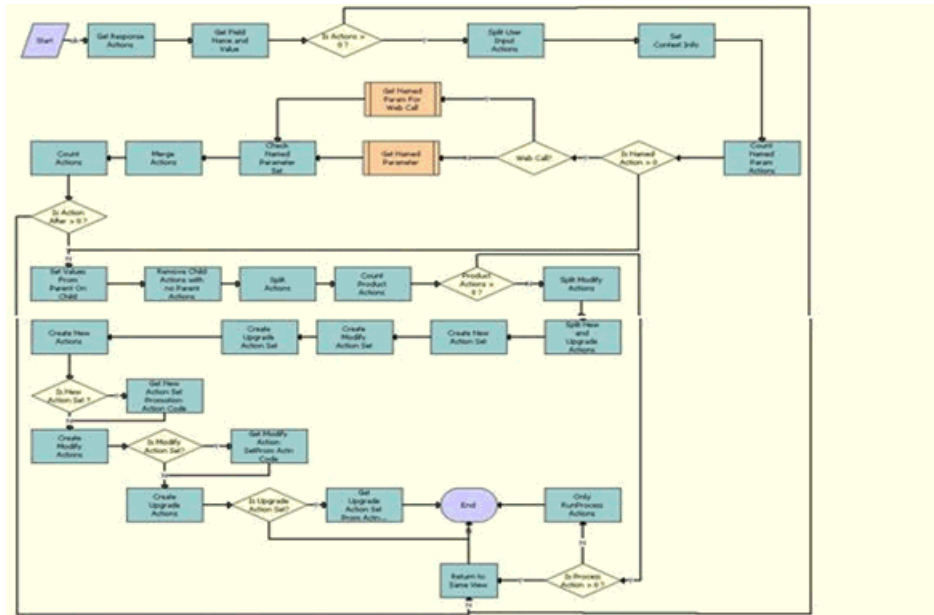

Figure 21. RAF Prepare Actions Sub Process Workflow

Workflow Description. This workflow performs the following actions:

- **Get Response Actions.** This step queries the RAF Product Offer Action business component to get all the actions defined for the product offer and the response which are not inactive. It gets the count of actions as well as building an actions property set which has details of each action.
- **Get Field Name and Value.** This step calls the method GetFieldValueCMU of the business service External Integration Service to get the value of the field Prod Prom Name.
- **Is Actions > 0?** This decision step routes the flow to Split User Input Actions if the actions count is greater than 0. Otherwise, it routes the flow to Return to Same View.
- **Split User Input Actions.** This step calls the method Split Transform of the business service Row Set Transformation Toolkit to prepare two row sets, splitting the User Input Action row set into one row set with actions for which the Named Parameter Flag is Y, and one with actions for which the flag is N.
- **Set Context Info.** This step calls the method Conditional Action Transform of the business service Row Set Transformation Toolkit to set the Account Id from the context to the value in the User Input Action row set.
- **Count Named Param Actions.** This step calls the method Conditional Action Transform of the business service Row Set Transformation Toolkit to count the number of actions in User Input Action row set.
- **Is Named Action > 0.** This decision step routes the flow to Web Call? if the named action count is greater than 0. Otherwise, it routes the flow to Is Process Action > 0?
- **Web Call?.** This decision step routes flow to Get Named Param For Web Call if it is a Web service call. Otherwise, it routes the flow to Get Named Parameter.
- **Get Named Parameter.** This step calls the subprocess RAF Get Named Parameter Workflow to process the User Input Action row set.
- **Get Named Param For Web Call.** This step calls the subprocess RAF Get Named Parameter For Web Call Workflow to process the User Input Action row set in the Web service call.
- **Check Named Parameter Set.** This step calls the method Conditional Action Transform of the business service Row Set Transformation Toolkit to set the argument Named Parameter Set to Y, in context if it is Y in User Input Action row set. Otherwise, it sets the this argument to N.
- **Merge Actions.** This step calls the method Merge Transform of the business service Row Set Transformation Toolkit to merge the Response Actions and User Input Action row sets.
- **Count Actions.** This step calls the method Conditional Action Transform of the business service Row Set Transformation Toolkit to count the number of actions in the Response Actions row set.
- **Is Action After > 0?** This decision step routes the flow to Set Values From Parent On Child if Action Count after is greater than 0. Otherwise, it routes the flow to Return to Same View.
- **Set Values From Parent On Child.** This step calls the method SetParentActionValuesInChild of the business service RAF Product Offers Service to set the values of the child actions field based on the parent actions field values, if the child action field value is empty. In other words, if the based product is null in child, then it will get the value from the parent action.
- **Remove Child Actions with no Parent Actions.** This step calls the method Conditional Action Transform of the business service Row Set Transformation Toolkit to remove actions which do not have parent action id entered from the response actions.

- **Split Actions.** This step calls the method Split Transform of the business service Row Set Transformation Toolkit to prepare two row sets, the RunProcess row set with actions for which the Action Type is Runprocess, and the Actions row set for other actions.
- **Count Product Actions.** This step calls the method Conditional Action Transform of the business service Row Set Transformation Toolkit to count the number of actions of type other than Run Process.
- **Product Actions > 0?** This decision step routes the flow to Split Modify Actions if the product action count is greater than 0. Otherwise, it routes the flow to Is Process Action > 0?
- **Split Modify Actions.** This step calls the method Split Transform of the business service Row Set Transformation Toolkit to prepare the row set Modify Actions for actions where the action type is Modify.
- **Split New and Upgrade Actions.** This step calls the method Split Transform of the business service Row Set Transformation Toolkit to prepare the row set New Actions for actions where action type is New and the row set Upgrade Actions for other actions.
- **Create New Action Set.** This step calls the method Conditional Action Transform of the business service Row Set Transformation Toolkit to create the New Actions row set.
- **Create Modify Action Set.** This step calls the method Conditional Action Transform of the business service Row Set Transformation Toolkit to create the Modify Actions row set.
- **Create Upgrade Action Set.** This step calls the method Conditional Action Transform of the business service Row Set Transformation Toolkit to create the Upgrade Actions row set.
- **Create New Actions.** This step calls the method Conditional Action Transform of the business service Row Set Transformation Toolkit to fill the New Actions row set with actions of the type New.
- **Is New Action Set?** This decision step routes the flow to Get New Action Set Promotion Action Code if the New Actions row set exists. Otherwise, it routes the flow to Create Modify Actions.
- **Get New Action Set Promotion Action Code.** This step calls the method GetPromotionActionCode of the business service ABO Bulk Request Validation Service to get promotion action codes for the New Actions row set.
- **Create Modify Actions.** This step calls the method Conditional Action Transform of the business service Row Set Transformation Toolkit to fill the Modify Actions row set with actions of the type Modify.
- **Is Modify Action Set?** This decision step routes the flow to Get Modify Action SetProm Actn Code if the Modify Actions row set exists. Otherwise, it routes the flow to Create Upgrade Actions.
- **Get Modify Action SetProm Actn Code.** This step calls the method GetPromotionActionCode of the business service ABO Bulk Request Validation Service to get promotion action codes for the Modify Actions row set.
- **Create Upgrade Actions.** This step calls the method Conditional Action Transform of the business service Row Set Transformation Toolkit to fill the Upgrade Actions row set with actions of the type Upgrade.
- **Is Upgrade Action Set?** This decision step routes the flow to Get Upgrade Action Set Prom Actn Code if the Upgrade Actions row set exists. Otherwise, it routes the flow to End.

- **Get Upgrade Action Set Prom Actn Code.** This step calls the method GetPromotionActionCode of the business service ABO Bulk Request Validation Service to get promotion action codes for the Upgrade Actions row set.
- **Is Process Action > 0?** This decision step routes the flow to Only RunProcess Actions if the action count is greater than 0. Otherwise, it routes the flow to Return to Same View.
- **Return to Same View.** This step calls the method Echo of the business service Workflow Utilities to set return to same view to Y.
- **Only RunProcess Actions.** This step calls the method Echo of the business service Workflow Utilities to set Only RunProcess Actions to Y.

RAF Check Prepaid Balance Workflow

RAF Check Prepaid Balance Workflow, shown in [Figure 22](#), is called when the action type is Run Process and the workflow name is SIS OM Submit Order Process.

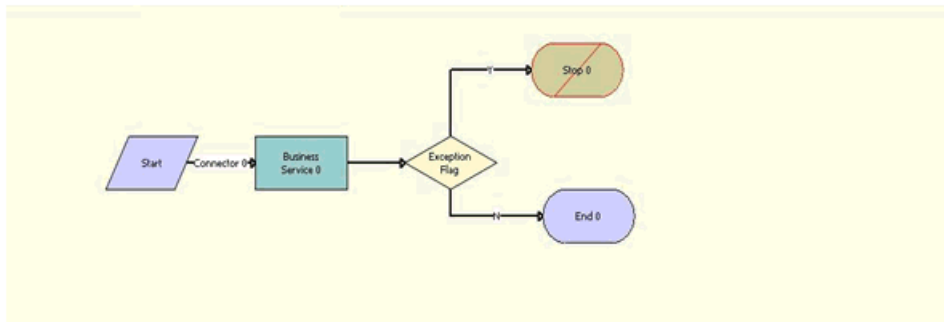

Figure 22. RAF Check Prepaid Balance

Workflow Description. This workflow performs the following actions:

- **Business Service 0.** This step calls the method GetFieldValue of the business service CMU External Integration Service to get values for fields Minimum Balance Required and Exception Flag from the context.
- **Exception Flag.** This decision step routes the flow to Stop 0 if Exception Flag is Y. Otherwise, it routes the flow to End.
- **Stop 0.** This step displays the error message: Exception: Order failed. Offer requires customer to have a minimum balance of [&Minimum Balance Required].

RAF Get Active Document Workflow

RAF Get Active Document Workflow, shown in [Figure 23](#), gets the Id of the active document. (the row_id of the latest pending order or latest open quote). It is called as a subprocess from the Get Active Doc Id step of the workflow RAF Prepare Header Sub Process.

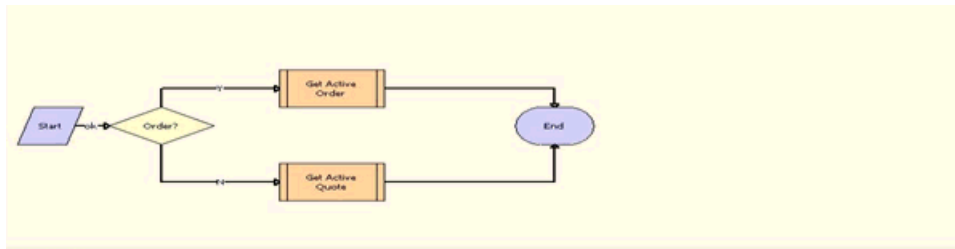

Figure 23. RAF Get Active Document Workflow

Workflow Description. This workflow performs the following actions:

- **Order?** This decision step routes the flow to Get Active Order if Account Type is Residential. Otherwise, it routes the flow to Get Active Quote.
- **Get Active Order.** This step calls the subprocess SIS OM Active Order Sub-Process and passes it the values of Account Id and Is RAF flag.
- **Get Active Quote.** This step calls the subprocess SIS OM Active Quote Sub-process and passes it the values of Account Id and Is RAF flag.

RAF Consolidate Actions Sub Process Workflow

RAF Consolidate Actions Sub Process Workflow, shown in [Figure 24](#), consolidates all actions based on the action type (other than the action type Run Process), and it groups them under one base product. It is called as a subprocess from the Consolidate Actions step of the RAF Create Document Workflow.

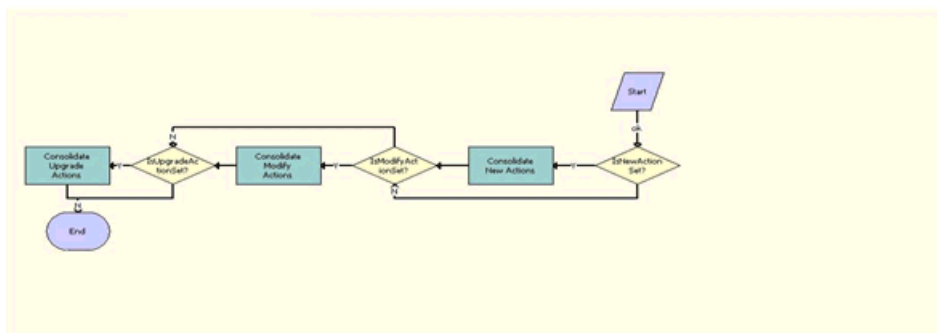

Figure 24. RAF Consolidate Actions Sub Process Workflow

Workflow Description. This workflow performs the following actions:

- **IsNewActionSet?** This decision step routes the flow to Consolidate New Actions if IsNewActionSet is not NULL. Otherwise, it routes the flow to IsModifyActionSet?
- **Consolidate New Actions.** This step calls the method ConsolidateAllActions of the business service ABO Bulk Request Processing Service to consolidate all actions in new action set under one Base product.
- **IsModifyActionSet?** This decision step routes the flow to Consolidate Modify Actions if IsModifyActionSet is not NULL. Otherwise, it routes the flow to IsUpgradeActionSet?
- **Consolidate Modify Actions.** This step calls the method ConsolidateAllActions of the business service ABO Bulk Request Processing Service to consolidate all actions in Modify action set under one Base product.
- **IsUpgradeActionSet?** This decision step routes the flow to Consolidate Upgrade Actions if IsUpgradeActionSet is not NULL. Otherwise, it routes the flow to End.
- **Consolidate Upgrade Actions.** This step calls the method ConsolidateAllActions of the business service ABO Bulk Request Processing Service to consolidate all actions in Upgrade action set under one Base product.

RAF Check For Promotion Sub Process Workflow

RAF Check For Promotion Sub Process Workflow, shown in [Figure 25](#), checks whether the promotion Name is correct and applies the Apply, Disconnect, Modify or Upgrade promotion. It is called as a subprocess from the Check For Promotion and Apply Promotion steps of the RAF Create Document Workflow.

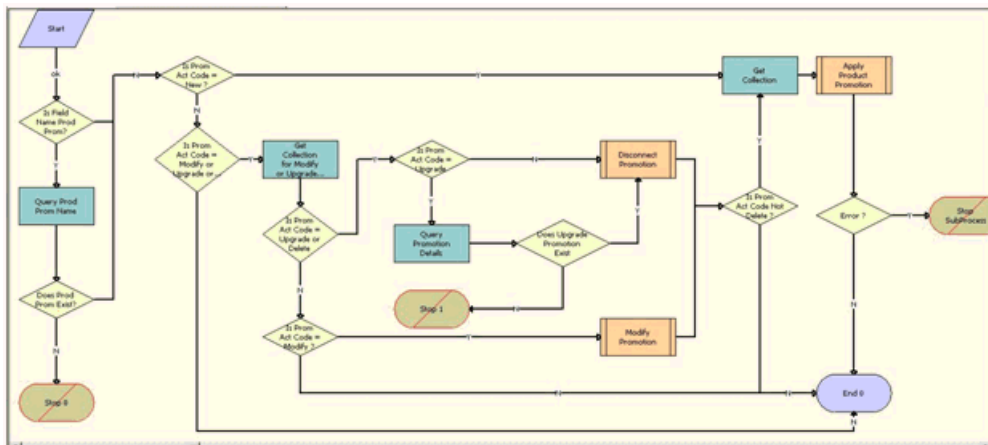

Figure 25. RAF Check For Promotion Sub Process Workflow

Workflow Description. This workflow performs the following actions:

- **Is Field Name Prod Prom?** This decision step routes the flow to Query Prod Prom Name if the field name is Prod Prom Name. Otherwise, it routes the flow to Is Prom Act Code = New?

- **Query Prod Prom Name.** This step queries the business component ISS Promotion for the field name to see whether this promotion exists.
- **Does Prod Prom Exist?** This decision step routes the flow to Is Prom Act Code = New? if the promotion name does not exist in the business component. Otherwise, it routes the flow to Stop 0.
- **Stop 0.** This error step displays the error message, "You selected a Invalid value/values for the Promotion Creation for <prom name>. Please change your selection and submit your request again."
- **Is Prom Act Code = New?** This decision step routes the flow to Get Collection if
`NewActnSetPromActnCode=' New' OR Modi fyActnSetPromActnCode=' New'`
Otherwise, it routes the flow to Is Prom Act Code = Modify or Upgrade or Delete.
- **Is Prom Act Code = Modify or Upgrade or Delete?** This decision step routes the flow to Get Collection for Modify or Upgrade or Delete if
`Modi fyActnSetPromActnCode=' Modi fy' OR Modi fyActnSetPromActnCode=' Del ete' OR UpgrdActnSetPromActnCode=' Upgrade' .`
Otherwise, it routes the flow to End.
- **Get Collection for Modify or Upgrade or Delete.** This step calls the method GetCollection of the business service ABO Bulk Request Processing Service to get details of the promotion to be deleted or, in case of upgrade, to get details of the promotion to be upgraded to.
- **Is Prom Act Code = Upgrade or Delete?** This decision step routes the flow to Is Prom Act Code = Upgrade? if
`Modi fyActnSetPromActnCode=' Del ete' OR UpgrdActnSetPromActnCode]=' Upgrade'`
Otherwise, it routes the flow to Is Prom Act Code = Modify?
- **Is Prom Act Code = Modify?** This decision step routes the flow to Modify Promotion if
`Modi fyActnSetPromActnCode=' Modi fy ' .`
Otherwise, it routes the flow to End.
- **Is Prom Act Code = Upgrade.** This decision step routes the flow to Query Promotion Details if
`UpgrdActnSetPromActnCode]=' Upgrade'`
Otherwise, it routes the flow to Disconnect Promotion.
- **Query Promotion Details.** This step queries business component ISS Promotion Upgrade To to get target promotion details.
- **Does Upgrade Promotion Exist.** This decision step routes the flow to Disconnect Promotion if
`[&Target Promoti on Id] = [&Upgrade Promoti on Id].`
Otherwise, it routes the flow to Stop 1.
- **Stop 1.** This error step displays the error message "You selected a Invalid value/values for the Promotion Creation for %1.Please change your selection and submit your request again."

- **Disconnect Promotion.** This step calls the subprocess ABO Bulk Request - Disconnect Products & Services Process to disconnect the existing promotion from the account's assets.
- **Modify Promotion.** This step calls the subprocess ABO Bulk Request - ModifyWebService-Order to modify the existing promotion.
- **Is Prom Act Code Not Delete?** This decision step routes the flow to Get Collection if `ModifyActnSetPromActnCode=' Delete '`.
Otherwise, it routes the flow to End.
- **Get Collection.** This step calls the method GetCollection of the business service ABO Bulk Request Processing Service to get details of the promotion, such as Prom Inst Id, Prod Prom Name, from the current instance.
- **Apply Product Promotion.** This step calls the subprocess ABO Bulk Request - ApplyProductPromotion to apply the promotion change to the asset.
- **Error?** This decision step routes the flow to Stop SubProcess if Err Flag is Y. Otherwise, it routes the flow to End.
- **Stop SubProcess.** This error step displays the error message from the step Apply Product Promotion.

RAF Ensure New Line Item Workflow

RAF Ensure New Line Item Workflow, shown in Figure 26, is a sub process that is invoked from RAF Create Document workflow. It extracts the Siebel message from the collection, stamps the Integration Id, and adds the Siebel message back to collection that would be used in the subsequent step to synchronize the row set data.

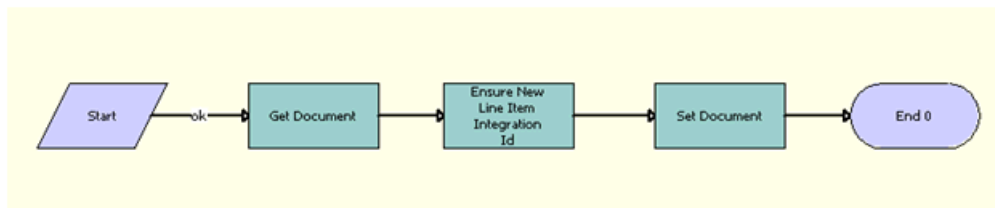

Figure 26. RAF Ensure New Line Item Workflow

Workflow Description. This workflow performs the following actions:

- **Get Document.** This step calls the Get Collection method of the ABO Bulk Request Processing Service business service to extract the Siebel message from the input property set which is used during the synchronization of the document.
- **Ensure New Line Item Integration Id.** This step calls the Set Field Value method of the SIS OM PMT business service to add the Integration Id field to the Siebel message which is the output of the previous step.

- **Set Document.** This step calls the AddItemtoCollection method of the ABO Bulk Request Processing business service, which adds the Siebel message from the previous step back to the collection.

RAF RunProcess Driver Workflow

RAF RunProcess Driver Workflow, shown in [Figure 27](#), is invoked whenever there is a Run Process Action Type. It takes Context, Row Set, Active Doc Id, Asset Id and Account Id as input arguments.

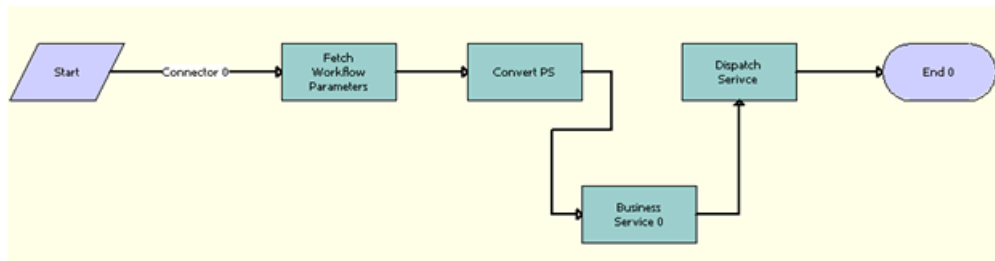

Figure 27. RAF RunProcess Driver Workflow

Workflow Description. This workflow performs the following actions:

- **Fetch Workflow Parameters.** This step calls the Query Transform method of the Row Set Transformation Toolkit business service to fetch the row set related to the Run Process action, querying the business component RAF Product Offer Workflow Parameters using the Action Id as the search specification.
- **Convert PS.** This step calls the ConvertPS method of the RAF Product Offers business service, which is a specialized method that takes Context and the output of the previous step (that is, the Workflow Parameters row set) and merges the workflow parameters into the context which is the output.
- **Business Service 0.** This step calls the GetFieldValue method of the CMU External Integration business service to extract Activity Description and Type from the context.
- **Dispatch Service.** This step calls the CallPSPWorkflow method of the ISS PSP Dispatch business service, which takes Context, Row Set, Instance Name and PSPWorkflowName, which is the Workflow name defined in the Run Process Action, thus invoking the required workflow.

RAF Get Named Parameter Workflow

RAF Get Named Parameter Workflow, shown in [Figure 28](#), is called as a subprocess from the Get Named Parameter step of the RAF Prepare Actions Sub Process workflow to process the User Input Action row set.

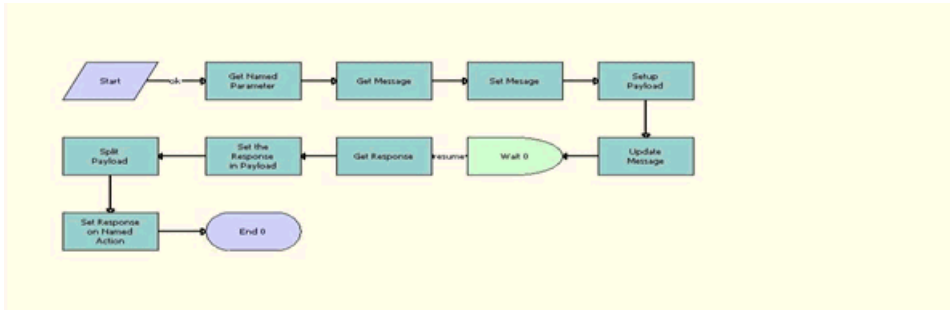

Figure 28. RAF Get Named Parameter Workflow

Workflow Description. This workflow performs the following actions:

- **Get Named Parameter.** This step calls the method Query Transform of the business service Row Set Transformation Toolkit to get the named parameters from the business component RAF Product Offer Parameters defined under the current action.
- **Get Message.** This step calls the method Query Transform of the business service Row Set Transformation Toolkit to get the message from the business component UMS Type and save it in the Msg row set.
- **Set Message.** This step calls the method Conditional Action Transform of the business service Row Set Transformation Toolkit to set message details on the Named Param row set from the Msg row set.
- **Setup Payload.** This step calls the method Conditional Action Transform of the business service Row Set Transformation Toolkit to set up the payload for the accept and reject responses.
- **UpdateMessage.** This step calls the method UpdateMessages of the business service Unified Messaging Service to the push message list to UMF Active Messages popup list applet.
- **Wait 0.** This step calls the method Sleep of the business service Workflow Utilities to wait until the user clicks OK or Cancel.
- **Get Response.** This step calls the GetMsgResponse method of the business service RAF Product Offers Service to get the response for the selected message in the process property Msg Response.
- **Set the Response in Payload.** This step calls the method Conditional Action Transform of the business service Row Set Transformation Toolkit to the set response for each message in the response row set.
- **Split Payload.** This step calls the method Split Transform of the business service Row Set Transformation Toolkit to create the Payload row set from the rows of the Response row set where the action Id is not null.

- **Set Response on Named Action.** This step calls the method Conditional Action Transform of the business service Row Set Transformation Toolkit to set details of the selected message in the User Input Action row set.

RAF Get Named Parameter For Web Call Workflow

RAF Get Named Parameter For Web Call Workflow, shown in [Figure 29](#), is the subprocess call for named parameters that use Web services.

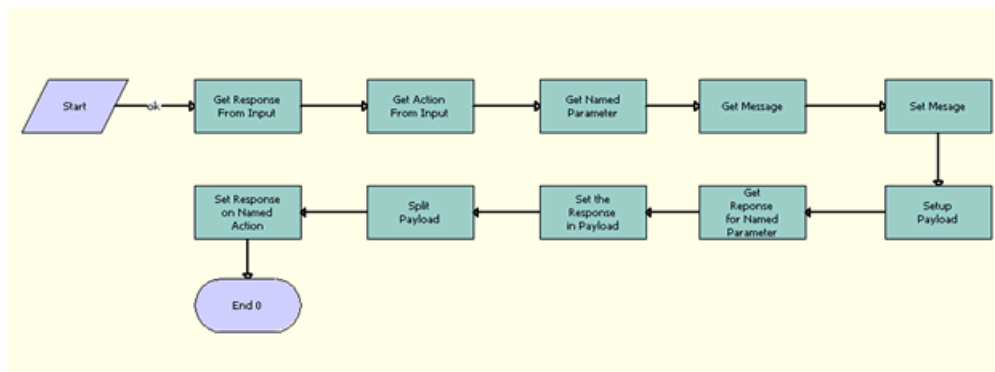

Figure 29. RAF Get Named Parameter For Web Call Workflow

Workflow Description. This workflow performs the following actions:

- **Get Response From Input.** This step uses the GetFieldValue method of the CMU External Integration business service to extract Action Name and Action Id from the Siebel message that is the input parameter.
- **Get Action From Input.** This step uses the GetFieldValue method of the CMU External Integration business service to extract Named Parameter Id, Upgrade Product, Component Product, Field Name, Attribute Value from the Siebel message that is the input parameter.
- **Get Named Parameter.** This step uses the Query Transform method of the Row Set Transformation Toolkit to query the RAF Product Offer Parameters business component to get the Named Parameter and User Input row sets.
- **Get Message.** This step uses the Query Transform method of the Row Set Transformation Toolkit to query the UMS Message business component to get the Msg row set.
- **Set Message.** This step uses the Conditional Action Transform method of the Row Set Transformation Toolkit to query based on the condition {Row. Name} IS NOT NULL from the output of the previous step to set the Named Parameter row set and the Msg row set as Row Set and Context respectively.
- **Set Up Payload.** To set the context and row set as the output, this step uses the Conditional Action Transform method of the Row Set Transformation Toolkit to query based on condition

```
{Row} += New(Payload", [Product Type Code] = {Row.Product Type Code} , [Account Id] = {Context.Account Id} , [Reject Action Type] = "RuntimeEvent" , [Accept Action Type] = "RuntimeEvent" , [Reject Action Name] = "EventMethodResumeParamWflw" , [Accept Action Name] = "EventMethodResumeParamWflw" , [Base Product Name] = {Context.Base Product Name} , [Action Id] = {Context.Id} , [Named Parameter Flag] = {Context.Named Parameter Flag} , [Product Path] = {Row.Component Product Path} , [Named Parameter Type] = {Context.Named Parameter Type} , [Base Product Id] = {Context.Base Product Id} , [Field Value] = {Row.Field Value} , [Product Name] = {Row.Product Name} , [Product Id] = {Row.Product Id} , [Component Product] = {Row.Component Product} , [Name] = {Row.Name} , [Attribute Value] = {Row.Attribute Value} )
```

- **Get Response for Named Parameter.** To obtain the Response row set, this step uses the Query Transform method of the Row Set Transformation Toolkit to query RAF Product Offer Parameters business component based on the condition

```
' [Product Offer Action Id] = ' + ''' + [&ActionId] + ''' AND [Id] = ' + ''' + [&ParameterId] + '''
```

- **Set the Response in Payload.** This step uses Conditional Action Transform method of the Row Set Transformation Toolkit to query based on the condition {Row.Action Id} IS NOT NULL to get the Response row set and Child Response row set.
- **Split Payload.** This step uses the Split Transform method of the Row Set Transformation Toolkit to split the output row set into Payload row set and Response row set based on the condition {Row.Action Id} IS NOT NULL.
- **Set Response on Named Action.** To arrive at the row sets pertaining to conditions satisfied having User Input Action Rowset and Payload Rowset respectively, this step uses the Conditional Action Transform method of the Row Set Transformation Toolkit to query based on the conditions

```
{Row.Named Parameter Type} = LookupValue("RAF_NAMED_PARM_TYPE", "Component Product") or {Row.Named Parameter Type} = LookupValue("RAF_NAMED_PARM_TYPE", "Base Product") or {Row.Named Parameter Type} = LookupValue("RAF_NAMED_PARM_TYPE", "Upgrade Product") or {Row.Named Parameter Type} = LookupValue("RAF_NAMED_PARM_TYPE", "Field Value") or {Row.Named Parameter Type} = LookupValue("RAF_NAMED_PARM_TYPE", "Domain Value").
```

RAF Apply Offer To Create Order Web Workflow

RAF Apply Offer To Create Order Web Workflow, shown in Figure 30, takes account, asset, and offer information and applies the offers for a residential customer to create an order. It also sends an error message as part of its output if there is an error while processing the offer. It is called while calling method ApplyOfferToCreateOrder of the Web service Product Offer Web Service.

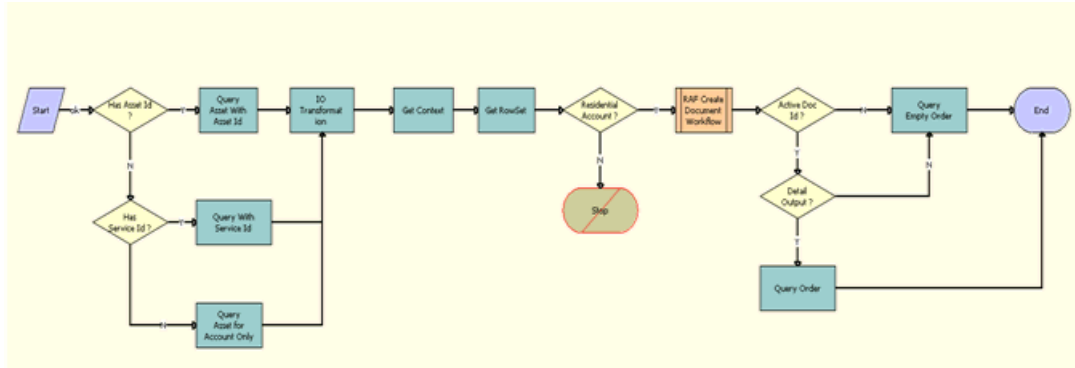

Figure 30. RAF Apply Offer To Create Order Web Workflow

Workflow Description. This workflow performs the following actions:

- **Has Asset Id?** This decision step checks whether the input of the Web service operation ApplyOfferToCreateOrder contains AssetId. If so, it routes the flow to the step Query Asset With Asset Id. Otherwise, it routes the flow to the step Has Service Id?
- **Has Service Id?** This decision step checks whether the input of the Web service operation ApplyOfferToCreateOrder contains ServiceId. If so, it routes the flow to the step Query With Service Id. Otherwise, it routes the flow to the step Query Asset for Account Only.
- **Query Asset With Asset Id.** This step calls Query method of the business service EAI Siebel Adapter, using the Account Id and Asset Id to retrieve all the asset Information for the specified account and asset.
- **Query With Service Id.** This step calls the Query method of the business service EAI Siebel Adapter, using the Account Id and Service Id to retrieve all the asset information for the specified account and service Id.
- **Query Asset for Account Only.** This step calls the Query method of business service EAI Siebel Adapter, using the Account Id to retrieve all the asset information for the specified account.
- **IO Transformation.** This step calls the method IntObjHierToPSHier of the business service IntObjHierToPSHier to transform the Input from Integration Object format to Property Set Format.
- **Get Context.** This step calls the method GetRowSetData of Context Service business service. It uses Variable Map Default Product Offer Recommendation Variable Map - Context to get the account header information.

- **Get Rowset.** This step calls the method GetRowSetData of Context Service business service. It uses Variable Map Default Product Offer Recommendation Variable Map - Row Set to get all asset information for the account.
- **Residential Account?** This decision step checks whether the account in the input of the Web service operation ApplyOfferToCreateOrder is of the type Residential. If so, it routes the flow to the step RAF Create Document Workflow. Otherwise, it routes the flow to the Stop step to set the error message.
- **Stop.** This stop step sets an error message as part of output message of the Web service operation ApplyOfferToCreateOrder, if the account is not a residential account.
- **RAF Create Document Workflow.** This step calls the subprocess RAF Create Document Workflow to apply the offer on the account, and to return the Order Id.
- **Active Doc Id?** This step verifies if the offer is successfully applied by creating an order with a non-null value for the DocId. If DocId (Order Id) is NULL, it routes the flow to the step Query Empty Order. Otherwise, it routes the flow to the step Detail Output?
- **Detail Output?** This step verifies if DetailOutput is set as Y in the input, to determine whether only the order Id or the full order structure is part of output message. If it is evaluated to TRUE, it routes the flow to the step Query Order. Otherwise, it routes the flow to Query Empty Order.
- **Query Order.** This step calls the Query method of the business service EAI Siebel Adapter by using the newly created order after applying the offer. It takes the DocId (Order Id) as input and returns the full order structure as the output that would be part of the response message to the Web service call.
- **Query Empty Order.** This step calls the Query method of the business service EAI Siebel Adapter, querying an invalid order to populate the empty value for the order message as part of response message the Web service call.

RAF Apply Offer To Create Quote Web Service Workflow

RAF Apply Offer To Create Quote Web Service Workflow, shown in [Figure 31](#), takes account, asset, and offer information and applies the offers for a nonresidential customer to create a quote. It also sends an error message as part of the output if there is an error while processing the offer. It is called while calling the method ApplyOfferToCreateQuote of the Web service Product Offer Web Service.

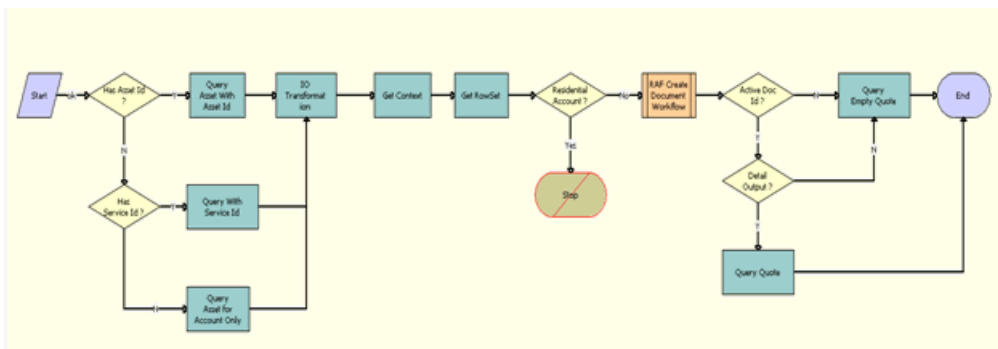

Figure 31. RAF Apply Offer To Create Quote Web Service Workflow

Workflow Description. This workflow performs the following actions:

- **Has Asset Id?** This decision step checks whether the input of the Web service operation ApplyOfferToCreateQuote contains the asset Id. If so, it routes the flow to the step Query Asset With Asset Id. Otherwise, it routes the flow to the step Has Service Id?
- **Has Service Id?** This decision step checks whether the input of the Web service operation ApplyOfferToCreateQuote contains the service Id. If so, it routes the flow to the step Query With Service Id. Otherwise, it routes the flow to the step Query Asset for Account Only.
- **Query Asset With Asset Id.** This step calls the Query method of the business service EAI Siebel Adapter by using the Account Id and Asset Id to retrieve all the asset information for the specified account and asset.
- **Query With Service Id.** This step calls the Query method of the business service EAI Siebel Adapter by using the Account Id and Service Id to retrieve all the asset information for the specified account and service.
- **Query Asset for Account Only.** This step calls the Query method of business service EAI Siebel Adapter by using the Account Id to retrieve all the asset Information for the specified account.
- **IO Transformation.** This step calls the method IntObjHierToPSHier of the business service IntObjHierToPSHier to transform the Input from Integration Object format to Property Set Format.
- **Get Context.** This step calls the method GetRowSetData of the Context Service business service. It uses the variable map Default Product Offer Recommendation Variable Map - Context to get the account header information.
- **Get Rowset.** This step calls the method GetRowSetData of the Context Service business service. It uses the variable map Default Product Offer Recommendation Variable Map - Row Set to get all asset information for the account.
- **Residential Account?** This decision step checks whether the account in the input of the Web service operation ApplyOfferToCreateQuote is of the type Residential. If not, it routes the flow to the step RAF Create Document Workflow. Otherwise, it routes the flow route to the Stop step to set the error message.
- **Stop.** This stop step sets the error message as part of output message of the Web service operation ApplyOfferToCreateQuote if the account is a residential account.
- **RAF Create Document Workflow.** This step calls the subprocess RAF Create Document Workflow to apply the offer on the account, and it returns the Quote Id.
- **Active Doc Id?** This step verifies if the offer is successfully applied by creating a quote with a non-null value for the DocId. If DocId (Quote Id) is NULL, it routes the flow to the step Query Empty Quote. Otherwise, it routes the flow to the step Detail Output?
- **Detail Output?** This step verifies if DetailOutput is set to Y in the input to determine whether to set only the quote Id or the full quote structure as part of output message. If it is evaluated to TRUE, it routes the flow to the step Query Quote. Otherwise, it routes the flow to the step Query Empty Quote.

- **Query Quote.** This step calls the Query method of the business service EAI Siebel Adapter by using the newly created quote after applying the offer. It takes the DocId (Quote Id) as input and returns the full quote structure as the output that will be part of the response message to the Web service call.
- **Query Empty Quote.** This step calls the Query method of the business service EAI Siebel Adapter by querying a invalid quote to populate the empty value for the quote message which will be used as part of response message the Web service call.

Product Offer GetProductOffer Workflow

Product Offer GetProductOffer Workflow, shown in [Figure 32](#), queries the product offer business component on ProductOfferId. It is called when calling the method GetProductOffer of the Web service Product Offer Web Service.

NOTE: For more information about the request and response messages for this workflows, see *Siebel CRM Web Services Reference*.

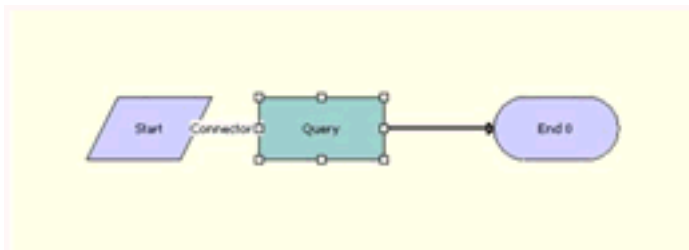

Figure 32. Product Offer GetProductOffer Workflow

Workflow Description. This workflow performs the following action:

- **Query.** This step calls the Query method of the business service EAI Siebel Adapter, using the ProductOfferId to retrieve the product offer from RAFProductOfferListIO. If the search specification is the asterisk wildcard, it returns all the offers.

Product Offer GetProductOfferStructure Workflow

Product Offer GetProductOfferStructure Workflow, shown in [Figure 33](#), queries the product offer business component on ProductOfferId to get the product offer structure. It is called when calling the method GetProductOfferStructure of the Web service Product Offer Web Service.

NOTE: For more information about the request and response messages for this workflows, see *Siebel CRM Web Services Reference*.

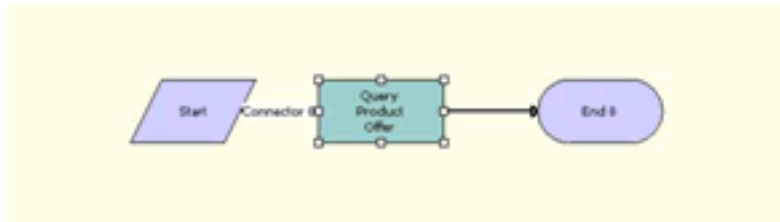

Figure 33. Product Offer GetProductOfferStructure Workflow

Workflow Description. This workflow performs the following actions:

- **Query Product Offer.** This step calls the Query method of the business service EAI Siebel Adapter by using the ProductOfferId to retrieve the product offer structure from RAFProductOfferStructureIO.

Product Offer GetRecommendedProductOffers Workflow

Product Offer GetRecommendedProductOffers Workflow, shown in [Figure 34](#), is a wrapper workflow which calls Product Recommendation Get Recommended Products. It is called when calling the method GetRecommendedProductOffers of the Web service Product Offer Web Service.

NOTE: For more information about the request and response messages for this workflows, see *Siebel CRM Web Services Reference*.

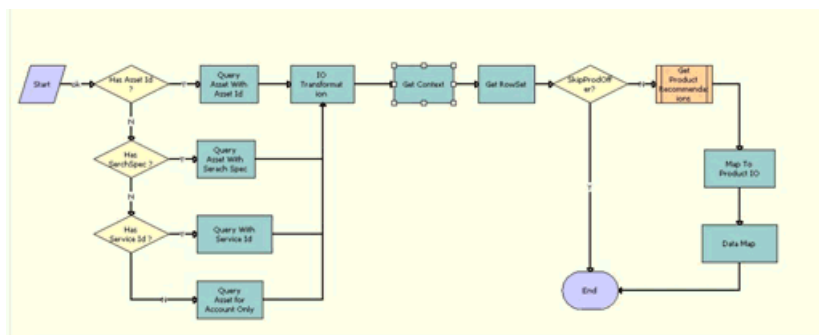

Figure 34. Product Offer GetRecommendedProductOffers Workflow

Workflow Description. This workflow performs the following actions:

- **Has Asset Id?** This decision step checks whether the input of the Web service operation ApplyOfferToCreateQuote contains the asset Id. If so, then it routes the flow to the step Query Asset With Asset Id. Otherwise, it routes the flow to the step Has Searchspec?
- **Has Searchspec?** This decision step checks whether the input of the Web service operation ApplyOfferToCreateQuote contains searchspec. If so, then it routes the flow to the step Query Asset With Search Spec. Otherwise, it routes the flow to the step Has Service Id?
- **Has Service Id?** This decision step checks whether the input of the Web service operation ApplyOfferToCreateQuote contains the service Id. If so, then it routes the flow to the step Query With Service Id. Otherwise, it routes the flow to the step Query Asset for Account Only.
- **Query Asset With Asset Id.** This step calls the Query method of the business service EAI Siebel Adapter by using the account Id and asset Id to retrieve all the asset information for the specified account and asset.
- **Query Asset with Search spec.** This step calls the Query method of the business service EAI Siebel Adapter by using the searchspec to retrieve all the asset information for the specified account and asset.
- **Query With Service Id.** This step calls the Query method of the business service EAI Siebel Adapter, using the account Id and service Id to retrieve all the asset information for the specified account and service.
- **Query Asset for Account Only.** This step calls the Query method of business service EAI Siebel Adapter, using the account Id to retrieve all the asset information for the specified account.
- **IO Transformation.** This step calls the method IntObjHierToPSHier of the business service IntObjHierToPSHier to transform the input from integration object format to property set format.
- **Get Context.** This step calls the method GetRowSetData of the Context Service business service. It uses the variable map Default Product Offer Recommendation Variable Map - Context to get the account header information.
- **Get Rowset.** This step calls the method GetRowSetData of the Context Service business service. It uses the variable map Default Product Offer Recommendation Variable Map - Row Set to get all asset information for the account.
- **SkipProdOffer?** This decision step routes the flow to End if skip prod offer is Y. Otherwise it routes the flow to Get Product Recommendations.
- **Get Product Recommendations.** This step calls the subprocess Product Recommendation Get Recommended Products by passing context and rowset.
- **Map To Product IO.** This step calls the method PSHierToIntObjHier of the business service EAI Integration Object to XML Hierarchy Converter to transform the Input from Property Set Format to Integration Object format.
- **Data Map.** This step calls the method Execute of the business service EAI Data Transformation Engine to get the output in RAF Offer Asset Data Map, which will be sent as output of the web service.

10 Creating Discount Matrices

This chapter covers discount matrices and includes the following topics:

- “About Discount Matrices” on page 141
- “About Discount Matrix Dimensions” on page 142
- “About Discount Matrix Types” on page 143
- “Defining a Discount Matrix” on page 146
- “Entering Discount Matrix Details” on page 147
- “Discount Matrix Integration” on page 147
- “About Configuring Discount Matrices” on page 148

About Discount Matrices

In many industries, prices and price adjustments often depend on both the product that is being sold and other information relevant to the sale. Often, customer and market conditions affect the price for which a product is sold.

Discount matrices allow you to tailor prices and adjustments to specific customer and market segments. They allow you to create and manage prices and adjustments for products in conjunction with other customer and market factors. The discount matrix administrative framework allows pricing administrators to logically group factors that result in a price or adjustment, working in the Siebel client without changing the Siebel repository.

For example, a company that sells laptop computers can create a discount matrix that allows it to charge a different price for laptops based on customer account type and sales region. In this example, customer account type, product, and sales region are the criteria for the price or discount. Therefore, the columns of the matrix would be Product, Account Type, Sales Region, Adjustment Type, Adjustment Amount, and a few additional columns that will be covered later in this chapter. Each row of the matrix defines the price or discount that will be applied when a given product is sold to a given account type in a given sales region, as shown in [Table 2](#).

Table 2. An Example of a Matrix Defining Discounts

Product	Account Type	Sales Region	Adjustment Type	Adjustment Amount
Laptop 2000	Platinum	Europe	% Discount	10
Laptop 2000	Gold	Europe	% Discount	5
Laptop 2000	Platinum	Asia	% Discount	11
Laptop 2000	Gold	Asia	% Discount	6

Discount matrices allow you to maintain all of this critical pricing information in a single matrix, instead of dispersing it across numerous Siebel views.

Discount matrices are recommended in cases where:

- There is a high volume of prices and adjustments.
- The criteria for prices and adjustments are known ahead of time and do not change frequently.

Because prices and adjustments are frequently stored in disparate applications, discount matrices:

- Support integration with SAP condition tables.
- Can be loaded using Enterprise Integration Manager (EIM) or Enterprise Application Integration (EAI) integration objects.
- Can be integrated with legacy applications using other XML-based integration technologies.

About Discount Matrix Dimensions

A discount matrix is a logical grouping of prices or adjustments that apply when specific combinations of criteria for prices or adjustments are met. For example, a discount matrix might contain all the adjustments for products when sold to specific account types, or all the adjustments for products when sold in specific regions.

Before you create discount matrices, you must determine the criteria for the prices or adjustments, based on your company's business model. After identifying criteria, you may begin creating the discount matrix. The criteria for the prices or adjustments will be the unique dimensions (or columns) of the discount matrix.

Along with the criteria dimensions, your discount matrix will include other dimensions. To continue the example, assume your company provides different discounts for each product based on the account type it is sold to and the region where it is sold. It would use the following dimensions:

- **Criteria Dimensions.** These are the fields that uniquely identify the adjustment. In the example, these dimensions would be Product, Account Type, and Region. For each record, all of the criteria dimensions must be populated.
- **Calculation Dimensions.** These fields allow administrators to enter various adjustments for the unique combinations of the discount criteria across various effective dates. These fields include Adjustment Type, Adjustment Amount, Currency Code, Effective Start Date, and Effective End Date.
- **Result Dimensions.** These fields allow administrators to associate other information to the adjustment record that may be needed in the quote, order, or agreement later in the pricing procedure, or by back-end applications. These fields include Volume Discount Schedule, Attribute Adjustment Matrix, Pricing Procedure, Aggregate Discount, and Accounting Code.

The discount details list will include the criteria dimensions that were selected when you created the discount matrix, as well as the default calculation and result dimensions. Each set of dimensions is configurable and extensible.

About Discount Matrix Types

The following topics describes the three types of discount matrices, and the criteria, calculation, and result dimensions that are available for each type:

- [“Product-Based Adjustment Discount Matrices” on page 143](#)
- [“Entitlement-Based Adjustment Discount Matrices” on page 144](#)
- [“Training-Based Adjustment Discount Matrices” on page 145](#)

The fields that are available by default are the fields that are most commonly used with each type of adjustment. In case your business model demands different criteria dimensions, each set is configurable and extensible, as described in [“About Configuring Discount Matrices” on page 148](#).

Product-Based Adjustment Discount Matrices

Product-Based Adjustment Discount Matrices allow administrators to define adjustments based on product, customer, and market information.

By default, the administrator can choose from the following dimensions:

- Criteria dimensions to identify product:
 - Product
 - Parent Product
 - Root Product
 - Product Line
 - Product Class
 - Price Type
- Criteria dimensions to identify customer:
 - Account
 - Account Type
- Criteria dimensions to identify market:
 - Region
 - Sales Organization
 - Division Code
 - Distribution Channel
- Dimensions to identify transaction:
 - Action
 - Approval Status

- Calculation dimensions:
 - Adjustment Type
 - Adjustment Amount
 - Currency Code
 - Effective Start Date
 - Effective End Date
- Result dimensions:
 - Volume discount
 - Attribute Adjustment
 - Pricing Procedure
 - Aggregate Discount Sequence
 - Accounting Code

Entitlement-Based Adjustment Discount Matrices

Entitlement-Based Adjustment Discount Matrices allow administrators to define adjustments based on product, entitlement, and transactional information.

By default, the administrator can choose from the following criteria dimensions:

- Criteria dimensions to identify product:
 - Product
 - Parent Product
 - Root Product
 - Product Line
 - Price Type
- Criteria dimensions to identify transaction:
 - Entitlement
 - Action
 - Qty from
 - Qty to
 - Reason Code
- Calculation dimensions:
 - Adjustment Type
 - Adjustment Amount
 - Currency Code

- Effective Start Date
- Effective End Date
- Result dimensions:
 - Volume discount
 - Attribute Adjustment
 - Pricing Procedure
 - Aggregate Discount Sequence
 - Accounting Code

Training-Based Adjustment Discount Matrices

Training-Based Adjustment Discount Matrices allow administrators to define adjustments based on account, transaction, and training event information.

By default, the administrator can choose from the following dimensions:

- Criteria dimensions to identify training:
 - Training Course
 - Event
 - Event Type
 - Event Location
 - Price Type
- Criteria dimensions to identify customer:
 - Account
 - Contact
- Criteria dimensions to identify transaction:
 - Action
 - Reason Code
 - Approval Status
- Calculation dimensions:
 - Adjustment Type
 - Adjustment Amount
 - Currency Code
 - Effective Start Date
 - Effective End Date

- Result dimensions:
 - Volume discount
 - Attribute Adjustment
 - Pricing Procedure
 - Aggregate Discount Sequence
 - Accounting Code

Defining a Discount Matrix

When you create a discount matrix, you specify what type of discount matrix it is, and which criteria dimensions will be shown in the Discount Details list applet.

To define a discount matrix

- 1 Navigate to the Administration - Pricing screen, then Discount Matrices View.
- 2 Add a new record to the Discount Matrices list and complete the necessary fields, as described in the following table:

Field	Comments
Name	Enter a name for the discount matrix.
Status	This field displays the status of the discount matrix. When you click the Complete Definition button, the value changes from In Progress to Active. You cannot enter any discount details until the status is Active.
Discount Matrix Type	Select one of the discount matrix types. The options are as follows: <ul style="list-style-type: none"> ■ Product-Based Adjustment. For more information, see “Product-Based Adjustment Discount Matrices” on page 143. ■ Entitlement-Based Adjustment. For more information, see “Entitlement-Based Adjustment Discount Matrices” on page 144. ■ Training-Based Adjustment. For more information, see “Training-Based Adjustment Discount Matrices” on page 145.

- 3 In the Discount Criteria list, add records for all the criteria dimensions that you want exposed in the discount matrix.

The criteria dimensions that you can add depend on the value selected in the Discount Matrix Type field in [Step 2](#).

- 4 After all the necessary criteria dimensions are added, click Complete Definition in the Discount Matrix list applet.

Clicking this button freezes the definition of the discount matrix. After this step, you cannot change the discount matrix type or the criteria dimensions.

- 5 In the Discount Matrix list, click the name of the new discount matrix.

The Discount Details list appears. It includes the criteria dimensions that you selected in [Step 3](#) and the default calculation and result dimensions.

Entering Discount Matrix Details

After a discount matrix has been defined, you enter details of each price adjustment in the matrix.

You must make entries in all the criteria dimension columns that have been defined.

Enter effective dates in the same way as price lists, as described in [“Giving a Product Multiple Prices with Different Effective Dates” on page 32](#). If you create records with overlapping effective dates, then the product resolves the issues in the same way as price lists, as described in [“About Effective Dates for Pricing Line Items” on page 29](#).

When you enter Discount Detail records, enter a value in the Currency Code field if the Adjustment Type is Price Override, Discount Amount, or Markup Amount. By default, the Currency Code field value is the system currency.

To enter details in a discount matrix

- 1 Navigate to the Administration - Pricing screen, then Discount Matrices View.
- 2 In the Discount Matrices list, click the name of the matrix to which you want to add details.
The dimensions in the Discount Details list applet are as follows:
 - The criteria dimensions specified on the discount matrix
 - The default calculation dimensions
 - The default result dimensions
- 3 In the Discount Details list, add a new record for each combination of criteria dimension values for which you want to define a price adjustment.

In each record, you must enter values for all the criteria dimensions.

Discount Matrix Integration

You can populate discount matrices with data from other applications, load them using EIM, and systematically update them using EAI. They are designed for integration with SAP condition tables.

Loading and Updating Data from Other Applications

Siebel Enterprise Integration Manager (EIM) tables are available for each discount matrix table.

To initially load data from another application, use EIM. For more information, see *Siebel Enterprise Integration Manager Administration Guide*.

Integration objects are available for each discount matrix table to enable integration using EAI.

For systematic incremental updates, use EAI. For more information, see *Overview: Siebel Enterprise Application Integration*.

Integration with SAP Condition Tables

The following SAP-specific dimensions columns are available for the product-based and entitlement-based discount matrix types:

- Sales Organization Code
- Division Code
- Distribution Channel Code

The following SAP-specific fields are available in the Discount Matrix table (S_ADJ_GROUP):

- SAP Condition Type: SAP_COND_NAME
- SAP Condition Table: SAP_TABLE_NAME

About Configuring Discount Matrices

The criteria, calculation, and result dimensions that are available for each discount matrix type are the ones that are most commonly used for that type of adjustment. However, your business model may require you to use additional dimensions that are not available by default.

To make these additional dimensions available, you can configure the application with Siebel Tools. For more information about Siebel Tools, see *Using Siebel Tools*.

To make additional dimensions available, you must understand the tables used to store the discount matrix data, which are shown in [Figure 35](#).

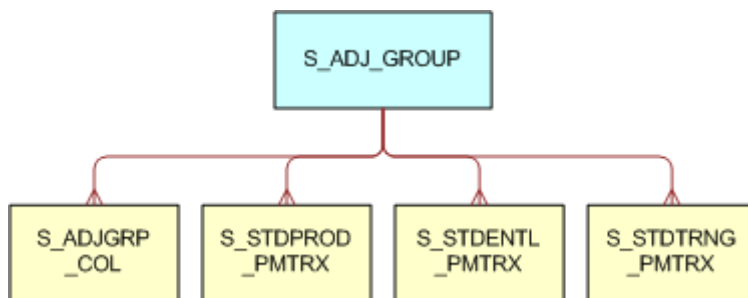

Figure 35. Discount Matrix Data Tables

Discount matrix fields are stored in the following tables:

- The Discount Matrix Name, Status, and Type are stored in the S_ADJ_GROUP table.
- The criteria dimensions that the administrator has selected for the discount matrix are stored in the S_ADJ_GRP_COL table.

- The discount details are stored in the following tables:
 - S_STDPROD_PMTRX (if the discount matrix type is Product-Based Adjustment)
 - S_STDENTL_PMTRX (if the discount matrix type is Entitlement-Based Adjustment)
 - S_STDTRNG_PMTRX (if the discount matrix type is Training-Based Adjustment)

To extend the available criteria, calculation, or result dimensions, you may add columns to any or all of these tables.

The following topics include instructions for configuring discount matrices:

- [“Adding New Dimensions to Existing Discount Matrix Types” on page 149](#)
- [“Creating New Discount Matrix Types for Custom Tables” on page 150](#)

Adding New Dimensions to Existing Discount Matrix Types

NOTE: This topic includes instructions that assume you are familiar with Siebel Tools. For more information, see *Using Siebel Tools*. These instructions also assume that you have made the appropriate data model extensions to the appropriate discount details table.

You must use Siebel Tools to add new dimensions to existing discount matrix types.

To add new dimensions to existing discount matrix types using Siebel Tools

- 1 In the Object Explorer, select the Business Component object.
- 2 Query to find the appropriate discount matrix Business Component (Product-Based Adjustment, Entitlement-Based Adjustment, or Training-Based Adjustment).
- 3 Add a new Business Component field based on the newly created extension column.
- 4 In the Object Explorer, select the Business Component User Prop object under the Business Component object.
- 5 Add the new field name to the appropriate user property.

NOTE: If the field will be used as a criteria dimension, then add it to the Dimension Columns user property. If the field will be used as a calculation or result dimension, then add it to the Default Columns user property. The appropriate syntax for the user properties is as follows:
#FieldName#FieldName#FieldName#

- 6 Compile the business component changes to the SRF.
- 7 In the Object Explorer, select the Applet object.
- 8 Query to find the appropriate discount details applet (Product-Based Adjustment list applet, Entitlement-Based Adjustment list applet, or Training-Based Adjustment list applet).
- 9 Create a new list column for the new field.
- 10 Bind the list column to the Edit List Web template.
- 11 Compile the applet changes to the SRF.

If the new field was added as a criteria dimension, then it now appears as a selection in the discount criteria pick applet for the appropriate discount matrix type. If the new field was added as a calculation or result dimension, then it now appears in the Discount Details applet when the user drills down on a discount matrix with the appropriate discount matrix type.

Creating New Discount Matrix Types for Custom Tables

NOTE: This topic includes instructions that assume you are familiar with Siebel Tools. For more information, see *Using Siebel Tools*.

You must use Siebel Tools to create new discount matrix types for custom tables.

To create a new discount matrix based on a custom table using Siebel Tools

- 1 Create a Business Component on top of the custom table:

For example create the Default Columns user property:

Name: Default Columns

Value: <buscomp field names separated by # sign>

This user property controls which columns always display in the Discount Matrix Details List applet for the new Discount Matrix Type.

- 2 Create the Dimension Columns user property:

Name: Dimension Columns

Value: <buscomp field names separated by # sign>

This user property controls which criteria dimensions will appear in the discount criteria pick applet for the new Discount Matrix Type.

- 3 Add the new matrix type to the Discount Matrix Type LOV:

Type: ADJ_GROUP_TYPE

Display Value: <the new matrix type>

LIC: <the new matrix type>

- 4 Modify the Discount Matrix Business Component by adding the following Business Component User Property:

Name: <Display Value of New Matrix Type from LOV>

Value: Adjustment Group#New Matrix BC Name#

This user property inserts the Business Object and Business Component values into the appropriate fields on the discount matrix header when the discount matrix type is selected.

- 5 Create a new Discount Matrix Details list applet for the new Business Component:

Name: <any name>

Business Component: <new matrix buscomp>

Class: CSSSWEFrameListPSPAdjRule

List Columns: <all fields from the new matrix Business Component that could possibly appear as criteria or default dimensions>

NOTE: Specialized applet class will only show dimensions defined and default columns from the Business Component user property.

- 6 Create a new Discount Matrix Details view as follows:

Name: <any name>

Business Object: Adjustment Group

View Web Template Items:

Adjustment Group form applet

New Applet from Above

- 7 Modify the Adjustment Group list applet as follows:

Create a New Drilldown Object:

Name: <new matrix type>

Hyperlink Field: Name

Destination View: <name of new details view>

Create a Dynamic Drilldown Destination for the new Drilldown Object:

Name: <new matrix type>

Field: Type - LIC

Value: <new matrix type LIC value from LOV>

Destination Drilldown Object: <name of drilldown object created in previous step>

- 8 Add the new view to the Administration - Pricing screen:

Name: <name of the new view>

View: <name of the new view>

Type: Details view

Parent Category: Adjustment Group Details

11 Creating Attribute Adjustments

This chapter describes how to create attribute pricing adjustments and includes the following topics:

- [“About Attribute Pricing” on page 153](#)
- [“Attribute Adjustments Design” on page 154](#)
- [“About the Attribute Adjustments View” on page 154](#)
- [“Variable Maps in Attribute Adjustments” on page 156](#)
- [“How Attribute Adjustments Apply Rules” on page 158](#)
- [“Single and Multiple Type Attribute Adjustments” on page 159](#)
- [“Process of Creating an Attribute Adjustment” on page 165](#)
- [“Example of Creating an Attribute Adjustment Based on Product Attributes” on page 171](#)
- [“Example of Creating an Attribute Adjustment with Nonproduct Attributes” on page 175](#)
- [“Guidelines for Creating Attribute Adjustments” on page 182](#)
- [“How the Pricing Procedure Uses Attribute Adjustments” on page 183](#)
- [“Upgrade Considerations for Attribute Adjustments” on page 183](#)

About Attribute Pricing

Users may customize products by selecting attributes of the product, such as size and color. Attribute-based pricing adjusts the price based on the attributes chosen, and displays the adjusted price in the quote or order.

For example, a sales agent might create a quote for a car and select the leather upholstery attribute. After selecting the leather upholstery attribute, the agent sees the net price increase by \$1000, the cost of this attribute. A home shopper using a Web site might select the same car model, but select the plush interior attribute. This shopper sees the net price increase by \$500, the cost of this attribute. These two different users might be using different price lists, so their attribute adjustments might be different.

In earlier versions, you used attribute-based pricing only to define pricing based on attributes of a product. Effective in version 7.8, the Attribute Adjustments view extends and generalizes the earlier attribute-based pricing feature, so it can also be used for defining price adjustments based on other criteria (such as Status of an Account, Age of an Asset, and so on) in addition to product attributes.

To create attribute adjustments, first you define a list of attributes that affect the price and the adjustments needed for each. Then, you associate the attribute adjustments with the product in a price list. Because the product can be in multiple price lists, you can create multiple attribute adjustments for the product that are used in different price lists.

This chapter assumes that you have general background knowledge about attribute-based products, classes, and attribute values. For more information, see *Siebel Product Administration Guide*. This chapter also assumes that you have general background knowledge about how the PSP engine works. For more information, see *Siebel Order Management Infrastructure Guide*.

NOTE: If you use attribute-based pricing with other types of price adjustments, then the final price depends on the order in which Siebel Pricer applies the pricing adjustments. For more information, see [“About the Processing Order of Price Adjustments” on page 15](#).

Attribute Adjustments Design

To plan attribute adjustments, begin by identifying the products, the product attributes that affect prices, and any other attributes (such as Status of an Account) for which you need to define price adjustments.

Determine which attributes you want to use for pricing. Be aware that you can use nonproduct attributes, such as Status of an Account, to set up price adjustments. Some product attributes that are necessary for customization have no effect on pricing. For example, some products may have a color attribute, because the user can select the color, but the color does not affect the price. You would not use the color attribute in the attribute adjustments table.

About the Attribute Adjustments View

You use the Attribute Adjustments view to create a list of attribute adjustments, which can be based on both product attributes and nonproduct attributes.

For example, [Table 3](#) shows a simple list of attribute adjustments that adjust shirt prices based on size and color of the shirt. Any shirt ordered that is XL size and not colored red is marked up by 10%. Any shirt that is L size and not colored white is marked up by 8%. Any shirt that is M size and not colored blue is marked up by 10%.

Table 3. An Example of Attribute Adjustments

Size	Color	Adjustment Type	Adjustment Amount
= XL	<> Red	% Markup	10
= L	<> White	% Markup	8
= M	<> Blue	% Markup	5

[Table 4](#) shows a simple example that adjusts shirt prices based on the size of the shirt and the status of the account. If the shirt ordered is XL size and the customer is a Gold account, then there is a 10% discount. If the shirt ordered is L size and the customer is a Silver account, then there is a 5% discount. If the shirt ordered is M size and the customer is a Bronze account, then there is a 3% discount.

Table 4. An Example of Attribute Adjustments

Size	Customer Status	Adjustment Type	Adjustment Amount
= XL	= Gold	% Discount	10
= L	= Silver	% Discount	5
= M	= Bronze	% Discount	3

Dimensions in Attribute Adjustments

The columns of these tables are called the *dimensions* of the attribute adjustment. The examples show that attribute adjustments have two types of dimensions:

- **Conditions.** These dimensions affect the price of the product and determine whether the rule is applied. In the example, the condition dimensions are the columns Size, Color, and Status. Conditions can be based on any text, number, or date field in any Siebel business object, but if a rule uses the greater than (>) or less than (<) comparison operator, then its condition must be a number or date field (otherwise, the results will be unpredictable).
- **Results.** These dimensions determine the result when the rule is applied. In the example, the results dimensions are the Adjustment Type and Adjustment Amount columns.

Navigate to the Attribute Adjustments screen, then the Dimensions view to specify these dimensions.

Variable Maps in Attribute Adjustments

Variable maps are used to map the dimensions of attribute adjustments to fields in Siebel business objects. Every condition dimension of an attribute adjustment table has to be mapped to a variable map. Variable maps are provided for use with attribute adjustments. You can modify these variable maps or set up new variable maps. For information about working with variable maps, see *Siebel Order Management Infrastructure Guide*.

The variable maps are transparent to the pricing administrator who defines the price adjustments based on attributes. The order management administrator sets up all the appropriate variable maps for use in pricing.

Without configuration, the view to associate the variable maps with an attribute adjustment table is hidden. You can display the variable maps associated to an attribute adjustment table only by using the site map to navigate to the Administration - Pricing, Attribute Adjustments, then Variable Maps view. For more information about how to use variable maps in attribute adjustments, see [“Variable Maps in Attribute Adjustments” on page 156](#).

Rules in Attribute Adjustments

The Rules view contains a list of conditions and results similar to the samples shown in [Table 3](#) and [Table 4](#). You can enter rules in this view in two ways:

- **Enter rules manually.** Add a new record and enter the information for each rule manually.

- **Generate rules.** Click the Generate Rules button. The rules list is populated with records for every possible combination of condition dimensions and domains entered in the Dimensions view. You enter the results dimensions for each record. If you do not need all the combinations that are generated, then you can edit or delete some of the generated records.

You enter the list of rules in the Attribute Adjustments, Rules view.

Variable Maps in Attribute Adjustments

You use variable maps to map the dimensions of attribute adjustments to fields in Siebel business objects. For information about variable maps, see *Siebel Order Management Infrastructure Guide*.

There are three types of variable maps:

- **Context.** This type maps the variable to header-level information, for example, to fields in the Order Header applet such as Account, Order Status, and so on.
- **Row set.** This type maps the variable to line item-level information, for example, to fields in the line items of an order such as Quantity, Product Line, Price Type, and so on.
- **XA.** This type maps the variable to the attribute names and values of a line item.

For attribute pricing, you need only the standard variable maps that are provided with the product.

The Siebel application provides standard variable maps for all of these variable map types. The variable maps that attribute adjustments use are declared in the Systems Preferences view as shown in [Table 5](#).

Table 5. Variable Maps for Attribute Pricing

System Preference Variable	Value
PSP Pricing Var Map - Context	Default Pricing Variable Map - Context
PSP Pricing Var Map - Row Set	Default Pricing Variable Map - Row Set
PSP Pricing Var Map - XA	Default Pricing Variable Map - XA

While setting up an Attribute Adjustment table, the pricing administrators can associate the variable maps shown in [Table 5](#) by clicking the Create Result Dimensions button. The three variable maps are created for the attribute adjustment in the Attribute Adjustments, Variable Maps view along with the two pricing results dimensions, Adjustment Type and Adjustment Amount. The system preferences, as shown in [Table 5](#), are read and a record is inserted for each variable map type in the System Preferences view.

CAUTION: If the system preference value is either empty, nonexistent, or invalid, then that variable map record is not created. No error message appears. If a user has already created the variable map records, then the application does not overwrite them.

The use of variable maps for attribute adjustments is transparent to the pricing administrator. The Variable Maps view tab does not appear in the user interface, but you can still access it using the Site Map to navigate to the Administration - Pricing screen, Attribute Adjustments, then Variable Map view.

You can set up variable maps in either of the following ways:

- [“Using System Preferences to Set Up Variable Maps for Pricing Adjustments” on page 157](#)
- [“Using the Variable Maps View to Set Up Variable Maps for Pricing Adjustments” on page 157](#)

Using System Preferences to Set Up Variable Maps for Pricing Adjustments

Use the following procedure to set up variable maps for pricing adjustments by modifying system preferences

To set up variable maps for pricing adjustments using the System Preferences view

- 1 Navigate to the Administration - Application screen, then System Preferences view.
- 2 In the System Preferences list, query for: *PSP Pricing Var Map**
Three records appear, as detailed in [Table 5](#).
- 3 Set the appropriate variable map names in the System Preference Value field.
- 4 Restart the server.

New attribute adjustments created after the server is restarted use the new variable maps declared in system preferences.

Using the Variable Maps View to Set Up Variable Maps for Pricing Adjustments

Use the following procedure to set up variable maps for pricing adjustments by overwriting the variable maps in the Variable Map view.

To set up variable maps for pricing adjustments using the Variable Maps view

- 1 Navigate to the Administration - Pricing screen , Attribute Adjustments, then Variable Map view.
- 2 Modify variable maps by selecting different variable maps in the picklists.

The first approach is a global level change, and any new attribute adjustment table created after the server is restarted uses the new variable maps. The second approach is a local level change, and only the attribute adjustment that is modified uses the new variable maps.

How Attribute Adjustments Apply Rules

When you set up attribute adjustments, a search specification template is dynamically generated based on the definition of the condition dimensions of the attribute adjustment.

The following properties of a condition dimension are important for generating the search specification template:

- **Operator.** This property specifies the type of comparison performed against the column during run time.
- **Sort Order.** This property specifies the sorting priority of the columns in the search specification.
- **Sort Method.** This property specifies ascending or descending ordering of the search specification.

At run time, this search specification template, along with run-time contextual values, executes a lookup against the rules of the attribute adjustments, as defined in the Conditions view.

For example, shirts have two attributes that affect their price, color and size. You enter the condition dimensions shown in [Table 6](#).

Table 6. Sample Condition Dimensions

Name	Operator	Variable Map	Data Type	Sort Order	Sort Method
Size	<	XA	Number	2	Descending
Color	=	XA	Text	1	Ascending

Based on these dimensions, at run time, the application generates and caches the search specification:

```
[Matrix.Color] = {Row.Color} AND [Matrix.Size] < {Row.Length}, Order by
[Matrix.Color] Ascending, [Matrix.Size] Descending
```

The notation [Matrix.<Column>] refers to a condition dimension of an attribute adjustment. {Row.<Var Name>} is a contextual value, generated at run time. You also enter the rules shown in [Table 7](#).

Table 7. Sample Rules

Sequence	Color	Size	Adjustment Type	Adjustment Amount
1	Red	15	% Discount	15
2	Blue	15	% Discount	15
3	Green	15	% Discount	15
4	Red	10	% Discount	25
5	Blue	10	% Discount	25
6	Green	10	% Discount	25

In run time, when there are incoming transactions, the application uses the search specification template with the contextual values from the specific transaction to see which rule applies. For example:

- If the transaction has Color = Red and Size = 11, then the application generates the search specification

[Matrix. Color] = "Red" AND [Matrix. Size] < 11.

This search specification matches the rule for Color = Red and Size = 10, so the discount of 25% is applied to the transaction.

- If the transaction has Color = Red and Size = 16, then the application generates the search specification

[Matrix. Color] = "Red" AND [Matrix. Size] < 16.

This search specification matches the rule for Color = Red and Size = 15, so the discount of 15% is applied to the transaction.

- If the transaction has Color = Red and Size = 8, then the application generates the search specification

[Matrix. Color] = "Red" AND [Matrix. Size] < 8.

This search specification does not match any rule, so no discount is applied to the transaction.

Single and Multiple Type Attribute Adjustments

After determining which attributes affect pricing, you must decide whether you need a single-attribute or multiple-attribute pricing adjustment table.

When you create an Attribute Adjustment record, you use the Type field to specify that it is a single-condition or a multiple-condition adjustment as follows:

- **Single condition.** Use this type if the price adjustments are based on condition dimensions that apply in isolation from each other. For example, a product with the attributes Size and Color could have a price adjustment for each of these individual attributes and not for a combination of both. In this case, set up a single type attribute adjustment table.
- **Multiple condition.** Use this type if the combination of condition dimensions affect pricing, for example, if the product size and its color together determine the price adjustment.

Single-condition attribute adjustments used for attribute pricing are relatively simple to create if you need them. For information, see ["Process of Creating an Attribute Adjustment" on page 165](#).

NOTE: The Price Override adjustment type is not available for single dimension attribute adjustments, so use the multiple dimension attribute adjustment option to apply just one adjustment as a price override.

Before you begin creating multiple-condition attribute adjustments, decide on the following fields:

- **Sort order.** You must use this field to specify the order in which attributes (condition dimensions) are processed, because the order affects the adjusted price. For more information, see [“Order of Conditions in Multiple-Condition Pricing Tables” on page 160](#).
- **Allow any.** You must decide whether to use this field to allow you to insert null value wildcards into the pricing table, so one record represents many values of an attribute (condition dimension). For more information, see [“About Wildcards in Attribute Adjustments” on page 161](#).
- **Display error.** You must decide whether to use this field to prevent the user from choosing an invalid combination of condition dimensions. For more information, see [“Preventing Users from Selecting Invalid Combinations of Attributes” on page 162](#).

Order of Conditions in Multiple-Condition Pricing Tables

If you set up a multiple type Attribute Adjustment record, then you must consider the processing order of the attributes (condition dimensions).

You can use the Sort Order and Sort Method fields of the Dimensions record to specify the order in which attributes (condition dimensions) are processed. The application assigns the dimension with the least numerical sort order value the highest processing priority while performing a lookup against the rules (the Conditions view). The sort method determines whether the values in the dimension are processed in ascending or descending order.

Processing order is important because:

- The order of attributes (condition dimensions) affects the lookup of the price adjustment.
- If there are multiple matches of rules (Conditions view), then the order of the attributes (condition dimensions) determines which rule is applied.
- The order of attributes (condition dimensions) affects processing speed.

Order of Conditions and Pricing Calculations

In a single-type attribute adjustment, each attribute (condition dimension) contributes to the price adjustment in isolation from the rest of the other attributes (condition dimensions). This means that the sort order of the attributes does not impact the price in any way.

Assume you are using a single-type attribute adjustment for attribute pricing. A product has a list price of \$100 with a 50 percent markup on the large size and a \$10 markup for the color gold. The application calculates the price of the product by considering each attribute adjustment in isolation, so the price of the product is $\$100 + (50\% \text{ of } \$100 \text{ for the size large}) + \$10 \text{ (markup for gold color)} = \160 . The application does not consider the sequence in which the adjustments need to be applied.

Order of Conditions and Precedence

In addition, the selection order also determines the relative importance of attributes in case of ties.

If two or more rules in an attribute adjustment are both valid, then the rule with the more explicitly defined attribute values (not blanks) in the left-most columns takes precedence. For example, if there are four fields for each record, and the first two fields of both records match what has been selected, then the engine returns the record that matches the first condition going from left to right. The dimension with least numerical sort order value is processed first.

Order of Conditions and Processing Speed

The left-most condition in each rule has the greatest impact on processing speed. If it does not make a difference in the final price, then follow these general rules to speed processing:

- Give the lowest sort orders to conditions with the most enumerated values.
- Do not give a condition a low sort order if it is flagged as Allow Any.
- Do not give conditions a low sort order if you allow wildcards in the condition.

CAUTION: Pricing administrators are responsible for correctly setting up the sort orders of the dimensions. Any duplicate or blank sort order values for condition dimensions with the Allow Any flag turned on can give unpredictable results.

About Wildcards in Attribute Adjustments

Selecting the Allow Any check box in a Dimension record lets you enter a blank instead of entering every different domain value for that dimension. This blank is called a *null value wildcard*. It represents all possible values in the given attribute’s domain.

For example, you sell T-shirts that come in the colors white, gray, and red, and also come in the sizes small, medium, large, and extra-large, with the pricing shown in [Table 8](#).

Table 8. Attribute Pricing for Each Combination of Attributes

Color	Size	Adjustment Type	Adjustment Amount
Red	Small	Markup Amount	\$2.00
Red	Medium	Markup Amount	\$2.00
Red	Large	Markup Amount	\$2.00
Red	Extra-Large	Markup Amount	\$5.00

There is no markup for any color except red. The red T-shirts are marked up \$2, except for the extra-large size, which is marked up \$5. Instead of the long list shown in Table 8, you can represent this with the short list shown in Table 9.

Table 9. Attribute Pricing Using a Null Wildcard

Color	Size	Adjustment Type	Adjustment Amount
Red	Not applicable	Markup Amount	\$2.00
Red	Extra Large	Markup Amount	\$5.00

In Table 9, the first row represents all the colors except red, and the second row represents all the sizes of red except extra-large.

The null value wildcard can reduce the work of creating a large attribute pricing table, but be careful to avoid the problems that it can create:

- If you are using the attribute adjustment for attribute pricing, then you may mistakenly enter wildcards that allow the user to choose invalid combinations of products.
- You may also mistakenly create several rules that represent the same combination of condition dimensions. Make sure that every combination of condition tables is unique.

If you do create several rules that represent the same combination of condition dimensions, then the application uses the rule with the most exact matches (not blanks) in the condition dimensions as the highest priority for processing. Priority is specified using the Sort Order field of the dimension.

Avoid using null value wildcards in the columns with the highest priority for processing. This increases the processing task for Siebel Pricer and causes the processing to take longer.

NOTE: If you use wildcards, then it is especially important to test your results after creating the attribute pricing table.

Preventing Users from Selecting Invalid Combinations of Attributes

You can select the Display Error check box in the Attribute Adjustment record to prevent users from selecting combinations of attributes that are not valid. Use this field judiciously, and not as a mechanism to enforce product configuration or other business rules. Attribute adjustments are primarily meant for pricing.

For example, if a product's large version comes in every color except green, you could use this option to display an error message if the user chooses both large and green.

If you select this option, then you must create a Rule record in the attribute adjustment representing every valid combination of attributes, even if the combination has zero effect on pricing. The application displays an error message if the user selects a combination of attributes that is not represented by a rule. For example, even if gold is the only color that requires a price markup, you will have to add Rule records for all the colors that the user can select. If there are 100 combinations of other attributes, and 10 possible colors, then you may have to create 1000 Rule records, even if only one color affects pricing (though you may be able to reduce the number using wildcards).

NOTE: If your deployment does not use the Display Error option, then you can remove the steps in the Dynamic Pricing Procedure that enforce the validity of the attribute combinations. These are the Invalid Combination Decision step and the Display Invalid Combination Error step. Removing these steps reduces processing time for the pricing. For more information about this pricing procedure, see [“Pricing Procedures and Workflow References”](#) on page 213.

To decide whether to use this option, weigh its benefits against its costs. There is a benefit to preventing users from choosing invalid combinations of attributes. However, the added administrative cost is high because there are many combinations of attributes that do not affect pricing.

If you select the Display Error option, then you must create a pricing adjustment item representing every valid combination of attribute values, but you must not create a pricing adjustment item for any invalid combination of attribute values. To create the correct pricing adjustment items, use one of the following two features of Siebel Pricer:

- **Wildcards.** If you select the Allow Any check box, then you can create adjustment items with null value wildcards that accommodate many dimension domain combinations, so you can use fewer adjustment items to represent all valid combinations. Wildcards may allow you to create rules representing every valid combination of attributes without entering a separate rule for each combination of attributes. For more information, see [“About Wildcards in Attribute Adjustments”](#) on page 161.
- **Generate Rules button in the Conditions view.** Use this button to automatically generate a full set of records for all possible combinations of values of attributes that affect pricing. You can delete the records that do not impact pricing and those that represent an invalid combination of attributes. After Rule records are generated, you must enter the adjustments. If any combinations of attributes are invalid, then you must delete those rules. For more information, see [“Adding Attribute Adjustment Conditions”](#) on page 170.

NOTE: If you select the Display Error option, then make sure that the default attributes for the product are a valid attribute pricing combination. If it is not a valid combination, then your Siebel application will not add the product when users click the Add Item button to add this product to a quote. Users will think that the Add Item button is not working.

It may be easier to use the Adjustment Item Generator to generate all possible attribute value combinations, each in its own adjustment item, than to use null value wildcards. To help make the decision, consider the following:

- If you use the Adjustment Item Generator, then you must do the extra administrative work of entering adjustment types and adjustment values in each record. This could involve much more work than using null value wildcards, if many combinations of attributes have the same price adjustment.

- If you use null value wildcards, then you may have a difficult conceptual task of analyzing the combinations of attributes to decide where you can use wildcards.
- If you choose the Display Error option, then you cannot use a null value wildcard for an attribute if that attribute is not always available. For example, if the extra-large size is available in all colors except gray, then you cannot create an adjustment item with the null value wildcard for both color and size (as in the previous example). If you create this adjustment value, then an error message is not generated when the user chooses extra-large and gray.

Zero-Effect Adjustment Items

If you choose the Display Error option, then you must create Rule records representing every valid combination of attributes, even if they have no effect on pricing. Even if you do not choose this option, you may want to create zero-effect rule records for the following reasons:

- To make the attribute adjustments easier to maintain. If a pricing attribute is not represented in the Rules list, then it can be difficult or impossible to add it later and integrate it with the rules already in the list.
- To create a comprehensive, well-structured set of rules. If a Rules list has a structured place for everything, then it can be easier to work with, even if it has items with zero effect.

Process of Creating an Attribute Adjustment

To create attribute adjustments, perform the following tasks:

- 1 [“Adding an Attribute Adjustment Record” on page 165](#)
- 2 [“Specifying Attribute Adjustment Dimensions and Domains” on page 166](#)
- 3 [“Adding Attribute Adjustment Conditions” on page 170](#)
- 4 [“Associating Attribute Adjustments with Price List Line Items” on page 170](#)

NOTE: Before you can perform this process, you must set up the appropriate variable maps, as described in [“Variable Maps in Attribute Adjustments” on page 156](#).

Adding an Attribute Adjustment Record

This task is a step in [“Process of Creating an Attribute Adjustment” on page 165](#).

The Attribute Adjustment record holds general information about the attribute adjustment.

To add an attribute adjustment record

- 1 Navigate to the Administration - Pricing screen, then Attribute Adjustments view.
- 2 In the Attribute Adjustments list, add a new record and complete the necessary fields.

Some fields are described in the following table:

Field	Comments
Name	Enter a name for the attribute adjustment.
Class	<p>If product attributes affect the price, then select the class where these attributes are defined.</p> <p>NOTE: If you are setting up attribute adjustments based on nonproduct attributes such as Account Type, Region, and so on, then leave this field blank.</p>
Type	<p>Select the type of the adjustment. options are as follows:</p> <ul style="list-style-type: none"> ■ Single. Each attribute (condition dimension) affects the price in isolation from the others. ■ Multiple. The price adjustment depends on a combination of attributes (condition dimensions). <p>For more information, see “Single and Multiple Type Attribute Adjustments” on page 159.</p>

Field	Comments
Display Error	<p>Select this check box if you want the application to display an error message when a user selects an invalid combination of attributes for the attribute pricing. The combination is considered invalid if it is not included in the list of rules. For more information about how to use this field, see “Preventing Users from Selecting Invalid Combinations of Attributes” on page 162.</p> <p>NOTE: This field is used only for attribute pricing. Do not select it if you are using attribute adjustment for some advanced use instead of for attribute pricing.</p>
Effective From and Effective To	Enter the start date and end date of the time period when this attribute adjustment is active.

Specifying Attribute Adjustment Dimensions and Domains

This task is a step in [“Process of Creating an Attribute Adjustment”](#) on page 165.

You must enter the dimensions of the attribute adjustment, which are used as the columns of the rules tables. There are two types of dimensions:

- **Condition dimensions.** These are the dimensions that affect the price of a product. They determine the conditions under which the adjustment is applied. Create one condition dimension for each attribute that impacts the price of a product.
- **Result dimensions.** These are the outputs of the attribute adjustment tables. When you click the Create Result Dimensions button, the application automatically creates the two result dimensions, Adjustment Type and Adjustment Amount.

Optionally, if you want to automatically generate rule records, then you can enter the domain of each dimension, which is all the possible values of that dimension.

Dimension domains can have multiple sources:

- **List of values (LOV).** Enter the LOV Name.
- **Business component field values.** Enter the Business Object, Business Component, Field, and Search Specification.
- **User defined.** Manually enter all the values in the domain.
- **Attribute values.** Enter the name of the attribute.

When you define domains, you also specify whether values other than those included in the domain can be added to the rules list.

CAUTION: If you change the source of the dimension by modifying the variable map type, then the Domain Type field, or making modifications in some other way, you must click the Create Domain button to regenerate the domain, and you must modify the rules (Conditions view) that have been set up so that the old domain values for a dimension are no longer used.

To specify attribute adjustment dimensions and their domains

- 1 Navigate to the Administration - Pricing screen, then Attribute Adjustments view.
- 2 In the Attribute Adjustments list, select the attribute adjustment whose dimensions you are specifying.
- 3 In the More Info view, click Create Result Dimensions.
- 4 Click the Dimensions view tab.
- 5 Add a record for each dimension that affects the price and complete the necessary fields, as described in the following table:

NOTE: The Adjustment Amount and Adjustment Type dimensions were added automatically when you clicked Create Result Dimensions.

Field	Comments
Dimension Type	Select the type of the dimension. The options are Condition and Result, as described in "Dimensions in Attribute Adjustments" on page 155.
Name	Enter the name of the dimension to specify the column name in the Rules list. NOTE: The name of the dimension can be different from the field name it maps to. For example, the dimension Product Color can map to the product attribute Color.
Operator	If this is a condition dimension, then select the operator that you want to use to compare it with a value. For example, if you want to create the rule Size = XL, and if this record is the Size dimension, then you must select the equal operator (=). For more information, see "How Attribute Adjustments Apply Rules" on page 158.
Variable Map Type	Use this field for condition dimensions only. Select the type of the variable map, which determines the hierarchical level (header, line item or XA) of the contextual variable: <ul style="list-style-type: none"> ■ To map a dimension based on a field from Order Header, such as Order Status, use Context as the type. ■ To map a dimension based on a Line Item such as Product Line, use Row as the type. ■ To map dimensions based on product attributes, use XA as the type. For more information, see "Variable Maps in Attribute Adjustments" on page 156.

Field	Comments
Variable Name	<p>For dimensions with Row or Context variable map type, select the name of the variable from the variable map to map the dimension to it.</p> <p>Do not use for dimensions that are mapped to product attributes (variable map type - XA). For more information, see “Variable Maps in Attribute Adjustments” on page 156.</p>
Data Type	Select the data type of this dimension.
Domain Type	<p>Select the source of the domain for a dimension. The options are as follows:</p> <ul style="list-style-type: none"> ■ Attribute. These are the values of an attribute that you want to use as the dimension domain. Any dimension that is associated with an XA variable map type automatically has Attribute as its domain type. ■ Business component. These are the values in a business component field that you want to use as the dimension domain. ■ LOV. These are the values in a list of values that you want to use as the dimension domain. ■ User defined. You will determine the dimension domain manually by adding new records to the Domain list.
Bounded	Select this check box to restrict the values used for this dimension in the rules. If you select this check box, then only the values listed in the domain of this dimension can be used in rules. If you do not select the check box, then any values can be used in rules.
Allow Any	Select this check box to allow any values to be entered for this dimension in rules.
Business Object, Business Component, Field, Search Spec	<p>This field applies only if you selected Business Component in the Domain Type field. To create the domain for the dimension, specify the business component field you must use along with the Business Object, Business Component, and a Search Spec. The Business Component has the field whose values are used for the domain. The Search Spec is used to limit which values from the field you want to use as the domain. After you enter values in these fields, click the Create Domain button to enter the values from the field in the Domain list.</p> <p>NOTE: To avoid poor performance, be sure to enter a Search Spec or the application may take a long time to generate all the domain records.</p>
Attribute	If you want to base the domain on the values of an attribute, then select the attribute. After you enter an attribute here, you can click the Create Domain button to enter all the values of this attribute in the Domain list.

Field	Comments
LOV	If you want to base the domain on the values in a list of values (LOV), then select the LOV. After you select an LOV here, you can click the Create Domain button to enter all the values of this LOV in the Domain list.
Sort Order	<p>Enter the number specifying where this dimension appears in the rules list. For example, if you want this to be the first column in the rules list, then enter 1.</p> <p>This field determines the priority of this rule when the application performs a lookup against the rules table. For more information, see “How Attribute Adjustments Apply Rules” on page 158.</p>
Sort Method	Select Ascending to display the dimensions in the order specified in the Sort Order field, or select Descending to display the dimensions in the reverse order. For more information, see “How Attribute Adjustments Apply Rules” on page 158 .
Translate	<p>This boolean flag is used for multi-lingual deployments. Out of the box, this flag is hidden in the Dimensions list and needs to be exposed if it is required for usage. This flag is used only for dimensions of the data type String that are based on domains Attribute and LOV.</p> <p>When checked, the application stores internally the Language Independent Code of the domain value.</p> <p>NOTE: Use the Translate flag only in multi-lingual deployments. Do not use for deployments that are not multi-lingual.</p>

- 6 If you selected User Defined in the Domain Type field, then you must enter the domain for this dimension manually as follows:
 - a In the Dimensions list, select the record.
 - b In the Domain list, add records and enter all possible values for the selected dimension.
- 7 If you selected Attribute, Business Component or LOV in the Domain Type field, then to generate values for domains, click Create Domain.

Adding Attribute Adjustment Conditions

This task is a step in [“Process of Creating an Attribute Adjustment” on page 165](#).

After you have set up the dimensions of the attribute adjustment, you can add conditions, which are the rules that state the result of the adjustment for each combination of condition dimensions.

To add attribute adjustment conditions

- 1 Navigate to the Administration - Pricing screen, then Attribute Adjustments view.
- 2 In the Attribute Adjustments list, select the attribute adjustment whose rules you are specifying.
- 3 Click the Conditions view tab.
The conditions list appears, with a Name column for the name of each condition.
- 4 If all domain values of each dimension impact price, then you can generate rules as follows:
 - a In the Attribute Adjustment form, click Generate Rules.
Records are added to the Rules list with every possible combination of domain values of the condition dimensions domains.
 - b Enter the Adjustment Type and Adjustment Value for each record in the Rules list.
- 5 If you are entering rules manually, then:
 - a In the Attribute Adjustment form, click New.
 - b In the new record, enter one possible value of the condition dimensions, and enter values in the Adjustment Type and Adjustment Amount columns to specify the result for that combination of conditions.
 - c Continue to add new records until you have entered all the necessary rules.

Associating Attribute Adjustments with Price List Line Items

This task is a step in [“Process of Creating an Attribute Adjustment” on page 165](#).

To apply adjustments to a product, you associate the attribute adjustment with the product in a price list line item. The attribute adjustments apply to all customers who use this price list.

To associate attribute adjustments with price list line items

- 1 Navigate to the Administration - Pricing screen, then Price Lists view.
- 2 In the Price Lists list, select the appropriate price list.
- 3 Click the Price List Line Items view tab.
- 4 In the Price List Line Items list, find the record for the appropriate price list and in the Attribute Adjustments field, select the attribute adjustment.

Example of Creating an Attribute Adjustment Based on Product Attributes

This topic gives one example of how to create attribute-based pricing based on product attributes. You may use this feature differently, depending on your business model.

In this example, adjustments are applied to the price of automobiles based on two attributes:

- Interior color has the possible values red, green, and blue.
- Transmission has the possible values automatic and manual.

Because of current market and inventory conditions, you want to create the three price adjustments shown in [Table 10](#). These price adjustments will apply only to vans sold to retail customers.

Table 10. Attribute-Based Price Adjustments in the Example

Interior Color	Transmission	Adjustment Type	Adjustment Amount
Green	Automatic	% Discount	\$10
Red	Manual	% Markup	\$10
Blue	Manual	Price Override	\$22,000

This example assumes that you have already created the class Horizon Autos, the product Van, and the price list Retail. For information about creating classes and products, see *Siebel Product Administration Guide*. For information about creating price lists, see [Chapter 3, "Creating and Assigning Price Lists."](#) This example also assumes that you have set up variable maps, as described in ["Variable Maps in Attribute Adjustments"](#) on page 156.

Creating the Attribute Adjustment Record

First, create the Attribute Adjustment record. The type must be multiple, because the price adjustments depend on more than one attribute. It must be associated with the class Horizon Autos, which includes these attributes.

To create the attribute adjustment record

- 1 Navigate to the Administration - Pricing screen, then Attribute Adjustments view.
- 2 In the Attribute Adjustments list, add a new record and complete the necessary fields.

Some fields are described in the following table:

Field	Value
Name	Horizon Autos Retail Van Adjustments
Class	Horizon Autos
Type	Multiple Dimension

Specifying Dimensions and Domains

Next, set up the dimensions that you want to use in the attribute adjustments. You must add two condition dimensions for the attributes that are the basis of price adjustments (Interior Color and Transmission).

You must also add two result dimensions that determine the amount of the price adjustment (Adjustment Amount and Adjustment Type), which are added automatically when you click Create Result Dimensions.

You also enter the domains for each of these dimensions, and you select the Bounded check box in the Dimension records. This controls data entry in the Rules list, so only valid values can be entered in the columns for these dimensions.

Use the following procedure to specify the result dimensions and their domains.

To specify the result dimensions and their domains

- 1 In the Attribute Adjustments list, click Create Result Dimensions.
- 2 Click the Pricing Dimensions view tab.
Records have already been added to the Dimensions list for the two result dimensions, Adjustment Amount and Adjustment Type.
- 3 In the Pricing Dimensions list, select the record for adjustment type, and click Create Domain.
Records are added to the Domain list for the five possible values of adjustment type.

Specifying Condition Dimensions and Domains

Use the following procedure to specify the condition dimensions and their domains.

To specify the condition dimensions and their domains

- 1 Add a record to the Dimensions list to represent the Interior Color attribute and complete the necessary fields, as described in the following table:

Field	Value
Dimension Type	Condition
Name	Int Color
Operator	=
Variable Map Type	XA
Data Type	Text
Domain Type	Attribute
Bounded	Y
Attribute	Interior Color

Field	Value
Sort Order	1
Sort Method	Ascending

- Click Create Domain.

The three values for this domain (red, blue, and green) appear in the Domain list.

- Add a record to the Dimensions list to represent the Transmission attribute and complete the necessary fields, as described in the following table:

Field	Value
Dimension Type	Condition
Name	Transmission
Operator	=
Variable Map Type	XA
Data Type	Text
Domain Type	Attribute
Bounded	Y
Attribute	Transmission
Sort Order	2
Sort Method	Ascending

- Click Create Domain.

The two values for this domain (automatic and manual) appear in the Domain list.

Adding Pricing Conditions

After you have set up the dimensions of the attribute adjustment, you can add conditions. The Conditions list has a column for each of the dimensions that you created.

Because you are creating conditions for only three price adjustments, you add the Conditions records manually instead of using the Generate Rules button.

To add pricing conditions

- Click the Conditions view tab.
- Add a record to the Conditions list and complete the necessary fields, as described in the following table:

Field	Value
Sequence	1
Int Color	Green
Transmission	Automatic
Adjustment Type	% Discount
Adjustment Amount	10

- 3 Add a second record to the Conditions list and complete the necessary fields, as described in the following table:

Field	Value
Sequence	2
Int Color	Red
Transmission	Manual
Adjustment Type	% Markup
Adjustment Amount	10

- 4 Add a third record to the Conditions list and complete the necessary fields, as described in the following table:

Field	Value
Sequence	3
Int Color	Blue
Transmission	Manual
Adjustment Type	Price Override
Adjustment Amount	22,000

Associating the Attribute Adjustment with a Product and Price List

After you have created the attribute pricing conditions, you must associate them with a product on a price list to make them effective. These conditions apply to vans sold to retail customers.

To associate the attribute adjustment with a product and price list

- 1 Navigate to the Administration - Pricing screen, then Price Lists view.
- 2 In the Price Lists list, select the record for the price list named Retail.
- 3 Click the Price List Line Items view tab.

- 4 In the Price List Line Items list, in the record for the product named Van, in the Attribute Adjustment field, select Horizon Autos Retail Van Adjustments.

Example of Creating an Attribute Adjustment with Nonproduct Attributes

This topic gives one example of how to create attribute-based pricing with nonproduct attributes. You may use this feature differently, depending on your business model.

In this example, adjustments are applied to the price of automobiles based on three attributes in three different business components:

- **Transmission.** This is a product attribute that has the possible values Automatic and Manual.
- **Account Type.** This is a header field that has the possible values Customer, Commercial, and Partner.
- **Quantity.** This is a line item field that can have any numeric value.

This example creates three possible adjustments based on these attributes:

- All vans (a product) ordered for a commercial account with manual transmission and a quantity greater than 20 will be priced at \$18,000 (price override).
- All vans ordered for a customer account with manual transmission and a quantity greater than 15 will be marked up by 10% (% Markup).
- All vans ordered for a partner account with automatic transmission and a quantity greater than 10 will be discounted by 10% (% Discount).

All these discounts apply to the price list named Americas Price List.

This example assumes that you have already created the class Horizon Autos, the product Van, and the price list Americas Price List. For information about creating classes and products, see *Siebel Product Administration Guide*. For information about creating price lists, see [Chapter 3, "Creating and Assigning Price Lists."](#)

Modifying the Variable Map

First, you must modify the variable map Default Pricing Variable Map - Context, so Account Type is defined as a variable in this map. Do this only if Account Type is not already defined as a variable in the map.

To modify the variable map

- 1 Navigate to the Administration - Order Management screen, then Variable Maps view.
- 2 Select and lock the variable map Default Pricing Variable Map - Context.
- 3 In the Versions list, click Workspace.

Details of the new version of the variable map appear.

- 4 In the Variable Definitions list, add a new record and complete the necessary fields.
Some fields are shown in the following table:

Field	Value
Variable Name	Account Type
In/Out	In
Type	Text
On Null	Ignore

- 5 In the Variable Sources list, specify the source of the new variable, as shown in the following table:

Field	Value
Mode	Any
Path	\$Current/Header/Account Type
Source Type	Instance

- 6 Restart the client application to make sure that the variable map changes are available.

Creating the Attribute Adjustment Record

The type of the Attribute Adjustment record must be multiple, because the price adjustments depend on more than one attribute. The type must be associated with the class Horizon Autos, which includes these attributes.

To create the attribute adjustment record

- 1 Navigate to the Administration - Pricing screen, then Attribute Adjustments view.
- 2 In the Attribute Adjustments list, add a new record and complete the necessary fields.

Some fields are described in the following table:

Field	Value
Name	Horizon Autos
Class	Horizon Autos
Type	Multiple Dimension

Specifying Dimensions and Domains

Next, set up the dimensions that you want to use in the attribute adjustments. You must add three condition dimensions for the attributes that are the basis of price adjustments (Transmission, Account Type, and Quantity).

Also, you must add two result dimensions that determine the amount of the price adjustment (Adjustment Amount and Adjustment Type), which are added automatically when you click Create Result Dimensions.

You also enter the domains for each of these dimensions. Select the Bounded check box in the Dimension records to control data entry in the Rules list, so only valid values can be entered in the columns for these dimensions.

To specify the result dimensions and their domains

- 1 In the Attribute Adjustments list, click Create Result Dimensions.
- 2 Click the Pricing Dimensions view tab.

Records have already been added to the Dimensions list for the two result dimensions, Adjustment Amount and Adjustment Type.

- 3 Add a record to the Dimensions list to represent the Transmission attribute and complete the necessary fields, as described in the following table:

Field	Value
Dimension Type	Condition
Name	Transmission
Operator	=
Variable Map Type	XA
Data Type	Text
Domain Type	Attribute
Bounded	Y
Attribute	Transmission
Sort Order	1
Sort Method	Ascending

- 4 Click Create Domain.

The two values for this domain (automatic and manual) appear in the Domain list.

- 5 Add a record to the Dimensions list to represent the Account Type attribute and complete the necessary fields, as described in the following table:

Field	Value
Dimension Type	Condition
Name	Act Type
Operator	=
Variable Map Type	Context
Data Type	Text
Domain Type	Business Component
Bounded	Y
Business Object	List of Values
Sort Order	2
Sort Method	Ascending
Business Component	List of Values
Field	Value
Search Spec	[Type] = "ACCOUNT_TYPE"

NOTE: In this example, Business Component is used as the domain for setting up the Act Type dimension. However, a better way to define the domain in practice would be to use LOV with the value ACCOUNT_TYPE in the LOV field.

- 6 Click Create Domain.

The values for this domain appear in the Domain list.

- 7 Add a record to the Dimensions list to represent the Quantity attribute and complete the necessary fields, as described in the following table:

Field	Value
Dimension Type	Condition
Name	Quantity
Operator	<
Variable Map Type	Row
Data Type	Number
Domain Type	User Defined
Bounded	Y
Sort Order	3

Field	Value
Sort Method	Ascending

- 8 Because Quantity has a user-defined domain, create its domain manually by adding records to the Domains list as follows:
- a Add a record to the Domains list and complete the necessary fields, as described in the following table:

Field	Value
Sequence	1
Domain	10

- b Add another record to the Domains list and complete the necessary fields, as described in the following table:

Field	Value
Sequence	2
Domain	15

- c Add another record to the Domains list and complete the necessary fields, as described in the following table:

Field	Value
Sequence	3
Domain	20

Adding Pricing Conditions

After you have set up the dimensions of the attribute adjustment, you can add conditions. The Conditions list has a column for each of the dimensions that you created.

In this example, you add the Conditions records manually instead of using the Generate Rules button.

To add pricing conditions

- 1 Click the Conditions view tab.
- 2 Add a record to the Conditions list and complete the necessary fields, as described in the following table:

Field	Value
Sequence	1
Transmission	Manual
Act Type [=]	Commercial
Quantity [<]	20
Adjustment Type	Price Override
Adjustment Amount	18,000

- 3 Add a second record to the Conditions list and complete the necessary fields, as described in the following table:

Field	Value
Sequence	2
Transmission	Manual
Act Type [=]	Customer
Quantity [<]	15
Adjustment Type	% Markup
Adjustment Amount	10

- 4 Add a third record to the Conditions list and complete the necessary fields, as described in the following table.

Field	Value
Sequence	3
Transmission	Automatic
Act Type [=]	Partner
Quantity [<]	10
Adjustment Type	% Discount
Adjustment Amount	10

Associating the Attribute Adjustment with a Product and Price List

After you have completed setting up the attribute adjustments, you must associate them with a product on a price list to make them effective. These conditions apply to the product named Van and to the price list named Americas Price List.

To associate the attribute adjustment with a product and price list

- 1 Navigate to the Administration - Pricing screen, then Price Lists view.
- 2 In the Price Lists list, select the record for the price list named Americas Price List.
- 3 Click the Price List Line Items view tab.
- 4 In the Price List Line Items list, find the record for the product named Van and in the Attribute Adjustment field, select Horizon Autos.

Testing the Attribute Adjustments

You can test the attribute adjustments for three different account types. This example assumes that you have created the following accounts:

- **ABC.** Account Type = Customer.
- **XYZ.** Account Type = Commercial.
- **123.** Account Type = Partner.

To test the attribute adjustments

- 1 In the Quotes screen, create a new quote with price list Americas Price List and account ABC (Account Type = Customer).
- 2 Add the product Van as a line item of the quote.
- 3 Set the attribute Transmission to Manual as follows:
 - a Click Customize to launch Configurator.
 - b In Configurator, set the attribute Transmission to Manual.
 - c Click Done to exit from Configurator.
- 4 For the quantity of the product Van, enter 16.
The net price of the product Van is marked up by 10%.
- 5 Click the Net Price field to display the pricing waterfall, to view this adjustment.
- 6 Test the second attribute adjustment as follows:
 - a In the Quote, change the account to XYZ (Account Type = Commercial).
 - b In the line item, change the product quantity to 21.
The net price of the product Van is \$18,000.
- 7 Test the third attribute adjustment as follows:
 - a In the Quote, change the account to 123 (Account Type = Partner).
 - b Click Customize and use Configurator to change the value of the attribute Transmission to Automatic.
 - c In the line item, change the product quantity to 11.
The net price of the product Van is discounted by 10%.

Guidelines for Creating Attribute Adjustments

This topic provides guidelines for creating attribute adjustments. Use attribute adjustments in cases where:

- The values of the variables that are used to determine the results are not known ahead of time.
- Integrations to external applications are secondary criteria.
- There is a small number of total rules, in the thousands at the most.

Use Sort Order to Improve Performance

You can use the Sort Order and Sort Method fields of the Dimensions record to specify the order in which attributes are processed. For information about how this affects performance, see [“Order of Conditions in Multiple-Condition Pricing Tables” on page 160](#).

Use Nonequality Operators to Improve Performance

You can reduce the number of rules required by using the nonequality comparison operators to limit the size of the rules table, when possible. For example, if any shirt that is of length 40 or smaller receives a 10% discount, then you can set up a condition dimension for the Length attribute with greater than (>) operator to set up the price adjustment rule. For more information, see [“Adding Attribute Adjustment Conditions” on page 170](#).

CAUTION: Make sure that the attribute adjustment is set up so that the attribute adjustment returns only one record. When nonequality operators are used, the attribute adjustment may return more than one record. Pricing administrators are responsible for setting up the dimensions in the appropriate way or setting up the pricing procedure to handle multiple matches.

Using wildcards does not improve performance, but it does decrease the number of records in the rules table.

Numeric Dimensions and Operators

If a condition dimension is compared with a numeric value using the equal (=) operator, then you can improve performance by setting its data type to text. Property sets can store only text values, and when you use a numeric comparison, there is an overhead to convert the text to numeric values at run time. You must use numeric values for less than (<) or greater than (>) comparisons, but if you are using an equal (=) comparison operator, then you will get the same result whether the data is numeric or text.

Comparison Operators

When the rules in attribute adjustments use comparison operators such as the greater than (>) and less than (<) operators:

- The data types of the condition dimensions must be number or date.
- Pay special attention to the following:

- Whether the rule must act on all the rows of data when you enter the values that the conditions must match
- The Sort Order properties of the dimensions. Blanking out or duplicating the sort order will give undefined results.
- The Sort Order and Sort Method fields of the dimensions. These fields determine the order in which the rules are processed, and you must select values that minimize the number of records that must be processed.

How the Pricing Procedure Uses Attribute Adjustments

After an attribute adjustment is set up, the pricing procedure must perform a lookup against it in the pricing procedure so that adjustments can be applied at run time. For more information about the pricing procedure, see [“Pricing Procedures and Workflow References” on page 213](#).

The pricing procedure does this lookup using the Attribute Adjustment step, which invokes the Dynamic Lookup Transform. For more information about the Dynamic Lookup Transform, see *Siebel Order Management Infrastructure Guide*.

Upgrade Considerations for Attribute Adjustments

When you upgrade from earlier versions of Siebel applications to version 7.8 or later, use the On First Match (Action) argument of the Dynamic Lookup Transform. This argument makes attribute pricing that is defined in the Attribute Adjustments list in version 7.8 or later work the same way as attribute-based pricing feature in earlier versions.

Without configuration, the pricing procedure provides the same functionality as in the earlier release.

The Attribute Adjustments list can return multiple rows. The first row it returns will always be consistent with attribute pricing behavior in earlier versions. Using On Match arguments can return results that are not consistent with the behavior of versions earlier than 7.8.

12 Setting Up Pricing for Products with Components

This chapter describes pricing for products with components. It instructs you on viewing a product's components and setting up component-based pricing. It also covers the processing order of price adjustments for products with components. This chapter covers the following topics:

- ["About Component-Based Pricing" on page 185](#)
- ["Impact of Product Versions and Price List Line Item Effectivity on Component-Based Pricing" on page 186](#)
- ["Viewing a Product's Components in the Pricing Designer" on page 187](#)
- ["About Setting Up Component-Based Pricing" on page 188](#)
- ["Viewing and Changing the Reference Price" on page 191](#)
- ["Defining a Relationship-Based Price Adjustment" on page 195](#)
- ["Verifying Component Prices Across Time Intervals" on page 196](#)

About Component-Based Pricing

Products with components include components that are themselves products in the product table. For example, if you sell computer monitors, CD-ROMs, and disk drives, then you also sell several models of desktop computer that include these products as components.

This chapter explains how to set up pricing for products with components, as follows:

- **View a product in the Pricing Designer.** You can use the Pricing Designer to view a product's components and for the other functionality described in this chapter.
- **Set up component-based pricing.** You set up pricing so the total price of a product either equals a base price plus the price of optional components, or equals the total price of all components.
- **Create relation-based price adjustments.** You can give customers discounts if they buy components as part of a specific product package. These are called relation-based price adjustments.

This chapter assumes that you have background knowledge about products with components. For more information about products with components, see *Siebel Product Administration Guide*.

If you create several types of price adjustments for products with components, then the order in which price adjustments are processed can affect the final price. For more information, see ["About the Processing Order of Price Adjustments" on page 15](#).

Impact of Product Versions and Price List Line Item Effectivity on Component-Based Pricing

A product can have multiple released versions with future dates. In addition, price list line items can have effective dates. As a result, the structure of a product can be dynamic over time, because multiple versions of it can exist.

Component-based pricing takes the following into account:

- Both root customizable product and its components can have multiple versions across a time interval.
- Both root customizable product and its components can have multiple entries on a price list for different effective dates.
- The Customizable Product Adjustments (The CP Pricing Designer) can have multiple versions for different effective dates.

This topic discusses some of the ways that multiple product versions and multiple effective dates affect component-based pricing.

Component Product Must Exist on the Price List of a Component-Based Product

If a component-based product does not exist on a price list as of a particular date, then the adjustments to its components are not applied as of that date. For the adjustment to apply to the component product, it must exist on the price list of the component-based product in the same time interval as the adjustment. Consider this example:

- A component-based product, product P, has only one component product, product P1.
- P and P1 have entries in the Price List Line Item list that are shown in [Table 11](#).

Table 11. Price List Line Item Entries in the Example

Product	Start Date	End Date	List Price
P	12/31/2004	04/01/2004	1000
P1	12/31/2003	01/15/2004	100

- Adjustments have been defined for P1 when it is a component of P that are shown in [Table 12](#).

Table 12. Adjustments for P1 in the Example

Adjustment Type	Adjustment Value	Start Date	End Date
Price Override	104	02/05/2004	02/29/2004
Percent Discount	10	03/01/2004	03/31/2004

- In this case, if the product P1 is ordered in the context of the root product P on 02/15/2004, then it will have a zero price. You might expect its price to be 104, based on the price override that is effective on that date, but because product P1 does not have an entry in the price list for the interval 02/05/2004 through 02/29/2004, no price appears on the transaction for it.

This behavior is consistent with the prior releases of Customer Order Management.

NOTE: If a root product with components does not exist on a price list on a given date, then the adjustments to its components are not applied for that date. For example, the adjustments in the CP Pricing Designer might be effective for a specific time interval during which the root product with components might not have an entry in the price list itself. The CP adjustments to the components of the root product with components do not apply during that time interval.

Time Intervals When a Product Is Not Customizable

The price list for a product with components can include a time interval when the product is not customizable. This is possible because a product might not have any structure on a given date, but might have a structure on some other date (specified in a released version with a future date).

In this case, if the user drills down from the price list line item to display the product, then the application displays an error message saying that the customizable product does not have versions in the date range, and that the user must choose an appropriate time interval to set up price adjustments for the product. This means that the customizable product does not have structure at that time. In other words, it does not have component products.

Viewing a Product's Components in the Pricing Designer

You can use the Pricing Designer to display the relationships and components of a product with components. You can query by relationships to look at all the component products available within a specific relationship.

The CP Pricing Designer displays a superset structure of the root product with components. It displays a consolidated view of all the versions of the root product with components that might exist in the price list during a given time interval. Thus, you might see products in a relationship in Pricing Designer that do not exist in the latest released version of the root product with components. They are visible in the pricing designer for the root product with components because they exist in released version of the product with a future date. Therefore, the structure of the root product in the pricing designer may not be identical to the latest released version of the root product. The Pricing Designer is sensitive to the start and end date of the root product with components on the price list, so the content of the Pricing Designer may vary for different time intervals.

To view a product's components in the pricing designer

- 1 Navigate to the Administration - Pricing screen, then Price Lists view.
- 2 In the Price Lists list, select the price list that contains the product.
- 3 Click the Price List Line Items view tab to display the products in the price list.

- 4 In the Price List Line Items list, click the name of the root product with components.

NOTE: The root product with components might have multiple entries on the price list for the different time intervals, so you must pick the root product with components with the appropriate time interval.

The Pricing Designer view appears.

NOTE: Using the New Effective Date button on the Price List Line Item applet for a product with components causes a deep copy that also copies any customizable product adjustments defined for the product. Delete the adjustments that do not apply in the new time interval.

About Setting Up Component-Based Pricing

There are two ways of setting up component-based pricing:

- [“Setting Up Base Pricing for Products With Components.”](#) Use this when products with components share a base configuration. Customers who purchase the base product can customize it by selecting options that are added to the base product.
- [“Setting Up Summation or Rollup Pricing for Products With Components.”](#) Use this when products with components do not share a common base configuration.

Setting Up Base Pricing for Products With Components

Use this pricing method when the user purchases a base product and customizes it by adding options. The total price is the sum of the base price plus the adjusted price of the components. For example, if a car has a base price of \$25,000, then the user can also purchase additional options such as air conditioning, sun roof, and so on. Use the following procedure to set up base pricing for a \$25,000 car.

To set up base pricing

- 1 Set the list price of the car to \$25,000.
- 2 Set the price for all other options and, if necessary, specify that some are default components.

When users configure the product, the price they see is the sum of the base price plus the adjusted price of the default options. If the user adds other options, then the price increases. For example, assume a car has a base price of \$25,000 and includes the following options:

- Chrome Wheels (Default) for \$2000
- Gold Wheels for \$3000

The user sees an initial price of \$27,000 for the car. This is the sum of the base price of the car plus the price of the default chrome wheels. If the user chooses the gold wheels, then the sum is recomputed and the price of the car becomes \$28,000.

An alternate method for setting up base pricing is to:

- Include options in the base price.
- Create price override adjustments for all default options included in the base price that sets their price to zero (0).
- Create a price override adjustment for related nondefault options that sets their price to the difference between the default option and the nondefault option.

In the example, you can use this alternative method to include chrome wheels in the list price of the car by doing the following:

- Set the list price of the car to \$27,000.
- Create a price override to zero (0) for the chrome wheels.
- Create a price override to \$1000 for the gold wheels. This is the price difference between the gold and chrome wheels.

Setting Up Base Pricing for Products with Components

Use the following procedure to set up base pricing for products with components.

To set up base pricing for products with components

- 1 Display the components of the product with components in the Pricing Designer, as described in [“Viewing a Product’s Components in the Pricing Designer” on page 187](#).
- 2 Define relationship-based pricing adjustments, if they are needed, as described in [“Viewing and Changing the Reference Price” on page 191](#).
- 3 In the Price List Item form, go to the List Price field and enter the base price.
- 4 In the Pricing Designer list, select the components. In the Adjustments list, enter price adjustments for each component.
- 5 If you are using the alternative method of setting up base pricing, then enter the necessary price overrides for default components.

Setting Up Summation or Rollup Pricing for Products With Components

Use this pricing method when all of a product’s components are configurable. Although each product has a default configuration, users can select nondefault components instead of the default components.

When you use the Pricing Designer, you must set a list price for the base product of a component-based product and define pricing adjustments on components. The price that is displayed for the user is the sum of the list price and the adjusted price of the default components. This price may display to the user in a quote, agreement, order, the selection pages in a configuration session, or in a catalog.

When you are using summation (or rollup) pricing, there is no base product, so you set the list price of the base product to zero (0). This means that the price the user sees is the sum of the prices of its default components (Quote, Agreement, Order, and configuration selection pages). In an eSales catalog, the user sees a price of 0.

An example would be a desktop computer made up entirely of components that you also sell separately. To set up rollup pricing for quote users you would do the following:

- Set the list price of the desktop computer to 0.
- Set a price for each of the components, and specify which ones are default components.

Because the list price is 0, the default price of the desktop computer is the sum of the prices of its default components. If the user who is configuring the product picks a nondefault component, then the sum is recomputed to include the price of the nondefault component. For example, for a desktop computer, you have entered a list price of 0 and the component pricing adjustments shown in [Table 13](#).

Table 13. Desktop Computer Components

Item	List Price	Adjustment Type	Adjusted Price
1.0 Chassis (default)	\$1200	Price override	\$1000
2.0 Monitor	Not applicable	Not applicable	Not applicable
2.1 Small monitor (default)	\$300	Price override	\$200
2.2 Large monitor	\$400	Price override	\$300

While configuring a quote, users see an initial price of \$1200 for the desktop computer (the sum of the prices of the default chassis and monitor). If the user chooses the large monitor, then the sum is recomputed, and the price of the desktop computer becomes \$1300.

NOTE: The price that is displayed includes any relationship-based pricing adjustments and other adjustments to the price of the components.

To set up rollup pricing for a product with components

- 1 Display the components of the product with components in the Pricing Designer, as described in [“Viewing a Product’s Components in the Pricing Designer” on page 187](#).
- 2 Define relationship-based pricing adjustments, if they are needed, as described in [“Viewing and Changing the Reference Price” on page 191](#).
- 3 Do not enter a price for the root product with components in the Price List line items view.
- 4 Enter prices for all the components.

Viewing and Changing the Reference Price

To give customers an accurate idea of the price they might expect to pay for a component-based product, Siebel Pricer calculates a reference price, which is the price of the product with its default options. The reference price is displayed to the customer in the Starting At Price field in the product catalog.

For the Starting At Price to function as expected, child components of the product must have a minimum cardinality greater than zero(0) to be reflected in the reference price. If the minimum cardinality is not set for a child component, then its price is not reflected in the reference price. Any component that is part of the default instance is used to evaluate the Starting At Price. Out of the box, only products with the price type *one-time* are included in the evaluation of the Starting At Price. Products with price types *recurring* and *usage* are not included.

NOTE: The default instance used for evaluation is based on the most effective applicable version of the component pricing.

Siebel Pricer displays both the list price and the reference price for the component-based product. The list price is the price for the root component. If you click Check Starting At Price, then Siebel Pricer adds the list price and the price of all the default components. This calculation does not include any attribute pricing adjustments that would come from default attributes.

In the catalog, this value is displayed to customers in the Starting At field. This value is displayed only for component-based products.

To change default the reference price, click the Edit button in the top applet. You can then edit the reference price manually.

The value displayed to customers does not change unless the pricing administrator clicks the Check Starting At Price again or overwrites the reference price manually.

NOTE: The reference price is used for products with components, including component-based products and bundles. It does not apply to attribute-based products.

Without configuration, the application executes the Basic Pricing Procedure. However, the Basic Pricing Procedure does *not* execute CP pricing. To be consistent, the Check Starting At Price button calls the same procedure as the run-time application (therefore, without configuration, the Basic Pricing Procedure) to determine the starting price for a customizable product. This ensures that the administrative user sees the same price as the end user.

Customers who have the Dynamic Pricer license and want to use CP Pricing need to enable the Dynamic Pricing Procedure, as detailed in the [“Dynamic Pricing Procedure Workflow” on page 223](#). In this procedure, the customer changes the CalculatePrice_Configurator signal to call the Dynamic Pricing Procedure.

This change ensures that the administrative user will see the effect of CP Price Adjustments in the starting price that is generated by clicking the Check Starting At Price button, and that the end user will see the effect of CP Price Adjustments in the starting price of the CP and its components in the Configurator's running time.

Viewing the Reference Price

Use the following procedure to view the reference price.

To view the reference price

- 1 Navigate to the Administration - Pricing screen, then Price List view.
- 2 In the Names field, select the price list that contains the component-based products.
The Price List Line Item list appears.
- 3 Click on a customizable product name.
A customizable product has a check in the Customizable field.
- 4 In the Price List Item form, click Check Starting At Price.
The reference price is recalculated based on the default components of the product, and the result displays in the Reference Price field.

Exposing the Starting Price At in the Product Catalog

Use the following enhancements to expose the Starting Price At field in the product catalog UI.

- 1 Workflow: In the Basic Pricing Procedure workflow and the Dynamic Pricing Procedure workflow, add the following input argument to the Get List Price step.

Input Argument	Value
On First Match 15	{Row. Reference Price} = {Match. Reference Price}

Then, activate the workflow after the change. For more information about using these workflows, see ["Pricing Procedures and Workflow References."](#)

- 2 Variable Map or Variable Source: In Product Pricing Variable Map - Row Set, and Product Pricing Variable Map - Row Set-Basic, use the following variable definition.

Variable Name	In/Out	Type	On Null
Reference Price	Out	Currency	Ignore

With the new definition, use the following variable sources:

Mode	Path	Source Type
Any	\$/Current/Product/Reference Price	Instance
Favorite	\$/Current/Favorite/Reference Price	Instance

For more information about using variable maps, see *Siebel Order Management Infrastructure Guide*.

- 3 Business Components: Modify the following business components (buscomps).

Business Component	User Property	Change This Value
Quote Catalog Internal Product by Price List Option	PSP: Price Fields	From: List Price, Net Price, Deals To: List Price, Net Price, Reference Price
Quote Catalog Internal Product by Price List Optional 2	PSP: Price Fields	From: List Price, Net Price, Deals To: List Price, Net Price, Reference Price
Quote Catalog Internal Product by Price List Optional - PSS	PSP: Price Fields	From: List Price, Net Price, Deals To: List Price, Net Price, Reference Price

For more information about business components, see *Siebel Order Management Infrastructure Guide*.

- 4 Applets: Update the following applets:

Applet	Change
Quote Catalog Product Form	Change field to Reference Price for control PriceStartingAt
Quote Catalog Product List - Add to Cart	Change field to Reference Price for list column Price Starting At
Sales Order Catalog Product List - Add to Cart	Change field to Reference Price for list column Price Starting At
Service Order Catalog Product List - Add to Cart	Change field to Reference Price for list column Price Starting At
Quote Catalog Product List - MultiSelect Checkbox	Change field to Reference Price for list column Reference Price
Sales Order Catalog Product List - MultiSelect Checkbox	Change field to Reference Price for list column Reference Price
Service Order Catalog Product List - MultiSelect Checkbox	Change field to Reference Price for list column Reference Price

For more information about working with applets, see *Using Siebel Tools*.

5 Integration Objects: Update the following objects:

a Integration Object: ISS Quote

- Integration Component: Internal Product PSP Integration

- Add Integration Component Field:

Name: Reference Price
 Data Type: DTYPE_CURRENCY
 External Name: Reference Price
 XML Tag: ReferencePrice
 Integration Component: Quote Catalog PSP Favorite Item

- Add Integration Component Field:

Name: Reference Price
 Data Type: DTYPE_CURRENCY
 External Name: Reference Price
 XML Tag: ReferencePrice

b Integration Object: ISS Order

- Integration Component: Internal Product PSP Integration

- Add Integration Component Field:

Name: Reference Price
 Data Type: DTYPE_CURRENCY
 External Name: Reference Price
 XML Tag: ReferencePrice
 Integration Component: Quote Catalog PSP Favorite Item

- Add Integration Component Field:

Name: Reference Price
 Data Type: DTYPE_CURRENCY
 External Name: Reference Price
 XML Tag: ReferencePrice

6 Business Components (Buscomp): Update these buscomps with the following information.

Business Component	Change
Quote Catalog PSP Favorite Item	Add a calculated field Reference Price with no Calculated Value and type of DTYPE_CURRENCY.
Internal Product PSP Integration	Add a calculated field Reference Price with no Calculated Value and type of DTYPE_CURRENCY.

Defining a Relationship-Based Price Adjustment

Relationship-based price adjustments let you adjust the price of a product when it is a component of a product with components. For example, you may sell a model of computer monitor for \$300 if the customer buys only the monitor. However, if the customer who is buying one of your desktop computers chooses this monitor model as an option, then you may reduce its price 10 percent from this list price, or you may sell it for \$250.

To create the relationship-based price adjustment, use the Adjustment Type and Adjustment Amount fields for the component.

To define a relationship-based pricing adjustment

- 1 Display the components of the product with components in the Pricing Designer, as described in [“Viewing a Product’s Components in the Pricing Designer” on page 187](#).
- 2 Select the records for any components that require a relationship-based pricing adjustment, add a new record to the Adjustments applet, and enter the values for the fields as described in the following table:

Field	Comments
Adjustment Type	Select the type of price adjustment applied to this product. Options are Discount Amount, % Discount, Markup Amount, % Markup, and Price Override.
Adjustment Value	Enter the value of the Adjustment. How this value is used depends on the selection in the Adjustment Type field: <ul style="list-style-type: none"> ■ Discount amount. The adjustment value is subtracted from the price. ■ % discount. The adjustment value is treated as a percentage, and that percentage of the price is subtracted from the price. ■ Markup amount. The adjustment value is added to the price. ■ % markup. The adjustment value is treated as a percentage, and that percentage of the price is added to the price. ■ Price override. The adjustment value is used as the price, overriding the original price.
Min Price	Enter the minimum price for this product as a component of this customizable product. This may be different from the minimum price of the product when it is purchased separately.
Max Price	Enter the maximum price for this product as a component of this customizable product. This may be different from the maximum price of the product when it is purchased separately.
Start Date	Enter the date when this adjustment becomes effective.

Field	Comments
End Date	Enter the date after which this adjustment is no longer effective.

- 3 Click Verify Adjustments to verify that the component's Reference Price reflects the pricing adjustment.

NOTE: You can modify the relationship-based adjustment by editing the amounts in the Adjustment Type and Adjustment Value fields for the records in the Adjustments applet, and you can delete the relationship-based adjustment by deleting the records in the Adjustments applet.

Verifying Component Prices Across Time Intervals

Products can have multiple versions with different effective dates. For more information, see *Siebel Product Administration Guide*.

Price lists can have multiple line items for the same product, with different effective dates for the price in each line item. For more information, see ["Giving a Product Multiple Prices with Different Effective Dates" on page 32](#).

The structure of a component-based product may change during a time interval, and the prices of the product and its components may change at different dates during this time interval. It may be necessary to apply the component price adjustments to future versions of the component-based product, which has a different structure. For more information, see ["Impact of Product Versions and Price List Line Item Effectivity on Component-Based Pricing" on page 186](#).

When you create a new time interval for a product with components in the Administration - Product screen, the component-product price adjustments are copied to the new time interval. However, these adjustments will apply in run time only if the component-product and its components exist in the price list during that same time interval.

You can click the Verify Adjustments button to display a list of the time intervals that have been defined for products with component prices. Check this list to make sure that component prices have been defined for every time interval.

To verify component prices across time intervals

- 1 Display the components of the product with components in the Pricing Designer, as described in ["Viewing a Product's Components in the Pricing Designer" on page 187](#).
- 2 Select a component in the Pricing Designer list.
- 3 Click Verify Adjustments.

The Reference Prices dialog box appears, listing the Start Date and End Date for all the prices for this product with components. For each time period, it lists the base price and price adjustments, if any.

- 4 Check the Reference Prices list to make sure that there are no time gaps when this product does not have a defined price.

Sample Output of Verifying Component Prices Across Time Intervals

As an example of verifying component prices across time intervals, consider a simple product with components:

- Product A is a product with components.
- Product A1 is a component of product A.

In the price list, Product A1 has the list prices shown in [Table 14](#).

Table 14. List Prices for Product A1 in the Price List

Start Date	End Date	List Price
12/31/04	6/30/05	\$100
7/15/04	12/31/05	\$105

Within Product A, there are the price adjustments for Product A1 shown in [Table 15](#).

Table 15. Price Adjustments for Product A1 Within Product A

Start Date	End Date	Adjustment
1/31/05	6/25/05	10% discount
7/15/04	12/31/05	10% markup

When you click the Verify Adjustments button, the pop-up applet contains the information shown in [Table 16](#).

Table 16. Verify Adjustments Output for Product A1

Start Date	End Date	Adjustment	List Price	Item Price
12/31/04	1/31/05	Not applicable	\$100	\$100
1/31/05	6/25/05	10% discount	\$100	\$90
6/25/05	6/30/05	Not applicable	\$100	\$100
6/30/05	7/15/05	Not applicable	Not applicable	\$0
7/15/05	12/31/05	10% markup	\$105	\$115.50

This pop-up applet shows the gaps in the pricing information. During several time periods, there is no component price adjustment. Between 6/30/05 and 7/15/05, there is no list price, so the item has a price of zero.

13 Creating Pricing Reports

This chapter describes available pricing reports and provides procedures to run, create, and modify pricing reports. This chapter covers the following topics:

- [“About Pricing Reports”](#)
- [“Running Reports” on page 199](#)
- [“About Creating and Modifying Reports” on page 200](#)

About Pricing Reports

Siebel Pricer includes a standard set of predefined reports that supply pricing administrators with fundamental pricing information. You are not limited to using these basic reports. You can create additional reports or modify existing ones.

Running Reports

While you are in a view, click Reports in the toolbar to see a list of the available preconfigured reports for the data in that view. The list specifies which reports are available as Oracle Business Intelligence Publisher reports. From the list you can access individual reports. You can run all the reports in the same way.

To run the price lists report

- 1 Navigate to the screen and view from which you access the report, as specified in the report's description.
- 2 In the application-level menu, click the Reports icon and select the appropriate report.
- 3 In the Reports dialog box, select a report format from the drop-down menu and click Submit. The selected report appears in the format specified.
- 4 You can print a copy of the report.

About Creating and Modifying Reports

You are not limited to working with these standard, predefined reports. The Siebel Pricer reports are part of a large set of Siebel application reports. You can modify these reports or add new reports in the following location:

- **Siebel Tools.** Use this location to define the data exported from the Siebel application to the report, and to attach reports to the Reports menus of specific views.

For information about defining and working with reports, see *Siebel Reports Guide*.

14 Pricing in the Run-Time Application

This chapter covers the ways that pricing affects the run-time application. For more information about how pricing affects quotes and orders, see *Siebel Order Management Guide*. This chapter includes the following topics:

- "Pricing Waterfalls" on page 201
- "Contract-Based Pricing" on page 204
- "Multiple Price Types and Totals" on page 206
- "About Configuring Pricing Fields in Catalog, eSales, and Configurator" on page 207
- "Multiple Currencies in a Quote, Order, or Agreement" on page 207
- "Spread Discount Pricing" on page 208
- "Totaling and Rollups of Pricing" on page 210

Pricing Waterfalls

The final net price that is charged to a customer is usually the result of many pricing adjustments. It begins with the product's list price, and then adjusts the price because of volume discounts, attribute pricing, aggregate discount pricing, manual price adjustments entered by the sales representative, and many other possible types of price adjustments.

The pricing waterfall lets the user see all the steps that went into calculating the net price. It is a list of prices that begins with the list price showing the price adjustments, in the order they were applied, with the price after each adjustment, ending with the final net price.

Pricing waterfalls include any manual price adjustments that the sales representative entered at the time of sale, as well as price adjustments applied by the pricing engine.

The end user displays a pricing waterfall by clicking the net price in any line item of a quote, order, or agreement. A pop-up pricing waterfall applet appears that lists all the steps used to calculate the net price. The fields in each row of the pricing waterfall applet are described in [Table 17](#).

Table 17. Pricing Waterfall Fields

Field	Comment
Adjustment	This field describes the price adjustment for this line, such as manual line item adjustment or volume discount. Alternatively, this field gives the list price or other start price and notes the price list it came from.
Type	This field displays the type of the adjustment. Examples are % Discount, Discount Amount, or Override. The start price is considered an override.

Table 17. Pricing Waterfall Fields

Field	Comment
Amount	This field displays the value used by the adjustment, whose use depends on the adjustment type. For example, if the adjustment type is % Discount, and the Adjustment Amount is 15, then the adjustment is a 15 percent discount. If the adjustment type is Discount Amount, and the Adjustment Amount is 15, then the adjustment is a discount of \$15 (assuming the currency is dollars). If the adjustment type is Override, and the Adjustment Amount is 15, then the adjustment is to replace the price with a price of \$15 (assuming the currency is dollars).
Price	This field displays the current price in each step of the price calculation. In the first row, this is the start price. In the last row, it is the final net price.

Configuring Pricing Waterfalls

To configure the pricing waterfall, you modify the pricing procedure used to display the waterfall. For more information about this pricing procedure and the PSP waterfall business service that it calls, see [Appendix A, "Siebel Pricer Technical Reference."](#) For more information about working with pricing procedures and messages, see *Siebel Order Management Infrastructure Guide*.

This topic gives you general instructions about some common ways of configuring pricing waterfalls.

Configuring a New Pricing Waterfall

Use the following procedure to add a new pricing waterfall.

To configure a new pricing waterfall

- 1 Create a new message type in the Administration - Application screen, Message Type Administration View as follows:
 - You must enter the name and full text of the message.
 - You can add translations for the full text if needed.
- 2 Specify the payload variables that will be substituted in the full text in the Message Type Payload Administration view.
- 3 Add an action to a step in the pricing procedure that creates the waterfall record using the new message type, passing the required payload fields.
- 4 Test the revised pricing procedure.

Adding a New Field to the Pricing Waterfall

You can add a new field to the information in each row of a waterfall. For example, you might want each row to include the approval level that was needed to give the discount in that row.

Use the following procedure to add a new field to the pricing waterfall.

To add a new field to the pricing waterfall

- 1 Edit the pricing procedure and add the new field to actions that generate waterfall output.

For example, to add the approval level as the last column of the waterfall, add it at the end of the standard actions that generate the waterfall, as follows:

```
{Row}. {Net Price Waterfall} += New('Waterfall', [Text] = LookupMessage('Pricer -
Dynamic Matrix Adjustment', [Price Book] = {Match.Price Book}), [Adjustment Type]
= {Match.Adjustment Type}, [Adjustment Amount] = {Match.Adjustment Amount},
[Currency Code] = {Row.Currency Code}, [Price] = {Row.Start Price}, [Approval
Level] = {Match.Approval Level})
```

- 2 Add the new field to the Net Price Waterfall VBC.
- 3 Add the new field to the Net Price Waterfall Pop-up List applet.

Saving Pricing Waterfall Output

In general, the pricing waterfall is generated on demand when the user clicks the Show Details button, instead of being stored in the database. When the record is repriced, the waterfall displays.

You can save the waterfall to the database at any time by selecting a line item, and then clicking the Save Waterfall button in the Line Items list of a quote, order, or agreement. You can also configure the product to invoke the SyncToDB method of the PSP waterfall business service to save the waterfall for an entire document.

However, writing the waterfall to the database can slow performance, so do it only if it is necessary. For example, you might save waterfalls to analyze the discounts you give customers, or to calculate incentive compensation.

To save a pricing waterfall

- 1 Select a line item (for a quote, order, or an agreement).
- 2 Click the Save Waterfall button in the Line Items list.

Configuration for Waterfalls

You must configure the Siebel application to create a user interface for viewing a stored waterfall. For more information about configuring Siebel applications, see *Using Siebel Tools*. For more information about configuring Siebel Pricer, see *Siebel Order Management Infrastructure Guide*.

Contract-Based Pricing

Contract-based pricing is pricing based on an agreement with a customer to give that customer a special price. In Siebel applications, contracts are also called agreements and are managed in the Agreements screen. For general information about working with contracts, see the topic about agreements in *Siebel Field Service Guide*. For more information about contract-based pricing, see the following information:

- [“About Hierarchical Contract-Based Pricing” on page 204](#)
- [“Defining Contract Pricing in the Agreements Screen” on page 204](#)
- [“Defining Contract Pricing in the Discount Matrices View” on page 205](#)
- [“Giving the Customer the Best Entitlement Price” on page 206](#)

About Hierarchical Contract-Based Pricing

You can configure the product to create hierarchical contract-based pricing.

After you have set up hierarchical contract-based pricing, if you give a pricing entitlement to a parent account, then it will be inherited by all its children accounts. If you give a pricing entitlement to a child account, then it will be combined with any entitlements for its parent account.

For example, when you give a global account a 10 percent discount on all surgical products, you also give a local account that is a child of that global account a 10 percent discount on scalpels. When the child account buys scalpels, it has an entitlement for a 19 percent discount, because it inherits a 10 percent discount from its parent account. and also receives a 10 percent discount on the 90 percent of the list price that it must pay after the inherited discount. For more information about configuring the product to create hierarchical contract-based pricing, see *Siebel Order Management Infrastructure Guide*.

Defining Contract Pricing in the Agreements Screen

When you define contract pricing in the Agreements screen, the entitlement must be based on a customer account and on products. You create an agreement with an account, and you define the products for which that account will get special pricing. For more information about other fields in the Agreements screen, see the topic about agreements in *Siebel Field Service Guide*.

To define contract pricing in the Agreements screen

- 1 Navigate to the Agreements screen.
- 2 In the Agreements list, add a new record and complete the necessary fields.
In the Account field, select the account for the customer who receives special pricing.
- 3 Click the Entitlements view tab.
- 4 In the Entitlements list, add a new record and complete the necessary fields.
In the Type field, select Pricing.

- 5 Click the Price Details view tab, which is beneath the Entitlement list.
- 6 Add one or more new records to the Price Details list and complete the necessary fields. Some fields are described in the following table:

Field	Comments
Product	Select the product for which this account gets a special price.
Target Price	Select the base price to which this special price is applied.
Type of Calculation	Select the type of special discount that this account receives. Options are Discount Amount, % Discount, Markup Amount, % Markup, and Price Override.
Adjustment Value	Select the value used by the calculation. How this value is used depends on the selection in the Type of Calculation field: <ul style="list-style-type: none"> ■ Discount Amount. The value is subtracted from the target price. ■ % Discount. The value is treated as a percentage, and that percentage is subtracted from the target price. ■ Markup Amount. The value is added to the target price. ■ % Markup. The value is treated as a percentage, and that percentage is added to the target price. ■ Price Override. The value replaces the target price.

Defining Contract Pricing in the Discount Matrices View

Discount matrices allow you to manage pricing entitlements for products or groups of products in one view.

For more detailed information about creating a discount matrix, see [Chapter 10, "Creating Discount Matrices."](#)

To define contract pricing in the Discount Matrices view

- 1 Navigate to the Administration - Pricing screen, then Discount Matrices view.
- 2 Add a new record to the Discount Matrices list and complete the necessary fields.
In the Discount Matrix Type field, select Entitlement-Based Adjustment.
- 3 In the Discount Criteria list, specify the fields that you want exposed in the discount matrix:
 - a Add a field to identify the entitlement, such as Entitlement.
 - b Add a field to identify the product or group of products, such as Product.
- 4 After all the fields are added, click Complete Definition.
- 5 In the Discount Matrix list, click the name of the new discount matrix.

6 In the Discount Details list, add one or more records.

In each record:

- a Select a value in the field that identifies the product.
- b Select a value in the field that identifies the entitlement.
- c Use the Adjustment Type and Adjustment Value to specify the adjustment that those products get when sold through that entitlement.

Giving the Customer the Best Entitlement Price

When a sales representative creates a quote for a customer who may have special contract-based pricing, the sales representative clicks the Entitle button to fill in the entitlements that apply to each line item.

You must modify the pricing procedure to apply the discount based on the entitlement returned. The best entitlement pricing works only off of the list price. For more information, see *Siebel Field Service Guide*.

To give the customer the best entitlement price

- 1 Create a quote or order, as described in *Siebel Order Management Guide*.
- 2 After adding all the line items, in the Quote Header form, click Entitle.

In each line item where there is an entitlement that applies, the Entitlement Name field is filled in with the name of the entitlement. That entitlement is used to calculate pricing for that line item.

Multiple Price Types and Totals

Multiple price types allow you to create simple products that have one of three price types. You can also create customizable products with components and assign a price type to each component and to the product root. Price Type is a required field when you define a product.

The three price types are:

- **One-Time.** This price is charged only once. For example, you assign this price type to a piece of equipment that the customer can purchase.
- **Recurring.** This price is charged on a recurring basis. For example, you assign this price type to a service to which the customer subscribes.
- **Usage.** This price is charged based on customer consumption. For example, you assign this price type to an electric service that is billed by kilowatt hour of usage. The Usage price type is provided for information only and is not used in any price calculations.

When a product has multiple price types, quotes and orders must also have multiple price totals, one for charges of each price type and unit of measure. This is important because these different types of prices cannot be added up as one total, because they use different units of measure (each and per month).

About Configuring Pricing Fields in Catalog, eSales, and Configurator

In earlier versions, Siebel Catalog, eSales, and Configurator supported only two pricing fields. In version 7.8 or later, they can be configured to add additional pricing fields.

Without configuration, Siebel Catalog includes two pricing fields: List Price and Your Price for simple products, and Starting At Price and Your Price for customizable products. You can configure Siebel Catalog to add additional price fields. For more information about Siebel Catalog, see *Siebel Order Management Guide*.

Without configuration, the Siebel eSales catalog and shopping cart both include the same two pricing fields as catalog. For more information about eSales, see *Siebel eSales Administration Guide*.

Without configuration, Siebel Configurator includes two pricing fields: Starting At Price and Your Price. You can configure these by changing the configurator template. For more information about Configurator, see *Siebel Product Administration Guide*.

Multiple Currencies in a Quote, Order, or Agreement

One quote, order, or agreement can include prices from multiple price lists that are in different currencies, because the sales representative can use a different price list for an individual line item, if necessary.

In the header, when a user selects the price list, the currency of that price list is automatically entered in the Currency field. All totals for the quote, order, or agreement are in this currency.

In the line items, the default price list is the one selected in the header. However, users can select a currency in the line item, and the line item will use the price list for that currency. Users work with currencies by using the fields described in [Table 18](#).

Table 18. Fields Used to Work with Multiple Currencies

Field	Comment
Currency Code	Enter the code for the currency.
Exchange Date	Enter the date used for currency conversion. The application uses the exchange rate on that day to convert currencies.

For more information, see the topic on creating quotes and orders in *Siebel Order Management Guide*.

Spread Discount Pricing

When sales representatives apply a manual discount to the total price of an order, they can spread that discount among the line items of the order. Because products can be defined with multiple price types, spread discount pricing must consider price types. Spread discount pricing spreads the discount to one-time charges only, not to recurring or usage charges.

Spread discounting performs any needed currency conversions. Users can specify the amount of the discount in a given currency. When it is spread among line items, the discount is converted to the currency in each line item. For more information about end users and spread discounting, see the topic about spreading a discount among line items in *Siebel Order Management Guide*. For more information useful to developers, see the following information:

- [“About the Spread Discount Algorithm” on page 208](#)
- [“About Use of the Spread Discount Service with Pricing Procedures” on page 209](#)
- [“About Configuring the Spread Discount Source Field” on page 209](#)

About the Spread Discount Algorithm

This topic contains a high-level description of the algorithm used by the spread discount service:

- Get the BasePrice (List Price or Net Price).
- Convert all prices (BasePrice, Min, Max) to BaseCurrency. (Defaults to system currency, but user chooses from dialog box.)
- Add up all BasePrices up (multiplying each by Qty) to get TotalBasePrice.
- Get TargetPrice (calculated from AmtToDiscount or PercentToDiscount if necessary).
- Calculate total to discount: $TotalToDiscount = TotalBasePrice - TargetPrice$.
- Loop through the discounts one at a time:
 - a Loop through all Rows that have not reached min or max:
 - Discount each amount by $(BasePrice/TotalBasePrice) * TotalToDiscount$
 - If that discount pushes price beyond min or max, then:
 - Set the final price of item to its min or max
 - Remove that row from further discounts
 - b After round completes, make adjustment so maxed out rows are not taken into account in the next round's calculation. For each of these rows:
 - Its $BaseValue * Qty$ will be subtracted from TotalBasePrice
 - Its $DiscountAmt * Qty$ will be subtracted from TotalToDiscount

- Looping continues until:
 - TotalToDiscount can be spread evenly across all remaining line items, or
 - All items have been discounted to their respective min or max.
- Loop through all rows to convert each back to the line item currency and to round each to line item precision.
Add up rounding remainders and amount discounted.
- The rounding remainder is added to element with highest BasePrice*Qty that has not already reached its min or max.
This continues until the rounding remainder rounds to 0 or until no items can be discounted further.

About Use of the Spread Discount Service with Pricing Procedures

When an end user clicks the Spread button, the following occurs:

- One signal is raised to invoke the workflow process Spread Discount Driver Workflow process, which uses the business service ISS Spread Discount Service in one of its steps.
- After this is done, another signal is raised to invoke the workflow process Dynamic Pricing Procedure.

To use the spread discount service with custom pricing procedures, raise signals to call the workflows in this order.

About Configuring the Spread Discount Source Field

When an end user uses spread discount, the list of values for the source field has two values, list price and net price. List price is the default value.

If you configure the application to add a new value to this list of values, then you must make sure the new field is in the row set variable map for the spread discount Spread Discount Variable Map - Row Set. For more information about variable maps, see *Siebel Order Management Infrastructure Guide*.

Totaling and Rollups of Pricing

Price totals and rollups consider price types:

- Totals and rollups include one-time and recurring prices.
- Totals and rollups do not include usage prices, because the price is not known until the customer's usage is known.

This information about totals is displayed in the one-time charge total and monthly charge total fields of quote, order, and agreement headers.

Users can specify the currency for the total or rollup, after which the application performs the currency conversions to calculate the total from line items in different currencies.

A

Siebel Pricer Technical Reference

This appendix is a technical reference explaining how Siebel Pricer works. It includes the following topics:

- “Siebel Pricer Architecture” on page 211
- “Pricing Procedures and Workflow References” on page 213
- “Switching from Basic to Dynamic Pricing Procedure” on page 232
- “Modifying Signals from Basic Pricing Procedure to Dynamic Pricing Procedure” on page 234
- “Miscellaneous Pricing Workflows” on page 248

Siebel Pricer Architecture

A high-level representation of the Siebel Pricing Management Architecture is shown in [Figure 36](#). This diagram includes four key components:

- **Siebel UI or Calling Application.** This is the point from which the end user requests pricing (for example, quotes and orders).
- **Pricing Data.** This is the administrative business objects that store prices, costs, and adjustments.
- **Pricing Procedures.** This is the centralized location for pricing policies and logic. Pricing procedures use the PSP engine to locate and apply prices and adjustments, and you can customize them for your company's business model. For details about the PSP Engine, see *Siebel Order Management Infrastructure Guide*.
- **Pricing Services.** This is the specialized business services for generic, complex pricing algorithms (such as spread discount).

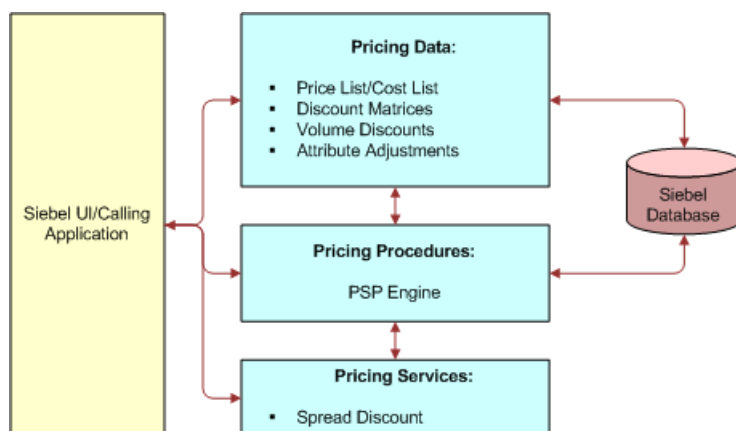

Figure 36. Pricing Architecture

When there is a request for pricing (for example, when a user adds a product to a quote or order or selects Reprice All), the application performs the following steps, illustrated in [Figure 37 on page 213](#):

- The end user action raises a signal, such as the CalculatePriceAll signal. A signal is a parameterized call to a business service or workflow process. For more information about signals, see *Siebel Order Management Infrastructure Guide*.
- The signal calls the controlling workflow process. To continue the previous example, the CalculatePriceAll signal calls the PSP Driver Workflow process. For more information about this workflow process, see [“Pricing Procedures and Workflow References” on page 213](#).
- The controlling workflow process uses variable maps to build the Context Row Set (header information) and Line Item Row Set (line item information).
 - The variable maps that build the row sets needed for pricing are identified in the definition of the signal invoked by the end user’s action. To continue the previous example, the Default Pricing Variable Map - Context and Default Pricing Variable Map - Row Set are specified as parameters to the PSP Driver Workflow process in the CalculatePriceAll Signal.
 - Variable maps build the row sets by mapping fields in the database to the variables for the row set. For more information about variable maps, see *Siebel Order Management Infrastructure Guide*.
- The controlling workflow process invokes a pricing procedure.
 - The pricing procedure invoked is identified in the definition of the signal invoked by the end user’s action. To continue the previous example, the Dynamic Pricing Procedure workflow is specified in the SubPSPWFName parameter to the PSP Driver Workflow process in the CalculatePriceAll Signal.
 - The controlling workflow passes the Context Row Set and Line Item Row Set to the pricing procedure. For more information about controlling workflows and pricing procedures, see *Siebel Order Management Infrastructure Guide*.
- The pricing procedure applies pricing logic to the data in the row sets.
 - To continue the previous example, for each line item in the line item row set, the Dynamic Pricing Procedure finds a starting price, executes a series of steps that may or may not adjust the net price, and outputs the final price.
 - The Dynamic Pricing Procedure passes the transformed Row Set back to the PSP Driver Workflow process. For detailed information about pricing procedures, see [“Pricing Procedures and Workflow References” on page 213](#).
- The Context Service updates the calling object (such as the quote or order) with the adjusted prices, and those prices appear in the end user interface.

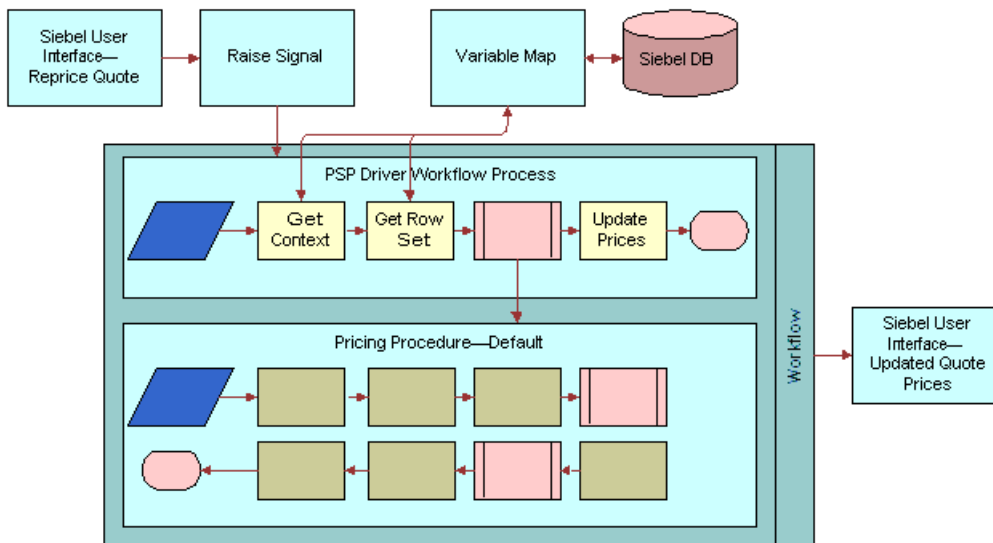

Figure 37. Overview of How Pricing Works

Pricing Procedures and Workflow References

To price products, Siebel Pricer uses the following workflows and pricing procedures:

- [“PSP Driver Workflow Process Workflow” on page 213](#)
- [“Basic Pricing Procedure Workflow” on page 214](#)
- [“Dynamic Pricing Procedure Workflow” on page 223](#)
- [“Pricing Procedure - Calculate Net Price Workflow” on page 227](#)
- [“Pricing Procedure - Aggregate Discounts Workflow” on page 230](#)
- [“Pricing Procedure - Service Workflow” on page 231](#)

PSP Driver Workflow Process Workflow

The PSP Driver Workflow Process is the beginning of all pricing operations and other features. For information about this workflow, see *Siebel Order Management Infrastructure Guide*.

Basic Pricing Procedure Workflow

The Basic Pricing Procedure workflow, as shown in Figure 38, provides basic pricer license functionality where the list price, volume discounts, and service pricing are supported.

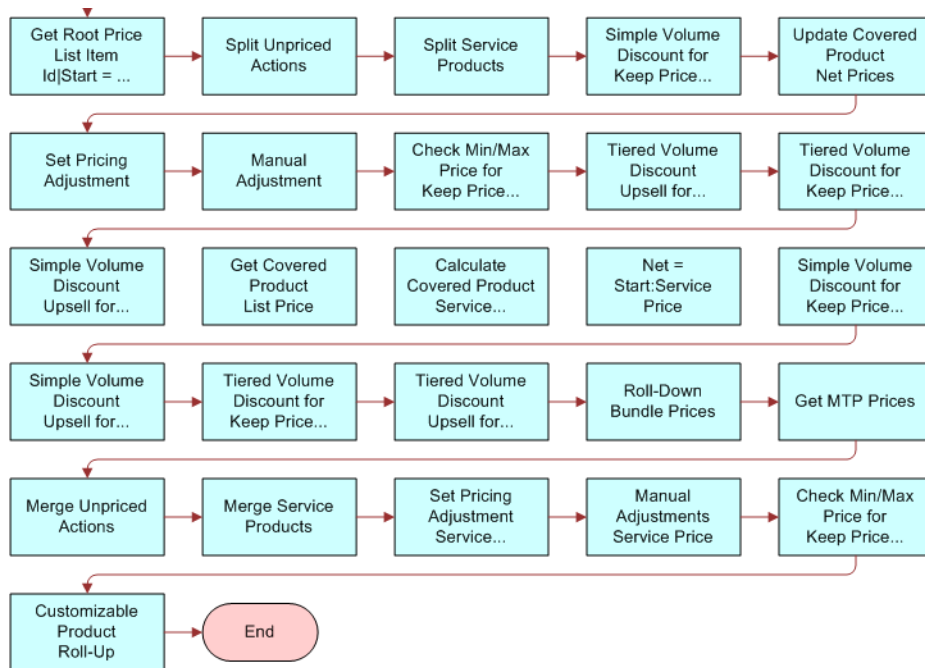

Figure 38. Basic Pricing Procedure Workflow

Workflow Description. This workflow does the following:

- 1 Stamps error codes by checking for various conditions on the Price list.
- 2 From the error codes stamped in step 2, branches out to the different actions listed in step 4.
- 3 Does the following:
 - a Raises Expired Error
 - b Raises Not Expired Error
 - c Calculates the quantity of each component in a customizable product instance, and rolls down the price list ID and promotion ID from the root.
- 4 Determines the price action code based on the item's Action Code and Price Type.
- 5 Using the Simple Look-up Transform business service, searches for the correct price list and stamps various price fields on the line item.
- 6 Gets Root Price List Item Id|Start = List|Net = Start.
- 7 Splits Unpriced Actions.

NOTE: Do not price line items with Skip Pricing Flag = 'Y'.

- 8 Splits service and nonservice line items so they can be priced separately.

NOTE: In this Pricing Procedure, products and service products need to be split and handled differently. Service procedures are services that are tied to products, for example, a maintenance service on a car. The pricing of a service is tied to the product it covers. Later in the this workflow, steps named " XXX service Pricing" will consume the Service Product Row Set.

- 9 Applies the volume discount adjustment that matches the quantity on the line item.
- 10 Finds out the upsell discount information.
- 11 Applies tiered volume discounts to the net price.
- 12 Finds out the tiered upsell discount information.
- 13 Forces the net price to be within the minimum and maximum values defined in the price list item.
- 14 Sets the manual adjustment and applies line item and header-level manual discounts.
- 15 Sets the pricing adjustment. Before adjustments and discounts, the Net Price = Start Price.
- 16 Updates the net price for any covered products that were repriced.
- 17 Looks up the list price information for covered products.
- 18 Calculates the start price for the service product by applying the percentage in the price list item to the net or start price of the covered product.
- 19 Before adjustments and discounts, ensures that the Net Price = Start Price.
- 20 Applies the volume discount adjustment that matches the quantity on the line item.
- 21 Determines the upsell discount information.
- 22 Applies tiered volume discounts to the net price.
- 23 Determines the tiered upsell discount information.
- 24 Applies line item and header-level manual discounts.
- 25 Merges service and nonservice line items.
- 26 Merges unpriced line items.
- 27 Gets the MPT Prices and the NRC and MRC price components.
- 28 Spreads discounts from bundle product root to subcomponents.
- 29 Calculates the total extended price of the customizable product, including all subcomponents.

Table 19 lists the steps in the Basic Pricing Procedure with the business service and method that is called by each.

Table 19. Steps of the Basic Pricing Procedure Workflow

Name	Type	Business Service	Method	Sub Process	Description
Check Header Price List	Business Service	Row Set Transformation Toolkit Service	Query Transform	Not applicable	Stamps error codes by checking for various conditions on the Price list.
Price List Error	Not applicable	Not applicable	Not applicable	Not applicable	From the error codes stamped in step 1, branches out to different actions in the next step.
Raise Expired Error	Business Service	Pricing Manager	Raise Price List Expired Error	Not applicable	Halts execution and provides an error message to the user if the header Price List is expired.
Raise Not Effective Error	Business Service	Pricing Manager	Raise Price List Not Effective Error	Not applicable	Halts execution and provides an error message to the user if the header Price List is not yet effective.
Customizable Product Roll-Down	Business Service	Row Set Transformation Toolkit Service	Hierarchical Transform	Not applicable	Calculates the quantity of each component in a customizable product instance. Rolls down the price list ID and promotion ID from the root.

Table 19. Steps of the Basic Pricing Procedure Workflow

Name	Type	Business Service	Method	Sub Process	Description
Determine Price Action	Not applicable	Not applicable	Not applicable	Not applicable	Determines the price action code based on the item Action Code and Price Type.
Get List Price	Business Service	Row Set Transformation Toolkit Service	Hierarchical Transform	Not applicable	Gets the list price for each row in the row set. Appends other values from the price list item Buscomp to the row.
Get Root Price List Item Id Start = List Net = Start	Not applicable	Not applicable	Not applicable	Not applicable	Not applicable
Split Unpriced Actions	Business Service	Row Set Transformation Toolkit Service	Split	Not applicable	Moves service products from the row set into another row set for use in the service pricing subprocedure.
Split Service Products	Business Service	Row Set Transformation Toolkit Service	Not applicable	Not applicable	Splits service and nonservice line items so they can be priced separately. (Note: Later in the workflow, steps named "XXX service Pricing" would consume the Service Product Row Set).

Table 19. Steps of the Basic Pricing Procedure Workflow

Name	Type	Business Service	Method	Sub Process	Description
Simple Volume Discount for Keep Price <> Y	Not applicable	Not applicable	Not applicable	Not applicable	Applies the volume discount adjustment that matches the quantity on the line item.
Split Service Products	Business Service	Row Set Transformation Toolkit Service	Not applicable	Not applicable	Splits service and nonservice line items so they can be priced separately. (Note: Later in the workflow, steps named "XXX service Pricing" would consume the Service Product Row Set).
Simple Volume Discount for Keep Price <> Y	Not applicable	Not applicable	Not applicable	Not applicable	Applies the volume discount adjustment that matches the quantity on the line item.
Simple Volume Discount Upsell for Keep Price <> Y	Not applicable	Not applicable	Not applicable	Not applicable	This is a step to find out upsell discount information.
Tiered Volume Discount for Keep Price <> Y	Not applicable	Not applicable	Not applicable	Not applicable	Applies tiered volume discounts to the Net Price.
Tiered Volume Discount Upsell for Keep Price <> Y	Not applicable	Not applicable	Not applicable	Not applicable	This is a step to find out tiered upsell discount information.

Table 19. Steps of the Basic Pricing Procedure Workflow

Name	Type	Business Service	Method	Sub Process	Description
Check Min or Max Price for Keep Price <> Y	Not applicable	Not applicable	Not applicable	Not applicable	Forces the Net Price to be within the Minimum and Maximum defined in the price list item.
Manual Adjustment	Not applicable	Not applicable	Not applicable	Not applicable	Applies line item and header-level manual discounts.
Set Pricing Adjustment	Business Service	Row Set Transformation Toolkit Service	Split Transform	Not applicable	Before adjustments and discounts, Net Price = Start Price.
Update Covered Product Net Prices	Business Service	Row Set Transformation Toolkit Service	Row Set Lookup Transform	Not applicable	Updates the net price for any covered products that were repriced.
Get Covered Product List Price	Not applicable	Not applicable	Not applicable	Not applicable	Looks up list price information for the covered product.
Update Covered Product Net Prices	Business Service	Row Set Transformation Toolkit Service	Row Set Lookup Transform	Not applicable	Updates the net price for any covered products that were repriced.
Get Covered Product List Price	Not applicable	Not applicable	Not applicable	Not applicable	Looks up list price information for the covered product.

Table 19. Steps of the Basic Pricing Procedure Workflow

Name	Type	Business Service	Method	Sub Process	Description
Calculate Covered Product Service Price	Not applicable	Not applicable	Not applicable	Not applicable	Calculates the Start Price for a service product by applying the percentage in the price list item to the Net or Start Price of the covered product.
Net = Start: Service Price	Not applicable	Not applicable	Not applicable	Not applicable	Before adjustments and discounts, Net Price = Start Price.
Update Covered Product Net Prices	Business Service	Row Set Transformation Toolkit Service	Row Set Lookup Transform	Not applicable	Updates the net price for any covered products that were repriced.
Get Covered Product List Price	Not applicable	Not applicable	Not applicable	Not applicable	Looks up list price information for the covered product.
Calculate Covered Product Service Price	Not applicable	Not applicable	Not applicable	Not applicable	Calculates the Start Price for a service product by applying the percentage in the price list item to the Net or Start Price of the covered product.
Net = Start: Service Price	Not applicable	Not applicable	Not applicable	Not applicable	Before adjustments and discounts, Net Price = Start Price.

Table 19. Steps of the Basic Pricing Procedure Workflow

Name	Type	Business Service	Method	Sub Process	Description
Simple Volume Discount for Keep Price <> Y: Service Price	Not applicable	Not applicable	Not applicable	Not applicable	Applies the volume discount adjustment that matches the quantity on the line item.
Simple Volume Discount Upsell for Keep Price <> Y: Service Price	Not applicable	Not applicable	Not applicable	Not applicable	This is a step to find out upsell discount information.
Tiered Volume Discount for Keep Price <> Y: Service Price	Not applicable	Not applicable	Not applicable	Not applicable	Applies tiered volume discounts to the Net Price.
Tiered Volume Discount Upsell for Keep Price <> Y: Service Price	Not applicable	Not applicable	Not applicable	Not applicable	Tiered Volume Discount Upsell for Keep Price <> Y: Service Price.
Check Min or Max Price for Keep Price <> Y: Service Price	Not applicable	Not applicable	Not applicable	Not applicable	Forces the Net Price to be within the Minimum and Maximum defined in the price list item.
Simple Volume Discount for Keep Price <> Y: Service Price	Not applicable	Not applicable	Not applicable	Not applicable	Applies the volume discount adjustment that matches the quantity on the line item.
Manual Adjustment: Service Price	Not applicable	Not applicable	Not applicable	Not applicable	Applies line item and header-level manual discounts.

Table 19. Steps of the Basic Pricing Procedure Workflow

Name	Type	Business Service	Method	Sub Process	Description
Set Pricing Adjustment: Service Price	Not applicable	Not applicable	Not applicable	Not applicable	Before adjustments and discounts, Net Price = Start Price.
Merge Service Products	Business Service	Row Set Transformation Toolkit Service	Merge Transform	Not applicable	Merges service and nonservice line items.
Merge Unpriced Actions	Business Service	Row Set Transformation Toolkit Service	Hierarchical Transform	Not applicable	Merges the priced and unpriced row sets into one.
Get MPT Prices	Business Service	Row Set Transformation Toolkit Service	Conditional Action Transform	Not applicable	Gets NRC and MRC price components.
Roll-Down Bundle Prices	Business Service	Row Set Transformation Toolkit Service	Hierarchical Transform	Not applicable	Spreads the discount from the bundle product root to subcomponents.
Customizable Product Roll-Up	Business Service	Row Set Transformation Toolkit Service	Hierarchical Transform	Not applicable	Calculates the total extended price of the customizable product including all subcomponent.

Dynamic Pricing Procedure Workflow

The Dynamic Pricing Procedure workflow, as shown in Figure 39, provides the advanced pricing capabilities. It contains steps and subprocedures that populate the List Price, Start Price, and Net Price fields. It also calculates the monthly recurring and nonrecurring subtotals for root Customizable Products. These prices and subtotals are calculated based on information from price lists, customizable product adjustments, volume discounts, attribute adjustments, aggregate discounts, service price details, product promotions, and manual discounts.

NOTE: The Dynamic Pricing Procedure replaces the Pricing Procedure - Default.

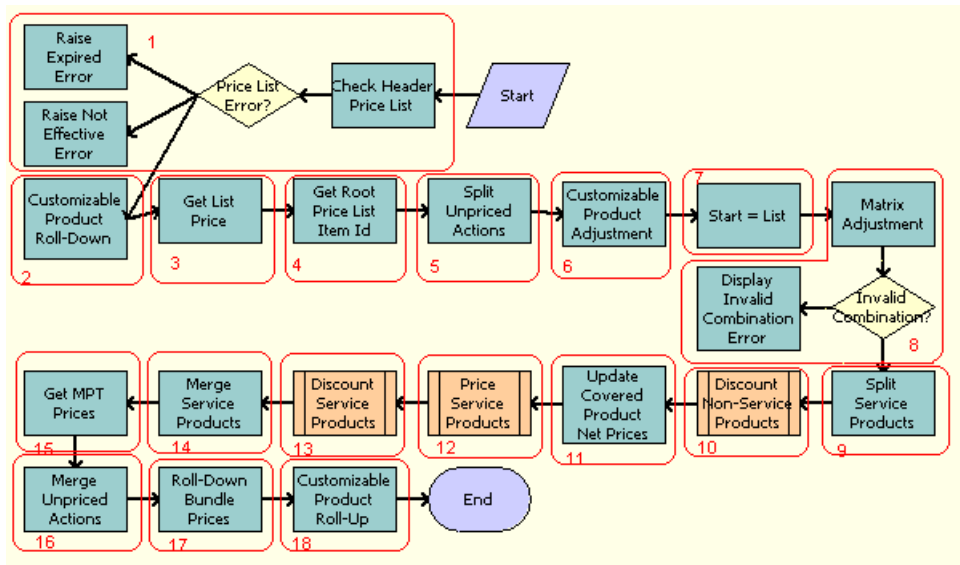

Figure 39. Dynamic Pricing Procedure Workflow Process

Workflow Description. This workflow does the following:

- 1 Checks for price list effectivity. The application will throw any error if the price list is not yet effective or has expired.
- 2 Calculates the extended quantity of all component products of a CP instance. Also, it carries over some useful information from the CP root to CP components for later use.
- 3 Gets the list price for each row in the row set, and appends other values from the Price List Item Buscomp to the row.
- 4 Puts the CP Root Price List Item Id on each component of the CP for later use.
- 5 Moves those rows with an action code that are not priced to another row set that will not be priced throughout the procedure.
- 6 Gets CP Pricing Designer adjustments for components of a CP.
- 7 Initializes the start price value as the list price value.

- 8 Applies attribute adjustments to the start price and throws an error when an invalid combination for attribute pricing occurs.
- 9 Moves service products from the row set into another row set for use in the service pricing subprocedure.
- 10 Calls subprocedure Pricing Procedure - Calculate Net Price for nonservice products.
- 11 Updates the covered product net price field on the service product rows in the row set.
- 12 Calls subprocedure Pricing Procedure – Service to handle the service product-specific pricing for service products.
- 13 Calls subprocedure Pricing Procedure - Calculate Net Price for service products.
- 14 Merges the service and nonservice row sets into one row set.
- 15 Establishes the NRC and MRC prices for one-time and monthly recurring price types, which will later be used for Customizable Product Rollup.
- 16 Merges the priced and unpriced row sets into one row set.
- 17 Spreads the discount of the root bundle products to the bundle component products.
- 18 Rolls up the prices of component products to the CP root.

Table 20 lists the steps in the Dynamic Pricing Procedure workflow with the business service and method that is called by each step.

Table 20. Steps of the Dynamic Pricing Procedure Workflow

Name	Type	Business Service	Method	Sub Process	Description
Check Header Price List	Business Service	Row Set Transformation Toolkit Service	Query Transform	Not applicable	Determines if the header price list is expired or not yet effective.
Raise Expired Error	Business Service	Pricing Manager	Raise Price List Expired Error	Not applicable	Halts execution and provides an error message to the user if the header Price List is expired.
Raise Not Effective Error	Business Service	Pricing Manager	Raise Price List Not Effective Error	Not applicable	Halts execution and provides an error message to the user if the header Price List is not yet effective.
Customizable Product Roll-Down	Business Service	Row Set Transformation Toolkit Service	Hierarchical Transform	Not applicable	Calculates the quantity of a component product of a CP instance.

Table 20. Steps of the Dynamic Pricing Procedure Workflow

Name	Type	Business Service	Method	Sub Process	Description
Get List Price	Business Service	Row Set Transformation Toolkit Service	Simple Look-Up Transform	Not applicable	Gets the list price for each row in the row set. Appends other values from the price list item Buscomp to the row.
Get Root Price List Item Id	Business Service	Row Set Transformation Toolkit Service	Hierarchical Transform	Not applicable	Puts the CP root price list item ID on each component of the CP for later use.
Split Unpriced Actions	Business Service	Row Set Transformation Toolkit Service	Split Transform	Not applicable	Moves those rows with an action code that are not priced to another row set that will not be priced throughout the procedure.
Customizable Product Adjustment	Business Service	Row Set Transformation Toolkit Service	Simple Look-Up Transform	Not applicable	Gets CP adjustments for components of a CP.
Start = List	Business Service	Row Set Transformation Toolkit Service	Conditional Action Transform	Not applicable	Initializes the start price value as the list price value.
Matrix Adjustment	Business Service	Row Set Transformation Toolkit Service	Dynamic Lookup Transform	Not applicable	Applies attribute adjustments to the start price.
Invalid Combination?	Decision Point	Not applicable	Not applicable	Not applicable	Determines if there was an invalid combination for the attribute pricing matrix.
Display Invalid Combination Error	Business Service	Dynamic Matrix Retrieval Service	Throw Invalid Combination Error	Not applicable	Halts execution of procedure and throws an error when an invalid combination for attribute pricing occurs.

Table 20. Steps of the Dynamic Pricing Procedure Workflow

Name	Type	Business Service	Method	Sub Process	Description
Split Service Products	Business Service	Row Set Transformation Toolkit Service	Split	Not applicable	Moves service products from the row set into another row set for use in the service pricing subprocedure.
Discount Non Service Products	Sub Process	Not applicable	Not applicable	Pricing Procedure – Calculate Net Price	Not applicable
Update Covered Product Net Prices	Business Service	Row Set Transformation Toolkit Service	Row Set Lookup Transform	Not applicable	Updates the covered product net price field on the service product rows in the row set.
Price Service Products	Sub Process	Not applicable	Not applicable	Pricing Procedure – Calculate Net Price	Prices the service product row set.
Discount Service Products	Sub Process	Not applicable	Not applicable	Pricing Procedure – Service	Service Pricing.
Merge Service Products	Business Service	Row Set Transformation Toolkit Service	Merge Transform	Not applicable	Merges the service and nonservice row sets into one.
Get MPT Prices	Business Service	Row Set Transformation Toolkit Service	Conditional Action Transform	Not applicable	Establishes the NRC and MRC prices for One-Time and Monthly Recurring price types.
Merge Unpriced Actions	Business Service	Row Set Transformation Toolkit Service	Merge Transform	Not applicable	Merges the priced and unpriced row sets into one.
Roll-down bundle prices	Business Service	Row Set Transformation Toolkit Service	Hierarchical Transform	Not applicable	Spreads the discount of the root bundle products to the child products.
Customizable Product Roll-ups	Business Service	Row Set Transformation Toolkit Service	Hierarchical Transform	Not applicable	Rolls up the prices of component products to the CP root.

Pricing Procedure - Calculate Net Price Workflow

The Pricing Procedure - Calculate Net Price workflow, as shown in Figure 40, is responsible for the net price calculation, which takes into account volume discount, aggregate discount sequence, product promotion, manual adjustment and minimum or maximum price bound checks.

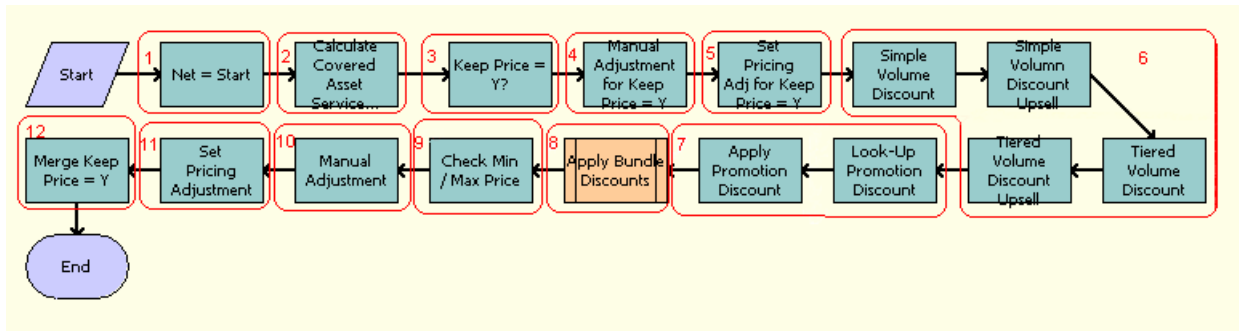

Figure 40. Pricing Procedure - Calculate Net Price Workflow Process

Workflow Description. This workflow does the following:

- 1 Initializes the net price value as the start price value.
- 2 Queries in FS Product Price Item Details Buscomp for any covered asset service pricing adjustment.
- 3 Moves those rows with the Exclude Pricing flag set to another the Keep Price Row Set row set. This will skip all Siebel-Pricer-generated discounts throughout the procedure.
- 4 Applies a manual adjustment (discount amount, discount percentage, discount price and header discount percentage) for the row set with Exclude Pricing flag Set.
- 5 Sets the pricing adjustment that indicates the total amount of Siebel-Pricer-generated discount accounts for the row set with Exclude Pricing flag = Y.
- 6 Evaluates simple and tiered volume discount. This would also populate the next discount and upsell message for upsell purposes.
- 7 Evaluates product promotion discounts.
- 8 Calls the Pricing Procedure - Bundle Discount subprocedure to evaluate the aggregate discount sequence.
- 9 Checks whether the current net price is within the boundary of the minimum and maximum price.
- 10 Applies a manual adjustment (discount amount, discount percentage, discount price and header discount percentage).
- 11 Sets the pricing adjustment that indicates the total amount of Siebel-Pricer-generated discount accounts.
- 12 Merges the two row sets generated from the Keep Price = Y? back into one row set.

Table 21 lists the steps of the Pricing Procedure - Calculate Net Price workflow with the business service and method that is called by each step.

Table 21. Steps of the Pricing Procedure - Calculate Net Price Workflow

Name	Type	Business Service	Method	Sub Process	Description
Net = Start	Business Service	Row Set Transformation Toolkit Service	Conditional Action Transform	Not applicable	Initializes the Net Price value as the Start Price value.
Calculate Covered Asset Service Price	Business Service	Row Set Transformation Toolkit	Simple Look-Up Transform	Not applicable	Queries in FS Product Price Item Details Buscomp for any covered asset service pricing adjustment.
Keep Price = Y?	Business Service	Row Set Transformation Toolkit	Split Transform	Not applicable	Moves those rows with Exclude Pricing Flag set to another row set, the Keep Price Row Set row set. For these, all Siebel-Pricer-generated discounts will be skipped throughout the procedure.
Manual Adjustment for Keep Price = Y	Business Service	Row Set Transformation Toolkit Service	Conditional Action Transform	Not applicable	Applies Manual Adjustment for Keep Price Row Set row set.
Set Pricing Adj for Keep Price = Y	Business Service	Row Set Transformation Toolkit Service	Conditional Action Transform	Not applicable	Sets the Pricing Adjustment that indicates the total amount of Siebel-Pricer-generated discounts for the Keep Price Row Set row set.
Simple Volume Discount	Business Service	Row Set Transformation Toolkit Service	Simple Look-Up Transform	Not applicable	Evaluates Simple Volume Discount.
Simple Volume Discount Upsell	Business Service	Row Set Transformation Toolkit Service	Simple Look-Up Transform	Not applicable	Populates Simple Volume Discount Upsell information.

Table 21. Steps of the Pricing Procedure - Calculate Net Price Workflow

Name	Type	Business Service	Method	Sub Process	Description
Tiered Volume Discount	Business Service	Row Set Transformation Toolkit Service	Simple Look-Up Transform	Not applicable	Evaluates Tiered Volume Discount.
Tiered Volume Discount Upsell	Business Service	Row Set Transformation Toolkit Service	Simple Look-Up Transform	Not applicable	Populates Tiered Volume Discount Upsell information.
Look-Up Promotion Discount	Business Service	Row Set Transformation Toolkit Service	Simple Look-Up Transform	Not applicable	Checks whether a promotion discount is defined.
Apply Promotion Discount	Business Service	Row Set Transformation Toolkit	Conditional Action Transform	Not applicable	Applies the Promotion Discount found in the previous step.
Apply Bundle Discounts	Sub Process	Not applicable	Not applicable	Pricing Procedure - Aggregate Discounts	Invokes a subprocedure for calculating Aggregate Sequence.
Check Min or Max Price	Business Service	Row Set Transformation Toolkit Service	Conditional Action Transform	Not applicable	Ensures that the net price is within the minimum and maximum defined in the price list item.
Manual Adjustment	Business Service	Row Set Transformation Toolkit	Conditional Action Transform	Not applicable	Applies manual adjustment.
Set Pricing Adjustment	Business Service	Row Set Transformation Toolkit Service	Conditional Action Transform	Not applicable	Sets the pricing adjustment, which is the total amount of Siebel-Pricer-generated discounts.
Merge Keep Price = Y	Business Service	Row Set Transformation Toolkit	Merge Transform	Not applicable	Merges back the Keep Price Row Set row set.

Pricing Procedure - Aggregate Discounts Workflow

The Pricing Procedure - Aggregate Discounts workflow, as shown in [Figure 41](#), is the subprocedure that evaluates the Aggregate Discount Sequence adjustment. The workflow first aggregates quantities for each product across line items. It then checks whether there are possible aggregate discounts set up by examining the price list on both the header and line item level.

The workflow then compares the aggregate discount with the product quantity aggregation it has evaluated earlier to see whether it qualifies for any discounts.

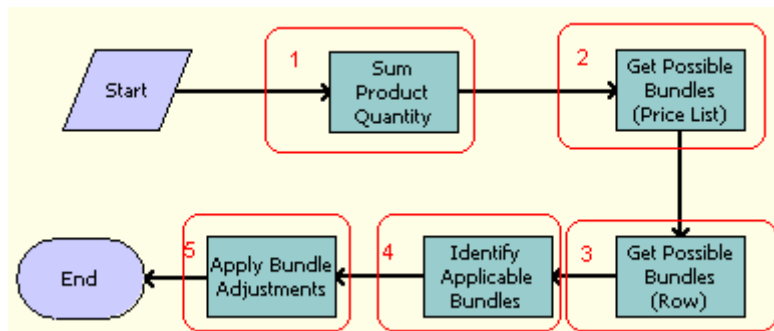

Figure 41. Pricing Procedure - Aggregate Discounts Workflow Process

Workflow Description. This workflow does the following:

- 1 Groups line items by Product ID and performs a quantity aggregation. The result of this operation is a property set with Product ID and corresponding aggregated quantities.
- 2 Uses Query Transformation to check if there is an Aggregate Discount Sequence associated with the price list from the header, and whether that Aggregate Discount Sequence is effective. If all conditions are met, then the list of IDs of all the aggregate discounts under that sequence would be stored in a property set.
- 3 This step is similar to the previous one except that it examines the Price List association of the line item. The IDs of all the possible aggregate discounts would be appended to the previously mentioned property set.
- 4 Using Rule Set Lookup Transformation and the information from previous steps, it identifies which of the possible aggregate discounts are satisfied along with the corresponding multiplier for each aggregate discount. This information is used as input to the next step.
- 5 Using Rule Set Lookup Transformation and the information from previous steps, it applies adjustments defined in the applicable aggregate discounts and put that on each of the line item. Line items having the same product would be ordered by their net price. Line items with a higher net price would have priority over items with a lower net price.

[Table 22](#) lists the steps in the Pricing Procedure - Aggregate Discounts workflow with the business service and method that is called by each step.

Table 22. Steps of the Pricing Procedure - Aggregate Discounts Workflow

Name	Type	Business Service	Method	Sub Process	Description
Sum Product Quantity	Business Service	Row Set Transformation Toolkit	Aggregate Transform	Not applicable	Sums up quantities of line items by Product ID.
Get Possible Bundles (Price List)	Business Service	Row Set Transformation Toolkit Service	Query Transform	Not applicable	Checks for the Aggregate Discount Sequence associated with the Price List from the Header.
Get Possible Bundles (Row)	Business Service	Row Set Transformation Toolkit Service	Simple Look-Up Transform	Not applicable	Checks for the Aggregate Discount Sequence associated with the Price Lists from the Line Items.
Identify Applicable Bundles	Business Service	Row Set Transformation Toolkit Service	Rule Set Look-Up Transform	Not applicable	Identifies applicable Aggregate Discounts and corresponding Multiplier.
Apply Bundle Adjustments	Business Service	Row Set Transformation Toolkit Service	Rule Set Look-Up Transform	Not applicable	Applies the adjustments defined in aggregate discounts.

Pricing Procedure - Service Workflow

The Pricing Procedure - Service workflow, as shown in Figure 42, adjusts the start prices for service products by taking account their covered products and primary covered assets.

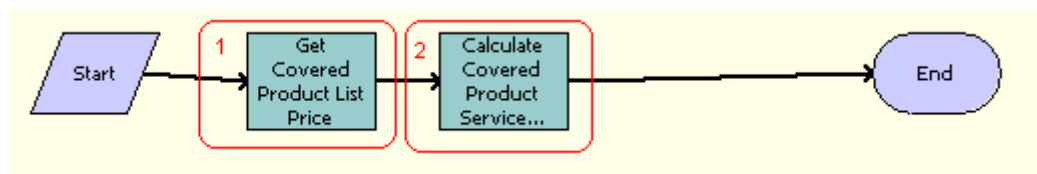

Figure 42. Pricing Procedure - Service Workflow Process

Workflow Description. This workflow does the following:

- 1 Looks up list price information for covered products.
- 2 Calculates the start price for a service product by applying the percentage in the Price List Item Buscomp to the net price or start price of the covered product.

Table 23 lists the steps in the Pricing Procedure - Service workflow with the business service and method that is called by each step.

Table 23. Steps of the Pricing Procedure - Service Workflow

Name	Type	Business Service	Method	Sub Process	Description
Get Covered Product List Price	Business Service	Row Set Transformation Toolkit Service	Simple Look-Up Transform	Not applicable	Looks up list price information for the covered product.
Calculate Covered Product Service Price	Business Service	Row Set Transformation Toolkit Service	Simple Look-Up Transform	Not applicable	Calculates the Start Price for a service product by applying the percentage in the Price List Item to the Net Price or Start Price of the covered product.

Switching from Basic to Dynamic Pricing Procedure

It is possible to switch from the Basic Pricing Procedure to the Dynamic Pricing Procedure, depending on your requirements.

- The Basic Pricing Procedure is enabled out of the box. It does the following:
 - Duplicates the 7.7 basic pricer license functionality where only the list price, volume discounts, and service pricing are supported.
 - Uses the variable maps that do not contain the XA child variable maps.
- The Dynamic Pricing Procedure is not enabled for out of the box execution. It does the following:
 - Uses the variable maps that contain the XA child variable maps.
 - Provides complete pricing capabilities such as attribute pricing, promotions, aggregate discounts and so on.

You can either *manually* enable the Dynamic Pricing Procedure for standard signals as required, or you can *automatically* enable the Dynamic Pricing Procedure for **all** signals, as described in the following procedure.

To switch from the Basic Pricing Procedure to the Dynamic Pricing Procedure

1 Make sure that you have the Dynamic Pricer license.

NOTE: Before proceeding any further, it is recommended that you familiarize yourself with the Dynamic Pricing Procedure, as described in [“Dynamic Pricing Procedure Workflow” on page 223](#).

2 Do one of the following:

a Manually enable the Dynamic Pricing Procedure for appropriate standard signals:

- ❑ For information about how to manually enable dynamic pricing for a signal, see [“Manually Enabling the Dynamic Pricing Procedure” on page 235](#).
- ❑ For a list of the standard signals that can be manually modified for dynamic pricing, including the parameters in each signal that must be modified, see [“Manual Signal Modifications for Siebel Business Applications and Industry Applications” on page 235](#).

b Automatically enable the Dynamic Pricing Procedure for all pricing signals:

- ❑ Navigate to the Administration - Pricing screen, then Price Lists view in your Siebel Business Application.
- ❑ Click Menu, and then select Enable Dynamic Pricing.

A message dialog displays confirming that Dynamic Pricing is enabled.

Doing this automatically makes the appropriate changes to all standard signal definitions.

You can extend the list of signals to which Dynamic Pricing applies as described in [“Extending the List of Signals to which Dynamic Pricing Applies” on page 233](#).

Extending the List of Signals to which Dynamic Pricing Applies

Extending the list of signals to which Dynamic Pricing applies involves adding a new signal that has been configured for dynamic pricing, so that it automatically gets enabled for dynamic pricing when the Enable Dynamic Pricing option is selected from the Applet Menu.

Complete the steps in the following procedure to extend the list of signals to which Dynamic Pricing applies.

To extend the list of signals to which dynamic pricing applies

1 In Siebel Tools, search for the Signal Modify Service business service.

2 Under the Business Service User Properties, add a new user property to the Business Service.

This new user property must correspond to the Signal that you want to enable dynamic pricing for. For example, to enable dynamic pricing for a Signal named TestSignal:

a Under the Business Service User Properties, search for Signal *.

b Add a new record and name it Signal *, where * corresponds to the next consecutive number.

For example, if the highest Signal * User Property is Signal 24, then create a new user property called Signal 25.

- c Specify the Signal name as the User Property Value, in this example TestSignal:

User Property Name	User Property Value
Signal 25	TestSignal

- 3 Under the Business Service User Properties, add another new record and specify the signal parameters to change to implement dynamic pricing for that signal.

For example, the following table lists the User Properties that you can create under the Signal Modify Service Business Service in order to enable dynamic pricing for a signal called TestSignal.

User Property Name	User Property Value
TestSignal 1	SubPSPPrimingWFName: Dynamic Pricing Procedure
TestSignal 2	Variable Map - Row Set: Default Pricing Variable Map - Row Set

The User Property Value corresponds to the Signal Parameter that you want to change, and is a combination of the Signal Parameter Name (for example, SubPSPPrimingWFName) and the Signal Parameter Value (for example, Dynamic Pricing Procedure) with a colon (:) separating them. For example:

SubPSPPrimingWFName: Dynamic Pricing Procedure

Continue to add more records, as necessary, specifying the signal parameters to change to implement dynamic pricing for the signal. For each new record, be sure to increase the numeric value after the Signal name (TestSignal 3, TestSignal 4, and so on).

- 4 Compile the Business Service to the srf, and apply it to the server.
- 5 Restart the server.

Modifying Signals from Basic Pricing Procedure to Dynamic Pricing Procedure

The Siebel Business Application executes the Basic Pricing Procedure. In order to leverage the Dynamic Pricing Procedure, you need to obtain a Dynamic Pricer license and either:

- Automatically enable the Dynamic Pricing Procedure for all signals, as described in Step 2b of [“Switching from Basic to Dynamic Pricing Procedure” on page 232](#).
- Or, manually modify several signal definitions as detailed in the following topics:

NOTE: If you automatically enable the Dynamic Pricing Procedure for all signals as described in Step 2b of [“Switching from Basic to Dynamic Pricing Procedure” on page 232](#), then you do not need to make any changes to the signal definitions, and can ignore the following tasks:

- [“Manually Enabling the Dynamic Pricing Procedure” on page 235](#)
- [“Manual Signal Modifications for Siebel Business Applications and Industry Applications” on page 235](#)

- [“Manual Signal Modifications for Communications, Media and Energy Applications” on page 246](#)

Manually Enabling the Dynamic Pricing Procedure

Manually enabling the Dynamic Pricing Procedure involves modifying several of the standard signals. Complete the following procedure to manually enable dynamic pricing for each standard signal.

NOTE: Complete this procedure only if you have not automatically enabled the Dynamic Pricing Procedure for all price lists as described in Step 2b of [“Switching from Basic to Dynamic Pricing Procedure” on page 232](#).

To manually enable the Dynamic Pricing Procedure

- 1 In the Siebel client, navigate to the Administration – Order Management screen, then the Signals view.
- 2 Check the Locked flag in the Signals list applet, then drill down on the Work Space version of the signal.
- 3 Modify the parameters listed for the specified signal actions. If more than one action is listed, then modify the parameters for all actions listed.
[“Manual Signal Modifications for Siebel Business Applications and Industry Applications” on page 235](#) lists the standard signals that must be modified, including the parameters in each signal that must be modified, to enable dynamic pricing for your Siebel Business Application.
- 4 After modifying the signal definition, you need to release the updated signal as follows:
 - a Return to the Signals list applet
 - b Highlight the modified signal record highlighted
 - c Click the Release New Version button.
- 5 You will need to log out and log back into the Siebel client to test the updated signal.

For additional details about using signals, see *Siebel Order Management Infrastructure Guide*.

Manual Signal Modifications for Siebel Business Applications and Industry Applications

NOTE: If you automatically enable the Dynamic Pricing Procedure for all signals as described in Step 2b of [“Switching from Basic to Dynamic Pricing Procedure” on page 232](#), then you do not need to implement any of the modifications outlined in this topic.

This topic lists the manual signal modifications required to implement dynamic pricing for Siebel Business Applications and Industry Applications. For each signal definition, you can modify the parameters of the actions listed. If multiple actions are listed for the signal, then make sure that you modify the parameters for each of the actions listed.

NOTE: In some cases, the signal definition includes additional actions and parameters that are not listed. The actions and parameters listed below are the only ones that must be changed to implement dynamic pricing.

CalculatePriceAndCheckEligibility

Table 24 describes the signal action, and Table 25 lists the parameters that you must modify to implement dynamic pricing for the CalculatePriceAndCheckEligibility signal.

Table 24. CalculatePriceAndCheckEligibility Signal Action

Definition	Service Type	Service Name	Mode	Instance Type
Action	Workflow	PSP Driver Workflow Process	-	-

Table 25. CalculatePriceAndCheckEligibility Parameters for Modification

Name	Value
SubPSPPrimingWFName	Dynamic Pricing Procedure
Variable Map - Row Set	Default Pricing Eligibility Variable Map - Row Set

QuotesAndOrdersValidate

Table 26 describes the signal actions, and Table 27 lists the parameters that you must modify to implement dynamic pricing for the QuotesAndOrdersValidate signal.

NOTE: Make sure you change the parameters for each of the four actions listed.

Table 26. QuotesAndOrdersValidate Signal Action

Definition	Service Type	Service Name	Mode	Instance Type
Action	Workflow	PSP Driver Workflow Process	Order	Header
	Workflow	PSP Driver Workflow Process	Order	Line Item
	Workflow	PSP Driver Workflow Process	Quote	Header
	Workflow	PSP Driver Workflow Process	Quote	Line Item

Table 27. QuotesAndOrdersValidate Parameters for Modification

Name	Value
SubPSPPrimingWFName	Dynamic Pricing Procedure
Variable Map - Row Set	Default Pricing Eligibility Variable Map - Row Set

Verifyitem

Table 28 describes the signal actions, and Table 29 lists the parameters that you must modify to implement dynamic pricing for the Verifyitem signal.

NOTE: Make sure you change the parameters for each of the three actions listed.

Table 28. Verifyitem Signal Actions

Definition	Service Type	Service Name	Mode	Instance Type
Action	Workflow	PSP Driver Workflow Process	Agreement	Header
	Workflow	PSP Driver Workflow Process	Order	Header
	Workflow	PSP Driver Workflow Process	Order	Header

Table 29. Verifyitem Parameters for Modification

Name	Value
SubPSPPrimingWFName	Dynamic Pricing Procedure
Variable Map - Row Set	Default Pricing Eligibility Variable Map - Row Set

ProductRecommendation

Table 30 describes the signal action, and Table 31 lists the parameter that you must modify to implement dynamic pricing for the ProductRecommendation signal.

Table 30. Product Recommendation Signal Action

Definition	Service Type	Service Name	Mode	Instance Type
Action	Workflow	Product Recommendation Driver Workflow	Not applicable	Line Item

Table 31. ProductRecommendation Parameter for Modification

Name	Value
SubPSPPrimingWFName	Dynamic Pricing Procedure

CalculatePriceExternal

Table 32 describes the signal action, and Table 33 lists the parameter that you must modify to implement dynamic pricing for the CalculatePriceExternal signal.

Table 32. CalculatePriceExternal Signal Action

Definition	Service Type	Service Name	Mode	Instance Type
Action	Business Service	RunPricerWorkflow	Not applicable	Not applicable

Table 33. CalculatePriceExternal Parameter for Modification

Name	Value
SubPSPPrimingWFName	Dynamic Pricing Procedure

SpreadDiscount

Table 34 describes the signal action, and Table 35 lists the parameter that you must modify to implement dynamic pricing for the SpreadDiscount signal.

Table 34. SpreadDiscount Signal Action

Definition	Service Type	Service Name	Mode	Instance Type
Action	Workflow	Spread Discount Driver Workflow Process	Not applicable	Not applicable

Table 35. SpreadDiscount Parameter for Modification

Name	Value
SubPSPPrimingWFName	Dynamic Pricing Procedure

SpreadDiscount - All

Table 36 describes the signal action, and Table 37 lists the parameter that you must modify to implement dynamic pricing for the SpreadDiscount - All signal.

Table 36. SpreadDiscount - All Signal Action

Definition	Service Type	Service Name	Mode	Instance Type
Action	Workflow	Spread Discount Driver Workflow Process	Not applicable	Not applicable

Table 37. SpreadDiscount - All Parameter for Modification

Name	Value
SubPSPPrimingWFName	Dynamic Pricing Procedure

Approveitem

Table 38 describes the signal actions, and Table 39 lists the parameters that you must modify to implement dynamic pricing for the Approveitem signal.

NOTE: Make sure you change the parameters for each of the three actions listed.

Table 38. Approveitem Signal Actions

Definition	Service Type	Service Name	Mode	Instance Type
Action	Workflow	PSP Driver Workflow Process	Agreement	Header
	Workflow	PSP Driver Workflow Process	Order	Header
	Workflow	PSP Driver Workflow Process	Quote	Header

Table 39. Approveitem Parameters for Modification

Name	Value
SubPSPWFName	Dynamic Pricing Procedure
Variable Map - Row Set	Default Pricing Variable Map - Row Set

CalculatePrice

Table 40 describes the signal action, and Table 41 lists the parameters that you must modify to implement dynamic pricing for the CalculatePrice signal.

Table 40. CalculatePrice Signal Action

Definition	Service Type	Service Name	Mode	Instance Type
Action	Workflow	PSP Driver Workflow Process	Not applicable	Not applicable

Table 41. CalculatePrice Parameters for Modification

Name	Value
SubPSPWFName	Dynamic Pricing Procedure
Variable Map - Row Set	Default Pricing Variable Map - Row Set

CalculatePriceAll

Table 42 describes the signal action, and Table 43 lists the parameters that you must modify to implement dynamic pricing for the CalculatePriceAll signal.

Table 42. CalculatePriceAll Signal Action

Definition	Service Type	Service Name	Mode	Instance Type
Action	Workflow	PSP Driver Workflow Process	Not applicable	Line Item

Table 43. CalculatePriceAll Parameters for Modification

Name	Value
SubPSPWFName	Dynamic Pricing Procedure
Variable Map - Row Set	Default Pricing Variable Map - Row Set

CalculatePrice_eSales

Table 44 describes the signal action, and Table 45 lists the parameters that you must modify to implement dynamic pricing for the CalculatePrice_eSales signal.

Table 44. CalculatePrice_eSales Signal Action

Definition	Service Type	Service Name	Mode	Instance Type
Action	Workflow	PSP Driver Workflow Process	Not applicable	Not applicable

Table 45. CalculatePrice_eSales Parameters for Modification

Name	Value
SubPSPWFName	Dynamic Pricing Procedure
Variable Map - Row Set	Default Pricing Variable Map - Row Set

CalculatePriceAll_eSales

Table 46 describes the signal action, and Table 47 lists the parameters that you must modify to implement dynamic pricing for the CalculatePriceAll_eSales signal.

Table 46. CalculatePriceAll_eSales Signal Action

Definition	Service Type	Service Name	Mode	Instance Type
Action	Workflow	PSP Driver Workflow Process	Not applicable	Line Item

Table 47. CalculatePriceAll_eSales Parameters for Modification

Name	Value
SubPSPWFName	Dynamic Pricing Procedure
Variable Map - Row Set	Default Pricing Variable Map - Row Set

CalculatePrice_Configurator

Table 48 describes the signal action, and Table 49 lists the parameters that you must modify to implement dynamic pricing for the CalculatePrice_Configurator signal.

Table 48. CalculatePrice_Configurator Signal Action

Definition	Service Type	Service Name	Mode	Instance Type
Action	Workflow	PSP Driver Workflow Process	Not applicable	Not applicable

Table 49. CalculatePrice_Configurator Parameters for Modification

Name	Value
SubPSPWFName	Dynamic Pricing Procedure
Variable Map - Row Set	Default Pricing Variable Map - Row Set

CalculatePrice_Advisor

Table 50 describes the signal action, and Table 51 lists the parameters that you must modify to implement dynamic pricing for the CalculatePrice_Advisor signal.

Table 50. CalculatePrice_Advisor Signal Action

Definition	Service Type	Service Name	Mode	Instance Type
Action	Workflow	PSP Driver Workflow Process	Not applicable	Not applicable

Table 51. CalculatePrice_Advisor Parameters for Modification

Name	Value
SubPSPWFName	Dynamic Pricing Procedure
Variable Map - Row Set	Default Pricing Variable Map - Row Set

MergeIntoOnePackage

Table 52 describes the signal action, and Table 53 lists the parameters that you must modify to implement dynamic pricing for the MergeIntoOnePackage signal.

Table 52. MergeIntoOnePackage Signal Action

Definition	Service Type	Service Name	Mode	Instance Type
Action	Workflow	PSP Driver Workflow Process	Not applicable	Line Item

Table 53. MergeIntoOnePackage Parameters for Modification

Name	Value
SubPSPWFName	Dynamic Pricing Procedure
Variable Map - Row Set	Default Pricing Variable Map - Row Set

OrderTemplate

Table 54 describes the signal actions, and Table 55 lists the parameters that you must modify to implement dynamic pricing for the OrderTemplate signal.

NOTE: Make sure you change the parameters for each of the two actions listed.

Table 54. OrderTemplate Signal Actions

Definition	Service Type	Service Name	Mode	Instance Type
Action	Workflow	PSP Driver Workflow Process	Order	Header
	Workflow	PSP Driver Workflow Process	Quote	Header

Table 55. OrderTemplate Parameters for Modification

Name	Value
SubPSPWFName	Dynamic Pricing Procedure
Variable Map - Row Set	Default Pricing Variable Map - Row Set

OrderTemplateCopy

Table 56 describes the signal actions, and Table 57 lists the parameters that you must modify to implement dynamic pricing for the OrderTemplateCopy signal.

Table 56. OrderTemplateCopy Signal Actions

Definition	Service Type	Service Name	Mode	Instance Type
Action	Workflow	PSP Driver Workflow Process	Order	Header

Table 57. OrderTemplateCopy Parameters for Modification

Name	Value
SubPSPWFName	Dynamic Pricing Procedure
Variable Map - Row Set	Default Pricing Variable Map - Row Set

OrderTemplateSelectItems

Table 58 describes the signal action, and Table 59 lists the parameters that you must modify to implement dynamic pricing for the OrderTemplateSelectItems signal.

Table 58. OrderTemplateSelectItems Signal Action

Definition	Service Type	Service Name	Mode	Instance Type
Action	Workflow	PSP Driver Workflow Process	Order	Header

Table 59. OrderTemplateSelectItems Parameters for Modification

Name	Value
SubPSPWFName	Dynamic Pricing Procedure
Variable Map - Row Set	Default Pricing Variable Map - Row Set

QuoteTemplateCopy

Table 60 describes the signal action, and Table 61 lists the parameters that you must modify to implement dynamic pricing for the QuoteTemplateCopy signal.

Table 60. QuoteTemplateCopy Signal Action

Definition	Service Type	Service Name	Mode	Instance Type
Action	Workflow	PSP Driver Workflow Process	Quote	Header

Table 61. QuoteTemplateCopy Parameters for Modification

Name	Value
SubPSPWFName	Dynamic Pricing Procedure
Variable Map - Row Set	Default Pricing Variable Map - Row Set

QuoteTemplateSelectItems

Table 62 describes the signal action, and Table 63 lists the parameters that you must modify to implement dynamic pricing for the QuoteTemplateSelectItems signal.

Table 62. QuoteTemplateSelectItems Signal Action

Definition	Service Type	Service Name	Mode	Instance Type
Action	Workflow	PSP Driver Workflow Process	Quote	Header

Table 63. QuoteTemplateSelectItems Parameters for Modification

Name	Value
SubPSPWFName	Dynamic Pricing Procedure
Variable Map - Row Set	Default Pricing Variable Map - Row Set

SetFieldValue

Table 64 describes the signal actions, and Table 65 lists the parameters that you must modify to implement dynamic pricing for the SetFieldValue signal.

NOTE: Make sure you change the parameters for each of the four actions listed.

Table 64. SetFieldValue Signal Actions

Definition	Service Type	Service Name	Mode	Instance Type
Action	Workflow	PSP Driver Workflow Process	Not applicable	Header
	Workflow	PSP Driver Workflow Process	Agreement	Line Item
	Workflow	PSP Driver Workflow Process	Order	Line Item
	Workflow	PSP Driver Workflow Process	Quote	Line Item

Table 65. SetFieldValue Parameters for Modification

Name	Value
SubPSPWFName	Dynamic Pricing Procedure
Variable Map - Row Set	Default Pricing Variable Map - Row Set

NOTE: The following fields are available for the Agreement, Order, and Quote actions: Product, Quantity Requested, Unit Price, Discount Amount, Discount Percent, Prod Prom Name, Currency Code, Item Price List, Covered Product Net Price. Fields available for the Header instance type are: Discount, Price List, and Currency Code.

GetConfigItemPrice

Table 66 describes the signal action, and Table 67 lists the parameter that you must modify to implement dynamic pricing for the GetConfigItemPrice signal.

Table 66. GetConfigItemPrice Signal Action

Definition	Service Type	Service Name	Mode	Instance Type
Action	Workflow	Get Config Item Price - Driver Workflow	Not applicable	Not applicable

Table 67. GetConfigItemPrice Parameter for Modification

Name	Value
SubPSPWFName	Get Config Item Price - Dynamic

GetProdPrice

Table 68 describes the signal action, and Table 69 lists the parameters that you must modify to implement dynamic pricing for the GetProdPrice signal.

Table 68. GetProdPrice Signal Action

Definition	Service Type	Service Name	Mode	Instance Type
Action	Workflow	PSP Driver Workflow Process	Not applicable	Not applicable

Table 69. GetProdPrice Parameters for Modification

Name	Value
SubPSPWFName	Dynamic Pricing Procedure
Variable Map - Row Set	Product Pricing Variable Map - Row Set

GetUsedProdPrice

Table 70 describes the signal action, and Table 71 lists the parameters that you must modify to implement dynamic pricing for the GetUsedProdPrice signal.

Table 70. GetUsedProdPrice Signal Action

Definition	Service Type	Service Name	Mode	Instance Type
Action	Workflow	PSP Driver Workflow Process	Not applicable	Not applicable

Table 71. GetUsedProdPrice Parameters for Modification

Name	Value
SubPSPWFName	Dynamic Pricing Procedure
Variable Map - Row Set	Product Pricing Variable Map - Row Set

Manual Signal Modifications for Communications, Media and Energy Applications

NOTE: If you automatically enable the Dynamic Pricing Procedure for all price lists as described in Step 2b of “Switching from Basic to Dynamic Pricing Procedure” on page 232, then you do not need to implement any of the modifications outlined in this topic.

This topic lists the manual signal modifications required to implement dynamic pricing for Siebel Communications, Media and Energy (CME) applications.

NOTE: If you are using tiered pricing, then the signals listed below should refer to Pricing Procedure - CME.

CalculatePriceCME

Table 72 describes the signal action, and Table 73 lists the parameters that you must modify to implement dynamic pricing for the CalculatePriceCME signal.

Table 72. CalculatePriceCME Signal Action

Definition	Service Type	Service Name	Mode	Instance Type
Action	Workflow	PSP Driver Workflow Process	Not applicable	Not applicable

Table 73. CalculatePriceCME Parameters for Modification

Name	Value
SubPSPWFName	Pricing Procedure - CME
Variable Map - Row Set	Default Pricing Variable Map - Row Set

CalculatePriceAllCME

Table 74 describes the signal action, and Table 75 lists the parameters that you must modify to implement dynamic pricing for the CalculatePriceAllCME signal.

Table 74. CalculatePriceAllCME Signal Action

Definition	Service Type	Service Name	Mode	Instance Type
Action	Workflow	PSP Driver Workflow Process	Not applicable	Line Item

Table 75. CalculatePriceAllCME Parameters for Modification

Name	Value
SubPSPWFName	Pricing Procedure - CME
Variable Map - Row Set	Default Pricing Variable Map - Row Set

SaveWaterfall-Quote

Table 76 describes the signal action, and Table 77 lists the parameter that you must modify to implement dynamic pricing for the SaveWaterfall-Quote signal.

Table 76. SaveWaterfall-Quote Signal Action

Definition	Service Type	Service Name	Service Method	Mode	Instance Type
Action	Business Service	PSP Waterfall Service	SyncToDB	Not applicable	Not applicable

Table 77. SaveWaterfall-Quote Parameters for Modification

Name	Value
Waterfall Signal	CalculatePriceAllCME

SaveWaterfall-Order

Table 78 describes the signal action, and Table 79 lists the parameter that you must modify to implement dynamic pricing for the SaveWaterfall-Order signal.

Table 78. SaveWaterfall-Order Signal Action

Definition	Service Type	Service Name	Service Method	Mode	Instance Type
Action	Business Service	PSP Waterfall Service	SyncToDB	Not applicable	Not applicable

Table 79. SaveWaterfall-Order Parameters for Modification

Name	Value
Waterfall Signal	CalculatePriceAllCME

SaveWaterfall-ServiceAgreement

Table 80 describes the signal action, and Table 81 lists the parameter that you must modify to implement dynamic pricing for the SaveWaterfall-ServiceAgreement signal.

Table 80. SaveWaterfall-ServiceAgreement Signal Action

Definition	Service Type	Service Name	Service Method	Mode	Instance Type
Action	Business Service	PSP Waterfall Service	SyncToDB	Not applicable	Not applicable

Table 81. SaveWaterfall-ServiceAgreement Parameters for Modification

Name	Value
Waterfall Signal	CalculatePriceAllCME

Miscellaneous Pricing Workflows

The workflows used for pricing are covered in [“Pricing Procedures and Workflow References”](#) on page 213.

The following workflows are used by Siebel Pricer for other purposes:

- [“PSP Dynamic Matrix - Refresh Matrix Cache Workflow”](#) on page 248
- [“PSP Waterfall Synch to DB Workflow”](#) on page 249
- [“Spread Discount Driver Workflow”](#) on page 249

PSP Dynamic Matrix - Refresh Matrix Cache Workflow

The PSP Dynamic Matrix - Refresh Matrix Cache workflow, as shown in [Figure 43](#), clears the cache for the Attribute Adjustment Rules that are internally maintained by the PSP Engine.

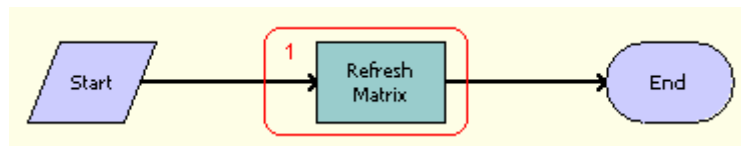

Figure 43. PSP Dynamic Matrix - Refresh Matrix Cache Workflow Process

This workflow refreshes the Attribute Adjustment cache for the currently highlighted record.

[Table 82](#) describes the step in the PSP Dynamic Matrix - Refresh Matrix Cache workflow with the business service and method that it calls.

Table 82. Steps of the PSP Dynamic Matrix - Refresh Matrix Cache Workflow

Name	Type	Business Service	Method	Sub Process	Description
Refresh Matrix	Business Service	Dynamic Matrix Retrieval Service	Refresh Matrix	Not applicable	Refreshes the Attribute Adjustment cache for the current highlighted record.

PSP Waterfall Synch to DB Workflow

The PSP Waterfall Synch to DB workflow, as shown in [Figure 44](#), writes waterfall records to the database according to input from the data map object.

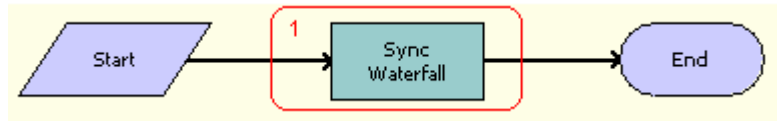

Figure 44. PSP Waterfall Synch to DB Workflow

[Table 83](#) lists describes the step in the PSP Waterfall Synch to DB workflow with the business service and method that is called.

Table 83. Steps of the PSP Waterfall Synch to DB Workflow

Name	Type	Business Service	Method	Sub Process	Description
Sync Waterfall	Business Service	PSP Waterfall Service	WriteWaterfall	Not applicable	Writes waterfall records to database.

Spread Discount Driver Workflow

The Spread Discount Driver workflow, as shown in [Figure 45](#), spreads a discount amount over the specified line items.

NOTE: The specialized implementation in the Quote Spread Discount Pop-up applet subsequently triggers Pricing Procedure – Default, which evaluates the net prices and subtotal based on the new discount amounts.

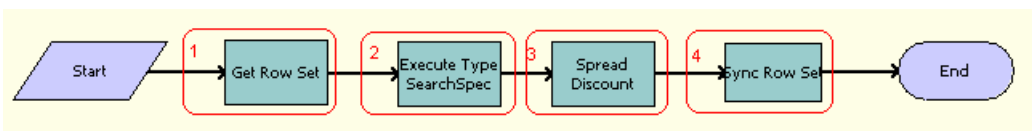

Figure 45. Spread Discount Driver Workflow Process

Workflow Description. This workflow does the following:

- 1 Generates a property set of the Line Item buscomp using Context Service variable maps. For more information, see *Siebel Order Management Guide*.
- 2 Filters out items that will not get a spread discount. By default, only nonrecurring change items are candidates for a spread discount.
- 3 Spreads a discount amount depending on the target total or target discount amount specified by the user.

4 Synchronizes the updated information back to the database.

Table 84 lists the steps in the Spread Discount Driver workflow with the business service and method that is called for each step.

Table 84. Steps of the Spread Discount Driver Workflow

Name	Type	Business Service	Method	Sub Process	Description
Get Row Set	Business Service	Context Service	GetRowSetData	Not applicable	Generates a property set from the Line Item business component.
Execute Type SearchSpec	Business Service	Row Set Transformation Toolkit	Split Transform	Not applicable	Filters out items that will not get a spread discount.
Spread Discount	Business Service	ISS Spread Discount Service	SpreadDiscount	Not applicable	Spreads a discount amount.
Sync Row Set	Business Service	Context Service	SyncRowSetData	Not applicable	Synchronizes the updated information back to database.

B

Siebel Pricer Deployment and Integration

This appendix contains information about integrating Siebel Pricer with Siebel business components and external applications. It covers the following topics:

- [“About Pricing Integration” on page 251](#)
- [“Integration Methods for Siebel Pricer” on page 253](#)
- [“Internal Integration of Siebel Pricer” on page 253](#)
- [“External Integration of Siebel Pricer Using Pricer as a Service” on page 274](#)
- [“Siebel Pricing Manager API Reference” on page 287](#)
- [“Workflows for External Pricing API” on page 290](#)
- [“Cache Configuration Settings” on page 293](#)

About Pricing Integration

You can integrate Siebel Pricer internally or externally, that is, from other Siebel application modules, or from other manufacturers' applications.

Siebel Pricer functionality is used internally for quotes, orders, and agreements, and can be used with popular external applications and services, for example, Enterprise Resource Planning (ERP) applications.

Figure 46 shows how the Pricing Manager business service can be integrated to provide Siebel Pricer functionality to both internal and external application modules.

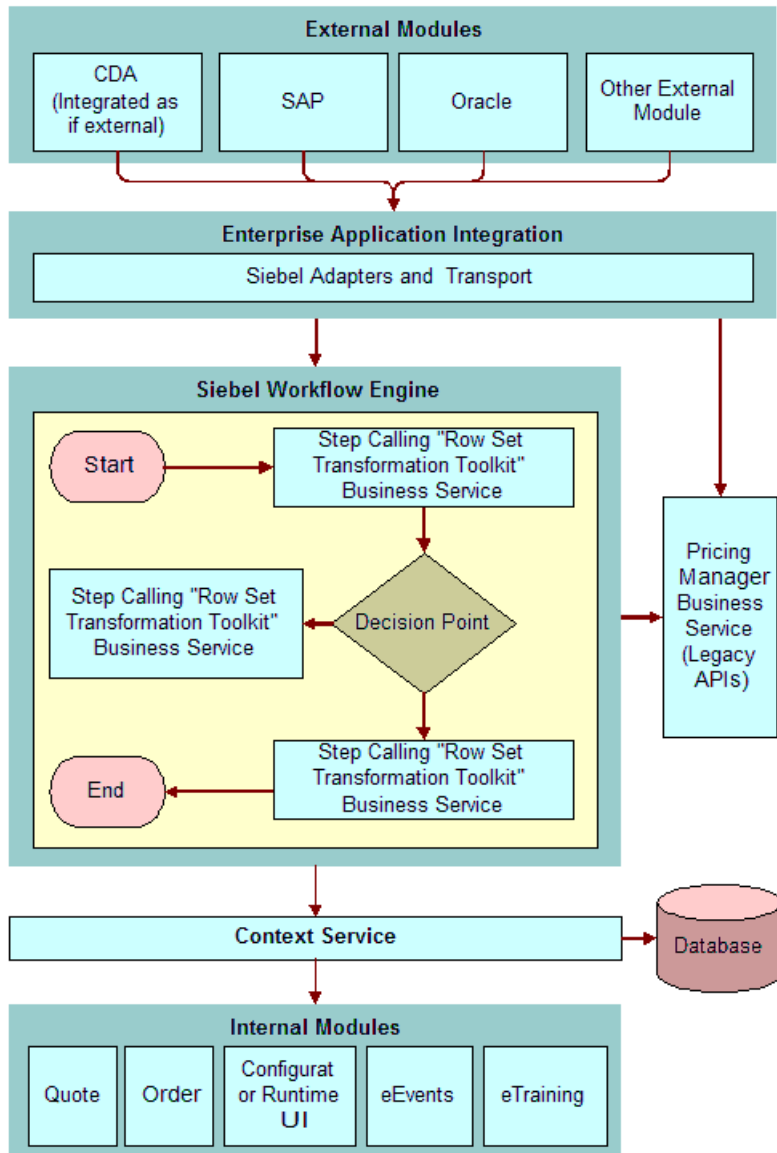

Figure 46. Pricing Manager Business Service (the Run-Time Pricing Engine)

Integration Methods for Siebel Pricer

Siebel Pricer supports the following types of integration:

- **Internal integration.** This allows you to configure the Siebel application so that Siebel Pricer works with other Siebel business objects. Without configuration, Siebel Pricer works with quotes, orders, and agreements. For more information, see [“Internal Integration of Siebel Pricer” on page 253](#).
- **External integration.** This allows you to integrate Siebel Pricer with other external applications, such as back office applications, in the following way:
 - **External integration using Pricer as a service.** You can use the Siebel Pricer engine without using the Siebel interface. Use this method when your business model does not require the external quotes and orders to be replicated in the Siebel application. For more information, see [“External Integration of Siebel Pricer Using Pricer as a Service” on page 274](#).
- **Integration using the Pricer API.** The API is retained to support users who used the Pricer API in earlier versions of the Siebel application, but for whom it is no longer the best practice in version 7.8 or later. For more information, see [“Siebel Pricing Manager API Reference” on page 287](#).

Internal Integration of Siebel Pricer

Without configuration, pricing functionality is used by quotes, orders, and agreements.

You can configure the application so that any business component can use pricing functionality. This topic gives an example of configuring the Opportunity business component to integrate it with Pricer. You can use similar methods for other business components.

This example allows the Opportunity and Opportunity Product business components to invoke the pricing procedure. For information about the pricing procedure, see [Appendix A, “Siebel Pricer Technical Reference.”](#)

CAUTION: Perform these changes on the local environment only. The change has enterprise-wide effect and may affect others using the same URL. Do not perform these changes unless you are familiar with Siebel Tools and Siebel order management infrastructure.

To allow the Opportunity and Opportunity Product business components to invoke the pricing procedure, do the following:

- [“Changing the Base Class of the Business Component to User CSSBCOrderMgmtBase” on page 254](#)
- [“Setting Up the Context Service Variable Map Integration Object and Mode” on page 254](#)
- [“Triggering CalculatePriceForOpportunity” on page 254](#)
- [“Designing the CalculatePriceForOpportunity Signal” on page 255](#)
- [“Creating an Integration Object” on page 256](#)
- [“Creating the Variable Map” on page 257](#)
- [“Creating the Pricing Procedure” on page 259](#)

Changing the Base Class of the Business Component to User CSSBCOrderMgmtBase

Use the following procedure to change the base class of the business component to user CSSBCOrderMgmtBase.

To change the base class of the business component to User CSSBCOrderMgmtBase

- 1 In Siebel Tools, in the Object Explorer, click Business Component.
- 2 Query for Opportunity Product and Opportunity.
- 3 Lock these objects.
- 4 For these objects, set Class to CSSBCOrderMgmtBase.

Setting the base class to CSSBCOrderMgmtBase enables a business component to raise a signal.

NOTE: You can do this only if the original business component is not using a specialized buscomp class. Otherwise, you risk losing the functionality offered by the specialized buscomp class.

Setting Up the Context Service Variable Map Integration Object and Mode

Use the following procedure to set up the Context Service Variable Map Integration Object and Mode

To set up the Context Service Variable Map Integration Object and Mode

- 1 In Siebel Tools, open the Object Explorer and under Business Component, click Business Component User Prop.
- 2 For both the Opportunity Product and Opportunity Buscomp, add the new user properties shown in the following table:

Name	Value
Instance Uniform Name EAI Object:Opportunity	ISS Opportunity
Mode	Opportunity

- a The first user property sets the Integration Object to be used for the variable map.
- b The second user property set the mode of the business component. This corresponds to the mode in the Signal and Variable Map definition. In this case, items with mode All and Opportunity would be picked up.

Triggering CalculatePriceForOpportunity

Use the following procedure to expose a button on the UI to trigger CalculatePriceForOpportunity.

To expose a button on the UI to trigger CalculatePriceForOpportunity

- 1** Alter the Opportunity Product applet as follows:
 - a** In the Object Explorer applet, drill down on Siebel Objects and Applet.
 - b** In Applets, input the following:
 - <New Query>
 - Name = Opportunity Product Applet
 - <Execute Query>
 Lock the project.
- 2** Add Controls <Reprice>
 - a** In the Object Explorer applet, click Control.
 - b** In the Controls applet, input the following:
 - <New Record>
 - Name = Reprice
 - Caption = Reprice
 - HTML Type = MiniButton
 - Method Invoked = CalculatePriceForOpportunity
- 3** Display the Web template:
 - a** In the Object Explorer applet, click Applet Web Template.
 - b** In Applet Web Templates, input the following:
 - Select Name = Edit List
 - Menu: View, Editors, Web Applet Editor
- 4** Add controls to the template as follows:
 - a** Navigate to the Controls or Columns applet at the bottom left of the screen.
 - b** Select Reprice, and then drag and drop to [x] next to last labeled control [Edit].
Create a button on the UI to raise a signal.

Designing the CalculatePriceForOpportunity Signal

Use the following procedure to design the CalculatePriceForOpportunity signal.

To design the CalculatePriceForOpportunity signal

- 1** Create a new signal with a name CalculatePriceForOpportunity.
- 2** Drill down on the workspace.

- 3 Create an Action as shown in the following table:

Sequence	Service Name	Service Type	Service Method
1	PSP Driver Workflow Process	Workflow	RunProcess

- 4 Create the parameters as shown in the following table:

Name	Value
CPScope	Whole
RowScope	Selected
SubPSPWFName	Pricing Procedure - Opportunity
Variable Map - Context	Opportunity Pricing Variable Map - Context
Variable Map - Row Set	Opportunity Pricing Variable Map - Row Set

- 5 Click the Release New Version button.
Create the signal to be triggered by the button created in [Step 4](#).

Creating an Integration Object

Use the following procedure to create an Integration Object.

To create an integration object

- 1 Create a new record, ISS Opportunity Integration Object, as shown in the following table:

Name	Project	Business Object	External Name	XML Tag
ISS Opportunity	ISS Order Management	Opportunity	ISS Object	ListOfISSObject

- 2 Create a new record, ISS Opportunity Integration Object, as shown in the following table:

Name	External Name Context	Parent Integration Component	External Name	External Sequence	Cardinality	XML Container Element	XML Tag
Header	Opportunity	-	Opportunity	1	One	ListOfHeader	Header
Line Item	Opportunity Product	Header	Opportunity Product	2	Zero or More	ListOfLineItem	LineItem

- 3 Enter Integration Component Fields of Opportunity, as shown in the following table:

Name	Data Type	Length	External Name	External Data Type	External Length	XML Style	XML Tag
Name	DTYPE_TEXT	50	Name	DTYPE_TEXT	50	Element	Name

- 4 Enter Integration Component Fields of Opportunity Product, as shown in the following table:

Name	Data Type	Length	Precision	External Name	External Data Type	External Length	XML Style	XML Tag
Comment	DTYPE_TEXT	255	N/A	Comment	DTYPE_TEXT	255	Element	Comment
Cost	DTYPE_NUMBER	N/A	N/A	Cost	DTYPE_NUMBER	N/A	Element	Cost
Product Id	DTYPE_ID	N/A	N/A	Product Id	DTYPE_ID	N/A	Element	Product Id
Product Price	DTYPE_NUMBER	N/A	N/A	Product Price	DTYPE_NUMBER	N/A	Element	Product Price
Product Quantity	DTYPE_NUMBER	N/A	16	Product Quantity	DTYPE_NUMBER	N/A	Element	Product Quantity
Quotable	DTYPE_TEXT	N/A	N/A	Quotable	DTYPE_BOOL	N/A	Element	Quotable
Revenue	DTYPE_NUMBER	N/A	N/A	Revenue	DTYPE_NUMBER	N/A	Element	Revenue

Create the uniform field map used by the variable map.

Creating the Variable Map

Use the following procedure to create the variable map.

To create the variable map

- 1 Create the Opportunity Pricing Variable Map - Context Variable Map.
- 2 Drill down on Workspace.
- 3 Create the Variable Definition as shown in the following table:

Variable Name	In/Out	Type	On Null
Name	In/Out	Text	Ignore

- 4 Create the Variable Source for the Variable Definition as shown in the following table:

Mode	Path	Source Type
Opportunity	\$Current/Header/Name	Instance

- 5 Click the Mode tab and create the recording as shown in the following table:

Mode	Object Name
Any	Header

- 6 Create the Opportunity Pricing Variable Map - Row Set Variable Map.

- 7 Drill down on Workspace.

- 8 Create the Variable Definitions as shown in the following table:

Variable Name	In/Out	Type	On Null
Comment	In/Out	Text	Ignore
Cost	In/Out	Number	Ignore
Product Id	In/Out	Id	Ignore
Product Price	In/Out	Number	Ignore
Product Quantity	In/Out	Number	Ignore
Quotable	In/Out	Boolean	Ignore
Revenue	In/Out	Number	Ignore

- 9 Create the Variable Source for each of these Variable Definitions as shown in the following table

Mode	Path	Source Type
Opportunity	\$Current/Line Item/Comment	Instance
Opportunity	\$Current/Line Item/Cost	Instance
Opportunity	\$Current/Line Item/Product Id	Instance
Opportunity	\$Current/Line Item/Product Price	Instance
Opportunity	\$Current/Line Item/Product Quantity	Instance
Opportunity	\$Current/Line Item/Quotable	Instance
Opportunity	\$Current/Line Item/Revenue	Instance

- 10 Click the Mode tab and create the recording as shown in the following table:

Mode	Object Name
Any	Line Item

Create the variable maps referenced by the signal.

Creating the Pricing Procedure

Use the following procedure to create the pricing procedure.

To create the pricing procedure

- Create a pricing procedure that drives the pricing logic.

One example is Pricing Procedure - Opportunity.xml in ["Sample Pricing Procedure for Internal Integration."](#) Make additions or modifications to this example as needed.

Pricing procedures are a type of PSP procedure. For more information about PSP procedures, see *Siebel Order Management Infrastructure Guide*.

Sample Pricing Procedure for Internal Integration

This topic contains Pricing Procedure - Opportunity.xml, the XML version of a sample pricing procedure meant to drive the pricing logic for internally integrating pricing with the Opportunity and Opportunity Product business components.

```
<?xml version="1.0" encoding="UTF-8" ?>
<?Siebel -Property-Set EscapeNames="false"?>
-<Siebel Message MessageId="" IntObjectName="Repository Workflow Definition Export
V. 7. 7. 1" MessageType="Integration Object" IntObjectFormat="Siebel Hierarchical">
-<ListOfRepositoryWorkflowProcess>
-<RepositoryWorkflowProcess>
  <BusinessObject />
  <CacheLocal />
  <Comments />
  <Description>Support Pricer APIs GetProductListPrice and GetConfigItemPrice</
Description>
  <EffectiveEndDate />
  <EffectiveStartDate />
  <ErrorProcessName />
  <Group />
  <Inactive>N</Inactive>
  <Module />
  <Name>Pricing Procedure - Opportunity: 3</Name>
  <PersistentFrequency>N</PersistentFrequency>
  <PersistentLevel />
  <ProcessName>Pricing Procedure - Opportunity</ProcessName>
  <ProjectName>Pricer</ProjectName>
  <RepliationLevel>None</RepliationLevel>
  <Runnable>N</Runnable>
  <Status>COMPLETED</Status>
```

```

<Version>3</Version>
<WorkflowMode>SRVFLOW</WorkflowMode>
- <ListOfRepositoryWfProcessProp>
- <RepositoryWfProcessProp>
  <AccessMode>RW</AccessMode>
<BusinessComponent />
  <Comments>Variables that are shared across all rows in Row Set.</Comments>
  <CorrelatorFlag>N</CorrelatorFlag>
  <DataType>PROPSET_CHILD</DataType>
  <DefaultDate />
  <DefaultNumber />
  <DefaultString />
  <DisplayName />
  <InOut>INOUT</InOut>
  <Inactive />
  <IntegrationObject />
  <Name2>Context</Name2>
  <VirtualField />
</RepositoryWfProcessProp>
- <RepositoryWfProcessProp>
  <AccessMode>RW</AccessMode>
  <BusinessComponent />
  <Comments>The set of line items to reprice.</Comments>
  <CorrelatorFlag>N</CorrelatorFlag>
  <DataType>PROPSET_CHILD</DataType>
  <DefaultDate />
  <DefaultNumber />
  <DefaultString />
  <DisplayName />
  <InOut>INOUT</InOut>
  <Inactive />
  <IntegrationObject />
  <Name2>Row Set</Name2>
  <VirtualField />
</RepositoryWfProcessProp>
</ListOfRepositoryWfProcessProp>
- <ListOfRepositoryWfStep>
- <RepositoryWfStep>
  <AllowRetryFlag>N</AllowRetryFlag>
  <BusinessComponent />
  <Operation />
  <BusinessServiceMethod />

```

```

    <BusinessServiceName />
    <Comments />
    <Description />
    <ErrorCode />
    <ErrorMessage />
    <EvaluateAll>Y</EvaluateAll>
    <Inactive>N</Inactive>
    <Layout>@0*0*3*0*0*0*1*r13*288 12 352 529*FillBgClr*167641088*ArrowEnd1*1</Layout>
    <MaximumIterations />
    <Name3>End</Name3>
    <ProcessingMode />
    <SubprocessName />
    <Type>END</Type>
    <UserInteractView />
    <ListOfRepositoryWfStepBranch />
    <ListOfRepositoryWfStepIOArgument />
    <ListOfRepositoryWfStepRecipient />
  </RepositoryWfStep>
- <RepositoryWfStep>
  <AllowRetryFlag>N</AllowRetryFlag>
  <BusinessComponent />
  <Operation />
  <BusinessServiceMethod>Simple Look-Up Transform</BusinessServiceMethod>
  <BusinessServiceName>Row Set Transformation Toolkit</BusinessServiceName>
  <Comments />
  <Description>Look up all values on the price list item.</Description>
  <ErrorCode />
  <ErrorMessage />
  <EvaluateAll>Y</EvaluateAll>
  <Inactive>N</Inactive>
  <Layout>@0*0*3*0*0*0*1*r13*180 12 244 529*FillBgClr*134217218*ArrowEnd1*1</Layout>
  <MaximumIterations />
  <Name3>Get List Price</Name3>
  <ProcessingMode />
  <SubprocessName />
  <Type>TASK</Type>
  <UserInteractView />
- <ListOfRepositoryWfStepBranch>
- <RepositoryWfStepBranch>
  <Comments />
  <Count />

```

```

<EvaluateSequence />
<Event />
<EventCancelFlag>N</EventCancelFlag>
<EventObject />
<EventObjectType />
<EventVisibility>ENTERPRISE</EventVisibility>
<Expression />
<Inactive>N</Inactive>
<Name2>NewConn: 1-3J9N9</Name2>
<Subevent />
<TimeLimit />
<Type>CONNECTOR</Type>
<UserEventName />
<UserEventStorage />
<UserEventTimeout>0</UserEventTimeout>
<ListOfRepositoryWfBranchCriteria />
</RepositoryWfStepBranch>
</ListOfRepositoryWfStepBranch>
- <ListOfRepositoryWfStepIOArgument>
- <RepositoryWfStepIOArgument>
  <BusinessComponent />
  <BusinessComponentField />
  <Comments />
  <Inactive>N</Inactive>
  <InputFlag>I</InputFlag>
  <ItemTypeName />
  <Name2>Business Component</Name2>
  <OutputArg />
  <PropertyName />
  <Sequence>0</Sequence>
  <Type>LITERAL</Type>
  <ValueSearchSpecification>Price List Item</ValueSearchSpecification>
</RepositoryWfStepIOArgument>
- <RepositoryWfStepIOArgument>
  <BusinessComponent />
  <BusinessComponentField />
  <Comments />
  <Inactive>N</Inactive>
  <InputFlag>I</InputFlag>
  <ItemTypeName />
  <Name2>Business Component</Name2>
  <OutputArg />

```

```

    <PropertyName />
    <Sequence>0</Sequence>
    <Type>LITERAL</Type>
    <ValueSearchSpecification>Price List Item</ValueSearchSpecification>
</RepositoryWorkflowArgument>
- <RepositoryWorkflowArgument>
    <BusinessComponent />
    <BusinessComponentField />
    <Comments />
    <Inactive>N</Inactive>
    <InputFlag>I</InputFlag>
    <ItemTypeName />
    <Name2>Business Component</Name2>
    <OutputArg />
    <PropertyName />
    <Sequence>0</Sequence>
    <Type>LITERAL</Type>
    <ValueSearchSpecification>Price List Item</ValueSearchSpecification>
</RepositoryWorkflowArgument>
- <RepositoryWorkflowArgument>
    <BusinessComponent />
    <BusinessComponentField />
    <Comments />
    <Inactive>N</Inactive>
    <InputFlag>I</InputFlag>
    <ItemTypeName />
    <Name2>Business Component</Name2>
    <OutputArg />
    <PropertyName />
    <Sequence>0</Sequence>
    <Type>LITERAL</Type>
    <ValueSearchSpecification>Price List Item</ValueSearchSpecification>
</RepositoryWorkflowArgument>
- <RepositoryWorkflowArgument>
    <BusinessComponent />
    <BusinessComponentField />
    <Comments />
    <Inactive>N</Inactive>
    <InputFlag>I</InputFlag>
    <ItemTypeName />
    <Name2>Business Object</Name2>
    <OutputArg />

```

```

    <PropertyName />
    <Sequence>0</Sequence>
    <Type>LITERAL</Type>
    <ValueSearchSpecification>Admin Price List</ValueSearchSpecification>
</RepositoryWorkflowArgument>
- <RepositoryWorkflowArgument>
    <BusinessComponent />
    <BusinessComponentField />
    <Comments />
    <Inactive>N</Inactive>
    <InputFlag>I</InputFlag>
    <ItemTypeName />
    <Name2>Business Object</Name2>
    <OutputArg />
    <PropertyName />
    <Sequence>0</Sequence>
    <Type>LITERAL</Type>
    <ValueSearchSpecification>Admin Price List</ValueSearchSpecification>
</RepositoryWorkflowArgument>
- <RepositoryWorkflowArgument>
    <BusinessComponent />
    <BusinessComponentField />
    <Comments />
    <Inactive>N</Inactive>
    <InputFlag>I</InputFlag>
    <ItemTypeName />
    <Name2>Business Object</Name2>
    <OutputArg />
    <PropertyName />
    <Sequence>0</Sequence>
    <Type>LITERAL</Type>
    <ValueSearchSpecification>Admin Price List</ValueSearchSpecification>
</RepositoryWorkflowArgument>
- <RepositoryWorkflowArgument>
    <BusinessComponent />
    <BusinessComponentField />
    <Comments />
    <Inactive>N</Inactive>
    <InputFlag>I</InputFlag>
    <ItemTypeName />
    <Name2>Business Object</Name2>
    <OutputArg />

```



```

    <PropertyName />
    <Sequence>0</Sequence>
    <Type>LITERAL</Type>
    <ValueSearchSpecification>Admin Price List</ValueSearchSpecification>
</RepositoryWfStep10Argument>
- <RepositoryWfStep10Argument>
    <BusinessComponent />
    <BusinessComponentField />
    <Comments />
    <Inactive>N</Inactive>
    <InputFlag>I</InputFlag>
    <ItemTypeName />
    <Name2>Context</Name2>
    <OutputArg />
    <PropertyName>Context</PropertyName>
    <Sequence>0</Sequence>
    <Type>PROPERTY</Type>
    <ValueSearchSpecification />
</RepositoryWfStep10Argument>
- <RepositoryWfStep10Argument>
    <BusinessComponent />
    <BusinessComponentField />
    <Comments />
    <Inactive>N</Inactive>
    <InputFlag>I</InputFlag>
    <ItemTypeName />
    <Name2>On First Match 5</Name2>
    <OutputArg />
    <PropertyName />
    <Sequence>0</Sequence>
    <Type>LITERAL</Type>
    <ValueSearchSpecification>{Row.Product Price} = {Match.List Price}</
    ValueSearchSpecification>
</RepositoryWfStep10Argument>
- <RepositoryWfStep10Argument>
    <BusinessComponent />
    <BusinessComponentField />
    <Comments />
    <Inactive>N</Inactive>
    <InputFlag>I</InputFlag>
    <ItemTypeName />
    <Name2>On First Match 5</Name2>
    <OutputArg />

```

```

    <PropertyName />
    <Sequence>0</Sequence>
    <Type>LITERAL</Type>
    <ValueSearchSpecification>{Row.Product Price} = {Match.List Price}</
    ValueSearchSpecification>
</RepositoryWorkflowStep10Argument>
- <RepositoryWorkflowStep10Argument>
    <BusinessComponent />
    <BusinessComponentField />
    <Comments />
    <Inactive>N</Inactive>
    <InputFlag>I</InputFlag>
    <ItemTypeName />
    <Name2>On First Match 5</Name2>
    <OutputArg />
    <PropertyName />
    <Sequence>0</Sequence>
    <Type>LITERAL</Type>
    <ValueSearchSpecification>{Row.Product Price} = {Match.List Price}</
    ValueSearchSpecification>
</RepositoryWorkflowStep10Argument>
- <RepositoryWorkflowStep10Argument>
    <BusinessComponent />
    <BusinessComponentField />
    <Comments />
    <Inactive>N</Inactive>
    <InputFlag>I</InputFlag>
    <ItemTypeName />
    <Name2>On First Match 5</Name2>
    <OutputArg />
    <PropertyName />
    <Sequence>0</Sequence>
    <Type>LITERAL</Type>
    <ValueSearchSpecification>{Row.Product Price} = {Match.List Price}</
    ValueSearchSpecification>
</RepositoryWorkflowStep10Argument>
- <RepositoryWorkflowStep10Argument>
    <BusinessComponent />
    <BusinessComponentField />
    <Comments />
    <Inactive>N</Inactive>
    <InputFlag>I</InputFlag>
    <ItemTypeName />

```

```

    <Name2>On First Match 6</Name2>
    <OutputArg />
    <PropertyName />
    <Sequence>0</Sequence>
    <Type>LITERAL</Type>
    <ValueSearchSpecification>{Row. Revenue} = {Match. MSRP Price}</
    ValueSearchSpecification>
</RepositoryWorkflowStep10Argument>
- <RepositoryWorkflowStep10Argument>
    <BusinessComponent />
    <BusinessComponentField />
    <Comments />
    <Inactive>N</Inactive>
    <InputFlag>I</InputFlag>
    <ItemTypeName />
    <Name2>On First Match 6</Name2>
    <OutputArg />
    <PropertyName />
    <Sequence>0</Sequence>
    <Type>LITERAL</Type>
    <ValueSearchSpecification>{Row. Revenue} = {Match. MSRP Price}</
    ValueSearchSpecification>
</RepositoryWorkflowStep10Argument>
- <RepositoryWorkflowStep10Argument>
    <BusinessComponent />
    <BusinessComponentField />
    <Comments />
    <Inactive>N</Inactive>
    <InputFlag>I</InputFlag>
    <ItemTypeName />
    <Name2>On First Match 6</Name2>
    <OutputArg />
    <PropertyName />
    <Sequence>0</Sequence>
    <Type>LITERAL</Type>
    <ValueSearchSpecification>{Row. Revenue} = {Match. MSRP Price}</
    ValueSearchSpecification>
</RepositoryWorkflowStep10Argument>
- <RepositoryWorkflowStep10Argument>
    <BusinessComponent />
    <BusinessComponentField />
    <Comments />
    <Inactive>N</Inactive>

```

```

<InputFlag>I</InputFlag>
<ItemTypeName />
<Name2>On First Match 6</Name2>
<OutputArg />
<PropertyName />
<Sequence>0</Sequence>
<Type>LITERAL</Type>
<ValueSearchSpecification>{Row. Revenue} = {Match. MSRP Price}</
ValueSearchSpecification>
</RepositoryWorkflowStepIOArgument>
- <RepositoryWorkflowStepIOArgument>
  <BusinessComponent />
  <BusinessComponentField />
  <Comments />
  <Inactive>N</Inactive>
  <InputFlag>I</InputFlag>
  <ItemTypeName />
  <Name2>On First Match 8</Name2>
  <OutputArg />
  <PropertyName />
  <Sequence>0</Sequence>
  <Type>LITERAL</Type>
  <ValueSearchSpecification>{Row. Cost} = {Match. Cost}</
ValueSearchSpecification>
</RepositoryWorkflowStepIOArgument>
- <RepositoryWorkflowStepIOArgument>
  <BusinessComponent />
  <BusinessComponentField />
  <Comments />
  <Inactive>N</Inactive>
  <InputFlag>I</InputFlag>
  <ItemTypeName />
  <Name2>On First Match 8</Name2>
  <OutputArg />
  <PropertyName />
  <Sequence>0</Sequence>
  <Type>LITERAL</Type>
  <ValueSearchSpecification>{Row. Cost} = {Match. Cost}</
ValueSearchSpecification>
</RepositoryWorkflowStepIOArgument>
- <RepositoryWorkflowStepIOArgument>
  <BusinessComponent />
  <BusinessComponentField />

```

```

    <Comments />
    <Inactive>N</Inactive>
    <InputFlag>I</InputFlag>
    <ItemTypeName />
    <Name2>On First Match 8</Name2>
    <OutputArg />
    <PropertyName />
    <Sequence>0</Sequence>
    <Type>LITERAL</Type>
    <ValueSearchSpecification>{Row. Cost} = {Match. Cost}</
    ValueSearchSpecification>
</RepositoryWfStep10Argument>
- <RepositoryWfStep10Argument>
    <BusinessComponent />
    <BusinessComponentField />
    <Comments />
    <Inactive>N</Inactive>
    <InputFlag>I</InputFlag>
    <ItemTypeName />
    <Name2>On First Match 8</Name2>
    <OutputArg />
    <PropertyName />
    <Sequence>0</Sequence>
    <Type>LITERAL</Type>
    <ValueSearchSpecification>{Row. Cost} = {Match. Cost}</
    ValueSearchSpecification>
</RepositoryWfStep10Argument>
- <RepositoryWfStep10Argument>
    <BusinessComponent />
    <BusinessComponentField />
    <Comments />
    <Inactive>N</Inactive>
    <InputFlag>I</InputFlag>
    <ItemTypeName />
    <Name2>Row Set</Name2>
    <OutputArg />
    <PropertyName>Row Set</PropertyName>
    <Sequence>0</Sequence>
    <Type>PROPERTY</Type>
    <ValueSearchSpecification />
</RepositoryWfStep10Argument>
- <RepositoryWfStep10Argument>
    <BusinessComponent />

```

```

    <BusinessComponentField />
    <Comments />
    <Inactive>N</Inactive>
    <InputFlag>I</InputFlag>
    <ItemTypeName />
    <Name2>Search Specification</Name2>
    <OutputArg />
    <PropertyName />
    <Sequence>0</Sequence>
    <Type>LITERAL</Type>
    <ValueSearchSpecification>[Price List Id] = {Context.Name} AND [Product Id] =
    {Row.Product Id}</ValueSearchSpecification>
</RepositoryWfStep10Argument>
- <RepositoryWfStep10Argument>
    <BusinessComponent />
    <BusinessComponentField />
    <Comments />
    <Inactive>N</Inactive>
    <InputFlag>I</InputFlag>
    <ItemTypeName />
    <Name2>Search Specification</Name2>
    <OutputArg />
    <PropertyName />
    <Sequence>0</Sequence>
    <Type>LITERAL</Type>
    <ValueSearchSpecification>[Price List Id] = {Context.Name} AND [Product Id] =
    {Row.Product Id}</ValueSearchSpecification>
</RepositoryWfStep10Argument>
- <RepositoryWfStep10Argument>
    <BusinessComponent />
    <BusinessComponentField />
    <Comments />
    <Inactive>N</Inactive>
    <InputFlag>I</InputFlag>
    <ItemTypeName />
    <Name2>Search Specification</Name2>
    <OutputArg />
    <PropertyName />
    <Sequence>0</Sequence>
    <Type>LITERAL</Type>
    <ValueSearchSpecification>[Price List Id] = {Context.Name} AND [Product Id] =
    {Row.Product Id}</ValueSearchSpecification>
</RepositoryWfStep10Argument>

```

```

- <RepositoryWfStep10Argument>
  <BusinessComponent />
  <BusinessComponentField />
  <Comments />
  <Inactive>N</Inactive>
  <InputFlag>I</InputFlag>
  <ItemTypeName />
  <Name2>Search Specification</Name2>
  <OutputArg />
  <PropertyName />
  <Sequence>0</Sequence>
  <Type>LITERAL</Type>
  <ValueSearchSpecification>[Price List Id] = {Context.Name} AND [Product Id] =
  {Row.Product Id}</ValueSearchSpecification>
</RepositoryWfStep10Argument>
- <RepositoryWfStep10Argument>
  <BusinessComponent />
  <BusinessComponentField />
  <Comments />
  <Inactive>N</Inactive>
  <InputFlag>0</InputFlag>
  <ItemTypeName />
  <Name2>0: Get List Price1</Name2>
  <OutputArg>Row Set</OutputArg>
  <PropertyName>Row Set</PropertyName>
  <Sequence>1</Sequence>
  <Type>ARGUMENT</Type>
  <ValueSearchSpecification />
</RepositoryWfStep10Argument>
- <RepositoryWfStep10Argument>
  <BusinessComponent />
  <BusinessComponentField />
  <Comments />
  <Inactive>N</Inactive>
  <InputFlag>0</InputFlag>
  <ItemTypeName />
  <Name2>0: Get List Price20</Name2>
  <OutputArg>Context</OutputArg>
  <PropertyName>Context</PropertyName>
  <Sequence>2</Sequence>
  <Type>ARGUMENT</Type>
  <ValueSearchSpecification />
</RepositoryWfStep10Argument>

```

```

    </ListOfRepositoryWfStepIOArgument>
    <ListOfRepositoryWfStepRecipient />
</RepositoryWfStep>
- <RepositoryWfStep>
  <AllowRetryFlag>N</AllowRetryFlag>
  <BusinessComponent />
  <Operation />
  <BusinessServiceMethod />
  <BusinessServiceName />
  <Comments />
  <Description />
  <ErrorCode />
  <ErrorMessage />
  <EvaluateAll>Y</EvaluateAll>
  <Inactive>N</Inactive>
  <Layout>@0*0*3*0*0*0*1*r12*96 12 160 529*FillBgClr8*167641088*ArrowEnd1*1</Layout>
  <MaximumIterations />
  <Name3>Start</Name3>
  <ProcessingMode />
  <SubprocessName />
  <Type>START</Type>
  <UserInteractView />
- <ListOfRepositoryWfStepBranch>
- <RepositoryWfStepBranch>
  <Comments />
  <Count />
  <EvaluateSequence />
  <Event />
  <EventCancelFlag>N</EventCancelFlag>
  <EventObject />
  <EventObjectType />
  <EventVisibility>ENTERPRISE</EventVisibility>
  <Expression />
  <Inactive>N</Inactive>
  <Name2>NewConn: 1-3J9N7</Name2>
  <Subevent />
  <TimeLimit />
  <Type>DEFAULT</Type>
  <UserEventName />
  <UserEventStorage />
  <UserEventTimeout>0</UserEventTimeout>

```



```

<ListOfWorkflowBranchCriteria />
</RepositoryWorkflowStepBranch>
</ListOfWorkflowStepBranch>
<ListOfWorkflowStepIOArgument />
<ListOfWorkflowStepRecipient />
</RepositoryWorkflowStep>
</ListOfWorkflowStep>
- <ListOfWorkflowBranchConnector>
- <RepositoryWorkflowBranchConnector>
  <Comments />
  <FromStepName>Start</FromStepName>
  <Inactive>N</Inactive>
  <Layout>@0*0*9*0*0*0*9*LineWidth1*24*FrHS1*22*P16*180 324*Npts1*22*P06*152
  324*ToID8*04-EAATQ6*FromID8*04-EAAU84*ToHS1*08*ArrowEnd1*1</Layout>
  <Name2>NewConn: 1-3J9N7</Name2>
  <ForBranchName>NewConn: 1-3J9N7</ForBranchName>
  <ParentType>DEFAULT</ParentType>
  <ToStepName>Get List Price</ToStepName>
</RepositoryWorkflowBranchConnector>
- <RepositoryWorkflowBranchConnector>
  <Comments />
  <FromStepName>Get List Price</FromStepName>
  <Inactive>N</Inactive>
  <Layout>@0*0*9*0*0*0*9*LineWidth1*24*FrHS1*22*P16*288 324*Npts1*22*P06*244
  324*ToID8*04-EAATP6*FromID8*04-EAATQ4*ToHS1*08*ArrowEnd1*1</Layout>
  <Name2>NewConn: 1-3J9N9</Name2>
  <ForBranchName>NewConn: 1-3J9N9</ForBranchName>
  <ParentType>CONNECTOR</ParentType>
  <ToStepName>End</ToStepName>
</RepositoryWorkflowBranchConnector>
</ListOfWorkflowBranchConnector>
</RepositoryWorkflowProcess>
</ListOfWorkflowProcess>
</Siebel Message>

```

External Integration of Siebel Pricer Using Pricer as a Service

You use Pricer as an external service if you do not want to use the Siebel interface, but only the Siebel pricing engine. The Siebel pricing engine must receive data in a particular format, which is called the property set. Integration involves getting data in that format and passing it to the pricing procedure.

A typical flow for this type of external integration is as follows:

- The property set is the standard data format for integration. It is created by a Business Service Script that is based on the data from the external application. However, the property set format must be understood by the pricing procedure. For the property set format expected by the pricing procedure, see “Sample Pricing Procedure for Internal Integration” on page 259 and “Sample XML Output Property Set for External Integration” on page 280.
- The desired pricing procedure is called with the property set generated in the previous step. Pricing information is updated on the property set.
- The Business Service Script extracts updated information from the property set and synchronizes back to the external data source.

The following example illustrates this process.

A simple product and a complex product with a component product are created. A price list is then created and the products are associated with it, as shown in Figure 47.

The screenshot shows the Siebel Price List Administration interface. The top navigation bar includes Home, Opportunities, Accounts, Contacts, Calendar, Quotes, Administration - Application, Administration - Business Service, and Administration - Pricing. The main window displays the 'Test Price List' details, including 'Price List: Test Price List', 'Effective From: 1/10/2005 12:00:00 AM', 'Currency: USD', and 'Description:'. Below this, there are tabs for 'More Info', 'Price List Line Items', and 'Service Pricing'. The 'Price List Line Items' tab is active, showing a table with the following data:

Product	Customizable	List Price	Promotional Price	Volume Discount	Attribute Adjuster	Start Date	End Date
Test Complex Product Component 1		\$2,000.00				1/10/2005 2:18:38 P	
Test Complex Product Root	✓	\$5,000.00				1/10/2005 2:18:23 P	
Test Simple Product 1		\$1,000.00				1/10/2005 2:18:23 P	

Figure 47. Price List for External Integration Example

Products are added to the quote, as shown in Figure 48. As expected, prices are stamped on each of the products, and all the steps under Internal Integration are performed to produce the prices.

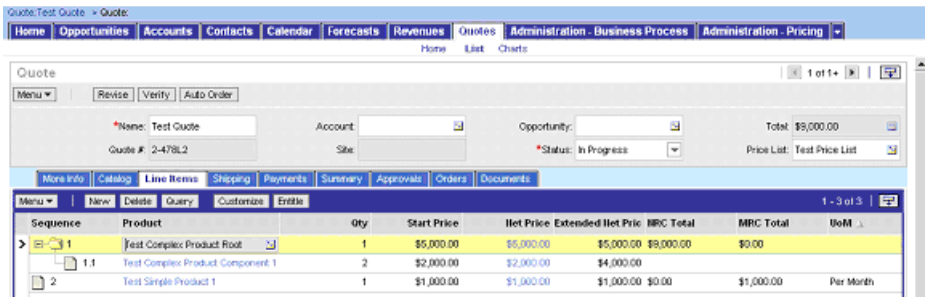

Figure 48. Quote for External Integration Example

Now, instead of using the Siebel application interface to create the quote, the following script is used to create the quote:

```

function Service_PreInvokeMethod (MethodName, Inputs, Outputs)
{
    var fileName = "C:\\log.txt";
    var xmlFile = "C:\\pricer_input.xml";
    var procedureName = "Dynamic Pricing Procedure";

    var psXMLSvcInputs = TheApplication().NewPropertySet();
    var psPricingProcedureInputs = TheApplication().NewPropertySet();
    var psPricingProcedureOutputs = TheApplication().NewPropertySet();

    // In this example, Read the Property Set from an XML file.
    // The Property Set contains a simple product and a complex product to be priced.
    // This can be generated from other sources as well, such as from
    // external systems, as long as the Property Set conformed to the format
    var xmlSvc = TheApplication().GetService("EAI XML Read from File");
    psXMLSvcInputs.SetProperty("FileName", xmlFile);
    xmlSvc.InvokeMethod("ReadPropSet", psXMLSvcInputs, psPricingProcedureInputs);

    // After the property set is created, the "Dynamic Pricing Procedure" WF
    // is invoked. The output would contain the simple product and the complex
    // product with updated pricing information.
    var wfSvc = TheApplication().GetService("Workflow Process Manager");
    psPricingProcedureInputs.SetProperty("ProcessName", procedureName);

    wfSvc.InvokeMethod("RunProcess", psPricingProcedureInputs,
    psPricingProcedureOutputs);
    return (CancelOperation);
}
    
```

The first function in this script contains three essential processes for external integration:

- A property set is created by a Business Service Script based on the data from the external application. In this example, the property set is loaded from an XML file. The property set format must be understood by the pricing procedure. For the required property set format, see the step that follows this one.

```
// In this example, Read the Property Set from an XML file.  
  
// The Property Set contains a simple product and a complex product to be priced.  
  
// This can be generated from other sources as well, such as from  
  
// external systems, as long as the Property Set conformed to the format  
  
var xmlSvc = TheApplication().GetService ("EAI XML Read from File");  
psXMLSvcInputs.SetProperty ("FileName", xmlFile);  
  
xmlSvc.InvokeMethod ("ReadPropSet", psXMLSvcInputs, psPricingProcedureInputs);
```

- The desired Pricing Workflow is called with the property set generated in the previous step. Pricing information is updated on the property set.

```
var procedureName = "Dynamic Pricing Procedure";  
  
// ...  
  
var wfSvc = TheApplication().GetService ("Workflow Process Manager");  
psPricingProcedureInputs.SetProperty ("ProcessName", procedureName);  
  
wfSvc.InvokeMethod ("RunProcess", psPricingProcedureInputs,  
psPricingProcedureOutputs);
```

- The Business Service Script extracts updated information from the property set and synchronizes back to the external data source. See the following examples for more information:
 - ["Sample XML Input Property Set for External Integration" on page 276](#)
 - ["Sample XML Output Property Set for External Integration" on page 280](#)

Sample XML Input Property Set for External Integration

The following code sample shows some sample XML Input Property Set for external integration:

```
<?xml version="1.0" encoding="UTF-8"?><?Siebel -Property-Set  
EscapeNames="true"?><PropertySet  
><Context  
  Local_spcLanguage="ENU"  
  Local_spcTime_spcZone="(GMT-08:00) Pacific Time (US & Canada); Tijuana"  
  CPScope="Whole"  
  CPCollapaseAI=""  
  RowScope="Current"
```

```

Mode="Quote"
>Default Pricing Variable Map - Context<Header
  Currency_spcCode="USD"
  Discount_spcPercent=""
  Exchange_spcDate="02/09/2005"
  Price_spcList_spcId="2-478KT"
>2-478L2</Header
></Context
><Row_spcSet
  Local_spcLanguage="ENU"
  Local_spcTime_spcZone="(GMT-08:00) Pacific Time (US & Canada); Tijuana"
  CPSCOPE="Whole"
  CPColIapseAI=""
  RowScope="Current"
  Mode="Quote"
>Default Pricing Variable Map - Row Set<Line_spcItem
  NRC_spcCxTotal="0"
  Class_spcId=""
  Unit_spcof_spcMeasure=""
  Service_spcPrice_spcMethod=""
  Id="2-478LF"
  Current_spcDiscount_spcId=""
  Exclude_spcPricing_spcFlag="N"
  Extended_spcQuantity_spcRequested="1"
  Sales_spcService_spcFlag="N"
  Covered_spcProduct_spcNet_spcPrice=""
  Currency_spcCode="USD"
  Product_spcId="2-478K6"
  Min_spcPrice=""
  Next_spcDiscount_spcId=""
  Discount_spcPercent=""
  Prod_spcProm_spcId=""
  Rollup_spcAmount="0"
  Covered_spcProduct_spcId=""
  Covered_spcAsset_spcProduct_spcId=""
  Parent_spcItem_spcId=""
  Product_spcPort_spcId=""
  Net_spcPrice=""
  List_spcPrice=""
  Promotion_spcItem_spcFlag="N"
  Upsell=""
  Root_spcBundle_spcFlag="N"

```

```
Pri ce_spcType="One-Ti me"
Covered_spcLi ne_spcI tem_spcI d=""
Product_spcLi ne_spcI d="No Match Row I d"
Uni t_spcPri ce=""
Max_spcPri ce=""
Di scount_spcAmount=""
Exchange_spcDate="02/09/2005"
Quanti ty="1"
Acti on_spcCode="Add"
Usage_spcAsset_spcProduct_spcI d=""
Pri ce_spcLi st_spcI d=""
Start_spcPri ce=""
Servi ce_spcPri ce_spcPercent=""
MRC_spcCxTotal ="0"
>2-478LF<Attri butes
>Defaul t Pri ci ng Vari able Map - XA</Attri butes
></Li ne_spcI tem
><Li ne_spcI tem
NRC_spcCxTotal =" "
Cl ass_spcI d=""
Uni t_spcof_spcMeasure=""
Servi ce_spcPri ce_spcMethod=""
I d="2-478NH"
Current_spcDi scount_spcI d=""
Excl ude_spcPri ci ng_spcFl ag="N"
Extended_spcQuanti ty_spcRequested="2"
Sal es_spcServi ce_spcFl ag="N"
Covered_spcProduct_spcNet_spcPri ce=""
Currency_spcCode="USD"
Product_spcI d="2-478JP"
Mi n_spcPri ce=""
Next_spcDi scount_spcI d=""
Di scount_spcPercent=""
Prod_spcProm_spcI d=""
Rol l up_spcAmount="0"
Covered_spcProduct_spcI d=""
Covered_spcAsset_spcProduct_spcI d=""
Parent_spcI tem_spcI d="2-478LF"
Product_spcPort_spcI d="2-478KD"
Net_spcPri ce=""
Li st_spcPri ce=""
Promoti on_spcI tem_spcFl ag="N"
```

```
Upsell=""
Root_spcBundle_spcFlag="N"
Price_spcType="One-Time"
Covered_spcLine_spcItem_spcId=""
Product_spcLine_spcId="No Match Row Id"
Unit_spcPrice=""
Max_spcPrice=""
Discount_spcAmount=""
Exchange_spcDate="02/09/2005"
Quantity="2"
Action_spcCode="Add"
Usage_spcAsset_spcProduct_spcId=""
Price_spcList_spcId=""
Start_spcPrice=""
Service_spcPrice_spcPercent=""
MRC_spcCxTotal=""
>2-478NH<Attributes
>Default Pricing Variable Map - XA</Attributes
></Line_spcItem
><Line_spcItem
  NRC_spcCxTotal="0"
  Class_spcId=""
  Unit_spcof_spcMeasure="Per Month"
  Service_spcPrice_spcMethod=""
  Id="2-4780D"
  Current_spcDiscount_spcId=""
  Exclude_spcPricing_spcFlag="N"
  Extended_spcQuantity_spcRequested="1"
  Sales_spcService_spcFlag="N"
  Covered_spcProduct_spcNet_spcPrice=""
  Currency_spcCode="USD"
  Product_spcId="2-478J6"
  Min_spcPrice=""
  Next_spcDiscount_spcId=""
  Discount_spcPercent=""
  Prod_spcProm_spcId=""
  Rollup_spcAmount="0"
  Covered_spcProduct_spcId=""
  Covered_spcAsset_spcProduct_spcId=""
  Parent_spcItem_spcId=""
  Product_spcPort_spcId=""
  Net_spcPrice=""
```

```
Li st_spcPri ce=""
Promoti on_spcLi ne_spcFl ag="N"
Upsel l=""
Root_spcBundl e_spcFl ag="N"
Pri ce_spcType="Recurri ng"
Covered_spcLi ne_spcLi ne_spcId=""
Product_spcLi ne_spcId="No Match Row Id"
Uni t_spcPri ce=""
Max_spcPri ce=""
Di scount_spcAmount=""
Exchange_spcDate="02/09/2005"
Quanti ty="1"
Acti on_spcCode="Add"
Usage_spcAsset_spcProduct_spcId=""
Pri ce_spcLi st_spcId=""
Start_spcPri ce=""
Servi ce_spcPri ce_spcPercent=""
MRC_spcCxTotal ="0"
>2-4780D<Attri butes
>Defaul t Pri ci ng Vari abl e Map - XA</Attri butes
></Li ne_spcLi ne
></Row_spcSet
></PropertySet
>
```

Sample XML Output Property Set for External Integration

The following code sample shows some sample XML Output Property Set for external integration:

```
<?xml versi on="1.0" encodi ng="UTF-8"?><?Si ebel -Property-Set
EscapeNames="true"?><PropertySet
><Context
  Local_spcLanguage="ENU"
  Local_spcTi me_spcZone="(GMT-08:00) Paci fi c Ti me (US & Canada); Ti juana"
  CPSCOpe="Whol e"
  CPCol l apseAl l=""
  RowScope="Current"
  Mode="Quote"
>Defaul t Pri ci ng Vari abl e Map - Context<Header
  Pri ce_spcLi st_spcName="Test Pri ce Li st"
  Currency_spcCode="USD"
```



```

Discount_spcPercent=""
Is_spcPricer_spcList_spcExpired_spcFlag="N"
Exchange_spcDate="02/09/2005"
Is_spcPricer_spcList_spcNot_spcEffective_spcFlag="N"
Pricer_spcList_spcId="2-478KT"
>2-478L2</Header
></Context
><Row_spcSet
  Local_spcLanguage="ENU"
  Local_spcTime_spcZone="(GMT-08:00) Pacific Time (US & Canada); Tijuana"
  CP_Scope="Whole"
  CPColapseAll=""
  RowScope="Current"
  Mode="Quote"
>Default Pricing Variable Map - Row Set<Line_spcItem
  Extended_spcQuantity_spcRequested="1"
  Temp_spcList_spcPricer="5000"
  Discount_spcPercent=""
  Rollup_spcAmount="4000"
  Upsell=""
  Covered_spcLine_spcItem_spcId=""
  Temp_spcMRC_spcRollup_spcItem_spcPricer="0"
  Quantity="1"
  Pricer_spcList_spcId="2-478KT"
  MRC_spcCxtotal="0"
  Temp_spcNRC_spcCxtotal="9000"
  Skip_spcPricing_spcFlag="N"
  Effective_spcPromotion_spcId=""
  Product_spcId="2-478K6"
  Prod_spcProm_spcId=""
  Temp_spcNRC_spcLine_spcTotal="9000"
  Covered_spcAsset_spcProduct_spcId=""
  Temp_spcMRC_spcLine_spcTotal="0"
  Max_spcPricer=""
  Root_spcPricer_spcList_spcItem_spcId="2-478KW"
  MSRP_spcPricer=""
  Temp_spcNRC_spcNet_spcPricer="5000"
  Bundle_spcSequence_spcId=""
  Net_spcPricer="5000"
  List_spcPricer="5000"
  Root_spcBundle_spcFlag="N"
  Pricer_spcType="One-Time"

```

```
Product_spcLine_spcId="No Match Row Id"
Unit_spcof_spcMeasure=""
Temp_spcMRC_spcNet_spcPrice="0"
Id="2-478LF"
Purchase_spcPrice=""
Parent_spcItem_spcId=""
Rollup_spcItem_spcPrice="9000"
Exchange_spcDate="02/09/2005"
Covered_spcProduct_spcNet_spcPrice=""
Currency_spcCode="USD"
Root_spcExchange_spcDate="02/09/2005"
Cost_spcPrice=""
Covered_spcProduct_spcId=""
Product_spcPort_spcId=""
Root_spcPromotion_spcId=""
Unit_spcPrice=""
Discount_spcAmount=""
Dynamic_spcMatrix=""
Root_spcPrice_spcList_spcId="2-478KT"
Root_spcCurrency_spcCode="USD"
Exclude_spcPricing_spcFlag="N"
List_spcPrice_spcWaterfall_spcText="List price from 'Test Price List' price list"
Price_spcList_spcItem_spcId="2-478KW"
Min_spcPrice=""
Temp_spcMRC_spcCxTotal="0"
Service_spcPrice_spcMethod=""
Next_spcDiscount_spcId=""
Promotion_spcItem_spcFlag="N"
Header_spcDiscount_spcAmount="0"
Action_spcCode="Add"
NRC_spcCxTotal="9000"
Class_spcId=""
List_spcPrice_spcWaterfall="5000"
Current_spcDiscount_spcId=""
Sales_spcService_spcFlag="N"
Rollup_spcAmount_spcMRC="0"
Temp_spcParent_spcQuantity="1"
Volume_spcDiscount_spcId=""
Root_spcProduct_spcId="2-478K6"
Pricing_spcAdjustment_spcAmount="0"
Usage_spcAsset_spcProduct_spcId=""
Start_spcPrice="5000"
```

```

    Servi ce_spcPri ce_spcPercent=""
>2-478LF<Attri butes
>Defaul t Pri cing Vari abl e Map - XA</Attri butes
><Net_spcPri ce_spcWaterfal l
><Waterfal l
  Adj ustment_spcAmount="5000"
  Pri ce="5000"
  Currency_spcCode="USD"
  Text="Li st price from &apos;Test Price Li st&apos; price li st"
  Adj ustment_spcType="Pri ce Overri de"
></Waterfal l
></Net_spcPri ce_spcWaterfal l
></Li ne_spcLi tem
><Li ne_spcLi tem
  Extended_spcQuanti ty_spcRequested="2"
  Temp_spcLi st_spcPri ce="2000"
  Di scount_spcPercent=""
  Rol l up_spcAmount="0"
  Upsel l=""
  Covered_spcLi ne_spcLi tem_spcI d=""
  Temp_spcMRC_spcRol l up_spcLi tem_spcPri ce="0"
  Quanti ty="2"
  Pri ce_spcLi st_spcI d="2-478KT"
  MRC_spcCxTotal=""
  Temp_spcNRC_spcCxTotal="4000"
  Ski p_spcPri ci ng_spcFl ag="N"
  Effecti ve_spcPromoti on_spcI d=""
  Product_spcI d="2-478JP"
  Prod_spcProm_spcI d=""
  Temp_spcNRC_spcLi ne_spcTotal="4000"
  Covered_spcAsset_spcProduct_spcI d=""
  Temp_spcMRC_spcLi ne_spcTotal="0"
  Max_spcPri ce=""
  Root_spcPri ce_spcLi st_spcLi tem_spcI d="2-478KW"
  MSRP_spcPri ce=""
  Temp_spcNRC_spcNet_spcPri ce="2000"
  Bundl e_spcSequence_spcI d=""
  Net_spcPri ce="2000"
  Li st_spcPri ce="2000"
  Root_spcBundl e_spcFl ag="N"
  Pri ce_spcType="One-Ti me"
  Product_spcLi ne_spcI d="No Match Row I d"

```

```
Uni t_spcof_spcMeasure=""
Temp_spcMRC_spcNet_spcPri ce="0"
Id="2-478NH"
Purchase_spcPri ce=""
Parent_spcI tem_spcI d="2-478LF"
Rol l up_spcI tem_spcPri ce="2000"
Exchange_spcDate="02/09/2005"
Covered_spcProduct_spcNet_spcPri ce=""
Currency_spcCode="USD"
Root_spcExchange_spcDate="02/09/2005"
Cost_spcPri ce=""
Covered_spcProduct_spcI d=""
Product_spcPort_spcI d="2-478KD"
Root_spcPromoti on_spcI d=""
Uni t_spcPri ce=""
Di scount_spcAmount=""
Dy nami c_spcMatri x=""
Root_spcPri ce_spcLi st_spcI d="2-478KT"
Root_spcCurrency_spcCode="USD"
Excl ude_spcPri ci ng_spcFl ag="N"
Li st_spcPri ce_spcWaterfal l_spcText="Li st pri ce from &apos;Test Pri ce Li st&apos;
pri ce Li st"
Pri ce_spcLi st_spcI tem_spcI d="2-478KY"
Mi n_spcPri ce=""
Temp_spcMRC_spcCxTotal ="0"
Servi ce_spcPri ce_spcMethod=""
Next_spcDi scount_spcI d=""
Promoti on_spcI tem_spcFl ag="N"
Header_spcDi scount_spcAmount="0"
Acti on_spcCode="Add"
NRC_spcCxTotal =""
Cl ass_spcI d=""
Li st_spcPri ce_spcWaterfal l ="2000"
Current_spcDi scount_spcI d=""
Sal es_spcServi ce_spcFl ag="N"
Rol l up_spcAmount_spcMRC="0"
Temp_spcParent_spcQuanti ty="1"
Vol ume_spcDi scount_spcI d=""
Root_spcProduct_spcI d="2-478K6"
Pri ci ng_spcAdj ustment_spcAmount="0"
Usage_spcAsset_spcProduct_spcI d=""
Start_spcPri ce="2000"
Servi ce_spcPri ce_spcPercent=""
```

```

>2-478NH<Attributes
>Default Pricing Variable Map - XA</Attributes
><Net_spcPrice_spcWaterfall
><Waterfall
  Adjustment_spcAmount="2000"
  Price="2000"
  Currency_spcCode="USD"
  Text="List price from 'Test Price List' price list"
  Adjustment_spcType="Price Override"
</Waterfall
></Net_spcPrice_spcWaterfall
></Line_spcItem
><Line_spcItem
  Extended_spcQuantity_spcRequested="1"
  Temp_spcList_spcPrice="1000"
  Discount_spcPercent=""
  Rollup_spcAmount="0"
  Upsell=""
  Covered_spcLine_spcItem_spcId=""
  Temp_spcMRC_spcRollup_spcItem_spcPrice="1000"
  Quantity="1"
  Price_spcList_spcId="2-478KT"
  MRC_spcCxCxTotal="1000"
  Temp_spcNRC_spcCxCxTotal="0"
  Skip_spcPricing_spcFlag="N"
  Effective_spcPromotion_spcId=""
  Product_spcId="2-478J6"
  Prod_spcProm_spcId=""
  Temp_spcNRC_spcLine_spcTotal="0"
  Covered_spcAsset_spcProduct_spcId=""
  Temp_spcMRC_spcLine_spcTotal="1000"
  Max_spcPrice=""
  Root_spcPrice_spcList_spcItem_spcId="2-478KX"
  MSRP_spcPrice=""
  Temp_spcNRC_spcNet_spcPrice="0"
  Bundle_spcSequence_spcId=""
  Net_spcPrice="1000"
  List_spcPrice="1000"
  Root_spcBundle_spcFlag="N"
  Price_spcType="Recurring"
  Product_spcLine_spcId="No Match Row Id"
  Unit_spcof_spcMeasure="Per Month"

```

```
Temp_spcMRC_spcNet_spcPri ce=" 1000"  
Id="2-4780D"  
Purchase_spcPri ce=""  
Parent_spcI tem_spcI d=""  
Rol l up_spcI tem_spcPri ce="0"  
Exchange_spcDate="02/09/2005"  
Covered_spcProduct_spcNet_spcPri ce=""  
Currency_spcCode="USD"  
Root_spcExchange_spcDate="02/09/2005"  
Cost_spcPri ce=""  
Covered_spcProduct_spcI d=""  
Product_spcPort_spcI d=""  
Root_spcPromoti on_spcI d=""  
Uni t_spcPri ce=""  
Di scount_spcAmount=""  
Dynami c_spcMatri x=""  
Root_spcPri ce_spcLi st_spcI d="2-478KT"  
Root_spcCurrency_spcCode="USD"  
Excl ude_spcPri ci ng_spcFl ag="N"  
Li st_spcPri ce_spcWaterfal l_spcText="Li st pri ce from &apos; Test Pri ce Li st&apos;  
pri ce Li st"  
Pri ce_spcLi st_spcI tem_spcI d="2-478KX"  
Mi n_spcPri ce=""  
Temp_spcMRC_spcCxTotal =" 1000"  
Servi ce_spcPri ce_spcMethod=""  
Next_spcDi scount_spcI d=""  
Promoti on_spcI tem_spcFl ag="N"  
Header_spcDi scount_spcAmount="0"  
Acti on_spcCode="Add"  
NRC_spcCxTotal =" 0"  
Cl ass_spcI d=""  
Li st_spcPri ce_spcWaterfal l =" 1000"  
Current_spcDi scount_spcI d=""  
Sal es_spcServi ce_spcFl ag="N"  
Rol l up_spcAmount_spcMRC="0"  
Temp_spcParent_spcQuanti ty=" 1"  
Vol ume_spcDi scount_spcI d=""  
Root_spcProduct_spcI d="2-478J6"  
Pri ci ng_spcAdj ustment_spcAmount="0"  
Usage_spcAsset_spcProduct_spcI d=""  
Start_spcPri ce=" 1000"  
Servi ce_spcPri ce_spcPercent=""  
>2-4780D<Attri butes
```

```
>Default Pricing Variable Map - XA</Attributes
><Net_spcPrice_spcWaterfall
><Waterfall
  Adjustment_spcAmount="1000"
  Price="1000"
  Currency_spcCode="USD"
  Text="List price from 'Test Price List' price list"
  Adjustment_spcType="Price Override"
<</Waterfall
<</Net_spcPrice_spcWaterfall
<</Line_spcItem
<</Row_spcSet
<</PropertySet
```

Siebel Pricing Manager API Reference

Earlier versions of the Pricing Manager API reference included a user property reference and a business service reference. These user properties are obsolete because of the new order management infrastructure. If your integration needed these user properties, then you must rework the integration using pricing procedures, signals, variable maps and other features of the new order management infrastructure. For more information, see *Siebel Order Management Infrastructure Guide*.

The methods are retained for backward compatibility, even though the API is no longer the best practice for external integration. For preferred integration methods, see [“Integration Methods for Siebel Pricer” on page 253](#).

This topic describes the following:

- Pricing Manager methods internal to the application in [Table 85 on page 287](#).
- Pricing Manager methods that are published in Siebel Tools in [Table 86 on page 288](#).
- Parameters for the CalculatePriceExternal Method in [Table 87 on page 289](#).

[Table 85](#) describes the Pricing Manager methods that are internal to Siebel application.

Table 85. Pricing Manager Methods Internal to the Application

Method Name	External or Internal	Purpose	Input Arguments	Output Arguments
CalculatePrice	Internal	Used for calling Siebel Pricer from other business components.	None	None
CalculatePriceAll	Internal	CalculatePrice for all quote Item discounts and calculate aggregate price for the whole quote.	None	None

Table 86 describes the Pricing Manager methods that are published in Siebel Tools.

Table 86. Pricing Manager Methods Published in Siebel Tools

Method Name	External or Internal	Purpose	Input Arguments	Output Arguments
CalculateFinalDiscountExternal	External	Calculates aggregate pricing for external application user. A multiple item record must be passed as the argument. Assumes the CalculatePrice function was called for each individual line.	Price list ID, current total (current total item price), Pricer VBC BO Name (current business component for pricing operations), list total (total list price of all items).	Pricing Comments, Final Discount Price, Pricing Comments and Discount Amount on the children Property set.
CalculatePrice	Internal	Used for calling Oracle's Siebel Pricer from other business components.	Not applicable	Not applicable
CalculatePrice-External	External	Single Item repricing for external users.	See Table 87 on page 289 .	Not applicable
GetFinalDiscount	Obsolete - will be removed	Obsolete.	Not applicable	Not applicable
GetProductListPrice	External or Internal	Retrieve List Prices and other information from Price List Item for a product and price list combination.	Price List Id, Product Id.	Currency Code, Min Sale Price, Max Sale Price, Price Book Id, Current Price, List Price, List Price Field x (Auxiliary outputs start with List Price Field, then followed by List Price Field 1, and so on.)
Reload Cache	External or Internal	Obsolete	None.	None.

Table 86. Pricing Manager Methods Published in Siebel Tools

Method Name	External or Internal	Purpose	Input Arguments	Output Arguments
SetPriceList	External or Internal	To set the price list at the profile attribute level. This is currently used in Sales to override the Price list ID set by the session.	No input because this set is based on the global profile attributes in eSales.	No output arguments as described for input arguments.
Start	Internal	Hidden - not for use by external users. Obsolete	None.	None.

Table 87 describes the Parameters for the CalculatePriceExternal Method.

Table 87. Parameters for CalculatePriceExternal Method

Name	Optional	Type	Explanation
Currency Code	N	Output	The currency code for the price
Current Discount	N	Output	The current volume discount.
Current Discount ID	N	Output	The current volume discount ID.
Current Price	N	Output	The final price.
List Price	N	Output	The start price.
Next Discount	N	Output	The next available item for volume discount.
Next Discount ID	N	Output	None
Original List Price	Y	Input	None
Price List ID	N	Input	Not applicable
Pricing Comments	N	Output	Not applicable
Product ID	N	Input	Not applicable
Quantity	N	Input	Not applicable
Service Price %	N	Output	Indicates the percentage used to determine the price of the Service Product, where the Service Price is set to a percentage of the product price.
Upsell Message	N	Output	The volume discount upsell message.
Volume Discount ID	N	Output	The volume discount ID (a copy of the ID in Quote).

Workflows for External Pricing API

Earlier releases expose APIs on the Pricing Manager Business Service for external integration. To support backward compatibility, Oracle continues to provide support for these APIs.

Because of changes to the pricing engine for version 7.8 or later, the internals of these APIs are replaced by the Row Set Transformation Toolkit Business Service, which is driven by workflows. External API support uses the following workflows:

- [“CalculatePriceExternal Workflow” on page 290](#) (for Business Service method *CalculatePriceExternal*)
- [“Get Config Item Price Workflow” on page 291](#) (for Business Service method *GetConfigItemPrice*)
- [“Get Product List Price Workflow” on page 292](#) (for Business Service method *GetProductListPrice*)

CalculatePriceExternal Workflow

The CalculatePriceExternal Business Service method is an external interface that takes in product line items in a property set and provides pricing information for each of the product line items. [Figure 49](#) illustrates the CalculatePriceExternal workflow process.

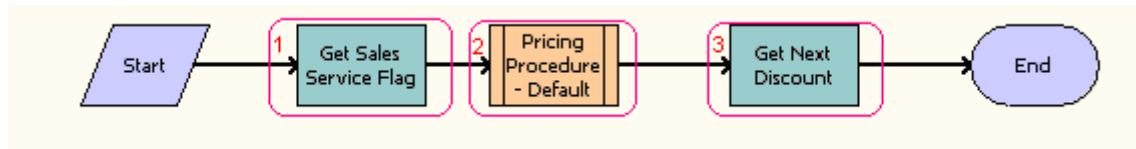

Figure 49. CalculatePriceExternal Workflow Process

Workflow Description. This workflow does the following:

- 1 Get Sales Service Flag.** Determines if the product is a service product. Service products have different pricing requirements from regular sales products. For more information, see [“Dynamic Pricing Procedure Workflow” on page 223](#).
- 2 Pricing Procedure - Default.** Calls the Dynamic Pricing Procedure workflow as a subprocess that handles all pricing operations.
- 3 Get Next Discount.** Populates Volume Discount upsell messages.

[Table 88](#) lists the steps in the CalculatePriceExternal workflow with the business service and method that is called by each.

Table 88. Steps of the CalculatePriceExternal Workflow

Name	Type	Business Service	Method	Sub Process	Description
Get Sales Service Flag	Business Service	Row Set Transformation Toolkit Service	Simple Look-Up Transform	Not applicable	Determines if the product is a service product.

Table 88. Steps of the CalculatePriceExternal Workflow

Name	Type	Business Service	Method	Sub Process	Description
Dynamic Pricing Procedure	Sub Process	Not applicable	Not applicable	Dynamic Pricing Procedure	Calls the Dynamic Pricing Procedure workflow as a subprocess that handles all the pricing operations.
Get Next Discount	Business Service	Row Set Transformation Toolkit Service	Simple Look-Up Transform	Not applicable	Populates Volume Discount upsell messages.

Get Config Item Price Workflow

The GetConfigItemPrice Business Service Method is an API that fetches price adjustments from Customizable Product Pricing Designer for a price list, product, or product port combination. Figure 50 illustrates the GetConfigItemPrice workflow process.

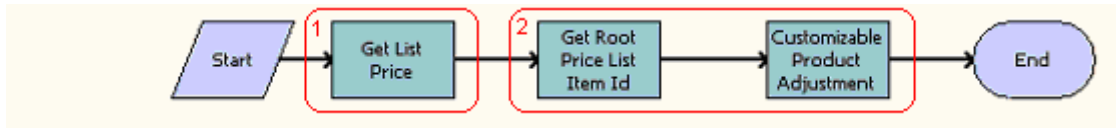

Figure 50. GetConfigItemPrice Workflow Process

Workflow Description. This workflow does the following:

- 1 Get List Price.** Gets the List Price for the input product and price list, which provides the basis for subsequent Pricing Designer adjustments.
- 2 Get Root Price List Item Id and Customizable Product Adjustment.** These steps retrieve the Customizable Product Pricing Designer adjustment.

Table 89 lists the steps in the GetConfigItemPrice workflow with the business service and method that is called by each.

Table 89. Steps of the GetConfigItemPrice Workflow

Name	Type	Business Service	Method	Sub Process	Description
Get List Price	Business Service	Row Set Transformation Toolkit Service	Simple Look-Up Transform	Not applicable	Gets the List Price for the input product and price list.

Table 89. Steps of the GetConfigItemPrice Workflow

Name	Type	Business Service	Method	Sub Process	Description
Get Root Price List Item Id	Business Service	Row Set Transformation Toolkit Service	Simple Look-Up Transform	Not applicable	Retrieves the Root Price List Item Id for each item for use in the next step.
Customizable Product Adjustment	Business Service	Row Set Transformation Toolkit Service	Simple Look-Up Transform	Not applicable	Queries in Price Config Item Buscomp for Pricing Designer adjustments.

Get Product List Price Workflow

The GetProductListPrice Business Service method is an API that gets the price and some other attributes from the Price List Item Business Component for a price list and product combination. Figure 51 illustrates the GetProductListPrice workflow process.

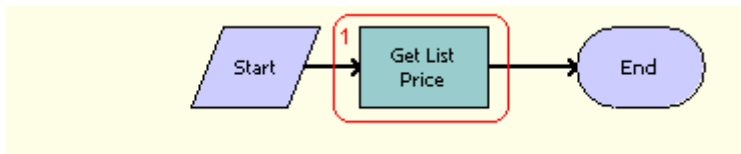

Figure 51. GetProductListPrice Workflow Process

This workflow gets the list price for the input product and price list. Also, it retrieves other information such as Min Price, Max Price, Volume Discount Id, Dynamic Matrix Id, and so on.

Table 90 lists the steps in the GetProductListPrice workflow with the business service and method that is called.

Table 90. Steps of the GetProductListPrice Workflow

Name	Type	Business Service	Method	Sub Process	Description
Get List Price	Business Service	Row Set Transformation Toolkit Service	Simple Look-Up Transform	Not applicable	Gets List Price for the input product and price list.

Cache Configuration Settings

Parameters specifying cache size typically determine the number of records cached locally. When the specified cache limit is reached, the next new record must be loaded. As a rule, you should not change the cache sizes specified for your application unless advised to do so by your server administrator.

Configuration settings for pricing can be set at the server level and at the remote client level. The standard configuration file includes a section called pricing cache which includes the following parameter settings and corresponding default values:

```
[PricingCache]
PriceListCacheLifeTime = -1
PriceListItemCacheLifeTime = -1
PricerMappingCacheSize = 100
PricerPriceItemCacheSize = 100
PricerPriceListCacheSize = 20
PricerPriceModelCacheSize = 50
```

Table 91 describes the pricing cache parameters in more detail.

Table 91. Pricing Cache Parameter Settings

Parameter Name	Description
PriceListCacheLifeTime	This is the lifetime of the price list header information where the integer value represents seconds, the time unit of measure. The price list header information must be reloaded after this number of seconds has passed. If all other factors remain the same, then there is a trade-off between refresh-time and loading speed. If you decrease a LifeTime value, then the result is more frequent refresh of data and a longer loading time for data. This is represented by the parameter PARAM_SUBSYS_PRICE_LIFE-TIME. The default value for PriceListItemCacheLifeTime is -1.
PriceListItemCacheLifeTime	This is the lifetime of the price list line item and volume discount information where the integer value represents seconds, the time unit of measure. The price list line item information must be reloaded after this number of seconds has passed. This is represented by the parameter PARAM_SUBSYS_PRICE_ITEM_LIFE_TIME. The default value for PriceListItemCacheLifeTime is -1.

Table 91. Pricing Cache Parameter Settings

Parameter Name	Description
PricerMappingCacheSize	Not Applicable. NOTE: This is the number of records to be cached for each mapping factor. The default is 100. If this value is set to zero, then mapping information will not be cached, and the database will immediately be searched.
PricerPriceItemCacheSize	Not applicable. NOTE: This applies to the price list line item records for each price list cache.
PricerPriceListCacheSize	Not applicable. NOTE: This applies to the price list records at the header level.
PricerPriceModelCacheSize	Not applicable. NOTE: This applies to the model cache.

The default value for PriceListCacheLifeTime and PriceListItemCacheLifeTime is -1, which means that the cache remains unrefreshed indefinitely. You can change this value to any number between zero and 86400. Zero means to turn off the cache. 86400 is the number of seconds in a full day.

If you want to reload new list prices for products without having to log out of and back in again to your Siebel Business Application, then you must set the following pricing cache parameters to, for example, 60:

```
Pri ceLi stCacheLi feTi me = 60
Pri ceLi stI temCacheLi feTi me = 60
```

Setting both parameters (PriceListCacheLifeTime and PriceListItemCacheLifeTime) to low values results in more frequent refreshing and slows down performance, but keeps the pricing information up to date.

Index

A

- about product offers** 89
- actions for responses to product offers** 91, 96
- adding aggregate discount record** 59
- adjustment item records**
 - attribute position, importance of 162
- aggregate discount**
 - adding record 59
 - for buy one get one free 63
- aggregate discount sequence**
 - attaching to price list 62
 - defining 60
- aggregate discounts**
 - about 57
 - buy and receive products 58
 - creating 58
 - for products with components 63
- API reference** 287
- architecture of Siebel Pricer** 211
- asset costing**
 - mapping, setting up for 49
- asset mapping**
 - overview 49
- assets, setting up**
 - cost of assets, by product line 49
- assigning price lists to users** 35
- assigning rate lists to users** 42
- associating service with covered product** 26
- attaching aggregate discount sequence to price list** 62
- attribute adjustments**
 - types of 159
- attribute pricing adjustments**
 - zero-effect adjustment items, benefits of 164
- attribute-based pricing**
 - overview 153
 - planning pricing adjustments 154
- attributes**
 - positioning in adjustment item records 162
- Average Cost cost method, described** 43

B

- base pricing**
 - creating 189
 - overview 188

- best entitlement pricing for contract-based pricing** 206
- buy one get one free discounts** 63
- buy products for aggregate discounts** 58

C

- CalculateFinalDiscountExternal method** 288
- CalculatePrice- External method** 288
- CalculatePrice method** 287, 288
- CalculatePriceAll method** 287
- cardinality of components of product promotions** 85
- clearing cache for product offers** 90
- clearing pricing data from the cache** 16
- compatibility rules for product offers** 100
- compatibility rules for product promotions** 75
- component-based pricing**
 - types of 188
- conditions for product promotions** 77
- configuring discount matrices** 148
- configuring pricing fields** 207
- configuring pricing waterfalls** 202
- contract-based pricing**
 - about 204
 - best entitlement pricing 206
 - defining in the Agreements screen 204
 - defining in the Discount Matrices view 205
 - hierarchical 204
- copying**
 - rate list, transforming copy of 41
 - rate lists 40
- cost list, creating and using**
 - about cost lists 43
 - cost list line item records, creating 45
 - cost list record, creating 44
 - cost list, associating with a price list 47
 - cost methods, list of 43
 - indirect cost, entering 46
 - price list or cost list, creating that cost list will reference 44
 - price list's costs, updating 48
 - product cost and margin, viewing in a price list 48
 - product cost and margin, viewing in a rate list 49
 - rate list, associating with cost list 47

cost lists 20
creating actions for responses to product offers 96
creating aggregate discounts 58
creating compatibility rules for product offers 100
creating eligibility rules for product offers 100
creating price list line item for service products 24
creating product offers 94
creating product offers with named parameters 105
creating product offers with parent actions 107
creating product promotion record 67
creating product promotions 66
creating recommendations for product offers 101
creating responses for product offers 95
creating translations for product offer messages 102
currency
 assigning 20
 Currency Code parameter 289
 Currency field, editing (warning) 33, 40
Current Discount Id parameter 289
Current Discount parameter 289
Current Price parameter 289
customizable products
 product promotions for 84
 roll-up pricing 189
 roll-up pricing, setting 190
 viewing components and relationships 187

D
defining a discount matrix 146
defining aggregate discount sequence 60
defining product offers 94
dimensions of discount matrices 142
discount matrices
 about 141
 adding new dimensions to existing types 149
 configuring 148
 creating new types for custom tables 150
 dimensions 142
 entering details 147
 entitlement-based adjustment 144
 integration 147
 product-based adjustment 143
 training-based adjustment 145
 types 143
discount matrix

 defining 146
discounts, simple product bundles 32
Display Error option
 use of 163
Dynamic 223
Dynamic Pricing Procedure workflow 223

E

effective dates for pricing line items
 about 29
 giving a product multiple prices 32
eligibility rules for product offers 100
eligibility rules for product promotions 75
enabling item-specific pricing logic 35
enabling price-list-specific pricing logic 35
entering discount matrix details 147
entitlement-based adjustment discount matrices 144
existing product promotions, upgrading 82
Exposing the Starting At Price 192
external integration using pricer as a service 274

G

GetFinalDiscount method 288
GetProductListPrice method 288

H

hierarchical contract-based pricing 204

I

image files for product promotions 66
indirect costs, entering 46
integration
 discount matrices 147
 external using Pricer as a service 274
 internal 253
 pricing integration, general overview 251
 references 253
 using APIs 287
Integration ID field 20
internal integration 253
item-specific pricing logic 35

L

Last Cost cost method, described 43
Last-In, First Out (LIFO) cost metric, described 43
LIFO (Last-In, First Out) Lost cost metric, described 43
list price and promotional price 22
List Price parameter 289

M

- margin calculation (% Margin)** 23
- maximum price, price list validation** 22, 24
- methods**
 - CalculateFinalDiscountExternal 288
 - CalculatePrice 287, 288
 - CalculatePrice- 288
 - CalculatePriceAll 287
 - CalculatePriceExternal parameters 289
 - GetFinalDiscount 288
 - GetProductListPrice 288
 - Pricing Manager methods known to Tools 288
 - Pricing Manager methods, external applications 287
 - Reload Cache 288
 - SetPriceList 289
 - Start 289
- migrating product offers** 111
- minimum price, price list validation** 22, 24
- modifying**
 - rate lists 40
- modifying product offers** 108
- MSRP** 23
- multiple currencies in quote, order, agreement** 207
- multiple price types** 206
- multiple prices for different effective dates** 32
- multiple-attribute pricing adjustments**
 - overview 159
- multiple-attribute pricing tables**
 - null value wildcard, advantages of 162
 - performance considerations 161
 - zero-effect adjustment items 164

N

- named parameters for product offers** 104
- Next Cost cost method, described** 43
- Next Discount Id parameter** 289
- Next Discount parameter** 289
- null value wildcard**
 - advantages of 162

O

- orders, volume discounts** 51
- Original List Price parameter** 289

P

- price list**
 - cost list, associating with a price list 47
 - cost list, creating that price list will

- reference 44
- price list's costs, updating 48
- product cost and margin, viewing 48

price list header record

- defining 19
- effective dates 20
- fields in 20

Price List Id parameter 289**price list line items**

- about 21, 24
- defining line items 21, 24
- fields in 22, 24
- in multiple price lists 21
- omitting the price 21
- simple product bundles 32

price lists

- about 19
- assigning to users 35
- copying and modifying price lists 33
- defined 17
- global changes to list prices 33
- importing price lists 34
- maximum and minimum price validation 22, 24
- MSRP 23
- optional data 18
- tasks prior to creating 18
- Transform function, modifying using 34

price-list-specific pricing logic 35**pricing a service with adjustment based on product** 27**pricing adjustments**

- relationship-based pricing adjustments 195

Pricing Comments parameter 289**pricing fields, configuring**

- in catalogs 207
- in configurator 207
- in eSales 207

pricing for product promotions, specifying 71**Pricing Manager business service**

- integration overview 251

Pricing Manager methods known to Tools 288**Pricing Procedure - Aggregate Discounts workflow** 230**Pricing Procedure - Calculate Net Price Workflow** 248**Pricing Procedure - Service workflow** 231**pricing service as percentage of covered asset** 26**pricing waterfalls**

- about 201
- configuring 202

product cost

- price list, viewing product cost and margin 48
- rate list, viewing product cost and margin 49

Product Id parameter 289**product offers**

- about 89
- actions for responses 91
- clearing cache 90
- creating 94
- creating actions for responses 96
- creating compatibility rules 100
- creating eligibility rules 100
- creating recommendations for 101
- creating responses 95
- creating translations for messages 102
- creating with named parameters 105
- creating with parent actions 107
- defining 94
- migrating 111
- modifying 108
- named parameters 104
- releasing 103
- setting up with named parameters 104
- suppressing component recommendations 110
- suppressing recommendations 109, 110
- updating cache 90
- versions 90
- viewing for an account 109

product promotions

- about 65
- changing the cardinality of components 85
- compatibility rules for 75
- constraining attributes available for product 86
- constraining products available for component 86
- creating 66
- creating record 67
- customizing recommendation messages for 76
- eligibility rules for 75
- for customizable products 84
- managing versions 83
- releasing 81
- setting up image files for 66
- specifying pricing for 71
- specifying products for 69
- terms and conditions 77
- that upgrade existing promotions 82
- translations of recommendation messages for 76
- viewing summary 83

- viewing the schedule of all 84

product-based adjustment discount matrices 143**products**

- attribute-based pricing, overview 153
- base pricing 188
- components and relationships, viewing 187
- mapping cost of assets 49
- product price, defined 17
- roll-up pricing, overview 189
- roll-up pricing, setting 190

products for product promotions, specifying 69**products with components**

- aggregate discounts for 63

promotional pricing

- promotional price and list price 22
- which type to use 16

PSP Driver Workflow Process workflow 213**PSP Dynamic Matrix - Refresh Matrix Cache workflow** 248**PSP Waterfall Synch to DB Workflow workflow** 249**purchase price** 23**Q****Quantity parameter** 289**quotes**

- application of volume discount 51

R**RAF Apply Offer To Create Order Web Workflow** 134**RAF Apply Offer To Create Quote Web Service Workflow** 135**RAF Check For Promotion Sub Process Workflow** 127**RAF Check Prepaid Balance Workflow** 125**RAF Consolidate Actions Sub Process Workflow** 126**RAF Create Activity Workflow** 119**RAF Create Document Workflow** 114**RAF Ensure New Line Item Workflow** 129**RAF Get Active Document Workflow** 126**RAF Get Named Parameter For Web Call Workflow** 132**RAF Get Named Parameter Workflow** 131**RAF Prepare Actions Sub Process Workflow** 122**RAF Prepare Header Sub Process Workflow** 121**RAF Product Offer Recommendation For Asset Workflow** 119

RAF Recommendation Driver Workflow 120
RAF RunProcess Driver Workflow 130
RAF Submit Order Process Workflow 118
RAF Update Recommendation SubProcess Workflow 118
RAF Update Recommendation Workflow 117
rate lists 18

- about and example 37
- copying and modifying 40
- cost list, associating with rate list 47
- price list or rate list, creating that cost list will reference 44
- product cost and margin, viewing in a rate list 49
- rate list line items, creating 39
- rate list record, creating 39
- resources as products, creating 38
- transforming 41
- user, assigning to 42
- uses of rate lists 37

receive products for aggregate discounts 58
recommendation messages for product promotions 76
recommendations for product offers 101
relationship-based price adjustments 195
releasing product offers 103
releasing product promotions 81
Reload Cache method 288
reports

- creating or modifying 200
- Price Lists report, running 199

responses for product offers 95
roll-up pricing

- price types and 210

rollup pricing

- overview 189
- setting for customizable products 190

S

sales products 18
schedule of all product promotions 84
Service Price Percentage parameter 289
service pricing

- adjustments based on product 27
- as percentage of covered asset 26
- associating service with covered product 26
- setting up for covered assets 25

service products 18
SetPriceList method 289
setting up product offers with named parameters 104
setting up service pricing for covered

assets 25
shipping method, assigning default 20
shipping terms, assigning default 20
Siebel EIM, importing price lists 34
simple product bundles, discounts 32
single-attribute pricing adjustments

- overview 159

specifying pricing for product promotions 71
specifying products for product promotions 69
Spread Discount Driver Workflow Process workflow 249
spread discount pricing

- about 208
- algorithm 208
- configuring source field 209
- use of service with pricing procedures 209

Standard Cost cost method, described 43
Start method 289
summaries of product promotions 83
suppressing component product offer recommendations 110
suppressing product offer recommendations 109, 110
Switching From Basic to Dynamic Pricing Procedure 232

T

terms for product promotions 77
totaling of pricing 210
training-based adjustment discount matrices 145
Transform function

- about 33
- field information 34
- price lists, modifying 34

transforming option, using on rate lists 41
translations for product offer messages 102
translations of recommendation messages for product promotions 76
types of discount matrices 143

U

updating cache for product offers 90
upgrading existing product promotions 82
Upsell Message parameter 289

V

versions of product offers 90
versions of product promotions 83
viewing product offers for an account 109
Volume Discount Id parameter 289

volume discount line items

- creating 54
- gaps or overlaps in quantity specification 54
- overview of 54

volume discounts

- across line items 52
- applying to a product 55
- definition of 51
- in price lists 18
- products with components 52
- reusing for multiple currencies 52
- types of 51
- volume discount record, creating 53
- volume discount record, deleting 53

W**Workflows**

- RAF Apply Offer To Create Order Web Workflow 134
- RAF Apply Offer To Create Quote Web Service Workflow 135
- RAF Check For Promotion Sub Process Workflow 127
- RAF Check Prepaid Balance Workflow 125
- RAF Consolidate Actions Sub Process Workflow 126
- RAF Create Activity Workflow 119
- RAF Create Document Workflow 114
- RAF Ensure New Line Item Workflow 129
- RAF Get Active Document Workflow 126

RAF Get Named Parameter For Web Call Workflow 132

RAF Get Named Parameter Workflow 131

RAF Prepare Actions Sub Process Workflow 122

RAF Prepare Header Sub Process Workflow 121

RAF Product Offer Recommendation For Asset Workflow 119

RAF Recommendation Driver Workflow 120

RAF RunProcess Driver Workflow 130

RAF Submit Order Process Workflow 118

RAF Update Recommendation SubProcess Workflow 118

RAF Update Recommendation Workflow 117

workflows

- Basic Pricing Procedure 214
- Dynamic Pricing Procedure 223
- Pricing Procedure - Aggregate Discounts 230
- Pricing Procedure - Service 231
- PSP Driver Workflow Process 213
- PSP Dynamic Matrix - Refresh Matrix Cache 248
- PSP Waterfall Synch to DB Workflow 249
- Spread Discount Driver Workflow Process 249

Z

zero-effect adjustment items 164