

Oracle® Fusion Middleware

Administering JDBC Data Sources for Oracle WebLogic Server

12c (12.2.1.2.0)

E77969-03

December 2016

This book contains JDBC data source configuration and administration information.

Copyright © 2015, 2016, Oracle and/or its affiliates. All rights reserved.

This software and related documentation are provided under a license agreement containing restrictions on use and disclosure and are protected by intellectual property laws. Except as expressly permitted in your license agreement or allowed by law, you may not use, copy, reproduce, translate, broadcast, modify, license, transmit, distribute, exhibit, perform, publish, or display any part, in any form, or by any means. Reverse engineering, disassembly, or decompilation of this software, unless required by law for interoperability, is prohibited.

The information contained herein is subject to change without notice and is not warranted to be error-free. If you find any errors, please report them to us in writing.

If this is software or related documentation that is delivered to the U.S. Government or anyone licensing it on behalf of the U.S. Government, then the following notice is applicable:

U.S. GOVERNMENT END USERS: Oracle programs, including any operating system, integrated software, any programs installed on the hardware, and/or documentation, delivered to U.S. Government end users are "commercial computer software" pursuant to the applicable Federal Acquisition Regulation and agency-specific supplemental regulations. As such, use, duplication, disclosure, modification, and adaptation of the programs, including any operating system, integrated software, any programs installed on the hardware, and/or documentation, shall be subject to license terms and license restrictions applicable to the programs. No other rights are granted to the U.S. Government.

This software or hardware is developed for general use in a variety of information management applications. It is not developed or intended for use in any inherently dangerous applications, including applications that may create a risk of personal injury. If you use this software or hardware in dangerous applications, then you shall be responsible to take all appropriate fail-safe, backup, redundancy, and other measures to ensure its safe use. Oracle Corporation and its affiliates disclaim any liability for any damages caused by use of this software or hardware in dangerous applications.

Oracle and Java are registered trademarks of Oracle and/or its affiliates. Other names may be trademarks of their respective owners.

Intel and Intel Xeon are trademarks or registered trademarks of Intel Corporation. All SPARC trademarks are used under license and are trademarks or registered trademarks of SPARC International, Inc. AMD, Opteron, the AMD logo, and the AMD Opteron logo are trademarks or registered trademarks of Advanced Micro Devices. UNIX is a registered trademark of The Open Group.

This software or hardware and documentation may provide access to or information about content, products, and services from third parties. Oracle Corporation and its affiliates are not responsible for and expressly disclaim all warranties of any kind with respect to third-party content, products, and services unless otherwise set forth in an applicable agreement between you and Oracle. Oracle Corporation and its affiliates will not be responsible for any loss, costs, or damages incurred due to your access to or use of third-party content, products, or services, except as set forth in an applicable agreement between you and Oracle.

Contents

Preface	xiii
Documentation Accessibility	xiii
Conventions.....	xiii
1 Introduction and Roadmap	
1.1 Document Scope and Audience.....	1-1
1.2 Guide to this Document.....	1-1
1.3 Related Documentation	1-2
1.4 JDBC Samples and Tutorials	1-3
1.4.1 Avitek Medical Records Application (MedRec) and Tutorials.....	1-3
1.4.2 JDBC Examples in the WebLogic Server Distribution	1-3
1.5 New and Changed JDBC Data Source Features in This Release	1-3
1.5.1 Default Data Source	1-4
1.5.2 Simplified Driver Installation/Update	1-4
1.5.3 Proxy Data Source Support.....	1-4
1.5.4 UCP Data Source Support.....	1-4
1.5.5 JDBC Data Source Support for Multitenancy.....	1-4
1.5.6 Connection Leak Profiling Enhancements.....	1-4
1.5.7 Enhanced Connection-Based System Properties	1-5
1.5.8 Application Continuity Runtime Statistics.....	1-5
1.5.9 ONS Node List Configuration Enhancements	1-5
1.5.10 DRCP Network Timeout Property	1-5
1.5.11 Enhanced Edition-Based Redefinition (EBR) Documentation.....	1-5
1.5.12 Guidelines for Planned Maintenance and Database Outages	1-5
1.5.13 Enabling ONS and JDBC Debugging Changes.....	1-5
1.5.14 Removed Support for Connect-Time Failover	1-6
2 Configuring WebLogic JDBC Resources	
2.1 Understanding JDBC Resources in WebLogic Server	2-1
2.2 Ownership of Configured JDBC Resources.....	2-2
2.3 Data Source Configuration Files.....	2-2
2.3.1 JDBC System Modules.....	2-3

2.3.2	JDBC Application Modules.....	2-5
2.3.3	JDBC Module File Naming Requirements.....	2-7
2.3.4	JDBC Modules in Versioned Applications	2-7
2.3.5	JDBC Schema.....	2-8
2.3.6	JDBC Data Source Type.....	2-8
2.4	JMX and WLST Access for JDBC Resources	2-9
2.4.1	JDBC MBeans for System Resources	2-9
2.4.2	JDBC Management Objects in the Java EE Management Model (JSR-77 Support) ...	2-10
2.4.3	Using WLST to Create JDBC System Resources	2-11
2.4.4	How to Modify and Monitor JDBC Resources.....	2-12
2.4.5	Best Practices when Using WLST to Configure JDBC Resources	2-13
2.5	Creating High-Availability JDBC Resources	2-13

3 Configuring JDBC Data Sources

3.1	Understanding JDBC Data Sources.....	3-1
3.2	Types of WebLogic Server JDBC Data Sources	3-1
3.3	Creating a JDBC Data Source.....	3-2
3.3.1	JDBC Data Source Properties.....	3-2
3.3.2	Configure Transaction Options	3-4
3.3.3	Configure Connection Properties	3-5
3.3.4	Test Connections	3-6
3.3.5	Target the Data Source.....	3-6
3.4	Configuring Generic Connection Pool Features	3-6
3.4.1	Enabling JDBC Driver-Level Features.....	3-7
3.4.2	Enabling Connection-based System Properties	3-7
3.4.3	Enabling Connection-based Encrypted Properties.....	3-8
3.4.4	Initializing Database Connections with SQL Code	3-8
3.5	Advanced Connection Properties.....	3-9
3.5.1	Define Fatal Error Codes	3-9
3.5.2	Using Edition-Based Redefinition.....	3-10
3.6	Configuring Oracle Parameters	3-12
3.7	Configuring an ONS Client.....	3-13
3.8	Tuning Generic Data Source Connection Pools	3-13
3.9	Generic Data Source Handling for Oracle RAC Outages	3-13
3.10	Generic Data Source Handling of Driver-Level Failover.....	3-13

4 Using the Default Data Source

4.1	What is the Default Data Source.....	4-1
4.2	Defining a Custom Default Data Source	4-2
4.3	Compatibility Limitations When Using a Default Data Source.....	4-3

5 Configuring JDBC Multi Data Sources

5.1	Multi Data Source Features	5-1
-----	----------------------------------	-----

5.1.1	Removing a Database Node.....	5-2
5.1.2	Adding a Database Node	5-2
5.2	Creating and Configuring Multi Data Sources.....	5-3
5.3	Choosing the Multi Data Source Algorithm	5-3
5.3.1	Failover	5-3
5.3.2	Load Balancing	5-4
5.4	Multi Data Source Fail-Over Limitations and Requirements.....	5-4
5.4.1	Test Connections on Reserve to Enable Fail-Over.....	5-4
5.4.2	No Fail-Over for In-Use Connections.....	5-4
5.5	Multi Data Source Failover Enhancements.....	5-4
5.5.1	Connection Request Routing Enhancements When a Generic Data Source Fails	5-5
5.5.2	Automatic Re-enablement on Recovery of a Failed Generic Data Source within a Multi Data Source	5-5
5.5.3	Enabling Failover for Busy Generic Data Sources in a Multi Data Source	5-5
5.5.4	Controlling Multi Data Source Failover with a Callback	5-6
5.5.5	Controlling Multi Data Source Failback with a Callback.....	5-8
5.6	Deploying JDBC Multi Data Sources on Servers and Clusters	5-9
5.7	Planned Database Maintenance with a Multi Data Source	5-9
5.7.1	Shutting Down the Data Source.....	5-10

6 Using Active GridLink Data Sources

6.1	What is an Active GridLink Data Source	6-1
6.1.1	Fast Connection Failover.....	6-2
6.1.2	Runtime Connection Load Balancing.....	6-3
6.1.3	GridLink Affinity.....	6-4
6.1.4	SCAN Addresses	6-6
6.1.5	Secure Communication using Oracle Wallet with ONS Listener	6-7
6.1.6	Support for Active Data Guard	6-7
6.2	Creating an Active GridLink Data Source	6-7
6.2.1	JDBC Data Source Properties.....	6-8
6.2.2	Configure Transaction Options.....	6-9
6.2.3	Configure Connection Properties	6-9
6.2.4	Test Connections	6-12
6.2.5	ONS Client Configuration.....	6-12
6.2.6	Test ONS Client Configuration	6-14
6.2.7	Target the Data Source.....	6-14
6.3	Using Socket Direct Protocol.....	6-14
6.3.1	Configuring Runtime Load Balancing using SDP	6-14
6.4	Configuring AGL Connection Pool Features.....	6-15
6.4.1	Enabling JDBC Driver-Level Features.....	6-15
6.4.2	Enabling Connection-based System Properties	6-15
6.4.3	Initializing Database Connections with SQL Code	6-16
6.5	Configuring Oracle Parameters	6-16

6.6	Configuring an ONS Client Using WLST	6-16
6.7	Tuning Active GridLink Data Source Connection Pools	6-17
6.8	Monitoring GridLink JDBC Resources	6-17
6.8.1	Viewing Run-Time Statistics.....	6-17
6.8.2	Debug Active GridLink Data Sources	6-18
6.9	Using Active GridLink Data Sources without FAN Notification.....	6-19
6.9.1	Understanding the ActiveGridlink Attribute.....	6-19
6.10	Best Practices for Active GridLink Data Sources	6-20
6.10.1	Catch and Handle Exceptions	6-20
6.10.2	Connection Creation with Active Gridlink Data Sources	6-20
6.11	Comparing AGL and Multi Data Sources.....	6-21
6.12	Migrating from Multi Data Source to Active GridLink	6-21
6.12.1	Application Changes to Migrate a Multi Data Source	6-21
6.12.2	Configuration Changes to Migrate a Multi Data Source.....	6-21
6.12.3	Basic Steps to Migrate a Multi Data Source to a Active GridLink Data Source.....	6-22
6.13	Managing Database Downtime with AGL Data Sources	6-23
6.13.1	Active GridLink Configuration for Database Outages.....	6-23
6.13.2	Planned Outage Procedures	6-24
6.13.3	Unplanned Outages	6-28
6.14	Gradual Draining.....	6-28
7	Using Proxy Data Sources	
7.1	What is a Proxy Data Source?.....	7-1
7.2	Creating a Proxy Data Source	7-2
7.2.1	Configuring a Proxy Data Source in the WebLogic Server Administration Console .	7-2
7.2.2	Configuring a Proxy Data Source Using WLST.....	7-4
7.3	Monitoring Proxy Data Source JDBC Resources.....	7-5
8	Using Universal Connection Pool Data Sources	
8.1	What is a Universal Connection Pool Data Source?	8-1
8.2	Creating a Universal Connection Pool Data Source	8-2
8.2.1	Configuring a UCP Data Source in the WebLogic Server Administration Console ...	8-2
8.2.2	Configuring a UCP Data Source Using WLST	8-8
8.3	Monitoring Universal Connection Pool JDBC Resources	8-9
9	Connection Harvesting	
9.1	What is Connection Harvesting?.....	9-1
9.2	Enable Connection Harvesting	9-2
9.3	Marking Connections Harvestable.....	9-2
9.4	Recover Harvested Connections.....	9-2
10	Advanced Configurations for Oracle Drivers and Databases	
10.1	Application Continuity	10-1

10.1.1	How Application Continuity Works	10-2
10.1.2	Requirements and Considerations.....	10-2
10.1.3	Configuring Application Continuity.....	10-3
10.1.4	Viewing Runtime Statistics for Application Continuity.....	10-7
10.1.5	Application Continuity Auditing	10-10
10.1.6	Limitations with Application Continuity with Oracle 12c Database.....	10-11
10.2	Database Resident Connection Pooling.....	10-11
10.2.1	Requirements and Considerations.....	10-11
10.2.2	Configuring DRCP	10-12
10.3	Global Database Services.....	10-14
10.3.1	Requirements and Considerations.....	10-14
10.3.2	Creating a GridLink DataSource for GDS Connectivity.....	10-15
10.4	Container Database with Pluggable Databases.....	10-15
10.4.1	Creating Service for PDB Access.....	10-15
10.4.2	DRCP and CDB/PDB	10-16
10.4.3	Setting the PDB using JDBC.....	10-16
10.5	Limitations with Tenant Switching.....	10-16

11 Labeling Connections

11.1	What is Connection Labeling.....	11-1
11.2	Implementing Labeling Callbacks.....	11-2
11.3	Creating a Labeling Callback	11-2
11.3.1	Example Labeling Callback.....	11-3
11.4	Registering a Labeling Callback	11-4
11.4.1	Removing a Labeling Callback.....	11-5
11.4.2	Applying Connection Labels.....	11-5
11.5	Reserving Labeled Connections	11-6
11.6	Checking Unmatched labels.....	11-6
11.7	Removing a Connection Label.....	11-7
11.8	Using Initialization and Reinitialization Costs to Select Connections.....	11-7
11.8.1	Considerations When Using Initialization and Reinitialization Costs.....	11-7
11.9	Using Connection Labeling with Packaged Applications	11-8
11.9.1	Considerations When using Labelled Connections in Packaged Applications	11-8

12 JDBC Data Source Transaction Options

12.1	Enabling Support for Global Transactions with a Non-XA JDBC Driver	12-2
12.2	Understanding the Logging Last Resource Transaction Option	12-3
12.2.1	Advantages to Using the Logging Last Resource Optimization.....	12-4
12.2.2	Enabling the Logging Last Resource Transaction Optimization.....	12-4
12.2.3	Programming Considerations and Limitations for LLR Data Sources.....	12-4
12.2.4	Administrative Considerations and Limitations for LLR Data Sources	12-6
12.3	Understanding the Emulate Two-Phase Commit Transaction Option.....	12-7

12.3.1	Limitations and Risks When Emulating Two-Phase Commit Using a Non-XA Driver.....	12-8
12.4	Local Transaction Completion when Closing a Connection	12-9
13	Understanding Data Source Security	
13.1	Introduction to WebLogic Data Source Security Options	13-1
13.2	WebLogic Data Source Security Options	13-2
13.2.1	Credential Mapping vs. Database Credentials	13-4
13.2.2	Set Client Identifier on Connection.....	13-5
13.2.3	Oracle Proxy Session.....	13-7
13.2.4	Identity-based Connection Pooling	13-8
13.3	Connections within Transactions	13-9
13.4	WebLogic Data Source Resource Permissions	13-10
13.5	Data Source Security Example.....	13-11
13.6	Using Encrypted Connection Properties.....	13-13
13.6.1	Best Practices for Encrypting Connection Properties when Using the Administration Console.....	13-13
13.6.2	WLST Examples to Encrypt Connection Properties.....	13-14
13.7	Using SSL and Encryption with Data Sources and Oracle Drivers.....	13-14
13.7.1	Using SSL with Data Sources and Oracle Drivers.....	13-15
13.7.2	Using Data Encryption with Data Sources and Oracle Drivers	13-16
14	Creating and Managing Oracle Wallet	
14.1	What is Oracle Wallet.....	14-1
14.2	Where to Keep Your Wallet.....	14-1
14.3	How to Create an External Password Store.....	14-2
14.4	Defining a WebLogic Server Datasource using the Wallet.....	14-3
14.4.1	Copy the Wallet Files	14-3
14.4.2	Update the Datasource Configuration	14-3
14.5	Using a TNS Alias instead of a DB Connect String	14-3
15	Deploying Data Sources on Servers and Clusters	
15.1	Deploying Data Sources on Servers and Clusters.....	15-1
15.2	Minimizing Server Startup Hang Caused By an Unresponsive Database	15-1
16	Using WebLogic Server with Oracle RAC	
16.1	Overview of Oracle Real Application Clusters	16-1
16.2	Software Requirements.....	16-2
16.3	JDBC Driver Requirements	16-2
16.4	Hardware Requirements	16-2
16.4.1	WebLogic Server Cluster.....	16-2
16.4.2	Oracle RAC Cluster.....	16-2
16.4.3	Shared Storage	16-3

16.5	Configuration Options in WebLogic Server with Oracle RAC	16-3
16.5.1	Choosing a WebLogic Server Configuration for Use with Oracle RAC	16-3
16.5.2	Validating Connections when using WebLogic Server with Oracle RAC	16-4
16.5.3	Additional Considerations When Using WebLogic Server with Oracle RAC	16-4
17	Using JDBC Drivers with WebLogic Server	
17.1	JDBC Driver Support.....	17-1
17.2	JDBC Drivers Installed with WebLogic Server.....	17-1
17.3	Adding Third-Party JDBC Drivers Not Installed with WebLogic Server	17-2
17.4	Globalization Support for the Oracle Thin Driver	17-5
17.5	Using the Oracle Thin Driver in Debug Mode	17-5
18	Monitoring WebLogic JDBC Resources	
18.1	Viewing Run-Time Statistics	18-1
18.1.1	Data Source Statistics	18-1
18.1.2	Prepared Statement Cache Statistics.....	18-2
18.2	Profile Logging.....	18-2
18.3	Collecting Profile Information	18-2
18.3.1	Profile Types	18-2
18.3.2	Accessing Diagnostic Data	18-7
18.3.3	Callbacks for Monitoring Driver-Level Statistics (Deprecated)	18-7
18.4	Debugging JDBC Data Sources.....	18-7
18.4.1	Enabling Debugging	18-8
18.4.2	JDBC Debugging Scopes	18-10
18.4.3	Setting Debugging for UCP/ONS	18-11
18.4.4	Request Dyeing.....	18-11
19	Managing WebLogic JDBC Resources	
19.1	Testing Data Sources and Database Connections	19-1
19.2	Managing the Statement Cache for a Data Source.....	19-2
19.2.1	Clearing the Statement Cache for a Data Source	19-2
19.2.2	Clearing the Statement Cache for a Single Connection	19-2
19.3	Shrinking a Connection Pool.....	19-3
19.4	Resetting a Connection Pool	19-3
19.5	Suspending a Connection Pool.....	19-3
19.6	Resuming a Connection Pool	19-5
19.7	Shutting Down a Data Source.....	19-5
19.8	Starting a Data Source.....	19-6
19.9	Managing DBMS Network Failures.....	19-6
20	Tuning Data Source Connection Pools	
20.1	Increasing Performance with the Statement Cache	20-1
20.1.1	Statement Cache Algorithms	20-2

20.1.2	Statement Cache Size	20-2
20.1.3	Usage Restrictions for the Statement Cache	20-3
20.2	Connection Testing Options for a Data Source	20-4
20.2.1	Database Connection Testing Semantics	20-6
20.2.2	Database Connection Testing Configuration Recommendations	20-9
20.2.3	Database Connection Testing Using Default Test Table Name.....	20-10
20.2.4	Database Connection Testing Options	20-11
20.3	Enabling Connection Creation Retries.....	20-11
20.4	Enabling Connection Requests to Wait for a Connection	20-11
20.4.1	Connection Reserve Timeout.....	20-12
20.4.2	Limiting the Number of Waiting Connection Requests	20-12
20.5	Automatically Recovering Leaked Connections	20-12
20.6	Avoiding Server Lockup with the Correct Number of Connections	20-13
20.7	Limiting Statement Processing Time with Statement Timeout	20-13
20.8	Using Pinned-To-Thread Property to Increase Performance.....	20-13
20.8.1	Changes to Connection Pool Administration Operations When PinnedToThread is Enabled	20-14
20.8.2	Additional Database Resource Costs When PinnedToThread is Enabled.....	20-14
20.9	Using Unwrapped Data Type Objects.....	20-15
20.9.1	How to Disable Wrapping	20-16
20.10	Tuning Maintenance Timers	20-17

A Using an Oracle 12c Database

A.1	WebLogic JDBC Features for Oracle 12c Database.....	A-1
A.1.1	JDBC 4.1 Support for JDK 7	A-1
A.1.2	Application Continuity Support	A-2
A.1.3	Database Resident Connection Pooling Support.....	A-2
A.1.4	Container Database with Pluggable Databases	A-2
A.1.5	Global Database Services Support.....	A-2
A.1.6	Automatic ONS Listeners	A-2
A.2	Summary of 12C Database Feature Support with WebLogic Server	A-2

B Configuring JDBC Application Modules for Deployment

B.1	Packaging a JDBC Module with an Enterprise Application: Main Steps	B-1
B.2	Creating Packaged JDBC Modules	B-2
B.2.1	Creating a JDBC Data Source Module Using the Administration Console	B-2
B.2.2	JDBC Packaged Module Requirements	B-2
B.2.3	JDBC Application Module Limitations.....	B-3
B.2.4	Creating a Generic Data Source Module	B-3
B.2.5	Creating an Active GridLink Data Source Module.....	B-4
B.2.6	Creating a Multi Data Source Module.....	B-5
B.2.7	Encrypting Database Passwords in a JDBC Module	B-5
B.2.8	Application Scoping for a Packaged JDBC Module.....	B-6

B.3	Referencing a JDBC Module in Java EE Descriptor Files	B-6
B.3.1	Packaged JDBC Module References in weblogic-application.xml	B-7
B.3.2	Packaged JDBC Module References in Other Descriptors.....	B-7
B.4	Packaging an Enterprise Application with a JDBC Module	B-8
B.5	Deploying an Enterprise Application with a JDBC Module.....	B-8
B.6	Getting a Database Connection from a Packaged JDBC Module.....	B-9

C Using Multi Data Sources with Oracle RAC

C.1	Overview of Oracle Real Application Clusters	C-1
C.1.1	Oracle RAC Scalability with WebLogic Server Multi Data Sources	C-2
C.1.2	Oracle RAC Availability with WebLogic Server Multi Data Sources.....	C-3
C.1.3	Oracle RAC Load Balancing with WebLogic Server Multi Data Sources	C-3
C.2	Software Requirements	C-3
C.3	JDBC Driver Requirements	C-3
C.4	Hardware Requirements.....	C-3
C.4.1	WebLogic Server Cluster	C-4
C.4.2	Oracle RAC Cluster.....	C-4
C.4.3	Shared Storage	C-4
C.5	Configuring Multi Data Sources with Oracle RAC	C-4
C.5.1	Choosing a Multi Data Source Configuration for Use with Oracle RAC.....	C-4
C.5.2	Configuring Multi Data Sources for use with Oracle RAC.....	C-5
C.5.3	Configuration Considerations for Failover.....	C-6
C.5.4	Configuring the Listener Process for Each Oracle RAC Instance.....	C-8
C.5.5	Configuring Multi Data Sources When Remote Listeners are Enabled or Disabled	C-10
C.5.6	Additional Configuration Considerations.....	C-10
C.6	Using Multi Data Sources with Global Transactions.....	C-11
C.6.1	Rules for Data Sources within a Multi Data Source Using Global Transactions	C-11
C.6.2	Required Attributes of Data Sources within a Multi Data Source Using Global Transactions.....	C-12
C.6.3	Sample Configuration Code.....	C-13
C.7	Using Multi Data Sources without Global Transactions.....	C-14
C.7.1	Attributes of Data Sources within a Multi Data Source Not Using Global Transactions.....	C-14
C.7.2	Sample Configuration Code.....	C-15
C.8	Configuring Connections to Services on Oracle RAC Nodes	C-16
C.8.1	Configuring a Data Source to Connect to a Service.....	C-16
C.8.2	Service Connection Configurations	C-17
C.8.3	Connection Pool Capacity Planning	C-19
C.9	Using SCAN Addresses with Multi Data Sources	C-22
C.10	XA Considerations and Limitations when using multi Data Sources with Oracle RAC .	C-23
C.10.1	Oracle RAC XA Requirements when using multi Data Sources	C-23
C.10.2	Known Limitations When Using Oracle RAC with multi Data Sources.....	C-24
C.10.3	Known Issue Occurring After Database Server Crash.....	C-25

C.11	JDBC Store Recovery with Oracle RAC.....	C-25
C.11.1	Configuring a JDBC Store for Use with Oracle RAC	C-25
C.11.2	Automatic Retry for JMS Connections	C-25
D	Using Fast Connection Failover with Oracle RAC	
D.1	JDBC Driver Configuration for use with Oracle Fast Connection Failover	D-1
E	Smart Upgrade Support for JDBC	
E.1	Smart Upgrade Features.....	E-1

Preface

This preface describes the document accessibility features and conventions used in this guide—.

Documentation Accessibility

For information about Oracle's commitment to accessibility, visit the Oracle Accessibility Program website at <http://www.oracle.com/pls/topic/lookup?ctx=acc&id=docacc>.

Access to Oracle Support

Oracle customers that have purchased support have access to electronic support through My Oracle Support. For information, visit <http://www.oracle.com/pls/topic/lookup?ctx=acc&id=info> or visit <http://www.oracle.com/pls/topic/lookup?ctx=acc&id=trs> if you are hearing impaired.

Conventions

The following text conventions are used in this document:

Convention	Meaning
boldface	Boldface type indicates graphical user interface elements associated with an action, or terms defined in text or the glossary.
<i>italic</i>	Italic type indicates book titles, emphasis, or placeholder variables for which you supply particular values.
monospace	Monospace type indicates commands within a paragraph, URLs, code in examples, text that appears on the screen, or text that you enter.

Introduction and Roadmap

This chapter describes the contents and organization of this guide—*Administering JDBC Data Sources for Oracle WebLogic Server*.

This chapter includes the following sections:

- [Document Scope and Audience](#)
- [Guide to this Document](#)
- [Related Documentation](#)
- [JDBC Samples and Tutorials](#)
- [New and Changed JDBC Data Source Features in This Release](#)

1.1 Document Scope and Audience

This document is a resource for software developers and system administrators who develop and support applications that use the Java Database Connectivity (JDBC) API. It also contains information that is useful for business analysts and system architects who are evaluating WebLogic Server. The topics in this document are relevant during the evaluation, design, development, pre-production, and production phases of a software project.

This document does not address specific JDBC programming topics. For links to WebLogic Server documentation and resources for this topic, see [Related Documentation](#).

It is assumed that the reader is familiar with Java EE and JDBC concepts. This document emphasizes the value-added features provided by WebLogic Server.

1.2 Guide to this Document

- This chapter, [Introduction and Roadmap](#), introduces the organization of this guide and lists new features in the current release.
- [Configuring WebLogic JDBC Resources](#), provides an overview of WebLogic JDBC resources.
- [Configuring JDBC Data Sources](#), describes WebLogic JDBC data source configuration.
- [Configuring JDBC Multi Data Sources](#), describes WebLogic JDBC multi data source configuration.
- [Using Active GridLink Data Sources](#), describes WebLogic Active GridLink Data Source configuration.

- [Advanced Configurations for Oracle Drivers and Databases](#), provides advanced configuration options that can provide improved data source and driver performance when using Oracle drivers and databases.
- [Connection Harvesting](#), describes how to configure and use connection harvesting in your applications.
- [Labeling Connections](#), provides information on how to label connections to increase performance.
- [JDBC Data Source Transaction Options](#), provides information on XA, non-XA, and Global Transaction options for WebLogic data sources.
- [Understanding Data Source Security](#), provides information on how WebLogic Server uses configuration options to secure JDBC data sources.
- [Creating and Managing Oracle Wallet](#), provides information on how to create and manage an Oracle Wallet to store database credentials for WebLogic Server datasource definitions.
- [Deploying Data Sources on Servers and Clusters](#), provides information on how to deploy data sources on servers and clusters.
- [Using WebLogic Server with Oracle RAC](#), describes how to configure WebLogic Server for use with Oracle Real Application Clusters.
- [Using JDBC Drivers with WebLogic Server](#), describes how to use JDBC drivers from other sources in your WebLogic JDBC data source configuration.
- [Monitoring WebLogic JDBC Resources](#), describes how to monitor JDBC resources, gather profile information about database connection usage, and enable JDBC debugging.
- [Managing WebLogic JDBC Resources](#), describes how to administer data sources.
- [Tuning Data Source Connection Pools](#), provides information on how to properly tune the connection pool attributes in JDBC data sources in your WebLogic Server domain to improve application and system performance.
- [Using an Oracle 12c Database](#), provides information on how to configure WebLogic Server Release 12.1.2 and higher to interoperate with an Oracle 12c database.
- [Configuring JDBC Application Modules for Deployment](#), describes how to package a WebLogic JDBC module with your enterprise application.
- [Using Multi Data Sources with Oracle RAC](#), describes how to configure multi data sources for use with Oracle Real Application Clusters.
- [Using Fast Connection Failover with Oracle RAC](#), describes how to use WebLogic server with Oracle Fast Connection Failover.

1.3 Related Documentation

This document contains JDBC data source configuration and administration information.

For comprehensive guidelines for developing, deploying, and monitoring WebLogic Server applications, see the following documents:

- *Developing JDBC Applications for Oracle WebLogic Server* is a guide to JDBC API programming with WebLogic Server.
- *Developing Applications for Oracle WebLogic Server* is a guide to developing WebLogic Server applications.
- *Deploying Applications to Oracle WebLogic Server* is the primary source of information about deploying WebLogic Server applications in development and production environments.

1.4 JDBC Samples and Tutorials

In addition to this document, Oracle provides a variety of JDBC code samples and tutorials that show configuration and API use, and provide practical instructions on how to perform key JDBC development tasks.

1.4.1 Avitek Medical Records Application (MedRec) and Tutorials

MedRec is an end-to-end sample Java EE application shipped with WebLogic Server that simulates an independent, centralized medical record management system. The MedRec application provides a framework for patients, doctors, and administrators to manage patient data using a variety of different clients.

MedRec demonstrates WebLogic Server and Java EE features, and highlights Oracle-recommended best practices. MedRec is optionally installed with the WebLogic Server installation. You can start MedRec from the `ORACLE_HOME\user_projects\domains\medrec` directory, where `ORACLE_HOME` is the directory you specified as the Oracle Home when you installed Oracle WebLogic Server.

1.4.2 JDBC Examples in the WebLogic Server Distribution

WebLogic Server optionally installs API code examples in `EXAMPLES_HOME\wl_server\examples\src\examples`, where `EXAMPLES_HOME` represents the directory in which the WebLogic Server code examples are configured. For more information, see Sample Applications and Code Examples in *Understanding Oracle WebLogic Server*.

1.5 New and Changed JDBC Data Source Features in This Release

This release includes the following new and changed features:

- [Default Data Source](#)
- [Simplified Driver Installation/Update](#)
- [Proxy Data Source Support](#)
- [UCP Data Source Support](#)
- [JDBC Data Source Support for Multitenancy](#)
- [Connection Leak Profiling Enhancements](#)
- [Enhanced Connection-Based System Properties](#)
- [Application Continuity Runtime Statistics](#)
- [ONS Node List Configuration Enhancements](#)

- [DRCP Network Timeout Property](#)
- [Guidelines for Planned Maintenance and Database Outages](#)
- [Enabling ONS and JDBC Debugging Changes](#)
- [Removed Support for Connect-Time Failover](#)

For a comprehensive listing of the new WebLogic Server features introduced in this release, see *What's New in Oracle WebLogic Server 12.2.1.2.0*.

1.5.1 Default Data Source

Oracle provides Default Data Source support required by a Java EE 7-compliant runtime. This includes a configured data source that can be used by an application to access the Derby Database installed with WebLogic Server. See [Using the Default Data Source](#)

1.5.2 Simplified Driver Installation/Update

In previous releases, adding a new JDBC driver or updating a JDBC driver where the replacement JAR has a different name than the original JAR required updating the WebLogic Server's classpath to include the location of the JDBC driver classes. In this release, you can simply put the drivers in the \$DOMAIN_HOME/lib directory and not have to change the classpath. See [Adding Third-Party JDBC Drivers Not Installed with WebLogic Server](#)

1.5.3 Proxy Data Source Support

Oracle provides a new data source type which provides the ability to switch between databases in a WebLogic Server Java EE Multitenant environment. See [Using Proxy Data Sources](#)

1.5.4 UCP Data Source Support

A UCP data source is provided as an option for users who wish to use Oracle Universal Connection Pooling (UCP) to connect to Oracle Databases. UCP provides an alternative connection pooling technology to Oracle WebLogic Server connection pooling. For more information, see [Using Universal Connection Pool Data Sources](#)

1.5.5 JDBC Data Source Support for Multitenancy

Data source configuration and monitoring support for WebLogic Server Multitenant. See [Configuring JDBC](#) in *Using WebLogic Server Multitenant*.

1.5.6 Connection Leak Profiling Enhancements

Connection leak profiling enhancements include:

- A new attribute, `Set Connection Leak Timeout Seconds`, that can be used instead of `Inactive Connection Timeout Seconds` to specify the length of time before a reserved connection is considered leaked.
- Two new profile records:
 - `JDBC Object Closed Usage`—Collect profile information about application components that close a connection, statement, or result set.

- Local Transaction Connection Leak—Collect profile information about application components that leak a local transaction (start it but don't commit or rollback the transaction).

For more information, see [Collecting Profile Information](#) in *Administering JDBC Data Sources for Oracle WebLogic Server*.

1.5.7 Enhanced Connection-Based System Properties

You can set connection-based system properties using variables based on your environment. For more information, see [Enabling Connection-based System Properties](#)

1.5.8 Application Continuity Runtime Statistics

Application Continuity (or Replay) statistics are available using the `JDBCReplayStatisticsRuntimeMBean` for Generic and Active GridLink data sources. For more information, see [Viewing Runtime Statistics for Application Continuity](#)

1.5.9 ONS Node List Configuration Enhancements

You can now use a property node list to configure the ONS node list. The property node list, which can be used instead of a single node list, is a string composed of multiple records, with each record consisting of a key=value pair. For more information, see [ONS Client Configuration](#)

1.5.10 DRCP Network Timeout Property

In this release, a system property `weblogic.jdbc.attachNetworkTimeout` is provided that, after an attach to the server, specifies a network timeout that forces a round-trip to the database (using an Oracle ping database operation). The timeout is then unset. For more information, see [Database Resident Connection Pooling](#)

1.5.11 Enhanced Edition-Based Redefinition (EBR) Documentation

The documentation that describes this feature has been enhanced to include details about using EBR with JDBC connections, and describes how to configure WebLogic data sources to use Editions. For more information, see [Using Edition-Based Redefinition](#)

1.5.12 Guidelines for Planned Maintenance and Database Outages

(Procedures and guidelines have been included for planning and managing database maintenance and downtimes for Multi Data Source and Active Gridlink data sources. For more information, see the following topics:

- [Planned Database Maintenance with a Multi Data Source](#)
- [Managing Database Downtime with AGL Data Sources](#)

1.5.13 Enabling ONS and JDBC Debugging Changes

To enable ONS and JDBC replay debugging, you must configure Java Util Logging. For more information, see the following topics:

- [Enabling JDBC Driver Debugging](#)

- [Debugging ONS](#)

1.5.14 Removed Support for Connect-Time Failover

Oracle Connect-Time Failover was deprecated in an earlier release. This functionality, and the supporting appendix, have been removed in this release.

Configuring WebLogic JDBC Resources

This chapter describes WebLogic JDBC resources, how they are configured, and how those resources apply to a WebLogic domain.

This chapter includes the following sections:

- [Understanding JDBC Resources in WebLogic Server](#)
- [Ownership of Configured JDBC Resources](#)
- [Data Source Configuration Files](#)
- [JMX and WLST Access for JDBC Resources](#)
- [Creating High-Availability JDBC Resources](#)

2.1 Understanding JDBC Resources in WebLogic Server

In WebLogic Server, you can configure database connectivity by configuring JDBC data sources and then targeting or deploying the JDBC resources to servers or clusters in your WebLogic domain.

Each data source that you configure contains a pool of database connections that are created when the data source instance is created—when it is deployed or targeted, or at server startup. Applications lookup a data source on the JNDI tree or in the local application context (`java:comp/env`), depending on how you configure and deploy the object, and then request a database connection. When finished with the connection, the application calls `connection.close()`, which returns the connection to the connection pool in the data source. For more information about data sources in WebLogic Server, see [Configuring JDBC Data Sources](#).

An Active GridLink (AGL) datasource provides a connection pool that spans one or more nodes in one or more Oracle RAC clusters. It supports dynamic load balancing of connections across the nodes and handles events that indicates nodes that are added and removed from the cluster(s). See [Using Active GridLink Data Sources](#).

A Multi Data Source is an abstraction around a selected list of Generic data sources that provides load balancing or failover processing between the generic data sources associated with the Multi Data Source. Multi Data Sources are bound to the JNDI tree or local application context just like Generic data sources are bound to the JNDI tree. Applications lookup a Multi Data Source on the JNDI tree or in the local application context (`java:comp/env`) just like they do for generic data sources, and then request a database connection. The Multi Data Source determines which Generic data source to use to satisfy the request depending on the algorithm selected in the Multi Data Source configuration: load balancing or failover. For more information about multi data sources, see [Configuring JDBC Multi Data Sources](#).

2.2 Ownership of Configured JDBC Resources

A key to understanding WebLogic JDBC data source configuration and management is that *who* creates a JDBC resource or *how* a JDBC resource is created determines how a resource is deployed and modified. Both WebLogic Administrators and programmers can create JDBC resources:

- WebLogic Administrators typically use the WebLogic Server Administration Console or the WebLogic Scripting Tool (WLST) to create and deploy (target) JDBC modules. These JDBC modules are considered *system modules*. See [JDBC System Modules](#) for more details.
- Programmers create modules in a development tool that supports creating an XML descriptor file, then package the JDBC modules with an application (for example, an EAR or WAR file) and pass the application to a WebLogic Administrator to deploy. These JDBC modules are considered *application modules*. See [JDBC Application Modules](#) for more details.

Table 2-1 lists the JDBC module types and how they can be configured and modified.

Table 2-1 JDBC Module Types and Configuration and Management Options

Module Type	Created with	Add/Remove Modules with Administration Console	Modify with JMX (remotely)	Modify with JSR-88 (non-remotely)	Modify with Administration Console
System	WebLogic Server Administration Console or WLST	Yes	Yes	No	Yes—via JMX
Application	Oracle Enterprise Pack for Eclipse (OEPE), Oracle JDeveloper, another IDE, or an XML editor	No	No	Yes—via a deployment plan	Yes—via a deployment plan

2.3 Data Source Configuration Files

WebLogic JDBC data source configurations are stored in XML documents that conform to the `jdbc-data-source.xsd` schema (available at <http://www.oracle.com/webfolder/technetwork/weblogic/jdbc-data-source/index.html>).

You create and manage JDBC resources either as system modules or as application modules. WebLogic supports either standard or proprietary JDBC application modules. The standard JDBC application modules are created using the JEE 6 annotations or schema definitions based on `datasourcedefinition`. The proprietary JDBC application modules are a WebLogic-specific extension of Java EE modules and can be configured either within a Java EE application or as stand-alone modules.

Regardless of whether you are using JDBC system modules or JDBC application modules, each JDBC data source is represented by an XML file (a module).

2.3.1 JDBC System Modules

When you create a JDBC resource (data source) using the WebLogic Server Administration Console or using the WebLogic Scripting Tool (WLST), WebLogic Server creates a JDBC module in the `config/jdbc` subdirectory of the domain directory, and adds a reference to the module in the domain's `config.xml` file. The JDBC module conforms to the `jdbc-data-source.xsd` schema (available at <http://www.oracle.com/webfolder/technetwork/weblogic/jdbc-data-source/index.html>).

JDBC data sources that you configure this way are considered *system modules*. System modules are owned by an Administrator, who can delete, modify, or add similar resources at any time. System modules are globally available for targeting to servers and clusters configured in the domain, and therefore are available to all applications deployed on the same targets and to client applications. System modules are also accessible through JMX as `JDBCSystemResourceMBeans`.

2.3.1.1 Generic Data Source Modules

Generic data source system modules are included in the domain's `config.xml` file as a `JDBCSystemResource` element, which includes the name of the JDBC module file and the list of target servers and clusters on which the module is deployed. [Figure 2-1](#) shows an example of a data source listing in a `config.xml` file and the module that it maps to.

Note:

"Generic" is the term used to distinguish a simple data source from a Multi Data Source or AGL data source.

Figure 2-1 Reference from config.xml to a Data Source System Module

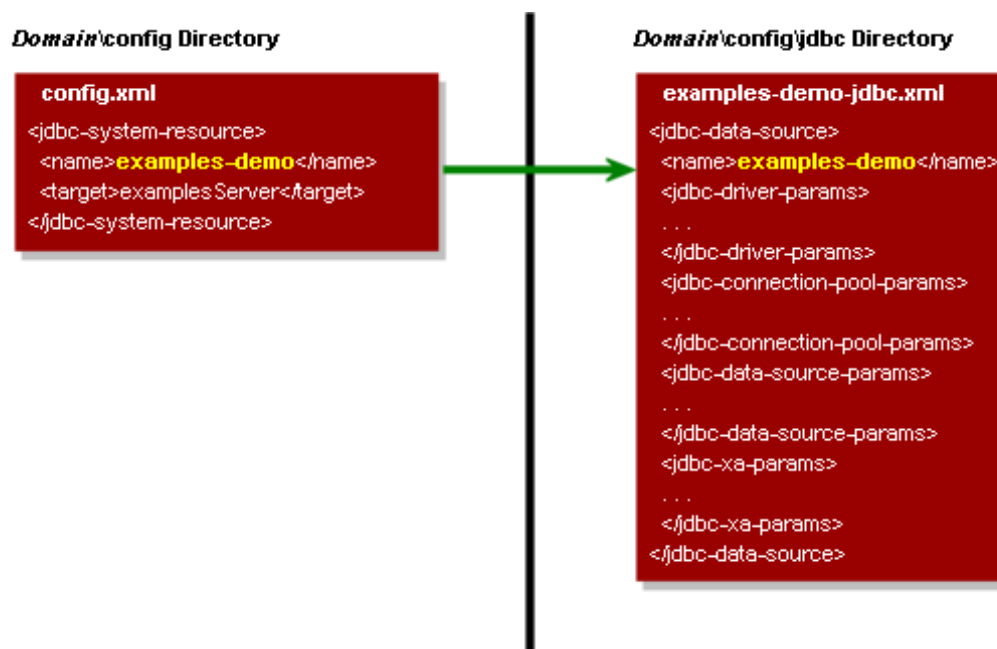

In this illustration, the `config.xml` file lists the `examples-demo` data source as a `jdbc-system-resource` element, which maps to the `examples-demo-jdbc.xml` module in the `domain\config\jdbc` folder.

2.3.1.2 Active GridLink Data Source System Modules

AGL data source system modules are included in the domain's `config.xml` file as a `JDBCSystemResource` element, similar to generic data source system modules. AGL data sources include an `jdbc-oracle-params` section that includes ONS and FAN.

For more information on AGL data sources, see [Using Active GridLink Data Sources](#).

2.3.1.3 Multi Data Source System Modules

Similarly, multi data source system modules are included in the domain's `config.xml` file as a `jdbc-system-resource` element. The multi data source module includes a `data-source-list` parameter that maps to the data source modules used by the multi data source. The individual data source modules are also included in the `config.xml`. [Figure 2-2](#) shows the relationship between elements in the `config.xml` file and the system modules in the `config/jdbc` directory.

Figure 2-2 Reference from config.xml to Multi Data Source and Data Source System Modules

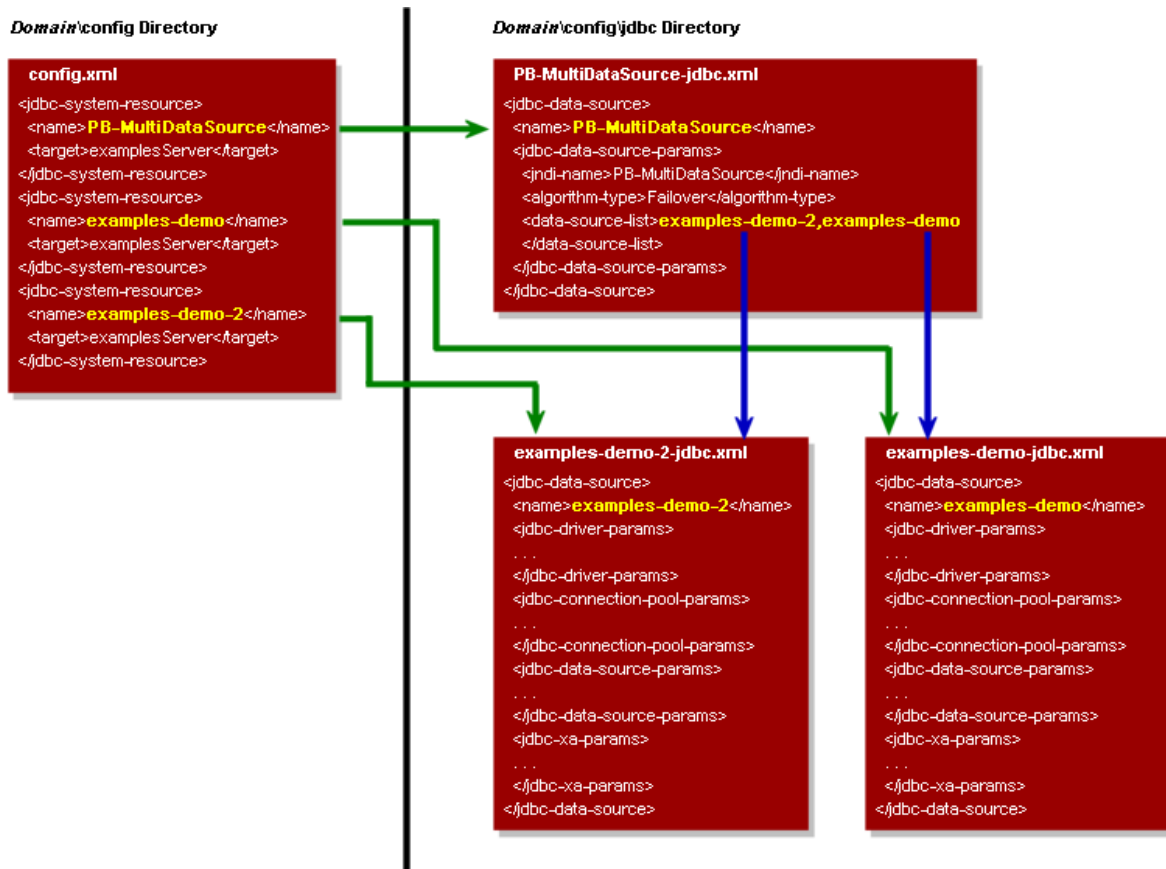

In this illustration, the `config.xml` file lists three JDBC modules—one multi data source and the two generic data sources used by the multi data source, which are also listed within the multi data source module. Your application can look up any of these modules on the JNDI tree and request a database connection. If you look up the multi data source, the multi data source determines which of the generic data sources to use to supply the database connection, depending on the data sources in the `data-`

source-list parameter, the order in which the data sources are listed, and the algorithm specified in the algorithm-type parameter.

Note:

Members of a multi data source must be generic data sources; they cannot be multi data sources or AGL data sources.

For more information about multi data sources, see [Configuring JDBC Multi Data Sources](#).

2.3.2 JDBC Application Modules

In contrast to system resource modules, JDBC modules that are packaged with an application are owned by the developer who created and packaged the module, rather than the Administrator who deploys the module. This means that the Administrator has more limited control over packaged modules. When deploying a resource module, an Administrator can change resource properties that were specified in the module, but the Administrator cannot add or delete modules. (As with other Java EE modules, deployment configuration changes for a resource module are stored in a deployment plan for the module, leaving the original module untouched.)

2.3.2.1 Standard Java EE Application Modules

Java EE 6 provides the ability to programmatically define DataSource resources as application modules for a more flexible and portable method of database connectivity. See Using DataSource Resource Definitions in *Developing JDBC Applications for Oracle WebLogic Server*.

2.3.2.2 Proprietary JDBC Application Modules

JDBC resources can also be managed as application modules, similar to standard Java EE modules. A proprietary JDBC application module is simply an XML file that conforms to the jdbc-data-source.xsd schema (available at <http://www.oracle.com/webfolder/technetwork/weblogic/jdbc-data-source/index.html>) and represents a data source.

JDBC modules can be included as part of an Enterprise Application as a *packaged module*. Packaged modules are bundled with an EAR or exploded EAR directory, and are referenced in all appropriate deployment descriptors, such as the weblogic-application.xml and ejb-jar.xml deployment descriptors. The JDBC module is deployed along with the enterprise application, and can be configured to be available only to the enclosing application or to all applications. Using packaged modules ensures that an application always has access to required resources and simplifies the process of moving the application into new environments. With packaged JDBC modules, you can migrate your application and the required JDBC configuration from environment to environment, such as from a testing environment to a production environment, without opening an EAR file and without extensive manual data source reconfiguration.

By definition, packaged JDBC modules are included in an enterprise application, and therefore are deployed when you deploy the enterprise application. For more information about deploying applications with packaged JDBC modules, see *Deploying Applications to Oracle WebLogic Server*.

A proprietary JDBC application module can also be deployed as a stand-alone resource using the `weblogic.Deployer` utility or the WebLogic Server Administration Console, in which case the resource is typically available to the server or cluster targeted during the deployment process. JDBC resources deployed in this manner are called *stand-alone modules* and can be reconfigured using the WebLogic Server Administration Console or a JSR-88 compliant tool, but are unavailable through JMX or WLST.

Stand-alone JDBC modules promote sharing and portability of JDBC resources. You can create a data source configuration and distribute it to other developers. Stand-alone JDBC modules can also be used to move data source configuration between domains, such as between the development domain and the staging domain.

Note:

When deploying proprietary JDBC modules as standalone modules, a multi data source needs to have a deployment order that is greater than the deployment orders of its member generic data sources.

For more information about JDBC application modules, see [Configuring JDBC Application Modules for Deployment](#).

For information about deploying stand-alone JDBC modules, see [Deploying JDBC, JMS, WLDF Application Modules in *Deploying Applications to Oracle WebLogic Server*](#).

2.3.2.2.1 Including Drivers in EAR/WAR Files

In WebLogic Server 10.3.6 and higher releases, you can include a database driver in the `APP-INF/lib` directory of the EAR/WAR file that contains a packaged data source. This allows you to deploy a self-contained EAR/WAR file that has both the data source and driver required for an application.

Note:

You do not need to update the `Classpath` of the manifest file to include the driver location.

An EAR has its own classloader and it is shared across all of the nested applications so any of them can use it. You can deploy multiple EAR/WAR files, each with a different driver version. However, if there are other versions of the driver in the system classpath, set `PREFER-WEB-INF-CLASSES=true` in the `weblogic.xml` file to ensure that the application uses the driver classes that it was packaged with which it was packaged.

When using the Oracle driver embedded in an EAR or WAR with `ojdbc6.jar` or `ojdbc7.jar`, there is a known problem related to cleaning up the associated classloader. To resolve this problem, call `oracle.jdbc.OracleDriver.deregisterHack()` from the `contextDestroyed()` method of a `ServletContextListener`.

You can also use the `WEB-INF/lib` directory to hold driver JAR files. The following example shows the location of the various directories in WAR and EAR files.

```
Application (ear)
  Web module (war)
    WEB-INF/lib
```

```
EJB module
META-INF
APP-INF/lib
```

However, you cannot have two versions of the same JAR in both `DOMAIN_HOME/lib` (see [Using a Third-Party JAR File in DOMAIN_HOME/lib](#) or the system classpath and `WEB-INF/lib` or `APP-INF/lib`, with `prefer-web-inf-classes` or `prefer-application-packages` set. That is, you should do only one of the following:

- Use `DOMAIN_HOME/lib` or system classpath to get the driver into all applications in the domain, or
- Use the driver embedded in the application.

Note: If you do not adhere to this restriction, it is possible (depending on the JAR, the version changes, and the order in which the JARs are referenced) that a `ClassCastException` will occur in the application.

If the JAR files are present in multiple locations, the following rules apply:

- If `prefer-web-inf-classes` in the `weblogic.xml` is false, the precedence is: system classpath > `DOMAIN_HOME/lib``APP-INF/lib``WEB-INF/lib`.
- If `prefer-web-inf-classes` in `weblogic.xml` is true, the classes in `WEB-INF/lib` will take precedence over all other locations.

2.3.3 JDBC Module File Naming Requirements

All WebLogic JDBC module files must end with the `-jdbc.xml` suffix, such as `examples-demo-jdbc.xml`. WebLogic Server checks the file name when you deploy the module. If the file does not end in `-jdbc.xml`, the deployment will fail and the server will not boot.

2.3.4 JDBC Modules in Versioned Applications

When you use production redeployment (versioning) to deploy a version of an application that includes a packaged JDBC module, WebLogic Server identifies the data source defined in the JDBC module with a name in the following format:

```
application_id#version_id@module_name@data_source_name
```

This name is used for data source run-time MBeans and for registering the data source instance with the WebLogic Server transaction manager.

If transactions in a retiring version of an application time out and the version of the application is then undeployed, you may have to manually resolve any pending or incomplete transactions on the data source in the retired version of the application. After a data source is undeployed (in this case, with the retired version of the application), the WebLogic Server transaction manager cannot recover pending or incomplete transactions.

For more information about production redeployment, see:

- [Developing Applications for Production Redeployment in *Developing Applications for Oracle WebLogic Server*](#)

- Using Production Redeployment to Update Applications in *Deploying Applications to Oracle WebLogic Server*

2.3.5 JDBC Schema

In support of the modular deployment model for JDBC resources in WebLogic Server, Oracle provides a schema for WebLogic JDBC objects: `weblogic-jdbc.xsd`. When you create JDBC resource modules (descriptors), the modules must conform to the schema. IDEs and other tools can validate JDBC resource modules based on the schema.

The schema is available at <http://www.oracle.com/webfolder/technetwork/weblogic/jdbc-data-source/index.html>.

Note:

The `scope` in the `jdbc-data-source-params` element of the schema may only be set to `Application` for packaged data sources. The value `Application` is not valid for:

- System resources in `config/jdbc`, including generic, multi-data sources, and AGL data sources.
- Stand-alone data sources that are deployed dynamically or statically using the `<app-deployment>` element in the `config.xml` file.

For these data source types, there is no application to scope the data source and no associated module. WebLogic Server does not generate a scope of `Application`. This omission was not flagged as an error in releases of prior to WebLogic Server 10.3.6.0 and is displayed in the console with an invalid name similar to `ds0@null@ds0`. For WebLogic Server 10.3.6.0 and higher, an `Error` message is logged for this configuration error and the system attempts to set the scope to `Global` and display the data source name as `ds0`. In future releases, this error may be treated as fatal.

2.3.6 JDBC Data Source Type

This topic describes the JDBC Data Source types.

Data sources should have a `datasource-type` set in the descriptor. This functionality was added in WebLogic Server 12.2.1 and is optional for backward compatibility. The valid values are:

- `GENERIC`—Generic data source
- `MDS` —Multi Data Source
- `AGL`—Active GridLink data source
- `UCP`—Universal Connection Pool data source
- `PROXY`—Proxy for multiple tenant data sources

If the `datasource-type` is not set to `UCP` or `PROXY`, the following validations are performed:

- If `datasource-type` is set to `AGL`, it is treated as an Active GridLink data source even if `FAN enabled` is `false` and no ONS list is configured, and the Active GridLink flag is `false`.
- If the `datasource-type` is not set to `AGL`, it is an error even if `FAN enabled` is `true` or an ONS list is configured or the Active GridLink flag is `true`.
- If no data source list exists (it does not have Multi Data Source members) and `datasource-type` is set to anything other than `GENERIC` or `AGL`, it is an error.
- If the data source list exists (it has Multi Data Source members) and the `datasource-type` is set to anything other than `MDS`, it is an error.

2.4 JMX and WLST Access for JDBC Resources

You can create JDBC resources using any of the administration tools listed in Summary of System Administration Tools and APIs in *Understanding Oracle WebLogic Server*. When you create JDBC resources, WebLogic Server creates MBeans (Managed Beans) for each of the resources. You can then access these MBeans using JMX or the WebLogic Scripting Tool (WLST). See *Developing Custom Management Utilities Using JMX for Oracle WebLogic Server* and *Understanding the WebLogic Scripting Tool* for more information.

- [JDBC MBeans for System Resources](#)
- [JDBC Management Objects in the Java EE Management Model \(JSR-77 Support\)](#)
- [Using WLST to Create JDBC System Resources](#)
- [How to Modify and Monitor JDBC Resources](#)
- [Best Practices when Using WLST to Configure JDBC Resources](#)

2.4.1 JDBC MBeans for System Resources

This topic describes the JDBC Bean tree structure.

[Figure 2-3](#) shows the hierarchy of the MBeans for JDBC objects in a WebLogic domain.

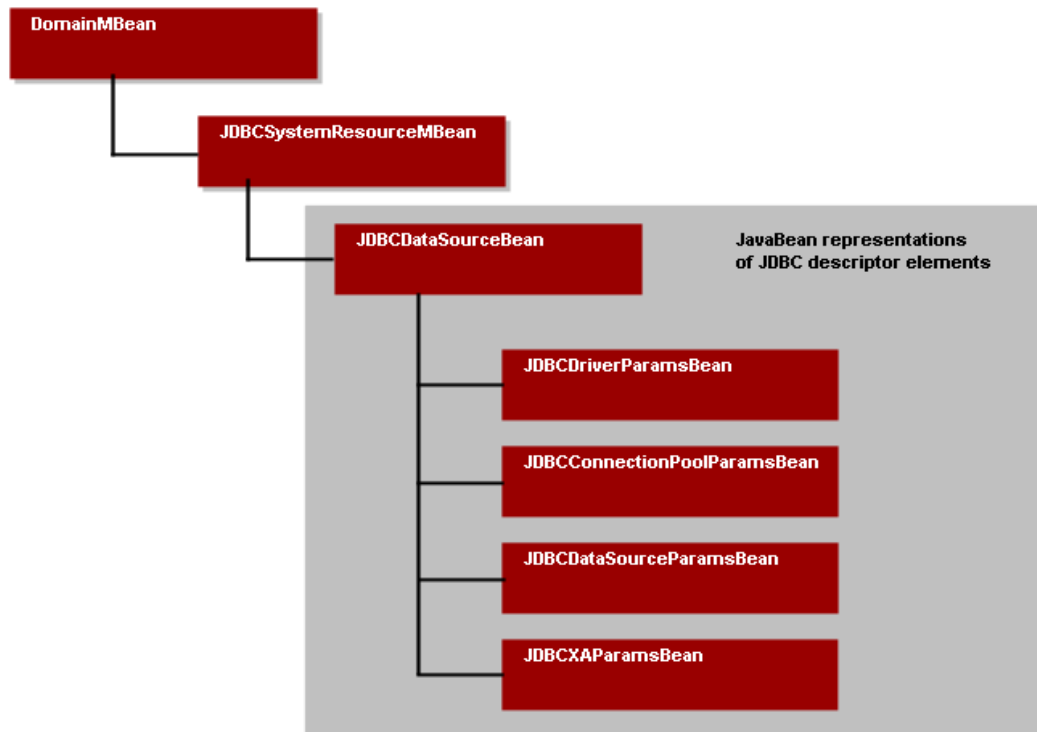
Figure 2-3 JDBC Bean Tree

The `JDBCSystemResourceMBean` is a container for the JavaBeans created from a data source module. However, all JMX access for a JDBC data source is through the `JDBCSystemResourceMBean`. You cannot directly access the individual JavaBeans created from the data source module.

2.4.2 JDBC Management Objects in the Java EE Management Model (JSR-77 Support)

The WebLogic Server JDBC subsystem supports JSR-77, which defines the Java EE Management Model. The Java EE Management Model is used for monitoring the run-time state of a Java EE Web application server and its resources. You can access the Java EE Management Model to monitor resources, including the WebLogic JDBC subsystem as a whole, JDBC drivers loaded into memory, and JDBC data sources.

To comply with the specification, Oracle added the following run-time MBean types for the WebLogic JDBC subsystem:

- `JDBCServiceRuntimeMBean`—Which represents the JDBC subsystem and provides methods to access the list of `JDBCDriverRuntimeMBeans`, `JDBCMultiDataSourceRuntimeMBean`, and `JDBCDataSourceRuntimeMBeans` currently available in the system.
- `JDBCMultiDataSourceRuntimeMBean`—Which represents a JDBC multi data source deployed on a server or cluster.
- `JDBCDriverRuntimeMBean`—Which represents a JDBC driver that the server loaded into memory.
- `JDBCDataSourceRuntimeMBeans`—Which represents a JDBC generic or AGL data source deployed on a server or cluster.

Note:

WebLogic JDBC run-time MBeans do not implement the optional Statistics Provider interfaces specified by JSR-77.

For more information about using the Java EE management model with WebLogic Server, see *Developing Java EE Management Applications for Oracle WebLogic Server*.

2.4.3 Using WLST to Create JDBC System Resources

Basic tasks you need to perform when creating JDBC resources with the WLST are:

- Start an edit session.
- Create a JDBC system module that includes JDBC system resources, such as pools, data sources, multi data sources, and JDBC drivers.
- Target your JDBC system module.

Example 2-1 WLST Script to Create JDBC Resources

```
#-----
# Create JDBC Resources
#-----

import sys
from java.lang import System

print "### Starting the script ..."
global props

url = sys.argv[1]
usr = sys.argv[2]
password = sys.argv[3]

connect(usr,password, url)
edit()
startEdit()

servermb=getMBean("Servers/examplesServer")
    if servermb is None:
        print '### No server MBean found'
    else:
        def addJDBC(prefix):

            print("")
            print("*** Creating JDBC resources with property prefix " + prefix)

# Create the Connection Pool. The system resource will have
# generated name of <PoolName>+"-jdbc"

myResourceName = props.getProperty(prefix+"PoolName")
print("Here is the Resource Name: " + myResourceName)

jdbcSystemResource = wl.create(myResourceName,"JDBCSystemResource")
myFile = jdbcSystemResource.getDescriptorFileName()
print ("HERE IS THE JDBC FILE NAME: " + myFile)

jdbcResource = jdbcSystemResource.getJDBCResource()
jdbcResource.setName(props.getProperty(prefix+"PoolName"))
```

```
# Create the DataSource Params
dpBean = jdbcResource.getJDBCDataSourceParams()
myName=props.getProperty(prefix+"JNDIName")
dpBean.setJNDINames([myName])

# Create the Driver Params
drBean = jdbcResource.getJDBCDriverParams()
drBean.setPassword(props.getProperty(prefix+"Password"))
drBean.setUrl(props.getProperty(prefix+"URLName"))
drBean.setDriverName(props.getProperty(prefix+"DriverName"))

propBean = drBean.getProperties()
driverProps = Properties()
driverProps.setProperty("user",props.getProperty(prefix+"UserName"))

e = driverProps.propertyNames()
while e.hasMoreElements() :
    propName = e.nextElement()
    myBean = propBean.createProperty(propName)
    myBean.setValue(driverProps.getProperty(propName))

# Create the ConnectionPool Params
ppBean = jdbcResource.getJDBCConnectionPoolParams()
ppBean.setInitialCapacity(int(props.getProperty(prefix+"InitialCapacity")))
ppBean.setMaxCapacity(int(props.getProperty(prefix+"MaxCapacity")))

if not props.getProperty(prefix+"ShrinkPeriodMinutes") == None:
    ppBean.setShrinkFrequencySeconds(int(props.getProperty(prefix+"ShrinkPeriodMinutes")))
if not props.getProperty(prefix+"TestTableName") == None:
    ppBean.setTestTableName(props.getProperty(prefix+"TestTableName"))

if not props.getProperty(prefix+"LoginDelaySeconds") == None:
    ppBean.setLoginDelaySeconds(int(props.getProperty(prefix+"LoginDelaySeconds")))

# Adding KeepXaConnTillTxComplete to help with in-doubt transactions.
xaParams = jdbcResource.getJDBCXAParams()
xaParams.setKeepXaConnTillTxComplete(1)

# Add Target
jdbcSystemResource.addTarget(wl.getMBean("/Servers/examplesServer"))
.
.
.
```

2.4.4 How to Modify and Monitor JDBC Resources

You can modify or monitor JDBC objects and attributes by using the appropriate method available from the MBean.

- You can modify JDBC objects and attributes using the set, target, untarget, and delete methods.
- You can monitor JDBC run-time objects using get methods.

For more information, see Navigating MBeans (WLST Online) in *Understanding the WebLogic Scripting Tool*.

2.4.5 Best Practices when Using WLST to Configure JDBC Resources

This section provides best practices information when using WLST to configure JDBC resources:

- Trap for Null MBean objects (such as pools, data sources, drivers) before trying to manipulate the MBean object.
- When using WLST offline, the following characters are not valid in names of management objects: period (.), forward slash (/), or backward slash (\). See Syntax for WLST Commands in *Understanding the WebLogic Scripting Tool*.

2.5 Creating High-Availability JDBC Resources

You can target or deploy a JDBC data source to the members of a cluster using the WebLogic Server Administration Console to improve the availability your JDBC resource and load balance communication between resources. However, connections do not fail over in the event that a cluster member becomes unavailable for any reason. New connections are created as needed on available cluster members. See [Deploying Data Sources on Servers and Clusters](#).

Note:

A multi data source can only use generic data sources that are deployed on the same cluster member (in the same JVM).

Configuring JDBC Data Sources

This chapter provides information on how to configure and tune JDBC data sources.

This chapter includes the following sections:

- [Understanding JDBC Data Sources](#)
- [Types of WebLogic Server JDBC Data Sources](#)
- [Creating a JDBC Data Source](#)
- [Configuring Generic Connection Pool Features](#)
- [Advanced Connection Properties](#)
- [Configuring Oracle Parameters](#)
- [Configuring an ONS Client](#)
- [Tuning Generic Data Source Connection Pools](#)
- [Generic Data Source Handling for Oracle RAC Outages.](#)
- [Generic Data Source Handling of Driver-Level Failover](#)

3.1 Understanding JDBC Data Sources

In WebLogic Server, you configure database connectivity by adding data sources to your WebLogic domain. WebLogic JDBC data sources provide database access and database connection management. Each data source contains a pool of database connections that are created when the data source is created and at server startup. Applications reserve a database connection from the data source by looking up the data source on the JNDI tree or in the local application context and then calling `getConnection()`. When finished with the connection, the application should call `connection.close()` as early as possible, which returns the database connection to the pool for other applications to use.

3.2 Types of WebLogic Server JDBC Data Sources

WebLogic Server provides five types of data sources:

- **Generic data sources**—Generic data sources and their connection pools provide connection management processes that help keep your system running efficiently. You can set options in the data source to suit your applications and your environment.
- **Active GridLink (AGL) data sources**—A data source that provides a connection pool that spans one or more nodes in one or more Oracle RAC clusters. It supports dynamic load balancing of connections across the nodes and handles events that

indicates nodes that are added and removed from the cluster(s). See [Using Active GridLink Data Sources](#).

- Multi data sources (MDS)—A *multi data source* is an abstraction around a group of generic data sources that provides load balancing or failover processing. See [Configuring JDBC Multi Data Sources](#).
- Proxy data source—A data source that provides the ability to switch between databases in a WebLogic Server Multitenant environment. See [Using Proxy Data Sources](#).
- Universal Connection Pool (UCP) data source—A UCP data source is provided as an option for users who wish to use Oracle Universal Connection Pooling (UCP) to connect to Oracle Databases. UCP provides an alternative connection pooling technology to Oracle WebLogic Server connection pooling. For more information, see [Using Universal Connection Pool Data Sources](#).

3.3 Creating a JDBC Data Source

You can create JDBC data sources in your WebLogic domain using the WebLogic Server Administration Console or the WebLogic Scripting Tool (WLST):

- [Create a JDBC Data Source](#) in the *Oracle WebLogic Server Administration Console Online Help*.

WebLogic Server JDBC Data Sources in *Administering Oracle WebLogic Server with Fusion Middleware Control*.

- The sample WLST script `EXAMPLES_HOME\wl_server\examples\src\examples\wlst\online\jdbc_data_source_creation.py`, where `EXAMPLES_HOME` represents the directory in which the WebLogic Server code examples are configured. See WLST Online Sample Scripts in *Understanding the WebLogic Scripting Tool*.

The following sections provide an overview of the basics steps used in the data source configuration wizard to create a data source using the WebLogic Server Administration Console:

- [JDBC Data Source Properties](#)
- [Configure Transaction Options](#)
- [Configure Connection Properties](#)
- [Test Connections](#)
- [Target the Data Source](#)

3.3.1 JDBC Data Source Properties

JDBC Data Source Properties include options that determine the identity of the data source and the way the data is handled on a database connection.

3.3.1.1 Data Source Names

JDBC data source names are used to identify the data source within the WebLogic domain. For system resource data sources, names must be unique among all other

JDBC system resources. To avoid naming conflicts, data source names should also be unique among other configuration object names, such as servers, applications, clusters, and JMS queues, topics, and servers. For JDBC application modules packaged in an application, data source names must be unique among JDBC data sources that are similarly scoped.

3.3.1.2 Data Source Scope

Select the scope for the data source from the list of available scopes. You can set the scope to Global (at the domain level), or to any existing Resource Group or Resource Group Template.

3.3.1.3 JNDI Names

You can configure a data source so that it binds to the JNDI tree with a single or multiple names. For more information, see *Developing JNDI Applications for Oracle WebLogic Server*.

3.3.1.4 Selecting a Database Type

Select a DBMS. For information about supported databases, see Supported Configurations in .

3.3.1.5 Selecting a JDBC Driver

When creating a JDBC data source using the WebLogic Server Administration Console, you are prompted to select a JDBC driver class. The WebLogic Server Administration Console provides most of the more common driver class names and in most cases tries to help you construct the URL as required by the driver. You should verify, however, that the URL is as you want it before asking the console to test it. The driver you select must be in the `classpath` on all servers on which you intend to deploy the data source. Some but not all JDBC drivers listed in the WebLogic Server Administration Console are shipped (and/or are already in the `classpath`) with WebLogic Server:

- Oracle Thin Driver
 - Oracle Thin Driver XA
 - Oracle Thin Driver non-XA
- MySQL (non-XA)
- Third-party JDBC drivers (see [Using JDBC Drivers with WebLogic Server](#)):
- WebLogic-branded DataDirect drivers for the following database management systems (see *Using WebLogic-branded DataDirect Drivers*):
 - DB2
 - Informix
 - Microsoft SQL Server
 - Sybase

All of these drivers are referenced by the `weblogic.jar` manifest file and do not need to be explicitly defined in a server's `classpath`.

When deciding which JDBC driver to use to connect to a database, you should try drivers from various vendors in your environment. In general, JDBC driver performance is dependent on many factors, especially the SQL code used in applications and the JDBC driver implementation.

For information about supported JDBC drivers, see Supported Configurations in *What's New in Oracle WebLogic Server 12.2.1.2.0*.

Note:

JDBC drivers listed in the WebLogic Server Administration Console when creating a data source are not necessarily certified for use with WebLogic Server. JDBC drivers are listed as a convenience to help you create connections to many of the database management systems available.

You must install JDBC drivers in order to use them to create database connections in a data source on each server on which the data source is deployed. Drivers are listed in the WebLogic Server Administration Console with known required configuration options to help you configure a data source. The JDBC drivers in the list are not necessarily installed. Driver installation can include setting system Path, Classpath, and other environment variables. See [Adding Third-Party JDBC Drivers Not Installed with WebLogic Server](#). When a JDBC driver is updated, configuration requirements may change. The WebLogic Server Administration Console uses known configuration requirements at the time the WebLogic Server software was released. If configuration options for your JDBC driver have changed, you may need to manually override the configuration options when creating the data source or in the property pages for the data source after it is created.

3.3.2 Configure Transaction Options

When you configure a JDBC data source using the WebLogic Server Administration Console, WebLogic Server automatically selects specific transaction options based on the type of JDBC driver:

- **For XA drivers**, the system automatically selects the **Two-Phase Commit** protocol for global transaction processing.
- **For non-XA drivers**, local transactions are supported by definition, and WebLogic Server offers the following options

Supports Global Transactions: (selected by default) Select this option if you want to use connections from the data source in global transactions, even though you have not selected an XA driver. See [Enabling Support for Global Transactions with a Non-XA JDBC Driver](#) for more information.

When you select Supports Global Transactions, you must also select the protocol for WebLogic Server to use for the transaction branch when processing a global transaction:

- **Logging Last Resource:** With this option, the transaction branch in which the connection is used is processed as the last resource in the transaction and is processed as a local transaction. Commit records for two-phase commit (2PC) transactions are inserted in a table on the resource itself, and the result determines the success or failure of the prepare phase of the global transaction. This option offers some performance benefits and greater data safety than

Emulate Two-Phase Commit, but it has some limitations. See [Understanding the Logging Last Resource Transaction Option](#).

Note:

Logging Last Resource is not supported for data sources used by a multi data source except when used with Oracle RAC version 10g Release 2 (10gR2) and greater versions as described in [Administrative Considerations and Limitations for LLR Data Sources](#).

- **Emulate Two-Phase Commit:** With this option, the transaction branch in which the connection is used always returns success for the prepare phase of the transaction. It offers performance benefits, but also has risks to data in some failure conditions. Select this option only if your application can tolerate heuristic conditions. See [Understanding the Emulate Two-Phase Commit Transaction Option](#).
- **One-Phase Commit:** (selected by default) With this option, a connection from the data source can be the only participant in the global transaction and the transaction is completed using a one-phase commit optimization. If more than one resource participates in the transaction, an exception is thrown when the transaction manager calls `XAResource.prepare` on the 1PC resource.

For more information on configuring transaction support for a data source, see [JDBC Data Source Transaction Options](#).

3.3.3 Configure Connection Properties

Connection Properties are used to configure the connection between the data source and the DBMS. Typical attributes are the database name, host name, port number, user name, and password.

Note:

You can use a Single Client Access Name (SCAN) address to represent the host name. When using Oracle RAC 11.2 and higher, consider the following:

- If the Oracle RAC `REMOTE_LISTENER` your data source connects to is set to `SCAN`, the data source connection url can only use a SCAN address.
- If the Oracle RAC `REMOTE_LISTENER` your data source connects to is set to `List of Node VIPs`, the data source connection url can only use a list of VIP addresses.
- If the Oracle RAC `REMOTE_LISTENER` your data source connects to is set to `Mix of SCAN and List of Node VIPs`, the data source connection url can use both SCAN and VIP addresses.

For more information on using SCAN addresses, see "Introduction to Automatic Workload Management" in Real Application Clusters Administration and Deployment Guide 11g Release 2 (11.2).

3.3.3.1 Configuring Connection Properties for Oracle BI Server

If you selected Oracle BI Server as your DBMS, configure the additional connection properties on the Connection Properties page as described in [Connection String](#) in *Oracle Business Intelligence Publisher Administrator's and Developer's Guide*.

3.3.4 Test Connections

Test Database Connection allows you to test a database connection before the data source configuration is finalized using a table name or SQL statement. If necessary, you can test additional configuration information using the `Properties` and `System Properties` attributes.

3.3.5 Target the Data Source

You can select one or more targets to which to deploy your new JDBC data source. If you don't select a target, the data source will be created but not deployed. You will need to deploy the data source at a later time before getting connections.

3.4 Configuring Generic Connection Pool Features

Each JDBC data source has a pool of JDBC connections that are created when the data source is deployed or at server startup. Applications use a connection from the pool then return it when finished using the connection. Connection pooling enhances performance by eliminating the costly task of creating database connections for the application.

Note:

Certain Oracle JDBC extensions, and possibly other non-standard methods available from other drivers may durably alter a connection's behavior in a way that future users of the pooled connection will inherit. WebLogic Server attempts to protect connections against some types of these calls when possible.

The following sections include information about connection pool options for a JDBC data source.

- [Enabling JDBC Driver-Level Features](#)
- [Enabling Connection-based System Properties](#)
- [Enabling Connection-based Encrypted Properties](#)
- [Initializing Database Connections with SQL Code](#)
- [Advanced Connection Properties](#)

You can see more information and set these and other related options through the:

- **JDBC Data Source: Configuration: Connection Pool** page in the WebLogic Server Administration Console. See [JDBC Data Source: Configuration: Connection Pool](#) in the *Oracle WebLogic Server Administration Console Online Help*
- `JDBCConnectionPoolParamsBean`, which is a child MBean of the `JDBCDataSourceBean`

3.4.1 Enabling JDBC Driver-Level Features

WebLogic JDBC data sources support the `javax.sql.ConnectionPoolDataSource` interface implemented by JDBC drivers. You can enable driver-level features by adding the property and its value to the `Properties` attribute in a JDBC data source. Driver-level properties in the `Properties` attribute are set on the driver's `ConnectionPoolDataSource` object.

3.4.2 Enabling Connection-based System Properties

WebLogic JDBC data sources support setting driver properties using the value of system properties. The value of each property is derived at runtime from the named system property. You can configure connection-based system properties using the WebLogic Server Administration Console by editing the `System Properties` attribute of your data source configuration.

If a system property value is set, it overrides an encrypted property value, which overrides a normal property value (you can only have one property value for each property name).

A system property value can contain one of the variables listed in [Table 3-1](#). If one or more of these variables is included in the system property, it is substituted with the corresponding value. If a value is not found, no substitution is performed. If none of these variables are found in the system property, then the value is taken as a system property name.

Table 3-1 Variables Supported in System Property Values for JDBC Data Source

Variable	Value Description
<code>\${pid}</code>	First half (up to @) of <code>ManagementFactory.getRuntimeMXBean().getName()</code>
<code>\${machine}</code>	Second half of <code>ManagementFactory.getRuntimeMXBean().getName()</code>
<code>\${user.name}</code>	Java system property <code>user.name</code>
<code>\${os.name}</code>	System property <code>os.name</code>
<code>\${datasourcename}</code>	Data source name from the JDBC descriptor. It does not contain the partition name.
<code>\${partition}</code>	Partition name or DOMAIN
<code>\${serverport}</code>	WebLogic Server server listen port
<code>\${serversslport}</code>	WebLogic Server server SSL listen port
<code>\${servername}</code>	WebLogic Server server name
<code>\${domainname}</code>	WebLogic Server domain name

A sample set of properties is shown in the following example:

```
<properties>
<property>
```

```

    <name>user</name>
    <sys-prop-value>user</sys-prop-value>
  </property>
</property>
<property>
  <name>v$session.osuser</name>
  <sys-prop-value>${user.name}</sys-prop-value>
</property>
<property>
  <name>v$session.process</name>
  <sys-prop-value>${pid}</sys-prop-value>
</property>
<property>
  <name>v$session.machine</name>
  <sys-prop-value>${machine}</sys-prop-value>
</property>
<property>
  <name>v$session.terminal</name>
  <sys-prop-value>${datasourcename}</sys-prop-value>
</property>
<property>
  <name>v$session.program</name>
  <sys-prop-value>WebLogic ${servername} Partition ${partition}</sys-prop-value>
</property>
</properties>

```

In this example:

- user is set to the value of `-Duser=value`
- `v$session` values are set as described in [Table 3-1](#)

For example, `v$session.program` running on `myserver` is set to `WebLogic myserver Partition DOMAIN`

Note that the values have the following length limitations:

- `osuser`—30
- `process`—24
- `machine`—64
- `terminal`—30
- `program`—48

3.4.3 Enabling Connection-based Encrypted Properties

WebLogic JDBC data sources support setting driver properties using encrypted values. You can configure connection-based encrypted properties using the WebLogic Server Administration Console by editing the `Encrypted Properties` attribute of your data source configuration. For more information, see [Using Encrypted Connection Properties](#).

3.4.4 Initializing Database Connections with SQL Code

When WebLogic Server creates database connections in a data source, the server can automatically run SQL code to initialize the database connection. To enable this feature, enter `SQL` followed by a space and the SQL code you want to run in the **Init SQL** attribute on the [JDBC Data Source: Configuration: Connection Pool](#) page in the

WebLogic Server Administration Console. Alternatively, you can specify simply a table name without SQL and the statement `SELECT COUNT(*) FROM tablename` is used. If you leave this attribute blank (the default), WebLogic Server does not run any code to initialize database connections.

WebLogic Server runs this code whenever it creates a database connection for the data source, which includes at server startup, when expanding the connection pool, and when refreshing a connection.

You can use this feature to set DBMS-specific operational settings that are connection-specific or to ensure that a connection has memory or permissions to perform required actions.

Start the code with SQL followed by a space. An Oracle DBMS example:

```
SQL alter session set NLS_DATE_FORMAT='YYYY-MM-DD HH24:MI:SS'
```

or an Informix DBMS:

```
SQL SET LOCK MODE TO WAIT
```

The SQL statement is executed using `JDBC Statement.execute()`. Options that you can set using `InitSQL` vary by DBMS. See the documentation for your database vendor for supported statements. If you want to execute multiple statements, you may want to create a stored procedure and execute it. The syntax is vendor specific. For example, to execute an Oracle stored procedure:

```
SQL CALL MYPROCEDURE()
```

3.5 Advanced Connection Properties

The following sections highlight some important advanced connection properties.

- [Define Fatal Error Codes](#)
- [Enabling Edition-Based Redefinition](#)

3.5.1 Define Fatal Error Codes

You can define fatal error codes that indicate that the database server with which the data source communicates is no longer accessible on a connection. The connection is marked invalid and taken out of the pool but the data source is not suspended. These errors include deployment errors that cause a server to fail to boot and connection errors that prevent a connection from being put back in the connection pool.

When specified as the exception code within a `SQLException` (retrieved by `SQLException.getErrorCode()`), it indicates that a fatal error has occurred, the connection is no longer good, and it is removed from the connection pool. For Oracle databases the following fatal error codes are predefined within WLS and do not need to be placed in the configuration file:

Error Code	Description
3113	end-of-file on communication channel
3114	not connected to ORACLE
1033	ORACLE initialization or shutdown in progress

Error Code	Description
1034	ORACLE not available
1089	immediate shutdown in progress - no operations are permitted
1090	shutdown in progress - connection is not permitted
17002	I/O exception

For DB2, the following fatal error codes are predefined: -4498, -4499, -1776, -30108, -30081, -30080, -6036, -1229, -1224, -1035, -1034, -1015, -924, -923, -906, -518, -514, 58004.

For Informix, the following fatal error codes are predefined: -79735, -79716, -43207, -27002, -25580, -4499, -908, -710, 43012.

To define fatal error codes in the WebLogic Server Administration Console, see [Define Fatal Error Codes](#) in *Oracle WebLogic Server Administration Console Online Help*.

3.5.2 Using Edition-Based Redefinition

Edition-based redefinition (EBR) provides the ability to upgrade the database component of an application while it is in use, thereby minimizing or eliminating down time. It allows a pre-upgrade and post-upgrade view of the data to exist at the same time, providing a hot upgrade capability. You can then specify which view you want for a particular session.

For more information, see:

- See [Using Edition-Based Redefinition](#) in the Oracle Database Development Guide
- Edition-Based Redefinition White Paper at <http://www.oracle.com/technetwork/database/features/availability/edition-based-redefinition-1-133045.pdf>

Using EBR with JDBC Connections

There are two approaches to using EBR with JDBC connections:

- If you use a database service to connect to the database and an initial session edition was specified for that service, then the initial session edition for the service is your initial session edition on the connection. This approach is recommended for minimal overhead on the connection.

When you create or modify a database service, you can specify its initial session edition. To create or modify a database service, Oracle recommends using the `srvctl add service` or `srvctl modify service` command. To specify the default initial session edition of the service, use the `-edition` option.

Alternatively, you can create or modify a database service with the `DBMS_SERVICE.CREATE_SERVICE` or `DBMS_SERVICE.MODIFY_SERVICE` procedure, and specify the default initial session edition of the service with the `EDITION` attribute.

- Changing your session edition after connecting to the database using the SQL statement `ALTER SESSION SET EDITION`. You can change your session edition to any edition on which you have the `USE` privilege. Note that changing the edition can require re-generating a significant amount of state on session and database server. Oracle recommends using `DBMS_SESSION.RESET_PACKAGE` to clean-up some of this state when changing the edition on a session.

Using Edition-based redefinition does not require any new WebLogic Server functionality.

To make use of EBR, your environment needs to consist of an earlier version of the application with a data source that references the earlier EDITION and a later version of the application with a data source that references the later EDITION. When referring to multiple versions of a WebLogic Server application, you should be using WebLogic Server versioned applications in the production redeployment feature. For more information, see *Developing Applications for Production Redeployment in Developing Applications for Oracle WebLogic Server*. By combining Oracle database EBR and WebLogic Server versioned applications, the application can be upgraded with no downtime, making the combination of features more powerful than either feature independently.

You need to run with a versioned database and a versioned application initially so that you can switch versions. To version a WebLogic Server application, simply add the `Weblogic-Application-Version` property in the `MANIFEST.MF` file (you can also specify it at deployment time).

Configuring WebLogic Data Sources to Use Editions

The following list describe the different ways you can configure WebLogic data sources to use Oracle database editions.

- **Packaged Data Source Using a Single Edition**—The recommended way to configure the data source is to use a packaged data source descriptor that is stored in the application EAR or WAR file so that everything is self-contained. By doing so, you can use the same name for each data source and you do not need to change the application to use a variable name based on the edition. The data source URL in the descriptor should reference the database service associated with the correct edition. If for some reason you are using a SID instead of a database service (no longer recommended), the alternative is to specify `SQL ALTER SESSION SET EDITION = name` in the Init SQL parameter in the data source descriptor. This SQL statement is executed for each newly created physical database connection in the data source pool. This approach assumes that a data source references only a single edition of the database and all connections use that edition.

Note the following restrictions when using a packaged data source.

- You cannot use a packaged data source with Logging Last Resource (LLR). You must use a system resource.
- You cannot use an application-scoped packaged data source with `EmulateTwoPhaseCommit` for the global-transactions-protocol with a versioned application. You must use a global-scoped data source.

Therefore, if you need to use `LoggingLastResource` or `EmulateTwoPhaseCommit`, you cannot use this approach. For more information, see [JDBC Application Module Limitations](#).

- **System Resource Data Source Using a Single Edition**—You can use a system resource as an alternative to a packaged data source. In this case, each data source must have a unique name and JNDI name. The application needs to be flexible enough to use that name at runtime. For example, you can pass in the data source JNDI name as a system property and the code that looks up the data source in JNDI will use that value.

The disadvantage of using a single edition per data source, whether packaged or as a system resource, is that it requires more database connections. A single edition

approach can work when the period during which the old and new editions are running is relatively short. For applications that are using a lot of data sources and/or connections, this is not a viable approach.

- **System Resource Data Source Using Multiple Editions**—An alternative is to have a data source that references multiple editions. The recommended configuration would still use a database service associated with a single edition. However, the connections will be re-associated with different editions during the lifetime of the connection.
- **Multiple Editions by Setting the Edition for Every Reservation**—It is possible for the application to set the database edition every time it gets a connection. There is some overhead associated with making this call each time (round trip to the database server and setting the session) and the application code needs to be modified everywhere that a connection is reserved. If you are using the replay driver, this initialization should be done in the `ConnectionInitializationCallback`. For more information, see [Using a Connection Callback](#).

It's important to optimize for the normal use case instead of optimizing for the (hopefully) short period during which the migration is done to a new edition. This approach doesn't optimize for the normal case where all connections are on the needed edition.

- **Multiple Editions using Connection Labeling**—You can also associate an edition with the connection and try to reserve a connection with the correct edition. The recommended way to tag a connection with a property is to use connection labeling. The application then needs to implement the pieces associated with connection labeling.
 - When a connection is reserved, it needs to determine the edition needed in the context.
 - A matching method is needed to determine if the property, in this case just the edition, matches.
 - A labeling initialization method is needed to make the connection match if it doesn't already match by using `SQL ALTER SESSION SET EDITION = name`.

There is overhead associated with connection labeling, particularly when exclusively scanning the list of existing connections to find a match. On the other hand, the normal use case is that every connection matches the current edition so there is no need to look far to find a match. It is only during migration that there will be thrashing between editions and potentially longer searches to find a match (or to determine that there is no match).

3.6 Configuring Oracle Parameters

WebLogic Server provides several attributes that provide improved Data Source performance when using Oracle drivers, for more information, see [Advanced Configurations for Oracle Drivers and Databases](#).

3.7 Configuring an ONS Client

Configuring an ONS client changes a generic data source to an AGL data source. For more detailed configuration information and additional environment requirements, see [Using Active GridLink Data Sources](#).

3.8 Tuning Generic Data Source Connection Pools

By properly configuring the connection pool attributes in JDBC data sources in your WebLogic Server domain, you can improve application and system performance. For more information, see [Tuning Data Source Connection Pools](#).

3.9 Generic Data Source Handling for Oracle RAC Outages

It is possible to use a generic data source with Oracle RAC with some limitations. These limitations complicate transaction processing, monitoring, and graceful handling of RAC outages.

Note:

Oracle recommends using MDS or AGL with an Oracle RAC database. See [Using Active GridLink Data Sources](#) or [Using Multi Data Sources with Oracle RAC](#).

The following limitations are due to WebLogic Server instances not being aware of the RAC instances associated with the connections in the pool:

- A generic data source does not have the ability to disable a single instance in the pool that a MDS or AGL data source provides. If one of the RAC instances goes down (planned or unplanned), the data source tests all connections in the pool for the down instance, disabling them individually. In addition to more overhead and application delays, the pool sees multiple failures which cause the entire pool to be disabled. To prevent the pool from being disabled, set the value of `Count Of Test Failures Till Flush` to 0. See the [JDBC Data Source: Configuration: Connection Pool](#) page in the WebLogic Server Administration Console or see [JDBCConnectionPoolParamsBean](#) in the *MBean Reference for Oracle WebLogic Server*.
- JTA or global transactions should not be used with this configuration. Because WebLogic Server is not aware of the RAC instances, it cannot guarantee transaction affinity. This is a problem if the transaction spans multiple servers or if a failure occurs such that another connection is used to complete the transaction. Since the additional connections required to complete the transaction may not be within the same RAC instance, transaction processing may fail.
- It is not possible to monitor the connections based on the RAC instances.

3.10 Generic Data Source Handling of Driver-Level Failover

Oracle recommends using a Multi Data Source or Active GridLink data source instead of a Generic data source using driver-level failover.

Several database drivers support a feature to define multiple database instances in the URL and failover from one database to the next. It is possible to use a Generic data source with driver-level failover with some limitations. These limitations complicate

transaction processing, monitoring, and graceful handling of database instance outages.

The following limitations are due to WebLogic Server instances not being aware of the database instances associated with the connections in the pool:

- A generic data source does not have the ability to disable a single instance in the pool that a Multi Data Source provides. If one of the database instances goes down (planned or unplanned), the data source tests all connections in the pool for the down instance, disabling them individually. In addition to more overhead and application delays, the pool sees multiple failures which cause the entire pool to be disabled. To prevent the pool from being disabled, set the value of `Count Of Test Failures Till Flush` to 0. For more information, see:
 - [JDBC Data Source: Configuration: Connection Pool](#) page in the Oracle WebLogic Server Administration Console Online Help
 - [JDBCConnectionPoolParamsBean](#) in the MBean Reference for Oracle WebLogic Server
- JTA or global transactions should not be used with this configuration. Because WebLogic Server is not aware of the database instances, it cannot guarantee transaction affinity. This is a problem if the transaction spans multiple servers or if a failure occurs such that another connection is used to complete the transaction. Since the additional connections required to complete the transaction may not be within the same database instance, transaction processing may fail.
- It is not possible to monitor the connections based on the database instances.

Using the Default Data Source

This chapter provides information on how to use the default data source.

This chapter provides information on how to use the default data source.

This chapter includes the following sections:

- [What is the Default Data Source](#)
- [Defining a Custom Default Data Source](#)
- [Compatibility Limitations When Using a Default Data Source](#)

4.1 What is the Default Data Source

This topic describes the default data source required by a Java EE 7-compliant runtime.

Oracle provides a default data source required by a Java EE 7-compliant runtime. This preconfigured data source can be used by an application to access the Derby Database installed with WebLogic Server. It is accessible under the JNDI name:

```
java:comp/DefaultDataSource
```

which is equivalent to:

```
@Resource(lookup=" java:comp/DefaultDataSource" )  
DataSource myDS;
```

You can explicitly bind a DataSource resource reference to the default data source using the lookup element of the Resource annotation or the lookup-name element of the resource-ref deployment descriptor element.

Note: The Derby database is started by the `startWebLogic` command by default. For more information on starting and stopping a WebLogic Server instance, see *Starting and Stopping Servers: in Administering Server Startup and Shutdown for Oracle WebLogic Server*.

Characteristics of a Default Data Source

A default data source has the following characteristics:

- Must be available for each component that is deployed.
- Only accessible for deployed components, not for data sources that are system resources or stand-alone deployments.
- Only visible in a console after it has been referenced.

- Appears as a deployment for each component, like other Java EE deployments.
- Not configurable.
- Has the lifecycle of the associated application.

The WebLogic Server Default Data Source Definition

The following table provides the configuration settings that define the WebLogic Server default data source definition:

Table 4-1 Default Data Source Configuration

Attribute	Value
Name	java:comp/DefaultDataSource
Initial capacity	0
Min capacity	0
Max capacity	15
Classname	org.apache.derby.jdbc.ClientDataSource
Port	1527
Host	localhost
Database name	DefaultDataSource
User	none
Password	none
Transactional	false
MaxStatements	0
MaxIdleTimeout	not set

4.2 Defining a Custom Default Data Source

This topic describes how to create a custom default Data source descriptor.

You can use the pre-configured default data source or you can implement a custom default data source. To implement a custom default data source, use one of the following methods:

- Define a custom default data source descriptor that is bound to `java:comp/DefaultDataSource`, see [Creating a Custom Default Data Source Descriptor](#).
- Override the default data source to point to another JNDI name, see [Overriding the Default Data Source](#).

After the component is deployed, if `java:comp/DefaultDataSource` is not available for the component, the WebLogic Server preconfigured default data source is available to the component. However, if you disabled the Derby database by setting `DERBY_FLAG=false` before running `startWebLogic.sh` script, the WebLogic Server preconfigured default data source is not available.

Creating a Custom Default Data Source Descriptor

You can configure a data source descriptor that is bound to `java:comp/DefaultDataSource` replacing the preconfigured default data source. For example, the following provides an example of Java EE 6 annotations in a EAR application:

```
@Stateless(mappedName="DSBean")
@DataSourceDefinition(name="java:comp/DefaultDataSource",
    className="oracle.jdbc.OracleDriver",
    portNumber=1521,
    serverName="myServer",
    databaseName="myDB",
    user="a username",
    password="a password",
    transactional=false
)
public class DSBean implements DSInterface
. . .
```

Overriding the Default Data Source

You can override the preconfigured default data source provided by WebLogic Server by updating the JNDI name in the Default Data Source attribute in the configuration of a server or server template to point to another existing data source. See the following topics in *Administering Oracle WebLogic Server with Fusion Middleware Control*:

- Define general server configuration
- Configure server template general settings

In a partitioned environment, you can override this attribute using the `DataSourcePartitionMBean`. See *Configuring JDBC in Using WebLogic Server Multitenant*.

4.3 Compatibility Limitations When Using a Default Data Source

This topic describes the compatibility limitation when using a default data source.

In releases prior to WebLogic Server 12.2.1, WebLogic Server tries to satisfy unresolved data source `res-ref` references automatically by attempting to lookup the data source in JNDI using the name of the `res-ref`. This behavior is undefined prior to Java EE 7. This WebLogic Server release uses the default data source as defined by Java EE 7.

Configuring JDBC Multi Data Sources

This chapter provides information on how to configure and use a multi data source to provides load balancing or failover processing at the time of connection requests, between the generic data sources associated with the multi data source.

A multi data source is an abstraction around a group of generic data sources that is bound to the JNDI tree or local application context just like generic data sources are bound to the JNDI tree. Applications lookup a multi data source on the JNDI tree or in the local application context (`java:comp/env`) just as they do for generic data sources, and then request a database connection. The multi data source determines which generic data source to use to satisfy the request depending on the algorithm selected in the multi data source configuration: load balancing or failover.

Note:

Active GridLink and Multi Data Source are designed to work with Oracle RAC clusters. Oracle does not recommend using generic data sources with Oracle RAC clusters. See [Comparing AGL and Multi Data Sources](#).

This section includes the following sections:

- [Multi Data Source Features](#)
- [Creating and Configuring Multi Data Sources](#)
- [Choosing the Multi Data Source Algorithm](#)
- [Multi Data Source Fail-Over Limitations and Requirements](#)
- [Multi Data Source Failover Enhancements](#)
- [Deploying JDBC Multi Data Sources on Servers and Clusters](#)
- [Planned Database Maintenance with a Multi Data Source](#)

5.1 Multi Data Source Features

A multi data source can be thought of as a pool of generic data sources. Multi data sources are best used for failover or load balancing between nodes of a highly available database system, such as redundant databases or Oracle Real Application Clusters (Oracle RAC).

The generic data source member list for a Multi data source supports dynamic updates. This allows environments, such as those using Oracle RAC, to add and remove database nodes and corresponding generic data sources without redeployment and provide the ability to:

- Grow and shrink Oracle RAC clusters in response to throughput. See [Adding a Database Node](#).
- Shutdown Oracle RAC nodes for maintenance. See [Removing a Database Node](#).

See [Using Multi Data Sources with Oracle RAC](#).

Note:

Multi data sources do not provide any synchronization between databases. It is assumed that database synchronization is handled properly outside of WebLogic Server so that data integrity is maintained. Adding and removing database nodes is a manual operation performed by the database administrator.

5.1.1 Removing a Database Node

You can remove a database node and corresponding generic data sources without redeployment. This capability provides you the ability to shutdown a node for maintenance or shrink a cluster. Use the following high-level steps to shutdown a database node:

Note:

Failure to follow these step may cause transaction roll-backs.

1. Remove the generic data source from the multi data source. See [Add or remove generic data sources in a JDBC multi data source](#) in *Oracle WebLogic Server Administration Console Online Help*
2. When all transactions have completed, suspend the generic data source. See [Suspend JDBC data sources](#) in *Oracle WebLogic Server Administration Console Online Help*
3. When all transactions have completed, shut down the generic data source. See [Shut down JDBC data sources](#) in *Oracle WebLogic Server Administration Console Online Help*
4. Shut down the database node.

5.1.2 Adding a Database Node

You can add a database node and corresponding generic data sources without redeployment. This capability provides you the ability to start a node after maintenance or grow a cluster. Use the following high-level steps to add a database node:

1. Restart the database node.
2. Restart the generic data source. See [Start JDBC data sources](#) in *Oracle WebLogic Server Administration Console Online Help*.
3. Add the generic data source back to the multi data source. See [Add or remove data sources in a JDBC multi data source](#) in *Oracle WebLogic Server Administration Console Online Help*.

5.2 Creating and Configuring Multi Data Sources

You create a multi data source by first creating generic data sources, then creating the multi data source using the WebLogic Server Administration Console or the WebLogic Scripting Tool and then assigning the generic data sources to the multi data source.

For instructions to create a multi data source, see [Configure JDBC multi data sources](#) in the *Oracle WebLogic Server Administration Console Online Help*.

For information about the configuration files created when configuring a multi data source, see [Understanding JDBC Resources in WebLogic Server](#). Also see [Creating a Multi Data Source Module](#).

Note:

In general, if a WebLogic Server data source setting of initial capacity is set to 0, WebLogic Server makes no DBMS connections at startup. But to startup a MultiDataSource of LLR data sources, WebLogic Server makes a connection at startup to see if the DBMS is a RAC or not. For a generic LLR MultiDataSource, all the data sources need to be available, but if it is using RAC, only one node needs to be accessible for LLR processing.

5.3 Choosing the Multi Data Source Algorithm

Before you set up a multi data source, you need to determine the primary purpose of the multi data source—failover or load balancing. You can choose the algorithm that corresponds with your requirements.

5.3.1 Failover

The Failover algorithm provides an ordered list of generic data sources to use to satisfy connection requests. Normally, every connection request to this kind of multi data source is served by the first generic data source in the list. If a database connection test fails and the connection cannot be replaced, or if the generic data source is suspended, a connection is sought sequentially from the next generic data source on the list.

Note:

This algorithm requires that Test Reserved Connections (`TestConnectionsOnReserve`) on the generic data source is enabled. If enabled, a connection in the first generic data source is tested to verify if the generic data source is healthy. If the connection fails the test, the multi data source uses a connection from the next generic data source listed in the multi data source. See [Connection Testing Options for a Data Source](#) for information about configuring `TestConnectionsOnReserve`.

JDBC is a highly stateful client-DBMS protocol, in which the DBMS connection and transactional state are tied directly to the socket between the DBMS process and the client (driver). For this reason, failover of a connection while it is in use is not supported.

5.3.2 Load Balancing

Connection requests to a load-balancing multi data source are served from any generic data source in the list. The multi data source selects generic data sources to use to satisfy connection requests using a round-robin scheme. When the multi data source provides a connection, it selects a connection from the generic data source listed just after the last generic data source that was used to provide a connection. Multi data sources that use the Load Balancing algorithm also fail over to the next generic data source in the list if a database connection test fails and the connection cannot be replaced, or if the generic data source is suspended.

5.4 Multi Data Source Fail-Over Limitations and Requirements

WebLogic Server provides the Failover algorithm for multi data sources so that if a generic data source fails (for example, if the database management system crashes), your system can continue to operate. However, you must consider the following limitations and requirements when configuring your system.

5.4.1 Test Connections on Reserve to Enable Fail-Over

Generic data sources rely on the Test Reserved Connections (`TestConnectionsOnReserve`) feature on the generic data source to know when database connectivity is lost. Testing reserved connections must be enabled for the generic data sources within the multi data source. WebLogic Server will test each connection before giving it to an application. With the Failover algorithm, the multi data source uses the results from connection test to determine when to fail over to the next generic data source in the multi data source. After a test failure, the generic data source attempts to recreate the connection. If that attempt fails, the multi data source fails over to the next generic data source.

5.4.2 No Fail-Over for In-Use Connections

It is possible for a connection to fail after being reserved, in which case your application must handle the failure. WebLogic Server cannot provide fail-over for connections that fail while being used by an application. Any failure while using a connection requires that the application code close the failed connection, and the transaction must be restarted from the beginning with a new connection.

5.5 Multi Data Source Failover Enhancements

The following enhancements improve failover processing for multi data sources:

- Connection request routing enhancements to avoid requesting a connection from an automatically disabled (dead) generic data source within a multi data source. See [Connection Request Routing Enhancements When a Generic Data Source Fails](#).
- Automatic fallback on recovery of a failed generic data source within a multi data source. See [Automatic Re-enablement on Recovery of a Failed Generic Data Source within a Multi Data Source](#).
- Failover for busy generic data sources within a multi data sources. See [Enabling Failover for Busy Generic Data Sources in a Multi Data Source](#).
- Failover callbacks for multi data sources with the Failover algorithm. See [Controlling Multi Data Source Failover with a Callback](#).

- Failback callbacks for multi data sources with either algorithm. See [Controlling Multi Data Source Failback with a Callback](#).

5.5.1 Connection Request Routing Enhancements When a Generic Data Source Fails

To improve performance when a generic data source within a multi data source fails, WebLogic Server automatically disables the generic data source when a pooled connection fails a connection test. After a generic data source is disabled, WebLogic Server does not route connection requests from applications to the generic data source. Instead, it routes connection requests to the next available generic data source listed in the multi data source.

This feature requires that generic data source testing options are configured for all generic data sources in a multi data source, specifically Test Table Name and Test Reserved Connections. See [Connection Testing Options for a Data Source](#).

If a callback handler is registered for the multi data source, WebLogic Server calls the callback handler before failing over to the next generic data source in the list. See [Controlling Multi Data Source Failover with a Callback](#) for more details.

5.5.2 Automatic Re-enablement on Recovery of a Failed Generic Data Source within a Multi Data Source

After a generic data source is automatically disabled because a connection failed a connection test, the multi data source periodically tests a connection from the disabled generic data source to determine when the generic data source (or underlying database) is available again. When the generic data source becomes available, the multi data source automatically re-enables the generic data source and resumes routing connection requests to the generic data source, depending on the multi data source algorithm and the position of the generic data source in the list of included generic data sources. Frequency of these tests is controlled by the Test Frequency Seconds attribute of the multi data source. The default value for Test Frequency is 120 seconds, so if you do not specifically set a value for the option, the multi data source will test disabled generic data sources every 120 seconds. See [JDBC Multi Data Source: Configuration: General](#) in the *Oracle WebLogic Server Administration Console Online Help*.

WebLogic Server does not test and automatically re-enable generic data sources that you manually disable. It only tests generic data sources that are automatically disabled.

If a callback handler is registered for the multi data source, WebLogic Server calls the callback handler before re-enabling the generic data source. See [Controlling Multi Data Source Failback with a Callback](#) for more details.

5.5.3 Enabling Failover for Busy Generic Data Sources in a Multi Data Source

By default, for multi data sources with the Failover algorithm, when the number of requests for a database connection exceeds the number of available connections in the current generic data source in the multi data source, subsequent connection requests fail.

To enable the multi data source to failover when all connections in the current generic data source are in use, you can enable the Failover Request if Busy option on the [JDBC Multi Data Source: Configuration: General](#) page in the WebLogic Server Administration Console. (Also available as the `FailoverRequestIfBusy` attribute in the [JDBCDataSourceParamsBean](#)). If enabled (set to `true`), when all connections in the current generic data source are in use, application requests for connections will be

routed to the next available generic data source within the multi data source. When disabled (set to `false`, the default), connection requests do not failover.

If a `ConnectionPoolFailoverCallbackHandler` is included in the multi data source configuration, WebLogic Server calls the callback handler before failing over. See [Controlling Multi Data Source Failover with a Callback](#) for more details.

5.5.4 Controlling Multi Data Source Failover with a Callback

You can register a callback handler with WebLogic Server that controls when a multi data source with the Failover algorithm fails over connection requests from one JDBC generic data source in the multi data source to the next generic data source in the list.

You can use callback handlers to control if or when the failover occurs so that you can make any other system preparations before the failover, such as priming a database or communicating with a high-availability framework.

Callback handlers are registered via the Failover Callback Handler attribute of the multi data source and are registered per multi data source. You must register the callback handler for each multi data source to which you want the callback handler to apply. And you can register different callback handlers for each multi data source in your domain.

5.5.4.1 Callback Handler Requirements

A callback handler used to control the failover and failback within a multi data source must include an implementation of the `weblogic.jdbc.extensions.ConnectionPoolFailoverCallback` interface. When the multi data source needs to failover to the next generic data source in the list or when a previously disabled generic data source becomes available, WebLogic Server calls the `allowPoolFailover()` method in the `ConnectionPoolFailoverCallback` interface, and passes a value for the three parameters, `currPool`, `nextPool`, and `opcode`, as defined below. WebLogic Server then waits for the return from the callback handler before completing the task.

Your application must return `OK`, `RETRY_CURRENT`, or `DONOT_FAILOVER` as defined below. The application should handle failover and failback cases.

See the [weblogic.jdbc.extensions.ConnectionPoolFailoverCallback](#) interface for more details.

Note:

Failover callback handlers are optional. If no callback handler is specified in the multi data source configuration, WebLogic Server proceeds with the operation (failing over or re-enabling the disabled generic data source).

5.5.4.2 Callback Handler Configuration

There are two multi data source configuration attributes associated with the failover and failback functionality:

- Failover Callback Handler (`ConnectionPoolFailoverCallbackHandler`)—To register a failover callback handler for a multi data source, you add a value for this attribute to the multi data source configuration. The value must be an absolute name, such as `com.bea.samples.wls.jdbc.MultiDataSourceFailoverCallbackAppli`

ation. You can set the Failover Callback Handler using the WebLogic Server Administration Console (see [Register a failover callback handler](#) in the *Oracle WebLogic Server Administration Console Online Help*) or on the `JDBCDataSourceParamsBean` for the multi data source using WLST.

- Test Frequency (`TestFrequencySeconds`)—To control how often the multi data source checks disabled (dead) generic data sources to see if they are now available. See [Automatic Re-enablement on Recovery of a Failed Generic Data Source within a Multi Data Source](#) for more details.

5.5.4.3 How It Works—Failover

WebLogic Server attempts to failover connection requests to the next generic data source in the list when the current generic data source fails a connection test or, if you enabled `FailoverRequestIfBusy`, when all connections in the current generic data source are busy.

To enable the callback feature, you register the callback handler with WebLogic Server using Failover Callback Handler in the multi data source configuration.

With the Failover algorithm, connection requests are served from the first generic data source in the list. If a connection from that generic data source fails a connection test, WebLogic Server marks the generic data source as dead and disables it. If a callback handler is registered, WebLogic Server calls the callback handler, passing the following information, and waits for a return:

- `currPool`—For failover, this is the name of generic data source currently being used to supply database connections. This is the "failover from" generic data source.
- `nextPool`—The name of next available generic data source listed in the multi data source. For failover, this is the "failover to" generic data source.
- `opcode`—A code that indicates the reason for the call:
 - `OPCODE_CURR_POOL_DEAD`—WebLogic Server determined that the current generic data source is dead and has disabled it.
 - `OPCODE_CURR_POOL_BUSY`—All database connections in the generic data source are in use. (Requires `FailoverIfBusy=true` in the multi data source configuration. See [Enabling Failover for Busy Generic Data Sources in a Multi Data Source](#).)

Failover is synchronous with the connection request: Failover occurs only when WebLogic Server is attempting to satisfy a connection request.

The return from the callback handler can indicate one of three options:

- `OK`—proceed with the operation. In this case, that means to failover to the next generic data source in the list.
- `RETRY_CURRENT`—Retry the connection request with the current generic data source.
- `DONOT_FAILOVER`—Do not retry the current connection request and do not failover. WebLogic Server will throw a `weblogic.jdbc.extensions.PoolUnavailableSQLException`.

WebLogic Server acts according to the value returned by the callback handler.

If the secondary generic data sources fails, WebLogic Server calls the callback handler again, as in the previous failover, in an attempt to failover to the next available generic data source in the multi data source, if there is one.

Note:

WebLogic Server does not call the callback handler when you manually disable a generic data source.

For multi data sources with the Load-Balancing algorithm, WebLogic Server does not call the callback handler when a generic data source is disabled. However, it does call the callback handler when attempting to re-enable a disabled generic data source. See the following section for more details.

5.5.5 Controlling Multi Data Source Failback with a Callback

If you register a failover callback handler for a multi data source, WebLogic Server calls the same callback handler when re-enabling a generic data source that was automatically disabled. You can use the callback to control if or when the disabled generic data source is re-enabled so that you can make any other system preparations before the generic data source is re-enabled, such as priming a database or communicating with a high-availability framework.

See the following sections for more details about the callback handler:

- ["Callback Handler Requirements"](#)
- ["Callback Handler Configuration"](#)

5.5.5.1 How It Works—Failback

WebLogic Server periodically checks the status of generic data sources in a multi data source that were automatically disabled. (See [Automatic Re-enablement on Recovery of a Failed Generic Data Source within a Multi Data Source](#).) If a disabled generic data source becomes available and if a failover callback handler is registered, WebLogic Server calls the callback handler with the following information and waits for a return:

- `currPool`—For failback, this is the name of the generic data source that was previously disabled and is now available to be re-enabled.
- `nextPool`—For failback, this is null.
- `opcode`—A code that indicates the reason for the call. For failback, the code is always `OPCODE_REENABLE_CURR_POOL`, which indicates that the generic data source named in `currPool` is now available.

Failback, or automatically re-enabling a disabled generic data source, differs from failover in that failover is *synchronous* with the connection request, but failback is *asynchronous* with the connection request.

The callback handler can return one of the following values:

- `OK`—proceed with the operation. In this case, that means to re-enable the indicated generic data source. WebLogic Server resumes routing connection requests to the generic data source, depending on the multi data source algorithm and the position of the generic data source in the list of included generic data sources.

- `DONOT_FAILOVER`—Do not re-enable the `currPool` generic data source. Continue to serve connection requests from the generic data source(s) in use.

WebLogic Server acts according to the value returned by the callback handler.

If the callback handler returns `DONOT_FAILOVER`, WebLogic Server will attempt to re-enable the generic data source during the next testing cycle as determined by the `TestFrequencySeconds` attribute in the multi data source configuration, and will call the callback handler as part of that process.

The order in which generic data sources are listed in a multi data source is very important. A multi data source with the Failover algorithm will always attempt to serve connection requests from the first available generic data source in the list of generic data sources in the multi data source. Consider the following scenario:

1. `MultiDataSource_1` uses the Failover algorithm, has a registered `ConnectionPoolFailoverCallbackHandler`, and includes three generic data sources: `DS1`, `DS2`, and `DS3`, listed in that order.
2. `DS1` becomes disabled, so `MultiDataSource_1` fails over connection requests to `DS2`.
3. `DS2` then becomes disabled, so `MultiDataSource_1` fails over connection requests to `DS3`.
4. After some time, `DS1` becomes available again and the callback handler allows WebLogic Server to re-enable the generic data source. Future connection requests will be served by `DS1` because `DS1` is the first generic data source listed in the multi data source.
5. If `DS2` subsequently becomes available and the callback handler allows WebLogic Server to re-enable the generic data source, connection requests will continue to be served by `DS1` because `DS1` is listed before `DS2` in the list of generic data sources.

5.6 Deploying JDBC Multi Data Sources on Servers and Clusters

All generic data sources used by a multi data source to satisfy connection requests must be deployed on the same servers and clusters as the multi data source. A multi data source always uses a generic data source deployed on the same server to satisfy connection requests. Multi data sources do not route connection requests to other servers in a cluster or in a domain.

To deploy a multi data source to a cluster or server, you select the server or cluster as a deployment target. When a multi data source is deployed on a server, WebLogic Server creates an instance of the multi data source on the server. When you deploy a multi data source to a cluster, WebLogic Server creates an instance of the multi data source on each server in the cluster.

For instructions, see [Target and deploy JDBC multi data sources](#) in the *Oracle WebLogic Server Administration Console Online Help*.

5.7 Planned Database Maintenance with a Multi Data Source

The following sections describe how to handle planned maintenance, without service interruption, on the database server when it is accessed by a WebLogic Multi Data Source.

To avoid service interruption, multiple database instances must be available so that the database can be updated in a rolling fashion. Oracle RAC cluster and Oracle

GoldenGate, or a combination of these products, can be used to help accomplish this goal. (Note that Oracle DataGuard cannot be used for planned maintenance without service interruption). Each database instance is configured as a Generic data source member of the Multi Data Source. This approach assumes that the application is returning connections to the pool on a regular basis.

Process Overview

The following steps provide a high-level overview of the planned maintenance process:

1. On mid-tier systems—Shutdown all member data sources associated with the Oracle RAC instance that will be shut down for maintenance. It is important that you do not shut down all data sources in each Multi Data Source list so that connections can be reserved for the other member(s). Wait for data source shutdown to complete. For more information, see:
 - [Shutting Down the Data Source](#)
 - [JDBCDataSourceRuntimeMBean shutdown operation](#) in MBean Reference for Oracle WebLogic Server
2. If desired, you may want to reduce the remaining connections on the database side that are not associated with the WebLogic data source. For the Oracle database server, this might include stopping (or relocating) the application services at the instances that will be shut down for maintenance, stopping the listener, and/or issuing a transactional disconnect for the services on the database instance.
3. Shut down the database instance using your preferred tools.
4. Perform the planned maintenance
5. Restart the database instance using your preferred tools.
6. Startup the services when the database instances are ready for application use.
7. On mid-tier systems—Start the member data sources. For more information, see the [JDBCDataSourceRuntimeMBean start operation](#) in MBean Reference for Oracle WebLogic Server.

5.7.1 Shutting Down the Data Source

This topic describes the process of shutting down a Data Source.

Shutting down the data source involves first suspending the data source and then releasing the associated resources including the connections. When a member data source in a Multi Data Source is marked as suspended, the Multi Data Source will not try to get connections from the suspended pool. Instead, to reserve connections, it will go to the next member data source. It is important that you do not shut down all member data sources in a Multi Data source list at the same time. If all members are shut down or fail, then access to the Multi Data Source fails and the application will see failures.

When you gracefully suspend a data source, which is the first step of the shut down process, the following occurs:

- The data source is immediately marked as suspended at the beginning of the operation and no further connections are created on the data source.

- Idle (not reserved) connections are marked closed
- After a timeout period for the suspend operation, all remaining connections in the pool are marked as suspended and the following exception is thrown for any operations on the connection, indicating that the data source is suspended:

```
java.sql.SQLRecoverableException: Connection has been
administratively disabled. Try later.
```

- All the remaining connections are then closed. We won't know until the data source is resumed if they are good or not. In this case, we know that the database will be shut down and the connections in the pool will not be good if the data source is resumed. Instead, we are doing a data source shutdown which will close all of the disabled connections.

The shutdown operation can be done synchronously or asynchronously. If you do a synchronous shutdown, the default timeout period is 60 seconds. You can change the value of this timeout period by configuring or dynamically setting `Inactive Connection Timeout Seconds` to a non-zero value. There is no upper limit on the inactive timeout period. Note that the processing actually checks for in-use (reserved) resources every tenth of a second so if the timeout value is set to 2 hours and all reserved resources are released a second later, the shut down will complete a second later. If you do an asynchronous operation, the timeout period is specified on the method itself. If set to 0, the default is used. The default is to use `Inactive Connection Timeout Seconds` if set or 60 seconds. If you want a minimal timeout, set the value to 1. If you want no timeout, set it to a large value (not recommended).

This shutdown operation runs synchronously; there is no asynchronous version of the MBean operation available.

You can also use this for Multi Data Sources configured with either Load-Balancing or Failover.

Example 5-1 WLST Example

The following WLST example script demonstrates how to edit the configuration to increase the suspend timeout period and then use the runtime MBean to shutdown a data source. This script must be integrated into the existing framework for all WebLogic Server servers and data sources.

```
import sys, socket, os
hostname = socket.gethostname()
datasource='ds'
svr='myserver'
connect("weblogic","password","t3://"+hostname+":7001")
# Shutdown the data source serverRuntime()
cd('/JDBCServiceRuntime/' + svr + '/JDBCDataSourceRuntimeMBeans/' + datasource )
task = cmo.shutdown(10000)
while (task.isRunning ()):
print 'SHUTTING DOWN';
java.lang.Thread.sleep(2000);
print 'Datasource task is in status' + task.getStatus();
exit()
$ java weblogic.WLST myscript2.py
Intializing Weblogic Scripting Tool (WLST)...
Welcome to WebLogic Server Administration Scripting Shell
....
Location changed to serverRuntime tree.
This is a read-only tree with ServerRuntimeMBean as the root. For more help, use
help('serverRuntime').
```

```
SHUTTING DOWN
Datasource task is in status
SUCCESS
Datasource task is in status
SUCCESS
Exiting WebLogic Scripting Tool.
```

Important Considerations

The following list describes issues you should be aware of when performing planned maintenance:

- If the Multi Data Source is using a database service, you cannot stop or relocate the database service before suspending or shutting down the Multi Data Source. If you do, the Multi Data Source may attempt to create a connection to the now missing service and it will react as though the database is down and kill all connections, preventing a graceful shutdown. Because suspending a Multi Data Source ensures that no new connections are created at the associated instance, it is not necessary to stop the service. (Note that the Multi Data Source only creates connections on this instance. It will never create connections on another instance even if it is relocated). Also, suspending a Multi Data Source ceases operations on all connections, therefore no further progress occurs on any sessions (the transactions will not complete) that remain in the Multi Data Source pool.
- You may encounter an issue related to XA affinity that is enforced by the Multi Data Source algorithms. When an XA branch is created on an Oracle RAC instance, all additional branches are created on the same instance. While Oracle RAC supports XA across instances, there are some significant limitations that applications run into before the prepare phase, and the Multi Data Source enforces that all operations are on the same instance. As soon as the graceful suspend operation starts, the member data source is marked as suspended and no further connections are allocated there. If an application using global transactions tries to start another branch on the suspending data source, it will fail to get a connection and the transaction fails. In the case of an XA transaction spanning multiple WebLogic servers, the suspend is not graceful. This issue does not apply to Emulate Two-Phase Commit or one-phase commit, which use a single connection for all work, and Logging Last Resource (LLR).
- If for some reason you must separate suspending the data source, at which point all connections are disabled, from releasing the resources, you can perform a suspend followed by `forceShutdown`. You must use a forced shutdown to avoid going through the waiting period a second time. Oracle does not recommend using this process.
- To get a graceful shutdown of the data source when shutting down the database, the data source must be involved. This process of shutting down the data source followed by shutdown of the database requires coordination between the mid-tier and the database server processing. Processing is simplified by using Active GridLink instead of Multi Data Source. For more information, see [Using Active GridLink Data Sources](#).
- When using the Oracle database, Oracle recommends that an application service be configured for each database so that it can be configured for high availability. By using an application service, you can start up the database on its own without the data source starting to use it. Once the application service is explicitly started, the administrator can make the database available to the data source.

Using Active GridLink Data Sources

This chapter provides information on how to configure and tune Active GridLink (AGL) data sources.

This chapter includes the following sections:

- [What is an Active GridLink Data Source](#)
- [Creating an Active GridLink Data Source](#)
- [Using Socket Direct Protocol](#)
- [Configuring AGL Connection Pool Features](#)
- [Configuring Oracle Parameters](#)
- [Configuring an ONS Client Using WLST](#)
- [Tuning Active GridLink Data Source Connection Pools](#)
- [Monitoring GridLink JDBC Resources](#)
- [Using Active GridLink Data Sources without FAN Notification](#)
- [Best Practices for Active GridLink Data Sources](#)
- [Comparing AGL and Multi Data Sources](#)
- [Migrating from Multi Data Source to Active GridLink](#)
- [Managing Database Downtime with AGL Data Sources](#)
- [Gradual Draining](#)

6.1 What is an Active GridLink Data Source

A single AGL data source provides connectivity between WebLogic Server and an Oracle Database service, which may include one or more Oracle RAC clusters. An Oracle Database service represents a workload with common attributes that enables administrators to manage the workload as a single entity. You scale the number of AGL data sources as the number of services increases in the data base, independent of the number of nodes in the Oracle RAC cluster(s). Examples of High Availability support for multiple clusters include Data Guard, GoldenGate, and Global Database Service.

Note:

Active GridLink and Multi Data Source are designed to work with Oracle RAC clusters. Oracle does not recommend using generic data sources with Oracle RAC clusters. See [Comparing AGL and Multi Data Sources](#).

Figure 6-1 Active GridLink Data Source Connectivity

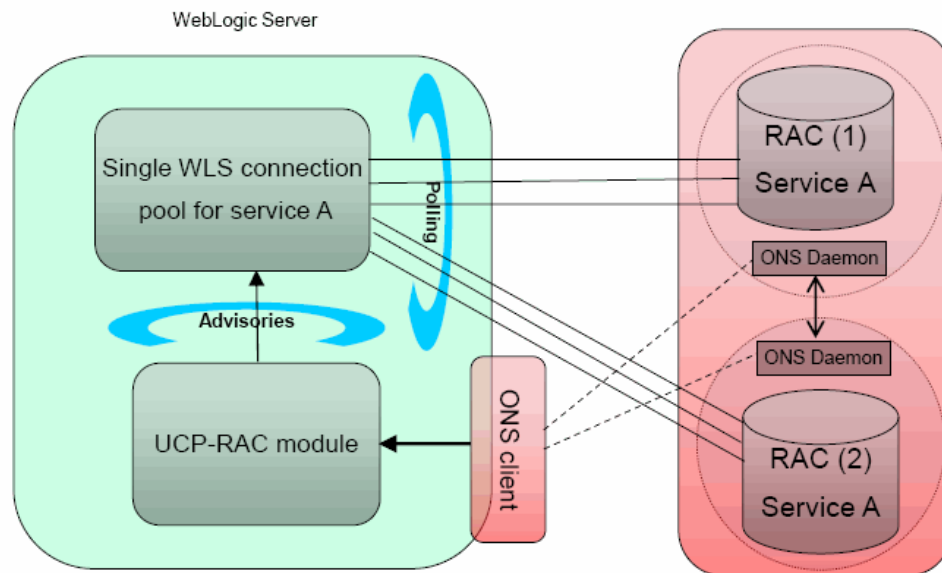

An AGL data source includes the features of generic data sources plus the following support for Oracle RAC:

- [Fast Connection Failover](#)
- [Runtime Connection Load Balancing](#)
- [GridLink Affinity](#)
- [SCAN Addresses](#)
- [Secure Communication using Oracle Wallet with ONS Listener.](#)

6.1.1 Fast Connection Failover

An AGL data source uses Fast Connection Failover and responds to Oracle RAC events using Oracle Notification Service (ONS). This ensures that the connection pool in the AGL data source contains valid connections (including reserved connections) without the need to poll and test connections. It also ensures that connections are created on new nodes as they become available.

Figure 6-2 Fast Connection Failover

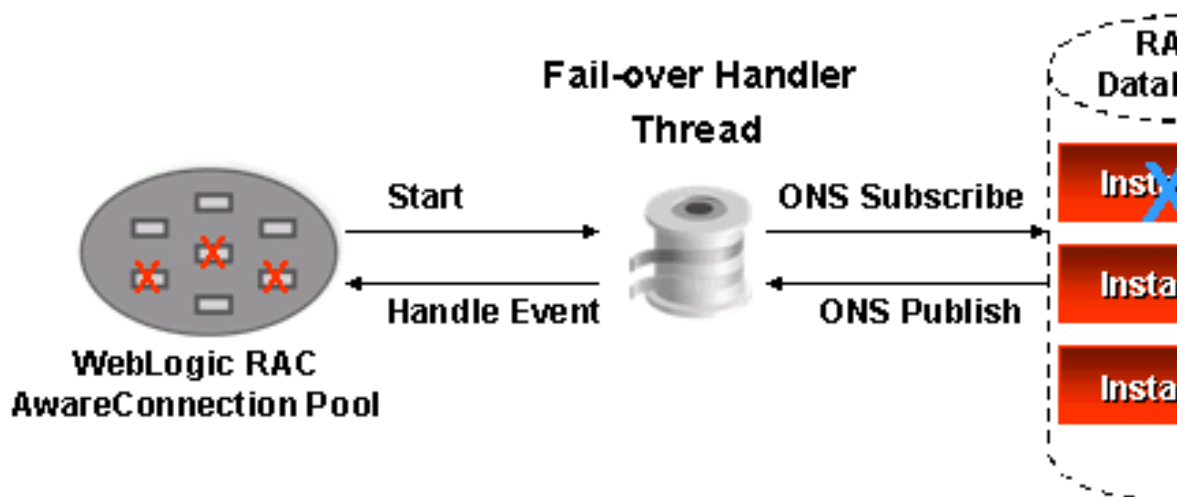

An AGL data source uses Fast Connection Failover to:

- Provide rapid failure detection.
- Abort and remove invalid connections from the connection pool.
- Perform graceful shutdown for planned and unplanned Oracle RAC node outages. See [Planned Outage Procedures](#) and [Unplanned Outages](#)
- Adapt to changes in topology, such as adding or removing a node.
- Distribute runtime work requests to all active Oracle RAC instances, including those rejoining a cluster.

Note:

AGL data sources do not support the deprecated `FastConnectionFailoverEnabled` connection property. An attempt to create an XA connection with this property enabled results in a `java.sql.SQLException: Can not use getXACONNECTION() when connection caching is enabled exception` because the driver implementation of Fast Connection Failover for this property does not support XA connections.

6.1.2 Runtime Connection Load Balancing

AGL data sources provide load balancing. AGL data sources use runtime connection load balancing (RCLB) to distribute connections to Oracle RAC instances based on Oracle FAN events issued by the database. This simplifies data source configuration and improves performance as the database drives load balancing of connections through the AGL data source, independent of the database topology.

Runtime Connection Load Balancing allows WebLogic Server to:

- Adjust the distribution of work based on back end node capacities such as CPU, availability, and response time.
- React to changes in Oracle RAC topology.
- Manage pooled connections for high performance and scalability.

Figure 6-3 Runtime Connection Load Balancing

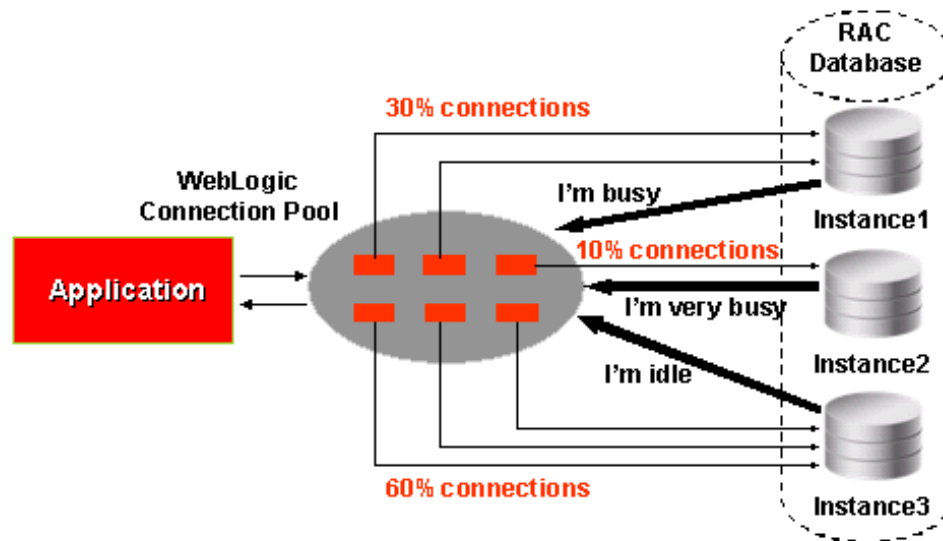

If FAN is not enabled, AGL data sources use a round-robin load balancing algorithm to allocate connections to Oracle RAC nodes.

Note:

Connections may be shut down periodically on AGL data sources. If the connections allocated to various RAC instances do not correspond to the Runtime Load Balancing percentages in the FAN load-balancing advisories, connections to overweight instances are destroyed and new connections opened. This process occurs every 30 seconds by default.

You can tune this behavior using the `weblogic.jdbc.gravitationShrinkFrequencySeconds` system property which specifies the amount of time, in seconds, the system waits before rebalancing connections. A value of 0 disables the rebalancing process.

6.1.3 GridLink Affinity

WebLogic Server GridLink affinity policies are designed to improve application performance by maximizing RAC cluster utilization. See:

- [Session Affinity Policy](#)
- [XA Affinity Policy](#)

6.1.3.1 Session Affinity Policy

Web applications have better performance when repeated operations against the same set of records are processed by the same RAC instance. Business applications such as online shopping and online banking are typical examples of this pattern.

An AGL data source uses the Session Affinity policy to ensure all the data base operations for a web session, including transactions, are directed to the same Oracle RAC instance of a RAC cluster.

Note:

The context is stored in the HTTP session. It is up to the application how windows (within a browser or across browsers) are mapped to HTTP sessions.

If an AGL data source with a session affinity policy is accessed outside the context of a web session, the affinity policy changes to the XA affinity policy. See [XA Affinity Policy](#).

Figure 6-4 Session Affinity

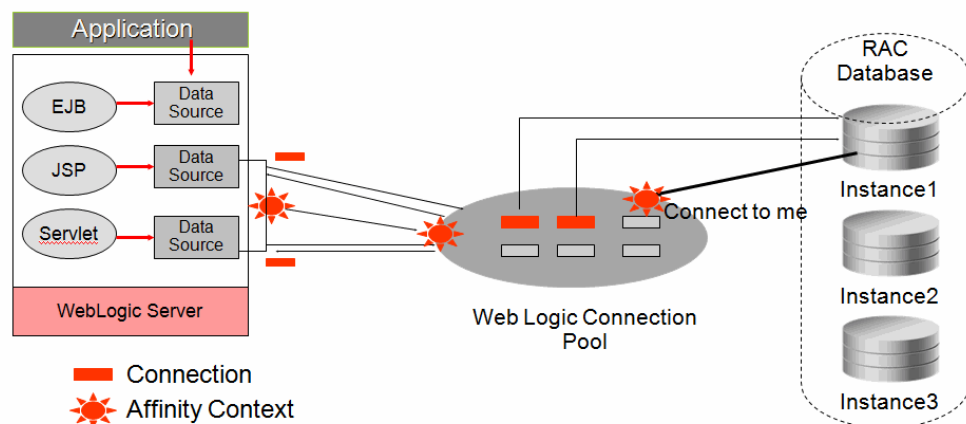

An AGL data source monitors RAC load balancing advisories (LBAs) using the [AffEnabled](#) attribute to determine if RAC affinity is enabled for a RAC cluster. The first connection request is load balanced using Runtime Connection Load-Balancing (RCLB) and is assigned an Affinity context. All subsequent connection requests are routed to the same Oracle RAC instance using the Affinity context of the first connection until the session ends or the transaction completes. Affinity is based on the database name, service name, and instance name. Although the Session Affinity policy for an AGL data source is always enabled by default, a Web session is active for Session Affinity if:

- Oracle RAC is enabled, active, and the service has enabled RCLB. RCLB is enabled for a service if the service GOAL (NOT CLB_GOAL) is set to either SERVICE_TIME or THROUGHPUT.
- The database determines there is sufficient performance improvement in the cluster wait time and the Affinity flag in the payload in the information from ONS is set to TRUE.

If the database determines it is not advantageous to implement session affinity, such as a high database availability condition, the database load balancing algorithm

reverts to its default work allocation policy and the Affinity flag in the payload is set to FALSE.

6.1.3.2 XA Affinity Policy

XA Affinity for global transactions ensures all the data base operations for a global transaction performed on an Oracle RAC cluster are directed to the same Oracle RAC instance. There are limitations to consider:

- XA transaction can't span instances.
- Strict affinity is enforced for connections within an XA transaction. If a connection cannot be created on the correct instance, an exception is thrown.

Figure 6-5 XA Affinity

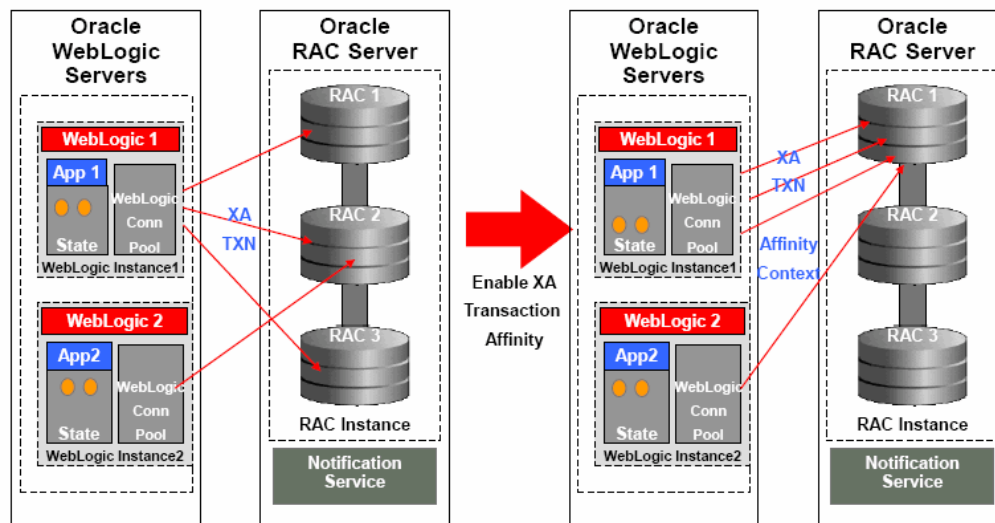

6.1.4 SCAN Addresses

There are two options to load balance connections across nodes:

- Use multiple non-SCAN addresses with LOAD_BALANCE=on

```
jdbc:oracle:thin:@(DESCRIPTION=(ADDRESS_LIST=(LOAD_BALANCE=ON)
) (ADDRESS=(PROTOCOL=TCP) (HOST=host1) (PORT=1521))
(ADDRESS=(PROTOCOL=TCP) (HOST=host2) (PORT=1521)))
(CONNECT_DATA=(SERVICE_NAME=myservice))
```

- Use a single Oracle Single Client Access Name (SCAN) address

```
jdbc:oracle:thin:@(DESCRIPTION=(ADDRESS=(PROTOCOL=TCP)
(HOST=scaname) (PORT=scanport))
(CONNECT_DATA=(SERVICE_NAME=myservice)))
```

SCAN addresses can be used to specify the host for both the TNS listener and the ONS listener in the WebLogic console. An AGL data source containing SCAN addresses does not need to change if you add or remove Oracle RAC nodes and is recommended over using multiple non-SCAN addresses. However, a SCAN address can only be used if your database is configured to use it. Contact your network administrator for appropriately configured SCAN URLs for your environment.

Note:

When using Oracle RAC 11.2 and higher, consider the following:

- If the Oracle RAC listener is set to `SCAN`, the AGL data source configuration can only use a SCAN address.
- If the Oracle RAC listener is set to `List of Node VIPs`, the AGL data source configuration can only use a list of VIP addresses.
- If the Oracle RAC listener is set to `Mix of SCAN and List of Node VIPs`, the AGL data source configuration can use both SCAN and VIP addresses.

For more information on using SCAN addresses, see:

- [Overview of Automatic Workload Management with Dynamic Database Services](#) in Real Application Clusters Administration and Deployment Guide.
 - Oracle Single Client Access Name (SCAN) White Paper at <http://www.oracle.com/technetwork/database/clustering/overview/scan-129069.pdf>
-

6.1.5 Secure Communication using Oracle Wallet with ONS Listener

This feature allows you to configure secure communication with the ONS listener using Oracle Wallet. See [Secure ONS Client Communication](#).

6.1.6 Support for Active Data Guard

This topic describes the support for active data guard.

Active GridLink also works with Oracle Active Data Guard. Oracle Clusterware must be installed and active on the primary and standby sites for both single instance (using Oracle Restart) and Oracle RAC databases. Oracle Data Guard broker coordinates with Oracle Clusterware to properly fail over role-based services to a new primary database after a Data Guard failover has occurred. Cluster Ready Services (CRS) posts FAN events when the role change occurs.

6.2 Creating an Active GridLink Data Source

To create an AGL data source in your WebLogic domain, you can use the WebLogic Server Administration Console or the WebLogic Scripting Tool (WLST).

See the following for more information:

- [Create JDBC GridLink data sources](#) in the *Oracle WebLogic Server Administration Console Online Help*.
- The sample WLST script `EXAMPLES_HOME\wl_server\examples\src\examples\wlst\online\jdbc_data_source_creation.py`, where `EXAMPLES_HOME` represents the directory in which the WebLogic Server code examples are configured. This example creates a generic data source. See WLST Online Sample Scripts in *Understanding the WebLogic Scripting Tool*.

The following sections provide an overview of the basics steps used in the data source configuration wizard to create a data source using the WebLogic Server Administration Console:

- [JDBC Data Source Properties](#)
- [Configure Transaction Options](#)
- [Configure Connection Properties](#)
- [Test Connections](#)
- [ONS Client Configuration](#)
- [Test ONS Client Configuration](#)
- [Target the Data Source](#)

6.2.1 JDBC Data Source Properties

JDBC Data Source Properties include options that determine the identity of the data source and the way the data is handled on a database connection.

6.2.1.1 Data Source Names

JDBC data source names are used to identify the data source within the WebLogic domain. For system resource data sources, names must be unique among all other JDBC system resources, including data sources. To avoid naming conflicts, data source names should also be unique among other configuration object names, such as servers, applications, clusters, and JMS queues, topics, and servers. For JDBC application modules scoped to an application, data source names must be unique among JDBC data sources that are similarly scoped.

6.2.1.2 Data Source Scope

Select the scope for the data source from the list of available scopes. You can set the scope to Global (at the domain level), or to any existing Resource Group or Resource Group Template.

6.2.1.3 JNDI Names

You can configure a data source so that it binds to the JNDI tree with a single or multiple names. You can use a multi-JNDI-named data source in place of legacy configurations that included multiple data sources that pointed to a single JDBC connection pool. For more information, see *Developing JNDI Applications for Oracle WebLogic Server*.

6.2.1.4 Select a Driver

Select the replay driver for application continuity, or the XA or non-XA Thin driver.

Note:

The replay driver does not currently support XA transactions.

6.2.2 Configure Transaction Options

When you configure a JDBC data source using the WebLogic Server Administration Console, WebLogic Server automatically selects specific transaction options based on the type of JDBC driver:

- For the XA driver, the system automatically selects the **Two-Phase Commit** protocol for global transaction processing.
- For the non-XA or replay driver, local transactions are supported by definition, and WebLogic Server offers the following options

Supports Global Transactions: (selected by default) Select this option if you want to use connections from the data source in global transactions, even though you have not selected an XA driver. See [Enabling Support for Global Transactions with a Non-XA JDBC Driver](#) for more information.

When you select Supports Global Transactions, you must also select the protocol for WebLogic Server to use for the transaction branch when processing a global transaction:

- **Logging Last Resource:** With this option, the transaction branch in which the connection is used is processed as the last resource in the transaction and is processed as a local transaction. Commit records for two-phase commit (2PC) transactions are inserted in a table on the resource itself, and the result determines the success or failure of the prepare phase of the global transaction. This option offers some performance benefits and greater data safety than Emulate Two-Phase Commit, but it has some limitations. See [Understanding the Logging Last Resource Transaction Option](#).
- **Emulate Two-Phase Commit:** With this option, the transaction branch in which the connection is used always returns success for the prepare phase of the transaction. It offers performance benefits, but also has risks to data in some failure conditions. Select this option only if your application can tolerate heuristic conditions. See [Understanding the Emulate Two-Phase Commit Transaction Option](#).
- **One-Phase Commit:** (selected by default) With this option, a connection from the data source can be the only participant in the global transaction and the transaction is completed using a one-phase commit optimization. If more than one resource participates in the transaction, an exception is thrown when the transaction manager calls `XAResource.prepare` on the 1PC resource.

For more information on configuring transaction support for a data source, see [JDBC Data Source Transaction Options](#).

6.2.3 Configure Connection Properties

Connection Properties are used to configure the connection between the data source and the DBMS. Typical attributes are the service name, database name, host name, port number, user name, and password.

Note:

Using service names:

- When a Database Domain is used, service names must be suffixed with the domain name. For example, if the database name is `db.country.myCorp.com`, the service name `myservice` would need to be entered as `myservice.db.country.myCorp.com`.

The console allows you to enter connection properties in one of the following ways:

- [Enter Connection Properties](#)
- [Enter a Complete URL](#)
- [Supported AGL Data Source URL Formats](#)

6.2.3.1 Enter Connection Properties

On the **GridLink data source connection Properties Options** page, select **Enter individual listener information** and click **Next**. Enter the connection properties. For example:

- Enter **myService** in *Service Name*.
- Enter **left:1234, center:1234, right:1234** in the *Host and Port*:. Separate the host and port of each listener with colon.
- Enter **myDataBase** in *Database User Name*.
- Enter **myPassword1** in *Password*.
- If required, set **Protocol** to **SDP**.

The console automatically generates the complete JDBC URL. For example:

```
jdbc:oracle:thin:@( DESCRIPTION = (ADDRESS_LIST =
(Load_Balance=on) (FAILOVER=ON) (ADDRESS=(PROTOCOL=TCP)
(HOST=left)(PORT=1521)) (ADDRESS=(PROTOCOL=TCP)(HOST=center)
(PORT=1521)) (ADDRESS=(PROTOCOL=TCP)(HOST=right)(PORT=1521)))
(CONNECT_DATA=(SERVICE_NAME=myService)))
```

6.2.3.2 Enter a Complete URL

On the **GridLink data source connection Properties Options** page, select **Enter complete JDBC URL** and click **Next**. Enter the connection properties. For example:

- In **Complete JDBC URL**, enter the JDBC URL. For example:

```
jdbc:oracle:thin:@( DESCRIPTION = (ADDRESS_LIST =
(Load_Balance=on) (FAILOVER=ON) (ADDRESS=(PROTOCOL=TCP)
(HOST=left)(PORT=1521)) (ADDRESS=(PROTOCOL=TCP)(HOST=center)
(PORT=1521)) (ADDRESS=(PROTOCOL=TCP)(HOST=right)(PORT=1521)))
(CONNECT_DATA=(SERVICE_NAME=myService)))
```

You can also use a SCAN address. For example:

```
jdbc:oracle:thin:@(DESCRIPTION=(ADDRESS_LIST=(PROTOCOL=TCP)
(HOST=MyScanAddr-scn.myCompany.com)(PORT=1234)))
(CONNECT_DATA=(SERVICE_NAME=myService)))
```

- Enter **myDataBase** in Database User Name.
- Enter **myPassword1** in Password.
- If required, set **Protocol** to SDP.

6.2.3.3 Supported AGL Data Source URL Formats

This topic describes the supported AGL data source url formats.

AGL data sources only support long format JDBC URLs. The supported long format pattern is:

```
jdbc:oracle:thin:@(DESCRIPTION=(ADDRESS_LIST=(ADDRESS=(PROTOCOL=
TCP)(HOST=[SCAN_VIP])(PORT=[SCAN_PORT])))
(CONNECT_DATA=(SERVICE_NAME=[SERVICE_NAME])))
```

Easy Connect (short) format URLs are not supported for AGL data sources. The following is an example of a Easy Connect URL pattern that is not supported for use with AGL data sources:

```
jdbc:oracle:thin:[SCAN_VIP]:[SCAN_PORT]/[SERVICE_NAME]
```

Recommendations for AGL Data Source URLs

The following section provides general recommendations when creating AGL data source URLs.

- Use a single DESCRIPTION. Avoid a DESCRIPTION_LIST to avoid connection delays.
- Use one ADDRESS_LIST for each RAC cluster or DataGuard database
- Enter RETRY_COUNT, RETRY_DELAY, CONNECT_TIMEOUT at the DESCRIPTION level so that all ADDRESS_LIST entries use the same value.
- RETRY_DELAY specifies the delay, in seconds, between the connection retries. This attribute is new in the Oracle 12.1.0.2 release.
- RETRY_COUNT is used to specify the number of times an ADDRESS list is traversed before the connection attempt is terminated. The default value is 0. When using SCAN listeners with FAILOVER=on, setting RETRY_COUNT to a value of 2 means that if you had 3 SCAN IP addresses, each would be traversed three times each, resulting in a total of nine connect attempts (3 * 3)
- Specify LOAD_BALANCE=on for each address list to balance the SCAN addresses.
- The service name should be a configured application service, not a PDB or administration service.
- CONNECT_TIMEOUT is used to specify the overall time used to complete the Oracle Net connect. Set CONNECT_TIMEOUT=90 or higher to prevent logon storms. For JDBC driver 12.1.0.2 and earlier, CONNECT_TIMEOUT is also used for the TCP/IP connection timeout for each address in the URL. When considering TCP/IP connections, a shorter CONNECT_TIMEOUT is preferred though secondary to overall timeout requirements.
- Do not set the oracle.net.CONNECT_TIMEOUT driver property on the data source because it is overridden by the URL property.

6.2.4 Test Connections

Test Database Connection allows you to test a database connection before the data source configuration is finalized using a table name or SQL statement. If necessary, you can test additional configuration information using the `Properties` and `System Properties` attributes.

6.2.5 ONS Client Configuration

This topic describes the ONS client configuration.

ONS client configuration allows the data source to subscribe to and process Oracle FAN events. When configuring the ONS node list, Oracle recommends not specifying a value and allowing auto-ONS to perform the ONS configuration. In some cases, however, it is necessary to explicitly configure the ONS configuration, for example if you need to specify an Oracle Wallet and password, or if you want to explicitly specify the ONS topology.

- [Enabling Fan Events](#)
- [Configure ONS Host and Port](#)
- [Secure ONS Client Communication](#)

You can also configure an ONS client using WLST. For an example, see [Configuring an ONS Client Using WLST](#)

To configure an ONS client from the Summary of Data Sources page in the Administration Console, see [Configure ONS client parameters](#) in Oracle WebLogic Server Administration Console Online Help.

Other Considerations

In general, if a WebLogic Server datasource setting of initial capacity is set to 0, WebLogic Server makes no DBMS connections at startup. For AGL datasources with Auto-ONS, WebLogic Server needs to connect to the DBMS once at startup to get the ONS information.

6.2.5.1 Enabling FAN Events

To ensure that the data source is configured to subscribe to and process Oracle Fast Application Notification (FAN) events, select `Fan Enabled`.

6.2.5.2 Configure ONS Host and Port

This topic describes configuration of ONS host and port.

There are two methods that you can use to configure the `OnsNodeList` value: a single node list or a property node list. You can use one or the other, but not both. If the WebLogic Server `OnsNodeList` contains an equals sign (=), it is assumed to be a property node list.

For both types of node lists you can use a Single Client Access Name (SCAN) address instead of a host name, and to access FAN notifications. For more information about SCAN addresses, see [Scan Addresses](#).

To configure the `OnsNodeList` value using a:

- Single node list—Specify a comma separated list of ONS daemon listen addresses and ports for receiving ONS-based FAN events. For example,

`rac1:6200, rac2:6200`. You can enter a single node list in the ONS host and port field in the Administration Console when creating an AGL Data Source.

- **Property node list**—Specify a string composed of multiple records, with each record consisting of a key=value pair and terminated by a new line ('\n') character. For example, `nodes.1=rac1:6200, rac2:6200`. You cannot enter a property node list in the ONS host and port field when creating a data source. Instead, you should leave this field blank. After you finish creating the data source, you can enter the property node list on the Configuration: ONS tab on the settings page for the data source.

You can specify the following keys in a property node list:

- `nodes.id`—A list of nodes representing a unique topology of remote ONS servers. `id` specifies a unique identifier for the node list. Duplicate entries are ignored. The list of nodes configured in any list must not include any nodes configured in any other list for the same client or duplicate notifications will be sent and delivered. The list format is a comma separated list of ONS daemon listen addresses and ports pairs separated by colon.
- `maxconnections.id`—Specifies the maximum number of concurrent connections maintained with the ONS servers. `id` specifies the node list to which this parameter applies. The default is 3
- `active.id` If `true`, the list is active and connections are automatically established to the configured number of ONS servers. If `false`, the list is inactive and is only be used as a fail over list in the event that no connections for an active list can be established. An inactive list can only serve as a fail over for one active list at a time, and once a single connection is re-established on the active list, the fail-over list reverts to being inactive. Note that only notifications published by the client after a list has failed over are sent to the fail over list. `id` specifies the node list to which this parameter applies. The default is `true`
- `remotetimeout` —The timeout period, in milliseconds, for a connection to each remote server. If the remote server has not responded within this timeout period, the connection is closed. The default is 30 seconds

Note: Although `walletfile` and `walletpassword` are supported in the string, WebLogic Server has separate configuration elements for these values, `OnsWalletFile` and `OnsWalletPasswordEncrypted`.

6.2.5.3 Secure ONS Client Communication

To use an Oracle Wallet file with WebLogic Server, you must:

- Update your AGL data source configuration to include the directory of the Oracle wallet file in which the SSL certificates are stored and optionally, the ONS Wallet password. See [Secure ONS Listener using Oracle Wallet](#) in *Oracle WebLogic Server Administration Console Online Help*.
- For more information on Oracle Wallet, see the [Creating and Managing Oracle Wallet](#).

6.2.6 Test ONS Client Configuration

Test ONS client configuration allows you to test a connection to the ONS listener before the data source configuration is finalized.

6.2.7 Target the Data Source

You can select one or more targets to which to deploy your new AGL data source. If you don't select a target, the data source will be created but not deployed. You will need to deploy the data source at a later time.

6.3 Using Socket Direct Protocol

To use Socket Direct Protocol (SDP), your database network must be configured to use Infiniband. SDP does not support SCAN addresses. See [Configuring SDP Support for InfiniBand Connections](#) in the *Oracle Database Net Services Administrator's Guide*.

6.3.1 Configuring Runtime Load Balancing using SDP

To configure load balancing across SDP connections, you must edit the `TNSNAMES.ORA` file on all nodes and add an SDP end-point to the `LISTENER_IBLOCAL` entry.

Note:

The `TNSNAMES.ORA` file is only read at instance startup or when using an `ALTER SYSTEM SET LISTENER_NETWORKS="listener address"` command. After updating the `TNSNAMES.ORA` file, restart all instances or run the `ALTER SYSTEM SET LISTENER_NETWORKS` command on all networks.

For example:

```
LISTENER_IBLOCAL =
  (DESCRIPTION =
    (ADDRESS_LIST =
      (ADDRESS = (PROTOCOL = TCP)(HOST =
        sclcgdb02ibvip.country.myCorp.com)(PORT=1522))
      (ADDRESS = (PROTOCOL = SDP)(HOST =
        sclcgdb02-bvip.country.myCorp.com)(PORT=1522))
    )
  )
```

You should then distribute connections on the `LISTENER_IB` network using the following URL:

```
jdbc:oracle:thin:@(DESCRIPTION=(ADDRESS_LIST=(ADDRESS=(PROTOCOL=SDP)
(HOST=sclcgdb01-bvip.country.myCorp.com)(PORT=1522)))(ADDRESS=(PROTOCOL=SDP)
(HOST=sclcgdb02-ibvip.country.myCorp.com)(PORT=1522)))
(CONNECT_DATA=(SERVICE_NAME=elservice))
```

6.4 Configuring AGL Connection Pool Features

Each JDBC data source has a pool of JDBC connections that are created when the data source is deployed or at server startup. Applications use a connection from the pool then return it when finished using the connection. Connection pooling enhances performance by eliminating the costly task of creating database connections for the application.

Note:

Certain Oracle JDBC extensions may durably alter a connection's behavior in a way that future users of the pooled connection will inherit. WebLogic Server attempts to protect connections against some types of these calls when possible.

The following sections include information about connection pool options for a JDBC data source.

- [Enabling JDBC Driver-Level Features](#)
- [Enabling Connection-based System Properties](#).
- [Initializing Database Connections with SQL Code](#)

You can see more information and set these and other related options through the:

- **JDBC Data Source: Configuration: Connection Pool** page in the WebLogic Server Administration Console. See [JDBC Data Source: Configuration: Connection Pool](#) in the *Oracle WebLogic Server Administration Console Online Help*
- [JDBCConnectionPoolParamsBean](#), which is a child MBean of the `JDBCDataSourceBean`

6.4.1 Enabling JDBC Driver-Level Features

WebLogic JDBC data sources support the `javax.sql.ConnectionPoolDataSource` interface implemented by JDBC drivers. You can enable driver-level features by adding the property and its value to the `Properties` attribute in a JDBC data source. Driver-level properties in the `Properties` attribute are set on the driver's `ConnectionPoolDataSource` object.

Note:

Do not use `FastConnectionFailoverEnabled`, `ConnectionCachingEnabled`, or `ConnectionCacheName` as Driver-level properties in the `Properties` attribute in a JDBC data source.

6.4.2 Enabling Connection-based System Properties

WebLogic JDBC data sources support setting driver properties using the value of system properties. The value of each property is derived at runtime from the named system property. You can configure connection-based system properties using the

WebLogic Server Administration Console by editing the `System Properties` attribute of your data source configuration.

Note:

Do not specify `oracle.jdbc.FastConnectionFailover` as a Java system property when starting the WebLogic Server.

6.4.3 Initializing Database Connections with SQL Code

When WebLogic Server creates database connections in a data source, the server can automatically run SQL code to initialize the database connection. To enable this feature, enter SQL followed by a space and the SQL code you want to run in the **Init SQL** attribute on the [JDBC Data Source: Configuration: Connection Pool](#) page in the WebLogic Server Administration Console. Alternatively, you can specify simply a table name without SQL and the statement `SELECT COUNT(*) FROM tablename` is used. If you leave this attribute blank (the default), WebLogic Server does not run any code to initialize database connections.

WebLogic Server runs this code whenever it creates a database connection for the data source, which includes at server startup, when expanding the connection pool, and when refreshing a connection.

You can use this feature to set DBMS-specific operational settings that are connection-specific or to ensure that a connection has memory or permissions to perform required actions.

Start the code with SQL followed by a space. An Oracle DBMS example:

```
SQL alter session set NLS_DATE_FORMAT='YYYY-MM-DD HH24:MI:SS'
```

or an Informix DBMS:

```
SQL SET LOCK MODE TO WAIT
```

The SQL statement is executed using `JDBC Statement.execute()`. Options that you can set using **InitSQL** vary by DBMS. See the documentation for your database vendor for supported statements. If you want to execute multiple statements, you may want to create a stored procedure and execute it. The syntax is vendor specific. For example, to execute an Oracle stored procedure:

```
SQL CALL MYPROCEDURE()
```

6.5 Configuring Oracle Parameters

WebLogic Server provides several attributes that provide improved Data Source performance when using Oracle drivers, for more information, see [Advanced Configurations for Oracle Drivers and Databases](#).

6.6 Configuring an ONS Client Using WLST

You can also configure the ONS client using WLST. The following fragment provides an example for setting the Oracle parameters of an Active Gridlink data source.

```
cd('/JDBCSystemResources/' + dsName + '/JDBCResource/' + dsName + '/'
JDBCOracleParams/' + dsName)
cmo.setFanEnabled(true)
cmo.setOnsNodeList('nodes.1=rac1:6200,rac2:6200\nmaxconnections.1=3\n')
```

For more information about configuring an ONS client, see [ONS Client Communication](#).

6.7 Tuning Active GridLink Data Source Connection Pools

By properly configuring the connection pool attributes in JDBC data sources in your WebLogic Server domain, you can improve application and system performance. For more information, see [Tuning Data Source Connection Pools](#).

6.8 Monitoring GridLink JDBC Resources

The following sections include details about monitoring GridLink JDBC objects:

- [Viewing Run-Time Statistics](#)
- [Debug Active GridLink Data Sources](#).

For more information on JDBC monitoring, see [Monitoring WebLogic JDBC Resources](#).

6.8.1 Viewing Run-Time Statistics

You can view run-time statistics for an AGL data source via the [WebLogic Server Administration Console](#) or through the associated runtime MBeans.

6.8.1.1 JDBCOracleDataSourceRuntimeMBean

The `JDBCOracleDataSourceRuntimeMBean` provides methods for getting the current state of the data source instance. The

`JDBCOracleDataSourceRuntimeMBean` provides methods for getting the current state of the data source and for getting statistics about the data source, such as the average number of active connections, the current number of active connections, and the highest number of active connections. This MBean also has a child `JDBCOracleDataSourceInstanceRuntimeMBean` for each node that is active in the AGL datasource. For more information, see [JDBCOracleDataSourceRuntimeMBean](#) in the *MBean Reference for Oracle WebLogic Server*.

6.8.1.2 JDBCOracleDataSourceInstanceRuntimeMBean

The `JDBCOracleDataSourceInstanceRuntimeMBean` provides methods for getting the current state of the data source instance. There an instance for each ONS listener that is active. In a configuration that uses `auto-ONS` where the administrator doesn't configure the ONS string, this is the only way to discover which ONS listeners are available. For more information, see [JDBCOracleDataSourceInstanceRuntimeMBean](#) in the *MBean Reference for Oracle WebLogic Server*.

6.8.1.3 ONSDaemonRuntimeMBean

The `ONSDaemonRuntimeMBean` provides methods for monitoring the ONS client configuration that is associated with an AGL data source.

The following is a WLST script for testing an ONS connection. In this example, the Active GridLink data source is named `glds` and it is targeted to `myserver`:

```
connect(<wuser>, <wpassword>, 't3://localhost:7001')
serverRuntime()
cd('JDBCServiceRuntime')
cd('myserver')
```

```
cd('JDBCDataSourceRuntimeMBeans')
cd('glds')
cd('ONSClientRuntime')
cd('glds')
cd('ONSDaemonRuntimes')
cd('glds_0')
cmo.ping()
```

For more information, see [ONSDaemonRuntimeMBean](#) in the *MBean Reference for Oracle WebLogic Server*.

6.8.2 Debug Active GridLink Data Sources

You can activate WebLogic Server's debugging features to track down the specific problem within the application

6.8.2.1 JDBC Debugging Scopes

The following are registered debugging scopes for JDBC:

- `DebugJDBCRCAC`—prints information about AGL data source lifecycle, UCP callback, and connection information.
- `DebugJDBCCONS`—traces ONS client information, including the LBA event body. One trace is available for each ONS listener that is active. In a configuration that uses auto-ONS where the administrator doesn't configure the ONS string, this is the only way to see what ONS listeners are available.
- `DebugJDBCReplay`—traces application continuity replay information.
- `DebugJDBCUCP`—traces low level RAC information from the UCP driver.

6.8.2.2 UCP JDK Logging

You can enable UCP JDK logging by following the instructions in **Setting Up Logging in UCP** in *Universal Connection Pool for JDBC Developer's Guide*.

6.8.2.3 Enable Debugging Using the Command Line

Set the appropriate AGL data source debugging properties on the command line. For example,

```
-Dweblogic.debug.DebugJDBCRCAC=true
-Dweblogic.debug.DebugJDBCCONS=true
-Dweblogic.debug.DebugJDBCUCP=true
-Dweblogic.debug.DebugJDBCREPLAY=true
```

Setting these values is static and can only be used at server startup.

To enable ONS debugging, you must configure Java Util Logging. To do so, set the following properties on the command line as follows:

```
-Djava.util.logging.config.file=configfile
-Doracle.ons.debug=true
```

In this command, `configfile` is the path and file name of the configuration property file property used by standard JDK logging to control the log output format and logging level. The `configfile` must include the following line:

```
oracle.ons.level=FINEST
```

For more information, see [java.util.logging](#) in Java Platform Standard Edition 7 API Specification.

6.9 Using Active GridLink Data Sources without FAN Notification

Although not recommended, you can configure and use an AGL data source without enabling Fast Application Notification (FAN). In this configuration, disabling a connection to a RAC node occurs after two successive connection test failures. Connectivity is reestablished after a successful connection test. Oracle recommends that you enable `TestConnectionsOnReserve`. You might need to turn off FAN if a configured firewall doesn't allow this protocol to flow.

The following table indicates the availability of AGL data source features when FAN Enabled set to `false`.

Table 6-1 GridLink Features when FAN Enabled is False

Active GridLink Feature	Available when FAN Enabled is False?
Single data source configuration for access to RAC cluster	Yes
Runtime MBeans for individual RAC cluster instances	Yes
Connection load balancing using Runtime Load Balancing (RLB)	No
Fast Application Notification (FAN)	No
Fast Connection Failover (FCF)	No
Graceful shutdown	No
Gravitation (rebalancing connections)	No
ONS Client Support, including password and encrypted wallet configurations	Yes
Transaction affinity	Yes
Session affinity	No

6.9.1 Understanding the ActiveGridlink Attribute

In WebLogic Server 12.1.2 and higher, the `ActiveGridlink` attribute is used to explicitly declare a data source configuration as an AGL datasource. It is automatically enabled by the WebLogic Server Administration Console when creating a GridLink data source. If you create data source configurations using WLST, you must remember to set `ActiveGridlink=true`.

Note:

To maintain backward compatibility with releases prior to WebLogic Server 12.1.2, a data source configuration is always an AGL data source configuration if `FanEnabled=true` or the `OnsNodeList` is non-null. In this case, the `ActiveGridlink` value is ignored.

Legacy data source configurations are not updated during the upgrade process. If you need to update a legacy AGL data source to access RAC clusters without enabling Fast Application Notification (FAN), edit or use WLST to set `ActiveGridlink=true` in the configuration.

6.10 Best Practices for Active GridLink Data Sources

The following sections provide best practices for using AGL data sources:

- [Catch and Handle Exceptions](#)
- [Connection Creation with Active Gridlink Data Sources](#)

6.10.1 Catch and Handle Exceptions

Applications need to catch and handle all exceptions. Applications using AGL data sources should expect exceptions, such as an `IO socket read error`, when performing JDBC operations on borrowed connections. Best practice is to check the connection validity and reconnect if necessary. Connection exceptions can occur if the driver detects an outage earlier than FAN event arrival or as a result of the cleanup of a connection. For unplanned down events, a connection pool aborts all borrowed connections that are affected by the outage.

6.10.2 Connection Creation with Active Gridlink Data Sources

This section summarizes the change in connections in AGL, assuming FAN and ONS are enabled:

- Connections are added to the pool initially based on the configured initial capacity. That uses connect time load balancing based on the listener. For that to work correctly, you must either specify `LOAD_BALANCE=ON` for multiple non-scan addresses or use `SCAN`.
- Connections are added to the pool on demand based on runtime load balancing. However, this is overridden by XA affinity or Web session affinity, in which case connections are added on the instance providing affinity to the last request in the transaction or Web session.
- When a planned down event occurs, unused connections for that instance are released immediately and connections in use are released when returned to the pool.
- When an unplanned down event occurs, all connections for that instance are destroyed immediately.
- When an up event occurs, connections are proactively created on the new instance.
- When gravitation shrinking occurs, one unused connection is destroyed on a heavily loaded instance (per period).
- When normal shrinking occurs, half of the unused connections down to minimum capacity are destroyed without respect to load (per period).

6.11 Comparing AGL and Multi Data Sources

AGL is a superior implementation to Multi Data Source (MDS) for supporting RAC clusters. The following section provides additional information on the benefits of AGL data sources. AGL:

- Requires one data source with a single URL. Multi data sources require a configuration with n generic data sources and a multi data source.
- Eliminates a polling mechanism that can fail if one of the generic data sources is performing slowly.
- Eliminates the need to manually add or delete a node to/from the cluster.
- Provides a fast internal notification (out-of-band) when nodes are available so that connections are load-balanced to the new nodes using Oracle Notification Service (ONS).
- Provides a fast internal notification when a node goes down so that connections are steered away from the node using ONS.
- Provides load balancing advisories (LBA) so that new connections are created on the node with the least load, and the LBA information is also used for gravitation to move idle connections around based on load.
- Provides affinity based on your XA transaction or your web session which may significantly improve performance.
- Leverages all the advantages of HA configurations like DataGuard. For more information, see Oracle WebLogic Server and Highly Available Oracle Databases: Oracle Integrated Maximum Availability Solutions on the Oracle Technology network at <http://www.oracle.com/technetwork/middleware/weblogic/learnmore/index.html>

6.12 Migrating from Multi Data Source to Active GridLink

Multi data source (MDS) for RAC connectivity has been supported in WebLogic Server since 2005. As the popularity of Oracle RAC has grown, so has the use of MDS. With the introduction of Active GridLink (AGL) in early 2011, many MDS users are migrating to AGL. Although there is no automated upgrade path, it is a simple manual process to implement AGL in your environment. See [Comparing AGL and Multi Data Sources](#).

6.12.1 Application Changes to Migrate a Multi Data Source

No changes should be required to your applications. A standard application looks up the MDS in JNDI and uses it to get connections. By giving the AGL the same JNDI name as the MDS, the process is exactly the same in the application to use a data source name from JNDI.

6.12.2 Configuration Changes to Migrate a Multi Data Source

The only changes necessary should be to your configuration. An AGL data source is composed of information from the MDS and the member generic data sources combined into a single AGL descriptor. The only additional information that is needed

is the configuration of Oracle Notification Service (ONS) on the RAC cluster. In many cases, the ONS information consists of the same host names as used in the MDS and the only additional information is the port number, and which can be simplified by the use of a SCAN address.

A MDS descriptor does not contain much information. The key components are:

- The JNDI name. It must become the name of your new AGL data source to keep things transparent to the application. If you want to run the MDS in parallel with the AGL data source, then you must give the AGL data source a new JNDI name but you must also update the application to use that new JNDI name.
- A list of the member generic data sources which provide any remaining information that you need to configure the AGL data source.

Each of the member generic data sources has its own URL. As described in [Using Multi Data Sources with Oracle RAC](#), it has the following pattern:

```
jdbc:oracle:thin:@(DESCRIPTION=(ADDRESS=
  (PROTOCOL=TCP)(HOST=host1-vip)(PORT=1521))
  (CONNECT_DATA=(SERVICE_NAME=dbservice)(INSTANCE_NAME=inst1)))
```

Each member should have its own host and port pair. The members probably have the same service and often have the same port on different hosts. The URL for the AGL data source is a combination of the host and port pairs. For example:

```
jdbc:oracle:thin:@(DESCRIPTION=(ADDRESS_LIST=
  (ADDRESS=(PROTOCOL=TCP)(HOST=host1-vip)(PORT=1521))
  (ADDRESS=(PROTOCOL=TCP)(HOST=host2-vip)(PORT=1521)))
  (CONNECT_DATA=(SERVICE_NAME=dbservice)))
```

It is preferable to use an Oracle Single Client Access Name (SCAN) address instead of multiple host or Virtual IP (VIP) addresses. SCAN addresses are simpler and makes changes to the nodes in the cluster transparent. For more information on SCAN addresses, see the *Oracle Real Application Clusters Administration and Deployment Guide*. For example:

```
jdbc:oracle:thin:@(DESCRIPTION=(ADDRESS_LIST=(ADDRESS=(PROTOCOL=TCP)
  (HOST=scanaddress)(PORT=1521)))(CONNECT_DATA=(SERVICE_NAME=dbservice)))
```

- Ignore the **Algorithm Type**.

6.12.3 Basic Steps to Migrate a Multi Data Source to a Active GridLink Data Source

The following section provides the basic steps needed to migrate a MDS to a AGL data source:

- Delete the MDS and the generic data sources from the configuration using the WebLogic Server Administration Console.
- Add a single AGL data source using the WebLogic Server Administration Console.
 - Give it the same JNDI name as the MDS.
 - Select an XA or non-XA driver based on your what generic data sources used.
 - Enter the complete URL as described in [Configuration Changes to Migrate a Multi Data Source](#).

- Set the user and password, it should be the same as what you had on the MDS members.
- On the **Test GridLink Datasource Connection** page, click **Test All Listeners** and verify the new URL.
- Enter the information for the ONS connections. Specify one or more *host:port* pairs. For example, *host1-vip:6200* or *scanaddress:6200*. If possible, use a single SCAN address and port. Make sure that **FAN Enabled** is checked.
- Test the ONS connections.
- Deploy the data source.
- Edit the AGL data source and configure additional parameters.

There are many data source parameters that can't be configured while creating a new data source. In most cases, you should be able to use the parameter setting used in the MDS. If there are conflicts, you will need to resolve them and select the appropriate settings for your environment.

For more information on creating AGL data sources using the WebLogic Server Administration Console, see [Configure JDBC GridLink data sources](#) in *Oracle WebLogic Server Administration Console Online Help*.

6.13 Managing Database Downtime with AGL Data Sources

This topic describes the managing of Database downtime with AGL.

The following sections discuss how to handle database downtimes with Active GridLink data sources in an Oracle RAC database environment.

- Active GridLink Configuration for Database Outages
- Planned Outage Procedures
- Unplanned Outages

6.13.1 Active GridLink Configuration for Database Outages

This topic describes how to configure Active GridLink for Database outages.

Ensure that the AGL data source is configured as follows:

- Fast Application Notification (FAN) is enabled. FAN provides rapid notification about state changes for database services, instances, the databases themselves, and the nodes that form the cluster. It allows for draining of work during planned maintenance with no errors returned to applications.
- Is using auto-ONS, or an explicitly defined ONS configuration. For more information, see [ONS Client Configuration](#).
- Is using a dynamic database service. Do not connect using the administrative service or PDB service. They are for intended for administration purposes only and are not supported for FAN.
- Test connections is enabled. Depending on the outage, applications may receive stale connections when connections are borrowed before a down event is processed. This can occur, for example, on a clean instance down when sockets are closed coincident with incoming connection requests. To prevent the application

from receiving any errors, connection checks should be enabled at the connection pool. This requires setting `test-connections-on-reserve` to true and setting the `test-table` (the recommended value for Oracle is `SQL ISVALID`).

- SCAN usage is optimized. For database drivers 12.1.0.2 and later, set the URL setting `LOAD_BALANCE=TRUE` for the `ADDRESSLIST` as an optimization to force re-ordering of the SCAN IP addresses that are returned from DNS for a SCAN address.

For database drivers before 12.1.0.2, use the connection property `oracle.jdbc.thinForcedDNSLoadBalancing=true`.

For more information, see [SCAN Addresses](#).

6.13.2 Planned Outage Procedures

For planned downtime, the primary goal is to manage scheduled maintenance with no application interruption while maintenance is underway at the database server. Achieving this goal requires the following:

- Transparent scheduled maintenance—Ensures that the scheduled maintenance process at the database servers is transparent to applications.
- Session Draining—When an instance is brought down for maintenance at the database server, session draining ensures that all work using instances at that node completes and that idle sessions are removed. Sessions are drained without impacting in-flight work.

For maintenance purposes (such as software and hardware upgrades, repairs, changes, migrations within and across systems), the services used are shutdown gracefully one or several at a time without disrupting the operations and availability of the WebLogic Server applications. Upon a FAN DOWN event, AGL drains sessions away from the instance(s) targeted for maintenance. It is necessary to stop non-singleton services running on the target database instance (assuming that they are still available on the remaining running instances) or relocate singleton services from the target instance to another instance. Once the services have drained, the instance is stopped with no application errors

The following steps provide a high level overview of the planned maintenance process:

1. Detect "DOWN" event triggered by DBA on instances targeted for maintenance.
2. Drain sessions away from the targeted instance(s).
3. Perform scheduled maintenance on the database servers.
4. Resume operations on the upgraded node(s).

Unlike Multi Data Source where operations need to be coordinated on both the database server and the mid tier, Active GridLink co-operates with the database so that all of these operations are managed from the database server, simplifying the process. [Table 6-2](#) lists the steps that are executed on the database server and the corresponding reactions at the mid tier.

Table 6-2 Steps Performed on Database Server for AGL Planned Maintenance

Step #	Database Server Steps	Command	Mid-Tier Reaction
1.	<p>Stop the non-singleton service without -force or relocate the singleton service.</p> <p>Omitting the -server option operates on all services on the instance.</p>	<pre>\$ srvctl stop service -db db_name -service service_name - instance instance_name or \$ srvctl relocate service -db db_name - service service_name - oldinst oldins - newinst newinst</pre>	<p>The FAN Planned Down (reason=USER) event for the service informs the connection pool that a service is no longer available for use and connections should be drained. Idle connections on the stopped service are released immediately. In-use connections are released when returned (logically closed) by the application. New connections are reserved on other instance(s) and databases offering the services. This FAN action invokes draining the sessions from the instance without disrupting the application.</p>
2.	<p>Disable the stopped service to ensure it is not automatically started again.</p> <p>Disabling the service is optional. This step is recommended for maintenance actions where the service must not restart automatically until the action has completed.</p>	<pre>\$ srvctl disable service -db db_name -service service_name - instance instance_name</pre>	<p>No new connections are associated with the stopped/disabled service at the mid-tier.</p>

Table 6-2 (Cont.) Steps Performed on Database Server for AGL Planned Maintenance

Step #	Database Server Steps	Command	Mid-Tier Reaction
3.	Allow sessions to drain.		The amount of time depends on the application. There may be long-running queries. Batch programs may not be written to periodically return connections and get new ones. It is recommended that batch be drained in advance of the maintenance.
4.	Check for long-running sessions. Terminate these sessions using a transactional disconnect. Wait for the sessions to drain. You can run the query again to check if any sessions remain.	<pre>SQL> select count(*) from (select 1 from v \$sessionwhere service_name in upper('service_n ame') union all select 1 from v \$transaction where status = 'ACTIVE') SQL> exec dbms_service.dis connect_session('service_name', DBMS_SERVICE.POS T_TRANSACTION)</pre>	The connection on the mid-tier will get an error. If using application continuity, it is possible to hide the error from the application by automatically replaying the operations on a new connection on another instance. Otherwise, the application gets a SQLException.
5.	Repeat steps 1 through 4.	Repeat for all services targeted for planned maintenance	
6.	Stop the database instance using the immediate option.	<pre>\$ srvctl stop instance -db db_name - instance instance_name - stopoption immediate</pre>	No impact on the mid-tier until the database and service are re-started.

Table 6-2 (Cont.) Steps Performed on Database Server for AGL Planned Maintenance

Step #	Database Server Steps	Command	Mid-Tier Reaction
7.	Optionally, disable the instance so that it will not automatically start again during maintenance. This step is for maintenance operations where the services cannot resume during the maintenance.	<pre>\$ srvctl disable instance -db db_name - instance instance_name</pre>	
8.	Perform the scheduled maintenance work (patches, repairs, and changes).		
9.	Enable and start the instance.	<pre>\$ srvctl enable instance -db db_name - instance instance_name \$ srvctl start instance -db db_name - instance instance_name</pre>	
10.	Enable and start the service back. Check that the service is up and running.	<pre>\$ srvctl enable service -db db_name -service service_name - instance instance_name \$ srvctl start service -db db_name -service service_name - instance instance_name</pre>	The FAN UP event for the service informs the connection pool that a new instance is available for use, allowing sessions to be created on this instance at the next request submission. Automatic rebalancing of sessions starts.

shows the distribution of connections for a service across two Oracle RAC instances before and after Planned Downtime. Notice that the connection workload moves from fifty-fifty across both instances to hundred-zero. In other words, RAC_INST_1 can be taken down for maintenance without any impact on the business operation.

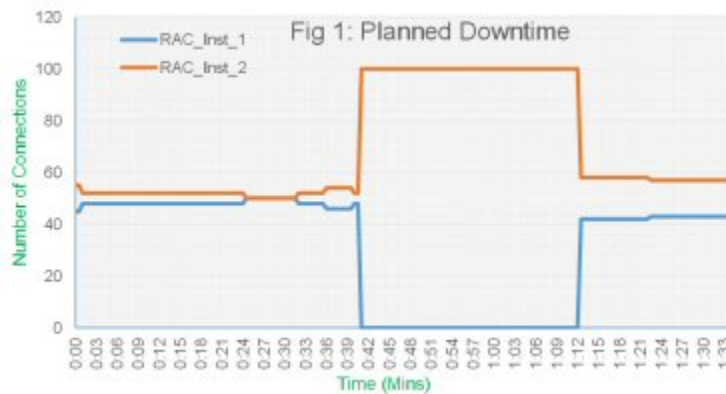
Figure 6-6 Distribution of Connections Across Two Oracle RAC Instances

6.13.3 Unplanned Outages

This topic describes about the unplanned outages.

There are several differences when an unplanned outage occurs:

- A component at the database server may fail making all services unavailable on the instances running at that node. There is no stop or disable on the services because they have failed.
- The FAN unplanned DOWN event (`reason=FAILURE`) is delivered to the mid-tier.
- All sessions are closed immediately, preventing the application from hanging on TCP/IP timeouts. Existing connections on other instances remain usable, and new connections are opened to these instances as needed.
- There is no graceful draining of connections. For those applications using services that are configured to use Application Continuity, active sessions are restored on a surviving instance and recovered by replaying the operations, masking the outage from applications. If not protected by Application Continuity, any sessions in active communication with the instance receive a `SQLException`.

6.14 Gradual Draining

When planned maintenance occurs, a planned down service event is processed by WebLogic Server datasource. By default, all unreserved connections in the pool are closed and borrowed connections are closed when returned to the pool. This can cause an uneven performance because:

- New connections need to be created on the alternative instances.
- It can also cause a logon storm on the other instances.

It is desirable to gradually drain connections instead of closing them all immediately. The application can define the length of the draining period, during which connections will be closed.

This feature is supported for an AGL datasource running with Oracle RAC.

Setting the Drain Timeout Period

The connection property `weblogic.jdbc.drainTimeout` is recognized to define the draining period in seconds. The value must be a non-negative integer. For example, the following is a sample from a WLST script that creates a datasource.

```
jdbcSR = create(dsname, 'JDBCSystemResource')
jdbcResource = jdbcSR.getJDBCResource()
driverParams = jdbcResource.getJDBCdriverParams()
driverProperties = driverParams.getProperties()
drainprop = driverProperties.createProperty('weblogic.jdbc.drainTimeout')
drainprop.setValue('60')
```

When running with the Oracle database 12.2 driver and the Oracle database 12.2 server, the drain timeout can be configured on the database server side by setting `-drain_timeout` on the database service. For example, a replayable service can be created by using:

```
srvctl add service -db ORCL -service otrade -clbgoal SHORT -
preferred orcl1,orcl2 -rlbgoal SERVICE_TIME -failoverretry 30 -
failoverdelay 10 -failovertypetype TRANSACTION -commit_outcome TRUE -
-replay_init_time 1800 -retention 86400 -notification TRUE -
drain_timeout 60
```

If both the connection property and the server-side drain timeout are set on an Oracle database 12.2 configuration, the server-side value takes precedence. This value is only used during a planned down event to stop some but not all of the instances on which a service is running. For example,

```
srvctl stop service -db ORCL -instance orcl2 -service
otrade.us.oracle.com
```

If the drain period is not set or set to 0, then by default, there is no drain period and connections are closed immediately.

A small value accelerates the migration, but might cause applications to experience higher response times, as requests on the target node hit a cold buffer cache. A larger value migrates work more gently and gives the buffer cache on the target node more time to warm-up, which in consequence leads to reduced impact on the application, but a longer overall migration duration.

Gradual Draining Processing

Processing starts when a database service that is configured for an AGL datasource is stopped using `srvctl stop service -db dbname -instance instancename -service servicename`

Note: Draining is not done if all services are shutdown (for example, when no instance name is specified).

- If the drain timeout is not set or set to 0, there is no drain period. Unreserved connections are immediately closed and borrowed connections are closed when returned to the pool.
- If the drain timeout is specified, it takes effect only if the service is available at another RAC instance. For active/active services draining is gradual. For active/passive services, version 12.2 of RAC relocates the service first, so gradual draining is also supported. This feature does not work with Oracle DataGuard, which has only one primary active service at a time.

- If an alternative instance is available, the drain timeout period is started. The granularity and reducing the connections is done on a five-second interval. The total connection count is the count of the unreserved and the count of the reserved connections. The total count is divided by the value “(drain period/5)” to compute the number of connections to be released per interval (note that if the number is less than 1, then some intervals may not have any connections drained). After each five-second interval, harvestable connections are harvested and interval count connections are closed if they are unreserved or marked for closure on return to the pool. After the last interval, the instance is marked as down (with respect to monitor status).
- If a datasource is suspended or shut down, draining is stopped on any instance that is currently draining. Unreserved connections are immediately closed and borrowed connections are closed when returned to the pool.
- If a service is started again on an instance that is draining for that service, draining is stopped.
- If a service is stopped on all instances by not specifying a instance name or the last instance is stopped, draining is stopped on all instances. For all instances, unreserved connections are immediately closed and borrowed connections are closed when returned to the pool.
- When draining is happening on an instance, connection gravitation on the datasource (rebalancing connections based on the runtime load balancing information) is stopped until the draining completes.
- When the service is stopped, the Load Balance Advisories (LBA) indicates that the percentage for the stopped service should be 0. This causes the preference for allocating existing connections to other instances first. If a connection does not exist on the other instances and a connection exists on the stopped service, it will pick that one instead of creating a connection. This applies to connections created using LBA or Session Affinity. XA affinity will try to create a new connection for the instance in the affinity context, and only use a different instance or branch if a new connection can't be created.

Example

Figure 6-7 shows the effect of gradual draining when a service on an instance is stopped. In this case, the service is stopped on instance “*beadev2*” just after 25:00. Note that it takes a while for the Load Balancing Advisories (LBA) to respond to the shut down at around 25 : 25 and the percentage goes to 0 for instance “*beadev2*”. WebLogic Server receives the shutdown event almost instantly and starts to take action. If gradual draining were not configured, the graph of *Current Capacity* would show the capacity dropping to 0 (or the count of active connections) immediately when the event is received. Instead, you can see that the capacity gradually goes down every five- seconds for the sixty-second drain period and there is a corresponding increase in capacity on “*beadev1*”. Note that the total capacity stays constant through the entire period.

Note: These graphs were generated from an artificial work-load of requests that are getting a connection, doing a little work, and releasing the connection. In the real world, the results may not be so perfect.

Figure 6-7

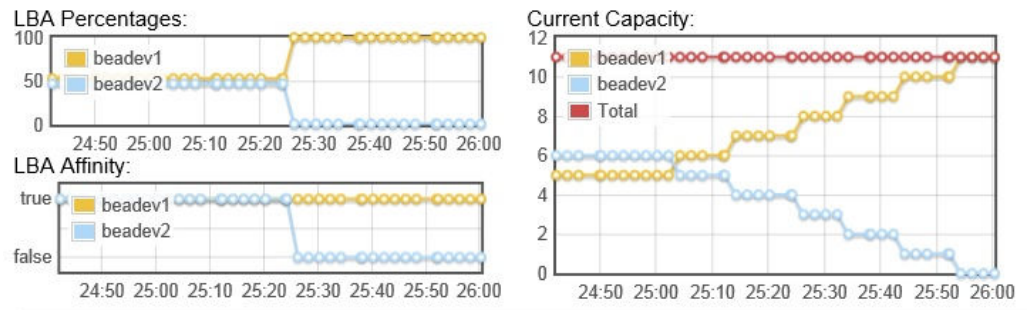

Using Proxy Data Sources

This chapter provides information on how to configure and monitor Proxy Data Sources.

This chapter provides information on how to configure and monitor Proxy data sources. Proxy data sources provide the ability to switch between databases in a WebLogic Server Multitenant environment.

Topics

- [What is a Proxy Data Source?](#)
- [Creating a Proxy Data Source](#)
- [Monitoring Proxy Data Source JDBC Resources](#)

7.1 What is a Proxy Data Source?

This topic describes the Proxy Data Source.

In a WebLogic Server Multitenant environment, resources, including data sources, are replicated for each partition. The Proxy data source simplifies the administration of multiple data sources by providing a light-weight mechanism for accessing a data source associated with a partition or tenant. Applications often need to quickly access a data source by name without needing to know the naming conventions, context names (partitions or tenants), and so on. The Proxy data source provides the access to the underlying data sources. All of the significant processing happens in the data sources to which it points. That is, the underlying data sources actually handle deployment, management, security, and so on.

Note: If desired, you can also use Proxy data sources in a non-multitenant environment.

The Proxy data source provides for WebLogic Server data source access with:

- Minimal configuration.
- Minimal performance overhead including no double connection pooling (for example, no pooling of connections in both the proxy and the underlying connection pool).
- The ability to switch between replicated data sources in the WebLogic Server Multitenant environment.
- JNDI access to a data source object.
- A data source object that implements `javax.sql.DataSource`.

- A callback interface that can be implemented to do the data source switching based on the context in the environment (for example, partition, tenant, and so on)
- Switching configuration by the application both at the context-level used for switching (such as tenant, partition, other information in the thread) and to which data sources the switch is done.
- Direct access to all of the data sources to which it may want to switch.

7.2 Creating a Proxy Data Source

This topic describes how to create a Proxy Data Source.

To create a Proxy data source in your WebLogic domain, you can use the WebLogic Server Administration Console, WebLogic Scripting Tool (WLST), and Fusion Middleware Control. The Administration Console and WLST methods are described in the following sections:

- [Configuring a Proxy Data Source in the WebLogic Server Administration Console](#)
- [Configuring a Proxy Data Source Using WLST](#)

Procedures for creating a Proxy data source using Fusion Middleware Control are described in [Create JDBC Proxy data sources in Administering Oracle WebLogic Server with Fusion Middleware Control](#).

When creating a Proxy data source, note the following:

- The Proxy data source does not validate the values in the switching properties to confirm that they match the context names or data sources. If an invalid data source is specified, getting a connection will fail. However, the data sources to which the proxy points do not have to be available when configured or deployed.
- There are no rules for the data sources to which the proxy points. In general, however, the members should basically provide the same functionality. They can be from different vendor drivers but should have the same schemas, transaction properties, and general functionality. Oracle does not assume that the underlying data sources are configured to use Oracle Container Database/Pluggable Database technology or that the data sources use an Oracle driver.
- The proxy data source provides a `javax.sql.DataSource` interface. The `XADataSource` equivalent is not provided or necessary. The additional methods on `XADataSource` are necessary only for handling transaction enlistment. Transaction processing is handled at the member/real data source level instead of at the proxy level; doing it at two levels would cause problems.
- Proxy data sources are not supported in an application-scoped environment, nor should they reference application-scoped data sources. They must be defined as system resources and targeted to server(s) and/or cluster(s) (WebLogic Server does not support targeting to a domain)

7.2.1 Configuring a Proxy Data Source in the WebLogic Server Administration Console

This topic describes how to configure a Proxy Data Source.

The procedure for creating a Proxy data source in the WebLogic Server Administration Console is provided in [Create Proxy data sources](#) in the Oracle WebLogic Server Administration Console Online Help. This procedure includes

instructions for accessing the data source configuration wizard. To create a Proxy data source, select Proxy Data Source from the New menu in the wizard.

The following sections provide an overview of the basics steps used in the data source configuration wizard to create a data source using the WebLogic Server Administration Console:

- [Set Proxy Data Source Properties](#)
- [Select Target](#)

Set Proxy Data Source Properties

The Proxy Data Source Properties section includes options that determine the identity of the data source and the way the data is handled on a database connection.

Guidelines for configuring these properties are described as follows:

- **Data Source Names**—Enter a name for the Proxy data source in the Name field. JDBC data source names are used to identify the data source within the WebLogic domain. For system resource data sources, names must be unique among all other JDBC system resources, including data sources. To avoid naming conflicts, data source names should also be unique among other configuration object names, such as servers, applications, clusters, and JMS queues, topics, and servers.
- **Scope**—Select the scope for the data source from the list of available scopes. You can set the scope to Global (at the domain level), or to any existing Resource Group or Resource Group Template.
- **JNDI Names**—Enter a JNDI name for the Proxy data source in the JNDI Name field. You can configure a data source so that it binds to the JNDI tree with a single name or multiple names. You can use a multi-JNDI-named data source in place of legacy configurations that included multiple data sources that pointed to a single JDBC connection pool. For more information, see *Developing JNDI Applications for Oracle WebLogic Server*.
- **Switching Properties**—Enter the switching properties to be passed to the switching callback method for the Proxy data source. This value is dependent on the requirements of the switching callback. For the default switching callback, the format of the proxy switching properties is `partition1=datasource1;partition2=datasource2;...;default=datasourcen`. It is passed to the second argument of `getDataSource()` in the switching callback.

The default WebLogic Server implementation uses the current partition to look up the data source in the switching properties. If it is not in a partition, the partition value is `DOMAIN`. If no match is found or it is not in a partition, the data source associated with `default` is used. If a `default` value is not appropriate, then do not provide a `default` value and a null is returned. The default callback can only be used within the WebLogic Server.

- **Switching Callback**—Enter the name of the proxy switching callback class. To use the default callback, leave this value empty. If you specify a callback class, it must implement the `weblogic.jdbc.extensions.DataSourceSwitchingCallback` interface. This interface has one method that takes two parameters. The format of the two parameters depends on the implementation. The first parameter, which is a comma-separated list of JNDI names for the proxy data source, is not used in the

default callback. The second parameter is described above in the Switching Properties.

Select Target

You can select one or more targets to which to deploy your new Proxy data source. If you don't select a target, the data source will be created but not deployed. You will need to deploy the data source at a later time.

7.2.2 Configuring a Proxy Data Source Using WLST

This topic describes how to configure a Proxy Data Source using a WLST.

You can create a Proxy data source using WLST in the same way that you create other data source types. However, Proxy data sources require less attributes.

The configuration elements for a Proxy data source are as follows.

- name
- datasource-type=PROXY
- jdbc-data-source-params proxy-switching-properties—A string that defines how the switching is done. This value is optional and is null if not specified. This value is configurable and dynamic.
- jdbc-data-source-params proxy-switching-callback—A string that defines the name of a class that implements `weblogic.jdbc.extensions.DataSourceSwitchingCallback`. This value is optional and a default callback class will be used for WebLogic Server. This value is configurable and dynamic.
- jdbc-data-source-params jndi-name—An array of String names at which the data source is mapped into the WebLogic Server (Java EE) JNDI. In addition to other naming conventions regarding JNDI names, JNDI name(s) for the proxy data source must not contain a comma (,).

No other elements from the WebLogic Server data source descriptor are recognized. If other elements are specified, they are ignored.

A sample WLST script for creating a Proxy data source is provided in [Example 7-1](#)

Example 7-1 Sample WLST Script to Create a Proxy Data Source

```
import sys, socket
import os
hostname = socket.gethostname()
connect("weblogic", "welcome1", "t3://" + hostname + ":7001")
edit()
startEdit()
serverName="AdminServer"
serverBean = getMBean('/Servers/' + serverName)
host = '%s.us.company.com' % hostname
print 'Creating Proxy datasource'
domain = getMBean("/")
startEdit()
resourceName='proxyDS'
print "Creating data source in domain"
systemResource=domain.createJDBCSystemResource(resourceName)
systemResource.setName(resourceName)
jdbcResource=systemResource.getJDBCResource()
```

```

jdbcResource.setName(resourceName)
jdbcResource.setDataSourceType('PROXY')
jdbcDataSourceParams=jdbcResource.getJDBCDataSourceParams()
jdbcDataSourceParams.addJNDIName(resourceName)
jdbcDataSourceParams.setProxySwitchingProperties('partition1=partition1:ds;default=do
main:ds')
cd('/SystemResources/' + resourceName )
set('Targets',jarray.array([ObjectName('com.bea:Name=' + serverName +
',Type=Server')]), ObjectName))
save()
activate()

```

Note: You can also use the sample WLST script for creating a Generic data source that is provided with WebLogic Server as the basis for your Proxy data source:

```

EXAMPLES_HOME\wl_server\examples\src\examples\wlst\online
\jdbc_data_source_creation.py

```

where EXAMPLES_HOME represents the directory in which the WebLogic Server code examples are configured. See WLST Online Sample Scripts in Understanding the WebLogic Scripting Tool.

7.3 Monitoring Proxy Data Source JDBC Resources

This topic describes run-time statistics for a JDBC Proxy Data Source through the associated runtime MBean.

You can view run-time statistics for a Proxy data source via the [WebLogic Server Administration Console](#) or through the associated runtime MBean.

The `JDBCProxyDataSourceRuntimeMBean` extends the `JDBCDataSourceRuntimeMBean` so that it can be returned with the list of other JDBC MBeans from the JDBC service for tools such as the WebLogic Server Administration Console. For a PROXY data source, it sets the state. All runtime statistics such as active connections and so on are not set (they will be set to -1).

In addition to runtime statistics, the `testPool()` operation returns null if the test is a success. Otherwise it returns an error string (similar to other data source types). The rest of the operations take no action.

For more information, see [JDBCProxyDataSourceRuntimeMBean](#) in the MBean Reference for Oracle WebLogic Server.

For more information on JDBC monitoring, see [Monitoring WebLogic JDBC Resources](#).

Using Universal Connection Pool Data Sources

This chapter provides information on how to configure and monitor Universal Connection Pool (UCP) data sources.

This chapter includes the following sections:

- [What is a Universal Connection Pool Data Source?](#)
- [Creating a Universal Connection Pool Data Source](#)
- [Monitoring Universal Connection Pool JDBC Resources](#)

8.1 What is a Universal Connection Pool Data Source?

This topic describes Universal Connection Pool Data.

A UCP data source is provided as an option for users who wish to use Oracle Universal Connection Pooling (UCP) to connect to Oracle Databases. UCP provides an alternative connection pooling technology to Oracle WebLogic Server connection pooling.

Note: Oracle generally recommends the use of Active GridLink data source, Multi Data Source, or Generic data source, and Oracle WebLogic Server connection pooling included in these data source implementations to establish connectivity with Oracle Databases.

The implementations of UCP data sources are loosely coupled, allowing the swapping of the `ucp.jar` to support the use of new UCP features by the applications. UCP data sources are not supported in an application-scoped/packaged or stand-alone module environment.

Oracle WebLogic Server provides the following support for a UCP data source:

- Configuration as an alternative data source to Generic data source, Multi Data Source, or Active GridLink data source.
- Deploy and undeploy data source.
- Basic monitoring and statistics:
 - `ConnectionsTotalCount`
 - `CurrCapacity`
 - `FailedReserveRequestCount`

- `ActiveConnectionsHighCount`
- `ActiveConnectionsCurrentCount`
- Certification with Oracle simple driver, XA driver, and application continuity driver.

A UCP data source does not support:

- WebLogic Server Transaction Manager (one-phase, LLR, JTS, JDBC TLog, determiner resource, and so on)
- Additional life cycle operations (suspend, resume, shutdown, forceshutdown, start, and so on.)
- Generic support for any connection pool.
- Oracle WebLogic Server Security options.
- JDBC drivers other than those listed above.
- Oracle WebLogic Server data operations such as JMS, Leasing, EJB, and so on.
- RMI access to a UCP data source.

For details about the Oracle Universal Connection Pool, see [Oracle Universal Connection Pool for JDBC Developer's Guide](#).

8.2 Creating a Universal Connection Pool Data Source

This topic describes how to create a Universal Connection Pool Data.

To create a UCP data source in your WebLogic domain, you can use the WebLogic Server Administration Console, WebLogic Scripting Tool (WLST), and Fusion Middleware Control. The Administration Console and WLST methods are described in the following sections:

- [Configuring a UCP Data Source in the WebLogic Server Administration Console](#).
- [Configuring a UCP Data Source Using WLST](#).

Procedures for creating a UCP data source using Fusion Middleware Control are described in [Create JDBC UCP data sources in Administering Oracle WebLogic Server with Fusion Middleware Control](#).

8.2.1 Configuring a UCP Data Source in the WebLogic Server Administration Console

This topic describes how to configure a UCP Data Source in the WebLogic Server Administration Console.

The procedure for creating a UCP data source in the WebLogic Server Administration Console is provided in [Create UCP data sources](#) in the Oracle WebLogic Server Administration Console Online Help. This procedure includes instructions for accessing the data source configuration wizard.

The following sections provide an overview of the basics steps used in the data source configuration wizard to create a data source using the WebLogic Server Administration Console:

- [Set JDBC Data Source Properties](#)

- [Set Connection Properties.](#)
- [Test Database Connections.](#)
- [Select Targets.](#)

Set JDBC Data Source Properties

The JDBC Data Source Properties section includes options that determine the identity of the data source and the way the data is handled on a database connection.

Guidelines for configuring these properties are described as follows:

- **Data Source Names**—Enter a name for the UCP data source in the Name field. JDBC data source names are used to identify the data source within the WebLogic domain. For system resource data sources, names must be unique among all other JDBC system resources, including data sources. To avoid naming conflicts, data source names should also be unique among other configuration object names, such as servers, applications, clusters, and JMS queues, topics, and servers.
- **Scope**—Select the scope for the data source from the list of available scopes. You can set the scope to Global (at the domain level), or to any existing Resource Group or Resource Group Template.
- **JNDI Names**—Enter a JNDI name for the UCP data source in the JNDI Name field. You can configure a data source so that it binds to the JNDI tree with a single name or multiple names. You can use a multi-JNDI-named data source in place of legacy configurations that included multiple data sources that pointed to a single JDBC connection pool. For more information, see *Developing JNDI Applications for Oracle WebLogic Server*.
- **Database Type and Driver**—The UCP data source is certified with three Oracle drivers: thin XA and non-XA, and an application continuity (replay) driver. Select the required driver from the menu.

The supported combinations of driver and JDBC connection factory are shown in [Table 8-1](#)

Table 8-1 Supported Driver and Connection Factory Combinations for UCP Data Source

Driver	Factory (ConnectionFactoryClassName)
oracle.ucp.jdbc.PoolDataSourceImpl (default)	oracle.ucp.jdbc.PoolDataSourceImpl
oracle.ucp.jdbc.PoolXADataSourceImpl	oracle.jdbc.xa.client.OracleXADataSource
oracle.ucp.jdbc.PoolDataSourceImpl	oracle.jdbc.replay.OracleDataSourceImpl

Note:

The replay driver does not currently support XA transactions.

If a non-XA driver from the list in [Table 8-1](#) is specified with an XA factory from the table, an error is generated. If you specify values that are not in the table they are not validated.

If the `driver-name` is not specified in the `jdbc-driver-params`, it defaults to `oracle.ucp.jdbc.PoolDataSourceImpl`.

If you specify a supported driver name but do not specify the `ConnectionFactoryClassName` connection property, the corresponding entry from [Table 8-1](#) is used. If you do not specify a supported driver name, an error is generated.

Set Connection Properties

Connection properties are used to configure the connection between the data source and the DBMS. There are two ways that you can enter the connection properties for a UCP data source in the Administration Console.

On the Connection Properties page of the wizard, all of the available connection properties for a UCP driver are displayed so that you can enter the appropriate values. As an alternative, you can configure properties by entering the properties directly into the Properties text box on the Test Database Connection page using the format `propertyName=value`. Any values that you entered on the Connection Properties page are already listed Properties text box.

[Table 8-2](#) describes the connection properties that you can configure for a UCP data source. For more information about UCP connection properties, see Class `PoolDataSourceImpl`. In Oracle Universal Connection Pool for JDBC Java API Reference. Attributes are determined by setters on the `PoolDataSourceImpl` class. Use the attribute name without the "set" prefix. The names are case insensitive.

Table 8-2 UCP Connection Pool Properties

Property	Type	Description
AbandonedConnectionTimeout	int	Sets the abandoned connection timeout. The range of valid values is 0 to <code>Integer.MAX_VALUE</code> . The default is 0.
ConnectionFactoryClassName	String	Sets the Connection Factory class name.
ConnectionFactoryProperties	name=value	Sets the connection factory properties on the connection factory.
ConnectionFactoryProperty	name=value	Sets a connection factory property on the connection factory.

Table 8-2 (Cont.) UCP Connection Pool Properties

Property	Type	Description
ConnectionHarvestMaxCount	int	Sets the maximum number of connections that can be harvested when the connection harvesting occurs.
ConnectionHarvestTriggerCount	int	Sets the number of available connections at which the connection pool's connection harvesting will occur.
ConnectionLabelingHighCost	int	Sets the cost value that identifies a connection as "high-cost" for connection labeling.
ConnectionPoolName	String	Sets the connection pool name.
ConnectionProperties	name=value	Sets the connection properties on the connection factory.
ConnectionProperty	name=value	Sets a connection property on the connection factory.
ConnectionWaitTimeout	int	Sets the amount of time to wait (in seconds) for a used connection to be released by a client. The range of valid values is 0 to Integer.MAX_VALUE. The default is 3.
DatabaseName	String	Sets the database name.
DataSourceName	String	Sets the data source name.
Description	String	Sets the data source description.
FastConnectionFailoverEnabled	Boolean	Enables Fast Connection Failover (FCF) for the connection pool accessed using this pool-enabled data source. Valid values are true and false.
HighCostConnectionReuseThreshold	int	Sets the high-cost connection reuse threshold for connection labeling.

Table 8-2 (Cont.) UCP Connection Pool Properties

Property	Type	Description
InactiveConnectionTimeout	int	Sets the inactive connection timeout. The range of valid values is 0 to Integer.MAX_VALUE. The default is 0.
InitialPoolSize	int	Sets the initial pool size. The range of valid values is 0 to Integer.MAX_VALUE. It is illegal to set this to a value greater than the maximum pool size. The default is 0.
LoginTimeout	int	Sets the login timeout.
MaxConnectionReuseCount	int	Sets the connection reuse count property.
MaxConnectionReuseTime	long	Sets the connection reuse time property.
MaxIdleTime	int	Sets Idle timeout for available connections in the pool.
MaxPoolSize	int	Sets the maximum number of connections. The range of valid values is 1 to Integer.MAX_VALUE. The default is Integer.MAX_VALUE.
MaxStatements	int	Sets the maximum number of statements that may be pooled or cached on a connection.
MinPoolSize	int	Sets the minimum number of connections. The range of valid values is 0 to Integer.MAX_VALUE. It is illegal to set this to a value greater than the maximum pool size. The default is 0.
NetworkProtocol	String	Sets the data source network protocol.

Table 8-2 (Cont.) UCP Connection Pool Properties

Property	Type	Description
ONSConfiguration	String	Sets the configuration string used for remote ONS subscription.
Password	String	Sets the password with which connections have to be obtained.
PortNumber	int	Sets the database port number.
PropertyCycle	int	Sets the Property cycle in seconds.
RoleName	String	Sets the data source role name.
ServerName	String	Sets the database server name.
SQLForValidateConnection	String	Sets the value (SQL) for SQLForValidateConnection property.
TimeoutCheckInterval	int	Sets the timeoutCheckInterval, in seconds.
TimeToLiveConnectionTimeout	int	Sets the maximum time, in seconds, that a connection may remain in-use.
URL	String	Sets the URL that the data source uses to obtain connections to the database.
User	String	Sets the user name with which connections have to be obtained.
ValidateConnectionOnBorrow	Boolean	Sets whether or not a connection being borrowed should first be validated. Valid values are <code>true</code> and <code>false</code> .

Note: System properties and encrypted properties are supported in addition to normal string literals. For more information, see the following topics in Oracle WebLogic Server Administration Console Online Help:

- [Set System Properties](#)
- [Encrypt connection properties](#)

If the `jdbc-driver-params` URL is set, any URL property is ignored. If the `encrypted-password` is set, any password property is ignored.

The attributes `ConnectionFactoryProperty`, `ConnectionFactoryProperties`, `ConnectionProperty`, and `ConnectionFactoryProperties` accept values of the form `"name1=value1,name2=value2..."`.

Test Database Connections

The Test Database Connection page allows you to enter free-form values for properties and to test a database connection before the data source configuration is finalized using a table name or SQL statement. If necessary, you can test additional configuration information using the `Properties` and `System Properties` attributes.

Select Targets

You can select one or more targets to which to deploy your new UCP data source. If you don't select a target, the data source will be created but not deployed. You will need to deploy the data source at a later time.

8.2.2 Configuring a UCP Data Source Using WLST

This topic describes the creating of a UCP Data Source using a WLST.

You can create a UCP data source using WLST in the same way that you create other data source types. However, UCP data sources require less attributes.

The configuration elements for a UCP data source are as follows.

- `name`
- `datasource-type=UCP`
- `jdbc-driver-params url`
- `jdbc-driver-params property - user`
- `jdbc-driver-params password-encrypted`
- `jdbc-data-source-params jndi-name`
- `jdbc-driver-params other properties`

No other elements from the WebLogic Server `datasource` descriptor are recognized. If other elements are specified, they are ignored.

A sample WLST script for creating a UCP data source is provided in [Example 8-1](#)

Example 8-1 Sample WLST Script to Create a UCP Data Source

```
import sys, socket
import os
hostname = socket.gethostname()
connect("weblogic","welcome1","t3://" + hostname + ":7001")
edit()
startEdit()
serverName="AdminServer"
serverBean = getMBean('/Servers/' + serverName)
host='%s.us.company.com' % hostname
```

```

print 'Creating UCP datasource'
domain = getMBean("/")
startEdit()
resourceName='ucpDS'
print "Creating datasource ds in domain"
systemResource=domain.createJDBCSystemResource(resourceName)
systemResource.setName(resourceName)
jdbcResource=systemResource.getJDBCResource()
jdbcResource.setName(resourceName)
jdbcResource.setDataSourceType('UCP')
driverParams=jdbcResource.getJDBCDriverParams()
driverParams.setDriverName('oracle.ucp.jdbc.PoolDataSourceImpl')
driverParams.setUrl('jdbc:oracle:thin:@dbhost:1521/otrade')
properties = driverParams.getProperties()
properties.createProperty('user', 'dbuser')
properties.createProperty('ConnectionFactoryClassName',
'oracle.jdbc.pool.OracleDataSource')
driverParams.setPassword('MYPASSWD')
jdbcDataSourceParams=jdbcResource.getJDBCDataSourceParams()
jdbcDataSourceParams.addJNDIName(resourceName)
jdbcDataSourceParams.setGlobalTransactionsProtocol('None')
cd('/SystemResources/' + resourceName)
set('Targets',jarray.array([ObjectName('com.bea:Name=' + serverName +
',Type=Server')]), ObjectName))
save()
activate()

```

Note: You can also use the sample WLST script for creating a Generic data source that is provided with WebLogic Server as the basis for your UCP data source:

```

EXAMPLES_HOME\wl_server\examples\src\examples\wlst\online
\jdbc_data_source_creation.py

```

where EXAMPLES_HOME represents the directory in which the WebLogic Server code examples are configured. See WLST Online Sample Scripts in Understanding the WebLogic Scripting Tool.

8.3 Monitoring Universal Connection Pool JDBC Resources

This topic describes the Monitoring Universal Connection Pool JDBC Resources.

You can view run-time statistics for a UCP data source via the [WebLogic Server Administration Console](#) or through the associated runtime MBean.

The `JDBCUCPDataSourceRuntimeMBean` provides methods for getting the current state of the data source and for getting statistics about the data source, such as the average number of active connections, the current number of active connections, and the highest number of active connections. This MBean extends the `JDBCDataSourceRuntimeMBean` so that it can be returned with the list of other JDBC MBeans from the JDBC service.

In addition to runtime statistics, the `testPool()` operation returns null if the test is success or an error string otherwise (similar to other data source types). Testing the pool is done only if `SQLForValidateConnection` is set to a SQL string to be executed for validation (for example `SELECT 1 from DUAL`). The rest of the operations will take no action.

For more information, see [JDBCUCPDataSourceRuntimeMBean](#) in the MBean Reference for Oracle WebLogic Server.

For more information on JDBC monitoring, see [Monitoring WebLogic JDBC Resources](#).

Connection Harvesting

This chapter provides information on how to configure and use connection harvesting in your applications.

This chapter includes the following sections:

- [What is Connection Harvesting?](#)
- [Enable Connection Harvesting](#)
- [Marking Connections Harvestable](#)
- [Recover Harvested Connections](#)

9.1 What is Connection Harvesting?

You can specify a number of reserved connections to be released when a data source reaches a specified number of available connections. Harvesting helps to ensure that a specified number of connections are always available in the pool and improves performance by minimizing connection initialization.

Connection harvesting is particularly useful if an application caches connection handles. Caching is typically performed for performance reasons because it minimizes the initialization of state necessary for connections to participate in a transaction. For example: A connection is reserved from the data source, initialized with necessary session state, and then held in a context object. Holding connections in this manner may cause the connection pool to run out of available connections. Connection harvesting appropriately reclaims the reserved connections and allows the connections to be reused.

Note: In WebLogic Server 12.2.1.1.0 and earlier releases, do not enable harvesting on data sources that are referenced by WebLogic JDBC or TLOG-in-DB stores. Harvesting may destabilize such stores, which can in turn destabilize WebLogic JMS or WebLogic JTA. If you want to enable harvesting on a data source used by WebLogic JDBC or TLOG-in-DB stores in WebLogic Server 12.2.1.1.0 and earlier releases, contact Oracle Support for a patch that protects their store connections from getting harvested.

Use the following steps to use connection harvesting in your applications:

1. [Enable Connection Harvesting](#)
2. [Marking Connections Harvestable](#)
3. [Recover Harvested Connections](#)

9.2 Enable Connection Harvesting

The `Connection Harvest Trigger Count` attribute of a data source configuration is used to enable and specify a threshold to trigger connection harvesting. For example, if `Connection Harvest Trigger Count` is set to 10, connection harvesting is enabled and the data source begins to harvest reserved connections when the number of available connections drops to 10. A value of -1, the default, indicates that connection harvesting is disabled.

When connection harvesting is triggered, the `Connection Harvest Max Count` specifies how many reserved connections should be returned to the pool. The number of connections actually harvested ranges from 1 to the value of `Connection Harvest Max Count`, depending on how many connections are marked harvestable.

See [Configure connection harvesting for a connection pool](#) in *Oracle WebLogic Server Administration Console Online Help*.

9.3 Marking Connections Harvestable

When connection harvesting is enabled, all connections are initially marked harvestable. If you do not want a connection to be harvestable, you must explicitly mark it as unharvestable by calling the `setConnectionHarvestable(boolean)` method in the `oracle.ucp.jdbc.HarvestableConnection` interface with `false` as the argument value.

For example, use the following statements to prevent harvesting when a transaction is used within a transaction:

```
. . .
Connection conn = datasource.getConnection();
((HarvestableConnection) conn).setConnectionHarvestable(false);
. . .
```

After work with the connection is completed, you can mark the connection as harvestable by setting `setConnectionHarvestable(true)` so the connection can be harvested if required. You can tell the harvestable status of a connection by calling `isConnectionHarvestable()`.

9.4 Recover Harvested Connections

When a connection is harvested, an application callback is executed to cleanup the connection if the callback has been registered. A unique callback must be generated for each connection; generally it needs to be initialized with the connection object. For example:

```
import java.sql.Connection;
. . .
public myHarvestingCallback implements ConnectionHarvestingCallback {
    private Connection conn;
    mycallback(Connection conn) {
        this.conn = conn;
    }
    public boolean cleanup() {
        try {
            conn.close();
        } catch (Exception ignore) {
            return false;
        }
    }
}
```

```
        return true;
    }
}
...
Connection conn = ds.getConnection();
try {
    (HarvestableConnection)conn.registerConnectionHarvestingCallback(
        new myHarvestingCallback(conn));
    (HarvestableConnection)conn.setConnectionHarvestable(true);
} catch (Exception exception) {
    // This can't be from registration - setConnectionHarvestable must have failed.
    // That most likely means that the connection has already been harvested.
    // Do whatever logic is necessary to clean up here and start over.
    throw new Exception("Need to get a new connection");
}
...
```

Note:

Consider the following:

- After a connection is harvested, an application can only call `Connection.close`.
 - If the connection is not closed by the application, a warning is logged indicating that the connection was forced closed if LEAK profiling is enabled.
 - If the callback throws an exception, a message is logged and the exception is ignored. Use `JDBCCONN` debugging to retrieve a full stack trace.
 - The return value of the cleanup method is ignored.
 - Connection harvesting releases reserved connections that are marked harvestable by the application when a data source falls to a specified number of available connections. By default, this check is performed every 30 seconds. You can tune this behavior using the `weblogic.jdbc.harvestingFrequencySeconds` system property which specifies the amount of time, in seconds, the system waits before harvesting marked connections. Setting this system property to less than 1 disables harvesting.
-

Advanced Configurations for Oracle Drivers and Databases

This chapter provides advanced configuration options that can provide management of connection reservation in the data source.

This chapter includes the following sections:

- [Application Continuity](#)
- [Database Resident Connection Pooling](#)
- [Global Database Services](#)
- [Container Database with Pluggable Databases](#)
- [Limitations with Tenant Switching](#)

10.1 Application Continuity

In today's environment, application developers are required to deal explicitly with outages of the underlying software, hardware, communications, and storage layers. As a result, application development is complex and outages are exposed to the end users. For example, some applications warn users not to hit the submit button twice. When the warning is not heeded, users may unintentionally purchase items twice or submit multiple payments for the same invoice.

Application Continuity (also referred to as Replay) is a general purpose, application-independent infrastructure for GridLink and Generic data sources that enables the recovery of work from an application perspective and masks many system, communication, and hardware failures. The semantics assure that end-user transactions can be executed on time and at-most-once. The only time an end user should see an interruption in service is when the outage is such that there is no point in continuing.

The following sections provide information on how to configure and use Application Continuity:

- [How Application Continuity Works](#)
- [Requirements and Considerations](#)
- [Configuring Application Continuity](#)
- [Viewing Runtime Statistics for Application Continuity](#)
- [Limitations with Application Continuity with Oracle 12c Database](#)

10.1.1 How Application Continuity Works

Following any outage that is due to a loss of database service, planned or unplanned, Application Continuity rebuilds the database session. Once an outage is identified by Fast Application Notification or a recoverable `ORACLE` error, the Oracle driver:

- Establishes a new database session to clear any residual state.
- If a callback is registered, issues a callback allowing the application to re-establish initial state for that session.
- Executes the saved history accumulated during the request.

The Oracle driver determines the timing of replay calls. Calls may be processed chronologically or using a lazy processing implementation depending on how the application changes the database state. The replay is controlled by the Oracle 12c Database Server. For a replay to be approved, each replayed call must return exactly the same client visible state that was seen and potentially used by the application during the original call execution.

Figure 10-1 Application Continuity

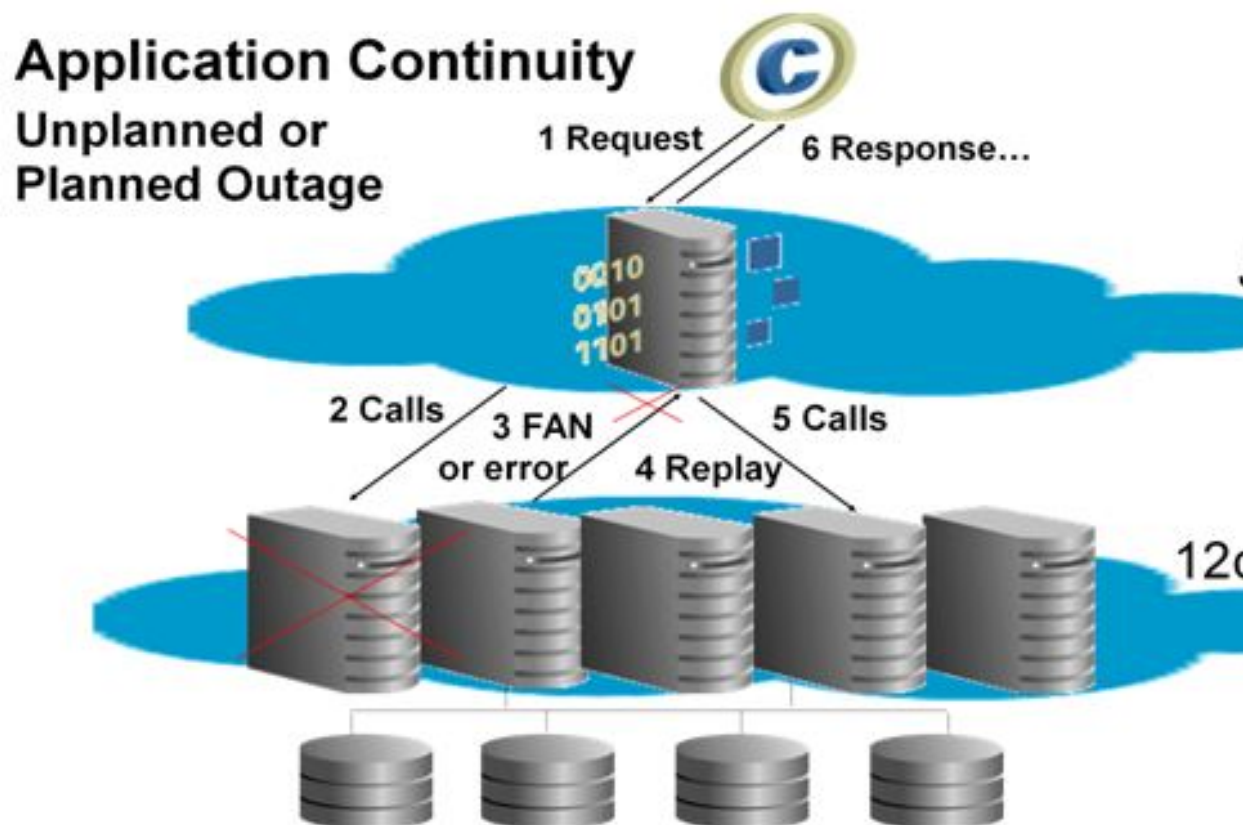

10.1.2 Requirements and Considerations

The following section provides requirements and items to consider when using Application Continuity with WebLogic applications:

- Requires an Oracle 12c JDBC Driver and Database. See [Using an Oracle 12c Database](#).
- Application Continuity supports read and read/write transactions. XA transactions are not supported. To support transactions using non-XA drivers such as an Oracle driver for Application Continuity, see Enabling Support for Global Transactions with a Non-XA JDBC Driver in *Administering JDBC Data Sources for Oracle WebLogic Server* for information.

Note:

Remember to call `connection.setAutoCommit(false)` in your application to prevent breaking the transaction semantics and disabling Application Continuity in your environment.

- Deprecated `oracle.sql.*` concrete classes are not supported. Occurrences should be changed to use either the corresponding `oracle.jdbc.*` interfaces or `java.sql.*` interfaces. Oracle recommends using the standard `java.sql.*` interfaces. See Using API Extensions for Oracle JDBC Types in *Developing JDBC Applications for Oracle WebLogic Server*.
- Application Continuity works by storing intermediate results in memory. An application may run slower and require significantly more memory than running without the feature.
- If the WebLogic statement cache is configured with Application Continuity, the cache is cleared every time the connection is replayed.
- There are additional limitations and exceptions to the Application Continuity feature which may affect whether your application can use Replay. For more information, see "Application Continuity for Java" in the *Oracle® Database JDBC Developer's Guide*.
- The database service that is specified in the URL for the data source must be configured with the failover type set to TRANSACTION and the `-commit_outcome` parameter to TRUE. For example:

```
srvctl modify service -d mydb -s myservice -e TRANSACTION -
commit_outcome TRUE -rlbgoal SERVICE_TIME -clbgoal SHORT
```

10.1.3 Configuring Application Continuity

The following sections provide information on how to implement Application Continuity in your environment:

- [Selecting the Driver for Application Continuity](#)
- [Using a Connection Callback](#)
- [Setting the Replay Timeout](#)
- [Disabling Application Continuity for a Connection](#)
- [Configuring Logging for Application Continuity](#)
- [Enabling JDBC Driver Debugging](#)

10.1.3.1 Selecting the Driver for Application Continuity

Configure your data source to use the correct JDBC driver using one of the following methods:

- If you are creating a new data source, when asked to select a Database driver from the drop-down menu in the configuration wizard, select the appropriate Oracle driver that supports Application Continuity for your environment. See [Enable Application Continuity](#) in *Oracle WebLogic Server Administration Console Online Help*.
- If you are editing an existing data source in the Administrator Console, select the **Connection Pool** tab, change the **Driver Class Name** to `oracle.jdbc.replay.OracleDataSourceImpl`, and click **Save**.
- When creating or editing a data source with a text editor or WLST, set the JDBC driver to `oracle.jdbc.replay.OracleDataSourceImpl`.

See [Requirements and Considerations](#).

10.1.3.2 Using a Connection Callback

The following sections provide information on how to use a Connection Callback:

- [Create an Initialization Callback](#)
- [Registering an Initialization Callback](#)
- [Unregister an Initialization Callback](#)

10.1.3.2.1 Create an Initialization Callback

To create a connection initialization callback, your application must implement the `initialize(java.sql.Connection connection)` method of the `oracle.ucp.jdbc.ConnectionInitializationCallback` interface. Only one callback can be created per connection pool.

The callback is ignored if a labeling callback is registered for the connection pool. Otherwise, the callback is executed at every connection check out from the pool and at each successful reconnect following a recoverable error at replay. Use the same callback at runtime and at replay to ensure that exactly the same initialization that was used when the original session was established is used during the replay. If the callback invocation fails, replay is disabled on that connection.

Note:

Connection Initialization Callback is not supported for clients (JDBC over RMI).

Connection callback once registered will be called even without Oracle driver.

The following example demonstrates a simple initialization callback implementation:

```
. . .
import oracle.ucp.jdbc.ConnectionInitializationCallback ;
. . .
class MyConnectionInitializationCallback implements ConnectionInitializationCallback
{
    public MyConnectionInitializationCallback() {
```



```

    }
    public void initialize(java.sql.Connection connection) throws SQLException {
        // Re-set the state for the connection, if necessary
    }
}

```

10.1.3.2.2 Registering an Initialization Callback

The `WLDataSource` interface provides the `registerConnectionInitializationCallback(ConnectionInitializationCallback callback)` method for registering initialization callbacks. Only one callback may be registered on a connection pool. The following example demonstrates registering an initialization callback that is implemented in the `MyConnectionInitializationCallback` class:

```

. . .
import weblogic.jdbc.extensions.WLDataSource;
. . .
MyConnectionInitializationCallback callback = new MyConnectionInitializationCallback(
);
((WLDataSource)ds).registerConnectionInitializationCallback(callback);
. . .

```

The callback can also be registered by entering the callback class in the **Connection Initialization Callback** attribute on the Oracle tab for a data source in the WebLogic Server Administration Console. Oracle recommends configuring this callback attribute instead of setting the callback at runtime. See [Enable Application Continuity](#) in *Oracle WebLogic Server Administration Console Online Help*.

10.1.3.2.3 Unregister an Initialization Callback

The `WLDataSource` interface provides the `unregisterConnectionInitializationCallback()` method for unregistering a `ConnectionInitializationCallback`. The following example demonstrates removing an initialization callback:

```

. . .
import weblogic.jdbc.extensions.WLDataSource;
((WLDataSource)ds).unregisterConnectionInitializationCallback();
. . .

```

10.1.3.3 Setting the Replay Timeout

Use the `ReplayInitiationTimeout` attribute on the **Oracle** tab for a data source in the WebLogic Server Administration Console to set the amount of time a data source allows for Application Continuity replay processing before timing out and ending a replay session context for a connection.

For applications that use the WebLogic HTTP request timeout, make sure to set the `ReplayInitiationTimeout` appropriately:

- You should set the `ReplayInitiationTimeout` value equal to the HTTP session timeout value to ensure the entire HTTP session is covered by a replay session. The default `ReplayInitiationTimeout` and the default HTTP session timeout are both 3600 seconds.
- If the HTTP timeout value is longer than `ReplayInitiationTimeout` value, replay events will not be available for the entire HTTP session.

- If the HTTP timeout value is shorter than the `ReplayInitiationTimeout` value, your application should close the connection to end the replay session.

10.1.3.4 Disabling Application Continuity for a Connection

You can disable Application Continuity on a per-connection basis using the following:

```
. . .
if (connection instanceof oracle.jdbc.replay.ReplayableConnection) {
    ((oracle.jdbc.replay.ReplayableConnection)connection).disableReplay();
}
. . .
```

You can disable application continuity at the database service level by modifying the service to have a failover type of NONE. For example:

```
srvctl modify service -d mydb -s myservice -e NONE
```

You can also disable application continuity at the data source level by setting the [ReplayInitializationTimeout](#) to 0. When set to zero (0) seconds, replay processing (failover) is disabled (begin and endRequest are still called).

10.1.3.5 Configuring Logging for Application Continuity

To enable logging of Application Continuity processing, use the following WebLogic property:

```
-Dweblogic.debug.DebugJDBCReplay=true
```

Use `-Djava.util.logging.config.file=configfile`, where *configfile* is the path and file name of the configuration file property used by standard JDK logging, to control the log output format and logging level. The following is an example of a configuration file that uses the `SimpleFormatter` and sets the logging level to `FINEST`:

```
handlers = java.util.logging.ConsoleHandler
java.util.logging.ConsoleHandler.level = ALL
java.util.logging.ConsoleHandler.formatter = java.util.logging.SimpleFormatter
#OR - use other formatters like the ones below
#java.util.logging.ConsoleHandler.formatter = java.util.logging.XMLFormatter
#java.util.logging.ConsoleHandler.formatter = oracle.ucp.util.logging.UCPFormatter

#OR - use FileHandler instead of ConsoleHandler
#handlers = java.util.logging.FileHandler
#java.util.logging.FileHandler.pattern = replay.log
#java.util.logging.FileHandler.limit = 3000000000
#java.util.logging.FileHandler.count = 1
#java.util.logging.FileHandler.formatter = java.util.logging.SimpleFormatter
oracle.jdbc.internal.replay.level = FINEST
```

See *Adding WebLogic Logging Services to Applications Deployed on Oracle WebLogic Server*.

10.1.3.6 Enabling JDBC Driver Debugging

To enable JDBC driver debugging, you must configure Java Util Logging. To do so, set the following properties on the command line as follows:

```
-Djava.util.logging.config.file=configfile
-Doracle.jdbc.Trace=true
```

In this command, `configfile` is the path and file name of the configuration property file property used by standard JDK logging to control the log output format and logging level.

The `configfile` must include one of the following lines:

- `oracle.jdbc.internal.replay.level=FINEST`—Replay debugging
- `oracle.jdbc.level = FINEST`—Standard JDBC debugging

For more information, see [java.util.logging](#) in Java Platform Standard Edition 7 API Specification.

10.1.4 Viewing Runtime Statistics for Application Continuity

This topic describes Runtime statics for application continuity.

Application Continuity (or Replay) statistics are available using the `JDBCReplayStatisticsRuntimeMBean` for Generic and Active GridLink data sources.

The `JDBCReplayStatisticsRuntimeMBean`:

- Is available for Generic and Active GridLink data sources. It is not available (null is returned) for Multi Data Source (MDS), PROXY, and UCP data sources
- Is available only if running with the 12.1.0.2 or later Oracle thin driver. It is not available (null is returned) for earlier driver versions.
- Is available only if the data source is configured to use the replay driver. It is not available (null is returned) for non-replay drivers (such as the Oracle driver and XA drivers)
- Will not have any statistics set initially (they will be initialized to -1). You must call the `refreshStatistics()` operation on the MBean to update the statistics before getting them.

Note: Refreshing the statistics is a heavy operation. It locks the entire pool and runs through all reserved and unreserved connections aggregating the statistics. Running this operation frequently will impact the performance of the data source. Performance can also be impacted when clearing the statistics.

[Table 10-1](#) lists the statistics that you can access using the `JDBCReplayStatisticsRuntimeMBean`.

Table 10-1 Runtime Statistics for `JDBCReplayStatisticsRuntimeMBean`

Name	Description
TotalRequests	Total number of successfully submitted requests.
TotalCompletedRequests	Total number of completed requests.
TotalCalls	Total number of JDBC calls executed.
TotalProtectedCalls	Total number of JDBC calls executed that are protected by Application Continuity.

Table 10-1 (Cont.) Runtime Statistics for JDBCReplayStatisticsRuntimeMBean

Name	Description
TotalCallsAffectedByOutages	Total number of JDBC calls affected by outages. This includes both local calls and calls that involve roundtrip(s) to the database server.
TotalCallsTriggeringReplay	Total number of JDBC calls that triggered replay. Replay can be disabled for some requests, therefore not all calls affected by an outage trigger replay.
TotalCallsAffectedByOutagesDuringReplay	Total number of JDBC calls affected by outages in the middle of replay. Outages may be cascaded and strike a call multiple times when replay is ongoing. Application Continuity automatically reattempts replay when this happens, unless it reaches the maximum retry limit.
SuccessfulReplayCount	Total number of replays that succeeded. Successful replays mask the outages from applications.
FailedReplayCount	Total number of replays that failed. When replay fails, it rethrows the original SQLRecoverableException to the application, along with the reason for the failure chained to the original exception. The application can call getNextException to retrieve the reason.
ReplayDisablingCount	Total number of times that replay is disabled. When replay is disabled in the middle of a request, the remaining calls in that request are no longer protected by Application Continuity. If an outage strikes one of the remaining calls, no replay is attempted, and the application gets an SQLRecoverableException.
TotalReplayAttempts	Total number of replay attempts. Application Continuity automatically reattempts when replay fails, so this number may exceed the number of JDBC calls that triggered replay.

For more information, see:

- [JDBCReplayStatisticsRuntimeMBean](#) in MBean Reference for Oracle WebLogic Server.
- [ReplayableConnection.StatisticsReportType](#) in Oracle JDBC Java API Reference

Example 10-1 WLST Sample

You can access the statistics on the runtime MBean using WLST. The following sample WLST script shows how to print the information on the JDBCReplayStatisticsRuntimeMBean:

```

import sys, socket, os
hostname = socket.gethostname()
datasource='JDBC GridLink Data Source-0'
svr='myserver'
connect("weblogic","password","t3://"+hostname+":7001")
serverRuntime()
cd('/JDBCServiceRuntime/' + svr + '/JDBCDataSourceRuntimeMBeans/' +
    datasource + '/JDBCReplayStatisticsRuntimeMBean/' +
    datasource + '.ReplayStatistics')
cmo.refreshStatistics()
ls()
total=cmo.getTotalRequests()
cmo.clearStatistics()

```

Example 10-2 Java Sample

The following Java example demonstrates how to expose the statistics using the JDBCReplayStatisticsRuntimeMBean:

```

import javax.naming.NamingException;
import javax.management.AttributeNotFoundException;
import javax.management.MBeanServer;
import javax.management.InstanceNotFoundException;
import javax.management.ReflectionException;
import javax.management.ObjectName;
import javax.management.MalformedObjectNameException;
import javax.management.MBeanAttributeInfo;
import javax.management.MBeanOperationInfo;
import javax.management.MBeanException;
import javax.management.MBeanParameterInfo;
import weblogic.management.runtime.JDBCReplayStatisticsRuntimeMBean;

public void printReplayStats(String dsName) throws Exception {
    MBeanServer server = getMBeanServer();
    ObjectName[] dsRTs = getJdbcDataSourceRuntimeMBeans(server);
    for (ObjectName dsRT : dsRTs) {
        String name = (String) server.getAttribute(dsRT, "Name");
        if (name.equals(dsName)) {
            ObjectName mb = (ObjectName)server.getAttribute(dsRT,
                "JDBCReplayStatisticsRuntimeMBean");
            server.invoke(mb, "refreshStatistics", null, null);
            MBeanAttributeInfo[] attributes =
                server.getMBeanInfo(mb).getAttributes();
            for (int i = 0; i < attributes.length; i++) {
                if (attributes[i].getType().equals("java.lang.Long")) {
                    System.out.println(attributes[i].getName()+"="+
                        (Long) server.getAttribute(mb, attributes[i].getName()));
                }
            }
        }
    }
}

MBeanServer getMBeanServer() throws Exception {
    InitialContext ctx = new InitialContext();
    MBeanServer server = (MBeanServer) ctx.lookup("java:comp/env/jmx/runtime");
    return server;
}

ObjectName[] getJdbcDataSourceRuntimeMBeans(MBeanServer server)
    throws Exception {
    ObjectName service = new ObjectName(
        "com.bea:Name=RuntimeService,Type=weblogic.management.mbeanservers.runtime.RuntimeServiceMBean");

```

```
ObjectName serverRT = (ObjectName) server.getAttribute(service,
"ServerRuntime");
ObjectName jdbcRT = (ObjectName) server.getAttribute(serverRT,
"JDBCServiceRuntime");
ObjectName[] dsRTs = (ObjectName[]) server.getAttribute(jdbcRT,
"JDBCDataSourceRuntimeMBeans");
return dsRTs;
}
```

10.1.5 Application Continuity Auditing

During a `ConnectionInitializationCallback`, between the first connection initialization and reinitialization during replay, the application may want to know when the connection work is being replayed. The `getReplayAttemptCount()` method on the `WLConnection` interface is available to get the number of times that replay is attempted on the connection.

When a connection is first being initialized, it will be set to 0. For subsequent initialization of the connection when it is being replayed, it will be set to a value greater than 0.

Note: This counter only indicates attempted replays since it is possible for replay to fail for various reasons (after which the connection is no longer valid). For a non-replay driver, it will always return 0.

Example 10-3 *WLST Sample*

The following is a sample callback class for initializing the connection. It assumes that there is some mechanism for getting an application identifier associated with the current work or transaction..

```
import java.sql.SQLException;
import java.util.Date;
import java.text.SimpleDateFormat;
import java.util.Properties;
import weblogic.jdbc.extensions.WLConnection;
import oracle.ucp.jdbc.ConnectionInitializationCallback;
public class callback implements ConnectionInitializationCallback {
    final String idLabel = "GUUID";
    public callback() {
    }
    public void initialize(java.sql.Connection conn) throws SQLException {
        if (((WLConnection)conn).getReplayAttemptCount() == 0) {
            // first time - initialize the label value
            ((WLConnection)conn).applyConnectionLabel(idLabel, Application.getGuid());
            // Get the id from somewhere and store it in the connection label
        } else {
            Properties props = ((WLConnection)conn).getConnectionLabels();
            String value = props.getProperty(idLabel);
            System.out.println("Transaction '"+value+"' is getting replayed at " + new
                SimpleDateFormat("yyyy-MM-dd HH:mm:ss.SSS").format(new
                Date()));
        }
    }
}
```

10.1.6 Limitations with Application Continuity with Oracle 12c Database

The following section provides information on limitations when using Oracle Database Release 12c with Application Continuity:

- DRCP is not supported. That is, a web request will not be replayed and the original `java.sql.SQLRecoverableException` is thrown if an outage occurs.
- Cannot be used with PDB tenant switching using `ALTER SESSION SET CONTAINER`.

10.2 Database Resident Connection Pooling

Database Resident Connection Pooling (DRCP) provides the ability for multiple web-tier and mid-tier data sources to pool database server processes and sessions that are resident in an Oracle database. See [Database Resident Connection Pooling \(DRCP\)](http://www.oracle.com/technetwork/articles/oracledrcp11g-1-133381.pdf) at <http://www.oracle.com/technetwork/articles/oracledrcp11g-1-133381.pdf>.

The following sections provide more information on using and configuring DRCP in WebLogic Server:

- [Requirements and Considerations](#)
- [Configuring a Data Source for DRCP](#)

10.2.1 Requirements and Considerations

The following section provides requirements and items to consider when using DRCP with WebLogic applications:

- Requires an Oracle 12c JDBC Driver and Database. See [Using an Oracle 12c Database](#).
- If the WebLogic statement cache is configured along with DRCP, the cache is cleared every time the connection is returned to the pool with `close()`.
- WebLogic Server data sources do not support connection labeling on DRCP connections and a `SQLException` is thrown. For example, using `getConnection` with properties on `WLDataSource` or a method on `LabelableConnection` is called, generates an exception. Note, `registerConnectionLabelingCallback` and `removeConnectionLabelingCallback` on `WLDataSource` are permitted.
- WebLogic Server does not support defining the `oracle.jdbc.DRCPConnectionClass` as a system property. It must be defined as a connection property in the data source descriptor.
- For DRCP to be effective, applications must return connections to the connection pool as soon as work is completed. Holding on to connections and using harvesting defeats the use of DRCP.
- When using DRCP, the JDBC program must attach to the server before performing operations on the connection and must detach from the server to allow other connections to use the pooled session. By default, when the JDBC program is attaching to the server, it does not actually reserve a session but returns and defers the reservation until the next database round-trip. As a result, the subsequent

database operation may fail because it cannot reserve a session. To prevent this from happening, there is a network timeout value that forces a round-trip to the database after an attach to the server. Once this occurs, the network timer is unset. The default network timeout is 10,000 milliseconds. You can set it to another value by setting the system property `weblogic.jdbc.attachNetworkTimeout`.

This property is the timeout, in milliseconds to wait for the attach to be done and the database round trip to return. If set to 0, then the additional processing around the server attach is not done.

For more information on configuring DRCP, see [Configuring Database Resident Connection Pooling](#) in the *Oracle® Database Administrator's Guide*.

10.2.2 Configuring DRCP

The following sections provide information on how to configure DRCP in your environment:

- [Configuring a Data Source for DRCP](#)
- [Configuring a Database for DRCP](#)

10.2.2.1 Configuring a Data Source for DRCP

To configure your data source to support DRCP:

- If you are creating a new data source, on the **Connection Properties** tab of the data source configuration wizard, under **Additional Configuration Properties**, enter the DRCP connection class in the `oracle.jdbc.DRCPConnectionClass` field. See [Create JDBC generic data sources](#) and [Create JDBC Active GridLink data sources](#) in *Oracle WebLogic Server Administration Console Online Help*.

In the resulting data source:

- The suffix `: POOLED` is added to the constructed short-form of the URL. For example: `jdbc:oracle:thin:@//host:port/service_name: POOLED`
- For the service form of the URL, `(SERVER= POOLED)` is added after the `(SERVICE_NAME=name)` parameter in the `CONNECT_DATA` element.
- The value/name pair of the DRCP connection class appears as a connection property on the **Connection Pool** tab. For example:
`oracle.jdbc.DRCPConnectionClass=myDRCPclass.`
- If you are editing an existing data source in the Administrator Console, select the **Connection Pool** tab:
 - Change the **URL** to include a suffix of `: POOLED` or `(SERVER= POOLED)` for service URLs.
 - Update the connection properties to include the value/name pair of the DRCP connection class. For example:
`oracle.jdbc.DRCPConnectionClass=myDRCPclass.`
 - Click **Save**.
- When creating or editing a data source with a text editor or using WLST:

- Change the URL element to include a suffix of : POOLED or (SERVER=POOLED) for service URLs. For example:
`<url>jdbc:oracle:thin:@host:port:service:POOLED</url>`

- Update the connection properties to include the value/name pair of the DRCP connection class. For example:

```
<properties>
  <property>
    <name>aname</name>
    <value>avalue</value>
  </property>
  <property>
    <name>oracle.jdbc.DRCPConnectionClass</name>
    <value>myDRCPclass</value>
  </property>
</properties>
```

- WebLogic Server throws a configuration error if the a datasource definition has a `oracle.jdbc.DRCPConnectionClass` connection property or a POOLED URL but not both. This validation is performed when testing the connection listener in the console, deploying a datasource during system boot, or when targeting a datasource.
- Set `TestConnectionsOnReserve=true` to minimize problems with `MAX_THINK_TIME`. See [Configuring a Database for DRCP](#).
- Set `TestFrequencySeconds` to a value less than `INACTIVITY_TIMEOUT`. See [Configuring a Database for DRCP](#).

10.2.2.2 Configuring a Database for DRCP

To configure your Oracle database to support DRCP:

- DRCP must be enabled on the Database side using:

```
SQL>
DBMS_CONNECTION_POOL.CONFIGURE_POOL( ' SYS_DEFAULT_CONNECTION_P
OOL ' )

SQL> EXECUTE DBMS_CONNECTION_POOL.START_POOL( ) ;
```

- The following parameters of the server pool configuration must be set correctly:

- **MAXSIZE:** The maximum number of pooled servers in the pool. The default value is 40. The connection pool reserves 5% of the pooled servers for authentication and at least one pooled server is always reserved for authentication. When setting this parameter, ensure that there are enough pooled servers for both authentication and connections.

It may be necessary to set `MAXSIZE` to the size of the largest WebLogic connection pool using the DRCP.

- **INACTIVITY_TIMEOUT:** The maximum time, in seconds, the pooled server can stay idle in the pool. After this time, the server is terminated. The default value is 300. This parameter does not apply if the server pool has a size of `MINSIZE`.

If a connection is reserved from the WebLogic datasource and then not used, the inactivity timeout may occur and the DRCP connection will be released. Set `INACTIVITY_TIMEOUT` appropriately or return connections to the WebLogic

datasource if they will not be used. You can also use `TestFrequencySeconds` to ensure that unused connections don't time out.

- `MAX_THINK_TIME`: The maximum time of inactivity, in seconds, for a client after it obtains a pooled server from the pool. After obtaining a pooled server from the pool, if the client application does not issue a database call for the time specified by `MAX_THINK_TIME`, the pooled server is freed and the client connection is terminated. The default value is 120.

If a connection is reserved from the WebLogic datasource and no activity is done within the `MAX_THINK_TIME`, the connection is released. You can set `TestConnectionsOnReserve` (see [Testing Reserved Connections](#)) or set `MAX_THINK_TIME` appropriately. You can minimize the overhead of testing connections by setting `SecondsToTrustAnIdlePoolConnection` to a reasonable value less than `MAX_THINK_TIME`. See [Tuning Data Source Connection Pools](#).

If the server pool configuration parameters are not set correctly for your environment, your datasource connections may be terminated and your applications may receive an error, such as a socket exception, when accessing a WebLogic datasource connection.

10.3 Global Database Services

Global Data Services (GDS) enables you to use a global service to provide seamless central management in a distributed database environment. A global server provides automated load balancing, fault tolerance and resource utilization across multiple RAC and single-instance Oracle databases interconnected by replication technologies such as Data Guard or GoldenGate.

The following sections provide information on requirements and configuration for GDS in WebLogic Server:

- [Requirements and Considerations](#)
- [Creating a GridLink DataSource for GDS Connectivity](#)

10.3.1 Requirements and Considerations

The following section provides requirements and considerations when using Global Database Services in WebLogic Server:

- Requires an Oracle 12c JDBC Driver and Database. See [Using an Oracle 12c Database](#).
- It is not possible to use a single SCAN address to replace multiple Global Service manger (GSM) addresses.
- For update operations to be handled correctly, you must define a service for updates that is only enabled on the primary database.
- Define a separate service for Read-only operations that is located on the primary and secondary databases.
- Since only a single service can be defined for a URL and a single URL for a datasource configuration, one datasource must be defined for the update service and another datasource defined for the read-only service.

- Your application must be written so that update operations are processed by the update datasource and read-only operations are processed by the read-only datasource.

10.3.2 Creating a GridLink DataSource for GDS Connectivity

Use the WebLogic Server Administration Console to create a GridLink datasource that uses a modified URL to provide GDS connectivity. See [Create JDBC Active GridLink data sources](#) in the *Oracle WebLogic Server Administration Console Online Help*.

The connection information for a GDS URL is similar to a RAC Cluster, containing the following basic information:

- Service name (Global Service Name)
- Address/port pairs for Global Service Managers
- GDS Region in the CONNECT_DATA parameter

The following is a sample URL:

```
jdbc:oracle:thin:@(DESCRIPTION=
  (ADDRESS_LIST=(LOAD_BALANCE=ON) (FAILOVER=ON)
    (ADDRESS=(HOST=myHost1.com) (PORT=1111) (PROTOCOL=tcp))
    (ADDRESS=(HOST=myHost2.com) (PORT=2222) (PROTOCOL=tcp)))
  (CONNECT_DATA=(SERVICE_NAME=my.gds.cloud) (REGION=west)))
```

10.4 Container Database with Pluggable Databases

Container Database (CDB) is an Oracle Database feature that minimizes the overhead of having many of databases by consolidating them into a single database with multiple Pluggable Databases (PDB) in a single CDB. See "Managing Oracle Pluggable Databases" in the *Oracle Database Administrator's Guide*.

- [Creating Service for PDB Access](#)
- [DRCP and CDB/PDB](#)
- [Setting the PDB using JDBC](#)

10.4.1 Creating Service for PDB Access

Access to a PDB is completely transparent to a WebLogic Server data source. It is accessed like any other database using a URL with a service. The service must be associated with the PDB. It can be created in SQLPlus by associating a session with the PDB, creating the service and starting it.

```
alter session set container = cdb1_pdb1; -- configure service for each PDB
execute
dbms_service.create_service('replaytest_cdb1_pdb1.regress.rdbms.dev.us.myCompany.com'
, 'replaytest_cdb1_pdb1.regress.rdbms.dev.us.myCompany.com');
execute
DBMS_SERVICE.START_SERVICE('replaytest_cdb1_pdb1.regress.rdbms.dev.us.myCompany.com')
;
```

If you want to set up the service for use with Application Continuity, it needs to be appropriately configured. For example, SQLPlus:

```
declare
params dbms_service.svc_parameter_array ;
```

```
begin
params('goal') := 'service_time' ;
params('commit_outcome') := 'true' ;
params('aq_ha_notifications') := 'true' ;
params('failover_method') := 'BASIC' ;
params('failover_type') := 'TRANSACTION' ;
params('failover_retries') := 60 ;
params('failover_delay') := 2 ;
dbms_service.modify_service('replaytest_cdb1_pdb1.regress.rdbms.dev.us.myCompany.com'
, params);
end;
/
```

10.4.2 DRCP and CDB/PDB

DRCP cannot be used in a PDB. It must be associated with a CDB only. To configure, set a session to point to the CDB and start the DRCP pool. For example:

```
alter session set container = cdb$root;
execute dbms_connection_pool.configure_pool('SYS_DEFAULT_CONNECTION_POOL');
execute dbms_connection_pool.start_pool();
```

10.4.3 Setting the PDB using JDBC

Initially when a connection is created for the pool, it is created using the URL with the service associated with a specific PDB in a CDB. It is possible to dynamically change the PDB within the same CDB. Changing PDB's is done by executing the SQL statement:

```
ALTER SESSION SET CONTAINER = name;
```

After the container is changed, the following do not change:

- The RAC instance
- The connection object
- The WebLogic connection lifecycle (enabled/disabled/destroyed)
- The WebLogic connection attributes.

Any remaining state on the connection is cleared to avoid leaking information between PDB's.

If configured, the following are reset:

- Application Continuity (Replay)
- DRCP
- `client identifier`
- `proxy user`
- The connection harvesting callback.

10.5 Limitations with Tenant Switching

When you switch from one tenant to another tenant using `ALTER SESSION SET CONTAINER`, there is currently no mechanism to indicate to which user service you want to switch in that PDB. Instead the PDB service on the new tenant is used. The

PDB service is an administrative service that is created for every PDB (so every PDB has at least one service for administration). As an administrative service, user-level service features are not supported. These restrictions will be removed in a future database release by allowing user services.

The following additional WebLogic Server limitations exist when using tenant switching with the 12.1 database release:

- XA and global transactions are not supported.
- FAN is not supported. Even though FAN is not supported, Active GridLink still provides the benefit of a single datasource view of multiple RAC instances and the ability to reserve connections on new instances as they are available without reconfiguration using connection load balancing. This connection load balancing is based strictly on session counts as there is no metrics support. If you want to use tenant switching with an Active GridLink data source, `FAN_enabled` must be set to `false`. Runtime Load Balancing is not available to optimally reserve existing connections (either local or with Global Data Services). Instead, round robin is used to assign connections. This also implies that connection gravitation is not supported since the runtime load balancing information is not available. Session affinity is not supported. ONS (including auto-ONS) is not supported; this also affects features like Global Data Services and Active Data Guard. Instead of receiving down events, WebLogic uses connection testing to see if an instance is down. See [Using Active GridLink Data Sources without FAN Notification](#) for details of what this implies for AGL. Transaction Affinity is not affected because it is not based on FAN. This restriction does not apply to Generic data sources (they don't use FAN).
- DRCP is not supported. If a connection is chosen from the database-resident connection pool that doesn't match the requested tenant, an error occurs (service switching is not supported by DRCP). Since WebLogic Server is not matching on the tenant when selecting a connection, WebLogic Server cannot guarantee that a valid connection will be selected.
- Application Continuity is not supported. The attributes needed (`FAILOVER_TYPE=TRANSACTION` and `COMMIT_OUTCOME=true`) can not be set on the PDB service.
- Proxy authentication is not supported. A `java.sql.SQLException` "ORA-01017: invalid username/password" is thrown.
- A number of database features based on services are not available including: management operations based on services, service-based metrics, top consumers in Enterprise Manager, database service-based alerts, restriction of parallel query to a user service.

Labeling Connections

This chapter provides information on how to label connections to increase performance:

This chapter includes the following sections:

- [What is Connection Labeling](#)
- [Implementing Labeling Callbacks](#)
- [Creating a Labeling Callback](#)
- [Registering a Labeling Callback](#)
- [Reserving Labeled Connections](#)
- [Checking Unmatched labels](#)
- [Removing a Connection Label](#)
- [Using Initialization and Reinitialization Costs to Select Connections](#)
- [Using Connection Labeling with Packaged Applications](#)

11.1 What is Connection Labeling

Applications often initialize connections retrieved from a connection pool before using the connection. The initialization varies and could include simple state re-initialization that requires method calls within the application code or database operations that require round trips over the network. The cost of such initialization may be significant.

Labeling connections allows an application to attach arbitrary name/value pairs to a connection. The application can request a connection with the desired label from the connection pool. By associating particular labels with particular connection states, an application can retrieve an already initialized connection from the pool and avoid the time and cost of re-initialization. The connection labeling feature does not impose any meaning on user-defined keys or values; the meaning of user-defined keys and values is defined solely by the application.

Some of the examples for connection labeling include role, NLS language settings, transaction isolation levels, stored procedure calls, or any other state initialization that is expensive and necessary on the connection before work can be executed by the resource.

Connection labeling is application-driven and requires the following:

- The `oracle.ucp.jdbc.LabelableConnection` interface is used to apply and remove connection labels, as well as retrieve labels that have been set on a connection.

- The `oracle.ucp.ConnectionLabelingCallback` interface is used to create a labeling callback that determines whether or not a connection with a requested label already exists. If no connections exist, the interface allows current connections to be configured as required.
- A Connection Labeling Callback, see [JDBC Data Source: Configuration: Connection Pool](#) in *Oracle WebLogic Server Administration Console Online Help*.

11.2 Implementing Labeling Callbacks

A labeling callback is used to define how the connection pool selects labeled connections and allows the selected connection to be configured before returning it to an application. Applications that use the connection labeling feature must provide a callback implementation.

A labeling callback is used when a labeled connection is requested but there are no connections in the pool that match the requested labels. The callback determines which connection requires the least amount of work in order to be re-configured to match the requested label and then allows the connection's labels to be updated before returning the connection to the application.

Note:

Connection Labeling is not supported from client applications that use RMI. See [Using the WebLogic RMI Driver \(Deprecated\)](#) in *Developing JDBC Applications for Oracle WebLogic Server*.

11.3 Creating a Labeling Callback

To create a labeling callback, an application implements the `oracle.ucp.ConnectionLabelingCallback` interface. One callback is created per connection pool. The interface provides two methods as shown below:

```
public int cost(Properties requestedLabels, Properties
currentLabels);

public boolean configure(Properties requestedLabels, Connection
conn);
```

The connection pool iterates over each connection available in the pool. For each connection, it calls the `cost` method. The result of the `cost` method is an integer which represents an estimate of the cost required to reconfigure the connection to the required state. The larger the value, the costlier it is to reconfigure the connection. The connection pool always returns connections with the lowest cost value. The algorithm is as follows:

- If the `cost` method returns 0 for a connection, the connection is a match (note that this does not guarantee that `requestedLabels` equals `currentLabels`). The connection pool does not call `configure` on the connection found and simply returns the connection.
- If the `cost` method returns a value that is not 0 (a negative or positive integer), then the connection pool iterates until it finds a connection with a cost value of 0 or runs out of available connections.

- If the pool has iterated through all available connections and the lowest cost of a connection is `Integer.MAX_VALUE` (2147483647 by default), then no connection in the pool is able to satisfy the connection request. The pool creates a new connection, calls the `configure` method on it, and then returns this new connection. If the pool has reached the maximum pool size (it cannot create a new connection), then the pool either throws an SQL exception or waits if the connection wait timeout attribute is specified.
- If the pool has iterated through all available connections and the lowest cost of a connection is less than `Integer.MAX_VALUE`, then the `configure` method is called on the connection and the connection is returned. If multiple connections are less than `Integer.MAX_VALUE`, the connection with the lowest cost is returned.

There is also an extended callback interface

`oracle.ucp.jdbc.ConnectionLabelingCallback` that has an additional `getRequestedLabels()` method. `getRequestedLabels` is invoked at `getConnection()` time when no requested labels are provided and there is an instance registered. This occurs when the standard `java.sql.DataSource` `getConnection()` methods are used that do not provide the label information on the `getConnection()` call.

11.3.1 Example Labeling Callback

The following code example demonstrates a simple labeling callback implementation that implements both the `cost` and `configure` methods. The callback is used to find a labeled connection that is initialized with a specific transaction isolation level.

Example 11-1 Labeling Callback

```
import oracle.ucp.jdbc.ConnectionLabelingCallback;
import oracle.ucp.jdbc.LabelableConnection;
import java.util.Properties;
import java.util.Map;
import java.util.Set;
import weblogic.jdbc.extensions.WLDataSource;
class MyConnectionLabelingCallback implements ConnectionLabelingCallback {

    public MyConnectionLabelingCallback() {
    }

    public int cost(Properties reqLabels, Properties currentLabels) {
        // Case 1: exact match
        if (reqLabels.equals(currentLabels)) {
            System.out.println("## Exact match found!! ##");
            return 0;
        }

        // Case 2: some labels match with no unmatched labels
        String iso1 = (String) reqLabels.get("TRANSACTION_ISOLATION");
        String iso2 = (String) currentLabels.get("TRANSACTION_ISOLATION");
        boolean match =
            (iso1 != null && iso2 != null && iso1.equalsIgnoreCase(iso2));
        Set rKeys = reqLabels.keySet();
        Set cKeys = currentLabels.keySet();
        if (match && rKeys.containsAll(cKeys)) {
            System.out.println("## Partial match found!! ##");
            return 10;
        }

        // No label matches to application's preference.
        // Do not choose this connection.
    }
}
```

```

        System.out.println("## No match found!! ##");
        return Integer.MAX_VALUE;
    }

    public boolean configure(Properties reqLabels, Object conn) {
        try {
            String isoStr = (String) reqLabels.get("TRANSACTION_ISOLATION");
            ((Connection)conn).setTransactionIsolation(Integer.valueOf(isoStr));
            LabelableConnection lconn = (LabelableConnection) conn;

            // Find the unmatched labels on this connection
            Properties unmatchedLabels =
                lconn.getUnmatchedConnectionLabels(reqLabels);
            // Apply each label <key,value> in unmatchedLabels to conn

            for (Map.Entry<Object, Object> label : unmatchedLabels.entrySet()) {
                String key = (String) label.getKey();
                String value = (String) label.getValue();

                lconn.applyConnectionLabel(key, value);
            }
        } catch (Exception exc) {
            return false;
        }
        return true;
    }

    public java.util.Properties getRequestedLabels() {
        Properties props = new Properties();

        // Set based on some application state that might be on a thread-local, http
        // session info, etc.
        String value = "value";

        props.put("TRANSACTION_ISOLATION", value);

        return props;
    }
}

```

11.4 Registering a Labeling Callback

A WLS data source provides the `registerConnectionLabelingCallback(ConnectionLabelingCallback callback)` method for registering labeling callbacks. Only one callback may be registered on a connection pool. The following code example demonstrates registering a labeling callback that is implemented in the `MyConnectionLabelingCallback` class:

```

. . .
import weblogic.jdbc.extensions.WLDataSource;
. . .
MyConnectionLabelingCallback callback = new MyConnectionLabelingCallback();
((WLDataSource)ds).registerConnectionLabelingCallback( callback );
. . .

```

You can also register the callback using the WebLogic Server Administration Console, see [Configure a connection labeling callback class](#) in *Oracle WebLogic Server Administration Console Online Help*.

11.4.1 Removing a Labeling Callback

You can remove a labeling callback by using one of the following methods:

- If you have programmatically set a callback, use the `removeConnectionLabelingCallback()` method as shown in the following example:

```
. . .
import weblogic.jdbc.extensions.WLDataSource;
. . .
((WLDataSource)ds).removeConnectionLabelingCallback( callback );
. . .
```

- If you have administratively configured the callback, remove the callback from the data source configuration. See [Configure a connection labeling callback class](#) in *Oracle WebLogic Server Administration Console Online Help*

Note:

An application must use one of the methods to register and remove callbacks but not both. For example, if you register the callback on a connection using `registerConnectionLabelingCallback(callback)`, you must use `removeConnectionLabelingCallback()` to remove it.

11.4.2 Applying Connection Labels

Labels are applied on a reserved connection using the `applyConnectionLabel` method from the `LabelableConnection` interface. Any number of connection labels may be cumulatively applied on a reserved connection. Each time a label is applied to a connection, the supplied key/value pair is added to the existing collection of labels. Only the last applied value is retained for any given key.

Note:

A labeling callback must be registered on the connection pool before a label can be applied on a reserved connection; otherwise, labeling is ignored. See [Creating a Labeling Callback](#).

The following example demonstrates initializing a connection with a transaction isolation level and then applying a label to the connection:

```
. . .
String pname = "property1";
String pvalue = "value";
Connection conn = ds.getConnection();
// initialize the connection as required.
conn.setTransactionIsolation(Connection.TRANSACTION_SERIALIZABLE);
((LabelableConnection) conn).applyConnectionLabel(pname, pvalue);
. . .
```

11.5 Reserving Labeled Connections

A WLS data source provides two `getConnection` methods that are used to reserve a labeled connection from the pool. The methods are shown below:

```
public Connection getConnection(java.util.Properties labels)
    throws SQLException;
```

```
public Connection getConnection(String user, String password,
    java.util.Properties labels) throws SQLException;
```

The methods require that the label be passed to the `getConnection` method as a `Properties` object. The following example demonstrates getting a connection with the label `property1` value.

```
. . .
import weblogic.jdbc.extensions.WLDataSource;
. . .
String pname = "property1";
String pvalue = "value";
Properties label = new Properties();
label.setProperty(pname, pvalue);
. . .
Connection conn = ((WLDataSource)ds).getConnection(label);
. . .
```

It is also possible to use the standard `java.sql.DataSource` `getConnection()` methods. In this case, the label information is not provided on the `getConnection()` call. The interface `oracle.ucp.jdbc.ConnectionLabelingCallback` is used:

```
java.util.Properties getRequestedLabels();
```

`getRequestedLabels` is invoked at `getConnection()` time when no requested labels are provided and there is an instance registered.

11.6 Checking Unmatched labels

A connection may have multiple labels that each uniquely identifies the connection based on some desired criteria. The [getUnmatchedConnectionLabels](#) method is used to verify which connection labels matched from the requested labels and which did not. The method is used after a connection with multiple labels is reserved from the connection pool and is typically used by a labeling callback. The following code example demonstrates checking for unmatched labels:

```
. . .
String pname = "property1";
String pvalue = "value";
Properties label = new Properties();
label.setProperty(pname, pvalue);
. . .
Connection conn = ((WLDataSource)ds).getConnection(label);
Properties unmatched =
    ((LabelableConnection)connection).getUnmatchedConnectionLabels (label);
. . .
```

11.7 Removing a Connection Label

The `removeConnectionLabel` method is used to remove a label from a connection. This method is used after a labeled connection is reserved from the connection pool. The following code example demonstrates removing a connection label:

```

. . .
String pname = "property1";
String pvalue = "value";
Properties label = new Properties();
label.setProperty(pname, pvalue);
Connection conn = ((WLDataSource)ds).getConnection(label);
. . .
((LabelableConnection) conn).removeConnectionLabel(pname);
. . .

```

11.8 Using Initialization and Reinitialization Costs to Select Connections

Some applications require that a connection pool to be able to identify *high-cost* connections and avoid using those connections to serve requests when the number of connections is below a certain threshold. This allows a pool to use brand-new physical connections to serve connection requests from different tenants without incurring re-initialization overhead on other tenant connections already in the pool.

WebLogic Server provides the following connection properties to identify high cost connections:

- `ConnectionLabelingHighCost`—When greater than 0, connections with a cost value equal to or greater than the property value are considered *high-cost* connections. The default value is `Integer.MAX_VALUE`.

For example, if the property value is set to 5, any connection whose calculated cost value from the labeling callback is equal to or greater than 5 is considered a *high-cost* connection.

- `HighCostConnectionReuseThreshold`—When greater than 0, specifies a threshold of the number of total connections in the pool beyond which Connection Labeling is allowed to reuse *high-cost* connections in the pool to serve a request. Below this threshold, Connection Labeling either uses an available low-cost connection or creates a brand-new physical connection to serve a request. The default value is 0.

For example, if set to 20, Connection Labeling reuses *high-cost* connections when there are no low-cost connections available and the total connections reach 20.

For more information on configuring configuration properties:

- For generic data sources see [Configuring Generic Connection Pool Features](#)
- For AGL data sources, see [Configuring AGL Connection Pool Features](#)

11.8.1 Considerations When Using Initialization and Reinitialization Costs

This section provides additional considerations when selecting connections based on connection costs:

- Valid callback registration activates Connection Labeling. Once registered, the connection pool checks for new threshold values at regular intervals and determines:
 - if a connection has a cost that is equal to or greater than `ConnectionLabelingHighCost`.
 - If the number of total connections accounts for the number of active connection creation requests, including restrictions for `MinCapacity` and `MaxCapacity`.
- Any labeled connection with cost value of `Integer.MAX_VALUE` is not reused, even if a new threshold is reached.
- There is no requirement not to reuse connections without labels (stateless) in the pool to serve connection requests with labels (labeled requests). Once the `HighCostConnectionReuseThreshold` is reached and Connection Labeling is activated, the pool continues to favor connections without labels (stateless) over creating new physical connections.

11.9 Using Connection Labeling with Packaged Applications

WebLogic Server allows callbacks, such as labeling and connection initialization, in EAR or WAR files used by a packaged application.

To define an application-packaged callback class in a datasource configuration:

- Define the datasource as part of the application.

For example, if the callback implementation classes are packaged in a WAR or defined as part of a shared library that is referenced by the application, the EAR file contains application packaged datasource configurations that reference the callback class names in their module descriptors.

- Specify the application WAR file (that contains the callback implementations) as part of the application classloader hierarchy in the `weblogic-application.xml` file.

For example:

```
. . .
<classloader-structure>
  <module-ref>
    <module-uri>appcallbacks.war</module-uri>
  </module-ref>
</classloader-structure>
```

11.9.1 Considerations When using Labelled Connections in Packaged Applications

WebLogic Server does not support specifying a connection labeling callback or connection initialization callback in the module descriptor for a globally scoped datasource system resource when the callback class is packaged in an application. A global datasource requires that callback implementation classes be on the WebLogic classpath. However, you can workaroud this restriction for an application callback that is packaged in a WAR or EAR by having the application register the callback at runtime using the [WLDDataSource](#) interface in the *Java API Reference for Oracle WebLogic Server*.

JDBC Data Source Transaction Options

This chapter provides information on XA, non-XA, and Global Transaction options for WebLogic data sources.

When you configure a JDBC data source using the WebLogic Server Administration Console, WebLogic Server automatically selects specific transaction options based on the type of JDBC driver:

- **For XA drivers**, the system automatically selects the **Two-Phase Commit** protocol for global transaction processing.
- **For non-XA drivers**, local transactions are supported by definition, and WebLogic Server offers the following options

Supports Global Transactions: (selected by default) Select this option if you want to use connections from the data source in global transactions, even though you have not selected an XA driver. See [Enabling Support for Global Transactions with a Non-XA JDBC Driver](#) for more information.

When you select Supports Global Transactions, you must also select the protocol for WebLogic Server to use for the transaction branch when processing a global transaction:

- **Logging Last Resource:** With this option, the transaction branch in which the connection is used is processed as the last resource in the transaction and is processed as a local transaction. Commit records for two-phase commit (2PC) transactions are inserted in a table on the resource itself, and the result determines the success or failure of the prepare phase of the global transaction. This option offers some performance benefits and greater data safety than Emulate Two-Phase Commit, but it has some limitations. See [Understanding the Logging Last Resource Transaction Option](#).

Note:

Logging Last Resource is not supported for data sources used by a multi data source except when used with Oracle RAC version 10g Release 2 (10gR2) and greater versions as described in [Administrative Considerations and Limitations for LLR Data Sources](#).

- **Emulate Two-Phase Commit:** With this option, the transaction branch in which the connection is used always returns success for the prepare phase of the transaction. It offers performance benefits, but also has risks to data in some failure conditions. Select this option only if your application can tolerate heuristic conditions. See [Understanding the Emulate Two-Phase Commit Transaction Option](#).

- **One-Phase Commit:** (selected by default) With this option, a connection from the data source can be the only participant in the global transaction and the transaction is completed using a one-phase commit optimization. If more than one resource participates in the transaction, an exception is thrown when the transaction manager calls `XAResource.prepare` on the 1PC resource.

This section includes the following sections:

- [Enabling Support for Global Transactions with a Non-XA JDBC Driver](#)
- [Understanding the Logging Last Resource Transaction Option](#)
- [Understanding the Emulate Two-Phase Commit Transaction Option](#)
- [Local Transaction Completion when Closing a Connection](#)

12.1 Enabling Support for Global Transactions with a Non-XA JDBC Driver

If you use global transactions in your applications, you should use an XA JDBC driver to create database connections in the JDBC data source. If an XA driver is unavailable for your database, or you prefer not to use an XA driver, you should enable support for global transactions in the data source. You should also enable support for global transaction if your applications meet any of the following criteria:

- Use the EJB container in WebLogic Server to manage transactions
- Include multiple database updates within a single transaction
- Access multiple resources, such as a database and the Java Messaging Service (JMS), during a transaction
- Use the same data source on multiple servers (clustered or non-clustered)

With an EJB architecture, it is common for multiple EJBs that are doing database work to be invoked as part of a single transaction. Without XA, the only way for this to work is if all transaction participants use the exact same database connection. When you enable global transactions and select either Logging Last Resource or Emulate Two-Phase Commit, WebLogic Server internally uses the JTS driver to make sure all EJBs use the same database connection within the same transaction context without requiring you to explicitly pass the connection from EJB to EJB.

If multiple EJBs are participating in a transaction and you do not use an XA JDBC driver for database connections, configure a Data Source with the following options:

- Supports Global Transactions selected
- Logging Last Resource or Emulate Two-Phase Commit selected

This configuration will force the JTS driver to internally use the same database connection for all database work within the same transaction.

With XA (requires an XA driver), EJBs can use a different database connection for each part of the transaction. WebLogic Server coordinates the transaction using the two-phase commit protocol, which guarantees that all or none of the transaction will be completed.

12.2 Understanding the Logging Last Resource Transaction Option

WebLogic Server supports the Logging Last Resource (LLR) transaction optimization through JDBC data sources. LLR is a performance enhancement option that enables one non-XA resource to participate in a global transaction with the same ACID guarantee as XA. LLR is a refinement of the "Last Agent Optimization." It differs from Last Agent Optimization in that it is transactionally safe. The LLR resource uses a local transaction for its transaction work. The WebLogic Server transaction manager prepares all other resources in the transaction and then determines the commit decision for the global transaction based on the outcome of the LLR resource's local transaction.

The LLR optimization improves performance by:

- Removing the need for an XA JDBC driver to connect to the database. XA JDBC drivers are typically inefficient compared to non-XA JDBC drivers.
- Reducing the number of processing steps to complete the transaction, which also reduces network traffic and the number of disk I/Os.
- Removing the need for XA processing at the database level

When a connection from a data source configured for LLR participates in a two-phase commit (2PC) global transaction, the WebLogic Server transaction manager completes the transaction by:

- Calling prepare on all other (XA-compliant) transaction participants.
- Inserting a commit record to a table on the LLR participant (rather than to the file-based transaction log).
- Committing the LLR participant's local transaction (which includes both the transaction commit record insert and the application's SQL work).
- Calling commit on all other transaction participants.

For a one-phase commit (1PC) global transaction, LLR eliminates the XA overhead by using a local transaction to complete the database operations, but no 2PC transaction record is written to the database.

The Logging Last Resource optimization maintains data integrity by writing the commit record on the LLR participant. If the transaction fails during the local transaction commit, the WebLogic Server transaction manager rolls back the transaction on all other transaction participants. For failure recovery, the WebLogic Server transaction manager reads the transaction log on the LLR resource along with other transaction log files in the default store and completes any transaction processing as necessary. Work associated with XA participants is committed if a commit record exists, otherwise their work is rolled back.

For instructions on how to create an LLR-enabled JDBC data source, see [Create LLR-enabled JDBC data sources](#) in the *Oracle WebLogic Server Administration Console Online Help*. For more details about the Logging Last Resource transaction processing, see Logging Last Resource Transaction Optimization in *Developing JTA Applications for Oracle WebLogic Server*.

12.2.1 Advantages to Using the Logging Last Resource Optimization

Depending on your environment, you may want to consider the LLR transaction protocol in place of the two-phase commit protocol for transaction processing because of its performance benefits. The LLR transaction protocol offers the following advantages:

- Allows non-XA JDBC drivers and even non-XA-capable databases to safely participate in two-phase commit transactions.
- Eliminates the database's use of the XA protocol.
- Performs better than JDBC XA connections.
- Reduces the length of time that database row locks are held.
- Always commits database work prior to other XA work. In XA transactions, these operations are committed in parallel, so, for example, when a JMS send participates in the transaction, the JMS message may be delivered before database work commits. With LLR, the database work in the local transaction is completed before all other transaction work.
- Has no increased risk of heuristic hazards, unlike the Emulate Two-Phase Commit option for a JDBC data source.

Note:

The LLR optimization provides a significant increase in performance for insert, update, and delete operations. However, for read operations with LLR, performance is somewhat slower than read operations with XA.

For more information about performance tuning with LLR, see *Optimizing Performance with LLR in Developing JTA Applications for Oracle WebLogic Server*.

12.2.2 Enabling the Logging Last Resource Transaction Optimization

To enable the LLR transaction optimization, you create a JDBC data source with the Logging Last Resource transaction protocol, then use database connections from the data source in your applications. WebLogic Server automatically creates the required table on the database.

See [Create LLR-enabled JDBC data sources](#) in the *Oracle WebLogic Server Administration Console Online Help*.

12.2.3 Programming Considerations and Limitations for LLR Data Sources

You use JDBC connections from an LLR-enabled data source in an application as you would use JDBC connections from any other data source: *after* beginning a transaction, you look up the data source on the JNDI tree, then request a connection from the data source. However, with the LLR optimization, WebLogic Server internally manages the connection request and handles the transaction processing differently than in an XA transaction. For more information about how Logging Last Resource works, see Logging Last Resource Transaction Optimization in *Developing JTA Applications for Oracle WebLogic Server*.

Note the following:

- When programming with an LLR data source, you must start the global transaction before calling `getConnection` on the LLR data source. If you call `getConnection` before starting the global transaction, the connection will be independent, and will not be associated with any subsequently started global transaction. The connection will operate in the `autoCommit(true)` mode. In this mode, every update will commit automatically on its own, and there will be no way to roll back any update unless application code has explicitly set the `autoCommit` state to false and is explicitly managing its own local transaction.
- Only one internal JDBC LLR connection is reserved per transaction. And that connection is used throughout the transaction processing.
- The reserved connection is always hosted on the transaction's coordinator server. Make sure that the data source is targeted to the coordinating server or to the cluster. Also see "Optimizing Performance with LLR" in *Developing JTA Applications for Oracle WebLogic Server*.
- For additional JDBC connection requests within the transaction from a same-named data source, operations are routed to the reserved connection from the original connection request, even if the subsequent connection request is made on a different instance of the data source (i.e., a data source deployed on a different server than the original data source that supplied the connection for the first request). Note the following:
 - Routed LLR connections may be less capable and less performant than locally hosted XA connections. (See [Possible Performance Loss with Non-XA Resources in Multi-Server Configurations](#).)
 - Connection request routing limits the number of concurrent transactions. The maximum number of concurrent LLR transactions is equal to the configured size (`MaxCapacity`) of the coordinator's JDBC LLR data source.
 - Routed connections have less capability than local connections, and may fail as a result. Specifically, non-serializable "custom" data types within a query `ResultSet` may fail.
- Only instances of a single LLR data source may participate in a particular transaction. A single LLR data source may have instances on multiple WebLogic servers, and two data sources are considered to be the same if they have the same configured name. If more than one LLR data source instance is detected and they are not instances of the same data source, the transaction manager will roll back the transaction.
- Resource adapters (connectors) that implement the `weblogic.transaction.nonxa.NonXAResource` interface cannot participate in global transaction in which an LLR resource also participates because both must be the last resource in the transaction. If both resource types participate in the same transaction, the `transaction.commit()` method throws a `javax.transaction.RollbackException` when this conflict is detected.
- Because the LLR connection uses a separate *local* transaction for database processing, any changes made (and locks held) to the same database using an XA connection are not visible during the LLR processing even though all of the processing occurs in the same *global* transaction. In some cases, this can cause

deadlocks in the database. You should not combine XA and LLR processing in the same database in a single global transaction.

- Connections from an LLR data source cannot participate in transactions coordinated by foreign transaction managers, such as a transaction started by a remote object request broker or by Tuxedo.
- Global transactions cannot span to another legacy domain that includes a data source with the same name as an LLR data source.
- For JDBC LLR 2PC transactions, if the transaction data is too large to fit in the LLR table, the transaction will fail with a rollback exception thrown during commit. This can occur if your application adds many transaction properties during transaction processing. (See Oracle WebLogic Extensions to JTA in *Developing JTA Applications for Oracle WebLogic Server*) Your database administrator can manually create a table with larger columns if this occurs.

12.2.4 Administrative Considerations and Limitations for LLR Data Sources

Consider the following requirements and limitations when configuring an LLR-enabled JDBC data source. For more information about how Logging Last Resource works, see Logging Last Resource Transaction Optimization in *Developing JTA Applications for Oracle WebLogic Server*.

- There is one LLR table per server:
 - Multiple LLR data sources may share a table.
 - WebLogic Server automatically creates the table if it is not found.
 - Default name is `WL_LLRL_SERVERNAME`. You can configure the table name in the WebLogic Server Administration Console on the Server > Configuration > General tab under Advanced options. See [Servers: Configuration: General](#) in *Oracle WebLogic Server Administration Console Online Help*.
- A server **will not boot** if the database is down or the LLR table is unreachable during boot.
- Multiple servers must *not* share the same LLR table. Boot checks to ensure domain and server name match the domain and server name stored in the table when the table is created. If WebLogic Server detects that more than one server is sharing the same LLR table, WebLogic Server will shut down one or more of the servers.
- LLR supports server migration and transaction recovery service migration. To use the transaction recovery service migration, ensure that each LLR resource be targeted to either the cluster or the set of candidate servers in the cluster. See *Recovering Transactions For a Failed Clustered Server* in *Developing JTA Applications for Oracle WebLogic Server*.
- The LLR transaction option is not permitted for use in JDBC application modules.
- When using multi data sources, the LLR transaction option can only be used with Oracle RAC version 10g Release 2 (10gR2) and greater versions with the following settings:
 - All WebLogic application database JDBC interactions must use the `READ_COMMITTED` transaction isolation level (the default).

- The Oracle RAC setting `MAX_COMMIT_PROPAGATION_DELAY` must be set to a value of 0 (zero, the default).

The use of LLR with Multi Data Sources is supported only with Oracle RAC. All (or none) of the members of the Multi Data Source must be LLR data sources.

- When using Oracle RAC, at least one of the members of the MDS must be available for recovery processing when the server is booted or the server fails to boot.
- When not using Oracle RAC, all of the members of the MDS must be available for recovery processing when the server is booted or the server fails to boot.
- If you use credential mapping or identity pooling on an LLR data source, all mapped users must have write permissions on the LLR table.
- You cannot use a JDBC XA driver to create database connections in a JDBC LLR data source. If the JDBC driver used in a JDBC LLR data source supports XA, a warning message is logged, and the data source participates in transactions as a full XA resource rather than as an LLR resource.
- Transaction statistics for LLR resources are tracked under "NonXAResource." See [View transaction statistics for non-XA resources](#) in the *Oracle WebLogic Server Administration Console Online Help*.
- When using LLR with a Sybase DBMS, Sybase's JDBC driver requires that certain JDBC stored procedures be installed in the DBMS in order to implement some standard JDBC metadata methods. See the Sybase jConnect documentation for details.

12.3 Understanding the Emulate Two-Phase Commit Transaction Option

If you need to support distributed transactions with a JDBC data source, but there is no available XA-compliant driver for your DBMS, you can select the Emulate Two-Phase Commit for non-XA Driver option for a data source to emulate two-phase commit for the transactions in which connections from the data source participate. This option is an advanced option on the Configuration > General tab of a data source configuration.

When the Emulate Two-Phase Commit for non-XA Driver option is selected (`EnableTwoPhaseCommit` is set to `true`), the non-XA JDBC resource always returns `XA_OK` during the `XAResource.prepare()` method call. The resource attempts to commit or roll back its local transaction in response to subsequent `XAResource.commit()` or `XAResource.rollback()` calls. If the resource commit or rollback fails, a heuristic error results. Application data may be left in an inconsistent state as a result of a heuristic failure.

When the Emulate Two-Phase Commit for non-XA Driver option is not selected in the Console (`EnableTwoPhaseCommit` is set to `false`), the non-XA JDBC resource causes `XAResource.prepare()` to fail. When there is only one resource participating in a transaction, the one phase optimization bypasses `XAResource.prepare()`, and the transaction commits successfully in most instances.

Note:

There are risks to data integrity when using the Emulate Two-Phase Commit for non-XA Driver option. Oracle recommends that you use an XA-compliant JDBC driver or the Logging Last Resource option rather than use the Emulate Two-Phase Commit option. Make sure you consider the risks below before enabling this option.

This non-XA JDBC driver support is often referred to as the "JTS driver" because WebLogic Server uses the WebLogic JTS Driver internally to support the feature. For more information about the WebLogic JTS Driver, see *Using the WebLogic JTS Driver in Developing JDBC Applications for Oracle WebLogic Server*.

12.3.1 Limitations and Risks When Emulating Two-Phase Commit Using a Non-XA Driver

WebLogic Server supports the participation of non-XA JDBC resources in global transactions with the Emulate Two-Phase Commit data source transaction option, but there are limitations that you must consider when designing applications to use such resources. Because a non-XA driver does not adhere to the XA/2PC contracts and only supports one-phase commit and rollback operations, WebLogic Server (through the JTS driver) has to make compromises to allow the resource to participate in a transaction controlled by the Transaction Manager.

Consider the following limitations and risks before using the Emulate Two-Phase Commit for non-XA Driver option.

12.3.1.1 Heuristic Completions and Data Inconsistency

When Emulate Two-Phase Commit is selected for a non-XA resource, (`enableTwoPhaseCommit = true`), the prepare phase of the transaction for the non-XA resource always succeeds. Therefore, the non-XA resource does not truly participate in the two-phase commit (2PC) protocol and is susceptible to failures. If a failure occurs in the non-XA resource after the prepare phase, the non-XA resource is likely to roll back the transaction while XA transaction participants will commit the transaction, resulting in a heuristic completion and data inconsistencies.

Because of the data integrity risks, the Emulate Two-Phase Commit option should only be used in applications that can tolerate heuristic conditions.

12.3.1.2 Cannot Recover Pending Transactions

Because a non-XA driver manipulates local database transactions only, there is no concept of a transaction pending state in the database with regard to an external transaction manager. When `XAResource.recover()` is called on the non-XA resource, it always returns an empty set of Xids (transaction IDs), even though there may be transactions that need to be committed or rolled back. Therefore, applications that use a non-XA resource in a global transaction cannot recover from a system failure and maintain data integrity.

12.3.1.3 Possible Performance Loss with Non-XA Resources in Multi-Server Configurations

Because WebLogic Server relies on the database local transaction associated with a particular JDBC connection to support non-XA resource participation in a global transaction, when the same JDBC data source is accessed by an application with a

global transaction context on multiple WebLogic Server instances, the JTS driver will always route to the first connection established by the application in the transaction. For example, if an application starts a transaction on one server, accesses a non-XA JDBC resource, then makes a remote method invocation (RMI) call to another server and accesses a data source that uses the same underlying JDBC driver, the JTS driver recognizes that the resource has a connection associated with the transaction on another server and sets up an RMI redirection to the actual connection on the first server. All operations on the connection are made on the one connection that was established on the first server. This behavior can result in a performance loss due to the overhead associated with setting up these remote connections and making the RMI calls to the one physical connection.

12.3.1.4 Multiple Non-XA Participants

If you use more than one non-XA resource in a global transaction, it is possible to see JTA `SystemExceptions` in the event of a non-atomic outcome. The chance for non-atomic outcomes and `SystemExceptions` tends to increase with the number of two-phase-emulated data source participants.

Note:

The use of a two-phase-emulated data source in a JTA transaction across domains of different versions is not supported.

12.4 Local Transaction Completion when Closing a Connection

For a non-XA connection, `setAutoCommit(true)` is called if the connection is currently in auto-commit false state when a connection is closed. According to the JDBC specification, this automatically commits any outstanding local transaction. There are some drivers (Oracle 10.x and 11.x driver) that do not commit the local transaction. If the application does not complete (commit or rollback) the local transaction before closing the connection, a connection is returned to the pool with outstanding work and that work may never be completed or it may be committed or rolled back by the next reservation of that connection. To prevent that situation from happening, a WebLogic data source calls `commit` on the connection when returning it to the pool, if running with the Oracle 10.x or 11.x driver. If an explicit commit is desired on close, then set the system property

```
weblogic.datasource.endLocalTxOnNonXaConWithCommit=true .
```

Some users may want an abandoned local transaction to rollback instead of commit on close. Setting the following properties will cause local transactions to be rolled back instead of committed if abandoned:

```
-Dweblogic.datasource.endLocalTxOnNonXaConWithCommit=false
-Dweblogic.datasource.endLocalTxOnNonXaConWithRollback=true
```

Note: It is not a good programming practice to leave abandoned transactions. It is recommended that applications explicitly commit or rollback local transactions.

For an XA connection, WebLogic data sources have always rolled back any local transaction when closing the connection. The transaction can be committed instead of rolled back by setting the system property

```
weblogic.datasource.endLocalTxOnXaConWithCommit=true.
```

For an XA connection, WebLogic data sources have always rolled back any local transaction when closing the connection. The transaction can be committed instead of rolled back by setting the system property `weblogic.datasource.endLocalTxOnXaConWithCommit=true`.

Understanding Data Source Security

This chapter provides information on how to configure and use data source security in your application environment. Considerations include the number and volatility of WebLogic Server and Database users, the granularity of data access, the depth of the security identity (property on the connection or a real user), performance, coordination of various components in the software stack, and driver capabilities.

The chapter includes the following sections:

- [Introduction to WebLogic Data Source Security Options](#)
- [WebLogic Data Source Security Options](#)
- [Connections within Transactions](#)
- [WebLogic Data Source Resource Permissions](#)
- [Data Source Security Example](#)
- [Using Encrypted Connection Properties](#)
- [Using SSL and Encryption with Data Sources and Oracle Drivers](#)

13.1 Introduction to WebLogic Data Source Security Options

By default, you define a single database user and password for a datasource. You can store it in the datasource descriptor or make use of the Oracle wallet (see [Creating and Managing Oracle Wallet](#)). This is a very simple and efficient approach to security. All of the connections in the connection pool are owned by this user and there is no special processing when a connection is given out. That is, it's a homogenous connection pool and any request can get any connection from a security perspective (there are other aspects, such as affinity). Regardless of the end user of the application, all connections in the pool use the same security credentials to access the DBMS. No additional information is needed when you get a connection because it's all available from the datasource descriptor or wallet. For example:

```
java.sql.Connection conn = mydatasource.getConnection();
```

Note:

You can enter the password as a name-value pair in the `Properties` field (this not permitted for production environments) or you can enter it in the `Password` field. The value in the `Password` field overrides any password value defined in the `Properties` passed to the JDBC Driver when creating physical database connections.

It is recommended that you use the `Password` attribute in place of the password property in the properties string because the `Password` value is encrypted in the configuration file (stored as the password-encrypted attribute in the `jdbc-driver-params` tag in the module file) and is hidden in the WebLogic Server Administration Console. The `Properties` and `Password` fields are located on the WebLogic Server Administration Console data source creation wizard or data source configuration page. See [JDBC Data Source: Configuration: Connection Pool](#) in *Oracle WebLogic Server Administration Console Online Help*.

The JDBC API can also be used to programmatically specify the database username and password as in the following.

```
java.sql.Connection conn = mydatasource.getConnection("user", "password");
```

Although the JDBC specification implies that the `getConnection("user", "password")` method should take a database user and associated password, software vendors have developed implementations according to their own interpretation of the specification. Oracle WebLogic Server, by default, treats this as an application server user and password:

- The pair is authenticated to see if it is a valid user and that user is used for WebLogic security permission checks.
- The user is then mapped to a database user and password using the data source credential mapper.

WebLogic Server's implementation generically follows the specification but the database credentials are one-step removed from the application code.

While the default approach is simple, it does mean that only one user is doing all of the work. You can't determine who actually did the update nor can you restrict SQL operations by who is running the operation, at least at the database level. Any type of per-user logic needs to be in the application code instead of relying on the database. There are various WebLogic datasources features that can be configured to provide per-user information about the operations.

13.2 WebLogic Data Source Security Options

The following table describes the various features available for WebLogic data sources to configure database security credentials.

Table 13-1 WebLogic Data Source Configuration Options for Security Credentials

Feature	Description	Can be used with . . .	Can't be used with . . .
User authentication (default)	Default <code>getConnection(user , password)</code> behavior – WebLogic validates the input and uses the user/password in the descriptor.	Proxy session, Set client identifier	Identity pooling, Use database credentials
Use database credentials	Instead of using the credential mapping, use the supplied user and password directly.	Set client identifier, Proxy session, Identity pooling	User authentication
Set Client Identifier	Set a client identifier property associated with the connection (Oracle and DB2 only).	Everything	N/A
Proxy Session	Set a light-weight proxy user associated with the connection (Oracle-only).	User authentication, Set client identifier, Use database credentials	Identity pooling
Identity pooling	Heterogeneous pool of connections owned by specified users.	Set client identifier, Use database credentials	Proxy session, User authentication, Labeling, Active GridLink

Note: All of these features are available with both XA and non-XA drivers.

All of these features are configurable on the Identity tab of the Data Source Configuration tab in the WebLogic Server Administration Console. See [JDBC Data Source: Configuration: Identity Option](#) in Oracle WebLogic Server Administration Console Online Help.

Note: Prior WebLogic Server Release 12.1.2, the Proxy Session and Use Database Credentials options were only on the Oracle tab.

The following sections describe these features in more detail:

- [Credential Mapping vs. Database Credentials](#)
- [Set Client Identifier on Connection](#)
- [Oracle Proxy Session](#)

- [Identity-based Connection Pooling](#)

13.2.1 Credential Mapping vs. Database Credentials

Each WebLogic data source has a credential map that is a mechanism used to map a key, in this case a WebLogic user, to security credentials (user and password). By default, when a user and password are specified when getting a connection, they are treated as credentials for a WebLogic user, validated, and are converted to a database user and password using a credential map associated with the data source. If a matching entry is not found in the credential map for the data source, then the user and password associated with the data source definition are used. Because of this defaulting mechanism, you should be careful what permissions are granted to the default user. Alternatively, you can define an invalid default user to ensure that no one can accidentally get through (in this case, you would need to set the initial capacity for the pool to zero so that the pool is populated only by valid users).

To create an entry in the credential map:

1. Create a WebLogic user. In the WebLogic Server Administration Console, go to Security realms, select your realm (for example, myrealm), select Users, and select New.
2. Create the mapping as described in [Configure credential mapping for a JDBC data source](#) in *Oracle WebLogic Server Administration Console Online Help*.

The advantages of using the credential mapping are that:

- You don't hard-code the database user/password into a program or need to prompt for it in addition to the WebLogic user/password.
- It provides a layer of abstraction between WebLogic security and database settings such that many WebLogic identities can be mapped to a smaller set of DB identities, thereby only requiring middle-tier configuration updates when WebLogic users are added/removed.

You can cut down the number of users that have access to a data source to reduce the user maintenance overhead. For example, suppose that a servlet has the one pre-defined WebLogic user/password for data source access that is hardwired in its code using a `getConnection(user, password)` call. Every WebLogic user can reap the specific DBMS access coded into the servlet, but none has to have general access to the data source. For instance, there may be a *Sales* DBMS which needs to be protected from unauthorized eyes, but it contains some day-to-day data that everyone needs. The *Sales* data source is configured with restricted access and a servlet is built that hardwires the specific data source access credentials in its connection request. It uses that connection to deliver only the generally needed day-to-day info to any caller. The servlet cannot reveal any other data and no WebLogic user can get any other access to the data source. This is the approach that many large applications use and is the logic behind the default mapping behavior in WebLogic Server.

The disadvantages of using the credential map are that:

- It is difficult to manage (create, update, delete) with a large number of users; it is possible to use WLST scripts or a custom JMX client utility to manage credential map entries.
- You can't share a credential map between data sources so they must be duplicated.

Some applications prefer not to use the credential map. Instead, the credentials passed to `getConnection(user, password)` should be treated as database credentials and

used to authenticate with the database for the connection, avoiding going through the credential map. This is enabled by setting the `use-database-credentials` to `true`. See [Configure Oracle parameters](#) in *Oracle WebLogic Server Administration Console Online Help*.

When `use-database-credentials` is enabled, it turns of credential mapping for the following attributes:

- `identity-based-connection-pooling-enabled`
- `oracle-proxy-session`
- `set client identifier`

Note:

in the data source schema, the `set client identifier` feature is poorly named `credential-mapping-enabled`. The documentation and the console refer to it as `set client identifier`.)

To review the behavior of credential mapping and using database credentials:

- If using the credential map, there needs to be a mapping for each WebLogic user to database user for those users that have access to the database; otherwise the default user for the data source is used. If you always specify a user/password when getting a connection, you only need credential map entries for those specific users.
- If using database credentials without specifying a user/password, the default user and password in the data source descriptor are always used. If you specify a user/password when getting a connection, that user is used for the credentials. WebLogic users are not involved at all in the data source connection process.

13.2.2 Set Client Identifier on Connection

When this feature is enabled on the data source, a client property is associated with the connection. The underlying SQL user remains unchanged for the life of the connection but the client value can change. This information can be used for accounting, auditing, or debugging. The `client` property is based on either the WebLogic user mapped to a database user based on the credential map or the database user parameter directly from the `getConnection()` method, based on the *use database credentials* setting described earlier.

To enable this feature, select `Set Client ID On Connection` in the WebLogic Server Administration Console. See [Enable Set Client ID On Connection for a JDBC data source](#) in *Oracle WebLogic Server Administration Console Online Help*.

The Set Client Identifier feature is only available for use with the Oracle thin driver and the IBM DB2 driver, based on the following interfaces:

- For pre-Oracle 12c, `oracle.jdbc.driver.OracleConnection.setClientIdentifier(client)` is used. For more information about how to use this for auditing and debugging, see [Using the CLIENT_IDENTIFIER Attribute to Preserve User Identity](#) in the *Oracle Database Security Guide*. You can get the value using `getClientIdentifier()` from the driver using the `ojdbcN.jar` or `ojdbcN_g.jar` files.

Note:

Setting the client identifier using the Oracle driver is disabled if you are using `ojdbcNdms.jar`, the default JAR file for Oracle Fusion MiddleWare and Oracle Fusion Applications. In this case, the Set Client Identifier feature is not supported.

To get back the value from the database as part of a SQL query, use a statement like the following:

```
select sys_context('USERENV','CLIENT_IDENTIFIER') from DUAL
```

- Starting in Oracle 12c, `java.sql.Connection.setClientInfo("OCSID.CLIENTID", client)` is used. This is a JDBC standard API, although the property values are proprietary. A problem with `setClientIdentifier` usage is that there are pieces of the Oracle technology stack that set and depend on this value. If application code also sets this value, it can cause problems. This has been addressed with `setClientInfo` by making use of this method a privileged operation. A well-managed container can restrict the Java security policy grants to specific namespaces and code bases, and protect the container from out-of-control user code. When running with the Java security manager, permission must be granted in the Java security policy file for:

```
permission "oracle.jdbc.OracleSQLPermission" "clientInfo.OCSID.CLIENTID";
```

Using the name `OCSID.CLIENTID` allows for upward compatible use of `select sys_context('USERENV','CLIENT_IDENTIFIER') from DUAL` or use the JDBC standard API `java.sql.Connection.getClientInfo("OCSID.CLIENTID")` to retrieve the value.
- Setting this value in the Oracle `USERENV` context can be used to drive the Oracle Virtual Private Database (VPD) feature to create security policies to control database access at the row and column level. Essentially, Oracle Virtual Private Database adds a dynamic `WHERE` clause to a SQL statement that is issued against the table, view, or synonym to which an Oracle Virtual Private Database security policy was applied. See [Using Oracle Virtual Private Database to Control Data Access](#) in the *Oracle Database Security Guide*. Using this data source feature means that no programming is needed on the WebLogic side to set this context. The context is set and cleared by the WebLogic data source code.
- For the IBM DB2 driver, `com.ibm.db2.jcc.DB2Connection.setDB2ClientUser(client)` is used for older releases (prior to version 9.5). This specifies the current client user name for the connection. Note that the current client user name can change during a connection (unlike the user). This value is also available in the `CURRENT_CLIENT_USERID` special register. You can select it using a statement like `select CURRENT_CLIENT_USERID from SYSIBM.SYSTABLES`.
- When running the IBM DB2 driver with JDBC 4.0 (starting with version 9.5), `java.sql.Connection.setClientInfo("ClientUser", client)` is used. You can retrieve the value using `java.sql.Connection.getClientInfo("ClientUser")` instead of the DB2 proprietary API (even if set using `setDB2ClientUser()`).

13.2.3 Oracle Proxy Session

Oracle proxy authentication allows one JDBC connection to act as a proxy for multiple (serial) light-weight user connections to an Oracle database with the thin driver. You can configure a WebLogic data source to allow a client to connect to a database through an application server as a proxy user. The client authenticates with the application server and the application server authenticates with the Oracle database. This allows the client's user name to be maintained on the connection with the database.

Note:

This feature is only supported when using the Oracle thin driver and a supported Oracle database (the database url must contain `oracle`).

Use the following steps to configure proxy authentication on a connection to an Oracle database.

1. If you have not yet done so, create the necessary database users.
2. On the Oracle database, provide `CONNECT THROUGH` privileges. For example:

```
SQL> ALTER USER connectionuser GRANT CONNECT THROUGH dbuser;
```

where `connectionuser` is the name of the application user to be authenticated and `dbuser` is an Oracle database user.
3. Create a generic or Active GridLink data source and set the user to the value of `dbuser`.
4. To use:
 - WebLogic credentials, create an entry in the credential map that maps the value of `wlsuser` to the value of `dbuser`, as described earlier.
 - Database credentials, enable "Use Database Credentials", as described earlier
5. Enable Oracle Proxy Authentication, see [Configure Oracle parameters](#) in *Oracle WebLogic Server Administration Console Help*.
6. Log on to a WebLogic Server instance using the value of `wlsuser` or `dbuser`.
7. Get a connection using `getConnection(username, password)`. The credentials are based on either the WebLogic user that is mapped to a database user or the database user directly, based on the "use database credentials" setting.

You can see the current user and proxy user by executing:

```
select user, sys_context('USERENV','PROXY_USER') from DUAL
```

Note:

`getConnection` fails if `Use Database Credentials` is not enabled and the value of the user/password is not valid for a WebLogic user. Conversely, it fails if `Use Database Credentials` is enabled and the value of the user/password is not valid for a database user.

A proxy session is opened on the connection based on the user each time a connection request is made on the pool. The proxy session is closed when the connection is returned to the pool. Opening or closing a proxy session has the following impact on JDBC objects:

- Closes any existing statements (including result sets) from the original connection.
- Clears the WebLogic Server statement cache.
- Clears the client identifier, if set.
- The WebLogic Server test statement for a connection is recreated for every proxy session.

These behaviors may impact applications that share a connection across instances and expect some state to be associated with the connection.

Oracle proxy session is also implicitly enabled when `use-database-credentials` is enabled and `getConnection(user, password)` is called.

The exact definition of `oracle-proxy-session` is as follows:

- If proxy authentication is enabled and identity based pooling is also enabled, it is an error.
- If a user is specified on `getConnection()` and `identity-based-connection-pooling-enabled` is `false`, then `oracle-proxy-session` is treated as `true` implicitly (it can also be explicitly `true`).
- If a user is specified on `getConnection()` and `identity-based-connection-pooling-enabled` is `true`, then `oracle-proxy-session` is treated as `false`.

13.2.4 Identity-based Connection Pooling

An identity based pool creates a heterogeneous pool of connections. This allows applications to use a JDBC connection with a specific DBMS credential by pooling physical connections with different DBMS credentials. The DBMS credential is based on either the WebLogic user mapped to a database user or the database user directly, based on the `use-database-credentials`. `use-database-credentials=true` is how some implementations interpret the JDBC standard—basically a heterogeneous pool with users specified by `getConnection(user, password)`.

The allocation of connections is more complex if `Enable Identity Based Connection Pooling` attribute is enabled on the data source. When an application requests a database connection, the WebLogic Server instance selects an existing physical connection or creates a new physical connection with requested DBMS identity.

The following section provides information on how heterogeneous connections are created:

1. At connection pool initialization, the physical JDBC connections based on the configured or default "initial capacity" are created with the configured default DBMS credential of the data source.
2. An application tries to get a connection from a data source.
3. If:

- `use-database-credentials` is not enabled, the user specified in `getConnection` is mapped to a DBMS credential, as described earlier. If the credential map doesn't have a matching user, the default DBMS credential is used from the data source descriptor.
 - `use-database-credentials` is enabled, the user and password specified in `getConnection` are used directly.
4. The connection pool is searched for a connection with a matching DBMS credential.
 5. If a match is found, the connection is reserved and returned to the application.
 6. If no match is found, a connection is created or reused based on the maximum capacity of the pool:
 - If the maximum capacity has not been reached, a new connection is created with the DBMS credential, reserved, and returned to the application.
 - If the pool has reached maximum capacity, based on the least recently used (LRU) algorithm, a physical connection is selected from the pool and destroyed. A new connection is created with the DBMS credential, reserved, and returned to the application.

It should be clear that finding a matching connection is more expensive than a homogeneous pool. Destroying a connection and getting a new one is very expensive. If possible, use a normal homogeneous pool or one of the light-weight options (client identity or an Oracle proxy connection) as they are more efficient than identity-based pooling.

Regardless of how physical connections are created, each physical connection in the pool has its own DBMS credential information maintained by the pool. Once a physical connection is reserved by the pool, it does not change its DBMS credential even if the current thread changes its WebLogic user credential and continues to use the same connection.

To configure this feature, select `Enable Identity Based Connection Pooling`. See [Enable identity-based connection pooling for a JDBC data source](#) in *Oracle WebLogic Server Administration Console Online Help*.

You must make the following changes to use Logging Last Resource (LLR) transaction optimization with Identity-based Pooling to get around the problem that multiple users access the associated transaction table:

- You must configure a custom schema for LLR using a fully qualified LLR table name. All LLR connections will then use the named schema rather than the default schema when accessing the LLR transaction table.
- Use database specific administration tools to grant permission to access the named LLR table to all users that could access this table via a global transaction. By default, the LLR table is created during boot by the user configured for the connection in the data source. In most cases, the database will only allow access to this user and not allow access to mapped users.

13.3 Connections within Transactions

Connections associated with a transaction context on a particular WebLogic Server instance have the following behaviors:

- When getting a connection with a data source configured with non-XA LLR or 1PC (JTS driver) with global transactions, the first connection obtained within the transaction is returned on subsequent connection requests regardless of the values of username/password specified and independent of the associated proxy user session, if any. The connection must be shared among all users of the connection when using LLR or 1PC.
- For XA data sources, the first connection obtained within the global transaction is returned on subsequent connection requests within the application server, regardless of the values of username/password specified and independent of the associated proxy user session, if any. The connection must be shared among all users of the connection within a global transaction within the application server/JVM.

In summary, when you get a connection within a transaction, it is associated with the transaction context on a particular WebLogic Server instance.

13.4 WebLogic Data Source Resource Permissions

You can optionally restrict access to JDBC data sources. In WebLogic Server, security policies answer the question "who has access" to a WebLogic data source resource. A security policy is created when you define an association between a WebLogic data source resource and a user, group, or role. A WebLogic data source resource has no protection until you assign it a security policy. As soon as you add one policy for a permission, then all other users are restricted. For example, if you add a policy so that `weblogic` can reserve a connection, then all other users fail to reserve connections unless they are also explicitly added. The validation is done for WebLogic user credentials, not database user credentials. See [Create policies for resource instances](#) in *Oracle WebLogic Server Administration Console Online Help*.

You can protect JDBC resource operations by assigning Administrator methods which can limit the actions that an administrator may take upon a JDBC data source. These resources can be defined on the **Policies** tab on the **Security** tab associated with the data source. When you secure an individual data source, you can choose whether to protect [JDBC operations](#) using one or more of the following administrator methods:

- `admin`—The following methods on the `JDBCDataSourceRuntimeMBean` are invoked as admin operations: `clearStatementCache`, `suspend`, `forceSuspend`, `resume`, `shutdown`, `forceShutdown`, `start`, `getProperties`, and `poolExists`.
- `reserve`—Applications reserve a connection in the data source by looking up the data source and then calling `getConnection`. Giving a user the `reserve` permission enables them to execute vendor-specific operations. Depending on the database vendor, some of these operations may have database security implications. See [WebLogic Data Source Security Options](#).
- `shrink`—Shrinks the number of connections in the data source to the maximum of the currently reserved connections or to the initial size.
- `reset`—Resets the data source connections by shutting down and re-establishing all physical database connections. This also clears the statement cache for each connection. You can only reset data source connections that are running normally.
- `All`—An individual data source is protected by the union of the `Admin`, `reserve`, `shrink`, and `reset` administrator methods.

Note:

Be aware of the following:

- If a security policy controls access to connections in a multi data source, access checks are performed at both levels of the JDBC resource hierarchy (once at the multi data source level, and again at the individual data source level). As with all types of WebLogic resources, this double-checking ensures that the most specific security policy controls access.

See Java DataBase Connectivity (JDBC) Resources in *Securing Resources Using Roles and Policies for Oracle WebLogic Server*.

The following table provides information on the user for permission checking when using the administrator method `reserve`:

Table 13-2 Determining the User when using the reserve Administration Method

API	Use-database-credential	User for permission checking
<code>getConnection()</code>	True or False	Current WebLogic user
<code>getConnection(user, password)</code>	False	User/password from API
<code>getConnection(user, password)</code>	True	Current WebLogic user

In summary, if a simple `getConnection()` is used or database credentials are enabled, the current user that is authenticated to the WebLogic system is checked. If database credentials are not enabled, then the user and password on the API are used. This feature is very useful to restrict what code and users can access your database.

For instructions on how to set up security for all WebLogic Server resources, see [Use roles and policies to secure resources](#) in *Oracle WebLogic Server Administration Console Online Help*. For more information about securing server resources, see *Securing Resources Using Roles and Policies for Oracle WebLogic Server*.

13.5 Data Source Security Example

The following is an actual example of the interactions between `identity-based-connection-pooling-enabled`, `oracle-proxy-session`, and `use-database-credentials`.

On the database side, the following objects are configured:

- `users: scott; jdbcqa; jdbcqa3`
- `alter user jdbcqa3 grant connect through jdbcqa;`
- `alter user jdbcqa grant connect through jdbcqa;`

The following WebLogic users are configured:

- `weblogic`
- `wluser`

The following WebLogic datasource objects are configured.

- Credential mapping `weblogic` to `scott`
- Credential mapping `wluser` to `jdbcqa3`
- Datasource configured with user `jdbcqa`
- All tests run with `Set Client ID` set to `true`.
- All tests run with `oracle-proxy-session` set to `false`.

The test program:

- Runs in servlet
- Authenticates to WebLogic as user `weblogic`

Table 13-3 Comparing Identity, Proxy, and Database Credentials

Use DB Credentials	Identity based	getConnection (scott,***)	getConnection (weblogic,***)	getConnection (jdbcqa3,***)	getConnection()
true	true	Identity scott Client weblogic Proxy null	weblogic fails – not a db user	User jdbcqa3 Client weblogic Proxy null	Default jdbcqa Client weblogic Proxy null
false	true	scott fails – not a WebLogic user	User scott Client scott Proxy null	jdbcqa3 fails – not a WebLogic user	User scott Client scott Proxy null
true	false	Proxy for scott failed	weblogic fails – not a db user	User jdbcqa3 Client weblogic Proxy jdbcqa	Default jdbcqa Client weblogic Proxy null
false	false	scott fails – not a WebLogic user	User jdbcqa Client scott Proxy null	jdbcqa3 fails – not a WebLogic user	Default jdbcqa Client scott Proxy null

If:

- `Set Client ID` is set to `false`, all cases would have `Client` set to `null`.
- The Oracle thin driver is not used, the one case with the non-`null` `Proxy` would throw an exception because proxy session is only supported with the Oracle thin driver.

When `oracle-proxy-session` is set to `true`, the only cases that pass (with a proxy of `jdbcqa`) are:

- Setting `use-database-credentials` to `true` and using `getConnection(jdbcqa3,...)` or `getConnection()`.

- Setting `use-database-credentials` is false and using `getConnection(wluser, ...)` or `getConnection()`.

13.6 Using Encrypted Connection Properties

As part of a secure configuration, it may be necessary to provide one or more connection property values that should not appear as clear text in the connection properties of the data source descriptor file. These properties can be added using the `Encrypted Properties` attribute. See [Encrypt connection properties](#) in *Oracle WebLogic Server Administration Console Online Help*.

Note:

You cannot encrypt connection properties when creating a data source in the WebLogic Server Administration Console. It can only be done when updating an existing data source configuration.

13.6.1 Best Practices for Encrypting Connection Properties when Using the Administration Console

The following section provides information on best practices and tips when encrypting connection properties in the WebLogic Server Administration Console:

- When creating a data source:
 - Create it without the encrypted property and do not target the data source.
 - It may not be possible to test the connection without the encrypted property. You might want to temporarily test with a clear text property, then replace the clear text property with the encrypted property later.
 - Edit the data source by going to **Summary of JDBC Data Sources** page, select the **Data Source**, go to the **Configuration** tab and then select the **Connection Pool** tab.
- To enter values without clear text values displayed on the screen:
 - Save any other changes that you wish to make to this page and click the **Add Securely** button next to the **Encrypted Properties** text box.
 - On the **Add a new Encrypted Property** page, enter the property name and masked value, and click **OK**.
 - Repeat for additional encrypted property values.
 - Click **Save** when you have finished entering encrypted properties.
- You can enter several values at once if it is appropriate in your environment to display the encrypted values on the screen until the changes are saved.
 - List each `property=value` pair on a separate line in the **Encrypted Properties** field.
 - Click **Save** to encrypt the values.
- Activate your changes:

- If the data source was untargeted: Go to the **Targets** tab, target the data source, and click **Save**.
- If the data source was already active when the encrypted property values were added: Go to the **Targets** tab, untarget the data source, click **Save**, retarget the data source, and click **Save**.

13.6.2 WLST Examples to Encrypt Connection Properties

The following sections provide examples of WLST scripts that encrypt connection properties:

- [Use WLST to Update an Existing Data Source with Encrypted Properties](#)
- [Use WLST to Create Encrypted Properties](#)

13.6.2.1 Use WLST to Update an Existing Data Source with Encrypted Properties

The following is an online WLST script shows how to add an encrypted property to an existing data source named *genericds*.

```
connect('admin','password','t3://localhost:7001')
edit()
startEdit()
cd('JDBCSystemResources/genericds/JDBCResource/genericds/JDBCResourceParams/genericds/Properties/genericds/Properties/genericds/Properties')
create('encryptedprop','Property')
cd('encryptedprop')
cmo.setEncryptedValueEncrypted(encrypt('foo'))
save()
activate()
```

13.6.2.2 Use WLST to Create Encrypted Properties

The following WLST script creates encrypted properties:

```
. . .
create('myProps','Properties')
cd('Properties/NO_NAME_0')
. . .
# Create other properties
. . .
p=create('javax.net.ssl.trustStoreType','Property')
p.setValue('JKS')

p=create('javax.net.ssl.trustStorePassword','Property')
p.setEncryptedValueEncrypted(encrypt('securityCommonTrustKeyStorePassPhrase'))
. . .
```

13.7 Using SSL and Encryption with Data Sources and Oracle Drivers

Oracle Advanced Security provides both data encryption and strong authentication for network connections to the database server. The following sections provide additional information on using these features with WebLogic Server.

- [Using SSL with Data Sources and Oracle Drivers](#)
- [Using Data Encryption with Data Sources and Oracle Drivers](#)

For more information, see JDBC Client-Side Security Features in the *Oracle® Database JDBC Developer's Guide*.

13.7.1 Using SSL with Data Sources and Oracle Drivers

This section provides additional information on a variety of options that use SSL with data sources and Oracle drivers.

The general requirement when using SSL, regardless of the option, is that you must specify a protocol of `tcps` in any url.

For detailed information on configuring and using SSL with Oracle drivers, see:

- <http://www.oracle.com/technetwork/middleware/weblogic/index-087556.html>
- <http://www.oracle.com/technetwork/database/enterprise-edition/wp-oracle-jdbc-thin-ssl-130128.pdf>.

If you use a provider that requires a password, such as the `javax.net.ssl.trustStorePassword` or `javax.net.ssl.keyStorePassword`, the value should be stored as an encrypted property. See [Using Encrypted Connection Properties](#).

13.7.1.1 Using SSL with Oracle Wallet

Oracle wallet can also be used with SSL. By using it correctly, passwords can be eliminated from the JDBC configuration and client/server configuration can be simplified by sharing the wallet). The following is a list of basic requirements to use SSL with Oracle wallet.

- Update the `sqlnet.ora` and `listener.ora` files with the location of the wallet. These files also indicate whether or not `SSL_CLIENT_AUTHENTICATION` is being used.
- If you use an auto-login wallet type, a password is not needed in the data source configuration to open the wallet. The store type for an auto-login wallet is `SSO` (not `JKS` or `PKCS12`) and the file name is `cwallet.sso`. If you use another provider type, use the encrypted property type to store the password as an encrypted value in the data source configuration.
- Enable the Oracle PKI provider in a WLS startup class using:

```
Security.insertProviderAt(new oracle.security.pki.OraclePKIProvider (), 3);
```
- For encryption and server authentication, use the datasource connection properties:

```
javax.net.ssl.trustStore=location of wallet
javax.net.ssl.trustStoreType="SSO"
```
- For client authentication, use the datasource connection properties:

```
javax.net.ssl.keyStore=location of wallet
javax.net.ssl.keyStoreType="SSO"
```
- Wallets are created using the `orapki`. They need to be created based on the usage (encryption or authentication).

Common use cases are:

- *Encryption and server authentication*, which requires just a trust store.
- *Encryption and authentication of both tiers* (client and server), which requires a trust store and a key store.

13.7.1.2 Active GridLink ONS over SSL

You can use SSL to secure communication between an Active GridLink (AGL) data source and the Oracle Notification Service (ONS) which is used to provide load balancing information and notification of node up/down events.

Use the following basic steps:

- Create an auto-login wallet and use the wallet on the client and server. The following is a sample sequence to create a test wallet for use with ONS.

```

orapki wallet create -wallet ons -auto_login -pwd ONS_Wallet
orapki wallet export -wallet ons -dn "CN=ons_test,C=US" -cert ons/cert.txt -pwd
ONS_Wallet
orapki wallet export -wallet ons -dn "CN=ons_test,C=US" -cert ons/cert.txt -pwd
ONS_Wallet

```
- On the database server side:
 1. Define the wallet file directory in the file `$CRS_HOME/opmn/conf/ons.config`.
 2. Run `onsctl stop/start`
- When configuring an AGL datasource, the connection to the ONS must be defined. In addition to the host and port, the wallet file directory must be specified. If you do not provide a password, a SSO wallet is assumed.

13.7.2 Using Data Encryption with Data Sources and Oracle Drivers

To use data encryption with the Oracle Thin driver, you must specify several connection properties, see [Configuration Parameters](#) in *Oracle® Database Advanced Security Administrator's Guide*. The following table maps the encryption and checksum configuration parameters to the string constants required when configuring data source descriptors using the Administration Console or WLST:

Table 13-4 Connection Encryption Parameters and WebLogic Configuration Constants

Client Configuration Parameter	WebLogic Server Configuration String Constant
<code>OracleConnection.CONNECTION_PROPERTY_THIN_NET_ENCRYPTION_LEVEL</code>	<code>oracle.net.encryption_client</code>
<code>OracleConnection.CONNECTION_PROPERTY_THIN_NET_ENCRYPTION_TYPES</code>	<code>oracle.net.encryption_types_client</code>
<code>OracleConnection.CONNECTION_PROPERTY_THIN_NET_CHECKSUM_LEVEL</code>	<code>oracle.net.crypto_checksum_client</code>
<code>OracleConnection.CONNECTION_PROPERTY_THIN_NET_CHECKSUM_TYPES</code>	<code>oracle.net.crypto_checksum_types_client</code>

Creating and Managing Oracle Wallet

This chapter describes how to create and manage an Oracle Wallet to store database credentials for WebLogic Server datasource definitions.

This chapter includes the following sections:

- [What is Oracle Wallet](#)
- [Where to Keep Your Wallet](#)
- [How to Create an External Password Store](#)
- [Defining a WebLogic Server Datasource using the Wallet](#)
- [Using a TNS Alias instead of a DB Connect String](#)

14.1 What is Oracle Wallet

Oracle Wallet provides a simple and easy method to manage database credentials across multiple domains. It allows you to update database credentials by updating the Wallet instead of having to change individual datasource definitions. This is accomplished by using a database connection string in the datasource definition that is resolved by an entry in the wallet.

This feature can be taken a step further by also using the Oracle TNS (Transparent Network Substrate) administrative file to hide the details of the database connection string (host name, port number, and service name) from the datasource definition and instead use an alias. If the connection information changes, it is simply a matter of changing the tnsnames.ora file instead of potentially many datasource definitions.

The wallet can be used to have common credentials between different domains. That includes two different WLS domains or sharing credentials between WLS and the database. When used correctly, it makes having passwords in the datasource configuration unnecessary.

14.2 Where to Keep Your Wallet

Oracle recommends that you create and manage the Wallet in a database environment. This environment provides all the necessary commands and libraries, including the `$ORACLE_HOME/oracle_common/bin/mkstore` command. Often this task is completed by a database administrator and provided for use by the client. A configured Wallet consists of two files, `cwallet.sso` and `ewallet.p12` stored in a secure Wallet directory

Note:

You can also install the Oracle Client Runtime package to provide the necessary commands and libraries to create and manage Oracle Wallet.

14.3 How to Create an External Password Store

Create a wallet on the client by using the following syntax at the command line:

```
mkstore -wrl <wallet_location> -create
```

where *wallet_location* is the path to the directory where you want to create and store the wallet.

This command creates an Oracle Wallet with the autologin feature enabled at the location specified. Autologin enables the client to access the Wallet contents without supplying a password and prevents exposing a clear text password on the client.

The `mkstore` command prompts for a password that is used for subsequent commands. Passwords must have a minimum length of eight characters and contain alphabetic characters combined with numbers or special characters. For example:

```
mkstore -wrl /tmp/wallet -create
Enter password: mysecret
PKI-01002: Invalid password.
Enter password: mysecret1 (not echoed)
Enter password again: mysecret1 (not echoed)
```

Note:

Using Oracle Wallet moves the security vulnerability from a clear text password in the datasource configuration file to an encrypted password in the Wallet file. Make sure the Wallet file is stored in a secure location.

You can store multiple credentials for multiple databases in one client wallet. You cannot store multiple credentials (for logging in to multiple schemas) for the same database in the same wallet. If you have multiple login credentials for the same database, then they must be stored in separate wallets.

To add database login credentials to an existing client wallet, enter the following command at the command line:

```
mkstore -wrl <wallet_location> -createCredential <db_connect_string> <username>
<password>
```

where:

- The *wallet_location* is the path to the directory where you created the wallet.
- The *db_connect_string* must be identical to the connection string that you specify in the URL used in the datasource definition (the part of the string that follows the @). It can be either the short form or the long form of the URL. For example:

```
myhost:1521/myService or
```

```
(DESCRIPTION=(ADDRESS_LIST=(ADDRESS=(PROTOCOL=TCP)
(HOST=myhost-scan)(PORT=1521)))
(CONNECT_DATA=(SERVICE_NAME=myservice)))
```

Note:

You should enclose this value in quotation marks to escape any special characters from the shell. Since this name is generally a long and complex value, an alternative is to use TNS aliases. See [Using a TNS Alias instead of a DB Connect String](#).

- The username and password are the database login credentials.
- Repeat for each database you want to use in a WebLogic datasource.

See the [Oracle Database Advanced Security Administrator's Guide](#) for more information about using autologin and maintaining Wallet passwords.

14.4 Defining a WebLogic Server Datasource using the Wallet

Use the following procedures to configure a WebLogic Server datasource to use Oracle Wallet:

- [Copy the Wallet Files](#)
- [Update the Datasource Configuration](#)

14.4.1 Copy the Wallet Files

Copy the Wallet files, `cwallet.sso` and `ewallet.p12`, from the database machine to the client machine and locate it in a secure directory.

14.4.2 Update the Datasource Configuration

Use the following steps to configure a WebLogic datasource to use Oracle Wallet:

1. Do not enter a user or password in the WebLogic Server Administration Console when creating a datasource or delete them from an existing datasource. If a user, password, or encrypted password appear in the configuration, they override the Oracle wallet values.
2. Modify the URL so that there is a "/" before the "@". For example: the short form of the URL should look like `jdbc:oracle:thin:@mydburl:1234/mydb`.
3. The following value must be added to Connection Properties:

```
oracle.net.wallet_location=wallet_directory
```

where `wallet_directory` is the secure directory location in Step 1 of [Copy the Wallet Files](#). An alternative method is use the -

```
oracle.net.wallet_location system property and add it to
JAVA_OPTIONS. Oracle recommends using the connection property.
```

14.5 Using a TNS Alias instead of a DB Connect String

Instead of specifying a matching database connection string in the URL and in the Oracle Wallet, you can create an alias to map the URL information. The connection

string information is stored in `tnsnames.ora` file with an associated alias name. The alias name is then used both in the URL and the Wallet.

1. Specify the system property `-Doracle.net.tns_admin=tns_directory` where `tns_directory` is the directory location of the `tnsnames.ora` file.

Note:

Do not use the `tns_directory` location as a connection property.

2. Create or modify a `tnsnames.ora` file in the directory location specified by `tns_directory`. The entry has the form:

```
alias=(DESCRIPTION=(ADDRESS=(PROTOCOL=TCP)(HOST=host)
(PORT=port))(CONNECT_DATA=(SERVICE_NAME=service)))
```

Where `host` is URL of a database listener, `port` is the port a database listener, and `service` is the service name of the database you would like to connect to.

There are additional attributes that can be configured, see [Local Naming Parameters \(tnsnames.ora\)](#) in the *Database Net Services Reference*. Oracle recommends that the string be entered on a single line.

3. Use the alias in the datasource definition URL by replacing the connection string with the alias. For example, change the **URL** attribute in the Connection Pool tab of the Administrative Console to `jdbc:oracle:thin:@alias`.

Once created, it should not be necessary to modify the alias or the datasource definition again. To change the user credential, update the Wallet. To change the connection information, update the `tnsnames.ora` file. In either case, the datasource must be re-deployed. The simplest way to redeploy a datasource is to untarget and target the datasource in the WebLogic Server Administration Console. This configuration is supported for Oracle release 10.2 and higher drivers.

Deploying Data Sources on Servers and Clusters

This chapter provides information on how to deploy data sources on servers and clusters.

This chapter includes the following sections:

- [Deploying Data Sources on Servers and Clusters](#)
- [Minimizing Server Startup Hang Caused By an Unresponsive Database](#)

15.1 Deploying Data Sources on Servers and Clusters

To deploy a data source to a cluster or server, you select the server or cluster as a deployment target. When a data source is deployed on a server, WebLogic Server creates an instance of the data source on the server, including the pool of database connections in the data source. When you deploy a data source to a cluster, WebLogic Server creates an instance of the data source on each server in the cluster.

For instructions, see [Target JDBC data sources](#) in the *Oracle WebLogic Server Administration Console Online Help*.

15.2 Minimizing Server Startup Hang Caused By an Unresponsive Database

On server startup, WebLogic Server attempts to create database connections in the data sources deployed on the server. If a database is unreachable, server startup may hang in the *STANDBY* state for a long period of time. This is due to WebLogic Server threads that hang inside the JDBC driver code waiting for a reply from the database server. The duration of the hang depends on the JDBC driver and the TCP/IP timeout setting on the WebLogic Server machine.

To work around this issue, WebLogic Server includes the `JDBCLoginTimeoutSeconds` attribute on the `ServerMBean`. When you set a value for this attribute, the value is passed into `java.sql.DriverManager.setLoginTimeout()`. If the JDBC driver being used to create database connections implements the `setLoginTimeout` method, attempts to create database connections will wait only as long as the timeout specified.

An alternative is to set the `InitialCapacity` for the data source to 0. That means that no connections are created when the data source is deployed and the database need not even be available at that time. Connection creation is deferred until the application needs them.

Using WebLogic Server with Oracle RAC

This chapter describes the requirements and configuration tasks for using Oracle Real Application Clusters (Oracle RAC) with WebLogic Server.

Oracle WebLogic Server provides strong support for Oracle Real Application Clusters (RAC), minimizing database access time while allowing transparent access to rich pooling management functions that maximizes both connection performance and availability.

This chapter includes the following sections:

- [Overview of Oracle Real Application Clusters](#)
- [Software Requirements](#)
- [JDBC Driver Requirements](#)
- [Hardware Requirements](#)
- [Configuration Options in WebLogic Server with Oracle RAC](#)

Both Oracle RAC and WebLogic Server are complex systems. To use them together requires specific configuration on both systems, as well as clustering software and a shared storage solution. This document describes the configuration required at a high level. For more details about configuring Oracle RAC, your clustering software, your operating system, and your storage solution, see the documentation from the respective vendors.

16.1 Overview of Oracle Real Application Clusters

Oracle Real Application Clusters (Oracle RAC) is a software component you can add to a high-availability solution that enables users on multiple machines to access a single database with increased performance. Oracle RAC comprises two or more Oracle database instances running on two or more clustered machines and accessing a shared storage device via cluster technology. To support this architecture, the machines that hosts the database instances are linked by a high-speed interconnect to form the cluster. The interconnect is a physical network used as a means of communication between the nodes of the cluster. Cluster functionality is provided by the operating system or compatible third party clustering software.

An Oracle RAC installation appears like a single standard Oracle database and is maintained using the same tools and practices. All the nodes in the cluster execute transactions against the same database and Oracle RAC coordinates each node's access to the shared data to maintain consistency and ensure integrity. You can add nodes to the cluster easily and there is no need to partition data when you add them. This means that you can horizontally scale the database tier as usage and demand grows by adding Oracle RAC nodes, storage, or both.

16.2 Software Requirements

To use WebLogic Server with Oracle RAC, you must install the following software on each Oracle RAC node:

- Operating system patches required to support Oracle RAC. See the release notes from Oracle for details.
- Oracle database management system. See Oracle® Fusion Middleware Licensing Information..
- Clustering software for your operating system. See the Oracle documentation for supported clustering software and cluster configurations.
- Shared storage software, such as Oracle Automatic Storage Management (ASM). Note that some clustering software includes a file storage solution, in which case additional shared storage software is not required.

Note:

See Supported Configurations in *What's New in Oracle WebLogic Server 12.2.1.2.0* for the latest WebLogic Server hardware platform and operating system support, and for the Oracle RAC versions supported by WebLogic Server versions and service packs. See the Oracle documentation for hardware and software requirements required for running the Oracle RAC software.

16.3 JDBC Driver Requirements

To use WebLogic Server with Oracle RAC, your WebLogic JDBC data sources must use the Oracle JDBC Thin driver 11g or later to create database connections.

16.4 Hardware Requirements

A typical WebLogic Server/Oracle RAC system includes a WebLogic Server cluster, an Oracle RAC cluster, and hardware for shared storage.

16.4.1 WebLogic Server Cluster

The WebLogic Server cluster can be configured in many ways and with various hardware options. See *Administering Clusters for Oracle WebLogic Server* for more details about configuring a WebLogic Server cluster.

16.4.2 Oracle RAC Cluster

For the latest hardware requirements for Oracle RAC, see the Oracle RAC documentation. However, to use Oracle RAC with WebLogic Server, you must run Oracle RAC instances on robust, production-quality hardware. The Oracle RAC configuration must deliver database processing performance appropriate for reasonably-anticipated application load requirements. Unusual database response delays can lead to unexpected behavior during database failover scenarios.

16.4.3 Shared Storage

In an Oracle RAC configuration, all data files, control files, and parameter files are shared for use by all Oracle RAC instances. An HA storage solution that uses one of the following architectures is recommended:

- Direct Attached Storage (DAS), such as a dual ported disk array or a Storage Area Network (SAN)
- Network Attached Storage (NAS)

For a complete list of supported storage solutions, see your Oracle documentation.

16.5 Configuration Options in WebLogic Server with Oracle RAC

When using WebLogic Server with Oracle RAC, you must configure your WebLogic Domain so that it can interact with Oracle RAC instances and so that it performs as expected. The following sections describe configuration options and requirements:

- [Choosing a WebLogic Server Configuration for Use with Oracle RAC](#)
- [Validating Connections when using WebLogic Server with Oracle RAC](#)
- [Additional Considerations When Using WebLogic Server with Oracle RAC](#)

16.5.1 Choosing a WebLogic Server Configuration for Use with Oracle RAC

Consider the following alternatives:

- Using Active Gradient (AGL) data sources, see Oracle® Fusion Middleware Licensing Information.. AGL supports automatic additional and removal of RAC instances. It also automatically handles when nodes go down and come up without waiting for connection failures and successes. See [Using Active GridLink Data Sources](#).
- To connect to multiple Oracle RAC instances when using global transactions (XA), Oracle recommends the use of transaction-aware WebLogic JDBC multi data sources, which support failover and load balancing, to connect to the Oracle RAC nodes. For more information see [Using Multi Data Sources with Global Transactions](#).
- To connect to multiple Oracle RAC instances when not using XA, Oracle recommends the use of (non-transaction-aware) multi data sources to connect to the Oracle RAC nodes. Use the standard multi data source configuration, which supports failover and load balancing. For more information see [Using Multi Data Sources without Global Transactions](#).
- WebLogic supports the use of Oracle Data Guard with Multi Data Source and AGL
- When using Multi Data Source with single instances on the primary and standby, the algorithm type must be set to `FAILOVER`. When the instance on the primary fails, connections on the primary will fail and connections will be created on the standby.

The following table may help you as you try to determine which configuration is right for your particular application:

Table 16-1 Choosing Configurations to Use with Oracle RAC

Requires Load Balancing?	Requires Failover?	Requires Global Transactions (XA)?	Uses Oracle RAC Services	See...
Yes	Yes	Yes	Yes	Using Active GridLink Data Sources
Yes	Yes	Yes	No	Using Multi Data Sources with Global Transactions
Yes	Yes	Yes	Yes	Configuring Connections to Services on Oracle RAC Nodes
Yes	Yes	No	Yes	Configuring Connections to Services on Oracle RAC Nodes
Yes	Yes	No	No	Using Multi Data Sources without Global Transactions

WebLogic supports the use of Oracle Data Guard with Multi Data Source and AGL. When used with a Multi Data Source, the following limitations exist:

- Only the failover policy is supported.
- Only one RAC instance is allowed in the primary data center. A single generic data source that is a member of the Multi Data Source is configured for the primary data center. If `SCAN` is used, an `INSTANCE_NAME` must also be specified.
- For each standby instance, a generic data source that is a member of the Multi Data Source must be configured. If `SCAN` is used, an `INSTANCE_NAME` must also be specified for each instance. No member of the Multi Data Source can represent more than one instance in a RAC cluster.

16.5.2 Validating Connections when using WebLogic Server with Oracle RAC

Applications can use the JDBC 4.0 [Connection.isValid](#) API to verify connection viability.

Note:

WebLogic Server does not support
`oracle.ucp.jdbc.ValidConnection.isValid` or
`oracle.ucp.jdbc.ValidConnection.setInvalid`.

16.5.3 Additional Considerations When Using WebLogic Server with Oracle RAC

The Distributed Transaction Processing (DTP) attribute on a database service should not be used to coordinate transactions when using AGL data sources or multi data sources with Oracle RAC. This option implies that the service is guaranteed to run on only one RAC instance at any time. Transaction affinity to a single instance is automatically managed by WebLogic Server for either AGL or Multi Data Source. This allows the whole RAC cluster to be available for distributed transactions, as opposed to DTP limiting all transactions for the service to a single RAC instance.

Using JDBC Drivers with WebLogic Server

This chapter describes how to set up and use JDBC drivers.

This chapter includes the following sections:

- [JDBC Driver Support](#)
- [JDBC Drivers Installed with WebLogic Server](#)
- [Adding Third-Party JDBC Drivers Not Installed with WebLogic Server](#)
- [Globalization Support for the Oracle Thin Driver](#)
- [Using the Oracle Thin Driver in Debug Mode](#)

17.1 JDBC Driver Support

WebLogic Server provides support for application data access to any database using a JDBC-compliant driver that meets the following requirements:

- The driver must be thread-safe.
- The driver must implement standard JDBC transactional calls, such as `setAutoCommit()` and `setTransactionIsolation()`, when used in transactional aware environments.
- If the driver that does not implement serializable or remote interfaces, it cannot pass objects to an RMI client application.

When WebLogic Server features use a database for internal data storage, database support is more restrictive than for application data access. The following WebLogic Server features require internal data storage:

- Container Managed Persistence (CMP)
- Rowsets
- JMS/JDBC Persistence and use of a WebLogic JDBC Store
- JDBC Session Persistence
- RDBMS Security Providers
- Database Leasing (for singleton services and server migration)
- JTA Logging Last Resource (LLR) optimization.

17.2 JDBC Drivers Installed with WebLogic Server

The 12c version of the Oracle Thin driver is installed with Oracle WebLogic Server.

- `ojdbc7.jar`, `ojdbc7_g.jar`, and `ojdbc7dms.jar` for JDK7
- `ojdbc6.jar`, `ojdbc6_g.jar`, and `ojdbc6dms.jar` for JDK 6

Note:

WebLogic-branded DataDirect drivers are also installed with WebLogic Server. For more information, see *Using WebLogic-branded DataDirect Drivers in Developing JDBC Applications for Oracle WebLogic Server*.

In addition to the Oracle Thin Driver, the MySQL 5.1.x (`mysql-connector-java-commercial-5.1.22-bin.jar`) JDBC driver is installed with WebLogic Server.

These drivers are installed in subdirectories of `$ORACLE_HOME/oracle_common/modules`. The manifest in the `weblogic.jar` lists this file so that it is loaded when `weblogic.jar` is loaded (when the server starts). Therefore, you do not need to add this JDBC driver to your `CLASSPATH`. If you plan to use a third-party JDBC driver that is not installed with WebLogic Server, you must install the drivers, which includes updating your `CLASSPATH` with the path to the driver files, and may include updating your `PATH` with the path to database client files. See **Supported Configurations** in *What's New in Oracle WebLogic Server 12.2.1.2*

If you plan to use a different version of any of the drivers installed with WebLogic Server, you can add the new file to the front of your `CLASSPATH`.

Note:

WebLogic Server includes a version of the Derby DBMS installed with the WebLogic Server examples in the `WL_HOME\common\derby` directory. Derby is an all-Java DBMS product included in the WebLogic Server distribution solely in support of demonstrating the WebLogic Server examples. For more information about Derby, see <http://db.apache.org/derby>.

17.3 Adding Third-Party JDBC Drivers Not Installed with WebLogic Server

To use third-party JDBC drivers that are not installed with WebLogic Server, you can add them to the `DOMAIN_HOME/lib` directory, where `DOMAIN_HOME` represents the directory in which the WebLogic Server domain is configured. The default path is `ORACLE_HOME/user_projects/domains`. For more information, see **Adding JARs to the Domain /lib Directory** in *Developing Applications for Oracle WebLogic Server*.

Note: In previous releases, adding a new JDBC driver or updating a JDBC driver where the replacement JAR has a different name than the original JAR required updating the WebLogic Server's classpath to include the location of the JDBC driver classes. This is no longer required.

Using a Third-Party JAR File in `DOMAIN_HOME/lib`

Using a third-party JAR file in `DOMAIN_HOME/lib` is only supported for third-party JDBC drivers that are not installed with WebLogic Server. The drivers installed with WebLogic Server are described in [JDBC Drivers Installed with WebLogic Server](#).

When you use a third-party JAR file in the `DOMAIN_HOME/lib` directory, note the following:

- The classloader that gets created is a child of the system classpath classloader in WebLogic Server.
- Any classes that are in JARs in this directory are visible only to Java EE applications in the server, such as EAR files.
- You can use the WebLogic Server Administration Console and WLST online to configure and manage the JAR files. (You may also be able to use WLST offline because the data source is not deployed.)
- These JAR files do not work when run from a standalone client (such as the t3 RMI client) or standalone applications (such as `java utils.Schema`).
- These JAR files are not supported for Application Data Access. See **Database Interoperability** in What's New in Oracle WebLogic Server 12.2.1.
- If there are multiple domain directories involved (that is, multiple machines without a shared file system), the JAR file must be installed in `/lib` in each domain directory.
- WebLogic Server use of methods called on third-party drivers (such as TimesTen `abort` and DB2 `setDB2ClientUser`) is supported.

Data Source Support

Third-party JAR files installed in `/lib` can be used with the following:

- All data source types supported by WebLogic Server system resources including Generic, Multi Data Source, Active GridLink, and Proxy data source. The UCP data source does not apply since the UCP JAR is not third-party)
- Packaged data sources in an EAR or a WAR.
- Java EE 6 data source definition defined in an EAR or WAR.

Although not JDBC methods, using a third-party JAR file in `/lib` does apply to WebLogic Server data source callbacks like Multi Data Source failover, connection, replay, and harvesting.

Example 17-1 Example of Using a Third-Party JAR File in /lib

The following example shows the files contained in a standalone WAR file named `getversion.war`. The Derby JAR files are located in `WEB-INF/lib` or `DOMAIN_HOME/lib` (or both). The class file is compiled and installed at `WEB-INF/classes/demo/GetVersion.class`.

```
<web-app>
  <welcome-file-list>
    <welcome-file>welcome.jsp</welcome-file>
  </welcome-file-list>
  <display-name>GetVersion</display-name>
  <servlet>
    <description></description>
    <display-name>GetVersion</display-name>
    <servlet-name>GetVersion</servlet-name>
    <servlet-class>
      demo.GetVersion
    </servlet-class>
  </servlet>
```

```

<!-- Data source description can go in the web.xml descriptor or as an annotation in
the java code - see below
<data-source>
  <name>java:global/DSD</name>
  <class-name>org.apache.derby.jdbc.ClientDataSource</class-name>
  <port-number>1527</port-number>
  <server-name>localhost</server-name>
  <database-name>examples</database-name>
  <transactional>>false</transactional>
</data-source>
-->
</web-app>

```

WEB-INF/weblogic.xml

```

<weblogic-web-app>
  <container-descriptor>
    <prefer-web-inf-classes>>true</prefer-web-inf-classes>
  </container-descriptor>
</weblogic-web-app>

```

Java file

```

package demo;

import java.io.IOException;
import java.io.PrintWriter;
import java.sql.Connection;
import java.sql.SQLException;
import javax.annotation.Resource;
import javax.annotation.sql.DataSourceDefinition;
import javax.servlet.ServletException;
import javax.servlet.annotation.WebServlet;
import javax.servlet.http.HttpServletRequest;
import javax.servlet.http.HttpServletResponse;
import javax.sql.DataSource;

@DataSourceDefinition(name="java:global/DSD",
  className="org.apache.derby.jdbc.ClientDataSource",
  portNumber=1527,
  serverName="localhost",
  databaseName="examples",
  transactional=false
)
@WebServlet(urlPatterns = {"/GetVersion"})
public class GetVersion extends javax.servlet.http.HttpServlet
  implements javax.servlet.Servlet {
  @Resource(lookup = "java:global/DSD")
  private DataSource ds;

  public GetVersion() {
    super();
  }

  protected void doGet(HttpServletRequest request,
    HttpServletResponse response) throws ServletException, IOException {
    doPost(request, response);
  }

  protected void doPost(HttpServletRequest request,
    HttpServletResponse response) throws ServletException, IOException {

```

```

response.setContentType("text/html");

PrintWriter writer = response.getWriter();
writer.println("<html>");
writer.println("<head><title>GetVersion</title></head>");
writer.println("<body>" + doit() + "</body>");
writer.println("</html>");
writer.close();
}

private String doit() {
String ret = "FAILED";
Connection conn = null;
try {
conn = ds.getConnection();
ret = "Connection obtained with version= " +
conn.getMetaData().getDriverVersion();
} catch(Exception e) {
e.printStackTrace();
} finally {
try {
if (conn != null)
conn.close();
} catch (Exception ignore) {}
}
return ret;
}
}

```

17.4 Globalization Support for the Oracle Thin Driver

For globalization support with the Oracle Thin driver, Oracle supplies the `orai18n.jar` file, which replaces `nls_charset.zip`. If you use character sets other than `US7ASCII`, `WE8DEC`, `WE8ISO8859P1` and `UTF8` with `CHAR` and `NCHAR` data in Oracle object types and collections, you must include `orai18n.jar` and `orai18n-mapping.jar` in your `CLASSPATH`.

The `orai18n.jar` and `orai18n-mapping.jar` are included with the WebLogic Server installation in the `ORACLE_HOME\oracle_common\modules\oracle.nlsrtl_12.1.0` folder. These files are *not* referenced by the `weblogic.jar` manifest file, so you must add them to your `CLASSPATH` before they can be used.

17.5 Using the Oracle Thin Driver in Debug Mode

The `ORACLE_HOME\oracle_common\modules\oracle.jdbc_12.1.0` folder includes the `ojdbc6_g.jar` (for JDK 6) file and `ojdbc7_g.jar` (for JDK7), which are the versions of the Oracle Thin driver with classes to support debugging and tracing. To use the Oracle Thin driver in debug mode, add the path to these files at the beginning of your `CLASSPATH`.

Monitoring WebLogic JDBC Resources

This chapter provides information on how to create, collect, analyze, archive, and access diagnostic data generated by a running server and the applications deployed within its containers.

This data provides insight into the run-time performance of servers and applications and enables you to isolate and diagnose faults when they occur. WebLogic JDBC takes advantage of this service to provide enhanced run-time statistics, profile information over a period of time, logging, and debugging to help you keep your WebLogic domain running smoothly.

You can use the run-time statistics to monitor the data sources in your WebLogic domain to see if there is a problem. If there is a problem, you can use profiling to determine which application is the source of the problem. Once you've narrowed it down to the application, you can then use JDBC debugging features to find the problem within the application.

This chapter includes the following sections:

- [Viewing Run-Time Statistics](#)
- [Profile Logging](#)
- [Collecting Profile Information](#)
- [Debugging JDBC Data Sources](#)

18.1 Viewing Run-Time Statistics

Viewing run-time statistics allows you to monitor the data sources in your WebLogic domain.

- [Data Source Statistics](#)
- [Prepared Statement Cache Statistics](#)

18.1.1 Data Source Statistics

You can view run-time statistics for a data source using the WebLogic Server Administration Console (see [JDBC Data Source:Monitoring:Statistics](#) in Oracle WebLogic Server Administration Console Online Help or through the `JBCDataSourceRuntimeMBean`. The `JBCDataSourceRuntimeMBean` provides methods for getting the current state of the data source and for getting statistics about the data source, such as the average number of active connections, the current number of active connections, the highest number of active connections, and so forth. For more information, see [JBCDataSourceRuntimeMBean](#) in the *MBean Reference for Oracle WebLogic Server*.

18.1.2 Prepared Statement Cache Statistics

You can view run-time statistics for a prepared statement cache via the WebLogic Server [Administration Console](#) or through the `JDBCDataSourceRuntimeMBean`. For more information, see [JDBCDataSourceRuntimeMBean](#) in the *MBean Reference for Oracle WebLogic Server*.

18.2 Profile Logging

WebLogic Server uses a data source profile log to store events. The profile log has the following benefits:

- **Log-rotation**—provides the ability to configure, rotate, and retire old data using the standard WebLogic logging implementation. See the [DataSourceLogFileMBean](#) in *MBean Reference for Oracle WebLogic Server*.
- **Data accessibility**—provides the ability to use common text editors, the WLDF Data Accessor, or the WebLogic Server Administration Console. See [Accessing Diagnostic Data](#).

Basic characteristics of the log for data source profiling are:

- A single log file is used for all data source profile types. Each profile record has the profile type name for filtering. See [Profile Types](#).
- A single log file is used for all data sources on the server. Each profile record has the decorated data source name for filtering (fully qualified with `application@module@component`, if applicable). See the [DataSourceLogFileMBean](#) in *MBean Reference for Oracle WebLogic Server*.

For more information on WebLogic logging services, see:

- [Enable and configure Datasource Profile logs](#) in *Oracle WebLogic Server Administration Console Online Help*.
- [Understanding WebLogic Logging Services in Configuring Log Files and Filtering Log Messages for Oracle WebLogic Server](#).

18.3 Collecting Profile Information

If the statistics that you are seeing indicate that there is a problem in your WebLogic Server domain, you can configure any data source to collect profile information to help you pinpoint the source of the problem. The collected profile information is stored in records in the profile log. The fields contain different information for different profile types, as described in the sections that follow.

When configuring your data source for profiling, you must specify the interval at which profile data is harvested (`Harvest Frequency Seconds`); if the interval is set to 0, harvesting of data is disabled. See [Configure diagnostic profiling for a JDBC data source](#) in *Oracle WebLogic Server Administration Console Online Help*.

18.3.1 Profile Types

For each of the profile types in this section, the `User` information provides a stack trace of the thread that allocated the connection and is associated with the operation being profiled. By default, the value is not set because of the overhead in tracking this information. To obtain this information, you must also enable profiling of connection

leaks in addition to profile type that you want to track. For more information about profiling connection leaks, see [Connection Leak \(WEBLOGIC.JDBC.CONN.LEAK\)](#)..

You can choose to profile the following information about data sources and the prepared statement cache, as described in the following sections of this document:

- [Connection Usage \(WEBLOGIC.JDBC.CONN.USAGE\)](#)
- [Connection Reservation Wait \(WEBLOGIC.JDBC.CONN.RESV.WAIT\)](#)
- [Connection Reservation Failed \(WEBLOGIC.JDBC.CONN.RESV.FAIL\)](#)
- [Connection Leak \(WEBLOGIC.JDBC.CONN.LEAK\)](#)
- [Connection Last Usage \(WEBLOGIC.JDBC.CONN.LAST_USAGE\)](#)
- [Connection Multithreaded Usage \(WEBLOGIC.JDBC.CONN.MT_USAGE\)](#)
- [Statement Cache Entry \(WEBLOGIC.JDBC.STMT_CACHE.ENTRY\)](#)
- [Statements Usage \(WEBLOGIC.JDBC.STMT.USAGE\)](#)
- [Connection Unwrap \(WEBLOGIC.JDBC.CONN.UNWRAP\)](#)
- [JDBC Object Closed Usage \(WEBLOGIC.JDBC.CLOSED_USAGE\)](#)
- [Local Transaction Connection Leak \(WEBLOGIC.JDBC.CONN.LOCALTX_LEAK\)](#)
- [Example Profile Information Record Log](#)

18.3.1.1 Connection Usage (WEBLOGIC.JDBC.CONN.USAGE)

Enable connection usage profiling to collect information about threads currently using connections from the pool of connections in the data source. This profile information can help determine why applications are unable to get connections from the data source.

The record contains the following information:

- PoolName - name of the data source to which this connection belongs
- ID - connection ID
- User - stack trace of the thread using the connection
- Timestamp - time stamp showing when the connection was given to the thread

18.3.1.2 Connection Reservation Wait (WEBLOGIC.JDBC.CONN.RESV.WAIT)

Enable connection reservation wait profiling to collect information about threads currently waiting to reserve a connection from the data source. This profile information can help determine why applications are unable to get connections from the data source or to wait for connections. The record contains the following information:

- PoolName - name of the data source to which this connection belongs
- ID - thread ID
- User - stack trace of the thread waiting for the connection
- Timestamp - time stamp showing when the thread started waiting for a connection

18.3.1.3 Connection Reservation Failed (WEBLOGIC.JDBC.CONN.RESV.FAIL)

Enable connection reservation failure profiling to collect information about threads that attempt to reserve a connection from the data source but fail to get that connection. This profile information can help determine why applications are unable to get connections from the data source even after reserving them. The record contains the following information:

- PoolName - name of the data source to which this connection belongs
- ID - thread ID
- User - stack trace of the thread waiting for the connection plus the exception received when the reservation request failed
- Timestamp - time stamp showing when the reservation request failed

18.3.1.4 Connection Leak (WEBLOGIC.JDBC.CONN.LEAK)

Enable connection leak profiling to collect information about threads that have reserved a connection from the data source and the connection leaked (was not properly returned to the pool of connections). This profile information can help determine which applications are not properly closing JDBC connections. Connection leak profiling must be enabled to get user stack trace information for any of the profile types. The record contains the following information:

- PoolName - name of the data source to which this connection belongs
- ID - connection ID
- User - stack trace of the thread waiting for the connection
- Timestamp - time stamp showing when the connection leak was detected

To specify the length of time before a reserved connection is considered leaked, do one of the following:

- Set `Inactive Connection Timeout Seconds` to a value greater than zero. WebLogic prints a stack trace of where a JDBC pool connection was reserved. The stack trace is printed after the `Inactive Connection Timeout Seconds` expires.
- Set `Connection Leak Timeout Seconds` to a value greater than zero. The value specifies the number of seconds that a JDBC connection needs to be held by an application before triggering a connection leak diagnostic profiling record. If set to 0, the timeout is disabled.

18.3.1.5 Connection Last Usage (WEBLOGIC.JDBC.CONN.LAST_USAGE)

Enable connection last usage profiling to collect information about the previous thread that last used the connection. This information is useful when you are debugging problems with connections infected in pending transactions that cause subsequent XA operations on the connections to fail. The record contains the following information:

- PoolName - name of the data source to which this connection belongs
- ID - stack trace of the XA exception thrown
- User - stack trace of the thread that last used the connection

- Timestamp - timestamp showing when the exception was thrown

18.3.1.6 Connection Multithreaded Usage (WEBLOGIC.JDBC.CONN.MT_USAGE)

Enable connection multithreaded usage profiling to collect information about threads that erroneously use a connection that was previously obtained by a different thread. This information is useful when an application reports a problem that you suspect may have been caused by the simultaneous use of a connection by more than one thread. The record contains the following information:

- PoolName - name of the data source to which this connection belongs
- ID - stack trace of the other thread that was found using the connection
- User - stack trace of the thread that reserved the connection
- Timestamp - time stamp showing when usage of the connection by multiple threads was detected

18.3.1.7 Statement Cache Entry (WEBLOGIC.JDBC.STMT_CACHE.ENTRY)

Enable statement cache entry profiling to collect information for prepared and callable statements added to the statement cache, and for the threads that originated the cached statements. This information can help you determine how the cache is being used. The record contains the following information:

- PoolName - name of the data source to which this connection belongs
- ID - string representation of the statement
- User - stack trace of the thread using the statement
- Timestamp - time stamp showing when the statement was added to the cache

18.3.1.8 Statements Usage (WEBLOGIC.JDBC.STMT.USAGE)

Enable statements usage profiling to collect information about threads currently executing SQL statements from the statement cache. This information can help you determine how statements are being used. The record contains the following information:

- PoolName - name of the data source to which this connection belongs
- ID - SQL statement being executed via the statement
- User - stack trace of the thread using the statement
- Timestamp - duration of statement execution

18.3.1.9 Connection Unwrap (WEBLOGIC.JDBC.CONN.UNWRAP)

Enable connection unwrap profiling to collect profile information about application components that access the underlying JDBC connection using either the `getVendorObject` WebLogic extension API or the JDBC 4.0 method `unwrap`. The record contains the following information:

- PoolName - name of the data source to which this connection belongs
- ID - stack trace of where the object was unwrapped

- User - stack trace of the thread unwrapping the object
- Timestamp - time stamp showing when the object was unwrapped.

18.3.1.10 JDBC Object Closed Usage (WEBLOGIC.JDBC.CLOSED_USAGE)

Enable JDBC object usage profiling to collect profile information about JDBC objects (Connection, Statement, or ResultSet) that are accessed after the close() method has been invoked. This information can help you determine both the thread that initially closed the object and the thread that attempted to access the closed object. The record contains the following information:

- PoolName - name of the data source to which this connection belongs
- ID - stack trace of the current thread attempting to close the object
- User - stack trace of the thread that closed the object plus where the close was done
- Timestamp - time stamp showing when the object was closed

18.3.1.11 Local Transaction Connection Leak (WEBLOGIC.JDBC.CONN.LOCALTX_LEAK)

Enable JDBC local transaction connection leak profiling to collect profile information about application components that leak a local transaction (start it but don't commit or rollback the transaction). The log record will include the call stack and details about the thread releasing the connection. The record contains the following information:

- PoolName - name of the data source to which this connection belongs
- ID - stack trace of the thread that is releasing the connection
- User - stack trace of the reserving thread plus a stack trace of the thread at the time the connection was closed
- Timestamp - time stamp showing when the connection was closed

18.3.1.12 Example Profile Information Record Log

The following is an example profile information record for [Statements Usage \(WEBLOGIC.JDBC.STMT.USAGE\)](#) from a standard output log.

```
####<JDBC Data Source-0> <WEBLOGIC.JDBC.STMT.USAGE> <0> <java.lang.Exception
  at
  .
  .
  .
  weblogic.servlet.provider.ContainerSupportProviderImpl
$WlsRequestExecutor.run( ContainerSupportProviderImpl.java:254)
  at weblogic.work.ExecuteThread.execute(ExecuteThread.java:295)
  at weblogic.work.ExecuteThread.run(ExecuteThread.java:254)
> <select 1 from dual>
```

Each component of the profile log is surrounded by brackets ("**<**" and "**>**"):

- The PoolName—JDBC Data Source-0
- The Profile Type—WEBLOGIC.JDBC.STMT.USAGE
- The Timestamp—0 (milliseconds)

- User—`java.lang.Exception at . . . at weblogic.work.ExecuteThread.run(ExecuteThread.java:254`
- ID—`select 1 from dual`

18.3.2 Accessing Diagnostic Data

You can use one of the following methods to access diagnostic data:

- The WebLogic Server Administration Console. See:
 - [View and configure logs](#) in *Oracle WebLogic Server Administration Console Online Help*.
 - [Monitor Statistics for a JDBC data source](#) in *Oracle WebLogic Server Administration Console Online Help*.
- The Data Accessor component of the WebLogic Diagnostic Framework (WLDF). See *Accessing Diagnostic Data With the Data Accessor in Configuring and Using the Diagnostics Framework for Oracle WebLogic Server*
- Manually review information using text editors.
- When running with DataSource profiling, the default harvesting time is 300 seconds so you may not be able to view data immediately. You may need to set the harvest time to a small value (say 5 seconds) to better visualize results. To see all connections, take a diagnostic image. To see the stack trace, enable leak profiling.

18.3.3 Callbacks for Monitoring Driver-Level Statistics (Deprecated)

Note:

This feature is deprecated in WebLogic Server 10.3.6.0 and may be removed in a future release.

WebLogic Server provides callbacks for methods called on a JDBC driver. You can use these callbacks to monitor and profile JDBC driver usage, including methods being executed, any exceptions thrown, and the time spent executing driver methods.

To enable the callback feature, you specify the fully qualified path of the callback handler for the driver-interceptor element in the JDBC data source descriptor (module). Your callback handler must implement the `weblogic.jdbc.extensions.DriverInterceptor` interface. When you enable JDBC driver callbacks, WebLogic Server calls the `preInvokeCallback()`, `postInvokeExceptionCallback()`, and `postInvokeCallback()` methods of the registered callback handler before and after invoking any method inside the JDBC driver.

Any time an application calls the JDBC driver, a callback is sent to the class that implemented the driver.

18.4 Debugging JDBC Data Sources

Once you have narrowed the problem down to a specific application, you can activate WebLogic Server's debugging features to track down the specific problem within the application.

- [Enabling Debugging](#)
- [JDBC Debugging Scopes](#)
- [Setting Debugging for UCP/ONS](#)
- [Request Dyeing](#)

18.4.1 Enabling Debugging

You can enable debugging by setting the appropriate `ServerDebug` configuration attribute to "true." Optionally, you can also set the server `StdoutSeverity` to "Debug".

You can modify the configuration attribute in any of the following ways.

18.4.1.1 Enable Debugging Using the Command Line

Set the appropriate properties on the command line. For example,

```
-Dweblogic.debug.DebugJDBCSQL=true  
-Dweblogic.log.StdoutSeverity="Debug"
```

This method is static and can only be used at server startup.

18.4.1.2 Enable Debugging Using the WebLogic Server Administration Console

Use the WebLogic Server Administration Console to set the debugging values:

1. If you have not already done so, in the Change Center of the WebLogic Server Administration Console, click Lock & Edit (see Using the Change Center in *Understanding Oracle WebLogic Server*).
2. In the left pane of the console, expand Environment and select Servers.
3. On the Summary of Servers page, click the server on which you want to enable or disable debugging to open the settings page for that server.
4. Click Debug.
5. Expand default.
6. Select the check box for the debug scopes or attributes you want to modify.
7. Select Enable to enable (or Disable to disable) the debug scopes or attributes you have checked.
8. To activate these changes, in the Change Center of the WebLogic Server Administration Console, click Activate Changes.
9. Not all changes take effect immediately—some require a restart (see Using the Change Center in *Understanding Oracle WebLogic Server*).

This method is dynamic and can be used to enable debugging while the server is running.

18.4.1.3 Enable Debugging Using the WebLogic Scripting Tool

Use the WebLogic Scripting Tool (WLST) to set the debugging values. For example, the following command runs a program for setting debugging values called `debug.py`:

```
java weblogic.WLST debug.py
```

The debug.py program contains the following code:

```
user='user1'
password='password'
url='t3://localhost:7001'
connect(user, password, url)
edit()
cd('Servers/myserver/ServerDebug/myserver')
startEdit()
set('DebugJDBCSQL', 'true')
save()
activate()
```

Note that you can also use WLST from Java. The following example shows a Java file used to set debugging values:

```
import weblogic.management.scripting.utils.WLSTInterpreter;
import java.io.*;
import weblogic.jndi.Environment;
import javax.naming.Context;
import javax.naming.InitialContext;
import javax.naming.NamingException;

public class test {
    public static void main(String args[]) {
        try {
            WLSTInterpreter interpreter = null;
            String user="user1";
            String pass="pw12ab";
            String url ="t3://localhost:7001";
            Environment env = new Environment();
            env.setProviderUrl(url);
            env.setSecurityPrincipal(user);
            env.setSecurityCredentials(pass);
            Context ctx = env.getInitialContext();

            interpreter = new WLSTInterpreter();
            interpreter.exec
            ("connect('"+user+"', '"+pass+"', '"+url+"'");
            interpreter.exec("edit()");
            interpreter.exec("startEdit()");
            interpreter.exec
            ("cd('Servers/myserver/ServerDebug/myserver')");
            interpreter.exec("set('DebugJDBCSQL', 'true')");
            interpreter.exec("save()");
            interpreter.exec("activate()");

        } catch (Exception e) {
            System.out.println("Exception "+e);
        }
    }
}
```

Using the WLST is a dynamic method and can be used to enable debugging while the server is running.

18.4.1.4 Changes to the config.xml File

Changes in debugging characteristics, through console, or WLST, or command line are persisted in the `config.xml` file. See [Example 18-1](#):

Example 18-1 Example Debugging Stanza for JDBC

```
.  
. .  
. .  
<server>  
<name>myserver</name>  
<server-debug>  
<debug-scope>  
<name>weblogic.transaction</name>  
<enabled>true</enabled>  
</debug-scope>  
<debug-jdbcsql>true</debug-jdbcsql>  
</server-debug>  
</server>  
. .  
. .  
.
```

This sample `config.xml` fragment shows a transaction debug scope (set of debug attributes) and a single JDBC attribute.

18.4.2 JDBC Debugging Scopes

The following are registered debugging scopes for JDBC:

- `DebugJDBCSQL` (scope `weblogic.jdbc.sql`) - prints information about all JDBC methods invoked, including their arguments and return values, and thrown exceptions.
- `DebugJDBCConn` (scope `weblogic.jdbc.connection`) - trace all connection reserve and release operations in data sources as well as all application requests to get or close connections.
- `DebugJDBCCons` (scope `weblogic.jdbc.rac`) - trace low-level ONS debugging.
- `DebugJDBCRCAC` (scope `weblogic.jdbc.rac`) - trace RAC debugging.
- `DebugJDBCUCP` (scope `weblogic.jdbc.rac`) - trace low-level UCP debugging.
- `DebugJDBCReplay` (scope `weblogic.jdbc.rac`) - trace Replay debugging.
- `DebugJDBCRCMI` (scope `weblogic.jdbc.rmi`) - similar to `JDBCSQL` but at the RMI level; turning on this one and `JDBCSQL` will get two sets of debug messages for each operation called from a client.
- `DebugJDBCInternal` (scope `weblogic.jdbc.internal`) - low level debugging in `weblogic/jdbc/common/internal` related to the data source, the connection environment, and the data source manager.
- `DebugJDBCdriverLogging` (scope `weblogic.jdbc.driverlogging`) - enables JDBC driver level logging (this replaces `ServerMBean JDBCLoggingEnabled` and `getJDBCLogFileName`). Note that to get driver level tracing for Oracle, you need to use `ojdbc6_g.jar` instead of `ojdbc6.jar`. Note that for this debug scope, it can be

turned on once via the command line or configuration when the server is booted but cannot be turned on or off dynamically (due to the DriverManager interface).

- DebugJTAJDBC (scope weblogic.jdbc.transaction) - trace transaction debugging.

18.4.3 Setting Debugging for UCP/ONS

The following sections provide information on how to set debugging for UCP/ONS.

18.4.3.1 Debugging UCP

Set UCP debugging directly using:

```
oracle.ucp.level = FINEST;  
oracle.ucp.jdbc.PoolDataSource = WARNING;
```

18.4.3.2 Debugging ONS

To enable debugging for ONS, you must configure Java Util Logging. To do so, set the following properties on the command line as follows:

```
-Djava.util.logging.config.file=configfile  
-Doracle.ons.debug=true
```

In this command, `configfile` is the path and file name of the configuration property file property used by standard JDK logging to control the log output format and logging level. The `configfile` must include the following line:

```
oracle.ons.level=FINEST
```

For more information, see [java.util.logging](#) in Java Platform Standard Edition 7 API Specification.

18.4.4 Request Dyeing

Another option for debugging is to trace the flow of an individual (typically "dyed") application request through the JDBC subsystem. For more information, see *Configuring the Dye Vector via the DyeInjection Monitor* in *Configuring and Using the Diagnostics Framework for Oracle WebLogic Server*.

Managing WebLogic JDBC Resources

This chapter provides information on how to use the WebLogic Server Administration Console, command line, JMX programs, or WebLogic Scripting Tool (WLST) scripts to manage the JDBC data sources in your domain.

This chapter includes the following sections:

- [Testing Data Sources and Database Connections](#)
- [Managing the Statement Cache for a Data Source](#)
- [Shrinking a Connection Pool](#)
- [Resetting a Connection Pool](#)
- [Suspending a Connection Pool](#)
- [Resuming a Connection Pool](#)
- [Shutting Down a Data Source](#)
- [Starting a Data Source](#)
- [Managing DBMS Network Failures](#)

19.1 Testing Data Sources and Database Connections

[JDBCDataSourceRuntimeMBean.testPool](#)

To make sure that the database connections in a data source remain healthy, you should periodically test the connections. WebLogic Server includes two basic types of testing: automatic testing that you configure with attributes on the data source and manual testing that you can do to trouble-shoot a data source.

Allowing WebLogic Server to automatically maintain the integrity of pool connections should prevent most DBMS connection problems. For more information about configuring automatic connection testing, see [Connection Testing Options for a Data Source](#).

To manually test a connection from a data source, you can use the Test Data Source feature on the [JDBC Data Source: Monitoring: Testing](#) page in the WebLogic Server Administration Console (see [Test JDBC data sources](#)) or the `testPool()` method in the `JDBCDataSourceRuntimeMBean`. To test a database connection from a data source, Test Reserved Connections must be enabled and Test Table Name must be defined in the data source configuration. Both are defined by default if you create the data source using the WebLogic Server Administration Console.

When you test a data source, WebLogic Server reserves a connection, tests it using the query defined in Test Table Name, and then releases the connection.

19.2 Managing the Statement Cache for a Data Source

For each connection in a data source in your system, WebLogic Server creates a statement cache. When a prepared statement or callable statement is used on a connection, WebLogic Server caches the statement so that it can be reused. For more information about the statement cache, see [Increasing Performance with the Statement Cache](#).

Each connection in the data source has its own statement cache, but configuration settings are made for all connections in the data source. You can clear the statement cache for *all* connections in a data source using the WebLogic Server Administration Console or you can programmatically clear the statement cache for an *individual* connection.

Note:

When the JDBC 4.0 `setPoolable(false)` method is called for a WebLogic data source that has prepared statement caching enabled, the statement is removed from the cache in addition to calling the method on the driver object.

19.2.1 Clearing the Statement Cache for a Data Source

[JDBCDataSourceRuntimeMBean.clearStatementCache](#)

You can manually clear the statement cache for all connections in a data source using the WebLogic Server Administration Console (see [Clear the statement cache in a JDBC data source](#) in Oracle WebLogic Server Administration Console Online Help) or with the `clearStatementCache()` method on the `JDBCDataSourceRuntimeMBean`.

19.2.2 Clearing the Statement Cache for a Single Connection

```
weblogic.jdbc.extensions.WLConnection.clearStatementCache()  
weblogic.jdbc.extensions.WLConnection.clearCallableStatement(java.lang.  
String sql)  
weblogic.jdbc.extensions.WLConnection.clearCallableStatement(java.lang.  
String sql,int resType,int resConcurrency)  
weblogic.jdbc.extensions.WLConnection.clearPreparedStatement(java.lang.  
String sql)  
weblogic.jdbc.extensions.WLConnection.clearPreparedStatement(java.lang.  
String sql,int resType,int resConcurrency)
```

You can use methods in the `weblogic.jdbc.extensions.WLConnection` interface to clear the statement cache for a single connection or to clear an individual statement from the cache. These methods return `true` if the operation was successful and `false` if the operation fails because the statement was not found.

When prepared and callable statements are stored in the cache, they are stored (keyed) based on the exact SQL statement and result set parameters (type and concurrency options), if any. When clearing an individual prepared or callable statement, you must use the method that takes the proper result set parameters. For example, if you have callable statement in the cache with `resSetType` of `ResultSet.TYPE_SCROLL_INSENSITIVE` and a `resSetConcurrency` of `ResultSet.CONCUR_READ_ONLY`, you must use the method that takes the result set parameters:

```
clearCallableStatement(java.lang.String sql,int resSetType,int resSetConcurrency)
```

If you use the method that only takes the SQL string as a parameter, the method will not find the statement, nothing will be cleared from the cache, and the method will return `false`.

When you clear a statement that is currently in use by an application, WebLogic Server removes the statement from the cache, but does not close it. When you clear a statement that is not currently in use, WebLogic Server removes the statement from the cache and closes it.

For more details about these methods, see the Javadoc for [WLConnection](#).

19.3 Shrinking a Connection Pool

[JDBCDataSourceRuntimeMBean.shrink](#)

A data source has a set of properties that define the initial, minimum, and maximum number of connections in the pool ([initialCapacity](#), [minCapacity](#), and [maxCapacity](#)). A data source automatically adds one connection to the pool when all connections are in use. When the pool reaches [maxCapacity](#), the maximum number of connections are opened, and they remain opened unless you enable automatic shrinking on the data source or manually shrink the data source with the `shrink()` method.

You may want to drop some connections from the data source when a peak usage period has ended, freeing up WebLogic Server and DBMS resources. You can use the Shrink option on the [JDBC Data Source: Control](#) page in the WebLogic Server Administration Console (see [Shrink the connection pool in a JDBC data source](#) in *Oracle WebLogic Server Administration Console Online Help*) or the `shrink()` method on the `JDBCDataSourceRuntimeMBean`. When you shrink a data source, WebLogic Server reduces the number of connections in the pool to the greater of either the [minCapacity](#) or the number of connections currently in use. The pool is decreased gradually to minimize thrashing. The number of unused connections is cut in half each time automatic shrinking is performed.

19.4 Resetting a Connection Pool

[JDBCDataSourceRuntimeMBean.reset](#)

To close and recreate all available database connections in a data source, you can use the Reset option on the [JDBC Data Source: Control](#) page in the WebLogic Server Administration Console (see [Reset connections in a JDBC data source](#) in *Oracle WebLogic Server Administration Console Online Help*) or the `reset()` method on the `JDBCDataSourceRuntimeMBean`. This may be necessary after the DBMS has been restarted, for example. Often when one connection in a data source has failed, all of the connections in the pool are bad.

19.5 Suspending a Connection Pool

[JDBCDataSourceRuntimeMBean.suspend](#)

[JDBCDataSourceRuntimeMBean.forceSuspend](#)

To suspend a data source, you can reserve the Suspend and Force Suspend options on the [JDBC Data Source: Control](#) page in the WebLogic Server Administration Console (see [Suspend JDBC data sources](#) in *Oracle WebLogic Server Administration Console Online*

Help) or the `suspend()` and `forceSuspend()` methods in the `JDBCDataSourceRuntimeMBean`.

When you suspend a data source (not forcibly suspend), the data source is marked as disabled and applications cannot reserve connections from the pool. Applications that already have a reserved connection from the data source when it is suspended will get an exception when trying to reserve the connection. WebLogic Server preserves all connections in the data source exactly as they were before the data source was suspended.

When you gracefully suspend a data source, the following occurs:

- The data source is immediately marked as suspended at the beginning of the operation and no further connections are created on the data source.
- Idle (not reserved) connections are marked as disabled.
- After a timeout period for the suspend operation, all remaining connections in the pool are marked as suspended and the following exception is thrown for any operations on the connection, indicating that the data source is suspended:

```
java.sql.SQLRecoverableException: Connection has been
administratively disabled. Try later.
```

- If graceful suspend is done as part of a graceful shutdown operation, connections are immediately closed when no longer reserved or at the end of the timeout period. If not done as part of a shutdown operation, these connections remain in the pool and are not closed because the pool may be resumed.

A graceful suspend can be done synchronously or asynchronously.

The synchronous operation does not have a timeout period on the method. By default, the timeout period is 60 seconds. You can change the value of this timeout period by configuring or dynamically setting Inactive Connection Timeout Seconds to a non-zero value. There is no upper limit on the inactive timeout period. Note that the processing actually checks for in-use (reserved) resources every tenth of a second so if the timeout value is set to 2 hours and all reserved resources are released a second later, the shutdown will complete a second later.

The asynchronous operation takes a timeout value in seconds. It returns a `JDBCDataSourceTaskRuntimeMBean` that can be used to check the status of the operation. The `getProgress()` method returns `TaskRuntimeMBean.PROGRESS_SUCCESS` ("success"), `TaskRuntimeMBean.PROGRESS_FAILED` ("failed"), or `TaskRuntimeMBean.PROGRESS_PROCESSING` ("processing"). The `getStatus()` method returns "SUCCESS", "FAILURE", and now "PROCESSING". There can be multiple task MBeans in existence. The next operation call on the datasource will clean up MBeans for tasks that have been completed for at least 30 minutes. Note that once a suspend or shutdown operation is started, the other operations will fail immediately but a task MBean is still created. The `isRunning()` method returns true if suspend or shutdown is still running. Timeout of the operation is controlled by the timeout parameter on the new task operations. If set to 0, the default is used. The default is to use Inactive Connection Timeout Seconds if set or 60 seconds. If you want a minimal timeout, set the value to 1. If you want no timeout, set it to a large value (not recommended).

When you forcibly suspend a data source, all pool connections are destroyed and any subsequent attempt to use reserved connections fail. Any transactions on the connections that are closed are rolled back.

19.6 Resuming a Connection Pool

[JDBCDataSourceRuntimeMBean.resume](#)

To re-enable a data source that you suspended, you can use the Resume option on the [JDBC Data Source: Control](#) page in the WebLogic Server Administration Console (see [Resume suspended JDBC data sources](#) in *Oracle WebLogic Server Administration Console Online Help*) or the `resume()` method on the `JDBCDataSourceRuntimeMBean`. When you resume a data source, WebLogic Server marks the data source as enabled and allows applications to reserve connections from the data source. If you suspended the data source (not forcibly suspended), all connections are preserved exactly as they were before the data source was suspended. Clients that had reserved a connection before the data source was suspended can continue exactly where they left off. If you forcibly suspended the data source, clients will have to reserve new connections to proceed.

Note:

You cannot resume a data source that did not start correctly, for example, if the database server is unavailable.

19.7 Shutting Down a Data Source

[JDBCDataSourceRuntimeMBean.shutdown](#)

[JDBCDataSourceRuntimeMBean.forceShutdown](#)

To shut down a data source, you can use the Shutdown and Force Shutdown options on the [JDBC Data Source: Control](#) page in the WebLogic Server Administration Console (see [Shut down JDBC data sources](#) in *Oracle WebLogic Server Administration Console Online Help*) or the `shutdown()` and `forceShutdown()` methods in the `JDBCDataSourceRuntimeMBean`.

A graceful (non-forced) datasource shutdown operation involves first gracefully suspending the data source and then releasing the associated resources including the connections. See the description above for details of gracefully suspending the datasource. After the datasource is gracefully suspended, all remaining in-use connections are closed and the datasource is marked as shut down.

A graceful shutdown can be done synchronously or asynchronously.

The synchronous operation does not have a timeout period on the method. The timeout period is 60 seconds by default. This can be changed by configuring or dynamically setting Inactive Connection Timeout Seconds to a non-zero value (note that this value is overloaded with another feature when connection leak profiling is enabled). There is no upper limit on the inactive timeout. Note that the processing actually checks for in-use (reserved) resources every tenth of a second so if the timeout value is set to 2 hours and it's done a second later, it will complete a second later.

The asynchronous operation takes a timeout value in seconds. It returns a `JDBCDataSourceTaskRuntimeMBean` that can be used to check the status of the operation. The `getProgress()` method returns `TaskRuntimeMBean.PROGRESS_SUCCESS` ("success"), `TaskRuntimeMBean.PROGRESS_FAILED` ("failed"), or `TaskRuntimeMBean.PROGRESS_PROCESSING` ("processing"). The `getStatus()` method returns "SUCCESS", "FAILURE", and now

"PROCESSING". There can be multiple task MBeans in existence. The next operation call on the datasource will clean up MBeans for tasks that have been completed for at least 30 minutes. Note that once a suspend or shutdown operation is started, the other operations will fail immediately but a task MBean is still created. The `isRunning()` method returns true if suspend or shutdown is still running. Timeout of the operation is controlled by the `timeout` parameter on the new task operations. If set to 0, the default is used. The default is to use Inactive Connection Timeout Seconds if set or 60 seconds. If you want a minimal timeout, set the value to 1. If you want no timeout, set it to a large value (not recommended).

When you forcibly shut down a data source, WebLogic Server closes database connections in the data source and shuts down the data source. All current connection users are forcibly disconnected. For a sample WLST script that shuts down a data source, see the WLST example [WLST example](#)

19.8 Starting a Data Source

[JDBCDataSourceRuntimeMBean.start](#)

After you shut down a data source, you can use the Start option on the [JDBC Data Source: Control](#) page in the WebLogic Server Administration Console (see [Start JDBC data sources](#) in *Oracle WebLogic Server Administration Console Online Help*) or the `start()` method in the `JDBCDataSourceRuntimeMBean`. Invoking the Start operation re-initializes the data source, creates connections and transitions the data source to a health state of Running.

19.9 Managing DBMS Network Failures

```
-Dweblogic.resourcepool.max_test_wait_secs=xx
```

where `xx` is the amount of time, in seconds, WebLogic Server waits for connection test before considering the connection test failed. By default, a server instance is assigned a value of 10 seconds.

This command line flag manages failures, such as a DBMS network failure, which can cause connection tests and connections in use by applications to hang for extended periods of time (for example, 10 minutes). If the assigned time period expires, the server instance purges unused connections and puts a watch on connections that are in use by the application.

A value of ten seconds provides a reasonable amount of time to allow for peak stress loads, when a DBMS may temporarily halt responses to clients, and then resume service on existing connections. However, if the wait time is too long or too short, add the flag to the `startWebLogic` script used for starting the server with a value that is more appropriate for your environment. Setting the value for the amount of time to zero (0) seconds, causes the server to wait indefinitely on a hanging connection test.

Tuning Data Source Connection Pools

This chapter provides information on how to properly tune the connection pool attributes in JDBC data sources in your WebLogic Server domain to improve application and system performance.

This chapter includes the following sections:

- [Increasing Performance with the Statement Cache](#)
- [Connection Testing Options for a Data Source](#)
- [Enabling Connection Creation Retries](#)
- [Enabling Connection Requests to Wait for a Connection](#)
- [Automatically Recovering Leaked Connections](#)
- [Avoiding Server Lockup with the Correct Number of Connections](#)
- [Limiting Statement Processing Time with Statement Timeout](#)
- [Using Pinned-To-Thread Property to Increase Performance](#)
- [Using Unwrapped Data Type Objects](#)
- [Tuning Maintenance Timers](#)

20.1 Increasing Performance with the Statement Cache

When you use a prepared statement or callable statement in an application or EJB, there is considerable processing overhead for the communication between the application server and the database server and on the database server itself. To minimize the processing costs, WebLogic Server can cache prepared and callable statements used in your applications. When an application or EJB calls any of the statements stored in the cache, WebLogic Server reuses the statement stored in the cache. Reusing prepared and callable statements reduces CPU usage on the database server, improving performance for the current statement and leaving CPU cycles for other tasks.

Each connection in a data source has its own individual cache of prepared and callable statements used on the connection. However, you configure statement cache options per data source. That is, the statement cache for each connection in a data source uses the statement cache options specified for the data source, but each connection caches its own statements. Statement cache configuration options include:

- **Statement Cache Type**—The algorithm that determines which statements to store in the statement cache. See [Statement Cache Algorithms](#).

- **Statement Cache Size**—The number of statements to store in the cache for each connection. The default value is 10. See [Statement Cache Size](#).

You can use the WebLogic Server Administration Console to set statement cache options for a data source. See [Configure the statement cache for a JDBC data source](#) in the *Oracle WebLogic Server Administration Console Online Help*.

20.1.1 Statement Cache Algorithms

The **Statement Cache Type** (or algorithm) determines which prepared and callable statements to store in the cache for each connection in a data source. You can choose from the following options:

- [LRU \(Least Recently Used\)](#)
- [Fixed](#)

20.1.1.1 LRU (Least Recently Used)

When you select **LRU** (Least Recently Used, the default) as the **Statement Cache Type**, WebLogic Server caches prepared and callable statements used on the connection until the statement cache size is reached. When an application calls `Connection.prepareStatement()`, WebLogic Server checks to see if the statement is stored in the statement cache. If so, WebLogic Server returns the cached statement (if it is not already being used). If the statement is not in the cache, and the cache is full (number of statements in the cache = statement cache size), WebLogic Server determines which existing statement in the cache was the least recently used and replaces that statement in the cache with the new statement.

The LRU statement cache algorithm in WebLogic Server uses an approximate LRU scheme.

20.1.1.2 Fixed

When you select **FIXED** as the **Statement Cache Type**, WebLogic Server caches prepared and callable statements used on the connection until the statement cache size is reached. When additional statements are used, they are not cached.

With this statement cache algorithm, you can inadvertently cache statements that are rarely used. In many cases, the **LRU** is preferred because rarely used statements will eventually be replaced in the cache with frequently used statements.

20.1.2 Statement Cache Size

The **Statement Cache Size** attribute determines the total number of prepared and callable statements to cache for each connection in each instance of the data source. By caching statements, you can increase your system performance. However, you must consider how your DBMS handles open prepared and callable statements:

- In many cases, the DBMS has a resource cost, such as a cursor, for each open statement. This applies to prepared and callable statements in the statement cache. For example, if you cache too many statements, you may exceed the limit of open cursors on your database server. If you have a data source with 10 connections deployed on 2 servers, and set the **Statement Cache Size** to 10 (the default), you may open 200 (10 x 2 x 10) cursors on your database server for the cached statements.

- Some drivers impose large memory requirements for every open statement. For a server, memory consumption is based on (number of data sources * number of connections * number of statements).
- Some DBMSs may impose limits on the number of statements/cursors per connection.

The statement cache size is dependent on your applications. Ideally it is the total number of every prepared or callable statement made with a connection from the DataSource. One way to approximate the maximum size used by your applications is to set the cache size to a huge number, observe the pool statistics of your application, and then take a value slightly larger than the largest observed value. From a WebLogic DataSource perspective, there is no loss in performance for having a cache size larger than your applications require.

However, having a cache size that is too small negatively impacts performance as the cache turnover can be so high while trying to accommodate new statements that old statements are flushed before they are ever reused. In some cases where you cannot allow a big enough statement cache to hold all or most of your statements, you may find the reuse rate is so small that your system performs better without a statement cache.

20.1.3 Usage Restrictions for the Statement Cache

Using the statement cache can dramatically increase performance, but you must consider its limitations before you decide to use it. Please note the following restrictions when using the statement cache.

There may be other issues related to caching statements that are not listed here. If you see errors in your system related to prepared or callable statements, you should set the statement cache size to 0, which turns off statement caching, to test if the problem is caused by caching prepared statements.

20.1.3.1 Calling a Stored Statement After a Database Change May Cause Errors

Prepared statements stored in the cache refer to specific database objects at the time the prepared statement is cached. If you perform any DDL (data definition language) operations on database objects referenced in prepared statements stored in the cache, the statements may fail the next time you run them. For example, if you cache a statement such as `select * from emp` and then drop and recreate the `emp` table, the next time you run the cached statement, the statement may fail because the exact `emp` table that existed when the statement was prepared, no longer exists.

Likewise, prepared statements are bound to the data type for each column in a table in the database at the time the prepared statement is cached. If you add, delete, or rearrange columns in a table, prepared statements stored in the cache are likely to fail when run again.

These limitations depend on the behavior of your DBMS.

20.1.3.2 Using `setNull` In a Prepared Statement

If you cache a prepared statement that uses a `setNull` bind variable, you must set the variable to the proper data type. If you use a generic data type, as in the following example, data may be truncated or the statement may fail when it runs with a value other than null.

```
java.sql.Types.Long sal=null
:
:
```

```
.  
if (sal == null)  
    setNull(2,int)//This is incorrect  
else  
    setLong(2,sal)
```

Instead, use the following:

```
if (sal == null)  
    setNull(2,long)//This is correct  
else  
    setLong(2,sal)
```

20.1.3.3 Statements in the Cache May Reserve Database Cursors

When WebLogic Server caches a prepared or callable statement, the statement may open a cursor in the database. If you cache too many statements, you may exceed the limit of open cursors for a connection. To avoid exceeding the limit of open cursors for a connection, you can change the limit in your database management system or you can reduce the statement cache size for the data source.

20.1.3.4 Other Considerations When Using the Statement Cache

When `oracle.jdbc.implicitstatementcachesize` is set in the connection properties of a data source, the WebLogic Server statement cache size is automatically set to zero (0).

There are several cases where special consideration is needed for the statement cache.

- If a data source is configured to use DRCP, the cache is cleared whenever the connection is closed by the application. See [Database Resident Connection Pooling](#).
- When a data source is configured to use Application Continuity using the replay driver, the WebLogic Server statement cache size is automatically set to 0.
- `oracle.jdbc.implicitstatementcachesize` is set in the connection properties of a datasource.
- For ease of use and to ensure caching is disabled, WebLogic Server automatically sets the statement cache size value to zero (0).
- When the JDBC 4.0 `setPoolable(false)` method is called for a WebLogic data source that has prepared statement caching enabled, the statement is removed from the cache in addition to calling the method on the driver object.

20.2 Connection Testing Options for a Data Source

To make sure that the database connections in a data source remain healthy, you should periodically test the connections. WebLogic Server includes two basic types of testing:

- Automatic testing that you configure with options on the data source so that WebLogic Server makes sure that database connections remain healthy.
- Manual testing that you can do to trouble-shoot a data source. See [Testing Data Sources and Database Connections](#).

To configure automatic testing options for a data source, you set the following options either through the WebLogic Server Administration Console or through WLST using the `JDBCConnectionPoolParamsBean`:

- **Test Frequency**—(`TestFrequencySeconds` in the `JDBCConnectionPoolParamsBean`) Use this attribute to specify the number of seconds between tests of unused connections. WebLogic Server tests unused connections, and closes and replaces any faulty connections. You must also set the **Test Table Name**.
- **Test Reserved Connections**—(`TestConnectionsOnReserve` in the `JDBCConnectionPoolParamsBean`) Enable this option to test each connection before giving to a client. This may add a slight delay to the request, but it guarantees that the connection is healthy. You must also set a **Test Table Name**.
- **Test Table Name**—(`TestTableName` in the `JDBCConnectionPoolParamsBean`) Use this attribute to specify a table name to use in a connection test. You can also specify SQL code to run in place of the standard test by entering SQL followed by a space and the SQL code you want to run as a test. **Test Table Name** is required to enable any database connection testing. See [Database Connection Testing Using Default Test Table Name](#).
- **Seconds to Trust an Idle Pool Connection**—(`SecondsToTrustAnIdlePoolConnection` in the `JDBCConnectionPoolParamsBean`) Use this option to specify the number of seconds after a connection has been proven to be OK that WebLogic Server trusts the connection is still viable and will skip the connection test, either before delivering it to an application or during the periodic connection testing process. This option is an optimization that minimizes the performance impact of connection testing, especially during heavy traffic. See [Minimizing Connection Request Delay with Seconds to Trust an Idle Pool Connection](#).
- **Count of Test Failures Till Flush**—(`CountOfTestFailuresTillFlush` in the `JDBCConnectionPoolParamsBean`) Use this option to specify the number of test failures allowed before WebLogic Server closes all connections in the connection pool to minimize the delay caused by further database testing. This parameter minimizes the amount of time allowed for failover when a Multi Data Source member fails. See [Minimizing Connection Test Delay After Database Connectivity Loss](#).
- **Connection Count of Refresh Failures Till Disable**—(`CountOfRefreshFailuresTillDisable` in the `JDBCConnectionPoolParamsBean`) Use this option to specify the number of test failures allowed before WebLogic Server disables the connection pool to minimize the delay in handling the connection request caused by a database failure. See [Minimizing Connection Request Delays After Loss of DBMS Connectivity](#).

See the [JDBC Data Source: Configuration: Connection Pool](#) page in the WebLogic Server Administration Console or see [JDBCConnectionPoolParamsBean](#) in the *MBean Reference for Oracle WebLogic Server* for more details about these options.

For instructions to set connection testing options, see [Configure testing options for a JDBC data source](#) in the *Oracle WebLogic Server Administration Console Online Help*.

The following section discusses automatic connection testing options:

- [Database Connection Testing Semantics](#)
- [Database Connection Testing Configuration Recommendations](#)
- [Database Connection Testing Using Default Test Table Name](#)
- [Database Connection Testing Options](#)

20.2.1 Database Connection Testing Semantics

When WebLogic Server tests database connections in a data source, it reserves a connection from the data source, runs a small query on the connection, then returns the connection to the pool in the data source. The server instance tracks statistics on the pool status, including the amount of time a required to complete a connection test, the number of connections waiting for a connection, and the number of connections being tested. The history of recent test connection behavior is used to calculate the amount of time the server instance waits until a connection test is determined to have failed.

If a thread appears to be taking longer than normal to complete a test, the server instance may delay testing on other threads until the abnormally long-running test completes. If that thread hangs too long in connection testing (10 seconds by default), a pool may declare a DBMS connectivity failure, disable itself, and kill all connections, whether unreserved or in application hands. A pool closes all in-test or unused connections, and flags in-use connections to check them later as they may be hanging. After the `Test Frequency Seconds` has passed, WebLogic Server kills any in-use connections that have not progressed.

This is very rare, and is intended to relieve the otherwise interminable hangs that can be caused by network cable disconnects and other problems that can lock any JVM thread which is doing a call in a socket read that the JVM will be unable to break until the OS TCP limit is hit (typically 10 minutes).

The query used in testing is determined by the value in `Test Table Name`. If the value is a table name, the query is `select count(*) from table_name`. If `Test Table Name` includes a full query starting with `SQL` followed by space and the query, WebLogic Server uses that query when testing database connections.

If a connection fails the test, WebLogic Server closes and recreates the connection, and then tests the new connection.

Details about the semantics of connection testing is discussed in the following sections:

- [Connection Testing When Database Connections are Created](#)
- [Periodic Connection Testing](#)
- [Testing Reserved Connections](#)
- [Minimizing Connection Test Delay After Database Connectivity Loss](#)
- [Minimizing Connection Request Delays After Loss of DBMS Connectivity](#)
- [Minimizing Connection Request Delay with Seconds to Trust an Idle Pool Connection](#)

20.2.1.1 Connection Testing When Database Connections are Created

When connections are created in a data source, WebLogic Server tests each connection using the query defined by the value in `Test Table Name`. Connections are created when a data source is deployed, either at server startup or when creating a data source, when increasing capacity to meet demand for connections, or when recreating a connection that failed a connection test.

The purpose of this testing is to ensure that new connections are viable and ready for use when an application requests a connection.

20.2.1.2 Periodic Connection Testing

If `Test Frequency` is greater than 0, WebLogic Server periodically tests the pooled connections that are not currently reserved by applications. The test is based on the query defined in `Test Table Name`. If a connection fails the test, WebLogic Server closes the connection, recreates the connection, and tests the new connection before returning it to the pool.

20.2.1.3 Testing Reserved Connections

When `Test Connections On Reserve` is enabled, when your application requests a connection from the data source, WebLogic Server tests the connection using the query specified in `Test Table Name` before giving the connection to the application. The default value is not enabled.

Testing reserved connections can cause a delay in satisfying connection requests, but it makes sure that the connection is viable when the application gets the connection. You can minimize the impact of testing reserved connections by tuning `Seconds to Trust an Idle Pool Connection`. See [Minimizing Connection Request Delay with Seconds to Trust an Idle Pool Connection](#).

20.2.1.4 Minimizing Connection Test Delay After Database Connectivity Loss

When connectivity to the DBMS is lost, even if only momentarily, some or all of the JDBC connections in a data source typically become terminated. If the data source is configured to test connections on reserve, then when an application requests a database connection, WebLogic Server tests the connection, discovers that the connection is terminated, and tries to replace it with a new connection to satisfy the request. Ordinarily, when the DBMS comes back online, the refresh process succeeds. However, in some cases and for some modes of failure, testing a terminated connection can impose a long delay.

To minimize this delay, WebLogic data sources include logic that considers *all* connections in the data source as terminated after a number of consecutive test failures, and closes all connections in the data source. After all connections are closed, when an application requests a connection, the data source creates a connection without first having to test a terminated connection. This behavior minimizes the delay for connection requests following the data source's connection pool flush.

WebLogic Server determines the number of test failures before closing all connections based on the `test frequency` setting for the data source:

- If test frequency is greater than 0, the number of test failures before closing all connections is set to `CountOfTestFailuresTillFlush`.

Note: The default value is 2.

- If test frequency is set to 0 (periodic testing is disabled), the number of test failures before closing all connections is set to 25% of the `Maximum Capacity` for the data source.

Note: This value is overridden by `CountOfTestFailuresTillFlush` value.

To minimize the delay that occurs during the test of dead database connections, you can set `CountOfTestFailuresTillFlush` attribute on the connection pool. To enable this feature, `TestConnectionsOnReserve` must also be set to `true`.

If the configured or default number of consecutive connection test failures are observed, then all currently unused connections in the pool are terminated so that any subsequent connection requests get a new connection. Active connections are not interrupted but are monitored for activity. If no activity is detected within 60 seconds, these connections are destroyed.

The default value is generally sufficient. You may need to increase this value if your environment has:

- Slow-running applications that may not show JDBC activity for several minutes
- Network/firewall issues that consistently terminate one or two connections

20.2.1.5 Minimizing Connection Request Delays After Loss of DBMS Connectivity

If your DBMS becomes and remains unavailable, the data source will persistently test and try to replace dead connections while trying to satisfy connection requests. This behavior is beneficial because it enables the data source to react immediately when the database becomes available. However, in cases where the DBMS is truly down, it may be minutes, hours, or days before the DBMS is restored. Testing a dead database connection can take as long as the network timeout, and can cause a long delay for clients. This delay occurs for each dead connection in the connection pool until all connections are replaced and can cause long delays to clients before getting the expected failure message.

To minimize the delay that occurs for client applications while a database is unavailable, you can set the `CountOfRefreshFailuresTillDisable` attribute on the connection pool. The default value is 2. To enable this feature, `TestConnectionsOnReserve` must also be set to `true` and `InitialCapacity` must be greater than 0.

If the configured or default number of consecutive failures to replace a dead connection are observed, WebLogic Server suspends the connection pool. If an application requests a connection from a suspended connection pool, WebLogic Server throws `PoolDisabledSQLException` to notify the client that a connection is not available.

For data sources that are disabled in this manner, WebLogic Server periodically runs a refresh process. The refresh process does the following:

- The server instance executes a health check on the database server every 5 seconds. This setting is not configurable.
- If the server instance recognizes that the database was recovered, it creates a new database connection and enables the data source.

You can also manually enable the data source using the WebLogic Server Administration Console or WLST.

Note:

If a data source is added to a multi data source, the multi data source takes over the responsibility of disabling and re-enabling its data sources. By default, a multi data source will check every two minutes (configurable) and re-enable any of its data sources that can re-establish connections. Configure using `test frequency seconds` at the multi data source level. Note that the semantics of this setting are different than at the data source level.

20.2.1.6 Minimizing Connection Request Delay with Seconds to Trust an Idle Pool Connection

For some applications that use DBMS connections in a lot of very short cycles (such as `reserve-do_one_query-close`), the data source's testing of the connection can contribute a significant amount of overhead to each use cycle. To minimize the impact of connection testing, you can set the Seconds To Trust An Idle Pool Connection attribute in the JDBC data source configuration to trust recently-used or recently-tested database connections and skip the connection test.

If Test Reserved Connections is enabled on your data source, when an application requests a database connection, WebLogic Server tests the database connection before giving it to the application. If the request is made within the time specified for Seconds to Trust an Idle Pool Connection, since the connection was tested or successfully used by an application, WebLogic Server skips the connection test before delivering it to an application.

If Test Frequency is greater than 0 for your data source (periodic testing is enabled), WebLogic Server also skips the connection test if the connection was successfully used and returned to the data source within the time specified for Seconds to Trust an Idle Pool Connection.

For instructions to set Seconds to Trust an Idle Pool Connection, see [Configure testing options for a JDBC data source](#) in the *Oracle WebLogic Server Administration Console Online Help*.

Seconds to Trust an Idle Pool Connection is a tuning feature that can improve application performance by minimizing the delay caused by database connection testing, especially during heavy traffic. However, it can reduce the effectiveness of connection testing, especially if the value is set too high. The appropriate value depends on your environment and the likelihood that a connection will become defunct.

20.2.2 Database Connection Testing Configuration Recommendations

You should set connection testing attributes so that they best fit your environment. For example, if your application cannot tolerate database connection failures, you should set Seconds to Trust an Idle Pool Connection to 0 and make sure Test Reserved Connections is enabled so that WebLogic Server will test every connection before giving it to an application. If your application is more sensitive to delays in getting a connection from the data source and can tolerate a possible application failure due to using a dead connection, you should set Seconds to Trust an Idle Pool Connection to a higher number, set Test Frequency to a lower number, and enable Test Reserved Connections.

With these settings, your application will rely more on the data source testing connections in the pool when they are not in use, rather than when an application requests a connection.

Note:

Ultimately, even if WebLogic does its best, a connection may fail in the instant after WebLogic successfully tested it, and just before the application uses it. Therefore, every application should be written to respond appropriately in the case of unexpected exceptions from a dead connection.

When running with AGL and FAN enabled:

- It is not necessary to run with `Test Connections on Reserve` because `ONS` will send *down events* when a database instance goes down. This can significantly improve performance by eliminating (or reducing) testing overhead in the database. However, `Test Connections on Reserve` tests for other failures such as network connectivity and application access to the database. Oracle recommends running with `Test Connections on Reserve` and using `SecondsToTrustAnIdlePoolConnection` and/or `TestFrequencySeconds` to reduce the overhead.
- `CountOfTestFailuresTillFlush` and `CountOfRefreshFailuresTillDisable` are ignored. The disabling an entire RAC instance occurs when a FAN event is received that indicates that the instance is down.

20.2.3 Database Connection Testing Using Default Test Table Name

When you create a data source using the WebLogic Server Administration Console, the WebLogic Server Administration Console automatically sets the `Test Table Name` attribute for a data source based on the DBMS that you select. The `Test Table Name` attribute is used in connection testing which is optionally performed periodically or when you create or reserve a connection, depending on how you configure the testing options. For database tests to succeed, the database user used to create database connections in the data source must have access to the database table. If not, you should either grant access to the user (make this change in the DBMS) or change the `Test Table Name` attribute to the name of a table to which the user does have access (make this change in the WebLogic Server Administration Console).

The `Test Table Name` is an overloaded parameter. Its simplest form is to name a table that WebLogic Server queries to test a connection. Setting it to any table, such as "DUAL" for Oracle, causes the data source to run the query `select count(*) from DUAL`. If used in this mode, Oracle recommends that you choose a small, infrequently updated table (preferably a pseudo-table such as DUAL).

The second manner in which you can define this parameter is to allow any specific SQL string to be executed to test the connection. To use this option, set the parameter to "SQL " plus the desired SQL string. For example `SQL select 1` works for SQLServer, which does not need a table in queries to select constants. This option is useful for adding DBMS-side control of WebLogic Server pool connection testing, and to make the test as fast as possible.

Table 20-1 Default Test Table Name by DBMS

DBMS	Default Test Table Name (Query)
DB2	SQL SELECT COUNT(*) FROM SYSIBM.SYSTABLES
Microsoft SQL Server	SQL SELECT 1

Table 20-1 (Cont.) Default Test Table Name by DBMS

DBMS	Default Test Table Name (Query)
MySQL	SQL SELECT 1
Oracle	SQL ISVALID
Sybase	SQL SELECT 1

20.2.4 Database Connection Testing Options

For applications using an Oracle data base, particularly those with Oracle RAC environments, using the default value of the `Test Table Name` attribute provides the best overall performance.

Oracle continues to support `SQL PINGDATABASE` and `SQL SELECT 1 FROM DUAL`. Although not as thorough as using the default value `SQL SELECT 1 FROM DUAL`, `SQL ISVALID` significantly eliminate processing overhead and improve SOA workload performance.

20.3 Enabling Connection Creation Retries

WebLogic JDBC data sources include the `Connection Creation Retry Frequency` option (`ConnectionCreationRetryFrequencySeconds` in the `JDBCConnectionPoolParamsBean`) that you can use to specify the number of seconds between attempts to establish connections to the database. If set and if the database is unavailable when the data source is created, WebLogic Server attempts to create connections in the pool again after the number of seconds you specify, and will continue to attempt to create the connections until it succeeds. This option applies to connections created when the data source is created at server startup or when the data source is deployed or if the initial capacity is increased. It does *not* apply to connections created for pool expansion or to replace a defunct connection in the pool.

By default, `Connection Creation Retry Frequency` is 0 seconds. When the value is set to 0, connection creation retries is disabled and data source creation fails if the database is unavailable.

See the [JDBC Data Source: Configuration: Connection Pool](#) page in the WebLogic Server Administration Console or see `JDBCConnectionPoolParamsBean` in the *MBean Reference for Oracle WebLogic Server* for more details about this option.

20.4 Enabling Connection Requests to Wait for a Connection

JDBC data sources have two attributes that you can set to enable connection requests to wait for a connection from a data source: `Connection Reserve Timeout` (`ConnectionReserveTimeoutSeconds`) and `Maximum Waiting for Connection` (`HighestNumWaiters`). You use these two attributes together to enable connection requests to wait for a connection without disabling your system by blocking too many threads.

See the [JDBC Data Source: Configuration: Connection Pool](#) page in the WebLogic Server Administration Console or see `JDBCConnectionPoolParamsBean` in the *MBean Reference for Oracle WebLogic Server* for more details about these options.

Also see [Enable connection requests to wait for a connection](#) in the *Administration Console Online Help*.

20.4.1 Connection Reserve Timeout

When an application requests a connection from a data source, if all connections in the data source are in use and if the data source has expanded to its maximum capacity, the application will get a `Connection Unavailable SQL Exception`. To avoid this, you can configure the `Connection Reserve Timeout` value (in seconds) so that connection requests will wait for a connection to become available. After the `Connection Reserve Timeout` has expired, if no connection becomes available, the request will fail and the application will get a `PoolLimitSQLException` exception.

If you set `Connection Reserve Timeout` to `-1`, a connection request will timeout immediately if there is no connection available. If you set `Connection Reserve Timeout` to `0`, a connection request will wait indefinitely. The default value is 10 seconds.

See [Enable connection requests to wait for a connection](#) in the *Oracle WebLogic Server Administration Console Online Help*.

20.4.2 Limiting the Number of Waiting Connection Requests

Connection requests that wait for a connection block a thread. If too many connection requests concurrently wait for a connection and block threads, your system performance can degrade. To avoid this, you can set the `Maximum Waiting for Connection` (`HighestNumWaiters`) attribute, which limits the number connection requests that can concurrently wait for a connection.

If you set `Maximum Waiting for Connection` (`HighestNumWaiters`) to `MAX-INT` (the default), there is effectively no bound on how many connection requests can wait for a connection. If you set `Maximum Waiting for Connection` to `0`, connection requests cannot wait for a connection. If the maximum number of requests has been met, a `SQLException` is thrown when an application requests a connection.

20.5 Automatically Recovering Leaked Connections

A leaked connection is a connection that was not properly returned to the connection pool in the data source. To automatically recover leaked connections, you can specify a value for `Inactive Connection Timeout` on the JDBC Data Source:
Configuration: `Connection Pool` page in the WebLogic Server Administration Console. When you set a value for `Inactive Connection Timeout`, WebLogic Server forcibly returns a connection to the data source when there is no activity on a reserved connection for the number of seconds that you specify. When set to `0` (the default value), this feature is turned off.

See the [JDBC Data Source: Configuration: Connection Pool](#) page in the WebLogic Server Administration Console or see [JDBCConnectionPoolParamsBean](#) in the *MBean Reference for Oracle WebLogic Server* for more details about this option.

Note that the actual timeout could exceed the configured value for `Inactive Connection Timeout`. The internal data source maintenance thread runs every 5 seconds. When it reaches the `Inactive Connection Timeout` (for example 30 seconds), it checks for inactive connections. To avoid timing out a connection that was reserved just before the current check or just after the previous check, the server gives an inactive connection a "second chance." On the next check, if the connection is still inactive, the server times it out and forcibly returns it to the data source. On average, there could be a delay of 50% more than the configured value.

20.6 Avoiding Server Lockup with the Correct Number of Connections

When your applications attempt to get a connection from a data source in which there are no available connections, the data source throws an exception stating that a connection is not available in the data source. To avoid this error, make sure your data source can expand to the size required to accommodate your peak load of connection requests. To increase the maximum number of connections available in the data source, increase the value for Maximum Capacity for the data source on the [JDBC Data Source: Configuration: Connection Pool](#) page in the *Oracle WebLogic Server Administration Console Online Help*.

20.7 Limiting Statement Processing Time with Statement Timeout

With the Statement Timeout option on a JDBC data source, you can limit the amount of time that a statement takes to execute on a database connection reserved from the data source. When you set a value for Statement Timeout, WebLogic Server passes the time specified to the JDBC driver using the `java.sql.Statement.setQueryTimeout()` method. WebLogic Server will make the call, and if the driver throws an exception, the value will be ignored. In some cases, the driver may silently not support the call, or may document limited support. Oracle recommends that you check the driver documentation to verify the expected behavior.

When Statement Timeout is set to -1, (the default) statements do not timeout.

See the [JDBC Data Source: Configuration: Connection Pool](#) page in the *Oracle WebLogic Server Administration Console Online Help* for more details about this option.

20.8 Using Pinned-To-Thread Property to Increase Performance

To minimize the time it takes for an application to reserve a database connection from a data source and to eliminate contention between threads for a database connection, you can set the `Pinned To Thread` option on the JDBC data source to `true`. See the [JDBC Data Source: Configuration: Connection Pool](#) page in the *Oracle WebLogic Server Administration Console Online Help*.

When `Pinned To Thread` is enabled, WebLogic Server pins a database connection from the data source to an execution thread the first time an application uses the thread to reserve a connection. When the application finishes using the connection and calls `connection.close()`, which otherwise returns the connection to the data source, WebLogic Server keeps the connection with the execute thread and does not return it to the data source. When an application subsequently requests a connection using the same execute thread, WebLogic Server provides the connection already reserved by the thread. There is no locking contention on the data source that occurs when multiple threads attempt to reserve a connection at the same time and there is no contention for threads that attempt to reserve the same connection from a limited number of database connections.

Note:

The `Pinned To Thread` feature does not work with an `IdentityPool`. Starting with WebLogic Server Release 12.1.2, configurations with this combination will cause the datasource to fail to deploy.

See [JDBC Data Source: Configuration: Connection Pool](#) in the *Oracle WebLogic Server Administration Console Online Help*.

20.8.1 Changes to Connection Pool Administration Operations When PinnedToThread is Enabled

Because the nature of connection pooling behavior is changed when `PinnedToThread` is enabled, some connection pool attributes or features behave differently or are disabled to suit the behavior change:

- **Maximum Capacity** is ignored. The number of connections in a connection pool equals the greater of either the initial capacity or the number of connections reserved from the connection pool.
- **Shrinking** does not apply to connection pools with `PinnedToThread` enabled because connections are never returned to the connection pool. Effectively, they are always reserved.
- When you **Reset** a connection pool, the reset connections from the connection pool are marked as `Test Needed`. The next time each connection is reserved, WebLogic Server tests the connection and recreates it if necessary. Connections are not tested synchronously when you reset the connection pool. This feature requires that `Test Connections on Reserve` is enabled and a `Test Table Name` or query is specified.

Consider the following when using the `PinnedToThread` feature:

- If used with `Identity Based Connection Pooling Enabled` set to `true`, an error is thrown and the data source will not deploy.
- When used with `Use Database Credentials` set to `true`, all connections are owned by the default user as defined in the JDBC descriptor but the Oracle proxy is set to the user and password specified on `getConnection(user, password)`. Similarly, with `Oracle Proxy` set to `true`, the user and password are mapped to a database credential and the Oracle proxy is set. This is the same behavior as without `PinnedToThread`.
- Connection labeling is not supported when using `PinnedToThread` and an exception is thrown when trying to get a connection with label properties.
- When using `Multi-datasource`, connections are maintained by each member datasources as they are selected by the multi-datasource. For example, with `Algorithm Type` of `Failover`, connections are initially be maintained only for the primary member of MDS. If a failover occurs, then connections are maintained for the next member of the MDS. When used with the `Algorithm Type` of `Load-Balancing`, connections are maintained for each member of the MDS.
- When using `Active GridLink`, `Affinity` and `Runtime Load Balancing` continue to work as before with regard to choosing an instance. As many as one connection is stored per instance per thread (the equivalent of setting `OnePinnedConnectionOnly=true` but on a per instance basis). `Gravitation` is not supported (no migration of connections to lightly used nodes).

20.8.2 Additional Database Resource Costs When PinnedToThread is Enabled

When `PinnedToThread` is enabled, the maximum capacity of the connection pool (maximum number of database connections created in the connection pool) becomes

the number of execute threads used to request a connection multiplied by the number of concurrent connections each thread reserves. This may exceed the **Maximum Capacity** specified for the connection pool. You may need to consider this larger number of connections in your system design and ensure that your database allows for additional associated resources, such as open cursors.

Also note that connections are never returned to the connection pool, which means that the connection pool can never shrink to reduce the number of connections and associated resources in use. You can minimize this cost by setting an additional driver parameter `onePinnedConnectionOnly`. When `onePinnedConnectionOnly=true`, only the first connection requested is pinned to the thread. Any additional connections required by the thread are taken from and returned to the connection pool as needed. Set `onePinnedConnectionOnly` using the `Properties` attribute, for example:

```
Properties="onePinnedConnectionOnly=true;user=examples"
```

If your system can handle the additional resource requirements, Oracle recommends that you use the `PinnedToThread` option to increase performance.

If your system cannot handle the additional resource requirements or if you see database resource errors after enabling `PinnedToThread`, Oracle recommends *not* using `PinnedToThread`.

20.9 Using Unwrapped Data Type Objects

Some JDBC objects from a driver that are returned from WebLogic Server are wrapped by default. Wrapping data source objects provides WebLogic Server the ability to:

- Generate debugging output from all method calls.
- Track connection utilization so that connections can be timed out appropriately.
- Provide transparent automatic transaction enlistment and security authorization.

WebLogic Server provides the ability to disable the wrapping of some objects which provides the following benefits:

- Although WebLogic Server generates a dynamic proxy for vendor methods that implement an interface to show through the wrapper, some data types do not implement an interface. For example, Oracle data types `Array`, `Blob`, `Clob`, `NClob`, `Ref`, `SQLXML`, and `Struct` are classes that do not implement interfaces. Disabling wrapping allows applications to use native driver objects directly.

Note:

Oracle recommends not using these concrete classes and instead using standard SQL types or corresponding Oracle interfaces. See *Using API Extensions for Oracle JDBC Types* in *Developing JDBC Applications for Oracle WebLogic Server*.

- Eliminating wrapping overhead can provide a significant performance improvement.

When wrapping is disabled (the `wrap-types` element is `false`), the following data types are not wrapped:

- Array
- Blob
- Clob
- NClob
- Ref
- SQLXML
- Struct
- ParameterMetaData
 - No connection testing performed.
- ResultSetMetaData
 - No connection testing performed.
 - No result set testing performed.
 - No JDBC MT profiling performed.

20.9.1 How to Disable Wrapping

You can use the WebLogic Server Administration Console and WLST to disable data type wrapping.

20.9.1.1 Disable Wrapping using the Administration Console

To disable wrapping of JDBC data type objects:

1. If you have not already done so, in the Change Center of the WebLogic Server Administration Console, click **Lock & Edit**.
2. In the **Domain Structure** tree, expand **Services**, then select **Data Sources**.
3. On the Summary of Data Sources page, click the data source name.
4. Select the **Configuration: Connection Pool** tab.
5. Scroll down and click **Advanced** to show the advanced connection pool options.
6. In **Wrap Data Types**, deselect the checkbox to disable wrapping.
7. Click **Save**.
8. To activate these changes, in the Change Center of the WebLogic Server Administration Console, click **Activate Changes**.

This change does not take effect immediately—it requires that the data source be redeployed or the server be restarted.

20.9.1.2 Disable Wrapping using WLST

The following is a WLST code snippet to disable data type wrapping:

```
. . .  
jdbcSR = create(dsname, "JDBCSystemResource");
```

```
theJDBCResource = jdbcSR.getJDBCResource();
poolParams = theJDBCResource.getJDBCConnectionPoolParams();
poolParams.setWrapTypes(false);
. . .
```

This change does not take effect immediately—it requires that the data source be redeployed or the server be restarted.

20.10 Tuning Maintenance Timers

The following section provides information on tunable timer properties used by WebLogic JDBC:

- `weblogic.jdbc.gravitationShrinkFrequencySeconds`—Connections may be shut down periodically on GridLink data sources. If the connections allocated to various RAC instances do not correspond to the Runtime Load Balancing percentages in the FAN load-balancing advisories, connections to overweight instances are destroyed and new connections opened. This process occurs every 30 seconds by default. You can tune this behavior using the `weblogic.jdbc.gravitationShrinkFrequencySeconds` system property which specifies the amount of time, in seconds, the system waits before rebalancing connections. A value less than or equal to 0 disables the rebalancing process.
- `weblogic.jdbc.harvestingFrequencySeconds`—Connection harvesting releases reserved connections that are marked harvestable by the application when a data source falls to a specified number of available connections. This check by default is done every 30 seconds. This system property can be used to change the frequency of harvesting by Data Source the amount of time, in seconds. If set less than or equal to 0, connection harvesting is turned off. See [Recover Harvested Connections](#).
- `weblogic.jdbc.securityCacheTimeoutSeconds`—Performance is impacted when reserving connections from a connection pool, due to the credentials for the WebLogic server user being checked for each reserve connection request. To resolve this, checking can be controlled by this system property. If less than or equal to zero, the cache is turned off and user authentication happens each time. If greater than zero, user authentication is done only once for each user in the specified time period in seconds; the value is then cached. In situations where pool access restrictions are dynamically altered, the pool re-authenticates the users once each time after the cache is cleared. The default value is 10 minutes.

Using an Oracle 12c Database

This appendix provides information on how use WebLogic Server Release 12.1.2 and higher with an Oracle 12c database. Oracle provides several new features that specifically require the use of an Oracle 12c database and Oracle 12c JDBC driver.

This appendix includes the following sections:

- [WebLogic JDBC Features for Oracle 12c Database](#)
- [Summary of 12C Database Feature Support with WebLogic Server](#)

A.1 WebLogic JDBC Features for Oracle 12c Database

The following section provides a list of WebLogic JDBC features for Oracle 12c Database:

- [JDBC 4.1 Support for JDK 7](#)
- [Application Continuity Support](#)
- [Database Resident Connection Pooling Support](#)
- [Container Database with Pluggable Databases](#)
- [Global Database Services Support](#)
- [Automatic ONS Listeners](#)

A.1.1 JDBC 4.1 Support for JDK 7

WebLogic Server supports the JDBC 4.1 Specification when the environment is using JDK 7 and the JDBC driver is JDBC 4.1 compliant. To use new JDBC 4.1 methods, you must use the `ojdbc7.jar`. See [JDBC™ 4.1 Specification](http://download.oracle.com/otndocs/jcp/jdbc-4_1-mrel-spec/index.html) at http://download.oracle.com/otndocs/jcp/jdbc-4_1-mrel-spec/index.html.

Note:

WebLogic Server currently does not support the `java.sql.driver` interfaces required to use the Java SE 7 `getParentLogger` method. See <http://docs.oracle.com/javase/7/docs/api/index.html?java/sql/Driver.html>.

JDK 7 also brings support for minor changes in Rowset 1.1 defined at <http://jcp.org/aboutJava/communityprocess/maintenance/jsr114/114MR2approved.pdf>. The WebLogic Server implementation of the new `RowSetFactory` is called `weblogic.jdbc.rowset.JdbcRowSetFactory`.

A.1.2 Application Continuity Support

Application Continuity is an Oracle database feature that provides a general purpose, application-independent infrastructure that enables recovery of work and masks many system, communication, and hardware failures. See [Application Continuity](#).

A.1.3 Database Resident Connection Pooling Support

Database Resident Connection Pooling (DRCP) is an Oracle database server feature that provides the ability to share connections among multiple connection pools that can span across mid-tier systems. See [Database Resident Connection Pooling](#).

A.1.4 Container Database with Pluggable Databases

Container Database (CDB) is an Oracle Database feature that minimizes the overhead of having many of databases by consolidating them into a single database with multiple Pluggable Databases (PDB) in a single CDB. See [Container Database with Pluggable Databases](#).

A.1.5 Global Database Services Support

Global Data Services (GDS) is an Oracle database server feature that provides automated load balancing, fault tolerance and resource utilization in a distributed database environment. See [Global Database Services](#).

A.1.6 Automatic ONS Listeners

If you are using an Oracle 12c database with WebLogic Server Release 12.1.2 and higher, you are no longer required to provide the ONS Listener list as part of an Active GridLink datasource configuration. The ONS list is automatically provided from the database to the driver. See [Enabling FAN Events](#).

A.2 Summary of 12C Database Feature Support with WebLogic Server

This section provides information on how Oracle 12c database features are supported in WebLogic Server releases.

Table A-1 Summary of 12c Database Feature Support with WebLogic Server

Feature	WebLogic Server 10.3.6/12.1.x with 11g drivers and 11gR2 DB	WebLogic Server 10.3.6/12.1.x with 11g drivers and 12c DB	WebLogic Server 10.3.6/12.1.1 with 12c drivers and 11gR2 DB	WebLogic Server 12.1.2 and higher with 12c drivers and 11gR2 DB	WebLogic Server 10.3.6/12.1.1 with 12c drivers and 12c DB	WebLogic Server 12.1.2 and higher with 12c drivers with 12c DB
JDBC replay (read/write)	No	No	No	No	Yes (Read/Write with Active GridLink only, no XA transactions)	Yes (Read/Write with Active GridLink and generic data source, no XA transactions)
Pluggable Database (PDB)	No	Yes (Except Set Container)	No	No	Yes	Yes
Dynamic switching between PDBs	No	No	No	No	No	Yes (no XA)
Database Resident Connection pooling (DRCP)	No	No	No	Yes	No	Yes
Oracle Notification Service (ONS) auto configuration	No	No	No	No	No	Yes (Active GridLink only)
Global Database Services (GDS)	No	Yes (Active GridLink only)	No	No	Yes (Active GridLink only)	Yes (Active GridLink only)
JDBC 4.1 (using ojdbc7.jar files & JDK 7)	No	No	Yes	Yes	Yes	Yes

Configuring JDBC Application Modules for Deployment

This appendix provides information on how to package and scope a datasource for use in enterprise applications and describes the details of packaged JDBC modules.

Note:

This chapter provides information on a proprietary mechanism provided by WebLogic Server prior to the DatasourceDefinition feature introduced in Java EE 6. See Using Java EE DataSources Resource Definitions in *Developing JDBC Applications for Oracle WebLogic Server*.

When you package your enterprise application, you can include JDBC resources in the application by packaging JDBC modules in the archive and adding references to the JDBC modules in all applicable descriptor files. When you deploy the application, the JDBC resources are deployed, too. Depending on how you configure the JDBC modules, the JDBC data sources deployed with the application will either be restricted for use only by the containing application (*application-scoped modules*) or will be available to all applications and clients (*globally-scoped modules*).

This appendix includes the following sections:

- [Packaging a JDBC Module with an Enterprise Application: Main Steps](#)
- [Creating Packaged JDBC Modules](#)
- [Referencing a JDBC Module in Java EE Descriptor Files](#)
- [Packaging an Enterprise Application with a JDBC Module](#)
- [Deploying an Enterprise Application with a JDBC Module](#)
- [Getting a Database Connection from a Packaged JDBC Module](#)

B.1 Packaging a JDBC Module with an Enterprise Application: Main Steps

The main steps for creating, packaging, and deploying a JDBC module with an enterprise application are as follows:

1. Create the module. See [Creating Packaged JDBC Modules](#).
2. Add references to the module in all applicable descriptor files. See [Referencing a JDBC Module in Java EE Descriptor Files](#).
3. Package all application modules in an EAR. See [Packaging an Enterprise Application with a JDBC Module](#).

4. Deploy the application. See [Deploying an Enterprise Application with a JDBC Module](#).

B.2 Creating Packaged JDBC Modules

You can create JDBC application modules using any development tool that supports creating an XML descriptor file. You then deploy and manage JDBC modules using JSR 88-based tools, such as the `weblogic.Deployer` utility, or the WebLogic Server Administration Console.

Note:

You can create a JDBC data source using the WebLogic Server Administration Console, then copy the module as a template for use in your applications. You must change the name and `jndi-name` elements of the module before deploying it with your application to avoid a naming conflict in the namespace.

Each JDBC module represents a data source. Modules that represent a generic or Active GridLink (AGL) data source include all of the configuration parameters for the generic or AGL data source. Modules that represent a multi data source include configuration parameters for the multi data source, including a list of generic data source modules used by the multi data source.

B.2.1 Creating a JDBC Data Source Module Using the Administration Console

To create a data source module in the WebLogic Server Administration Console that you can re-use as an application module, follow these steps.

1. Create a data source as described in [Creating a JDBC Data Source](#). The data source module is created in the `config/jdbc` subdirectory of the domain directory.
2. Copy the `data-source-name.xml` file to a subdirectory within your application and rename the copy to include `-jdbc` as a suffix, such as `new-data-source-name-jdbc.xml`.
3. Open the file in an editor and change the following elements:
 - `name`—change the name to a name that is unique within the domain.
 - `jndi-name`—change the `jndi-name` to a name that you want the enterprise application to use to lookup the data source in the local application context.
 - `scope`—optionally, to limit access to the data source to only the containing application, add a `scope` element to the `jdbc-data-source-params` section of the module. For example, `<scope>Application</scope>`. See [Application Scoping for a Packaged JDBC Module](#).
4. Continue with adding references to the descriptor files in the enterprise application. See [Referencing a JDBC Module in Java EE Descriptor Files](#).

B.2.2 JDBC Packaged Module Requirements

A JDBC module must meet the following criteria:

- Conforms to the `jdbc-data-source.xsd` schema. The schema is available at <http://www.oracle.com/webfolder/technetwork/weblogic/jdbc-data-source/index.html>.
- Uses a file name that ends in `-jdbc.xml`.
- Includes a name element that is unique within the WebLogic domain.

Data source modules must also include the following JDBC driver parameters:

- `url`
- `driver-name`
- `properties`, including any properties required by the JDBC driver to create database connections, such as a user name and password.

Multi data source modules must also include the `data-source-list`, which is a list of data source modules, separated by commas, that the multi data source uses to satisfy database connection requests from applications.

Note:

All data sources listed in the `data-source-list` must have the same XA and transaction protocol settings.

All other configuration parameters are optional or have a default value that WebLogic Server uses if a value is not specified. However, to create a useful JDBC module, you will likely need to specify additional configuration options as required by your applications and your environment.

B.2.3 JDBC Application Module Limitations

Note the following limitations for JDBC application modules:

- The `LoggingLastResource` global-transactions-protocol is not permitted for use in JDBC application modules.
- When deploying an application in production with application-scoped JDBC resources, if the resource uses `EmulateTwoPhaseCommit` for the global-transactions-protocol, you cannot deploy multiple versions of the application at the same time.

B.2.4 Creating a Generic Data Source Module

The main sections within a JDBC data source module are:

- `jdbc-driver-params`—includes entries for the JDBC driver used to create database connections, including `url`, `driver-name`, and individual driver property entries. See the `jdbc-data-source.xsd` schema for more valid entries. For an explanation of each element, see [JDBCDataSourceParamsBean](#) in the *MBean Reference for Oracle WebLogic Server*.
- `jdbc-connection-pool-params`—includes entries for connection pool configuration, including connection testing options, statement cache options, and so forth. This element also inherits `connection-pool-params` from the `weblogic-javaee.xsd` schema, including `initial-capacity`, `min-`

capacity, max-capacity, and other options common to pooled resources. For more information, see the following:

- ["JDBCConnectionPoolParamsBean"](#) in the *MBean Reference for Oracle WebLogic Server*
- jdbc-data-source.xsd schema
- jdbc-data-source-params—includes entries for data source behavior options and transaction processing options, such as jndi-name, row-prefetch-size, and global-transactions-protocol. See the jdbc-data-source.xsd schema for more valid entries. For an explanation of each element, see [JDBCDataSourceParamsBean](#) in the *MBean Reference for Oracle WebLogic Server*.
- jdbc-xa-params—includes entries for XA database connection handling options, such as keep-xa-conn-till-tx-complete, and xa-transaction-timeout. For an explanation of each element, see ["JDBCXAParamsBean"](#) in the *MBean Reference for Oracle WebLogic Server*.

Example B-1 shows an example of a JDBC module for a data source with some typical configuration options.

Example B-1 Sample Generic Data Source Module

```
<jdbc-data-source xsi:schemaLocation="http://www.bea.com/ns/weblogic/90/domain.xsd"
xmlns="http://xmlns.oracle.com/weblogic/jdbc-data-source"
xmlns:sec="http://www.bea.com/ns/weblogic/90/security"
xmlns:xsi="http://www.w3.org/2001/XMLSchema-instance"
xmlns:wls="http://www.bea.com/ns/weblogic/90/security/wls">
  <name>examples-demoXA-2</name>
  <jdbc-driver-params>
    <url>jdbc:derby://localhost:1527/examples;create=true</url>
    <driver-name>org.apache.derby.jdbc.ClientXADataSource</driver-name>
    <properties>
      <property>
        <name>user</name>
        <value>examples</value>
      </property>
      <property>
        <name>DatabaseName</name>
        <value>examples</value>
      </property>
    </properties>
    <password-encrypted>{AES}MEK6bPum8M69KRP4FANx3TG/00iSWRYu2rZGUwnVo6U=</password-encrypted>
  </jdbc-driver-params>
  <jdbc-connection-pool-params>
    <max-capacity>100</max-capacity>
    <connection-reserve-timeout-seconds>25</connection-reserve-timeout-seconds>
    <test-table-name>SQL SELECT 1 FROM SYS.SYSTABLES</test-table-name>
  </jdbc-connection-pool-params>
  <jdbc-data-source-params>
    <global-transactions-protocol>TwoPhaseCommit</global-transactions-protocol>
  </jdbc-data-source-params>
</jdbc-data-source>
```

B.2.5 Creating an Active GridLink Data Source Module

AGL data source modules are similar to generic data source system modules. AGL data sources include an jdbc-oracle-params section that includes ONS and FAN.

B.2.6 Creating a Multi Data Source Module

A JDBC multi data source module is much simpler than a generic data source module. Only one main section is required: `jdbc-data-source-params`. The `jdbc-data-source-params` element in a multi data source differs in that it contains options for multi data source behavior options instead of data source behavior options. Only the following parameters in the `jdbc-data-source-params` are valid for multi data sources:

- `jndi-name` (required)
- `data-source-list` (required)
- `scope`
- `algorithm-type`
- `connection-pool-failover-callback-handler`
- `failover-request-if-busy`

For an explanation of each element, see [JDBCDataSourceParamsBean](#) in the *MBean Reference for Oracle WebLogic Server*.

[Example B-2](#) shows an example of a JDBC module for a data source with some typical configuration options.

Example B-2 Sample JDBC Multi Data Source Module

```
<jdbc-data-source xmlns="http://xmlns.oracle.com/weblogic/jdbc-data-source">
  <name>examples-demoXA-multi-data-source</name>
  <jdbc-data-source-params>
    <jndi-name>examples-demoXA -multi-data-source</jndi-name>
    <algorithm-type>Load-Balancing</algorithm-type>
    <data-source-list>examples-demoXA,examples-demoXA-2</data-source-list>
  </jdbc-data-source-params>
</jdbc-data-source>
```

B.2.7 Encrypting Database Passwords in a JDBC Module

Oracle recommends that you encrypt database passwords in a JDBC module to keep your data secure. To encrypt a database password, you process the password with the WebLogic Server `encrypt` utility, which returns an encrypted equivalent of the password that you include in the JDBC module as the `password-encrypted` element. For more details about using the WebLogic Server `encrypt` utility, see `encrypt` in the *WLST Command Reference for WebLogic Server*.

B.2.7.1 Deploying JDBC Modules to New Domains

It is common practice for JDBC modules to be moved from one domain to another, such as moving an application from development to production. However, the encryption key generated by the WebLogic Server `encrypt` utility is not transferable to a new domain. When moving a JDBC module with an encrypted database password, you must do one of the following:

- Override the old encrypted password within a deployment plan that includes a password that was encrypted specifically for the new domain. See [Update a deployment plan](#) in *Oracle WebLogic Server Administration Console Online Help*.

- Re-encrypt the passwords for your new domain. See [Encrypting Database Passwords in a JDBC Module](#).
- If you use the Oracle wallet, you can simply reference the wallet and copy the wallet file to the new domain. See [Creating and Managing Oracle Wallet](#).

B.2.8 Application Scoping for a Packaged JDBC Module

By default, when you package a JDBC module with an application, the JDBC resource is globally scoped—that is, the resource is bound to the global JNDI namespace and is available to all applications and clients. To reserve the resource for use only by the enclosing application, you must include the `<scope>Application</scope>` parameter in the `jdbc-data-source-params` element in the JDBC module, which binds the resource to the local application namespace. For example:

```
<jdbc-data-source-params>
  <jndi-name>examples-demoXA-2</jndi-name>
  <scope>Application</scope>
</jdbc-data-source-params>
```

All generic data sources in a multi data source for an application-scoped JDBC module must also be application scoped.

B.3 Referencing a JDBC Module in Java EE Descriptor Files

When you package a JDBC module with an enterprise application, you must reference the module in all applicable descriptor files, including among others:

- `weblogic-application.xml`
- `ejb-jar.xml`
- `weblogic-ejb-jar.xml`
- `web.xml`
- `weblogic.xml`

[Figure B-1](#) shows the relationship between entries in various descriptor files for an EJB application and how they refer to a JDBC module packaged with the application.

Figure B-1 Relationship Between JDBC Modules and Descriptors in an Enterprise Application

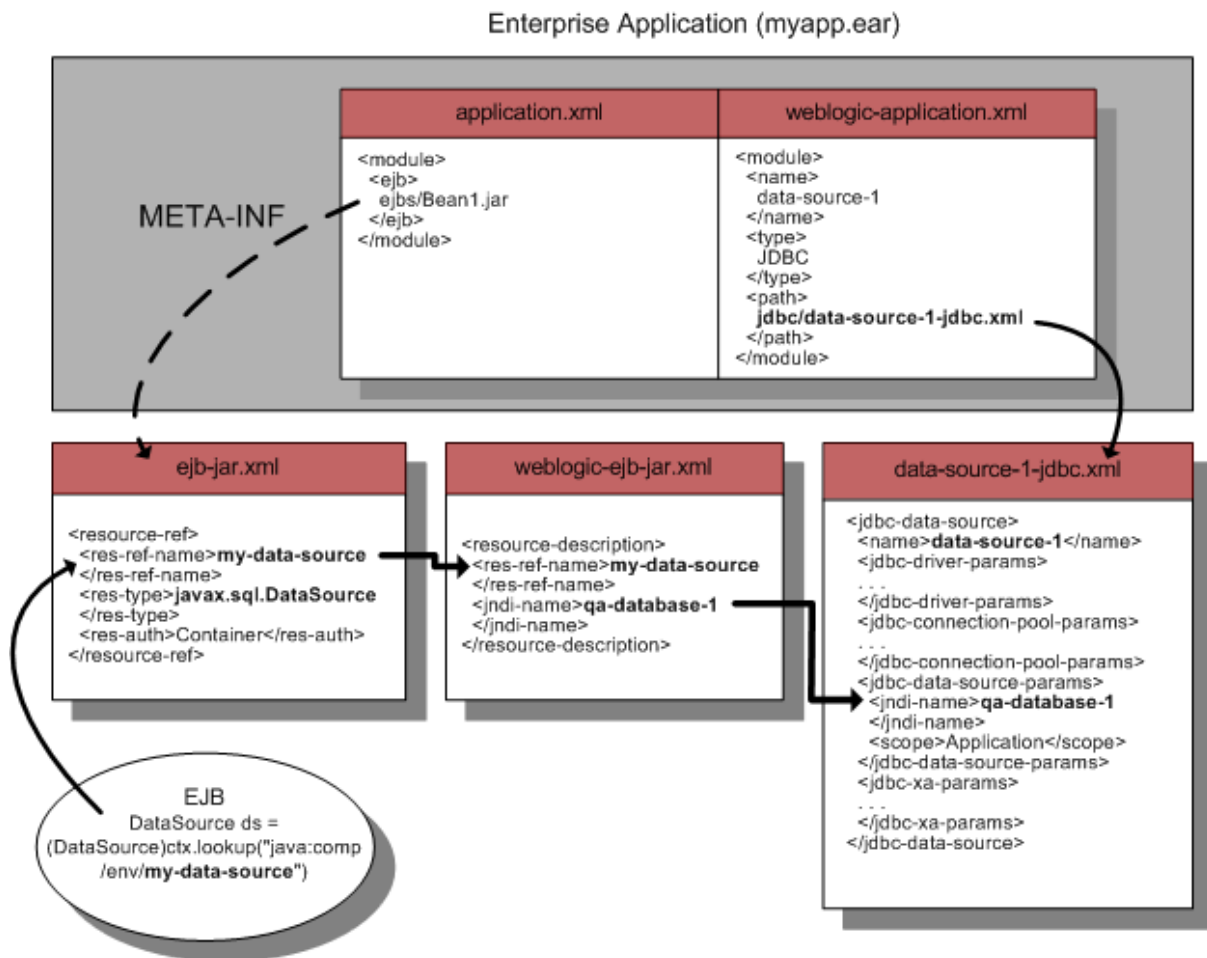

B.3.1 Packaged JDBC Module References in weblogic-application.xml

When including JDBC modules in an enterprise application, you must list each JDBC module as a `module` element of type `JDBC` in the `weblogic-application.xml` descriptor file packaged with the application. For example:

```
<module>
  <name>data-source-1</name>
  <type>JDBC</type>
  <path>databases/data-source-1-jdbc.xml</path>
</module>
```

B.3.2 Packaged JDBC Module References in Other Descriptors

For other application modules in your enterprise application to use the JDBC modules packaged with your application, you must add the following entries in the descriptor files packaged with application modules:

- In the standard Java EE descriptor files packaged with your application modules, such as `ejb-jar.xml` for an EJB, you must add `resource-ref-name` references to specify the JNDI name of the data source as used in the application. For example:

```
<resource-ref>
  <res-ref-name>my-data-source</res-ref-name>
  <res-type>javax.sql.DataSource</res-type>
  <res-auth>Container</res-auth>
</resource-ref>
```

In this example, `my-data-source` is the data source name as used in the application module. Your application would look up the data source with the following code:

```
javax.sql.DataSource ds =
    (javax.sql.DataSource) ctx.lookup("java:comp/env/my-data-source");
```

- In the WebLogic-specific descriptor files, such as `weblogic-ejb-jar.xml` for an EJB, you must map each `resource-ref-name` reference to the `jndi-name` element of a data source. For example:

```
<resource-description>
  <res-ref-name>my-data-source</res-ref-name>
  <jndi-name>qa-database-1</jndi-name>
</resource-description>
```

In this example, the resource name (`<res-ref-name>my-data-source</res-ref-name>`) from the standard descriptor is mapped to the JNDI name (`<jndi-name>qa-database-1</jndi-name>`) of the data source in the JDBC module.

[Figure B-1](#) shows the mapping of the of the data source name as used in the application module to the JNDI name of the JDBC data source in the JDBC module.

Note:

For application-scoped data sources, if you do not add these entries to the descriptor files, your application will be unable to look up the data source to get a database connection.

B.4 Packaging an Enterprise Application with a JDBC Module

You package an application with a JDBC module as you would any other enterprise application. See *Packaging Applications Using `wlpackage` in *Developing Applications for Oracle WebLogic Server*.*

B.5 Deploying an Enterprise Application with a JDBC Module

You deploy an application with a JDBC module as you would any other enterprise application. See *Deploying Applications Using `wldeploy` in *Developing Applications for Oracle WebLogic Server*.*

Note:

When deploying an application in production with application-scoped JDBC resources, if the resource uses `EmulateTwoPhaseCommit` for the `global-transactions-protocol`, you cannot deploy multiple versions of the application at the same time.

B.6 Getting a Database Connection from a Packaged JDBC Module

To get a connection from JDBC module packaged with an enterprise application, you look up the data source defined in the JDBC module in the local environment (`java:comp/env`) or on the JNDI tree and then request a connection from the data source or multi data source. For example:

```
javax.sql.DataSource ds =  
    (javax.sql.DataSource) ctx.lookup("java:comp/env/my-data-source");  
java.sql.Connection conn = ds.getConnection();
```

When you are finished using the connection, make sure you close the connection to return it to the connection pool in the data source:

```
conn.close();
```

Using Multi Data Sources with Oracle RAC

This appendix provides information on how to configure and use multi data sources when using Oracle Real Application Clusters (RAC) with WebLogic Server. Oracle continues to support multi data source configurations for legacy application environments using RAC.

This appendix includes the following sections:

- [Overview of Oracle Real Application Clusters](#)
- [Software Requirements](#)
- [JDBC Driver Requirements](#)
- [Hardware Requirements](#)
- [Configuring Multi Data Sources with Oracle RAC](#)
- [Using Multi Data Sources with Global Transactions](#)
- [Using Multi Data Sources without Global Transactions](#)
- [Configuring Connections to Services on Oracle RAC Nodes](#)
- [Using SCAN Addresses with Multi Data Sources](#)
- [XA Considerations and Limitations when using multi Data Sources with Oracle RAC](#)
- [JDBC Store Recovery with Oracle RAC](#)

Both Oracle RAC and WebLogic Server are complex systems. To use them together requires specific configuration on both systems, as well as clustering software and a shared storage solution. This section describes the configuration required at a high level. For more details about configuring Oracle RAC, your clustering software, your operating system, and your storage solution, see the documentation from the respective vendors.

Note:

Oracle recommends using Active GridLink data sources when developing new Oracle RAC applications and when legacy applications do not use multi data sources. See [Using WebLogic Server with Oracle RAC](#).

C.1 Overview of Oracle Real Application Clusters

Oracle Real Application Clusters (Oracle RAC) is a software component you can add to a high-availability solution that enables users on multiple machines to access a

single database with increased performance. Oracle RAC comprises two or more Oracle database instances running on two or more clustered machines and accessing a shared storage device via cluster technology. To support this architecture, the machines that host the database instances are linked by a high-speed interconnect to form the cluster. The interconnect is a physical network used as a means of communication between the nodes of the cluster. Cluster functionality is provided by the operating system, Oracle Automatic Storage Management (ASM), or compatible third party clustering software. [Figure C-1](#) shows an Oracle RAC configuration.

Figure C-1 Oracle Real Application Clusters Configuration

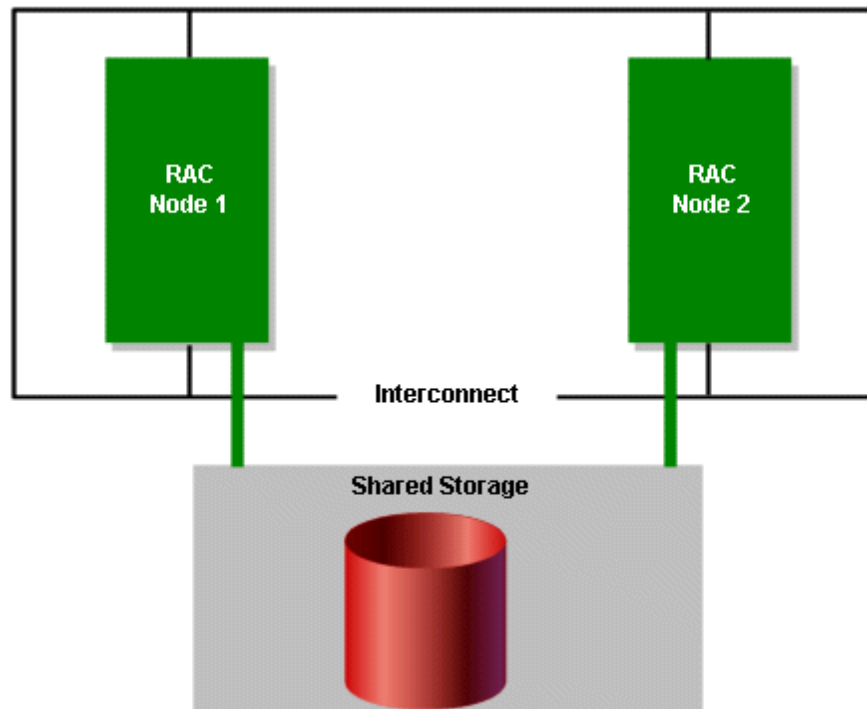

Oracle RAC offers features in the following areas:

- [Oracle RAC Scalability with WebLogic Server Multi Data Sources.](#)
- [Oracle RAC Availability with WebLogic Server Multi Data Sources.](#)
- [Oracle RAC Load Balancing with WebLogic Server Multi Data Sources.](#)

C.1.1 Oracle RAC Scalability with WebLogic Server Multi Data Sources

An Oracle RAC installation appears like a single standard Oracle database and is maintained using the same tools and practices. All the nodes in the cluster execute transactions against the same database and Oracle RAC coordinates each node's access to the shared data to maintain consistency and ensure integrity. You can add nodes to the cluster easily and there is no need to partition data when you add them. This means that you can horizontally scale the database tier as usage and demand grows by adding Oracle RAC nodes, storage, or both.

As the number of nodes in an Oracle RAC increases, you scale the number of generic data sources by the number of nodes added to the Oracle RAC. This requires a complex configuration (requiring $n+1$ data sources where n is the number of generic data sources plus a multi data source) that requires administrative intervention when the Oracle RAC topology changes.

C.1.2 Oracle RAC Availability with WebLogic Server Multi Data Sources

A multi data source provides an ordered list of generic data sources to use to satisfy connection requests. Normally, every connection request to this kind of multi data source is served by the first generic data source in the list. If a database connection test fails and the connection cannot be replaced, or if the generic data source is suspended, a connection is sought sequentially from the next generic data source on the list. See [Failover](#) and [Multi Data Source-Managed Failover and Load Balancing](#).

C.1.3 Oracle RAC Load Balancing with WebLogic Server Multi Data Sources

Multi data sources provide load balancing for XA and non-XA environments. The generic data sources that form a multi data source are accessed using a round-robin scheme. When switching connections, WebLogic Server selects a connection from the next generic data source in the order listed.

C.2 Software Requirements

To use WebLogic Server with Oracle RAC, you must install the following software on each Oracle RAC node:

- Operating system patches required to support Oracle RAC. See the release notes from Oracle for details.
- Oracle 11g database management system
- Clustering software for your operating system. See the Oracle documentation for supported clustering software and cluster configurations.
- Shared storage software, such as Oracle Automated Storage Management (ASM). Note that some clustering software includes a file storage solution, in which case additional shared storage software is not required.

Note:

See Supported Configurations in *What's New in Oracle WebLogic Server 12.2.1.2.0* for the latest WebLogic Server hardware platform and operating system support, and for the Oracle RAC versions supported by WebLogic Server versions and service packs. See the Oracle documentation for hardware and software requirements required for running the Oracle RAC software.

C.3 JDBC Driver Requirements

To use WebLogic Server with Oracle RAC, your WebLogic generic data sources must use the Oracle JDBC Thin driver 11g or later to create database connections.

C.4 Hardware Requirements

A typical WebLogic Server/Oracle RAC system includes a WebLogic Server cluster, an Oracle RAC cluster, and hardware for shared storage.

C.4.1 WebLogic Server Cluster

The WebLogic Server cluster can be configured in many ways and with various hardware options. See *Administering Clusters for Oracle WebLogic Server* for more details about configuring a WebLogic Server cluster.

C.4.2 Oracle RAC Cluster

For the latest hardware requirements for Oracle RAC, see the Oracle RAC documentation. However, to use Oracle RAC with WebLogic Server, you must run Oracle RAC instances on robust, production-quality hardware. The Oracle RAC configuration must deliver database processing performance appropriate for reasonably-anticipated application load requirements. Unusual database response delays can lead to unexpected behavior during database failover scenarios.

C.4.3 Shared Storage

In an Oracle RAC configuration, all data files, control files, and parameter files are shared for use by all Oracle RAC instances. An HA storage solution that uses one of the following architectures is recommended:

- Direct Attached Storage (DAS), such as a dual ported disk array or a Storage Area Network (SAN)
- Network Attached Storage (NAS)

For a complete list of supported storage solutions, see your Oracle documentation.

C.5 Configuring Multi Data Sources with Oracle RAC

When using Multi data sources with Oracle RAC, you must configure your WebLogic Domain so that it can interact with Oracle RAC instances and so that it performs as expected. The following sections describe configuration options and requirements:

- [Choosing a Multi Data Source Configuration for Use with Oracle RAC](#)
- [Configuring Multi Data Sources for use with Oracle RAC](#)
- [Configuration Considerations for Failover](#)
- [Configuring the Listener Process for Each Oracle RAC Instance](#)
- [Configuring Multi Data Sources When Remote Listeners are Enabled or Disabled](#)
- [Additional Configuration Considerations](#)

C.5.1 Choosing a Multi Data Source Configuration for Use with Oracle RAC

WebLogic Server multi data sources support several configuration options for using Oracle RAC:

- To connect to multiple Oracle RAC instances when using global transactions (XA), see [Using Multi Data Sources with Global Transactions](#).
- To connect to multiple Oracle RAC instances when not using XA, see [Using Multi Data Sources without Global Transactions](#).

- You can also configure multi data sources to connect to specific services that are running on Oracle RAC nodes. Both XA and non-XA drivers are supported, see [Configuring Connections to Services on Oracle RAC Nodes](#).

C.5.2 Configuring Multi Data Sources for use with Oracle RAC

To connect WebLogic Server to multiple Oracle RAC nodes using multi data sources, first configure a generic data source for each Oracle RAC instance in your Oracle RAC cluster with the Oracle Thin driver. Then configure a multi data source, using either the algorithm for load balancing or the algorithm for failover, and add generic data sources to it.

[Figure C-2](#) shows a typical multi data source configuration.

Figure C-2 Multi Data Source Configuration

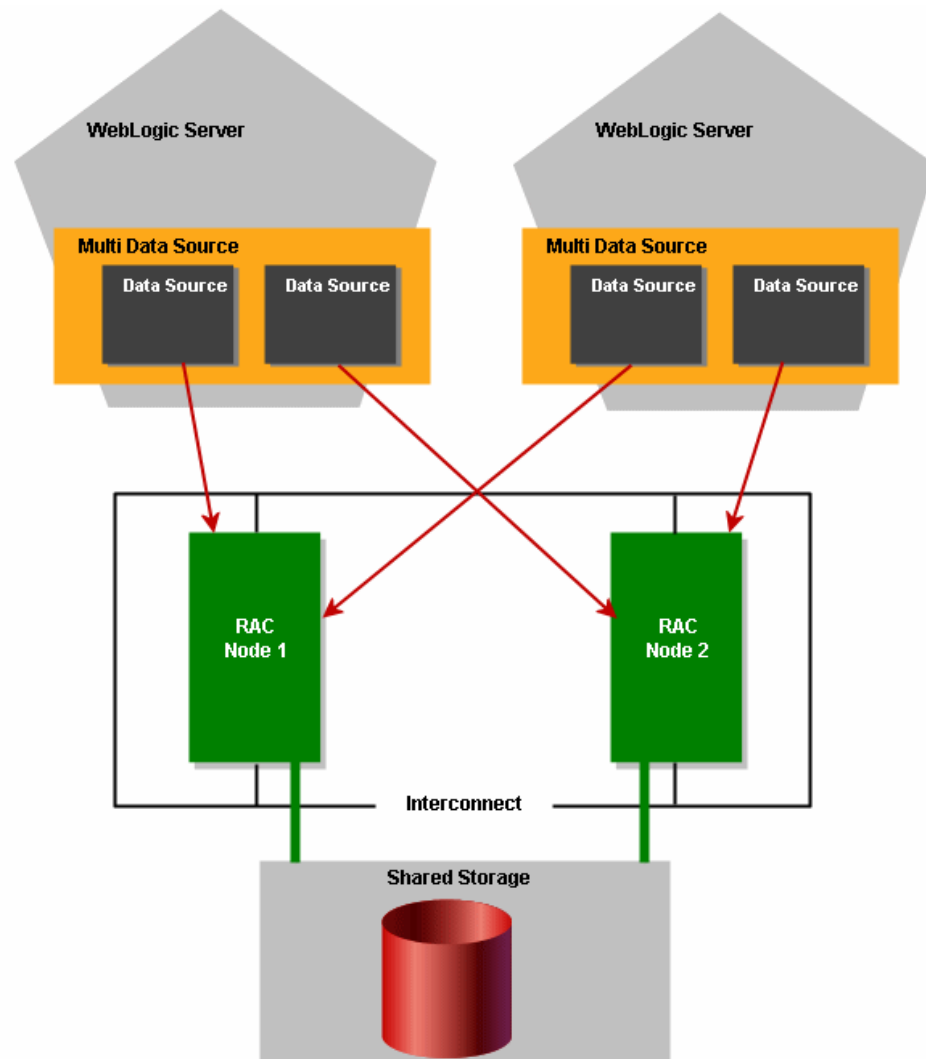

You can use the WebLogic Server Administration Console or any other means that you prefer to configure your domain, such as the WebLogic Scripting Tool (WLST) or a JMX program. For information about configuring a WebLogic JDBC multi data source see [Configuring JDBC Multi Data Sources](#). For information on how to configure the generic data sources in a multi data source to connect to services running on Oracle RAC nodes, see [Configuring Connections to Services on Oracle RAC Nodes](#).

To use a database connection in this configuration, your applications look up one multi data source on the JNDI tree and then request a connection. The multi data source determines which generic data source to use to satisfy the connection request based on the algorithm type specified in the configuration (that is, failover or load balancing).

C.5.2.1 Attributes of a Multi Data Source

The multi data source may have the following attributes, depending on the role of Oracle RAC in your system—load balancing or failover:

- `AlgorithmType="Load-Balancing"` or `AlgorithmType="Failover"`

With the `Load-Balancing` option, connection requests are distributed among available generic data sources; with the `Failover` option, connection requests are served by the first available pool in the list. When a generic data source becomes defunct, connection requests are served by the next generic data source in the list.

- `FailoverRequestIfBusy="true"`

With the `Failover` algorithm, this attribute enables failover when all connections in a generic data source are in use.

- `TestFrequencySeconds="120"`

This attribute controls the frequency at which WebLogic Server checks the health of generic data sources previously marked as unhealthy to see if connections can be recreated and if the generic data source can be re-enabled. For more details see [Configuring JDBC Multi Data Sources](#).

For fast failover of Oracle RAC nodes, set this value to a smaller interval, for example, 10 (seconds).

C.5.3 Configuration Considerations for Failover

Consider the following information when configuring for failover.

C.5.3.1 Multi Data Source-Managed Failover and Load Balancing

Multi data sources offer failover and load balancing for global transactions. For a description of multi data source failover features, see [Multi Data Source Failover Enhancements](#).

With this configuration, pictured in [Figure C-2](#), you get:

- Fast failover controlled by the multi data source
- Automatic failback by the WebLogic Server health monitor

The multi data source handles failover for database connections when an Oracle RAC node becomes unavailable. When WebLogic Server tests a connection and the connection fails, it attempts to recreate the connection. If that attempt fails, the server disables the generic data source and routes connection requests to other generic data sources (which correspond to other Oracle RAC nodes) in the multi data source. WebLogic Server periodically tries to recreate the database connections in the disabled generic data source. When WebLogic Server is successful in recreating the connections, it next re-enables the generic data source and begins routing connection requests to the generic data source again. Because of the connection request routing and automatic health checking features, there is minimal delay in satisfying connection requests after a failure.

C.5.3.2 Delays During Failover

Occasionally, when one Oracle RAC node fails over to another, there may be a delay before the data associated with a transaction branch in progress on the now failed node is available throughout the cluster. This prevents incomplete transactions from being properly completed, which could further result in data locking in the database. To protect against the potential consequences of such a delay, WebLogic Server provides two configuration attributes that enable XA call retry for Oracle RAC: `XARetryDurationSeconds` and `XARetryIntervalSeconds`.

When a server acting as Coordinator returns to service, it takes the following actions during recovery:

- The Transaction Manager reads the transaction checkpoints and the resource checkpoints from the TLog.
- The transactions read from the TLOG (transaction checkpoints) become active and the state is set to committing. The TM tries to commit these transactions just as it does for other runtime transactions. If the commit fails a retry-commit process takes place until `AbandonTimeoutSeconds` after a grace period has expired.
- The TM calls `xa.recover` on resources read from the TLOG (resource checkpoints) to obtain a list of pending transactions. If the `xa.recover` call fails, the TM retries the `xa.recover` call on the resource every `XARetryIntervalSeconds` for a period of `XARetryDurationSeconds`.

Use the following formula to determine the value for `XARetryDurationSeconds`:

$$\text{XARetryDurationSeconds} = (\text{longest transaction timeout for transactions that use connections from the generic data source}) + (\text{delay before XIDs are available on all Oracle RAC nodes, typically less than 5 minutes})$$

For example, if your application sets the longest transaction timeout as 180 seconds, you should set `XARetryDurationSeconds` to 180 seconds + 300 seconds, for a total of 480 seconds.

Note:

It is generally better to set `XARetryDurationSeconds` higher than minimally necessary to make sure that all transactions are completed properly. Setting the value higher than minimally required should not affect application performance during normal operations. The additional processing only affects transactions that have been prepared but have failed to complete.

You can also optionally set a value for `XARetryIntervalSeconds`. This value determines the time between XA retry calls. By default, the value is 60 seconds. Decreasing the value will decrease the amount of time between XA retry attempts. The default value should suffice in most cases.

To enable `XARetryDurationSeconds` and `XARetryIntervalSeconds` from the WebLogic Server Administration Console, use the following steps:

1. If you have not already done so, in the Change Center of the WebLogic Server Administration Console, click **Lock & Edit**.
2. In the **Domain Structure** tree, expand **Services > JDBC**, then select **Data Sources**.

3. On the Summary of Data Sources page, click the data source name.
4. Select the **Configuration: Connection Pool** tab.
5. Scroll down and click **Advanced** to show the advanced connection pool options.
6. Update XA Retry Duration and XA Retry Interval.
7. Click **Save**.

Optionally, you can use WebLogic Scripting Tool (WLST) or a JMX program.

C.5.3.3 Failure Handling Walkthrough for Global Transactions

What happens to in-flight transactions to a database node if that node fails? When the primary Oracle RAC node fails? Does WebLogic Server support transparent failover? To answer these and other questions about how WebLogic Server handles failures, let's walk through the transaction processing steps and describe how a failure would be handled at each stage along the way.

The first stage at which a failure may occur is before the application calls for the transaction to be committed. If a database or Oracle RAC node fails at this stage, the application receives an exception and must get a new connection and make a new attempt at processing the transaction. WebLogic Server does not support transparent failover.

If a failure occurs after the application has called for the transaction to be committed, the handling of any in-flight transaction depends upon whether the `PREPARE` operation is complete. If the `PREPARE` operation is not complete, the transaction manager rolls back the transaction and sends the application an exception for the failed transaction. If the `PREPARE` operation is complete, the transaction manager attempts to drive the in-flight transaction to completion using another node.

If a failure occurs during the `COMMIT` operation, the transaction manager attempts to retry the `COMMIT` operation several times. Note that the connection is blocked during these attempts. If the `COMMIT` operation is not successful during the first set of retry attempts, the application receives an exception. The transaction manager then continues to retry the `COMMIT` operation periodically until it is successful; if the transaction cannot be completed successfully within the abandon time period, the transaction is driven to completion heuristically.

C.5.4 Configuring the Listener Process for Each Oracle RAC Instance

For Oracle RAC, the listener process establishes a communication pathway between a user process and an Oracle instance. When you use Oracle RAC with WebLogic Server, the user process is typically a data source.

When a multi data source is created, it attempts to create a pool of database connections for applications to borrow. If a pooled database connection becomes inoperative or if the generic data source is configured to grow in capacity, the data source attempts to create additional database connections up to the maximum specified in the configuration file. In all of these instances, the Oracle listener process handles the connection request on the Oracle RAC instance.

[Figure C-3](#) shows the Oracle listener process functionality.

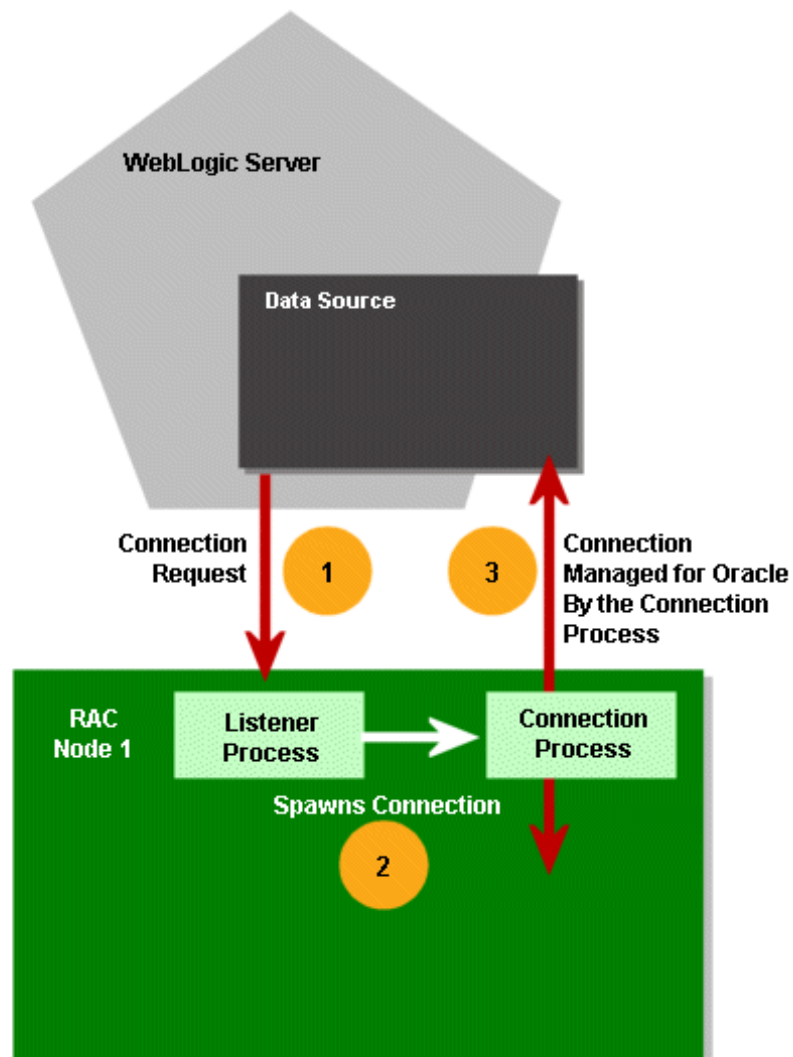
Figure C-3 Oracle Listener Process Functionality

To enable this functionality, you have two options:

- **Use local listeners.** Configure the listener process for each Oracle RAC instance in the Oracle cluster. WebLogic Server requires that you configure a local listener on each Oracle RAC instance. Each database instance should be configured to register *only* with its local listener.

Oracle instances can be configured to register with the listener statically in the `listener.ora` file or registered dynamically using the instance initialization parameter `local_listener`, or both. Oracle recommends using dynamic registration.

A listener can start either a shared dispatcher process or a dedicated process. When using with WebLogic Server, Oracle recommends using dedicated processes.

- **Use remote listeners.** WLS requires that you specify both the `SERVICE_NAME` and the `INSTANCE_NAME` in the JDBC URL for the generic data sources in the multi data source. See [Configuring Multi Data Sources When Remote Listeners are Enabled or Disabled](#).

C.5.5 Configuring Multi Data Sources When Remote Listeners are Enabled or Disabled

If the server-side load balancing feature has been enabled for the Oracle RAC backend (using `remote_listeners`), the JDBC URL that you use in the generic data sources of a multi data source configuration should include the `INSTANCE_NAME`. For example, the URL can be specified in the following format:

```
jdbc:oracle:thin:@(DESCRIPTION=(ADDRESS=(PROTOCOL=TCP)(HOST=host-vip)(PORT=1521))
(CONNECT_DATA=(SERVICE_NAME=dbservice)(INSTANCE_NAME=inst1)))
```

If specifying the `INSTANCE_NAME` in the URL is not possible, remote listeners must be disabled. To disable remote listeners, delete any listed remote listeners in `spfile.ora` on each Oracle RAC node. For example:

```
*.remote_listener=""
```

In this case, the recommended URL that you use in the generic data sources of a multi data source configuration is:

```
jdbc:oracle:thin:@host-vip:port/dbservice
```

or

```
jdbc:oracle:thin:@(DESCRIPTION=(ADDRESS=(PROTOCOL=TCP)(HOST=host-vip)(PORT=1521))
(CONNECT_DATA=(SERVICE_NAME=dbservice)))
```

C.5.6 Additional Configuration Considerations

In some deployments of Oracle RAC, you may need to set parameters in addition to the out of the box configuration of a data source in an Oracle RAC configuration. The additional parameters are:

- Set `oracle.jdbc.ReadTimeout=300000` (300000 milliseconds) for each generic data source.

The actual value of the `ReadTimeout` parameter used may differ based on your application environment.

- If the network is not reliable, it is difficult for a client to detect the frequent disconnections when the server is abruptly disconnected. By default, a client running on Linux takes 7200 seconds (2 hours) to sense the abrupt disconnections. This value is equal to the value of the `tcp_keepalive_time` property. To configure the application to detect the disconnections faster, set the value of the `tcp_keepalive_time`, `tcp_keepalive_interval`, and `tcp_keepalive_probes` properties to a lower value at the operating system level.

Note:

Setting a low value for the `tcp_keepalive_interval` property leads to frequent probe packets on the network, which can make the system slower. Set the value of this property based on system requirements of your application environment.

For example, set `tcp_keepalive_time=600` for a system running a WebLogic Server managed server.

- Specify the `ENABLE=BROKEN` parameter in the `DESCRIPTION` clause in the connection descriptor. For example:

```
jdbc:oracle:thin:@(DESCRIPTION=(enable=broken)
  (ADDRESS_LIST=(ADDRESS=(PROTOCOL=TCP)(HOST=node1-
vip.mycompany.com)(PORT=1521)))
  (CONNECT_DATA=(SERVICE_NAME=orcl.country.myCorp.com)
  (INSTANCE_NAME=orcl1)))
```

The following code snippet provides an example generic data source configuration:

```
<url>jdbc:oracle:thin:@(DESCRIPTION=(enable=broken)
  (ADDRESS_LIST=(ADDRESS=(PROTOCOL=TCP)(HOST=node1-vip.country.myCorp.com)(PORT=1521)))
  (CONNECT_DATA=(SERVICE_NAME=orcl.country.myCorp.com)(INSTANCE_NAME=orcl1)))</url>
<driver-name>oracle.jdbc.xa.client.OracleXADataSource</driver-name>
<properties>
  <property>
    <name>oracle.jdbc.ReadTimeout</name>
    <value>300000</value>
  </property>
  <property>
    <name>user</name>
    <value>jmsuser</value>
  </property>
  <property>
    <name>oracle.net.CONNECT_TIMEOUT</name>
    <value>10000</value>
  </property>
</properties>
```

C.6 Using Multi Data Sources with Global Transactions

In this configuration, a multi data source "pins" a transaction to one and only one Oracle RAC instance. Individual transactions are load balanced with the initial connection request for the transaction. Failover is handled at the multi data source level when a Oracle RAC instance becomes unavailable. If there is a failure on a Oracle RAC instance before `PREPARE`, the transaction is lost. If there is a failure after `PREPARE`, the transaction is failed over to another instance.

- [Rules for Data Sources within a Multi Data Source Using Global Transactions](#)
- [Required Attributes of Data Sources within a Multi Data Source Using Global Transactions](#)
- [Sample Configuration Code](#)

C.6.1 Rules for Data Sources within a Multi Data Source Using Global Transactions

The following rules apply to the XA data sources within a multi data source:

- All the data sources must be homogeneous. In other words, either all of them must use an XA driver or none of them can use an XA driver.
- If you choose to specify them, all XA-related attributes must be set to the same values for each generic data source. The attributes include the following:
 - `XARetryDurationSeconds`
 - `SupportsLocalTransaction`

- KeepXAConnTillTxComplete
- NeedTxCtxOnClose
- XAEndOnlyOnce
- NewXAConnForCommit
- RollbackLocalTxUponConnClose
- RecoverOnlyOnce
- KeepLogicalConnOpenOnRelease

Note:

If you are not using Active GridLink data sources, Oracle recommends the use of multi data sources for failover and load balancing across Oracle RAC instances for XA and non-XA environments. For more information on using multi data sources in non-XA environments, see [Using Multi Data Sources without Global Transactions](#).

C.6.2 Required Attributes of Data Sources within a Multi Data Source Using Global Transactions

Each generic data source within the multi data source should have the following attributes:

- Oracle JDBC Thin driver. For example:

```
<url>jdbc:oracle:thin:@host1:1521:SNRAC1</url>
<driver-name>oracle.jdbc.xa.client.OracleXADataSource</driver-name>
```
- `KeepXAConnTillTxComplete="true"`
 - Forces the generic data source to reserve a physical database connection and provide the same connection to an application throughout transaction processing until the distributed transaction is complete.
 - Required for proper transaction processing with Oracle RAC.
- `XARetryDurationSeconds="300"`
 - Enables the WebLogic Server transaction manager to retry XA recover, commit, and rollback calls for the specified amount of time.
- `TestConnectionsOnReserve="true"`
 - Enables testing of a database connection when an application reserves a connection from the generic data source. See [Test Connections on Reserve to Enable Fail-Over](#) for more details about this attribute.
 - Required to enable failover to another Oracle RAC node.
- `TestTableName="name_of_small_table"` The name of the table used to test a physical database connection. For more details about this attribute, see [Connection Testing Options for a Data Source](#).

C.6.3 Sample Configuration Code

Sample configuration code for a multi data source and two associated generic data sources is shown below.

```
<jdbc-data-source xmlns="http://xmlns.oracle.com/weblogic/jdbc-data-source"
  xmlns:sec="http://xmlns.oracle.com/weblogic/security"
  xmlns:xsi="http://www.w3.org/2001/XMLSchema-instance"
  xmlns:wls="http://xmlns.oracle.com/weblogic"
  xsi:schemaLocation="http://xmlns.oracle.com/weblogic/domain/1.0/domain.xsd">
<name>oracleRACXAPool</name>
<jdbc-driver-params>
  <url>jdbc:oracle:thin:@host1:1521:SNRAC1</url>
  <driver-name>oracle.jdbc.xa.client.OracleXADataSource</driver-name>
  <properties>
    <property>
      <name>user</name>
      <value>wlsqa</value>
    </property>
  </properties>
  <password-encrypted>{3DES}aP/xScCS8uI=</password-encrypted>
</jdbc-driver-params>
<jdbc-connection-pool-params>
  <test-table-name>SQL SELECT 1 FROM DUAL</test-table-name>
  <profile-type>0</profile-type>
</jdbc-connection-pool-params>
<jdbc-data-source-params>
  <jndi-name>oracleRACXAJndiName</jndi-name>
  <global-transactions-protocol>TwoPhaseCommit
    </global-transactions-protocol>
</jdbc-data-source-params>
<jdbc-xa-params>
  <keep-xa-conn-till-tx-complete>true</keep-xa-conn-till-tx-complete>
  <xa-end-only-once>true</xa-end-only-once>
  <xa-set-transaction-timeout>true</xa-set-transaction-timeout>
  <xa-transaction-timeout>120</xa-transaction-timeout>
  <xa-retry-duration-seconds>300</xa-retry-duration-seconds>
</jdbc-xa-params>
</jdbc-data-source>

<jdbc-data-source xmlns="http://xmlns.oracle.com/weblogic/jdbc-data-source"
  xmlns:sec="http://xmlns.oracle.com/weblogic/security"
  xmlns:xsi="http://www.w3.org/2001/XMLSchema-instance"
  xmlns:wls="http://xmlns.oracle.com/weblogic"
  xsi:schemaLocation="http://xmlns.oracle.com/weblogic/domain/1.0/domain.xsd">
<name>oracleRACXAPool2</name>
<jdbc-driver-params>
  <url>jdbc:oracle:thin:@host2:1521:SNRAC2</url>
  <driver-name>oracle.jdbc.xa.client.OracleXADataSource</driver-name>
  <properties>
    <property>
      <name>user</name>
      <value>wlsqa</value>
    </property>
  </properties>
  <password-encrypted>{3DES}aP/xScCS8uI=</password-encrypted>
</jdbc-driver-params>
<jdbc-connection-pool-params>
  <test-table-name>SQL SELECT 1 FROM DUAL</test-table-name>
  <profile-type>0</profile-type>
```

```

</jdbc-connection-pool-params>
<jdbc-data-source-params>
  <jndi-name>oracleRACXAJndiName2</jndi-name>
  <global-transactions-protocol>TwoPhaseCommit
    </global-transactions-protocol>
</jdbc-data-source-params>
<jdbc-xa-params>
  <keep-xa-conn-till-tx-complete>true</keep-xa-conn-till-tx-complete>
  <xa-end-only-once>true</xa-end-only-once>
  <xa-set-transaction-timeout>true</xa-set-transaction-timeout>
  <xa-transaction-timeout>120</xa-transaction-timeout>
  <xa-retry-duration-seconds>300</xa-retry-duration-seconds>
</jdbc-xa-params>
</jdbc-data-source>

<jdbc-data-source xmlns="http://xmlns.oracle.com/weblogic/jdbc-data-source"
  xmlns:sec="http://xmlns.oracle.com/weblogic/security"
  xmlns:xsi="http://www.w3.org/2001/XMLSchema-instance"
  xmlns:wls="http://xmlns.oracle.com/weblogic"
  xsi:schemaLocation="http://xmlns.oracle.com/weblogic/domain/1.0/domain.xsd">
  <name>oracleRACXAMDS</name>
  <jdbc-data-source-params>
    <jndi-name>oracleRACMDSJndiName</jndi-name>
    <algorithm-type>Load-Balancing</algorithm-type>
    <data-source-list>oracleRACXAPool,oracleRACXAPool2</data-source-list>
  </jdbc-data-source-params>
</jdbc-data-source>

```

C.7 Using Multi Data Sources without Global Transactions

The following sections describe a configuration that uses Oracle RAC with multi data sources in an application that does not require global transactions.

- [Attributes of Data Sources within a Multi Data Source Not Using Global Transactions](#)
- [Sample Configuration Code](#)

C.7.1 Attributes of Data Sources within a Multi Data Source Not Using Global Transactions

Generic data sources must have the following attributes:

- Oracle JDBC Thin driver. For example:

```

<url>jdbc:oracle:thin:@host1:1521:SNRAC1</url>
<driver-oracle.jdbc.OracleDriver/driver-name>

```
- `TestConnectionsOnReserve="true"`
 - Enables testing of a database connection when an application reserves a connection from the generic data source. [Test Connections on Reserve to Enable Fail-Over](#) for more details about this attribute.
 - Required to enable failover and connection request routing within a multi data source (effectively, failover to another Oracle RAC node).
- `TestTableName="name_of_small_table"`

- The name of the table used to test a physical database connection. For more details about this attribute, see [Connection Testing Options for a Data Source](#).

C.7.2 Sample Configuration Code

Sample configuration code for a WebLogic JDBC multi data source and associated generic data sources is shown below.

```
<jdbc-data-source xmlns="http://xmlns.oracle.com/weblogic/jdbc-data-source"
  xmlns:sec="http://xmlns.oracle.com/weblogic/security"
  xmlns:xsi="http://www.w3.org/2001/XMLSchema-instance"
  xmlns:wls="http://xmlns.oracle.com/weblogic"
  xsi:schemaLocation="http://xmlns.oracle.com/weblogic/domain/1.0/domain.xsd">
  <name>jdbcPool</name>
  <jdbc-driver-params>
    <url>jdbc:oracle:thin:@host1:1521:snrac1</url>
    <driver-name>oracle.jdbc.OracleDriver</driver-name>
    <properties>
      <property>
        <name>user</name>
        <value>wlsqa</value>
      </property>
    </properties>
    <password-encrypted>{3DES}aP/xScCS8uI=</password-encrypted>
  </jdbc-driver-params>
  <jdbc-connection-pool-params>
    <test-connections-on-reserve>true</test-connections-on-reserve>
    <test-table-name>SQL SELECT 1 FROM DUAL</test-table-name>
  </jdbc-connection-pool-params>
  <jdbc-data-source-params>
    <jndi-name>jdbcDataSource</jndi-name>
  </jdbc-data-source-params>
</jdbc-data-source>

<jdbc-data-source xmlns="http://xmlns.oracle.com/weblogic/jdbc-data-source"
  xmlns:sec="http://xmlns.oracle.com/weblogic/security"
  xmlns:xsi="http://www.w3.org/2001/XMLSchema-instance"
  xmlns:wls="http://xmlns.oracle.com/weblogic"
  xsi:schemaLocation="http://xmlns.oracle.com/weblogic/domain/1.0/domain.xsd">
  <name>jdbcPool2</name>
  <jdbc-driver-params>
    <url>jdbc:oracle:thin:@host2:1521:SNRAC2</url>
    <driver-name>oracle.jdbc.OracleDriver</driver-name>
    <properties>
      <property>
        <name>user</name>
        <value>wlsqa</value>
      </property>
    </properties>
    <password-encrypted>{3DES}aP/xScCS8uI=</password-encrypted>
  </jdbc-driver-params>
  <jdbc-connection-pool-params>
    <test-connections-on-reserve>true</test-connections-on-reserve>
    <test-table-name>SQL SELECT 1 FROM DUAL</test-table-name>
  </jdbc-connection-pool-params>
  <jdbc-data-source-params>
    <jndi-name>jdbcDataSource2</jndi-name>
    <global-transactions-protocol>OnePhaseCommit
      </global-transactions-protocol>
  </jdbc-data-source-params>
</jdbc-data-source>
```

```
<jdbc-data-source xmlns="http://xmlns.oracle.com/weblogic/jdbc-data-source"
xmlns:sec="http://xmlns.oracle.com/weblogic/security"
xmlns:xsi="http://www.w3.org/2001/XMLSchema-instance"
xmlns:wls="http://xmlns.oracle.com/weblogic"
xsi:schemaLocation="http://xmlns.oracle.com/weblogic/domain/1.0/domain.xsd">
<name>jdbcNonXAMultiPool</name>
<jdbc-data-source-params>
  <jndi-name>jdbcDataSource</jndi-name>
  <algorithm-type>Failover</algorithm-type>
  <data-source-list>jdbcPool, jdbcPool2</data-source-list>
  <failover-request-if-busy>true</failover-request-if-busy>
</jdbc-data-source-params>
</jdbc-data-source>
```

Note:

Line breaks added for readability.

C.8 Configuring Connections to Services on Oracle RAC Nodes

If you rely on Oracle services in your Oracle RAC cluster for workload management, you must use multi data sources to connect to those services instead of you using a Service ID (SID). A WebLogic Server generic data source can be configured to connect only to a specific service on a specific Oracle RAC node, providing both workload management and load balancing.

In general, to connect to Oracle RAC services, you need to:

- Create a multi data source for each service to which you want to connect.
- Within each multi data source, create one generic data source for each Oracle RAC node in the cluster on which the service will be configured, whether or not the service will be actively running on each node.

[Configuring a Data Source to Connect to a Service](#), describes special considerations for configuring these data sources. [Service Connection Configurations](#), shows example configurations for either load balancing or workload management.

C.8.1 Configuring a Data Source to Connect to a Service

You configure a generic data source to connect to a service running on an Oracle RAC node in the same way as you configure any generic data source (using WLST, the WebLogic Server Administration Console, or the Configuration Wizard), with the following exceptions:

- `initial-capacity="0"`

This prevents pool creation failure for inactive pools at WLS startup, and enables WLS to create the generic data source even if it can't connect to the service on the node. Without setting this option to 0, generic data source creation will fail and the server may fail to boot normally.

In the WebLogic Server Administration Console, edit the generic data source after creating it, and set **Initial Capacity** to 0.

- Oracle JDBC Thin (or Thin XA) driver. For example:

For non-XA:

```
driver-name="oracle.jdbc.OracleDriver"
url="jdbc:oracle:thin:@(DESCRIPTION=(ADDRESS_LIST=(ADDRESS=(PROTOCOL=TCP)
(HOST=RAC1)(PORT=1521)))(CONNECT_DATA=(SERVICE_NAME=Service_1)
(INSTANCE_NAME=DB_02)))"
```

If configuring via the WebLogic Server Administration Console, select **Oracle's Driver (Thin) for RAC Service-Instance connections** from the **Database Driver** drop-down and specify the service in the **Service Name** field.

For XA:

```
driver-name="oracle.jdbc.xa.client.OracleXADataSource"
url="jdbc:oracle:thin:@(DESCRIPTION=(ADDRESS_LIST=(ADDRESS=(PROTOCOL=TCP)
(HOST=RAC1)(PORT=1521)))(CONNECT_DATA=(SERVICE_NAME=Service1)
(INSTANCE_NAME=DBase1)))"
```

If configuring via the WebLogic Server Administration Console, select **Oracle's Driver (Thin XA) for RAC Service-Instance connections** from the **Database Driver** drop-down and specify the service in the **Service Name** field.

Note:

The SERVICE_NAME must be the same for all generic data sources in a given multi data source.

Specify a different HOST NAME and/or port for each generic data source in a given multi data source.

- When specifying `max-capacity` (**Maximum Capacity** in the WebLogic Server Administration Console) for the connection pool, you need to consider the connection capacity of each of the Oracle RAC nodes in your configuration, and the total number of connections from all generic data sources. See [Connection Pool Capacity Planning](#), for more information.

Selecting the Appropriate Multi Data Source Algorithm

For service connection scenarios, Oracle recommends that you configure your multi data source with the **Load Balancing** algorithm. If the multi data source is configured with the **Load Balancing** algorithm, its connection pools are used in a round robin fashion. In this case, workload is load-balanced across all of the Oracle RAC nodes on which the associated service is currently active.

If the multi data source is configured with the **Failover** algorithm, the first generic data source is used to connect to the service on its associated Oracle RAC node, until a connection attempt fails for any reason (for example, the Oracle RAC node becomes unavailable or there are no more connections available in the generic data source). At that point, the second generic data source is used to connect to the service on its associated Oracle RAC node, and so on. In this case, the Oracle RAC node to which the first generic data source is connected will experience more use than the remaining nodes on which the service is running.

C.8.2 Service Connection Configurations

You can design your configuration to provide:

- [Workload Management](#)
- [Load Balancing](#)

C.8.2.1 Workload Management

In a workload management configuration, each multi data source has one generic data source configured for a given service on each Oracle RAC node, regardless of whether the service you are connecting to is active or inactive on a given Oracle RAC node. This lets you quickly start an inactive service on a node and create connections to that service should another node become unavailable due to unplanned downtime or scheduled maintenance. It also lets you quickly increase or decrease the available capacity for a given service based on workload demands.

When you start the service on a node, the associated generic data source detects that the service is now active, and the generic data source will then start making connections to that node as needed. When you stop a service on a given node, the associated generic data source can no longer make connections to that node, and will become inactive until the service is restarted on that node.

The WLS generic data source performs connection testing. This lets the generic data source adjust to changes in the topology of the Oracle RAC configuration. The generic data source performs polling to see if its associated service is active or inactive. The connection test fails if the service is no longer available on the Oracle RAC node.

Figure C-4 Workload Management using Multi Data Sources

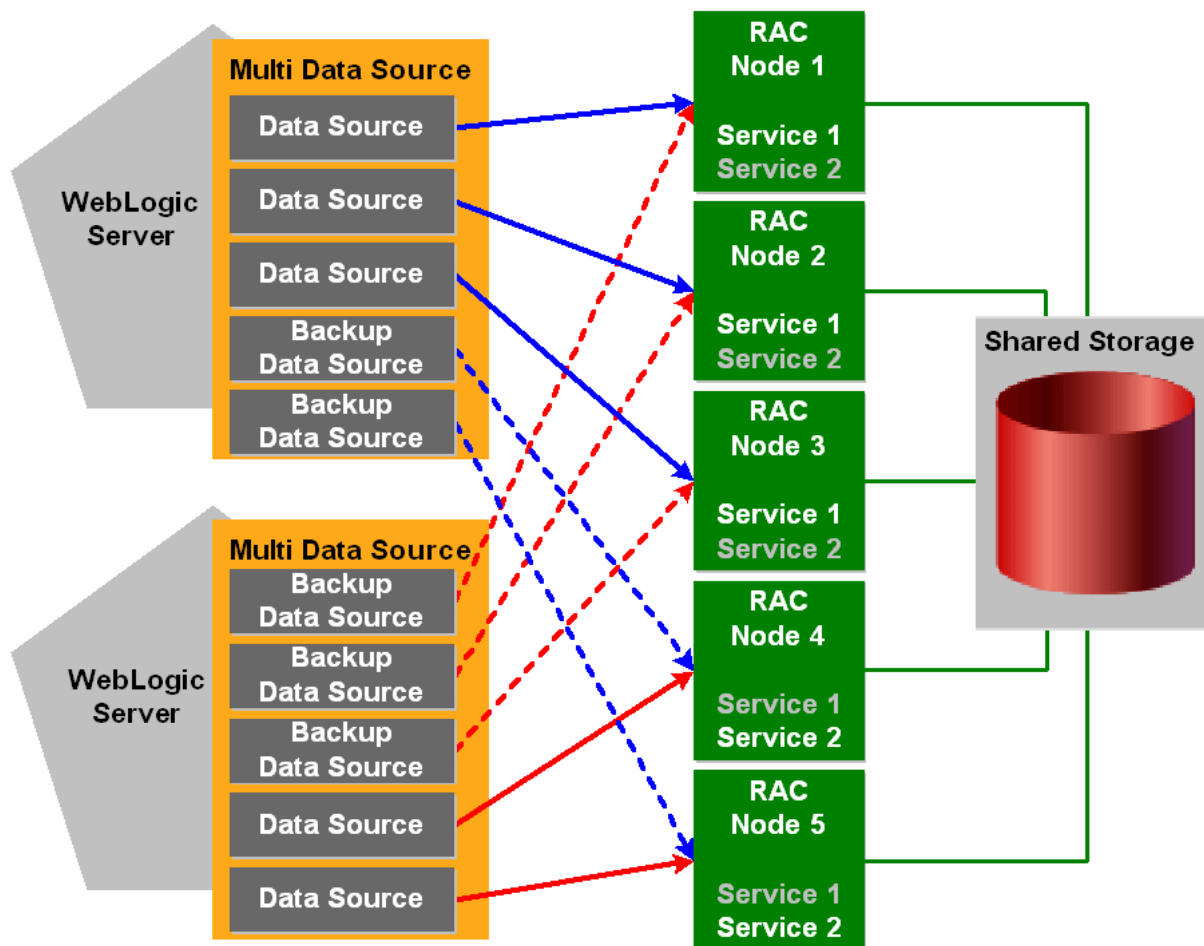

In this example, Service 1 is active on Oracle RAC Nodes 1, 2, and 3, while Service 2 is inactive on those nodes. Service 2 is active on Oracle RAC Nodes 4 and 5, while Service 1 is inactive on those nodes.

If Oracle RAC Node 1 becomes unavailable for any reason, you can start Service 1 on Oracle RAC Node 4. WebLogic Server will detect that the service is running on Node 4, and will begin making connections from the associated backup generic data source to Node 4 as needed.

C.8.2.2 Load Balancing

In a load balancing configuration, there are multiple services running concurrently on each Oracle RAC node. Each WLS multi data source has an active connection pool configured to connect to a given service on each of the nodes. In this scenario, you would configure each multi data source to use the Load Balancing algorithm.

Figure C-5 Load Balancing with Multi Data Sources

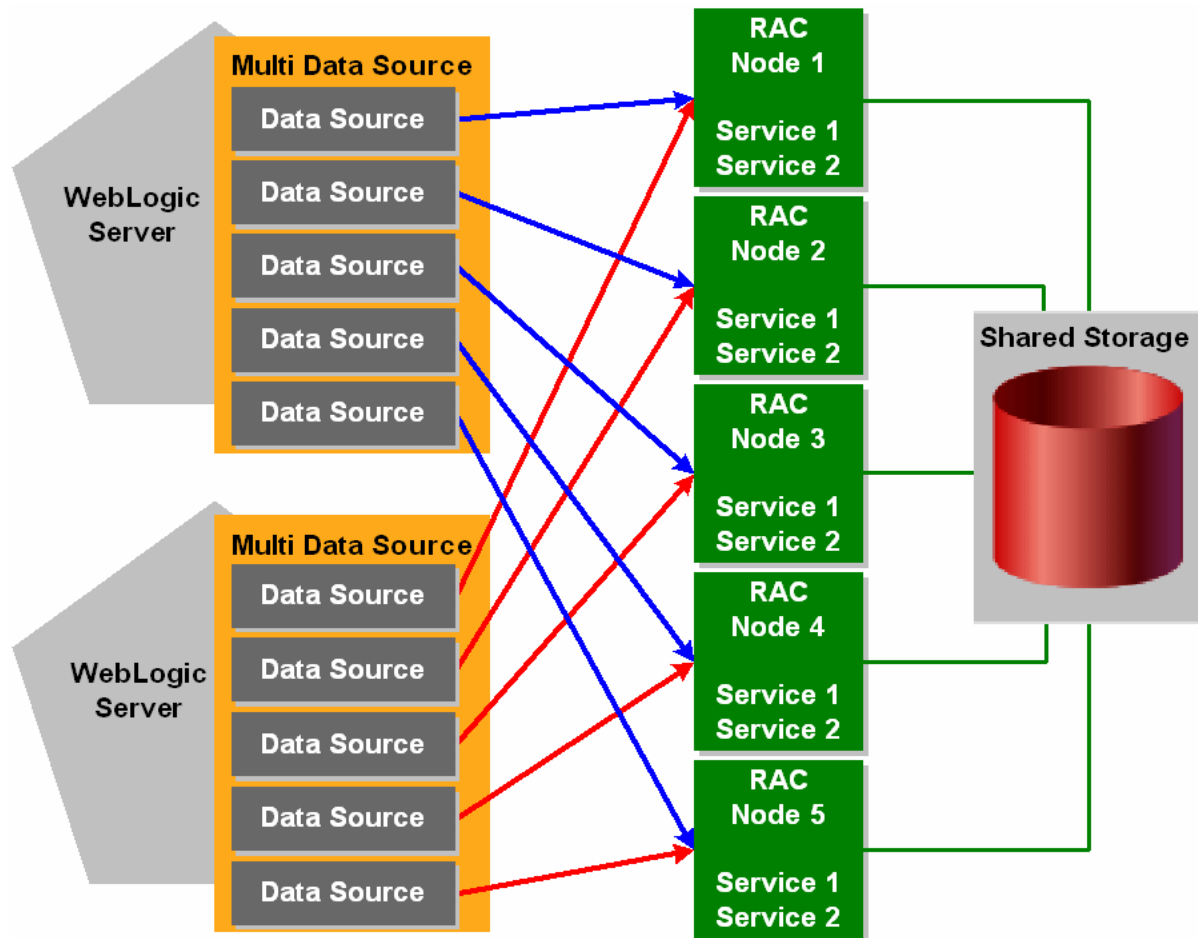

In this example, Service 1 and Service 2 are each actively running on all of the available Oracle RAC nodes. As a result, all of the connection pools in each multi data source will actively make connections in a round-robin fashion, balancing workload among the five nodes.

C.8.3 Connection Pool Capacity Planning

It is important to note the **Maximum Capacity** value you specify for a generic data source can cause the connection capacity to a given Oracle RAC node to be exceeded. You must consider the following factors when determining how to set this value for each of your generic data sources:

- The maximum number of simultaneous connections that a Oracle RAC node can support. This is based on the available memory on a given Oracle RAC node and the amount of memory consumed by each service connection (which can vary for each service). Memory consumption by each connection is a major limitation on the amount of work that can be generated from the WLS servers. Exceeding the amount of available memory by creating too many connections from your WLS generic data sources to a given Oracle RAC node can result in degraded performance on the Oracle RAC node, or could lead to failed connections.

Available memory for a node should be based on the PGA target attribute (per session memory).

- The *maximum* number of generic data sources that can potentially create connections to a given Oracle RAC node, and the number of WebLogic server instances to which each generic data source/multi data source is targeted. For example, if you have one generic data source that is targeted to three WLS servers, that generic data source counts as three generic data sources, as each server uses its own instance of the generic data source. This is the case whether the servers are part of a cluster or are independent server instances.
- The *maximum* number of services that may be actively running on a given Oracle RAC node, and the memory consumed on the node by each connection to each service.
- The expected relative workload for each service on a given node. For example, the expected workload of Service1 may be double that of the expected workload of Service2.

Regardless of whether or not a service is always active on a node, you should allocate resources for that service in the event you have to start it on the node.

- Always use the worst-case scenario when setting the **Maximum Capacity** value for your generic data sources. For example, assume that all available services will be actively running on the Oracle RAC node associated with each generic data source.

The following example explains how you could go about determining each generic data source's **Maximum Capacity** value. Keep in mind that this is a very simple example intended to illustrate the issue conceptually, and that real-world situations are much more complicated. In general, it is best to under-configure your generic data sources with a low **Maximum Capacity** value, monitor your Oracle RAC nodes for memory usage and performance, then adjust the **Maximum Capacity** values upward until you are approaching the maximum capacity of the associated Oracle RAC nodes.

Example

Suppose you have the following basic configuration:

- Five Oracle RAC nodes, each with 16 GB of memory.
- Two services actively running on each Oracle RAC node. Service1 uses 10MB per connection, Service2 uses 20MB per connection.
- Workload for each service is the same, that is, each service will generate an equivalent number of connections on a given Oracle RAC node.
- Two WebLogic Server clusters. Cluster1 has five servers. Cluster2 has four servers.
- For a given Oracle RAC node, one generic data source is targeted to Cluster1 and is configured to connect to Service1.

- For a given Oracle RAC node, one generic data source is targeted to Cluster 2 and is configured to connect to Service2.

Because Service2 uses twice as much memory per connection as Service1, you should allocate approximately 10GB of the node's memory for Service 2 and approximately 5GB for Service1.

Because Cluster1 has five WLS servers, there will be five generic data sources making connection requests to this Oracle RAC node. This gives you 1GB of memory available for connections from a given generic data source (5GB/5). Each connection requires 10MB of memory, so the **Maximum Capacity** value for each generic data source targeted to Cluster1 should be 100 or lower.

Because Cluster 2 has four WLS servers, there will be four generic data sources making connection requests to this Oracle RAC node. This gives you 2.5GB of memory available for connections from a given generic data source (10GB/4). Each connection requires 20MB, so the **Maximum Capacity** value for each generic data source targeted to Cluster2 should be 125 or lower.

If Service 2 generates more workload than Service1, you would have to adjust these values appropriately (increase the **Maximum Capacity** value for the generic data source connecting to Service2, decrease the value for the generic data source connecting to Service1). As long as:

$$(\text{Max. connections to Service1} \times \text{memory used per connection}) + (\text{Max. connections to Service2} \times \text{memory used per connection}) < \text{Available memory}$$

you can avoid the potential for performance degradation or connection failures.

Alternatively, in a simple configuration, such as is shown in [Figure C-6](#), the **Maximum Capacity** value you specify for each of your generic data sources can be loosely determined using the following formula:

Maximum connection pool capacity = Maximum number of connections to Oracle RAC nodes / (Number of WebLogic Server instances x Number of generic data sources targeted to each instance x Number of active Oracle RAC services configured x Number of Oracle RAC Nodes)

where:

Maximum number of connections to Oracle RAC nodes is determined by total memory available on all nodes divided by the memory consumed by each connection.

Number of WebLogic Server instances is the number of server instances to which the generic data sources are targeted. If the generic data sources is targeted to a WLS cluster, this is the number of servers in the cluster.

In the example in [Figure C-6](#):

- assume that a maximum of 4000 total connections can be made to the group of Oracle RAC nodes, based on 8GB of available memory per Oracle RAC node, and 10MB of memory used per connection.
- there are a total of five server instances to which the generic data sources are targeted
- there are five generic data sources targeted to each server instance
- there are two services running on each Oracle RAC node, and
- there are five Oracle RAC nodes.

In this configuration, the **Maximum Capacity** value you would enter for each of your generic data sources would be:

Maximum connection pool capacity = $4000 / (5 \text{ server instances} \times 5 \text{ generic data sources} \times 2 \text{ services} \times 5 \text{ Oracle RAC nodes})$

which would give you a **Maximum Capacity** value of 16 for each of your generic data sources.

Figure C-6 Example multi data source Connection Configuration

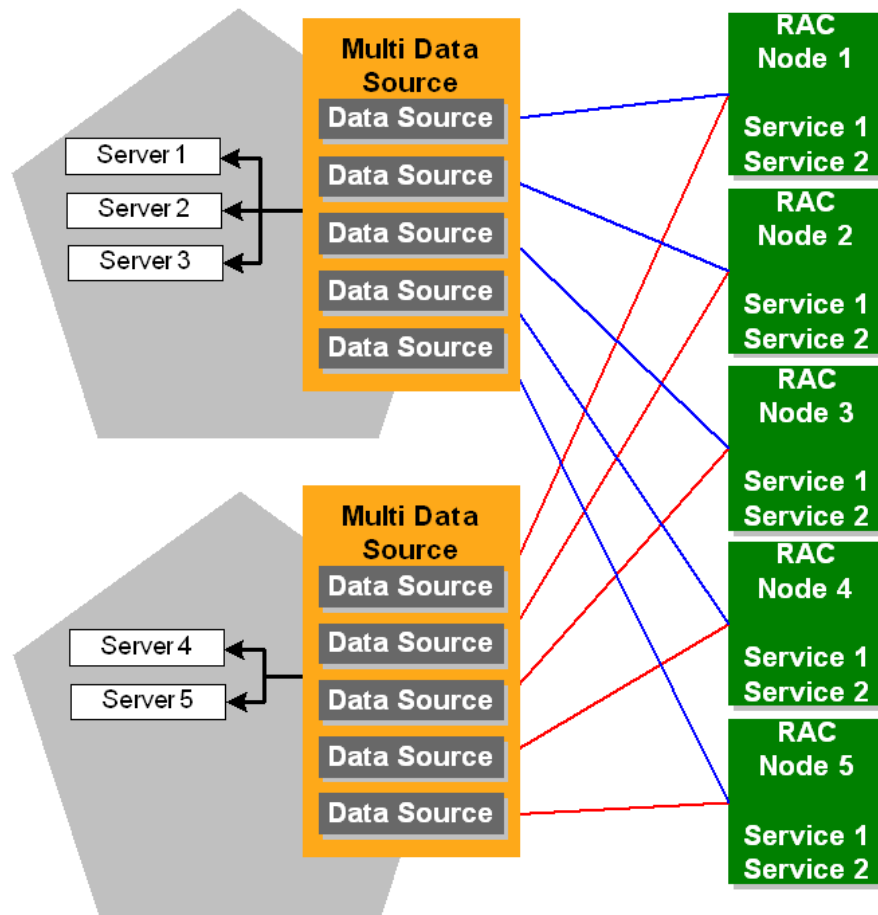

Keep in mind that this formula is just a general guideline for configuring your generic data sources, as many configurations will be too complex for you to use such a simple calculation.

When calculating the **Maximum Capacity** value you should use, always consider the worst-case scenario that you will have in your overall configuration. It is best to under-configure this value for normal operation than to have it over-configured when a worst-case situation develops. You can always monitor your Oracle RAC nodes to determine if it is safe to increase the **Maximum Capacity** value for any of your generic data sources.

C.9 Using SCAN Addresses with Multi Data Sources

Single Client Access Name (SCAN) is not recommended for use with multi data sources. This can be a problem if your configuration is set up to use SCAN (for

example, you can't use non-scan addresses if the database listener is set up to use SCAN).

SCAN has two purposes:

- Provide connect time listener failover
- Provide connection load-balancing

Connection load-balancing cannot be used with a multi data source because the multi data source must be in control of handling the connection load balancing and failover. To turn off this capability, use a URL with an `INSTANCE_NAME` attribute. Each of the generic datasources in the multi data source should point to a different instance. When the multi data source recognizes that an instance is down on the first generic datasource, it guides connections to the instance on the first generic datasource that is not down. When SCAN used with an `INSTANCE_NAME` attribute, the multi data source provides load-balancing, failover of connections, and continues to provide a more reliable way to get to a listener.

If you need to configure SCAN address for a multi data source, configure each generic data source member with a URL that has a different `INSTANCE_NAME` value. For example:

```
(DESCRIPTION=(ADDRESS=(PROTOCOL=TCP)(HOST=scaname)(PORT=scanport))
(CONNECT_DATA=(SERVICE_NAME=myservice)(INSTANCE_NAME=myinstance)))
```

Note:

If you add a node, you need to manually add a generic data source member and add it to the multi data source.

Another way to avoid having SCAN do connection load-balancing is to specify a service name that is available on a single instance and omit the instance name. Each member data source must have it's own unique service name and each service name must be available on only one instance that doesn't overlap with any other member data source.

C.10 XA Considerations and Limitations when using multi Data Sources with Oracle RAC

When using XA (global transactions) with multi data sources for Oracle RAC, consider the following requirements and limitations.

- [Oracle RAC XA Requirements when using multi Data Sources](#)
- [Known Limitations When Using Oracle RAC with multi Data Sources](#)
- [Known Issue Occurring After Database Server Crash](#)

C.10.1 Oracle RAC XA Requirements when using multi Data Sources

Oracle RAC has the following requirements when using multi data sources with global transactions.

- [Use Multi Data Sources](#)

- [A Global Transaction Must Be Initiated_ Prepared_ and Concluded in the Same Instance of the Oracle RAC Cluster](#)
- [Transaction IDs Must Be Unique Within the Oracle RAC Cluster](#)

C.10.1.1 Use Multi Data Sources

Always use a multi data source when using XA transactions with multi data sources for Oracle RAC.

C.10.1.2 A Global Transaction Must Be Initiated, Prepared, and Concluded in the Same Instance of the Oracle RAC Cluster

Global transactions must be initiated, prepared, and concluded in the same instance of the Oracle RAC cluster. WebLogic Server generic data sources manage this for you when you set `KeepXAConnTillTxComplete="true"` in the generic data source configuration.

C.10.1.3 Transaction IDs Must Be Unique Within the Oracle RAC Cluster

When using global transactions, transaction IDs (XIDs) must be unique within the Oracle RAC cluster. However, neither the Oracle Thin driver nor an Oracle RAC instance can determine if an XID is unique within the Oracle RAC cluster. Transactions with the same XID can execute SQL code on different instances of the Oracle RAC cluster without any exception.

C.10.2 Known Limitations When Using Oracle RAC with multi Data Sources

The following sections describe known issues and limitations when using XA and multi data sources with Oracle RAC:

- [Potential for Data Deadlocks in Some Failure Scenarios](#)
- [Potential for Transactions Completed Out of Sequence](#)

Note:

Some of these limitations are also described in Oracle's bug numbers 3428146 and 395790. Contact Oracle for more information about these issues.

C.10.2.1 Potential for Data Deadlocks in Some Failure Scenarios

There is a window of time in which transaction IDs are not available across the Oracle RAC cluster. Because of this known limitation, after some failure conditions, some incomplete transactions cannot be properly completed, which can result in deadlocks in the database. To prevent these failure conditions from arising, WebLogic Server provides two configuration attributes that enable XA call retry for Oracle RAC: `XARetryDurationSeconds` and `XARetryIntervalSeconds`. For more information about these configuration options, see [Delays During Failover](#).

C.10.2.2 Potential for Transactions Completed Out of Sequence

When using the Oracle DataBase Control, the order of transaction processing is not guaranteed. For example, if you implement a web service that uses DataBase Control do the following transaction sequence:

1. Create a table

2. Insert record 1
3. Insert record 2
4. Insert record 3
5. Select records

If the primary node goes down momentarily after the table is created, it is possible that transactions submitted to the database are performed out of sequence.

C.10.3 Known Issue Occurring After Database Server Crash

If, while a transaction is being processed, the database server instance crashes after the PREPARE operation is complete but before the results of that operation have been written to the transaction log, a COMMIT call from a client for that transaction may hang for several minutes and possibly until the TCP timeout period has expired. The window of time in which this might occur is small and the problem occurs rarely. There is no workaround for the issue at this time.

C.11 JDBC Store Recovery with Oracle RAC

If you are using a JDBC Store with Oracle RAC, there are features and limitations to consider that concern Oracle RAC node failover. See the following sections:

- [Configuring a JDBC Store for Use with Oracle RAC](#)
- [Automatic Retry for JMS Connections](#)

For a list of the major services that use the JDBC store, see Monitoring Store Connections in *Administering the WebLogic Persistent Store*.

C.11.1 Configuring a JDBC Store for Use with Oracle RAC

The way that a JDBC Store works limits the options you have for configuring one for use with Oracle RAC. You cannot configure a JDBC store to use a generic data source that is configured to support global transactions. The JDBC store must use a generic data source that uses a non-XA JDBC driver. For more information about this configuration option, see [Using Multi Data Sources without Global Transactions](#).

A JDBC Store holds on to a connection until that connection fails, at which point it moves on to the next connection and repeats the process. Therefore you cannot implement load balancing with a JDBC Store, including using a load balancing multi data source. You should configure a multi data source for a JDBC store to use the Failover algorithm.

In short, for a JDBC store:

- Use a non-XA driver
- Configure the multi data source for Failover mode.

C.11.2 Automatic Retry for JMS Connections

JMS has a limited connection retry mechanism which enables it to silently react to the failure of the Oracle RAC node that hosts its database connection. If the database has experienced either a minor network 'hiccup' or a Oracle RAC database has failed over to another node, the second connection attempt (the retry) will succeed to the next Oracle RAC node.

The time within which this retry is attempted and the number of retries attempted are limited to minimize the negative effects that an extended connection retry time could cause. If the database connection remains unavailable for a long period of time, the delay can impede the ability of JMS to properly continue its processing (for example, to maintain proper message ordering). Also, the transaction manager could declare the JMS resource of a transaction to be dead if there is not enough processing progress made within this time period, or out-of memory conditions could arise. There are system-level tuning guidelines that can help minimize the Oracle RAC failover time frame which is critical to the success of the automatic retry.

The tight loop on the automatic retry is particularly important when JMS processing occurs with transactions. If an I/O failure occurs in the JDBC Store, the store record is in an unknown state which will put the message itself in an unknown state. To prevent the message from being committed in this unknown state, JMS will mark the transaction associated with the message as a "failedTransaction." Any future attempts by the transaction manager to finishing committing the message will cause JMS to throw a `javax.transaction.xa.XAException` with an `errorCode` set to `XAException.XAER_RMERR`. This exception is an indication to the transaction manager that a transient error has occurred in the resource manager (JMS) and that the transaction manager should retry commit processing. The retry logic provides a second attempt to establish the connection before JMS communicates any failure to the upper layer which would translate into an RMERR. If the RMERR is generated, then the only way to recover the message and complete the transaction is to either restart WebLogic Server or configure Automatic Service Migration (ASM) `restart-in-place` option for Singleton Services. Otherwise, when the I/O fails, the transaction is marked in a way that cannot be recovered until the JMS server is restarted.

The automatic connection retry logic is currently governed by an option on WebLogic Server as follows:

```
-Dweblogic.store.jdbc.IORetryDelayMillis=x
```

Where `x` is the number of milliseconds to elapse before the connection to the database is retried. The default value is 1000 milliseconds. This value is restricted to the range 0 to 15000 milliseconds, and the retry is only be attempted once. If a failure occurs on the second attempt, an exception is propagated up the call stack and a manual restart is required to recover the messages associated with the failed transaction.

Note:

In the event that an automatic retry attempt is not successful, you must restart WebLogic Server. Automatic Service Migration (ASM) `restart-in-place` option for Singleton Services can be used to trigger an automatic restart of failed JMS Services.

The automatic retry delay only applies to the connection retry mechanism. There is no configurable retry delay available for JDBC Store I/O failures.

Using Fast Connection Failover with Oracle RAC

This appendix provides information on how to use WebLogic Server with Oracle Fast Connection Failover.

WebLogic Server supports Fast Connection Failover, an Oracle feature which provides an application-independent method to implement Oracle RAC event notifications, such as detection and cleanup of invalid connections, load balancing of available connections, and work redistribution on active Oracle RAC instances.

For more information, see [Using Fast Connection Failover](#) in *Universal Connection Pool for JDBC Developer's Guide*.

D.1 JDBC Driver Configuration for use with Oracle Fast Connection Failover

To enable Fast Connection Failover on a data source, set the following connection pool properties:

- In Driver Class Name—set the class name to `oracle.jdbc.pool.OracleDataSource`.
- In Properties—set the ONS configuration string to remotely subscribe the Oracle RAC nodes to Oracle FAN/ONS events. For example:
`ONSConfiguration=nodes=hostname1:port1,hostname2:port2`

Note:

Oracle's `OracleDataSource` class is not XA-capable, so the resulting data source does not implement a XA connection pool.

Smart Upgrade Support for JDBC

This appendix describes WebLogic Server SmartUpgrade Support for JDBC. WebLogic Server SmartUpgrade is an Oracle JDeveloper extension and command-line utility that analyzes the applications previously deployed on Oracle OC4J. It then offers advice and performs actions that can help you successfully redeploy the applications on Oracle WebLogic Server. You can analyze an application archive, or you can analyze an application or project you have opened in Oracle JDeveloper. In addition, SmartUpgrade can analyze the OC4J server where you deployed your applications and provide advice on how to set up a similar configuration in Oracle WebLogic Server.

E.1 Smart Upgrade Features

In addition to providing a comprehensive report with specific findings about each application, SmartUpgrade can also automate some of the upgrade tasks. For JDBC, the OC4J `J2EE_HOME\home\config\data-sources.xml` file and each data source configuration file defined for an application (ear) can be upgraded to the corresponding WebLogic Server JDBC data source definitions.

Smart upgrade supports the following feature conversions.

- If an OC4J datasource is configured with a RAC service (long form) URL and `fastConnectionFailoverEnabled=true` or `ONSConfiguration` is set, an Active GridLink datasource is configured.
- `fastConnectionFailoverEnabled=true` implies that `fan-enabled` is set to `true`.
- `ONSConfiguration` (nodes and optional wallet information), for example, `nodes=racnode1:4200, racnode2:4200\nwalletfile=/mydir/Wallet\nwalletpassword=mypasswd`, is parsed to get the node list and the optional wallet information. This information is then used to set the node-list, wallet directory, and wallet password.
- `Remove-infected-connections` is always be set to `false` to match the OC4J behavior.
- `Wrap-types` is always set to `true` to match the OC4J behavior.
- `Oracle-proxy-session` is set to `true` if OC4J `proxy-sessions` is set to `true`.
- The `fatal-error-codes` list is set if the OC4J `fatal-error-codes` and values are available.
- `Min-capacity` is set to OC4J `min-connections`, if available.
- `Identity-based-connection-pooling-enabled` and `use-database-credentials` is always set to `true` to match the OC4J behavior.

Smart Upgrade is not shipped with WebLogic Server but can be downloaded separately from <http://www.oracle.com/technetwork/middleware/downloads/smartupgrade-085160.html>.