



Siebel Application Services Interface Reference

Innovation Pack 2015

May 2015

ORACLE®

Copyright © 2005, 2015 Oracle and/or its affiliates. All rights reserved.

This software and related documentation are provided under a license agreement containing restrictions on use and disclosure and are protected by intellectual property laws. Except as expressly permitted in your license agreement or allowed by law, you may not use, copy, reproduce, translate, broadcast, modify, license, transmit, distribute, exhibit, perform, publish, or display any part, in any form, or by any means. Reverse engineering, disassembly, or decompilation of this software, unless required by law for interoperability, is prohibited.

The information contained herein is subject to change without notice and is not warranted to be error-free. If you find any errors, please report them to us in writing.

If this is software or related documentation that is delivered to the U.S. Government or anyone licensing it on behalf of the U.S. Government, the following notice is applicable:

U.S. GOVERNMENT END USERS: Oracle programs, including any operating system, integrated software, any programs installed on the hardware, and/or documentation, delivered to U.S. Government end users are "commercial computer software" pursuant to the applicable Federal Acquisition Regulation and agency-specific supplemental regulations. As such, use, duplication, disclosure, modification, and adaptation of the programs, including any operating system, integrated software, any programs installed on the hardware, and/or documentation, shall be subject to license terms and license restrictions applicable to the programs. No other rights are granted to the U.S. Government.

This software or hardware is developed for general use in a variety of information management applications. It is not developed or intended for use in any inherently dangerous applications, including applications that may create a risk of personal injury. If you use this software or hardware in dangerous applications, then you shall be responsible to take all appropriate fail-safe, backup, redundancy, and other measures to ensure its safe use. Oracle Corporation and its affiliates disclaim any liability for any damages caused by use of this software or hardware in dangerous applications.

Oracle and Java are registered trademarks of Oracle and/or its affiliates. Other names may be trademarks of their respective owners.

Intel and Intel Xeon are trademarks or registered trademarks of Intel Corporation. All SPARC trademarks are used under license and are trademarks or registered trademarks of SPARC International, Inc. AMD, Opteron, the AMD logo, and the AMD Opteron logo are trademarks or registered trademarks of Advanced Micro Devices. UNIX is a registered trademark of The Open Group.

This software or hardware and documentation may provide access to or information on content, products, and services from third parties. Oracle Corporation and its affiliates are not responsible for and expressly disclaim all warranties of any kind with respect to third-party content, products, and services unless otherwise set forth in an applicable agreement between you and Oracle. Oracle Corporation and its affiliates will not be responsible for any loss, costs, or damages incurred due to your access to or use of third-party content, products, or services, except as set forth in an applicable agreement between you and Oracle.

Documentation Accessibility

For information about Oracle's commitment to accessibility, visit the Oracle Accessibility Program website at <http://www.oracle.com/pls/topic/lookup?ctx=acc&id=docacc>.

Access to Oracle Support

Oracle customers that have purchased support have access to electronic support through My Oracle Support. For information, visit <http://www.oracle.com/pls/topic/lookup?ctx=acc&id=info> or visit <http://www.oracle.com/pls/topic/lookup?ctx=acc&id=trs> if you are hearing impaired.

Contents

Chapter 1: What's New in This Release

Chapter 2: Siebel Application Services Interfaces Overview

Defining ASIs 9

About the Two Types of ASIs 9

ASI Usage Examples 11

Chapter 3: Application Services Interfaces

About ASI Structure 13

About Integration Object Structure 13

 Components and Fields in Integration Objects 14

 List of Value Fields in Integration Objects 14

 Related Business Component Selection in Database Updates 15

 Unique Keys in Integration Objects 15

ASI Data Synchronization Services 15

 Data Mapping for ASI Release Independence 16

 Data Synchronization Methods for ASIs 19

Exposing ASIs with Interface Technologies 24

About ASIs and Web Services 24

 Protocols Used with ASIs 24

 Handling Errors for ASIs 25

Authentication and Security for ASIs 26

Chapter 4: Administering Application Services Interfaces

Using ASIs 27

 Configuring ASIs 27

 Deactivating ASI Components and Fields 28

 Real Time and Asynchronous Processing with ASIs 29

User Scenarios for ASI Administration 29

Chapter 5: Customizing an Application Services Interface

About ASI Framework	31
Extending an ASI	31
Customizing Workflows to Use ASIs	32
Building Customized Interfaces Using the ASI Framework	34
User Scenarios for ASIs	37

Appendix A: Predefined Application Service Interfaces

About Prebuilt ASIs	40
Siebel Account	41
Siebel Action	55
Siebel Business Address	61
Siebel Personal Address	63
Siebel Asset	64
Siebel Contact	68
Siebel CUT Address MSAG Service	74
Siebel Cost List	75
Siebel Employee	78
Siebel Financial Account	91
Siebel Forecast	96
Siebel Invoice	99
External Opportunity Create/External Opportunity Query/External Opportunity Update	109
ANI Opportunity Message (PRM ANI)	110
ANI Message Header (PRM ANI)	120
Opportunity (PRM ANI)	121
Destination Channel Partner (PRM ANI)	126
Source Organization (PRM ANI)	127
Opportunity Account (PRM ANI)	128
Siebel Order	130
Siebel Position	147
Siebel Price List	148
Siebel Quote/External Quote	151
Siebel ATP Response/External ATP Check	166

External Credit Check	174
Credit Check Request	174
Credit Check Response	177
External Shipment Tracking	177
Shipment Tracking Interface Request	178
Shipment Tracking Interface Response	179
Siebel SIA Service Request	182
Siebel Service Request	185
Siebel Simple Product	189

Appendix B: Siebel Communications, Media, and Energy ASIs

About Prebuilt Communications, Media, and Energy ASIs	200
Order Management	201
Siebel Order	201
Customer Lifecycle Management	220
Siebel Account	220
Billing Management	230
Siebel Invoice	230
Siebel Invoice Adjustment	237
CUT Payment Interface Integration Object	241
CUT Account Balance Interface - Request Integration Object	243
CUT Account Balance Interface - Response Integration Object	244
Siebel Meter Reading	245
Siebel Meter Usage Data	246
Siebel Payment	249
Siebel Simple Product	251
Trouble Ticketing Management	259
Siebel Trouble Ticket	259

Index

1

What's New in This Release

What's New in Siebel Application Services Interface Reference, Siebel Innovation Pack 2015

No new features have been added to this guide for this release. This guide has been updated to reflect only product name changes.

NOTE: Siebel Innovation Pack 2015 is a continuation of the Siebel 8.1/8.2 release.

2

Siebel Application Services Interfaces Overview

This chapter provides general information about Oracle's Siebel Application Services Interfaces (ASIs), the definition, benefits, and types of ASIs, and general examples of ASIs to give you an overview of this component. Topics include:

- [Defining ASIs](#)
- [About the Two Types of ASIs](#)
- [ASI Usage Examples](#)

Defining ASIs

An Application Services Interface (ASI) is a release-independent interface published by Oracle that allows you to integrate Siebel applications with external applications. An ASI is a collection of related methods; each method contains input and output parameters. The methods and parameters are listed on the business service definition. Simple method parameters (such as a string or number) are defined directly in the service definition. Hierarchical method parameters are defined using integration objects.

NOTE: Web Services are used in ASI development, but they may not be apparent in the implementation on specific integration servers. ASIs are published in a standard metadata format—such as Extensible Markup Language Document Type Definitions (XML DTD) and Web Services Descriptive Language/XML Schemas (WSDL/XSD)—and are built using the ASI Framework. See [“About ASI Framework” on page 31](#) for more information.

Siebel ASIs are prebuilt and can be used immediately. ASIs provide a release-independent integration interface to the Siebel application, which remains unchanged with each upgrade to a new release. ASIs use the standard metadata format, which makes ASIs language-independent, so they return the same value type regardless of language setting.

About the Two Types of ASIs

There are two types of ASIs—inbound and outbound.

Inbound ASI

An inbound ASI defines an interface for services provided by Oracle. External applications use this type of ASI to invoke Siebel-provided services.

An external application makes an inbound request that the inbound dispatcher receives. Based on the information in the ASI, the dispatcher invokes one of several services to pass its data to the Siebel application—either a data synchronization service, other business services, or a workflow process. For further details about data synchronization services, see [“ASI Data Synchronization Services” on page 15](#). For more information about business services and workflows, see *Business Processes and Rules: Siebel Enterprise Application Integration*.

The dispatcher determines which service to invoke, according to the ASI configuration and transport protocols. The ASI determines whether the service request is a request-response operation (a response containing the status of the operation or the data retrieved) or a one-way request (where no response is required). ASIs are configured to have the same input and output argument (Siebel Message), and always return a response unless you change the ASI argument. External applications can use inbound ASIs, which can be exposed as a Web service, XML, or Java. [Figure 1 on page 10](#) shows these processes.

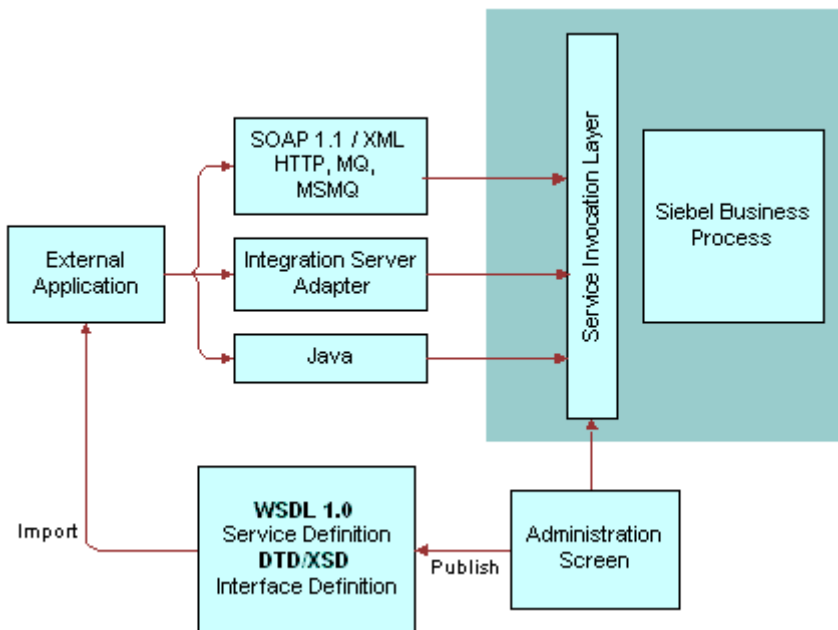

Figure 1. Inbound ASI

Outbound ASI

An outbound ASI defines an interface from a Siebel application to an external application and provides a proxy to the external application that can be called from within the Siebel application. The Siebel application invokes this proxy to make a service request to the external application, soliciting information from the external service, which the Siebel database updates or displays to the user.

A workflow or a user interface event calls an outbound dispatcher. Based on the ASI configuration, the dispatcher invokes one of several services at runtime—Siebel Services, Partner Adapters, XML, or Web Services. The outbound dispatcher links a service name, interface, and transport or protocol binding to the ASI, which is also sent to the external application, as shown in [Figure 2 on page 11](#).

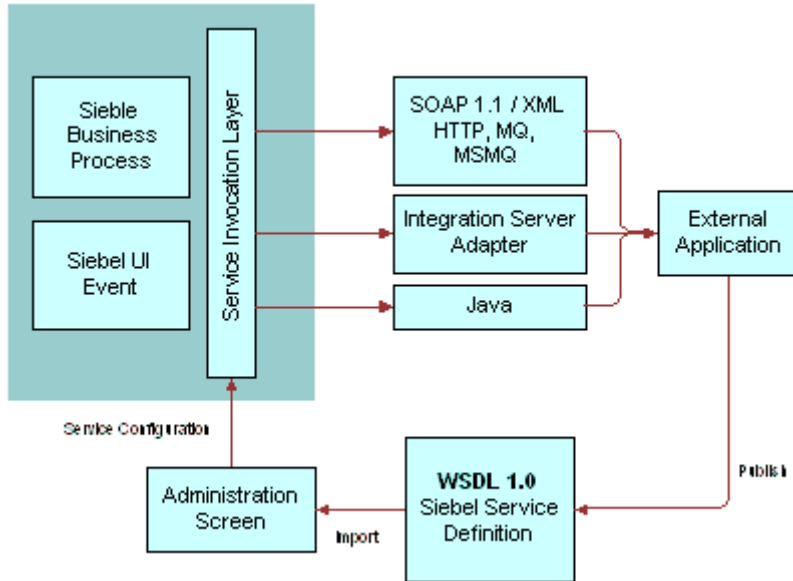

Figure 2. Outbound ASIs

ASI Usage Examples

The following example in [Figure 3 on page 11](#) demonstrates how to use inbound and outbound ASIs in the workflow.

Inbound ASI Example

A customer using an external application needs to update an account within the Siebel database. As shown in [Figure 3](#), an external application invokes an inbound ASI, Siebel Account, to retrieve the correct customer information from the Siebel database using the method, QueryById.

In the External Account proxy step, an outbound ASI is called, and the account information is sent to the external systems for processing.

After the update is completed in the external system, the response is passed to an inbound ASI, Siebel Account, to update the information in the Siebel database, using the Synchronize method.

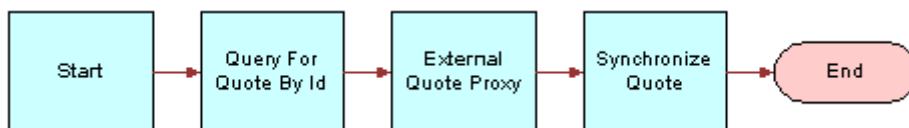

Figure 3. Update Account

For a more detailed description of this example, see [“Customizing Workflows to Use ASIs” on page 32](#).

Outbound ASI Example

The following example uses an outbound ASI to retrieve information and display it to the user.

A customer using a Siebel application might need to check the inventory of a product, Request ATP Check, to fulfill an order. The Siebel application sends an outbound request to the external system, retrieves the information, and displays it to the user.

3

Application Services Interfaces

This chapter describes the underlying structure of an Application Services Interface (ASI) and the specialized types of ASIs used by business services. It also explains the relationship between ASIs, EAI, and Web services, as well as authentication and security issues. Topics include the following:

- [About ASI Structure](#)
- [About Integration Object Structure](#)
- [ASI Data Synchronization Services](#)
- [Exposing ASIs with Interface Technologies](#)
- [About ASIs and Web Services](#)
- [Authentication and Security for ASIs](#)

About ASI Structure

As defined earlier, an ASI is an interface whose implementation is defined by a business service or workflow. A specialized class of business services is implemented as data synchronization services.

[Figure 4 on page 13](#) shows an example of the structure of the Account ASI. For information regarding specific ASIs, see [Appendix A, “Predefined Application Service Interfaces”](#) and [Appendix B, “Siebel Communications, Media, and Energy ASIs.”](#)

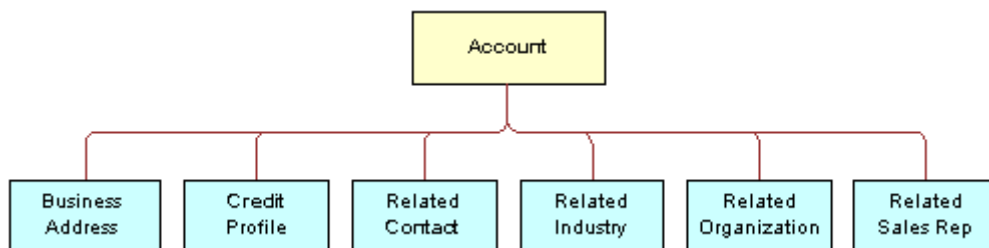

Figure 4. Account ASI

About Integration Object Structure

Integration objects are metadata structures that represent hierarchical objects using components and fields. For example, the Contact integration object might have the following components—Personal Address, Account, and Opportunity. [Figure 5 on page 14](#) shows a sample of the Contact integration object, and the integration object instance containing the data for Contact. The structure of integration objects includes:

- [“Components and Fields in Integration Objects” on page 14](#)

- [“List of Value Fields in Integration Objects” on page 14](#)
- [“Related Business Component Selection in Database Updates” on page 15](#)
- [“Unique Keys in Integration Objects” on page 15](#)

For data synchronization services, there are two types of integration objects. For more information about data synchronization services, see [“ASI Data Synchronization Services” on page 15](#).

For more information about integration objects, see *Integration Platform Technologies: Siebel Enterprise Application Integration*.

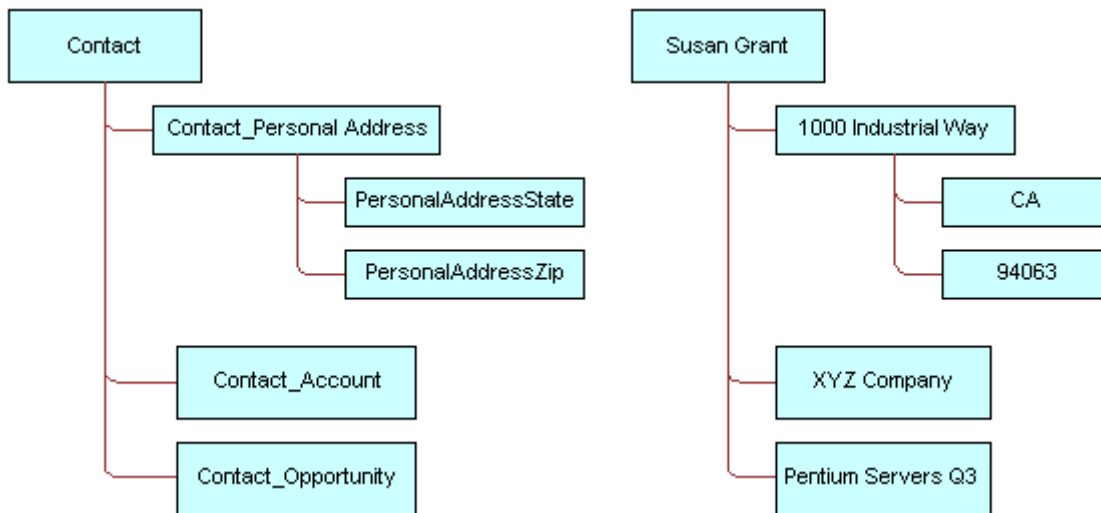

Figure 5. Integration Object and Integration Object Instance

Components and Fields in Integration Objects

Components define the hierarchy of an integration object, and a component contains one or more fields and child components. In [Figure 5](#), the Contact integration object has these components: Contact_Personal Address, Contact_Account, and Contact_Opportunity; Personal Address has the additional fields, PersonalAddressState and PersonalAddressZip.

By default, all fields are active. However, you can deactivate these fields to satisfy the different requirements for each ASI and to increase performance of the ASI. For more information about deactivating field components, see [“Deactivating ASI Components and Fields” on page 28](#).

List of Value Fields in Integration Objects

Fields can map to a Siebel predefined List of Values (LOV). The fields in the integration components that are based on such fields can take values only from that list—the fields are bound to the values of that LOV. For example, in [Figure 5 on page 14](#), PersonalAddressState can map to an LOV of the different states in the U.S. (such as AZ, CA, FL, and so on).

These LOV fields should use a language-independent representation. For each LOV field, the internal integration object returns a Language Independent Code (LIC) if the user property, `AllLangIndependentVals`, is set to Y at the object level.

The integration object can expose the Siebel LIC or map the field to an industry standard code.

Related Business Component Selection in Database Updates

When a row is inserted or updated in the Siebel database, it is often necessary to create relationships with other business components through a foreign key. For example, an account has a many-to-one relationship with Price List—an account is associated with one price list; the same price list can be used with different accounts. The correct price list is identified by the foreign key `Price List Id`, which exists in the Account component. This relationship is implemented through the picklist.

For this type of integration, a pointer to the appropriate price list row is stored in the account row, where it is identified by a foreign key.

Unique Keys in Integration Objects

Internal integration objects implement user keys that the Siebel application creates for each component, based on the user primary key defined for the underlying table. User keys are a group of fields whose values uniquely identify only one Siebel record. When an ASI executes, it searches the list of user keys to find the first key present in the component instance and uses it to determine whether the record has a match in the Siebel database.

You can deactivate, modify, or create additional keys for an ASI depending on your business and application needs. However, it is recommended that each component contain a set of three unique keys:

- **Row ID.** The Siebel Row ID.
- **Integration ID.** A cross-reference that links the Siebel application to the corresponding record in the external application.
- **User Key.** Corresponds to the U1 index of the underlying table.

ASI Data Synchronization Services

A data synchronization service is a specialized type of business service used by a class of ASIs. Data synchronization services import and export data from Siebel applications and are based on the framework provided by the EAI Siebel adapter. For more information about the EAI Siebel adapter, see *Integration Platform Technologies: Siebel Enterprise Application Integration*. The components of a data synchronization service include:

- [“Data Mapping for ASI Release Independence” on page 16](#)
- [“Data Synchronization Methods for ASIs” on page 19](#)

Many inbound ASIs are built using data synchronization services, and can also be used to populate the parameters of an outbound ASI. The inbound ASI isolates the interface of the outbound ASI and provides an interface that is independent from the data model by isolating the underlying data model through the use of a data map.

NOTE: Data mapping cannot be specified for outbound ASIs using the internal integration object and data map business service user properties. These user properties are only for use by the data synchronization business service.

Data synchronization services use a pair of integration objects—the internal integration object and the interface integration object—that define the schema of the release-independent interface. Both objects must be provided, even if they are exactly the same, for the ASI to be upgraded at a later date. An internal integration object mirrors the schema of the Siebel business object, while an interface integration object defines the external representation of the data.

Figure 6 on page 16 illustrates these concepts.

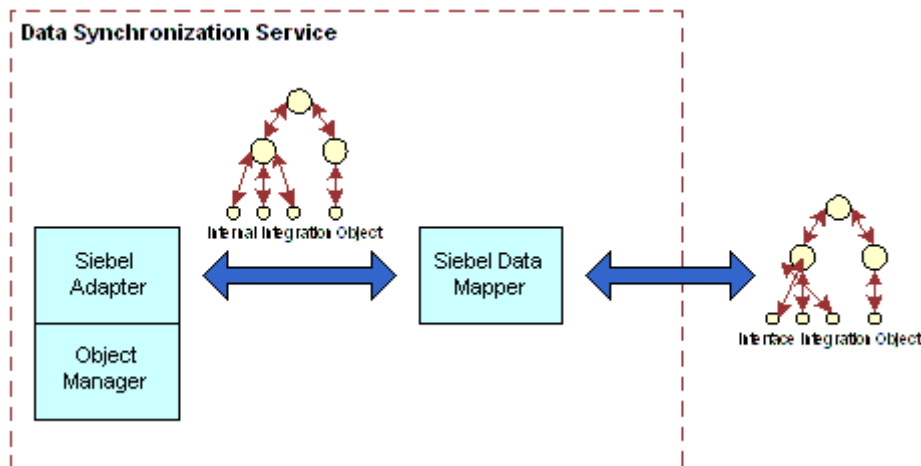

Figure 6. Data Synchronization Services

Component and field names of the internal integration object must match the names of the underlying Siebel business object’s components and fields. The interface integration object’s components and fields do not need to match; you determine them based on your business requirements.

Data Mapping for ASI Release Independence

Within data synchronization, a data map translates the data in the form of integration objects between an internal integration object and an interface integration object, making ASIs release-independent.

Data synchronization services use data mapping to translate data between integration objects and support a subset of methods that are used by the EAI Siebel adapter, such as Insert, Update, and Delete. See [“Data Synchronization Methods for ASIs” on page 19](#) for more information. An ASI usually requires two types of data maps—one for each direction, as shown in [Figure 7 on page 17](#). For more information about data mapping, see *Business Processes and Rules: Siebel Enterprise Application Integration*.

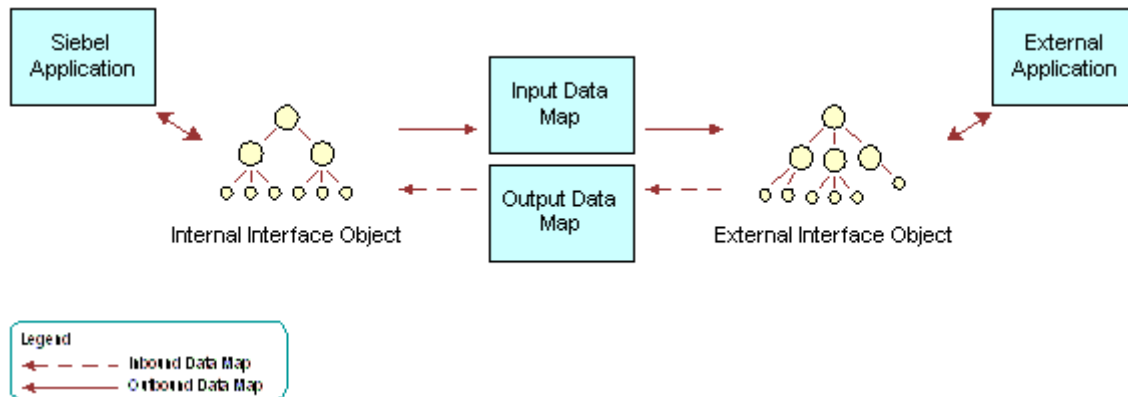

Figure 7. Mapping Between Integration Objects

For ASIs using data synchronization services, there are two types of data mapping—implicit data mapping and explicit data mapping.

Implicit Data Mapping for Integration Objects

Data synchronization services support implicit data mapping when the internal integration object is a subset or exactly the same as the interface integration object; the reverse also holds true. Implicit mapping occurs when:

- A source component maps to a target component with the same name.
- A source component maps to a target component and both components have fields with the same name.
- Data synchronization service does not specify a data map.

Every component, field, and child component is mapped between integration objects.

[Figure 8 on page 18](#) shows an example of implicit mapping between two integration objects. In this diagram, components and fields with the same name are automatically mapped; data synchronization services map these fields when a data map is not specified.

In Figure 8, the child component, Organization, which appears on the interface integration object only, is not mapped because it is not considered important to the ASI. Consequently, the two integration objects are sufficiently similar, and a data map is not necessary. Implicit mapping ignores any components and fields unique only to the interface or internal integration object, but not both.

NOTE: Implicit data mapping requires that the root components of the internal and interface integration objects have the same name.

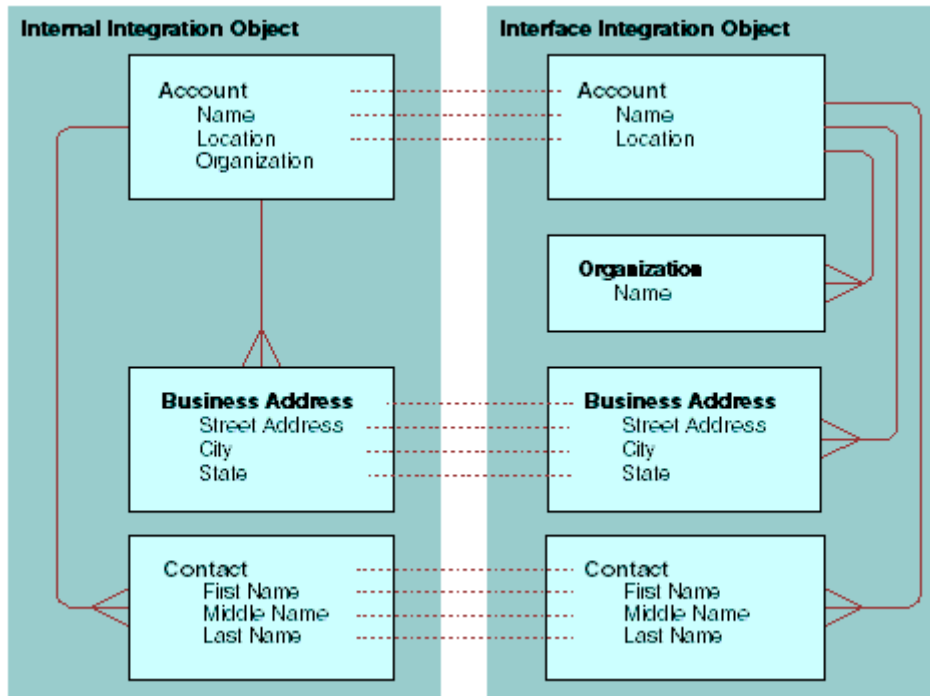

Figure 8. Implicit Data Mapping

Explicit Data Mapping for Integration Objects

You must define an explicit data map whenever a component or field name of an interface integration object does not exactly match the component or field name of the internal interface object.

Oracle provides prebuilt explicit data maps for its ASIs. These data maps make sure that the ASIs are release-independent.

NOTE: To preserve the release-independent properties of fields, do not alter Siebel-defined explicit data maps except when you deactivate fields.

Automatic Mapping for Integration Objects

You can automatically extend a data map for an integration object whenever new components and fields have been added to an existing ASI. Within the Data Map Administration screen, the Auto-Map feature enables you to automatically create submaps for these new components and fields. The Auto-Map feature checks the definition of the internal integration object and the interface integration object, finds components and fields of the same name with no current map, and creates the data map for it.

You can use automatic mapping and explicit mapping together.

Upgrading Data Maps for Integration Objects

When the Siebel application is upgraded, a three-way merge is performed on the internal and interface integration objects. This merge makes sure that the customer's extensions to these objects carry forward to the new version.

If an explicit data map exists in the previous version of the ASI, a new version of the map replaces the old with the Siebel application upgrade. Any automatic mapping is regenerated. The automatic mapping exposes the customer's extensions through the new version of the interface.

Data Synchronization Methods for ASIs

Data synchronization services use a subset of methods supported by the EAI Siebel Adapter, as listed in [Table 1](#). However, an ASI might not use all of the methods listed; you can define which methods an ASI uses. For more information, see *Integration Platform Technologies: Siebel Enterprise Application Integration*.

Table 1. Data Synchronization Methods

Method	Description	Input	Output
QueryByExample	Queries for objects based on the example object provided.	Interface Integration Object	One or more integration objects that matches the query.
QueryById	Queries for objects based on the primary row ID.	Primary Row ID	An integration object that matches the specific row ID. If no row ID exists, no object is returned.

Table 1. Data Synchronization Methods

Method	Description	Input	Output
QueryPage	Queries for a given number of objects based on the example object.	<ul style="list-style-type: none"> ■ Interface Integration Object ■ PageSize ■ StartRowNum ■ ViewMode 	<ul style="list-style-type: none"> ■ One or more integration objects up to <pagesize> number of integration objects that match the query. ■ Boolean LastPage argument indicates whether the last record is returned.
Insert	Creates the object in the database.	Interface Integration Object	The status key of all the objects created. If the object exists, this request errors out. See “Using Status Keys” on page 21 for information about status keys.
Update	Updates the object in the database. If the object does not exist, the request returns an error.	Interface Integration Object	The status key of all objects updated.
InsertOrUpdate	Merges the object with the same object in the database or creates a new object if none exists in the database.	Interface Integration Object	The status key of all objects created or updated.
Synchronize	Synchronizes the database object to exactly match the input object.	Interface Integration Object	The status key of all objects created or updated.
Delete	Deletes the object.	Interface Integration Object	The status key of all objects deleted.

Data Synchronization Input Method Arguments for ASIs

Table 2 describes the arguments of the various methods. For more information about the input arguments, see *Integration Platform Technologies: Siebel Enterprise Application Integration*.

Table 2. Input Method Arguments

Argument	Display Name	Type	Data Type	Description
Interface Integration Object	None	Input/Output	Integration Object	<ul style="list-style-type: none"> ■ The integration object or set of integration objects that is either passed to or returned to the method. ■ The name of the method argument can be anything, but you should use <code>SiebelMessage</code> if the ASI is to be used in a workflow process with other EAI services. ■ The integration object attribute must specify the name of the interface integration object.
LastPage	Last Page	Output	Boolean	Indicates whether the last record has been returned by the <code>QueryById</code> method.
PageSize	Page Size	Input	Number	The default is 10. This argument indicates the number of records to be returned for the <code>QueryPage</code> method.
PrimaryRowID	Object ID	Input	String	The ID that corresponds to the Siebel business component row ID for the primary integration component. This argument is only applicable to the <code>QueryById</code> method.
StartRowNum	Starting Row Number	Input	Number	The default is 0. The row number to start retrieving records for the <code>QueryPage</code> method.
RowID IntegrationId UserKey	None	Output	Status key	See "Using Status Keys" on page 21 for more information about this output argument.
ViewMode	None	Input	String	Specifies the visibility mode applied to the parent integration object. Applicable only to the <code>QueryPage</code> method.

Using Status Keys

A status key is an integration component key of the type Status key. Status keys are similar to unique keys (see ["Unique Keys in Integration Objects" on page 15](#)), and need to be defined for the output arguments. It is recommended that each component contain a set of these three unique keys:

- **Row ID.** The Siebel Row ID.
- **Integration ID.** A cross-reference that links the Siebel application to the corresponding record in the external application.
- **User Key.** Corresponds to the U1 index of the underlying table.

For more information about status keys, see *Integration Platform Technologies: Siebel Enterprise Application Integration*.

Handling Error Messages

If a method cannot find the integration object as specified by the method arguments, a SiebelMessage returns containing an empty list of integration objects.

However, if an error occurs during the execution of a method:

- The Business Service returns an error.
- A SOAP message is returned if the method is invoked as a Web service. See [“Handling Errors for ASIs” on page 25](#) for more information about Web services error messages.

Business Service User Properties for ASIs

User properties, as listed in [Table 3](#), control the behavior of an ASI. These values become input arguments to the service that invokes the ASI.

For example, an ASI using the Synchronize method can specify that an input data map for Synchronize is used—for example, Input Data Map (Synchronize). If Input Data Map (Synchronize) is not specified, the default data map, Input Data Map, is used instead. If a default data map is not specified, implicit mapping is used.

For more information about Business Service User Properties, see *Integration Platform Technologies: Siebel Enterprise Application Integration*.

Table 3. Business Service User Properties

Argument	Required	Description
Internal Integration Object	Yes	Name of the integration object defining the business object to expose.
Input Data Map	No	Name of the default data map for the input arguments. If no map or method is specified, implicit mapping occurs between the internal and input interface objects.
Output Data Map	No	Name of the default data map for the output arguments. If no map and method are specified, implicit mapping occurs between the internal and output interface objects.

Table 3. Business Service User Properties

Argument	Required	Description
Input Data Map (name of method)	No	Name of the data map for the input arguments for the specified method—for example, Input Data Map (Synchronize).
Output Data Map (name of method)	No	Name of the data map for the output arguments for the specified method—for example, Output Data Map (Update).

XML Method Example

The following XML example demonstrates an upsert-and-delete operation:

```
<Siebel Message MessageId="" MessageType="Integration Object" IntObjectName="Sample
Account">
  <ListOfSampleAccount>
    <Account operation="upsert">
      <Name>A. K. Parker Di stri buti on</Name>
      <Locati on>HQ-Di stri buti on</Locati on>
      <Organi zati on>North Ameri can Organi zati on</Organi zati on>
      <Di vi si on/>

      <CurrencyCode>USD</CurrencyCode>

      <Descripti on>This is the key account in the AK Parker
        Fami ly</Descripti on>

      <HomePage>www. parker. com</HomePage>

      <Li neofBusi ness>Manufacturi ng</Li neofBusi ness>

    <Li stOfContact>
      <Contact operation="del ete">
        <Fi rstName>Stan</Fi rstName>
        <JobTi tle>Seni or Mgr of MI S</JobTi tle>
        <LastName>Graner</LastName>
        <Mi ddl eName>A</Mi ddl eName>
        <Personal Contact>N</Personal Contact>
        <Account>A. K. Parker Di stri buti on</Account>
        <AccountLocati on>HQ-Di stri buti on</AccountLocati on>
      </Contact>
    </Li stOfContact>

  </Account>
</ListOfSampleAccount>

</Siebel Message>
```

Exposing ASIs with Interface Technologies

ASIs can be exposed through any of Siebel's interface technologies, which includes the Web Services Framework as well as the broader EAI Framework. The Web Services Framework supports Web service-related standards, including SOAP, WSDL, and XML Schema. You can use the broader EAI Framework for more flexibility in XML formatting and in choice of transport.

ASIs use supported transport technologies including HTTP, MQSeries from IBM, and MSMQ from Microsoft. For more information about XML processing, see *XML Reference: Siebel Enterprise Application Integration*. For more information about transports, see *Transports and Interfaces: Siebel Enterprise Application Integration*.

About ASIs and Web Services

Web services can make ASIs externally available by using information protocols (such as HTTP) and data formats (such as XML), and other communication protocols, such as SOAP, Universal Description Discovery and Integration (UDDI), and WSDL. Because ASIs are business services, ASIs can be exposed externally as Web services. However, while ASIs can be published as Web services, not all Web services are ASIs.

For more information about Web services and how to use them, see *Integration Platform Technologies: Siebel Enterprise Application Integration*.

Topics in this section include:

- [Protocols Used with ASIs](#)
- [Handling Errors for ASIs](#)

Protocols Used with ASIs

ASIs support the standard XML envelope for Web services and SOAP. Siebel applications support two types of SOAP protocols—SOAP-Remote Call Procedure (RPC) and SOAP-DOC. If an inbound ASI supports an industry standard other than the protocols that Oracle supports, the ASI cannot be defined as an inbound Web service. The ASI must be defined and supported through the existing EAI framework.

Table 4 lists the various types of transport and protocols available. The Null Protocol implements a loopback—a call back into the Siebel servers. Any method arguments passed using the Null Protocol or that are not directly specified are forwarded to the local business service or local workflow. When testing an ASI, you can use the File protocol.

Table 4. Protocols

Transport	SOAP-RPC	SOAP-DOC	Null
HTTP	Inbound/Outbound	Inbound/Outbound	Not Applicable
MQ	Inbound/Outbound	Outbound	Not Applicable
MSMQ	Inbound/Outbound	Outbound	Not Applicable
Local Business Service	Inbound/Outbound	Not Applicable	Not Applicable
Local Web Service	Outbound	Outbound	Outbound
Local Workflow	Outbound	Outbound	Outbound
File	Outbound	Outbound	Outbound

Handling Errors for ASIs

The SOAP fault message returns any errors for inbound and outbound ASIs.

Errors for Inbound ASIs

The SOAP fault block returns any inbound error messages, as defined by the SOAP 1.1 specification. The faultcode contains either a Client or Server value, and the faultstring contains a description of the error. The error message <siebel:errmsg> details the problems with the request. The information in the SOAP fault block can be extracted and displayed to the user.

The following XML shows an example of a fault message.

```
<?xml version="1.0" encoding="UTF-8" ?>
<?Siebel -Property-Set EscapeNames="false"?>
<SOAP-ENV:Envelope xmlns:SOAP-ENV="http://schemas.xmlsoap.org/soap/envelope/"
SOAP-ENV:encodingStyle="http://schemas.xmlsoap.org/soap/encoding/">
  <SOAP-ENV:Body>
    <SOAP-ENV:Fault xmlns:siebel="http://www.oracle.com/ws/fault">
      <faultcode>Client</faultcode>
      <faultstring>
        Supplied input is not well formed or does not contain the
        expected data.
      </faultstring>
    </SOAP-ENV:Fault>
  </SOAP-ENV:Body>
</SOAP-ENV:Envelope>
```

```

<detail >
  <si ebel f: errorstack>
    <si ebel f: error>
      <si ebel f: errorsymbol />

      <si ebel f: errormsg>Supplied input is not well formed
        or does not contain the expected data.
      </si ebel f: errormsg>

    </si ebel f: error>

    <si ebel f: error>
      <si ebel f: errorsymbol >
        IDS_XMLCNV_ERR_EMPTYMSG
      </si ebel f: errorsymbol >

      <si ebel f: errormsg>XML Hierarchy Converter error - empty
        input message, expecting an XML document in <Value> of
        input arguments
      </si ebel f: errormsg>

    </si ebel f: error>

  </si ebel f: errorstack>
</detail >
</SOAP-ENV: Fault >
</SOAP-ENV: Body >
</SOAP-ENV: Envelope >

```

Errors for Outbound ASIs

If an error occurs during an outbound ASI that has been exposed as a Web service, the business service raises the error and returns the SOAP fault message as the output method argument, soap:fault, for the application to process. The error is represented as an XML hierarchy property set.

Authentication and Security for ASIs

The authentication and security for ASIs depend on the underlying transport used to access the ASI and standard Siebel login logic. HTTP enables the authentication of individual Siebel users, while the MQ Series and MSMQ rely on the operating system's level of security of the underlying transport.

For more information about authentication and security, see the *Siebel Security Guide*.

NOTE: The Siebel Bookshelf is available on Oracle Technology Network (OTN) and Oracle Software Delivery Cloud. It might also be installed locally on your intranet or on a network location.

4

Administering Application Services Interfaces

This chapter describes how to implement ASIs and how to apply them to your workflows. Some user scenarios are described for you to better understand how to administer ASIs. Topics include:

- [Using ASIs](#)
- [User Scenarios for ASI Administration](#)

Using ASIs

Siebel ASIs are prebuilt and ready to use for integration between Siebel applications and external applications. ASIs require no change to the actual interface to be deployed and include prebuilt data maps that require no customization. You can deactivate fields and components within ASIs with no loss of their release-independence or upgradeability.

You can customize ASIs by adding new components and fields. For more information about customizing, see [Chapter 5, “Customizing an Application Services Interface.”](#)

NOTE: For other, customized interfaces (that is, *not* prebuilt ASIs) that you build, upgradeability across releases is not guaranteed.

The key activities when using ASIs include:

- [“Configuring ASIs” on page 27](#)
- [“Deactivating ASI Components and Fields” on page 28](#)
- [“Real Time and Asynchronous Processing with ASIs” on page 29](#)

Configuring ASIs

Although ASIs are prebuilt, for them to be exposed to external applications, you must configure them to the requirements of the IT application environment.

To configure an inbound data synchronization ASI

- 1 Open Siebel Tools and select the integration object you want to update and deactivate the components and fields you do not require for your business service.

NOTE: If an inbound ASI needs to be invoked through a workflow process, you need to define a named subsystem. See *Integration Platform Technologies: Siebel Enterprise Application Integration* for more information about named subsystems and how to define them.

See [“Deactivating ASI Components and Fields” on page 28](#) for more information. If you only deactivated fields and no map is specified in the ASI, a data map is unnecessary. Implicit data mapping still applies.

- 2 Recompile the project into an SRF file.
The ASI is now ready to use as a business service.
- 3 (Optional) If the ASI is to be made into a Web service, create a new entry in the Inbound Web Services Administration view.

To configure an outbound ASI

- 1 Open Siebel Tools and select the integration object you want to change and deactivate the components and fields you do not require for the ASI.

See [“Deactivating ASI Components and Fields” on page 28](#) for more information.

NOTE: Skip steps 3 through 5 of this procedure if a WSDL file exists for the internal interface. You can run the WSDL Wizard to import the necessary information. If a WSDL file does not exist, complete steps 2 through 4 of this procedure.

- 2 Open the Siebel Client, choose the Administration - Web Services menu, select the Outbound Web Services screen, and define an entry for the outbound ASI.

The port type should reference the business service created for the outbound ASI. The name of the business service and port must match the default names set on the business services definition.
- 3 Open Siebel Tools, select Business User Properties, and configure the following properties:
 - **Transport.** The service to send the request. See [“Exposing ASIs with Interface Technologies” on page 24](#) for more information.
 - **Protocol.** Defines the formatting of the data. See [“Protocols Used with ASIs” on page 24](#) for more information.
 - **Address.** The location to send the request. Use the URL or queue name associated with the transport.
- 4 Recompile the projects with the integration objects and business services definition into the SRF file.

Deactivating ASI Components and Fields

By default, all fields are active for use. You can deactivate fields for your particular business needs. In general, if you are deactivating the fields of an inbound ASI, you must also deactivate the corresponding outbound ASI fields; if you deactivate the fields for an outbound ASI, you must also deactivate the inbound ASI fields.

To deactivate a component or field

- 1 Open Siebel Tools.
- 2 Navigate to Integration Object, and choose the integration object you want to modify.
- 3 Select the components or fields you want to deactivate.

- 4 Check the Inactive column to make that component or field inactive.
- 5 Deactivate the map for the component, if an explicit map exists.

NOTE: Setting all fields as active slows the performance time. By deactivating fields, the amount of data sent decreases. For high-volume ASIs, deactivating fields might significantly reduce the performance and physical considerations surrounding a given integration object. Deactivate unnecessary fields to help increase performance time.

Real Time and Asynchronous Processing with ASIs

After an ASI request has been submitted, it executes immediately for the Siebel application or the external application in real time (synchronously). However, you can model asynchronous requests by creating two ASI methods.

To create an asynchronous process

- 1 Create an outbound ASI to provide the request arguments. See [“To define an inbound interface” on page 34](#).
- 2 Create an inbound ASI to accept the result from the external application. See [“To define an external interface” on page 35](#).
- 3 Create an explicit correlation ID in the outbound and inbound ASI to link the result to the original request.

Batch Processing

You can perform batch processing on ASIs by customizing the workflows to call an ASI at a specific time.

To create a batch process

- 1 Create the workflow process to call an ASI.
- 2 Schedule a Server Component Request to invoke the Workflow Process Batch Manager to run the workflow process.

See the application-specific documentation for information about customizing workflows.

User Scenarios for ASI Administration

The following scenario describes ASI administration. John is an integration administrator at ABC Company who must configure the prebuilt Siebel ASIs. The key activities in this scenario are:

- [Deactivating ASI Components and Fields](#)
- [Exposing an Inbound ASI](#)
- [Specifying an ASI Implementation](#)

A back-office application is sending customer information to be synchronized from the Siebel application to a back-office system. John needs to expose an existing inbound ASI, Sync Siebel Product, to receive the customer information, which uses data synchronization services. He also needs to use an existing outbound ASI, Sync External Account, to send the updated information to another system. In addition, John must also deactivate fields in the integration objects that are not being used for these particular ASIs.

Deactivating Fields in the Integration Object

John needs to deactivate various fields in the integration objects for the inbound ASI, AccountReceive, and the outbound ASI, AccountSend, that are not relevant for his company's business object. For each ASI, John:

- Chooses the internal integration object for the specific ASI and deactivates the unnecessary fields in Siebel Tools.
- Chooses the interface integration object for the specific ASI and deactivates the same fields he deactivated in the internal integration object. He deactivates these fields in Siebel Tools.

Exposing an Inbound ASI

John needs to expose the inbound ASI, AccountReceive, to receive the customer information from the back-office system. He wants the inbound ASI to be available over HTTP.

- In the Inbound Web Services screen in the Siebel Client, he specifies the port binding information: transport, protocol, and address.
- He publishes the WSDL file to advertise the inbound ASI and its address.

Specifying an ASI Implementation

For the outbound ASI, AccountSend, John wants to send the customer information as SOAP over HTTP. In the Outbound Web Services screen in the Siebel Client, he specifies the following for AccountSend:

- Transport—HTTP
- Protocol—SOAP
- File address—`http://ABCcompany/sendRequests/customer`

5

Customizing an Application Services Interface

This chapter describes the ASI framework, extending existing ASIs, and building your own interfaces. Also included is an in-depth description of how to customize your workflows to use ASIs. Topics include:

- [About ASI Framework](#)
- [Customizing Workflows to Use ASIs](#)
- [Building Customized Interfaces Using the ASI Framework](#)
- [User Scenarios for ASIs](#)

About ASI Framework

As defined in [“Defining ASIs” on page 9](#), an ASI is a release-independent interface published by Oracle in a standard metadata format and built using the ASI Framework.

The ASI Framework provides the technology in which ASIs are implemented. You can use this framework to extend existing ASIs or to define your own Web service and proxies in a Siebel application for externally defined services. Other interfaces can be built using the ASI Framework, but are not considered to be ASIs. Only Siebel prebuilt ASIs are supported across releases.

NOTE: For other, customized interfaces (that is, *not* prebuilt ASIs) that you build using the ASI Framework, upgradeability across releases is not guaranteed.

Extending an ASI

The following procedure describes extending an existing Siebel ASI to meet specific business needs.

To extend an ASI

- 1 Identify the integration objects to modify—the internal integration object and the interface integration object.
- 2 Open Siebel Tools, select the internal integration object, and add the required components and fields.
- 3 Select the interface integration object and add the required components and fields, matching the component and field names from the internal integration object.
- 4 Choose the Tools menu and select Validate Object to check the definition of the integration objects.
- 5 Recompile the project into an SRF file, and replace the SRF file on the application server with the new SRF file.

- 6 Open the Siebel Client, select the Administration - Integration menu, choose the Data Maps screen, query for the data map, and click Auto-Map if an explicit map exists for this service.

Clicking Auto-Map automatically creates an explicit map for the newly added components and fields to the ASI. Auto-Map maps the matching root components, fields, and child components between the integration objects, if the names are the same and no current mapping exists. For more information about the Auto-Map feature, see [“Automatic Mapping for Integration Objects” on page 19](#).

- 7 Click Validate in the Data Map screen to check any changes to the data map before testing.
- 8 If you are using a data map for the ASI, make sure you purge the Data Map cache to remove any traces of the current data map and enable the correct data map to be used.

CAUTION: Purge the data map only during the development and testing phases of the ASI.

NOTE: To purge the Data Map cache, you need to define a workflow under Business Process Administration. For more information about creating this workflow, see *Business Processes and Rules: Siebel Enterprise Application Integration*.

- 9 Test the ASI to make sure it is accurate and correct.

For instructions about defining your own Web service and proxies in a Siebel application for externally defined services, see *Integration Platform Technologies: Siebel Enterprise Application Integration*.

Customizing Workflows to Use ASIs

Workflows can invoke some ASIs for their processes. You can customize workflows to use the ASIs in the individual Siebel applications. In the following scenario, [Figure 9 on page 33](#) illustrates a workflow to Synchronize Account, invoking different ASI methods, QuerybyID and Synchronize.

NOTE: For more information about customizing workflows, see the application-specific documentation.

Customized Workflow Example

A customer using an external application needs to update an account within the Siebel database. The following scenario demonstrates how this customized workflow operates.

In the scenario illustrated in [Figure 9](#), the object ID is used to query for the account being sent. The QueryById method returns the account, which is stored in the SiebelMessage property. The account information is passed to the External Account Proxy, which sends the account information to the external system through Web services. The external system synchronizes the information and returns any new account information. The Synchronize method takes that new account information and synchronizes the information on the internal system.

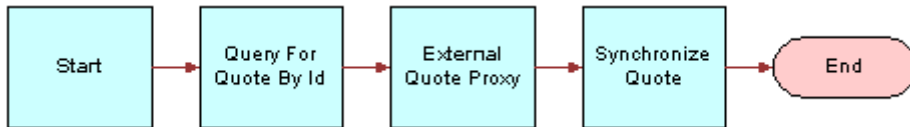

Figure 9. Synchronize Account Workflow

The QueryById method contains the method arguments shown in [Table 5](#).

Table 5. QueryById Method Arguments

Name	Display Name	Integration Object	Data Type	Type	Storage Type
PrimaryRowID	ID	None	String	Input	Property
SiebelMessage	Account Interface	Account Interface	Integration Object	Output	Hierarchy

The Synchronize method contains the method argument shown in [Table 6](#).

Table 6. Synchronize Method Argument

Name	Display Name	Integration Object	Data Type	Type	Storage Type
SiebelMessage	Account Interface	Account Interface	Integration Object	Input/Output	Hierarchy

In this example, an interface integration object with the name Account Interface is created to define the external representation of the account. An internal integration object with the name Internal Account Interface is created to describe the structure of the Account business object.

The workflow process properties are used to store data in the workflow. The Object ID property (data type String) is included in each workflow by default. Account Message (data type Integration Object) is defined to store the output of the Query by Account ID step.

The Query by Account step calls the QueryById method of the Siebel Account data synchronization service. The process property Object ID is passed as an input argument. Account Interface is passed as an output argument to the process property Account Message. The External Account Proxy step calls the Synchronize method of the External Account outbound ASI. For the input argument, the process property, Account Message, is passed to the input argument, Account Interface. For the output argument, the method output argument, Account Interface, is passed to the process property, Account Message.

Table 7 shows the input arguments.

Table 7. Input Arguments

Input Argument	Type	Property Name	Property Data Type
ID	Process Property	Object ID	String
Account Interface	Process Property	Account Message	Integration Object

Table 8 shows the output argument.

Table 8. Output Argument

Property Name	Type	Output Argument
Account Message	Output Argument	Account Interface

Building Customized Interfaces Using the ASI Framework

You can build your own interfaces using the ASI Framework.

To define an inbound interface

- 1 Determine the schema and fields of the integration objects based on your business needs.
- 2 Open Siebel Tools, create the internal integration object using the Integration Object Wizard, and deactivate the components and fields that are not required.

NOTE: Deleting fields is not recommended. For more information about creating integration objects, see *Integration Platform Technologies: Siebel Enterprise Application Integration*.

- 3 Create the interface integration object in Siebel Tools using one of the following methods:
 - Copy the internal integration object, if the internal and interface objects are the same.
 - Use the DTD or XML schema wizard. For more information about using the XML schema wizard, see *Integration Platform Technologies: Siebel Enterprise Application Integration*.
 - Create the object manually.

- 4 Deactivate the components and fields that are not required.
Deleting fields is not recommended.
- 5 Choose the Tools menu and select Validate Object to check the definition of the integration objects.
- 6 Compile the SRF file, and import it to the Siebel Server.
- 7 Open Siebel Client, select the Administration - Integration menu, and select the Data Maps screen.
NOTE: Do not create an explicit data map if an object is a subset of another or if the objects are the same. The data synchronization service automatically maps the subsets if the root integration components have the same name.
- 8 Open the Integration Administration menu and choose the Data Map editor to create an explicit data map if the two objects contain different component or field names.
A map is required for each direction:
 - From Interface Object to Internal Object
 - From Internal Object to Interface Object
- 9 Click Validate in the Data Map editor to check the data map changes before testing.
- 10 Open Siebel Tools, define the business service, and set the class property to CSSEAIDataSyncService.
Within the business service:
 - a Define the methods needed for this service. See ["Data Synchronization Methods for ASIs" on page 19](#) for more details.
 - b Define the Business Service User Properties to configure the internal object and the data map names. See ["Business Service User Properties for ASIs" on page 22](#) for more details.
- 11 Recompile the projects with the integration objects and business services definition into the SRF file.
- 12 Open Siebel Client, select the Administration - Web Services menu, and choose the Inbound Web Services screen. Create an entry if the inbound interface is to be made available as a Web service.

To create an outbound interface, you must publish it as a Web service to use it externally.

To define an external interface

- 1 Open Siebel Tools and define the integration objects manually or by using the Integration Object Wizard.
 - a Deactivate components and fields that are not required.
Deleting fields is not recommended.

- b Create interface integration objects manually by copying and changing the internal object, or by importing an XML DTD.

NOTE: Skip to [Step 5](#) of this procedure if a WSDL file exists for the internal interface. You can run the WSDL Wizard to automatically import the information that is created manually in [Step 3](#) through [Step 5](#). If a WSDL file does not exist, complete [Step 2](#) through [Step 4](#). For more information about using the WSDL Wizard, see *Integration Platform Technologies: Siebel Enterprise Application Integration*.

- 2 Open Siebel Tools and define the business service to describe the interface to the ASI, including all methods and parameters for each method.

This business service references the integration objects created in [Step 1](#).

- a Set the business service's class to CSSWSOutboundDispatcher.
- b Set the parameters on methods to type Integration Object and refer to the specified interface object.

- 3 Define the Business Service User Properties in Siebel Tools:

- a Choose a name for the default service, siebel_web_service_name.
- b Choose the properties for the default port, siebel_port_name.
- c Register the name on the business service as a user property, and define the service and port name as the proxy's default service name, siebel_web_service_namespace.

NOTE: The user property, ApplicationServicesInterface, is set to Y for each ASI Business Service. You can use it for visual identification to differentiate this business service from other business services. The user property has no functional implication.

- 4 Open Siebel Client, choose the Outbound Web Services screen, and select a name for the default service. Configure the following properties:

- Port types are all the published proxy business services used to define the outbound ASI interface. The port name is the business service you created in Siebel Tools in [Step 2 on page 36](#).
- Transports describe the transport type for your particular platform and system. For more information, see ["Exposing ASIs with Interface Technologies" on page 24](#).
- Protocols describes the formatting of the integration object being sent. For more information, see ["Protocols Used with ASIs" on page 24](#).
- Address is the physical location of the touchpoint files.

- 5 Recompile the projects with the integration objects and business services definition into the SRF file.

- 6 Define an entry for the outbound ASI in the Outbound Services Administration View.

The port type should reference the business service created for the outbound ASI. The name of the business service and port must match the default names set on the business services definition.

To define the data map

- An inbound and outbound data map need to be created for each interface. In Siebel Client, use the Data Maps view under the Administration - Integration menu to create a new data map for new or customized integration objects. See [“Data Mapping for ASI Release Independence” on page 16](#) for more information about data mapping.

For more information about creating a data map for the ASI, see *Business Processes and Rules: Siebel Enterprise Application Integration*.

User Scenarios for ASIs

The Siebel prebuilt ASIs might not be sufficient, depending on your business needs. You can extend existing ASIs for further customization, or you can create new interfaces using the ASI Framework. The following scenarios describe an integration developer who needs to customize the interface to reflect her company’s business needs, rules, and processes. The key activities in these scenarios are:

- [Defining an Outbound ASI](#)
- [Defining an Outbound ASI](#)

Extending an ASI

At the ABC company, Jane needs to extend an existing ASI by adding a new field, LifeTimeValue, to the business component, Account, and expose the new field in the ASI, Siebel Account, which uses data synchronization services.

To accomplish these tasks, Jane must:

- 1 Create the new field, LifeTimeValue, in the Account business component using Siebel Tools.
- 2 Add LifeTimeValue to Account’s internal integration object using Siebel Tools.
- 3 Add LifeTimeValue to Account’s interface integration object using Siebel Tools. She must make sure that the two fields in the internal and interface integration objects have matching names.
- 4 Recompile the integration objects and project into an SRF file, and test the new ASI.
- 5 Use the Auto-Map function in the Siebel Data Mapper to automatically map the new field in the internal integration object to the new field in the interface integration object.

After completing these tasks, the new field is available to the business component, Account, and all ASIs based on it, including Siebel Account.

Defining an Outbound ASI

Jane needs to define an outbound ASI for her company, ABC Company, that submits an order to a back-office system using data synchronization services. She calls the ExternalOrder ASI.

To create this ASI, Jane must do the following in Siebel Tools:

- 1 Create an internal integration object, ExternalOrder Internal, with the necessary components and fields based on ABC Company’s business needs.

- 2 Create an interface integration object, ExternalOrder Interface, with the same components and field names as the ExternalOrder Internal integration object. Because both integration objects have the same component and field names, Jane does not need to create a data map, because she uses the data synchronization service's implicit mapping function.
- 3 Define a new Business Service, named ExternalOrder, as an outbound ASI, by specifying CSSWSOutboundDispatcher as Class.
- 4 Define all the methods used by this ASI.
- 5 For each method, create the method argument parameters as Integration Object, String, Hierarchy, Number, or Date, and specify the Type as input or output.
- 6 Specify the implementation for the ASI by setting the Business Service User Properties, because she does not have a current WSDL template to import. Consequently, Jane must create the following Business Service User Properties:

Business Service User Property	Value
siebel_web_service_namespace	ExternalOrder
siebel_web_services_name	ExternalOrder
siebel_port_name	Default

- 7 Compile all integration objects and business services into an SRF file for the Siebel Server.
- 8 In the Siebel Client, navigate to the Administration - Web Services screen, and then Outbound Web Services.
- 9 Define a new outbound ASI called ExternalOrder, provide a namespace, and make it Active.
- 10 For the outbound ASI, create the Service Port External Order and reference it to the External Order that she created and compiled in Siebel Tools.
- 11 Select the correct transport, WSDL address, and binding.
- 12 Under Operations, list the methods needed for this ASI. The new ExternalOrder ASI is created and ready to use.

A

Predefined Application Service Interfaces

This appendix provides a list of the prebuilt ASIs that are provided with Siebel applications. You can use these ASIs to receive, send, or request data from other applications.

An ASI consists of a business service, which implements various methods and integration objects, and holds whatever data is present in run time. An integration object can consist of multiple integration components, each with multiple fields. All these fields are active by default and are used by the ASI. You can deactivate unnecessary fields. For more information, see [“Deactivating ASI Components and Fields” on page 28](#).

Each ASI is based on an integration object and can be used to integrate data for all fields of that integration object.

This appendix includes the following topics:

- [About Prebuilt ASIs](#)
- [Siebel Account](#)
- [Siebel Action](#)
- [Siebel Business Address](#)
- [Siebel Personal Address](#)
- [Siebel Asset](#)
- [Siebel Contact](#)
- [Siebel CUT Address MSAG Service](#)
- [Siebel Cost List](#)
- [Siebel Employee](#)
- [Siebel Financial Account](#)
- [Siebel Forecast](#)
- [Siebel Invoice](#)
- [External Opportunity Create/External Opportunity Query/External Opportunity Update](#)
- [Siebel Order](#)
- [Siebel Position](#)
- [Siebel Price List](#)
- [Siebel Quote/External Quote](#)
- [Siebel ATP Response/External ATP Check](#)
- [External Credit Check](#)
- [External Shipment Tracking](#)

- [Siebel SIA Service Request](#)
- [Siebel Service Request](#)
- [Siebel Simple Product](#)

NOTE: Required is abbreviated as Req. and Not Applicable is abbreviated as NA in the following tables.

About Prebuilt ASIs

Table 9 lists the prebuilt ASIs provided by Oracle.

Table 9. Prebuilt Application Services Interfaces

ASI	Description
Siebel Account	ASI to facilitate the inbound and outbound transfer of account data from the Siebel application. For details, see “Siebel Account” on page 41 .
Siebel Action	ASI to facilitate the inbound and outbound transfer of activity data from the Siebel application. For details, see “Siebel Action” on page 55 .
Siebel Business Address	ASI to facilitate the inbound and outbound transfer of business address data from the Siebel application. For details, see “Siebel Business Address” on page 61 .
Siebel Personal Address	ASI to facilitate the inbound and outbound transfer of personal address data from the Siebel application. For details, see “Siebel Personal Address” on page 63 .
Siebel Asset	ASI that associates a customer with a unique product. For details, see “Siebel Asset” on page 64 .
Siebel Contact	ASI to facilitate the inbound and outbound transfer of contact data from the Siebel application. For details, see “Siebel Contact” on page 68 .
Siebel Cost List	ASI to enable the synchronization and update of a cost list and the cost list items. For details, see “Siebel Cost List” on page 75 .
Siebel Employee	ASI to facilitate the inbound and outbound transfer of employee data from the Siebel application. For details, see “Siebel Employee” on page 78 .
Siebel Financial Account	ASI to facilitate the inbound and outbound financial account data synchronization between the Siebel application and the UCM system. For details, see “Siebel Financial Account” on page 91 .
Siebel Forecast	ASI to facilitate the outbound data synchronization between the Siebel application and an external back-office system. For details, see “Siebel Forecast” on page 96 .
Siebel Invoice	ASI to facilitate the inbound and outbound transfer of invoice data from the Siebel application. For details, see “Siebel Invoice” on page 99 .

Table 9. Prebuilt Application Services Interfaces

ASI	Description
External Opportunity Create/External Opportunity Query/ External Opportunity Update	ASI to facilitate the inbound and outbound transfer of opportunity data from the Siebel application. For details, see “External Opportunity Create/ External Opportunity Query/External Opportunity Update” on page 109.
Siebel Order	ASI to facilitate the inbound and outbound transfer of order data from the Siebel application. For details, see “Siebel Order” on page 130.
Siebel Position	ASI to facilitate the inbound and outbound transfer of position data from the Siebel application. For details, see “Siebel Position” on page 147.
Siebel Price List	ASI to enable the synchronization and update of a price list and the price list items. For details, see “Siebel Price List” on page 148.
Siebel ATP Response/ External ATP Check	ASI to facilitate request of availability-to-promise data. For details, see “Siebel ATP Response/External ATP Check” on page 166.
External Credit Check	ASI to facilitate the request for a credit check from an external system. For details, see “External Credit Check” on page 174.
Siebel SIA Service Request	ASI to create an SIA service request within the Siebel application. For details, see “Siebel SIA Service Request” on page 182.
Siebel Service Request	ASI to synchronize service requests in the Siebel application with an external target application. For details, see “Siebel Service Request” on page 185.
Siebel Simple Product	ASI to facilitate the inbound and outbound transfer of simple product data from the Siebel application. For details, see “Siebel Simple Product” on page 189.

Siebel Account

Use this ASI for customer information management-related business processes. This ASI facilitates inbound and outbound account data synchronization between a Siebel application and any external system. [Figure 10](#) describes the Siebel Account ASI structure.

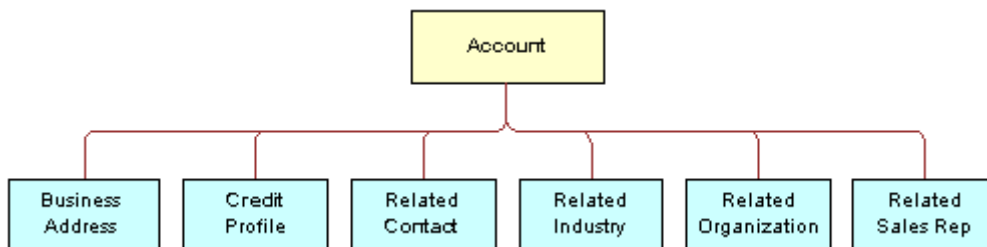

Figure 10. Siebel Account ASI

Table 10 lists the user keys of the Siebel Account ASI.

Table 10. Siebel Account Integration Components

Integration Component	XML Tag	User Keys
Account	Account	<ol style="list-style-type: none"> 1 Account Id 2 Integration Id 3 Location, Name, Primary Organization
Business Address	BusinessAddress	<ol style="list-style-type: none"> 1 Address Id 2 Address Integration Id 3 City, State, Street Address
Credit Profile	CreditProfile	<ol style="list-style-type: none"> 1 Credit Profile Id 2 Credit Profile Integration Id 3 Credit Area
Related Bill To Account	RelatedBillToAccount	<ol style="list-style-type: none"> 1 Id 2 Integration Id 3 Bill To Account, Location 4 CSN
Related Contact	RelatedContact	<ol style="list-style-type: none"> 1 Person UId, Primary Organization 2 Contact Id 3 Contact Integration Id 4 First Name, Last Name, Middle Name
Related Credit Profile	RelatedCreditProfile	<ol style="list-style-type: none"> 1 Credit Control Area Code
Related Industry	RelatedIndustry	<ol style="list-style-type: none"> 1 Industry Id 2 Industry Integration Id 3 Industry 4 SIC Code
Related Organization	RelatedOrganization	<ol style="list-style-type: none"> 1 Organization Id 2 Organization Integration Id 3 Organization

Table 10. Siebel Account Integration Components

Integration Component	XML Tag	User Keys
Related Payer Account	RelatedPayerAccount	<ol style="list-style-type: none"> 1 Id 2 Integration Id 3 Payer Account, Location 4 CSN
Related Sales Organization	RelatedSalesOrganization	<ol style="list-style-type: none"> 1 Organization Id
Related Sales Rep	RelatedSalesRep	<ol style="list-style-type: none"> 1 Position Id 2 Position Integration Id 3 Division, Position 4 Login
Related Ship To Account	RelatedShipToAccount	<ol style="list-style-type: none"> 1 Id 2 Integration Id 3 Ship To Account, Location 4 CSN
Related Sold To Account	RelatedSoldToAccount	<ol style="list-style-type: none"> 1 Id 2 Integration Id 3 Sold To Account, Location 4 CSN

Table 11 lists the fields and attributes of this ASI.

Table 11. Siebel Account ASI Fields

Name	XML Tag	Data Type	Length	Req.	Notes
Account					
Account Id	AccountId	DTYPE_ID	30	No	None
Account Organization Integration Id	AccountOrganizationIntegrationId	DTYPE_TEXT	30	No	None
Account Status	AccountStatus	DTYPE_TEXT	24	No	None
Alias	Alias	DTYPE_TEXT	50	No	None
Assignment Area Code	AssignmentAreaCode	DTYPE_TEXT	5	No	None

Table 11. Siebel Account ASI Fields

Name	XML Tag	Data Type	Length	Req.	Notes
Assignment Country Code	AssignmentCountryCode	DTYPE_TEXT	5	No	None
Back Office Order Query End Dt	BackOfficeOrderQueryEndDt	DTYPE_DATE TIME	NA	No	None
Back Office Order Query Start Dt	BackOfficeOrderQueryStartDt	DTYPE_DATE TIME	NA	No	None
Back Office Sales Area Division Code	BackOfficeSalesAreaDivisionCode	DTYPE_TEXT	30	No	None
CSN	CSN	DTYPE_TEXT	30	No	None
Competitor Flag	CompetitorFlag	DTYPE_BOOLEAN		No	None
Created	Created	DTYPE_DATE TIME	30	No	None
Credit Auto Approval Limit	CreditAutoApprovalLimit	DTYPE_CURRENCY	NA	No	None
Credit Status Date	CreditStatusDate	DTYPE_UTC DAYETIME	7	No	None
Currency Code	CurrencyCode	DTYPE_TEXT	15	No	Used for picking a related entity.
Customer Account Group	CustomerAccountGroup	DTYPE_TEXT	30	No	None
Description	Description	DTYPE_TEXT	255	No	None
Disable Data Cleansing	DisableDataCleansing	DTYPE_TEXT	NA	No	None
Division	Division	DTYPE_TEXT	30	No	None
DUNS Number	DUNSNumber	DTYPE_TEXT	15	No	None
Domestic Ultimate DUNS	DomesticUltimateDUNS	DTYPE_TEXT	15	No	None
EAI Sync Date	EAISyncDate	DTYPE_TEXT	NA	No	None
EAI Sync Error Text	EAISyncErrorText	DTYPE_TEXT	2000	No	None
EAI Sync Status Code	EAISyncStatusCode	DTYPE_TEXT	30	No	None

Table 11. Siebel Account ASI Fields

Name	XML Tag	Data Type	Length	Req.	Notes
Expertise	Expertise	DTYPE_TEXT	30	No	Bound by ACCOUNT_EXPERTISE LOV.
Freight Terms	FreightTerms	DTYPE_TEXT	30	No	None
Freight Terms Info	FreightTermsInfo	DTYPE_TEXT	100	No	None
Global Ultimate DUNS	GlobalUltimateDUNS	DTYPE_TEXT	15	No	None
Home Page	HomePage	DTYPE_TEXT	100	No	None
Integration Id	IntegrationId	DTYPE_TEXT	30	No	User key field.
Internal Org Flag	InternalOrgFlag	DTYPE_TEXT	NA	No	None
Language Code	LanguageCode	DTYPE_ID	NA	No	None
Location	Location	DTYPE_TEXT	50	No	None
Main Fax Number	MainFaxNumber	DTYPE_PHONE	NA	No	None
Main Phone Number	MainPhoneNumber	DTYPE_PHONE	NA	No	None
Name	Name	DTYPE_TEXT	100	No	User key field.
Number of Employees	NumberOfEmployees	DTYPE_NUMBER	NA	No	None
operation	operation	DTYPE_TEXT	30	No	None
PO Approved Flag	POApprovedFlag	DTYPE_TEXT	NA	No	None
PO Auto Approval Currency Code	POAutoApprovalCurrencyCode	DTYPE_TEXT	20	No	Used for picking a related entity.
PO Auto Approval Date	POAutoApprovalDate	DTYPE_DATE TIME	NA	No	None
PO Auto Approval Limit	POAutoApprovalLimit	DTYPE_TEXT	NA	No	None
Parent Account Division	ParentAccountDivision	DTYPE_TEXT	NA	No	None
Parent Account Id	ParentAccountId	DTYPE_ID	NA	No	None
Parent Account Integration Id	ParentAccountIntegrationId	DTYPE_TEXT	30	No	None

Table 11. Siebel Account ASI Fields

Name	XML Tag	Data Type	Length	Req.	Notes
Parent Account Location	ParentAccountLocation	DTYPE_TEXT	50	No	None
Parent Account Location Level	ParentAccountLocationLevel	DTYPE_TEXT	30	No	None
Parent Account Name	ParentAccountName	DTYPE_TEXT	100	No	None
Parent Account Region	ParentAccountRegion	DTYPE_TEXT	30	No	None
Parent HQ DUNS	ParentHQDUNS	DTYPE_TEXT	15	No	None
Partner Flag	PartnerFlag	DTYPE_TEXT	1	No	None
Partners	Partners	DTYPE_TEXT	100	No	None
Party Name	PartyName	DTYPE_TEXT	30	No	None
Party Type Code	PartyTypeCode	DTYPE_TEXT	30	No	None
Party UId	PartyUId	DTYPE_TEXT	30	No	None
Price List	PriceList	DTYPE_TEXT	NA	No	None
Price List End Date	PriceListEndDate	DTYPE_TEXT	NA	No	None
Price List Id	PriceListId	DTYPE_ID	NA	No	None
Price List Integration Id	PriceListIntegrationId	DTYPE_TEXT	30	No	None
Price List Start Date	PriceListStartDate	DTYPE_TEXT	NA	No	None
Primary Account City	PrimaryAccountCity	DTYPE_TEXT	50	No	None
Primary Account Country	PrimaryAccountCountry	DTYPE_TEXT	30	No	None
Primary Account Postal Code	PrimaryAccountPostalCode	DTYPE_TEXT	30	No	None
Primary Account State	PrimaryAccountState	DTYPE_TEXT	10	No	None
Primary Account Street Address	PrimaryAccountStreetAddress	DTYPE_TEXT	200	No	None
Primary Address Id	PrimaryAddressId	DTYPE_ID	NA	No	None

Table 11. Siebel Account ASI Fields

Name	XML Tag	Data Type	Length	Req.	Notes
Primary Assignment Denorm Flag	PrimaryAssignmentDenormFlag	DTYPE_TEXT	NA	No	None
Primary Assignment Manual Flag	PrimaryAssignmentManualFlag	DTYPE_TEXT	NA	No	None
Primary Assignment System Flag	PrimaryAssignmentSystemFlag	DTYPE_TEXT	NA	No	None
Primary Assignment Type	PrimaryAssignmentType	DTYPE_TEXT	30	No	None
Primary Bill To Address Id	PrimaryBillToAddressId	DTYPE_ID	NA	No	None
Primary Bill To City	PrimaryBillToCity	DTYPE_TEXT	50	No	None
Primary Bill To Country	PrimaryBillToCountry	DTYPE_TEXT	30	No	None
Primary Bill To First Name	PrimaryBillToFirstName	DTYPE_TEXT	50	No	None
Primary Bill To Job Title	PrimaryBillToJobTitle	DTYPE_TEXT	75	No	None
Primary Bill To Last Name	PrimaryBillToLastName	DTYPE_TEXT	50	No	None
Primary Bill To Person Id	PrimaryBillToPersonId	DTYPE_ID	NA	No	None
Primary Bill To Postal Code	PrimaryBillToPostalCode	DTYPE_TEXT	30	No	None
Primary Bill To State	PrimaryBillToState	DTYPE_TEXT	10	No	None
Primary Bill To Street Address	PrimaryBillToStreetAddress	DTYPE_TEXT	200	No	None
Primary Fulfill InvLoc Integration Id	PrimaryFulfillInvLocIntegrationId	DTYPE_TEXT	30	No	None
Primary Fulfillment InvLoc Id	PrimaryFulfillmentInvLocId	DTYPE_TEXT	NA	No	None

Table 11. Siebel Account ASI Fields

Name	XML Tag	Data Type	Length	Req.	Notes
Primary Fulfillment Inventory Location	PrimaryFulfillmentInventoryLocation	DTYPE_TEXT	NA	No	None
Primary Industry Id	PrimaryIndustryId	DTYPE_ID	NA	No	None
Primary Organization	PrimaryOrganization	DTYPE_TEXT	100	No	User key field.
Primary Organization Id	PrimaryOrganizationId	DTYPE_ID	NA	No	None
Primary Payer Account	PrimaryPayerAccount	DTYPE_TEXT	100	No	None
Primary Payer Account Id	PrimaryPayerAccountId	DTYPE_ID	NA	No	None
Primary Position Id	PrimaryPositionId	DTYPE_ID	NA	No	None
Primary Service Agreement Id	PrimaryServiceAgreementId	DTYPE_ID	NA	No	None
Primary Ship To Address Id	PrimaryShipToAddressId	DTYPE_ID	NA	No	None
Primary Ship To City	PrimaryShipToCity	DTYPE_TEXT	50	No	None
Primary Ship To Country	PrimaryShipToCountry	DTYPE_TEXT	30	No	None
Primary Ship To First Name	PrimaryShipToFirstName	DTYPE_TEXT	50	No	None
Primary Ship To Job Title	PrimaryShipToJobTitle	DTYPE_TEXT	75	No	None
Primary Ship To Last Name	PrimaryShipToLastName	DTYPE_TEXT	50	No	None
Primary Ship To Person Id	PrimaryShipToPersonId	DTYPE_ID	NA	No	None
Primary Ship To Postal Code	PrimaryShipToPostalCode	DTYPE_TEXT	30	No	None
Primary Ship To State	PrimaryShipToState	DTYPE_TEXT	10	No	None

Table 11. Siebel Account ASI Fields

Name	XML Tag	Data Type	Length	Req.	Notes
Primary Ship To Street Address	PrimaryShipToStreetAddress	DTYPE_TEXT	200	No	None
Primary Territory Id	PrimaryTerritoryId	DTYPE_ID	NA	No	None
Primary Type Id	PrimaryTypeId	DTYPE_ID	NA	No	None
Region	Region	DTYPE_TEXT	30	No	None
Relationship Type	RelationshipType	DTYPE_TEXT	30	No	None
Revenue Growth	RevenueGrowth	DTYPE_NUMBER	NA	No	None
Skip Credit Check	SkipCreditCheck	DTYPE_TEXT	NA	No	None
Start Date	StartDate	DTYPE_DATE TIME	NA	No	None
Strategies	Strategies	DTYPE_TEXT	500	No	None
Strategy	Strategy	DTYPE_TEXT	2000	No	None
Success Factors	SuccessFactors	DTYPE_TEXT	500	No	None
Territory Item Type	TerritoryItemType	DTYPE_TEXT	30	No	None
Type	Type	DTYPE_TEXT	255	No	None
Updated	Updated	DTYPE_DATE TIME	30	No	None
VAT registration number	VATregistrationnumber	DTYPE_TEXT	30	No	None
Business Address					
Address Active Status	AddressActiveStatus	DTYPE_TEXT	NA	No	None
Address Id	AddressId	DTYPE_ID	30	No	None
Address Integration Id	AddressIntegrationId	DTYPE_TEXT	30	No	None
Address Name	AddressName	DTYPE_TEXT	100	No	None
Bill Address Flag	BillAddressFlag	DTYPE_TEXT	NA	No	None
City	City	DTYPE_TEXT	50	No	None
Country	Country	DTYPE_TEXT	50	No	None

Table 11. Siebel Account ASI Fields

Name	XML Tag	Data Type	Length	Req.	Notes
County	County	DTYPE_TEXT	50	No	None
Disable Data Cleansing	DisableDataCleansing	DTYPE_TEXT	NA	No	None
Email Address	EmailAddress	DTYPE_TEXT	50	No	None
Fax Number	FaxNumber	DTYPE_TEXT	NA	No	None
Main Address Flag	MainAddressFlag	DTYPE_TEXT	NA	No	None
operation	operation	DTYPE_TEXT	30	No	None
Phone Number	PhoneNumber	DTYPE_TEXT	NA	No	None
IsPrimaryMVG	IsPrimaryMVG	DTYPE_TEXT	1	No	None
Postal Code	PostalCode	DTYPE_TEXT	30	No	None
Province	Province	DTYPE_TEXT	50	No	None
Ship Address Flag	ShipAddressFlag	NA	NA	No	None
State	State	DTYPE_TEXT	10	No	None
Street Address	StreetAddress	DTYPE_TEXT	200	No	None
Street Address 2	Street Address2	DTYPE_TEXT	100	No	None
Credit Profile					
Credit Area	CreditArea	DTYPE_TEXT	30	No	None
Credit Available	CreditAvailable	DTYPE_NUMBER	NA	No	None
Credit Currency Code	CreditCurrencyCode	DTYPE_TEXT	20	No	None
Credit Limit	CreditLimit	DTYPE_NUMBER	NA	No	None
Credit Profile Id	CreditProfileId	DTYPE_ID	30	No	None
Credit Profile Integration Id	CreditProfileIntegrationId	DTYPE_TEXT	30	No	None
Credit Reporting Group	CreditReportingGroup	DTYPE_TEXT	50	No	None
Credit Status Code	CreditStatusCode	DTYPE_TEXT	30	No	None
Credit Status Message	CreditStatusMessage	DTYPE_TEXT	NA	No	None

Table 11. Siebel Account ASI Fields

Name	XML Tag	Data Type	Length	Req.	Notes
Credit Used	CreditUsed	DTYPE_NUMBER	NA	No	None
IsPrimaryMVG	IsPrimaryMVG	DTYPE_TEXT	1	No	None
Risk Category Code	RiskCategoryCode	DTYPE_TEXT	30	No	None
operation	operation	DTYPE_TEXT	30	No	None
Related Contact					
Alternate Phone #	AlternatePhone	DTYPE_TEXT	NA	No	None
Assistant Phone #	AssistantPhone	DTYPE_TEXT	NA	No	None
Cellular Phone #	CellularPhone	DTYPE_TEXT	NA	No	None
Conflict Id	ConflictId	DTYPE_ID	30	No	None
Contact Id	ContactId	DTYPE_ID	30	No	None
Contact Integration Id	ContactIntegrationId	DTYPE_TEXT	30	No	None
Email Address	EmailAddress	DTYPE_TEXT	50	No	None
Employee Number	EmployeeNumber	DTYPE_TEXT	30	No	None
Fax Phone #	FaxPhone	DTYPE_TEXT	NA	No	None
First Name	FirstName	DTYPE_TEXT	50	No	None
Home Phone #	HomePhone	DTYPE_TEXT	NA	No	None
Job Title	JobTitle	DTYPE_TEXT	75	No	None
Last Name	LastName	DTYPE_TEXT	50	No	None
M/F	MF	DTYPE_TEXT	255	No	None
M/M	MM	DTYPE_TEXT	15	No	None
Middle Name	MiddleName	DTYPE_TEXT	50	No	None
Organization	Organization	DTYPE_TEXT	50	No	None
Person UId	PersonUId	DTYPE_TEXT	100	No	None
Primary Organization	PrimaryOrganization	DTYPE_TEXT	100	No	None
Work Phone #	WorkPhone	DTYPE_TEXT	NA	No	None

Table 11. Siebel Account ASI Fields

Name	XML Tag	Data Type	Length	Req.	Notes
Work Phone Extension	WorkPhoneExtension	DTYPE_TEXT	10	No	None
Related Industry					
Industry	Industry	DTYPE_TEXT	50	No	None
Industry Id	IndustryId		30	No	None
Industry Integration Id	IndustryIntegrationId	DTYPE_TEXT	30	No	None
IsPrimaryMVG	IsPrimaryMVG	DTYPE_TEXT	1	No	None
SIC Code	SICCode	DTYPE_TEXT	30	No	None
Related Organization					
IsPrimaryMVG	IsPrimaryMVG	DTYPE_TEXT	1	No	None
Organization	Organization	DTYPE_TEXT	50	No	None
Organization Id	OrganizationId	DTYPE_ID	15	No	None
Organization Integration Id	OrganizationIntegrationId	DTYPE_TEXT	30	No	None
Related Sales Rep					
Division	Division	DTYPE_TEXT	255	No	None
IsPrimaryMVG	IsPrimaryMVG	DTYPE_TEXT	1	No	None
Login	Login	DTYPE_TEXT	50	No	None
Position	Position	DTYPE_TEXT	50	No	None
Position Id	PositionId	DTYPE_ID	30	No	None
Position Integration Id	PositionIntegrationId	DTYPE_TEXT	30	No	None
Related Sales Organization					
Account Status	AccountStatus	DTYPE_TEXT	30	No	None
Back Office Distribution Channel	BackOfficeDistributionChannel	DTYPE_TEXT	30	No	None
Back Office Sales Area Division Code	BackOfficeSalesAreaDivisionCode	DTYPE_TEXT	30	No	None
Back Office Sales Organization	BackOfficeSalesOrganization	DTYPE_TEXT	30	No	None
Conflict Id	ConflictId	DTYPE_ID	30	No	None

Table 11. Siebel Account ASI Fields

Name	XML Tag	Data Type	Length	Req.	Notes
Created	Created	DTYPE_DATE TIME	30	No	None
Currency Code	CurrencyCode	DTYPE_TEXT	20	No	None
Freight Terms	FreightTerms	DTYPE_TEXT	30	No	None
Freight Terms Info	FreightTermsInfo	DTYPE_TEXT	100	No	None
Id	Id	DTYPE_TEXT	30	No	None
Integration Id	IntegrationId	DTYPE_TEXT	30	No	None
Language Code	LanguageCode	DTYPE_ID	NA	No	None
Mod Id	ModId	DTYPE_ID	30	No	None
Organization	Organization	DTYPE_TEXT	100	No	None
Organization Id	OrganizationId	DTYPE_ID	NA	No	None
Parent Account Id	ParentAccountId	DTYPE_ID	NA	No	None
Party Id	PartyId	DTYPE_ID	NA	No	None
Payment Terms	PaymentTerms	DTYPE_ID	NA	No	None
Payment Terms Integration Id	PaymentTermsIntegrationId	DTYPE_TEXT	NA	No	None
Payment Terms Name	PaymentTermsName	DTYPE_TEXT	NA	No	None
Price List Type	PriceListType	DTYPE_ID	NA	No	None
Primary Bill To Account Id	PrimaryBillToAccountId	DTYPE_ID	NA	No	None
Primary Fulfillment InvLoc	PrimaryFulfillmentInvLoc	DTYPE_TEXT	NA	No	None
Primary Fulfillment InvLoc ID	PrimaryFulfillmentInvLocID	DTYPE_ID	NA	No	None
Primary Fulfillment InvLoc Integration Id	PrimaryFulfillmentInvLocIntegrationId	DTYPE_TEXT	NA	No	None
Primary Payer Account Id	PrimaryPayerAccountId	DTYPE_ID	NA	No	None

Table 11. Siebel Account ASI Fields

Name	XML Tag	Data Type	Length	Req.	Notes
Primary Ship To Account Id	PrimaryShipToAccountId	DTYPE_ID	NA	No	None
Shipping Conditions	ShippingConditions	DTYPE_TEXT	30	No	None
Type	Type	DTYPE_TEXT	30	No	None
Updated	Updated	DTYPE_DATE TIME	30	No	None
Related Bill To Account					
Bill To Account	BillToAccount	DTYPE_TEXT	100	No	None
CSN	CSN	DTYPE_TEXT	30	No	None
Id	Id	DTYPE_TEXT	30	No	None
Integration Id	IntegrationId	DTYPE_TEXT	30	No	None
IsPrimaryMVG	IsPrimaryMVG	DTYPE_TEXT	1	No	None
Location	Location	DTYPE_TEXT	50	No	None
Related Payer Account					
CSN	CSN	DTYPE_TEXT	30	No	None
Id	Id	DTYPE_TEXT	30	No	None
Integration Id	IntegrationId	DTYPE_TEXT	30	No	None
IsPrimaryMVG	IsPrimaryMVG	DTYPE_TEXT	1	No	None
Location	Location	DTYPE_TEXT	50	No	None
Payer Account	PayerAccount	DTYPE_TEXT	100	No	None
Related Ship To Account					
CSN	CSN	DTYPE_TEXT	30	No	None
Id	Id	DTYPE_TEXT	30	No	None
Integration Id	IntegrationId	DTYPE_TEXT	30	No	None
IsPrimaryMVG	IsPrimaryMVG	DTYPE_TEXT	1	No	None
Location	Location	DTYPE_TEXT	50	No	None
Ship To Account	ShipToAccount	DTYPE_TEXT	100	No	None
Related Sold To Account					
CSN	CSN	DTYPE_TEXT	30	No	None
Id	Id	DTYPE_TEXT	30	No	None
Integration Id	IntegrationId	DTYPE_TEXT	30	No	None

Table 11. Siebel Account ASI Fields

Name	XML Tag	Data Type	Length	Req.	Notes
IsPrimaryMVG	IsPrimaryMVG	DTYPE_TEXT	1	No	None
Location	Location	DTYPE_TEXT	50	No	None
Sold To Account	SoldToAccount	DTYPE_TEXT	100	No	None
Related Credit Profile					
Block Credit Flag	BlockCreditFlag	DTYPE_TEXT	NA	No	None
Credit Control Area Code	CreditControlAreaCode	DTYPE_TEXT	30	No	None

Siebel Action

The Siebel Action ASI is based on the Siebel Action Business Component. It is an ASI for business processes related to Activity management (for example, a Calendar event such as an appointment). This ASI facilitates inbound and outbound activity data synchronization between Siebel 6.3 applications and Siebel 7.5 applications.

Figure 11 describes the Siebel Action ASI structure.

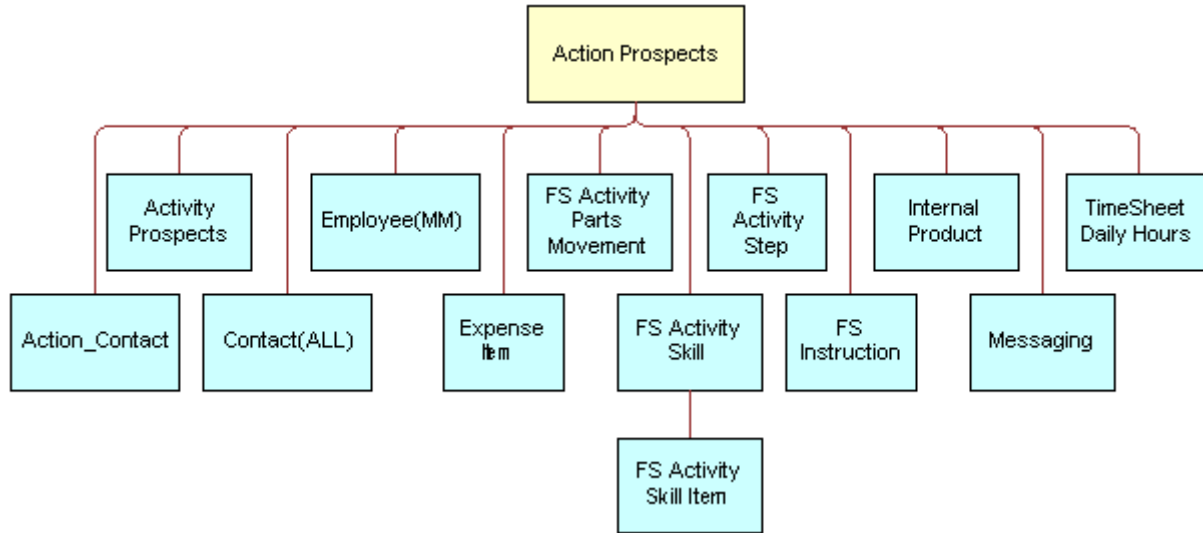

Figure 11. Siebel Action ASI

Table 12 lists the integration components and user keys of the Siebel Action ASI.

Table 12. Siebel Action Integration Components

Integration Component	XML Tag	User Keys
Action	Action	1 Id 2 Activity UID
Action_Contact	Action_Contact	1 Contact Id
Activity Prospects	ActivityProspects	1 Prospective Contact UID
Contact(All)	ContactAll	1 Party UId
Employee (MM)	EmployeeMm	1 Party UId
Expense Item	ExpenseItem	1 Expense Item Number, Owner Id
FS Activity Parts Movement	FsactivityPartsMovement	1 PartMvtNum
FS Activity Skill	FsActivitySkill	1 Name 2 Item Type Name
FS Activity Skill Item	FsActivitySkillItem	1 Expertise Code, Low Char 1 2 Low Char 2, Low Number 1
FS Activity Step	FsActivityStep	1 SeqNum, Step Type Id
FS Instruction	FsInstruction	1 Instruction, Instruction Type
Internal Product	InternalProduct	1 Id
Messaging	Messaging	1 Message Number
Time Sheet Daily Hours	TimeSheetDailyHours	1 Id 2 Item Date, Owner Id, Time Sheet Item Num

Table 13 lists the fields and their attributes. Fields without a length specified do not have a maximum length associated with them.

Table 13. Siebel Action ASI Fields

Name	XML Tag	Data Type	Length	Req.
Action				
Account Id	AccountId	DTYPE_ID	Not applicable	No
Activity SR Id	ActivitySRId	DTYPE_ID	Not applicable	No
Activity UID	ActivityUID	DTYPE_TEXT	30	No

Table 13. Siebel Action ASI Fields

Name	XML Tag	Data Type	Length	Req.
Alarm	Alarm	DTYPE_TEXT	Not applicable	No
Appt Alarm Time Min	ApptAlarmTimeMin	DTYPE_NUMBER	Not applicable	No
Asset Id	AssetId	DTYPE_ID	Not applicable	No
Assignment Excluded	AssignmentExcluded	DTYPE_TEXT	Not applicable	No
Associated Cost	AssociatedCost	DTYPE_TEXT	Not applicable	No
Audience	Audience	DTYPE_TEXT	30	No
Billable Flag	BillableFlag	DTYPE_TEXT	Not applicable	No
Call Id	CallId	DTYPE_TEXT	30	No
Class	Class	DTYPE_TEXT	30	No
Comment	Comment	DTYPE_TEXT	1,500	No
Currency Code	CurrencyCode	DTYPE_TEXT	Not applicable	No
Description	Description	DTYPE_TEXT	100	No
Display	Display	DTYPE_TEXT	30	No
Done	Done	DTYPE_DATETIME	Not applicable	No
Due	Due	DTYPE_TEXT	Not applicable	No
Est Work Time Remaining	EstWorkTimeRemaining	DTYPE_NUMBER	Not applicable	No
Exchange Date	ExchangeDate	DTYPE_DATETIME	Not applicable	No
Id	Id	DTYPE_ID	30	No
Meeting Location	MeetingLocation	DTYPE_TEXT	100	No
No Sooner Than Date	NoSoonerThanDate	DTYPE_DATETIME	Not applicable	No
Opportunity Id	OpportunityId	DTYPE_ID	Not applicable	No
Percent Complete	PercentComplete	DTYPE_NUMBER	Not applicable	No
Planned	Planned	DTYPE_DATETIME	Not applicable	No
Planned Completion	PlannedCompletion	DTYPE_DATETIME	Not applicable	No
Previous Activity Id	PreviousActivityId	DTYPE_ID	Not applicable	No
Price List Id	PriceListId	DTYPE_ID	Not applicable	No
Primary Owner Id	PrimaryOwnerId	DTYPE_ID	Not applicable	No
Priority	Priority	DTYPE_TEXT	30	No
Private	Private	DTYPE_TEXT	Not applicable	No

Table 13. Siebel Action ASI Fields

Name	XML Tag	Data Type	Length	Req.
Rate List Id	RateListId	DTYPE_ID	Not applicable	No
Repeating Expires	RepeatingExpires	DTYPE_DATETIME	Not applicable	No
Repeating Type	RepeatingType	DTYPE_TEXT	30	No
Resolution Code	ResolutionCode	DTYPE_TEXT	30	No
Started	Started	DTYPE_DATETIME	Not applicable	No
Status	Status	DTYPE_TEXT	30	No
Status Report Flag	StatusReportFlag	DTYPE_TEXT	Not applicable	No
Type	Type	DTYPE_TEXT	30	No
operation	operation	DTYPE_TEXT	30	No
searchspec	searchspec	DTYPE_TEXT	250	No
Action_Contact				
Contact Id	Contact Id	DTYPE_ID	30	No
IsPrimaryMVG	IsPrimaryMVG	DTYPE_TEXT	1	No
Activity_Prospects				
Prospective Contact UID	ProspectiveContactUID	DTYPE_TEXT	100	No
Contact				
Party UID	PartyUID	DTYPE_TEXT	30	No
Employee (MM)				
Party UID	PartyUID	DTYPE_TEXT	30	No
Expense Item				
Account Id	AccountId	DTYPE_ID	Not applicable	No
Amount	Amount	DTYPE_TEXT	Not applicable	No
Billable Flag	BillableFlag	DTYPE_TEXT	Not applicable	No
Comments	Comments	DTYPE_TEXT	250	No
Currency Code	CurrencyCode	DTYPE_TEXT	20	No
Description	Desc	DTYPE_TEXT	250	No
End Date	EndDate	DTYPE_DATETIME	Not applicable	No
Establishment	Establishment	DTYPE_TEXT	50	No
Exchange Date	ExchangeDate	DTYPE_DATETIME	Not applicable	No
Exchange Rate	ExchangeRate	DTYPE_NUMBER	Not applicable	No

Table 13. Siebel Action ASI Fields

Name	XML Tag	Data Type	Length	Req.
Expense Item Number	ExpenseItemNumber	DTYPE_ID	Not applicable	No
Expense Item Type	ExpenseItemTypeName	DTYPE_TEXT	50	No
Internal Comments	InternalComments	DTYPE_TEXT	250	No
Item Room Amount	ItemRoomAmount	DTYPE_TEXT	Not applicable	No
Item Room Other Tax Amount	ItemRoomOtherTaxAmount	DTYPE_TEXT	Not applicable	No
Item Room Tax Amount	ItemRoomTaxAmount	DTYPE_TEXT	Not applicable	No
Mileage Distance	MileageDistance	DTYPE_NUMBER	Not applicable	No
Mileage Rate	MileageRate	DTYPE_TEXT	Not applicable	No
Mileage Route	MileageRoute	DTYPE_TEXT	100	No
Opty Id	OptyId	DTYPE_ID	Not applicable	No
Owner Id	OwnerId	DTYPE_ID	Not applicable	No
Payment Type	PaymentType	DTYPE_TEXT	30	No
Project Billing Class	ProjectBillingClass	DTYPE_TEXT	30	No
Reimbursable Flag	ReimbursablFlag	DTYPE_TEXT	Not applicable	No
Start Date	StartDate	DTYPE_DATETIME	Not applicable	No
FS Activity Parts Movement				
Asset Id	AssetId	DTYPE_ID	Not applicable	No
Billable Flag	BillableFlag	DTYPE_TEXT	Not applicable	No
Commit Txn Flag	CommitTxnFlag	DTYPE_TEXT	Not applicable	No
Destination	Destination	DTYPE_TEXT	30	No
Movement Date	MovementDate	DTYPE_DATETIME	Not applicable	No
Order Id	OrderId	DTYPE_ID	Not applicable	No
Order Item Id	OrderItemId	DTYPE_ID	Not applicable	No
PartMvtNum	PartMvtNum	DTYPE_ID	Not applicable	No
Product Id	ProductId	DTYPE_ID	Not applicable	No
Product Name	ProductName	DTYPE_TEXT	100	No
Source	Source	DTYPE_TEXT	30	No
Status	Status	DTYPE_TEXT	30	No
Trunk Invloc Id	TrunkInvlocId	DTYPE_ID	Not applicable	No

Table 13. Siebel Action ASI Fields

Name	XML Tag	Data Type	Length	Req.
Used Quantity	UsedQuantity	DTYPE_NUMBER	Not applicable	No
FS Activity Skill				
Comments	Comments	DTYPE_TEXT	250	No
Item Type Name	ItemTypeName	DTYPE_TEXT	75	No
Name	Name	DTYPE_TEXT	50	No
FS Activity Skill Item				
Expertise Code	ExpertiseCode	DTYPE_TEXT	30	No
Low Char 1	LowChar1	DTYPE_TEXT	50	No
Low Char 2	LowChar2	DTYPE_TEXT	50	No
Low Number 1	LowNumber1	DTYPE_NUMBER	Not applicable	No
Product Id	ProdId	DTYPE_TEXT	Not applicable	No
FS Activity Step				
Comments	Comments	DTYPE_TEXT	250	No
End Date	EndDate	DTYPE_DATETIME	Not applicable	No
Performed	Performed	DTYPE_TEXT	Not applicable	No
Performed by	Performedby	DTYPE_ID	Not applicable	No
SeqNum	SeqNum	DTYPE_NUMBER	Not applicable	No
Start Date	StartDate	DTYPE_DATETIME	Not applicable	No
Step Type Id	StepTypeId	DTYPE_ID	Not applicable	No
FS Instruction				
Instruction	Instruction	DTYPE_NOTE	Not applicable	No
Instruction Type	InstructionType	DTYPE_TEXT	30	No
Messaging				
Account Id	AccountId	DTYPE_ID	Not applicable	No
Alert Type CD	AlertTypeCD	DTYPE_TEXT	30	No
Comments	Comments	DTYPE_TEXT	2000	No
Contact Last Name	ContactLastName	DTYPE_TEXT	50	No
Creation Time	CreationTime	DTYPE_TEXT	Not applicable	No
Message Number	MessageNumber	DTYPE_TEXT	30	No
Message Status CD	MessageStatusCD	DTYPE_TEXT	30	No
Message Text	Message Text	DTYPE_TEXT	2000	No

Table 13. Siebel Action ASI Fields

Name	XML Tag	Data Type	Length	Req.
Opportunity Id	OpportunityId	DTYPE_ID	Not applicable	No
Priority	Priority	DTYPE_TEXT	30	No
Private Flag	PrivateFlag	DTYPE_TEXT	Not applicable	No
Recipient Id	Recipient Id	DTYPE_ID	Not applicable	No
Sender Id	SenderId	DTYPE_ID	Not applicable	No
Service Request Id	ServiceRequestId	DTYPE_ID	Not applicable	No
Time Sheet Daily Hours				
Billable Flag	BillableFlag	DTYPE_TEXT	Not applicable	No
Billing Class	BillingClass	DTYPE_TEXT	Not applicable	No
Billing Rate Type	BillingRateType	DTYPE_TEXT	Not applicable	No
Created	Created	DTYPE_DATETIME	Not applicable	No
End Time	EndTime	DTYPE_DATETIME	Not applicable	No
External Comments	ExternalComments	DTYPE_TEXT	Not applicable	No
Id	Id	DTYPE_ID	Not applicable	No
Internal Comments	InternalComments	DTYPE_TEXT	Not applicable	No
Item Date	ItemDate	DTYPE_DATETIME	Not applicable	No
Oppty Id	OpptyId	DTYPE_ID	Not applicable	No
Owner Id	OwnerId	DTYPE_ID	Not applicable	No
Project Id	ProjectId	DTYPE_ID	Not applicable	No
Service Request Id	ServiceRequestId	DTYPE_ID	Not applicable	No
Start Time	StartTime	DTYPE_DATETIME	Not applicable	No
Time Sheet Item Num	TimeSheetItemNum	DTYPE_TEXT	Not applicable	No

Siebel Business Address

Siebel Business Address is part of the Customer Order Lifecycle business process. The Customer Address is a business address associated with a specific customer. This ASI facilitates inbound and outbound address data synchronization between Siebel applications and external systems.

Figure 12 describes the Siebel Business Address ASI structure.



Figure 12. Siebel Business Address ASI

Table 14 lists the integration components and user keys of this ASI.

Table 14. Siebel Business Address Integration Components

Integration Component	XML Tag	User Keys
Address	Address	<ol style="list-style-type: none"> 1 Id 2 Integration Id

Table 15 lists the fields and their attributes. Fields without a length specified do not have a maximum length associated with them.

Table 15. Siebel Business Address ASI Fields

Name	XML Tag	Data Type	Length	Required
Address				
Address Line 1	AddressLine1	DTYPE_TEXT	200	No
Address Line 2	AddressLine2	DTYPE_TEXT	200	No
City	City	DTYPE_TEXT	50	No
Country	Country	DTYPE_TEXT	50	No
Id	Id	DTYPE_TEXT	30	No
Integration Id	IntegrationId	DTYPE_TEXT	30	No
operation	operation	DTYPE_TEXT	30	No
Postal Code	PostalCode	DTYPE_TEXT	50	No
State	State	DTYPE_TEXT	10	No

Siebel Personal Address

Siebel Personal Address is part of the Customer Order Lifecycle business process. The Customer Address is a personal address associated with a specific customer. This ASI facilitates inbound and outbound address data synchronization between Siebel applications and external systems.

Figure 13 describes the Siebel Personal Address ASI structure.



Figure 13. Siebel Personal Address ASI

Table 16 lists the integration components and user keys of the Siebel Personal Address ASI.

Table 16. Siebel Personal Address Integration Components

Integration Component	XML Tag	User Keys
Address	Address	<ol style="list-style-type: none"> 1 Id 2 Integration Id

Table 17 lists the fields and their attributes. Fields without a length specified do not have a maximum length associated with them.

Table 17. Siebel Personal Address ASI Fields

Name	XML Tag	Data Type	Length	Required
Address				
Address Line 1	AddressLine1	DTYPE_TEXT	200	No
Address Line 2	AddressLine2	DTYPE_TEXT	200	No
City	City	DTYPE_TEXT	50	No
Country	Country	DTYPE_TEXT	50	No
Id	Id	DTYPE_TEXT	30	No
Integration Id	IntegrationId	DTYPE_TEXT	30	No
operation	operation	DTYPE_TEXT	30	No

Table 17. Siebel Personal Address ASI Fields

Name	XML Tag	Data Type	Length	Required
Postal Code	PostalCode	DTYPE_TEXT	50	No
State	State	DTYPE_TEXT	10	No

Siebel Asset

Siebel Asset is part of the Customer Order Lifecycle business process. The Customer Asset is a serialized product or service that a customer has purchased from a company. When a customer creates an order, the seller removes the product from the finished goods inventory, and upon shipment, the item becomes a customer asset with a unique serial number. The asset is only associated with that specific customer.

Figure 14 describes the Siebel Asset ASI structure.

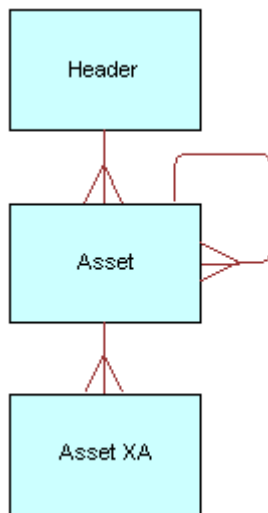

Figure 14. Siebel Asset ASI

Table 18 lists the integration components and user keys of this ASI.

Table 18. Siebel Asset Integration Components

Integration Component	XML Tag	User Keys
Asset Mgmt - Asset	Asset	1 Id 2 Integration Id 3 Asset Number, Product Id
Asset Mgmt - Asset - Header	AssetHeader	1 Id 2 Integration Id 3 Asset Number, Product Id
Asset Mgmt - Asset XA	AssetXA	1 Integration Id 2 Name

Table 19 lists the fields and their attributes. Fields without a length specified do not have a maximum length associated with them.

Table 19. Siebel Asset ASI Fields

Name	XML Tag	Data Type	Length	Req.
Asset Mgmt - Asset XA				
Data Type	DataType	DTYPE_TEXT	30	No
Description	AttributeDescription	DTYPE_TEXT	250	No
Display Name	DisplayName	DTYPE_TEXT	100	No
Id	Id	DTYPE_ID	15	No
Integration Id	IntegrationId	DTYPE_TEXT	30	No
Name	AttributeName	DTYPE_TEXT	75	No
Required	Required	DTYPE_TEXT	1	No
Unit of Measure	UnitofMeasure	DTYPE_TEXT	30	No
Value	AttributeValue	DTYPE_TEXT	100	No
operation	operation	DTYPE_TEXT	30	No
Asset Mgmt - Asset - Header				
Asset Currency Code	AssetCurrencyCode	DTYPE_TEXT	20	No
Asset Description	AssetDescription	DTYPE_TEXT	250	No
Asset Number	AssetNumber	DTYPE_TEXT	100	No

Table 19. Siebel Asset ASI Fields

Name	XML Tag	Data Type	Length	Req.
Comments	Comments	DTYPE_TEXT	255	No
Id	Id	DTYPE_ID	15	No
Install Date	InstallDate	DTYPE_DATETIME	Not applicable	No
Integration Id	IntegrationId	DTYPE_TEXT	30	No
Inventory Location Id	InventoryLocationId	DTYPE_ID	15	No
Name	ProductName	DTYPE_TEXT	100	No
Organization Id	OrganizationId	DTYPE_ID	15	No
Original Cost	OriginalCost	DTYPE_NUMBER	NA	No
Original Order Id	OriginalOrderId	DTYPE_ID	15	No
Owner Account Id	OwnerAccountId	DTYPE_ID	15	No
Parent Asset Id	ParentAssetId	DTYPE_ID	15	No
Primary Contact Id	PrimaryContactId	DTYPE_ID	15	No
Product Id	ProductId	DTYPE_ID	15	No
Purchase Date	PurchaseDate	DTYPE_DATETIME	Not applicable	No
Quantity	Quantity	DTYPE_NUMBER	Not applicable	No
Root Asset Id	RootAssetId	DTYPE_ID	15	No
Serial Number	SerialNumber	DTYPE_TEXT	100	No
Serialized Flag	ProductSerializedFlag	DTYPE_TEXT	1	No
Status	Status	DTYPE_TEXT	30	No
Version	Version	DTYPE_TEXT	30	No
operation	operation	DTYPE_TEXT	30	No
Asset Mgmt - Asset				
Asset Currency Code	AssetCurrencyCode	DTYPE_TEXT	20	No
Asset Description	AssetDescription	DTYPE_TEXT	250	No
Asset Number	AssetNumber	DTYPE_TEXT	100	No
Comments	Comments	DTYPE_TEXT	255	No
Customizable Flag	CustomizableFlag	DTYPE_TEXT	1	No
Extended Quantity	ExtendedQuantity	DTYPE_NUMBER	Not applicable	No
Id	Id	DTYPE_ID	15	No
Install Date	InstallDate	DTYPE_DATETIME	Not applicable	No
Integration Id	IntegrationId	DTYPE_TEXT	30	No

Table 19. Siebel Asset ASI Fields

Name	XML Tag	Data Type	Length	Req.
Inventory Location Id	InventoryLocationId	DTYPE_ID	15	No
Name	Name	DTYPE_TEXT	100	No
operation	operation	DTYPE_TEXT	30	No
Operating Status	OperatingStatus	DTYPE_TEXT	30	No
Order Integration Id	OrderIntegrationId	DTYPE_TEXT	30	No
Organization Id	OrganizationId	DTYPE_ID	15	No
Original Cost	OriginalCost	DTYPE_NUMBER	Not applicable	No
Original Order Id	OriginalOrderId	DTYPE_ID	15	No
Owner	Owner	DTYPE_ID	15	No
Owner Account Id	OwnerAccountId	DTYPE_ID	15	No
Parent Asset Id	ParentAssetId	DTYPE_ID	15	No
Price List Id	PriceListId	DTYPE_ID	15	No
Primary Contact Id	PrimaryContactId	DTYPE_ID	15	No
Prod Item Id	ProdItemId	DTYPE_ID	15	No
Product Description	ProductDescription	DTYPE_TEXT	255	No
Product Id	ProductId	DTYPE_ID	15	No
Product Name	ProductName	DTYPE_TEXT	100	No
Product Serialized Flag	ProductSerializedFlag	DTYPE_TEXT	1	No
Purchase Date	PurchaseDate	DTYPE_DATETIME	Not applicable	No
Quantity	Quantity	DTYPE_NUMBER	Not applicable	No
Root Asset Id	RootAssetId	DTYPE_ID	15	No
Root Product Id	RootProductId	DTYPE_ID	15	No
Serial Number	SerialNumber	DTYPE_TEXT	100	No
Status	Status	DTYPE_TEXT	30	No
Version	Version	DTYPE_TEXT	30	No

Siebel Contact

The Siebel Contact ASI is an ASI for customer information management-related business processes. This ASI facilitates inbound and outbound contact data synchronization between a Siebel application and any external system. [Figure 15](#) describes the Siebel Contact ASI structure.

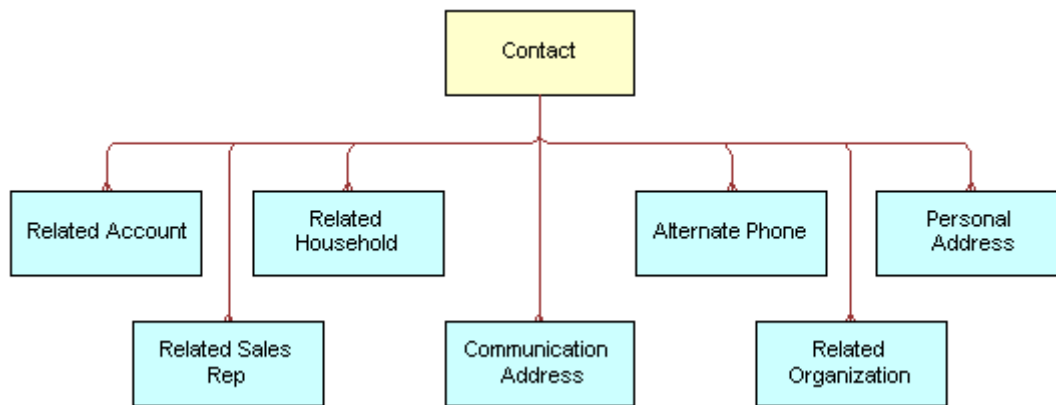

Figure 15. Siebel Contact ASI

[Table 20](#) lists the integration component and user keys of this ASI.

Table 20. Siebel Contact Integration Components

Integration Component	XML Tag	User Keys
Contact	Contact	<ol style="list-style-type: none"> 1 Contact ID 2 Integration ID 3 Person UId
Related Account	RelatedAccount	<ol style="list-style-type: none"> 1 Id 2 Integration Id 3 Account, Account Organization
Personal Address	PersonalAddress	<ol style="list-style-type: none"> 1 Id 2 Integration Id
Communication Address	CommunicationAddress	<ol style="list-style-type: none"> 1 Id 2 Integration Id 3 Alternate Email Address, Communication Address Medium Type, Communication Address Name

Table 20. Siebel Contact Integration Components

Integration Component	XML Tag	User Keys
Alternate Phone	AlternatePhone	<ol style="list-style-type: none"> 1 Id 2 Integration Id 3 Alternate Phone #, Alternate Phone Medium Type, Alternate Phone Name
Related Households	RelatedHouseholds	<ol style="list-style-type: none"> 1 Id 2 Integration Id
Related Organization	RelatedOrganization	<ol style="list-style-type: none"> 1 Id 2 Integration Id 3 Organization
Related Sales Rep	RelatedSalesRep	<ol style="list-style-type: none"> 1 Id 2 Integration Id 3 Division, Position 4 Login

Table 21 lists the fields and their attributes.

Table 21. Siebel Contact ASI Fields

Name	XML Tag	Data Type	Length	Req.	Note
Contact					
Alias	Alias	DTYPE_TEXT	50	No	None
Assistant	Assistant	DTYPE_TEXT	50	No	None
Birth Date	BirthDate	DTYPE_DATETIME	7	No	None
Cellular Phone #	CellularPhone	DTYPE_TEXT	NA	No	None
Comment	Comment	DTYPE_TEXT	255	No	None
Disable Data Cleansing	DisableDataCleansing	DTYPE_TEXT	NA	No	None
Email Address	EmailAddress	DTYPE_TEXT	50	No	None
Fax Phone #	FaxPhone	DTYPE_TEXT	NA	No	None
First Name	FirstName	DTYPE_TEXT	50	No	None
Gender	Gender	DTYPE_TEXT	255	No	None
Home Phone #	HomePhone	DTYPE_TEXT	NA	No	None

Table 21. Siebel Contact ASI Fields

Name	XML Tag	Data Type	Length	Req.	Note
Id	Id	DTYPE_ID	30	No	None
Income	Income	DTYPE_TEXT	NA	No	None
Income Currency Code	IncomeCurrencyCode	DTYPE_TEXT	20	No	None
Income Exchange Date	IncomeExchangeDate	DTYPE_DATETIME	NA	No	None
Integration Id	IntegrationId	DTYPE_TEXT	30	No	User key field
Job Title	JobTitle	DTYPE_TEXT	75	No	None
Last Name	LastName	DTYPE_TEXT	50	No	None
Manager First Name	ManagerFirstName	DTYPE_TEXT	50	No	None
Manager Id	ManagerId	DTYPE_ID	15	No	None
Manager Integration Id	ManagerIntegrationId	DTYPE_TEXT	30	No	None
Manager Last Name	ManagerLastName	DTYPE_TEXT	50	No	None
Manager Middle Name	ManagerMiddleName	DTYPE_TEXT	50	No	None
Manager Primary Organization	ManagerPrimaryOrganization	DTYPE_TEXT	100	No	None
Manager UId	ManagerUId	DTYPE_TEXT	100	No	None
Middle Name	MiddleName	DTYPE_TEXT	50	No	None
operation	operation	DTYPE_TEXT	30	No	None
Person UId	PersonUId	DTYPE_TEXT	100	No	None
Personal Title	PersonalTitle	DTYPE_TEXT	15	No	None
Preferred Communications	PreferredCommunications	DTYPE_TEXT	30	No	None
Preferred Language Code	PreferredLanguageCode	DTYPE_TEXT	3	No	None
Primary Address Id	PrimaryAddressId	DTYPE_ID	NA	No	None
Social Security Number	SocialSecurityNumber	DTYPE_TEXT	NA	No	None

Table 21. Siebel Contact ASI Fields

Name	XML Tag	Data Type	Length	Req.	Note
Status	Status	DTYPE_TEXT	30	No	Bound by CONTACT_ST ATUS LOV.
Suppress All Calls	SuppressAllCalls	DTYPE_TEXT	1	No	None
Suppress All Emails	SuppressAllEmails	DTYPE_TEXT	1	No	None
Suppress All Faxes	SuppressAllFaxes	DTYPE_TEXT	NA	No	None
Suppress All Mailings	SuppressAllMailings	DTYPE_TEXT	1	No	None
Time Zone Id	TimeZoneId	DTYPE_ID	NA	No	None
Time Zone Name	TimeZoneName	DTYPE_TEXT	100	No	None
Work Phone #	WorkPhone	DTYPE_TEXT	NA	No	None
Work Phone Extension	WorkPhoneExtension	DTYPE_TEXT	10	No	None
Personal Address					
Id	Id	DTYPE_ID	30	No	None
Integration Id	IntegrationId	DTYPE_TEXT	30	No	None
IsPrimaryMVG	IsPrimaryMVG	DTYPE_TEXT	1	No	None
operation	operation	DTYPE_TEXT	30	No	None
Personal City	PersonalCity	DTYPE_TEXT	50	No	None
Personal Country	PersonalCountry	DTYPE_TEXT	50	No	None
Personal Postal Code	PersonalPostalCode	DTYPE_TEXT	30	No	None
Personal State	PersonalState	DTYPE_TEXT	10	No	None
Personal Street Address	PersonalStreetAddress	DTYPE_TEXT	200	No	None
Personal Street Address 2	PersonalStreetAddress2	DTYPE_TEXT	100	No	None
searchspec	searchspec	DTYPE_TEXT	250	No	None
Communication Address					
Alternate Email Address	AlternateEmailAddress	DTYPE_TEXT	100	No	None

Table 21. Siebel Contact ASI Fields

Name	XML Tag	Data Type	Length	Req.	Note
Communication Address Medium Type	CommunicationAddressMediumType	DTYPE_TEXT	30	No	None
Communication Address Name	CommunicationAddressName	DTYPE_TEXT	50	No	None
Id	Id	DTYPE_ID	30	No	None
Integration Id	IntegrationId	DTYPE_TEXT	30	No	None
IsPrimaryMVG	IsPrimaryMVG	DTYPE_TEXT	1	No	None
operation	operation	DTYPE_TEXT	30	No	None
searchspec	searchspec	DTYPE_TEXT	250	No	None
Alternate Phone					
Alternate Phone #	AlternatePhone	DTYPE_TEXT	100	No	None
Alternate Phone Medium Type	AlternatePhoneMediumType	DTYPE_TEXT	30	No	None
Alternate Phone Name	AlternatePhoneNumber	DTYPE_TEXT	50	No	None
Id	Id	DTYPE_ID	30	No	None
Integration Id	IntegrationId	DTYPE_TEXT	30	No	None
IsPrimaryMVG	IsPrimaryMVG	DTYPE_TEXT	1	No	None
operation	operation	DTYPE_TEXT	30	No	None
searchspec	searchspec	DTYPE_TEXT	250	No	None
Related Account					
Account	Account	DTYPE_TEXT	100	No	None
Account Location	AccountLocation	DTYPE_TEXT	50	No	None
Account Organization	AccountOrganization	DTYPE_TEXT	100	No	None
Id	Id	DTYPE_ID	30	No	None
Integration Id	IntegrationId	DTYPE_TEXT	30	No	None
IsPrimaryMVG	IsPrimaryMVG	DTYPE_TEXT	1	No	None
operation	operation	DTYPE_TEXT	30	No	None
searchspec	searchspec	DTYPE_TEXT	250	No	None
Related Households					
HouseHold Name	HouseHoldName	DTYPE_TEXT	50	No	None

Table 21. Siebel Contact ASI Fields

Name	XML Tag	Data Type	Length	Req.	Note
Household Number	HouseholdNumber	DTYPE_TEXT	100	No	None
Id	Id	DTYPE_ID	30	No	None
Integration Id	IntegrationId	DTYPE_TEXT	30	No	None
IsPrimaryMVG	IsPrimaryMVG	DTYPE_TEXT	1	No	None
operation	operation	DTYPE_TEXT	30	No	None
searchspec	searchspec	DTYPE_TEXT	250	No	None
Related Organization					
Id	Id	DTYPE_ID	30	No	None
Integration Id	IntegrationId	DTYPE_TEXT	30	No	None
Organization	Organization	DTYPE_TEXT	50	No	None
IsPrimaryMVG	IsPrimaryMVG	DTYPE_TEXT	1	No	None
operation	operation	DTYPE_TEXT	30	No	None
searchspec	searchspec	DTYPE_TEXT	250	No	None
Related Sales Rep					
Division	Division	DTYPE_TEXT	255	No	None
Id	Id	DTYPE_ID	30	No	None
Integration Id	IntegrationId	DTYPE_TEXT	30	No	None
IsPrimaryMVG	IsPrimaryMVG	DTYPE_TEXT	1	No	None
Login	Login	DTYPE_TEXT	50	No	None
operation	operation	DTYPE_TEXT	30	No	None
Position	Position	DTYPE_TEXT	50	No	None
searchspec	searchspec	DTYPE_TEXT	250	No	None

Siebel CUT Address MSAG Service

The Siebel CUT Address MSAG Service ASI is an ASI for address validation business processes. This ASI facilitates inbound and outbound address data synchronization between a Siebel application and any external system. [Figure 16](#) describes the Siebel CUT Address MSAG Service ASI structure.



Figure 16. Siebel CUT Address MSAG Service ASI

[Table 22](#) lists the integration component and user keys of this ASI.

Table 22. Siebel CUT Address MSAG Service Integration Components

Integration Component	XML Tag	User Keys
CUT MSAG Profile	CutMsagProfile	<ol style="list-style-type: none"> 1 Id 2 Address Id, Profile Type

[Table 23](#) lists the fields and their attributes.

Table 23. Siebel CUT Address MSAG Service ASI Fields

Name	XML Tag	Data Type	Length	Req.
CUT MSAG Profile				
Address Id	AddressId	DTYPE_ID		No
Conflict Id	ConflictId	DTYPE_ID	30	No
Created	Created	DTYPE_DATETIME	30	No
Id	Id	DTYPE_ID	30	No
Internal Validation Flag	InternalValidationFlag	DTYPE_TEXT	Not applicable	No
Mod Id	ModId	DTYPE_ID	30	No
Profile Type	ProfileType	DTYPE_TEXT	30	No
SA Access Instruction	SAAccessInstruction	DTYPE_TEXT	255	No
SA City	SACity	DTYPE_TEXT	50	No
SA Country	SACountry	DTYPE_TEXT	50	No

Table 23. Siebel CUT Address MSAG Service ASI Fields

Name	XML Tag	Data Type	Length	Req.
SA County	SACounty	DTYPE_TEXT	50	No
SA Descriptive Location	SADescriptiveLocation	DTYPE_TEXT	30	No
SA Directional	SADirectional	DTYPE_TEXT	10	No
SA Driving Instructions	SADrivingInstruction	DTYPE_NOTE	Not applicable	No
SA House Number	SAHouseNumber	DTYPE_TEXT	8	No
SA House Prefix	SAHousePrefix	DTYPE_TEXT	5	No
SA House Suffix	SAHouseSuffix	DTYPE_TEXT	5	No
SA Location Designator 1	SALocationDesignator1	DTYPE_TEXT	50	No
SA Location Designator 2	SALocationDesignator2	DTYPE_TEXT	50	No
SA Location Designator 3	SALocationDesignator3	DTYPE_TEXT	50	No
SA Location Value 1	SALocationValue1	DTYPE_TEXT	50	No
SA Location Value 2	SALocationValue2	DTYPE_TEXT	50	No
SA Location Value 3	SALocationValue3	DTYPE_TEXT	50	No
SA State	SASState	DTYPE_TEXT	10	No
SA Street Name	SASStreetName	DTYPE_TEXT	50	No
SA Street Suffix	SASStreetSuffix	DTYPE_TEXT	4	No
SA Thoroughfare	SAThoroughfare	DTYPE_TEXT	20	No
SA Zipcode	SAZipcode	DTYPE_TEXT	30	No
Updated	Updated	DTYPE_DATETIME	30	No
operation	operation	DTYPE_TEXT	30	No
searchspec	searchspec	DTYPE_TEXT	250	No

Siebel Cost List

Standard product costs that exist in external systems are created in the Siebel application based on the costs existing in the external manufacturing and accounting systems. The initial cost types include standard costs, base costs, and the variable costs for a given product.

This inbound ASI enables the synchronization and update of a cost list and the cost list items. [Figure 17](#) describes the Siebel Cost List ASI structure.

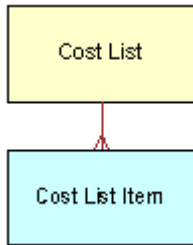

Figure 17. Siebel Cost List ASI

[Table 24](#) lists the integration components and user keys of this ASI.

Table 24. Siebel Cost List Integration Components

Integration Component	XML Tag	User Keys
Cost List	CostList	<ol style="list-style-type: none"> 1 Name, Type 2 Id 3 Integration Id
Cost List Item	CostListItem	<ol style="list-style-type: none"> 1 Product Id 2 Id 3 Integration Id

[Table 25](#) lists the fields and their attributes. Fields without a length specified do not have a maximum length associated with them.

Table 25. Siebel Cost List ASI Fields

Name	XML Tag	Data Type	Length	Req.	Note
Cost List					
Cost Method	CostMethod	DTYPE_TEXT	30	No	None
Currency Code	CurrencyCode	DTYPE_TEXT	20	No	None
Description	Description	DTYPE_TEXT	255	No	None
End Date	EndDate	DTYPE_TEXT	NA	No	None

Table 25. Siebel Cost List ASI Fields

Name	XML Tag	Data Type	Length	Req.	Note
Id	Id	DTYPE_ID	30	No	Used for picking a related entity. This read-only field is automatically populated by the Siebel application on insertion and cannot be updated.
Integration Id	IntegrationId	DTYPE_TEXT	30	No	None
Name	Name	DTYPE_TEXT	50	No	User key field.
Start Date	StartDate	DTYPE_TEXT	NA	No	None
Type	Type	DTYPE_TEXT	30	No	User key field.
operation	operation	DTYPE_TEXT	30	No	None
searchspec	searchspec	DTYPE_TEXT	250	No	None
Cost List Item					
Average Cost	AverageCost	DTYPE_TEXT	NA	No	None
Currency Code	CurrencyCode	DTYPE_TEXT	20	No	None
Description	Description	DTYPE_TEXT	255	No	None
End Date	EndDate	DTYPE_TEXT	NA	No	None
Ext OT Pct Increase	ExtOTPctIncrease	DTYPE_NUMBER	NA	No	None
Id	Id	DTYPE_ID	30	No	<ul style="list-style-type: none"> ■ Used for picking a related entity. This read-only field is automatically populated by the Siebel application on insertion and cannot be updated. ■ User key field.
Integration Id	IntegrationId	DTYPE_TEXT	30	No	User key field.
Last Cost	LastCost	DTYPE_TEXT	NA	No	None
Next Cost	NextCost	DTYPE_TEXT	NA	No	None

Table 25. Siebel Cost List ASI Fields

Name	XML Tag	Data Type	Length	Req.	Note
Product Id	ProductId	DTYPE_ID	NA	No	<ul style="list-style-type: none"> ■ Used for picking a related entity. This read-only field is automatically populated by the Siebel application on insertion and cannot be updated. ■ User key field.
Standard Cost	StandardCost	DTYPE_TEXT	NA	No	None
Start Date	StartDate	DTYPE_TEXT	NA	No	None
Std OT Pct Increase	StdOTPctIncrease	DTYPE_NUMBER	NA	No	None
operation	operation	DTYPE_TEXT	30	No	None
searchspec	searchspec	DTYPE_TEXT	250	No	None

Siebel Employee

The Siebel Employee ASI is an ASI for employee-related business processes. The Employee Integration Object enables inbound and outbound data integration between Siebel applications and third-party applications that process employee data. This can include employee core data, job-related data, responsibilities, position, or resume data. The integration business services are included to perform the basic Create, Update, Delete, and Query functions on Employee objects in the Siebel application. [Figure 18](#) shows the Siebel Employee ASI structure.

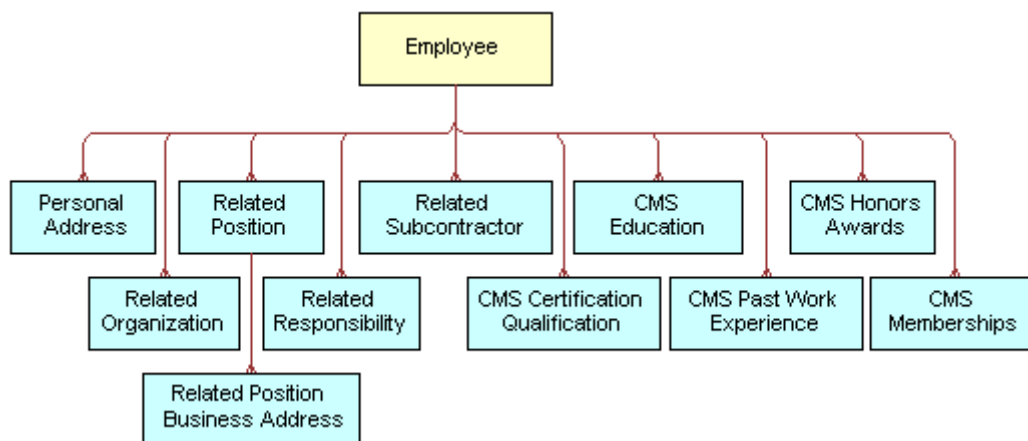

Figure 18. Siebel Employee ASI

Table 26 lists the Siebel Employee integration components.

Table 26. Siebel Employee Integration Components

Integration Component	XML Tag	User Keys
CMS Certifications Qualifications	CmsCertificationsQualifications	<ol style="list-style-type: none"> 1 Id 2 Integration Id 3 Certification
CMS Education	CmsEducation	<ol style="list-style-type: none"> 1 Id 2 Integration Id 3 Education
CMS Employee Competency Administration	CmsEmployeeCompetencyAdministration	<ol style="list-style-type: none"> 1 Competency Id 2 Employee Id
CMS Honors Awards	CmsHonorsAwards	<ol style="list-style-type: none"> 1 Id 2 Integration Id 3 Honor Award
CMS Memberships	CmsMemberships	<ol style="list-style-type: none"> 1 Id 2 Integration Id 3 Membership
CMS Past Work Experience	CmsPastWorkExperience	<ol style="list-style-type: none"> 1 Id 2 Integration Id 3 Company Name
Employee	Employee	<ol style="list-style-type: none"> 1 Id 2 Integration Id 3 Login Domain, Login Name 4 Login Name 5 First Name, Last Name, Middle Name
Employee_Employee Organization	EmployeeEmployeeOrganization	<ol style="list-style-type: none"> 1 Employee Organization Id 2 Employee Organization Integration Id 3 Employee Organization

Table 26. Siebel Employee Integration Components

Integration Component	XML Tag	User Keys
Employee_Personal Address	EmployeePersonalAddress	<ol style="list-style-type: none"> 1 Personal Address Id 2 Personal Address Integration Id
Employee_Position	EmployeePosition	<ol style="list-style-type: none"> 1 Position Id 2 Position Integration Id 3 Division, Position
Employee_Subcontractor	EmployeeSubcontractor	<ol style="list-style-type: none"> 1 Subcontractor Account Id 2 Subcontractor Integration Id 3 Subcontractor Name
Employee_Responsibility	EmployeeResponsibility	<ol style="list-style-type: none"> 1 Responsibility Id 2 Responsibility Integration Id 3 Responsibility
Personal Address	PersonalAddress	<ol style="list-style-type: none"> 1 Personal Address Id 2 Personal Address Integration Id
Related Employee Organization	RelatedEmployeeOrganization	<ol style="list-style-type: none"> 1 Employee Organization Id 2 Employee Organization Integration Id 3 Employee Organization
Related Position	RelatedPosition	<ol style="list-style-type: none"> 1 Position Id 2 Position Integration Id 3 Division, Position
Related Position Business Address	RelatedPositionBusinessAddress	<ol style="list-style-type: none"> 1 Address Id

Table 26. Siebel Employee Integration Components

Integration Component	XML Tag	User Keys
Related Responsibility	RelatedResponsibility	<ol style="list-style-type: none"> 1 Responsibility Id 2 Responsibility Integration Id 3 Responsibility
Related Subcontractor	RelatedSubcontractor	<ol style="list-style-type: none"> 1 Subcontractor Account Id 2 Subcontractor Integration Id 3 Subcontractor Name

Table 27 lists the fields and their attributes.

Table 27. Siebel Employee ASI Fields

Name	XML Tag	Data Type	Length	Req.
CMS Certifications Qualifications				
Certification	Certification	DTYPE_TEXT	30	No
Comments	Comments	DTYPE_TEXT	250	No
Date of Certification	DateofCertification	DTYPE_TEXT	Not applicable	No
Id	Id	DTYPE_ID	30	No
Institution	Institution	DTYPE_TEXT	30	No
Integration Id	IntegrationId	DTYPE_TEXT	30	No
operation	operation	DTYPE_TEXT	30	No
CMS Education				
Comments	Comments	DTYPE_TEXT	250	No
Country	Country	DTYPE_TEXT	30	No
Degree	Degree	DTYPE_TEXT	30	No
Education	Education	DTYPE_TEXT	30	No
Grade	Grade	DTYPE_TEXT	30	No
Graduation Date	GraduationDate	DTYPE_TEXT	Not applicable	No
Id	Id	DTYPE_ID	30	No
Institution	Institution	DTYPE_TEXT	30	No

Table 27. Siebel Employee ASI Fields

Name	XML Tag	Data Type	Length	Req.
Integration Id	IntegrationId	DTYPE_TEXT	30	No
Major	Major	DTYPE_TEXT	30	No
Number of Years	NumberofYears	DTYPE_NUMBER	Not applicable	No
Scale	Scale	DTYPE_TEXT	30	No
Type of Education	TypeofEducation	DTYPE_TEXT	30	No
operation	operation	DTYPE_TEXT	30	No
CMS Employee Competency Administration				
Competency Id	CompetencyId	DTYPE_ID	Not applicable	No
Skill Name	SkillName	DTYPE_TEXT	50	No
Current Skill Level	CurrentSkillLevel	DTYPE_TEXT	100	No
Current Skill Level Id	CurrentSkillLevelId	DTYPE_ID	Not applicable	No
Current Skill Level Value	CurrentSkillLevelValue	DTYPE_NUMBER	Not applicable	No
Date of Accomplishment	DateOfAccomplishment	DTYPE_DATETIME	Not applicable	No
Employee Id	EmployeeId	DTYPE_ID	Not applicable	No
Id	Id	DTYPE_ID	30	No
Required Skill Level Value	RequiredSkillLevelValue	DTYPE_NUMBER	Not applicable	No
Required Skill Level Id	RequiredSkillLevelId	DTYPE_ID	Not applicable	No
Parent Skill	ParentSkill	DTYPE_TEXT	50	No
Rating Scale Id	RatingScaleId	DTYPE_ID	Not applicable	No
Required Skill Level	Required Skill Level	DTYPE_TEXT	100	No
operation	operation	DTYPE_TEXT	30	No
Updated	Updated	DTYPE_DATETIME	30	No
Status	Status	DTYPE_TEXT	30	No
Skill Gap	SkillGap	DTYPE_NUMBER	Not applicable	No
Skill Description	SkillDescription	DTYPE_TEXT	250	No
Root Category Id	RootCategoryId	DTYPE_ID	Not applicable	No

Table 27. Siebel Employee ASI Fields

Name	XML Tag	Data Type	Length	Req.
Root Category	RootCategory	DTYPE_TEXT	50	No
searchspec	searchspec	DTYPE_TEXT	250	No
Manager Comments	ManagerComments	DTYPE_TEXT	2000	No
Employee Comments	EmployeeComments	DTYPE_TEXT	2000	No
Delete Record Flag	DeleteRecordFlag	DTYPE_TEXT	Not applicable	No
Criticality	Criticality	DTYPE_TEXT	30	No
Created	Created	DTYPE_DATETIME	30	No
Conflict Id	ConflictId	DTYPE_ID	30	No
Category Id	CategoryId	DTYPE_ID	Not applicable	No
Assessment Type	AssessmentType	DTYPE_TEXT	30	No
Approved By Id	ApprovedById	DTYPE_ID	Not applicable	No
Mod Id	ModId	DTYPE_ID	30	No
CMS Honors Awards				
Comments	Comments	DTYPE_TEXT	250	No
Honor Award	HonorAward	DTYPE_TEXT	30	No
Id	Id	DTYPE_ID	30	No
Institution	Institution	DTYPE_TEXT	30	No
Integration Id	IntegrationId	DTYPE_TEXT	30	No
Received Date	ReceivedDate	DTYPE_TEXT	Not applicable	No
Relevance to Company	RelevancetoCompany	DTYPE_TEXT	30	No
operation	operation	DTYPE_TEXT	30	No
CMS Memberships				
Active Status	ActiveStatus	DTYPE_TEXT	Not applicable	No
Comments	Comments	DTYPE_TEXT	250	No
End Date	EndDate	DTYPE_TEXT	Not applicable	No
Id	Id	DTYPE_ID	30	No
Institution	Institution	DTYPE_TEXT	30	No

Table 27. Siebel Employee ASI Fields

Name	XML Tag	Data Type	Length	Req.
Integration Id	IntegrationId	DTYPE_TEXT	30	No
Membership	Membership	DTYPE_TEXT	30	No
Relevance to Company	RelevancetoCompany	DTYPE_TEXT	30	No
Start Date	StartDate	DTYPE_TEXT	Not applicable	No
operation	operation	DTYPE_TEXT	30	No
CMS Past Work Experience				
Business Title	BusinessTitle	DTYPE_TEXT	50	No
Business Unit	BusinessUnit	DTYPE_TEXT	30	No
Comments	Comments	DTYPE_TEXT	250	No
Company Name	CompanyName	DTYPE_TEXT	30	No
End Date	EndDate	DTYPE_TEXT	Not applicable	No
First Name	FirstName	DTYPE_TEXT	50	No
Id	Id	DTYPE_ID	30	No
Industry	Industry	DTYPE_ID	Not applicable	No
Integration Id	IntegrationId	DTYPE_TEXT	30	No
Last Name	LastName	DTYPE_TEXT	50	No
Position	Position	DTYPE_TEXT	50	No
Start Date	StartDate	DTYPE_TEXT	Not applicable	No
operation	operation	DTYPE_TEXT	30	No
Employee				
Alias	Alias	DTYPE_TEXT	50	No
Availability Status	AvailabilityStatus	DTYPE_TEXT	30	No
Availability Status Until	AvailabilityStatusUntil	DTYPE_TEXT	Not applicable	No
Bonus Target %	BonusTarget	DTYPE_NUMBER	Not applicable	No
Building Number	BuildingNumber	DTYPE_TEXT	30	No
CP Region	CPRegion	DTYPE_TEXT	50	No
CP Region Id	CPRegionId	DTYPE_ID	Not applicable	No
CP Region Integration Id	CPRegionIntegrationId	DTYPE_TEXT	30	No
Cell Phone #	CellPhone	DTYPE_TEXT	Not applicable	No

Table 27. Siebel Employee ASI Fields

Name	XML Tag	Data Type	Length	Req.
Cost Currency Code	CostCurrencyCode	DTYPE_TEXT	30	No
Cost Per Hour	CostPerHour	DTYPE_TEXT	Not applicable	No
Cubicle Number	CubicleNumber	DTYPE_TEXT	20	No
E-Mail Addr	EMailAddr	DTYPE_TEXT	50	No
Emergency Notification	EmergencyNotification	DTYPE_TEXT	30	No
Emp #	Emp	DTYPE_TEXT	30	No
Employee Flag	EmployeeFlag	DTYPE_TEXT	Not applicable	No
Employee Type Code	EmployeeTypeCode	DTYPE_TEXT	30	No
Employment Status	EmploymentStatus	DTYPE_TEXT	30	No
End Shift to	EndShiftto	DTYPE_TEXT	30	No
Fax #	Fax	DTYPE_TEXT	Not applicable	No
First Name	FirstName	DTYPE_TEXT	50	No
Hire Date	HireDate	DTYPE_DATETIME	Not applicable	No
Home Phone #	HomePhone	DTYPE_TEXT	Not applicable	No
Id	Id	DTYPE_ID	30	No
Integration Id	IntegrationId	DTYPE_TEXT	30	No
Job Code Id	JobCodeId	DTYPE_ID	Not applicable	No
Job Code Integration Id	JobCodeIntegrationId	DTYPE_TEXT	30	No
Job Code Name	JobCodeName	DTYPE_TEXT	30	No
Job Title	JobTitle	DTYPE_TEXT	75	No
Last Name	LastName	DTYPE_TEXT	50	No
Last Promotion Date	LastPromotionDate	DTYPE_DATETIME	Not applicable	No
License Plate Number	LicensePlateNumber	DTYPE_TEXT	50	No
Login Domain	LoginDomain	DTYPE_TEXT	50	No
Login Name	LoginName	DTYPE_TEXT	50	No

Table 27. Siebel Employee ASI Fields

Name	XML Tag	Data Type	Length	Req.
M/F	MF	DTYPE_TEXT	1	No
Maiden Name	MaidenName	DTYPE_TEXT	50	No
Middle Name	MiddleName	DTYPE_TEXT	50	No
Next Annual Review Date	NextAnnualReviewDate	DTYPE_DATETIME	Not applicable	No
Next Availability Status	NextAvailabilityStatus	DTYPE_TEXT	30	No
Nick Name	NickName	DTYPE_TEXT	50	No
Overtime Code	OvertimeCode	DTYPE_TEXT	30	No
Pager PIN	PagerPIN	DTYPE_TEXT	10	No
Pager Phone #	PagerPhone	DTYPE_TEXT	Not applicable	No
Pager Type	PagerType	DTYPE_TEXT	30	No
Personal Title	PersonalTitle	DTYPE_TEXT	15	No
Phone #	Phone	DTYPE_TEXT	Not applicable	No
Preferred Communications	PreferredCommunications	DTYPE_TEXT	30	No
Private	Private	DTYPE_TEXT	Not applicable	No
Readiness	Readiness	DTYPE_TEXT	30	No
Seniority Date	SeniorityDate	DTYPE_TEXT	Not applicable	No
Share Address Flag	ShareAddressFlag	DTYPE_TEXT	Not applicable	No
Share Home Phone Flag	ShareHomePhoneFlag	DTYPE_TEXT	Not applicable	No
Shift Id	ShiftId	DTYPE_ID	Not applicable	No
Shift Integration Id	ShiftIntegrationId	DTYPE_TEXT	30	No
Shift Name	ShiftName	DTYPE_TEXT	100	No
Standard Notification	StandardNotification	DTYPE_TEXT	30	No
Start Shift From	StartShiftFrom	DTYPE_TEXT	30	No
Subcontractor Flag	SubcontractorFlag	DTYPE_TEXT	Not applicable	No
Termination Date	TerminationDate	DTYPE_DATETIME	Not applicable	No

Table 27. Siebel Employee ASI Fields

Name	XML Tag	Data Type	Length	Req.
Time Zone Id	TimeZoneId	DTYPE_ID	Not applicable	No
Time Zone Name	TimeZoneName	DTYPE_TEXT	100	No
operation	operation	DTYPE_TEXT	30	No
Employee_Employee Organization				
Employee Organization	EmployeeOrganization	DTYPE_TEXT	50	No
Employee Organization Id	EmployeeOrganizationId	DTYPE_ID	30	No
Employee Organization Integration Id	EmployeeOrganizationIntegratid	DTYPE_TEXT	30	No
IsPrimaryMVG	IsPrimaryMvg	DTYPE_TEXT	1	No
Employee_Personal Address				
IsPrimaryMVG	IsPrimaryMvg	DTYPE_TEXT	1	No
Personal Address Id	PersonalAddressId	DTYPE_ID	30	No
Personal Address Integration Id	PersonalAddressIntegrationId	DTYPE_TEXT	30	No
Personal City	PersonalCity	DTYPE_TEXT	50	No
Personal Country	PersonalCountry	DTYPE_TEXT	50	No
Personal County	PersonalCounty	DTYPE_TEXT	50	No
Personal Postal Code	PersonalPostalCode	DTYPE_TEXT	30	No
Personal Province	PersonalProvince	DTYPE_TEXT	50	No
Personal State	PersonalState	DTYPE_TEXT	10	No
Personal Street Address	PersonalStreetAddress	DTYPE_TEXT	200	No
Personal Street Address 2	PersonalStreetAddress2	DTYPE_TEXT	100	No
operation	operation	DTYPE_TEXT	30	No
Employee_Position				
Division	Division	DTYPE_TEXT	255	No
Division Id	DivisionId	DTYPE_ID	Not applicable	No

Table 27. Siebel Employee ASI Fields

Name	XML Tag	Data Type	Length	Req.
Division Integration Id	DivisionIntegrationId	DTYPE_TEXT	30	No
Employee End Date	EmployeeEndDate	DTYPE_DATETIME	NA	No
Employee Start Date	EmployeeStartDate	DTYPE_DATETIME	Not applicable	No
IsPrimaryMVG	IsPrimaryMvg	DTYPE_TEXT	1	No
Position	Position	DTYPE_TEXT	50	No
Position Id	PositionId	DTYPE_ID	30	No
Position Integration Id	PositionIntegrationId	DTYPE_TEXT	30	No
Employee_Responsibility				
IsPrimaryMVG	IsPrimaryMVG	DTYPE_TEXT	1	No
Responsibility	Responsibility	DTYPE_TEXT	50	No
Responsibility Id	ResponsibilityId	DTYPE_ID	30	No
Responsibility Integration Id	ResponsibilityIntegrationId	DTYPE_TEXT	30	No
Employee_Subcontractor				
IsPrimaryMVG	IsPrimaryMVG	DTYPE_TEXT	1	No
Subcontractor Account Id	SubcontractorAccountId	DTYPE_ID	30	No
Subcontractor Integration Id	SubcontractorIntegrationId	DTYPE_TEXT	30	No
Subcontractor Name	Subcontractor Name	DTYPE_TEXT	100	No
Personal Address				
IsPrimaryMVG	IsPrimaryMVG	DTYPE_TEXT	1	No
Personal Address Id	PersonalAddressId	DTYPE_ID	30	No
Personal Address Integration Id	PersonalAddressIntegrationId	DTYPE_TEXT	30	No
Personal City	PersonalCity	DTYPE_TEXT	50	No
Personal Country	PersonalCountry	DTYPE_TEXT	50	No
Personal County	PersonalCounty	DTYPE_TEXT	50	No

Table 27. Siebel Employee ASI Fields

Name	XML Tag	Data Type	Length	Req.
Personal Postal Code	PersonalPostalCode	DTYPE_TEXT	30	No
Personal Province	PersonalProvince	DTYPE_TEXT	50	No
Personal State	PersonalState	DTYPE_TEXT	10	No
Personal Street Address	PersonalStreetAddress	DTYPE_TEXT	200	No
Personal Street Address 2	PersonalStreetAddress2	DTYPE_TEXT	100	No
operation	operation	DTYPE_TEXT	30	No
Related Employee Organization				
Employee Organization	EmployeeOrganization	DTYPE_TEXT	50	No
Employee Organization Id	EmployeeOrganizationId	DTYPE_ID	30	No
Employee Organization Integration Id	EmployeeOrganizationIntegrationId	DTYPE_TEXT	30	No
IsPrimaryMVG	IsPrimaryMVG	DTYPE_TEXT	1	No
Related Position				
Division	Division	DTYPE_TEXT	255	No
Division Id	DivisionId	DTYPE_ID	Not applicable	No
Division Integration Id	DivisionIntegrationId	DTYPE_TEXT	30	No
Employee End Date	EmployeeEndDate	DTYPE_DATETIME	Not applicable	No
Employee Start Date	EmployeeStartDate	DTYPE_DATETIME	Not applicable	No
IsPrimaryMVG	IsPrimaryMVG	DTYPE_TEXT	1	No
Position	Position	DTYPE_TEXT	50	No
Position Id	PositionId	DTYPE_ID	30	No
Position Integration Id	PositionIntegrationId	DTYPE_TEXT	30	No
Related Position Business Address				
Address Id	AddressId	DTYPE_ID	30	No

Table 27. Siebel Employee ASI Fields

Name	XML Tag	Data Type	Length	Req.
Address Integration Id	AddressIntegrationId	DTYPE_TEXT	30	No
Address Name	AddressName	DTYPE_TEXT	100	No
City	City	DTYPE_TEXT	50	No
Country	Country	DTYPE_TEXT	30	No
IsPrimaryMVG	IsPrimaryMVG	DTYPE_TEXT	1	No
Postal Code	PostalCode	DTYPE_TEXT	30	No
State	State	DTYPE_TEXT	10	No
Street Address	StreetAddress	DTYPE_TEXT	200	No
Related Responsibility				
IsPrimaryMVG	IsPrimaryMVG	DTYPE_TEXT	1	No
Responsibility	Responsibility	DTYPE_TEXT	50	No
Responsibility Id	ResponsibilityId	DTYPE_ID	30	No
Responsibility Integration Id	ResponsibilityIntegrationId	DTYPE_TEXT	30	No
Related Subcontractor				
IsPrimaryMVG	IsPrimaryMVG	DTYPE_TEXT	1	No
Subcontractor Account Id	SubcontractorAccountId	DTYPE_ID	30	No
Subcontractor Integration Id	SubcontractorIntegrationId	DTYPE_TEXT	30	No
Subcontractor Name	SubcontractorName	DTYPE_TEXT	100	No

Siebel Financial Account

The Siebel Financial Account ASI is an ASI for privacy data management-related business processes. This ASI facilitates inbound and outbound financial account data synchronization between a Siebel application and a UCM system. [Figure 19](#) describes the Siebel Financial Account ASI structure.

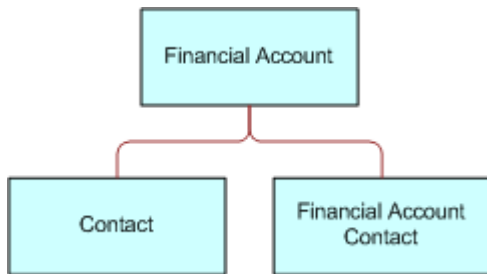

Figure 19. Siebel Financial Account ASI

[Table 28](#) lists the integration components and user keys of the Siebel Financial Account ASI.

Table 28. Siebel Financial Account Integration Components

Integration Component	XML Tag	User Keys
FINCORP Account	FincorpAccount	<ol style="list-style-type: none"> 1 Integration Id 2 Row Id 3 Account Number, Primary Organization Name Status Key: Account Number, Id, Integration Id, operation
Contact	Contact	<ol style="list-style-type: none"> 1 Integration Id 2 Party UIId 3 Row Id 4 Account Integration Id, Employee Number, Personal Contact 5 Person Uid, Personal Contact, Primary Organization Status Key: Id, Integration Id, operation
FINCORP Account Contact	FincorpAccountContact	<ol style="list-style-type: none"> 1 Asset Id, Contact Id 2 Contact Id

Table 29 lists the fields and their attributes. Fields without a length specified do not have a maximum length associated with them.

Table 29. Siebel Financial Account ASI Fields

Name	XML Tag	Data Type	Length	Req.
FINCORPAccount				
ABA Number	ABANumber	DTYPE_TEXT	50	No
Account Alias	AccountAlias	DTYPE_TEXT	100	No
Account Branch ABA	AccountBranchABA	DTYPE_TEXT	50	No
Account Branch Id	AccountBranchId	DTYPE_ID	Not applicable	No
Account Branch Name	AccountBranchName	DTYPE_TEXT	100	No
Account Branch Number	AccountBranchNumber	DTYPE_TEXT	30	No
Account Holder	AccountHolder	DTYPE_TEXT	Not applicable	No
Account Name	AccountName	DTYPE_TEXT	100	No
Account Number	AccountNumber	DTYPE_TEXT	100	Yes
Account Row Id	AccountRowId	DTYPE_ID	Not applicable	No
Account Status	AccountStatus	DTYPE_TEXT	30	No
Account Type	AccountType	DTYPE_TEXT	30	No
Acct Gen - Account Id	AcctGen-AccountId	DTYPE_ID	Not applicable	No
Acct Gen - Average Balance	AcctGen-AverageBalance	DTYPE_CURRENCY	Not applicable	No
Acct Gen - Branch Id	AcctGen-BranchId	DTYPE_ID	Not applicable	No
Acct Gen - Organization Address Id	AcctGen-OrganizationAddressId	DTYPE_ID	Not applicable	No
Acct Gen - Pers Addr - City	AcctGen-PersAddr-City	DTYPE_TEXT	50	No
Acct Gen - Pers Addr - Country	AcctGen-PersAddr-Country	DTYPE_TEXT	30	No
Acct Gen - Pers Addr - Id	AcctGen-PersAddr-Id	DTYPE_ID	Not applicable	No
Acct Gen - Pers Addr - State	AcctGen-PersAddr-State	DTYPE_TEXT	10	No
Acct Gen - Pers Addr - Street	AcctGen-PersAddr-Street	DTYPE_TEXT	200	No
Acct Gen - Pers Addr - Zip Code	AcctGen-PersAddr-ZipCode	DTYPE_TEXT	30	No

Table 29. Siebel Financial Account ASI Fields

Name	XML Tag	Data Type	Length	Req.
Acct Gen - Primary Contact Id	AcctGen-PrimaryContactId	DTYPE_ID	Not applicable	No
Acct Gen - Product Line Id	AcctGen-ProductLineId	DTYPE_ID	Not applicable	No
Available Balance	AvailableBalance	DTYPE_CURRENCY	Not applicable	No
Balance	Balance	DTYPE_CURRENCY	Not applicable	No
Bank Number	BankNumber	DTYPE_TEXT	50	No
Billing Option	BillingOption	DTYPE_TEXT	30	No
Branch	Branch	DTYPE_TEXT	50	No
Branch Number	BranchNumber	DTYPE_TEXT	50	No
CA Next Statement Date	CANextStatementDate	DTYPE_DATE	Not applicable	No
Comments	Comments	DTYPE_TEXT	250	No
Commitment Amount	CommitmentAmount	DTYPE_CURRENCY	Not applicable	No
Conflict Id	ConflictId	DTYPE_ID	30	No
Contact Address Id	ContactAddressId	DTYPE_ID	Not applicable	No
Created	Created	DTYPE_DATETIME	30	No
Currency	Currency	DTYPE_TEXT	20	No
Current Balance	CurrentBalance	DTYPE_CURRENCY	Not applicable	No
Customer Number	CustomerNumber	DTYPE_TEXT	50	No
Customer Type	CustomerType	DTYPE_TEXT	30	No
First Name	FirstName	DTYPE_TEXT	50	No
Id	Id	DTYPE_ID	30	No
Integration Id	IntegrationId	DTYPE_TEXT	30	No
Last Name	LastName	DTYPE_TEXT	50	No
Mod Id	ModId	DTYPE_ID	30	No
Name	Name	DTYPE_TEXT	100	No
Organization Id	OrganizationId	DTYPE_ID	Not applicable	No
Parent ABA Number	ParentABANumber	DTYPE_TEXT	50	No
Parent Account Branch ABA	ParentAccountBranchABA	DTYPE_TEXT	50	No
Parent Account Branch Id	ParentAccountBranchId	DTYPE_ID	Not applicable	No

Table 29. Siebel Financial Account ASI Fields

Name	XML Tag	Data Type	Length	Req.
Parent Account Id	ParentAccountId	DTYPE_ID	Not applicable	No
Parent Account Number	ParentAccountNumber	DTYPE_TEXT	100	No
Parent Asset ID	ParentAssetID	DTYPE_ID	Not applicable	No
Parent Asset Number	ParentAssetNumber	DTYPE_TEXT	100	No
Parent Bank	ParentBank	DTYPE_TEXT	50	No
Payment Type	PaymentType	DTYPE_TEXT	30	No
Previous Balance	PreviousBalance	DTYPE_CURRENCY	Not applicable	No
Primary Account Id	PrimaryAccountId	DTYPE_ID	Not applicable	No
Primary Employee Id	PrimaryEmployeeId	DTYPE_ID	Not applicable	No
Primary Org Id	PrimaryOrgId	DTYPE_ID	Not applicable	No
Primary Organization Name	PrimaryOrganizationName	DTYPE_TEXT	100	No
Primary Position Id	PrimaryPositionId	DTYPE_ID	Not applicable	No
Product Id	ProductId	DTYPE_ID	Not applicable	Yes
Start Date	StartDate	DTYPE_DATE	Not applicable	No
Type	Type	DTYPE_TEXT	30	No
Updated	Updated	DTYPE_DATETIME	30	No
operation	operation	DTYPE_TEXT	30	No
searchspec	searchspec	DTYPE_TEXT	250	No
Contact				
Account Id	AccountId	DTYPE_ID	Not applicable	No
Account Integration Id	AccountIntegrationId	DTYPE_TEXT	30	No
Assistant	Assistant	DTYPE_TEXT	50	No
Assistant Email Address	AssistantEmailAddress	DTYPE_TEXT	100	No
Assistant Phone #	AssistantPhone	DTYPE_PHONE	Not applicable	No
Cellular Phone #	CellularPhone	DTYPE_PHONE	Not applicable	No
Created	Created	DTYPE_DATETIME	30	No
Employee Number	EmployeeNumber	DTYPE_TEXT	30	No
Fax Phone #	FaxPhone	DTYPE_PHONE	Not applicable	No
First Name	FirstName	DTYPE_TEXT	50	Yes
Home Phone #	HomePhone	DTYPE_PHONE	Not applicable	No

Table 29. Siebel Financial Account ASI Fields

Name	XML Tag	Data Type	Length	Req.
Id	Id	DTYPE_ID	30	No
Integration Id	IntegrationId	DTYPE_TEXT	30	No
Job Title	JobTitle	DTYPE_TEXT	75	No
Last Name	LastName	DTYPE_TEXT	50	Yes
Login Name	LoginName	DTYPE_TEXT	50	No
M/F	MF	DTYPE_TEXT	30	No
M/M	MM	DTYPE_TEXT	15	No
Market Cap Pref	MarketCapPref	DTYPE_TEXT	30	No
Middle Name	MiddleName	DTYPE_TEXT	50	No
Mod Id	ModId	DTYPE_ID	30	No
Party Type Code	PartyTypeCode	DTYPE_TEXT	30	Yes
Party UId	PartyUId	DTYPE_TEXT	100	Yes
Person UId	PersonUId	DTYPE_TEXT	100	Yes
Personal Contact	PersonalContact	DTYPE_BOOL	Not applicable	No
Preferred Communication Method	PreferredCommunication Method	DTYPE_TEXT	20	No
Primary Organization	PrimaryOrganization	DTYPE_TEXT	50	No
Privacy Code	PrivacyCode	DTYPE_TEXT	30	Yes
SSN	SSN	DTYPE_TEXT	11	No
Short Name	ShortName	DTYPE_TEXT	50	No
Status	Status	DTYPE_TEXT	30	No
Type	Type	DTYPE_TEXT	30	No
Updated	Updated	DTYPE_DATETIME	30	No
Updated By Name	UpdatedByName	DTYPE_TEXT	50	No
User Type	UserType	DTYPE_TEXT	30	No
Work Phone #	WorkPhone	DTYPE_PHONE	Not applicable	No
operation	operation	DTYPE_TEXT	30	No
searchspec	searchspec	DTYPE_TEXT	250	No
FINCORPAccountContact				
Account	Account	DTYPE_TEXT	100	No
Account Id	AccountId	DTYPE_ID	Not applicable	No

Table 29. Siebel Financial Account ASI Fields

Name	XML Tag	Data Type	Length	Req.
Asset Id	AssetId	DTYPE_ID	Not applicable	No
Cellular Phone Number	CellularPhoneNumber	DTYPE_PHONE	Not applicable	No
Conflict Id	ConflictId	DTYPE_ID	30	No
Contact Id	ContactId	DTYPE_ID	Not applicable	No
Created	Created	DTYPE_DATETIME	30	No
Currency	Currency2	DTYPE_TEXT	Not applicable	No
Email Address	EmailAddress3	DTYPE_TEXT	100	No
Fax Number	FaxNumber	DTYPE_PHONE	Not applicable	No
First Name	FirstName	DTYPE_TEXT	50	No
Home Phone Number	HomePhoneNumber	DTYPE_PHONE	Not applicable	No
Id	Id	DTYPE_ID	30	No
Job Title	JobTitle	DTYPE_TEXT	75	No
Last Name	LastName	DTYPE_TEXT	50	Yes
Middle Initial	MiddleInitial	DTYPE_TEXT	50	No
Mod Id	ModId	DTYPE_ID	30	No
Mother's Maiden Name	MothersMaidenName	DTYPE_TEXT	50	No
Mr./Ms.	Mr.Ms.	DTYPE_ID	Not applicable	No
Primary Personal Address Id	PrimaryPersonalAddressId	DTYPE_ID	Not applicable	No
Short Name	ShortName	DTYPE_TEXT	50	No
Social Security Number	SocialSecurityNumber2	DTYPE_TEXT	11	No
Title	Title	DTYPE_TEXT	75	No
Updated	Updated	DTYPE_DATETIME	30	No
Work Phone #	WorkPhone	DTYPE_PHONE	Not applicable	No
operation	operation	DTYPE_TEXT	30	No
searchspec	searchspec	DTYPE_TEXT	250	No

Siebel Forecast

The Siebel Forecast ASI consists of internal and external integration objects and a business service. This ASI facilitates the outbound data synchronization between the Siebel application and an external back-office system. This ASI is used by the Export Forecast business process, which queries the Siebel application for data on a given forecast and returns the data to a back-office system.

Figure 20 describes the Siebel Forecast ASI structure.

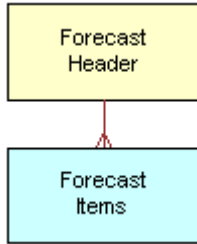

Figure 20. Siebel Forecast ASI

Table 30 lists the integration components and user keys of the Siebel Forecast ASI.

Table 30. Siebel Forecast Integration Components

Integration Component	XML Tag	User Keys
Forecast	Forecast	1 Forecast Number
Forecast Item Detail Flat	ForecastItemDetailFlat	1 Detail Date 2 Forecast Item Id 3 Owner Forecast Id

Table 31 lists the fields and their attributes. Fields without a length specified do not have a maximum length associated with them.

Table 31. Siebel Forecast ASI Fields

Name	XML Tag	Data Type	Length	Req.
Forecast				
Archive Timestamp	ArchiveTimestamp	DTYPE_TEXT	Not applicable	No
Created By Login	CreatedByLogin	DTYPE_TEXT	50	No
Forecast Base Period Type	ForecastBasePeriodType	DTYPE_TEXT	30	No
Forecast Date	ForecastDate	DTYPE_TEXT	Not applicable	No
Forecast End Date	ForecastEndDate	DTYPE_TEXT	Not applicable	No
Forecast Id	ForecastId	DTYPE_ID	15	No
Forecast Name	ForecastSeriesName	DTYPE_TEXT	20	No
Forecast Number	ForecastNumber	DTYPE_TEXT	30	No
Forecast Start Date	ForecastStartDate	DTYPE_TEXT	Not applicable	No
operation	operation	DTYPE_TEXT	30	No

Table 31. Siebel Forecast ASI Fields

Name	XML Tag	Data Type	Length	Req.
Owner Organization Id	OwnerOrganizationId	DTYPE_ID	15	No
Owner Position Id	OwnerPositionId	DTYPE_ID	15	No
Forecast Item Detail Flat				
Account Id	AccountId	DTYPE_ID	15	No
Amount Revenue	Revenue	DTYPE_TEXT	Not applicable	No
Best Case	BestCase	DTYPE_TEXT	Not applicable	No
Commit Flag	CommitFlag	DTYPE_TEXT	1	No
Cost	Cost	DTYPE_TEXT	Not applicable	No
Currency	CurrencyCode	DTYPE_TEXT	Not applicable	No
Detail Date	DetailDate	DTYPE_TEXT	Not applicable	No
DUNS Number	DUNSNumber	DTYPE_TEXT	15	No
Forecast Id	ForecastId	DTYPE_ID	15	No
Forecast Item Id	ForecastItemId	DTYPE_ID	15	No
Id	Id	DTYPE_ID	15	No
Link Type	LinkType	DTYPE_TEXT	30	No
operation	operation	DTYPE_TEXT	30	No
Opportunity Id	OpportunityId	DTYPE_ID	15	No
Organization Id	OrganizationId	DTYPE_ID	15	No
Owner Forecast Id	OwnerForecastId	DTYPE_ID	15	No
Primary Product Line Id	ProductLineId	DTYPE_ID	15	No
Product Id	ProductId	DTYPE_ID	15	No
Product Price	ProductPrice	DTYPE_TEXT	Not applicable	No
Product Quantity	ProductQuantity	DTYPE_TEXT	Not applicable	No
Sales Rep Id	SalesRepPositionId	DTYPE_ID	15	No
Service Request Id	ServiceRequestId	DTYPE_ID	15	No
Unit of Measure	UnitOfMeasure	DTYPE_TEXT	30	No
Worst Case	WorstCase	DTYPE_TEXT		No

Siebel Invoice

The Siebel Invoice ASI enables the implementation of replication of invoices from back-office accounting systems to the Siebel application, which allows sales professionals, call center agents, partners, as well as the customer, to access invoice information in the Siebel application for related inquiries. A typical process involves the creation of the invoice in the back-end system after the fulfillment of an order, which is then followed by the replication of this invoice (as well as all of its updates) in the front-end systems. The Siebel Invoice ASI enables the creation, update, deletion and queries of invoice information for inbound and outbound directions in Siebel applications.

Figure 21 describes the structure of the Siebel Invoice ASI.

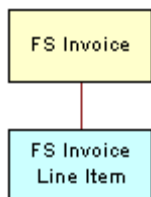

Figure 21. Siebel Invoice ASI

Table 32 lists the integration components of this ASI.

Table 32. Siebel Invoice Integration Components

Integration Component	XML Tag	User Keys
FS Invoice (primary)	Invoice	<ol style="list-style-type: none"> 1 Id 2 Integration Id 3 Document Type, Document Number
FS Invoice Line Items	FSInvoiceLineItems	<ol style="list-style-type: none"> 1 Id 2 Integration Id 3 Line Number

The Siebel Invoice ASI uses the same user keys as the FS Invoice integration component. You can use the fields for the integration, which means that values for each of these fields may be written to an XML file for transport. [Table 33](#) lists the fields and their attributes.

Table 33. Siebel Invoice ASI Fields

Name	XML Tag	Data Type	Length	Req.	Note
FS Invoice					
Account Id	AccountId	DTYPE_ID	15	No	<ul style="list-style-type: none"> ■ Used for picking from Picklist Account. ■ User key field.
Account Integration Id	AccountIntegrationId	DTYPE_TEXT	30	No	<ul style="list-style-type: none"> ■ Used for picking from Picklist Account. ■ User key field.
Account Location	AccountLocation	DTYPE_TEXT	30	No	Used for picking from Picklist Account.
Account Name	AccountName	DTYPE_TEXT	50	No	Used for picking from Picklist Account.
Account Organization Name	AccountOrganizationName	DTYPE_TEXT	100	No	Used for picking from Picklist Account.
Activity Id	ActivityId	DTYPE_ID	15	No	Used for picking from FS Activity Pick List.
Activity User Defined Unique Id	ActivityUserDefinedUniqueId	DTYPE_TEXT	30	No	Used for picking from FS Activity Pick List.
Amount Paid	AmountPaid	DTYPE_CURRENCY	22	No	None

Table 33. Siebel Invoice ASI Fields

Name	XML Tag	Data Type	Length	Req.	Note
Balance Forward	BalanceForward	DTYPE_CURRENCY	22	No	None
Contract Id	ContractId	DTYPE_ID	15	No	Used for picking from Service Agreement.
Contract Integration Id	ContractIntegrationId	DTYPE_TEXT	30	No	Used for picking from Service Agreement.
Contract Name	ContractName	DTYPE_TEXT	50	No	Used for picking from Service Agreement.
Contract Organization Name	ContractOrganizationName	DTYPE_TEXT	100	No	Used for picking from Service Agreement.
Contract Revision Number	ContractRevisionNumber	DTYPE_NUMBER	22	No	Used for picking from Service Agreement.
Currency Code	CurrencyCode	DTYPE_TEXT	20	Yes	Used for picking from Picklist Currency.
Delinquent Flag	DelinquentFlag	DTYPE_BOOL	1	No	None
Document Date	DocumentDate	DTYPE_UTCDATETIME	7	No	None
Document Description	DocumentDescription	DTYPE_TEXT	250	No	None
Document Number	DocumentNumber	DTYPE_TEXT	50	Yes	User key field for Invoice.
Document Period Id	DocumentPeriodId	DTYPE_ID	15	No	Used for picking from Picklist Period.

Table 33. Siebel Invoice ASI Fields

Name	XML Tag	Data Type	Length	Req.	Note
Document Period Name	DocumentPeriodName	DTYPE_TEXT	50	No	Used for picking from Picklist Period.
Document Period Organization Name	DocumentPeriodOrganizationName	DTYPE_TEXT	100	No	Used for picking from Picklist Period.
Document Revision Number	DocumentRevisionNumber	DTYPE_NUMBER	15	No	None
Document Status	DocumentStatus	DTYPE_TEXT	30	No	Bound by FS_INVOICE_TYPE LOV.
Document Sub Type	DocumentSubType	DTYPE_TEXT	30	No	Bound by FS_INVOICE_CODE LOV.
Document Type	DocumentType	DTYPE_TEXT	30	No	<ul style="list-style-type: none"> ■ Bound by FS_INVOICE_TYPE LOV. ■ User key field.
Id	Id	DTYPE_ID	30	No	None
Integration Id	IntegrationId	DTYPE_TEXT	30	No	None
Order Id	OrderId	DTYPE_ID	15	No	Used for picking from Order Entry Picklist.
Order Integration Id	OrderIntegrationId	DTYPE_TEXT	30	No	Used for picking from Order Entry Picklist.
Order Number	OrderNumber	DTYPE_TEXT	30	No	Used for picking from Order Entry Picklist.

Table 33. Siebel Invoice ASI Fields

Name	XML Tag	Data Type	Length	Req.	Note
Order Organization Name	OrderOrganizationName	DTYPE_TEXT	100	No	Used for picking from Order Entry Picklist.
Order Type	OrderType	DTYPE_TEXT	50	No	Used for picking from Order Entry Picklist.
Payment Term	PaymentTerm	DTYPE_TEXT	50	No	Used for picking from Picklist Payment Term.
Payment Term Id	PaymentTermId	DTYPE_ID	15	No	Used for picking from Picklist Payment Term.
Project Id	ProjectId	DTYPE_ID	15	No	Used for picking from Picklist Project.
Project Integration Id	ProjectIntegrationId	DTYPE_TEXT	30	No	Used for picking from Picklist Project.
Project Number	ProjectNumber	DTYPE_TEXT	30	No	Used for picking from Picklist Project.
Project Organization Name	ProjectOrganizationName	DTYPE_TEXT	100	No	Used for picking from Picklist Project.
STORED Adjustment Amount	STOREDAdjustmentAmount	DTYPE_CURRENCY	22	No	None
STORED Discount Amount	STOREDDiscountAmount	DTYPE_CURRENCY	22	No	None

Table 33. Siebel Invoice ASI Fields

Name	XML Tag	Data Type	Length	Req.	Note
STORED Gross Amount	STOREDGrossAmount	DTYPE_CURRENCY	22	No	None
STORED Surcharge Amount	STOREDSurchargeAmount	DTYPE_CURRENCY	22	No	None
STORED Tax Amount	STOREDTaxAmount	DTYPE_CURRENCY	22	No	None
Service Request Id	ServiceRequestId	DTYPE_ID	15	No	Used for picking from Service Request Picklist.
Service Request Number	ServiceRequestNumber	DTYPE_TEXT	64	No	Used for picking from Service Request Picklist.
Service Request Organization Name	ServiceRequestOrganization Name	DTYPE_TEXT	100	No	Used for picking from Service Request Picklist.
FS Invoice Line Items					
Activity Id	ActivityId	DTYPE_ID	15	No	Used for picking from FS Activity Picklist.
Activity User Defined Unique Id	ActivityUserDefinedUniqueId	DTYPE_TEXT	30	No	Used for picking from FS Activity Picklist.
Contract Id	ContractId	DTYPE_ID	15	No	Used for picking from FS PickList Agreement Item - All.
Contract Integration Id	ContractIntegrationId	DTYPE_TEXT	30	No	Used for picking from FS PickList Agreement Item - All.

Table 33. Siebel Invoice ASI Fields

Name	XML Tag	Data Type	Length	Req.	Note
Contract Line Id	ContractLineId	DTYPE_ID	15	No	Used for picking from FS PickList Agreement Item - All.
Contract Name	ContractName	DTYPE_TEXT	50	No	Used for picking from FS PickList Agreement Item - All.
Contract Organization Name	ContractOrganizationName	DTYPE_TEXT	100	No	Used for picking from FS PickList Agreement Item - All.
Contract Revision Number	ContractRevisionNumber	DTYPE_NUMBER	22	No	Used for picking from FS PickList Agreement Item - All.
CurrencyCode	CurrencyCode	DTYPE_TEXT	20	Yes	Used for picking from Picklist Currency.
Description	Description	DTYPE_TEXT	250	No	None
Discount Amount	DiscountAmount	DTYPE_CURRENCY	22	No	None
Gross Amount	GrossAmount	DTYPE_CURRENCY	22	No	None
Id	Id	DTYPE_ID	30	No	User key field for Line Item.
Integration Id	IntegrationId	DTYPE_TEXT	30	No	User key field for Line Item.
Line Number	LineNumber	DTYPE_NUMBER	22	Yes	User key field for Line Item.
Line Quantity	LineQuantity	DTYPE_NUMBER	22	Yes	None
Line Type	LineType	DTYPE_TEXT	30	No	Used for picking from FS Invoice Line Item Type Picklist.

Table 33. Siebel Invoice ASI Fields

Name	XML Tag	Data Type	Length	Req.	Note
Order Id	OrderId	DTYPE_ID	15	No	Used for picking from Order Entry Picklist.
Order Integration Id	OrderIntegrationId	DTYPE_TEXT	30	No	Used for picking from Order Entry Picklist.
Order Item Id	OrderItemId	DTYPE_ID	15	No	Used for picking from Order Entry - Line Item Picklist.
Order Item Integration Id	OrderItemIntegrationId	DTYPE_TEXT	30	No	Used for picking from Order Entry - Line Item Picklist.
Order Line Number	OrderLineNumber	DTYPE_NUMBER	22	No	Used for picking from Order Entry - Line Item Picklist.
Order Number	OrderNumber	DTYPE_TEXT	30	No	Used for picking from Order Entry - Line Item Picklist.
Order Organization Name	OrderOrganizationName	DTYPE_TEXT	100	No	Used for picking from Order Entry - Line Item Picklist.
Order Type	OrderType	DTYPE_TEXT	50	No	Used for picking from Order Entry - Line Item Picklist.

Table 33. Siebel Invoice ASI Fields

Name	XML Tag	Data Type	Length	Req.	Note
Person Id	PersonId	DTYPE_ID	15	No	Used for picking from PS PickList Project Resource.
Product Id	ProductId	DTYPE_ID	15	No	Used for picking from Order Entry - Product PickList.
Product Integration Id	ProductIntegrationId	DTYPE_TEXT	30	No	Used for picking from Order Entry - Product PickList.
Product Name	ProductName	DTYPE_TEXT	100	No	Used for picking from Order Entry - Product PickList.
Product Organization Name	ProductOrganizationName	DTYPE_TEXT	100	No	Used for picking from Order Entry - Product PickList.
Product Vendor Organization Name	ProductVendorOrganizationName	DTYPE_TEXT	100	No	Used for picking from Order Entry - Product PickList.
Project Id	ProjectId	DTYPE_ID	15	No	Used for picking from Picklist Project.
Project Integration Id	ProjectIntegrationId	DTYPE_TEXT	30	No	Used for picking from Picklist Project.
Project Item Id	ProjectItemId	DTYPE_ID	15	No	Used for picking from Project Item PickList.

Table 33. Siebel Invoice ASI Fields

Name	XML Tag	Data Type	Length	Req.	Note
Project Item Number	ProjectItemNumber	DTYPE_TEXT	30	No	Used for picking from Project Item PickList.
Project Number	ProjectNumber	DTYPE_TEXT	30	No	Used for picking from Picklist Project.
Project Organization Name	ProjectOrganizationName	DTYPE_TEXT	100	No	Used for picking from Picklist Project.
Project Resource Id	ProjectResourceId	DTYPE_ID	15	No	Used for picking from PS PickList Project Resource.
Project Resource Number	ProjectResourceNumber	DTYPE_TEXT	30	No	Used for picking from PS PickList Project Resource.
Service Request Id	ServiceRequestId	DTYPE_ID	15	No	Used for picking from Service Request Picklist.
Service Request Number	ServiceRequestNumber	DTYPE_TEXT	64	No	Used for picking from Service Request Picklist.
Service Request Organization Name	ServiceRequestOrganizationName	DTYPE_TEXT	100	No	Used for picking from Service Request Picklist.
Surcharge Amount	SurchargeAmount	DTYPE_CURRENCY	22	No	None

Table 33. Siebel Invoice ASI Fields

Name	XML Tag	Data Type	Length	Req.	Note
Tax Amount	TaxAmount	DTYPE_CURRENCY	22	No	None
Unit of Measure	UnitofMeasure	DTYPE_TEXT	30	Yes	Bound by UNIT_OF_MEASURE LOV.

External Opportunity Create/External Opportunity Query/External Opportunity Update

The External Opportunity Create/External Opportunity Query/External Opportunity Update ASI facilitates the inbound and outbound transfer of opportunity data and associated child-level data such as contacts, notes, revenues, and activities. It is based on the Opportunity business object and supports the create, update, and query functions. The Opportunity Sharing ASIs are as follows:

- [“ANI Opportunity Message \(PRM ANI\)” on page 110](#)
- [“ANI Message Header \(PRM ANI\)” on page 120](#)
- [“Opportunity \(PRM ANI\)” on page 121](#)
- [“Destination Channel Partner \(PRM ANI\)” on page 126](#)
- [“Source Organization \(PRM ANI\)” on page 127](#)
- [“Opportunity Account \(PRM ANI\)” on page 128](#)

Figure 22 describes the structure of the External Opportunity Create/External Opportunity Query/External Opportunity Update ASI.

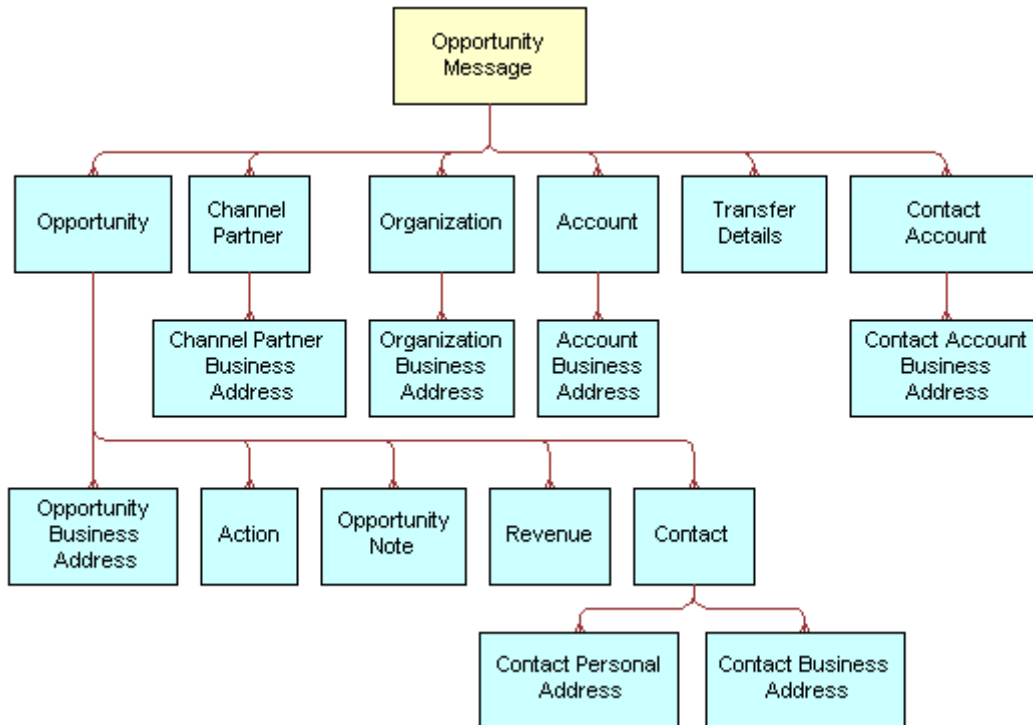

Figure 22. Opportunity Sharing ASI

ANI Opportunity Message (PRM ANI)

The ANI Opportunity Message (PRM ANI) ASI is the main interface for the Opportunity Sharing ASI, which encapsulates these ASIs (Opportunity, Opportunity Account, ANI Message Header, Destination Channel Partner, and Source Organization) and the associated data contained in the ASIs.

Table 34 lists the primary integration components of ANI Opportunity Message (PRM ANI).

Table 34. ANI Opportunity Message (PRM ANI) Integration Components

Integration Component	XML Tag	User Keys
Account	Account	No user keys.
Account_Business Address	Account_BusinessAddress	<ol style="list-style-type: none"> 1 City, Country, Postal Code, State, Street Address, Street Address 2 2 Address Name, City, Postal Code, State, Street Address 3 City, Postal Code, State 4 Address Name
Action	Action	<ol style="list-style-type: none"> 1 Due, Id, Type 2 Comment, Description, Due, Type 3 Comment, Description, Due, Type
Channel Partner	ChannelPartner	<ol style="list-style-type: none"> 1 Location, Name
Channel Partner Business Address	ChannelPartnerAddress	<ol style="list-style-type: none"> 1 City, Country, Postal Code, State, Street Address, Street Address 2 2 Account Id, Address Name, City, Postal Code, State, Street Address 3 City, Postal Code, State 4 Account Id, Address Name

Table 34. ANI Opportunity Message (PRM ANI) Integration Components

Integration Component	XML Tag	User Keys
Contact	Contact	<ul style="list-style-type: none"> 1 First Name, Id, Last Name 2 First Name, Last Name, Middle Name, Primary Account Name 3 Account Integration Id, First Name, Last Name, Middle Name 4 First Name, Last Name, Middle Name 5 First Name, Last Name 6 Account Integration Id, First Name, Last Name, Middle Name 7 First Name, Last Name, Middle Name, Primary Account Name 8 First Name, Last Name, Middle Name
Contact_Account	Contact_Account	<ul style="list-style-type: none"> 1 Account, Account Location
Contact_Account_Business Address	Contact_Account_BusinessAddress	<ul style="list-style-type: none"> 1 City, Country, Postal Code, State, Street Address, Street Address 2 2 Address Name, City, Postal Code, State, Street Address 3 City, Postal Code, State 4 Address Name
Contact_Personal Address	Contact_PersonalAddress	<ul style="list-style-type: none"> 1 City, Country, Postal Code, State, Street Address, Street Address 2 2 City, Country, Postal Code, State, Street Address, Street Address 2 3 City, Postal Code, State 4 Integration Id
Message Details	MessageDetails	No user keys.

Table 34. ANI Opportunity Message (PRM ANI) Integration Components

Integration Component	XML Tag	User Keys
Opportunity	Opportunity	<ul style="list-style-type: none"> 1 Name 2 Account Integration Id, Name 3 Account, Account Location, Name 4 Name
Opportunity Note	OpportunityNote	<ul style="list-style-type: none"> 1 Id, Note, Note Type, Oppty Name 2 Note Type, Oppty Name 3 Note, Note Type 4 Note Type, Oppty Name 5 Id, Note, Note Type, Oppty Name
Opportunity_Business Address	OpportunityBusinessAddress	<ul style="list-style-type: none"> 1 City, Country, Postal Code, State, Street Address, Street Address 2 2 City, Postal Code, State, Street Address 3 City, Postal Code, State 4 City, Postal Code, State 5 City, Country, Postal Code, State, Street Address, Street Address 2 6 Integration Id
Organization	Organization	<ul style="list-style-type: none"> 1 DUNS Number
Organization Business Address	OrganizationAddress	<ul style="list-style-type: none"> 1 City, Country, Postal Code, State, Street Address, Street Address 2 2 City, Postal Code, State, Street Address 3 City, Postal Code, State 4 Account Id, Address Name
Revenue	Revenue	<ul style="list-style-type: none"> 1 Revenue Item Number
Transfer Details	TransferDetails	No user keys.

Table 35 lists the fields and their attributes.

Table 35. ANI Opportunity Message (PRM ANI) ASI Fields

Name	XML Tag	Data Type	Length	Req.
Account				
Currency Code	CurrencyCode	DTYPE_TEXT	15	No
Customer Account Group	CustomerAccountGroup	DTYPE_TEXT	30	No
DUNS Number	DUNSNumber	DTYPE_TEXT	15	No
Group Type Code	GroupTypeCode	DTYPE_TEXT	30	No
Id	Id	DTYPE_ID	30	No
Location	Location	DTYPE_TEXT	50	No
Name	Name	DTYPE_TEXT	100	No
Party Type Code	PartyTypeCode	DTYPE_TEXT	30	No
Account_Business Address				
Address Name	AddressName	DTYPE_TEXT	100	No
City	City	DTYPE_TEXT	50	No
Country	Country	DTYPE_TEXT	50	No
Email Address	EmailAddress	DTYPE_TEXT	50	No
IsPrimaryMVG	IsPrimaryMVG	DTYPE_TEXT	1	No
Phone Number	PhoneNumber	DTYPE_TEXT	40	No
Postal Code	PostalCode	DTYPE_TEXT	30	No
State	State	DTYPE_TEXT	10	No
Street Address	StreetAddress	DTYPE_TEXT	200	No
Street Address 2	StreetAddress2	DTYPE_TEXT	100	No
Action				
Comment	Comment	DTYPE_TEXT	1,500	No
Description	Description	DTYPE_TEXT	100	No
Done	Done	DTYPE_TEXT	50	No
Due	Due	DTYPE_TEXT	50	No
Id	Id	DTYPE_ID	30	No
Planned	Planned	DTYPE_TEXT	50	No
Planned Completion	PlannedCompletion	DTYPE_TEXT	50	No

Table 35. ANI Opportunity Message (PRM ANI) ASI Fields

Name	XML Tag	Data Type	Length	Req.
Priority	Priority	DTYPE_TEXT	30	No
Started	Started	DTYPE_TEXT	50	No
Status	Status	DTYPE_TEXT	50	No
Type	Type	DTYPE_TEXT	30	No
Channel Partner				
DUNS Number	DUNSNumber	DTYPE_TEXT	15	No
Location	Location	DTYPE_TEXT	50	No
Name	Name	DTYPE_TEXT	100	No
Channel Partner Business Address				
Account Id	AccountId	DTYPE_ID	15	No
Address Name	AddressName	DTYPE_TEXT	100	No
City	City	DTYPE_TEXT	50	No
Country	Country	DTYPE_TEXT	50	No
County	County	DTYPE_TEXT	50	No
Email Address	EmailAddress	DTYPE_TEXT	50	No
Phone Number	PhoneNumber	DTYPE_TEXT	40	No
Postal Code	PostalCode	DTYPE_TEXT	30	No
Province	Province	DTYPE_TEXT	50	No
State	State	DTYPE_TEXT	10	No
Street Address	StreetAddress	DTYPE_TEXT	200	No
Street Address 2	StreetAddress2	DTYPE_TEXT	100	No
Contact				
Account Id	AccountId	DTYPE_ID	15	No
Account Integration Id	AccountIntegrationId	DTYPE_TEXT	30	No
Cellular Phone #	CellularPhone	DTYPE_TEXT	40	No
Comment	Comment	DTYPE_TEXT	255	No
DUNS Number	DUNSNumber	DTYPE_TEXT	15	No
Email Address	EmailAddress	DTYPE_TEXT	50	No
Fax Phone #	FaxPhone	DTYPE_TEXT	40	No
First Name	FirstName	DTYPE_TEXT	50	No
Home Phone #	HomePhone	DTYPE_TEXT	40	No

Table 35. ANI Opportunity Message (PRM ANI) ASI Fields

Name	XML Tag	Data Type	Length	Req.
Id	Id	DTYPE_ID	30	No
Job Title	JobTitle	DTYPE_TEXT	75	No
Last Name	LastName	DTYPE_TEXT	50	No
M/M	MM	DTYPE_TEXT	15	No
Middle Name	MiddleName	DTYPE_TEXT	50	No
Primary Account Name	PrimaryAccountName	DTYPE_TEXT	100	No
Work Phone #	WorkPhone	DTYPE_TEXT	40	No
Contact_Account				
Account	Name	DTYPE_TEXT	100	No
Account Location	Location	DTYPE_TEXT	50	No
Currency Code	CurrencyCode	DTYPE_TEXT	15	No
Customer Account Group	CustomerAccountGroup	DTYPE_TEXT	30	No
DUNS Number	DUNSNumber	DTYPE_TEXT	15	No
Group Type Code	GroupTypeCode	DTYPE_TEXT	30	No
IsPrimaryMVG	IsPrimaryMVG	DTYPE_TEXT	1	No
Party Type Code	PartyTypeCode	DTYPE_TEXT	30	No
Contact_Account_Business Address				
Address Name	AddressName	DTYPE_TEXT	100	No
City	City	DTYPE_TEXT	50	No
Country	Country	DTYPE_TEXT	50	No
Email Address	EmailAddress	DTYPE_TEXT	50	No
IsPrimaryMVG	IsPrimaryMVG	DTYPE_TEXT	1	No
Phone Number	PhoneNumber	DTYPE_TEXT	40	No
Postal Code	PostalCode	DTYPE_TEXT	30	No
State	State	DTYPE_TEXT	10	No
Street Address	StreetAddress	DTYPE_TEXT	200	No
Street Address 2	StreetAddress2	DTYPE_TEXT	100	No
Contact_Personal Address				
Address Name	AddressName	DTYPE_TEXT	100	No
Integration Id	IntegrationId	DTYPE_TEXT	30	No

Table 35. ANI Opportunity Message (PRM ANI) ASI Fields

Name	XML Tag	Data Type	Length	Req.
IsPrimaryMVG	IsPrimaryMVG	DTYPE_TEXT	1	No
Personal City	PersonalCity	DTYPE_TEXT	50	No
Personal Country	PersonalCountry	DTYPE_TEXT	50	No
Personal Postal Code	PersonalPostalCode	DTYPE_TEXT	30	No
Personal State	PersonalState	DTYPE_TEXT	10	No
Personal Street Address	PersonalStreetAddress	DTYPE_TEXT	200	No
Personal Street Address 2	PersonalStreetAddress2	DTYPE_TEXT	100	No
Message Details				
External Id	ExternalId	DTYPE_TEXT	250	No
External Id Description	ExternalIdDescription	DTYPE_TEXT	50	No
Internal Id	InternalId	DTYPE_TEXT	250	No
Internal Id Description	InternalIdDescription	DTYPE_TEXT	50	No
Message Generation Time Stamp	MessageGenerationTimeStamp	DTYPE_DATETIME	50	No
Method	Method	DTYPE_TEXT	50	No
Redirection URL	RedirectionURL	DTYPE_TEXT	50	No
Opportunity				
Account	AccountName	DTYPE_TEXT	100	No
Account Id	AccountId	DTYPE_TEXT	30	No
Account Integration Id	AccountIntegrationId	DTYPE_TEXT	30	No
Account Location	AccountLocation	DTYPE_TEXT	50	No
Currency Code	CurrencyCode	DTYPE_TEXT	15	No
DUNS Number	DUNSNumber	DTYPE_TEXT	15	No
Description	Description	DTYPE_TEXT	255	No
Id	Id	DTYPE_ID	30	No
Name	Name	DTYPE_TEXT	100	No
Parent Opportunity Name	ParentOpportunityName	DTYPE_TEXT	100	No
Primary Revenue Amount	PrimaryRevenueAmount	DTYPE_TEXT	22	No

Table 35. ANI Opportunity Message (PRM ANI) ASI Fields

Name	XML Tag	Data Type	Length	Req.
Primary Revenue Class	PrimaryRevenueClass	DTYPE_TEXT	30	No
Primary Revenue Close Date	PrimaryRevenueCloseDate	DTYPE_DATETIME	50	No
Primary Revenue Type	PrimaryRevenueType	DTYPE_TEXT	30	No
Primary Revenue Win Probability	PrimaryRevenueWinProbability	DTYPE_NUMBER	22	No
Sales Method	SalesMethod	DTYPE_TEXT	30	No
Sales Stage	SalesStage	DTYPE_TEXT	30	No
Opportunity Note				
Id	Id	DTYPE_ID	30	No
Note	Note	DTYPE_NOTE	1,000	No
Note Type	NoteType	DTYPE_TEXT	30	No
Opportunity Name	OpportunityName	DTYPE_TEXT	100	No
Opportunity_Business Address				
City	City	DTYPE_TEXT	50	No
Country	Country	DTYPE_TEXT	50	No
Integration Id	IntegrationId	DTYPE_TEXT	30	No
IsPrimaryMVG	IsPrimaryMVG	DTYPE_TEXT	1	No
Postal Code	PostalCode	DTYPE_TEXT	30	No
State	State	DTYPE_TEXT	10	No
Stree Address Line 2	StreetAddressLine2	DTYPE_TEXT	100	No
Street Address	StreetAddress	DTYPE_TEXT	200	No
Organization				
DUNS Number	DUNSNumber	DTYPE_TEXT	15	No
Id	Id	DTYPE_ID	15	No
Name	Name	DTYPE_TEXT	100	No
Organization Business Address				
City	City	DTYPE_TEXT	50	No
Country	Country	DTYPE_TEXT	50	No
Integration Id	Integration Id	DTYPE_TEXT	30	No
IsPrimaryMVG	IsPrimaryMVG	DTYPE_TEXT	1	No

Table 35. ANI Opportunity Message (PRM ANI) ASI Fields

Name	XML Tag	Data Type	Length	Req.
Postal Code	PostalCode	DTYPE_TEXT	30	No
State	State	DTYPE_TEXT	10	No
Street Address	StreetAddress	DTYPE_TEXT	200	No
Street Address 2	StreetAddress2	DTYPE_TEXT	100	No
Revenue				
Account	Account	DTYPE_TEXT	100	No
Account Location	AccountLocation	DTYPE_TEXT	50	No
Committed	Committed	DTYPE_TEXT	1	No
Currency Code	CurrencyCode4	DTYPE_TEXT	20	No
Date	Date	DTYPE_DATETIME	50	No
Description	Description	DTYPE_TEXT	100	No
Id	Id	DTYPE_ID	30	No
Part Number	PartNumber	DTYPE_TEXT	50	No
Price	Price	DTYPE_TEXT	22	No
Product	Product	DTYPE_TEXT	50	No
Quantity	Quantity	DTYPE_NUMBER	22	No
Revenue	Revenue	DTYPE_TEXT	22	No
Revenue Class	RevenueClass	DTYPE_TEXT	30	No
Revenue Item Number	RevenueItemNumber	DTYPE_TEXT	30	No
Revenue Type	RevenueType	DTYPE_TEXT	30	No
Summary	Summary	DTYPE_TEXT	1	No
Win Probability	WinProbability	DTYPE_NUMBER	22	No
Transfer Details				
Transfer Date	TransferDate	DTYPE_DATETIME	50	No
Transfer Recipient	TransferRecipient	DTYPE_TEXT	20	No
Transfer Status	TransferStatus	DTYPE_TEXT	50	No
Transfer Status Message	TransferStatusMessage	DTYPE_TEXT	200	No

ANI Message Header (PRM ANI)

The ANI Message Header ASI (PRM ANI) encapsulates information related to the exchange of the Opportunity Sharing message, such as whether the creation or update of the opportunity was successful.

Table 36 lists the primary integration components of ANI Message Header (PRM ANI).

Table 36. ANI Message Header (PRM ANI) Integration Components

Integration Component	XML Tag	User Keys
Message Details	MessageDetails	No user keys.
Transfer Details	TransferDetails	No user keys.

Table 37 lists the fields and their attributes.

Table 37. ANI Message Header (PRM ANI) ASI Fields

Name	XML Tag	Data Type	Length	Req.
Message Details				
External Id	ExternalId	DTYPE_TEXT	Not applicable	No
External Id Description	ExternalIdDescription	DTYPE_TEXT	Not applicable	No
Internal Id	InternalId	DTYPE_TEXT	Not applicable	No
Internal Id Description	InternalIdDescription	DTYPE_TEXT	Not applicable	No
Message Generation Time Stamp	MessageGenerationTimeStamp	DTYPE_DATETIME	Not applicable	No
Method	Method	DTYPE_TEXT	Not applicable	No
Redirection URL	RedirectionURL	DTYPE_TEXT	Not applicable	No
Transfer Details				
Transfer Date	TransferDate	DTYPE_DATETIME	Not applicable	No
Transfer Recipient	TransferRecipient	DTYPE_TEXT	Not applicable	No

Table 37. ANI Message Header (PRM ANI) ASI Fields

Name	XML Tag	Data Type	Length	Req.
Transfer Status	TransferStatus	DTYPE_TEXT	Not applicable	No
Transfer Status Message	TransferStatusMessage	DTYPE_TEXT	Not applicable	No

Opportunity (PRM ANI)

The Opportunity (PRM ANI) ASI encapsulates all the data that is directly related to the Opportunity object. This data includes fields such as Opportunity Name, Status, and so on.

Table 38 lists the primary integration components of Opportunity (PRM ANI).

Table 38. Opportunity (PRM ANI) Integration Components

Integration Component	XML Tag	User Keys
Action	Action	<ol style="list-style-type: none"> 1 Due, Id, Type 2 Comment, Description, Due, Type 3 Comment, Description, Due, Type
Contact	Contact	<ol style="list-style-type: none"> 1 DUNS Number, First Name, ID, Last Name, Middle Name 2 DUNS Number, First Name, Last Name, Middle Name 3 First Name, Last Name, Middle Name, Primary Account Name 4 First Name, Last Name, Middle Name, Primary Account Name 5 First Name, Last Name
Contact_Account	Contact_Account	<ol style="list-style-type: none"> 1 Account, Account Location

Table 38. Opportunity (PRM ANI) Integration Components

Integration Component	XML Tag	User Keys
Contact_Account_Business Address	Contact_Account_BusinessAddress	<p>1 City, Country, Postal Code, State, Street Address, Street Address 2</p> <p>2 Address Name, City, Postal Code, State, Street Address</p> <p>3 City, Postal Code, State</p> <p>4 Address Name</p>
Contact_Personal Address	Contact_PersonalAddress	<p>1 City, Country, Postal Code, State, Street Address, Street Address 2</p> <p>2 Address Name, City, Postal Code, State, Street Address</p> <p>3 City, Integration Id, Postal Code, State</p> <p>4 Integration Id</p>
Opportunity	Opportunity	1 Name
Opportunity Note	OpportunityNote	<p>1 Note, Note Type, Oppty Name</p> <p>2 Note Type, Oppty Name</p> <p>3 Note, Note Type</p> <p>4 Note Type</p> <p>5 Id</p>
Opportunity_Business Address	OpportunityBusinessAddress	<p>1 Address Name, City, Country, Postal Code, State, Street Address, Street Address 2</p> <p>2 City, Postal Code, State, Street Address</p> <p>3 City, Integration Id, Postal Code, State</p> <p>4 Integration Id</p>
Revenue	Revenue	1 Revenue Item Number

Table 39 lists the fields and their attributes.

Table 39. Opportunity (PRM ANI) ASI Fields

Name	XML Tag	Data Type	Length	Req.
Action				
Comment	Comment	DTYPE_TEXT	1,500	No
Description	Description	DTYPE_TEXT	100	No
Done	Done	DTYPE_TEXT	50	No
Due	Due	DTYPE_TEXT	50	No
Id	Id	DTYPE_ID	30	No
Planned	Planned	DTYPE_TEXT	50	No
Planned Completion	PlannedCompletion	DTYPE_TEXT	50	No
Priority	Priority	DTYPE_TEXT	30	No
Started	Started	DTYPE_TEXT	50	No
Status	Status	DTYPE_TEXT	30	No
Type	Type	DTYPE_TEXT	30	No
Contact				
Account Id	AccountId	DTYPE_ID	15	No
Account Integration Id	AccountIntegrationId	DTYPE_TEXT	30	No
Cellular Phone #	CellularPhone	DTYPE_TEXT	40	No
Comment	Comment	DTYPE_TEXT	255	No
DUNS Number	DUNSNumber	DTYPE_TEXT	15	No
Email Address	EmailAddress	DTYPE_TEXT	50	No
Fax Phone #	FaxPhone	DTYPE_TEXT	40	No
First Name	FirstName	DTYPE_TEXT	50	No
Home Phone #	HomePhone	DTYPE_TEXT	40	No
Id	Id	DTYPE_ID	30	No
Job Title	JobTitle	DTYPE_TEXT	75	No
Last Name	LastName	DTYPE_TEXT	50	No
M/M	MM	DTYPE_TEXT	15	No
Middle Name	MiddleName	DTYPE_TEXT	50	No
Primary Account Name	PrimaryAccountName	DTYPE_TEXT	100	No
Work Phone #	WorkPhone	DTYPE_TEXT	40	No

Table 39. Opportunity (PRM ANI) ASI Fields

Name	XML Tag	Data Type	Length	Req.
Contact_Account				
Account	Name	DTYPE_TEXT	100	No
Account Location	Location	DTYPE_TEXT	50	No
Currency Code	CurrencyCode	DTYPE_TEXT	15	No
Customer Account Group	CustomerAccountGroup	DTYPE_TEXT	30	No
DUNS Number	DUNSNumber	DTYPE_TEXT	15	No
Group Type Code	GroupTypeCode	DTYPE_TEXT	30	No
IsPrimaryMVG	IsPrimaryMVG	DTYPE_TEXT	1	No
Party Type Code	PartyTypeCode	DTYPE_TEXT	30	No
Contact_Account_Business Address				
Address Name	AddressName	DTYPE_TEXT	100	No
City	City	DTYPE_TEXT	50	No
Country	Country	DTYPE_TEXT	50	No
Email Address	EmailAddress	DTYPE_TEXT	50	No
IsPrimaryMVG	IsPrimaryMVG	DTYPE_TEXT	1	No
Phone Number	PhoneNumber	DTYPE_TEXT	40	No
Postal Code	PostalCode	DTYPE_TEXT	30	No
State	State	DTYPE_TEXT	10	No
Street Address	StreetAddress	DTYPE_TEXT	200	No
Street Address 2	StreetAddress2	DTYPE_TEXT	100	No
Contact_Personal Address				
Address Name	AddressName	DTYPE_TEXT	100	No
Integration Id	IntegrationId	DTYPE_TEXT	30	No
IsPrimaryMVG	IsPrimaryMVG	DTYPE_TEXT	1	No
Personal City	PersonalCity	DTYPE_TEXT	50	No
Personal Country	PersonalCountry	DTYPE_TEXT	50	No
Personal Postal Code	PersonalPostalCode	DTYPE_TEXT	30	No
Personal State	PersonalState	DTYPE_TEXT	10	No
Personal Street Address	PersonalStreetAddress	DTYPE_TEXT	200	No
Personal Street Address 2	PersonalStreetAddress2	DTYPE_TEXT	100	No

Table 39. Opportunity (PRM ANI) ASI Fields

Name	XML Tag	Data Type	Length	Req.
Opportunity				
Account	AccountName	DTYPE_TEXT	100	No
Account Integration Id	AccountIntegrationId	DTYPE_TEXT	30	No
Account Location	AccountLocation	DTYPE_TEXT	50	No
Currency Code	CurrencyCode	DTYPE_TEXT	15	No
DUNS Number	DUNSNumber	DTYPE_TEXT	15	No
Description	Description	DTYPE_TEXT	255	No
Id	Id	DTYPE_ID	30	No
Name	Name	DTYPE_TEXT	100	No
Parent Opportunity Name	ParentOpportunityName	DTYPE_TEXT	100	No
Primary Revenue Amount	PrimaryRevenueAmount	DTYPE_TEXT	22	No
Primary Revenue Class	PrimaryRevenueClass	DTYPE_TEXT	30	No
Primary Revenue Close Date	PrimaryRevenueCloseDate	DTYPE_DATETIME	50	No
Primary Revenue Type	PrimaryRevenueType	DTYPE_TEXT	30	No
Primary Revenue Win Probability	PrimaryRevenueWinProbability	DTYPE_NUMBER	22	No
Sales Method	SalesMethod	DTYPE_TEXT	30	No
Sales Stage	SalesStage	DTYPE_TEXT	30	No
Opportunity Note				
Id	Id	DTYPE_ID	30	No
Note	Note	DTYPE_NOTE	1,000	No
Note Type	NoteType	DTYPE_TEXT	30	No
Opportunity Name	OpportunityName	DTYPE_TEXT	100	No
Opportunity_Business Address				
Address Name	AddressName	DTYPE_TEXT	50	No
City	City	DTYPE_TEXT	50	No
Country	Country	DTYPE_TEXT	50	No
Integration Id	IntegrationId	DTYPE_TEXT	30	No
IsPrimaryMVG	IsPrimaryMVG	DTYPE_TEXT	1	No
Postal Code	PostalCode	DTYPE_TEXT	30	No

Table 39. Opportunity (PRM ANI) ASI Fields

Name	XML Tag	Data Type	Length	Req.
State	State	DTYPE_TEXT	10	No
Stree Address Line 2	StreeAddressLine2	DTYPE_TEXT	100	No
Street Address	StreetAddress	DTYPE_TEXT	200	No
Revenue				
Account	Account	DTYPE_TEXT	100	No
Account Location	AccountLocation	DTYPE_TEXT	50	No
Committed	Committed	DTYPE_TEXT	1	No
Currency Code	CurrencyCode	DTYPE_TEXT	20	No
Date	Date	DTYPE_DATETIME	50	No
Description	Description	DTYPE_TEXT	100	No
Id	Id	DTYPE_ID	30	No
Part Number	PartNumber	DTYPE_TEXT	50	No
Price	Price	DTYPE_TEXT	22	No
Product	Product	DTYPE_TEXT	50	No
Quantity	Quantity	DTYPE_NUMBER	22	No
Revenue	Revenue	DTYPE_TEXT	22	No
Revenue Class	RevenueClass	DTYPE_TEXT	30	No
Revenue Item Number	RevenueItemNumber	DTYPE_TEXT	30	No
Revenue Type	RevenueType	DTYPE_TEXT	30	No
Summary	Summary	DTYPE_TEXT	1	No
Win Probability	WinProbability	DTYPE_NUMBER	22	No

Destination Channel Partner (PRM ANI)

The Destination Channel Partner (PRM ANI) ASI encapsulates information related to the partner company with which the opportunity is being shared. Examples of this information include Partner DUNS Number and Company Name.

Table 40 lists the primary integration components of Destination Channel Partner (PRM ANI).

Table 40. Destination Channel Partner (PRM ANI) Integration Components

Integration Component	XML Tag	User Keys
Channel Partner	ChannelPartner	1 Location, Name
Channel Partner Business Address	ChannelPartnerAddress	1 Account Id, Address Name

Table 41 lists the fields and their attributes.

Table 41. Destination Channel Partner (PRM ANI) ASI Fields

Name	XML Tag	Data Type	Length	Required
Channel Partner				
DUNS Number	DUNSNumber	DTYPE_TEXT	15	No
Location	Location	DTYPE_TEXT	50	No
Name	Name	DTYPE_TEXT	100	No
Channel Partner Business Address				
Account Id	AccountId	DTYPE_ID	15	No
Address Name	AddressName	DTYPE_TEXT	100	No
City	City	DTYPE_TEXT	50	No
Country	Country	DTYPE_TEXT	50	No
County	County	DTYPE_TEXT	50	No
Email Address	EmailAddress	DTYPE_TEXT	50	No
Phone Number	PhoneNumber	DTYPE_TEXT		No
Postal Code	PostalCode	DTYPE_TEXT	30	No
Province	Province	DTYPE_TEXT	50	No
State	State	DTYPE_TEXT	10	No
Street Address	StreetAddress	DTYPE_TEXT	200	No
Street Address 2	StreetAddress2	DTYPE_TEXT	100	No

Source Organization (PRM ANI)

The Source Organization (PRM ANI) ASI encapsulates information related to the source company that is initiating the create or update opportunity message. Examples of this information include Partner DUNS Number, Company Name, and so on.

Table 42 lists the primary integration components of Source Organization (PRM ANI).

Table 42. Source Organization (PRM ANI) Integration Components

Integration Component	XML Tag	User Keys
Organization	Organization	1 DUNS Number
Organization Business Address	OrganizationAddress	1 Account Id, Address Name

Table 43 lists the fields and their attributes.

Table 43. Source Organization (PRM ANI) ASI Fields

Name	XML Tag	Data Type	Length	Required
Organization				
DUNS Number	DUNSNumber	DTYPE_TEXT	15	No
Id	Id	DTYPE_ID	15	No
Name	Name	DTYPE_TEXT	100	No
Organization Business Address				
Account Id	AccountId	DTYPE_ID	15	No
Address Name	AddressName	DTYPE_TEXT	100	No
City	City	DTYPE_TEXT	50	No
Country	Country	DTYPE_TEXT	50	No
County	County	DTYPE_TEXT	50	No
Email Address	EmailAddress	DTYPE_TEXT	50	No
Phone Number	PhoneNumber	DTYPE_TEXT	Not applicable	No
Postal Code	PostalCode	DTYPE_TEXT	30	No
Province	Province	DTYPE_TEXT	50	No
State	State	DTYPE_TEXT	10	No
Street Address	StreetAddress	DTYPE_TEXT	200	No
Street Address 2	StreetAddress2	DTYPE_TEXT	100	No

Opportunity Account (PRM ANI)

The Opportunity Account (PRM ANI) ASI encapsulates account-related information for all the opportunity accounts identified in the opportunity message.

Table 44 lists the primary integration components of Opportunity Account (PRM ANI).

Table 44. Opportunity Account (PRM ANI) Integration Components

Integration Component	XML Tag	User Keys
Account	Account	1 Location, Name
Account Business Address	Account_BusinessAddress	1 City, Country, Postal Code, State, Street Address, Street Address 2 2 Address Name, City, Postal Code, State, Street Address 3 City, Postal Code, State 4 Address Name

Table 45 lists the fields and their attributes.

Table 45. Opportunity Account (PRM ANI) ASI Fields

Name	XML Tag	Data Type	Length	Required
Account				
Currency Code	CurrencyCode	DTYPE_TEXT	15	No
Customer Account Group	CustomerAccountGroup	DTYPE_TEXT	30	No
DUNS Number	DUNSNumber	DTYPE_TEXT	15	No
Group Type Code	GroupTypeCode	DTYPE_TEXT	30	No
Id	Id	DTYPE_ID	30	No
Location	Location	DTYPE_TEXT	50	No
Name	Name	DTYPE_TEXT	100	No
Party Type Code	PartyTypeCode	DTYPE_TEXT	30	No
Account Business Address				
Address Name	AddressName	DTYPE_TEXT	100	No
City	City	DTYPE_TEXT	50	No
Country	Country	DTYPE_TEXT	50	No
Email Address	EmailAddress	DTYPE_TEXT	50	No
IsPrimaryMVG	IsPrimaryMVG	DTYPE_TEXT	1	No
Phone Number	PhoneNumber	DTYPE_TEXT	40	No
Postal Code	PostalCode	DTYPE_TEXT	30	No

Table 45. Opportunity Account (PRM ANI) ASI Fields

Name	XML Tag	Data Type	Length	Required
State	State	DTYPE_TEXT	10	No
Street Address	StreetAddress	DTYPE_TEXT	200	No
Street Address 2	StreetAddress2	DTYPE_TEXT	100	No

Siebel Order

The Siebel Order ASI allows customers to accurately capture and validate orders in order to submit them to a fulfillment system. [Figure 23](#) describes the structure of the Siebel Order ASI.

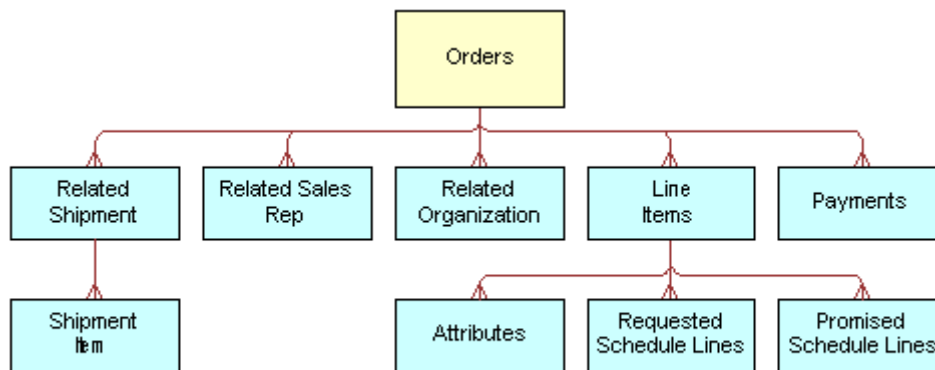

Figure 23. Siebel Order ASI

[Table 46](#) lists the integration components of this ASI.

Table 46. Siebel Order Integration Components

Integration Component	XML Tag	User Keys
Attributes	Attributes	<ol style="list-style-type: none"> 1 Id 2 Integration Id 3 Name
Line Items	LineItems	<ol style="list-style-type: none"> 1 Id 2 Integration Id 3 Line Number

Table 46. Siebel Order Integration Components

Integration Component	XML Tag	User Keys
Orders	Orders	<ul style="list-style-type: none"> 1 Id 2 Integration Id 3 Order Number, Order Type, Primary Organization, Revision 4 External Order Number 5 Order Number, Order Type, Organization DUNS Number, Revision
Payments	Payments	<ul style="list-style-type: none"> 1 Id 2 Integration Id 3 Payment Number, Payment Type
Promised Schedule Lines	PromisedScheduleLines	<ul style="list-style-type: none"> 1 Id 2 Integration Id 3 Line Item Action Number
Related Organization	RelatedOrganization	<ul style="list-style-type: none"> 1 Id 2 Integration Id 3 Name
Related Sales Rep	RelatedSalesRep	<ul style="list-style-type: none"> 1 Id 2 Integration Id 3 Position Name 4 Login
Related Shipment	RelatedShipment	<ul style="list-style-type: none"> 1 Id 2 Integration Id 3 Shipment Number
Requested Schedule Lines	RequestedScheduleLines	<ul style="list-style-type: none"> 1 Id 2 Integration Id 3 Line Number
Shipment Item	ShipmentItem	<ul style="list-style-type: none"> 1 Id 2 Integration Id 3 Line Number

The Siebel Order ASI uses the same user keys as the Orders integration component. You can use the component fields for the integration, which means that values for each of these fields can be written to an XML file for transport. [Table 47](#) lists the fields and their attributes.

Table 47. Siebel Order ASI Fields

Name	XML Tag	Data Type	Length	Req.
Attributes				
Action Code	ActionCode	DTYPE_TEXT	30	No
Attribute Id	AttributeId	DTYPE_ID	NA	No
Data Type	Data Type	DTYPE_TEXT	30	No
Description	Description	DTYPE_TEXT	255	No
Hidden	Hidden	DTYPE_TEXT	NA	No
Id	Id	DTYPE_ID	30	No
Integration Id	IntegrationId	DTYPE_TEXT	30	No
LOV Type	ListOfValueType	DTYPE_TEXT	30	No
Name	Name	DTYPE_TEXT	75	No
Object Id	ObjectId	DTYPE_ID	NA	No
Read Only	ReadOnly	DTYPE_TEXT	NA	No
Required	Required	DTYPE_TEXT	NA	No
Sequence	Sequence	DTYPE_NUMBER	NA	No
Validation	Validation	DTYPE_TEXT	250	No
Value	Value	DTYPE_TEXT	100	No
operation	operation	DTYPE_TEXT	30	No
Line Items				
Action Code	ActionCode	DTYPE_TEXT	30	No
Asset Id	AssetId	DTYPE_ID	NA	No
Asset Integration Id	AssetIntegrationId	DTYPE_TEXT	30	No
Asset Number	AssetNumber	DTYPE_TEXT	NA	No
Available Date	AvailableDate	DTYPE_TEXT	NA	No
Available Quantity	AvailableQuantity	DTYPE_NUMBER	NA	No
Available Status	AvailableStatus	DTYPE_TEXT	30	No
Available Status As Of Date	AvailableStatusAsOfDate	DTYPE_TEXT	NA	No

Table 47. Siebel Order ASI Fields

Name	XML Tag	Data Type	Length	Req.
Base Price	BasePrice	DTYPE_TEXT	NA	No
Billable Flag	BillableFlag	DTYPE_TEXT	NA	No
Billing Account Id	BillingAccountId	DTYPE_ID	NA	No
Cancelled Quantity	CancelledQuantity	DTYPE_NUMBER	NA	No
Carrier Priority	CarrierPriority	DTYPE_TEXT	30	No
Covered Product Unit Price	CoveredProductUnitPrice	DTYPE_TEXT	NA	No
Delivery Status	DeliveryStatus	DTYPE_TEXT	30	No
Description	Description	DTYPE_TEXT	NA	No
Destination Inventory Location	DestinationInventoryLocation	DTYPE_TEXT	100	No
Destination Inventory Location Id	DestinationInventoryLocationId	DTYPE_ID	NA	No
Destination Inventory Location Integration Id	DestinationInventoryLocationIntegrationId	DTYPE_TEXT	30	No
Discount Amount	DiscountAmount	DTYPE_TEXT	NA	No
Extended Quantity	ExtendedQuantity	DTYPE_NUMBER	NA	No
Freight Amount	FreightAmount	DTYPE_TEXT	NA	No
Has Children	HasChildren	DTYPE_TEXT	NA	No
Hold Flag	HoldFlag	DTYPE_TEXT	NA	No
Hold Reason	HoldReason	DTYPE_TEXT	30	No
Id	Id	DTYPE_ID	30	No
Integration Id	IntegrationId	DTYPE_TEXT	30	No
Integration Status	IntegrationStatus	DTYPE_TEXT	30	No
Integration Status As Of Date	IntegrationStatusAsOfDate	DTYPE_TEXT	NA	No
Invoiced Quantity	InvoicedQuantity	DTYPE_NUMBER	NA	No
IsComplexProduct	IsComplexProduct	DTYPE_TEXT	NA	No
Item Price	ItemPrice	DTYPE_TEXT	NA	No
Line Number	LineNumber	DTYPE_NUMBER	NA	No
Loaner Flag	LoanerFlag	DTYPE_TEXT	NA	No

Table 47. Siebel Order ASI Fields

Name	XML Tag	Data Type	Length	Req.
Net Price	NetPrice	DTYPE_TEXT	NA	No
Note	Note	DTYPE_TEXT	1,500	No
Order Header Id	OrderHeaderId	DTYPE_ID	NA	No
Order Number	OrderNumber	DTYPE_TEXT	30	No
Package Name (Inbound)	PackageNameInbound	DTYPE_TEXT	50	No
Package Name (Outbound)	PackageNameOutbound	DTYPE_TEXT	NA	No
Parent Order Item Id	ParentOrderItemId	DTYPE_ID	NA	No
Parent Order Item Number	ParentOrderItemNumber	DTYPE_NUMBER	NA	No
Part Number	PartNumber	DTYPE_TEXT	50	No
Partial Ship	PartialShip	DTYPE_TEXT	NA	No
Product	Product	DTYPE_TEXT	100	No
Product Global Identifier	ProductGlobalIdentifier	DTYPE_TEXT	50	No
Product Id	ProductId	DTYPE_ID	NA	No
Product Integration Id	ProductIntegrationId	DTYPE_TEXT	30	No
Product Port Id	ProductPortId	DTYPE_ID	15	No
Requested Date	RequestedDate	DTYPE_TEXT	NA	No
Requested Quantity	RequestedQuantity	DTYPE_NUMBER	NA	No
Return To Account DUNS Number	ReturnToAccountDUNSNumber	DTYPE_TEXT	9	No
Return To Account Id	ReturnToAccountId	DTYPE_ID	NA	No
Return To Account Integration Id	ReturnToAccountIntegrationId	DTYPE_TEXT	30	No
Return To Account Name	ReturnToAccountName	DTYPE_TEXT	100	No
Return To Account Site	ReturnToAccountSite	DTYPE_TEXT	50	No
Return To Address Id	ReturnToAddressId	DTYPE_ID	NA	No

Table 47. Siebel Order ASI Fields

Name	XML Tag	Data Type	Length	Req.
Return To Address Integration Id	ReturnToAddressIntegrationId	DTYPE_TEXT	30	No
Return To Contact Id	ReturnToContactId	DTYPE_ID	NA	No
Return To Contact Integration Id	ReturnToContactIntegrationId	DTYPE_TEXT	30	No
Return To First Name	ReturnToFirstName	DTYPE_TEXT	50	No
Return To Last Name	ReturnToLastName	DTYPE_TEXT	50	No
Rollup Item Price	RollupItemPrice	DTYPE_TEXT	NA	No
Root Order Item Id	RootOrderItemId	DTYPE_ID	NA	No
Sales Unit of Measure	SalesUnitofMeasure	DTYPE_TEXT	30	No
Ship Complete	ShipComplete	DTYPE_TEXT	NA	No
Ship Date	ShipDate	DTYPE_DATETIME	NA	No
Ship Instruction	ShipInstruction	DTYPE_TEXT	250	No
Ship Quantity	ShipQuantity	DTYPE_NUMBER	NA	No
Ship To Account	ShipToAccount	DTYPE_TEXT	100	No
Ship To Account DUNS Number	ShipToAccountDUNSNumber	DTYPE_TEXT	9	No
Ship To Account Id	ShipToAccountId	DTYPE_ID	NA	No
Ship To Account Integration Id	ShipToAccountIntegrationId	DTYPE_TEXT	30	No
Ship To Account Site	ShipToAccountSite	DTYPE_TEXT	50	No
Ship To Address	ShipToAddress	DTYPE_TEXT	50	No
Ship To Address 2	ShipToAddress2	DTYPE_TEXT	50	No
Ship To Address Id	ShipToAddressId	DTYPE_ID	NA	No
Ship To City	ShipToCity	DTYPE_TEXT	30	No
Ship To Contact - First Name	ShipToContact-FirstName	DTYPE_TEXT	50	No
Ship To Contact - Last Name	ShipToContact-LastName	DTYPE_TEXT	50	No

Table 47. Siebel Order ASI Fields

Name	XML Tag	Data Type	Length	Req.
Ship To Contact Id	ShipToContactId	DTYPE_ID	NA	No
Ship To Contact Integration Id	ShipToContactIntegrationId	DTYPE_TEXT	30	No
Ship To Country	ShipToCountry	DTYPE_TEXT	15	No
Ship To State	ShipToState	DTYPE_TEXT	15	No
Ship To Zip	ShipToZip	DTYPE_TEXT	15	No
Ship to Address Integration Id	ShiptoAddressIntegrationId	DTYPE_TEXT	30	No
Shipping Carrier	ShippingCarrier	DTYPE_TEXT	30	No
Shipping Charges	ShippingCharges	DTYPE_TEXT	NA	No
Shipping Method	ShippingMethod	DTYPE_TEXT	30	No
Shipping Terms	ShippingTerms	DTYPE_TEXT	30	No
Single Source	SingleSource	DTYPE_TEXT	NA	No
Smart Part Number	SmartPartNumber	DTYPE_TEXT	250	No
Source Inventory Loc Integration Id	SourceInventoryLocationIntegrationId	DTYPE_TEXT	30	No
Source Inventory Location	SourceInventoryLocation	DTYPE_TEXT	100	No
Source Inventory Location Id	SourceInventoryLocationId	DTYPE_ID	NA	No
Start Price	StartPrice	DTYPE_TEXT	NA	No
Status	Status	DTYPE_TEXT	30	No
Status As Of Date	StatusAsOfDate	DTYPE_TEXT	NA	No
Tax Amount	TaxAmount	DTYPE_TEXT	NA	No
Unit Price	UnitPrice	DTYPE_TEXT	NA	No
Unit of Measure	UnitofMeasure	DTYPE_TEXT	30	No
Volume	Volume	DTYPE_NUMBER	NA	No
Volume Unit of Measure	VolumeUnitofMeasure	DTYPE_TEXT	30	No
Weight	Weight	DTYPE_NUMBER	NA	No
Weight Unit of Measure	WeightUnitofMeasure	DTYPE_TEXT	30	No
operation	operation	DTYPE_TEXT	30	No

Table 47. Siebel Order ASI Fields

Name	XML Tag	Data Type	Length	Req.
Orders				
Account	Account	DTYPE_TEXT	100	No
Account DUNS Number	AccountDUNSNumber	DTYPE_TEXT	9	No
Account Id	AccountId	DTYPE_ID	NA	No
Account Integration Id	AccountIntegrationId	DTYPE_TEXT	30	No
Account Site	AccountSite	DTYPE_TEXT	100	No
Active	Active	DTYPE_TEXT	NA	No
Approved	Approved	DTYPE_TEXT	NA	No
Approved By	ApprovedBy	DTYPE_TEXT	NA	No
Approved By Date	ApprovedByDate	DTYPE_TEXT	NA	No
Available Date	AvailableDate	DTYPE_TEXT	NA	No
Available Status	AvailableStatus	DTYPE_TEXT	30	No
Available Status As Of Date	AvailableStatusAsOfDate	DTYPE_TEXT	NA	No
Bill To - First Name	BillTo-FirstName	DTYPE_TEXT	50	No
Bill To - Last Name	BillTo-LastName	DTYPE_TEXT	50	No
Bill To Account	BillToAccount	DTYPE_TEXT	100	No
Bill To Account DUNS Number	BillToAccountDUNSNumber	DTYPE_TEXT	9	No
Bill To Account Id	BillToAccountId	DTYPE_ID	NA	No
Bill To Account Integration Id	BillToAccountIntegrationId	DTYPE_TEXT	30	No
Bill To Account Site	BillToAccountSite	DTYPE_TEXT	50	No
Bill To Address	BillToAddress	DTYPE_TEXT	50	No
Bill To Address 2	BillToAddress2	DTYPE_TEXT	50	No
Bill To Address Id	BillToAddressId	DTYPE_ID	NA	No
Bill To Address Integration Id	BillToAddressIntegrationId	DTYPE_TEXT	30	No
Bill To City	BillToCity	DTYPE_TEXT	30	No
Bill To Contact Id	BillToContactId	DTYPE_ID	NA	No

Table 47. Siebel Order ASI Fields

Name	XML Tag	Data Type	Length	Req.
Bill To Contact Integration Id	BillToContactIntegrationId	DTYPE_TEXT	30	No
Bill To Country	BillToCountry	DTYPE_TEXT	15	No
Bill To State	BillToState	DTYPE_TEXT	30	No
Bill To Zip	BillToZip	DTYPE_TEXT	15	No
Billable Flag	BillableFlag	DTYPE_TEXT	NA	No
Billing Block	BillingBlock	DTYPE_TEXT	30	No
Campaign Id	CampaignId	DTYPE_ID	NA	No
Campaign Integration Id	CampaignIntegrationId	DTYPE_TEXT	30	No
Campaign Name	CampaignName	DTYPE_TEXT	100	No
Carrier	Carrier	DTYPE_TEXT	30	No
Carrier Priority	CarrierPriority	DTYPE_TEXT	30	No
Comments	Comments	DTYPE_TEXT	250	No
Contact First Name	ContactFirstName	DTYPE_TEXT	50	No
Contact Id	ContactId	DTYPE_ID	NA	No
Contact Integration Id	ContactIntegrationId	DTYPE_TEXT	30	No
Contact Last Name	ContactLastName	DTYPE_TEXT	50	No
Contract Id	ContractId	DTYPE_ID	NA	No
Contract Integration Id	ContractIntegrationId	DTYPE_TEXT	30	No
Contract Name	ContractName	DTYPE_TEXT	50	No
Credit Status	CreditStatus	DTYPE_TEXT	NA	No
Currency Code	CurrencyCode	DTYPE_TEXT	20	No
Delivery Status	DeliveryStatus	DTYPE_TEXT	30	No
Description	Description	DTYPE_TEXT	255	No
Destination Inventory Id	DestinationInventoryLocationId	DTYPE_ID	NA	No
Destination Inventory Location	DestinationInventoryLocation	DTYPE_TEXT	100	No

Table 47. Siebel Order ASI Fields

Name	XML Tag	Data Type	Length	Req.
Destination Inventory Location Integration Id	DestinationInventoryLocationIntegrationId	DTYPE_TEXT	30	No
Discount Amount	DiscountAmount	DTYPE_TEXT	NA	No
Entitlement Id	EntitlementId	DTYPE_ID	NA	No
Entitlement Name	EntitlementName	DTYPE_TEXT	50	No
External Order Number	ExternalOrderNumber	DTYPE_TEXT	NA	No
Hold Flag	HoldFlag	DTYPE_TEXT	NA	No
Hold Reason	HoldReason	DTYPE_TEXT	30	No
Id	Id	DTYPE_ID	30	No
Integration Id	IntegrationId	DTYPE_TEXT	30	No
Integration Message	IntegrationMessage	DTYPE_TEXT	2,000	No
Integration Status	IntegrationStatus	DTYPE_TEXT	30	No
Integration Status As Of Date	IntegrationStatusAsOfDate	DTYPE_TEXT	NA	No
Opportunity Id	OpportunityId	DTYPE_ID	NA	No
Opportunity Integration Id	OpportunityIntegrationId	DTYPE_TEXT	30	No
Opportunity Name	OpportunityName	DTYPE_TEXT	100	No
Order Date	OrderDate	DTYPE_TEXT	NA	No
Order Number	OrderNumber	DTYPE_TEXT	30	No
Order Priority	OrderPriority	DTYPE_TEXT	30	No
Order Type	OrderType	DTYPE_TEXT	30	No
Order Type Id	OrderTypeId	DTYPE_ID	NA	No
Organization DUNS Number	OrganizationDUNSNumber	DTYPE_TEXT	9	No
Parent Order Id	ParentOrderId	DTYPE_ID	NA	No
Partial Ship	PartialShip	DTYPE_TEXT	NA	No
Pay To Account	PayToAccount	DTYPE_TEXT	100	No
Pay To Account DUNS Number	PayToAccountDUNSNumber	DTYPE_TEXT	9	No

Table 47. Siebel Order ASI Fields

Name	XML Tag	Data Type	Length	Req.
Pay To Account Id	PayToAccountId	DTYPE_ID	NA	No
Pay To Account Integration Id	PayToAccountIntegrationId	DTYPE_TEXT	30	No
Pay To Account Site	PayToAccountSite	DTYPE_TEXT	50	No
Pay To Address Id	PayToAddressId	DTYPE_ID	NA	No
Pay To Address Integration Id	PayToAddressIntegrationId	DTYPE_TEXT	30	No
Pay To Contact First Name	PayToContactFirstName	DTYPE_TEXT	50	No
Pay To Contact Id	PayToContactId	DTYPE_ID	NA	No
Pay To Contact Integration Id	PayToContactIntegrationId	DTYPE_TEXT	30	No
Pay To Contact Last Name	PayToContactLastName	DTYPE_TEXT	50	No
Payment Term	PaymentTerm	DTYPE_TEXT	50	No
Payment Term Id	PaymentTermId	DTYPE_ID	NA	No
Payment Term Integration Id	PaymentTermIntegrationId	DTYPE_TEXT	30	No
Price List	PriceList	DTYPE_TEXT	50	No
Price List Id	PriceListId	DTYPE_ID	NA	No
Price List Integration Id	PriceListIntegrationId	DTYPE_TEXT	30	No
Pricing Date	PricingDate	DTYPE_TEXT	NA	No
Primary Organization	PrimaryOrganization	DTYPE_TEXT	100	No
Primary Organization Id	PrimaryOrganizationId	DTYPE_ID	NA	No
Project Id	ProjectId	DTYPE_ID	NA	No
Project Integration Id	ProjectIntegrationId	DTYPE_TEXT	30	No
Project Name	ProjectName	DTYPE_TEXT	100	No
Promotion Id	PromotionId	DTYPE_ID	NA	No
Purchase Order Number	PurchaseOrderNumber	DTYPE_TEXT	50	No

Table 47. Siebel Order ASI Fields

Name	XML Tag	Data Type	Length	Req.
Quote Id	QuoteId	DTYPE_ID	NA	No
Quote Integration Id	QuoteIntegrationId	DTYPE_TEXT	30	No
Quote Number	QuoteNumber	DTYPE_TEXT	30	No
Requested Date	RequestedDate	DTYPE_TEXT	NA	No
Return Reason	ReturnReason	DTYPE_TEXT	30	No
Return To Account	ReturnToAccount	DTYPE_TEXT	100	No
Return To Account DUNS Number	ReturnToAccountDUNSNumber	DTYPE_TEXT	9	No
Return To Account Id	ReturnToAccountId	DTYPE_ID	NA	No
Return To Account Integration Id	ReturnToAccountIntegrationId	DTYPE_TEXT	30	No
Return To Account Site	ReturnToAccountSite	DTYPE_TEXT	50	No
Return To Address Id	ReturnToAddressId	DTYPE_ID	NA	No
Return To Address Integration Id	ReturnToAddressIntegrationId	DTYPE_TEXT	30	No
Return To Contact First Name	ReturnToContactFirstName	DTYPE_TEXT	50	No
Return To Contact Id	ReturnToContactId	DTYPE_ID	NA	No
Return To Contact Integration Id	ReturnToContactIntegrationId	DTYPE_TEXT	30	No
Return To Contact Last Name	ReturnToContactLastName	DTYPE_TEXT	50	No
Revision	Revision	DTYPE_NUMBER	NA	No
Service Request Id	ServiceRequestId	DTYPE_ID	NA	No
Service Request Number	ServiceRequestNumber	DTYPE_TEXT	NA	No
Ship Complete	ShipComplete	DTYPE_TEXT	NA	No
Ship Instructions	ShipInstructions	DTYPE_TEXT	250	No
Ship To - First Name	ShipTo-FirstName	DTYPE_TEXT	50	No

Table 47. Siebel Order ASI Fields

Name	XML Tag	Data Type	Length	Req.
Ship To - Last Name	ShipTo-LastName	DTYPE_TEXT	50	No
Ship To Account	ShipToAccount	DTYPE_TEXT	100	No
Ship To Account DUNS Number	ShipToAccountDUNSNumber	DTYPE_TEXT	9	No
Ship To Account Id	ShipToAccountId	DTYPE_ID	NA	No
Ship To Account Integration Id	ShipToAccountIntegrationId	DTYPE_TEXT	30	No
Ship To Account Site	ShipToAccountSite	DTYPE_TEXT	50	No
Ship To Address	ShipToAddress	DTYPE_TEXT	50	No
Ship To Address 2	ShipToAddress2	DTYPE_TEXT	50	No
Ship To Address Id	ShipToAddressId	DTYPE_ID	NA	No
Ship To Address Integration Id	ShipToAddressIntegrationId	DTYPE_TEXT	30	No
Ship To City	ShipToCity	DTYPE_TEXT	30	No
Ship To Contact Id	ShipToContactId	DTYPE_ID	NA	No
Ship To Contact Integration Id	ShipToContactIntegrationId	DTYPE_TEXT	30	No
Ship To Country	ShipToCountry	DTYPE_TEXT	15	No
Ship To State	ShipToState	DTYPE_TEXT	30	No
Ship To Zip	ShipToZip	DTYPE_TEXT	15	No
Shipping Charges	ShippingCharges	DTYPE_TEXT	NA	No
Shipping Method	ShippingMethod	DTYPE_TEXT	30	No
Shipping Terms	ShippingTerms	DTYPE_TEXT	30	No
Shipping Terms Info	FreightTermsInfo	DTYPE_TEXT	100	No
Source Inventory Id	SourceInventoryLocationId	DTYPE_ID	NA	No
Source Inventory Loc Integration Id	SourceInventoryLocationIntegrationId	DTYPE_TEXT	30	No
Source Inventory Location	SourceInventoryLocation	DTYPE_TEXT	100	No
Status	Status	DTYPE_TEXT	30	No

Table 47. Siebel Order ASI Fields

Name	XML Tag	Data Type	Length	Req.
Status As Of Date	StatusAsOfDate	DTYPE_TEXT	NA	No
Submit Date	SubmitDate	DTYPE_TEXT	NA	No
Tax Amount	TaxAmount	DTYPE_TEXT	NA	No
Tax Exempt	TaxExempt	DTYPE_TEXT	NA	No
Tax Exempt Code	TaxExemptCode	DTYPE_TEXT	80	No
Tax Exempt Id	TaxExemptId	DTYPE_TEXT	30	No
Tax Rate	TaxRate	DTYPE_NUMBER	NA	No
Total Volume	TotalVolume	DTYPE_NUMBER	NA	No
Total Volume UoM	TotalVolumeUoM	DTYPE_TEXT	30	No
Total Weight	TotalWeight	DTYPE_NUMBER	NA	No
Total Weight UoM	TotalWeightUoM	DTYPE_TEXT	30	No
operation	operation	DTYPE_TEXT	30	No
Payments				
Account Number	AccountNumber	DTYPE_TEXT	50	No
Authorization Code	AuthorizationCode	DTYPE_TEXT	40	No
Bill To Address Id	BillToAddressId	DTYPE_ID	NA	No
Bill To Address Integration Id	BillToAddressIntegrationId	DTYPE_TEXT	30	No
Card Holder	CardHolder	DTYPE_TEXT	50	No
Credit Card Expiration Month	CreditCardExpirationMonth	DTYPE_TEXT	30	No
Credit Card Expiration Year	CreditCardExpirationYear	DTYPE_TEXT	30	No
Credit Check Message	CreditCheckMessage	DTYPE_TEXT	250	No
Credit Check Status	CreditCheckStatus	DTYPE_TEXT	30	No
Credit Check Status As Of Date	CreditCheckStatusAsOfDate	DTYPE_TEXT	NA	No
Encryption Key	EncryptionKey	DTYPE_TEXT	30	No
Encryption Key Reference	EncryptionKeyReference	DTYPE_TEXT	30	No
Id	Id	DTYPE_ID	30	No
Integration Id	IntegrationId	DTYPE_TEXT	30	No

Table 47. Siebel Order ASI Fields

Name	XML Tag	Data Type	Length	Req.
Issuing Bank Customer Id	IssuingBankCustomerId	DTYPE_TEXT	30	No
Issuing Bank Name	IssuingBankName	DTYPE_TEXT	30	No
Issuing Bank Phone Number	IssuingBankPhoneNumber	DTYPE_TEXT	40	No
Merchant Id	MerchantId	DTYPE_TEXT	30	No
Payment #	Payment	DTYPE_TEXT	30	No
Payment Account Id	PaymentAccountId	DTYPE_ID	NA	No
Payment Account Integration Id	PaymentAccountIntegrationId	DTYPE_TEXT	30	No
Payment Account Name	PaymentAccountName	DTYPE_TEXT	100	No
Payment Account Site	PaymentAccountSite	DTYPE_TEXT	50	No
Payment Method	PaymentMethod	DTYPE_TEXT	30	No
Payment Status	PaymentStatus	DTYPE_TEXT	30	No
Payment Status As Of Date	PaymentStatusAsOfDate	DTYPE_DATETIME	NA	No
Payment Type	PaymentType	DTYPE_TEXT	30	No
Transaction Amount	TransactionAmount	DTYPE_TEXT	NA	No
Transaction Id	TransactionId	DTYPE_TEXT	30	No
Transaction Time	TransactionTime	DTYPE_TEXT	30	No
Verification Number	VerificationNumber	DTYPE_TEXT	10	No
operation	operation	DTYPE_TEXT	30	No
Promised Schedule Lines				
Available Status	AvailableStatus	DTYPE_TEXT	30	No
Available Status As Of Date	AvailableStatusAsOfDate	DTYPE_TEXT	NA	No
Id	Id	DTYPE_ID	30	No
Integration Id	IntegrationId	DTYPE_TEXT	30	No

Table 47. Siebel Order ASI Fields

Name	XML Tag	Data Type	Length	Req.
Line Item Action Number	LineItemActionNumber	DTYPE_TEXT	NA	No
Order Item Id	OrderItemId	DTYPE_ID	NA	No
Order Item Integration Id	OrderItemIntegrationId	DTYPE_TEXT	30	No
Part Number	PartNumber	DTYPE_TEXT	50	No
Product Id	ProductId	DTYPE_ID	NA	No
Product Integration Id	ProductIntegrationId	DTYPE_TEXT	30	No
Product Name	ProductName	DTYPE_TEXT	100	No
Promised Date	PromisedDate	DTYPE_TEXT	NA	No
Promised Quantity	PromisedQuantity	DTYPE_NUMBER	NA	No
Source Inventory Location	SourceInventoryLocation	DTYPE_TEXT	100	No
Source Inventory Location Id	SourceInventoryLocationId	DTYPE_ID	NA	No
Source Inventory Location Integration Id	SourceInventoryLocationIntegrationId	DTYPE_TEXT	30	No
operation	operation	DTYPE_TEXT	30	No
Related Organization				
Integration Id	IntegrationId	DTYPE_TEXT	30	No
IsPrimaryMVG	IsPrimaryMVG	DTYPE_TEXT	1	No
Organization	Organization	DTYPE_TEXT	50	No
Organization Id	OrganizationId	DTYPE_ID	NA	No
Related Sales Rep				
Id	Id	DTYPE_ID	30	No
Integration Id	IntegrationId	DTYPE_TEXT	30	No
IsPrimaryMVG	IsPrimaryMVG	DTYPE_TEXT	1	No
Login	Login	DTYPE_TEXT	50	No
Position	Position	DTYPE_TEXT	50	No
Requested Schedule Lines				
Id	Id	DTYPE_ID	30	No

Table 47. Siebel Order ASI Fields

Name	XML Tag	Data Type	Length	Req.
Integration Id	IntegrationId	DTYPE_TEXT	30	No
Line Number	LineNumber	DTYPE_NUMBER	NA	No
Order Item Id	OrderItemId	DTYPE_ID	NA	No
Requested Date	RequestedDate	DTYPE_TEXT	NA	No
Requested Quantity	RequestedQuantity	DTYPE_NUMBER	NA	No
Source Inventory Location	SourceInventoryLocation	DTYPE_TEXT	100	No
Source Inventory Location Id	SourceInventoryLocationId	DTYPE_ID	NA	No
Source Inventory Location Integration Id	SourceInventoryLocationIntegrationId	DTYPE_TEXT	30	No
operation	operation	DTYPE_TEXT	30	No
Related Shipment				
Carrier	Carrier	DTYPE_TEXT	30	No
Destination Inventory Location Id	DestinationInventoryId	DTYPE_ID	15	No
Id	Id	DTYPE_ID	30	No
Integration Id	IntegrationId	DTYPE_TEXT	30	No
Shipment Number	ShipmentNumber	DTYPE_TEXT	30	No
Source Inventory Location Id	SourceInventoryId	DTYPE_ID	15	No
Waybill Number	WaybillNumber	DTYPE_TEXT	50	No
operation	operation	DTYPE_TEXT	NA	No
Shipment Item				
Confirmed Qty	ConfirmedQty	DTYPE_NUMBER	NA	No
Delivery Date	DeliveryDate	DTYPE_DATETIME	NA	No
Delivery Qty	DeliveryQty	DTYPE_NUMBER	NA	No
Id	Id	DTYPE_ID	NA	No
Integration Id	IntegrationId	DTYPE_TEXT	NA	No
Order Line Id	OrderLineId	DTYPE_ID	NA	No
Product Id	ProductId	DTYPE_ID	NA	No

Table 47. Siebel Order ASI Fields

Name	XML Tag	Data Type	Length	Req.
Shipment Date	ShipmentDate	DTYPE_DATETIME	NA	No
Shipment Line Number	ShipmentLineNumber	DTYPE_TEXT	NA	No
Shipment Qty	ShipmentQty	DTYPE_NUMBER	NA	No
operation	operation	DTYPE_TEXT	NA	No

Siebel Position

The Siebel Position ASI is based on the Position Interface integration object, which is based on the Position integration component and the Position business component. Figure 24 describes the Siebel Position ASI structure.

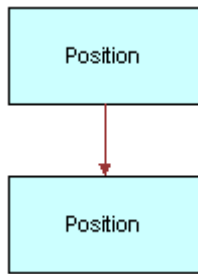

Figure 24. Siebel Position ASI

Table 48 lists the integration components and user keys of this ASI.

Table 48. Siebel Position Integration Components

Integration Component	Business Component	XML Tag	User Keys
Position	Position	Position	<ol style="list-style-type: none"> 1 App Id 2 Integration Id 3 Division 4 Name

The Siebel Position ASI uses the same user keys as the Position Interface integration component and has 19 fields. You can use these fields for the integration, which means that values for each of these fields may be written to an XML file for transport. [Table 49](#) lists the fields and their attributes.

Table 49. Siebel Position ASI Fields

Name	XML Tag	Data Type	Length	Req.
Billing Product	BillingProduct	DTYPE_TEXT	100	No
Billing Product Id	BillingProductId	DTYPE_ID	Not applicable	No
Billing Product Integration Id	BillingProductIntegrationId	DTYPE_TEXT	30	No
Compensatable	Compensatable	DTYPE_TEXT	Not applicable	No
Description	Description	DTYPE_TEXT	255	No
Division	Division	DTYPE_TEXT	255	Yes
Division Id	DivisionId	DTYPE_ID	Not applicable	Yes
Division Integration Id	DivisionIntegrationId	DTYPE_TEXT	30	No
Id	Id	DTYPE_ID	30	No
Integration Id	IntegrationId	DTYPE_TEXT	30	No
Name	Name	DTYPE_TEXT	50	Yes
Organization	Organization	DTYPE_TEXT	255	No
Organization Id	OrganizationId	DTYPE_ID	Not applicable	No
Organization Integration Id	OrganizationIntegrationId	DTYPE_TEXT	30	No
Parent Position Id	ParentPositionId	DTYPE_ID	Not applicable	No
Parent Position Integration Id	ParentPositionIntegrationId	DTYPE_TEXT	30	No
Parent Position Name	ParentPositionName	DTYPE_TEXT	50	No
Position Type	PositionType	DTYPE_TEXT	30	No
operation	operation	DTYPE_TEXT	30	No

Siebel Price List

A price list is a set of standard prices for products and services. Price lists contain the prices a buyer first sees, before any pricing adjustments have occurred. A product must be assigned a price in a given price list in order to appear in a catalog and to become visible to customers.

A product's price, as defined in the price list, is commonly used as a starting price for other prices generated by the Siebel Pricer application.

This inbound ASI enables the synchronization and update of a price list and the price list items. Figure 25 describes the Siebel Price List ASI structure.



Figure 25. Siebel Price List ASI

Table 50 lists the integration components and user keys of this ASI.

Table 50. Siebel Price List Integration Components

Integration Component	XML Tag	User Keys
Price List	PriceList	<ol style="list-style-type: none"> 1 Integration Id 2 Id 3 Name, Type
Price List Item	PriceListItem	<ol style="list-style-type: none"> 1 Integration Id 2 Id 3 List Price Type Code, Price List Id, Product Id
Price List_Organization	PriceList_Organization	<ol style="list-style-type: none"> 1 Integration Id 2 Division Id

Table 51 lists the fields and their attributes. Fields without a length specified do not have a maximum length.

Table 51. Siebel Price List ASI Fields

Name	XML Tag	Data Type	Length	Req.	Note
Price List					
Currency Code	CurrencyCode	DTYPE_TEXT	15	No	None
Description	Description	DTYPE_TEXT	255	No	None
End Date	EndDate	DTYPE_TEXT		No	None

Table 51. Siebel Price List ASI Fields

Name	XML Tag	Data Type	Length	Req.	Note
Freight Terms	FreightTerms	DTYPE_TEXT	30	No	None
Id	Id	DTYPE_ID	30	No	Used for picking a related entity. This read-only field is automatically populated by the Siebel application on insertion and cannot be updated.
Integration Id	IntegrationId	DTYPE_TEXT	30	No	None
Name	Name	DTYPE_TEXT	50	No	None
Payment Term	PaymentTerm	DTYPE_TEXT	50	No	None
Payment Term Id	PaymentTermId	DTYPE_ID		No	Used for picking a related entity.
Primary Organization	PrimaryOrganization	DTYPE_TEXT	50	No	None
Primary Organization Id	PrimaryOrganizationId	DTYPE_ID		No	Used for picking a related entity.
Shipping Method	ShippingMethod	DTYPE_TEXT	30	No	None
Start Date	StartDate	DTYPE_TEXT		No	None
Type	Type	DTYPE_TEXT	30	No	None
operation	operation	DTYPE_TEXT	30	No	None
Price List Item					
End Date	EndDate	DTYPE_TEXT		No	None
Id	Id	DTYPE_ID	30	No	Used for picking a related entity. This read-only field is automatically populated by the Siebel application on insertion and cannot be updated.
Integration Id	IntegrationId	DTYPE_TEXT	30	No	None
List Price Type Code	ListPriceTypeCode	DTYPE_TEXT	30	No	None
Original List Price	OriginalListPrice	DTYPE_TEXT		No	None

Table 51. Siebel Price List ASI Fields

Name	XML Tag	Data Type	Length	Req.	Note
Price List Id	PriceListId	DTYPE_ID		No	Used for picking a related entity. This read-only field is automatically populated by the Siebel application on insertion and cannot be updated.
Product Id	ProductId	DTYPE_ID		No	Used for picking a related entity.
Promotional Price	PromotionalPrice	DTYPE_TEXT		No	None
Start Date	StartDate	DTYPE_TEXT		No	None
operation	operation	DTYPE_TEXT	30	No	None
Price List_Organization					
Division Id	DivisionId	DTYPE_ID	30	No	None
Integration Id	IntegrationId	DTYPE_TEXT	30	No	None
operation	operation	DTYPE_TEXT	30	No	None

Siebel Quote/External Quote

The Siebel Quote/External Quote ASI is an ASI for quote and order management-related business processes. This ASI facilitates the transfer of quote data between the Siebel application and any external system. Figure 26 shows the Siebel Quote/External Quote ASI structure.

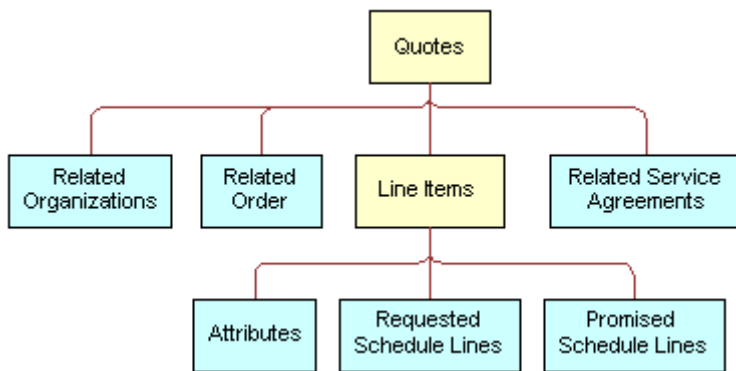

Figure 26. Siebel Quote/External Quote ASI

Table 52 lists the integration components and user keys for this ASI.

Table 52. Siebel Quote/External Quote Integration Components

Integration Component	XML Tag	User Keys
Quote	Quote	<ol style="list-style-type: none"> 1 Id 2 Integration Id 3 Quote Number, Primary Organization Name, Revision
Attributes	Attribute	<ol style="list-style-type: none"> 1 Id 2 Integration Id 3 Name
Line Items	LineItems	<ol style="list-style-type: none"> 1 Integration Id 2 Line Item Id 3 Line Number, Line Number 2 4 Parent Quote Item Id 5 Root Quote Item Id
Promised Schedule Lines	PromisedScheduleLines	<ol style="list-style-type: none"> 1 Id 2 Integration Id 3 Line Number
Related Order	RelatedOrder	<ol style="list-style-type: none"> 1 Order Number 2 Order Type 3 Primary Organization 4 Revision
Related Organization	RelatedOrganization	<ol style="list-style-type: none"> 1 Integration Id 2 Organization 3 Organization Id

Table 52. Siebel Quote/External Quote Integration Components

Integration Component	XML Tag	User Keys
Related Service Agreement	RelatedServiceAgreement	<ul style="list-style-type: none"> 1 Account 2 Id 3 Integration Id 4 Primary Organization 5 Revision
Requested Schedule Lines	RequestedScheduleLines	<ul style="list-style-type: none"> 1 Id 2 Integration Id 3 Line Number

Table 53 lists the fields and their attributes for this ASI.

Table 53. Siebel Quote/External Quote ASI Fields

Name	XML Tag	Data Type	Length	Req.	Note
Quote					
Account	Account	DTYPE_TEXT	100	No	Used for picking a related entity.
Account Id	AccountId	DTYPE_ID	15	No	None
Account Integration Id	AccountIntegrationId	DTYPE_TEXT	30	No	Used for picking a related entity.
Account Site	AccountSite	DTYPE_TEXT	50	No	Used for picking a related entity.
Active	Active	DTYPE_BOOL	1	No	None
Available Date	AvailableDate	DTYPE_UTCDATETIME	7	No	None
Available Status	AvailableStatus	DTYPE_TEXT	30	No	None
Available Status As Of Date	AvailableStatusAsOfDate	DTYPE_UTCDATETIME	7	No	None
Bill To Account	BillToAccount	DTYPE_TEXT	100	No	None
Bill To Account Id	BillToAccountId	DTYPE_ID	15	No	None

Table 53. Siebel Quote/External Quote ASI Fields

Name	XML Tag	Data Type	Length	Req.	Note
Bill To Account Integration Id	BillToAccountIntegrationId	DTYPE_TEXT	30	No	Used for picking a related entity.
Bill To Account Site	BillToAccountSite	DTYPE_TEXT	50	No	None
Bill To Address Id	BillToAddressId	DTYPE_ID	15	No	None
Bill To Address Integration Id	BillToAddressIntegrationId	DTYPE_TEXT	30	No	Used for picking a related entity.
Bill To Contact Last Name	BillToContactLastName	DTYPE_TEXT	50	No	None
Bill To Contact First Name	BillToContactFirstName	DTYPE_TEXT	50	No	None
Bill To Contact Id	BillToContactId	DTYPE_ID	15	No	Used for picking a related entity. This read-only field is automatically populated by the Siebel application on insertion and cannot be updated.
Bill To Contact Integration Id	BillToContactIntegrationId	DTYPE_TEXT	30	No	Used for picking a related entity.
Carrier	Carrier	DTYPE_TEXT	30	No	Bound by FS_CARRIER LOV.
Carrier Priority	CarrierPriority	DTYPE_TEXT	30	No	Bound by CARRIER_PRIORITY LOV.
Contact First Name	ContactFirstName	DTYPE_TEXT	50	No	None
Contact Id	ContactId	DTYPE_ID	15	No	None
Contact Integration Id	ContactIntegrationId	DTYPE_TEXT	30	No	Used for picking a related entity.
Contact Last Name	ContactLastName	DTYPE_TEXT	50	No	Used for picking a related entity.

Table 53. Siebel Quote/External Quote ASI Fields

Name	XML Tag	Data Type	Length	Req.	Note
Credit Card Expiration Month	CreditCardExpirationMonth	DTYPE_TEXT	30	No	Bound by MONTH_NUMBER LOV.
Credit Card Expiration Year	CreditCardExpirationYear	DTYPE_TEXT	30	No	Bound by YEAR LOV.
Credit Card Holder	CreditCardHolder	DTYPE_TEXT	50	No	None
Credit Card Name	CreditCardName	DTYPE_TEXT	50	No	Used for picking a related entity.
Credit Card Number	CreditCardNumber	DTYPE_TEXT	50	No	Used for picking a related entity.
Credit Status	CreditStatus	DTYPE_TEXT	30	No	Bound by ACCT_CRDT_STAT_TYPE LOV.
Credit Status As Of Date	CreditStatusAsOfDate	DTYPE_UTCDATETIME	7	No	None
Credit Status Message	CreditStatusMessage	DTYPE_TEXT	250	No	None
Currency Code	CurrencyCode	DTYPE_TEXT	20	Yes	Used for picking a related entity.
Description	Description	DTYPE_TEXT	255	No	None
Discount Amount	DiscountAmount	DTYPE_CURRENCY	22, 7	No	None
Due Date	DueDate	DTYPE_DATE	7	No	None
Effective Date	EffectiveDate	DTYPE_DATE	7	No	None
Expiration Date	ExpirationDate	DTYPE_DATE	7	No	None
Id	Id	DTYPE_ID	15	No	This read-only field is automatically populated by the Siebel application on insertion and cannot be updated. User key field for Quote.

Table 53. Siebel Quote/External Quote ASI Fields

Name	XML Tag	Data Type	Length	Req.	Note
Integration Id	IntegrationId	DTYPE_TEXT	30	No	User key field for Quote.
Integration Message	IntegrationMessage	DTYPE_TEXT	2,000	No	None
Integration Status	IntegrationStatus	DTYPE_TEXT	30	No	Bound by EAI_ORDER_SYNC_STATUS LOV.
Integration Status As Of Date	IntegrationStatusAsOfDate	DTYPE_UTCDATETIME	7	No	None
Name	Name	DTYPE_TEXT	50	Yes	None
Opportunity Id	OpportunityId	DTYPE_ID	15	No	None
Opportunity Integration Id	OpportunityIntegrationId	DTYPE_TEXT	30	No	Used for picking a related entity.
Opportunity Name	OpportunityName	DTYPE_TEXT	100	No	Used for picking a related entity.
Payment Method	PaymentMethod	DTYPE_TEXT	30	No	Used for picking a related entity.
Payment Term	PaymentTerm	DTYPE_TEXT	50	No	Used for picking a related entity.
Payment Term Id	PaymentTermId	DTYPE_ID	15	No	None
Payment Term Integration Id	PaymentTermIntegrationId	DTYPE_TEXT	30	No	Used for picking a related entity.
Price List	PriceList	DTYPE_TEXT	50	No	Used for picking a related entity.
Price List Id	PriceListId	DTYPE_ID	15	No	Used for picking a related entity. This read-only field is automatically populated by the Siebel application on insertion and cannot be updated.
Price List Integration Id	PriceListIntegrationId	DTYPE_TEXT	30	No	Used for picking a related entity.

Table 53. Siebel Quote/External Quote ASI Fields

Name	XML Tag	Data Type	Length	Req.	Note
Primary Organization	PrimaryOrganization	DTYPE_TEXT	100	No	User key field for Quote.
Quote Number	QuoteNumber	DTYPE_TEXT	30	No	User key field for Quote.
Quote Type	QuoteType	DTYPE_TEXT	30	No	Used for picking a related entity.
Requested Date	RequestedDate	DTYPE_UTCDATETIME	7	No	None
Revision	Revision	DTYPE_INTEGER	22, 7	No	User key field for Quote.
Ship Complete	ShipComplete	DTYPE_BOOL	1	No	None
Ship To Account	ShipToAccount	DTYPE_TEXT	100	No	Used for picking a related entity.
Ship To Account Id	ShipToAccountId	DTYPE_ID	15	No	None
Ship To Account Integration Id	ShipToAccountIntegrationId	DTYPE_TEXT	30	No	Used for picking a related entity.
Ship To Account Site	ShipToAccountSite	DTYPE_TEXT	50	No	None
Ship To Address Id	ShipToAddressId	DTYPE_ID	15	No	Used for picking a related entity. This read-only field is automatically populated by the Siebel application on insertion and cannot be updated.
Ship To Address Integration Id	ShipToAddressIntegrationId	DTYPE_TEXT	30	No	Used for picking a related entity.
Ship To Contact First Name	ShipToContactFirstName	DTYPE_TEXT	50	No	None

Table 53. Siebel Quote/External Quote ASI Fields

Name	XML Tag	Data Type	Length	Req.	Note
Ship To Contact Id	ShipToContactId	DTYPE_ID	15	No	Used for picking a related entity. This read-only field is automatically populated by the Siebel application on insertion and cannot be updated.
Ship To Contact Integration Id	ShipToContactIntegrationId	DTYPE_TEXT	30	No	Used for picking a related entity.
Ship To Contact Last Name	ShipToContactLastName	DTYPE_TEXT	50	No	None
Shipping Charges	ShippingCharges	DTYPE_CURRENCY	22, 7	No	None
Shipping Info	ShippingInfo	DTYPE_TEXT	250	No	None
Shipping Terms	ShippingTerms	DTYPE_TEXT	30	No	Bound by FREIGHT_TERMS LOV.
Source Inventory Location	SourceInventoryLocation	DTYPE_TEXT	100	No	Used for picking a related entity.
Source Inventory Location Id	SourceInventoryLocationId	DTYPE_ID	15	No	None
Source Inventory Location Integration Id	SourceInventoryLocationIntegrationId	DTYPE_TEXT	30	No	Used for picking a related entity.
Status	Status	DTYPE_TEXT	30	Yes	Bound by FS_ORDER_STAT US LOV.
Status As Of Date	StatusAsOfDate	DTYPE_UTCDATETIME	7	No	None
Tax Amount	TaxAmount	DTYPE_CURRENCY	22, 7	No	None
Tax Exempt	TaxExempt	DTYPE_BOOL	1	No	None

Table 53. Siebel Quote/External Quote ASI Fields

Name	XML Tag	Data Type	Length	Req.	Note
Tax Exemption Code	TaxExemptionCode	DTYPE_TEXT	80	No	Bound by GLOBAL_TAX_EXEMPTION LOV.
Tax Exemption Id	TaxExemptionId	DTYPE_TEXT	30	No	None
Tax Rate	TaxRate	DTYPE_NUMBER	22, 7	No	None
Operation	Operation	DTYPE_TEXT	30	No	System field.
Attributes					
Action Code	ActionCode	DTYPE_TEXT	30	No	None
Attribute Id	AttributeId	DTYPE_ID	15	No	None
Data Type	DataType	DTYPE_TEXT	30	No	Bound by XA_ATTR_DTYPE LOV.
Description	Description	DTYPE_TEXT	250	No	None
Id	Id	DTYPE_ID	30	No	This read-only field is automatically populated by the Siebel application on insertion and cannot be updated. User key field for Attributes.
Integration Id	IntegrationId	DTYPE_TEXT	30	No	User key field for Attributes.
List Of Value Type	ListOfValueType	DTYPE_TEXT	30	No	Bound by LOV._TYPE LOV.
Name	Name	DTYPE_TEXT	75	No	User key field for Attributes.
Value	Value	DTYPE_TEXT	100	No	Bound by Type.
Operation	Operation	DTYPE_TEXT	30	No	System field.
Line Items					
Action Code	ActionCode	DTYPE_TEXT	30	No	Bound by DELTA_ACTION_CODE LOV.

Table 53. Siebel Quote/External Quote ASI Fields

Name	XML Tag	Data Type	Length	Req.	Note
Available Date	AvailableDate	DTYPE_UTCDAT ETIME	7	No	None
Available Quantity	AvailableQuantity	DTYPE_NUMBER	22, 7	No	None
Base Price	BasePrice	DTYPE_CURREN CY	22, 7	No	None
Discount Amount	DiscountAmount	DTYPE_CURREN CY	22, 7	No	None
Extended Quantity	ExtendedQuantity	DTYPE_NUMBER	22, 7	No	None
Integration Id	IntegrationId	DTYPE_TEXT	30	No	User key field for Line Items.
Line Item Id	LineItemId	DTYPE_ID	15	No	This read-only field is automatically populated by the Siebel application on insertion and cannot be updated. User key field for Line Items.
Line Number	LineNumber	DTYPE_NUMBER	22, 7	Yes	User key field for Line Items.
Line Number 2	LineNumber2	DTYPE_NUMBER	22, 7	No	User key field for Line Items.
Note	Note	DTYPE_TEXT	1500	No	None
Package Name External	PackageNameExternal	DTYPE_TEXT	100	No	None
Package Name Siebel	PackageNameSiebel	DTYPE_TEXT	50	No	None
Parent Quote Item Id	ParentQuoteItemId	DTYPE_ID	15	No	User key field for Line Items.
Product	Product	DTYPE_TEXT	100	No	Used for picking a related entity.
Product Id	ProductId	DTYPE_ID	15	No	None

Table 53. Siebel Quote/External Quote ASI Fields

Name	XML Tag	Data Type	Length	Req.	Note
Product Integration Id	ProductIntegrationId	DTYPE_TEXT	30	No	Used for picking a related entity.
Requested Date	RequestedDate	DTYPE_DATE	7	No	None
Requested Quantity	RequestedQuantity	DTYPE_NUMBER	22, 7	Yes	The default is 1.
Root Quote Item Id	RootQuoteItemId	DTYPE_ID	15	No	User key field for Line Items.
Ship To Account	ShipToAccount	DTYPE_TEXT	100	No	Used for picking a related entity.
Ship To Account Id	ShipToAccountId	DTYPE_ID	15	No	None
Ship To Account Site	ShipToAccountSite	DTYPE_TEXT	50	No	None
Ship To Address Id	ShipToAddressId	DTYPE_ID	15	No	None
Ship To Address Integration Id	ShipToAddressIntegrationId	DTYPE_TEXT	30	No	Used for picking a related entity.
Ship to Account Integration Id	ShiptoAccountIntegrationId	DTYPE_TEXT	30	No	Used for picking a related entity.
Shipping Charges	ShippingCharges	DTYPE_CURRENCY	22, 7	No	None
Single Source	SingleSource	DTYPE_BOOL	1	No	None
Source Inventory Location	SourceInventoryLocation	DTYPE_TEXT	100	No	Used for picking a related entity.
Source Inventory Location Id	SourceInventoryLocationId	DTYPE_ID	15	No	None
Source Inventory Location Integration Id	SourceInventoryLocationIntegrationId	DTYPE_TEXT	30	No	Used for picking a related entity.
Start Price	StartPrice	DTYPE_CURRENCY	22, 7	No	None

Table 53. Siebel Quote/External Quote ASI Fields

Name	XML Tag	Data Type	Length	Req.	Note
Tax Amount	TaxAmount	DTYPE_CURRENCY	22, 7	No	None
Unit of Measure	UnitofMeasure	DTYPE_TEXT	30	No	None
Operation	Operation	DTYPE_TEXT	30	No	System field.
Promised Schedule Lines					
Available Status	AvailableStatus	DTYPE_TEXT	30	No	None
Available Status As Of Date	AvailableStatusAsOfDate	DTYPE_UTCDATE	7	No	None
Id	Id	DTYPE_ID	30	No	This read-only field is automatically populated by the Siebel application on insertion and cannot be updated. User key field for Promised Schedule Lines.
Integration Id	IntegrationId	DTYPE_TEXT	30	No	User key field for Promised Schedule Lines.
Line Number	LineNumber	DTYPE_NUMBER	22, 7	No	User key field for Promised Schedule Lines.
Promised Date	PromisedDate	DTYPE_DATE	7	No	None
Promised Quantity	PromisedQuantity	DTYPE_NUMBER	22, 7	No	None
Source Inventory Location	SourceInventoryLocation	DTYPE_TEXT	100	No	Used for picking a related entity.
Source Inventory Location Id	SourceInventoryLocationId	DTYPE_ID	15	No	None

Table 53. Siebel Quote/External Quote ASI Fields

Name	XML Tag	Data Type	Length	Req.	Note
Source Inventory Location Integration Id	SourceInventoryLocationIntegrationId	DTYPE_TEXT	30	No	Used for picking a related entity.
Operation	Operation	DTYPE_TEXT	30	No	System field.
Related Order					
Id	Id	DTYPE_ID	30	No	This read-only field is automatically populated by the Siebel application on insertion and cannot be updated.
Integration Id	IntegrationId	DTYPE_TEXT	30	No	
Order Number	OrderNumber	DTYPE_TEXT	30	Yes	User key field for Related Order.
Order Type	OrderType	DTYPE_TEXT	30	Yes	Used for picking a related entity.
Primary Organization	PrimaryOrganization	DTYPE_TEXT	100	No	User key field for Related Order.
Revision	Revision	DTYPE_INTEGER	22, 7	No	User key field for Related Order.
Operation	Operation	DTYPE_TEXT	30	No	System field.
Related Organization					
Integration Id	IntegrationId	DTYPE_TEXT	30	No	User key field for Related Organization.
IsPrimaryMVG	IsPrimaryMVG	DTYPE_TEXT	1	No	This field determines whether this child record is the primary one. The value is determined in run time.
Organization	Organization	DTYPE_TEXT	50	No	User key field for Related Organization.

Table 53. Siebel Quote/External Quote ASI Fields

Name	XML Tag	Data Type	Length	Req.	Note
Organization Id	OrganizationId	DTYPE_ID	15	No	User key field for Related Organization.
Related Service Agreement					
Account	Account	DTYPE_TEXT	100	No	Used for picking a related entity. User key field for Related Service Agreement.
Id	Id	DTYPE_ID	30	No	This read-only field is automatically populated by the Siebel application on insertion and cannot be updated. User key field for Related Service Agreement.
Integration Id	IntegrationId	DTYPE_TEXT	30	No	User key field for Related Service Agreement.
Name	Name	DTYPE_TEXT	50	Yes	User key field for Related Service Agreement.
Primary Organization	PrimaryOrganization	DTYPE_TEXT	100	No	User key field for Related Service Agreement.
Revision	Revision	DTYPE_NUMBER	22, 7	Yes	User key field for Related Service Agreement.
Operation	Operation	DTYPE_TEXT	30	No	System field.
Requested Schedule Lines					

Table 53. Siebel Quote/External Quote ASI Fields

Name	XML Tag	Data Type	Length	Req.	Note
Id	Id	DTYPE_ID	30	No	This read-only field is automatically populated by the Siebel application on insertion and cannot be updated. User key field for Requested Schedule Lines.
Integration Id	IntegrationId	DTYPE_TEXT	30	No	User key field for Requested Schedule Lines.
Line Number	LineNumber	DTYPE_NUMBER	22, 7	Yes	User key field for Requested Schedule Lines.
Requested Date	RequestedDate	DTYPE_UTCDATETIME	7	No	None
Requested Quantity	RequestedQuantity	DTYPE_NUMBER	22, 7	No	None
Source Inventory Location	SourceInventoryLocation	DTYPE_TEXT	100	No	Used for picking a related entity.
Source Inventory Location Id	SourceInventoryLocationId	DTYPE_ID	15	No	None
Source Inventory Location Integration Id	SourceInventoryLocationIntegrationId	DTYPE_TEXT	30	No	Used for picking a related entity.
Operation	Operation	DTYPE_TEXT	30	No	System field.

Siebel ATP Response/External ATP Check

The Siebel ATP Response/External ATP Check ASI enables a customer to check for a quantity of goods that is available for delivery in the desired time frame, and for the price of these goods in the external system. Siebel ATP Response/External ATP Check uses two ASIs for request and response, which use the same components and field definitions. [Figure 27](#) describes the structure of this ASI.

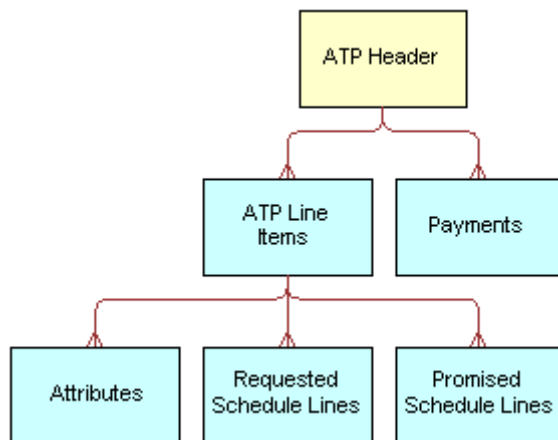

Figure 27. Siebel ATP Response/External ATP Check ASI

[Table 54](#) lists the XML tags and user keys for this ASI.

Table 54. Siebel ATP Response/External ATP Check Integration Components

Integration Component	XML Tag	User Keys
ATP Header	ATPHeader	<ul style="list-style-type: none"> 1 Id 2 Order Number, Organization Type, Revision 3 Order Number, Revision 4 Id
ATP Line Items	ATPLineItems	<ul style="list-style-type: none"> 1 Line Number 2 Id
Attributes	Attributes	<ul style="list-style-type: none"> 1 Id
Payments	Payments	<ul style="list-style-type: none"> 1 Id
Promised Schedule Line	PromisedScheduleLine	<ul style="list-style-type: none"> 1 Integration Id

Table 55 lists the fields and definitions of the Siebel ATP Response/External ATP Check ASI. Fields without a length specified do not have a maximum length associated with them.

Table 55. Siebel ATP Response/External ATP Check ASI Fields

Name	XML Tag	Data Type	Length	Req.
ATPHeader				
Account	Account	DTYPE_TEXT	Not applicable	No
Account Id	AccountId	DTYPE_TEXT	Not applicable	No
Account Integration Id	AccountIntegrationId	DTYPE_TEXT	Not applicable	No
Available Date	AvailableDate	DTYPE_TEXT	Not applicable	No
Available Message	AvailableMessage	DTYPE_TEXT	Not applicable	No
Available Status	AvailableStatus	DTYPE_TEXT	Not applicable	No
Available Status As Of Date	AvailableStatusAsOfDate	DTYPE_TEXT	Not applicable	No
Carrier	Carrier	DTYPE_TEXT	Not applicable	No
Contact First Name	ContactFirstName	DTYPE_TEXT	Not applicable	No
Contact Id	ContactId	DTYPE_TEXT	Not applicable	No
Contact Last Name	ContactLastName	DTYPE_TEXT	Not applicable	No
Currency Code	CurrencyCode	DTYPE_TEXT	Not applicable	No
Document Type Id	DocumentTypeId	DTYPE_TEXT	Not applicable	No
Header Number	HeaderNumber	DTYPE_TEXT	Not applicable	No
Id	HeaderRowId	DTYPE_TEXT	Not applicable	No
Integration Id	IntegrationId	DTYPE_TEXT	Not applicable	No

Table 55. Siebel ATP Response/External ATP Check ASI Fields

Name	XML Tag	Data Type	Length	Req.
Name	Name	DTYPE_TEXT	Not applicable	No
Order Date	OrderDate	DTYPE_TEXT	Not applicable	No
Order Priority	OrderPriority	DTYPE_TEXT	Not applicable	No
Organization	Organization	DTYPE_TEXT	Not applicable	No
Organization DUNS Number	OrganizationDUNSNumber	DTYPE_TEXT	Not applicable	No
Organization Id	OrganizationId	DTYPE_TEXT	Not applicable	No
Organization Integration Id	OrganizationIntegrationId	DTYPE_TEXT	Not applicable	No
Requested Date	RequestedDate	DTYPE_TEXT	Not applicable	No
Revision	Revision	DTYPE_NUMBER	Not applicable	No
Ship Complete Flag	ShipCompleteFlag	DTYPE_TEXT	Not applicable	No
Ship To Account	ShipToAccount	DTYPE_TEXT	Not applicable	No
Ship To Account Id	ShipToAccountId	DTYPE_TEXT	Not applicable	No
Ship To Account Integration Id	ShipToAccountIntegrationId	DTYPE_TEXT	Not applicable	No
Ship To Address	ShipToAddress	DTYPE_TEXT	Not applicable	No
Ship To Address Id	ShipToAddressId	DTYPE_TEXT	Not applicable	No
Ship To Address Integration Id	ShipToAddressIntegrationId	DTYPE_TEXT	Not applicable	No
Ship To City	ShipToCity	DTYPE_TEXT	Not applicable	No
Ship To Country	ShipToCountry	DTYPE_TEXT	Not applicable	No

Table 55. Siebel ATP Response/External ATP Check ASI Fields

Name	XML Tag	Data Type	Length	Req.
Ship To First Name	ShipToFirstName	DTYPE_TEXT	Not applicable	No
Ship To Last Name	ShipToLastName	DTYPE_TEXT	Not applicable	No
Ship To Site	ShipToSite	DTYPE_TEXT	Not applicable	No
Ship To State	ShipToState	DTYPE_TEXT	Not applicable	No
Ship To Zip	ShipToZip	DTYPE_TEXT	Not applicable	No
Shipping Method	ShippingMethod	DTYPE_TEXT	Not applicable	No
Shipping Terms	ShippingTerms	DTYPE_TEXT	Not applicable	No
Shipping Terms Info	ShippingTermsInfo	DTYPE_TEXT	Not applicable	No
Single Delivery	SingleDelivery	DTYPE_TEXT	Not applicable	No
Source Inventory Loc Id	SourceInventoryLocId	DTYPE_TEXT	Not applicable	No
Source Inventory Loc Integration Id	SourceInventoryLocIntegrationId	DTYPE_TEXT	Not applicable	No
Source Inventory Location	SourceInventoryLocation	DTYPE_TEXT	Not applicable	No
Time To Reserve	TimeToReserve	DTYPE_TEXT	Not applicable	No
Time To Reserve UOM	TimeToReserveUOM	DTYPE_TEXT	Not applicable	No
operation	operation	DTYPE_TEXT	30	No
ATPLineItems				
ATP Message Line	ATPMessageLine	DTYPE_TEXT	Not applicable	No
Available Date	AvailableDate	DTYPE_TEXT	Not applicable	No
Available Quantity	AvailableQuantity	DTYPE_TEXT	Not applicable	No

Table 55. Siebel ATP Response/External ATP Check ASI Fields

Name	XML Tag	Data Type	Length	Req.
Available Status	AvailableStatus	DTYPE_TEXT	Not applicable	No
Available Status As Of Date	AvailableStatusAsOfDate	DTYPE_TEXT	Not applicable	No
Carrier	Carrier	DTYPE_TEXT	Not applicable	No
Extended Quantity	ExtendedQuantity	DTYPE_TEXT	Not applicable	No
Id	RowId	DTYPE_TEXT	Not applicable	No
Integration Id	IntegrationId	DTYPE_TEXT	Not applicable	No
Item Price	ItemPrice	DTYPE_TEXT	Not applicable	No
Line Number	LineNumber	DTYPE_TEXT	Not applicable	No
Minimum Lot Size	MinimumLotSize	DTYPE_TEXT	Not applicable	No
Net Price	NetPrice	DTYPE_TEXT	Not applicable	No
Package	Package	DTYPE_TEXT	Not applicable	No
Parent Row Id	ParentRowId	DTYPE_TEXT	Not applicable	No
Parent Row Line Number	ParentRowLineNumber	DTYPE_TEXT	Not applicable	No
Part Number	PartNumber	DTYPE_TEXT	Not applicable	No
Product Global Identifier	ProductGlobalIdentifier	DTYPE_TEXT	Not applicable	No
Product Id	ProductId	DTYPE_TEXT	Not applicable	No
Product Integration Id	ProductIntegrationId	DTYPE_TEXT	Not applicable	No
Product Status Code	ProductStatusCode	DTYPE_TEXT	Not applicable	No

Table 55. Siebel ATP Response/External ATP Check ASI Fields

Name	XML Tag	Data Type	Length	Req.
Product Unit Of Measure	ProductUnitOfMeasure	DTYPE_TEXT	Not applicable	No
Requested Date	RequestedDate	DTYPE_TEXT	Not applicable	No
Requested Quantity	RequestedQuantity	DTYPE_TEXT	Not applicable	No
Rollup Item Price	RollupItemPrice	DTYPE_TEXT	Not applicable	No
Sales Unit Of Measure	SalesUnitOfMeasure	DTYPE_TEXT	Not applicable	No
Ship Complete Flag	ShipCompleteFlag	DTYPE_TEXT	Not applicable	No
Ship To Account Id	ShipToAccountId	DTYPE_TEXT	Not applicable	No
Ship To Account Integration Id	ShipToAccountIntegrationId	DTYPE_TEXT	Not applicable	No
Ship To Address	ShipToAddress	DTYPE_TEXT	Not applicable	No
Ship To Address Id	ShipToAddressId	DTYPE_TEXT	Not applicable	No
Ship To Address Integration Id	ShipToAddressIntegrationId	DTYPE_TEXT	Not applicable	No
Ship To City	ShipToCity	DTYPE_TEXT	Not applicable	No
Ship To Contact First Name	ShipToContactFirstName	DTYPE_TEXT	Not applicable	No
Ship To Contact Last Name	ShipToContactLastName	DTYPE_TEXT	Not applicable	No
Ship To Country	ShipToCountry	DTYPE_TEXT	Not applicable	No
Ship To State	ShipToState	DTYPE_TEXT	Not applicable	No
Ship To Zip	ShipToZip	DTYPE_TEXT	Not applicable	No
Shipping Method	ShippingMethod	DTYPE_TEXT	Not applicable	No

Table 55. Siebel ATP Response/External ATP Check ASI Fields

Name	XML Tag	Data Type	Length	Req.
Shipping Terms	ShippingTerms	DTYPE_TEXT	Not applicable	No
Single Delivery	SingleDelivery	DTYPE_TEXT	Not applicable	No
Smart Part Number	SmartPartNumber	DTYPE_TEXT	Not applicable	No
Source Inventory Loc Id	SourceInventoryLocId	DTYPE_TEXT	Not applicable	No
Source Inventory Location	SourceInventoryLocation	DTYPE_TEXT	Not applicable	No
Source Inventory Location Integration Id	SourceInventoryLocIntegrationId	DTYPE_TEXT	Not applicable	No
Start Price	StartPrice	DTYPE_TEXT	Not applicable	No
Time To Reserve	TimeToReserve	DTYPE_TEXT	Not applicable	No
Time To Reserve UOM	TimeToReserveUOM	DTYPE_TEXT	Not applicable	No
Unit Of Measure	UnitOfMeasure	DTYPE_TEXT	Not applicable	No
Unit Price	UnitPrice	DTYPE_TEXT	Not applicable	No
operation	operation	DTYPE_TEXT	30	No
Attributes				
Description	AttributeDescription	DTYPE_TEXT	Not applicable	No
Id	AttributeId	DTYPE_ID	Not applicable	No
Name	AttributeName	DTYPE_TEXT	Not applicable	No
Value	AttributeValue	DTYPE_TEXT	Not applicable	No
operation	operation	DTYPE_TEXT	30	No

Table 55. Siebel ATP Response/External ATP Check ASI Fields

Name	XML Tag	Data Type	Length	Req.
Payments				
Credit Check Message	CreditCheckMessage	DTYPE_TEXT	Not applicable	No
Credit Check Status	CreditCheckStatus	DTYPE_TEXT	Not applicable	No
Credit Check Status As Of Date	CreditCheckStatusAsOfDate	DTYPE_TEXT	Not applicable	No
Id	Id	DTYPE_TEXT	Not applicable	No
Payment Method	PaymentMethod	DTYPE_TEXT	Not applicable	No
Transaction Amount	TransactionAmount	DTYPE_TEXT	Not applicable	No
operation	operation	DTYPE_TEXT	Not applicable	No
PromisedScheduleLine				
Available Date	AvailableDate	DTYPE_TEXT	Not applicable	No
Available Quantity	AvailableQuantity	DTYPE_TEXT	Not applicable	No
Available Status	AvailableStatus	DTYPE_TEXT	Not applicable	No
Available Status As Of Date	AvailableStatusAsOfDate	DTYPE_TEXT	Not applicable	No
Id	Id	DTYPE_TEXT	Not applicable	No
Line Number	LineNumber	DTYPE_TEXT	Not applicable	No
Part Number	PartNumber	DTYPE_TEXT	Not applicable	No
Product Id	ProductId	DTYPE_TEXT	Not applicable	No
Product Integration Id	ProductIntegrationId	DTYPE_TEXT	Not applicable	No
Source Inventory Loc Id	SourceInventoryLocId	DTYPE_TEXT	Not applicable	No

Table 55. Siebel ATP Response/External ATP Check ASI Fields

Name	XML Tag	Data Type	Length	Req.
Source Inventory Loc Integration Id	SourceInventoryLocIntegrationId	DTYPE_TEXT	Not applicable	No
Source Inventory Location	SourceInventoryLocation	DTYPE_TEXT	Not applicable	No
operation	operation	DTYPE_TEXT	30	No

External Credit Check

The External Credit Check ASI is an ASI for quote and order management-related business processes. This ASI enables the Siebel application to request a credit check from a back-office or credit management system. There are two ASIs for External Credit Check—one for requests and one for responses.

Credit Check Request

The Credit Check Request ASI is an outbound call that triggers the back-office credit limit check business service in an order, and populates the credit status check result in the Siebel application. The Siebel application issues a warning; if a customer does not have a sufficient credit limit, the status shown indicates failure.

Figure 28 describes the structure of this ASI.

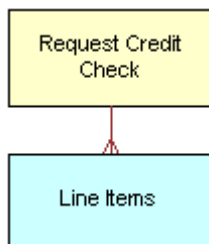

Figure 28. Credit Check Request

Table 56 lists the integration component of this ASI.

Table 56. Credit Check Request Integration Components

Integration Component	XML Tag	User Keys
Line Items	LineItems	No user keys
Request Credit Check	RequestCreditCheck	No user keys

Table 57 lists the fields and definitions. Fields without a length specified do not have a maximum length associated with them.

Table 57. Credit Check Request ASI Fields

Name	XML Tag	Data Type	Length	Req.	Note
Request Credit Check					
Amount	Amount	DTYPE_NUMBER		No	None
Bill To Account Id	BillToAccountId	DTYPE_ID	15	No	None
Bill To Account Integration Id	BillToAccountIntegrationId	DTYPE_ID	30	No	None
Bill To Account Location	BillToAccountLocation	DTYPE_TEXT	50	No	None
Bill To Account Name	BillToAccountName	DTYPE_TEXT	100	No	None
Bill To Address Id	BillToAddressId	DTYPE_ID	15	No	None
Bill To Alias	BillToAlias	DTYPE_TEXT	50	No	None
Bill To City	BillToCity	DTYPE_TEXT	50	No	None
Bill To Country	BillToCountry	DTYPE_TEXT	50	No	None
Bill To County	BillToCounty	DTYPE_TEXT	50	No	None
Bill To DUNS Number	BillToDUNSNumber	DTYPE_TEXT	15	No	None
Bill To Postal Code	BillToPostalCode	DTYPE_TEXT	30	No	None
Bill To Primary Organization Id	BillToPrimaryOrganizationId	DTYPE_ID	15	No	None
Bill To Primary Organization Name	BillToPrimaryOrganizationName	DTYPE_TEXT	100	No	None
Bill To Province	BillToProvince	DTYPE_TEXT	50	No	None
Bill To State	BillToState	DTYPE_TEXT	10	No	None
Bill To Street Address	BillToStreetAddress	DTYPE_TEXT	200	No	None
Bill To Street Address 2	BillToStreetAddress2	DTYPE_TEXT	100	No	None
Bill To VAT Registration Number	BillToVATRegistrationNumber	DTYPE_TEXT	30	No	None

Table 57. Credit Check Request ASI Fields

Name	XML Tag	Data Type	Length	Req.	Note
Currency	Currency	DTYPE_TEXT	20	No	None
Document Id	DocumentId	DTYPE_TEXT	30	Yes	None
Document Integration Id	DocumentIntegrationId	DTYPE_TEXT	30	No	None
Document Type	DocumentType	DTYPE_TEXT	10	Yes	Contains either Quote or Order value.
Order Type Id	OrderTypeId	DTYPE_ID	15	No	Applicable only if Document Type is Order.
Line Items					
Extended Quantity	ExtendedQuantity	DTYPE_NUMBER	22	No	None
Id	Id	DTYPE_ID	15	No	None
Item Price	ItemPrice	DTYPE_NUMBER	22	No	None
Line Number	LineNumber	DTYPE_NUMBER	22	No	None
Net Price	NetPrice	DTYPE_NUMBER	22	No	None
Parent Order Item Number	ParentOrderItemNumber	DTYPE_NUMBER	22	No	None
Product Id	ProductId	DTYPE_ID	15	No	None
Quantity Requested	QuantityRequested	DTYPE_NUMBER	22	No	None
Rollup Item Price	RollupItemPrice	DTYPE_NUMBER	22	No	None
Start Price	StartPrice	DTYPE_NUMBER	22	No	None
Unit Price	UnitPrice	DTYPE_NUMBER	22	No	None

Credit Check Response

Table 58 lists the integration component of this ASI.

Table 58. Credit Check Response Integration Components

Integration Component	XML Tag	User Keys
Request Credit Check Response	RequestCreditCheckResponse	No user keys

Table 59 lists the fields and attributes of this ASI.

Table 59. Credit Check Response ASI Fields

Name	XML Tag	Data Type	Length	Req.
Request Credit Check Response				
Bill To Account Id	BillToAccountId	DTYPE_ID	15	No
Bill To Account Integration Id	BillToAccountIntegrationId	DTYPE_ID	30	No
Bill To Account Location	BillToAccountLocation	DTYPE_TEXT	50	No
Bill To Account Name	BillToAccountName	DTYPE_TEXT	100	No
Bill To Primary Organization Id	BillToPrimaryOrganizationId	DTYPE_ID	15	No
Bill To Primary Organization Name	BillToPrimaryOrganizationName	DTYPE_TEXT	100	No
Credit Status As Of	CreditStatusAsOf	DTYPE_DATETIME	Not applicable	No
Credit Status Code	CreditStatusCode	DTYPE_TEXT	30	No
Credit Status Message	CreditStatusMessage	DTYPE_TEXT	250	No
Document Id	DocumentId	DTYPE_ID	15	Yes
Document Integration Id	DocumentIntegrationId	DTYPE_TEXT	15	No
Document Type	DocumentType	DTYPE_TEXT	10	Yes
Error Status	ErrorStatus	DTYPE_TEXT	30	Yes
Error Text	ErrorText	DTYPE_TEXT	250	No

External Shipment Tracking

The External Shipment Tracking ASI enables a customer to check the location and status of an order after it leaves the seller.

There are two ASIs for External Shipment Tracking—one for requests and one for responses.

Shipment Tracking Interface Request

The Shipment Tracking Interface Request uses the Shipment Information Business Component. [Table 60](#) lists the components of this ASI.

Table 60. Shipment Tracking Interface Request Integration Components

Integration Component	XML Tag	User Keys
Shipment Information	ShipmentInformation	No user keys

[Table 61](#) lists the fields and their attributes.

Table 61. Shipment Tracking Interface Request ASI Fields

Name	XML Tag	Data Type	Length	Req.	Note
Carrier	Carrier	DTYPE_TEXT	30	No	Used for picking a related entity.
Country Code	CountryCode	DTYPE_TEXT	10	No	None
Language	Language	DTYPE_TEXT	10	No	None
Package Tracking Number	PackageTrackingNumber	DTYPE_TEXT	40	C ¹	Package tracking number (required if Shipment Identification Number or Shipment Reference Number is not provided).
Request Action	RequestAction	DTYPE_TEXT	20	Yes	None
Request Option	RequestOption	DTYPE_TEXT	20	No	None
Shipment Identification Number	ShipmentIdentificationNumber	DTYPE_TEXT	50	C ¹	Shipment tracking number (required if Package Tracking Number or Shipment Reference Number is not provided).

Table 61. Shipment Tracking Interface Request ASI Fields

Name	XML Tag	Data Type	Length	Req.	Note
Shipment Reference Number	ShipmentReferenceNumber	DTYPE_TEXT	30	C ¹	Shipment Reference number is defined by the seller (required if Package Tracking Number or Shipment Identification Number is not provided).
Shipper Number	ShipperNumber	DTYPE_TEXT	60	C ¹	Required if Shipment Reference Number is provided.

1. Conditional.

Shipment Tracking Interface Response

Figure 29 describes the structure for Shipment Tracking Interface Response.

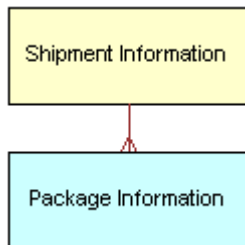

Figure 29. Shipment Tracking Interface Response ASI

Table 62 lists all the integration components of this ASI.

Table 62. Shipment Tracking Interface Response ASI Integration Components

Integration Component	XML Tag	User Keys
Shipment Information	ShipmentInformation	No user keys
Package Information	PackageInformation	No user keys

Table 63 lists the fields and their attributes. Fields without a length specified do not have a maximum length associated with them.

Table 63. Shipment Tracking Interface Response ASI Fields

Name	XML Tag	Data Type	Length	Req.	Notes
Shipment Information					
Response Code	ResponseCode	DTYPE_TEXT	10	Yes	None
Response Message	ResponseMessage	DTYPE_TEXT	100	Yes	None
Shipment Identification Number	ShipmentIdentificationNumber	DTYPE_TEXT	50	C ¹	Tracking number at the shipment level (logical construct). Conditionally required if Shipment Reference Number not provided.
Shipment Pickup Date	ShipmentPickupDate	DTYPE_UTCDA TETIME	10	No	None
Shipment Reference Number	ShipmentReferenceNumber	DTYPE_TEXT	30	C ¹	Conditionally required if Shipment Identification Number not provided.
Shipment Scheduled Delivery Date	ShipmentScheduledDeliveryDate	DTYPE_UTCDA TETIME	10	No	None
Shipment Service Description	ShipmentServiceDescription	DTYPE_TEXT	100	No	None
Shipment Ship To Address Line 1	ShipmentShipToAddressLine1	DTYPE_TEXT	200	No	None

Table 63. Shipment Tracking Interface Response ASI Fields

Name	XML Tag	Data Type	Length	Req.	Notes
Shipment Ship To Address Line 2	ShipmentShipToAddressLine2	DTYPE_TEXT	100	No	None
Shipment Ship To City	ShipmentShipToCity	DTYPE_TEXT	50	No	None
Shipment Ship To Country	ShipmentShipToCountry	DTYPE_TEXT	30	No	None
Shipment Ship To Postal Code	ShipmentShipToPostalCode	DTYPE_TEXT	30	No	None
Shipment Ship To State	ShipmentShipToState	DTYPE_TEXT	10	No	None
Shipper Number	ShipperNumber	DTYPE_TEXT	60	Y	None
Package Information					
Comments	Comments	DTYPE_TEXT	100	No	None
Package Activity Date	PackageActivityDate	DTYPE_DATE	20	No	None
Package Activity Location City	PackageActivityLocationCity	DTYPE_TEXT	20	No	None
Package Activity Location Country	PackageActivityLocationCountry	DTYPE_TEXT	20	No	None
Package Activity Location Description	PackageActivityLocationDescription	DTYPE_TEXT	20	No	None

Table 63. Shipment Tracking Interface Response ASI Fields

Name	XML Tag	Data Type	Length	Req.	Notes
Package Activity Location Signed For By Name	PackageActivityLocationSignedForByyName	DTYPE_TEXT	20	No	None
Package Activity Status Description	PackageActivityStatusDescription	DTYPE_TEXT	20	No	None
Package Activity Time	PackageActivityTime	DTYPE_TIME	20	No	None
Package Tracking Number	PackageTrackingNumber	DTYPE_TEXT	20	Yes	None
Response Code	ResponseCode	DTYPE_TEXT	10	No	None
Response Message	ResponseMessage	DTYPE_TEXT	100	No	None

1. Conditional

Siebel SIA Service Request

This ASI enables an application to create an SIA service request within the Siebel application. [Figure 30](#) describes the Siebel SIA Service Request ASI structure.

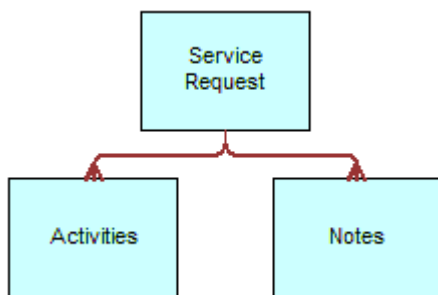

Figure 30. Siebel SIA Service Request ASI

Table 64 lists the integration components of this ASI.

Table 64. Siebel SIA Service Request Integration Components

Name	XML Tag	User Keys
Action	Action	1 Id 2 Activity UId
Related Account External Product	AccountExternalProduct	1 Id 2 AEP Account Id, AEP Product Id, Version
SR External Product	SRExternalProduct	1 Name, Version
Service Request	ServiceRequest	1 Id 2 Primary Organization Id, SR Number

Table 65 lists the integration components and field attributes.

Table 65. Siebel SIA Service Request ASI Fields

Name	XML Tag	Data Type	Length	Required
Action				
Abstract	Abstract	DTYPE_TEXT	100	No
Activity SR Id	ActivitySRId	DTYPE_ID	15	No
Activity UID	ActivityUID	DTYPE_TEXT	30	No
Asset Id	AssetId	DTYPE_ID	15	No
Asset Number	AssetNumber	DTYPE_TEXT	100	No
Audience	Audience	DTYPE_TEXT	30	No
Comment	Comment	DTYPE_TEXT	1,500	No
Description	Description	DTYPE_TEXT	100	No
Done	Done	DTYPE_TEXT	30	No
Duration Hours	DurationHours	DTYPE_NUMBER	22	No
Duration Minutes	DurationMinutes	DTYPE_NUMBER	22	No
Id	Id	DTYPE_ID	30	No
Planned	Planned	DTYPE_TEXT	30	No
Planned Completion	PlannedCompletion	DTYPE_TEXT	30	No

Table 65. Siebel SIA Service Request ASI Fields

Name	XML Tag	Data Type	Length	Required
Primary Owner Id	PrimaryOwnerId	DTYPE_ID	15	No
Resolution Code	ResolutionCode	DTYPE_TEXT	30	No
Started	Started	DTYPE_TEXT	30	No
Type	Type	DTYPE_TEXT	30	No
Related Account External Product				
AEP Account Id	AEPAccountId	DTYPE_ID	30	No
AEP Product Id	AEPProductId	DTYPE_ID	30	No
Id	Id	DTYPE_ID	30	No
Version	Version	DTYPE_TEXT	30	No
SR External Product				
Name	Name	DTYPE_TEXT	100	No
Version	Version	DTYPE_TEXT	30	No
Service Request				
Abstract	Abstract	DTYPE_TEXT	100	No
Account	Account	DTYPE_TEXT	100	No
Account Id	AccountId	DTYPE_ID	15	No
Account Location	AccountLocation	DTYPE_TEXT	50	No
Agreement Id	AgreementId	DTYPE_ID	15	No
Asset Id	AssetId	DTYPE_ID	15	No
Closed Date	ClosedDate	DTYPE_TEXT	30	No
Commit Time	CommitTime	DTYPE_TEXT	30	No
Contact Business Phone	ContactBusinessPhone	DTYPE_TEXT	30	No
Contact Created	ContactCreated	DTYPE_TEXT	30	No
Contact First Name	ContactFirstName	DTYPE_TEXT	50	No
Contact Id	ContactId	DTYPE_ID	15	No
Contact Last Name	ContactLastName	DTYPE_TEXT	50	No
Customer Ref Number	CustomerRefNumber	DTYPE_TEXT	64	No
Description	Description	DTYPE_TEXT	2,000	No
Entitlement Id	EntitlementId	DTYPE_ID	15	No

Table 65. Siebel SIA Service Request ASI Fields

Name	XML Tag	Data Type	Length	Required
Entitlement Name	EntitlementName	DTYPE_TEXT	50	No
Group Id	GroupId	DTYPE_ID	15	No
Id	Id	DTYPE_ID	30	No
Owned By Id	OwnedById	DTYPE_ID	15	No
Owner	Owner	DTYPE_TEXT	50	No
Primary Organization Id	PrimaryOrganizationId	DTYPE_ID	15	No
Primary Service Agreement Id	PrimaryServiceAgreementId	DTYPE_ID	15	No
Priority	Priority	DTYPE_TEXT	30	No
Product	Product	DTYPE_TEXT	100	No
Product Id	ProductId	DTYPE_ID	15	No
SR Number	SRNumber	DTYPE_TEXT	64	No
SR Type	SRType	DTYPE_TEXT	30	No
Serial Number	SerialNumber	DTYPE_TEXT	100	No
Service Request Type	ServiceRequestType	DTYPE_TEXT	30	No
Severity	Severity	DTYPE_TEXT	30	No
Source	Source	DTYPE_TEXT	30	No
Status	Status	DTYPE_TEXT	30	No
Sub-Area	Subarea	DTYPE_TEXT	30	No
Sub-Status	Sub-Status	DTYPE_TEXT	30	No
Type	Type	DTYPE_TEXT	30	No
operation	operation	DTYPE_TEXT	30	No
searchspec	searchspec	DTYPE_TEXT	250	No

Siebel Service Request

The Siebel Service Request ASI is part of the Manage Service Request business process. Use this ASI to synchronize service requests in the Siebel application with an external target application. This ASI facilitates both outbound and inbound data synchronization between the Siebel application and an external target application.

Figure 31 describes the Siebel Service Request ASI structure.

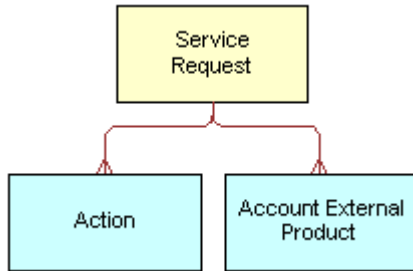

Figure 31. Siebel Service Request ASI

Table 66 lists the integration components and user keys of this ASI.

Table 66. Siebel Service Request Integration Components

Integration Component	XML Tag	User Keys
Action	Action	1 Id 2 Activity UID
Account External Product	AccountExternalProduct	1 Id 2 AEP Account Id, AEP Product Id, Version
Service Request	ServiceRequest	1 Id 2 Primary Organization Id, SR Number
SR External Product	SrExternalProduct	1 Name, Version

Table 67 lists the fields and their attributes. Fields without a length specified do not have a maximum length associated with them.

Table 67. Siebel Service Request ASI Fields

Name	XML Tag	Data Type	Length	Required
Account External Product				
AEP Account Id	AEPAccountId	DTYPE_ID	30	No
AEP Product Id	AEPProductId	DTYPE_ID	30	No
Id	Id	DTYPE_ID	30	No
Version	Version	DTYPE_TEXT	30	No
Action				

Table 67. Siebel Service Request ASI Fields

Name	XML Tag	Data Type	Length	Required
Abstract	Abstract	DTYPE_TEXT	100	No
Activity SR Id	ActivitySRId	DTYPE_ID	15	No
Activity UID	ActivityUID	DTYPE_TEXT	30	No
Asset Id	AssetId	DTYPE_ID	15	No
Asset Number	AssetNumber	DTYPE_TEXT	100	No
Audience	Audience	DTYPE_TEXT	30	No
Comment	Comment	DTYPE_TEXT	1,500	No
Description	Description3	DTYPE_TEXT	100	No
Done	Done	DTYPE_TEXT	30	No
Duration Hours	DurationHours	DTYPE_NUMBER	22	No
Duration Minutes	DurationMinutes	DTYPE_NUMBER	22	No
Id	Id	DTYPE_ID	30	No
Planned	Planned	DTYPE_TEXT	30	No
Planned Completion	PlannedCompletion	DTYPE_TEXT	30	No
Primary Owner Id	PrimaryOwnerId	DTYPE_ID	15	No
Resolution Code	ResolutionCode	DTYPE_TEXT	30	No
Started	Started	DTYPE_TEXT	30	No
Type	Type	DTYPE_TEXT	30	No
Service Request				
Abstract	Abstract	DTYPE_TEXT	100	No
Account	Account	DTYPE_TEXT	100	No
Account Id	AccountId	DTYPE_ID	15	No
Account Location	AccountLocation	DTYPE_TEXT	50	No
Agreement Id	AgreementId	DTYPE_ID	15	No
Area	Area	DTYPE_TEXT	30	No
Asset Id	AssetId	DTYPE_ID	15	No
Closed Date	ClosedDate	DTYPE_TEXT	30	No
Commit Time	CommitTime	DTYPE_TEXT	30	No
Contact Business Phone	ContactBusinessPhone	DTYPE_TEXT	NA	No
Contact Created	ContactCreated	DTYPE_TEXT	30	No

Table 67. Siebel Service Request ASI Fields

Name	XML Tag	Data Type	Length	Required
Contact First Name	ContactFirstName	DTYPE_TEXT	50	No
Contact Id	ContactId	DTYPE_ID	15	No
Contact Last Name	ContactLastName	DTYPE_TEXT	50	No
Customer Reference Number	CustomerReferenceNumber	DTYPE_TEXT	64	No
Description	Description	DTYPE_TEXT	2,000	No
Entitlement Id	EntitlementId	DTYPE_ID	15	No
Entitlement Name	EntitlementName	DTYPE_TEXT	50	No
Group Id	GroupId	DTYPE_ID	NA	No
Id	Id	DTYPE_ID	30	No
Owned By Id	OwnedById	DTYPE_ID	30	No
Owner	Owner	DTYPE_TEXT	50	No
Primary Organization Id	PrimaryOrganizationId	DTYPE_ID	15	No
Primary Service Agreement Id	PrimaryServiceAgreementId	DTYPE_ID	15	No
Priority	Priority	DTYPE_TEXT	30	No
Product	Product	DTYPE_TEXT	100	No
Product Id	ProductId	DTYPE_ID	15	No
SR Number	SRNumber	DTYPE_TEXT	64	No
SR Type	SRTYPE	DTYPE_TEXT	30	No
Serial Number	SerialNumber	DTYPE_TEXT	NA	No
Service Request Type	ServiceRequestType	DTYPE_TEXT	30	No
Severity	Severity	DTYPE_TEXT	30	No
Source	Source	DTYPE_TEXT	30	No
Status	Status	DTYPE_TEXT	30	No
Sub-Area	Sub-Area	DTYPE_TEXT	30	No
Sub-Status	Sub-Status	DTYPE_TEXT	30	No
Type	Type	DTYPE_TEXT	30	No
operation	operation	DTYPE_TEXT	30	No
searchspec	searchspec	DTYPE_TEXT	250	No

SR External Product

Table 67. Siebel Service Request ASI Fields

Name	XML Tag	Data Type	Length	Required
Name	Name	DTYPE_TEXT	100	No
Version	Version	DTYPE_TEXT	30	No

Siebel Simple Product

This ASI receives information about simple products created in third-party systems and enables users to create, update, and query a product in the Siebel application. The Siebel Simple Product ASI is intended to synchronize the Siebel application to external product masters, and does not support the receipt of information for customized products or bundles.

Figure 32 describes the structure of the Siebel Simple Product ASI.

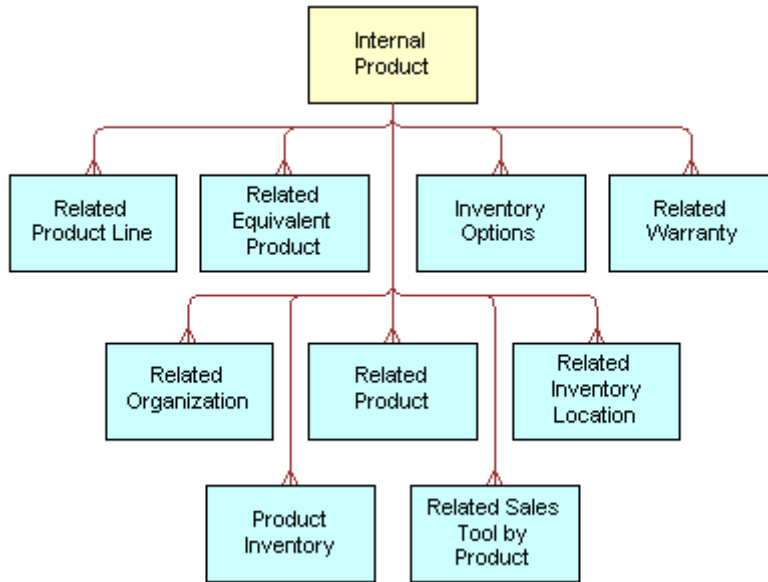

Figure 32. Siebel Simple Product ASI

Table 68 lists the integration components and user keys for this ASI.

Table 68. Siebel Simple Product ASI Integration Components

Integration Component	XML Tag	User Keys
Internal Product	InternalProduct	<ol style="list-style-type: none"> 1 Id 2 Integration Id 3 Product Name, Primary Organization, Primary Vendor, Vendor Site, Vendor Primary Organization
Inventory Options	InventoryOptions	<ol style="list-style-type: none"> 1 Id 2 Integration Id 3 Inventory Type, Product Name
Product Inventory	ProductInventory	<ol style="list-style-type: none"> 1 Id 2 Product Name, Inventory Location Id
Related Equivalent Product	RelatedEquivalentProduct	<ol style="list-style-type: none"> 1 Id 2 Integration Id 3 Equivalent Product, Equivalent Product Primary Organization, Equivalent Product Vendor, Equivalent Product Vendor Location, Equivalent Product Vendor Organization
Related Inventory Location	RelatedInventoryLocation	<ol style="list-style-type: none"> 1 Id 2 Integration Id 3 Inventory Name, Primary Organization
Related Organization	RelatedOrganization	<ol style="list-style-type: none"> 1 Id 2 Integration Id 3 Organization
Related Product	RelatedProduct	<ol style="list-style-type: none"> 1 Id 2 Integration Id 3 Product Name, Vendor, Vendor Location, Organization

Table 68. Siebel Simple Product ASI Integration Components

Integration Component	XML Tag	User Keys
Related Product Line	RelatedProductLine	<ol style="list-style-type: none"> 1 Id 2 Integration Id 3 Product Line
Related Sales Tool by Product	RelatedSalesToolByProduct	<ol style="list-style-type: none"> 1 Id 2 Integration Id 3 Name, Primary Organization
Related Warranty	RelatedWarranty	<ol style="list-style-type: none"> 1 Id 2 Integration Id 3 Warranty Name, Warranty Provider Name, Warranty Provider Primary Organization, Warranty Provider Site

Table 69 lists the fields and their attributes. Fields without a length specified do not have a maximum length associated with them.

Table 69. Siebel Simple Product ASI Fields

Name	XML Tag	Data Type	Length	Req.
Internal Product				
Allocate Below Safety Flag	AllocateBelowSafetyFlag	DTYPE_TEXT	30	No
Auto Allocate Flag	AutoAllocateFlag	DTYPE_TEXT	30	No
Auto Substitute Flag	AutoSubstituteFlag	DTYPE_TEXT	30	No
Class Id	ClassId	DTYPE_ID	NA	No
Class Integration Id	ClassIntegrationId	DTYPE_TEXT	30	No
Class Name	ClassName	DTYPE_TEXT	75	No
Class Type	ClassType	DTYPE_TEXT	30	No
Compensable	CompensableFlag	DTYPE_TEXT	NA	No
Description	Description	DTYPE_TEXT	255	No
Division Code	DivisionCode	DTYPE_TEXT	30	No
Effective End Date	EffectiveEndDate	DTYPE_DATETIME	NA	No
Effective Start Date	EffectiveStartDate	DTYPE_DATETIME	NA	No
Field Replacable	FieldReplacable	DTYPE_TEXT	NA	No

Table 69. Siebel Simple Product ASI Fields

Name	XML Tag	Data Type	Length	Req.
Global Assembly Level Code	GlobalAssemblyLevelCode	DTYPE_TEXT	50	No
Global Product Classification Code	GlobalProductClassificationCode	DTYPE_TEXT	50	No
Global Product Identifier	GlobalProductIdentifier	DTYPE_TEXT	50	No
Global Product Lifecycle Status Code	GlobalProductLifecycleStatusCode	DTYPE_TEXT	50	No
Global Supply Chain Code	GlobalSupplyChainCode	DTYPE_TEXT	50	No
Id	Id	DTYPE_ID	30	No
Image Name	ImageName	DTYPE_TEXT	100	No
Image Primary Organization Name	ImagePrimaryOrganizationName	DTYPE_TEXT	100	No
ImageFileName	ImageFileName	DTYPE_TEXT	200	No
Integration Id	IntegrationId	DTYPE_TEXT	30	No
IsAdminMode	IsAdminMode	DTYPE_TEXT	NA	No
Item Size	ItemSize	DTYPE_NUMBER	NA	No
Lead Time	LeadTime	DTYPE_TEXT	30	No
MTBF	MTBF	DTYPE_NUMBER	NA	No
MTRR	MTRR	DTYPE_NUMBER	NA	No
Maximum Quantity	MaximumQuantity	DTYPE_NUMBER	NA	No
Minimum Quantity	MinimumQuantity	DTYPE_NUMBER	NA	No
Orderable	Orderable	DTYPE_TEXT	NA	No
Parent Internal Product Id (Joined)	ParentInternalProductId	DTYPE_ID	NA	No
Parent Internal Product Integration Id	ParentInternalProductIntegrationId	DTYPE_TEXT	30	No
Parent Internal Product Name	ParentInternalProductName	DTYPE_TEXT	100	No
Parent Internal Product Primary Organization	ParentInternalProductPrimaryOrganization	DTYPE_TEXT	100	No

Table 69. Siebel Simple Product ASI Fields

Name	XML Tag	Data Type	Length	Req.
Parent Internal Product Vendor	ParentInternalProductVendor	DTYPE_TEXT	100	No
Parent Internal Product Vendor Location	ParentInternalProductVendorLocation	DTYPE_TEXT	50	No
Parent Internal Product Vendor Organization	ParentInternalProductVendorOrganization	DTYPE_TEXT	100	No
Part Number	PartNumber	DTYPE_TEXT	50	No
Primary Organization	PrimaryOrganization	DTYPE_TEXT	50	No
Primary Vendor	PrimaryVendor	DTYPE_TEXT	100	No
Product Image Id	ProductImageId	DTYPE_ID	NA	No
Product Image Integration Id	ProductImageIntegrationId	DTYPE_TEXT	30	No
Product Level	ProductLevel	DTYPE_NUMBER	NA	No
Product Name	ProductName	DTYPE_TEXT	100	No
Product Thumbnail Image Id	ProductThumbnailImageId	DTYPE_ID	NA	No
Product Type	ProductType	DTYPE_TEXT	30	No
Return if Defective	ReturnifDefective	DTYPE_TEXT	NA	No
Revision	Version	DTYPE_TEXT	30	No
Sales Product	SalesProduct	DTYPE_TEXT	NA	No
Serialized	Serialized	DTYPE_TEXT	NA	No
Service Product	ServiceProduct	DTYPE_TEXT	NA	No
Ship Carrier	Carrier	DTYPE_TEXT	30	No
Shipping Via	ShippingVia	DTYPE_TEXT	30	No
Status	Status	DTYPE_TEXT	30	No
Targeted Country	TargetedCountry	DTYPE_TEXT	250	No
Targeted Industry	TargetedIndustry	DTYPE_TEXT	250	No
Targeted Max Age	TargetedMaxAge	DTYPE_NUMBER	NA	No
Targeted Min Age	TargetedMinAge	DTYPE_NUMBER	NA	No
Targeted Postal Code	TargetedPostalCode	DTYPE_TEXT	250	No
Tool Flag	ToolFlag	DTYPE_TEXT	NA	No

Table 69. Siebel Simple Product ASI Fields

Name	XML Tag	Data Type	Length	Req.
Unit of Measure	UnitofMeasure	DTYPE_TEXT	30	No
Units In Inventory	UnitsInInventory	DTYPE_NUMBER	NA	No
Units In Inventory As Of	UnitsInInventoryAsOf	DTYPE_TEXT	NA	No
Vendor Id	VendorId	DTYPE_ID	NA	No
Vendor Integration Id	VendorIntegrationId	DTYPE_TEXT	30	No
Vendor Part Number	VendorPartNumber	DTYPE_TEXT	50	No
Vendor Primary Organization	VendorPrimaryOrganization	DTYPE_TEXT	100	No
Vendor Site	VendorSite	DTYPE_TEXT	50	No
operation	operation	DTYPE_TEXT	30	No
searchspec	searchspec	DTYPE_TEXT	250	No
Inventory Options				
Allocate Below Safety Flag	AllocateBelowSafetyFlag	DTYPE_TEXT	30	No
Auto Allocate Flag	AutoAllocateFlag	DTYPE_TEXT	30	No
Auto Substitute Flag	AutoSubstituteFlag	DTYPE_TEXT	30	No
Class ABC	ClassABC	DTYPE_TEXT	30	No
Class XYZ	ClassXYZ	DTYPE_TEXT	30	No
Id	Id	DTYPE_ID	30	No
Integration Id	IntegrationId	DTYPE_TEXT	30	No
Inventory Type	InventoryType	DTYPE_TEXT	30	No
Product Name	ProductName	DTYPE_TEXT	100	No
operation	operation	DTYPE_TEXT	30	No
searchspec	searchspec	DTYPE_TEXT	250	No
Product Inventory				
Allocate Below Safety Stock Flag	AllocateBelowSafetyStockFlag	DTYPE_TEXT	30	No
Auto Allocate Flag	AutoAllocateFlag	DTYPE_TEXT	30	No
Auto Substitute Flag	AutoSubstituteFlag	DTYPE_TEXT	30	No
Id	Id	DTYPE_ID	30	No

Table 69. Siebel Simple Product ASI Fields

Name	XML Tag	Data Type	Length	Req.
Inventory Location Id	InventoryLocationId	DTYPE_ID	30	No
Maximum Inventory Level	MaximumInventoryLevel	DTYPE_NUMBER	22	No
Minimum Inventory Level	MinimumInventoryLevel	DTYPE_NUMBER	22	No
Movement Class	MovementClass	DTYPE_TEXT	30	No
Product Id	ProductId	DTYPE_TEXT	30	No
Product Name	ProductName	DTYPE_TEXT	100	No
Safety Stock Level	SafetyStockLevel	DTYPE_NUMBER	22	No
Value Class	ValueClass	DTYPE_TEXT	30	No
operation	operation	DTYPE_TEXT	30	No
searchspec	searchspec	DTYPE_TEXT	250	No
Related Equivalent Product				
Equivalent Product	EquivalentProduct	DTYPE_TEXT	100	No
Equivalent Product Primary Organization	EquivalentProductPrimaryOrganization	DTYPE_TEXT	50	No
Equivalent Product Vendor	EquivalentProductVendor	DTYPE_TEXT	100	No
Equivalent Product Vendor Location	EquivalentProductVendorLocation	DTYPE_TEXT	50	No
Equivalent Product Vendor Organization	EquivalentProductVendorOrganization	DTYPE_TEXT	100	No
Id	Id	DTYPE_ID	30	No
Integration Id	IntegrationId	DTYPE_TEXT	30	No
IsPrimaryMVG	IsPrimaryMVG	DTYPE_TEXT	1	No
operation	operation	DTYPE_TEXT	30	No
searchspec	searchspec	DTYPE_TEXT	250	No
Related Inventory Location				
Id	Id	DTYPE_ID	30	No
Integration Id	IntegrationId	DTYPE_TEXT	30	No
Inventory Name	InventoryName	DTYPE_TEXT	100	No
Primary Organization Name	PrimaryOrganizationName	DTYPE_TEXT	100	No

Table 69. Siebel Simple Product ASI Fields

Name	XML Tag	Data Type	Length	Req.
operation	operation	DTYPE_TEXT	30	No
searchspec	searchspec	DTYPE_TEXT	250	No
Related Organization				
Id	Id	DTYPE_ID	30	No
Integration Id	IntegrationId	DTYPE_TEXT	30	No
IsPrimaryMVG	IsPrimaryMVG	DTYPE_TEXT	1	No
Organization	Organization	DTYPE_TEXT	50	No
Sales Unit of Measure	SalesUnitofMeasure	DTYPE_TEXT	30	No
operation	operation	DTYPE_TEXT	30	No
searchspec	searchspec	DTYPE_TEXT	250	No
Related Product				
Id	Id	DTYPE_ID	30	No
Integration Id	IntegrationId	DTYPE_TEXT	30	No
IsPrimaryMVG	IsPrimaryMVG	DTYPE_TEXT	1	No
Organization	Organization	DTYPE_TEXT	50	No
Product Name	ProductName	DTYPE_TEXT	100	No
Vendor	Vendor	DTYPE_TEXT	100	No
Vendor Location	VendorLocation	DTYPE_TEXT	50	No
operation	operation	DTYPE_TEXT	30	No
searchspec	searchspec	DTYPE_TEXT	250	No
Related Product Line				
Id	Id	DTYPE_ID	30	No
Integration Id	IntegrationId	DTYPE_TEXT	30	No
IsPrimaryMVG	IsPrimaryMVG	DTYPE_TEXT	1	No
Product Line	ProductLine	DTYPE_TEXT	100	No
operation	operation	DTYPE_TEXT	30	No
searchspec	searchspec	DTYPE_TEXT	250	No
Related Sales Tool by Product				
Id	Id	DTYPE_ID	30	No
Integration Id	IntegrationId	DTYPE_TEXT	30	No
Literature Type	LiteratureType	DTYPE_TEXT	30	No

Table 69. Siebel Simple Product ASI Fields

Name	XML Tag	Data Type	Length	Req.
LitFileName	LitFileName	DTYPE_TEXT	220	No
Name	Name	DTYPE_TEXT	50	No
Primary Organization	PrimaryOrganization	DTYPE_TEXT	50	No
operation	operation	DTYPE_TEXT	30	No
searchspec	searchspec	DTYPE_TEXT	250	No
Related Warranty				
Id	Id	DTYPE_ID	30	No
Integration Id	IntegrationId	DTYPE_TEXT	30	No
Warranty Name	WarrantyName	DTYPE_TEXT	100	No
Warranty Provider Name	WarrantyProviderName	DTYPE_TEXT	100	No
Warranty Provider Primary Organization	WarrantyProviderPrimaryOrganization	DTYPE_TEXT	100	No
Warranty Provider Site	WarrantyProviderSite	DTYPE_TEXT	50	No
operation	operation	DTYPE_TEXT	30	No
searchspec	searchspec	DTYPE_TEXT	250	No

B

Siebel Communications, Media, and Energy ASIs

This appendix provides a list of the prebuilt Siebel Communications, Media, and Energy ASIs that are provided with Siebel applications. You can use these ASIs to receive, send, or request data from other applications.

This appendix includes the following topics:

- [About Prebuilt Communications, Media, and Energy ASIs](#)
- [Order Management](#)
- [Siebel Order](#)
- [Customer Lifecycle Management](#)
- [Siebel Account](#)
- [Billing Management](#)
- [Siebel Invoice](#)
- [CUT Account Balance Interface - Request Integration Object](#)
- [CUT Account Balance Interface - Response Integration Object](#)
- [Siebel Meter Reading](#)
- [Siebel Meter Usage Data](#)
- [Siebel Simple Product](#)
- [Trouble Ticketing Management](#)
- [Siebel Trouble Ticket](#)

NOTE: Required is abbreviated as Req. and Not Applicable is abbreviated as NA in the following tables.

About Prebuilt Communications, Media, and Energy ASIs

Table 70 lists all the Communications, Media, and Energy ASIs and integration objects that Oracle provides. Each ASI is based on an integration object and can be used to integrate data for all the fields of that integration object.

Table 70. Prebuilt Communications, Media, and Energy ASIs and Integration Objects

ASI, Integration Object	Description
Order Management	
Siebel Order	For details, see "Siebel Order" on page 201 .
Customer Life Cycle Management	
Siebel Account	For details, see "Siebel Account" on page 220 .
Siebel Contact	ASI to facilitate the inbound and outbound transfer of contact data from the Siebel application. For details, see "Siebel Contact" on page 68 .
Siebel CUT Address MSAG Service	For details, see "Siebel CUT Address MSAG Service" on page 74 .
Billing Management	
Siebel Invoice	For details, see "Siebel Invoice" on page 230 .
Siebel Invoice Adjustment	For details, see "Siebel Invoice Adjustment" on page 237 .
CUT Payment Interface Integration Object	For details, see "CUT Payment Interface Integration Object" on page 241 .
CUT Account Balance Interface - Request Integration Object	For details, see "CUT Account Balance Interface - Request Integration Object" on page 243 .
CUT Account Balance Interface - Response Integration Object	For details, see "CUT Account Balance Interface - Response Integration Object" on page 244 .
Siebel Meter Reading	ASI to facilitate the inbound and outbound transfer of meter reading data from the Siebel application. For details, see "Siebel Meter Reading" on page 245 .
Siebel Meter Usage Data	ASI to facilitate the inbound and outbound transfer of meter usage data from the Siebel application. For details, see "Siebel Meter Usage Data" on page 246 .
Siebel Payment	For details, see "Siebel Payment" on page 249 .
Product and Pricing Administration	
Siebel Simple Product	For details, see "Siebel Simple Product" on page 251 .

Table 70. Prebuilt Communications, Media, and Energy ASIs and Integration Objects

ASI, Integration Object	Description
Siebel Price List	ASI to enable the synchronization and update of a price list and the price list items. For details, see “Siebel Price List” on page 148 .
Siebel Asset	ASI that associates a customer with a unique product. For details, see “Siebel Asset” on page 64 .
Trouble Ticketing Management	
Siebel Trouble Ticket	ASI that results in the use of a trouble ticket in the Siebel application when an external application detects an outage or network fault. For details, see “Siebel Trouble Ticket” on page 259 .

Order Management

Order Management uses a single ASI, Siebel Order, to enable the submission and processing of orders and the update of order line items.

Siebel Order

The Siebel Order ASI enables customers to capture and validate orders so that they can successfully submit the orders to a fulfillment system.

Figure 33 describes the Siebel Order ASI structure.

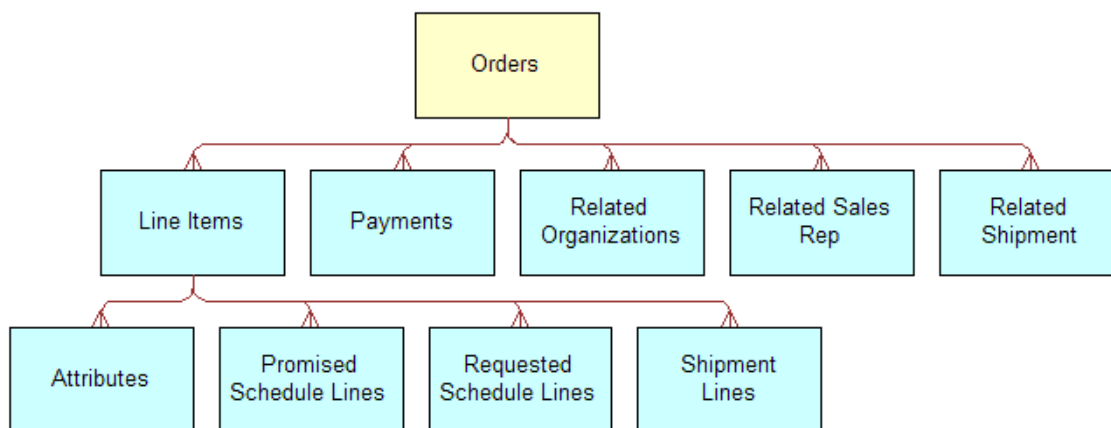

Figure 33. Siebel Order ASI

Table 71 lists the integration components and XML tags of this ASI.

Table 71. Siebel Order ASI Integration Components

Integration Component	XML Tag	User Keys
Attributes	Attributes	<ol style="list-style-type: none"> 1 Id 2 Integration Id 3 Name, Object Id
Line Items	LineItems	<ol style="list-style-type: none"> 1 Id 2 Integration Id 3 Line Number
Orders	Orders	<ol style="list-style-type: none"> 1 Id 2 Integration Id 3 Order Number, Revision, Primary Organization, Order Type 4 Order Number, Revision, Organization DUNS Number, Order Type
Payments	Payments	<ol style="list-style-type: none"> 1 Id 2 Integration Id 3 Payment #, Payment Type
Promised Schedule Lines	PromisedScheduleLines	<ol style="list-style-type: none"> 1 Id 2 Integration Id 3 Line Item Action Number
Related Organization	RelatedOrganization	<ol style="list-style-type: none"> 1 Id 2 Integration Id 3 Organization
Related Sales Rep	RelatedSalesRep	<ol style="list-style-type: none"> 1 Id 2 Integration Id 3 Position 4 Login
Related Shipment	RelatedShipment	<ol style="list-style-type: none"> 1 Id 2 Integration Id 3 Shipment Number

Table 71. Siebel Order ASI Integration Components

Integration Component	XML Tag	User Keys
Requested Schedule Lines	RequestedScheduleLines	<ol style="list-style-type: none"> 1 Id 2 Integration Id 3 Line Number
Shipment Lines	ShipmentItem	<ol style="list-style-type: none"> 1 Id 2 Integration Id 3 Shipment Line Number

Table 72 lists the fields and their attributes.

Table 72. Siebel Order ASI Fields

Name	XML Tag	Data Type	Length	Req.
Orders				
Account	Account	DTYPE_TEXT	100	No
Account DUNS Number	AccountDUNSNumber	DTYPE_TEXT	9	No
Account Id	AccountId	DTYPE_ID	NA	No
Account Integration Id	AccountIntegrationId	DTYPE_TEXT	30	No
Account Site	AccountSite	DTYPE_TEXT	100	No
Active	Active	DTYPE_TEXT	NA	No
Approved	Approved	DTYPE_TEXT	NA	No
Approved By	ApprovedBy	DTYPE_TEXT	NA	No
Approved By Date	ApprovedByDate	DTYPE_TEXT	NA	No
Available Date	AvailableDate	DTYPE_TEXT	NA	No
Available Status	AvailableStatus	DTYPE_TEXT	30	No
Available Status As Of Date	AvailableStatusAsOfDate	DTYPE_TEXT	NA	No
Bill To - First Name	BillTo-FirstName	DTYPE_TEXT	50	No
Bill To - Last Name	BillTo-LastName	DTYPE_TEXT	50	No
Bill To Account	BillToAccount	DTYPE_TEXT	100	No

Table 72. Siebel Order ASI Fields

Name	XML Tag	Data Type	Length	Req.
Bill To Account DUNS Number	BillToAccountDUNSNumber	DTYPE_TEXT	9	No
Bill To Account Id	BillToAccountId	DTYPE_ID	NA	No
Bill To Account Integration Id	BillToAccountIntegrationId	DTYPE_TEXT	30	No
Bill To Account Site	BillToAccountSite	DTYPE_TEXT	50	No
Bill To Address	BillToAddress	DTYPE_TEXT	50	No
Bill To Address 2	BillToAddress2	DTYPE_TEXT	50	No
Bill To Address Id	BillToAddressId	DTYPE_ID	NA	No
Bill To Address Integration Id	BillToAddressIntegrationId	DTYPE_TEXT	30	No
Bill To City	BillToCity	DTYPE_TEXT	30	No
Bill To Contact Id	BillToContactId	DTYPE_ID	NA	No
Bill To Contact Integration Id	BillToContactIntegrationId	DTYPE_TEXT	30	No
Bill To Country	BillToCountry	DTYPE_TEXT	15	No
Bill To State	BillToState	DTYPE_TEXT	30	No
Bill To Zip	BillToZip	DTYPE_TEXT	15	No
Billable Flag	BillableFlag	DTYPE_TEXT	NA	No
Billing Block	BillingBlock	DTYPE_TEXT	30	No
Campaign Id	CampaignId	DTYPE_ID	NA	No
Campaign Integration Id	CampaignIntegrationId	DTYPE_TEXT	30	No
Campaign Name	CampaignName	DTYPE_TEXT	100	No
Carrier	Carrier	DTYPE_TEXT	30	No
Carrier Priority	CarrierPriority	DTYPE_TEXT	30	No
Comments	Comments	DTYPE_TEXT	250	No
Contact First Name	ContactFirstName	DTYPE_TEXT	50	No
Contact Id	ContactId	DTYPE_ID	NA	No

Table 72. Siebel Order ASI Fields

Name	XML Tag	Data Type	Length	Req.
Contact Integration Id	ContactIntegrationId	DTYPE_TEXT	30	No
Contact Last Name	ContactLastName	DTYPE_TEXT	50	No
Contract Id	ContractId	DTYPE_ID	NA	No
Contract Integration Id	ContractIntegrationId	DTYPE_TEXT	30	No
Contract Name	ContractName	DTYPE_TEXT	50	No
Credit Status	CreditStatus	DTYPE_TEXT	NA	No
Currency Code	CurrencyCode	DTYPE_TEXT	20	No
Delivery Status	DeliveryStatus	DTYPE_TEXT	30	No
Description	Description	DTYPE_TEXT	255	No
Destination Inventory Id	DestinationInventoryLocationId	DTYPE_ID	NA	No
Destination Inventory Location	DestinationInventoryLocation	DTYPE_TEXT	100	No
Destination Inventory Location Integration Id	DestinationInventoryLocationIntegrationId	DTYPE_TEXT	30	No
Discount Amount	DiscountAmount	DTYPE_TEXT	NA	No
Entitlement Id	EntitlementId	DTYPE_ID	NA	No
Entitlement Name	EntitlementName	DTYPE_TEXT	50	No
External Order Number	ExternalOrderNumber	DTYPE_TEXT	NA	No
Hold Flag	HoldFlag	DTYPE_TEXT	NA	No
Hold Reason	HoldReason	DTYPE_TEXT	30	No
Id	Id	DTYPE_ID	30	No
Integration Id	IntegrationId	DTYPE_TEXT	30	No
Integration Message	IntegrationMessage	DTYPE_TEXT	2,000	No

Table 72. Siebel Order ASI Fields

Name	XML Tag	Data Type	Length	Req.
Integration Status	IntegrationStatus	DTYPE_TEXT	30	No
Integration Status As Of Date	IntegrationStatusAsOfDate	DTYPE_TEXT	NA	No
Opportunity Id	OpportunityId	DTYPE_ID	NA	No
Opportunity Integration Id	OpportunityIntegrationId	DTYPE_TEXT	30	No
Opportunity Name	OpportunityName	DTYPE_TEXT	100	No
Order Date	OrderDate	DTYPE_TEXT	NA	No
Order Number	OrderNumber	DTYPE_TEXT	30	No
Order Priority	OrderPriority	DTYPE_TEXT	30	No
Order Type	OrderType	DTYPE_TEXT	30	No
Order Type Id	OrderTypeId	DTYPE_ID	NA	No
Organization DUNS Number	OrganizationDUNSNumber	DTYPE_TEXT	9	No
Parent Order Id	ParentOrderId	DTYPE_ID	NA	No
Partial Ship	PartialShip	DTYPE_TEXT	NA	No
Pay To Account	PayToAccount	DTYPE_TEXT	100	No
Pay To Account DUNS Number	PayToAccountDUNSNumber	DTYPE_TEXT	9	No
Pay To Account Id	PayToAccountId	DTYPE_ID	NA	No
Pay To Account Integration Id	PayToAccountIntegrationId	DTYPE_TEXT	30	No
Pay To Account Site	PayToAccountSite	DTYPE_TEXT	50	No
Pay To Address Id	PayToAddressId	DTYPE_ID	NA	No
Pay To Address Integration Id	PayToAddressIntegrationId	DTYPE_TEXT	30	No
Pay To Contact First Name	PayToContactFirstName	DTYPE_TEXT	50	No

Table 72. Siebel Order ASI Fields

Name	XML Tag	Data Type	Length	Req.
Pay To Contact Id	PayToContactId	DTYPE_ID	NA	No
Pay To Contact Integration Id	PayToContactIntegrationId	DTYPE_TEXT	30	No
Pay To Contact Last Name	PayToContactLastName	DTYPE_TEXT	50	No
Payment Term	PaymentTerm	DTYPE_TEXT	50	No
Payment Term Id	PaymentTermId	DTYPE_ID	NA	No
Payment Term Integration Id	PaymentTermIntegrationId	DTYPE_TEXT	30	No
Price List	PriceList	DTYPE_TEXT	50	No
Price List Id	PriceListId	DTYPE_ID	NA	No
Price List Integration Id	PriceListIntegrationId	DTYPE_TEXT	30	No
Pricing Date	PricingDate	DTYPE_TEXT	NA	No
Primary Organization	PrimaryOrganization	DTYPE_TEXT	100	No
Primary Organization Id	PrimaryOrganizationId	DTYPE_ID	NA	No
Project Id	ProjectId	DTYPE_ID	NA	No
Project Integration Id	ProjectIntegrationId	DTYPE_TEXT	30	No
Project Name	ProjectName	DTYPE_TEXT	100	No
Promotion Id	PromotionId	DTYPE_ID	NA	No
Purchase Order Number	PurchaseOrderNumber	DTYPE_TEXT	50	No
Quote Id	QuoteId	DTYPE_ID	NA	No
Quote Integration Id	QuoteIntegrationId	DTYPE_TEXT	30	No
Quote Number	QuoteNumber	DTYPE_TEXT	30	No
Requested Date	RequestedDate	DTYPE_TEXT	NA	No
Return Reason	ReturnReason	DTYPE_TEXT	30	No
Return To Account	ReturnToAccount	DTYPE_TEXT	100	No

Table 72. Siebel Order ASI Fields

Name	XML Tag	Data Type	Length	Req.
Return To Account DUNS Number	ReturnToAccountDUNSNumber	DTYPE_TEXT	9	No
Return To Account Id	ReturnToAccountId	DTYPE_ID	NA	No
Return To Account Integration Id	ReturnToAccountIntegrationId	DTYPE_TEXT	30	No
Return To Account Site	ReturnToAccountSite	DTYPE_TEXT	50	No
Return To Address Id	ReturnToAddressId	DTYPE_ID	NA	No
Return To Address Integration Id	ReturnToAddressIntegrationId	DTYPE_TEXT	30	No
Return To Contact First Name	ReturnToContactFirstName	DTYPE_TEXT	50	No
Return To Contact Id	ReturnToContactId	DTYPE_ID	NA	No
Return To Contact Integration Id	ReturnToContactIntegrationId	DTYPE_TEXT	30	No
Return To Contact Last Name	ReturnToContactLastName	DTYPE_TEXT	50	No
Revision	Revision	DTYPE_NUMBER	NA	No
Service Request Id	ServiceRequestId	DTYPE_ID	NA	No
Service Request Number	ServiceRequestNumber	DTYPE_TEXT	NA	No
Ship Complete	ShipComplete	DTYPE_TEXT	NA	No
Ship Instructions	ShipInstructions	DTYPE_TEXT	250	No
Ship To - First Name	ShipTo-FirstName	DTYPE_TEXT	50	No
Ship To - Last Name	ShipTo-LastName	DTYPE_TEXT	50	No

Table 72. Siebel Order ASI Fields

Name	XML Tag	Data Type	Length	Req.
Ship To Account	ShipToAccount	DTYPE_TEXT	100	No
Ship To Account DUNS Number	ShipToAccountDUNSNumber	DTYPE_TEXT	9	No
Ship To Account Id	ShipToAccountId	DTYPE_ID	NA	No
Ship To Account Integration Id	ShipToAccountIntegrationId	DTYPE_TEXT	30	No
Ship To Account Site	ShipToAccountSite	DTYPE_TEXT	50	No
Ship To Address	ShipToAddress	DTYPE_TEXT	50	No
Ship To Address 2	ShipToAddress2	DTYPE_TEXT	50	No
Ship To Address Id	ShipToAddressId	DTYPE_ID	NA	No
Ship To Address Integration Id	ShipToAddressIntegrationId	DTYPE_TEXT	30	No
Ship To City	ShipToCity	DTYPE_TEXT	30	No
Ship To Contact Id	ShipToContactId	DTYPE_ID	NA	No
Ship To Contact Integration Id	ShipToContactIntegrationId	DTYPE_TEXT	30	No
Ship To Country	ShipToCountry	DTYPE_TEXT	15	No
Ship To State	ShipToState	DTYPE_TEXT	30	No
Ship To Zip	ShipToZip	DTYPE_TEXT	15	No
Shipping Charges	ShippingCharges	DTYPE_TEXT	NA	No
Shipping Method	ShippingMethod	DTYPE_TEXT	30	No
Shipping Terms	ShippingTerms	DTYPE_TEXT	30	No
Shipping Terms Info	FreightTermsInfo	DTYPE_TEXT	100	No
Source Inventory Id	SourceInventoryLocationId	DTYPE_ID	NA	No
Source Inventory Loc Integration Id	SourceInventoryLocationIntegrationId	DTYPE_TEXT	30	No

Table 72. Siebel Order ASI Fields

Name	XML Tag	Data Type	Length	Req.
Source Inventory Location	SourceInventoryLocation	DTYPE_TEXT	100	No
Status	Status	DTYPE_TEXT	30	No
Status As Of Date	StatusAsOfDate	DTYPE_TEXT	NA	No
Submit Date	SubmitDate	DTYPE_TEXT	NA	No
Tax Amount	TaxAmount	DTYPE_TEXT	NA	No
Tax Exempt	TaxExempt	DTYPE_TEXT	NA	No
Tax Exempt Code	TaxExemptCode	DTYPE_TEXT	80	No
Tax Exempt Id	TaxExemptId	DTYPE_TEXT	30	No
Tax Rate	TaxRate	DTYPE_NUMBER	NA	No
Total Volume	TotalVolume	DTYPE_NUMBER	NA	No
Total Volume UoM	TotalVolumeUoM	DTYPE_TEXT	30	No
Total Weight	TotalWeight	DTYPE_NUMBER	NA	No
Total Weight UoM	TotalWeightUoM	DTYPE_TEXT	30	No
operation	operation	DTYPE_TEXT	30	No
Line Items				
Action Code	ActionCode	DTYPE_TEXT	30	No
Asset Id	AssetId	DTYPE_ID	NA	No
Asset Integration Id	AssetIntegrationId	DTYPE_TEXT	30	No
Asset Internal Integration Id	AssetInternalIntegrationId	DTYPE_TEXT	30	No
Asset Number	AssetNumber	DTYPE_TEXT	NA	No
Available Date	AvailableDate	DTYPE_TEXT	NA	No
Available Quantity	AvailableQuantity	DTYPE_NUMBER	NA	No
Available Status	AvailableStatus	DTYPE_TEXT	30	No
Available Status As Of Date	AvailableStatusAsOfDate	DTYPE_TEXT	NA	No

Table 72. Siebel Order ASI Fields

Name	XML Tag	Data Type	Length	Req.
Base Price	BasePrice	DTYPE_TEXT	NA	No
Billable Flag	BillableFlag	DTYPE_TEXT	NA	No
Billing Account	BillingAccount	DTYPE_TEXT	NA	No
Billing Account Id	BillingAccountId	DTYPE_ID	NA	No
Billing Profile Id	BillingProfileId	DTYPE_TEXT	NA	No
Cancelled Quantity	CancelledQuantity	DTYPE_NUMBER	NA	No
Covered Product Unit Price	CoveredProductUnitPrice	DTYPE_TEXT	NA	No
Delivery Status	DeliveryStatus	DTYPE_TEXT	30	No
Description	Description	DTYPE_TEXT	NA	No
Destination Inventory Location	DestinationInventoryLocation	DTYPE_TEXT	100	No
Destination Inventory Location Id	DestinationInventoryLocationId	DTYPE_ID	NA	No
Destination Inventory Location Integration Id	DestinationInventoryLocationIntegrationId	DTYPE_TEXT	30	No
Discount Amount	DiscountAmount	DTYPE_TEXT	NA	No
Freight Amount	FreightAmount	DTYPE_TEXT	NA	No
Hold Flag	HoldFlag	DTYPE_TEXT	NA	No
Hold Reason	HoldReason	DTYPE_TEXT	30	No
Id	Id	DTYPE_ID	30	No
Integration Id	IntegrationId	DTYPE_TEXT	30	No
Integration Status	IntegrationStatus	DTYPE_TEXT	30	No
Integration Status As Of Date	IntegrationStatusAsOfDate	DTYPE_TEXT	NA	No
Invoiced Quantity	InvoicedQuantity	DTYPE_NUMBER	NA	No

Table 72. Siebel Order ASI Fields

Name	XML Tag	Data Type	Length	Req.
Item Price	ItemPrice	DTYPE_TEXT	NA	No
Line Integration Id	LineIntegrationId	DTYPE_TEXT	30	No
Line Number	LineNumber	DTYPE_NUMBER	NA	No
Loaner Flag	LoanerFlag	DTYPE_TEXT	NA	No
Net Price	NetPrice	DTYPE_TEXT	NA	No
Note	Note	DTYPE_TEXT	1,500	No
Order Header Id	OrderHeaderId	DTYPE_ID	NA	No
Order Number	OrderNumber	DTYPE_TEXT	30	No
Package Name (Inbound)	PackageNameInbound	DTYPE_TEXT	50	No
Package Name (Outbound)	PackageNameOutbound	DTYPE_TEXT	NA	No
Parent Order Item Id	ParentOrderItemId	DTYPE_ID	NA	No
Part Number	PartNumber	DTYPE_TEXT	50	No
Partial Ship	PartialShip	DTYPE_TEXT	NA	No
Product	Product	DTYPE_TEXT	100	No
Product Global Identifier	ProductGlobalIdentifier	DTYPE_TEXT	50	No
Product Id	ProductId	DTYPE_ID	NA	No
Product Integration Id	ProductIntegrationId	DTYPE_TEXT	30	No
Product Primary Organization Id	ProductPrimaryOrganizationId	DTYPE_TEXT	NA	No
Requested Date	RequestedDate	DTYPE_TEXT	NA	No
Requested Quantity	RequestedQuantity	DTYPE_NUMBER	NA	No
Return To Account DUNS Number	ReturnToAccountDUNSNumber	DTYPE_TEXT	9	No
Return To Account Id	ReturnToAccountId	DTYPE_ID	NA	No

Table 72. Siebel Order ASI Fields

Name	XML Tag	Data Type	Length	Req.
Return To Account Integration Id	ReturnToAccountIntegrationId	DTYPE_TEXT	30	No
Return To Account Name	ReturnToAccountName	DTYPE_TEXT	100	No
Return To Account Site	ReturnToAccountSite	DTYPE_TEXT	50	No
Return To Address Id	ReturnToAddressId	DTYPE_ID	NA	No
Return To Address Integration Id	ReturnToAddressIntegrationId	DTYPE_TEXT	30	No
Return To Contact Id	ReturnToContactId	DTYPE_ID	NA	No
Return To Contact Integration Id	ReturnToContactIntegrationId	DTYPE_TEXT	30	No
Return To First Name	ReturnToFirstName	DTYPE_TEXT	50	No
Return To Last Name	ReturnToLastName	DTYPE_TEXT	50	No
Root Order Item Id	RootOrderItemId	DTYPE_ID	NA	No
Sales Unit of Measure	SalesUnitofMeasure	DTYPE_TEXT	30	No
Service Account	ServiceAccount	DTYPE_TEXT	NA	No
Service Account Id	ServiceAccountId	DTYPE_TEXT	30	No
Service Account Type	ServiceAccountType	DTYPE_TEXT	NA	No
Service Id	ServiceId	DTYPE_TEXT	NA	No
Service Instance Flag	ServiceInstanceFlag	DTYPE_TEXT	NA	No
Service Point	ServicePoint	DTYPE_TEXT	NA	No
Service Profile Id	ServiceProfileId	DTYPE_TEXT	NA	No
Service Type	ServiceType	DTYPE_TEXT	30	No

Table 72. Siebel Order ASI Fields

Name	XML Tag	Data Type	Length	Req.
Ship Date	ShipDate	DTYPE_DATETIME	NA	No
Ship Instruction	ShipInstruction	DTYPE_TEXT	250	No
Ship Quantity	ShipQuantity	DTYPE_NUMBER		No
Ship To Account	ShipToAccount	DTYPE_TEXT	100	No
Ship To Account DUNS Number	ShipToAccountDUNSNumber	DTYPE_TEXT	9	No
Ship To Account Id	ShipToAccountId	DTYPE_ID	NA	No
Ship To Account Integration Id	ShipToAccountIntegrationId	DTYPE_TEXT	30	No
Ship To Account Site	ShipToAccountSite	DTYPE_TEXT	50	No
Ship To Address	ShipToAddress	DTYPE_TEXT	50	No
Ship To Address 2	ShipToAddress2	DTYPE_TEXT	50	No
Ship To Address Id	ShipToAddressId	DTYPE_ID	NA	No
Ship To City	ShipToCity	DTYPE_TEXT	30	No
Ship To Contact - First Name	ShipToContact-FirstName	DTYPE_TEXT	50	No
Ship To Contact - Last Name	ShipToContact-LastName	DTYPE_TEXT	50	No
Ship To Contact Id	ShipToContactId	DTYPE_ID	NA	No
Ship To Contact Integration Id	ShipToContactIntegrationId	DTYPE_TEXT	30	No
Ship To Country	ShipToCountry	DTYPE_TEXT	15	No
Ship To State	ShipToState	DTYPE_TEXT	15	No
Ship To Zip	ShipToZip	DTYPE_TEXT	15	No
Ship to Address Integration Id	ShiptoAddressIntegrationId	DTYPE_TEXT	30	No
Shipping Carrier	ShippingCarrier	DTYPE_TEXT	30	No
Shipping Charges	ShippingCharges	DTYPE_TEXT	NA	No

Table 72. Siebel Order ASI Fields

Name	XML Tag	Data Type	Length	Req.
Shipping Method	ShippingMethod	DTYPE_TEXT	30	No
Shipping Terms	ShippingTerms	DTYPE_TEXT	30	No
Single Source	SingleSource	DTYPE_TEXT	NA	No
Smart Part Number	SmartPartNumber	DTYPE_TEXT	250	No
Source Inventory Loc Integration Id	SourceInventoryLocationIntegrationId	DTYPE_TEXT	30	No
Source Inventory Location	SourceInventoryLocation	DTYPE_TEXT	100	No
Source Inventory Location Id	SourceInventoryLocationId	DTYPE_ID	NA	No
Start Price	StartPrice	DTYPE_TEXT	NA	No
Status	Status	DTYPE_TEXT	30	No
Status As Of Date	StatusAsOfDate	DTYPE_TEXT	NA	No
Tax Amount	TaxAmount	DTYPE_TEXT	NA	No
Unit of Measure	UnitofMeasure	DTYPE_TEXT	30	No
Volume	Volume	DTYPE_NUMBER	NA	No
Volume Unit of Measure	VolumeUnitofMeasure	DTYPE_TEXT	30	No
Weight	Weight	DTYPE_NUMBER	NA	No
Weight Unit of Measure	WeightUnitofMeasure	DTYPE_TEXT	30	No
operation	operation	DTYPE_TEXT	30	No
Attributes				
Action Code	ActionCode	DTYPE_TEXT	30	No
Attribute Id	AttributeId	DTYPE_ID	NA	No
Data Type	DataType	DTYPE_TEXT	30	No
Description	Description	DTYPE_TEXT	255	No
Hidden	Hidden	DTYPE_TEXT	NA	No

Table 72. Siebel Order ASI Fields

Name	XML Tag	Data Type	Length	Req.
Id	Id	DTYPE_ID	30	No
Integration Id	IntegrationId	DTYPE_TEXT	30	No
LOV Type	ListOfValueType	DTYPE_TEXT	30	No
Name	Name	DTYPE_TEXT	75	No
Object Id	ObjectId	DTYPE_ID	NA	No
Read Only	ReadOnly	DTYPE_TEXT	NA	No
Required	Required	DTYPE_TEXT	NA	No
Sequence	Sequence	DTYPE_NUMBER	NA	No
Validation	Validation	DTYPE_TEXT	250	No
Value	Value	DTYPE_TEXT	100	No
operation	operation	DTYPE_TEXT	30	No
Promised Schedule Lines				
Available Status	AvailableStatus	DTYPE_TEXT	30	No
Available Status As Of Date	AvailableStatusAsOfDate	DTYPE_TEXT	NA	No
Id	Id	DTYPE_ID	30	No
Integration Id	IntegrationId	DTYPE_TEXT	30	No
Line Item Action Number	LineItemActionNumber	DTYPE_TEXT	NA	No
Order Item Id	OrderItemId	DTYPE_ID	NA	No
Order Item Integration Id	OrderItemIntegrationId	DTYPE_TEXT	30	No
Part Number	PartNumber	DTYPE_TEXT	50	No
Product Id	ProductId	DTYPE_ID	NA	No
Product Integration Id	ProductIntegrationId	DTYPE_TEXT	30	No
Product Name	ProductName	DTYPE_TEXT	100	No
Promised Date	PromisedDate	DTYPE_TEXT	NA	No
Promised Quantity	PromisedQuantity	DTYPE_NUMBER	NA	No
Source Inventory Location	SourceInventoryLocation	DTYPE_TEXT	100	No

Table 72. Siebel Order ASI Fields

Name	XML Tag	Data Type	Length	Req.
Source Inventory Location Id	SourceInventoryLocationId	DTYPE_ID	NA	No
Source Inventory Location Integration Id	SourceInventoryLocationIntegrationId	DTYPE_TEXT	30	No
operation	operation	DTYPE_TEXT	30	No
Requested Schedule Lines				
Id	Id	DTYPE_ID	30	No
Integration Id	IntegrationId	DTYPE_TEXT	30	No
Line Number	LineNumber	DTYPE_NUMBER	NA	No
Order Item Id	OrderItemId	DTYPE_ID	NA	No
Requested Date	RequestedDate	DTYPE_TEXT	NA	No
Requested Quantity	RequestedQuantity	DTYPE_NUMBER	NA	No
Source Inventory Location	SourceInventoryLocation	DTYPE_TEXT	100	No
Source Inventory Location Id	SourceInventoryLocationId	DTYPE_ID	NA	No
Source Inventory Location Integration Id	SourceInventoryLocationIntegrationId	DTYPE_TEXT	30	No
operation	operation	DTYPE_TEXT	30	No
Payments				
Account Number	AccountNumber	DTYPE_TEXT	50	No
Authorization Code	AuthorizationCode	DTYPE_TEXT	40	No
Bill To Address Id	BillToAddressId	DTYPE_ID	NA	No
Bill To Address Integration Id	BillToAddressIntegrationId	DTYPE_TEXT	30	No
Card Holder	CardHolder	DTYPE_TEXT	50	No

Table 72. Siebel Order ASI Fields

Name	XML Tag	Data Type	Length	Req.
Credit Card Expiration Month	CreditCardExpirationMonth	DTYPE_TEXT	30	No
Credit Card Expiration Year	CreditCardExpirationYear	DTYPE_TEXT	30	No
Credit Check Message	CreditCheckMessage	DTYPE_TEXT	250	No
Credit Check Status	CreditCheckStatus	DTYPE_TEXT	30	No
Credit Check Status As Of Date	CreditCheckStatusAsOfDate	DTYPE_TEXT	NA	No
Encryption Key	EncryptionKey	DTYPE_TEXT	30	No
Encryption Key Reference	EncryptionKeyReference	DTYPE_TEXT	30	No
Id	Id	DTYPE_ID	30	No
Integration Id	IntegrationId	DTYPE_TEXT	30	No
Issuing Bank Customer Id	IssuingBankCustomerId	DTYPE_TEXT	30	No
Issuing Bank Name	IssuingBankName	DTYPE_TEXT	30	No
Issuing Bank Phone Number	IssuingBankPhoneNumber	DTYPE_TEXT	40	No
Merchant Id	MerchantId	DTYPE_TEXT	30	No
Payment #	Payment	DTYPE_TEXT	30	No
Payment Account Id	PaymentAccountId	DTYPE_ID	NA	No
Payment Account Integration Id	PaymentAccountIntegrationId	DTYPE_TEXT	30	No
Payment Account Name	PaymentAccountName	DTYPE_TEXT	100	No
Payment Account Site	PaymentAccountSite	DTYPE_TEXT	50	No
Payment Method	PaymentMethod	DTYPE_TEXT	30	No

Table 72. Siebel Order ASI Fields

Name	XML Tag	Data Type	Length	Req.
Payment Status	PaymentStatus	DTYPE_TEXT	30	No
Payment Status As Of Date	PaymentStatusAsOfDate	DTYPE_DATETIME	NA	No
Payment Type	PaymentType	DTYPE_TEXT	30	No
Transaction Amount	TransactionAmount	DTYPE_TEXT	NA	No
Transaction Id	TransactionId	DTYPE_TEXT	NA	No
Transaction Time	TransactionTime	DTYPE_TEXT	NA	No
Verification Number	VerificationNumber	DTYPE_TEXT	10	No
operation	operation	DTYPE_TEXT	30	No
Related Organization				
Integration Id	IntegrationId	DTYPE_TEXT	30	No
IsPrimaryMVG	IsPrimaryMVG	DTYPE_TEXT	1	No
Organization	Organization	DTYPE_TEXT	50	No
Organization Id	OrganizationId	DTYPE_ID	NA	No
Related Sales Rep				
Id	Id	DTYPE_ID	30	No
Integration Id	IntegrationId	DTYPE_TEXT	30	No
IsPrimaryMVG	IsPrimaryMVG	DTYPE_TEXT	1	No
Login	Login	DTYPE_TEXT	50	No
Position	Position	DTYPE_TEXT	50	No
Related Shipment				
Carrier	Carrier	DTYPE_TEXT	30	No
Destination Inventory Location Id	DestinationInventoryLocationId	DTYPE_ID	15	No
Id	Id	DTYPE_ID	30	No
Integration Id	IntegrationId	DTYPE_TEXT	30	No
Shipment Number	ShipmentNumber	DTYPE_TEXT	30	No

Table 72. Siebel Order ASI Fields

Name	XML Tag	Data Type	Length	Req.
Source Inventory Location Id	SourceInventoryLocationId	DTYPE_ID	15	No
Waybill Number	WaybillNumber	DTYPE_TEXT	50	No
Shipment Lines				
Confirmed Qty	ConfirmedQty	DTYPE_NUMBER	NA	No
Delivery Date	DeliveryDate	DTYPE_DATETIME	NA	No
Delivery Qty	DeliveryQty	DTYPE_NUMBER	NA	No
Id	Id	DTYPE_ID	NA	No
Integration Id	IntegrationId	DTYPE_TEXT	NA	No
Order Line Id	OrderLineId	DTYPE_ID	NA	No
Shipment Date	ShipmentDate	DTYPE_DATETIME	NA	No
Shipment Line Number	ShipmentLineNumber	DTYPE_TEXT	NA	No
Shipment Qty	ShipmentQty	DTYPE_NUMBER	NA	No

Customer Lifecycle Management

The Siebel Account ASI supports the Customer Lifecycle Management process. This process enables the user to create and validate accounts and to perform other account-related tasks, such as credit approval.

Siebel Account

The Siebel Account ASI is used for business processes related to customer information management. This ASI facilitates inbound and outbound data synchronization between Siebel applications and external systems.

Figure 34 describes the Siebel Account ASI structure.

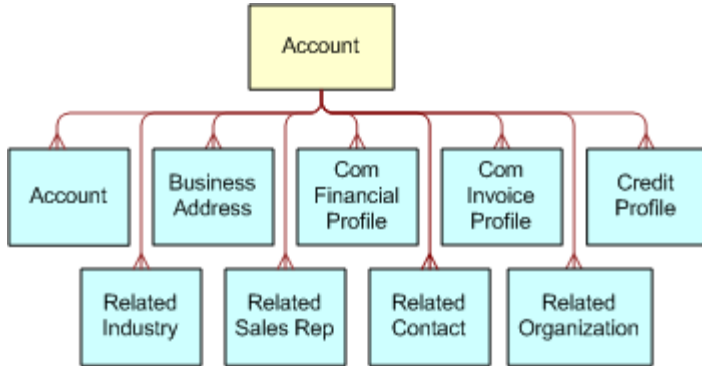

Figure 34. Siebel Account ASI

Table 73 lists the integration components and XML tags of this ASI.

Table 73. Siebel Account ASI Integration Components

Integration Component	XML Tag	User Keys
Account	Account	<ol style="list-style-type: none"> 1 Account Id 2 Integration Id 3 Location, Name, Primary Organization
Business Address	BusinessAddress	<ol style="list-style-type: none"> 1 Address Id 2 Address Integration Id
Com Financial Profile	FinancialProfile	<ol style="list-style-type: none"> 1 Id 2 Name
Com Invoice Profile	BillingProfile	<ol style="list-style-type: none"> 1 Id, Name 2 Name
Credit Profile	CreditProfile	<ol style="list-style-type: none"> 1 Credit Profile Id 2 Credit Profile Integration Id 3 Credit Area
Related Contact	RelatedContact	<ol style="list-style-type: none"> 1 Person UId, Primary Organization 2 Contact Id 3 Contact Integration Id

Table 73. Siebel Account ASI Integration Components

Integration Component	XML Tag	User Keys
Related Industry	RelatedIndustry	<ol style="list-style-type: none"> 1 Industry Id 2 Industry Integration Id 3 Industry 4 SIC Code
Related Organization	RelatedOrganization	<ol style="list-style-type: none"> 1 Organization Id 2 Organization Integration Id 3 Organization
Related Sales Rep	RelatedSalesRep	<ol style="list-style-type: none"> 1 Position Id 2 Position Integration Id 3 Division, Position 4 Login

Table 74 lists the Siebel Account fields and their attributes.

Table 74. Siebel Account ASI Fields

Name	XML Tag	Data Type	Length	Req.
Account				
Account Id	AccountId	DTYPE_ID	30	No
Account Status	AccountStatus	DTYPE_TEXT	24	No
Alias	Alias	DTYPE_TEXT	50	No
Assignment Area Code	AssignmentAreaCode	DTYPE_TEXT	5	No
Assignment Country Code	AssignmentCountryCode	DTYPE_TEXT	5	No
Competitor Flag	CompetitorFlag	DTYPE_TEXT	Not applicable	No
Credit Auto Approval Limit	CreditAutoApprovalLimit	DTYPE_NUMBER	Not applicable	No
Credit Status Date	CreditStatusDate	DTYPE_TEXT	Not applicable	No
Currency Code	CurrencyCode	DTYPE_TEXT	15	No
DUNS Number	DUNSNumber	DTYPE_TEXT	15	No
Description	Description	DTYPE_TEXT	255	No

Table 74. Siebel Account ASI Fields

Name	XML Tag	Data Type	Length	Req.
Domestic Ultimate DUNS	DomesticUltimateDUNS	DTYPE_TEXT	15	No
Expertise	Expertise	DTYPE_TEXT	30	No
Global Ultimate DUNS	GlobalUltimateDUNS	DTYPE_TEXT	15	No
Home Page	HomePage	DTYPE_TEXT	100	No
Integration Id	IntegrationId	DTYPE_TEXT	30	No
Language Code	LanguageCode	DTYPE_ID	15	No
Location	Location	DTYPE_TEXT	50	No
Main Fax Number	MainFaxNumber	DTYPE_TEXT	Not applicable	No
Main Phone Number	MainPhoneNumber	DTYPE_TEXT	Not applicable	No
Master Account Id	MasterAccountId	DTYPE_ID	Not applicable	No
Name	Name	DTYPE_TEXT	100	No
Number of Employees	NumberOfEmployees	DTYPE_NUMBER	Not applicable	No
PO Approved Flag	POApprovedFlag	DTYPE_TEXT	Not applicable	No
PO Auto Approval Currency Code	POAutoApprovalCurrencyCode	DTYPE_TEXT	20	No
PO Auto Approval Date	POAutoApprovalDate	DTYPE_DATETIME	Not applicable	No
PO Auto Approval Limit	POAutoApprovalLimit	DTYPE_TEXT	Not applicable	No
Parent Account Id	ParentAccountId	DTYPE_ID	Not applicable	No
Parent Account Integration Id	ParentAccountIntegrationId	DTYPE_TEXT	30	No
Parent Account Location	ParentAccountLocation	DTYPE_TEXT	50	No
Parent Account Name	ParentAccountName	DTYPE_TEXT	100	No
Parent HQ DUNS	ParentHQDUNS	DTYPE_TEXT	15	No
Partner Flag	PartnerFlag	DTYPE_TEXT	Not applicable	No
Price List	PriceList	DTYPE_TEXT	Not applicable	No
Price List Id	PriceListId	DTYPE_ID	Not applicable	No

Table 74. Siebel Account ASI Fields

Name	XML Tag	Data Type	Length	Req.
Price List Integration Id	PriceListIntegrationId	DTYPE_TEXT	30	No
Primary Organization	PrimaryOrganization	DTYPE_TEXT	100	No
Skip Credit Check	SkipCreditCheck	DTYPE_TEXT	Not applicable	No
Type	Type	DTYPE_TEXT	255	No
VAT registration number	VATregistrationnumber	DTYPE_TEXT	30	No
operation	operation	DTYPE_TEXT	30	No
Business Address				
Address Id	AddressId	DTYPE_ID	30	No
Address Integration Id	AddressIntegrationId	DTYPE_TEXT	30	No
City	City	DTYPE_TEXT	50	No
Country	Country	DTYPE_TEXT	50	No
County	County	DTYPE_TEXT	50	No
Email Address	EmailAddress	DTYPE_TEXT	50	No
IsPrimaryMVG	IsPrimaryMVG	DTYPE_TEXT	1	No
Postal Code	PostalCode	DTYPE_TEXT	30	No
Province	Province	DTYPE_TEXT	50	No
State	State	DTYPE_TEXT	10	No
Street Address	StreetAddress	DTYPE_TEXT	200	No
Street Address 2	StreetAddress2	DTYPE_TEXT	100	No
operation	operation	DTYPE_TEXT	30	No
Com Financial Profile				
Account Id	AccountId	DTYPE_ID	Not applicable	No
Account Type	AccountType	DTYPE_TEXT	30	No
Annual Income	AnnualIncome	DTYPE_TEXT	Not applicable	No
Bank Account Name	BankAccountName	DTYPE_TEXT	100	No
Bank Account Number	BankAccountNumber	DTYPE_TEXT	50	No
Bank Branch	BankBranch	DTYPE_TEXT	100	No
Bank Name	BankName	DTYPE_TEXT	100	No

Table 74. Siebel Account ASI Fields

Name	XML Tag	Data Type	Length	Req.
Conflict Id	ConflictId	DTYPE_ID	30	No
Contact First Name	ContactFirstName	DTYPE_TEXT	50	No
Contact Id	ContactId	DTYPE_ID	Not applicable	No
Contact Last Name	ContactLastName	DTYPE_TEXT	50	No
Corporate Number	CorporateNumber	DTYPE_TEXT	30	No
Created	Created	DTYPE_DATETIME	30	No
Credit Agency	CreditAgency	DTYPE_TEXT	30	No
Credit Card Expire Date	CreditCardExpireDate	DTYPE_DATETIME	Not applicable	No
Credit Card Number	CreditCardNumber	DTYPE_TEXT	30	No
Credit Card Type	CreditCardType	DTYPE_TEXT	30	No
Credit Score	CreditScore2	DTYPE_NUMBER	Not applicable	No
Credit Update Date	CreditUpdateDate	DTYPE_DATETIME	Not applicable	No
Credit Updated By	CreditUpdatedBy	DTYPE_ID	Not applicable	No
Currency Code	CurrencyCode2	DTYPE_TEXT	20	No
Current Address Id	CurrentAddressId	DTYPE_ID	Not applicable	No
Current City	CurrentCity	DTYPE_TEXT	50	No
Current Country	CurrentCountry	DTYPE_TEXT	30	No
Current Hire Date	CurrentHireDate	DTYPE_DATETIME	Not applicable	No
Current Postal Code	CurrentPostalCode	DTYPE_TEXT	30	No
Current State	CurrentState	DTYPE_TEXT	10	No
Current Street Address	CurrentStreetAddress	DTYPE_TEXT	200	No
D B Identifier	DBIdentifier	DTYPE_TEXT	30	No
Employer Id	EmployerId	DTYPE_ID	Not applicable	No
Employer Name	EmployerName	DTYPE_TEXT	100	No
Exchange Date	ExchangeDate	DTYPE_DATETIME	Not applicable	No
Former Address Id	FormerAddressId	DTYPE_ID	Not applicable	No
Former City	FormerCity	DTYPE_TEXT	50	No
Former Country	FormerCountry	DTYPE_TEXT	30	No
Former Postal Code	FormerPostalCode	DTYPE_TEXT	30	No

Table 74. Siebel Account ASI Fields

Name	XML Tag	Data Type	Length	Req.
Former State	FormerState	DTYPE_TEXT	10	No
Former Street Address	FormerStreetAddress	DTYPE_TEXT	200	No
Id	Id	DTYPE_ID	30	No
Id Type	IdType	DTYPE_TEXT	30	No
Identifier	Identifier	DTYPE_TEXT	30	No
Legal Name	LegalName	DTYPE_TEXT	100	No
Mod Id	ModId	DTYPE_ID	30	No
Name	Name	DTYPE_TEXT	100	No
Own or Rent	OwnorRent	DTYPE_TEXT	30	No
Previous Employer Id	PreviousEmployerId	DTYPE_ID	Not applicable	No
Status	Status	DTYPE_TEXT	30	No
Tax Id	TaxId2	DTYPE_TEXT	30	No
Tax Profile Cd	TaxProfileCd	DTYPE_TEXT	30	No
Type	Type	DTYPE_TEXT	30	No
Updated	Updated	DTYPE_DATETIME	30	No
operation	operation	DTYPE_TEXT	30	No
searchspec	searchspec	DTYPE_TEXT	250	No
Com Invoice Profile				
Account Id	AccountId	DTYPE_ID	Not applicable	No
Address Id	AddressId2	DTYPE_ID	Not applicable	No
Bank Account Name	BankAccountName2	DTYPE_TEXT	Not applicable	No
Bank Account Number	BankAccountNumber2	DTYPE_TEXT	Not applicable	No
Bank Account Type	BankAccountType	DTYPE_TEXT	30	No
Bank Authorization Flag	BankAuthorizationflag	DTYPE_TEXT	Not applicable	No
Bank Branch	BankBranch2	DTYPE_TEXT	Not applicable	No
Bank Language Code	BankLanguageCode	DTYPE_TEXT	5	No
Bank Language Id	BankLanguageId	DTYPE_TEXT	5	No
Bank Name	BankName2	DTYPE_TEXT	Not applicable	No
Bill Average	BillAverage	DTYPE_TEXT	Not applicable	No

Table 74. Siebel Account ASI Fields

Name	XML Tag	Data Type	Length	Req.
Bill Cycle	BillCycle	DTYPE_NUMBER	Not applicable	No
Bill Cycle Day	BillCycleDay	DTYPE_NUMBER	Not applicable	No
Bill Frequency	BillFrequency	DTYPE_TEXT	Not applicable	No
Bill Sequence	BillSequence	DTYPE_NUMBER	Not applicable	No
Bill Source	BillSource	DTYPE_TEXT	30	No
Bill Type	BillType	DTYPE_TEXT	Not applicable	No
Bill Vendor Id	BillVendorId	DTYPE_ID	Not applicable	No
Budget Billing Flag	BudgetBillingFlag	DTYPE_TEXT	Not applicable	No
CPNI Date	CPNIDate	DTYPE_DATETIME	Not applicable	No
CPNI Flag	CPNIFlag	DTYPE_TEXT	Not applicable	No
Collections Flag	CollectionsFlag	DTYPE_TEXT	Not applicable	No
Conflict Id	ConflictId	DTYPE_ID	30	No
Contact First Name	ContactFirstName	DTYPE_TEXT	50	No
Contact Id	ContactId	DTYPE_ID	Not applicable	No
Contact Last Name	ContactLastName	DTYPE_TEXT	50	No
Created	Created	DTYPE_DATETIME	30	No
Credit Card Block Flag	CreditCardBlockFlag	DTYPE_TEXT	Not applicable	No
Credit Card Block Reason	CreditCardBlockReason	DTYPE_TEXT	30	No
Credit Card Category	CreditCardCategory	DTYPE_TEXT	30	No
Credit Card Expiration Date	CreditCardExpirationDate	DTYPE_DATETIME	Not applicable	No
Credit Card Name	CreditCardName	DTYPE_TEXT	Not applicable	No
Credit Card Number	CreditCardNumber2	DTYPE_TEXT	Not applicable	No
Credit Card Type	CreditCardType2	DTYPE_TEXT	Not applicable	No
Currency Type	CurrencyType	DTYPE_TEXT	20	No
Days To Cash	DaysToCash	DTYPE_NUMBER	Not applicable	No
Email Bill To	EmailBillTo	DTYPE_TEXT	100	No
External Billing Account Number	ExternalBillingAccountNumber	DTYPE_TEXT	30	No
Extra Copies	ExtraCopies	DTYPE_NUMBER	Not applicable	No

Table 74. Siebel Account ASI Fields

Name	XML Tag	Data Type	Length	Req.
Id	Id	DTYPE_ID	30	No
Interest at Invoice Flag	InterestatInvoiceFlag	DTYPE_TEXT	Not applicable	No
Last Bill Amount	LastBillAmount	DTYPE_TEXT	Not applicable	No
Last Bill Date	LastBillDate	DTYPE_DATETIME	Not applicable	No
Media Type	MediaType	DTYPE_TEXT	30	No
Mod Id	ModId	DTYPE_ID	30	No
Name	Name	DTYPE_TEXT	100	No
No Pay Form Flag	NoPayFormFlag	DTYPE_TEXT	Not applicable	No
Number of Manual Invoices	NumberofManualInvoices	DTYPE_NUMBER	Not applicable	No
Payment Method	PaymentMethod	DTYPE_TEXT	30	No
Reason for Manual Outsource	ReasonforManualOutsource	DTYPE_TEXT	30	No
Repeat Debtor Flag	RepeatDebtorFlag	DTYPE_TEXT	Not applicable	No
Row Id	RowId	DTYPE_ID	Not applicable	No
Standing Order Flag	StandingOrderFlag	DTYPE_TEXT	Not applicable	No
Statement Flag	StatementFlag	DTYPE_TEXT	Not applicable	No
Status	Status	DTYPE_TEXT	30	No
Updated	Updated	DTYPE_DATETIME	30	No
Yearly Advance Payment Flag	YearlyAdvancePaymentFlag	DTYPE_TEXT	Not applicable	No
operation	operation	DTYPE_TEXT	30	No
searchspec	searchspec	DTYPE_TEXT	250	No
Credit Profile				
Credit Area	CreditArea	DTYPE_TEXT	30	No
Credit Available	CreditAvailable	DTYPE_NUMBER	Not applicable	No
Credit Currency Code	CreditCurrencyCode	DTYPE_TEXT	20	No
Credit Limit	CreditLimit	DTYPE_NUMBER		No
Credit Profile Id	CreditProfileId	DTYPE_ID	30	No
Credit Profile Integration Id	CreditProfileIntegrationId	DTYPE_TEXT	30	No

Table 74. Siebel Account ASI Fields

Name	XML Tag	Data Type	Length	Req.
Credit Reporting Group	CreditReportingGroup	DTYPE_TEXT	50	No
Credit Status Code	CreditStatusCode	DTYPE_TEXT	30	No
Credit Status Message	CreditStatusMessage	DTYPE_TEXT	250	No
Credit Used	CreditUsed	DTYPE_NUMBER	Not applicable	No
IsPrimaryMVG	IsPrimaryMVG	DTYPE_TEXT	1	No
Risk Category Code	RiskCategoryCode	DTYPE_TEXT	30	No
operation	operation	DTYPE_TEXT	30	No
Related Industry				
Industry	Industry	DTYPE_TEXT	50	No
Industry Id	IndustryId	DTYPE_ID	30	No
Industry Integration Id	IndustryIntegrationId	DTYPE_TEXT	30	No
IsPrimaryMVG	IsPrimaryMVG	DTYPE_TEXT	1	No
SIC Code	SICCode	DTYPE_TEXT	30	No
Related Sales Rep				
Division	Division	DTYPE_TEXT	255	No
IsPrimaryMVG	IsPrimaryMVG	DTYPE_TEXT	1	No
Login	Login	DTYPE_TEXT	50	No
Position	Position	DTYPE_TEXT	50	No
Position Id	PositionId	DTYPE_ID	30	No
Position Integration Id	PositionIntegrationId	DTYPE_TEXT	30	No
Related Contact				
Assistant Phone #	AssistantPhone	DTYPE_TEXT	Not applicable	No
Cellular Phone #	CellularPhone	DTYPE_TEXT	Not applicable	No
Contact Id	ContactId	DTYPE_ID	30	No
Contact Integration Id	ContactIntegrationId	DTYPE_TEXT	30	No
Email Address	EmailAddress	DTYPE_TEXT	50	No
Fax Phone #	FaxPhone	DTYPE_TEXT		No

Table 74. Siebel Account ASI Fields

Name	XML Tag	Data Type	Length	Req.
First Name	FirstName	DTYPE_TEXT	50	No
Job Title	JobTitle	DTYPE_TEXT	75	No
Last Name	LastName	DTYPE_TEXT	50	No
M/F	MF	DTYPE_TEXT	255	No
M/M	MM	DTYPE_TEXT	15	No
Person UId	PersonUId	DTYPE_TEXT	100	No
Primary Organization	PrimaryOrganization	DTYPE_TEXT	100	No
Work Phone #	WorkPhone	DTYPE_TEXT		No
Related Organization				
IsPrimaryMVG	IsPrimaryMVG	DTYPE_TEXT	1	No
Organization	Organization	DTYPE_TEXT	50	No
Organization Id	OrganizationId	DTYPE_ID	Not applicable	No
Organization Integration Id	OrganizationIntegrationId	DTYPE_TEXT	30	No

Billing Management

One ASI and four integration objects are associated with eight Billing Management Business Integration Processes: Siebel Invoice ASI, CUT Payment Interface Integration Object, and a request and response set for CUT Account Balance Interface Integration Object.

Siebel Invoice

The Siebel Invoice ASI is used by multiple Business Integration Processes, including Sync Invoice Header, Query Invoice Details, and Request Duplicate Invoice. The ASI has four types of fields associated with it, a different subset of which is used by each calling Business Integration Process to access information in an external billing system.

Figure 35 describes the Siebel Invoice ASI structure.

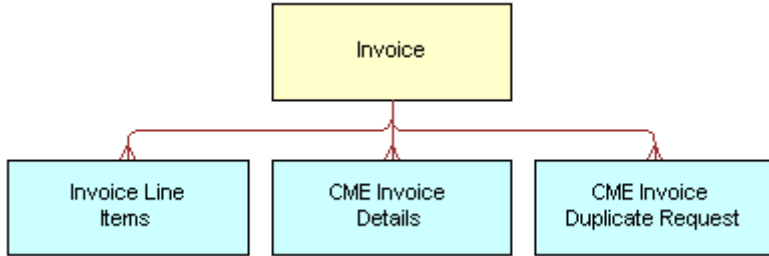

Figure 35. Siebel Invoice ASI

Table 75 lists the integration components and XML tags of this ASI.

Table 75. Siebel Invoice Integration Components

Integration Component	XML Tag	User Keys
CME Invoice Details	CmeInvoiceDetails	No user keys.
CME Invoice Duplicate Request	CmeInvoiceDuplicateRequest	No user keys.
Invoice	Invoice	<ol style="list-style-type: none"> 1 Id 2 Document Number, Document Type
Invoice Line Items	InvoiceLineItems	<ol style="list-style-type: none"> 1 Id 2 Integration Id 3 Line Number

Table 76 lists the fields and their attributes.

Table 76. Siebel Invoice ASI Fields

Name	XML Tag	Data Type	Length	Req.
Invoice				
Account Id	AccountId	DTYPE_ID	Not applicable	No
Account Integration Id	AccountIntegrationId	DTYPE_TEXT	30	No
Account Location	AccountLocation	DTYPE_TEXT	30	No
Account Name	AccountName	DTYPE_TEXT	50	No

Table 76. Siebel Invoice ASI Fields

Name	XML Tag	Data Type	Length	Req.
Account Organization Name	AccountOrganizationName	DTYPE_TEXT	100	No
Activity Id	ActivityId	DTYPE_ID	Not applicable	No
Activity User Defined Unique Id	ActivityUserDefinedUniqueId	DTYPE_TEXT	30	No
Amount Paid	AmountPaid	DTYPE_TEXT	Not applicable	No
Balance Forward	BalanceForward	DTYPE_TEXT	Not applicable	No
Bill To Person Id	BillToPersonId	DTYPE_TEXT	30	No
Billing End Date	BillingEndDate	DTYPE_TEXT	Not applicable	No
Billing Start Date	BillingStartDate	DTYPE_TEXT	Not applicable	No
Contract Id	ContractId	DTYPE_ID	Not applicable	No
Contract Integration Id	ContractIntegrationId	DTYPE_TEXT	30	No
Contract Name	ContractName	DTYPE_TEXT	50	No
Contract Organization Name	ContractOrganizationName	DTYPE_TEXT	100	No
Contract Revision Number	ContractRevisionNumber	DTYPE_NUMBER	Not applicable	No
Currency Code	CurrencyCode	DTYPE_TEXT	20	No
Delinquent Flag	DelinquentFlag	DTYPE_TEXT	Not applicable	No
Document Date	DocumentDate	DTYPE_TEXT	Not applicable	No
Document Description	DocumentDescription	DTYPE_TEXT	250	No
Document Number	DocumentNumber	DTYPE_TEXT	50	No
Document Period Id	DocumentPeriodId	DTYPE_ID	Not applicable	No
Document Period Name	DocumentPeriodName	DTYPE_TEXT	50	No

Table 76. Siebel Invoice ASI Fields

Name	XML Tag	Data Type	Length	Req.
Document Period Organization Name	DocumentPeriodOrganizationName	DTYPE_TEXT	100	No
Document Revision Number	DocumentRevisionNumber	DTYPE_NUMBER	Not applicable	No
Document Status	DocumentStatus	DTYPE_TEXT	30	No
Document Sub Type	DocumentSubType	DTYPE_TEXT	30	No
Document Type	DocumentType	DTYPE_TEXT	30	No
Id	Id	DTYPE_ID	30	No
Integration Id	IntegrationId	DTYPE_TEXT	30	No
Order Id	OrderId	DTYPE_ID		No
Order Integration Id	OrderIntegrationId	DTYPE_TEXT	30	No
Order Number	OrderNumber	DTYPE_TEXT	30	No
Order Organization Name	OrderOrganizationName	DTYPE_TEXT	100	No
Order Type	OrderType	DTYPE_TEXT	50	No
Payment Term	PaymentTerm	DTYPE_TEXT	50	No
Payment Term Due Date	PaymentTermDueDate	DTYPE_DATETIME	Not applicable	No
Payment Term Id	PaymentTermId	DTYPE_ID	Not applicable	No
Payment Term Net Days	PaymentTermNetDays	DTYPE_NUMBER	Not applicable	No
Project Id	ProjectId	DTYPE_ID	Not applicable	No
Project Integration Id	ProjectIntegrationId	DTYPE_TEXT	30	No
Project Number	ProjectNumber	DTYPE_TEXT	30	No
Project Organization Name	ProjectOrganizationName	DTYPE_TEXT	100	No
STORED Adjustment Amount	STOREDAdjustmentAmount	DTYPE_TEXT	Not applicable	No
STORED Discount Amount	STOREDDiscountAmount	DTYPE_TEXT	Not applicable	No
STORED Gross Amount	STOREDGrossAmount	DTYPE_TEXT	Not applicable	No

Table 76. Siebel Invoice ASI Fields

Name	XML Tag	Data Type	Length	Req.
STORED Surcharge Amount	STOREDSurchargeAmount	DTYPE_TEXT	Not applicable	No
STORED Tax Amount	STOREDTaxAmount	DTYPE_TEXT	Not applicable	No
Service Request Id	ServiceRequestId	DTYPE_ID	Not applicable	No
Service Request Number	ServiceRequestNumber	DTYPE_TEXT	64	No
Service Request Organization Name	ServiceRequestOrganizationName	DTYPE_TEXT	100	No
Status	Status	DTYPE_TEXT	30	No
Total Amount	TotalAmount	DTYPE_TEXT	Not applicable	No
Type Code	TypeCode	DTYPE_TEXT	Not applicable	No
operation	operation	DTYPE_TEXT	30	No
Invoice Line Items				
Activity Id	ActivityId	DTYPE_ID	Not applicable	No
Activity User Defined Unique Id	ActivityUserDefinedUniqueId	DTYPE_TEXT	30	No
Contract Id	ContractId	DTYPE_ID	Not applicable	No
Contract Integration Id	ContractIntegrationId	DTYPE_TEXT	30	No
Contract Line Id	ContractLineId	DTYPE_ID	Not applicable	No
Contract Name	ContractName	DTYPE_TEXT	50	No
Contract Organization Name	ContractOrganizationName	DTYPE_TEXT	100	No
Contract Revision Number	ContractRevisionNumber	DTYPE_NUMBER	Not applicable	No
Currency Code	CurrencyCode	DTYPE_TEXT	20	No
Description	Description	DTYPE_TEXT	250	No
Discount Amount	DiscountAmount	DTYPE_TEXT	Not applicable	No

Table 76. Siebel Invoice ASI Fields

Name	XML Tag	Data Type	Length	Req.
Gross Amount	GrossAmount	DTYPE_TEXT	Not applicable	No
Id	Id	DTYPE_ID	30	No
Integration Id	IntegrationId	DTYPE_TEXT	30	No
Line Number	LineNumber	DTYPE_NUMBER	Not applicable	No
Line Quantity	LineQuantity	DTYPE_NUMBER	Not applicable	No
Line Type	LineType	DTYPE_TEXT	30	No
Order Id	OrderId	DTYPE_ID	Not applicable	No
Order Integration Id	OrderIntegrationId	DTYPE_TEXT	30	No
Order Item Id	OrderItemId	DTYPE_ID	Not applicable	No
Order Item Integration Id	OrderItemIntegrationId	DTYPE_TEXT	30	No
Order Line Number	OrderLineNumber	DTYPE_NUMBER	Not applicable	No
Order Number	OrderNumber	DTYPE_TEXT	30	No
Order Organization Name	OrderOrganizationName	DTYPE_TEXT	100	No
Order Type	OrderType	DTYPE_TEXT	50	No
Person Id	PersonId	DTYPE_ID	Not applicable	No
Product Id	ProductId	DTYPE_ID	Not applicable	No
Product Integration Id	ProductIntegrationId	DTYPE_TEXT	30	No
Product Name	ProductName	DTYPE_TEXT	100	No
Product Organization Name	ProductOrganizationName	DTYPE_TEXT	100	No
Product Vendor Organization Name	ProductVendorOrganizationName	DTYPE_TEXT	100	No
Project Id	ProjectId	DTYPE_ID	Not applicable	No

Table 76. Siebel Invoice ASI Fields

Name	XML Tag	Data Type	Length	Req.
Project Integration Id	ProjectIntegrationId	DTYPE_TEXT	30	No
Project Item Id	ProjectItemId	DTYPE_ID	Not applicable	No
Project Item Number	ProjectItemNumber	DTYPE_TEXT	30	No
Project Number	ProjectNumber	DTYPE_TEXT	30	No
Project Organization Name	ProjectOrganizationName	DTYPE_TEXT	100	No
Project Resource Id	ProjectResourceId	DTYPE_ID	Not applicable	No
Project Resource Number	ProjectResourceNumber	DTYPE_TEXT	30	No
Service Request Id	ServiceRequestId	DTYPE_ID	Not applicable	No
Service Request Number	ServiceRequestNumber	DTYPE_TEXT	64	No
Service Request Organization Name	ServiceRequestOrganizationName	DTYPE_TEXT	100	No
Surcharge Amount	SurchargeAmount	DTYPE_TEXT	Not applicable	No
Tax Amount	TaxAmount	DTYPE_TEXT	Not applicable	No
Unit of Measure	UnitofMeasure	DTYPE_TEXT	30	No
operation	operation	DTYPE_TEXT	30	No
CME Invoice Details				
Amount	Amount2	DTYPE_TEXT	Not applicable	No
Call Type	CallType	DTYPE_TEXT	Not applicable	No
Currency	Currency	DTYPE_TEXT	Not applicable	No
Date/Time	DateTime	DTYPE_TEXT	Not applicable	No
Duration	Duration	DTYPE_TEXT	Not applicable	No

Table 76. Siebel Invoice ASI Fields

Name	XML Tag	Data Type	Length	Req.
Id	Id	DTYPE_ID	30	No
Invoice Header Id	InvoiceHeaderId	DTYPE_TEXT	Not applicable	No
Line Number	LineNumber	DTYPE_TEXT	Not applicable	No
Location	Location	DTYPE_TEXT	Not applicable	No
Number Called	NumberCalled	DTYPE_TEXT	Not applicable	No
Originating Number	OriginatingNumber	DTYPE_TEXT	Not applicable	No
Period	Period	DTYPE_TEXT	Not applicable	No
Rate	Rate	DTYPE_TEXT	Not applicable	No
Segment	Segment	DTYPE_TEXT	Not applicable	No
Service	Service	DTYPE_TEXT	Not applicable	No
Vid	Vid	DTYPE_ID	Not applicable	No
operation	operation	DTYPE_TEXT	30	No
CME Invoice Duplicate Request				
Copies	Copies	DTYPE_NUMBER	Not applicable	No
Id	Id	DTYPE_ID	30	No
operation	operation	DTYPE_TEXT	30	No

Siebel Invoice Adjustment

The Siebel Invoice Adjustment ASI is used to modify invoices.

Figure 36 describes the structure of the Siebel Invoice Adjustment ASI.

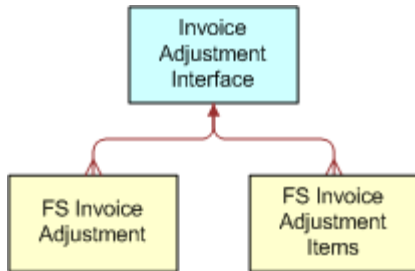

Figure 36. Siebel Invoice Adjustment ASI

Table 77 lists the integration components of this ASI.

Table 77. Siebel Invoice Adjustment Components

Integration Component	XML Tag	User Keys
FS Invoice Adjustment	Adjustment	1 Adjustment ID 2 Integration Id
FS Invoice Adjustment Items	AdjustmentItem	1 Item Adjustment ID 2 Integration Id

Table 78 lists the fields and their attributes.

Table 78. Siebel Invoice Adjustment ASI Fields

Name	XML Tag	Data Type	Length	Req.
FS Invoice Adjustment				
Account Id	AccountId	DTYPE_ID	Not applicable	No
Account Name	AccountName	DTYPE_TEXT	100	No
Adjustment ID	AdjustmentID	DTYPE_ID	Not applicable	No
Alert Id	AlertId	DTYPE_ID	Not applicable	No
Approved Amt	ApprovedAmt	DTYPE_TEXT	Not applicable	No
Approved Currency	ApprovedCurrency	DTYPE_TEXT	20	No

Table 78. Siebel Invoice Adjustment ASI Fields

Name	XML Tag	Data Type	Length	Req.
Approved Date	ApprovedDate	DTYPE_TEXT	Not applicable	No
Approved Exchange Date	ApprovedExchangeDate	DTYPE_DATETIME	Not applicable	No
Conflict Id	ConflictId	DTYPE_ID	30	No
Created	Created	DTYPE_DATETIME	30	No
Created By Login	CreatedByLogin	DTYPE_TEXT	50	No
Customer Decision	CustomerDecision	DTYPE_TEXT	30	No
Customer Decision Date	CustomerDecisionDate	DTYPE_DATETIME	Not applicable	No
Decision Description	DecisionDescription	DTYPE_TEXT	250	No
Description	Description	DTYPE_TEXT	250	No
First Name	FirstName	DTYPE_TEXT	50	No
Id	Id	DTYPE_ID	30	No
Integration Id	IntegrationId	DTYPE_TEXT	30	No
Invoice ID	InvoiceID	DTYPE_ID	Not applicable	No
Invoice Line Item ID	InvoiceLineItemID	DTYPE_ID	Not applicable	No
Invoice Number	InvoiceNumber	DTYPE_TEXT	50	No
Invoice Number No Constrain	InvoiceNumberNoConstrain	DTYPE_TEXT	50	No
Item Line Number	ItemLineNumber	DTYPE_NUMBER	Not applicable	No
Last Name	LastName	DTYPE_TEXT	50	No
Line Number	LineNumber	DTYPE_NUMBER	Not applicable	No
Mod Id	ModId	DTYPE_ID	30	No
Reason For Request	ReasonForRequest	DTYPE_TEXT	30	No
Request Amt	RequestAmt	DTYPE_TEXT	Not applicable	No
Request Currency	RequestCurrency	DTYPE_TEXT	20	No
Request Date	RequestDate	DTYPE_TEXT	Not applicable	No

Table 78. Siebel Invoice Adjustment ASI Fields

Name	XML Tag	Data Type	Length	Req.
Request Exchange Date	RequestExchangeDate	DTYPE_DATETIME	Not applicable	No
Status	Status	DTYPE_TEXT	30	No
Type	Type	DTYPE_TEXT	30	No
Updated	Updated	DTYPE_DATETIME	30	No
operation	operation	DTYPE_TEXT	30	No
searchspec	searchspec	DTYPE_TEXT	250	No
FS Invoice Adjustment Items				
Approved Amt	ApprovedAmt	DTYPE_TEXT	Not applicable	No
Approved Currency Code	ApprovedCurrencyCode	DTYPE_TEXT	20	No
Approved Description	ApprovedDescription	DTYPE_TEXT	250	No
Approved Exchange Date	ApprovedExchangeDate	DTYPE_DATETIME	Not applicable	No
Conflict Id	ConflictId	DTYPE_ID	30	No
Created	Created	DTYPE_DATETIME	30	No
Description	Description	DTYPE_TEXT	250	No
Id	Id	DTYPE_ID	30	No
Integration Id	IntegrationId	DTYPE_TEXT	30	No
Invoice Adj ID	InvoiceAdjID	DTYPE_ID	Not applicable	No
Invoice Item ID	InvoiceItemID	DTYPE_ID	Not applicable	No
Item Adjustment ID	ItemAdjustmentID	DTYPE_ID	Not applicable	No
Line Number	LineNumber	DTYPE_NUMBER	Not applicable	No
Mod Id	ModId	DTYPE_ID	30	No
Original Amount	OriginalAmount	DTYPE_TEXT	Not applicable	No
Request Amt	RequestAmt	DTYPE_TEXT	Not applicable	No
Request Currency	RequestCurrency	DTYPE_TEXT	20	No

Table 78. Siebel Invoice Adjustment ASI Fields

Name	XML Tag	Data Type	Length	Req.
Request Date	RequestDate	DTYPE_TEXT	Not applicable	No
Request Exchange Date	RequestExchangeDate	DTYPE_DATETIME	Not applicable	No
Status	Status	DTYPE_TEXT	30	No
Updated	Updated	DTYPE_DATETIME	30	No
operation	operation	DTYPE_TEXT	30	No
searchspec	searchspec	DTYPE_TEXT	250	No

CUT Payment Interface Integration Object

The CUT Payment Interface integration object is used by both the CME Sync Payment and CME Update Payment Status Business Integration Processes to share information with external systems about payments made through the Siebel application.

Figure 37 describes the CUT Payment Interface integration object structure.

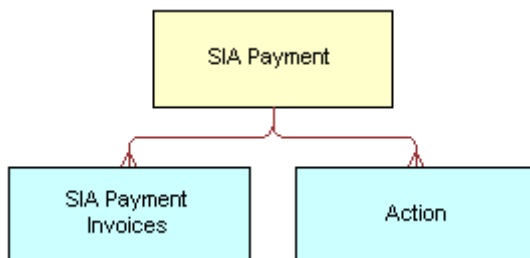

Figure 37. CUT Payment Interface Integration Object

Table 79 lists the integration components and XML tags.

Table 79. CUT Payment Interface ASI Integration Components

Integration Component	XML Tag	User Keys
Action	ListOfCutPaymentInterface	1 Description
SIA Payment	SiaPayment	1 Id
SIA Payment Invoices	SiaPaymentInvoices	1 Invoice Id

Table 80 lists the fields and their attributes.

Table 80. CUT Payment Interface Integration Object Fields

Name	XML Tag	Data Type	Length	Req.
SIA Payment				
Account Id	AccountId	DTYPE_ID	Not applicable	No
Alert Id	AlertId	DTYPE_ID	Not applicable	No
Bank Account Number	BankAccountNumber	DTYPE_TEXT	50	No
Bank Location	BankLocation	DTYPE_TEXT	100	No
Bank Name	BankName	DTYPE_TEXT	100	No
Cheque Number	ChequeNumber	DTYPE_TEXT	30	No
Cheque Status	ChequeStatus	DTYPE_TEXT	30	No
Comments	Comments	DTYPE_TEXT	255	No
Credit Card Expiration Date	CreditCardExpirationDate	DTYPE_DATETIME	Not applicable	No
Credit Card Holder Name	CreditCardHolderName	DTYPE_TEXT	50	No
Credit Card Number	CreditCardNumber	DTYPE_TEXT	50	No
Currency Code	CurrencyCode	DTYPE_TEXT	20	No
Desired Payment Date	DesiredPaymentDate	DTYPE_DATETIME	Not applicable	No
Exchange Date	ExchangeDate	DTYPE_DATETIME	Not applicable	No
Id	Id	DTYPE_ID	30	No
Invoice Amount	InvoiceAmount	DTYPE_TEXT	Not applicable	No
Invoice Num	InvoiceNum	DTYPE_ID	Not applicable	No
Payment Amount	PaymentAmount	DTYPE_TEXT	Not applicable	No
Payment Date	PaymentDate	DTYPE_DATETIME	Not applicable	No
Payment Method	PaymentMethod	DTYPE_TEXT	30	No
Payment Number	PaymentNumber	DTYPE_TEXT	30	No
Payment Type	PaymentType	DTYPE_TEXT	30	No
Received Date	ReceivedDate	DTYPE_TEXT	Not applicable	No
Reference Location	ReferenceLocation	DTYPE_TEXT	100	No
Reference Number	ReferenceNumber	DTYPE_TEXT	30	No
Status	Status	DTYPE_TEXT	30	No
Updated	Updated	DTYPE_DATETIME	30	No

Table 80. CUT Payment Interface Integration Object Fields

Name	XML Tag	Data Type	Length	Req.
Updated By	UpdatedBy	DTYPE_TEXT	50	No
operation	operation	DTYPE_TEXT	30	No
SIA Payment Invoices				
Currency Code	CurrencyCode	DTYPE_TEXT	20	No
Id	Id	DTYPE_ID	30	No
Invoice Date	InvoiceDate	DTYPE_TEXT	Not applicable	No
Invoice Id	InvoiceId	DTYPE_ID	Not applicable	No
Payment Amount Applied	PaymentAmountApplied	DTYPE_TEXT	Not applicable	No
Payment Id	PaymentId	DTYPE_ID	Not applicable	No
operation	operation	DTYPE_TEXT	30	No
Action				
Account Id	AccountId	DTYPE_ID	Not applicable	No
Description	Description	DTYPE_TEXT	100	No
Primary Owner Id	PrimaryOwnerId	DTYPE_ID	Not applicable	No
Type	Type	DTYPE_TEXT	30	No

CUT Account Balance Interface - Request Integration Object

The CME Query Account Balance Business Integration Process uses the CUT Account Balance Interface - Request integration object to query the external application with an account number for balance and dunning information.

Figure 38 describes the CUT Account Balance Interface - Request Integration Object structure.

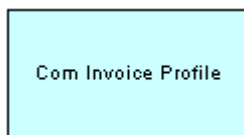

Figure 38. CUT Account Balance Interface Request Integration Object

Table 81 lists the integration components and XML tags.

Table 81. CUT Account Balance Request Integration Object Integration Components

Integration Component	XML Tag	User Keys
Com Invoice Profile	ComInvoiceProfile	No user keys.

Table 82 lists the fields and their attributes.

Table 82. CUT Account Balance Interface - Request Integration Object Fields

Name	XML Tag	Data Type	Length	Req.
Com Invoice Profile				
Account Id	AccountId	DTYPE_ID	Not applicable	No
External Billing Account Number	ExternalBillingAccountNumber	DTYPE_TEXT	30	No

CUT Account Balance Interface - Response Integration Object

The CME Query Account Balance Business Integration Process uses the CUT Account Balance Interface - Response integration object to receive balance and dunning information related to an account.

Figure 39 describes the CUT Account Balance Interface - Response Integration Object structure.

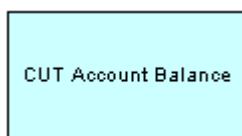

Figure 39. CUT Account Balance Interface - Response Integration Object

Table 83 lists the integration components and XML tags.

Table 83. CUT Account Balance Interface - Response Integration Object Integration Components

Integration Component	XML Tag	User Keys
CUT Account Balance	CutAccountBalance	No user keys.

Table 84 lists the fields and their attributes.

Table 84. CUT Account Balance Interface - Response Integration Object Fields

Name	XML Tag	Data Type	Length	Req.
CUT Account Balance				
30 Days Due	DaysDue30	DTYPE_TEXT	Not applicable	No
60 Days Due	DaysDue60	DTYPE_TEXT	Not applicable	No
90 Days Due	DaysDue90	DTYPE_TEXT	Not applicable	No
Balance	Balance	DTYPE_TEXT	Not applicable	No
Currency	Currency	DTYPE_TEXT	Not applicable	No
Current Balance	CurrentBalance	DTYPE_TEXT	Not applicable	No
Due Date	DueDate	DTYPE_TEXT	Not applicable	No
External Account #	ExternalAccountNum	DTYPE_TEXT	Not applicable	No
Pending Credits	PendingCredits	DTYPE_TEXT	Not applicable	No
Pending Debits	PendingDebits	DTYPE_TEXT	Not applicable	No
Unbilled Usage	UnbilledUsage	DTYPE_TEXT	Not applicable	No
operation	operation	DTYPE_TEXT	30	No
searchspec	searchspec	DTYPE_TEXT	250	No

Siebel Meter Reading

The CME Update Meter Usage Business Integration Process uses the Siebel Meter Reading ASI to update the external application with meter reading data for billing information.

Figure 40 describes the Siebel Meter Reading ASI structure.

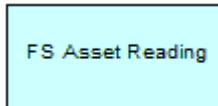

Figure 40. Siebel Meter Reading ASI

Table 85 lists the integration components and XML tags of this ASI.

Table 85. Siebel Meter Reading ASI Integration Components

Integration Component	XML Tag	User Keys
FS Asset Reading	FsAssetReading	1 Id

Table 86 lists the fields and their attributes.

Table 86. Siebel Meter Reading ASI Fields

Name	XML Tag	Data Type	Length	Req.
FS Asset Reading				
Account Id	AccountId	DTYPE_ID	Not applicable	No
Asset Id	AssetId	DTYPE_ID	Not applicable	No
Asset Number	AssetNumber	DTYPE_TEXT	100	No
Asset Serial Number	AssetSerialNumber	DTYPE_TEXT	100	No
Complete Flag	CompleteFlag	DTYPE_TEXT	Not applicable	No
Conflict Id	ConflictId	DTYPE_ID	30	No
Created	Created	DTYPE_DATETIME	30	No
Employee	Employee	DTYPE_TEXT	50	No
Id	Id	DTYPE_ID	30	No
Measurement Method Code	MeasurementMethodCode	DTYPE_TEXT	30	No
Mod Id	ModId	DTYPE_ID	30	No
Product Id	ProductId	DTYPE_ID	Not applicable	No
Reading	Reading	DTYPE_NUMBER	Not applicable	No
Service Point Number	ServicePointNumber	DTYPE_ID	Not applicable	No
Timestamp	Timestamp	DTYPE_TEXT	Not applicable	No
Units	Units	DTYPE_TEXT	30	No
Updated	Updated	DTYPE_DATETIME	30	No
operation	operation	DTYPE_TEXT	30	No
searchspec	searchspec	DTYPE_TEXT	250	No

Siebel Meter Usage Data

The CME Query Meter Usage Business Integration Process uses the Siebel Meter Usage Data ASI to query the external application with meter usage data for billing information.

Figure 41 describes the Siebel Meter Usage Data ASI structure.

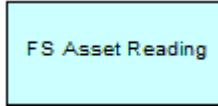

Figure 41. Siebel Meter Usage Data ASI

Table 87 lists the integration components and XML tags of this ASI.

Table 87. Siebel Meter Usage Data ASI Integration Components

Integration Component	XML Tag	User Keys
SIS OM Asset Mgmt - Asset - Complex Header Billing	Asset	1 Id 2 Asset Number
UT Usage Detail	UtUsageDetail	1 Period Id

Table 88 lists the fields and their attributes.

Table 88. Siebel Meter Usage Data ASI Fields

Name	XML Tag	Data Type	Length	Req.
SIS OM Asset Mgmt - Asset - Complex Header Billing				
Billing Account Id	BillingAccountId	DTYPE_ID	Not applicable	No
Id	Id	DTYPE_ID	30	No
Product Id	ProductId	DTYPE_ID	Not applicable	No
Service Point Id	ServicePointId	DTYPE_ID	Not applicable	No
Service Point Serial Number	ServicePointSerialNumber	DTYPE_TEXT	100	No
Status	Status	DTYPE_TEXT	30	No
operation	operation	DTYPE_TEXT	30	No
searchspec	searchspec	DTYPE_TEXT	250	No
UT Usage Detail				
Asset Id	AssetId	DTYPE_ID	Not applicable	No
Billed Demand	BilledDemand	DTYPE_NUMBER	Not applicable	No
Billing Account	BillingAccount	DTYPE_TEXT	100	No
Billing Account Id	BillingAccountId	DTYPE_ID	Not applicable	No

Table 88. Siebel Meter Usage Data ASI Fields

Name	XML Tag	Data Type	Length	Req.
Billing Account Number	BillingAccountNumber	DTYPE_TEXT	30	No
Billing Days	BillingDays	DTYPE_NUMBER	Not applicable	No
Conflict Id	ConflictId	DTYPE_ID	30	No
Created	Created	DTYPE_DATETIME	30	No
Data Source	DataSource	DTYPE_TEXT	30	No
Degree Days	DegreeDays	DTYPE_NUMBER	Not applicable	No
Demand UOM	DemandUOM	DTYPE_TEXT	30	No
End Date	EndDate	DTYPE_DATETIME	Not applicable	No
Id	Id	DTYPE_ID	30	No
Intermediate Usage	IntermediateUsage	DTYPE_NUMBER	Not applicable	No
Load Factor	LoadFactor	DTYPE_NUMBER	Not applicable	No
Mod Id	ModId	DTYPE_ID	30	No
Off Peak Demand	OffPeakDemand	DTYPE_NUMBER	Not applicable	No
Off Peak Usage	OffPeakUsage	DTYPE_NUMBER	Not applicable	No
On Peak Demand	OnPeakDemand	DTYPE_NUMBER	Not applicable	No
On Peak Usage	OnPeakUsage	DTYPE_NUMBER	Not applicable	No
Period	Period	DTYPE_TEXT	50	No
Period Id	PeriodId	DTYPE_ID	Not applicable	No
Power Factor	PowerFactor	DTYPE_NUMBER	Not applicable	No
Rate Code	RateCode	DTYPE_TEXT	30	No
Rate Exception	RateException	DTYPE_TEXT	30	No
Read Code	ReadCode	DTYPE_TEXT	30	No
Start Date	StartDate	DTYPE_DATETIME	Not applicable	No
Supplier	Supplier	DTYPE_TEXT	100	No
Supplier Id	SupplierId	DTYPE_ID	Not applicable	No
Total Usage	TotalUsage	DTYPE_NUMBER	Not applicable	No
Updated	Updated	DTYPE_DATETIME	30	No
Usage UOM	UsageUOM	DTYPE_TEXT	30	No
operation	operation	DTYPE_TEXT	30	No
searchspec	searchspec	DTYPE_TEXT	250	No

Siebel Payment

The Siebel Payment ASI is used to query payment information from the external systems.

Figure 42 describes the structure of the Siebel Payment ASI.

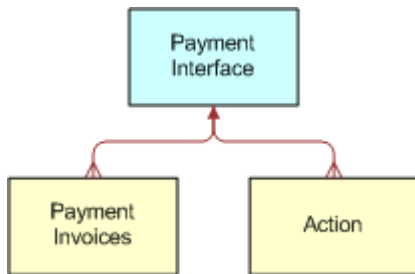

Figure 42. Siebel Payment ASI

Table 89 lists the integration components of this ASI.

Table 89. Siebel Payment Integration Component

Integration Component	XML Tag	User Keys
Action	Action	1 Description
SIA Payment	SiaPayment	1 Id 2 Integration Id
SIA Payment Invoices	SiaPaymentInvoices	1 Invoice Id

Table 90 lists the fields and their attributes.

Table 90. Siebel Payment ASI Fields

Name	XML Tag	Data Type	Length	Req.
Action				
Account Id	AccountId	DTYPE_ID	Not applicable	N
Description	Description	DTYPE_TEXT	100	N
Primary Owner Id	PrimaryOwnerId	DTYPE_ID	Not applicable	N
Type	Type	DTYPE_TEXT	30	N
SIA Payment				
Account Id	AccountId	DTYPE_ID	Not applicable	N
Alert Id	AlertId	DTYPE_ID	Not applicable	N

Table 90. Siebel Payment ASI Fields

Name	XML Tag	Data Type	Length	Req.
Bank Account Number	BankAccountNumber	DTYPE_TEXT	50	N
Bank Location	BankLocation	DTYPE_TEXT	100	N
Bank Name	BankName	DTYPE_TEXT	100	N
Cheque Number	ChequeNumber	DTYPE_TEXT	30	N
Cheque Status	ChequeStatus	DTYPE_TEXT	30	N
Comments	Comments	DTYPE_TEXT	255	N
Credit Card Expiration Date	CreditCardExpirationDate	DTYPE_DATETIME	Not applicable	N
Credit Card Holder Name	CreditCardHolderName	DTYPE_TEXT	50	N
Credit Card Number	CreditCardNumber	DTYPE_TEXT	50	N
Currency Code	CurrencyCode	DTYPE_TEXT	20	N
Desired Payment Date	DesiredPaymentDate	DTYPE_DATETIME	Not applicable	N
Exchange Date	ExchangeDate	DTYPE_DATETIME	Not applicable	N
Id	Id	DTYPE_ID	30	N
Integration Id	IntegrationId	DTYPE_TEXT	30	N
Invoice Amount	InvoiceAmount	DTYPE_TEXT	Not applicable	N
Invoice Num	InvoiceNum	DTYPE_ID	Not applicable	N
Payment Amount	PaymentAmount	DTYPE_TEXT	Not applicable	N
Payment Date	PaymentDate	DTYPE_DATETIME	Not applicable	N
Payment Method	PaymentMethod	DTYPE_TEXT	30	N
Payment Number	PaymentNumber	DTYPE_TEXT	30	N
Payment Type	PaymentType	DTYPE_TEXT	30	N
Received Date	ReceivedDate	DTYPE_TEXT	Not applicable	N
Reference Location	ReferenceLocation	DTYPE_TEXT	100	N
Reference Number	ReferenceNumber	DTYPE_TEXT	30	N
Status	Status	DTYPE_TEXT	30	N
Updated	Updated	DTYPE_DATETIME	30	N
Updated By	UpdatedBy	DTYPE_TEXT	50	N
operation	operation	DTYPE_TEXT	30	N
SIA Payment Invoices				
Currency Code	CurrencyCode	DTYPE_TEXT	20	N

Table 90. Siebel Payment ASI Fields

Name	XML Tag	Data Type	Length	Req.
Id	Id	DTYPE_ID	30	N
Invoice Date	InvoiceDate	DTYPE_TEXT	Not applicable	N
Invoice Id	InvoiceId	DTYPE_ID	Not applicable	N
Payment Amount Applied	PaymentAmountApplied	DTYPE_TEXT	Not applicable	N
Payment Id	PaymentId	DTYPE_ID	Not applicable	N
operation	operation	DTYPE_TEXT	30	N

Siebel Simple Product

Oracle’s Siebel Simple Product ASI is used in the CME Create Product Business Integration Process and the CME Update Product Business Integration Process to create and synchronize Siebel simple products.

Figure 43 describes the Siebel Simple Product ASI structure.

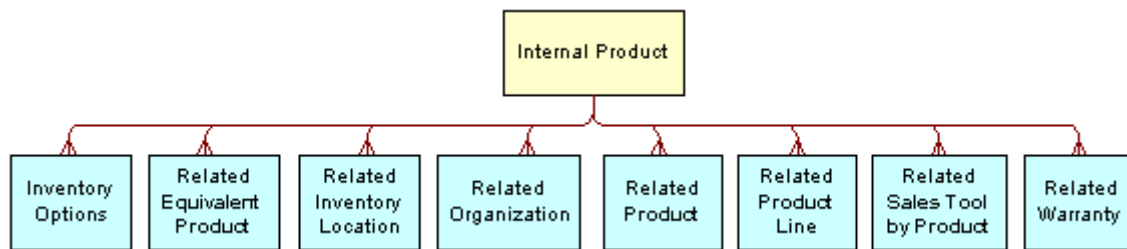

Figure 43. Siebel Simple Product ASI

Table 91 lists the integration components and XML tags of this ASI.

Table 91. Siebel Simple Product Components

Integration Component	XML Tag	User Keys
Internal Product	InternalProduct	<ol style="list-style-type: none"> 1 Id 2 Integration Id, Product Name 3 Integration Id, Primary Organization, Primary Vendor, Product Name, Vendor Primary Organization, Vendor Site 4 Primary Organization, Primary Vendor, Product Name, Vendor Primary Organization, Vendor Site
FS Inventory Options	InventoryOptions	<ol style="list-style-type: none"> 1 Id 2 Integration Id 3 Inventory Type, Product Name
Internal Product_Equivalent Product	RelatedEquivalentProduct	<ol style="list-style-type: none"> 1 Id 2 Integration Id 3 Equivalent Product, Equivalent Product Primary Organization, Equivalent Product Vendor, Equivalent Product Vendor Location, Equivalent Product Vendor Organization
FS Inventory Location	RelatedInventoryLocation	<ol style="list-style-type: none"> 1 Id 2 Integration Id 3 Inventory Name, Primary Organization
Internal Product_Organization	RelatedOrganization	<ol style="list-style-type: none"> 1 Id 2 Integration Id 3 Organization
Internal Product_Related Product	RelatedProduct	<ol style="list-style-type: none"> 1 Id 2 Integration Id 3 Organization, Product Name, Vendor, Vendor Location

Table 91. Siebel Simple Product Components

Integration Component	XML Tag	User Keys
Internal Product_Admin Product Line	RelatedProductLine	<ol style="list-style-type: none"> 1 Id 2 Integration Id 3 Product Line
Sales Tool by Product	RelatedSalesToolByProduct	<ol style="list-style-type: none"> 1 Id 2 Integration Id 3 Name, Primary Organization
FS Warranty	RelatedWarranty	<ol style="list-style-type: none"> 1 Id 2 Integration Id 3 Warranty Name, Warranty Provider Name, Warranty Provider Primary Organization, Warranty Provider Site

Table 92 lists the fields and their attributes.

Table 92. Siebel Simple Product ASI Fields

Name	XML Tag	Data Type	Length	Req.
Internal Product				
Allocate Below Safety Flag	AllocateBelowSafetyFlag	DTYPE_TEXT	30	No
Auto Allocate Flag	AutoAllocateFlag	DTYPE_TEXT	30	No
Auto Substitute Flag	AutoSubstituteFlag	DTYPE_TEXT	30	No
Class Id	ClassId	DTYPE_ID	NA	No
Class Integration Id	ClassIntegrationId	DTYPE_TEXT	30	No
Class Name	ClassName	DTYPE_TEXT	75	No
Class Type	ClassType	DTYPE_TEXT	30	No
Compensable	CompensableFlag	DTYPE_TEXT	NA	No
Description	Description	DTYPE_TEXT	255	No
Division Code	DivisionCode	DTYPE_TEXT	30	No
Effective End Date	EffectiveEndDate	DTYPE_DATETIM E	NA	No

Table 92. Siebel Simple Product ASI Fields

Name	XML Tag	Data Type	Length	Req.
Effective Start Date	EffectiveStartDate	DTYPE_DATETIME	NA	No
Field Replacable	FieldReplacable	DTYPE_TEXT	NA	No
Global Assembly Level Code	GlobalAssemblyLevelCode	DTYPE_TEXT	50	No
Global Product Classification Code	GlobalProductClassificationCode	DTYPE_TEXT	50	No
Global Product Identifier	GlobalProductIdentifier	DTYPE_TEXT	50	No
Global Product Lifecycle Status Code	GlobalProductLifecycleStatusCode	DTYPE_TEXT	50	No
Global Supply Chain Code	GlobalSupplyChainCode	DTYPE_TEXT	50	No
Id	Id	DTYPE_ID	30	No
Image Name	ImageName	DTYPE_TEXT	100	No
Image Primary Organization Name	ImagePrimaryOrganizationName	DTYPE_TEXT	100	No
Image File Name	ImageFileName	DTYPE_TEXT	200	No
Integration Id	IntegrationId	DTYPE_TEXT	30	No
IsAdminMode	IsAdminMode	DTYPE_TEXT	NA	No
Item Size	ItemSize	DTYPE_NUMBER	NA	No
Lead Time	LeadTime	DTYPE_TEXT	30	No
MTBF	MTBF	DTYPE_NUMBER	NA	No
MTRR	MTRR	DTYPE_NUMBER	NA	No
Maximum Quantity	MaximumQuantity	DTYPE_NUMBER	NA	No
Minimum Quantity	MinimumQuantity	DTYPE_NUMBER	NA	No
Orderable	Orderable	DTYPE_TEXT	NA	No
Parent Internal Product Id (Joined)	ParentInternalProductId	DTYPE_ID	NA	No

Table 92. Siebel Simple Product ASI Fields

Name	XML Tag	Data Type	Length	Req.
Parent Internal Product Integration Id	ParentInternalProductIntegrationId	DTYPE_TEXT	30	No
Parent Internal Product Name	ParentInternalProductName	DTYPE_TEXT	100	No
Parent Internal Product Primary Organization	ParentInternalProductPrimaryOrganization	DTYPE_TEXT	100	No
Parent Internal Product Vendor	ParentInternalProductVendor	DTYPE_TEXT	100	No
Parent Internal Product Vendor Location	ParentInternalProductVendorLocation	DTYPE_TEXT	50	No
Parent Internal Product Vendor Organization	ParentInternalProductVendorOrganization	DTYPE_TEXT	100	No
Part Number	PartNumber	DTYPE_TEXT	50	No
Price Type	PriceType	DTYPE_TEXT	NA	No
Primary Organization	PrimaryOrganization	DTYPE_TEXT	50	No
Primary Vendor	PrimaryVendor	DTYPE_TEXT	100	No
Product Image Id	ProductImageId	DTYPE_ID	NA	No
Product Image Integration Id	ProductImageIntegrationId	DTYPE_TEXT	30	No
Product Level	ProductLevel	DTYPE_NUMBER	NA	No
Product Name	ProductName	DTYPE_TEXT	100	No
Product Type	ProductType	DTYPE_TEXT	30	No
Return if Defective	ReturnifDefective	DTYPE_TEXT	NA	No
Revision	Version	DTYPE_TEXT	30	No
Sales Product	SalesProduct	DTYPE_TEXT	NA	No
Serialized	Serialized	DTYPE_TEXT	NA	No
Service Product	ServiceProduct	DTYPE_TEXT	30	No
Service Type	ServiceType	DTYPE_TEXT	NA	No

Table 92. Siebel Simple Product ASI Fields

Name	XML Tag	Data Type	Length	Req.
Ship Carrier	Carrier	DTYPE_TEXT	30	No
Shipping Via	ShippingVia	DTYPE_TEXT	30	No
Status	Status	DTYPE_TEXT	30	No
Targeted Country	TargetedCountry	DTYPE_TEXT	250	No
Targeted Industry	TargetedIndustry	DTYPE_TEXT	250	No
Targeted Max Age	TargetedMaxAge	DTYPE_NUMBER	NA	No
Targeted Min Age	TargetedMinAge	DTYPE_NUMBER	NA	No
Targeted Postal Code	TargetedPostalCode	DTYPE_TEXT	250	No
Tool Flag	ToolFlag	DTYPE_TEXT	NA	No
Unit of Measure	UnitofMeasure	DTYPE_TEXT	30	No
Units In Inventory	UnitsInInventory	DTYPE_NUMBER	NA	No
Units In Inventory As Of	UnitsInInventoryAsOf	DTYPE_TEXT	NA	No
Vendor Id	VendorId	DTYPE_ID	NA	No
Vendor Integration Id	VendorIntegrationId	DTYPE_TEXT	30	No
Vendor Part Number	VendorPartNumber	DTYPE_TEXT	50	No
Vendor Primary Organization	VendorPrimaryOrganization	DTYPE_TEXT	100	No
Vendor Site	VendorSite	DTYPE_TEXT	50	No
operation	operation	DTYPE_TEXT	30	No
searchspec	searchspec	DTYPE_TEXT	250	No
FS Inventory Options				
Allocate Below Safety Flag	AllocateBelowSafetyFlag	DTYPE_TEXT	30	No
Auto AllocateFlag	AutoAllocateFlag	DTYPE_TEXT	30	No

Table 92. Siebel Simple Product ASI Fields

Name	XML Tag	Data Type	Length	Req.
Auto Substitute Flag	AutoSubstituteFlag	DTYPE_TEXT	30	No
Class ABC	ClassABC	DTYPE_TEXT	30	No
Class XYZ	ClassXYZ	DTYPE_TEXT	30	No
Id	Id	DTYPE_ID	30	No
Integration Id	IntegrationId	DTYPE_TEXT	30	No
Inventory Type	InventoryType	DTYPE_TEXT	30	No
Product Name	ProductName	DTYPE_TEXT	100	No
operation	operation	DTYPE_TEXT	30	No
searchspec	searchspec	DTYPE_TEXT	250	No
Internal Product_Equivalent Product				
Equivalent Product	EquivalentProduct	DTYPE_TEXT	100	No
Equivalent Product Primary Organization	EquivalentProductPrimaryOrganization	DTYPE_TEXT	50	No
Equivalent Product Vendor	EquivalentProductVendor	DTYPE_TEXT	100	No
Equivalent Product Vendor Location	EquivalentProductVendorLocation	DTYPE_TEXT	50	No
Equivalent Product Vendor Organization	EquivalentProductVendorOrganization	DTYPE_TEXT	100	No
Id	Id	DTYPE_ID	30	No
Integration Id	IntegrationId	DTYPE_TEXT	30	No
IsPrimaryMVG	IsPrimaryMVG	DTYPE_TEXT	1	No
operation	operation	DTYPE_TEXT	30	No
searchspec	searchspec	DTYPE_TEXT	250	No
FS Inventory Location				
Id	Id	DTYPE_ID	30	No
Integration Id	IntegrationId	DTYPE_TEXT	30	No
Inventory Name	InventoryName	DTYPE_TEXT	100	No

Table 92. Siebel Simple Product ASI Fields

Name	XML Tag	Data Type	Length	Req.
Primary Organization Name	PrimaryOrganizationName	DTYPE_TEXT	100	No
operation	operation	DTYPE_TEXT	30	No
searchspec	searchspec	DTYPE_TEXT	250	No
Internal Product_Organization				
Id	Id	DTYPE_ID	30	No
Integration Id	IntegrationId	DTYPE_TEXT	30	No
IsPrimaryMVG	IsPrimaryMVG	DTYPE_TEXT	1	No
Organization	Organization	DTYPE_TEXT	50	No
operation	operation	DTYPE_TEXT	30	No
searchspec	searchspec	DTYPE_TEXT	250	No
Internal Product_Related Product				
Id	Id	DTYPE_ID	30	No
Integration Id	IntegrationId	DTYPE_TEXT	30	No
IsPrimaryMVG	IsPrimaryMVG	DTYPE_TEXT	1	No
Organization	Organization	DTYPE_TEXT	50	No
Product Name	ProductName	DTYPE_TEXT	100	No
Vendor	Vendor	DTYPE_TEXT	100	No
Vendor Location	VendorLocation	DTYPE_TEXT	50	No
operation	operation	DTYPE_TEXT	30	No
searchspec	searchspec	DTYPE_TEXT	250	No
Internal Product_Admin Product Line				
Id	Id	DTYPE_ID	30	No
Integration Id	IntegrationId	DTYPE_TEXT	30	No
IsPrimaryMVG	IsPrimaryMVG	DTYPE_TEXT	1	No
Product Line	ProductLine	DTYPE_TEXT	100	No
operation	operation	DTYPE_TEXT	30	No
searchspec	searchspec	DTYPE_TEXT	250	No
Sales Tool by Product				
Id	Id	DTYPE_ID	30	No

Table 92. Siebel Simple Product ASI Fields

Name	XML Tag	Data Type	Length	Req.
Integration Id	IntegrationId	DTYPE_TEXT	30	No
LitFileName	LitFileName	DTYPE_TEXT	220	No
Name	Name	DTYPE_TEXT	50	No
Primary Organization	PrimaryOrganization	DTYPE_TEXT	50	No
operation	operation	DTYPE_TEXT	30	No
searchspec	searchspec	DTYPE_TEXT	250	No
FS Warranty				
Id	Id	DTYPE_ID	30	No
Integration Id	IntegrationId	DTYPE_TEXT	30	No
Warranty Name	WarrantyName	DTYPE_TEXT	100	No
Warranty Provider Name	WarrantyProviderName	DTYPE_TEXT	100	No
Warranty Provider Primary Organization	WarrantyProviderPrimaryOrganization	DTYPE_TEXT	100	No
Warranty Provider Site	WarrantyProviderSite	DTYPE_TEXT	50	No
operation	operation	DTYPE_TEXT	30	No
searchspec	searchspec	DTYPE_TEXT	250	No

Trouble Ticketing Management

Trouble Ticketing Management uses a single ASI, Trouble Ticket, to enable the submission and processing of trouble tickets and the update of trouble ticket line items.

Siebel Trouble Ticket

The Oracle's Siebel Trouble Ticket ASI enables the use of a trouble ticket in the Siebel application to create, request, and update the external application with trouble ticket data when the external application has detected an outage or network fault.

Figure 44 describes the Siebel Trouble Ticket ASI structure.

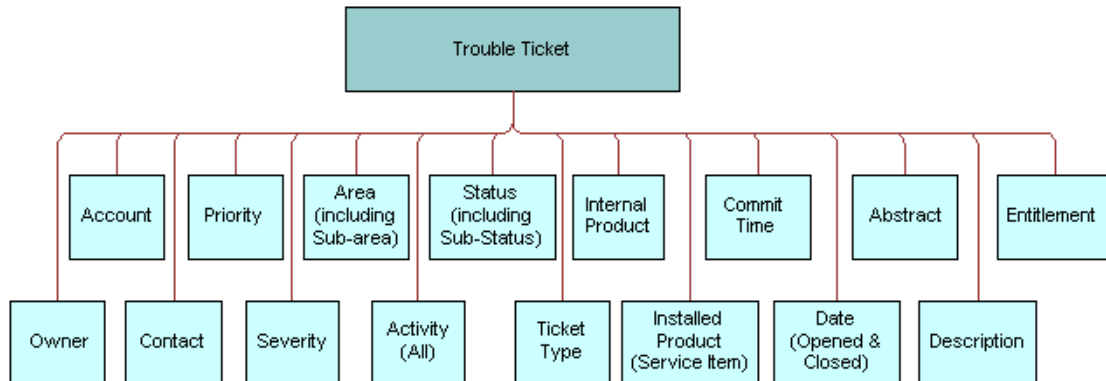

Figure 44. Siebel Trouble Ticket ASI

Table 93 lists the integration components and XML tags of this ASI.

Table 93. Siebel Trouble Ticket ASI Integration Components

Integration Component	XML Tag	User Keys
Related Service Request_ Service Elements	RelatedServiceRequest_ServiceElements	1 Service Element Id
Related Service Request	RelatedServiceRequest	1 Integration Id 2 Id
Service Request_Service Elements	ServiceRequest_ServiceElements	1 Service Element Id
Service Request	ServiceRequest	1 Id 2 Integration Id

Table 94 lists the fields and their attributes.

Table 94. Siebel Trouble Ticket ASI Fields

Name	XML Tag	Data Type	Length	Req.
Related Service Request_Service Elements				
IsPrimaryMVG	IsPrimaryMVG	DTYPE_TEXT	1	No
Service Element Id	ServiceElementId	DTYPE_ID	30	No
operation	operation	DTYPE_TEXT	30	No
searchspec	searchspec	DTYPE_TEXT	250	No

Table 94. Siebel Trouble Ticket ASI Fields

Name	XML Tag	Data Type	Length	Req.
Related Service Request				
Abstract	Abstract	DTYPE_TEXT	100	No
Account Id	AccountId	DTYPE_ID	Not applicable	No
Area	Area	DTYPE_TEXT	30	No
Closed Date	ClosedDate	DTYPE_TEXT	Not applicable	No
Commit Time	CommitTime	DTYPE_TEXT	Not applicable	No
Contact Id	ContactId	DTYPE_ID	Not applicable	No
Created	Created	DTYPE_DATETIME	30	No
Customer Ref Number	CustomerRefNumber	DTYPE_TEXT	64	No
Description	Description	DTYPE_TEXT	2000	No
Entitlement Id	EntitlementId	DTYPE_ID	Not applicable	No
Id	Id	DTYPE_ID	30	No
Integration Id	IntegrationId	DTYPE_TEXT	30	No
Owned By Id	OwnedById	DTYPE_ID	Not applicable	No
Priority	Priority	DTYPE_TEXT	30	No
Service Point Asset Id	ServicePointAssetId	DTYPE_TEXT	15	No
Severity	Severity	DTYPE_TEXT	30	No
Status	Status	DTYPE_TEXT	30	Yes
Sub-Area	Sub-Area	DTYPE_TEXT	30	No
Sub-Status	Sub-Status	DTYPE_TEXT	30	Yes
TT Source	TTSrc	DTYPE_TEXT	30	No
Ticket Type	TicketType	DTYPE_TEXT	30	No
operation	operation	DTYPE_TEXT	30	No
searchspec	searchspec	DTYPE_TEXT	250	No
Service Request				
Abstract	Abstract	DTYPE_TEXT	100	No
Account Id	AccountId	DTYPE_ID	Not applicable	No
Area	Area	DTYPE_TEXT	30	No
Closed Date	ClosedDate	DTYPE_TEXT	Not applicable	No
Commit Time	CommitTime	DTYPE_TEXT	Not applicable	No
Contact Id	ContactId	DTYPE_ID	Not applicable	No

Table 94. Siebel Trouble Ticket ASI Fields

Name	XML Tag	Data Type	Length	Req.
Created	Created	DTYPE_DATETIME	30	No
Customer Ref Number	CustomerRefNumber	DTYPE_TEXT	64	No
Description	Description	DTYPE_TEXT	2000	No
Entitlement Id	EntitlementId	DTYPE_ID	Not applicable	No
Id	Id	DTYPE_ID	30	No
Integration Id	IntegrationId	DTYPE_TEXT	30	No
Opened Date	OpenedDate	DTYPE_TEXT	Not applicable	Yes
Owned By Id	OwnedById	DTYPE_ID	Not applicable	No
Priority	Priority	DTYPE_TEXT	30	No
Service Point Asset Id	ServicePointAssetId	DTYPE_TEXT	15	No
Severity	Severity	DTYPE_TEXT	30	No
Status	Status	DTYPE_TEXT	30	Yes
Sub-Area	Sub-Area	DTYPE_TEXT	30	No
Sub-Status	Sub-Status	DTYPE_TEXT	30	No
TT Source	TTSrc	DTYPE_TEXT	30	No
Ticket Type	TicketType	DTYPE_TEXT	30	No
operation	operation	DTYPE_TEXT	30	No
searchspec	searchspec	DTYPE_TEXT	250	No
Service Request_Service Elements				
IsPrimaryMVG	IsPrimaryMVG	DTYPE_TEXT	1	No
Service Element Id	ServiceElementId	DTYPE_ID	30	No
operation	operation	DTYPE_TEXT	30	No
searchspec	searchspec	DTYPE_TEXT	250	No

Index

A

- Account Balance Request ASI** 244
- Account Balance Response ASI** 244
- Account Interface ASI** 220
- ANI Message Header ASI**
 - ASI fields 120
 - integration components 120
- ANI Opportunity Message ASI**
 - ASI fields 114
 - integration components 110
- Application Services Interfaces (ASI)**
 - authentication and security, about 26
 - defined and format 9
 - exposing, about 24
 - extending 31
 - extending, user scenario 37
 - External Credit Check ASI 174
 - External Opportunity Create/External Opportunity Query/External Opportunity Update ASI 109
 - External Shipment Tracking ASI 177
 - inbound ASI example 11
 - inbound ASI, about 9
 - outbound ASI example 12
 - outbound ASI, about 10
 - prebuilt, table of 40
 - Siebel Account ASI 41
 - Siebel Action ASI 55
 - Siebel Asset ASI 64
 - Siebel ATP Response/External ATP Check ASI 166
 - Siebel Business Address ASI 61
 - Siebel Contact ASI 68
 - Siebel Cost List ASI 75
 - Siebel CUT Address MSAG Service ASI 74
 - Siebel Employee ASI 78
 - Siebel Financial Account ASI 91
 - Siebel Forecast ASI 96
 - Siebel Invoice Adjustment ASI 237
 - Siebel Invoice ASI 99
 - Siebel Order ASI 130
 - Siebel Personal Address ASI 63
 - Siebel Position ASI 147
 - Siebel Price List ASI 148
 - Siebel Quote/External Quote ASI 151
 - Siebel Service Request ASI 185
 - Siebel SIA Service Request ASI 182

- Siebel Simple Product ASI 189

Application Services Interfaces (ASI) structure

- Application Services Interfaces (ASI) 14
- components and fields 14
- components, about picking related 15
- data mapping, implicit 17
- defined and structure example 13
- integration objects and instance diagram 14
- integration objects, about and sample 13
- List of Value fields, about 14
- user keys, about 15

ASI Framework

- about 31
- ASI, extending 31
- customized workflow example 32
- Data Map, defining 37
- external interface, defining 35
- inbound interface, defining 34

asynchronous processing, creating 29

authentication, for ASIs 26

automatic mapping

- about 19
- upgrading data maps, about 19

B

batch processing, creating 29

Billing Management ASIs

- about 230
- CUT Account Balance Interface - Request Integration Object ASI 243
- CUT Account Balance Interface - Response Integration Object ASI 244
- Siebel Invoice ASI 230
- Siebel Meter Reading ASI 245
- Siebel Meter Usage Data ASI 246
- Siebel Trouble Ticket ASI 259

business service user properties, about and table of 22

C

CME ASIs, prebuilt

- Billing Management ASIs 230
- Customer Lifecycle Management ASI 220
- CUT Account Balance Interface - Request Integration Object ASI 243

- CUT Account Balance Interface - Response
 - Integration Object ASI 244
 - Order Management ASI 201
 - Siebel Account ASI 220
 - Siebel Invoice ASI 230
 - Siebel Meter Reading ASI 245
 - Siebel Meter Usage Data ASI 246
 - Siebel Order ASI 201
 - Siebel Simple Product ASI 251
 - Siebel Trouble Ticket ASI 259
 - table of 200
 - Trouble Ticketing Management ASI 259
 - Communications, Media, and Energy ASIs**
 - See CME ASIs, prebuilt
 - components**
 - deactivating 28
 - defined 14
 - picking related, about 15
 - configuring**
 - inbound data synchronization ASI 27
 - outbound ASI 28
 - Credit Check Request ASI**
 - about and diagram 174
 - ASI fields 175
 - integration components 174
 - Credit Check Response ASI 177**
 - customer information management-related business processes 220**
 - Customer Lifecycle Management ASI 220**
 - Customer Order Lifecycle business process**
 - Siebel Asset ASI 64
 - Siebel Business Address ASI 61
 - Siebel Personal Address ASI 63
 - CUT Account Balance Interface - Request Integration Object ASI**
 - about and diagram 243
 - fields and attributes 244
 - integration components and XML tags 244
 - structure and field definitions 243
 - CUT Account Balance Interface - Response Integration Object ASI**
 - about and diagram 244
 - fields and attributes 245
 - integration components and XML tags 244
 - CUT Payment Interface Integration Object ASI**
 - about and diagram 241
 - fields and attributes 242
 - integration components and XML tags 241
- D**
- Data Map**
 - cache, purging 32
 - defining the data map 37
 - data mapping**
 - automatic mapping, about 19
 - data synchronization, within 16
 - explicit data mapping, about 18
 - implicit data mapping, about 17
 - upgrading data maps, about 19
 - data synchronization services**
 - about 15
 - data mapping and synchronization 16
 - data mapping, implicit 17
 - methods, arguments (table) 21
 - methods, table of 19
 - Destination Channel Partner ASI**
 - ASI fields 127
 - integration components 126
- E**
- EAI Framework, using to expose ASIs 24**
 - Employee Management business integration application**
 - Siebel CUT Address MSAG Service ASI 74
 - error messages**
 - inbound error handling 25
 - integration objects, about returning 22
 - outbound error handling 26
 - explicit mapping**
 - about 18
 - upgrading data maps, about 19
 - External Credit Check ASI**
 - about 174
 - Credit Check Request ASI 174
 - Credit Check Response ASI 177
 - External Opportunity Create/External Opportunity Query/External Opportunity Update ASI**
 - about and diagram 109
 - ANI Message Header (PRM ANI) ASI 120
 - ANI Opportunity Message (PRM ANI) ASI 110
 - Destination Channel Partner (PRM ANI) ASI 126
 - Opportunity (PRM ANI) ASI 121
 - Opportunity Account (PRM ANI) ASI 128
 - Source Organization (PRM ANI) ASI 127
 - External Shipment Tracking ASI**
 - about 177
 - Shipment Tracking Interface Request ASI 178
 - Shipment Tracking Interface Response ASI 179

F**fields**

- about 14
- deactivating 28
- deactivating fields example 29

foreign key, about using to pick related components 15**I****implementation, specifying 30****inbound ASI**

- component or field, deactivating 28
- configuring 27
- defined and use of 9
- error message handling 25
- example 11
- exposing example 30
- outbound ASI 11

information protocols, about using to make ASIs externally available 24**integration objects**

- about and sample 13
- instance diagram 14

interfaces

- Data Map, defining 37
- external interfaces, defining 35
- inbound interfaces, defining 34

Invoice Interface ASI 230**L****List of Value fields, about 14****M****methods**

- arguments, table of 21
- business service user properties, about and table of 22
- data synchronization, table of 19
- error messages, about returning 22
- status key, about and recommended keys 21
- XML method example 23

O**Opportunity Account ASI**

- ASI fields 129
- integration components 128

Opportunity ASI

- ASI fields 123

Order Management ASI 201

- Siebel Interface ASI 201

outbound ASI

- component of field, deactivating 28

- configuring 28
- defined and use of 10
- defining, user scenario 37
- error message handling 26
- example 12
- inbound ASI 10

P**Payment Interface ASI 241****prebuilt CME ASIs**

- Billing Management ASIs 230
- Customer Lifecycle Management ASI 220
- CUT Account Balance Interface - Request Integration Object ASI 243
- CUT Account Balance Interface - Response Integration Object ASI 244
- Order Management ASI 201
- Siebel Account ASI 220
- Siebel Invoice ASI 230
- Siebel Meter Reading ASI 245
- Siebel Meter Usage Data ASI 246
- Siebel Order ASI 201
- Siebel Simple Product ASI 251
- Siebel Trouble Ticket ASI 259
- table of 200

- Trouble Ticketing Management ASI 259

predefined, Application Service Interfaces (ASI)

- ANI Message Header (PRM ANI) ASI 120
- ANI Opportunity Message (PRM ANI) ASI 110
- Credit Check ASI 174
- Credit Check Response ASI 177
- Destination Channel Partner (PRM ANI) ASI 126
- External Credit Check ASI 174
- External Opportunity Create/External Opportunity Query/External Opportunity Update ASI 109
- External Shipment Tracking ASI 177
- Opportunity (PRM ANI) ASI 121
- Opportunity Account (PRM ANI) ASI 128
- Shipment Tracking Interface Request ASI 178
- Shipment Tracking Interface Response ASI 179
- Siebel Account ASI 41
- Siebel Action ASI 55
- Siebel Asset ASI 64
- Siebel ATP Response/External ATP Check ASI 166
- Siebel Business Address ASI 61
- Siebel Contact ASI 68

- Siebel Cost List ASI 75
- Siebel CUT Address MSAG Service ASI 74
- Siebel Employee ASI 78
- Siebel Forecast ASI 91, 96
- Siebel Invoice Adjustment ASI 237
- Siebel Invoice ASI 99
- Siebel Order ASI 130
- Siebel Personal Business Address ASI 63
- Siebel Position ASI 147
- Siebel Price List ASI 148
- Siebel Quote/ External Quote ASI 151
- Siebel Service Request ASI 185
- Siebel Simple Product ASI 189
- Source Organization (PRM ANI) ASI 127
- table of 40

processing

- asynchronous processing 29
- batch processing 29

Product and Pricing Administration ASIs

- Siebel Simple Product ASI 251

protocols, about and table of 24**S****scenarios**

- ASI, extending 37
- deactivating fields 29
- implementation, specifying 30
- inbound ASI, exposing 30
- outbound ASI, defining 37

security, for ASIs 26**Shipment Tracking Interface Request****ASI 178**

- about 178
- ASI Fields 178
- integration components 178

Shipment Tracking Interface Response**ASI 179**

- about and diagram 179
- ASI fields 180
- integration components 179

Siebel Account ASI

- about and diagram 41
- ASI fields 43
- Customer Lifecycle Management 220
- fields and attributes 222
- integrated components 42
- integration components and XML tags 221
- predefined, Application Service Interfaces (ASI) 41

Siebel Action ASI

- about and diagram 55
- ASI fields 56
- integration components 56

Siebel Action Business Component 55**Siebel Asset ASI**

- about and diagram 64
- ASI fields 65
- integrated components 65

Siebel ATP Response/External ATP Check ASI

- about and diagram 166
- ASI fields 167
- integration components 166

Siebel Business Address ASI

- about and diagram 61
- ASI fields 62
- integrated components 62

Siebel Contact ASI

- about and diagram 68
- ASI fields 69
- integration components 68

Siebel Cost List ASI

- about and diagram 75
- ASI fields 76
- integration components 76

Siebel CUT Address MSAG Service ASI

- about and diagram 74
- ASI fields 74
- integration components 74

Siebel Employee ASI

- about and diagram 78
- ASI fields 81
- integration components 79

Siebel Financial Account ASI

- about and diagram 91
- ASI fields 92
- integration components 91

Siebel Forecast ASI

- about and diagram 96
- ASI fields 97
- integration components 97

Siebel Invoice Adjustment ASI

- about and diagram 237
- ASI fields 238
- integration components 238

Siebel Invoice ASI

- about and diagram 99, 230
- ASI fields 100, 238
- billing management 230
- fields and attributes 231
- integration components 99
- integration components and XML tags 231
- predefined, Application Service Interfaces (ASI) 99

Siebel Meter Reading ASI

- about and diagram 245
- fields and attributes 246

- integration components and XML tags 245
 - structure and field definitions 245
 - Siebel Meter Usage Data ASI**
 - about and diagram 246
 - fields and attributes 247
 - integration components and XML tags 247
 - structure, and field definitions 246
 - Siebel Order ASI**
 - about and diagram 130
 - ASI fields 132
 - CME ASIs, prebuilt 201
 - fields and attributes 203
 - integration components 130
 - integration components and XML tags 202
 - predefined, Application Service Interfaces (ASI) 130
 - Siebel Payment ASI**
 - about and diagram 249
 - ASI fields 249
 - integration components 249
 - Siebel Personal Address ASI**
 - about and diagram 63
 - ASI fields 63
 - integration components 63
 - Siebel Position ASI**
 - about and diagram 147
 - ASI fields 148
 - integration components 147
 - Siebel Price List ASI**
 - about and diagram 148
 - ASI fields 149
 - integration components 149
 - Siebel Quote/External Quote ASI**
 - about and diagram 151
 - ASI fields 153
 - integration components 152
 - Siebel Service Request ASI**
 - about and diagram 185
 - ASI fields 186
 - integration components 186
 - Siebel SIA Service Request ASI**
 - about and diagram 182
 - fields and attributes 183
 - integration components 183
 - Siebel Simple Product ASI**
 - about and diagram 189
 - ASI fields 191
 - CME ASIs, prebuilt 251
 - fields and attributes 253
 - integration components 190
 - integration components and XML tags 252
 - predefined, Application Service Interfaces (ASI) 189
 - Siebel Trouble Ticket ASI**
 - about and diagram 259
 - fields and attributes 260
 - integration components and XML tags 260
 - structure and field definitions 259
 - Source Organization ASI**
 - ASI fields 128
 - integration components 127
 - status key, about and recommended keys 21**
- T**
- Trouble Ticketing Management ASI 259**
- U**
- user keys, about 15**
 - user properties, about and table of 22**
 - user scenarios**
 - ASI, extending 37
 - deactivating fields 29
 - implementation, specifying 30
 - inbound ASI, exposing 30
 - outbound ASI, defining 37
- W**
- Web services**
 - ASIs, about making externally available 24
 - inbound error handling 25
 - outbound error handling 26
 - protocols, about and table of 24
 - workflow, customized example 32**
- X**
- XML method, example 23**

