

Oracle Communications Diameter Signaling Router

Release 7.1 Feature Guide

ORACLE WHITE PAPER | OCTOBER 2015



Table of Contents

List of Terms	8
INTRODUCTION TO DIAMETER SIGNALING ROUTER	10
Diameter Routing Challenges	10
Diameter Signaling Router Solution	12
DSR FEATURES AND FUNCTIONS	13
Overview	13
Operations, Administration and Maintenance	14
Diameter Agent Message Processor (DA MP)	15
SS7 Message Processor (SS7 MP)	15
IP Front End (IPFE)	15
Session / Subscriber Binding Repository (SBR)	15
Subscriber Data Server (SDS)	16
Database Processor (DP)	16
Query Server (QS)	17
Integrated Diameter Intelligence Hub (IDIH)	17
DSR Nodes (Identity)	17
Diameter Core Routing	18
Extended Command Codes (ECC)	22
Routing and Transaction Related Parameters in the DSR	23
Peer Routing Table (PRT)	24
Application Routing Table (ART)	25

Routing Option Sets	26
Pending Answer Timer (PAT)	26
Transport	27
Message Priority Configuration Set (MPCS)	29
IPSec	30
TLS / DTLS	30
Connectivity Enhancements	30
Configurable Disable of CEx Peer IP Validation	30
Congestion Control	30
DNS Support	42
Diameter Mediation	42
Rule Templates and Rules	43
States of a Rule Template	44
Trigger Points	44
Measurements Associated with Rules	44
AVP Dictionaries	45
IP Front End (IPFE)	45
Traffic Distribution	45
High availability	47
Topology Hiding	47
Path Topology Hiding	47
S6a/S6d MME/SGSN Topology Hiding	50
S6a/S6d HSS Topology Hiding	52

S9 PCRF Topology Hiding	55
S9 AF/pCSCF Topology Hiding	55
DSR Applications	56
Offline Charging Proxy (OFCS)	56
Range Based Address Resolution (RBAR)	57
Full Address Based Resolution (FABR)	57
MAP-Diameter IWF	59
Policy and Charging Application (PCA)	59
Gateway Location Application (GLA)	69
Diameter Message Copy	71
Integrated Diameter Intelligence Hub (IDIH)	71
Network IDIH (N-IDIH)	72
Supported Interfaces	73
Flexible IP Addressing	74
Full IPV6 Support	74
Subscriber Data Server (SDS) Integration	75
Bulk Import/Export	76
High-Availability	76
Capacity and Performance	77
DSR OAM&P	77
Overview	77
Network Interfaces	77
Web-Based GUI	78



Operations and Provisioning	78
Network Information	78
Network Elements	78
Maintenance	78
Alarms and Events	79
Key Performance Indicators	79
Measurements	80
DSR Dashboard	83
Automatic Performance Data Export (APDE)	85
Administration	85
Database Management	86
File Management	86
Security	86

FIGURE 1 - SELECTED DIAMETER INTERFACES IN LTE AND IMS	10
FIGURE 2 - 3GPP INTER/INTRA-OPERATOR DIAMETER INFRASTRUCTURE	11
FIGURE 3 - GSMA ROAMING IMPLEMENTATION ARCHITECTURE	12
FIGURE 4 – EXAMPLE OF OPERATOR’S EPC/IMS CORE NETWORK WITH DSR	13
FIGURE 5 - DSR 7.X ARCHITECTURE	14
FIGURE 6 - MULTIPLE NODES PER MESSAGE PROCESSOR	18
FIGURE 7 - HIGH LEVEL MESSAGE PROCESSING AND ROUTING IN DSR	19
FIGURE 8 - CONNECTION ROUTE GROUP	20
FIGURE 9 - ROUTE LIST, ROUTE GROUP, PEER RELATIONSHIP EXAMPLE	21
FIGURE 10 - LOAD BALANCING BASED ON ROUTE GROUPS AND PEER WEIGHTS	22
FIGURE 11 SCTP MULTI-HOMING	29
FIGURE 12 - SCTP MULTI-HOMING VIA PORT BONDING	29
FIGURE 13 - DSR INGRESS MPS CONFIGURATION EXAMPLE 1 - NORMAL CASE.....	32
FIGURE 14 - MESSAGE COLORING AND PRIORITY/COLOR-BASED DA-MP OVERLOAD CONTROL	33
FIGURE 15 – EXAMPLE CONGESTION LEVEL ABATEMENT	36
FIGURE 16 - DSR PER-CONNECTION EGRESS THROTTLING	37
FIGURE 17 - DSR AGGREGATE AND PER-CONNECTION EGRESS THROTTLING	38
FIGURE 18 - 2 DSR SITES: COORDINATED EGRESS THROTTLING EXAMPLE	39
FIGURE 19 - CONNECTION BUSY	41
FIGURE 20 - CONGESTION LEVEL ABATEMENT OVER TIME FOR REMOTE BUSY.....	42
FIGURE 21 - IPFE INITIATOR + RESPONDER SUPPORT.....	46
FIGURE 22 - PROXY-HOST TOPOLOGY HIDING MESSAGE FLOW	50
FIGURE 23 - MME/SGSN TOPOLOGY HIDING.....	51
FIGURE 24 - S6A/S6D HSS TOPOLOGY HIDING - ULR MESSAGE FLOW.....	54
FIGURE 25 - S6A/S6D HSS TOPOLOGY HIDING CLR MESSAGE FLOW.....	55
FIGURE 26 - CHARGING PROXY NETWORK ARCHITECTURE	57
FIGURE 27 - DSR WITH MAP-DIAMETER IWF.....	59
FIGURE 28 - ONLINE CHARGING SYSTEM AND ARCHITECTURE	60
FIGURE 29: A TYPICAL ONLINE CHARGING SESSION.....	61



FIGURE 30 – NETWORK VIEW OF P-DRA MATED PAIRS	63
FIGURE 31 - OVERALL PCC LOGICAL ARCHITECTURE (NON-ROAMING).....	64
FIGURE 32 - PCRF TOPOLOGY HIDING.....	66
FIGURE 33 - RELATIONSHIP BETWEEN APNS AND PCRF POOLS	67
FIGURE 34 - RELATIONSHIP BETWEEN IMSIS AND PCRF POOLS.....	68
FIGURE 35 - PCA EXAMPLE DEPLOYMENT	69
FIGURE 36 - IMSI QUERY WITH SINGLE MATCHING GX SESSION USE CASE	69
FIGURE 37 - PCA AND GLA NOAM ARCHITECTURE.....	70
FIGURE 38 - MESSAGE COPY OVERVIEW.....	71
FIGURE 39 - IDIH TRACE DATA	72
FIGURE 40 - MESSAGE FLOW FOR NETWORK WIDE TRACE	73
FIGURE 41 - SUBSCRIBER DATA SERVER ARCHITECTURE.....	75
FIGURE 42 - DSR 3-TIERED TOPOLOGY ARCHITECTURE.....	77
FIGURE 43 FLOW OF ALARMS.....	79
FIGURE 44: DSR DASHBOARD ON THE NOAM	83



List of Tables

TABLE 1: MODIFIED ROUTING AND TRANSACTION PARAMETER SELECTION PRECEDENCE ORDER.....	23
TABLE 2: PRT PRECEDENCE	25
TABLE 2 DSR INGRESS MPS CONFIGURATION EXAMPLE 1	32
TABLE 3 CONGESTION LEVELS BASED ON REMOTE BUSY.....	41
TABLE 4 MME/SGSN PSEUDO-HOST NAME MAPPING	52
TABLE 5 DSR KPI SUMMARY	80
TABLE 6 PLATFORM KPI SUMMARY.....	80
TABLE 7 DSR MEASUREMENTS	81

List of Terms

Acronym	Meaning
ACL	Access Control List
APDE	Automatic Performance Data Export
AVP	Attribute Value Pair
CLI	Command Line Interface
DA	Diameter Agent
DA-MP	Diameter Agent Message Processor
DAS	Diameter Application Server
DEA	Diameter Edge Agent
DIH	Diameter Intelligence Hub
DNS	Domain Name Server
DP	Database Processor
DR	Disaster Recovery
DTLS	Datagram Transport Layer Security
ECC	Extended Command Code
EMS	Element Management System
EPC	Evolved Packet Core
FQDN	Fully Qualified Domain Name
GLA	Gateway Location Application
GUI	Graphical User Interface
HSS	Home Subscriber Server
IDIH	Integrated Diameter Intelligence Hub
ILO	Integrated Lights Out
IMI	Internal Management Interface
IMS	IP Multi-media System
IOT	Interoperability Tests
IWF	Interworking Function
KPI	Key Performance Indicator
LTE	Long Term Evolution
MEAL	Measurements, Events, Alarms, and Logging
MME	Mobility Management Entity
MP	Message Processor
MPS	Messages per Second

M-D IWF	Map to Diameter Interworking Framework
NAI	Network Access Identifier
NE	Network Element
NMS	Network Management System
OAM	Operations, Administration, Maintenance
OAM&P	Operations, Administration, Maintenance and Provisioning
OC-DRA	Online Charging Diameter Routing Agent
OCF	On-line Charging Function
OFCF	Off-line Charging Function
PAT	Pending Answer Timer
PCA	Policy and Charging Application
PCRF	Policy Control and Charging Rules Function
P-CSCF	Proxy-Call Session Control Function
P-DRA	Policy Diameter Routing Agent
PDU	Protocol Data Unit
PM&C	Platform, Management, and Control
QS	Query Server
ROS	Routing Option Set
SBR	Session Binding Repository
SDS	Subscriber Data Server
SLF	Subscriber Location Function
SS7 MP	Signaling System 7 Message Processor
TLS	Transport Layer Security
VIP	Virtual IP Address
XMI	External Management Interface
XSI	External Signaling Interface

References

- [1] DSR Operation, Administration, and Maintenance (OAM) Guide – Available at Oracle.com on the Oracle Technology Network (OTN)
- [2] DSR Alarms, KPIs, and Measurements – Available at Oracle.com on the Oracle Technology Network (OTN)
- [3] Platform Feature Guide – Available upon request
- [4] Diameter Signaling Router (DSR) 7.0 Security Guide (E61125)– Available on MyOracleSupport

Implementing an IMS or LTE network without a signaling framework may be sufficient initially, but as traffic levels grow, the lack of a capable signaling infrastructure poses a number of challenges:

- » **Scalability and load balancing:** Each endpoint must maintain a separate SCTP association or TCP connection with each of its Diameter peers as well as the status of each, placing a heavy burden on the endpoints as the number of nodes grows. This burden is made more complex with the responsibility of load balancing placed on each end point.
- » **Congestion control:** Diameter lacks the well-defined congestion control mechanisms found in other protocols such as SS7. For example, if an HSS has multiple Diameter front ends, the lack of sufficient congestion control increases the risk of a cascading HSS failure.
- » **Secure Network interconnect:** A fully meshed network is completely unworkable when dealing with connections to other networks because there is no central interconnect point, which also exposes the operator's network topology to other operators and can lead to security breaches.
- » **Interoperability:** Protocol interworking becomes unmanageable as the number of devices supplied by multiple vendors increases. With no separate signaling or session framework, interoperability testing (IOT) must be performed at every existing node when a new node or software load is placed in service. IOT activities consume a considerable amount of operator time and resources, with costs increasing in proportion to the number of tests that must be performed.
- » **Support for legacy EIR:** A need for MAP to Diameter interworking is required as transitions are made and LTE is quickly introduced into a network while still needing to support legacy HLRs.
- » **Support for both SCTP and TCP implementations:** SCTP elements cannot communicate with TCP elements. Without a central conversion element, operators will either have to upgrade TCP elements or require all elements in the network to support both stacks.
- » **Subscriber to HSS mapping:** When there are multiple HSSs in the network, subscribers may be homed on different HSSs. Therefore, there must be some function in the network that maps subscriber identities to HSSs. With no separate Diameter signaling infrastructure, that task must be handled by a standalone subscription locator function (SLF), or by the HSS itself. Either approach wastes MME (or call session control function [CSCF]) processing and can add unnecessary delays. The HSS approach wastes HSS resources and may even result in the need for more HSSs than would otherwise be necessary.
- » **Policy and charging rules function (PCRF) binding:** When multiple PCRFs are required in the network, there must be a way to ensure that all messages associated with a user's particular IP connectivity access network (IP-CAN) session are processed by the same PCRF. This requires an element in the network that maintains session binding dynamically.

In recognition of Diameter routing issues, 3GPP has defined the need for a Diameter signaling infrastructure and a Diameter border infrastructure as shown below which is taken from TR 29.909. In addition, the GSMA has specified the need for a Diameter Proxy Agent as shown below which is taken from PRD IR.88.

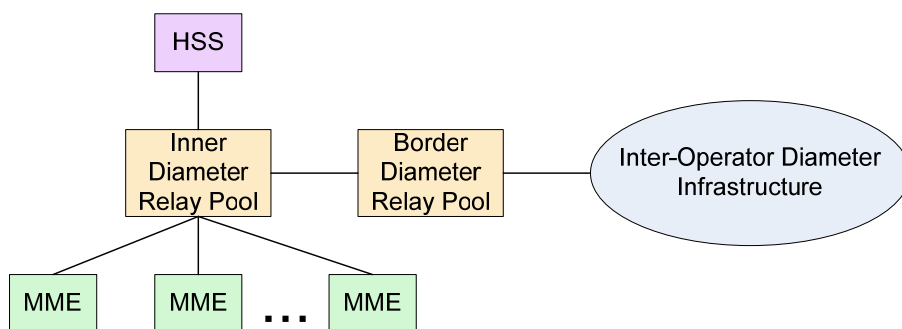

Figure 2 - 3GPP Inter/Intra-operator Diameter infrastructure

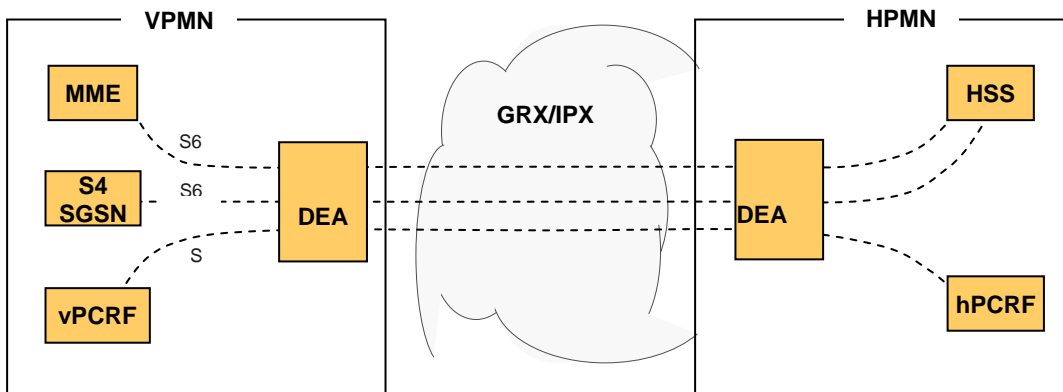

Figure 3 - GSMA roaming implementation architecture

Diameter Signaling Router Solution

Oracle Communication's Diameter Signaling Router (DSR) creates a centralized core Diameter signaling layer that relieves LTE, IMS and 3G Diameter endpoints of routing, traffic management and load balancing tasks and provides a single interconnect point to other networks. Each endpoint only needs one connection to a DSR to gain access to all other Diameter destinations reachable by the DSR. This approach eliminates the Diameter/SCTP (or TCP) mesh that is created by having direct signaling connections between each network element. Having one or more connection hubs that centralize the Diameter traffic to all end nodes simplifies interoperability between different network elements and enhances network scalability.

Centralizing Diameter routing with a DSR creates a signaling architecture that reduces the cost and complexity of the core network and enables core networks to grow incrementally to support increasing service and traffic demands. It also facilitates network monitoring by providing a centralized vantage point in the signaling network.

A centralized signaling architecture:

- » Improves signaling performance and scalability by alleviating issues related to the limited signaling capacity of MMEs, HSSs, CSCFs and other Diameter endpoints;
- » Provides a centralized point from which to implement load balancing;
- » Simplifies network expansion because routing configuration changes for new endpoints are performed only on the DSR;
- » Increases reliability by providing geographic redundancy;
- » Provides mediation point for Diameter variants to support interoperability between multi-vendor endpoints;
- » Creates a gateway to other networks to support roaming, security and topology hiding;
- » Reduces provisioning, maintenance and IOT costs associated with adding new network nodes;
- » Enables HSS routing flexibility by providing a central point to perform HSS address resolution;
- » Creates a centralized monitoring and network intelligence data collection point to isolate problems and track key performance indicators (KPIs); and
- » Provides network-wide PCRF binding to ensure that all messages associated with a user's particular IP-CAN session are processed by the same PCRF.

The DSR can be deployed as a core router routing traffic between Diameter elements in the home network and as a gateway router routing traffic between Diameter elements in the visited network and the home network. Refer to the figure below for a representation of an operator's EPC/IMS core network with DSR.

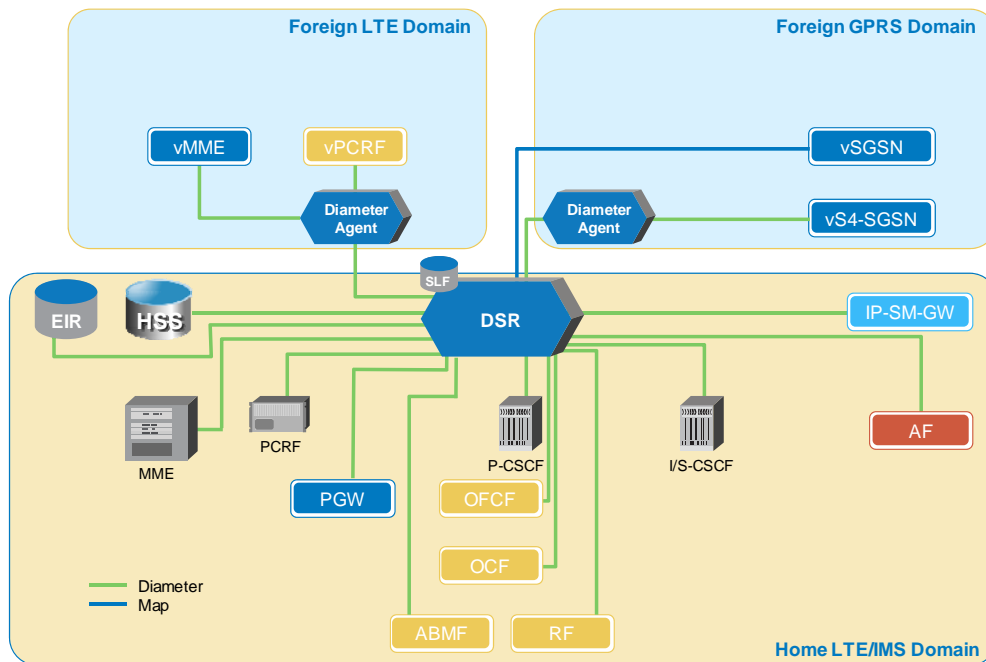

Figure 4 – Example of Operator's EPC/IMS Core network with DSR

The resulting architecture enables IP networks to grow incrementally and systematically to support increasing service and traffic demands. A centralized Diameter router is the ideal place to add other advanced network functionalities like network performance intelligence via centralized monitoring, address resolution, Diameter interworking and traffic steering.

DSR FEATURES AND FUNCTIONS

Overview

One primary function of the DSR is as a Diameter relay per RFC 6733 to route Diameter traffic based on provisioned routing data. As a result, the DSR reduces the complexity and cost of maintaining a large number of SCTP connections in LTE, IMS and 3G networks, simplifies the Diameter network and streamlines the provisioning of Diameter interfaces. The DSR supports flexible traffic load sharing and redundancy schemes and offloads Diameter clients and servers from having to perform many of these tasks, thereby reducing cost and time to market and freeing up valuable resources in the end points.

DSR network elements are deployed in geographically diverse mated pairs with each NE servicing signaling traffic to/from a collection of Diameter clients, servers and agents. The DSR Message Processor (MP) provides the Diameter message handling function and each DSR MP supports connections to all Diameter peers (defined as an element to which the DSR has a direct transport connection).

The figure below shows an overview of a DSR system architecture. Only single elements are shown for simplicity. The key components of the solution are:

- » Operations, Administration, Maintenance and Provisioning (OAMP)
 - » System OAM per signaling node

- » Network OAMP
- » Diameter Agent Message Processor (DA MP)
- » SS7 Message Processor
- » IP Front End (IPFE)
- » Session Binding Repository (SBR)
- » Database Processor (DP) / Subscriber Data Server (SDS)
- » Query Server (QS)
- » Integrated Diameter Intelligence Hub (IDIH)

These components are described at a high level in the following subsections. Although each component plays a key role, the OAM and DA MP components are the mandatory components of the system.

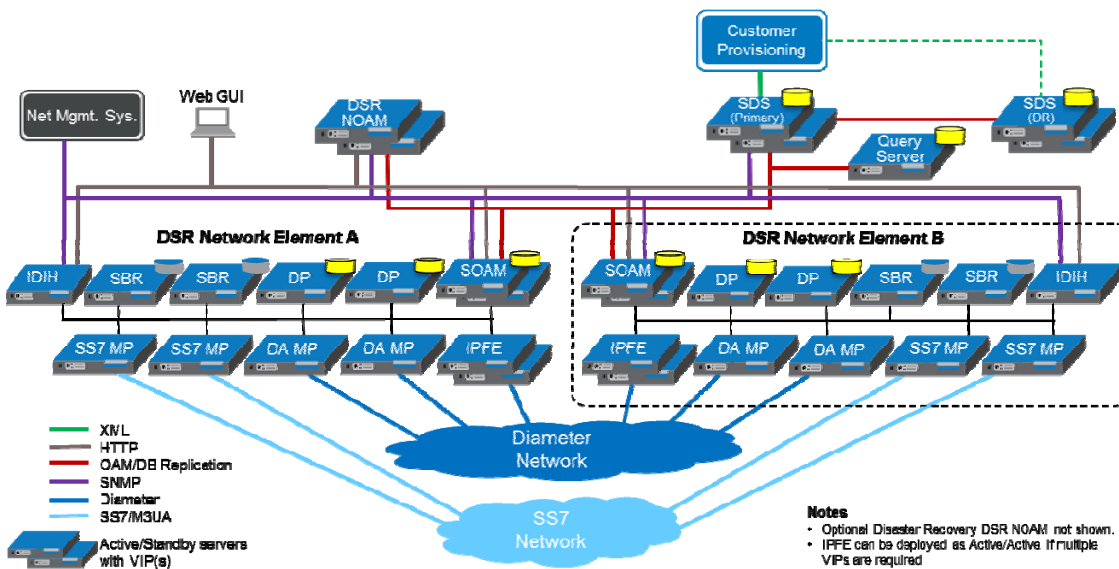

Figure 5 - DSR 7.x Architecture

Operations, Administration and Maintenance

The Operations, Administration, Maintenance and Provisioning components of the DSR include the System OAM located at each signaling node and the Network OAMP (NOAMP).

Key characteristics of the Network OAMP are as follows:

- » centralized OAMP for the DSR network
- » supports SNMP northbound interface to operations support systems for fault management
- » runs on a pair of servers in active/standby configuration or can be virtualized on the System OAM blades at one signaling site (for small systems with two DSR signaling nodes only)
- » optionally supports Disaster Recovery site for geographic redundancy
- » provides configuration and management of topology data
- » maintains event and security logs
- » centralizes collection and access to measurements and reports
- » centralized view of key operational metrics which identifies potential operational issues

Key characteristics of the System OAM at each signaling node are as follows:

- » centralized OAM interface for the node
- » provides mechanism to configure the diameter data (routing tables, mediation, etc.)
- » maintains local copy of the configuration database
- » supports SNMP northbound interface to operations support systems for fault management
- » provides mechanism to create user groups with various access levels
- » maintains event and security logs
- » centralizes collection and access to measurements and reports
- » centralized view of key operational metrics which identifies potential operational issues

Diameter Agent Message Processor (DA MP)

The DA MP hosts Proxy applications such as Address Resolution, Policy and Charging Application, Charging Proxy etc. and scales by adding blades.

Key characteristics of a DA MP are as follows:

- » provides application specific handling of real-time Diameter messages
- » accesses DPs for real-time version of the subscriber DB, as needed
- » accesses session and subscriber binding from SBRs, as needed
- » interfaces with System OAM

SS7 Message Processor (SS7 MP)

The SS7 MP provides the MAP to Diameter interworking function.

Key characteristics of an SS7 MP are as follows:

- » performs message content conversion between MAP and Diameter.
- » performs address mapping between SS7 (SCCP/MTP) and Diameter.
- » supports 3G<->LTE authentication interworking as needed.
- » interfaces with System OAM

IP Front End (IPFE)

The DSR IP Front End provides TCP/SCTP connection based load balancing to hide the internal DSR hardware architecture and IP addresses from the customer network. The IPFE is typically deployed in sets of Active-Active pairs and it distributes connections to DA MPs. IPFE provides load balancing of connections to DA MPs. The connections are active/active with TSAs (Target Set Addresses) and they provide TCP and SCTP connectivity.

Key characteristics of an IPFE are as follows:

- » optional component of the DSR
- » supports up to two active / standby pairs with 3.2 Gbps bandwidth per active/standby pair
- » Supported with SCTP Multi-homing

Session / Subscriber Binding Repository (SBR)

The SBR stores diameter sessions and subscriber bindings for stateful applications. Two stateful applications are supported:

1. Charging Proxy Application (CPA) for off-line charging
2. Policy Charging Application (PCA) for Policy Diameter Routing Agent (Policy DRA) and Online Charging Diameter Routing Agent (OC-DRA).

The off-line charging application uses charging SBRs (cSBR), OC-DRA uses session database SBRs (SBR(s)) and Policy DRA uses both session database SBRs (SBR(s)) and subscriber binding database SBR's (SBR(b)).



Throughout this document the SBRs are referred to individually when there are significant differences discussed, and referred as SBR, without distinguishing the application, when the attribute applies to all types. The SBR scales by adding blades.

Key characteristics of an SBR are as follows:

- » optional component of the DSR
- » provides repository for subscriber and session state data
- » provides DSRs with network-wide access to bindings

A number of capabilities are available to allow the SBR to be reconfigured once deployed including:

- » Binding SBR Capacity Growth/Degrowth: Allows in-service growth and degrowth of the Binding SBR database capacity in an existing P-DRA deployment, to include augmenting the physical location of the Binding SBR servers.
- » Session SBR Capacity Growth/Degrowth: Allows in-service growth and degrowth of the Session SBR database capacity in an existing P-DRA / OC-DRA deployment, to include augmenting the physical location of the Session SBR servers.
- » Per mated pair sizing of Session SBR: Supports independent sizing of the Session SBR databases in a P-DRA / OC-DRA network managed by a common DSR NOAM.
- » P-DRA support for 2.1M network wide MPS on P-DRA: Provides world-class scaling of Policy network traffic, supporting up to 2.1 M network wide MPS of P-DRA traffic, including network-wide stateful Gx/Rx correlation to support VoLTE.

Subscriber Data Server (SDS)

The SDS provides a centralized provisioning system for distributed subscriber data repository. The SDS is a highly-scalable database with flexible schema.

Key characteristics of the SDS are as follows:

- » interfaces with provisioning systems to provision subscriber related data
- » interfaces with DPs at each DSR network element
- » replicates data to multiple sites
- » stores and maintains the master copy of the subscriber database
- » supports bulk import of subscriber data
- » correlates records belonging to a single subscriber
- » provides web based GUI for provisioning, configuration and administration of the data
- » supports SNMP v2c northbound interface to operations support systems for fault management
- » provides mechanism to create user groups with various access levels
- » provides continuous automated audit to maintain integrity of the database
- » supports backup and restore of the subscriber database
- » runs on a pair of servers in active / hot standby, and can provide geographic redundancy by deploying two SDS pairs at diverse locations
- » Disaster Recovery site capabilities

Database Processor (DP)

The DP is the repository of subscriber data on the individual DSR node elements. The DP hosts the full address resolution database and scales by adding blades.

Key characteristics of a DP are as follows:

- » provides high capacity real-time database query capability to DA MPs

- » interfaces with DP-SOAM (application hosted on the same blades as the DSR SOAM) for provisioning of subscriber data and for measurements reporting across all DPs
- » maintains synchronization of data across all DPs
- » can also host other Oracle SDS based applications

Query Server (QS)

The Query Server contains a replicated copy of the local SDS database and supports a northbound MySQL interface for free-form verification queries of the SDS Provisioning Database. The Query Server's northbound MySQL interface is accessible via its local server IP.

Key characteristics of the QS are as follows:

- optional component that contains a real-time, replicated instance of the subscriber DB
- provides LDAP, XML and SQL access

Integrated Diameter Intelligence Hub (IDIH)

The IDIH supports advanced troubleshooting for Diameter traffic handled by the DSR. The IDIH is an optional feature of the DSR that enable the selective collection and storage of diameter traffic and provides nodal diameter troubleshooting.

DSR Nodes (Identity)

Each DSR message processor (MP) can host up to 48 Diameter Nodes (also called Diameter Identities). Hosting more than one node/identity allows a DSR deployment at the Network Edge where DSR acts as the single point of contact for all Diameter elements external to the operator network and similarly all internal Diameter elements use it as the point of contact when reaching Diameter servers external to the operator network. Another use case for hosting multiple Diameter nodes on each MP is to support multiple connections from an external Diameter element to the DSR.

Each Diameter Node has the following attributes.

- » Diameter Realm that may be unique or shared across the nodes
- » Up to 128 local IP addresses - IPv4 or IPv6 addresses or a combination of IPv4 and IPv6 addresses. (Each DA-MP supports up to 8 local IP addresses and 16 DA-MPs are supported)
- » A unique Fully Qualified Domain Name (FQDN)

DSR allows an IP address to be shared across nodes provided the combination of IP address, port and transport are unique across nodes.

See Figure 6 for a sample configuration.

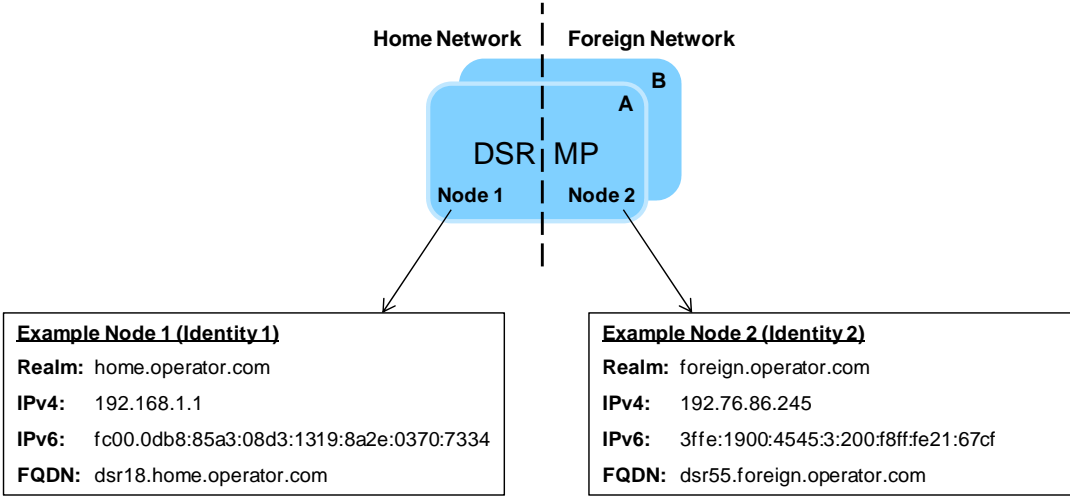

Figure 6 - Multiple Nodes per Message Processor

Diameter Core Routing

The DSR application provides a Diameter Routing Agent to forward messages to the appropriate destination based on information contained within the message including header information and applicable Attribute Value Pairs (AVP). As per the core Diameter specification, the DSR provides the capability to route Diameter messages based on any combination, or presence/absence, of Destination-Host, Destination-Realm and Application-ID. In addition DSR optionally provides the capability to look at Command-Code and origination information, namely Origin-Realm and Origin-Host for advanced routing functionality. The average diameter message size supported is 2K bytes with a maximum message size of 60K bytes.

DSR high level message processing and routing is shown below. The numbers show the message flow through the system.

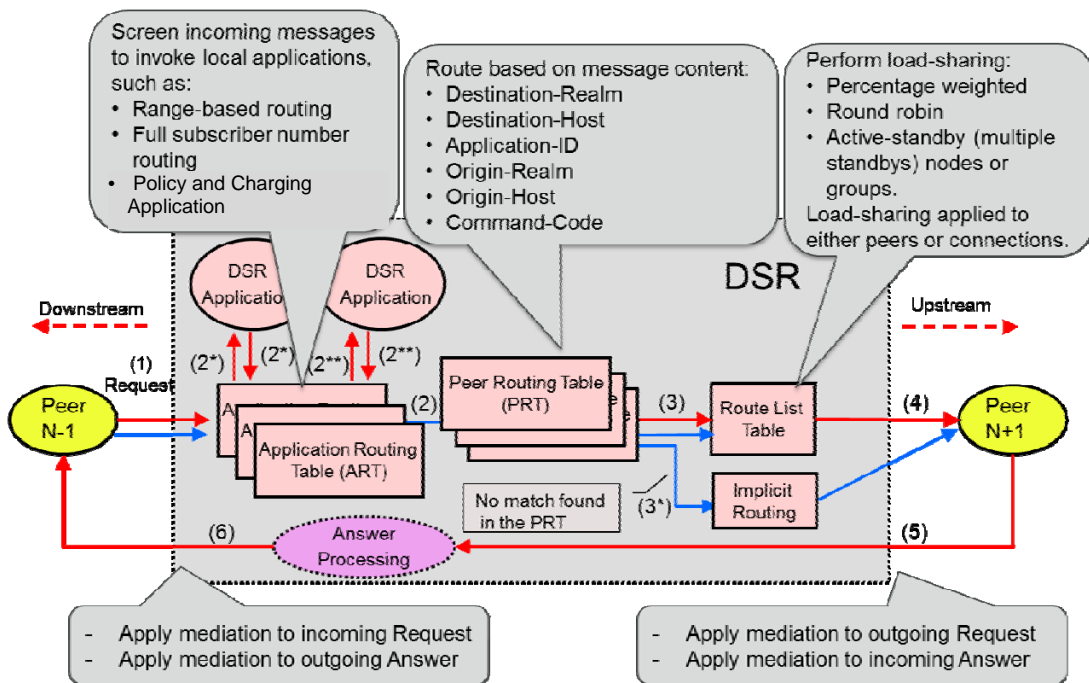

Figure 7 - High Level Message Processing and Routing in DSR

DSR supports the following routing functions:

- » Message routing to Diameter peers based upon user-defined message content rules
- » Message routing to Diameter peers based upon user-defined priorities and weights
- » Message routing to Diameter peers with multiple transport connections
- » Alternate routing on connection failures
- » Alternate routing on Answer timeouts
- » Alternate routing on user-defined Answer responses
- » Route management based on peer transport connection status changes
- » Route management based on OAM configuration changes

Routing rules and rule actions are used to implement the routing behavior required by the operator. Routing rules are defined using combinations of the following data elements:

- » Destination-Realm (leading, trailing characters, exact match, contains, not equal or always true)
- » Destination-Host (leading, trailing characters, exact match, contains, always true, present and not equal, or presence/absence)
- » Application-ID (exact match, not equal, or always true)
- » Command-Code (exact match, not equal or always true)
- » Origin-Realm (leading, trailing characters, exact match, contains, not equal or always true)
- » Origin-Host (leading, trailing characters, exact match, contains, not equal or always true)

A set of configurable timers (100 – 180,000 milliseconds) control the length of time the DSR waits to receive an answer to an outstanding request. The maximum number of times a request can be rerouted upon connection failure or timeout is configurable from 0 – 4 retries.

DSR supports the concepts of routes, peer route tables, peer route groups, connection route groups, route lists, and peer node groups to provide a very powerful and flexible load balancing solution. A Route Group is comprised of a prioritized list of peers or connections used for routing messages. A route list is comprised of multiple route groups – only one of which is designated as active at any one time. Each route list supports the following configurable information:

- » Route List ID
- » Up to 3 Route Groups containing a total of up to 480 Peer IDs or Connection IDs
- » Up to 160 Peers IDs or up to 64 Connection IDs per Route Group
- » Route Group Priority level (1 – 3)
- » Each Peer or Connection's weight (1 – 64k)

When peers/connections have the same priority level a weight is assigned to each peer/connection which defines the weighted distribution of messages amongst the peers/connections. For example, if two peers with equal priority have weights 100 and 150 respectively then 40% of the messages will be forward to peer-1 ($100/(100+150)$) and 60% of the messages will be forward to peer-2 ($150/(100+150)$).

Peer Rout Tables can be assigned to Peer Nodes or Application IDs. Each Peer Route Table has its own set of Peer Route Rules.

A set of peers with equal priority within a Route List is called a "Peer Route Group". Multiple connections to the same peer can be assigned to a Connection Route Group (CRG). The use of CRGs allows for prioritized routing between connections to the same peer. An example use case would be connecting to Peers across different sites which share the same hostname. The peer within the site would be contacted for any traffic originated within the site and the remote peer should be contacted only if the local peer is unavailable

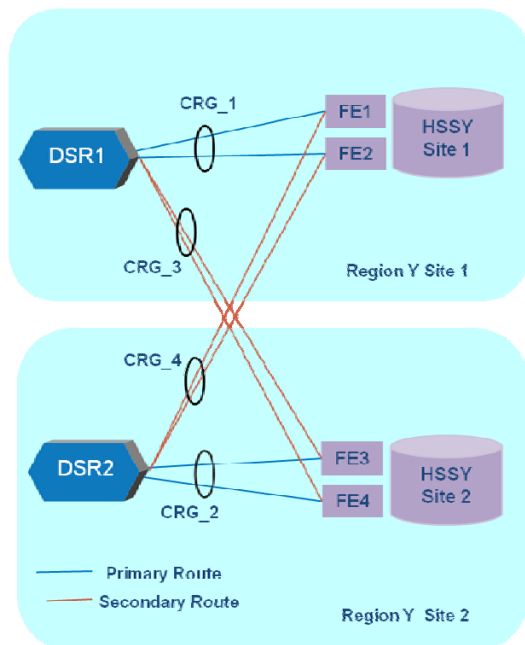

Figure 8 - Connection Route Group

When multiple Route Groups are assigned to a Route List, only one of the Route Groups is designated as the "Active Route Group" for routing messages for that Route List. The remaining Route Groups within the Route List are referred to as "Standby Route Groups". DSR designates the "Active Route Group" within each Route List based

on the Route Group's priority and available capacity relative to the provisioned minimum capacity (described below) of the Route List. When the "Operational Status" of peers change or the configuration of either the Route List or Route Groups within the Route List change, then DSR may need to change the designated "Active Route Group" for the Route List. An example of Route List and Route Group relationships is shown below.

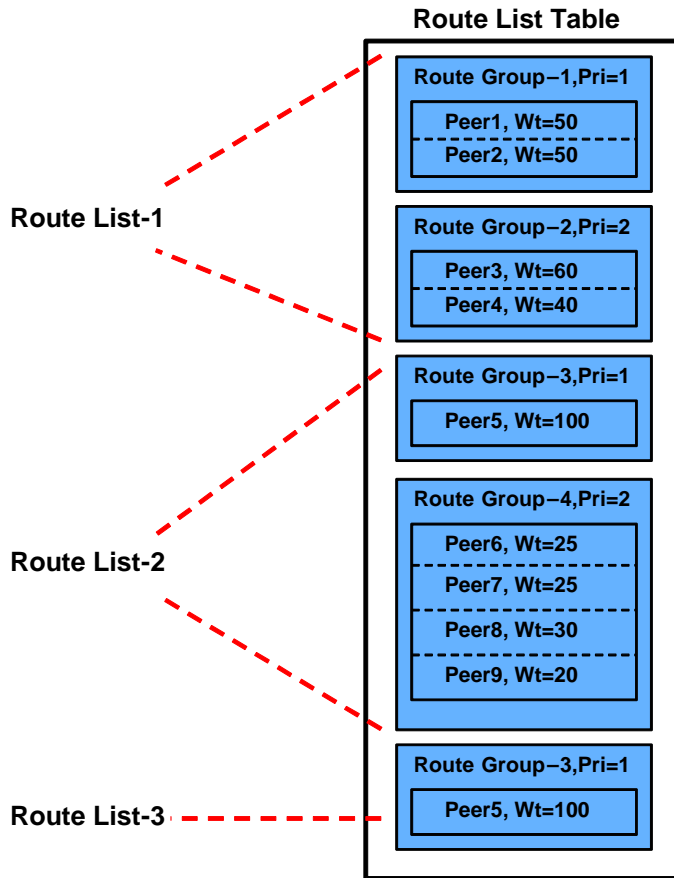

Figure 9 - Route List, Route Group, Peer Relationship Example

Showing a different set of route lists and route groups, an example of peer routing based on route groups with a route list is shown in the figure below. DSR supports provisioning up to 160 routes in a route group (same priority) and allows for provisioning of 3 route groups per route list.

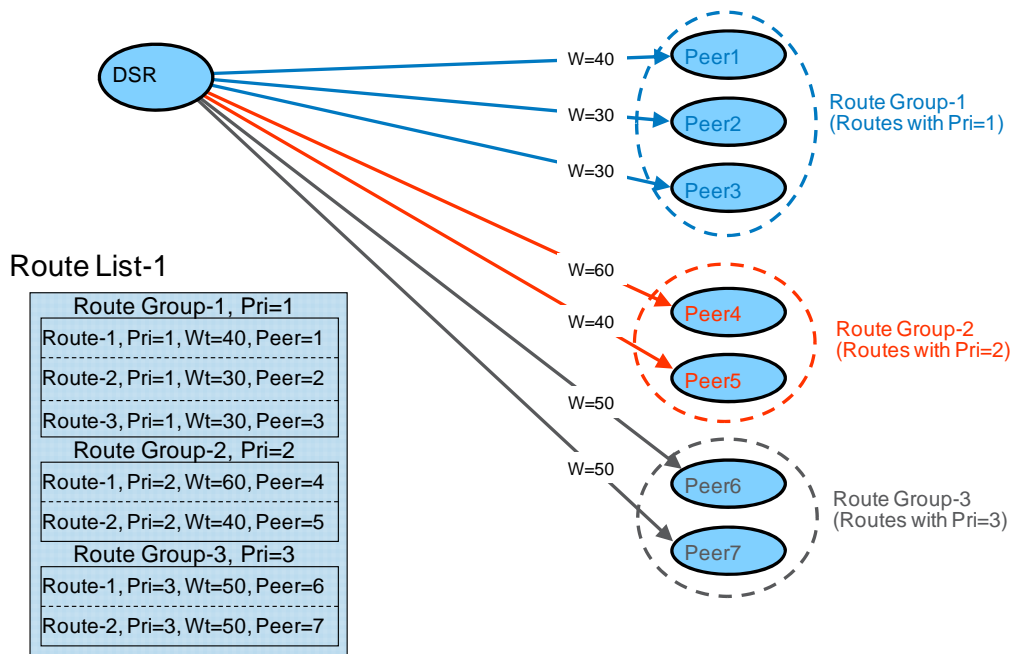

Figure 10 - Load Balancing Based on Route Groups and Peer Weights

To further enhance the load balancing scheme, the DSR allows the operator to provision a “minimum route list capacity” threshold for each route list. This provisioned “minimum route list capacity” is compared against the route group capacity. The route group capacity is dynamically computed based on the availability status of each route within the route group and is the sum of all the weights of “available” routes in a route group. If the route group capacity is higher than the threshold, the route group is considered “available” for routing messages. If the route group capacity is lower (due to one or more failures on certain routes in the route group), the route group is not considered “available” for routing messages. DSR uses the highest priority (lowest value) “available” route group within a route list when routing messages over the route list. If none of the route groups in the route list are “available”, DSR will use the route group with the most “available” capacity, also honoring route group priority, when routing messages over the route list.

A peer node group is a configuration managed object that provides a container for a collection of DSR peer nodes with like attributes (Example: same network element or same capacity requirement). The user configures DSR peer nodes with their IP addresses in the peer node group container. Applications can use this IP address grouping for various functions such as IPFE for a distribution algorithm.

Extended Command Codes (ECC)

Routing attributes by extended command code broadens the definition of a Diameter command code to include additional application specific single Diameter or 3GPP AVP content per command code. An ECC comprises the following attributes:

- » ECC Name
- » CC value
- » AVP code value
- » AVP data value

For example, there are four types of Credit-Control-Request (CCR) transactions which are uniquely identified by the content of the CCR's "CC-Request-Type" AVP: (For a complete list of ECCs please see the DSR Documentation set available at Oracle.com on the Oracle Technology Network (OTN).)

1. Initial_Request (typically called CCR-I)
2. Update_Request (typically called CCR-U)
3. Termination_Request (typically called CCR-T)
4. Event_Request (typically called CCR-E)

Extended command codes can be used in ART, PRT, ROS, PAT and MPCs.

Routing and Transaction Related Parameters in the DSR

The DSR has a hierarchical configuration and selection criteria for routing and transaction related (ART, PRT, ROS and PAT) parameters. Customers can configure DSR and choose per ingress peer node scoped additional transaction-specific granularity in routing and transaction parameters selection process.

Customers can create Transaction Configuration Groups which are composed of Transaction Configuration Sets. The Transaction Configuration Sets are composed of individual Diameter Transactions (represented by Appl-id+Extended Command Codes) with each transaction optionally specifying a ART, PRT, ROS and PAT. Once a Transaction Configuration Group is associated with an ingress peer, any Requests from the peer that match a Transaction Configuration Set within the assigned Transaction Configuration Group uses the associated ART, PRT, ROS and PAT if specified. The following table provides the precedence order for routing and transaction related parameter selection.

Table 1: Modified Routing and Transaction Parameter Selection Precedence Order

Parameter Selection Criteria	Parameter Selection Precedence Order			
DSR Configuraiton Elements	ROS (Note 3)	PAT	ART (Note 1)	PRT (Note 2)
Ingress Peer Node Selected Transaction Configuration Group	1	1	1	1
Ingress Peer Node	2	2	2	2
Egress Peer Node	NA	3	NA	NA
Default Transaction Configuration Group	3	4	4	3
System Default	4	5	4	4

Note 1: For multiple DRA Application invocation on the same message, the applications can select a different ART and override the core routing ART precedence.

Note 2: Local DSR applications can select a different PRT and override this core routing PRT precedence

Note 3: Existing OAM configuration rule: A Routing Option Set with a configured Pending Answer Timer can not be associated with an application-ID.

DSR supports configuring of up to 100 Transaction Configuration Groups, where each group instance can contain up to 1000 transaction configuration set entries. The maximum transaction set entries per DSR system cannot be greater than 1000.

Peer Routing Table (PRT)

A peer route table is a set of prioritized peer routing rules that define routing to peer nodes based on message content. Peer routing rules are prioritized lists of user-configured rules that define where to route a message to upstream peer nodes. Routing is based on message content matching a peer routing rule's conditions. There are six peer routing rule parameters:

- » Destination-Realm
- » Destination-Host
- » Application-ID
- » Command-Code
- » Origin-Realm
- » Origin-Host

When a diameter message matches the condition of peer routing rules then the action specified for the rule occurs. If you choose to route the diameter message to a peer node, the message is sent to a peer node in the selected route list based on the route group priority and peer node configured capacity settings. If you choose to send an answer, then the message is not routed and the specified diameter answer code is returned to the sender.

Peer routing rules are assigned a priority in relation to other peer routing rules. A message is handled based on the highest priority routing rule that it matches. The lower the number a peer routing rule is assigned the higher priority it has. (1 is the highest priority and 1000 is the lowest priority.)

If a message does not match any of the peer routing rules and the destination-host parameter contains a Fully Qualified Domain Name (FQDN) matching a peer node, then the message is directly routed to that peer node if it has an available connection. If there is not an available connection, the message is routed using the alternate implicit route configured for the peer node.

PRT Partitioning

Routing rules can be prioritized (1 – 1000) for cases where an inbound Diameter request may match multiple user-defined routing rules. The DSR supports up to 100 PRTs on the DSR. Any one of the PRTs can be optionally associated with either the (ingress) peer or Ingress Peer Node selected Transaction Configuration Group or Default Transaction Configuration Group.. A local application can also specify the PRT that needs to be used for routing a request. Each of these PRTs have no more than 1000 rules and the total number of rules across all PRTs cannot exceed 10,000. A system wide PRT is also present by default and is used if a PRT has not been assigned.

The PRT can be associated with the ingress peer node which can be useful to separate routing tables for example for LTE domain, IMS domain, or routing partners.

Rule Action defines the action to perform when a routing rule is invoked. Actions supported are:

- Route to Peer - use Route List Table
- Send Answer Response - an Answer response is sent with a configurable Result-Code and no further message processing occurs

- Abandon With No Answer - discard the message and no Answer is sent to the originating Peer Node.

The table below is used to determine the PRT instance to be used:

TABLE 2: PRT PRECEDENCE

PRT Used	PRT specified by local app (if supported)	PRT associated with Ingress Peer Node Selected Transaction Configuration Group	PRT associated with an Ingress Peer	PRT associated with Default Transaction Configuration Group	Default PRT
Default PRT	No	No	No	No	Yes
Default Transaction Configuration Group PRT	No	No	No	Yes	Yes
Peer PRT	No	No	Yes	Don't Care	Yes
PRT associated with Ingress Peer Node Selected Transaction Configuration Group	No	Yes	Don't Care	Don't Care	Yes
Local App PRT	Yes	Don't Care	Don't Care	Don't Care Yes	Yes

Application Routing Table (ART)

An application route table contains one or more application routing rules that can be used for routing request messages to DSR applications. Up to 400 application routing rules can be configured per application route table. Up to 100 application route tables can be configured per DSR network element; a total of 1000 application routing rules can be configured across the application route tables per network element.

An application routing rule defines message routing to a DSR application based on message content matching the application routing rule's conditions. There are six application routing rule parameters:

- Destination-Realm
- Destination-Host
- Application-Id
- Command-Code
- Origin-Realm
- Origin-Host

When a diameter message matches the conditions of an application routing rule the message is routed to the DSR application specified in the rule.

Rule Action defines the action to perform when a routing rule is invoked. Actions supported are:

- Route to Application - route the message to the local Application associated with this Rule
- Forward to Egress Routing - ART search stops and moves on to PRT
- Send Answer Response – ART generates an Answer. This Answer unwinds any previously encountered DSR Applications that want to process the Answer. Normal controls for Answer are given (Result-Code vs Experimental Result Code, Result-Code value, Vendor-ID, and ErrorMessage string)

Abandon With No Answer - discard the message and no Answer is sent to the originating Peer

NodeApplication routing rules are assigned a priority in relation to other application routing rules. A message is handled based on the highest priority routing rule that it matches. The lower the number an application routing rule is assigned the higher priority it has. (1 is highest priority and 1000 is lowest priority.)

One or more DSR applications must be activated before application routing rules can be configured.

Routing Option Sets

This feature allows for the creation of up to 20 routing option sets (ROS) (including default) which can then be optionally associated to a diameter transaction in several ways (in precedence order): (Refer to Table 1: Modified Routing and Transaction Parameter Selection Precedence Order.)

- » If the Transaction Configuration Group is selected on the ingress peer node configuration object, then the Transaction Configuration Group is used and the longest/strongest match search criteria is applied. Otherwise,
- » The Routing Option Set is assigned to the ingress peer node. Otherwise,
- » The Routing Option Set is assigned to the default TCG. Otherwise,
- » The system default ROS is used.

Some items included in the Routing Option Set are:

- » Resource Exhausted Action
- » No Peer Response Action
- » Connection Failure
- » Connection Congestion Action
- » Maximum Forwarding
- » Transaction LifeTime
- » Pending Answer Timer (PAT)

Alternate routing is supported in cases of transport failure, message response timeout and upon receipt of user defined answer responses.

- » Alternate Routing on Answer
 - » User defines which Result Codes trigger alternate routing
 - » User defines which Application IDs are associated with each Result Code
- » Alternate routing on transport failure
 - » Connection failure occurs after message has been sent
 - » T-bit set on re-routed message to warn of possible duplicate
- » Alternate routing on timeout
 - » No response received for message
 - » T-bit set on re-routed message to warn of possible duplicate

Pending Answer Timer (PAT)



Pending Answer Timers specify the amount of time the DSR waits for an Answer after sending a Request to a Peer Node. DSR allows for the specification of up to 16 pending answer timers that can be associated with the transactions/peers. This allows for different peers to respond to answers with different response times.

This feature addresses the ability to configure the Pending Answer Timer in the DSR which can then be optionally associated to a Diameter transaction in several ways (in precedence order): (Refer to Table 1: Modified Routing and Transaction Parameter Selection Precedence Order.)

- » If the Transaction Configuration Group is select on the ingress peer node configuration object, then the transaction configuration group is used and the longest/strongest match criteria is applied for request message parameters to compare and if a match is found, then the PAT assigned to the transaction set defined under this group. Otherwise,
- » The PAT from the ROS assigned to the ingress peer node is used. Otherwise,
- » The PAT assigned to the egress peer node is used. Otherwise,
- » The PAT assigned to the default TCG is used. Otherwise,
- » The System default PAT is used.

Transport

The DSR supports SCTP and TCP transport simultaneously including support for both protocols to the same Diameter peer. The DSR supports up to 64 connections per single Diameter peer which can either be uni-homed via TCP or SCTP or multi-homed via SCTP. The DSR maintains the availability status of each Diameter peer. Supported values are *available*, *unavailable* and *degraded*.

The following information are some of the configurable items for each connection:

- » Peer Host FQDN, Realm ID and optionally IPv4 or IPv6 address
- » Local Host and Realm ID (defined as part of the Diameter node)
- » Message Priority Configuration Set
- » Egress Throttling Configuration Set
- » Remote Busy Usage / Remote Busy Abatement Timer
- » Transport Congestion Abatement Time-out
- » DSR Local Node status as the connection initiator only, initiator & responder (default) or responder-only
- » Other connection characteristics such as timer values detailed below
- » For SCTP connections:
 - » RTO.Initial
 - » RTO.Min
 - » RTO.Max
 - » RTO.Max.Init
 - » Association.Max.Retrans
 - » Path.Max.Retrans
 - » Max.Init.Retrans
 - » HB.Interval
 - » SACK Delay
 - » Maximum number of Inbound and Outbound Streams
 - » Partial Reliability Lifetime
 - » Socket Send/Rx Buffer
 - » Max Burst

- » Datagram Bundling
- » Maximum Segment Size
- » Fragmentation Flag
- » Data Chunk Delivery Flag
- » For TCP connections:
 - » Nagle Algorithm ON/OFF indicator
 - » Socket Send/Rx Buffer
 - » Maximum Segment Size (bytes)
 - » TCP Keep Alive
 - » TCP Idle Time For Keep Alive
 - » TCP Probe Interval For Keep Alive
 - » TCP Keep Alive Max Count
- » Diameter Connect Timer (Tc as per RFC6733)
- » Diameter Watchdog Timer Initial value (Twinit as per RFC3539)
- » Diameter Capabilities Exchange Timer (Oracle extension to RFC6733)
- » Diameter Disconnect Timer (Oracle extension to RFC6733)
- » Diameter Proving Mode (Oracle extension to RFC3539)
- » Diameter Proving Timer (Oracle extension to RFC3539)
- » Diameter Proving Times (Oracle extension to RFC3539)

DSR supports multiple SCTP streams as follows:

- » DSR negotiates the number of SCTP inbound and outbound streams with peers per RFC4960 during connection establishment using the number of streams configured for the connection
- » DSR sends CER, CEA, DPR, and DPA messages on outbound stream 0
- » If stream negotiation results in more than 1 outbound stream toward a peer, DSR evenly distributes DWR, DWA, Request, and Answer messages across non-zero outbound streams
- » DSR accepts and processes messages from the peer on any valid inbound stream

The DSR supports SCTP multi-homing as an option which provides a level of fault tolerance against IP network failures. By implementing multi-homing the DSR can establish an alternate path to the Diameter peers it connects to through the IP network using SCTP protocol. Failure of the primary network path will result in the DSR re-routing Diameter messages through the configured alternate IP path. Multi-homed associations can be created through multiple IP interfaces on a single MP blade. This is independent of any port bonding existing on the Ethernet interfaces. Multi-homing is supported for both IPv4 & IPv6 networks but IPv4 and IPv6 cannot co-exist on the same connection.

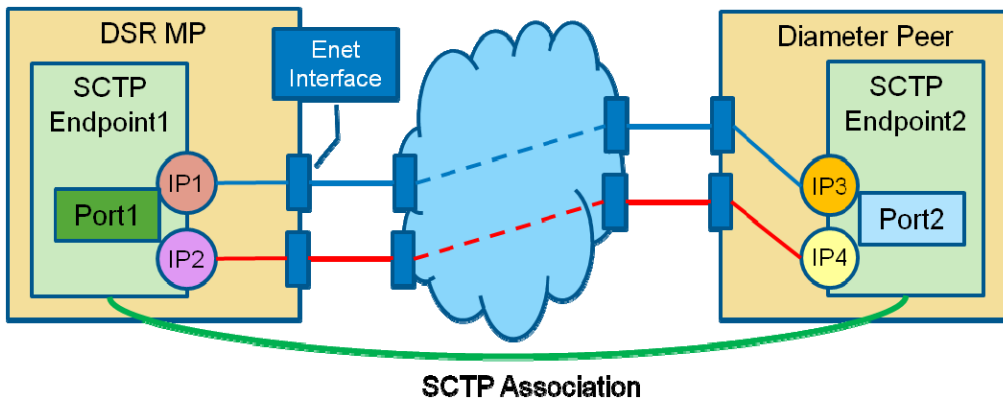

Figure 11 Sctp Multi-Homing

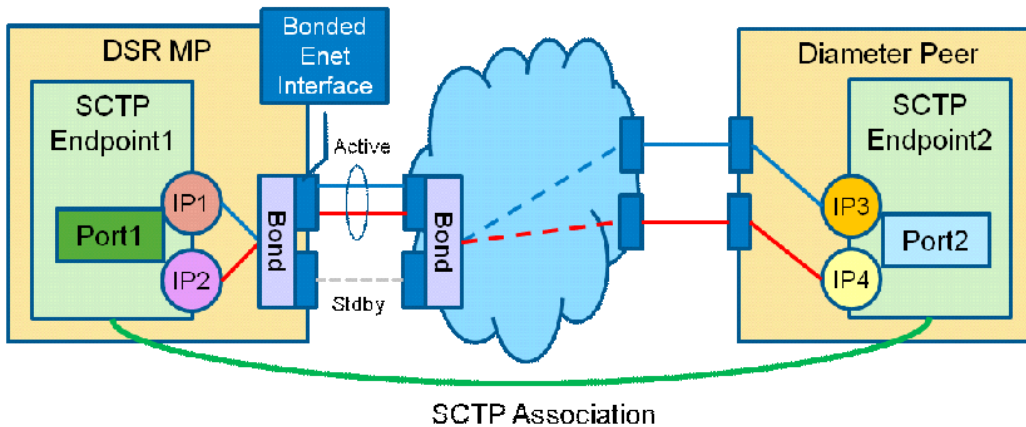

Figure 12 - Sctp Multi-Homing via Port Bonding

Message Priority Configuration Set (MPCS)

The MPCS defines how the message priority gets set. The following are some of the defined methods:

- » Based on the connection upon which a message arrives
- » Based on the peer from which a message is sent
- » Based on an Application Routing Rule
- » Based on a Peer Routing Rule

Each MPCS will contain the following information:

- » MPCS ID – The ID is used when associating the configuration set with a connection
- » Set of Application-ID, Command-code, priority tuples, also called message priority rules
 - » Application-ID – The Diameter application-ID. The application-id can be a wildcard indicating that all application-ids match this message priority rule.
 - » Command-code – The Diameter command-code. The command-code can be a wildcard indicating that all command-codes within the specified application match this message priority rule.

Note: If multiple command-codes with the same appl-id are to get the same message priority then there will be a separate message priority rule tuple for each command-code.

- » Priority – The priority applied to all request messages that match the Application-ID, Command-Code combination.



This feature provides a method for DSR administrators to assign message priorities to incoming Diameter requests. This priority configuration can be associated with a connection, peer node, application routing rule, or a peer routing rule. As messages arrive they are marked with a message priority. Once the message priority is set it can be used as input into decisions around load shedding and message throttling.

IPSec

The DSR optionally supports IPSec encryption per Diameter connection or association. Use of IPSec reduces MPS throughput by up to 40%. IPSec is supported for SCTP over IPv6 connections. The DSR IPSec implementation is based on 3GPP TS 33.210 version 9.0.0 and supports the following:

- » Encapsulating Security Payload (ESP)
- » Internet Key Exchange (IKE) v1 and v2
- » Tunnel Mode (entire IP packet is encrypted and/or authenticated)
- » Up to 100 tunnels
- » Encryption transforms/ciphers supported: ESP_3DES (default) and AES-CBC (128 bit key length)
- » Authentication transform supported: ESP_HMAC_SHA-1
- » Configurable Security Policy Database with backup and restore capability

TLS / DTLS

The DSR optionally supports TLS for TCP connections and DTLS for SCTP associations in the DSR. This provides RFC compliant support for security protocol enabled certificate and key exchange. TLS/DTLS can be independently enabled on each DSR diameter connection. TLS/DTLS encrypts packets within a segment of network TCP connections or SCTP associations at the application layer using asymmetric cryptography for key exchange, symmetric encryption for privacy, and message authentication codes for message integrity. TLS/DTLS provides tighter encryption via handshake mechanisms. This feature uses the certificate management component from platform. Please see DSR Operation, Administration, and Maintenance (OAM) Guide – Available at Oracle.com on the Oracle Technology Network (OTN) for more information on the certificate management feature.

Connectivity Enhancements

The Capability Exchanges on the DSR have been enhanced to provide flexibility to inter-op with other Diameter nodes. These enhancements include:

- » Support of any Application –Id
- » Configurable list of Application-Ids (up to 10 maximum) that can be advertised to the peer on a per connection basis
- » Authentication of minimum mandatory Application-Ids in the advertised list
- » Support for more than one Vendor specific Application-Id

Configurable Disable of CEx Peer IP Validation

The DSR provides a mechanism to enable or disable the validation of Host-IP-Address AVPs in the CEx message against the actual peer connection IP address on a per connection configuration set basis.

Congestion Control

The DSR supports local and remote congestion control via the use of congestion levels. Congestion levels are defined for which only a percentage of Request messages will be processed during the congestion period. The DSR supports a method for limiting the volume of Diameter Request traffic that DSR is willing to receive from DSR peers. In addition, the DSR provides a method for partitioning the MPS capacity among DSR peer connections, providing some user-configurable prioritization of DSR traffic handling. Congestion levels correspond to minor, major and critical alarms associated with resource utilization. The percentage of Request messages to be processed for



each level is shown in below. The DSR may return a user configurable Answer message when a Request message is not successfully routed during congestion. Under severe congestion conditions, the DSR may not return an Answer message. Request messages that are not processed will be discarded. An OAM event will be raised upon entering and exiting congestion levels.

Per Connection Ingress MPS Control

The Per-Connection Ingress MPS Control feature provides the following:

- » A method to reserve/guarantee a user-configured minimum ingress message capacity for each peer connection
- » A method for limiting the ingress message capacity for a peer connection to a user-configured maximum
- » A method for multiple peer connections to have a 'shared' ingress message capacity
- » A method to prevent the total reserved ingress message capacity of all active peer connections on a DA MP from exceeding the DA MP's capacity
- » A method for limiting the overall rate at which a DA MP attempts to process messages from all peer connections.
- » A method for coloring (Green or Yellow) messages ingressing a DSR

There are two user-configurable capacity configuration set parameters for DSR Connections .

- » Reserved Ingress MPS
 - » Ingress capacity (in Messages per Second) reserved for use by the peer connection. It is not available for use by other connections on the same DA MP.
 - » Min value: 0
 - » Max value: Minimum (Connection engineered capacity, DA MP's licensed MPS capacity)
 - » Default: 0

When a DSR Connection's ingress message rate is equal to or below its configured Reserved Ingress MPS, all messages ingressing the connection are colored Green. When a DSR Connection's ingress message rate is above its configured Reserved Ingress MPS, all messages ingressing the connection are colored Yellow.

- » Maximum Ingress MPS
 - » Maximum ingress capacity (in Messages per Second) allowed on this connection. Capacity beyond "reserved" and up to "max" is shared by all connections on the DA MP and comes from DA MP capacity leftover after all connections' "reserved" capacities have been deducted from the DA MP capacity.
 - » Min value: 10
 - » Max value: Minimum (Connection engineered capacity, DA MP's licensed MPS capacity)
 - » Default: Minimum (Connection engineered capacity, DA MP's licensed MPS capacity)

A fundamental principal of Per-Connection Ingress MPS Control is to allocate a DA-MP's ingress message processing capacity among the Diameter peer connections that it hosts. Each peer connection is allocated, via user-configuration, a reserved and a maximum ingress message processing capacity. The reserved capacity for a connection is available for exclusive use by the connection. The capacity between a connection's reserved and maximum is shared with other connections hosted by the DA-MP. The DA-MP reads messages arriving from a peer connection and attempts to process them as long as reserved or shared ingress message capacity is available for the connection. When neither reserved nor shared ingress message capacity is available for a connection, the DA-MP enforces a short discard period, during which time all ingress messages are read from the connection and discarded without generation of any response to the peer. This approach provides some user-configurable bounding of the DSR application memory and compute resources that are allocated for each peer connection, reducing the likelihood that a subset of DSR downstream peers which are offering an excessive/unexpected Request load can cause DSR congestion or congestion of DSR upstream peers.

When the ingress message rate on a DSR peer connection exceeds the maximum configured ingress MPS for the connection -OR- the connection is unable to obtain shared ingress message processing capacity due to demand for shared capacity by other connections, ingress messages are read from the connection and discarded for a short time period. This discarding of ingress messages by the DSR results in the DSR Peer experiencing Request timeouts (when DSR discards Request messages) and/or receiving duplicate Requests (when DSR discards Answer messages).

It should be noted that the DSR is enforcing ingress message rate independent of the type (i.e. Request/Answer) or size of the ingress messages.

The figure below depicts a DSR DA MP hosting 3 connections with the attributes shown in the following table:

TABLE 3 DSR INGRESS MPS CONFIGURATION EXAMPLE 1

Connection	Reserved Ingress MPS	Maximum Ingress MPS	MPS shared with other connections
Connection1	100	500	400
Connection 2	0	5000	5000
Connection 3	500	500	0

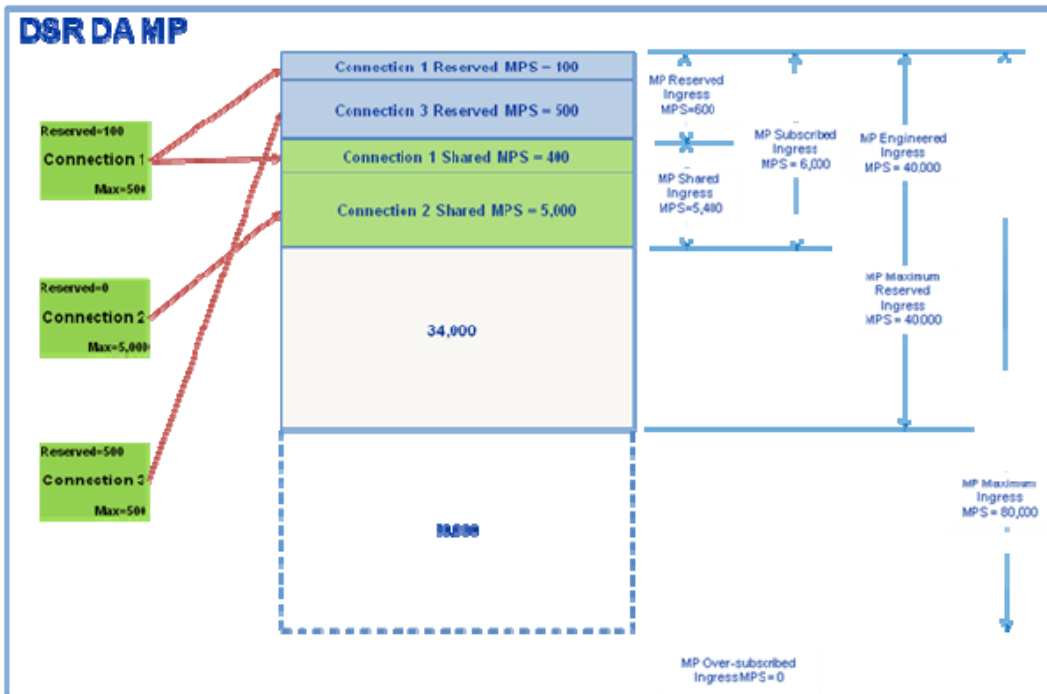

Figure 13 - DSR Ingress MPS Configuration Example 1 - Normal Case

The DSR prevents the total Reserved Ingress MPS of all connections hosted by a DA MP from exceeding the DA MP's maximum ingress MPS. The enforced limit for this is the DA MP's licensed MPS capacity, which defaults to the DA MP's maximum engineered capacity. The enforcement of this requirement on 'configured' connections versus 'Enabled' or 'Active' connections is a design decision.

This feature addresses the functionality to assist DSR overload and throttling algorithms in differentiating messages ingressing a DSR connection whose ingress message rate is above (vs equal to or below) its configured reserved ingress MPS.

When a DSR connection's ingress message rate is equal to or below its configured reserved ingress MPS, all messages ingressing the connection are colored green. When a DSR connection's ingress message rate is above its configured reserved ingress MPS, all messages ingressing the connection are colored yellow.

Message color is used as a means for differentiating diameter connections that are under-utilized versus those that are over-utilized with respect to ingress traffic. Traffic from under-utilized connections are marked "green" by the per-connection ingress MPS control (PCIMC) feature, while traffic from over-utilized connections are marked "yellow". In the event of danger of congestion or of CPU congestion and based on the specified discard policy, traffic from over-utilized connections is considered for discard before traffic from under-utilized connections. Traffic discarded by PCIMC due to capacity exhaustion (per-connection or shared) is marked "red" and is not considered for any subsequent processing.

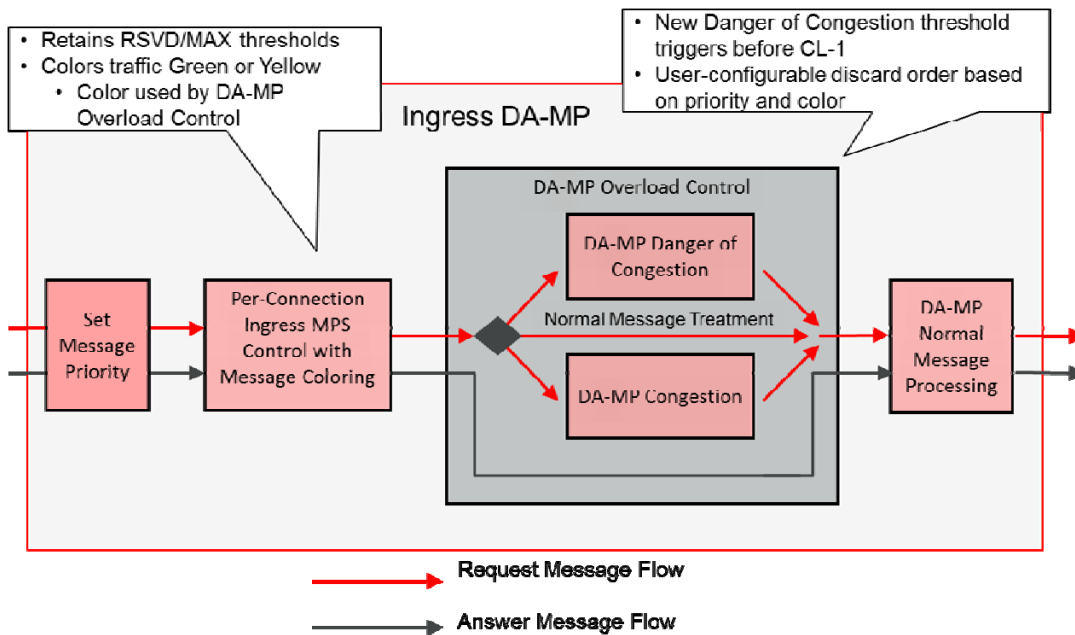

Figure 14 - Message Coloring and Priority/Color-based DA-MP Overload Control

MP Overload Control

DSR MP Overload Control utilizes proven platform infrastructure to monitor the CPU utilization of each DSR MP and implement incremental load-shedding algorithms as engineered CPU utilization thresholds are exceeded. MP overload control provides DSR stability in the presence of extremely deteriorated network conditions, message loads that exceed the engineered capacity of a DSR MP, or improper configurations. It is important to note that MP overload control algorithm only monitors and acts on the CPU utilization of the DSR MP software functions (i.e. message & event handling), allowing a sufficient CPU budget for other non-critical (i.e. best effort) DSR MP functions. In this way, the load-shedding algorithms are not invoked when non-critical DSR MP functions consume more than their budgeted CPU when it has no impact on critical DSR MP functions. Message priority and Message color are used as input to the DSR's message throttling and shedding decisions. In addition, exponential smoothing

is applied to the CPU utilization samples in order to prevent the load-shedding algorithms from introducing more instability to an already degraded system. The following message rates are tracked by the DSR as input:

- » DAMP-Request-Rate – The rate, in terms of messages per second (MPS), that Request messages arrive at the DA-MP Overload Control component.
- » MP0-Rate – The rate, in terms of MPS, that messages of priority zero, independent of message color, arrive at the DA-MP Overload Control component.
- » MP0-Green-Rate – The rate, in terms of MPS, that messages of priority zero and marked as green arrive at the DA-MP Overload Control component.
- » MP0-Yellow-Rate – The rate, in terms of MPS, that messages of priority zero and marked as yellow arrive at the DA-MP Overload Control component.
- » MP1-Rate – The rate, in terms of MPS, that messages of priority one, independent of message color, arrive at the DA-MP Overload Control component.
- » MP1-Green-Rate – The rate, in terms of MPS, that messages of priority one and marked as green arrive at the DA-MP Overload Control component.
- » MP1-Yellow-Rate – The rate, in terms of MPS, that messages of priority zero and marked as yellow arrive at the DA-MP Overload Control component.
- » MP2-Rate – The rate, in terms of MPS, that messages of priority two, independent of message color, arrive at the DA-MP Overload Control component.
- » MP2-Green-Rate – The rate, in terms of MPS, that messages of priority two and marked as green arrive at the DA-MP Overload Control component.
- » MP2-Yellow-Rate – The rate, in terms of MPS, that messages of priority zero and marked as yellow arrive at the DA-MP Overload Control component.
- » MP3-Rate – The rate, in terms of MPS, that messages of priority three arrive at the DA-MP Overload Control component. Note: although priority 3 messages may be colored, there is no need to differentiate color here since the DA-MP Overload Control algorithms do not discard priority 3 messages.

A DA-MP Danger of Congestion (DOC) threshold is less than the threshold set for DA-MP congestion level 1. There is a DOC onset threshold, a DOC abatement threshold, and a DOC warning event.

When it has been determined that a system is actually in congestion, the request messages discarded are based on the priority of the message, the color of the message, and the user-configurable DA-MP Danger of Congestion discard policy. There are three user-configurable options:

- » Discard by color within priority (Y-P0, G-P0, Y-P1, G-P1, Y-P2, G-P2)
- » Discard by priority within color (Y-P0, Y-P1, Y-P2, G-P0, G-P1, G-P2)
- » Discard by priority only (P0, P1, P2)

The following elements are configurable for the DA-MP Overload Control feature:

- » Congestion Level 1 Discard Percentage - The percent below the DA-MP engineered ingress MPS that DA-MP overload control polices the total DA-MP ingress MPS when the DA-MP is in congestion level 1.
- » Congestion Level 2 Discard Percentage - The percent below the DA-MP engineered ingress MPS that DA-MP overload control polices the total DA-MP ingress MPS to when the DA-MP is in congestion level 2.
- » Congestion Level 3 Discard Percentage - The percent below the DA-MP engineered ingress MPS that DA-MP overload control polices the total DA-MP ingress MPS to when the DA-MP is in congestion level 3.
- » Congestion Discard Policy - The order of message priority and color-based traffic segments to consider when determining discard candidates for the application of treatment during DA-MP congestion processing.
- » Danger of Congestion Discard Percentage - The percent of total DA-MP ingress MPS above the DA-MP Engineered Ingress MPS that DA-MP Overload Control discards when the DA-MP is in danger of congestion,

- » Danger of Congestion Discard Policy - The order of Message Priority and Color-based traffic segments to consider when determining discard candidates for the application of treatment during DA-MP Danger of Congestion (DOC) processing. The following order is considered: Color within Priority, Priority within Color, and Priority Only.

The DSR always attempts to forward Diameter Answer messages received from peers. As the DSR MP CPU utilization exceeds the engineered thresholds, the MP congestion level is updated and message load-shedding is performed by the DSR.

Internal Resource Management

DSR utilizes proven platform infrastructure to monitor, alarm, and manage the resources used by internal message queues and protocol data unit (PDU) buffer pools to prevent loss of critical events and monitor and manage PDU pool exhaustion.

Message Queue Management

- » Enforces a maximum queue depth for non-critical events; non-critical events are never allowed to overflow a queue's maximum capacity
- » The system attempts to always queue critical events even when the queue's maximum capacity is reached
- » Measurements and informational alarms are maintained for discards of all events

PDU Buffer Pool Management

- » Similar to message queues, the DSR monitors the size of each PDU Buffer Pool, alarms when the utilization crosses configured thresholds, and discards messages when the PDU Buffer pool is exhausted
- » Measurements are maintained for all discards

Egress Transport Congestion

When a DSR peer connection becomes blocked due to transport layer congestion the DSR acts in the following manner:

- » When a DSR peer connection becomes blocked, the DSR sets the connection's congestion level to CL-4 (Requests nor Answers can be sent on the connection)
- » The DSR waits for the connection to unblock and then abate a connection's egress transport congestion using a time-based step-wise abatement algorithm similar to Remote BUSY Congestion
- » A user-configurable Egress Transport Abatement Timer exists for each DSR Peer Connection. The abatement timer defines the time spent abating each congestion level during abatement and is not started until the socket unblocks and becomes writable.
- » Messages already committed to the connection by the DSR routing layer when a connection initially becomes transport congested will be discarded

The above can be summarized using the chart below.

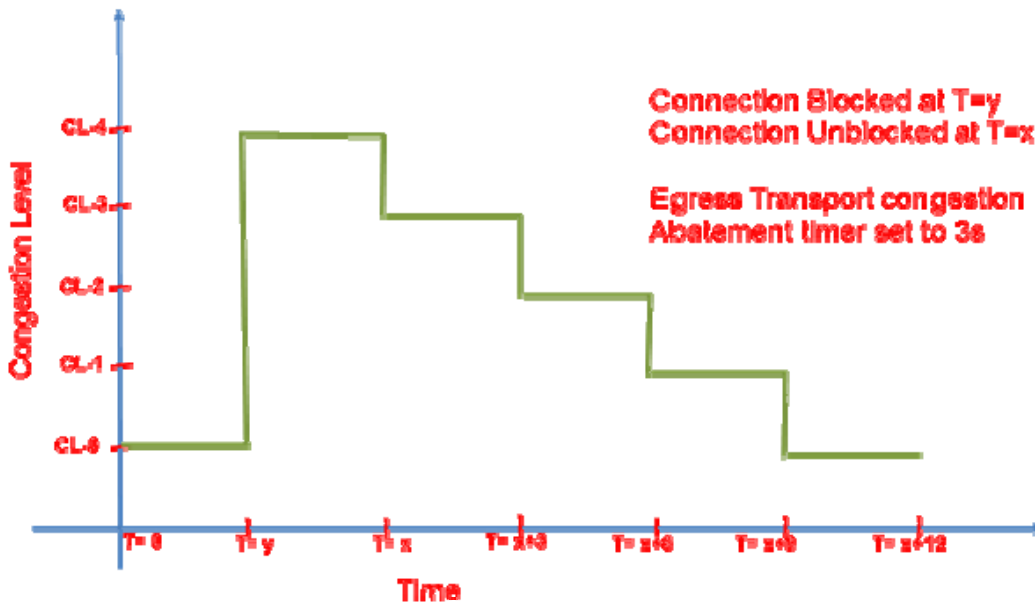

Figure 15 – Example Congestion level abatement

Per Connection Egress MPS Control

The Egress Message Throttling feature provides a mechanism that assists with the prevention of Diameter peer overload. It does so by allowing the user to configure the max Egress Message Rate (EMR) on a per connection basis and shedding messages as the offered message rate gets closer to the max EMR. The feature works in conjunction with the message prioritization infrastructure and provides intelligent load shedding based on the volume of the offered load. The load shedding is performed by dropping requests based on priority and the offered Message Rate. It should be noted that if a Message Priority Configuration Set is not assigned to the connection, load shedding is still performed but it is primarily restricted to Requests as all requests are assigned a priority of '0'.

The connection egress message throttling behavior is governed by user-configurable Egress Message Throttling Configuration Sets. Each Egress Message Throttling Configuration Set contains:

- » A maximum allowed EMR
- » A minimum of one and up to a maximum of three pairs of user-configurable EMR Throttle and Abatement Thresholds (TT & AT) expressed as % of max EMR
- » Convergence Rate: The time the algorithm takes for the measured rate to converge on the actual rate. Useful for bursty traffic.
- » Abatement Time

The “maximum allowed EMR” dictates the maximum volume of traffic that can be served over a particular connection. Each EMR throttle & abatement threshold pair are then expressed as percentages of the maximum allowed EMR and dictate how the connection congestion state will be updated.

The DSR allows for egress message throttling to be enabled for at least 500 peer connections in a single DSR NE. To enable egress message throttling on a connection, the user creates an Egress Message Throttling Configuration Set and assigns it to one or more DSR peer connections that are to be throttled using the configuration set settings. The DSR supports at least 50 user-configurable Egress Message Throttling Configuration Sets.

Egress Throttle Group (ETG) Limiting

Network operators cannot control the ingress load-shedding behavior of all nodes in their networks and many become unstable and fail when offered excessive ingress traffic loads. Therefore, DSR can be utilized to enforce maximum egress traffic rates and maximum pending transaction counts on a connection, a peer, or an aggregate group of connections/peers.

- » Egress Throttle Group Rate Limiting: A method to control the total egress Request traffic rate that DSR can route to a user-defined group of connections or peers
- » Egress Throttle Group Pending Transaction Limiting: A method to control the total number of transactions that DSR can allow to be pending for a user-defined group of connections or peers

These features provide DSR egress throttling capability that allows the user to:

- » Configure an ETG with a max of 128 entries, each peer/connection can be in only 1 ETG
- » Identify a group of peers and/or connections and associate them with an Egress Throttle Group
- » Set the ETG's maximum egress Request rate
- » Configure throttling and abatement thresholds with convergence rate and abatement timer
- » Set the ETG's maximum pending transaction limit

Example: DSR Connects to a Single Server Node with Multiple Connections

DSR typically connects to a single server node with more than 1 connection for redundancy (and sometimes for capacity). DSR per-connection egress throttling functionality may result in underutilization of a server node's capacity when a subset of the DSR connections to the server node fail and the remaining connections are capable of carrying the full capacity of the server node. For example, consider the scenario depicted in the figure below where:

- » Constraint 1: Server 1 has a total capacity of X TPS
- » Constraint 2: Server 1 can process as much as 50% of its total capacity on a single connection
- » DSR throttles each connection to Server 1 to X/3 (addresses constraint 1 only)

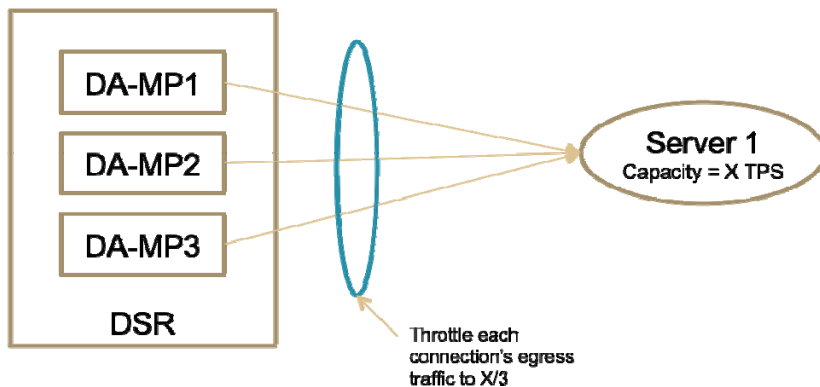

Figure 16 - DSR Per-Connection Egress Throttling

In the above example, the per-connection egress throttling is used to limit the aggregate egress traffic rate to Server 1 (constraint 1). As a result, each of the 3 connections to Server 1 must be throttled at 1/3 of Server 1's capacity to prevent DSR from offering a load greater than X when all 3 connections are in-service. However, if one of the connections to Server 1 fails DSR will restrict egress traffic to 2/3 of Server 1's capacity even though the remaining two connections are be capable of carrying the entire capacity of Server 1.

The ability for DSR to throttle the aggregate egress traffic across all 3 DSR connections to Server 1 while also throttling the egress traffic on individual connections to Server 1 reduces the limitations described above. This is shown in the figure above where:

- » Constraint 1: Server 1 has a total capacity of X TPS
- » Constraint 2: Server 1 can process as much as 50% of its total capacity on a single connection
- » DSR throttles the aggregate egress traffic over all connections to Server 1 to X (addresses constraint 1)
- » DSR throttles each connection to Server 1 to X/2 (addresses constraint 2)

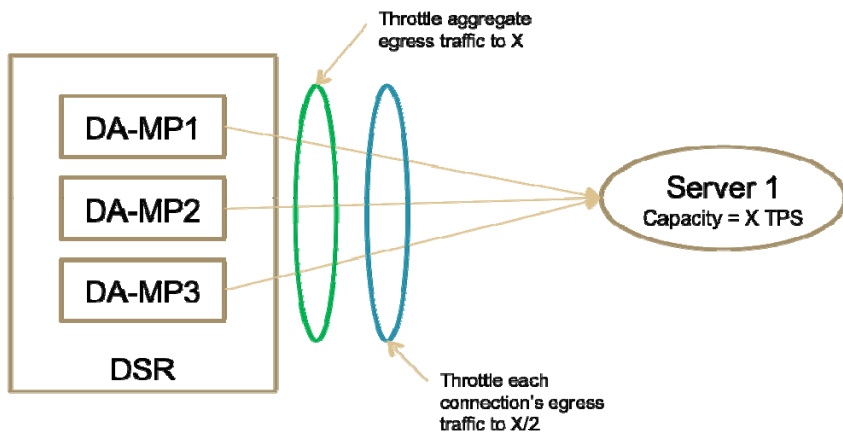

Figure 17 - DSR Aggregate and Per-Connection Egress Throttling

In Figure 17 figure above, use of aggregate egress traffic rate limiting to address constraint 1 allows the per-connection egress throttling limits to be relaxed as it is being used appropriately to address the connection constraint (constraint 2).

The DSR can aggregate and distribute information about the ETG across all DA-MPs for use in routing decisions.

During Request routing, if the DSR selects a peer/connection that is a member of an ETG and determines that either the rate or pending transaction cumulative limit for that ETG has already been reached, then the DSR does not route to that peer/connection and continues to search for an acceptable peer/connection via standard DSR routing operations

DSR utilizes the existing user-configurable response behavior in the Routing Option Set for Requests that are throttled and cannot be routed via other connections.

DSR uses standard alarming capabilities against the ETG to alert the user when limits are exceeded.

Per Egress Throttling Across Multiple DSRs

When multiple DSRs (mated pair or triplet) connect to common servers, there is a need for the DSRs to share egress throttling information to avoid under-utilization or overload of the common servers in load share or failure scenarios. This feature allows multiple DSRs to share real-time Egress Throttle Group Rate and Pending Transaction information in order to maximize utilization of servers common to the DSRs while also protecting the common servers from overload.

To address communication failure amongst the contributing DSRs when under coordinated egress throttling, DSR supports a user configuration option that specifies how much the coordinated ETGs Rate and/or Pending Transaction Limit should be reduced from the coordinated maximum egress rate and pending transaction value. This user configurable option 'Coordination Failure (% Reduction)' affects egress Request rate and pending

transaction maximum value proportional to the number of peer DSR communication failures. Also, please note that this 'Coordination Failure (% Reduction)' parameter does not apply when a DSR is providing SOAM managed single DSR scoped egress throttling.

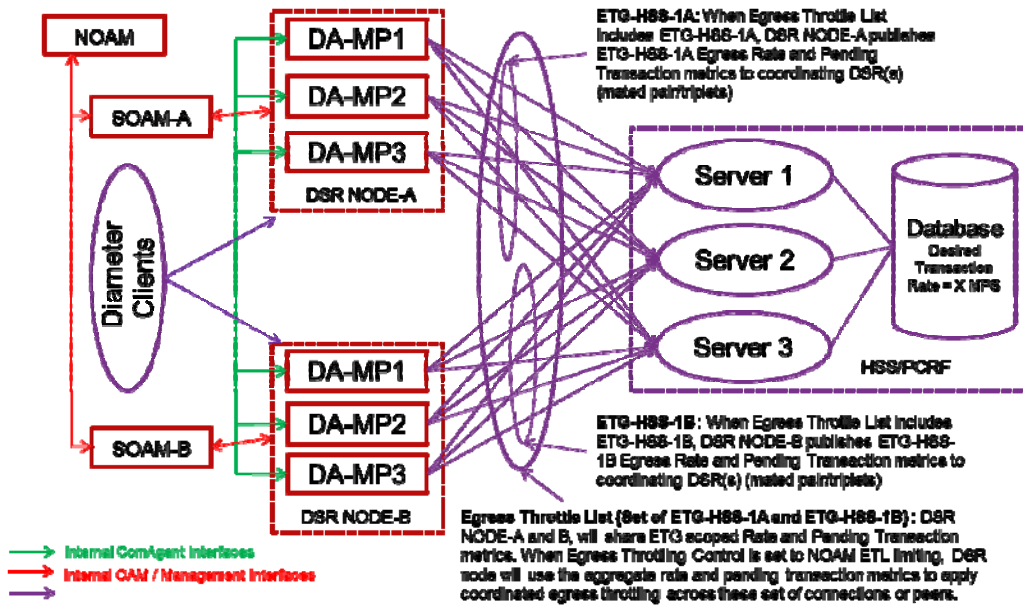

Figure 18 - 2 DSR Sites: Coordinated Egress Throttling Example

Connection Pending Transaction Limiting

This feature makes the connection Pending Transaction Limiting attribute user configurable and tunable on a per connection basis. The primary use of Connection Pending Transaction Limits on a DSR DA-MP is to prevent a small number of connections on a DA-MP from consuming a disproportionate number of the available Pending Transaction Records on the DA-MP, which could result in limited Pending Transaction Record availability for the remaining connections.

DSR peer nodes have differing requirements regarding the maximum number of pending transactions required on the DSR

- » DSR-to-Server connections typically carry higher traffic volumes than DSR-to-Client connections due to DSR aggregation of traffic from many client connections to few server connections
- » A high percentage of the traffic on DSR-to-Server connections requires Pending Transaction Records in the DSR since the majority of the traffic egressing the DSR on these connections are Requests
- » A low percentage of the traffic on DSR-to-Client connections requires Pending Transaction Records in the DSR since the majority of the traffic egressing the DSR on these connections are Answers
- » DSR-to-Server connections may encounter significant increases in offered load in a very short time immediately following network events such as MME failures or failures of redundant Servers providing the service. 'Riding through' these types of sudden increases in traffic volume may require higher Pending Transaction Limits on the connections.

In order to support customization of the distribution of the available Pending Transaction Records on a DA-MP based on the varying deployment requirements, this feature provides user-configuration of the Connection Pending Transaction Limit for each DSR peer connection. The limit configured is enforced independently by all DA-MPs in the DSR.

Remote Busy Congestion

The intent of this feature is to provide remedial measures if it is determined that a connection to a DSR peer node is unable to process messages as fast as they are sent to it on a given DSR connection to the peer node. A connection is considered congested (BUSY) if an Answer message containing 'DIAMETER_TOO_BUSY' result code is received on the connection and was originated by the peer node.

Remote BUSY Congestion is determined by analyzing Diameter Answer from a connected peer. The result code 'DIAMETER TOO BUSY' in a Diameter Answer from a connected peer indicates the connection is congested or BUSY.

When this feature is configured, DSR sets the status of a connection to 'BUSY' in the following conditions:

- » The result code of Diameter Answer is 'DIAMETER TOO BUSY' **and**
- » Origin-Host of the Answer messages is same as the connection's Peer FQDN

The DSR sets the status 'BUSY' only to the connection of a peer on which 'DIAMETER TOO BUSY' is received. The other connections between the DSR and the peer may or may not be BUSY.

Typically, if a connection is BUSY, it is not selected for routing of Diameter Request messages. However, based on the configuration, this behavior may be overridden and a BUSY connection may be selected to route the Request when the message is addressed to the connection's peer FQDN.

A BUSY connection becomes uncongested after a certain minimum time has elapsed in 'BUSY' state. DSR provides a configurable timer to set this value.

Note: - Diameter Protocol does not provide any mechanism for a node to signal to its peers that its busy condition has abated.

The figure below shows the message flow diagram for determination of congestion in a normal case.

- » DSR receives a Diameter Request Message.
- » DSR selects a connection and forwards it to a connected peer (Server).
- » The peer replies with 'DIAMETER_TOO_BUSY' result code in the Answer.
- » DSR sets the Connection Status to 'BUSY' and starts 'Connection Busy Abatement Timer'.
- » DSR forward the DIAMETER_TOO_BUSY to client.

If 'Reroute on Answer' feature is configured, the DSR may attempt to perform alternate routing of Request based on DSR routing configuration.

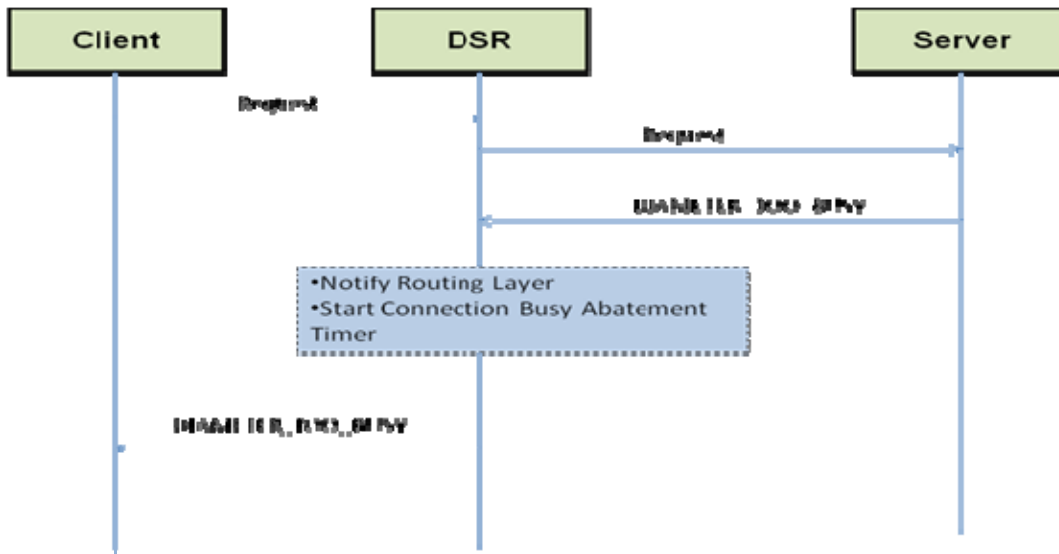

Figure 19 - Connection Busy

TABLE 4 CONGESTION LEVELS BASED ON REMOTE BUSY

Request Priority for which a remote busy was received	Associated Connection Congestion Level	Message Priorities Allowed	Messages Priorities Not Allowed	Comment
2	CL-3	3	0,1,2	Only allow Answers to be sent on connection
1	CL-2	3,2	0,1	Only allow Answers and Priority=2 Requests to be sent on connection
0	CL-1	3,2,1	0	Only allow Answers and Priority=2, 1 Requests to be sent on connection

When the abatement timer expires, the congestion level is decremented by one thereby allowing Requests with the next lower priority and the abatement timer is restarted. For the example above, after the abatement timer expires, priority 2 and above Requests will be allowed over the connection. This process continues until the congestion level of the connection drops back to zero. This behavior is illustrated in the figure below.

Note: - Diameter Protocol does not provide any mechanism for a node to signal to its peers that its busy condition has abated.

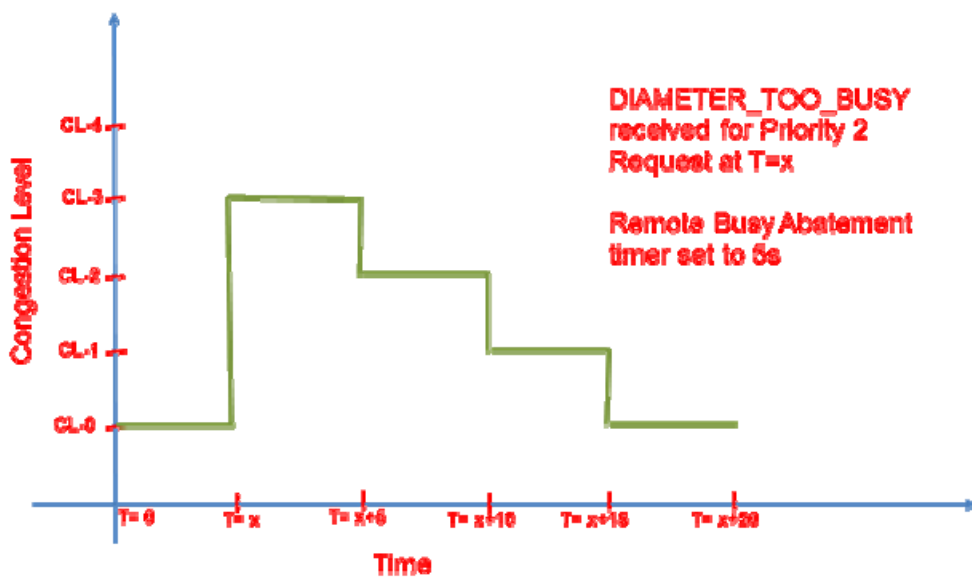

Figure 20 - Congestion level abatement over time for Remote Busy

DNS Support

The DSR supports DNS lookups for resolving peer host names to an IP address. The operator can configure up to two DNS server addresses designated as primary and secondary servers. The wait time for DNS queries for connections initiated by the DSR is configurable between 100 to 5000 milliseconds with a default of 500 milliseconds.

The DSR supports both A (IPv4) and AAAA (IPv6) DNS queries. If the configured local IP address of the connection is IPv4 the DSR will perform an “A” lookup and if it is IPv6 the DSR will perform an “AAAA” lookup. If the IP address of the connection is undefined by the operator, the DSR will resolve the host name using both A and AAAA DNS queries when initiating the connection. The DSR can either use the peer’s FQDN or an FQDN specified for the connection as a hostname for the DNS lookup.

Diameter Mediation

The Diameter Protocol has been designed with extensibility in mind. Standards bodies have defined quite a few applications on top of the base Diameter protocol for use in 3G, LTE and IMS networks. Over time, the standards bodies will continue to extend these applications by adding, altering or deleting AVPs or modifying the header to meet new market needs.

In an effort to differentiate themselves, Vendors often include additional functionality into the protocol by adding proprietary AVPs or overloading existing AVPs. Such additions do not pose an interoperability issue where all the equipment is provided by a single vendor, but that is rarely the case. As most operators rely on equipment from multiple vendors, interoperability issues are almost guaranteed. To make matters worse, vendors continue to extend their proprietary versions of the protocol making them incompatible with other elements that communicate using the previous version of the proprietary protocol.

Even in the absence of vendor-specific extensions, it is possible that two vendors interpret the standard in slightly different ways which could then lead to interoperability issues. The operator can mitigate this by forcing the two vendors to perform interoperability testing prior to deployment. However, in certain scenarios, such as the S9



interface (HPCRF-VPCRF), where two operator networks have to exchange Diameter traffic between each other, performing interoperability exercises with all other operator networks is not practical.

Operators may choose to deploy components of a solution in a phased manner. For example, an operator can start with just the charging and billing systems and roll in the policy control parts of the solution at a later time. As new components are added to the solution, operators will have to ensure that these new components work seamlessly with the existing setup. In such situations, operators often see a need for performing activities such as Digit Manipulation or mapping of Result-Codes.

Therefore, as Diameter networks get more complex, inter-operability issues in a multi-vendor environment or inter operator Diameter traffic exchange could pose challenges. Also as new components are added to the solution, operators will have to ensure that these new components work seamlessly with the existing setup.

The Diameter Mediation feature offers an intuitive GUI that can be used by the operator to build mediation rules to resolve inter-operability issues. This logic can be seamlessly applied to all messages transiting the DSR. As an example, the mediation feature can be utilized by the customer for topology hiding. Operators often desire to hide the topology details of their network for protection purposes and for seamless interworking functionality. The customer is able to use the provided mediation framework to create the necessary rules that would implement topology hiding in their network. In addition mediation enables the DSR to route based on session-id. This is done by using the hashing mechanism to identify messages with matching session-ids that are then all configured to go to the same host.

Rule Templates and Rules

Upon identifying the need for message mediation, an operator begins by creating a "Rule Template". A Rule Template includes the logic required to perform a specific mediation. Conditions and Actions are defined as part of the template and then the rule template is associated with one or more Trigger Points (defined below). Once the definition is complete, the operator provisions the data (Rules) needed for the conditions and the actions. An operator can provision up to 250 Rules per Rule Template.

The Rule Template allows for up to 5 conditions and 5 actions to be defined in a template. When multiple conditions are present in a Rule Template, the framework allows the conditions to be combined using the logical operators (AND, OR) and also the order in which the actions must be executed.

Some examples of the conditions supported are:

- » checking for the presence or absence of well-known or proprietary AVPs or
- » checking for the value of AVP header components or data part of well-known or proprietary AVPs or
- » checking the values of any of the components that make up the Diameter header.
- » checking if a message has been redirected

Some examples of the actions supported are:

- » adding or deleting AVPs
- » Modifying parts of AVP header
- » Modifying the Diameter header
- » Set a message priority
- » Activate message copy
- » Set alarm/event
- » Redirect a message
- » Parse decorated NAI

- » Peg a mediation framework counter

Both actions and conditions can be applied to Grouped AVPs. A max depth of 8 is supported for the Grouped AVPs.

Rule Templates and their associated Rules can be independently exported on one system (such as a lab system) and then imported into another system (such as a production system). This capability is useful when the Rule Templates and Rules are being tested in a lab environment and for moving the Rule templates and Rules to production system upon successful completion of testing. The import and export all comes in handy when a Rule Template has to be updated and replaced with a newer version of the Rule Template but the older Rules need to be preserved.

States of a Rule Template

A Rule Template is in one of three states at any point in time. These states are Development, Test and Active. Each Mediation Template begins in the “Development” state when created. Once the template definition is complete the State can be changed to “Test” or “Active”. An operator can provision rules (data) against the Template only after a Template is in the “Test” or “Active” states. In the “Test” state, the template logic is executed for Requests arriving on “test” connections. (see connections GUI to designate a connection as a “test” connection). However, only Requests (not answers) can be processed in this state and so it is recommended to test the Templates by placing them in an “Active” state but on a lab system prior to moving into production. Upon successful execution of tests in the lab system, the templates and the associated rules (if applicable) can be imported to the production system and the state of the Mediation Template can be changed to “Active” by the operator.. If the execution of tests is unsuccessful, the Mediation Template can be transitioned back into the “Development” state where it can be altered and the process is repeated. It should be noted that rules cannot be associated with a template in “development” state and hence it is recommended to export the rules associated with the template prior to this operation to avoid the need of manually configuring the rules again.

Trigger Points

Trigger points are specific points in call processing where the Rule Templates along with their associated Rules can be executed. The trigger points supported in the DSR are:

- » upon receipt of a Request (including a Redirected Request) (including CER, DWR, DPR)
- » prior to relay/proxy/sending of the Request (including CER, DWR, DPR)
- » prior to forwarding a re-routed Request
- » upon receipt of an Answer (including CEA, DWA, DPA)
- » just prior to forwarding/sending the Answer downstream. (including CEA, DWA, DPA)
- » just prior to the invocation of an application
- » immediately after the Request exits the application
- » just prior to the Answer being routed to the application
- » immediately after the answer exits the application

The mediation framework also supports defining multiple mediation rules at a single trigger point or invoking the same mediation rule at multiple trigger points.

Measurements Associated with Rules

In order to allow an operator to see how many times a rule is invoked for debugging purposes or for fine tuning purposes, rule counts are maintained for the rules in a rule set. These counts can be enabled/disabled as a property of the template and once enabled the counters appear against the individual rules in the rule set (i.e. there is one counter per each rule in the rule set.) These counters track the number of times a rule is successfully



matched on all the conditions in the template. The counters are based on conditions only and the outcomes of the actions do not impact the counters. They are incremented sequentially until they are disabled.

AVP Dictionaries

The GUI driven definition is much simplified by using AVP names instead of AVP codes wherever possible. The Diameter Mediation Framework includes a Base AVP Dictionary where well known AVPs are defined. This dictionary includes AVPs defined in the base Diameter Protocol and AVPs defined by popular applications such as Diameter Credit Control Application, and S6a interface. Any additions made by the operator are included into the Custom AVP Dictionary. Once defined, these AVPs are available for use by their name during rule template definition.

A grouped or non-grouped AVP defined in the base dictionary or in the custom dictionary can be cloned, modified and saved into the customer dictionary. An AVP cannot be saved if the combination of the same AVP code and/or AVP name already exists in the custom dictionary. If the user clones an AVP that is referred from some template/rule, then the GUI only allows adding new sub AVPs to the grouped AVP, no other changes are allowed. If the AVP is not used by any template/rule, the user can do other modifications.

IP Front End (IPFE)

The presence of IPFE does not prevent a system from having DA MPs directly connected to clients using for example SCTP Multi-homing connections.

The IP Front End (IPFE) is a traffic distributor that transparently does the following:

- » Presents a routable IP address representing a set of up to 16 application servers to application clients. This reduces the number of addresses with which the clients need to be configured.
- » Routes packets from the clients that establish new TCP or SCTP connections to selected application servers.
- » Routes packets in existing TCP or SCTP connections to the correct servers for the connection.

Traffic Distribution

The IPFE presents one or more externally routable IP addresses to accept TCP or SCTP traffic from clients. These externally visible addresses are known as Target Set Addresses (TSAs). Each TSA has an associated set of IP addresses for application servers, up to 16 addresses, known as a Target Set. The IP addresses in a given Target Set are of the same IP version (that is, IPv4 or IPv6) as the associated TSA.

A typical client is configured to send TCP or SCTP traffic to one or more of the TSAs, rather than directly to an application server. When the IPFE receives a packet at a TSA, it first checks to see if it has a transaction state that associates the packet's source address and port to a particular application server.

This state is known as an "association." If no such association exists (that is, the packet was an "initial" packet), the IPFE runs a selection function (which has been configured by the user selecting a method such as hash, least load, peer node aware least load, etc.) to choose an application server address from the eligible addresses in the Target Set. The selection function uses a configurable weighting factor when selecting the target address from the list of eligible addresses. The IPFE routes the packet to the selected address, and creates an association mapping the source address and port to the selected address. When future packets arrive with the same source address and port, the IPFE routes them to the same selected address according the association.

Because the IPFE has no visibility into the transaction state between client and application server, it cannot know if an association no longer represents an active connection. The IPFE makes available a per Target Set configuration parameter, known as delete age, that specifies the elapse of time after which an association is to be deleted. The IPFE treats packets that had their associations deleted as new packets and runs the application server selection

function for them. The IPFE sees only packets sent from client to server. Return traffic from server to client bypasses the IPFE for performance reasons. However, the client's TCP or SCTP stack "sees" only one address for the TSA; that is, it sends all traffic to the TSA, and perceives all return traffic as coming from the TSA.

The IPFE neither interprets nor modifies anything in the TCP or SCTP payload. The IPFE also does not maintain TCP or SCTP state, per se, but keeps sufficient state to route all packets for a particular session to the same application server.

In high-availability configurations, four IPFEs may be deployed as two mated pairs, with each pair sharing TSAs and Target Sets. The mated pairs share sufficient state so that they may identically route any client packet sent to a given TSA.

The IPFE supports the following types of DSR Diameter connections:

- » Responder Only
- » Initiator Only
- » Initiator and Responder

Support for the IPFE initiator + responder connections removes the need for roaming partners to negotiate Initiator / Responder responsibilities. DSR initiates and listens for Diameter connections on a single connection using shared IPFE signaling IP addresses. The DSR provides DSR system wide distributed connection election algorithm to resolve race conditions between IPFE initiator and responder state machine instances.

The DSR currently allows up to 1 IPFE 'initiator+responder' per TSA per peer node. If there are more than 1 TSA per DSR, each TSA can be associated with 1 'initiator+responder' connection. Please note that this can co-exist 'initiator only' or 'responder only' connections to the same Peer node. In the case of an election, one of the two connections shuts down.

- » Local Node FQDN > Peer Node FQDN = responder connection survives
- » Local Node FQDN < Peer Node FQDN = initiator connection survives
- » All subsequent messages are sent on the surviving connection

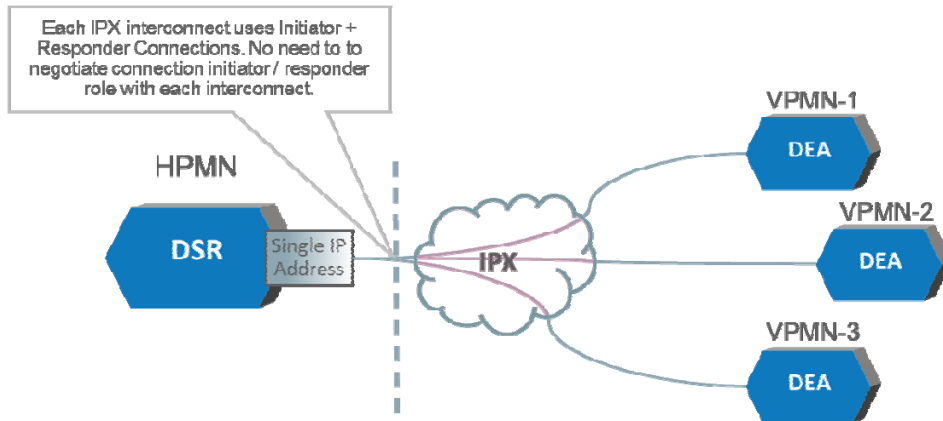



Figure 21 - IPFE Initiator + Responder Support

Connection Balancing

Under normal operation, the IPFE distributes connections among application servers according to the weighting factors defined in the Target Sets. However, certain failure and recovery scenarios can result in an application server having significantly more or fewer connections than is intended by its weighting factor. The IPFE considers the system to be "out of balance" if this discrepancy is so large that the overall system cannot reach its rated



capacity even though individual application servers still have capacity to spare, or so that a second failure is likely to cause one of the remaining servers to become overloaded. The IPFE determines this by measuring the number of packets sent to each server and applying a “balance” heuristic.

When the IPFE detects that the system is out of balance, it sets an alarm and directs any new connections to under loaded application servers to relieve the imbalance. There are a few types of connection distribution algorithms that can be used: hash, least load, and peer node group aware least load distribution

High availability

When paired with another IPFE instance and configured with at least two Target Set Addresses, the IPFE supports high availability. In the case of an IPFE pair and two Target Set Addresses, each IPFE is configured to handle one Target Set Address. Each IPFE is automatically aware of the ruleset for the secondary Target Set Address. If one IPFE should become unavailable, the other IPFE becomes active for the failed IPFE's Target Set Address while continuing to handle its own.

In the case of an IPFE pair, but only one Target Set Address, then one IPFE is active for the Target Set Address and the other is standby.

Topology Hiding

In various interworking scenarios LTE service providers need to protect their networks. The Topology Hiding features remove or hide all Diameter addresses from messages being routed out of the home network on connections with this feature enabled. This feature also re-inserts the appropriate addresses in messages coming back into the home network on these connections. In addition, peer networks are prevented from determining the topology of the home service provider's network by obscuring the number of host names in the network. As a result of this, the peer network service provider is not able to determine how many MME/SGSNs, HSSs, PCRFs, AFs, and pCSCFs are deployed. Nor can the peer service providers derive any deployment architecture information through inspection of host names.

Path Topology Hiding

Path Topology Hiding is the most generic form of topology hiding. It is required for Topology Hiding on any Diameter interface type. Path Topology Hiding involves removing Diameter host names from the Route-Record AVPs included in request messages. This feature does more than just Path Topology Hiding. It might be better called Diameter Topology Hiding, as there are host names that are hidden that are beyond just the path recorded in Route-Record AVPs. This feature hides all of the host names included by the base Diameter protocol, with the exception of the Session-Id header, which is left to the TH feature for the specific interface to handle.

Path Topology Hiding also hides addresses in other AVPs that are part of the base Diameter specification. This includes the following:

- » The Error-Reporting-Host AVP contains the name of the host that generated an error response. When present, this host name needs to be obscured in answer messages.
- » The Proxy-Host which is an embedded AVP within the grouped Proxy-Info AVP contains the name of a proxy that handled a request. This is used as a way for the proxy to insert state into a request message and receive the state back in the answer message. As such, the method for hiding the name of the Proxy-Host name must allow for reconstruction of the name when the answer message is received.

Route-Record Hiding

The Route-Record AVP has two uses in Diameter signaling:

1. The primary purpose is to detect loops in the routing of Diameter Request. In this case, a Diameter Relay or Proxy looks at Route-Record AVPs to determine if a message loop has or will occur. This is detected

either by the relay or proxy (the DSR in our case) finding its own host-id in the Route-Record message or by the DSR determining that the host to which the request is to be routed in the Route-Record AVP (referred to as forward loop detection). Note that not all Diameter Relays/Proxies do forward loop detection. The DSR, however, does.

Note: For the purposes of this feature, the definition of a loop is modified slightly to include any time that a Request leaves the home or interworking network and then returns to the home or interworking network. This is independent of the DEA or DIA at which request returns to the home or interworking network. This means that a Request leaving the network on one DEA/DIA and returning to the network on a different DEA/DIA is considered a loop.

2. The other defined purpose of the Route-Record AVP is for authorization of the request. A Diameter service might not want to accept a request if it has traveled through a suspect realm. While the DSR does not support such an authorization feature, the Path TH feature does not remove the ability for other Diameter agents or servers to use the Route-Record AVPs to authorize the request.

Each Route-Record AVP contains a Host-Id of a Diameter node that has handled the request. A Relay/Proxy Agent inserts a Route-Record AVP into the message containing the Host-Id of the Diameter node from which it received the request.

It is the Protected Network's Host-Ids included in the Route-Record AVPs that need to be hidden.

For Request messages leaving a protected network, the Path TH feature handles Route-Record AVPs by stripping the protected network's Route-Record AVPs and replacing them with a single Route-Record AVP containing a Route-Record pseudo-host name.

For example, the following request:

```
xxR
...
Route-Record: host1.protectednetwork1.net
Route-Record: host2.protectednetwork1.net
...
```

Would be modified to the following:

```
xxR
...
Route-Record: pseudohost.protectednetwork1.net
...
```

Route-Record AVPs for network other than the Protected Network are preserved. As such, the following request:

```
xxR
...
Route-Record: host.foreign1.net
Route-Record: host.foreign2.net
Route-Record: host.protectednetwork1.net
...
```



Would be modified to the following:

```
xxR
...
Route-Record: host.foreign1.net
Route-Record: host.foreign2.net
Route-Record: pseudohost.protectednetwork1.net
...
```

For requests ingressing into a protected network, the Path TH feature examines the Route-Record headers in the request. If any of the Route-Record AVPs contains a host name matching a protected network's Route Record pseudo-host name then the DSR considers it a loop and returns an answer message with Result-Code AVP value 3005 (DIAMETER_LOOP_DETECTED).

It is also necessary to hide the names of hosts that occur in the other base Diameter AVPs listed here:

- » Proxy-Host AVP (embedded in the grouped Proxy-Info AVP)
- » Error-Reporting-Host AVP

Proxy-Host Hiding

The handling of the Proxy-Host AVP can be achieved using a pseudo-host name. In this case, the real name is stored in the pending transaction record. The pseudo-host name found in the answer message is replaced by the real host name stored in the pending transaction record. The figure below shows a simple message flow illustrating this functionality.

This handles the instance that multiple proxies are in the path of the request. As a result, a single Proxy-Host pseudo-host name is not sufficient, as the original name is restored when the answer returns. To address this, the DEA/DIA is able to insert a different Proxy-Host pseudo-host name per Proxy-Host AVP. These Proxy-Host pseudo-host names are also generated in a fashion that does not expose the number of proxies in the protected network. In order to achieve this, the Proxy-Host pseudo-host name consists of two components, the user-defined Proxy-Host pseudo-host name string and a random set of 3-digits prefixed to that name. If the user-defined Proxy-Host pseudo-host name string is proxy.example.com, then the value inserted into a Proxy-Host AVP would then be of the form nnnproxy.example.com, where “nnn” is a randomly generated set of digits.

Proxy-Host Topology Hiding – Simple Request

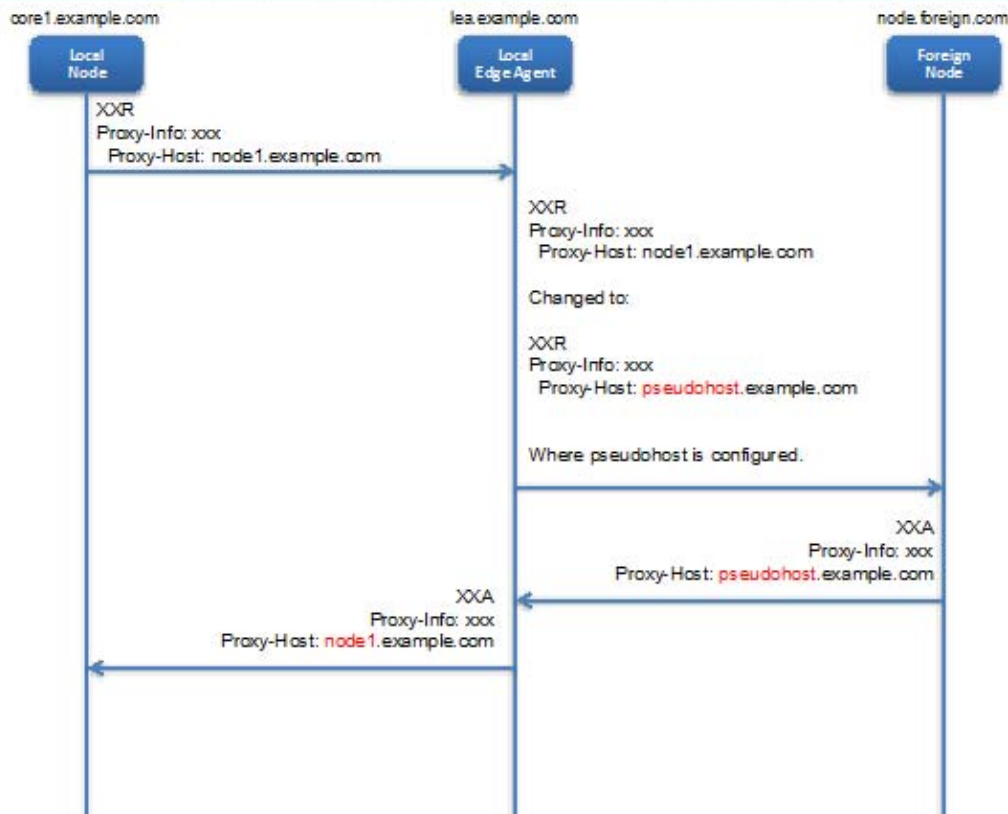

Figure 22 - Proxy-Host Topology Hiding Message Flow

Error-Reporting-Host Hiding

When obscuring the Error-Reporting-Host AVP the real host name is recovered in case it is needed for troubleshooting activities. Encryption is used for obscuring the Error-Reporting-Host AVP. This allows for troubleshooters in the protected network to decrypt the AVP to determine the original value. The encryption algorithm used only requires the operator to know the key for decrypting this value in a common troubleshooting tool such as Wireshark.

S6a/S6d MME/SGSN Topology Hiding

In S6a/S6d transactions, a host name sent by the MME/SGSN in the Origin-Host AVP in a ULR message is saved by the HSS and used in the Destination-Host AVP for requests, such as the CLR, sent by the HSS. The figure below shows this linking of host names across Diameter transactions. As a result of this, it is necessary to ensure that a DSR receiving a CLR request from an untrusted peer network HSS can determine which MME/SGSN host is the target of the request.

With this approach, there is a configured mapping of real MME/SGSN host names to MME/SGSN pseudo-host names. When a request or answer associated with a protected network is forwarded towards an untrusted peer network, the MME/SGSN host name in the message is replaced by a MME/SGSN pseudo-host name. When a

request or answer is received by a DSR with TH enabled on the ingress Peer Node and it contains a MME/SGSN pseudo-host name, the MME/SGSN pseudo-host name is replaced by the real MME/SGSN host name.

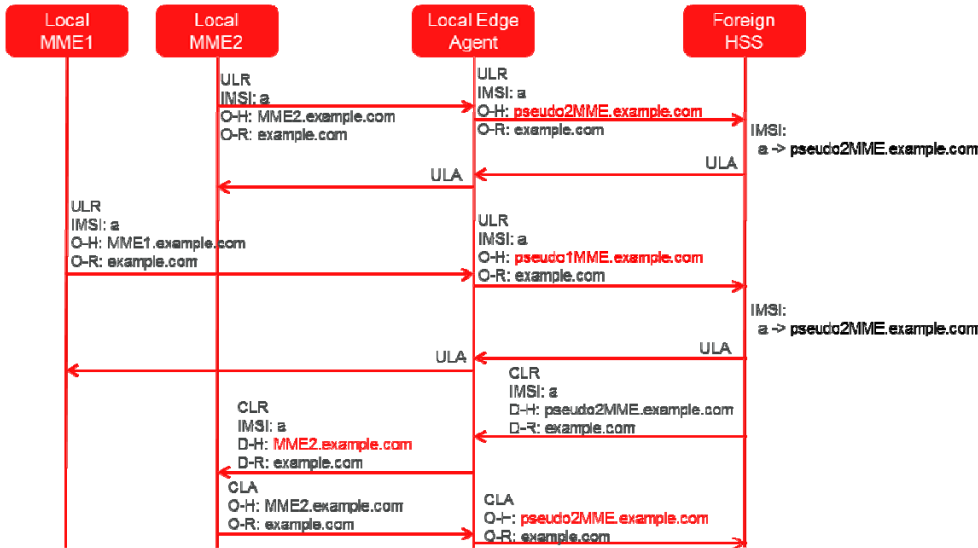

Figure 23 - MME/SGSN Topology Hiding

The MME/SGSN TH feature also hides the number of MME/SGSNs in the protected network. To achieve this requirement the MME/SGSN Topology Hiding feature allows for the mapping of a variable number of MME/SGSN pseudo-host names per real MME/SGSN host name.

When configuring the MME/SGSN Topology Hiding feature, the real host names of the MME/SGSNs in the network are entered. A pattern is entered that is used to generate the MME/SGSN pseudo-host names. The DSR then generates from one to three pseudo-host names per entered MME/SGSN.

As an example, assume that a carrier has five MME/SGSNs with the following real names:

- » mme1.westregion.example.com
- » mme2.westregion.example.com
- » mme1.eastregion.example.com
- » mme2.eastregion.example.com
- » mme1.texasregion.example.com

When configuring MME/SGSN TH, the carrier enters these five real MME/SGSN host names. The carrier also enters the pattern to be used in generating the MME/SGSN pseudo-host names. The pattern is in the form:

prefix|digits|suffix

where the variable portion of the name is the digits field. For example, assume the carrier enters the following pattern:

prefix = "mme"

digits = "nnn"

suffix = ".example.com"

The resulting generated names look as follows:

mme|nnn|.example.com

In this case, the nnn portion of the MME/SGSN pseudo-host name contains three digits used to differentiate the MME/SGSN pseudo-host names.

The DSR then generates the mapping between real and pseudo-host names. The following table is an example mapping that could result from this example:

TABLE 5 MME/SGSN PSEUDO-HOST NAME MAPPING

MME/SGSN Real Host Name	MME/SGSN Pseudo-Host Name(s)
mme1.westregion.example.com	mme042.example.com
	mme123.example.com
mme2.westregion.example.com	mme533.example.com
mme1.eastregion.example.com	mme922.example.com
mme2.eastregion.example.com	mme411.example.com
	mme218.example.com
	mme331.example.com
mme1.texasregion.example.com	mme776.example.com
	mme295.example.com
	mme333.example.com

This mapping is then used for replacing MME/SGSN real host names with MME/SGSN pseudo-host names for messages directed toward the untrusted peer network HSS and for replacing MME/SGSN pseudo-host names with real host names for messages from the untrusted peer network HSS targeted for a protected network MME/SGSN.

The algorithm for selection of the MME/SGSN pseudo-host name ensures that the same MME/SGSN pseudo-host name is always selected for the same IMSI from the same MME/SGSN. This is to ensure that the HSS receiving a ULR doesn't mistakenly think that the request is from a new MME/SGSN, triggering a CLR transaction. The MME/SGSN topology hiding feature also hides the host names included as part of the Session-Id AVP.

S6a/S6d HSS Topology Hiding

The S6a/S6d HSS TH feature applies to all Diameter S6a/S6d messages between a protected network HSS and an untrusted peer network MME/SGSN.

For Diameter transactions originated by an MME/SGSN in an untrusted peer network, the following actions are taken for S6a/S6d HSS Topology Hiding:

- » Request Messages – If the request message contains the Destination-Host address of S6a/S6d HSS and if HSS pseudo-name was selected from a list of HSS pseudo-names in previous S6a/S6d HSS Answer, then S6a/S6d HSS Topology Hiding restores the original S6a/S6d HSS addresses in the Destination-Host AVP. Restoral of Protected S6a/S6d HSS original host name is not done if single pseudo-name is used in S6a/S6d HSS Topology Hiding. Instead this replacement is done by HSS Address resolution application such as DSR's FABR or RBAR application.
- » Answer Messages – The answer message contains the HSS real host name in the Origin-Host AVP. This real host name is replaced based on one of the following 2 methods for HSS pseudo host name selection:

- » a single HSS pseudo-host name which has been defined for all the network HSS real host names in the Protected Network, or,
- » a HSS pseudo-host name selected from a list of HSS pseudo-host names that have been defined for each real HSS host name in the Protected Network (this approach is similar to the one described for MME/SGSN Topology Hiding).

For Diameter transactions originated by the protected network HSS and targeted for an untrusted peer network MME/SGSN the following actions must be taken for S6a/S6d HSS Topology Hiding:

» Request Messages –

- » The request message contains the HSS real host name in the Origin-Host AVP. Based on which HSS pseudo-host name selection method has been selected (as described above), this host name is replaced with either the single HSS pseudo-host name defined for all HSS real host names in the protected network, or by a HSS pseudo-host name from the list of HSS pseudo host names defined for each of the Protected Network real HSS host names.
- » The request message also contains a Session-Id AVP that contains the HSS's Diameter-ID. Based on which HSS pseudo-host name selection method has been selected (as described above), this HSS real host name is also replaced with either the single HSS pseudo-host name defined for all HSS real host names in the protected network, or by a HSS pseudo-host name from the list of HSS pseudo host names defined for each of the Protected Network real HSS host names.

» Answer Messages –

- » The answer message also contains a Session-Id AVP that contains a HSS pseudo host name in the Diameter-ID portion. This is replaced with the HSS real host name stored in the transaction state.

The figures below show message flows illustrating S6a/S6d HSS TH for requests originating at an untrusted peer network MME/SGSN as well as the protected network HSS.

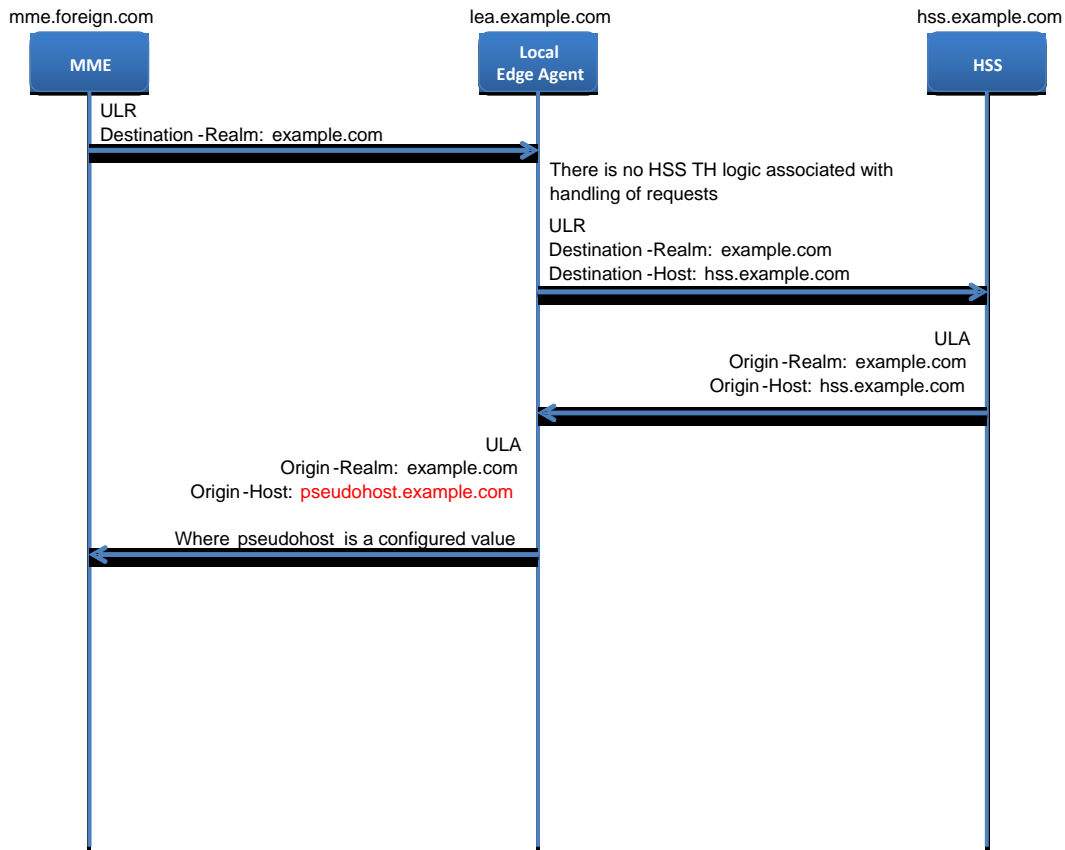

Figure 24 - S6a/S6d HSS Topology Hiding - ULR Message Flow

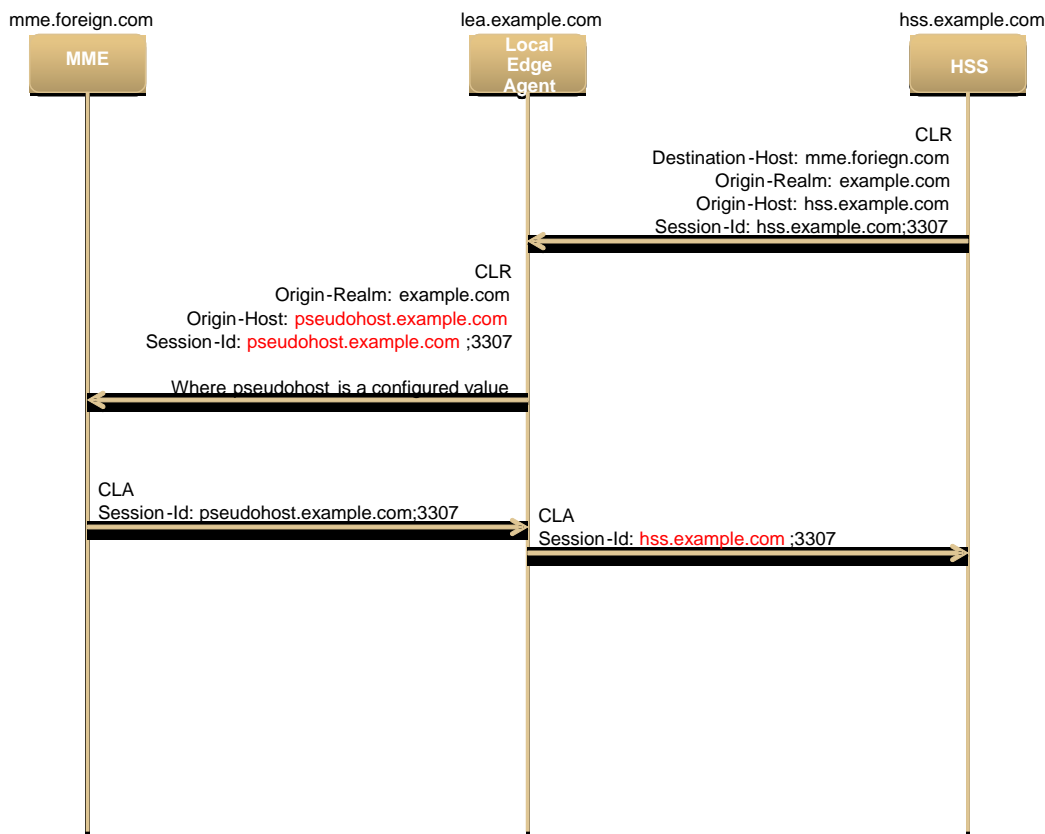

Figure 25 - S6a/S6d HSS Topology Hiding CLR Message Flow

S9 PCRF Topology Hiding

S9 PCRF topology hiding is concerned with hiding the identity of a Protected Network's PCRFs, as well as the number of PCRF's in the network, when it exchanges messages with Untrusted Networks. A PCRF's identity is embedded in the Origin-Host and Session-Id AVPs sent in Request messages and the Origin-Host AVP sent in Answer messages. This capability is associated with the Diameter S9 and Rx application messages over the S9 Reference Point. This S9 PCRF Topology Hiding feature encompasses:

- » PCRF Topology Hiding in inbound and outbound roaming use cases – Hiding of PCRF host names in S9 messages over the S9 Reference Point in Local Breakout (LBO) roaming architecture with the AF in the Visited Network or with the AF in the Home Network. Also hiding of PCRF host names in S9 messages over the S9 Reference Point in the Home Routed Access roaming architecture.
- » PCRF Topology Hiding in outbound roaming use case: Hiding of PCRF host names in Rx messages over the S9 Reference Point in Local Breakout (LBO) roaming architecture with the AF in the Visited Network.
- » PCRF Topology Hiding in inbound roaming use case – Hiding of PCRF host names in Rx messages over the S9 Reference Point in Local Breakout (LBO) roaming architecture with the AF in the Visited Network where the Visited PCRF is implemented as a client/server of Rx messages to/from the Home PCRF.

The technique to hide and restore PCRF identities is similar to as described in S6a/S6d MME Topology Hiding.

S9 AF/pCSCF Topology Hiding

S9 AF/pCSCF topology hiding is concerned with hiding the identity of a Protected Home Network's AF/pCSCFs, as well as the number of AF/pCSCF's in the network, when it exchanges messages with Untrusted Networks. An AF/pCSCF identity is embedded in the Origin-Host and Session-Id AVPs sent in Request messages and the Origin-



Host AVP sent in Answer messages. This is associated with the Diameter Rx application messages over the S9 Reference point. This AF/pCSCF Topology Hiding feature encompasses:

- » S9 AF/ pCSCF Topology Hiding (inbound roaming use case) – Hiding of AF/pCSCF host names in Rx messages over the S9 Reference Point in Local Breakout (LBO) roaming architecture with the AF in the Visited Network where the Visited PCRF is implemented as a Proxy of Rx messages to/from the Home PCRF.

The technique to hide and restore S9 AF/pCSCF identities is similar to as described in S6a/S6d MME Topology Hiding.

DSR Applications

Certain functionality on the DSR is deemed important or complicated enough to be called an application and the details on those items can be found in this section. In general, the DSR is positioned as a flexible multi-functional router that can provide any or all of the applications listed below, and would evolve to support additional applications. Operators have varying network designs.

Support for multiple applications and application chaining is supported with some restrictions. The following application limitations exist:

- » The following applications are mutually exclusive on the same DSR Signaling node:
 - » CPA (OFCS) and PCA
 - » GLA is only supported on nodes with PCA
- » The following application combinations are not supported on the same Diameter Agent Server:
 - » CPA (OFCS) and PCA
 - » All three of FABR, RBAR and PCA
- » The following application and function chaining combinations are supported:
 - » RBAR -> PCA OCDRA function
 - » RBAR -> DM IWF
 - » FABR -> DM IWF
 - » RBAR -> PCA OCDRA function

Offline Charging Proxy (OFCS)

In a real network, the multiple instances of Charging Trigger Function (CTF) and Charging Data Function (CDF) forces the CTFs as Diameter clients to support load distribution and failover for Rf messages toward the CDFs (servers). To address this problem, the DSR can act as a Charging Proxy Function (CPF) between the CTF and the CDF.

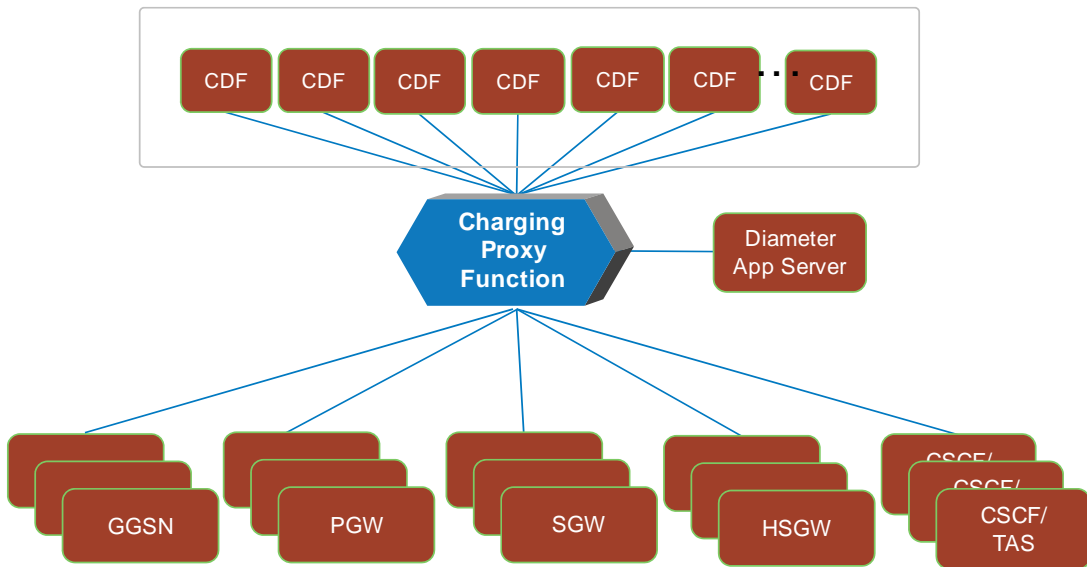

Figure 26 - Charging Proxy Network Architecture

In this manner the CPF provides load distribution and failover support functionality between the CTFs (clients) and CDFs(servers). The CPF distributes sessions to the CDFs and also ensures that all of the messages in an Rf charging session get forwarded to the same CDF. The CPF supports scalability, security, resilience, and maintainability. The CPF also supports topology hiding. Topology hiding means the CPF appears as a single CDF (or significantly reduced set of CDF's) to the CTFs, and vice-versa. The CPF is also able to copy messages to Diameter application server(s) (DAS) based on the value of particular AVPs in the message.

Range Based Address Resolution (RBAR)

Range based address resolution is a DSR enhanced routing application which allows the user to route Diameter end-to-end transactions based on Application ID, Command Code, "Routing Entity" Type, and Routing Entity address ranges. A Routing Entity can be a User Identity (IMSI, MSISDN, IMPI or IMPU) or an IP Address associated with the User Equipment (IPv4 or IPv6-prefix address). Charging characteristics are supported for the "Routing Entity" Type as well. Routing resolves to a "Destination" which can be configured with any combination of a Realm and FQDN (Realm-only, FQDN-only, or Realm and FQDN). Prefix filtering is provided with the creation of a user-configurable table filled with invalid IMSI MCC values that is used during IMSI validation prior to using the IMSI value for address resolution. The address resolution application checks against ranges of MCC values which are then used to invalidate an IMSI. The RBAR application routes all messages as a Diameter Proxy Agent. When a message successfully resolves to a Destination, RBAR replaces the Destination-Host and possibly Destination-Realm AVP in the ingress message, with the corresponding values assigned to the resolved Destination, and forwards the message to the DSR Relay Agent for egress routing into the network. A GUI is provided allowing the operator to provision MCC-MNC combinations of all network operators in the world which includes the country and network name. A list of all the well-known MCC-MNC combinations are pre-populated at installation time but these can be modified/deleted at a later time.

Full Address Based Resolution (FABR)

Full address based resolution is a DSR enhanced routing application which allows the user to route Diameter end-to-end transactions based on Application ID, Command Code, "Routing Entity" Type, and individual Routing Entity. For FABR a Routing Entity can be a User Identity (IMSI, MSISDN, URI, wild carded NAI, IMPI or IMPU). As in RBAR, routing resolves to a "Destination" which can be configured with any combination of a Realm and FQDN



(Realm-only, FQDN-only, or Realm and FQDN). Prefix filtering is provided with the creation of a user-configurable table filled with invalid IMSI MCC values that is used during IMSI validation prior to using the IMSI value for address resolution. The address resolution application checks against ranges of MCC values which are then used to invalidate an IMSI.

The FABR application routes all messages as a Diameter Proxy Agent. When a message successfully resolves to a Destination, FABR replaces the Destination-Host and possibly Destination-Realm AVP in the ingress message, with the corresponding values assigned to the resolved Destination, and forwards the message to the DSR Relay Agent for egress routing into the network. FABR uses the remote database storage called DSR Data Repository (DDR) to store subscriber data. DDR is hosted on the Database Processor blades at each node.

A GUI is provided allowing the operator to provision MCC-MNC combinations of all network operators in the world including the country and network name. A list of all the well-known MCC-MNC combinations are pre-populated at installation time but these can be modified/deleted at a later time.

FABR Blacklist

The FABR application also supports the rejection of Diameter requests which carry a blacklisted IMSI/MSISDN. A blacklist search is performed prior to the Full address search. This search can be enabled for a combination of Application-Id, Command-Code, and Routing Entity. If a match is found during the blacklist search, the operator is able to configure FABR, on a per Application-Id basis, to either respond to the Diameter request with a configurable Result-Code/ Experimental Result-Code, or Forward the Request to a default destination or forward the Request unchanged.

A total of 1 Million IMSIs and 1 Million MSISDNs (not prefixes) are supported for blacklisting. The IMSIs are of fixed length (15 digits long) and the MSISDNs are provisioned as E.164 numbers (includes the Country code but without the + sign). The blacklisted IMSIs and MSISDNs are provisioned via the SDS GUI or via bulk import using a CSV file.

IMSI/MSISDN Prefix lookUPS

Operators use FABR to resolve individual subscriber IMSIs or MSISDNs to specific end points such as a HSS. This ability to resolve the address on an individual subscriber basis provides the highest degree of freedom and flexibility to the operator and allows for subscribers to be assigned to an HSS based on a criteria that fits the operator's needs.

The prefix lookups allow an operator to manage routing based on IMSI prefixes/ranges. All the IMSIs that fall under a particular IMSI prefix/range resolve to the same end point. For example, a block of IMSIs for Machine-to-Machine (M2M) communication could be used and the operator wishes to route all registration requests arising from these IMSIs to a specific HSS (or a set of HSSs) that is dedicated for M2M. Providing the ability to provision ranges results in significant operational savings from a provisioning point of view.

Prefix based lookups are performed after the full address lookup. The prefix based lookup is only performed if the full address lookup does not find a match and can be enabled by the operator for a combination of Application-Id, Command-Code and Routing Entity Type. For example, an operator can choose to perform the prefix lookup only on the S6a-AIR request but not on the other S6a requests. The Routing Entity Type provides additional granularity when the same request carries multiple subscriber identities and the prefix lookup is performed only for one of those identities but not both. For example, certain Cx Requests are known to carry both an IMSI and an MSISDN and this feature allows an operator to perform a prefix lookup for the IMSI but not for the MSISDN.

MSISDN prefixes are supported as well. This allows an operator to route a Diameter Request such as the Cx-LIR based on a prefix if the individual entry is not found.

MAP-Diameter IWF

The primary purposes of the MAP-Diameter IWF are:

- » Performing message content conversion between MAP and Diameter.
- » Performing address mapping between SS7 (SCCP/MTP) and Diameter.
- » Supporting 3G->LTE authentication interworking as needed.

The MAP-Diameter IWF features can either be deployed on a DSR which is only providing the M-D IWF function, or on a DSR which is also providing other functions, such as basic relay, in addition to M-D IWF. As a result, it is necessary for the DSR to determine whether M-D IWF is required when receiving a Diameter request message to be routed. This can be done based on Destination-Host and/or Destination-Realm combined with Application-ID.

There are three primary use cases solved by the MAP-Diameter IWF feature:

1. Base: Any MAP-Diameter IWF use case on the DSR and the related mechanisms for the IWF including message routing
2. Mobility Management: Interworking between MAP-based Gr and Diameter-based S6a and S6d interfaces.
3. EIR: Interworking between MAP-based Gf and Diameter-based S13 and S13a interfaces.

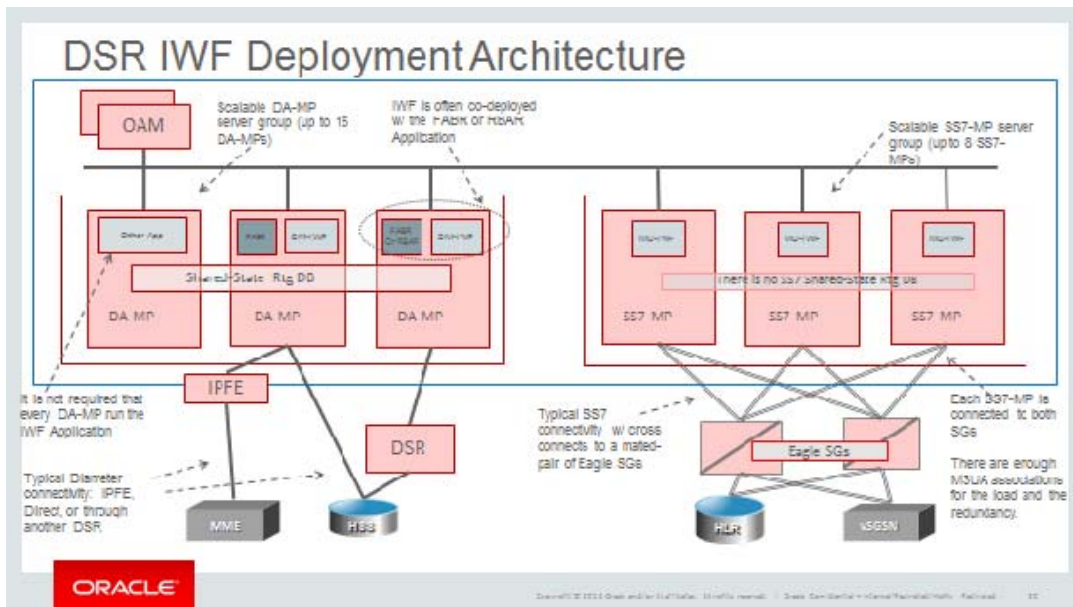

Figure 27 - DSR with MAP-Diameter IWF

Policy and Charging Application (PCA)

The Policy and Charging Application provides two functions on the DSR:

1. Online Charging Proxy (also known as Online Charging Diameter Routing Agent (OC-DRA))
2. Policy Proxy (also known as Policy Diameter Routing Agent (P-DRA))

A PCA DSR can be deployed in a Diameter network with either P-DRA function or OC-DRA function enabled or with both P-DRA and OC-DRA functions enabled on a network-wide basis.

Online Charging Proxy (OC-DRA – Online Charging Diameter Routing Agent)

Mobile Operators are increasingly using Diameter based infrastructure for subscriber charging. 3G operators use a mix of CAMEL and Diameter for charging voice and data sessions respectively while LTE/VoLTE standards call for using Diameter exclusively for the transport of charging messages between charging servers and charging clients.

Online Charging and Offline Charging mechanisms were originally put in place by the standards bodies to address prepaid and postpaid subscribers, but lately, operators seem to be migrating towards convergent charging systems that use Online Charging mechanisms for both prepaid and postpaid subscribers. In the DSR, the Online Charging Proxy provides the Online Charging Diameter Routing Agent (OC-DRA) function.

The figure below shows the Online Charging Architecture as per 3GPP. The architecture does not mandate a DRA and thus does not depict a DRA but shows the various CTFs that can initiate Online Charging messages via Ro or CAP. The figure also shows the components within the Online Charging System (blue box) which typically maps to the Online Charging Server.

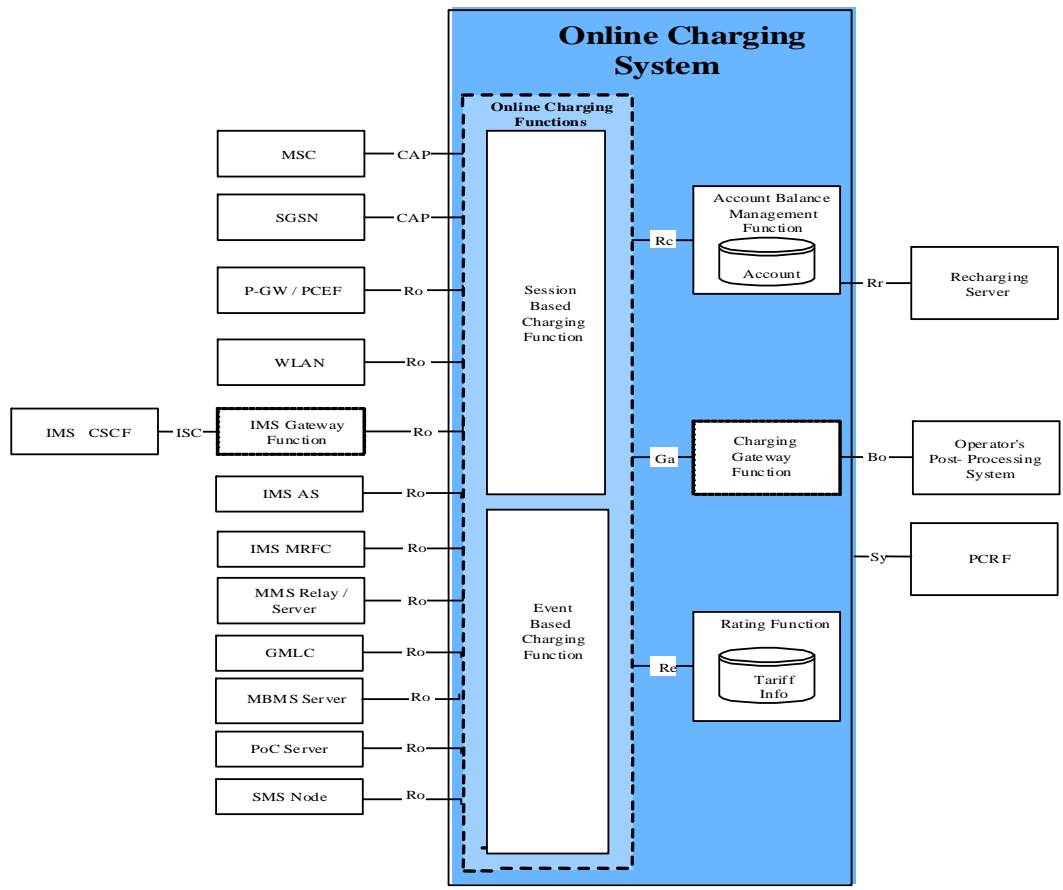

Figure 28 - Online Charging System and Architecture

The following features are supported as part of the Online Charging Proxy:

- » Support Gy/Ro interfaces for online charging sessions between Charging Trigger Function (CTF) and Online Charging System (OCS),
- » Selection of an OCS or OCS cluster for a specific user based on subscriber's ID and/or APN,

- » Creation and maintaining of session state info for some online charging sessions, if configured so,
- » Stateful Session-base routing of online charging messages to available OCSs,
- » High Availability within the site using N+1 DA MP deployment model,
- » Geo-Redundancy by sharing session state across mated sites where needed

The OC-DRA solution retrieves the subscriber's identity from any of the above mentioned AVPs and stores them as part of subscriber state if needed and used for debugging/tracing customer sessions.

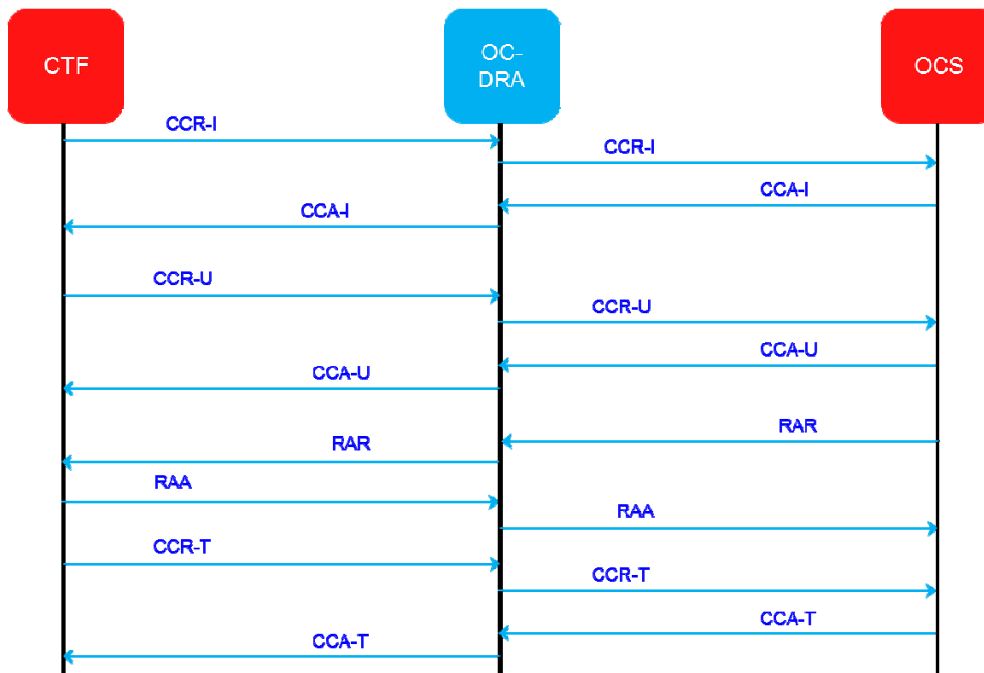



Figure 29: A typical Online Charging Session

Policy Proxy (PDRA – Policy Diameter Routing Agent)

With the advent of LTE and high-speed wireless networks, network providers have a need to manage subscriber resource usage across their entire network. To accomplish network-wide resource monitoring and control requires identification of subscriber resource usage using multiple keys (e.g. IMSI, MSISDN, IP addresses) in a network with large numbers of policy enforcement clients and policy rules servers (PCRFs). Subscriber requests for access to network resources must be routed to a single PCRF in the network so that policy decisions can be made with knowledge of all the resources being used by all of that subscriber's policy sessions. Rather than creating a provisioned relationship between subscribers and PCRFs, which would be difficult and expensive to manage, subscribers are dynamically assigned to a PCRF when the initial bearer session (Gx or Gxx interface) is created. All subscriber policy sessions from anywhere in the network are routed to the assigned PCRF until that subscriber's last Gx or Gxx session ends, at which point the next Gx or Gxx session may be routed to a different PCRF. This dynamic mapping of subscribers to PCRFs provides automatic load distribution to available PCRFs, while still mapping all of a subscriber's sessions to a single PCRF.

Operators are relying on PDRA for its session binding/correlation abilities to enable VoLTE in their networks. In the VoLTE scenarios, Rx Requests initiated by the AS (P-CSCF) are correlated by the PDRA and routed to the PCRF serving the corresponding Gx session. PDRA creates bindings as policy sessions are established and this binding information is then used to route subsequent sessions initiated by the subscriber. In certain situations, such as the



failure or the reboot of a PCRF, the binding information in the PDRA becomes invalid and must be deleted as soon as possible. In the case of a PCRF failure the subscriber's Gx session is torn down. This cleanup action forces the subscriber to re-initiate the IP-CAN session and the Gx session so that it may be routed to a functioning PCRF. This feature allows the removal of any binding capable interface supported by PDRA which can be triggered off Diameter based failures. The DSR monitors the type and the number of error responses originated by the PCRF. (In some situations, the error responses maybe generated by the DSR on behalf of the PCRF.) The PDRA marks a binding as suspect upon seeing certain error responses (also called as session removal events) and tears down the subscriber's Gx session when the number of such error responses exceed a pre-configured value. This forces the subscriber to re-initiate the Gx session which can then be routed to a functioning PCRF. Furthermore, the feature removes all of the subscriber's Gx sessions (or other binding capable sessions) associated with the failed PCRF. The subscriber's Gx sessions (or other binding capable sessions) associated with other PCRFs are not impacted.

In addition to managing a subscriber's resource usage across the network, network providers may have a need to perform topology hiding of the PCRF from some policy clients. This topology hiding prevents the policy client from obtaining knowledge of the PCRF identity (host name or IP address), or indeed knowledge of the number or location of PCRFs deployed in the network.

In summary, the Policy DRA function provides the following capabilities:

- » Distribution of Gx, Gxx, and S9 policy sessions (i.e. binding capable sessions) to available PCRFs
- » Binding of subscriber keys such as IMSI, MSISDN, and IP addresses to the PCRF selected when the initial Gx, Gxx, or S9 session was established
- » Providing network-wide correlation of subscriber sessions such that a policy session initiated anywhere in the network will be routed to the PCRF that is serving the subscriber
- » Providing multiple binding keys by which a subscriber can be identified so that policy clients that use different keys can still be routed to the PCRF assigned to the subscriber
- » Efficient routing of Diameter messages such that any policy client in the network can signal to any PCRF in the network, and vice-versa, without requiring full-mesh Diameter connectivity
- » Hiding of PCRF topology information from specified policy clients

The figure below illustrates an example policy network with P-DRA DSRs deployed.

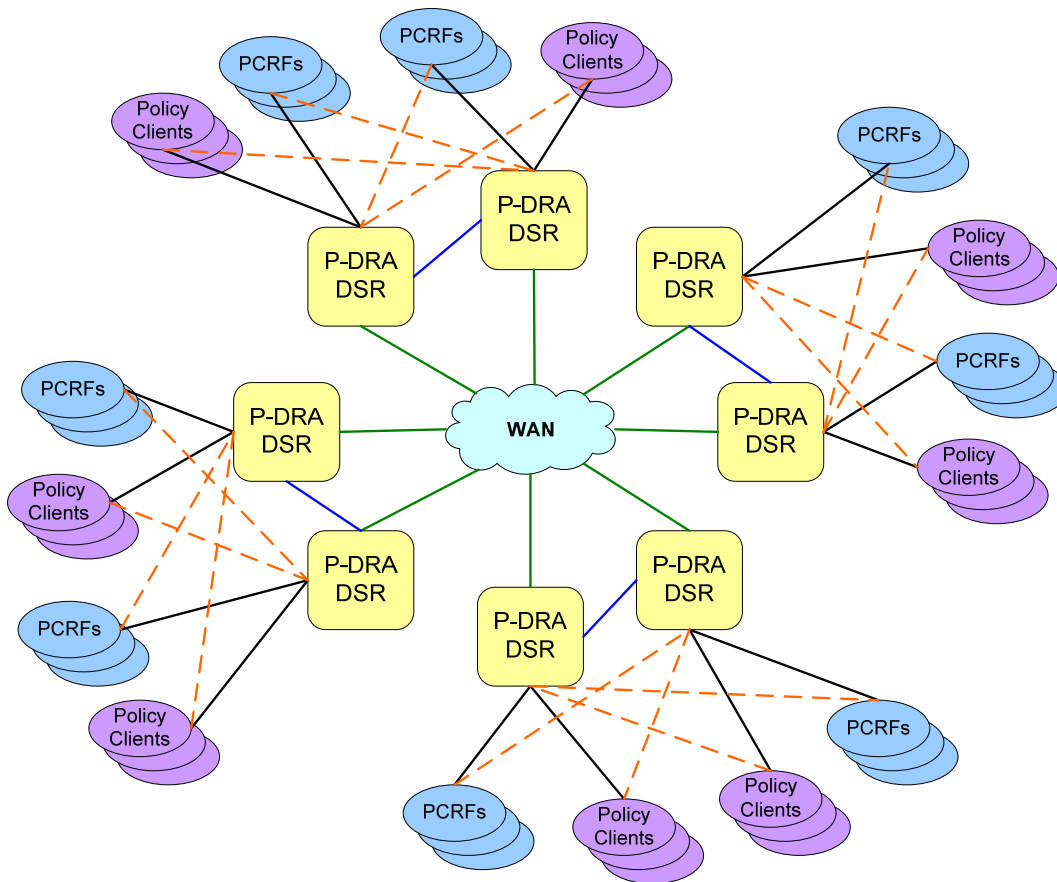

Figure 30 – Network View of P-DRA Mated Pairs

The primary Diameter interfaces to/from the PCRF in a non-roaming environment are Gx (PCEF-PCRF), Gxx (BBERF-PCRF), Gx'/Gx-Lite and Rx (AF-PCRF). These are highlighted in the figure below.. All of these may not be, and often are not, present in all networks. In addition, variants of these interfaces are sometimes used, for example from systems which perform DPI (Deep Packet Inspection) and augment other PCEFs such as GGSNs and PGWs.

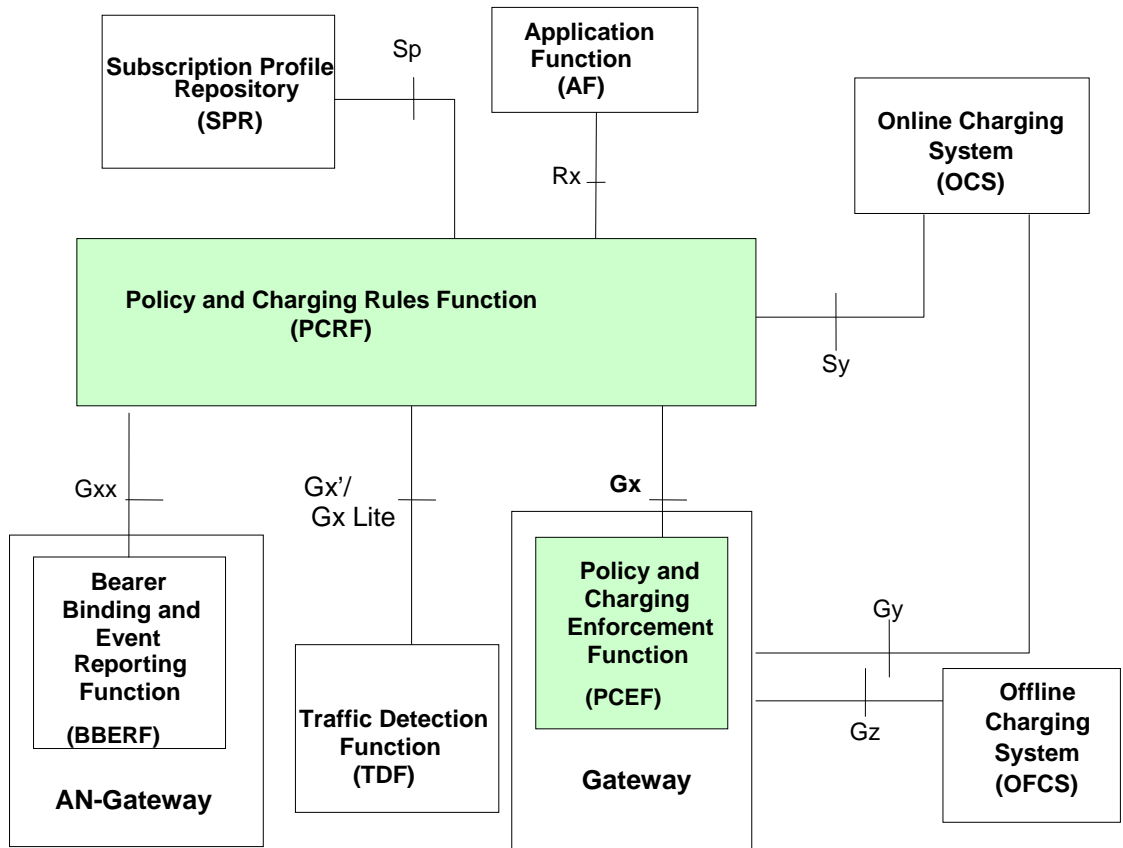

Figure 31 - Overall PCC logical architecture (non-roaming)

The DRA first provides distribution of subscribers' initial Gx sessions, which correspond to their data (IP-CAN) sessions, to PCRFs. This can be done in dynamic (e.g. round-robin) or static (e.g. range-based routing) fashion. Via PCRF binding, the DRA then remembers the PCRF that has been assigned for a subscriber's data session(s) and makes sure that all policy related messages associated with that user's active data session(s) are routed to the same PCRF. Via session correlation, the DRA associates multiple simultaneous Gx/Gxx and Rx sessions for the same user to the same PCRF.

For various reasons, there may be the need to hide the specific Diameter identities of PCRFs from other devices or networks. The DRA is the logical place to perform such topology hiding.

The primary purposes of the DSR Policy DRA function are:

- » Distributing initial Gx, Gxx and S9 sessions across available PCRFs.
- » Providing network wide subscriber binding by storing the relationship between various subscriber data session identities, such as MSISDN / IP address(es) / IMSI, and the assigned PCRF. All P-DRA in the defined P-DRA pool must work together as a single logical P-DRA.
- » Providing network wide session correlation by using the stored binding data to associate other Diameter sessions with the initial session for the subscriber and route messages to the assigned PCRF.
- » Performing topology hiding to hide the true identities of the PCRFs from other elements in the network.

1) Support for Gx' / Gx Lite

The PCRF's primary enforcement point today in the mobile networks is the PGW and is achieved over the Gx interface. This control is based on the subscriber's profile which is provisioned by the operator and provides a certain amount of control over the subscriber's voice and data sessions.

Lately, operators are seeing the need for a finer level of control that is based on the data being exchanged between a user and the internet. This can be for reasons such as video optimization, parental controls, content filtering and traffic/bandwidth management. To help with this, several vendors have built products (generally called as DPI/MOS servers) that reside in the data path and can inspect the data being exchanged at much finer granularity and provide feedback to the PCRF servers. The PCRF servers can then use this information to influence the PGW via the Gx session (in a manner similar to how the Rx interface influences the Gx session).

3GPP has defined the Sd interface in 3GPP release 11 and beyond, for use between the DPI and PCRF servers. However, some of the DPI vendors have produced these boxes before the Sd interface was standardized, adopted Gx with minor variations as the protocol between DPI and PCRF servers. These Gx variations are referred to by some as Gx' and by others as Gx-Lite. It should be noted that Gx' interface does not carry the IMSI which is usually present on the Gx interface. The same is true for Sd interface as well.

The DSR based Policy DRA application manages state required to route Gx, Gxx, Rx and S9 Diameter sessions that belong to a single subscriber to the same PCRF. Given the introduction of DPI/MOS servers into the mobile networks, the Policy DRA must be enhanced to support the interfaces used by these servers(Gx') so that these sessions are routed to the same PCRF that is hosting the corresponding Gx/Gxx session.

Supporting the Gx'/Gx Lite interface involves identifying these sessions, extracting the subscriber keys from the requests, performing a binding lookup and finally routing these requests to the appropriate PCRF. The lookup is typically done on the session initiating the request with subsequent requests performing destination-host based routing but if PCRF topology hiding is enabled, the session information has to be stored in the session database and a lookup is required for subsequent requests in the session.

2) PCRF Topology Hiding

The P-DRA also supports PCRF topology hiding, which can optionally be enabled on a per-destination basis. If enabled for a destination, topology hiding means the PCRF appears as a single large PCRF to that destination. An example where the peer is a PCEF is shown in the figure below, which shows the message flow for a CCR message. This same flow applies to all CCR messages, with the exception that the Initial message might not contain a Destination-Host, in which case the P-DRA adds a Destination-Host to the message before sending to the PCRF. The P-DRA distributes CCR-Initial messages for a user's first session over the Diameter connections to a pool of PCRF connections. The P-DRA, absent of failures, sends all messages of a Diameter session to the same PCRF for the duration of the session.

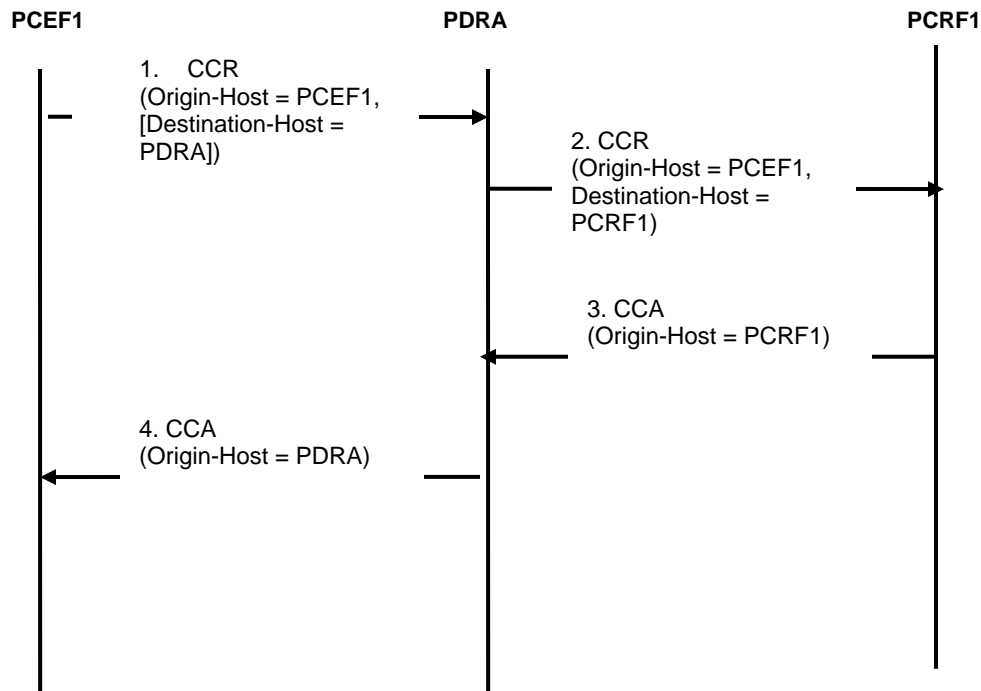

Figure 32 - PCRF topology hiding

In the CCR-I, the PCEF optionally includes the Destination-Host of P-DRA and upon receiving an initial CCA from the P-DRA, populates the Destination-Host AVP with the P-DRA ID for subsequent messages (CCR-U and CCR-T). This is based on the Origin-Host AVP received in the initial CCA from the P-DRA.

Topology hiding also applies to Request messages sent from a PCRF to the affected destination.

3) APN Based PCRF Pooling

Service providers require flexibility in the deployment of new policy-controlled services. They need the ability to roll in new services or new PCRF infrastructure without disturbing existing services. For instance, a carrier might want to have one set of PCRF servers handle policy control for all consumer data accesses to their network and a second set of PCRF servers handle all enterprise data accesses for their network. The policy rules and/or PCRF implementations might be different enough needs to have these two services segregated at the PCRF level.

The introduction of multiple PCRF pools also introduces the requirement to differentiate the binding records in the binding SBR. It is possible for the same UE, as indicated by the IMSI, to have multiple active IPcan sessions spread across the different pools.

The contents of binding generating Gx CCR-I messages are inspected to select the type of PCRF to which the CCR-I messages are to be routed. This feature allows sets of PCRFs to be service specific. The APN used by the UE to connect to the network is used to determine the PCRF pool. The Origin-Host of the PCEF sending the CCR-I can then be used to select a PCRF sub-pool.

A PCRF pool is a set of PCRF's able to handle a set of policy-based services. Multiple pools are supported requiring the PDRA to allow the selection to which a new-binding CCR-I belongs.

Note: While the concept of a PCRF pool might be a network wide concept for a service provider, the configuration of PCRF pools is done on a PDRA site-by-site basis. It is a requirement that PDRA in different sites be able to have different PCRF Pool Selection configuration.

When deploying multiple PCRF pools, each pool supports either different policy-based services or different versions of the same policy based services. Each PCRF pool has a set of DSR PDRA peers that are part of the pool.

As shown below, there is a many to one relationship between APNs and PCRF pools. New sessions for the same IMSI can come from multiple APNs and map to the same PCRF Pool.

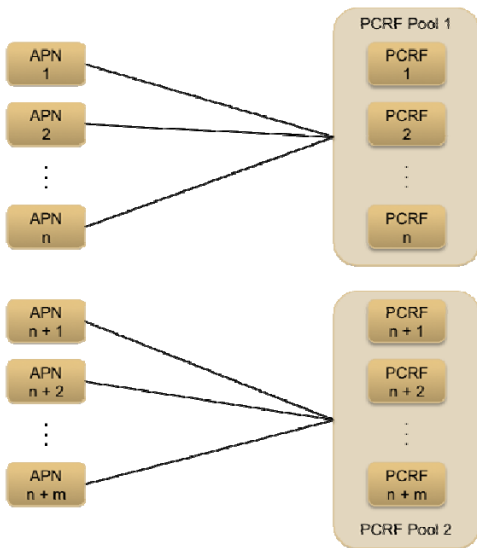

Figure 33 - Relationship between APNs and PCRF Pools

The figure below illustrates the relationship between IMSI and PCRF pool. The same IMSI is able to have active bindings to multiple PCRF pools.

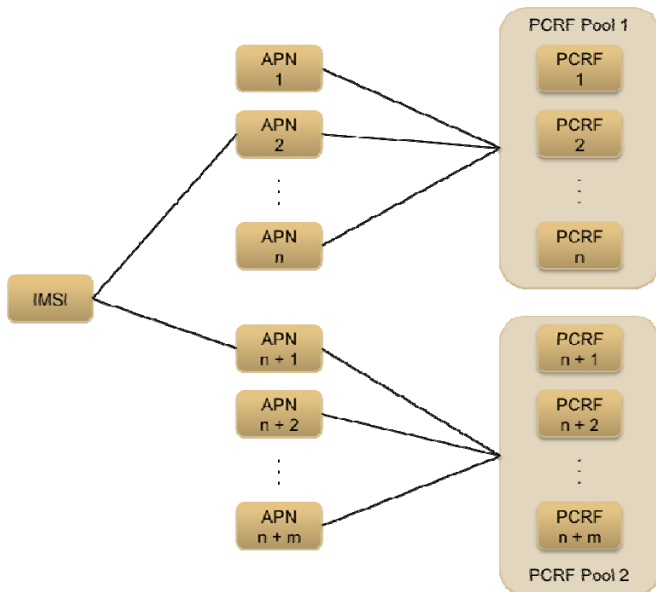

Figure 34 - Relationship between IMSIs and PCRF pools

PCA Deployment

A PCA DSR consists of a number of PCA DA-MP servers, a number of SBR servers, OAM server, and optionally, IPFE servers. The PCA DA-MP servers are responsible for handling Diameter signaling and implementing the Policy DRA and Online Charging DRA feature business logics. PCA DA-MP servers run the PCA application in the same process with the Oracle/Tekelec Diameter stack.

SBR servers host the policy session and policy binding databases for P-DRA function, and online charging session database for OC-DRA function respectively. These are special purpose MP blades that provide an off-board database for use by the PCA application business logic hosted on the PCA DA-MP servers. The P-DRA function always maintains session records for binding capable sessions (Gx, Gxx, and the S9 versions of Gx and Gxx), and binding dependent sessions (Rx and Gx-Prime) for which topology hiding is in effect. The OC-DRA function maintains session records for binding independent sessions (Gy and Ro) based on configuration and Diameter message content.

Each PCA DSR hosts connections to clients and to policy/charging servers such as OCSs and PCRFs. Clients are devices (not provided by Oracle/Tekelec) that request authorization for access to network resources on behalf of user equipment (e.g. mobile phones) from the PCRF, or request billing/charging instructions from an OCS. Policy clients sit in the media stream and enforce policy rules specified by the PCRF. Policy authorization requests and rules are carried in Diameter messages that are routed through P-DRA. P-DRA makes sure that all policy authorization requests for a given subscriber are routed to the same PCRF. Charging clients (CTF) generates charging events based on the observation of network resource usage and collect the information pertaining to chargeable events within the network element, assembling this information into matching charging events, and sending these charging events towards the OCS.

PCA DSRs can be deployed in mated pairs such that policy session state is not lost even if an entire PCA DSR fails or becomes inaccessible. When PCA mated pairs are deployed, the clients and PCRFs/OCSs are typically cross-connected such that both PCA DSRs have connections to all clients and all PCRFs/OCSs at both mated sites.

PCA DSRs can be deployed in mated triplets such that session states are not lost even if two PCA DSRs fail or become inaccessible. When a PCA mated triplet is deployed, clients and PCRFs/OCSs are cross-connected such that all three PCA DSRs have connections to all policy clients and all PCRFs/OCSs associated with the mated triplet.

PCA network is the term used to describe a set of PCA mated pairs and network OAM&P server pair/triplet. All clients and PCRFs/OCSs are reachable for Diameter signaling from any PCA DSR in the PCA network.

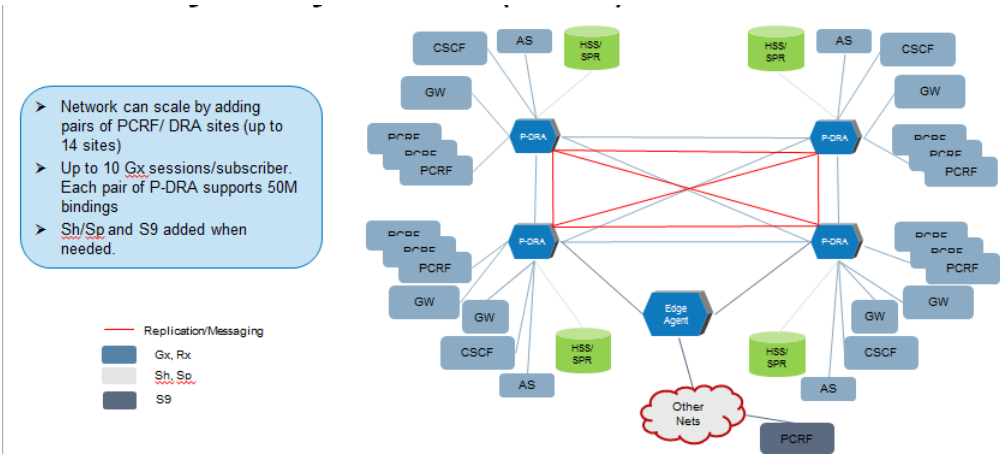

Figure 35 - PCA Example Deployment

Gateway Location Application (GLA)

The DSR based PCA PDRA function manages state required to route Gx, Rx and other policy related Diameter sessions. The Policy DRA SBR-B is a network wide repository for that state.

Customers are recognizing the value of having a centralized, network wide repository for binding state and are identifying additional ways to leverage the Policy DRA managed state.

The Gateway Location Application (GLA) provides a Diameter signaling approach for accessing that binding state. The GLA gives the ability to retrieve the Diameter identity that initiated Gx sessions for a given IMSI or MsISDN.

A use case for this application is an IMSI query with a single matching Gx session. The figure below shows this use case where the GGR message includes a query that has IMSI as the query key. In this example a single Gx session matches the query.

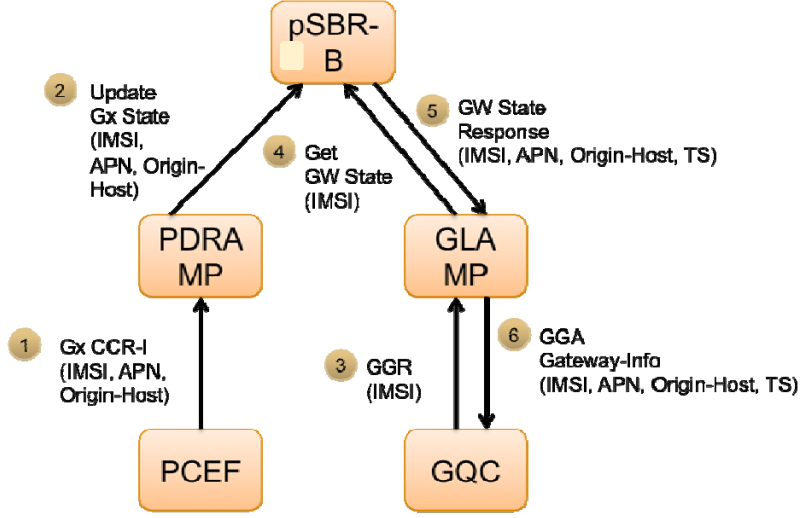

Figure 36 - IMSI Query with Single Matching Gx Session Use Case

The steps for this use case are as follows:

1. Existing Policy DRA handling of a Gx CCR-I session. This session is the first for the IMSI and results in a new binding.
2. The Policy DRA application stores the gateway state associated with the Gx session. This includes the APN for the session and the Origin-Host received in the CCR-I message. The Origin-Host contains the Diameter Identity of the PCEF that originates the CCR-I and will generally be the FQDN of the PCEF.
3. The GQC generates a GGR message with IMSI as the query key.
4. The GLA queries the SBR-B to get the gateway state for the Gx session or sessions associated with the IMSI combination.
5. The SBR-B returns the gateway state for all sessions associated with the IMSI. In this case there is one Gx session, the one that resulted in the binding. The state returned included the Origin-Host and APN associated with the session. A timestamp for when the session was initiated is also included.
6. The GLA returns the Gx session state in a GGA message. If no matching sessions are included in the GW State Response then the GLA returns a response

The GLA application's role is to provide access to state generated by the PCA PDRA function. As a result, the GLA application must be deployed in a network that includes the PCA. The implication of this is that the PCA and the GLA application must be managed by the same NOAM. This is illustrated in the figure below.

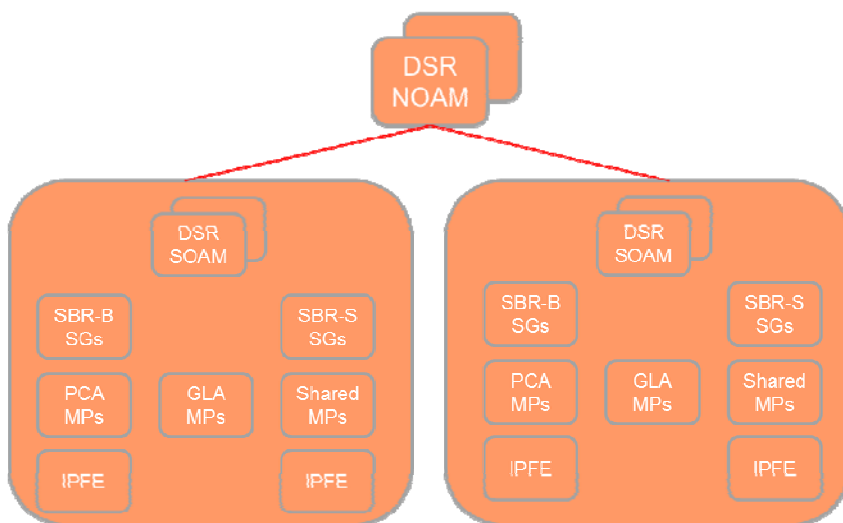

Figure 37 - PCA and GLA NOAM Architecture

Within a single DSR Network Element, there are three alternatives for deploying the GLA application.

1. Dedicated GLA DA-MPs – The GLA application is deployed in a DSR NE that also supports the PCA but is deployed on dedicated DA-MPs. The benefit of this deployment architecture is that it isolates the GLA Diameter traffic from the Policy DRA Diameter traffic. The GLA traffic can vary greatly and at times can spike to a high traffic rate. This deployment alternative helps to minimize the impact of those traffic spikes on the mainline PCA. Note that the full impact of the traffic cannot be isolated as the GLA queries result in interactions with the SBR-B database.
2. Shared GLA DA-MPs – The GLA application is deployed in a DSR NE that also supports the PCA. The GLA application and PCA are both enabled on common DA-MPs.
3. Dedicated GLA Network Element – The GLA application is deployed as a separate set of DSR NEs. This must be in a network that includes DSR NEs running the PCA.

When deployed using separate sets of MPs and when using IPFE to distribute client-initiated connections, it is necessary to configure separate target sets for each application. One IPFE target set contains the PCR MPs and a second IPFE target set contains the GLA MPs.

Diameter Message Copy

The DSR is able to copy certain Diameter Requests or Requests and Answers that transit the system. The copied messages can be used for book keeping/verification or for offering additional services such as sending a welcome SMS. The copied messages are sent towards Diameter Application Servers (DAS) which behave like RFC6733 compliant standard Diameter servers.

The figure below provides a high level overview and shows the message processing sequence followed by DSR when performing Message Copy. It should be noted that the Message Copy is performed after the completion of the original transaction. In cases where a copy of the Answer message is to be copied, the Answer message is embedded into a Proprietary AVP and included in the copied message.

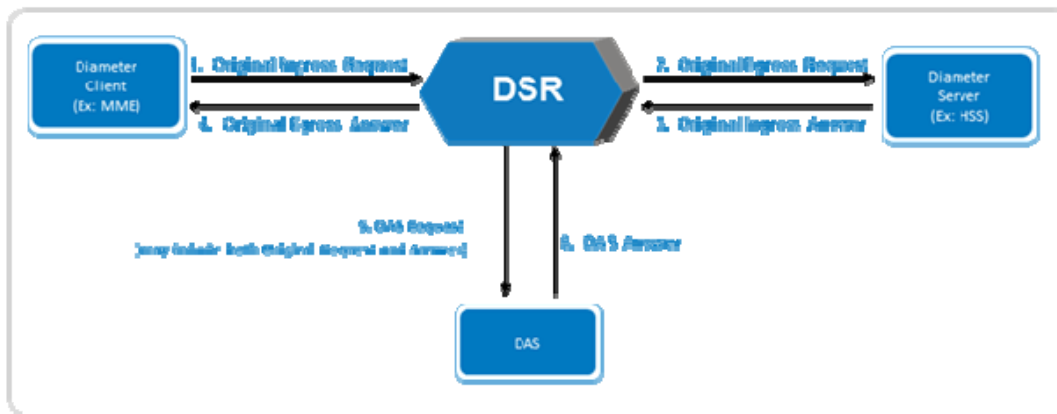

Figure 38 - Message Copy Overview

The Message Copy function can be triggered by the following mechanisms:

- » PRT based triggering
- » Using DSR's mediation rules
- » DSR application triggering (e.g. FABR)

Integrated Diameter Intelligence Hub (IDIH)

Integrated DIH is an integrated troubleshooting capability for the DSR that provides detailed information on how specific messages are processed within the DSR. Integrated DIH allows the user to create trace filters on DSR to capture messages needed for troubleshooting service issues, and presenting those traces to the user via the graphical visualization capabilities provided by IDIH. This feature provides the ability to configure and manage traces from the DSR, as well as filtering, viewing, and storing their results with IDIH.

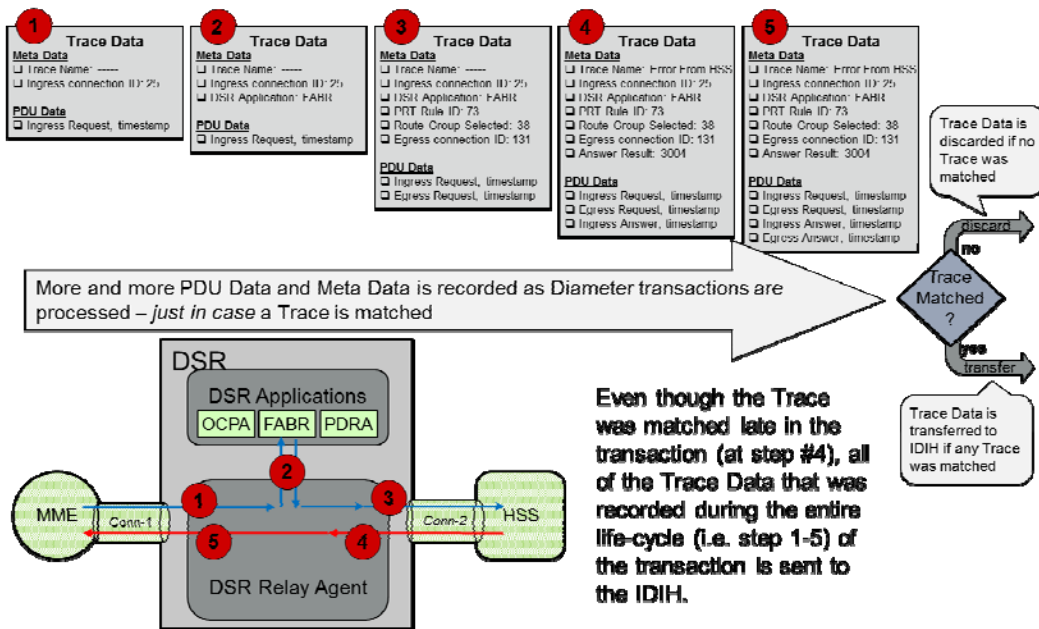

Figure 39 - IDIH Trace Data

The integration of trouble shooting capabilities into the DSR product provides a high value proposition for customers to be able to troubleshoot issues that might be identified with the Diameter traffic that transits the DSR. These troubleshooting capabilities can supplement other network monitoring functions provided by the customer's OSS and network support centers to help to quickly pinpoint the root cause of signaling issues associated with connections, peer signaling nodes, or individual subscribers.

The capabilities provided by this feature are distributed between the DA-MP(s) and an instance of Integrated DIH that resides on the PM&C server within the solution. The DSR plays the role of determining which messages should be captured, based on trace criteria that are created and activated by the user. The trace criteria identifies the "scope" as well as the "content". "Scope" refers to the non-protocol-related elements (such as connections or peers) that are used to select messages for trace content evaluation. "Content" refers to the protocol-related elements (such as command codes, AVPs, etc.) that are used to refine the trace criteria. Any trace filter, regardless of scope and content, can be defined as either a "site trace" or a "network trace". A site trace is the default behavior. A network trace results in capturing TTRs that meet the trace filter criteria on any DA-MP within the network. As request and answer messages are processed by the DSR, they are analyzed for matching any of the active trace definitions, and if so, transfer message components along with supplemental information to the IDIH called trace data. A network trace also captures the path that both the Diameter request and answer take as they traverse through multiple DA-MPs within the network. The IDIH can assemble the trace data, and present it to the user leveraging graphical visualization interfaces for additional filtering and analysis. There are three options for then exporting the trace: export the TTR in HTML, export the TTR in PCAP, or export the trace in PCAP.

This feature provides the ability to manage the processing resources associated with capturing trace information as well as the bandwidth for communicating trace data between the DSR and IDIH so that it does not impact the rated signaling capacity of the DSR.

Network IDIH (N-IDIH)

Operators with multiple DSRs have a need to diagnose and troubleshoot problems in their Diameter network with end-to-end visibility. N-IDIH provides support for network-wide IDIH trigger installation and trace analysis allowing centralized, end-to-end troubleshooting of transactions traversing any DSR in the network.

Whenever a Diameter message matches the trace criteria at a given site, the network trace also captures the path that the message took as it traversed through multiple DA-MPs within the network. Whenever a network trace is created, the trace criteria associated with the trace becomes active at each DA-MP within the network. Whenever a DA-MP determines that a particular diameter request or answer matches the trace criteria for an active network trace, the DA-MP captures the TTR associated with the Diameter transaction and forwards the TTR to the IDIH. In addition, the DA-MP compels any subsequent DSR node through which the Diameter message traverses to also capture TTR data associated with the Diameter message. Each DA-MP that was compelled forwards the captured TTRs to the IDIH associated with its site. The craftsman can then use the DSR maintenance GUI from any DSR site to visualize the captured trace data, which includes TTRs captured at every site within the network.

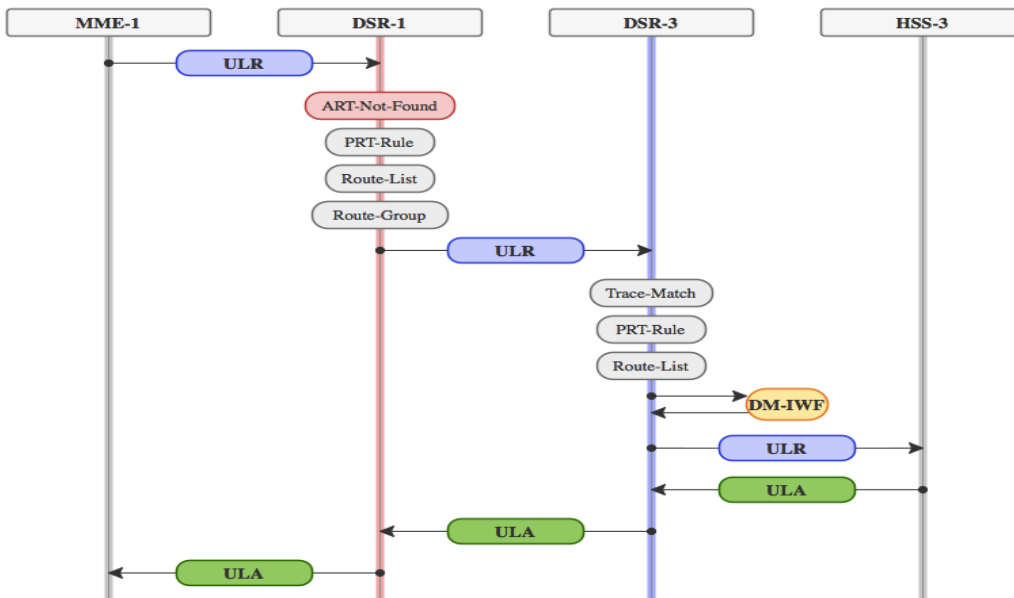

Figure 40 - Message Flow for Network Wide Trace

Supported Interfaces

IDIH supports a variety of Diameter Interfaces as a part of the rendering and visualizing messages within captured traces. In addition, DSR allows trace filters to be created for user identity, which is integrated with each of the supported interfaces. IDIH can render and visualize messages for other diameter interfaces beyond those that are officially supported, but any AVPs specific to those interfaces will not be available in the summary record of the TTR. IDIH cannot provide a full decode of AVPs specific to interfaces that are not specifically supported.

IDIH currently supports the following interfaces:

- » Diameter (Base Protocol) – (can be used on all interfaces, but provides minimal information)
- » Diameter Sh
- » Diameter Cx
- » Diameter Gq'
- » Diameter S6a/d

- » Diameter Gx
- » Diameter Rx
- » Diameter Gy
- » Diameter SLg
- » Diameter SLh
- » Diameter Gxa
- » Diameter SWm
- » Diameter SWx
- » Diameter STa
- » Diameter S6b
- » Diameter S9
- » Diameter Sd
- » Diameter Sy
- » Diameter S13
- » Diameter Zh

Flexible IP Addressing

The DSR supports IPv4 and IPv6 simultaneously for local DSR node addressing. Optionally, either an IPv4 or IPv6 address can be defined for each Diameter connection. The DSR supports both Layer 2 and Layer 3 connectivity at the customer demarcation using 1GB and optionally 10 GB (signaling only) uplinks.

The Oracle DSR supports establishing Diameter connections with IPv4 and IPv6 peers as follows:

- » Multiple IPv4 and IPv6 IP addresses can be hosted simultaneously on a DSR MP utilizing dual-stack capability in the DSR operating system.
- » Each Diameter connection (SCTP or TCP) configured in the DSR will specify a local DSR node and an associated local IPv4 or IPv6 address set for use when establishing the connection with the peer.
- » Each Diameter connection (SCTP or TCP) configured in the DSR will specify a Peer Node and optionally the Peer Node's IPv4 or IPv6 address set.
- » If the Peer Node's IP address set is specified, it must be of the same type (IPv4 or IPv6) as the local DSR IP address set specified for the connection.
- » If the Peer Node's IP address set is not specified, DSR will resolve the Peer Node's FQDN to an IPv4 or IPv6 address set by performing a DNS A or AAAA record lookup as appropriate based on the type (IPv4 or IPv6) of the local DSR IP address set specified for the connection.

The DSR supports IPv4/IPv6 adaptation by allowing connections to be established with IPv4 and IPv6 Diameter peers simultaneously and allowing Diameter Requests and Answers to be routed between the IPv4 and IPv6 peers.

Full IPV6 Support

As the global public IPv4 address pool is getting exhausted, more and more customers are requiring IPv6 support to either field new deployments or to grow existing deployments. This feature provides IPv6 support on all internal and external management interfaces. This along with DSR's support for IPv6 on signaling networks, allows DSR to be deployed without the need for IPv4.

This feature provides support for IPv6 for all Communication Agent functionality. This includes all solution components such as DP, all variations of SBRs, and the internal bus communication agent. Also, IPv6 is supported across all server group functions (including SS7 blades), SDS, and IDIH. There is also IPv6 support for the SDS provisioning interface. And finally, for any OAM interface (internal/external devices) the user can either configure

an IPv4 or IPv6 or both and IPv4 and IPv6 address. The external servers currently supported by the OAM are LDAP servers, export servers, DNS servers and SNMP servers.

Subscriber Data Server (SDS) Integration

Oracle Communication's Subscriber Data Server (SDS) integrates with the DSR to provide the following functions:

- » Provisioning and storage of large amounts of database information required for the Full Address Based Resolution (FABR) feature
- » Replication of information across multiple sites so that the data may be queried at the DSR sites
- » Support for querying by backend Operating systems to maintain reports and audit information

The central provisioning capability is provided by the SDS component. The SDS is deployed optionally geo-redundantly at a Primary and Disaster recovery site. A Query Server component that processes queries from backend customer operations systems is deployed optionally geo-redundantly at the Primary and Disaster Recovery SDS site. FABR data along with any other future DSR specific subscriber data is termed DSR Data. The application hosting the DSR Data is termed the DSR Data Repository (DDR). The SDS supports a SOAP/XML interface for provisioning. This interface supports Insert, Update & Delete functions on the Subscriber profile.

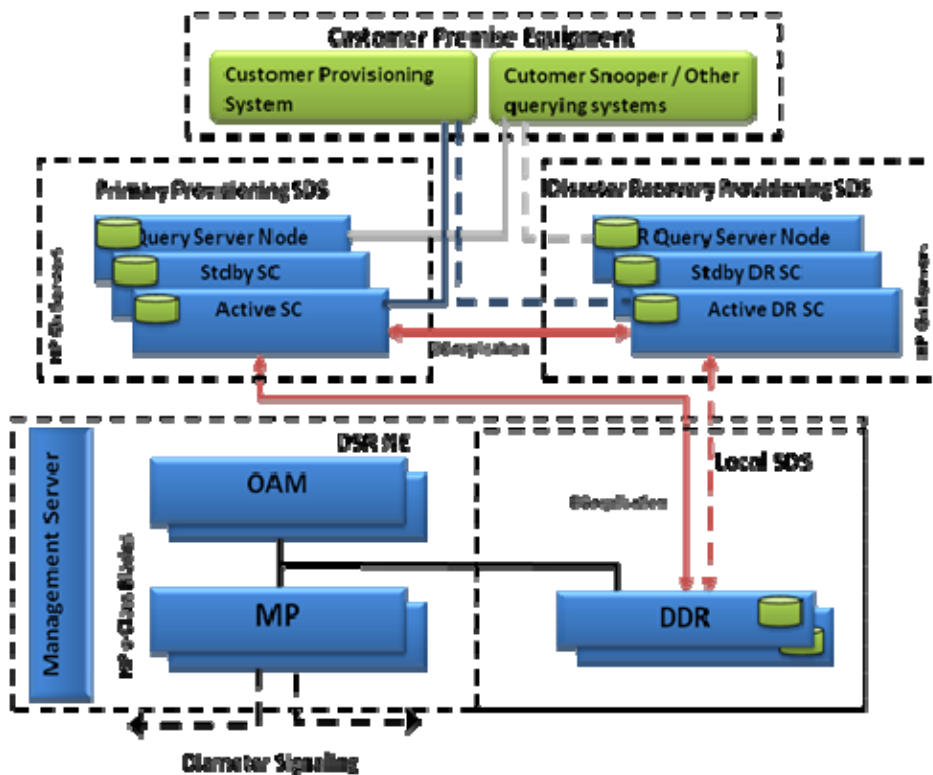



Figure 41 - Subscriber Data Server Architecture

The SDS also supports Split NPA data. When a service provider exhausts all MSISDNs within a Numbering Plan Area (NPA), the service provider commonly adds another NPA to the region. The result of assigning a new NPA is called a NPA Split. As new NXXs are defined in the new NPA, existing exchanges (NXXs) may be assigned to the newly created NXXs from the old NPA. The new and the old NXX have the same value.



When an NPA split occurs, a period of time is set aside during which a subscriber can be reached via phone number using old NPA-NXX and via phone number using new NPA-NXX. This period is called Permissive Dialing Period (PDP).

NPA splits apply to MSISDNs. During the NPA Split process, the SDS will automatically create duplicate MSISDN records at the start of Permissive Dialing Period (PDP) time (activation) and delete old MSISDN records at the end of PDP time (completion).

The SDS Subscriber Identity Grouping (Subscribers page) allows users to group optional customer-specified account IDs, multiple MSISDNs routing entities, and/or multiple IMSI routing entities together into one Subscriber. After a Subscriber (a group of related routing entities and an optional Account ID value) is created, the destinations for all of the related routing entities can be updated, all data from the subscriber can be read, and the subscriber can be deleted or its addresses modified by using any of the subscriber's addresses (account ID, MSISDN, or IMSI).

In order to help maintenance personnel with trouble shooting at the Query Server, records belonging to a single subscriber are now correlated at the SDS and the Query Server.

Bulk Import/Export

DSR supports bulk import and export of provisioning and configuration data using comma separated values (csv) file format. The import and export operations can be initiated from the DSR GUI. The import operation supports insertion, updating & deletion of provisioned data. Both the import & export operations will generate log files.

High-Availability

The DSR is built on a field proven platform and supports 99.999% availability when deployed in geographically redundant pairs. DSR signaling network elements are configured for geographic redundancy with either site able to support the total required signaling traffic in the event of a loss of the mated site. Geographic redundancy requires the originating network element to support alternate routing in the event the primary route becomes unavailable.

The platform supports fully redundant and isolated power architecture. Refer to the Platform Feature Guide – Available upon request for more information.

Multiple DA MPs are supported in an active-active configuration up to a maximum of sixteen DA MPs per DSR signaling node. DSR also supports existing active-standby configurations for up to two DA MPs per DSR signaling node.

If operating in Active-Standby redundancy mode, then automatic failover to the standby server is supported. If the active server fails, automatic failover does not require manual intervention.

The IP layer from the MP to the customer network interface is fully redundant. Enclosure switches and aggregation switches are deployed in redundant pairs. Refer to the Platform Feature Guide – Available upon request for more information on the networking components of the platform.

The DSR factors in the availability of Diameter peers when routing. It maintains the status of each peer. If a peer is not available, the traffic destined to that peer is redistributed to other peers, if available, that provide the same application. The DSR also supports the unique ability to choose alternate routes based on Answer responses. Refer to the Routing and Load Balancing section of this document for more information.

The DSR maintains the status of the connection (SCTP association or TCP socket) and application of each peer. Transport status considers connection status and congestion level. Application status is determined via standard Diameter heartbeat mechanisms.

Capacity and Performance

Capacity and performance values are specific to the platform hardware on which DSR is deployed. Please refer to the DSR Planning Guide for details on capacity and performance.

DSR OAM&P

Overview

The DSR has a 3-tiered topology as described in the diagram below.

The OAM servers provide the following services:

- » Central Operational interface
- » Distribution of provisioned and configuration data to all message processors in all sites
- » Event collection and administration from all message processors
- » User and access administration
- » Supports Northbound SNMP interface towards an operator EMS/NMS
- » Supports a web based GUI for configuration

The DSR MPs host the Diameter Signaling Router application and process Diameter messages.

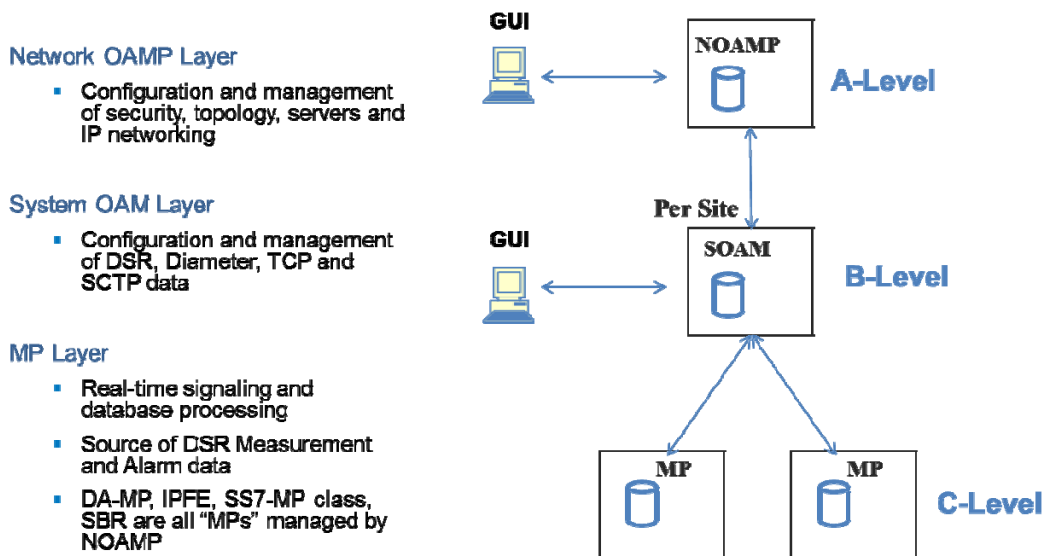

Figure 42 - DSR 3-tiered Topology Architecture

Network Interfaces

Three types of network interfaces are used in the DSR:

- » XMI - External Management Interface: Interface to the operator's management network. XMI can be found on the OAM servers. All OAM&P functions are available to the User through the XMI.

- » IMI - Internal Management Interface: Interface to the DSR's internal management network. All DSR nodes have this interface and use the IMI for exchange of crucial internal data. The User does not have access to the internal management network.
- » XSI - Signaling Interface: Interface to the operator's signaling network. Only the Message Processors (MPs) have this interface. The XSI is used exclusively by the application and is not used by OAM&P for any purpose.

Web-Based GUI

The DSR provides a web-based graphical user interface as the primary interface that administrators and operators use to configure and maintain the network. GUI access is user id and password protected.

Operations and Provisioning

- » Operations and Provisioning of the DSR can be accomplished via one of the 10 GUI sessions that are made available to the User through an internal web server(s). Through the GUI, the User is able to make all operations and provisioning changes to the DSR, including:
 - » Network Information (does not include switch configuration)
 - » Network Element
 - » Servers
 - » Routing and Configuration Databases
 - » Status and Manage for:
 - » Network Elements
 - » Servers
 - » Replication
 - » Collection
 - » HA (High Availability)
 - » Database
 - » KPIs
 - » Processes
 - » Files

Network Information

The network information defines the network name, the layout or shape of the network elements and their components. It defines the interlinking and the intercommunicating of the components. The network information represents all server relationships within the application. The server relationships are then used to control data replication and data collection, and define HA relationships. Switch configuration is not defined by the network information.

Network Elements

The DSR application is a collection of servers linked by standardized interfaces. Network Elements (NE) are containers that group and create relationships among servers in the network. A network element can contain multiple servers but a single server is part of only one network element. The DSR solution is comprised of a Network OAMP network element, at least one signaling node, and an optional database provisioning node (SDS).

Maintenance

The DSR provides the following maintenance capabilities:

- » Alarms and Events
- » Measurements

» Key Performance Indicators

Alarms and Events

The platform and DSR software raise minor, major and critical alarms and events for a wide variety of conditions. These are immediately sent up to the OAM system and can also be sent to the operator's network management system using SNMP. Alarm/event logs at the OAM are stored for up to seven days. The OAM provides a dashboard view of all alarms on the downstream MPs. This information is maintained locally for up to three days.

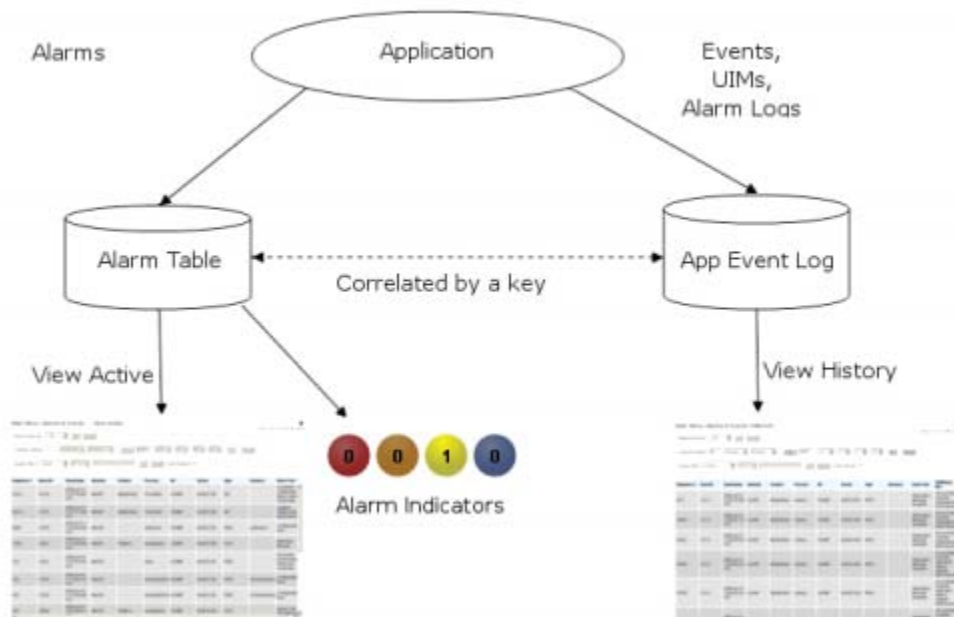

Figure 43 Flow of Alarms

Below are some of the alarms and events supported by DSR:

- » Connection to peer failed/ restored
- » Peer unavailable/available
- » Connection to peer congested/not-congested
- » Route list available/unavailable
- » OAM server failed/ restored
- » MP failed/ restored
- » MP entered/exited/changed local congestion

A detailed list of all alarms supported in DSR can be found in DSR Alarms, KPIs, and Measurements – Available at Oracle.com on the Oracle Technology Network (OTN).

Key Performance Indicators

Key Performance Indicators (KPIs) allow the user to monitor system performance data, including CPU, memory, swap space, and uptime per server. This performance data is collected from all servers within the defined topology. Key Performance Indicators supported by the platform and DSR software are in the following tables.

TABLE 6 DSR KPI SUMMARY

KPI Category	KPI Examples
Server Element KPIs	A group of KPIs that appear regardless of server role such as CPU, Network Element, etc
CAPM KPIs	Counters related to Computer-Aided Policy Making such as Active Templates, Test Templates, etc
Charging Proxy Application KPIs	KPIs related to the CPA feature such as CPA Answer Message Rate, CPA Ingress Message Rate, cSBR Query Error Rate, etc
Communications Agent KPIs	KPIs related to the communication agent such as User Data Ingress message rate
Connection Maintenance KPIs	KPIs pertaining to connection maintenance such as RxConnAvgMPS
DIAM KPIs	<i>Basic Diameter KPIs such as Avg Rsp Time and Ingress Trans Success Rate</i>
IPFE KPIs	<i>KPIs associated with IPFE such as CPU % and IPFE Mbytes/Sec</i>
MP KPIs	<i>KPIs relating to the Message Processor such as Avg Diameter Process CPU Util and Average routing message rate</i>
FABR KPIs	<i>KPIs related to the Full Address Based Resolution feature such as Ingress Message Rate and DP Response Time Average</i>
RBAR KPIs	<i>KPIs related to the Range Based Address Resolution feature such as Avg Resolved Message Rate and Ingress Message Rate</i>
SBR KPIs	<i>KPIs related to Session Binding Repository such as Current Session Bindings and Request Rate</i>

TABLE 7 PLATFORM KPI SUMMARY

KPI Name	KPI Description
System.CPU_UtilPct	Reflects current CPU usage, from 0-100%. (100% means all CPU Cores are completely busy)
System.RAM_UtilPct	Reflects the current committed RAM usage as a percentage of total physical RAM. Based on the Committed_AS measurement from Linux /proc/meminfo. This metric can exceed 100% if the kernel has committed more resources than provided by physical RAM, in which case swapping will occur.
System.Swap_UtilPct	Reflects the current usage of Swap space as a percentage of total configured Swap space. This metric will be 0-100%.
System.Uptime_Srv	Length of time since the last server reboot

A detailed list of all KPIs supported in DSR can be found in the DSR Alarms, KPIs, and Measurements document found on the Oracle Technology Network (OTN) area of www.oracle.com.

Measurements

All components of the DSR solution measure the amount and type of messages sent and received. Measurement data collected from all components of the solution can be used for multiple purposes, including discerning traffic patterns and user behavior, traffic modeling, size traffic sensitive resources, and troubleshooting.

The measurements framework allows applications to define, update, and produce reports for various measurements.

- » Measurements are ordinary counters that count occurrences of different events within the system, for example, the number of messages received. Measurement counters are also called pegs.
- » Applications simply peg (increment) measurements upon the occurrence of the event that needs to be measured.
- » Measurements are collected and merged at the OAM servers.
- » The GUI allows reports to be generated from measurements.

A subset of the measurements supported in DSR are listed in the following table. A detailed list of all measurements supported in DSR can be found in the DSR Alarms, KPIs, and Measurements document found on the Oracle Technology Network (OTN) area of www.oracle.com.

TABLE 8 DSR MEASUREMENTS

Measurement Category	Description
Application Routing Rules	A set of measurements associated with the usage of application routing rules. These allow the user to determine which application routing rules are most commonly used and the percentage of times that messages were successfully or unsuccessfully routed
Charging Proxy Application (CPA) Performance	This group contains measurements that provide performance information that is specific to the CPA application.
Charging Proxy Application Exception	These measurements provide information about exceptions and unexpected messages and events that are specific to the CPA application
Charging Proxy Application Session DB	These measurements provide information about events that occur when the CPA queries the SBR
Computer Aided Policy Making (CAPM)	A set of measurements containing usage-based measurements related to the Diameter Mediation feature
Communication Agent Performance	This group is a set of measurements that provide performance information that is specific to the ComAgent protocol. They allow the user to determine how many messages are successfully forwarded and received to and from each DSR application
Communication Agent Exception	This group is a set of measurements that provide information about exceptions and unexpected messages and events that are specific to the ComAgent protocol
Connection Congestion	These measurements contain per-connection measurements related to Diameter connection congestion states
Connection Exception	These measurements provide information about exceptions and unexpected messages and events for individual SCTP/TCP connections that are not specific to the Diameter protocol
Connection Performance	This group contains measurements that provide performance information for individual SCTP/TCP connections that are not specific to the Diameter protocol
DSR Application Exception	A set of measurements that provide information about exceptions and unexpected messages and events that are specific to the DSR protocol
DSR Application Performance	A set of measurements that provide performance information that is specific to the DSR protocol. These allow the user to determine how many messages are successfully forwarded and received to and from each DSR application
Diameter Egress Transaction	These are measurements providing information about Diameter peer-to-peer transactions forwarded to upstream peers

Diameter Exception	A set of measurements that provide information about exceptions and unexpected messages and events that are specific to the Diameter protocol
Diameter Ingress Transaction Exception	These measurements provide information about exceptions associate with the routing of Diameter transactions received from downstream peers
Diameter Ingress Transaction Performance	A set of measurements providing information about the outcome of Diameter transactions received from downstream peers.
Diameter Performance	Measurements that provide performance information that is specific to the Diameter protocol
Diameter Rerouting	These measurements allow the user to evaluate the amount of message rerouting attempts which are occurring, the reasons for why message rerouting is occurring, and the success rate of message rerouting attempts
Full Address Based Resolution (FABR) Application Performance	A set of measurements that provide performance information that is specific to the FABR feature. They allow the user to determine how many messages are successfully forwarded and received to and frm the FABR application
Full Address Based Resolution (FABR) Application Exception	A set of measurements that provide information about exceptions and unexpected messages and events that are specific to the FBAR feature
IP Front End (IPFE) Exception	This group is a set of measurements that provide information about exceptions and unexpected messages and events specific to the IPFFE application
IP Front End (IPFE) Performance	This group contains measurements that provide performance information that is specific to the IPFE application. Counts for various expected/normal messages and events are included in this group
Message Copy	These measurements from the Diameter Application Server reflect the message copy performance. They allow the user to monitor the amount of traffic being copied and the percentage of times that messages were successfully or unsuccessfully copied
Message Priority	This group contains measurements that provide information on message priority assigned to ingress Diameter messages.
Message Processor (MP) Performance	These measurements provide performance information for an MP server
OAM Alarm	General measurements about the alarm system such as number of critical, major, and minor alarms
OAM System	General measurements about the overall OAM system
Peer Node Performance	Measurements that provide performance information that is specific to a Peer Node. These measurements allow users to determine how many messages are successfully forwarded and received to/from each peer node.
Peer Routing Rules	These are measurements associated with the usage of peer routing rules. They allow the user to determine which peer routing rules are most commonly used and the percentage of times that messages were successfully or unsuccessfully routed using the route list
Range Based Address Resolution (RBAR) Application Performance	A set of measurements that provide performance information that is specific to the RBAR application. They allow the user to determine how many messages are successfully forwarded and received to/from each RBAR application
Range Based Address Resolution (RBAR) Exception	A set of measurements that provide information about exceptions and unexpected messages and events that are specific to the RBAR feature
Route List	A set of measurements associated with the usage of route lists. They allow the user to determine which route lists are most commonly used and the percentage of times that messages were successfully or unsuccessfully routed using the route list
Routing Usage	This report allows the user to evaluate how ingress request messages are being routed internally within the relay agent
Session Binding Repository (SBR) Exception	A set of measurements that provide information about exceptions

	and unexpected messages and events specific to the SBR application
	This group contains measurements that provide performance information that is specific to the SBR application. Counts for various expected / normal messages and events are included in this group
Session Binding Repository (SBR) Performance	

DSR Dashboard

This GUI display is an operational tool allowing customers to easily identify the potential for or existence of a DSR Node or Diameter Network outage. This dashboard is accessible via the SOAM or NOAM GUI and provides the following high-level capabilities:

- » Centralized view: Allows operators to view a high level summary of key operational metrics
- » Identifies potential operational issues: Assists operators in identifying problems via visual enhancements such as colorization and highlighting;
- » Centralized Launch-Point: Allows operators to drill-down to the next level of status information to assist in pinpointing the source of a potential problem.

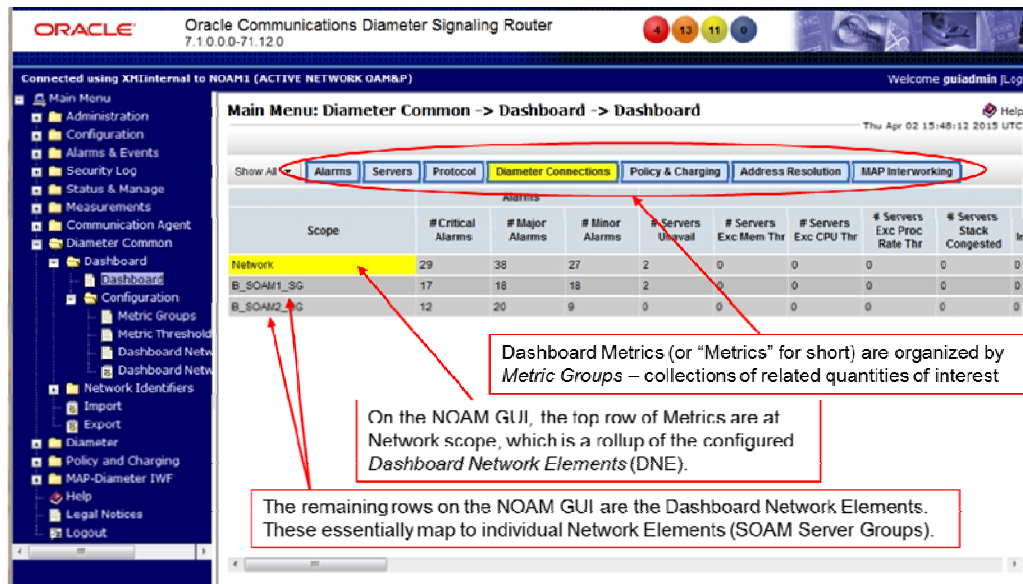

Figure 44: DSR Dashboard on the NOAM

The Dashboard is comprised of the following concepts and components:

- » Dashboard Metrics:
 - » Metrics are the core component of the DSR Dashboard. The operator can determine which Metrics can be viewed on their Dashboard display through configuration.
 - » Server metrics are maintained by each MP. Per-Server metric values are periodically pushed to their local SOAM which can be displayed on the SOAM Dashboard display.
 - » “Server Type” metrics allow the operator see to a roll-up of Server metrics by Server type. The formula for calculating a Server Type metric value is identical to that for calculating the per-NE metric for that metric.
 - » Network Element (NE) metrics are derived from per-Server metrics. A “Network Element” is the set of servers managed by a SOAM. The formula for calculating a per-NE metric value is metric-specific although, in general, most NE metrics are the sum of the per-Server metrics.
 - » Per Network metrics are derived from per-NE summary metrics. A “Network” is the set of DSR NEs managed by a NOAM. The formula for calculating a Network metric value is identical to that for calculating the per-NE metric for that metric.

- » Metric Groups:
 - » A Metric Group allows the operator to physically group Metrics onto the Dashboard display and for creating an aggregation status for a group of metrics.
 - » The “status” of a Metric Group is the worst-case status of the metrics within that group.
- » Server Type:
 - » A Server Type physically groups Metrics associated with a particular type of Server (e.g., DA-MP) onto the Dashboard display and for creating summary metrics for Servers of a similar type.
 - » The following Server Types are supported: DA-MP, SS7-MP, IPFE, SBR, cSBR, SOAM.
- » Network Element (NE):
 - » A “Network Element” is a set of Servers which are managed by a SOAM.
 - » The set of servers which are managed by a SOAM is determined through standard NOAM configuration and cannot be modified via Dashboard configuration.
 - » A NOAM can manage up to 32 NEs.
- » Dashboard Network Element (NE):
 - » A “Dashboard Network Element” is a logical representation of a Network Element which can be assigned a set of Metrics, NE Metric Thresholds and Server Metric Thresholds via configuration that defines the content and thresholds of a SOAM Dashboard display.
 - » Up to 32 Dashboard NEs are supported.
- » Dashboard Network:
 - » A “Dashboard Network” is a set of Dashboard Network Elements, Metrics and associated Network Metric Thresholds that is created by configuration that defines the content and thresholds of a NOAM Dashboard display.
 - » The set of Dashboard Network Elements assigned to a Dashboard Network is determined from configuration.
 - » One Dashboard Network is supported.
- » Visualization Enhancements:
 - » Visualization enhancements such as coloring are used on the Dashboard to attract the operator’s attention to a potential problem.
 - » Visualization enhancements are enabled through metric thresholds.
 - » Visualization enhancements can be applied independently to Server Type, NE and Network summary metrics and Server metrics.
 - » Visualization enhancements are applied to Dashboard row and columns headers to ensure that any metric value which has exceeded a threshold but cannot be physically viewed on a single physical monitor is not totally hidden from the operator’s view.
- » Metric Thresholds:
 - » Metric thresholds allow the operator to enable visualization enhancements on the Dashboard.
 - » Up to three separate threshold values (e.g., thresh-1, thresh-2, thresh-3) can be assigned to each metric.
 - » Dashboard Network summary, Dashboard NE summary and Server metric thresholds are supported.
 - » Dashboard Network summary and Dashboard NE summary metric threshold values can be assigned by the operator.
 - » Metric thresholds are used for Dashboard visualization enhancements.
 - » Most (but not necessarily all) metrics have thresholds.
 - » Whether a Metric can be assigned thresholds is determined from configuration.
- » Dashboard GUI Display:
 - » The Dashboard GUI display allows an operator to view a set of metric values used for monitoring the status of a Network or NE.

- » The NOAM Dashboard allows the operator to view both Network summary and NE summary metrics.
- » The SOAM Dashboard allows the operator to view the NE's summary metrics, its per-Server Type summary metrics and its per-Server metrics.
- » Metric values are displayed as text.
- » Sets of Metrics associated with network components are displayed vertically on the Dashboard in network hierarchical order. For example, on the NOAM Dashboard, Network metrics are displayed first followed by per-NE metrics.
- » Each column on the Dashboard contains the set of values for a particular Metric.
- » The operator can control which metrics are displayed on the Dashboard via configuration.
- » The order that Metric Groups are displayed on the Dashboard is determined from configuration.
- » The order that Metrics are displayed within a Metric Group on the Dashboard display is determined from configuration.
- » Metrics selected for display on the Dashboard via configuration are hidden/viewed via a Dashboard GUI control based on "threshold level" filters (e.g., only display metrics having at least one value exceeding its threshold-3 value).
- » Drill-down via hyperlinks:
 - » A Dashboard provides high level metrics providing an overall view of the health of one or more Network Elements of the customer's network.
 - » When a visual enhancement on the Dashboard is enabled when a user-defined threshold is exceeded, the operator may want to investigate the potential problem by inspection of additional information.
 - » The Dashboard facilitates operator trouble-shooting via context-sensitive hyperlinks on the Dashboard to assist in viewing more detailed information via existing DSR status and maintenance screens.
 - » The linkage between content on the Dashboard to DSR status and maintenance screens is determined from configuration.

Automatic Performance Data Export (APDE)

The Automatic Performance Data Export feature provides the following capabilities:

- » periodic generation and remote copy of filtered performance data,
- » proper management of the file space associated with the exported data.

Specifically, Automatic PDE provides the ability to create custom queries of performance data and to schedule periodic remote copy operations to export the performance data to remote export systems.

Administration

Administration functions are tasks that are supported at the system level. Administration functions of the DSR include:

- » User Administration
- » Passwords
- » Group Administration
- » User's Session Administration
- » Authorized IPs
- » System Level Options
- » SNMP Administration
- » ISO Administration
- » Upgrade Administration
- » Software Versions



For more details on platform related features please see the Platform Feature Guide – Available upon request.

Database Management

Database Management for DSR provides 4 major functions:

- » Database Status - maintains status information on each database image in the DSR network and makes the information accessible through the OAM server GUI.
- » Backup and Restore - Backup function captures and preserves snapshot images of Configuration and Provisioning database tables. Restore function allows User to restore the preserved databases images. The DSR supports interface to and/or integration with 3rd party backup systems (i.e. Symantec NetBackup).
- » Replication Control - allows the User to selectively enable and disable replication of Configuration and Provisioning data to servers. Note: This function is provided for use during an upgrade and should be used by Oracle Personnel only.
- » Provisioning Control - provides the User the ability to lockout Provisioning and Configuration updates to the database. Note: This function is provided for use during an upgrade and should be used by Oracle Personnel only.

File Management

The File Management function includes a File Management Area, which is a designated storage area for any file the user requests the system to generate. The list of possible files includes, but is not limited to: database backups, alarms logs, measurement reports and security logs. The File Management function also provides secure access for file transfer on and off the servers. The easy-to-use web pages give the user the ability to export any file in the File Management Area off to an external element for long term storage. It also allows the user to import a file from an external element, such as an archived database backup image.

Security

Oracle addresses Product Security with a comprehensive strategy that covers the design, deployment and support phases of the product life-cycle. Drawing from industry standards and security references, Oracle hardens the platform and application to minimize security risks. Security hardening includes minimizing the attack surface by removing or disabling unnecessary software modules and processes, restricting port usage, consistent use of secure protocols, and enforcement of strong authentication policies. Vulnerability management ensures that new application releases include recent security updates. In addition a continuous tracking and assessment process identifies emerging vulnerabilities that may impact fielded systems. Security updates are delivered to the field as fully tested Maintenance Releases.

Networking topologies provide separation of signaling and administrative traffic to provide additional security. Firewalls can be established at each server with IP Table rules to establish White List and/or Black List access control. The DSR supports transporting Diameter messages over IPSec thereby ensuring data confidentiality & data integrity of Diameter messages traversing the DSR.

Oracle realizes the importance of having distinct interfaces at the Network-Network Interface layer. To maintain the separation of traffic between internal and external Diameter elements, the DSR supports separate network interfaces towards the internal and external traffic. The routing tables in DSR support the implementation of a Diameter Access Control List which make it possible to reject requests arriving from certain origin-hosts or origin-realms or for certain command codes.

Oracle recommends that Layer 2 and Layer 3 ACLs be implemented at the Border Gateway. However, Professional Services available from the Oracle Consulting team can implement Layer 2 and Layer 3 ACLs at the aggregation switch which serves as the demarcation point or at the individual MPs that serve the Diameter traffic.



In addition to supporting security at the transport and network layers, Oracle's solution provides Access Control Lists based on IP addresses to restrict user access to the database on IP interfaces used for querying the database.

These interfaces support SSL.

DSR maintains a record of all system users' interactions in its Security Logs. Security Logs are maintained on OAM servers. Each OAM server is capable of storing up to seven days' worth of Security Logs. Log files can be exported to an external network device for long term storage. The security logs include:

- » Successful logins
- » Failed login attempts
- » User actions (e.g. configure a new OAM, initiate a backup, view alarm log)





Please see the [Diameter Signaling Router \(DSR\) 7.0 Security Guide \(E61125\)](#)– Available on MyOracleSupport for more details on the security component of the DSR.



Oracle Corporation, World Headquarters
500 Oracle Parkway
Redwood Shores, CA 94065, USA

Worldwide Inquiries
Phone: +1.650.506.7000
Fax: +1.650.506.7200

CONNECT WITH US

-  blogs.oracle.com/oracle
-  facebook.com/oracle
-  twitter.com/oracle
-  oracle.com

Hardware and Software, Engineered to Work Together

Copyright © 2014, Oracle and/or its affiliates. All rights reserved. This document is provided for information purposes only, and the contents hereof are subject to change without notice. This document is not warranted to be error-free, nor subject to any other warranties or conditions, whether expressed orally or implied in law, including implied warranties and conditions of merchantability or fitness for a particular purpose. We specifically disclaim any liability with respect to this document, and no contractual obligations are formed either directly or indirectly by this document. This document may not be reproduced or transmitted in any form or by any means, electronic or mechanical, for any purpose, without our prior written permission.

Oracle and Java are registered trademarks of Oracle and/or its affiliates. Other names may be trademarks of their respective owners.

Intel and Intel Xeon are trademarks or registered trademarks of Intel Corporation. All SPARC trademarks are used under license and are trademarks or registered trademarks of SPARC International, Inc. AMD, Opteron, the AMD logo, and the AMD Opteron logo are trademarks or registered trademarks of Advanced Micro Devices. UNIX is a registered trademark of The Open Group. 1115

 | Oracle is committed to developing practices and products that help protect the environment