

Reporting and Analysis Guide

Oracle[®] Health Sciences InForm 6.1.1

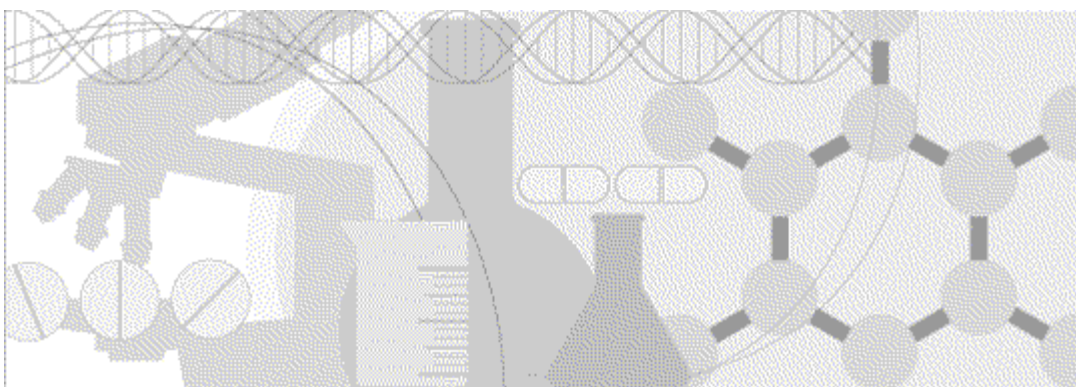

ORACLE[®]

Copyright © 2014, 2016, Oracle and/or its affiliates. All rights reserved.

This software and related documentation are provided under a license agreement containing restrictions on use and disclosure and are protected by intellectual property laws. Except as expressly permitted in your license agreement or allowed by law, you may not use, copy, reproduce, translate, broadcast, modify, license, transmit, distribute, exhibit, perform, publish, or display any part, in any form, or by any means. Reverse engineering, disassembly, or decompilation of this software, unless required by law for interoperability, is prohibited.

The information contained herein is subject to change without notice and is not warranted to be error-free. If you find any errors, please report them to us in writing.

If this is software or related documentation that is delivered to the U.S. Government or anyone licensing it on behalf of the U.S. Government, the following notice is applicable:

U.S. GOVERNMENT END USERS: Oracle programs, including any operating system, integrated software, any programs installed on the hardware, and/or documentation, delivered to U.S. Government end users are "commercial computer software" pursuant to the applicable Federal Acquisition Regulation and agency-specific supplemental regulations. As such, use, duplication, disclosure, modification, and adaptation of the programs, including any operating system, integrated software, any programs installed on the hardware, and/or documentation, shall be subject to license terms and license restrictions applicable to the programs. No other rights are granted to the U.S. Government.

This software or hardware is developed for general use in a variety of information management applications. It is not developed or intended for use in any inherently dangerous applications, including applications that may create a risk of personal injury. If you use this software or hardware in dangerous applications, then you shall be responsible to take all appropriate fail-safe, backup, redundancy, and other measures to ensure its safe use. Oracle Corporation and its affiliates disclaim any liability for any damages caused by use of this software or hardware in dangerous applications.

Oracle and Java are registered trademarks of Oracle and/or its affiliates. Other names may be trademarks of their respective owners.

Intel and Intel Xeon are trademarks or registered trademarks of Intel Corporation. All SPARC trademarks are used under license and are trademarks or registered trademarks of SPARC International, Inc. AMD, Opteron, the AMD logo, and the AMD Opteron logo are trademarks or registered trademarks of Advanced Micro Devices. UNIX is a registered trademark of The Open Group.

This software or hardware and documentation may provide access to or information about content, products, and services from third parties. Oracle Corporation and its affiliates are not responsible for and expressly disclaim all warranties of any kind with respect to third-party content, products, and services unless otherwise set forth in an applicable agreement between you and Oracle. Oracle Corporation and its affiliates will not be responsible for any loss, costs, or damages incurred due to your access to or use of third-party content, products, or services, except as set forth in an applicable agreement between you and Oracle.

This documentation may include references to materials, offerings, or products that were previously offered by Phase Forward Inc. Certain materials, offerings, services, or products may no longer be offered or provided. Oracle and its affiliates cannot be held responsible for any such references should they appear in the text provided.

Contents

Chapter 1 Introduction to Reporting and Analysis **1**

About report data	2
The Reporting and Analysis database	2
Basic relational database concepts	2
Reporting and Analysis terminology	3
Data models	4
Data model security	5
Packages	5
Locales in the Reporting and Analysis module	6
Reporting basics and options	7
Reporting and Analysis portal	7
Renewing your credentials	9
Personal pages	10
Report options	11
Report types	15
Scheduling reports	17
Comments in saved reports	18
Study design considerations	20
Subject status requirements	20
DOV controls	21
Labels for clinical report elements	21
Optional study elements	21
Reserved words for Reporting and Analysis	22
Configuring computer settings for Reporting and Analysis	26
Browser settings for Internet Explorer	26
Browser settings for Mozilla Firefox	27
Windows Explorer settings	27

Chapter 2 Ad Hoc Reporting **29**

About Ad Hoc Reporting	30
InForm to Cognos naming correspondence	31
Accessing the Ad Hoc Reporting workspace	32
Ad Hoc Reporting workspace	33
Ad Hoc Reporting tree	34
Ad Hoc Reporting menu	35
Running and saving ad hoc reports	37
Using the Ad Hoc Reporting tree to create reports	37
Running an ad hoc report from the Ad Hoc Reporting workspace	37
Running an ad hoc report in a new window	37
Saving an ad hoc report	37
Previewing report output with limited or no data	38
Preview formats	38
Using the design-time report viewer	39
Using the run-time report viewer	39
Opening an ad hoc report in Report Studio	40
Editing data in an ad hoc report	41
Opening an existing report	41
Editing tools in the Ad Hoc Reporting workspace	41
Using predefined filters	42
Sorting the elements in a report	44

Summarization	45
Configuring drill up, drill down, and drill through settings	46
Lineage information for data	46
Changing the display format for report elements	47
Renaming titles and headings	47
Changing the page layout for a report	47
Suppressed and deleted data in reports	48
Internal IDs.....	49
About internal IDs	49
Internal IDs in the Clinical Data by Form folder.....	49
Internal IDs in the Trial Management data model.....	49
Calculations and conversion rules.....	51
About calculations and conversion rules.....	51
Calculations on date time elements	51
Creating a calculation.....	52
Dates with unknown date parts	52
Calculations on string elements	53
Calculations on numeric elements.....	53
Calculating business days versus number of days.....	54
Crosstab reports.....	55
About crosstab reports	55
Crosstab development tools.....	55
Charts.....	56
About charts	56
Chart development tools.....	56
Custom groups	58
About custom groups	58
Defining a custom group	58
Custom groups on date time elements	58
Custom groups on numeric elements	59
Custom groups on string elements.....	59
Reporting on study management data.....	61
Study management report elements.....	61
InForm Trial Management reporting tree.....	62
Element descriptions	63
Study Info report elements	64
Sites report elements.....	68
Subject report elements.....	71
Visit report elements.....	83
Forms report elements	90
Section report elements.....	122
Item report elements.....	122
Rule report elements	130
Query report elements.....	131
Comment report elements.....	140
User Info report elements.....	142
Predefined filters.....	146
Reporting on clinical data.....	149
Clinical data reports	149
Reporting on clinical data	149
Clinical reporting tree	150
Clinical reporting elements	151
Creating reports with both clinical and study management data	152
Clinical data in the Ad Hoc Reporting tree	152
Reporting on multi-instance forms and visits	159

Chapter 3 InForm standard reports 167

Standard reports.....	168
InForm standard reports by category.....	169
Running and saving standard reports.....	170
Running a standard report from the Reporting and Analysis portal.....	170
Running a standard report in a new window.....	170
Saving a standard report definition	170
Saving a standard report as a report view	170
Opening a standard report in the Report Studio application.....	172
Components of a standard report.....	173
Report prompt page.....	173
Report/Graph page	176
Data in standard reports	178
Report folders.....	179
Report actions	180
Query reports.....	181
Outstanding Queries by Site and Visit.....	181
Query Aging by Site	184
Query Cycle Times by Site.....	187
Query Cycle Times by User.....	192
Query Performance Summary by Site.....	196
Query Performance Summary by User.....	201
Query Status by Site.....	206
Query Status by Site and Subject	210
Query Status by Site and Visit.....	215
Query Status by User	219
Query Volume by Month by Site.....	223
Query Volume by Rule.....	226
Subject Counts with Outstanding Queries	229
Case Report Form (CRF) reports	232
CRF Aging by Site report.....	232
CRF Cycle Time Detail by Site	237
CRF Cycle Time Detail for a Site.....	244
CRF Site Performance Summary by Site.....	250
CRF Status Detail by Site and Subject.....	257
CRF Status Detail by Visit and Site.....	265
CRF Status Summary by Site.....	273
CRF Status Summary by User.....	280
Item reports	287
CRF Item Listing.....	287
Source Verification Listing	295
Subject reports.....	301
Case Book Completion and Query Summary by Site	301
Cumulative Subject Enrollment by Month.....	306
Subject Dropout Count by Reason	308
Subject Enrollment Status by Site	310
Audit Trail reports	316
Audit Trail Report	316
Historical Login Report.....	319

About the documentation 323

Where to find the product documentation.....	323
Documentation accessibility.....	323
Access to Oracle Support	323
Documentation	323

Index

327

CHAPTER 1

Introduction to Reporting and Analysis

In this chapter

About report data.....	2
Reporting basics and options.....	7
Study design considerations	20
Configuring computer settings for Reporting and Analysis.....	26

About report data

The Reporting and Analysis database

All data used for reporting resides in the Reporting and Analysis database, a database schema that is replicated from the InForm transactional database schema. Because data for reports is stored separately from InForm transactional data, you can write and run reports in the Reporting and Analysis module without affecting the performance of the InForm application.

Data in the Reporting and Analysis database is updated in real time, allowing you to access up-to-date information for your study.

The Reporting and Analysis database contains two types of data:

- **Study management data**

Study management data includes metrics and status data for a study. Use study management data to report on the completion status of your study. You can report on such things as the number of visits that are complete for a study or the number of forms that are frozen or locked.

The Reporting and Analysis database study management schema is installed with each InForm installation. It is not specific to your study.

- **Clinical reporting data**

Clinical data for reports includes data about each subject visit. Use clinical data to report on specific clinical questions and responses. You can report on such things as adverse events, vital signs information, and dosing records.

The Reporting and Analysis database clinical schema is built from the forms that are installed with your study. Therefore, the clinical data available for reports is unique for each study.

Basic relational database concepts

Term	Description	Example
Tables	Made up of rows and columns. Store collections of related data.	Subjects, Visits, and Forms tables.
Rows	Occurrences (records) of related data values in a database table. Each time you enter new data in a table, you create a row in that table.	Subjects, Visits, and Forms rows.
Columns	Occurrences (records) of individual data values in a database table.	The columns in the Subjects table might store a Subject ID, Subject Number, Subject Initials, Current Status, and First Screened Date for each subject (row) in the study.

Term	Description	Example
Primary keys	Columns in a database table whose values uniquely identify a row in a table.	The Subject ID column in the Subjects table is a primary key because each Subject ID value can only occur one time in that table and is unique to each subject.
Foreign keys	Columns in a database table that establish relationships with other tables in the database.	The Subject ID column in the Visits table is a foreign key that allows you to create a relationship between the Visits table and the Subjects table as well as a relationship between the Visits table and the Forms table.
Joins	Expressions of relationships between database tables. A join occurs when you match the data value of a key (primary or foreign) in one table to the data value of a key in another table to retrieve related data.	To retrieve a visit and form data for a subject: <ul style="list-style-type: none"> • Join the Subject ID value in the Subjects table to the Subject ID value in the Visits table. • Join the Subject ID value in the Visits table to the Subject ID value in the Forms table.

Reporting and Analysis terminology

Term	Description
Aggregate values	Quantitative (numeric) values that represent counts, averages, and totals.
Calculation	A report element that can perform many types of operations such as calculating the sum or average of the values in one column, or multiplying the values in two columns.
Chart	A report that shows patterns and trends in data using a graphical presentation: pie chart, bar chart, line chart, and so on.
Crosstab report	A report that shows summary data at the intersection points of rows and columns.
Data model	A logical representation of the data in the Reporting and Analysis database that describes data objects, structure, grouping, data relationships, and security.
Job	A group of ad hoc reports or other items that you can run and schedule as a batch.
List report	A report that shows detailed data in rows and columns.

Term	Description
Measure (or fact)	A report element that contains cumulative values that can be aggregated to produce meaningful results. Measures are quantitative performance indicators that produce the numbers that usually appear in the cells of a crosstab report or in a chart. Measures appear in the Ad Hoc Reporting tree for use in ad hoc reports.
Non-aggregate values	Non-numeric data that represents string (text) or date values.
Package	A graphical representation (container) for one or more data models and reports.
Personal folder	A folder in the Reporting and Analysis portal that only the folder owner can access.
Portal	A website or page that provides a single presentation and a single starting point for a set of information.
Prompts	Controls that allow you to select criteria and choose sort options for your report.
Public folder	A folder in the Reporting and Analysis portal that users with appropriate rights can access.
Report element	The equivalent of a column of data that contains the actual data from the Reporting and Analysis database. Report elements appear in the Ad Hoc Reporting tree for use in ad hoc reports.
Report palette	A workspace onto which the user drags and drops report elements to include in an ad hoc report.
Report topic	An object in a data model that is equivalent to a table of columns in the Reporting and Analysis database. Report topics appear in the Ad Hoc Reporting tree for use in ad hoc reports.
Report view	A report that contains data from the Reporting and Analysis database at any given point during a study. Use report views to compare and compile data over time.

Data models

A data model is a layer of the Reporting and Analysis database that describes the data objects, structure, grouping, data relationships, and security. The Reporting and Analysis module uses one or more data models to make the data in the Reporting and Analysis database available for reports.

Two data models exist for every InForm study.

Data model	Description
Trial Management data model	Describes only the study management portion of the Reporting and Analysis database. Note: This is also called the Operational model.

Data model	Description
Clinical data model	Describes the clinical and study management portions of the Reporting and Analysis database.

Data model security

Display override settings and site associations determine the clinical data that is available from the clinical model for use in reports. For example:

- If an item is not visible to you in the InForm application, when you create a report that contains the item, the cells in the column that corresponds to the item contain the text **N/A**.
- You can see and create reports using only information for the sites in the study to which you have access.

The clinical model also contains relationships to the operational report topics. These relationships allow you to create reports in the Ad Hoc Reporting workspace by dragging and dropping clinical and operational report elements onto the report palette. This operation is conceptually similar to creating an SQL join directly between a clinical view and an operational view.

Packages

A package is a grouping of data from one or more data models. Two packages are installed with every InForm study.

Package	Description
InForm Trial Management	Contains data from the Trial Management data model only. This package is installed with every InForm study.
Study-specific clinical	Contains data from both the Trial Management data model and the clinical data model (unique for each study).

In the Ad Hoc Reporting workspace, you can see each package structure in the Ad Hoc Reporting tree.

InForm Trial Management package

The InForm Trial Management package is installed with every instance of the Reporting and Analysis module, and is identical across studies. It contains report topics and report elements from the Trial Management data model only.

Note: Use the InForm Trial Management package to create reports that contain only study management data. Reports that you create with the InForm Trial Management package can be shared across studies.

Study-specific clinical package

The study-specific clinical package provides access to both clinical and study management data. It consists of report topics and report elements from both the clinical and Trial Management data

models.

Note: Use the study-specific package to create reports that include clinical data. Because clinical data is unique to each study, report definitions using the study-specific package might not be validated to work across different studies.

A clinical package groups data in each report topic into four sub-folders: Basic Data, Additional Data, Incomplete Data Reasons, and Internal IDs.

Locales in the Reporting and Analysis module

There are multiple locales that affect the languages that appear in the Reporting and Analysis environment.

- Default product locale
 - Set during the InForm installation.
 - Controls the language of the prefixes for clinical metadata, such as **Code~**, **Unit~**, and **Date~**, which appear in the Ad Hoc Reporting tree.
- Reporting product locale
 - Based on the default or user product locale settings in the InForm application.
 - Controls the language of Cognos commands and navigation controls.
 - Controls the language of the study metadata, such as the names of the report topics in the Ad Hoc Reporting tree, for the Trial Management data model.
- Review schema locale
 - Set automatically when you deploy your study to the InForm application.

Note: You can use the PFAdmin utility to change the review schema locale after the Reporting and Analysis installation. For more information, see the *Study and Reporting Setup Guide*.

- Defines the language in which language-dependent resources such as clinical data are displayed.

Note: Make sure that the review schema locale that you select for the Reporting and Analysis module contains all the forms and data elements from all the study locales for the study.

Reporting basics and options

Reporting and Analysis portal

The Reporting and Analysis portal is the first page that appears after you click **Reports** in the navigation toolbar.







Report folders

From the Reporting and Analysis portal, use the folder tabs to navigate to specific reports.

Tab	Description
Public Folders	Provides access to the InForm standard reports and custom reports that are shared with all users.
My Folders	Provides access to reports that only you can access.

Report output icons

The icons that appear next to the name of a saved report indicate the format in which you can view the report.

Icon	Description
	View the report in HTML format.
	View the report in PDF format.
	View the report in XML format.
	View the report in Excel 2007 Data format.
	View the report in Excel 2007 format.
	View the report in Excel 2002 format.
	View the report in CSV format.

Portal icons

Icons in the upper-right corner of the Reporting and Analysis portal let you perform actions on public or personal folders.

- Navigate between list and detailed folder views.
- Create new folders, packages, jobs, URLs, and pages.
- Cut, copy and paste folders.
- Delete folders.
- Set folder properties.
- Order folders.

Portal tools

The following options are available from the Reporting and Analysis portal, based on your InForm rights.

Tool	Description
Log On menu	
Log On	Log in to other available namespaces.
Log Off	Log out of the namespace. Note: After you use the Log Off option, you must log out of the InForm application, and log back in to access the Reporting and Analysis module.
Refresh button	
Refresh	Update the portal with the most current settings.
Search menu	
Name field	Search for entries in the name field.
Description field	Search for entries in the description field.
Name or description field	Search for entries in the name and description fields.
Home menu	
Home	Navigate to your Home page.
Set View as Home	Set the current page as your Home page.
My Area	
My Watch Items	Navigate to the Alerts tab to monitor your watched items.
My Preferences	Change the default preferences for the Reporting and Analysis portal.

Tool	Description
My Activities and Schedules	Navigate to the My Activities and Schedules page, where you can create and modify activities and job schedules.
Launch menu	
Ad Hoc Reporting	Launch the Ad Hoc Reporting workspace. The Cognos Query Studio application provides the Ad Hoc Reporting capability for the InForm application.
Report Studio	Launch the Cognos Report Studio application. Note: You must purchase the license for the Report Studio application separately from Oracle.
Drill-through Definitions	Create, edit, or delete drill-through definitions for packages in the Reporting and Analysis module.
Reporting Administration	Manage styles, Cognos portlets, and third-party portlets in the Reporting and Analysis module. <ul style="list-style-type: none"> • Status—View and manage schedules, run a report, and view report outputs. • Security—Create and manage users, groups, and roles; capabilities; and user interface profiles. • Configuration—Create and manage datasources, content administration, distribution lists and contacts, styles, portlets, and dispatchers and services.

Renewing your credentials

If you set up scheduled reports and then change your account password, you must renew your credentials. Otherwise, the report fails at the next scheduled time after the password change.

To renew your credentials:

- 1 Click the **My Area** icon () > **My Preferences**.
- 2 On the **Personal** tab, click **Renew the credentials**.
- 3 At the bottom-right corner of the window, click **Return**.

Personal pages

You can create up to 50 personal portal pages to organize the information that is most important to you. Using personal pages, you can access in one place the Reporting and Analysis features that you use the most, organized in the way that you want.

The personal page content consists of one or more frames that you display in a single-column, two-column, or three-column configuration. Each personal page frame can display:

- The contents of a public or a personal folder.
- Lists of public and private folders.
- Reports.

You can set up your personal pages to run your reports automatically during non-peak hours so that when you access your personal page at the beginning of the work day, the report output is ready for you to review.

- Bookmarks of URLs to websites.
- Web pages that you visit often.
- RSS feeds.

A toolbar provides personal page configuration and management functions. Each page has a Set Properties button () . Use the Set Properties button to modify personal pages.

New Page wizard

The New Page Wizard walks you through the pages that you use to create and configure personal portal pages.

Page	Description
Specify a name and description	Provides basic properties for a personal page. <ul style="list-style-type: none"> • Name. • Description. • Screen tip. • Location (folder).
Set columns and layout	Allows you to configure the columns on a personal page. <ul style="list-style-type: none"> • Number of columns. • Content. • Column width. • Layout options.
Set page style	Allows you to add titles and instructions to the page, configure their style settings, and set the style of all portlets on the page.

Page	Description
Select an action	Allows you to select what to do after closing the wizard. <ul style="list-style-type: none"> • Add the page to the portal tabs. • View the page.

Report options

You can configure the way the output appears for ad hoc and standard reports by using **Run with options** and **Run with advanced options** for the report. The options available allow you to specify settings such as output format, frequency of report generation, and so forth.

Report options for ad hoc reports

Ad hoc report option	Description
Set Properties	Set the characteristics of the ad hoc report, including the report name, report options, and permissions.
Run with options	Specify the output format and delivery options for the ad hoc report at runtime.
Open with Ad Hoc Reporting	Opens the report in the Ad Hoc Reporting workspace, where you can edit and modify the report content and layout.
Create a report view of this report	Create a report view of the report. Only users with Publisher rights or Report Administrator rights can access this option. Note: If you save a report view with the same name as the report, when you click the report name, the report does not re-generate and you only see the report view. To avoid overwriting data, save a report and its report view with different names.
Schedule	Specify when to generate the report.

Ad hoc report option	Description
More link	<p>Access the features that are listed in this table, as well as:</p> <ul style="list-style-type: none"> • Version management actions: <ul style="list-style-type: none"> ▪ View report output versions. ▪ View my permissions. ▪ New schedule. ▪ Alert me about new versions. ▪ Do not alert any about new versions. • File management actions: <ul style="list-style-type: none"> ▪ Move. ▪ Copy. ▪ Create a shortcut to this entry. ▪ Delete.

Report options for standard reports

Standard report option	Description
Set Properties	Set the characteristics of the standard report, including the report name, report options, and permissions.
Run with options	Specify the output format and delivery options for the standard report at runtime.
Open with Report Studio	Available only if you have access to Report Studio. Opens the report in the Report Studio application.
Create a report view of this report	<p>Create a report view of the report.</p> <p>Only users with Publisher rights or Report Administrator rights can access this option.</p> <p>Note: If you save a report view with the same name as the report, when you click the report name, the report does not re-generate and you only see the report view. To avoid overwriting data, save a report and its report view with different names.</p>
Schedule	Specify when to generate the standard report.

Standard report option	Description
More link	<p>Access the features that are listed in this table, as well as:</p> <ul style="list-style-type: none"> • Version management actions: <ul style="list-style-type: none"> ▪ View report output versions. ▪ View my permissions. ▪ New schedule. ▪ Alert me about new versions. ▪ Do not alert any about new versions. • File management actions: <ul style="list-style-type: none"> ▪ Move. ▪ Copy. ▪ Create a shortcut to this entry. ▪ Delete.

Run with options for ad hoc and standard reports

Run with options	Description
Format	<p>Specifies the delivery format for the report output:</p> <ul style="list-style-type: none"> • HTML (including the number of rows per page). • PDF (including the page orientation and paper size). • Microsoft Excel in single or multiple spreadsheet formats. • Delimited text (CSV). • XML. <p>Note: CSV and XML formats are only available for ad hoc reports, and are not supported for standard reports.</p>
Accessibility	<p>Allows you to enable or disable accessibility support.</p> <p>Note: Enabling accessibility support creates report output that can be read by a screen reader.</p>
Language	<p>Specifies the language in which to produce the report output.</p>

Run with options	Description
Delivery	<p>Any of the following delivery mechanisms:</p> <ul style="list-style-type: none"> • View the report now. • Save the report. <p>Saving the report output as a view produces a snapshot of the data at the time that you generate the report. This produces an archive that you can quickly review without having to regenerate the report output.</p> <p>Note: If you save a report view with the same name as the report, when you click the report name, the report does not re-generate and you only see the report view. To avoid overwriting data, save a report and its report view with different names.</p>
Prompt values	Specifies the range of data that is included in a report.
Advanced options	Specify additional options.

Run with advanced options for ad hoc and standard reports

Advanced option	Description
Time and mode	<p>Specifies when to generate the report:</p> <ul style="list-style-type: none"> • View the report now—Run the report immediately. • Run in the background—Specify whether to run the report immediately, or at a scheduled time. <p>Selecting Run in the background:</p> <ul style="list-style-type: none"> ▪ Gives you access to additional HTML formats. ▪ Allows you to set additional PDF formatting preferences. ▪ Specifies the delivery mechanism: <ul style="list-style-type: none"> ▪ Save the report, or save the report as a report view. Allows you to edit the options. ▪ Send a link to the report by email. Allows you to edit the options.

Advanced option	Description
Format	<p>Specifies the delivery format for the report output.</p> <ul style="list-style-type: none"> • HTML—Allows you to specify: <ul style="list-style-type: none"> ▪ Number of rows per web page. ▪ Whether to enable selection-based interactivity. • PDF—Allows you to specify: <ul style="list-style-type: none"> ▪ Orientation ▪ Paper size • Excel 2007 • Excel 2007 Data • Excel 2002 • Delimited text (CSV) • XML <p>Note: CSV and XML formats are only available for ad hoc reports, and are not supported for standard reports.</p>
Accessibility	<p>Allows you to enable or disable accessibility support.</p> <p>Note: Enabling accessibility support creates report output that can be read by a screen reader.</p>
Language	Specifies the language in which to produce the report output.
Prompt values	Specifies the range of data that is included in a report.

Report types

The Reporting and Analysis module includes ad hoc and standard reports, by default. You can also purchase the Report Studio application, which allows you to create more advanced custom reports, or you can contact Oracle for assistance in creating custom reports using the Report Studio application.

Ad hoc reports

You create ad hoc reports on both clinical and study management data using the Ad Hoc Reporting workspace, which is powered by the Query Studio application. Ad hoc reports allow limited use of Cognos features such as data output styles, report layout and formatting, summarizations and aggregations, mathematical functions, and prompts.

Note: References to *Query Studio* and *queries* have been removed from the Reporting and Analysis user interface and documentation to avoid confusion by clinical users to whom the term *query* means a clinical discrepancy, not a database operation. For example, in the Cognos documentation, report topics are referred to as query subjects and report elements are referred to as query topics.

InForm standard reports

The InForm application includes a set of management reports that provide information about the progress of a study. These reports contain several categories of information, and several views of each report are available. For example, you can display the query status reports by site and by user; month by month or study-to-date; and in text or graphical formats. Standard reports are created using the Report Studio application and are validated and optimized for the InForm application.

There are five categories of standard reports:

- Query reports provide information about query aging, status, and cycle time.
- Case Report Form (CRF) reports provide information about the progress of data entry and query activity on started case books.
- Item reports provide information about the progress of item source verification, as well as listings of items on forms.
- Subject reports provide information on the progress of case book completion for individual subjects. These reports also provide subject enrollment and dropout counts, as well as subject enrollment status.
- Audit trail reports provide auditing and operational information such as audit trail information and login history.

Custom reports

Custom reports are advanced reports that are created in the Report Studio application using all the Cognos features and functionality, such as different data output methods, increased report layout and formatting options, summarizations and aggregations, prompts, user-definable sorting, and drill-through reports.

Note: For more information on creating custom reports, contact Oracle or see the Cognos documentation.

Comparison of report types

Reporting and Analysis users can create ad hoc reports, standard reports, and custom reports. The reports contain data from different sources, and vary in complexity.

Report type	Ad hoc	Standard	Custom
Design complexity	Simple to medium	Medium	Simple to advanced
Data source	Model	Model and SQL	Model and SQL
Database schema	Reporting	Reporting	Transactional and Reporting and Analysis
Revisions	Current*	Current**	All
Data blinding	Inherent in model	In SQL	In SQL

* For ad hoc reports, you can see all revisions for operational data only.

** The audit trail standard report covers all revisions.

Scheduling reports

You can schedule ad hoc or standard reports to run automatically at times that are convenient for you. If you choose to schedule a report:

- Avoid scheduling reports during peak periods for the study.
- If a study is complete, remember to cancel any associated scheduled reports.

Note: For more information, see the Cognos documentation, which is available from the Help icon in the upper-right of the InForm window.

Scheduling a single report

- 1 Run the report.
- 2 Save the report.
- 3 Click the **Schedule** icon () for the report.
The Schedule - [Report Name] page appears.
- 4 Specify the following information for the report:
 - Priority.
 - Start and end date.
 - Frequency.
- 5 Specify whether you want to override the format, accessibility settings, report language, or delivery settings.
- 6 Specify whether you want to override the report prompt default values.
- 7 Click **OK**.

Scheduling multiple reports

To create a list of multiple reports, report views, or other items for which you want to share schedule settings and that you want to run simultaneously, you create a job.

Using the job development tools, you can:

- Create a new job using the New Job wizard.
- Manage a job using the Set Properties button for the job.
- Run a job manually using the Run with options page.
- Manage jobs using the My Activities and Schedules page.

Note: **Run with advanced options** settings for a report take precedence over job settings. For example, if you use the **Run with advanced options** page to schedule the Query Cycle Times by Site report to run at a specific date and time, and you create a job that includes the same report, and is scheduled to run daily, the Query Cycle Times by Site report will run at the time you specified on the **Run with advanced options** page.

New Job wizard

You create jobs using the New Job wizard ()

- The job identification provides the following options:
 - The language in which to display the job identification information.
 - The name of the job.
 - An optional screen tip for a job.
 - An optional description of a job.
- Jobs contain job steps:
 - Steps reference the individual reports, jobs, and report views.
 - Submission of steps specifies whether to run the steps all at one time or in sequence.

For more information, see the Cognos documentation.

Run with options page for an existing job

The Run with options page provides options for running a job manually. This page includes the same information as the Schedule page, which appears if you choose to schedule the job from the New Job wizard.

- **Time section**—Allows you to specify whether to run the job immediately or at a specified time.
- **Steps section**—Lists the components of the job.

Note: The settings that you implement on the **Run with options** page are in effect for this execution of the job only, and do not affect the original job definition.

For more information, see the Cognos documentation.

Set Properties page for an existing job

- Click the **Set properties** button () associated with a job to open the Set properties page and edit the job definition.

Comments in saved reports

To allow users to add comments to a report:

- 1 Save the report output in the Reporting and Analysis portal in one of the following output formats:
 - HTML
 - PDF
 - XML
- 2 Enable comments for the report.

Enabling comments in a saved report

- 1 For a saved report in HTML, PDF or XML output, click **Set Properties** ().
- 2 Do one of the following:
 - For an ad hoc report, select the **Query** tab.
 - For a standard report, select the **Report** tab.
- 3 Click **Advanced options**.
- 4 Select **Enable comments in saved output versions**.

Adding a comment to a report

- 1 Open a saved report in HTML, PDF or XML output.
- 2 Click **Add comments > Add a comment**.

The Add a comment dialog box appears.
- 3 In the **Name** field, type your name.
- 4 In the **Comment** field, type the comment text.
- 5 Click **Finish**.

Study design considerations

Subject status requirements

The subject status that appears in reports depends on which InForm features you use to set the state. For instance, to display status data for a subject in the Randomized state, you must perform subject randomization through the InForm application.

This table outlines the requirements for subject status in the InForm application. If your organization does not take advantage of these InForm features, subject status reporting capabilities are limited in the Reporting and Analysis module.

Subject status	Required action in the InForm application
Screened	InForm Screening form (as designed per InForm requirements) must be successfully submitted for the subject.
Enrolled	InForm Enrollment form (as designed per InForm requirements) must be successfully submitted for the subject.
Screened Failed	InForm Screening form (as designed per InForm requirements) must be submitted for the subject. The subject subsequently fails the InForm screening process.
Enrolled Failed	InForm Enrollment form (as designed per InForm requirements) must be submitted for the subject. The subject subsequently fails the InForm enrollment process.
Enrolled Override	InForm Enrollment Override process must be successfully completed after the subject initially fails screening or enrollment.
Randomized	Subject must be randomized in the InForm application.
Dropped Out	InForm Study Completion form (as designed per InForm requirements) must be completed for the subject. The form must indicate that the subject has dropped out of the study.
Completed	InForm Study Completion form (as designed per InForm requirements) must be completed for the subject. The form must indicate that the subject has completed the study.

DOV controls

Form aging and cycle time reports show the amount of time it takes to capture data throughout various steps of the electronic data entry process. These calculations begin with the date of visit (DOV).

There are several options for designing DOV controls. In general, the DOV control should:

- Have a specific Universal Unique Identifier (UUID).
- Appear within a form section that is identified with a specific UUID.
- Not appear on a common form.

Note: For information on designing DOV controls, see the *Utilities Guide*.

The Reporting and Analysis module retrieves DOV data from the database, assuming that your study uses specific UUIDs.

If a study uses the special DOV UUIDs, an InForm user can leave the DOV item blank during data entry. When the DOV item does not contain data in the InForm application, reports that include the date of visit or calculations that rely on the date of visit do not contain data.

If an InForm user enters a DOV that is later than the data entry date, reports show negative values in cycle time columns.

Labels for clinical report elements

In the Central Designer application, study designers can specify a label in the Short Question property for an item. For items in an itemset, this label appears as the column heading in the row and column representation of the itemset in the Reporting and Analysis module.

Note: Do not use Subject Number as an Itemset Column Header name. It causes an error when you create the clinical model for the study.

In the Reporting and Analysis module, the Itemset Column Header property is also the default short name for the field in the clinical data model, whether or not the item is in an itemset.

Optional study elements

When you design a study in the Central Designer application, you can specify whether a study element is required or optional. Optional items that are included in the study design and deployed to the InForm application may be left blank by InForm users. If an optional element does not contain data, the row that corresponds to the element in an ad hoc report does not contain data.

For example, your study may include a Sponsor Name element, for which you can choose not to enter data. In this case, ad hoc reports that contain the SponsorName report element display a row for the item, but the cells in the row do not contain the sponsor name.

Reserved words for Reporting and Analysis

The reserved words below cannot be used for the following item properties:

- Short question.
- Default question or Question if a Short question is not provided, or is populated with a reserved word.

If you specify a reserved word for the item Default question or Question you must provide a Short question that is not a reserved word, or the clinical model in the Reporting and Analysis module fails to generate.

Note: You cannot use the English reserved words or Japanese reserved characters for any locale.

For example, to design an item for which a reserved word appears as the question on the form in the InForm application, specify the following:

- Question—Reserved word such as Subject Number.
- Default question or Short question—A word that is not on the reserved words list, such as Subj Number.

Subject Number appears as the question on the form, and Subj Number appears in the clinical model in the Reporting and Analysis module and as the itemset column header on the form in the InForm application. In addition, the clinical model is successfully generated.

A warning does not appear in the Central Designer application if a reserved word is used incorrectly.

English words	Japanese characters
SITECOUNTRY	施設の国名
SITENAME	施設名
SITEMNEMONIC	施設略称
SUBJECTINITIALS	症例イニシャル
SUBJECTNUMBERSTR	症例番号
VISITMNEMONIC	ビジット略称
VISITORDER	ビジットオーダー
VISITIDX	ビジットインデックス
FORMMNEMONIC	フォーム略称
FORMIDX	フォームインデックス
DELETED	削除フォーム
ITEMSETIDX	アイテムセットインデックス
DELETEDITEMSET	削除アイテムセット
DOV	ビジット日時

English words	Japanese characters
NOTDONE	未実施
CREATEDBYUSERID	基本データ
CREATEDDATETIME	その他のデータ
MODIFIEDBYUSERID	不完全データの理由
MODIFIEDDATETIME	内部ID
SITEID	施設
SUBJECTID	症例
VISITID	ビジット
VISITINDEX	フォーム
SUBJECTVISITID	セクション
FORMID	アイテム
FORMREV	ルール
FORMINDEX	クエリ
SECTIONID	コメント
ITEMSETID	定義済フィルタ
ITEMSETINDEX	すべての登録済症例
FORMASSOCID	脱落者を除いたすべての登録済症例
CD_COUNT	有効症例
Basic Data	クリニカルビジット
Additional Data	クリニカルフォーム
Incomplete Data Reasons	開始フォーム
Internal Id's	見込フォーム:予定ビジット
Sites	見込フォーム:予定ビジットまたは開始ビジット
Subjects	見込フォーム:現在までの予定ビジットまたは開始ビジット
Visits	見込フォーム:現在までの予定ビジットまたは開始フォーム
Forms	データ完了(クエリを含む)
Sections	データ完了(オープンクエリを含まない)
Items	クリーンデータ:完了かつSDV済み
Rules	

English words	Japanese characters
Queries	
Comments	
Predefined Filters	
All Enrolled Subjects	
All Enrolled Subjects except Dropped	
Active Subjects	
Clinical Visit	
Clinical Form	
Started Forms	
Expected Forms: Scheduled Visits	
Expected Forms: Scheduled or Started Visits	
Expected Forms: Scheduled or Started Visits to Date	
Expected Forms: Scheduled Visits or Started Forms to Date	
Data Complete (Queries Allowed)	
Data Complete, No Open Queries	
Data Clean: Complete and SV	
Site Country	
Site Name	
Site Mnemonic	
Subject Initials	
Subject Number	
Visit Mnemonic	
Visit Order	
Visit Index	
Form Mnemonic	
Form Index	
Deleted Form	
Itemset Index	
Deleted Itemset	
DOV	
Not Done	

Configuring computer settings for Reporting and Analysis

Browser settings for Internet Explorer

Configure the following Internet Explorer settings to access the InForm application and the Reporting and Analysis module.

- Specify the preferred browser language.
- To view reports in Microsoft Excel format:
 - Set the InForm website domain and the Reporting and Analysis website domain as trusted sites.
 - Enable automatic prompting for file downloads.
 - Enable notifications when downloads complete.
- Configure pop-up blocking to allow pop-ups for the InForm website domain and the Reporting and Analysis website domain.
- Prevent automatic password completion.
- Specify that you want to save encrypted files to disk.
- Automatically check for newer versions of stored pages.
- Set the amount of disk space to use to 6 MB.
- Set the HTTP and SSL options to use HTTP 1.1 and SSL 3.0.
- Enable printing background colors and images for graphics.
- Modifying security settings:
 - Allow META REFRESH.
 - Enable active scripting.
- Set up tabbed browsing to launch links in a new tab.

For more information, see the Internet Explorer documentation.

Browser settings for Mozilla Firefox

Configure the following Firefox settings to access the InForm application and the Reporting and Analysis module.

- Specify the preferred browser language.
- Configure pop-up blocking to allow pop-ups for the InForm website domain and the Reporting and Analysis website domain.
- Prevent Firefox from using stored passwords.
- Set the SSL option to use SSL 3.0.
- Modify security settings to accept cookies.
- Set up tabbed browsing to launch links in a new tab.

For more information, see the Mozilla Firefox documentation.

Windows Explorer settings

Configure the following Windows Explorer settings to access the InForm application and the Reporting and Analysis module.

- Make sure the files with the XLS and XLSX extensions are not set to Browse in the same window.
- Associate files with the XLS and XLSX extensions with the Microsoft Excel spreadsheet software.

CHAPTER 2

Ad Hoc Reporting

In this chapter

About Ad Hoc Reporting.....	30
InForm to Cognos naming correspondence	31
Accessing the Ad Hoc Reporting workspace	32
Ad Hoc Reporting workspace	33
Ad Hoc Reporting tree.....	34
Ad Hoc Reporting menu	35
Running and saving ad hoc reports.....	37
Editing data in an ad hoc report.....	41
Internal IDs.....	49
Calculations and conversion rules	51
Crosstab reports	55
Charts.....	56
Custom groups	58
Reporting on study management data.....	61
Reporting on clinical data	149

About Ad Hoc Reporting





The Ad Hoc Reporting workspace provides the flexibility to quickly create different types of reports:

- **List**—Data details in columns and rows.
- **Crosstab**—Summary data in columns and rows.
- **Chart**—Summary data using graphical presentations, such as pie charts and bar charts.

You create ad hoc reports on both clinical and study management data using the Ad Hoc Reporting workspace, which is powered by the Query Studio application. Ad hoc reports allow limited use of Cognos features such as data output styles, report layout and formatting, summarizations and aggregations, mathematical functions, and prompts.

Note: References to *Query Studio* and *queries* have been removed from the Reporting and Analysis user interface and documentation to avoid confusion by clinical users to whom the term *query* means a clinical discrepancy, not a database operation. For example, in the Cognos documentation, report topics are referred to as query subjects and report elements are referred to as query topics.

InForm to Cognos naming correspondence

Icon	Ad Hoc Reporting	Cognos Query Studio	Description
	Package	Package	Subset of a data model that contains topics you can add to a report.
	Folder	Folder	Organizer for report items. You cannot import a folder into a report.
	Namespace	Namespace	Used to prevent naming conflicts within a package. Can contain a variety of objects such as dimensions, report elements, and filters.
	Report topic	Query Subject	Categories of different reporting areas representing tables in the database.
	Report element	Query Item	Representation of the data point to include in reports.
	Measure	Measure	Represents quantitative data such as counts, calculations, or aggregations.

Accessing the Ad Hoc Reporting workspace

- 1 In the navigation toolbar, click **Reports**.

The Reporting and Analysis portal appears.

- 2 Select **Launch > Ad Hoc Reporting**.

The Select a package page appears.

- 3 Click the link for a package:

- **InForm Trial Management package**—Click **<study name> InForm Trial Management**.
- **Study-specific clinical package** (containing both clinical and study management data)—Click the link with the name of your study.

The Ad Hoc Reporting workspace appears. The Ad Hoc Reporting tree reflects the package that you selected.

Ad Hoc Reporting workspace

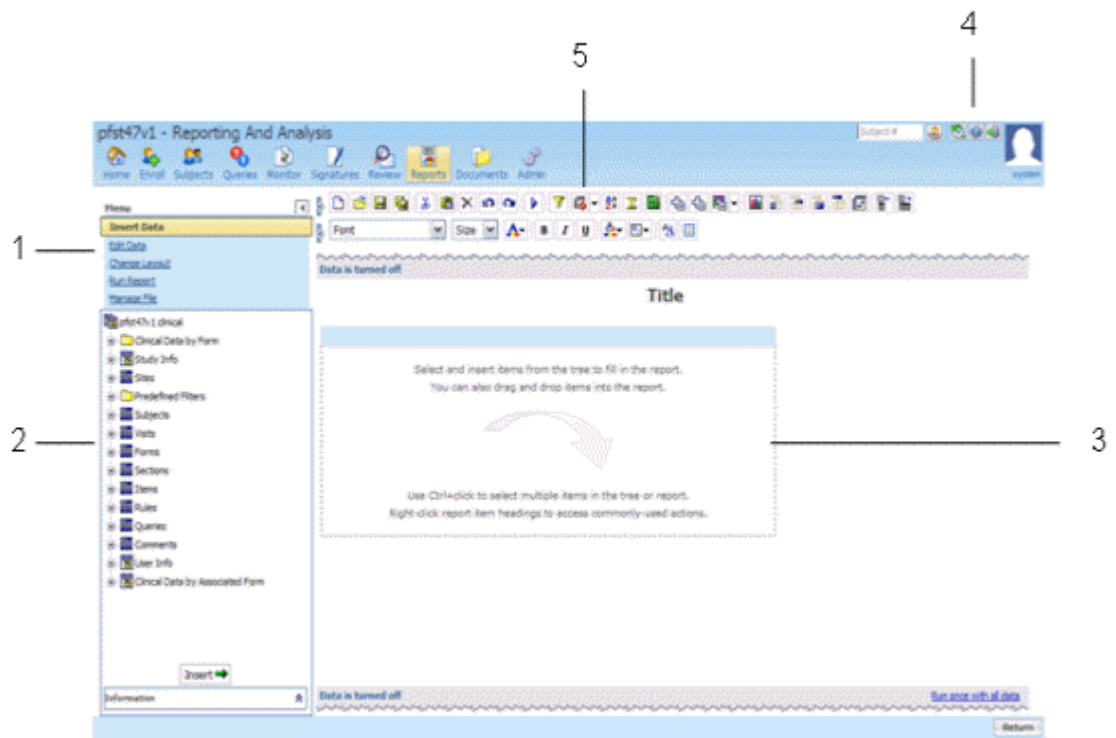

- 1—(Points to the Ad Hoc Reporting menu.) Use the **Ad Hoc Reporting menu** to insert and edit data, save reports, run reports, and change the report layout.
- 2—(Points to the Ad Hoc Reporting tree.) Use the **Ad Hoc Reporting tree** to make data available for reporting.
- 3—(Points to the report palette.) Drag report topics and elements to the **report palette** to create ad hoc reports.
- 4—(Points to the Help icon.) Use the **Ad Hoc Tools Help** to launch the online User Guide for Cognos Query Studio, which provides the Ad Hoc Reporting capability to the InForm application.
- 5—(Points to the Cognos 10 Business Intelligence toolbar.) Use the **Cognos 10 Business Intelligence tools** to save reports, cut and paste data, apply filters, and summarize data.

Ad Hoc Reporting tree

The Ad Hoc Reporting tree is the graphical representation of a package structure that appears in the Ad Hoc Reporting workspace.

For more information, see:

- *Using the Ad Hoc Reporting tree to create reports* (on page 37).
- *InForm Trial Management reporting tree* (on page 62).
- *Clinical reporting tree* (on page 150).

Ad Hoc Reporting menu

Menu option	Description
Insert Data	Add report elements to the report palette for inclusion in an ad hoc report.
Edit Data	<p>Modify data on the report:</p> <ul style="list-style-type: none"> • Apply filters. • Suppress data. • Sort and summarize columns. • Format data. • Add calculations. • Define custom groups. • Go to other reports. • Rename the column heading. • Cut, paste, and delete data. • Undo and redo changes.
Change Layout	<p>Modify the presentation of a report:</p> <ul style="list-style-type: none"> • Create charts. • Define conditional styles. • Change font and border styles. • Apply templates. • Edit the title area. • Set the web page size and page breaks. • Group, ungroup, and pivot columns. • Create sections in a report. • Swap rows and columns. • Collapse and expand groups.
Run Report	<p>Specify options for running the report:</p> <ul style="list-style-type: none"> • Run the report with all data. • Preview the report with limited or no data. • Specify an output format for your report. • Set advanced options.

Menu option	Description
Manage File	<ul style="list-style-type: none"><li data-bbox="639 205 959 237">• Create and save reports.<li data-bbox="639 258 1438 321">• Access Report Studio, if you have purchased it and have sufficient rights to access it.<li data-bbox="639 342 1008 373">• Create reporting definitions.<li data-bbox="639 394 867 426">• Set preferences.

Running and saving ad hoc reports

Using the Ad Hoc Reporting tree to create reports

To create an ad hoc report, do one of the following:

- Drag a report element or report topic from the Ad Hoc Reporting tree to the Ad Hoc Reporting workspace.
- Double-click a report element or report topic.
- Select the report element or report topic, and click **Insert**.

When you double-click or drag a report topic, all report elements it contains appear as columns in the ad hoc report.

When you double-click or drag a report element, a single element appears as a report column in the ad hoc report.

Note: By default, data is turned off in the Ad Hoc Reporting workspace. When you add report topics or report elements to the report palette, the columns are populated with **abcd**. When you click **Run with all data** or **Preview with limited data**, the report is populated with the actual data.

Running an ad hoc report from the Ad Hoc Reporting workspace

- 1 From the **Ad Hoc Reporting** menu, click **Run Report**.
- 2 Choose an option:
 - Run with all data.
 - Preview with limited data.
 - Preview with no data. (This option is selected by default.)

Note: For reports that contain a large amount of data, Oracle recommends that you save the report and open it from your local machine.

Running an ad hoc report in a new window

- Right-click the link for any report to launch a new browser window in which to display the report.

Saving an ad hoc report

When you save an ad hoc report, you save the report definition. Each subsequent time you run the report, the data in the report reflects any changes in the Reporting and Analysis database.

- 1 Click **Save**.
- 2 If you are saving the report for the first time, specify:
 - **Name**—Name of the report.

- **Description**—Descriptive text about the report.
 - **Screen tip**—Hover text that appears for the report.
 - **Location**—Location in the Ad Hoc Reporting workspace in which to save the report.
- 3 Click **OK**.

Previewing report output with limited or no data

After you drag a report topic on to the Ad Hoc Reporting palette, you can view a sample report output.

- From the **Run Report** menu, click **Preview with Limited Data** or **Preview with No Data** to view a sample of the report.
 - **Preview with Limited Data**—Displays a subset of the data for the ad hoc report you created.
 - **Preview with No Data**—Displays the columns that you added to the Ad Hoc Reporting palette, populated with sample data.

For each option, the following appears in the Ad Hoc Reporting workspace:

- A jagged (torn-page look) top edge.
- A header with:
 - The report title that you created.
 - If you clicked **Preview with Limited Data**, a **Limited data** label.
 - If you clicked **Preview with No Data**, a **Data is turned off** label.
- A footer with:
 - The date when the preview was created.
 - The page number.
 - The time when the preview was created.
 - A **Run once with all data** link, which allows you to run the report with all the data you added.

Preview formats

The Ad Hoc Reporting workspace provides Run Report menu selections to preview the output format for a report during report development:

- View in PDF Format.
- View in Excel 2007 Format.
- View in Excel 2007 Data Format.
- View in Excel 2002 Format.
- View in CSV Format.
- View in XML Format.

Using the design-time report viewer

You can preview the report output in several different formats using the Run Report menu. When you select an output format, a separate window opens (either the report viewer or another window) in which to display the output.

Preview output	Display utility
PDF Format	Report Viewer
Microsoft Excel Formats	Microsoft Excel
Comma-Separated Values Format	Microsoft Excel
XML Format (read-only)	Report Viewer

To access the design-time report viewer:

- 1 Open a saved report from the Reporting and Analysis portal.
- 2 From the **Menu** list in the Ad Hoc Reporting workspace, select **Run Report**.
- 3 From the **Run Report** menu, click a format option.

Using the run-time report viewer

You can run a report from the Reporting and Analysis portal using the run-time report viewer. For each output format, the report viewer or a separate window launches and displays the output.

Preview output	Display utility
HTML Format	Report Viewer
Adobe Acrobat Portable Document Format	Report Viewer
Microsoft Excel 2007 Format	Microsoft Excel
Microsoft Excel 2007 Data Format	Microsoft Excel
Microsoft Excel 2002 Format	Microsoft Excel
Comma-Separated Values Format	Microsoft Excel
XML Format (read-only)	Report Viewer

To access the run-time report viewer:

- 1 Access a saved report in a folder (public or personal).
- 2 From the folder, click the **Run with options** button that appears with the report name.
- 3 From the Run with options page, select a value from the **Format** drop-down list.
 - HTML
 - PDF
 - Excel 2007

- Excel 2007 Data
 - Excel 2002
 - CSV
 - XML
- 4 Click **Run**.

Opening an ad hoc report in Report Studio

If you have access to the Report Studio application, you can open a report in Report Studio from the Ad Hoc Reporting workspace. You can then use the Report Studio application to add advanced functionality to the report.

- In the Ad Hoc Reporting menu, click **Manage File > Open in Report Studio**.









Editing data in an ad hoc report

Opening an existing report

You can open an existing report from within the Ad Hoc Reporting workspace.

- 1 Click **Manage File**.
- 2 Click **Open**.
- 3 Select the report to open, and click **OK**.
- 4 To use the report as the basis of a new report, click **Save As**.

Editing tools in the Ad Hoc Reporting workspace

Option	Description
 Filter	Select the data to appear in a report.
Combine Filters	Combine two or more filters using AND or OR logical operators.
 Suppress	Suppress data you want to exclude from a report. You can suppress the following types of values: <ul style="list-style-type: none"> • Zero values • Divide by zero • Missing values • Overflow values
 Sort	Sort to reorder a column of data in ascending or descending order.
 Summarize	Include summaries (such as totals, averages, and counts) in the footer of the report.
 Format Data	Change the appearance of numbers, dates, times, and text, without changing the underlying data.
 Calculate	Add calculated values to a report using data from one or more existing report elements.
Define Custom Groups	Produce new report elements containing values from multiple report elements, and that are meaningful to you.
 Drill Down	See lower levels of detail.
 Drill Up	See higher levels of detail.
 Go To	Access links to other reports. See your administrator about related links available in your study.
Rename Column Heading	Customize the column heading text.

Option	Description
	Typical editing functions. Cut, Paste, Delete, Undo, and Redo

Using predefined filters

Predefined filters let you limit a report to specific subjects, visits, and forms. These filters are shipped with the Reporting and Analysis module and can be used in all reports. The Predefined Filters folder is available in both the InForm Trial Management package and the clinical package.

You can also create filters. Each user-created filter is saved with the report in which it was created. The filter can be used only with that report and cannot be used globally across multiple reports.

Filter definitions

When you select a filter option for a column heading, the Filter pane appears. The following fields appear on the Filter pane:

- **Filter links**—Let you choose the way that you indicate your data selections.
 - Pick values from a list (default).
 - Search for values.
 - Type in values.
- **Filter on**—Identifies the column on which to apply the filter.
- **Prompt every time the report runs** checkbox—Select whether to prompt every time the report is run.
- **Condition** drop-down list—Includes the following options:
 - **Show only the following**—Select values to include in the report.
 - **Do not show the following (NOT)**—Select values to exclude from the report.
- **Data values** section—Indicates your selection values.
- **Missing values drop-down list**—Indicate whether to:
 - Include missing values.
 - Leave out missing values.
 - Show only missing values.
- **Apply the filter to individual values in the data source** checkbox—Allows you to apply the filter while retrieving the data from the database so that you retrieve only the data that you want. The alternative is to retrieve all the data from the database, then apply the filter to the retrieved data.

The following table shows which filters work with each type of reporting data.

Feature	Aggregate	Non-Aggregate	Date
---------	-----------	---------------	------

Feature	Aggregate	Non-Aggregate	Date
Links		X	
Filter on	X	X	X
Prompt every time the report runs	X	X	X
Condition	X	X	X
Data values	X	X	X
Missing values	X	X	X
Apply the filter to individual values...		X	X

Adding a filter

- 1 Create a report.
- 2 In the Ad Hoc Reporting report palette, select the column header for a report topic on which to filter the report.
- 3 Right-click the report column header and select **Filter**.

Or

Click the **Filter** button () in the toolbar.

The Filter (Pick values from a list) pane appears.

- 4 Do one of the following:
 - From the Filter (Pick values from a list) pane, select a filter from a list.
 - Click **Search for values** to search for a filter using keywords.
 - Click **Type in values** to search for a filter using text in the filter name.

Adding a filter without adding a column

You can filter a report based on a particular report element without adding a column for that item to the report.

- 1 In the Ad Hoc Reporting tree, right-click the report element name.
- 2 Select **Filter for report**.
The Filter pane appears.
- 3 Specify the parameters by which to filter the report.
- 4 Click **OK**.

Removing a filter

When you add a filter on a report column, the report output includes a link to the filter just below the report title. If you click this link, you can change the filter parameters to produce different output.

To hide filter links from the title area of an ad hoc report:

- 1 Double-click the report title.
- 2 Deselect **Show filters**.

This removes the links but not the filters.

Note: You cannot modify the parameters for a predefined filter.

Combining filters

Combine two or more filters to create a complex filter. For example, you can filter the columns Site Name, Visit Name, and Actual Date in a report.

- 1 From the Edit Data menu, select **Combine Filters**.
- 2 To add a filter, click **Add a filter line**.
- 3 To select a set of filters, click the name of the filter while holding down **Ctrl** or **Shift**.
- 4 Click **Group**.
- 5 Click the operator that appears between the filters and select **AND** or **OR** to combine them.
- 6 To convert a filter line or a combined filter into a NOT filter, click the filter line or combined filter and click **Apply NOT**.
- 7 Click **OK**.

Sorting the elements in a report

In the Sort Options section of the prompt page, you can choose the columns on which to sort a report.

Drop-down lists appear at the bottom of each report prompt page. Default sorting selections are automatically selected. You can change these to create your own report definition.

Each sort drop-down list includes **Ascending** and **Descending** radio buttons. Ascending sorts are automatically selected by default. Use the radio buttons to change the sort type.

Reports that include groupings, such as organization by user or by site, are sorted at the detail level within the grouping, according to the selections made in the drop-down lists. The grouping sort order can be modified (ascending or descending) but will always take precedence over other sorting settings.

Note: You can also sort data based on a report element without first adding the element to the report. For more information, see *Sorting data without adding a column* (on page 45).

Sorting data without adding a column

You can sort the data in a report based on a particular report element without adding a column for that item to the report.

- 1 In the Ad Hoc Reporting tree, right-click the report element name.
- 2 Select **Sort for report**.
The Sort pane appears.
- 3 Specify whether to sort the report in ascending order, descending order, or not to sort the report at all.
- 4 Click **OK**.

Summarization

When you create an ad hoc report, you can include summary data in the report output. Summary data provides high-level information such as totals, counts, calculations, minimum and maximum values, and so forth. The summary data that is available depends on the report element for which you are providing summary data.

In addition to providing the option to summarize specific data in ad hoc report outputs, the Ad Hoc Reporting workspace automatically suppresses duplicate data in the report output, and displays only unique combinations of data.

Adding summary data to a report

- 1 In the report palette, select the column heading for the report element for which to configure summary data.
- 2 Select **Edit Data > Summarize**.
or
Right-click a column header and select **Summarize**.
The Summarize pane for the type of data in the selected column appears.
- 3 Specify the type of summary to add to the report.
- 4 Click **OK**.

Configuring automatic summarization settings

- 1 Click **Run Report > Advanced Options**.
- 2 In the **Query Options** section, specify the following:
 - **Automatically generate footer summaries for measures** (selected by default)—Display a summary for each measure in the footer of the report output.
For example, if a report contains the Visit Mnemonic and Form Count report items, a row that contains the total number of forms for each visit exists in the report output.
 - **Automatically summarize detail values, suppressing duplicates** (selected by default)—Display only each unique combination of data, and display a summary of details.
For example, if you select this checkbox for a report that contains multiple combinations of Subject Number and Site data, the report displays only each unique combination of subject

and site. If the report also contains the Visit Mnemonic and Form Count report items, a row that contains the total number of forms for each visit exists in the report output.

- 3 Click **OK**.

Configuring drill up, drill down, and drill through settings

- 1 Click **Run Report > Advanced Options**.
- 2 In the **Drill Options** section, select the following:
 - **Enable drill up and drill down in the report output** (selected by default)—Allows you to navigate a report output according to a specific report item.

For example, if a report displays query data, organized by form, you can drill up and down through the report data by form name.
 - **Enable drill through from a package in the report output** (selected by default)—Allows you to navigate between reports that exist in a report package, if a drill-through definition exists for the package.

For example, you can navigate from an ad hoc report to a standard report in the same package.
- 3 Click **OK**.

Lineage information for data

Before you add a report element to an ad hoc report, you can view its origin. The lineage information displays metadata such as the report package, visit, form, and so forth, associated with the report element. Use the lineage information to ensure that you include the correct report element to a report.

- Right-click the report element, and click **Lineage**.

Lineage information for the report element appears in two views:

- **Business View**—Displays information about the report element and the package in which it exists.
- **Technical View** includes two panes:
 - **Diagram pane**—Graphical representation of the package, the database table, and the database (either the InForm database or the Reporting and Analysis database) in which the report element exists. This information appears in two columns:
 - **Package**—Displays metadata including the report topic and database table associated with the report element.
 - **Data Sources**—Indicates the database in which the report element exists (the InForm database or the Reporting and Analysis database).
 - **Properties for <Report Element> pane**—Displays additional information about the item that you select in the **Package** column in the Diagram pane.

Note: Lineage information is not available for reports that are created in Report Studio and include an if-then-else-if-then-else construct. This includes, but is not limited to, most InForm standard reports, and Oracle custom reports.

Changing the display format for report elements

- 1 On the report palette, click the column heading for a report column, and do one of the following:
 - From the **Edit Data** menu, select **Format Data**.
 - Right-click the column heading and select **Format Data**.
 The Format pane appears.
- 2 Specify the display characteristics for the selected column.
- 3 Click **OK**.

Renaming titles and headings

To customize a report title:





- Click the title in the report palette and enter data in the **Edit title area** pane.







To customize a report heading, do one of the following:

- Double-click the column heading in the report palette and enter data in the **Rename** pane.

Changing the page layout for a report

Use the following Change Layout menu selections to change the look and feel of an ad hoc report.

Option	Description
 Chart	Present information graphically using one of several 2D and 3D formats.
 Define Conditional Styles	Apply font styles depending on the data values in a column.
 Change Font Styles	Specify font types and sizes for a report.
 Change Border Styles	Specify the line weight and color for report borders.
Reset Font and Border Styles	Reset the report output to the default format.
Apply Template	Apply formatting that you create using Report Studio.
Edit Title area	Include meaningful report titles and optional subtitles.
Set Web Page Size	Specify the maximum number of rows of data that appear on any page of an ad hoc report.
Set Page Breaks	Specify page breaks on groups or report sections.

Option	Description
 Group	Organize a report so that identical values in a column appear together and suppress the display of duplicate values. <ul style="list-style-type: none"> • The grouped column automatically sorts in ascending order. • Duplicate values are suppressed. • A summary is generated for each distinct group value.
 Pivot	Convert a list report to a crosstab report.
 Ungroup	Revert to showing all values in a column including duplicates.
 Create Sections	Organize a report into a distinct section for each unique value within a column.
 Swap Rows and Columns	Interchange rows and columns in a crosstab, a chart based on a crosstab, or both.
 Collapse Group	Temporarily reduce progressive levels of detail to high-level summaries.
 Expand Group	Restore temporary collapsed levels from a Collapse Group action to the full detail levels.

Suppressed and deleted data in reports

The Ad Hoc Reporting module automatically suppresses cells that correspond to items or controls without data and duplicate data from ad hoc reports. You can configure this functionality using the automatic summarization settings for a report.

The Ad Hoc Reporting module includes data from deleted records by default. To indicate that a form, visit, or subject and so forth is deleted, add the **Is Deleted** report item from the Properties folder for the report item to the report. You can also choose not to display deleted records to create reports for current data only.

Note: Calculations are performed before cells are suppressed.

In the Ad Hoc Reporting module, for clinical data, the text **N/A** appears for the following:

- Items or controls that are not started.
- Items or controls that are blank; that is, data for the item or control has been cleared.
- Items or controls that are blinded for the user running the report.
- Items or controls that are marked as Unknown.

Internal IDs

About internal IDs

Each clinical topic contains an Internal IDs folder. These folders contain unique database identifiers for various study components.

Use the following internal IDs to enhance reports:

- **Subject ID**—Unique ID that identifies a subject when the Subject Number is not unique. The Subject ID is unique for each subject.
- **Form Index, Itemset Index, and Visit Index**—Use with repeating forms, items, and visits to report on status information for individual instances of repeating objects.

Note: Indexes are also known as *sequence numbers*.

Use internal IDs when you need to identify unique instances of clinical data when there are no other elements containing unique data values.

For example, if the subject numbers in a study are not unique, to uniquely identify a subject in a report, you can use the SUBJECTID element from the Internal IDs folder.

Note: Because internal IDs access database indexes directly, they can improve the efficiency of reports that you create with the Report Studio application. Knowledge of database principles and the Reporting and Analysis database schema is recommended.

Internal IDs in the Clinical Data by Form folder

In the Clinical Data by Form folder, the content of the Internal IDs folder is the same for each report topic. Using the unique identifiers, you can focus a report on specific:

- Subjects
- Sites
- Study versions
- Visits
- Forms

Note: If your study does not enforce unique subject numbers, site mnemonics, or visit mnemonics, you can use the SUBJECTID, SITEID, or VISITID to uniquely identify a subject, site, or visit in a report.

Internal IDs in the Trial Management data model

In the Trial Management data model, the content of the Internal IDs folder depends on the level of nesting for a report element. The more nested an element is, the more internal IDs are available.

For example, the Internal IDs folder for the Subjects report topic focuses primarily on subject identifiers (primary keys), whereas the Visits Internal IDs folder contains unique identifiers for both

visits (primary keys) and subjects (secondary keys).

Calculations and conversion rules

About calculations and conversion rules

Some studies use calculations and conversions. Calculations and conversions set the value of data items by performing calculations that use the value in one or more related items. You can perform calculations such as:

- Aging on date time data.
- Concatenations and other string manipulation.
- Arithmetic and analytical operations on numeric data.

Note: You cannot edit a calculation. To modify a calculation, you must delete the calculated report element and recalculate it.

Calculations on date time elements

The Calculate page for date time elements allows you to perform the following operations.

Operation	Description
- (difference)	The difference between the date in the report and another specified date.
- (difference in days)	The number of days between the date in the report and another specified date.
- (difference in months)	The number of months between the date in the report and another specified date.
- (difference in years)	The number of years between the date in the report and another specified date.
Add days	Specify the number of days to add to a date.
Add months	Specify the number of months to add to a date.
Add years	Specify the number of years to add to a date.
Earliest	Determine the earliest date between the date in the report and another specified date.
Latest	Determine the latest date between the date in the report and another specified date.
Year	Extract the year value from a date.
Month (number)	Extract the month value from a date.
Week	Extract the week value from a date.
Day	Extract the day value from a date.
Hour	Extract the hour value from a date.

Operation	Description
Minute	Extract the minute value from a date.
Second	Extract the seconds value from a date.

Creating a calculation

- 1 On the report palette, click a column heading.
- 2 Optionally, select additional column headings by clicking them while holding down the Shift key.
- 3 Do one of the following:
 - From the Edit Data menu, click **Calculate**.
 - From the toolbar, click the **Calculate** () button.
 - Right-click a highlighted column heading, and select **Calculate**.
- 4 Complete the Calculate page:
 - a Select the operations.
 - b Select from other calculation parameters.
 - c Optionally, apply a new item name to the calculation.
- 5 To add the calculation to the ad hoc report, click **Insert**.

Note: When you select more than one column upon which to base a calculation, you can only select columns that contain the same type of data (numeric, string, date/time).

Dates with unknown date parts

If a date field allows unknown (UNK) values for a complete date, the InForm application stores the following date values:

- For a complete date:
 - A date/time column.
 - A date string column.
 - A month column.
 - A day column.
 - A year column.
- If there is at least one unknown value, the InForm application stores the date values in a date string column only.

Calculations on string elements

The Calculate page for string elements enables operations on text and alphanumeric values.

Operation	Description
First characters	Specify the number of left-most characters to display in the report column.
Last characters	Specify the number of right-most characters to display in the report column.
Concatenation	Specify how to join single or multiple report values together including: <ul style="list-style-type: none"> • Preceding text. • Following text. • Separator between report elements.
Remove trailing spaces	Delete the blank characters at the end (right) of a string value.

Calculations on numeric elements

The Calculate page for numeric elements allows arithmetic and other analysis operations.

Operation type	Operations
Arithmetic	+ (sum) - (difference) * (multiplication) / (division) ^ (power) Absolute value Round Round down Square root
Percentage	% % of total % difference (growth)

Operation type	Operations
Analytic	Average
	Maximum
	Minimum
	Rank
	% of total
	Percentile
	Quartile
	Quintile

Calculating business days versus number of days

The - (difference in days) operation determines the total number of days between the date value in the report element and another specified date.

To calculate the number of business days between two date values:

- 1 Create a - (difference in days) calculation.
- 2 From the original calculation, create a new calculation (product) that multiplies the difference calculation by .7142857142857 (this represents 5/7).
- 3 From the product calculation, create a new calculation that adds .5 to the product.
- 4 From the addition calculation, create a new calculation that rounds the result.
- 5 Delete the difference, product, and addition calculations from the report.

Crosstab reports

About crosstab reports

Crosstab reports show summary information in a two-dimensional grid. Using crosstab reports, you can display large amounts of tabular data.



A crosstab report must contain at least three reporting elements.

- A non-aggregate report element that provides distinct categories of values that become row labels.
- A non-aggregate report element that provides distinct categories of values that become column labels.
- A measure (aggregate) report element that provides numeric values upon which to produce summaries.

Crosstab development tools

Use Change Layout options to:

- Create a new crosstab report.
- Convert a list report to a crosstab report.
- Convert a crosstab report back to a list report.
- Switch the column and row headers in a crosstab report.

Option	Description
 Pivot	Converts a list report to a crosstab report.
 Ungroup	Reverts to a list report, showing all values in a column, including duplicates.
 Swap Rows and Columns	Interchanges rows and columns in a crosstab report, a chart based on a crosstab report, or both.

Charts

About charts

Charts show summary information graphically. Charts consist of at least two reporting elements:

- A non-aggregate report element that provides distinct categories of values.
- A measure (aggregate) report element that provides numeric values upon which to produce summaries.



Note: You can have up to two non-aggregate report elements and any number of measures in a chart.

For more information, see the Cognos documentation.

Chart development tools

Using Change Layout tools, you can:

- Create a new chart report.
- Convert a list report to a chart report.
- Convert a crosstab report to a chart report.
- Convert a chart report back to a list report.
- Switch the category values to change the focus of a chart.

Option	Description
Change layout menu or toolbar buttons	
 Chart	Converts a list or crosstab report to a chart report.
 Ungroup	Reverts to a list report, showing all values in a column including duplicates.
 Swap Rows and Columns	Changes the focus of the chart by interchanging category values in a chart that is based on a crosstab report.
Chart page	
Chart type	Choose from: <ul style="list-style-type: none"> • Seven available chart types (such as column and pie). • Four configuration options (such as standard and stacked).
Show the values on the chart	Includes the actual summary values in the chart.

Option	Description
Show the following in the report	Choose: <ul style="list-style-type: none"><li data-bbox="756 260 1422 323">• Chart and table—Displays both the chart and the list report upon which it is based.<li data-bbox="756 344 1357 382">• Chart only—Includes only the graphical display.

Note: You can use the Ungroup button only if you opted to display the table (crosstab report) along with the chart.

Custom groups

About custom groups

The Define Custom Groups selection in the Edit Data menu produces new report elements that contain groups of report values.

You can organize the data in a report using custom groups that create new report elements based on the values in a column. For example:

- Categorize a list of numeric results. For example, you can display the number of new, recent, and old queries.
- Divide the number of values into smaller sets. For example, you can organize a list of sites by region.

Customization type	Description	Numeric	Date Time	String
Ranges of values	Identify the ranges of values that constitute value groups.	X	X	X
Individual values	Identify the lists of specific values that constitute value groups.			X

Defining a custom group

- 1 On the report palette, click a column heading.
- 2 Select **Edit Data > Define Custom Groups**.
- 3 Complete the Define Custom Groups page:
 - a Select the customization type: Ranges (for any data type) or Individual values (for string data only).
 - b Identify the group categories using the Create range template (ranges) or the New group template (individual values).
 - c Optionally, apply a new item name to the custom group.
- 4 Click **OK**.

Custom groups on date time elements

The Define Custom Groups page for date time elements enables custom groups on ranges of values.

Customization type	Parameters	Description
Ranges	Ranges (in sequential order)	The name of the value ranges that you define.

Customization type	Parameters	Description
	Create range: <ul style="list-style-type: none"> • New range name • From • Earliest Date • To • Latest Date 	A template that you complete to define a value range.
	Item Name	An optional name that you can give to the custom group. Default value: column name followed by (custom) .

Custom groups on numeric elements

The Define Custom Groups page for numeric elements enables custom groups on ranges of values.

Customization type	Parameters	Description
Ranges	Ranges (in sequential order)	The name of the value ranges that you define.
	Create range: <ul style="list-style-type: none"> • New range name • From • Lowest Value • To • Highest Value 	A template that you complete to define a value range.
	Item Name	An optional name that you can give to the custom group. Default value: column name followed by (custom) .

Custom groups on string elements

The Define Custom Groups page for string elements enables custom groups on:

Customization type	Parameters	Description
Ranges	Ranges (in sequential order)	The name of the value ranges that you define.

Customization type	Parameters	Description
	Create range: <ul style="list-style-type: none"> • New range name • From • Lowest Value • To • Highest Value 	A template that you complete to define a value range.
	New Item Name	An optional name that you can give to the custom group. Default value: column name followed by (custom) .
Individual Values	New Group Name: <ul style="list-style-type: none"> • Custom Group • Custom Group Values • Available Values 	A template that you complete to define a value group.
	New Item Name	An optional name that you can give to the custom group. Default value: column name followed by (custom) .

Reporting on study management data

Study management report elements

Every InForm study includes the Trial Management data model. Because the Trial Management data model is standard in all InForm studies, you can create reports from this data model and reuse them in other studies. The data model contains:

- Report elements that provide study metrics.
- Predefined filters that allow you to limit the data in a report.

Study management data includes the following topics or report elements:

Report elements	Description
Study info	Provide information about the study, the study sponsor, and study version in your reports. Note: If an optional item is left blank in the InForm application, data does not appear in reports that contain the report element for that item.
Sites	Provide identifying and descriptive data for all sites in a given study.
Subjects	Provide metrics and status information about subjects during the course of the study. The elements and measures in this report topic return study management data. You can use these elements and measures to access such data as current status, status dates, and counts.
Visits	Allow you to create reports on visit properties, status, and dates. All visit types are included in general visit counts for ad hoc reports. To limit your reports to clinical visit counts only, use a predefined filter.
Forms	Provide metrics and status information about forms in your study. Use this report topic to include: <ul style="list-style-type: none"> • Counts of different form types. • Information about form properties and states. • Information on when forms were initially created and changed.
Sections	Allow you to report on form sections in a study design.
Items	Provide metrics and status information about items on forms in the study. Use this report topic to include counts of different item types, information about item properties, and information on when items were initially created and changed.
Rules	Provide information about rule types and the number of times rules have been triggered.
Queries	Display query text and type, to gather counts on manual and automatic queries, and to see query status.
Comments	Allow you to report on both item-level and form-level comments.

Report elements	Description
User Info	Allow you to gather information on your InForm users.
	Note: If an optional item is left blank in the InForm application, data does not appear in reports that contain the report element for that item.

InForm Trial Management reporting tree

The study management portion of the Ad Hoc Reporting tree contains report topics and elements related to non-clinical data such as subject numbers, visit and form mnemonics, query text, itemset indexes, comments, and so on.

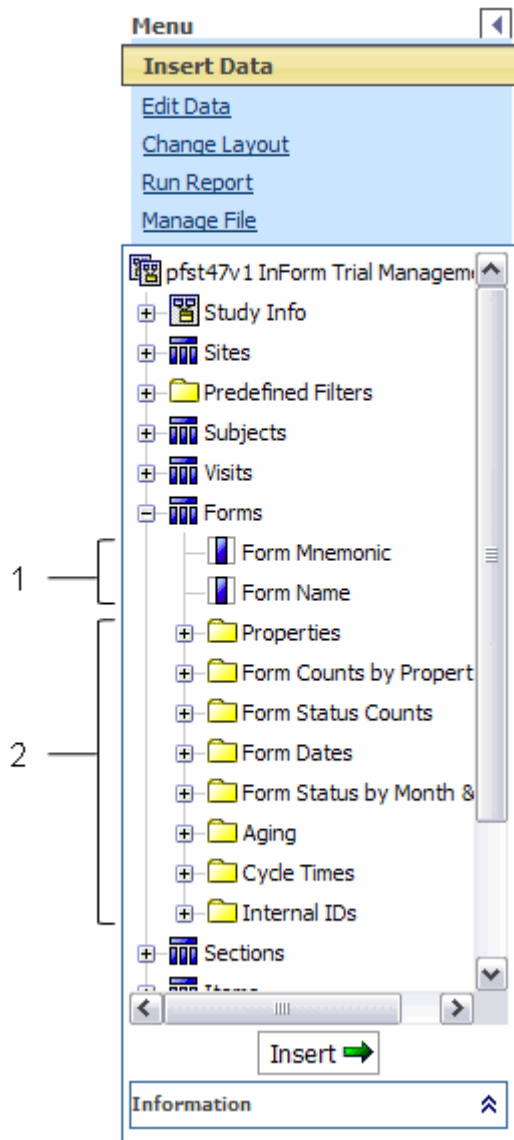

- **1**—Study management report elements used to organize data, and indicate where in the study the data comes from. For example, use the Form Name property to develop a report that displays the number of queries that exist on each form in the study.
- **2**—Study management data that is used to track study progress. For example, use the report elements in the Form Status Counts folder to determine the number of forms in the Completed state for your study.

Element descriptions

The description of each element in this document might include the following:

- **Data displayed**—The type of data that is returned in the report. Possible values are:
 - Numeric
 - String (text)
 - Date/Time
 - Y/N
- **Description**—A brief description of the element.
- **How calculated**—Information about how data is calculated. (Included only for counts.)
- **Data source**—A description of where the data came from.

Data source	Description
Replicated from the InForm Transactional database to the Reporting and Analysis database (not a derived value).	This data resides in both the InForm Transactional database and in the Reporting and Analysis database.
Replicated from the InForm Transactional database to the Reporting and Analysis database. Database value has been decoded for display.	This data resides in both the InForm Transactional database and in the Reporting and Analysis database. The value has been derived for display. For example, a Y/N value that displays in a report may be stored as a 0/1 value in the database.
Derived by the Ad Hoc Reporting workspace. Not stored in the Reporting and Analysis database.	This data is derived when you run a report. The data does not appear in any InForm database.
Derived and stored in the Reporting and Analysis database.	This data is derived by the Ad Hoc Reporting workspace and resides only in the Reporting and Analysis database.

- **Date type**—A description of the type of date displayed. (Included only for dates.)

Date type	Description
-----------	-------------

Date type	Description
System date (GMT).	A date recorded by the InForm application at data entry. All Oracle production servers are set to GMT time.
System date and time (GMT).	A date and time recorded by the InForm application at data entry.
System date (GMT), derived for display.	A date recorded by the InForm application, but derived for display. For example, the Form Status by Month, Year report element returns only the Month and Year portion of the date.
Reporting and Analysis database system date and time.	A system date on the Reporting and Analysis database server.
Clinical.	A date entered by an InForm user in local time.
Specified in study design code.	A date specified in the study MedML.
May be specified in study design code. If not, this is a system date.	A date that may be specified in the study MedML. If it is not, the date is a date recorded by the InForm application at data entry.

- **Example**—An example to help illustrate a calculation or concept.

For more information, see *Reporting on study management data* (on page 61).

Study Info report elements

Use the Study Info report elements to include information about the study, the study sponsor, and study version in your reports.

Note: If an optional item is left blank in the InForm application, data does not appear in reports that contain the report element for that item.

Study Info: Sponsor

Study Info: Sponsor report elements let you report on specifics about the sponsor of the study.

Report element	Description
Sponsor Name	<p>Data type: String</p> <p>Description: The name of the sponsor of the study.</p> <p>Data source: Replicated from the InForm transactional database to the Reporting and Analysis database.</p>

Report element	Description
Note	<p>Data type: String</p> <p>Description: An optional description of the study, as specified in the study design code.</p> <p>Data source: Replicated from the InForm transactional database to the Reporting and Analysis database.</p>
Address 1	<p>Data type: String</p> <p>Description: The text stored in the Address 1 line for the study sponsor.</p> <p>Data source: Replicated from the InForm transactional database to the Reporting and Analysis database.</p>
Address 2	<p>Data type: String</p> <p>Description: The text stored in the Address 2 line for the sponsor.</p> <p>Data source: Replicated from the InForm transactional database to the Reporting and Analysis database.</p>
City	<p>Data type: String</p> <p>Description: The city in which the study sponsor is located.</p> <p>Data source: Replicated from the InForm transactional database to the Reporting and Analysis database.</p>
State/Province	<p>Data type: String</p> <p>Description: The state or province in which the study sponsor is located.</p> <p>Data source: Replicated from the InForm transactional database to the Reporting and Analysis database.</p>
Country	<p>Data type: String</p> <p>Description: The country in which the study sponsor is located.</p> <p>Data source: Replicated from the InForm transactional database to the Reporting and Analysis database.</p>
Postal Code	<p>Data type: String</p> <p>Description: The postal code for the sponsor location.</p> <p>Data source: Replicated from the InForm transactional database to the Reporting and Analysis database.</p>
Phone	<p>Data type: String</p> <p>Description: The primary telephone number for the sponsor.</p> <p>Data source: Replicated from the InForm transactional database to the Reporting and Analysis database.</p>

Report element	Description
Alt Phone	<p>Data type: String</p> <p>Description: The secondary telephone number for the sponsor.</p> <p>Data source: Replicated from the InForm transactional database to the Reporting and Analysis database.</p>
Fax	<p>Data type: String</p> <p>Description: The fax number for the sponsor.</p> <p>Data source: Replicated from the InForm transactional database to the Reporting and Analysis database.</p>
Email	<p>Data type: String</p> <p>Description: An email address specified by the sponsor for a primary contact related to the study.</p> <p>Data source: Replicated from the InForm transactional database to the Reporting and Analysis database.</p>
Therapeutic Area	<p>Data type: String</p> <p>Description: The medical area being investigated by the study. Use of the Therapeutic Area field varies from sponsor to sponsor.</p> <p>Data source: Replicated from the InForm transactional database to the Reporting and Analysis database.</p>
Program Name	<p>Data type: String</p> <p>Description: The name of the medical program into which the study can be categorized. Program names might be medical areas such as Oncology, Dermatology, and so forth. Use of the Program name field varies from sponsor to sponsor.</p> <p>Data source: Replicated from the InForm transactional database to the Reporting and Analysis database.</p>

Study Info: Study

Study Info: Study report elements report on specifics of the study.

Report element	Description
Study Name	<p>Data type: String</p> <p>Description: The name associated with the study, as specified in the study design code.</p> <p>Data source: Replicated from the InForm transactional database to the Reporting and Analysis database.</p>

Report element	Description
Trade Drug/Device Name	<p>Data type: String</p> <p>Description: The proprietary, trademark-protected name under which the drug, device, biologic, or compound is being marketed. This name is specified in the study design code.</p> <p>Data source: Replicated from the InForm transactional database to the Reporting and Analysis database.</p>
Generic Drug/Device Name	<p>Data type: String</p> <p>Description: The name used for the generic, therapeutic equivalent of the brand-name drug, device, biologic, or compound (if any). This name is specified in the study design code.</p> <p>Data source: Replicated from the InForm transactional database to the Reporting and Analysis database.</p>
Sponsor Drug/Device Name	<p>Data type: String</p> <p>Description: The name the sponsor uses to refer to the drug, device, biologic, or compound being studied. This name is specified in the study design code.</p> <p>Data source: Replicated from the InForm transactional database to the Reporting and Analysis database.</p>
Refresh Time	<p>Data type: Date/Time</p> <p>Description: The last date and time the reporting data was refreshed. This time reflects the last time data was refreshed in the Reporting and Analysis database, regardless of whether data was changed.</p> <p>Date type: Reporting and Analysis database system date and time.</p>
Transaction Time	<p>Data type: Date/Time</p> <p>Description: The most current InForm transaction time.</p> <p>Date type: System date and time (GMT).</p>

Study Info: Study Versions

Study Info: Study Versions reporting elements allow you to report on data about the particular study versions.

Report element	Description
Version	<p>Data type: String</p> <p>Description: The name that is associated with a given study version, as specified in the study design code. This report element returns all study versions.</p> <p>Data source: Replicated from the InForm transactional database to the Reporting and Analysis database.</p>

Report element	Description
Version Date	<p>Data type: Date/Time</p> <p>Description: The date the study version was defined for the study.</p> <p>Date type: May be specified in study design code. If not, this is a system date.</p>
Description	<p>Data type: String</p> <p>Description: Text that describes what has changed in the study version. Study version description text is unique to each study version. Often, this field is used to reflect the iteration of a particular study. For example, a 2 in this field may indicate that the study version is the second revision.</p> <p>Data source: Replicated from the InForm transactional database to the Reporting and Analysis database.</p>
Design Note	<p>Data type: String</p> <p>Description: Optional notes for the study version entered in the study design code.</p> <p>Data source: Replicated from the InForm transactional database to the Reporting and Analysis database.</p>
Sponsor Approval Date	<p>Data type: Date/Time</p> <p>Description: The projected date on which the sponsor approved the InForm study version. This date is set by the study designer. It does not necessarily reflect the actual date the study version goes live.</p> <p>Date type: Specified in study design code.</p>

Sites report elements

Site report elements and measures allow you to create reports that provide identifying and descriptive data for all sites in a given study. Use the Sites report topic when you want to see information broken out by each site participating in the study.

Sites

Note: If an optional item is left blank in the InForm application, data does not appear in reports that contain the report element for that item.

Report element	Description
Site Name	<p>Data type: String</p> <p>Description: The name of the site, as entered in the InForm Administration interface.</p> <p>Data source: Replicated from the InForm transactional database to the Reporting and Analysis database.</p>

Report element	Description
Site Mnemonic	<p>Data type: String</p> <p>Description: An abbreviation that identifies a site, as entered in the InForm Administration interface.</p> <p>Data source: Replicated from the InForm transactional database to the Reporting and Analysis database.</p>
Address 1	<p>Data type: String</p> <p>Description: First line of the site address, as entered in the InForm Administration interface.</p> <p>Data source: Replicated from the InForm transactional database to the Reporting and Analysis database.</p>
Address 2	<p>Data type: String</p> <p>Description: Second line of the site address, as entered in the InForm Administration interface.</p> <p>Data source: Replicated from the InForm transactional database to the Reporting and Analysis database.</p>
City	<p>Data type: String</p> <p>Description: The city in which a site is located, as entered in the InForm Administration interface.</p> <p>Data source: Replicated from the InForm transactional database to the Reporting and Analysis database.</p>
State/Province	<p>Data type: String</p> <p>Description: The state or province in which the site is located, as entered in the InForm Administration interface.</p> <p>Data source: Replicated from the InForm transactional database to the Reporting and Analysis database.</p>
Country	<p>Data type: String</p> <p>Description: The country in which a site is located, as entered in the InForm Administration interface.</p> <p>Data source: Replicated from the InForm transactional database to the Reporting and Analysis database.</p>
Postal Code	<p>Data type: String</p> <p>Description: The postal code for the site address, as entered in the InForm Administration interface.</p> <p>Data source: Replicated from the InForm transactional database to the Reporting and Analysis database.</p>

Report element	Description
Phone	<p>Data type: String</p> <p>Description: The primary telephone number for the study site, as entered in the InForm Administration interface.</p> <p>Data source: Replicated from the InForm transactional database to the Reporting and Analysis database.</p>
Alt Phone	<p>Data type: String</p> <p>Description: The site secondary telephone number, as entered in the InForm Administration interface.</p> <p>Data source: Replicated from the InForm transactional database to the Reporting and Analysis database.</p>
Fax	<p>Data type: String</p> <p>Description: The fax number for a study site, as entered in the InForm Administration interface.</p> <p>Data source: Replicated from the InForm transactional database to the Reporting and Analysis database.</p>
Email	<p>Data type: String</p> <p>Description: The email address for a site contact, as entered in the InForm Administration interface.</p> <p>Data source: Replicated from the InForm transactional database to the Reporting and Analysis database.</p>
Time Zone	<p>Data type: String</p> <p>Description: The time zone in which a study site is located, as entered in the InForm Administration interface.</p> <p>Data source: Replicated from the InForm transactional database to the Reporting and Analysis database.</p>
Date Format	<p>Data type: Numeric</p> <p>Description: The format used for all references to dates for the site. Valid values are:</p> <ul style="list-style-type: none"> • 1—Day/Month/Year • 2—Year/Month/Day • 3—Month/Day/Year <p>Data source: Replicated from the InForm transactional database to the Reporting and Analysis database.</p>

Report element	Description
Site Activation Date	<p>Data type: Date/Time</p> <p>Description: The projected date for the activation of the study by the site. It does not necessarily reflect the actual date on which the activation occurs.</p> <p>Date type: May be specified in study design code. If not, this is a system date.</p>
Current Study Version	<p>Data type: String</p> <p>Description: Displays a description of the most current study version, as specified in the study design code. Many study designers use this field to indicate study version iteration. For example, 2 indicates the second version of the study. The value may also be a text description for the study version.</p> <p>Data source: Replicated from the InForm transactional database to the Reporting and Analysis database.</p>
Current Site Acceptance Date	<p>Data type: Date/Time</p> <p>Description: The date on which the site was assigned to the current study version.</p> <p>Date type: May be specified in study design code. If not, this is a system date. The date that appears here depends on how the site was associated with the current study version:</p> <ul style="list-style-type: none"> • If the site was associated with the study version through the InForm Administration interface, the Current Site Acceptance Date is the system date when the association took place. • If the site was associated with the study version through the MedML Installer utility, the Current Site Acceptance Date is the date specified in the MedML for the new study version.

Subject report elements

Subject report elements and measures allow you to create reports that provide metrics and status information about subjects during the course of the study.

Note: The elements and measures in this report topic return study management data. You can use these elements and measures to access such data as current status, status dates, and counts. These elements and measures do not provide any clinical information about a subject. You can create reports that contain clinical data about subjects only if you have access to both study management and clinical items and measures in your reporting package.

Subjects

Subjects report elements return identifying information about the subject. This report element also includes a count item, which allows you to see totals for subjects, regardless of status.

Report element	Description
Subject Number	<p>Data type: String</p> <p>Description: The number that identifies the subject. This number can also be changed post-enrollment, if configured in the study.</p> <p>Note: Subject number might not be unique at your site.</p> <p>Data source: Replicated from the InForm transactional database to the Reporting and Analysis database.</p>
Subject Initials	<p>Data type: String</p> <p>Description: The initials of the subject enrolled in the study. These initials can be changed post-enrollment.</p> <p>Data source: Replicated from the InForm transactional database to the Reporting and Analysis database.</p>
Subject DOB (Screening)	<p>Data type: Date</p> <p>Description: The date of birth for the subject, as entered on the Screening form for the subject. The DOB field may or may not be used on the Screening form for your study.</p> <p>You cannot change this date after the subject is enrolled. You can change it after the Screening form is submitted, as long as the subject has not yet been enrolled.</p> <p>Many study designers also include a date of birth field for the subject on other clinical forms in the study to correct data entry errors that might have occurred when the subject was screened. Unlike the DOB field on the screening form, a DOB field on a clinical form can be changed at any time.</p> <p>As a result, a subject may have two different dates of birth recorded in the Reporting and Analysis database; one recorded on the Screening form, and one recorded on another clinical form in the study. These dates may or may not match.</p> <p>You can report on clinical DOB dates using report elements that appear in the Clinical Data by Form folder.</p> <p>Data type: Clinical</p>

Report element	Description
SV Selected	<p>Data type: Y/N</p> <p>Description: Indicates whether the subject is selected for source verification.</p> <ul style="list-style-type: none"> • Y—The subject is selected for source verification. All forms for this subject must be source verified. • N—The subject is not selected for source verification. Forms for this subject do not require source verification. <p>Data source: Replicated from the InForm transactional database to the Reporting and Analysis database.</p>

Subjects: Subject Status (text)

The elements in the Subjects: Subject Status (text) reporting topic allow you to create reports that describe subject status.

Note: The subject states listed here are states internal to the InForm application. They may or may not correlate with clinical state definition, since events like screening and randomization are often performed outside of the InForm application.

Report element	Description
----------------	-------------

Report element	Description
Subject Status	<p>Data type: String</p> <p>Description: The current InForm subject status. Subjects can be in only one state at a time in the InForm application. Valid values are:</p> <ul style="list-style-type: none"> • Screened—The Screening form for the subject was started, but the subject is not enrolled. • Screen Failed—The subject has failed the InForm screening process. • Enroll Failed—The subject has passed the InForm screening process, but failed the enrollment process. • Enrolled—The subject was properly enrolled in the InForm application, but has not reached the status of randomized, completed, or dropped out. • Randomized—The subject was enrolled and has been randomized in the InForm application, but is not yet completed or dropped out. • Complete—The subject has completed the study, as recorded in the Complete control of the Study Completion form for that subject. • Dropped out—The subject has dropped out of the study, as recorded in the Complete control of the Study Completion form for that subject. <p>Data source: Replicated from the InForm transactional database to the Reporting and Analysis database.</p>
Screen Failure Reason	<p>Data type: String</p> <p>Description: Text that indicates why the subject failed the screening process.</p> <p>Data source: Replicated from the InForm transactional database to the Reporting and Analysis database.</p>
Enroll Failure Reason	<p>Data type: String</p> <p>Description: Text that indicates why the subject failed enrollment.</p> <p>Data source: Replicated from the InForm transactional database to the Reporting and Analysis database.</p>
Enroll Override Reason	<p>Data type: String</p> <p>Description: Text that indicates why the screening or enrollment failure was overridden for the subject.</p> <p>Data source: Replicated from the InForm transactional database to the Reporting and Analysis database.</p>

Report element	Description
Drop Out Reason	<p>Data type: String</p> <p>Description: Text that indicates why the subject dropped out of the study. The dropout reason is clinical data that is specified on the Study Completion form for the subject.</p> <p>Note: This report displays only those reasons that were specified when a subject dropped out of the study. If a dropout reason was never used, the reason does not appear in this report.</p> <p>UUIDs: PF_SC_COMPLETECTL, PF_SC_REASONCTL_ <i>internal_reason_value</i></p> <p>Data source: Replicated from the InForm transactional database to the Reporting and Analysis database.</p>

Subjects: Subject Status Counts

The Subjects: Subject Status Counts folder contains reporting elements that calculate subject counts that are based on subject state. The listed subject states are internal to the InForm application. Whether these states correlate to actual clinical states depends on your use of InForm features.

A subject can be in only one state at a time in the InForm application. Therefore, if a subject is randomized after being enrolled in the InForm application, the current state for the subject is Randomized, not Enrolled.

However, when you create reports on subjects who are still actively participating in the study, you will likely need to see totals that reflect the number of subjects who have ever been enrolled in the study. For example, a count of enrolled subjects should include all subjects who have ever been enrolled in the InForm application, even if their status changed to Randomized, because in clinical terms, a subject who has been randomized is still considered enrolled. Therefore, these subject status counts return totals of subjects who have ever had these states:

- Screened
- Enrolled
- Enrolled Override
- Randomized

To report on subjects who are no longer active in the study, use the Screened Failed, Enrolled Failed, Dropped Out, and Complete subject status counts. Unlike the other subject status counts, these report elements return totals of those subjects currently in any of these states. Subjects will have Dropped Out and Complete status only if your study uses the Study Completion form.

Note: The status assigned to a subject depends on the InForm features you use to set the status. For instance, for a subject to have a randomized state, you must perform subject randomization through the InForm application. For more information, see *Subject status requirements* (on page 20).

You can use any of the predefined subject filters to further qualify the Subject Status Count totals.

Report element	Description
----------------	-------------

Report element	Description
Subject Count	<p>Data type: Numeric</p> <p>Description: The number of subjects who enrolled at the site.</p> <p>How calculated: For each site, counts subjects who enrolled at the site, including subjects who are currently assigned other states.</p> <p>Note: The Enrollment form, designed according to InForm specifications, must be completed for the subject.</p> <p>UUID: PF_SC_COMPLETECTL</p> <p>Data source: Status is determined by the value on the Enrollment form, which is stored in the Reporting and Analysis database. Status is set to 1 when the subject is enrolled.</p> <p>Note: You can use any of the predefined subject filters to further qualify this count.</p>
Screened	<p>Data type: Numeric</p> <p>Description: The number of subjects who have ever been in the Screened state in the InForm application.</p> <p>How calculated: Counts subjects who have ever been assigned a Screened status in the InForm application. This count includes subjects whose states have changed from Screened to a new state.</p> <p>Data source: Status is determined by the Screening form and stored in the Reporting and Analysis database. The status count is derived from the status and is set to 1 when the subject enters that status.</p> <p>Note: The Screening form must be completed for the subject for the report to display this information.</p>
Screen Failed	<p>Data type: Numeric</p> <p>Description: The number of subjects who have a current status of Screened Failed in the InForm application.</p> <p>How calculated: Counts subjects who were rejected by the InForm screening process, based on some screening eligibility requirement that was not met. Subjects can have a status of Screened Failed in the InForm application only if screening eligibility requirements are being used for your study.</p> <p>A subject is not counted if the screen failure was overridden for the subject.</p> <p>Data source: Status is determined by the Screening form and stored in the Reporting and Analysis database. The status count is derived from the status and is set to 1 when the subject enters that status.</p>

Report element	Description
Enrolled	<p>Data type: Numeric</p> <p>Description: The number of subjects who have ever been enrolled in the study through the InForm application.</p> <p>How calculated: Counts subjects whose Enrollment form was completed and successfully submitted. This count includes:</p> <ul style="list-style-type: none"> • Subjects whose states have changed from Enrolled to a new state. • All subjects who have ever been in the Enrolled state. • Subjects who have gone through the enrollment override process. <p>Data source: Status is determined by the value on the Enrollment form, which is stored in the Reporting and Analysis database. Status is set to 1 when the subject is enrolled.</p> <p>Note: The Enrollment form must be completed for the subject for the report to display this information.</p>
Enrolled Failed	<p>Data type: Numeric</p> <p>Description: The number of subjects who have a current status of Enrolled Failed in the InForm application.</p> <p>How calculated: Counts subjects whose Enrollment form was rejected by the InForm application, based on some eligibility requirement that was not met. This count includes subjects whose current states have changed from Enrolled Failed to a new state.</p> <p>A subject is not counted if the enroll failure was overridden for the subject.</p> <p>Subjects can have this status only if the enrollment eligibility requirements are being used in the InForm application for your study.</p> <p>Data source: Status is determined by the value on the Enrollment form, which is stored in the Reporting and Analysis database. Status is set to 1 when the subject is enrolled.</p> <p>Note: You can use any of the predefined subject filters to further qualify this count.</p>
Enrolled Override	<p>Data type: Numeric</p> <p>Description: The number of subjects who initially failed the InForm screening or enrollment process, but whose failure was overridden in the InForm application.</p> <p>How calculated: Counts subjects who were screened or enrolled successfully through the InForm Enrolled Override process. This count includes all subjects whose status has changed from Enrolled Override to a new status.</p> <p>Data source: Status is determined by the InForm Screening/Enrollment override process and stored in the Reporting and Analysis database. The status count is derived from the status and is set to 1 when the subject enters that status.</p>

Report element	Description
Randomized	<p>Data type: Numeric</p> <p>Description: The number of subjects in the study who have ever been randomized in the InForm application. Subjects have a status of Randomized immediately after they have been randomized with the InForm randomization feature.</p> <p>How calculated: Counts subjects who have ever been randomized in the InForm application. This count includes subjects whose status has changed from Randomized to a new status.</p> <p>If you randomize subjects outside of the InForm application, the randomized subject count will always be 0.</p> <p>Data source: Status is determined by the InForm Randomization feature and stored in the Reporting and Analysis database. The status count is derived from the status and is set to 1 when the subject enters that status.</p> <p>Note: The randomization process, as designed per InForm requirements, must be completed for the subject for the report to display this information.</p>
Dropped Out	<p>Data type: Numeric</p> <p>Description: The number of subjects who have a current status of Dropped Out.</p> <p>How calculated: Counts subjects who have dropped out of the study, as recorded in the Study Completion form for that subject.</p> <p>Data source: Replicated from the InForm transactional database to the Reporting and Analysis database.</p> <p>Note: The Study Completion form, as designed per InForm requirements, must be completed for the subject for the report to display this information.</p>
Subject Complete	<p>Data type: Numeric</p> <p>Description: The number of subjects who have a current status of Complete.</p> <p>How calculated: Counts subjects who have a current status of Complete, as recorded in the Study Completion form for that subject.</p> <p>Data source: Replicated from the InForm transactional database to the Reporting and Analysis database.</p> <p>Note: The Study Completion form, as designed per InForm requirements, must be completed for the subject for the report to display this information.</p>

Subjects: CRB Status Counts

The Subjects: CRB Status Counts return metrics on the number of case books in various states. CRB states are set at the case book level only. A CRB state is not set by actions performed on individual

forms within the case book.

Report element	Description
CRB Started	<p>Data type: Numeric</p> <p>Description: The number of started case books in the InForm application.</p> <p>How calculated: Counts case books that have a started noncommon form from the first visit in the case book; that is, with any entered data, queries, or comments on the form.</p> <p>Data source: Derived and stored in the Reporting and Analysis database.</p>
CRB SV Ready	<p>Data type: Numeric</p> <p>Description: The number of case books with a current status of SV ready.</p> <p>How calculated: Counts case books that have a current status of SV ready.</p> <p>Data source: Replicated from the InForm transactional database to the Reporting and Analysis database.</p>
CRB Frozen	<p>Data type: Numeric</p> <p>Description: The number of frozen case books.</p> <p>How calculated: Counts case books that have a current status of Frozen.</p> <p>Data source: Replicated from the InForm transactional database to the Reporting and Analysis database.</p>
CRB Signed	<p>Data type: Numeric</p> <p>Description: The number of case books that have been signed.</p> <p>How calculated: Counts case books that have a current status of Signed.</p> <p>Data source: Replicated from the InForm transactional database to the Reporting and Analysis database.</p>
CRB Locked	<p>Data type: Numeric</p> <p>Description: The number of locked case books.</p> <p>How calculated: Counts case books that have a current status of Locked.</p> <p>Data source: Replicated from the InForm transactional database to the Reporting and Analysis database.</p>

Report element	Description
CRB w/ Query	<p>Data type: Numeric</p> <p>Description: The number of the case books that have at least one opened or unanswered query.</p> <p>How calculated: Counts case books that have at least one form with at least one opened or answered query. Does not count case books that only have an associated query in the Candidate state.</p> <p>Data source: Derived and stored in the Reporting and Analysis database.</p>

Subjects: Subject Status Dates

The Subjects: Subject Status Dates report elements return dates when subjects were assigned to particular states in the InForm application.

Subjects may be set to some states more than one time. For these states, First and Last date report elements appear in the Ad Hoc Reporting tree. Use these report elements to identify when subjects are moved from one state to another, as follows:

- Use Last dates to determine the current status for a subject and the date on which the status change occurred.
- Use the First and Last dates together to identify subjects who were, but are no longer, in a given state.

Report element	Description
Subject Status Date	<p>Data type: Date/Time</p> <p>Description: The date on which the subject was assigned the current subject status. For example, if the current subject state is Complete, the Subject Status date indicates the date on which the subject status was set to Complete.</p> <p>Date type: System date (GMT).</p>
InForm Screened Date	<p>Data type: Date/Time</p> <p>Description: The date on which the subject was screened for the study in the InForm application. A Screened status indicates that the Screening form for the subject was started, but the subject is not yet enrolled. This covers these cases:</p> <ul style="list-style-type: none"> • The subject is fully screened, but the enrollment form has not been started. • The subject is fully screened and the enrollment process has started but not completed. <p>Data type: Clinical</p>

Report element	Description
InForm Enrolled Date	<p>Data type: Date/Time</p> <p>Description: The date on which the subject was enrolled in the InForm application. A status of enrolled indicates the subject was properly enrolled in the InForm application, but has not reached the status of randomized, completed, or dropped out.</p> <p>Date type: System date (GMT).</p>
InForm Screen Failure Date	<p>Data type: Date/Time</p> <p>Description: The date on which the subject failed the screening process.</p> <p>Date type: System date (GMT).</p>
InForm Randomized Date	<p>Data type: Date/Time</p> <p>Description: The date on which the subject was randomized through the InForm application. A status of randomized indicates that a subject was enrolled and randomized in the InForm application, but is not yet completed or dropped out.</p> <p>Note: If you perform randomization outside of the InForm application, the resulting report column does not contain randomization data.</p> <p>Date type: System date (GMT).</p>
First Dropped Date	<p>Data type: Date/Time</p> <p>Description: The date on which the subject first dropped out of the study, as recorded in the Study Completion form for that subject.</p> <p>Date type: System date (GMT).</p>
Last Dropped Date	<p>Data type: Date/Time</p> <p>Description: The date on which the subject most recently dropped out of the study, as recorded in the Study Completion form for that subject. If the subject is removed from the dropped out state, the resulting report column does not contain data.</p> <p>Date type: System date (GMT).</p>
Subject First Complete Date	<p>Data type: Date/Time</p> <p>Description: The first date on which the subject completed the study, as recorded in the Study Completion form as designed per InForm requirements.</p> <p>Date type: System date (GMT).</p>
Subject Last Complete Date	<p>Data type: Date/Time</p> <p>Description: The most recent date on which the subject completed the study, as recorded in the Study Completion form as designed per InForm requirements. If the subject is removed from the Complete state, the resulting report column is does not contain data.</p> <p>Date type: System date (GMT).</p>

Report element	Description
CRB SV Ready Date	<p>Data type: Date/Time</p> <p>Description: The date on which the case book was marked SV ready.</p> <p>Date type: System date (GMT).</p>
CRB Frozen Date	<p>Data type: Date/Time</p> <p>Description: The date on which the case book was frozen in the InForm application. If the CRB is unfrozen, the resulting report column does not contain data.</p> <p>Date type: System date (GMT).</p>
CRB Signed Date	<p>Data type: Date/Time</p> <p>Description: The date on which the case book was signed in the InForm application. If the CRB is not signed, the resulting report column does not contain data.</p> <p>Date type: System date (GMT).</p>
CRB Locked Date	<p>Data type: Date/Time</p> <p>Description: The date on which the case book was locked in the InForm application. If the CRB is not locked, the resulting report column does not contain data.</p> <p>Date type: System date (GMT).</p>

Subjects: Subject Status by Month and Year

The Subjects: Subject Status by Month and Year report elements let you create reports on subject status by month. Use these report elements with subject status counts to see the number of subjects who were assigned a particular status each month.

If the report is sorted by one of the Month/Year report elements. (You can apply a filter to specify a date range to one appropriate for your study.) You can then add the Subject Count element to see how many forms were assigned a particular status in each month.

Report element	Description
Subject Status Month, Year	<p>Data type: Date/Time</p> <p>Description: Each month/year combination from the start of the study to present day. Use this column with Subject Count to see the month and year each subject was assigned the current InForm status.</p> <p>Date type: System date (GMT), derived for display.</p>
Screened Month, Year	<p>Data type: Date/Time</p> <p>Description: Each month/year combination from the start of the study to present day. Use this column with Subject Count to see how many subjects were screened in the InForm application each month.</p> <p>Date type: System date (GMT), derived for display.</p>

Report element	Description
Enrolled Month, Year	<p>Data type: Date/Time</p> <p>Description: Each month/year combination from the start of the study to present day. Use this column with Subject Count to see how many subjects were enrolled each month.</p> <p>Date type: System date (GMT), derived for display.</p>
Randomized Month, Year	<p>Data type: Date/Time</p> <p>Description: Each month/year combination from the start of the study to present day. Use this column with Subject Count to see how many subjects were randomized in the InForm application each month.</p> <p>Date type: System date (GMT), derived for display.</p>
Subject Complete Month, Year	<p>Data type: Date/Time</p> <p>Description: Each month/year combination from the start of the study to present day. Use this column with Subject Count to see how many subjects were completed each month.</p> <p>Date type: System date (GMT), derived for display.</p>
Dropped Month, Year	<p>Data type: Date/Time</p> <p>Description: Each month/year combination from the start of the study to present day. Use this column with Subject Count to see how many subjects dropped out of the study each month.</p> <p>Date type: System date (GMT), derived for display.</p>

Visit report elements

Visit report elements allow you to create reports on visit properties, status, and dates.

Visit type	Description
Clinical visit types	
Subject Visit	A visit that contains clinical data within the case book for the subject.
Common Visit	An internal mechanism that contains common forms used in the study.
Non-clinical visit types	
Screening	The visit that contains the Screening form, which is used for InForm screening. Note that the Screening visit is not included in the case book for the subject.
Enrollment	The visit that contains the Enrollment form, which is used for InForm enrollment. Note that the Enrollment visit is not included in the case book for the subject.
Monitor (Reg Docs)	An internal mechanism that is used to record information about a review of the study documentation.

Visit type	Description
Monitor (Visit Report)	An internal mechanism that is used to record information about a visit to a site by a monitor.

All visit types are included in general visit counts for ad hoc reports. To limit your reports to clinical visit counts only, use a predefined filter. For more information, see *Predefined filters* (on page 146).

Visits

Visits report elements return identifying information about the visit.

Report element	Description
Visit Mnemonic	<p>Data type: String</p> <p>Description: An abbreviation of the visit title, as specified in the study design. For CRF visits, this title appears at the top of a collection of forms in the visit timeline and may not be a unique identifier.</p> <p>Data source: Replicated from the InForm transactional database to the Reporting and Analysis database.</p>
Visit Name	<p>Data type: String</p> <p>Description: The complete name that identifies the visit in the InForm application, as specified in study design code. The visit name is not a unique identifier.</p> <p>Data source: Replicated from the InForm transactional database to the Reporting and Analysis database.</p>

Visits: Visit Properties

Visits: Visit Properties report elements return information about the type of visit.

Report element	Description
----------------	-------------

Report element	Description
Visit Type	<p>Data type: String</p> <p>Description: The type of visit. Valid types are:</p> <ul style="list-style-type: none"> • Subject Visit—A visit used to gather clinical data within the case book for the subject. • Common Visit—An internal mechanism used to contain common forms used in the study. • Screening—The visit that contains the Screening form, used for InForm screening. The Screening visit is not included in the case book for the subject. • Enrollment—The visit that contains the Enrollment form, used for InForm enrollment. The Enrollment visit is not included in the case book for the subject. • Monitor (Reg Docs)—An internal mechanism used to record information about a review of the study documentation. • Monitor (Visit Report)—An internal mechanism used to record information about a visit to a site by a monitor. <p>Note: To report only on clinical data, filter this column to include only common and subject visits.</p> <p>Data source: Replicated from the InForm transactional database to the Reporting and Analysis database and decoded for display.</p>
Start Hours	<p>Data type: Numeric</p> <p>Description: Number of hours from the subject enrollment to the start of the visit. This number is specified in the study design code and is used to create the proposed schedule of visits shown in the Visit Calculator when a subject is enrolled.</p> <p>Data source: Replicated from the InForm transactional database to the Reporting and Analysis database.</p>
Is Scheduled Visit	<p>Data type: Y/N</p> <p>Description: Indicates whether the visit is a scheduled visit. Scheduled visits occur in a fixed relationship to the beginning of enrollment in a study by a subject. Scheduled visits start a specified number of hours after enrollment. Valid values are:</p> <ul style="list-style-type: none"> • Y—The visit is scheduled. • N—The visit is not a scheduled visit. <p>Data source: Replicated from the InForm transactional database to the Reporting and Analysis database and decoded for display.</p>

Report element	Description
Is Repeating Visit	<p>Data type: Y/N</p> <p>Description: Indicates whether the visit is a repeating visit. Repeating visits are those that occur multiple times within a study. Repeating visits are always unscheduled. Valid values are:</p> <ul style="list-style-type: none"> • Y—The visit is a repeating visit. • N—The visit is not a repeating visit. <p>Data source: Replicated from the InForm transactional database to the Reporting and Analysis database and decoded for display.</p>
Is Dynamic Visit	<p>Data type: Y/N</p> <p>Description: Indicates whether the visit is a dynamic visit. Dynamic visits are created automatically when subject data satisfies certain criteria that you test by attaching a rule to a form item. Valid values are:</p> <ul style="list-style-type: none"> • Y—The visit is dynamic. • N—The visit is not dynamic. <p>Data source: Replicated from the InForm transactional database to the Reporting and Analysis database and decoded for display.</p>
Dynamic Projected Start Hours	<p>Data type: Numeric</p> <p>Description: The number of hours after the study starts that this visit is scheduled to take place. This value is used for dynamic visit scheduling.</p> <p>Data source: Replicated from the InForm transactional database to the Reporting and Analysis database.</p>
Visit Order	<p>Data type: Numeric</p> <p>Description: A number that indicates the relative order of the visit within the study.</p> <p>Note: Use Visit Order to sort visits in a report. This is helpful when the visit order is not implied in the Visit Mnemonic or Visit Name.</p> <p>Data source: Replicated from the InForm transactional database to the Reporting and Analysis database.</p>
Design Note	<p>Data type: String</p> <p>Description: Optional text containing special information about the visit, specified in the study design code. This information is for documentation only and is not displayed in the InForm application.</p> <p>Data source: Replicated from the InForm transactional database to the Reporting and Analysis database.</p>

Visits: Visit Counts by Property

Visits: Visit Counts by Property report elements return totals of different types of visits.

Note: These visit counts are totals of all subject visits, regardless of visit type. To report on clinical visits only, use the Clinical Visits filter in the Predefined Filters folder.

Report element	Description
Scheduled Visit	<p>Data type: Numeric</p> <p>Description: The number of scheduled subject visits, regardless of visit type.</p> <p>How calculated: This calculation includes:</p> <ul style="list-style-type: none"> • All scheduled visits. • All started dynamic visits. • All started unscheduled visits. <p>Data source: Derived and stored in the Reporting and Analysis database.</p>
Repeating Visit	<p>Data type: Numeric</p> <p>Description: The number of started repeating (unscheduled) visits.</p> <p>How calculated: A visit is counted if it is repeating (unscheduled) and has been started.</p> <p>Data source: Derived and stored in the Reporting and Analysis database.</p>
Dynamic	<p>Data type: Numeric</p> <p>Description: The number of started dynamic visits.</p> <p>How calculated: A visit is counted if it is dynamic and has been started.</p> <p>Data source: Derived and stored in the Reporting and Analysis database.</p>

Visits: Visit Status Counts

Visits: Visit Status Count report elements return visit totals by their status. Visit states are derived from the state of each form within each visit. For example, a visit is considered completed only if all forms within the visit have a status of complete.

Note: Visit status does not correlate to status indicators on the InForm subject list.

Report element	Description
----------------	-------------

Report element	Description
Visit Count (Across subjects)	<p>Data type: Numeric</p> <p>Description: The total number of subject visits for the study.</p> <p>How calculated: Counts all subject visit instances, regardless of visit type or status. This count includes non-clinical visits. (You can apply a predefined filter if you want to limit visit counts to clinical visits only.)</p> <p>In addition to counting Visits that have expected forms (including activated dynamic visits), this count includes unscheduled visits.</p> <p>Data source: Derived and stored in the Reporting and Analysis database.</p>
Visit Started	<p>Data type: Numeric</p> <p>Description: The number of visits that have a non-common form that has been started in the InForm application.</p> <p>How calculated: A visit is counted as started if at least one non-common expected form in the visit has been started.</p> <p>Data source: Derived for the report; not stored in the Reporting and Analysis database.</p>
Visit Complete	<p>Data type: Numeric</p> <p>Description: The number of visits where each expected form has a current status of Complete.</p> <p>How calculated: Counts visits that have all expected forms marked Complete.</p> <p>Note: Visit status reported here differs from visit status indicated by the status icon in the InForm user interface.</p> <ul style="list-style-type: none"> • Visit complete in Ad Hoc Reporting—All expected forms must be complete for the visit to be considered complete. • Visit complete in the InForm user interface—At least one started form must be complete for the visit to be considered complete. <p>Data source: Derived and stored in the Reporting and Analysis database.</p>

Report element	Description
Visit Frozen	<p>Data type: Numeric</p> <p>Description: The number of visits where each expected form has a current status of Frozen.</p> <p>How calculated: Counts visits that have all expected forms marked Frozen.</p> <ul style="list-style-type: none"> • Visit complete in Ad Hoc Reporting—All expected forms must be frozen for the visit to be considered frozen. • Visit complete in the InForm user interface—At least one started form must be frozen for the visit to be considered frozen. <p>Data source: Derived and stored in the Reporting and Analysis database.</p>
Visit SV Complete	<p>Data type: Numeric</p> <p>Description: The number of visits where each expected form has been source verified in the InForm application.</p> <p>How calculated: Counts visits that have all expected forms marked SV complete.</p> <p>Note: Visit status reported here differs from visit status indicated in the InForm user interface.</p> <ul style="list-style-type: none"> • Visit Source Verified in Ad Hoc Reporting—All expected forms must be source verified for the visit to be considered source verified. • Visit Source Verified in the InForm user interface—At least one started form must be source verified for the visit to be considered source verified. <p>Data source: Derived and stored in the Reporting and Analysis database.</p>
Visit Locked	<p>Data type: Numeric</p> <p>Description: The number of visits where each expected form has a status of Locked.</p> <p>How calculated: Counts visits that have all expected forms marked Locked.</p> <p>Note: Visit status reported here differs from visit status indicated in the InForm user interface.</p> <ul style="list-style-type: none"> • Visit Locked in Ad Hoc Reporting—All expected forms must be locked for the visit to be considered locked. • Visit Locked in the InForm user interface—At least one expected form must be locked for the visit to be considered locked. <p>Data source: Derived and stored in the Reporting and Analysis database.</p>

Visits: Visit Dates

Visits: Visit Dates report elements return dates associated with visits.

Report element	Description
Scheduled Date	<p>Data type: Date</p> <p>Description: The date on which the visit is scheduled.</p> <p>How calculated: Calculates the date by adding the value in the Start Hour property for the visit to the enrollment date.</p> <p>Date type: System date (GMT), derived for display.</p>
Actual Date (DOV)	<p>Data type: Date</p> <p>Description: The date that is recorded in a standard Date of Visit control in the InForm application.</p> <p>Data type: Clinical</p> <p>Note: This report element assumes that your study was developed using a specific design for the DOV controls.</p> <p>UUIDs:</p> <ul style="list-style-type: none"> • DateTimeControl—BD991BC0-B0A4-11D2-80E3-00A0C9AF7674 • Item—BD991BBF-B0A4-11D2-80E3-00A0C9AF7674 <p>Section—BD991BBE-B0A4-11D2-80E3-00A0C9AF7674</p> <p>For more information, see <i>DOV controls</i> (on page 21).</p>
Data Entry Date	<p>Data type: Date</p> <p>Description: The date on which data was entered for the visit. This date is equal to the first date that any form is submitted for the visit.</p> <p>Date type: System date (GMT).</p>

Forms report elements

Forms report elements and measures allow you to create reports that provide metrics and status information about forms in your study. Use this report topic to include:

- Counts of different form types.
- Information about form properties and states.
- Information about custom review states and stages associated with forms.
- Information on when forms were initially created and changed.

Form elements and expected forms

Unless otherwise noted, all of the calculations and dates that the elements in the Forms report topic return are based on expected form counts.

A form is counted as expected if it meets any of the following criteria:

- It appears within a scheduled visit (regardless of whether the form is started).
- It appears within a started unscheduled visit.
- It is a dynamic form that has been activated.

Note: Non-started common forms are not counted as expected.

Expected forms are counted for subjects in the following states:

- Enrolled
- Randomized
- Complete
- Dropped-out

Note: For subjects that have completed or dropped-out (as indicated by the Study Completion form), only forms in started visits or dynamic started forms are counted.

The expected forms calculation assumes the following:

Only CRFs are counted. Other special CRFs (such as screening and enrollment) are not included.

- **Alternate forms**—One form in each visit is counted.
- **Common forms**—A common form is counted only once for the study, regardless of the number of visits in which it occurs.
 - For enrolled or randomized subjects, common forms are considered expected.
 - For complete or dropped-out subjects, only started common forms are considered expected.

- **Common dynamic forms**—Each activated or started instance is counted once.
- **Common dynamic repeating forms**—Each activated or started instance is counted once.
- **Common repeating forms**—Each instance is counted once.
- **Dynamic forms**—One activated dynamic form is counted for each visit in which it exists. Deleted (removed) form instances are not counted as expected.
- **Dynamic repeating forms**—Each activated or started instance is counted once.
- **Regular forms**—One form is counted for each visit.
- **Repeating forms**—For repeating forms that have not been started, one instance of the form is counted as expected. For repeating forms that have been started, each started instance counts as expected. Deleted (removed) form instances are not counted as expected.

Only subject visits and common visits are counted. Other special visits (such as screening/enrollment or monitor) are not included.

- **Started visits (scheduled and unscheduled)**
 - Regular and repeating forms are counted as expected.
 - All activated dynamic forms are counted as expected.
 - All alternate forms are counted as expected.
- **Unstarted scheduled visits**
 - For enrolled or randomized subjects:
 - Regular and repeating forms are counted as expected.
 - All activated dynamic forms are counted as expected.
 - Started alternate forms are counted as expected.
 - For complete or dropped-out subjects:
 - No forms are counted as expected.
- **Unstarted unscheduled visits**
 - No forms are counted as expected.

Forms

Form report elements return identifying information about forms.

Report element	Description
Form Mnemonic	<p>Data type: String</p> <p>Description: A short name or abbreviation for the form, as specified in the study design code. This name appears in the Visit ruler and along the left side of certain pages for use with the form selectors, and is used to access a specific form in the InForm application.</p> <p>Data source: Replicated from the InForm transactional database to the Reporting and Analysis database.</p>

Report element	Description
Form Name	<p>Data type: String</p> <p>Description: The complete name that identifies the form in the InForm application.</p> <p>Data source: Replicated from the InForm transactional database to the Reporting and Analysis database.</p>
SV Selected	<p>Data type: Y/N</p> <p>Description: Indicates whether the form is selected for source verification.</p> <ul style="list-style-type: none"> • Y—The form is selected for source verification. • N—The form is not selected for source verification. <p>A form has been selected for source verification if one of the following is true:</p> <ul style="list-style-type: none"> • The form contains one or more critical items. • The form is on the Critical Forms list. • The subject with which the form is associated is in the SV Pool. • The subject with which the form is associated is not in the SV Pool, but an item on the form is marked critical for that subject. <p>Data source: Replicated from the InForm transactional database to the Reporting and Analysis database.</p>

Forms: Properties

Forms: Properties report elements return information about the properties associated with forms.

Report element	Description
Form Type	<p>Data type: String</p> <p>Description: Displays the type of form. Valid values are:</p> <ul style="list-style-type: none"> • CRF—Identifies a form that is used in a clinical subject visit. • Enrollment—Identifies forms that are used in Screening and Enrollment visits. • Monitor RegDoc—Identifies forms that are used in Regulatory Documentation visits. • Monitor Visit Report—Identifies forms that are used for Visit Reports. <p>Use the predefined form filters with this element to limit the data on your report to a particular form type.</p> <p>Data source: Derived for the report; not stored in the Reporting and Analysis database. Value decoded for display.</p>

Report element	Description
Is Dynamic	<p>Data type: Y/N</p> <p>Description: Specifies whether the form is dynamic. Valid values are:</p> <ul style="list-style-type: none"> • Y—The form is dynamic. • N—The form is not dynamic. <p>Data source: Replicated from the InForm transactional database to the Reporting and Analysis database and decoded for display.</p>
Is Repeating	<p>Data type: Y/N</p> <p>Description: Specifies whether the form is a repeating form. Valid values are:</p> <ul style="list-style-type: none"> • Y—The form is a repeating form. • N—The form is not a repeating form. <p>A repeating form occurs multiple times in the same visit or study. For example, if a protocol calls for multiple blood draws at intervals after administering a medication, you can capture the repeating data on multiple instances of a repeating form.</p> <p>Data source: Replicated from the InForm transactional database to the Reporting and Analysis database and decoded for display.</p>
Is Common	<p>Data type: Y/N</p> <p>Description: Specifies whether the form is a common form. Valid values are:</p> <ul style="list-style-type: none"> • Y—The form is a common form. • N—The form is not a common form. <p>Data source: Replicated from the InForm transactional database to the Reporting and Analysis database and decoded for display.</p>
Is Alternate Form	<p>Data type: Y/N</p> <p>Description: Specifies whether the form is an alternate form. Valid values are:</p> <ul style="list-style-type: none"> • Y—The form is an alternate form. • N—The form is not an alternate form. <p>Data source: Replicated from the InForm transactional database to the Reporting and Analysis database and decoded for display.</p>

Report element	Description
Contains SV Required Items	<p>Data type: Y/N</p> <p>Description: Specifies whether the form contains items that require Source Verification.</p> <ul style="list-style-type: none"> • Y—The form contains SV Required items. • N—The form does not contain SV Required items. <p>An item is considered SV Required only if it is marked SV Required.</p> <p>Data source: Replicated from the InForm transactional database to the Reporting and Analysis database and decoded for display.</p>
Contains Required Items	<p>Data type: Y/N</p> <p>Description: Specifies whether the form contains items that require data entry for the form to be complete. Valid values are:</p> <ul style="list-style-type: none"> • Y—The form contains required items. • N—The form does not contain required items. <p>Data source: Replicated from the InForm transactional database to the Reporting and Analysis database and decoded for display.</p>
Form Order	<p>Data type: Numeric</p> <p>Description: An ordinal that specifies the position of the form within the visit. For example, 3 indicates that the form is the third form in the visit.</p> <p>Data source: Replicated from the InForm transactional database to the Reporting and Analysis database and decoded for display.</p>
Design Note	<p>Data type: String</p> <p>Description: Optional text, as specified in the study design code, that is used by study designers for documentation purposes only. This note does not appear in the InForm interface.</p> <p>Data source: Replicated from the InForm transactional database to the Reporting and Analysis database.</p>
Form Note	<p>Data type: String</p> <p>Description: Optional text, as specified in the study design code, that appears on the form.</p> <p>Data source: Replicated from the InForm transactional database to the Reporting and Analysis database.</p>

Report element	Description
Is SV Selected	<p>Data type: Y/N</p> <p>Description: Indicates whether the form has been selected for source verification.</p> <ul style="list-style-type: none"> • Y—The form has been selected for source verification. • N—The form has not been selected for source verification. <p>A form has been selected for source verification if one of the following is true:</p> <ul style="list-style-type: none"> • The form contains one or more critical items. • The form is on the Critical Forms list. • The subject with which the form is associated is in the SV Pool. • The subject with which the form is associated is not in the SV Pool, but an item on the form is marked critical for that subject. <p>Data source: Replicated from the InForm transactional database to the Reporting and Analysis database and decoded for display.</p>

Forms: Form Counts by Property

Forms: Form Counts by Property report elements return totals of different types of forms. Form counts here are expected form counts.

Note: When used by themselves, these report elements return form totals multiplied by the number of subjects participating in the study. You can add other report elements to see different totals for specific subjects.

Report element	Description
Dynamic Form	<p>Data type: Numeric</p> <p>Description: The number of expected dynamic forms.</p> <p>How calculated: Counts forms that are dynamic and have been activated or started. Does not count dynamic forms that have been removed.</p> <p>Example: A subject (who is pregnant) is participating in a study that requires the collection of additional information for subjects who are pregnant. A dynamic form is activated for the subject when entered data indicates that she is pregnant.</p> <p>Dynamic form count for this example = 1.</p> <p>Data source: Derived and stored in the Reporting and Analysis database.</p>

Report element	Description
Repeating Form	<p>Data type: Numeric</p> <p>Description: The number of started, non-started, and deleted repeating forms within the study.</p> <p>How calculated: Counts not started repeating once. Counts each started instance of a repeating form.</p> <p>Example: Two subjects are participating in a study with a repeating form that records blood draws at different intervals within the study. Subject A has had one blood draw; therefore one instance of the repeating form has been started for the subject. Subject B has had two blood draws; therefore two instances of the repeating form have been started for Subject B.</p> <p>Repeating form count for this example =3.</p> <p>Data source: Derived and stored in the Reporting and Analysis database.</p>
Common Form	<p>Data type: Numeric</p> <p>Description: The number of possible common forms across all subjects.</p> <p>How calculated: Counts each common form one time, regardless of the number of visits in which the form appears.</p> <p>Example: A study contains a common form for Adverse Events, which appears in each visit. This form has been completed for a subject in three different visits.</p> <p>Common form count for this example = 1.</p> <p>Data source: Derived and stored in the Reporting and Analysis database.</p>
Alternate Form	<p>Data type: Numeric</p> <p>Description: The number of possible alternate forms across all subjects.</p> <p>How calculated: Counts forms that are started alternate forms.</p> <p>Example: An alternate form is completed for two subjects who are enrolled in the study.</p> <p>Alternate form count for this example=2.</p> <p>Data source: Derived and stored in the Reporting and Analysis database.</p>

Report element	Description
Has Required Items	<p>Data type: Numeric</p> <p>Description: The number of possible expected forms across all subjects that contain required items.</p> <p>How calculated: Counts forms that could be expected or started and that contain required items. This calculation includes dynamic and repeating forms with required items, as follows:</p> <ul style="list-style-type: none"> • Dynamic form <ul style="list-style-type: none"> ▪ Counted if it contains required items and it is activated or started. ▪ Not counted if it has been removed. • Repeating form <ul style="list-style-type: none"> ▪ Not started—Counted one time if it contains required items. ▪ Started—Counts each instance that contains required items. <p>Data source: Derived and stored in the Reporting and Analysis database.</p>
Has SV Required Items	<p>Data type: Numeric</p> <p>Description: The number of possible expected forms across all subjects that contain items marked SV Required.</p> <p>How calculated: Counts forms that are expected or started, and that contain items marked SV Required. This calculation includes dynamic and repeating forms with items marked SV Required, as follows:</p> <ul style="list-style-type: none"> • Dynamic form <ul style="list-style-type: none"> ▪ Counted if it contains items marked SV Required, and is activated or started. ▪ Not counted if it has been removed. • Repeating form <ul style="list-style-type: none"> ▪ Not started—Counted one time if it contains items marked SV Required. ▪ Started—Counts each instance that contains items marked SV Required. <p>Data source: Derived and stored in the Reporting and Analysis database.</p>

Report element	Description
SV Selected	<p>Data type: Numeric</p> <p>Description: The number of forms that have been selected for source verification.</p> <p>How calculated: Counts forms that have been selected for source verification.</p> <p>A form has been selected for source verification if one of the following is true:</p> <ul style="list-style-type: none"> • The form contains one or more critical items. • The form is on the Critical Forms list. • The subject with which the form is associated is in the SV Pool. • The subject with which the form is associated is not in the SV Pool, but an item on the form is marked critical for that subject. <p>Data source: Derived and stored in the Reporting and Analysis database.</p>

Forms: Form Status Counts

Forms: Form Status Counts report elements return totals of forms according to their status.

Report element	Description
Form Count	<p>Data type: Numeric</p> <p>Description: The total number of forms.</p> <p>How calculated: This calculation includes all forms, including expected forms, forms that have not been started, and unscheduled forms. Use this report element in combination with other predefined filters to narrow report results.</p> <p>Data source: Derived and stored in the Reporting and Analysis database.</p>

Report element	Description
Expected	<p>Data type: Numeric</p> <p>Description: The number of expected forms in the study.</p> <p>How calculated: Counts forms that meet any of the following criteria:</p> <ul style="list-style-type: none">• Appear within a scheduled visit (regardless of whether the form is started).• Appear within a started unscheduled visit.• Are activated dynamic forms. <p>Counts expected forms only for subjects who have been enrolled in the InForm application (includes enrolled, randomized, completed, and dropped subjects).</p> <p>For subjects that have completed or dropped (as indicated by the Study Completion form), only forms in started visits or dynamic started forms are counted. Non-started common forms are not counted as expected.</p>

Report element	Description
	<p>Only CRFs are counted. Other special CRFs (such as screening and enrollment) are not included.</p> <ul style="list-style-type: none"> • Alternate forms—One form in each visit is counted. • Common forms—A common form is counted only once for the study, regardless of the number of visits in which it occurs. <ul style="list-style-type: none"> • For enrolled or randomized subjects, common forms are considered expected. • For complete or dropped-out subjects, only started common forms are considered expected. • Common dynamic forms—Each activated or started instance is counted one time. • Common dynamic repeating forms—Each activated or started instance is counted one time. • Common repeating forms—Each instance is counted one time. • Dynamic forms—One activated dynamic form is counted for each visit in which it exists. Deleted (removed) form instances are not counted as expected. • Dynamic repeating forms—Each activated or started instance is counted one time. • Regular forms—One form is counted for each visit. • Repeating forms—For repeating forms that have not been started, one instance of the form is counted as expected. For repeating forms that have been started, each started instance counts as expected. Deleted (removed) form instances are not counted as expected. <p>Data source: Derived and stored in the Reporting and Analysis database.</p>
Started	<p>Data type: Numeric</p> <p>Description: Total count of all forms that are started across all subjects, by visit and by site.</p> <p>How calculated: An expected form is considered started if any type of data entry activity (form data, queries, or comments) has started on the form.</p> <p>Data source: Replicated from the InForm transactional database to the Reporting and Analysis database.</p> <p>Note: To report on forms that are started but incomplete, subtract the complete count (Complete report element) from the started count (Started report element).</p>

Report element	Description
Missing Required Items	<p>Data type: Numeric</p> <p>Description: The number of started forms for which at least one required item is empty.</p> <p>How calculated: Counts forms that:</p> <ul style="list-style-type: none"> • Are started. • Contain required items. • Have at least one required item that does not contain data. <p>Data source: Replicated from the InForm transactional database to the Reporting and Analysis database.</p>
Complete	<p>Data type: Numeric</p> <p>Description: Total count of all forms that are complete across all subjects, by visit and by site.</p> <p>How calculated: An expected form is considered complete if all of the required items for the form are supplied. For repeating forms, the form cannot be in a deleted state.</p> <p>Data source: Derived and stored in the Reporting and Analysis database.</p>
Frozen	<p>Data type: Numeric</p> <p>Description: The number of expected forms that are currently marked Frozen.</p> <p>How calculated: Counts forms that are expected and have been frozen using any of the following InForm features:</p> <ul style="list-style-type: none"> • Freeze CRF • Freeze CRB • Freeze Visit <p>Data source: Replicated from the InForm transactional database to the Reporting and Analysis database.</p>

Report element	Description
SV Ready	<p>Data type: Numeric</p> <p>Description: The number of forms that are currently marked SV Ready.</p> <p>How calculated: Counts forms that are marked SV Ready, and are selected for source verification.</p> <p>A form has been selected for source verification if one of the following is true:</p> <ul style="list-style-type: none"> • The form contains one or more critical items. • The form is on the Critical Forms list. • The subject with which the form is associated is in the SV Pool. • The subject with which the form is associated is not in the SV Pool, but an item on the form is marked critical for that subject. <p>Data source: Replicated from the InForm transactional database to the Reporting and Analysis database.</p>
SV Partial	<p>Data type: Numeric</p> <p>Description: The number of forms that are currently marked SV Partial.</p> <p>How calculated: Counts forms that are in the SV Partial state.</p> <p>A form is considered SV Partial if one of the following is true:</p> <ul style="list-style-type: none"> • The form contains unverified critical items. • The form is on the Critical Forms list, and contains unverified items that are marked SV Required. • The subject with which the form is associated is in the SV Pool, and the form contains unverified items that are marked SV Required. • The subject with which the form is associated is not in the SV Pool, but an item on the form is marked critical for that subject, and the form contains unverified items that are marked SV Required. <p>Data source: Replicated from the InForm transactional database to the Reporting and Analysis database.</p>

Report element	Description
SV Complete	<p>Data type: Numeric</p> <p>Description: The number of verified forms.</p> <p>How calculated: Counts forms that are marked Verified.</p> <p>A form is considered Verified if one of the following is true:</p> <ul style="list-style-type: none"> • The form does not contain critical items, and all items on the form that are marked SV Required are verified. • The form contains critical items, and all critical items on the form are verified. • The form is on the Critical Forms list, and all items on the form that are marked SV Required are verified. • The subject with which the form is associated is in the SV Pool, and all items marked SV Required are verified. • The subject with which the form is associated is not in the SV Pool, but an item on the form is marked critical for that subject, and all items marked SV Required are verified. <p>If none of the items on the form require source verification, the InForm application marks the form Verified.</p> <p>Data source: Replicated from the InForm transactional database to the Reporting and Analysis database.</p>
Signed	<p>Data type: Numeric</p> <p>Description: The number of signed forms and the percentage of expected forms that are currently signed in the InForm application.</p> <p>How calculated: Counts forms that have been signed by all groups that are required to sign the form. This value appears as a whole number and as a percentage of expected forms that are signed:</p> $[\text{signed, \% of expected}] = [\text{signed forms count}] * 100 / [\text{expected forms count}]$ <p>Data source: Replicated from the InForm transactional database to the Reporting and Analysis database.</p>
Locked	<p>Data type: Numeric</p> <p>Description: The number of locked forms.</p> <p>How calculated: Counts forms that:</p> <ul style="list-style-type: none"> • Have been locked in the InForm application at the form level or visit level. • Are contained within a case book that has been locked in the InForm application. <p>Data source: Replicated from the InForm transactional database to the Reporting and Analysis database.</p>

Report element	Description
Marked Incomplete	<p>Data type: Numeric</p> <p>Description: The number of forms that have been marked Incomplete.</p> <p>How calculated: Counts forms that have an existing form comment(s) with an Incomplete Reason of Not Done, Not Applicable, or Unknown.</p> <p>Data source: Replicated from the InForm transactional database to the Reporting and Analysis database.</p>
Has Data	<p>Data type: Numeric</p> <p>Description: The number of forms on which some data has been entered.</p> <p>How calculated: Counts forms that have entered data in at least one item. The item with data does not need to be a required item.</p> <p>Data source: Replicated from the InForm transactional database to the Reporting and Analysis database.</p>
Has Open Query	<p>Data type: Numeric</p> <p>Description: The number of forms with open queries.</p> <p>How calculated: Counts forms that contain items with open queries. This count does not include forms that contain items with queries in states other than Open.</p> <p>Data source: Replicated from the InForm transactional database to the Reporting and Analysis database.</p>
Has Answered Query	<p>Data type: Numeric</p> <p>Description: The number of forms with answered queries.</p> <p>How calculated: Counts forms that contain items with open queries. This count does not include forms that contain items with queries in states other than Answered.</p> <p>Data source: Derived and stored in the Reporting and Analysis database.</p>
Candidate Query	<p>Data type: Numeric</p> <p>Description: The number of candidate queries. Use with the Form Name report element to see the number of candidate queries that are associated with a particular form.</p> <p>How calculated: A query is counted if it is currently a candidate query.</p> <p>Data source: Derived and stored in the Reporting and Analysis database.</p>

Report element	Description
Open Query	<p>Data type: Numeric</p> <p>Description: The number of open queries. Use with the Form Name report element to see the number of open queries that are associated with a particular form.</p> <p>How calculated: A query is counted if it is currently open. This count includes reissued queries.</p> <p>Data source: Derived and stored in the Reporting and Analysis database.</p>
Answered Query	<p>Data type: Numeric</p> <p>Description: The number of answered queries. Use with the Form Name report element to see the number of answered queries that are associated with a particular form.</p> <p>How calculated: A query is counted if it is currently answered.</p> <p>Data source: Derived and stored in the Reporting and Analysis database.</p>
Has Form Comment	<p>Data type: Numeric</p> <p>Description: The number of forms that contain form-level comments.</p> <p>How calculated: Counts forms that contain at least one form-level comment. This calculation includes forms that have been marked Incomplete. This count does not include forms with only item-level comments.</p> <p>Data source: Replicated from the InForm transactional database to the Reporting and Analysis database.</p>
Has Item Comment	<p>Data type: Numeric</p> <p>Description: The number of forms that contain items with item-level comments.</p> <p>How calculated: Counts forms that contain at least one item-level comment. This calculation includes items that have been marked Incomplete. This calculation does not include forms that include only form-level comments.</p> <p>Data source: Derived and stored in the Reporting and Analysis database.</p>
Deleted Repeating	<p>Data type: Numeric</p> <p>Description: The number of repeating forms that have been deleted.</p> <p>How calculated: Counts forms that are repeating forms that have been deleted.</p> <p>Data source: Replicated from the InForm transactional database to the Reporting and Analysis database.</p>

Forms: Review States

Forms: Review States report elements return the custom review state with which each form in the report is associated.

You create custom review states and stages for the Data Viewer using the Central Designer application. You can define as many as five custom review states, and each custom review state must include three stages. If you do not define custom review states and stages for your study, the associated report elements do not appear in the Ad Hoc Reporting tree. For more information, see the Central Designer *InForm Design Guide*.

Note: This folder contains study-specific clinical data. It only appears for the Forms report topic if you select the study-specific clinical package on the **Select a package** page when accessing the Ad Hoc Reporting workspace.

Report element	Description
<i>Review state name</i>	<p>Data type: String</p> <p>Description: The custom review state associated with the form, if custom review states are defined for the study.</p> <p>Data source: Calculated in the clinical data model.</p>

Forms: Review States Counts

Forms: Review States Counts report elements return the number of forms that are associated with each custom review state and stage in a study. The folder contains one measure element for each custom review state and stage combination.

You create custom review states and stages for the Data Viewer using the Central Designer application. You can define as many as five custom review states, and each custom review state must include three stages. If you do not define custom review states and stages for your study, the associated report elements do not appear in the Ad Hoc Reporting tree. For more information, see the Central Designer *InForm Design Guide*.

Note: This folder contains study-specific clinical data. It only appears for the Forms report topic if you select the study-specific clinical package on the **Select a package** page when accessing the Ad Hoc Reporting workspace.

Report element	Description
<i>Review state name ~ Review stage name</i>	<p>Data type: Numeric</p> <p>Description: The number of forms associated with a stage in a custom review state.</p> <p>Data source: Derived and stored in the Reporting and Analysis database.</p>

Forms: Form Dates

Forms: Form Dates report elements allow you to report on dates associated with form status.

Forms may be set to some states more than one time. For these states, First and Last date report elements appear in the Ad Hoc Reporting tree. Use these report elements to identify when a form moved from one state to another, as follows:

- Use Last dates to determine the current status for a form, and the date on which the status change occurred.
- Use the First and Last dates together to identify forms that were, but are no longer in a given state. You can also use these dates to identify forms that changed after being assigned a given state. For example, you can compare the Data Last Modified Date to the Last SV Complete date to see whether the form changed after it was marked SV Complete.

If a form has been in a particular state only one time, the First and Last dates for that state display the same date.

If a form has never been assigned a particular status, the columns for the First and Last dates for that state do not contain data.

Report element	Description
Current Status Date	<p>Data type: Date/Time</p> <p>Description: The date on which the form was assigned its current state. For instance, if the current state of a form is Started, this element would return the date on which the form was started.</p> <p>Date type: System date (GMT).</p>
Data Last Modified Date	<p>Data type: Date/Time</p> <p>Description: The date on which data was last entered or modified on the form.</p> <p>Date type: System date (GMT).</p>
Form's Scheduled Visit Date	<p>Data type: Date</p> <p>Description: The date on which the scheduled visit that contains the form should occur.</p> <p>Date type: System date (GMT).</p>
Form's Visit Data Entry Date	<p>Data type: Date/Time</p> <p>Description: The date on which data was first entered for the visit that contains the form.</p> <p>Date type: System date (GMT).</p>

Report element	Description
DOV	<p>Data type: Date/Time</p> <p>Description: The date that is recorded in a standard Date of Visit control in the InForm application.</p> <p>Data type: Clinical</p> <p>Note: This report element assumes that your study was developed using a specific design for the DOV controls.</p> <p>UUIDs:</p> <ul style="list-style-type: none"> • DateTimeControl—BD991BC0-B0A4-11D2-80E3-00A0C9AF7674 • Item—BD991BBF-B0A4-11D2-80E3-00A0C9AF7674 • Section—BD991BBE-B0A4-11D2-80E3-00A0C9AF7674 <p>For more information, see <i>DOV controls</i> (on page 21).</p>
Started Date	<p>Data type: Date/Time</p> <p>Description: The date on which the form was started.</p> <p>Date type: System date (GMT).</p>
Complete Date	<p>Data type: Date/Time</p> <p>Description: The date on which the form was completed. Counts forms that are expected and meet the following criteria:</p> <ul style="list-style-type: none"> • Are started. • Contain data for all required items. <p>Date type: System date (GMT).</p>
Deleted Date	<p>Data type: Date/Time</p> <p>Description: The date on which the form was deleted.</p> <p>Date type: System date (GMT).</p>
First Frozen Date	<p>Data type: Date/Time</p> <p>Description: The date on which the status of the form was first set to Frozen. A form is frozen if it has been frozen using any of these InForm features:</p> <ul style="list-style-type: none"> • Freeze CRF • Freeze CRB • Freeze Visit <p>This report element retrieves only those dates for forms frozen at the form or visit level. It does not retrieve a first frozen date for forms that were frozen at the case book level.</p> <p>Date type: System date (GMT).</p>

Report element	Description
Last Frozen Date	<p>Data type: Date/Time</p> <p>Description: The most recent date on which the status of the form was set to Frozen. This report element retrieves only those dates for forms that were frozen at the form or visit level. It does not retrieve a last frozen date for forms that were frozen at the case book level.</p> <p>Date type: System date (GMT).</p>
First SV Ready Date	<p>Data type: Date/Time</p> <p>Description: The date on which the status of the form was first considered SV Ready.</p> <p>A form is considered SV Ready if it has a status of SV Ready, and is selected for source verification.</p> <p>A form has been selected for source verification if one of the following is true:</p> <ul style="list-style-type: none"> • The form contains one or more critical items. • The form is on the Critical Forms list. • The subject with which the form is associated is in the SV Pool. • The subject with which the form is associated is not in the SV Pool, but an item on the form is marked critical for that subject. <p>Date type: System date (GMT).</p>
Last SV Ready Date	<p>Data type: Date/Time</p> <p>Description: The most recent date on which the status of the form was set to SV Ready.</p> <p>A form is considered SV Ready if it has a status of SV Ready, and is selected for source verification.</p> <p>A form has been selected for source verification if one of the following is true:</p> <ul style="list-style-type: none"> • The form contains one or more critical items. • The form is on the Critical Forms list. • The subject with which the form is associated is in the SV Pool. • The subject with which the form is associated is not in the SV Pool, but an item on the form is marked critical for that subject. <p>Date type: System date (GMT).</p>

Report element	Description
First SV Partial Date	<p>Data type: Date/Time</p> <p>Description: The date on which the form status was first set to SV Partial.</p> <p>A form is considered SV Partial if one of the following is true:</p> <ul style="list-style-type: none"> • The form contains unverified critical items. • The form is on the Critical Forms list, and contains unverified items that are marked SV Required. • The subject with which the form is associated is in the SV Pool, and the form contains unverified items that are marked SV Required. • The subject with which the form is associated is not in the SV Pool, but an item on the form is marked critical for that subject, and the form contains unverified items that are marked SV Required. <p>Date type: System date (GMT).</p>
Last SV Partial Date	<p>Data type: Date/Time</p> <p>Description: The date on which the form was last considered SV Partial.</p> <p>A form is considered SV Partial if one of the following is true:</p> <ul style="list-style-type: none"> • The form contains unverified critical items. • The form is on the Critical Forms list, and contains unverified items that are marked SV Required. • The subject with which the form is associated is in the SV Pool, and the form contains unverified items that are marked SV Required. • The subject with which the form is associated is not in the SV Pool, but an item on the form is marked critical for that subject, and the form contains unverified items that are marked SV Required. <p>Date type: System date (GMT).</p>

Report element	Description
First SV Complete Date	<p>Data type: Date/Time</p> <p>Description: The date on which the form was first considered Verified.</p> <p>A form is considered Verified if one of the following is true:</p> <ul style="list-style-type: none"> • The form does not contain critical items, and all items on the form that are marked SV Required are verified. • The form contains critical items, and all critical items on the form are verified. • The form is on the Critical Forms list, and all items on the form that are marked SV Required are verified. • The subject with which the form is associated is in the SV Pool, and all items marked SV Required are verified. • The subject with which the form is associated is not in the SV Pool, but an item on the form is marked critical for that subject, and all items marked SV Required are verified. <p>If none of the items on the form require source verification, the InForm application marks the form Verified.</p> <p>Date type: System date (GMT).</p>
Last SV Complete Date	<p>Data type: Date/Time</p> <p>Description: The most recent date on which the form was marked Verified.</p> <p>A form is considered Verified if one of the following is true:</p> <ul style="list-style-type: none"> • The form does not contain critical items, and all items on the form that are marked SV Required are verified. • The form contains critical items, and all critical items on the form are verified. • The form is on the Critical Forms list, and all items on the form that are marked SV Required are verified. • The subject with which the form is associated is in the SV Pool, and all items marked SV Required are verified. • The subject with which the form is associated is not in the SV Pool, but an item on the form is marked critical for that subject, and all items marked SV Required are verified. <p>If none of the items on the form require source verification, the InForm application marks the form Verified.</p> <p>Date type: System date (GMT).</p>
First Signed Date	<p>Data type: Date/Time</p> <p>Description: The date on which the form was first signed.</p> <p>Date type: System date (GMT).</p>

Report element	Description
Last Signed Date	<p>Data type: Date/Time</p> <p>Description: The date on which the form was last signed.</p> <p>Date type: System date (GMT).</p>
First Locked Date	<p>Data type: Date/Time</p> <p>Description: The date on which the form was first locked. This report element retrieves only those dates for forms that were locked at the form or visit level. It does not retrieve a first locked date for forms that were locked at the case book level.</p> <p>Date type: System date (GMT).</p>
Last Locked Date	<p>Data type: Date/Time</p> <p>Description: The date on which the form was last locked. This report element retrieves only those dates for forms that were locked at the form or visit level. It does not retrieve a last locked date for forms that were locked at the case book level.</p> <p>Date type: System date (GMT).</p>
<i>Review state name</i> Date Changed	<p>Data type: Date/Time</p> <p>Description: The date on which the review state for the form was last updated.</p> <p>Date type: System date (GMT).</p> <p>Notes:</p> <p>You create custom review states and stages for the Data Viewer using the Central Designer application. You can define as many as five custom review states, and each custom review state must include three stages. If you do not define custom review states and stages for your study, the associated report elements do not appear in the Ad Hoc Reporting tree. For more information, see the Central Designer <i>InForm Design Guide</i>.</p> <p>The <i>Review state name</i> Date report element contains study-specific clinical data. It only appears in the Form Dates folder for the Forms report topic if you select the study-specific clinical package on the Select a package page when accessing the Ad Hoc Reporting workspace.</p>

Forms: Form Status by Month and Year

Forms: Form Status by Month and Year report elements let you create reports on form status by month. Use these report elements with form status counts to see the number of forms that were set to a particular status each month.

If the report is sorted by one of the Month/Year report elements. You can add the Form Count element to see how many forms were assigned a particular status in each month.

Report element	Description
----------------	-------------

Report element	Description
Started Month, Year	<p>Data type: Date</p> <p>Description: Each month/year combination from the start of the study to present day. Use with the Form Count report element to see how many forms were started each month.</p> <p>Date type: System date (GMT), derived for display.</p>
Completed Month, Year	<p>Data type: Date/Time</p> <p>Description: Each month/year combination from the start of the study to present day. Use with the Form Count report element to see how many forms have been completed each month.</p> <p>Date type: System date (GMT), derived for display.</p>
Frozen Month, Year	<p>Data type: Date/Time</p> <p>Description: Each month/year combination from the start of the study to present day. Use with the Form Count report element to see how many forms were frozen each month.</p> <p>Date type: System date (GMT), derived for display.</p>
SV Complete Month, Year	<p>Data type: Date/Time</p> <p>Description: Each month/year combination from the start of the study to present day. Use with the Form Count report element to see how many forms were source verified each month.</p> <p>A form is considered Verified if one of the following is true:</p> <ul style="list-style-type: none"> • The form does not contain critical items, and all items on the form that are marked SV Required are verified. • The form contains critical items, and all critical items on the form are verified. • The form is on the Critical Forms list, and all items on the form that are marked SV Required are verified. • The subject with which the form is associated is in the SV Pool, and all items marked SV Required are verified. • The subject with which the form is associated is not in the SV Pool, but an item on the form is marked critical for that subject, and all items marked SV Required are verified. <p>If none of the items on the form require source verification, the InForm application marks the form Verified.</p> <p>Date type: System date (GMT), derived for display.</p>
Signed Month, Year	<p>Data type: Date/Time</p> <p>Description: Each month/year combination from the start of the study to present day. Use with the Form Count report element to see how many forms were signed each month.</p> <p>Date type: System date (GMT), derived for display.</p>

Report element	Description
Locked Month, Year	<p>Data type: Date/Time</p> <p>Description: Each month/year combination from the start of the study to present day. Use with the Form Count report element to see how many forms were locked each month.</p> <p>Date type: System date (GMT), derived for display.</p>

Forms: Aging

Forms: Aging report elements allow you to report on how long forms have been in an incomplete state.

Report element	Description
Days Incomplete from DOV	<p>Data type: Numeric</p> <p>Description: The number of days the status of an incomplete form has been incomplete, beginning with the recorded date of visit.</p> <p>How calculated: This calculation begins on the recorded date of visit on the form and ends on the most recent date that the status of the form was set to Incomplete.</p> <p>Data source: Derived and stored in the Reporting and Analysis database.</p>
Days Incomplete from Started	<p>Data type: Numeric</p> <p>Description: The number of days the status of an incomplete form has been incomplete, beginning with the date on which the form was started.</p> <p>How calculated: This calculation begins on the date the form was started and ends on the most recent date that the status of the form was set to Incomplete.</p> <p>Data source: Derived and stored in the Reporting and Analysis database.</p>

Forms: Cycle Times

Forms: Cycle times report elements let you report on the amount of time it takes for forms to move from one state to another. These elements may return a specific value or an average, depending on other elements used in your report.

Report element	Description
----------------	-------------

Report element	Description
DOV to Form Started	<p>Data type: Numeric</p> <p>Description: The number of days from the recorded date of visit to when the form was started.</p> <p>Note: The date entered on the DOV form could be different from the date of data entry recorded in the database. The date that is entered on the DOV form will most commonly reflect the time zone for the site, and the date of data entry that is recorded in the database is in UTC.</p> <p>How calculated: This calculation begins on the recorded date of visit for the form and ends on the date when the form status was set to Started.</p> <p>Data source: Derived and stored in the Reporting and Analysis database.</p> <p>Note: This report element assumes that your study was developed using a specific design for the DOV controls.</p> <p>For more information, see <i>DOV controls</i> (on page 21).</p>
Started to Complete	<p>Data type: Numeric</p> <p>Description: The number of days from when the form was started to when it was completed.</p> <p>How calculated: This calculation begins on the date when the form status was set to Started and ends on the most recent date when the form status was set to Complete. Counts forms that are expected and meet the following criteria:</p> <ul style="list-style-type: none"> • Are started. <p>Contain data for all required items.</p> <p>Data source: Derived and stored in the Reporting and Analysis database.</p>
Complete to Frozen	<p>Data type: Numeric</p> <p>Description: The number of days from when a form was completed to when it was frozen.</p> <p>How calculated: This calculation begins on the first date when the form status was set to Complete and ends on the most recent date when the form status was set to Frozen.</p> <p>Data source: Derived and stored in the Reporting and Analysis database.</p>

Report element	Description
Complete to SV Ready	<p>Data type: Numeric</p> <p>Description: The number of days from when a form was completed to when it became SV Ready.</p> <p>How calculated: This calculation begins on the first date when the form status was set to Complete and ends on the most recent date when the form status was set to SV Ready.</p> <p>A form is considered SV Ready if it has a status of SV Ready, and is selected for source verification.</p> <p>A form has been selected for source verification if one of the following is true:</p> <ul style="list-style-type: none"> • The form contains one or more critical items. • The form is on the Critical Forms list. • The subject with which the form is associated is in the SV Pool. • The subject with which the form is associated is not in the SV Pool, but an item on the form is marked critical for that subject. <p>Data source: Derived and stored in the Reporting and Analysis database.</p>
Complete to SV Complete	<p>Data type: Numeric</p> <p>Description: The number of days from when a form was completed to when it became verified.</p> <p>How calculated: This calculation begins on the first date when the form status was set to Complete and ends on the most recent date when the form status was set to Verified.</p> <p>A form is considered Verified if one of the following is true:</p> <ul style="list-style-type: none"> • The form does not contain critical items, and all items on the form that are marked SV Required are verified. • The form contains critical items, and all critical items on the form are verified. • The form is on the Critical Forms list, and all items on the form that are marked SV Required are verified. • The subject with which the form is associated is in the SV Pool, and all items marked SV Required are verified. • The subject with which the form is associated is not in the SV Pool, but an item on the form is marked critical for that subject, and all items marked SV Required are verified. <p>If none of the items on the form require source verification, the InForm application marks the form Verified.</p> <p>Data source: Derived and stored in the Reporting and Analysis database.</p>

Report element	Description
Complete to Signed	<p>Data type: Numeric</p> <p>Description: The number of days from when a form was completed to when it was signed.</p> <p>How calculated: This calculation begins on the first date when the form status was set to Complete and ends on the most recent date when the form status was set to Signed.</p> <p>Data source: Derived and stored in the Reporting and Analysis database.</p>
Signed to SV Complete	<p>Data type: Numeric</p> <p>Description: The number of days from when a form was signed to when it became verified.</p> <p>How calculated: This calculation begins on the first date when the form status was set to Signed and ends on the most recent date when the form status was set to Verified.</p> <p>A form is considered Verified if one of the following is true:</p> <ul style="list-style-type: none"> • The form does not contain critical items, and all items on the form that are marked SV Required are verified. • The form contains critical items, and all critical items on the form are verified. • The form is on the Critical Forms list, and all items on the form that are marked SV Required are verified. • The subject with which the form is associated is in the SV Pool, and all items marked SV Required are verified. • The subject with which the form is associated is not in the SV Pool, but an item on the form is marked critical for that subject, and all items marked SV Required are verified. <p>If none of the items on the form require source verification, the InForm application marks the form Verified.</p> <p>Data source: Derived and stored in the Reporting and Analysis database.</p>

Report element	Description
SV Ready to SV Complete	<p>Data type: Numeric</p> <p>Description: The number of days from when a form became SV Ready to when it became verified.</p> <p>How calculated: This calculation begins on the first date when the form status was SV Ready and ends on the most recent date when the form status form was set to Verified.</p> <p>A form is considered SV Ready if it has a status of SV Ready, and is selected for source verification.</p> <p>A form has been selected for source verification if one of the following is true:</p> <ul style="list-style-type: none"> • The form contains one or more critical items. • The form is on the Critical Forms list. • The subject with which the form is associated is in the SV Pool. • The subject with which the form is associated is not in the SV Pool, but an item on the form is marked critical for that subject. <p>A form is considered Verified if one of the following is true:</p> <ul style="list-style-type: none"> • The form does not contain critical items, and all items on the form that are marked SV Required are verified. • The form contains critical items, and all critical items on the form are verified. • The form is on the Critical Forms list, and all items on the form that are marked SV Required are verified. • The subject with which the form is associated is in the SV Pool, and all items marked SV Required are verified. • The subject with which the form is associated is not in the SV Pool, but an item on the form is marked critical for that subject, and all items marked SV Required are verified. <p>If none of the items on the form require source verification, the InForm application marks the form Verified.</p> <p>Data source: Derived and stored in the Reporting and Analysis database.</p>

Report element	Description
Frozen to SV Complete	<p data-bbox="656 212 894 243">Data type: Numeric</p> <p data-bbox="656 260 1425 323">Description: The number of days from when a form was frozen to when it became verified.</p> <p data-bbox="656 344 1479 443">How calculated: This calculation begins on the first date when the form was frozen and ends on the most recent date when the form status was set to Verified.</p> <p data-bbox="656 464 1338 495">A form is considered Verified if one of the following is true:</p> <ul data-bbox="656 516 1479 968" style="list-style-type: none"><li data-bbox="656 516 1479 579">• The form does not contain critical items, and all items on the form that are marked SV Required are verified.<li data-bbox="656 600 1479 663">• The form contains critical items, and all critical items on the form are verified.<li data-bbox="656 684 1479 747">• The form is on the Critical Forms list, and all items on the form that are marked SV Required are verified.<li data-bbox="656 768 1479 831">• The subject with which the form is associated is in the SV Pool, and all items marked SV Required are verified.<li data-bbox="656 852 1479 968">• The subject with which the form is associated is not in the SV Pool, but an item on the form is marked critical for that subject, and all items marked SV Required are verified. <p data-bbox="656 989 1479 1052">If none of the items on the form require source verification, the InForm application marks the form Verified.</p> <p data-bbox="656 1073 1382 1136">Data source: Derived and stored in the Reporting and Analysis database.</p>

Report element	Description
SV Complete to Signed	<p>Data type: Numeric</p> <p>Description: The number of days from when a form became verified to when it was signed.</p> <p>How calculated: This calculation begins on the first date when the form status was set to Verified and ends on the most recent date when the form was signed.</p> <p>A form is considered Verified if one of the following is true:</p> <ul style="list-style-type: none"> • The form does not contain critical items, and all items on the form that are marked SV Required are verified. • The form contains critical items, and all critical items on the form are verified. • The form is on the Critical Forms list, and all items on the form that are marked SV Required are verified. • The subject with which the form is associated is in the SV Pool, and all items marked SV Required are verified. • The subject with which the form is associated is not in the SV Pool, but an item on the form is marked critical for that subject, and all items marked SV Required are verified. <p>If none of the items on the form require source verification, the InForm application marks the form Verified.</p> <p>Data source: Derived and stored in the Reporting and Analysis database.</p>
Signed to Locked	<p>Data type: Numeric</p> <p>Description: The number of days from when a form was signed to when it was locked.</p> <p>How calculated: This calculation begins on the first date when the form status was set to Signed and ends on the most recent date when the form status was set to Locked.</p> <p>Data source: Derived and stored in the Reporting and Analysis database.</p>
Complete to Locked	<p>Data type: Numeric</p> <p>Description: The number of days from when a form was completed to when it was locked.</p> <p>How calculated: This calculation begins on the first date the form became complete and ends on the most recent date when the form status was set to Locked.</p> <p>Data source: Derived and stored in the Reporting and Analysis database.</p>

Section report elements

Forms in your study may be designed in sections. Section report elements let you report on these form sections in study design.

Sections

Section report elements let you report on sections of forms in your study.

Report element	Description
Section Title	<p>Data type: String</p> <p>Description: The title of a section in a form, as specified in the study design code.</p> <p>Data source: Replicated from the InForm transactional database to the Reporting and Analysis database.</p>

Sections: Properties

Sections: Properties report elements return information about the properties associated with sections.

Report element	Description
Grid Itemset	<p>Data type: Y/N</p> <p>Description: Specifies whether the section contains a Repeating Data itemset. Valid values are:</p> <ul style="list-style-type: none"> • Y—The section contains a Repeating Data itemset. • N—The section does not contain a Repeating Data itemset. <p>Data source: Replicated from the InForm transactional database to the Reporting and Analysis database and decoded for display.</p>
Initial Row Count	<p>Data type: Numeric</p> <p>Description: Counts the initial number of rows in the itemset.</p> <ul style="list-style-type: none"> • 0—If the section contains an Add Entry itemset. • NULL—If the section does not contain an itemset. • n—If the section contains a Repeating Data itemset, displays the number of rows in the itemset. <p>Data source: Replicated from the InForm transactional database to the Reporting and Analysis database.</p>

Item report elements

The Items report topic contains elements and measures that provide metrics and status information about items on forms in the study. Use this report topic to include counts of different item types,

information about item properties, and information on when items were initially created and changed.

- Items may be set to some states more than one time. For these states, First and Last date report elements appear in the Ad Hoc Reporting tree. Use these report elements to identify when an item moved from one state to another, as follows:
 - Use Last dates to determine the current status for an item and the date on which the status change occurred.
 - Use the First and Last dates together to identify items that were, but are no longer in a given state. You can also use these dates to identify items that changed after being assigned a given state. For example, you can compare the Last Modified Date to the Last SV date to see whether the form was changed after it was last source verified.
- If an item has been in a particular state only one time, the First and Last dates for that state display the same date.
- If an item has never been assigned a particular status, the columns for the First and Last dates for that state do not contain data.

Items

Items report elements return metrics on the items in your study.

Report element	Description
Item Name	<p>Data type: String</p> <p>Description: The itemset header text, as specified in the study design code. Access to this data can be restricted in the InForm application. When users who do not have access to this data run a report with this report element, the resulting report displays a series of asterisks (*****) rather than the actual itemset header text.</p> <p>InForm items that have never had data will not appear on reports that pair Item Name with Form Mnemonic or Form Name.</p> <p>Data source: Replicated from the InForm transactional database to the Reporting and Analysis database.</p>
Item Question	<p>Data type: String</p> <p>Description: Text of the question or prompt that instructs the user to enter specific clinical data. Access to this data can be restricted in the InForm application. When users who do not have access to this data run a report with this report element, the resulting report displays a series of asterisks (*****) rather than the actual item question.</p> <p>InForm items that have never contained data will not appear on reports that pair Item Question with Form Name or Form Mnemonic.</p> <p>Data source: Replicated from the InForm transactional database to the Reporting and Analysis database.</p>

Report element	Description
Reason for Change	<p>Data type: String</p> <p>Description: Text that explains the reason for the most recent clinical data change (if any) for the item. Text appears here only when the clinical data for the item has been changed since initial entry.</p> <p>Data source: Replicated from the InForm transactional database to the Reporting and Analysis database.</p>
Incomplete Reason	<p>Data type: String</p> <p>Description: Text that explains why the item was marked Incomplete. Text appears here only when the item has been marked Incomplete. Use this report element with the Subject Number report element to see incomplete reason text broken out by subject.</p> <p>Data source: Replicated from the InForm transactional database to the Reporting and Analysis database.</p>
Status Change User	<p>Data type: String</p> <p>Description: The user name of the InForm user who made the most recent change to the status of the item. A change to the SV status of the item is considered a status change for the item.</p> <p>Data source: Replicated from the InForm transactional database to the Reporting and Analysis database.</p>
Data Change User	<p>Data type: String</p> <p>Description: The user name of the InForm user who made the most recent change to the item.</p> <p>Data source: Replicated from the InForm transactional database to the Reporting and Analysis database.</p>

Items: Item Properties

Items: Item Properties report elements let you report on types of items.

Report element	Description
Is Required	<p>Data type: Y/N</p> <p>Description: Indicates whether the item requires a value for the form to be considered data entry complete. Valid values are:</p> <ul style="list-style-type: none"> • Y—The item is required. • N—The item is not required. <p>Note: Itemset items cannot be required.</p> <p>Data source: Replicated from the InForm transactional database to the Reporting and Analysis database and decoded for display.</p>

Report element	Description
Is SV Required	<p>Data type: Y/N</p> <p>Description: Indicates whether the item requires source verification.</p> <ul style="list-style-type: none"> • Y—The item requires InForm source verification. • N—The item does not require source verification. <p>An item is considered SV Required only if it is marked SV Required.</p> <p>Data source: Replicated from the InForm transactional database to the Reporting and Analysis database and decoded for display.</p>
Is SV Selected	<p>Data type: Y/N</p> <p>Description: Indicates whether the item has been selected for source verification.</p> <ul style="list-style-type: none"> • Y—The item has been selected for source verification. • N—The item has not been selected for source verification. <p>An item has been selected for source verification if one of the following is true:</p> <ul style="list-style-type: none"> • The item is marked SV Required and SV Critical. • The form on which the item exists is on the Critical Forms list. • The subject with which the item is associated is part of the SV Pool. • The subject with which the item is associated is not part of the SV Pool, but the item is marked critical for that subject. <p>Data source: Replicated from the InForm transactional database to the Reporting and Analysis database and decoded for display.</p>
Is Critical Override	<p>Data type: Y/N</p> <p>Description: Indicates whether the critical setting for the item in the study design was overridden using the Central Designer application or the InForm user interface.</p> <ul style="list-style-type: none"> • Y—The critical setting for the item in the study design was overridden using the Central Designer application or the InForm user interface. • N—The critical setting for the item in the study design was not overridden using the Central Designer application or the InForm user interface. <p>Data source: Replicated from the InForm transactional database to the Reporting and Analysis database and decoded for display.</p>

Report element	Description
Is Blank	<p>Data type: Y/N</p> <p>Description: Indicates whether the item is blank.</p> <ul style="list-style-type: none"> • Y—The item is in a Repeating Data itemset and is blank. • N—The item is in a Repeating Data itemset and is not blank, or the item is not in a Repeating Data itemset. <p>Data source: Replicated from the InForm transactional database to the Reporting and Analysis database and decoded for display.</p>

Items: Item Counts by Property

Items: Item Counts by Property report elements let you report item totals based on their design characteristics.

Note: All item counts include only items that have at one time contained clinical data. These counts do not include items for which clinical data has never been entered.

Report element	Description
Required	<p>Data type: Y/N</p> <p>Description: Indicates whether the item is required.</p> <ul style="list-style-type: none"> • Y—A value must be entered for the item. • N—Data entry is not required for the item. <p>Data source: Derived and stored in the Reporting and Analysis database.</p>
SV Required	<p>Data type: Numeric</p> <p>Description: The total number of items that require source verification and have ever contained clinical data.</p> <p>How calculated: Counts items that:</p> <ul style="list-style-type: none"> • Are marked SV Required. • Contain (or have ever contained) clinical data. <p>Data source: Derived and stored in the Reporting and Analysis database.</p>

Report element	Description
Calculated	<p>Data type: Numeric</p> <p>Description: The total number of calculated items, as specified in the study design code.</p> <p>How calculated: Counts items that:</p> <ul style="list-style-type: none"> • Have the item property set as a calculated control. • Have ever contained clinical data. <p>Data source: Derived and stored in the Reporting and Analysis database.</p>
Blank	<p>Data type: String</p> <p>How calculated:</p> <ul style="list-style-type: none"> • For a Repeating Data itemset, counts the number of blank items in the itemset. • For an item, indicates whether the item is blank, as designed in the study. <ul style="list-style-type: none"> ▪ 0—Item is not in a Repeating Data itemset, or is in a Repeating Data itemset, but is not blank. ▪ 1—Item is in a Repeating Data itemset, and is blank. <p>Data source: Replicated from the InForm transactional database to the Reporting and Analysis database.</p>
SV Selected	<p>Data type: Numeric</p> <p>How calculated: Counts items that have been selected for source verification.</p> <p>An item has been selected for source verification if one of the following is true:</p> <ul style="list-style-type: none"> • The item is marked SV Required and SV Critical. • The form on which the item exists is on the Critical Forms list. • The subject with which the item is associated is part of the SV Pool. • The subject with which the item is associated is not part of the SV Pool, but the item is marked critical for that subject. <p>Data source: Replicated from the InForm transactional database to the Reporting and Analysis database and decoded for display.</p>

Items: Item Status Counts

Items: Item Status Counts return totals of items (relative to the number of subjects) in various states.

Report element	Description
----------------	-------------

Report element	Description
Item Count	<p>Data type: Numeric</p> <p>Description: The total number of items, relative to the subjects participating in the study.</p> <p>How calculated: Counts each item for each subject if it contains (or ever has contained) clinical data.</p> <p>Data source: Derived and stored in the Reporting and Analysis database.</p>
Empty	<p>Data type: Numeric</p> <p>Description: The total number of items that currently have no data.</p> <p>How calculated: Counts items for each subject if both of the following are true:</p> <ul style="list-style-type: none"> • The item currently contains no clinical data. • The item contained clinical data at one time. <p>Data source: Derived and stored in the Reporting and Analysis database.</p>
Source Verified	<p>Data type: Numeric</p> <p>Description: The total number of items with a current status of Verified.</p> <p>How calculated: Counts items that have a current status of Verified.</p> <p>Data source: Replicated from the InForm transactional database to the Reporting and Analysis database.</p>
Marked Incomplete	<p>Data type: Numeric</p> <p>Description: The total number of items that are currently marked Incomplete.</p> <p>How calculated: Counts items that have comments with an Incomplete Reason of Not Done, Not Applicable, or Unknown.</p> <p>Data source: Replicated from the InForm transactional database to the Reporting and Analysis database.</p>
Deleted	<p>Data type: Numeric</p> <p>Description: The total number of items that have been deleted in the InForm application.</p> <p>How calculated: Counts items that are add-entry items and have been removed.</p> <p>Data source: Replicated from the InForm transactional database to the Reporting and Analysis database.</p>

Report element	Description
Has Item Comment	<p>Data type: Numeric</p> <p>Description: The total number of items that have had an item-level comment associated with them.</p> <p>How calculated: Counts items that:</p> <ul style="list-style-type: none"> • Have item-level comments (item-level comments are manually entered by user). • Are marked Not Done (item-level comments are autogenerated). <p>Data source: Replicated from the InForm transactional database to the Reporting and Analysis database.</p>
Has Query	<p>Data type: Numeric</p> <p>Description: The total number of items that have at least one associated open query.</p> <p>How calculated: Counts items that have at least one associated open query. Does not count items whose only associated query is a candidate query.</p> <p>Data source: Derived and stored in the Reporting and Analysis database.</p>
Source Verified Targeted	<p>Data type: Numeric</p> <p>How calculated: Counts items that have been source verified and have been selected for source verification.</p> <p>An item has been selected for source verification if one of the following is true:</p> <ul style="list-style-type: none"> • The item is marked SV Required and SV Critical. • The form on which the item exists is on the Critical Forms list. • The subject with which the item is associated is part of the SV Pool. • The subject with which the item is associated is not part of the SV Pool, but the item is marked critical for that subject. <p>Data source: Derived and stored in the Reporting and Analysis database.</p>

Items: Item Dates

Items: Item Dates report elements let you report on when items were completed and modified.

Report element	Description
Original Value Date	<p>Data type: Date</p> <p>Description: The date on which data was originally entered into the item.</p> <p>Date type: System date (GMT).</p>

Report element	Description
Last Modified Date	<p>Data type: Date</p> <p>Description: The date on which data was most recently entered into the item.</p> <p>Date type: System date (GMT).</p>
First SV Date	<p>Data type: Date</p> <p>Description: The date on which the item was first source verified. An item is considered source verified if it is in the Verified state.</p> <p>Date type: System date (GMT).</p>
Last SV Date	<p>Data type: Date</p> <p>Description: The most recent date on which the item was source verified. An item is considered source verified if it is in the Verified state.</p> <p>Date type: System date (GMT).</p>

Rule report elements

Rule report elements and measures allow you to create reports using information about rules that are attached to the study. Use this report topic to include information about rule types and the number of times rules have been triggered.

Rules

Rules report elements return information on rules in your study.

Report element	Description
Rule Item RefName	<p>Data type: String</p> <p>Description: The name that uniquely identifies the item to which the rule is attached in the study design code. This corresponds to the Short Question in the Central Designer application or Itemset Column Header in the InForm application. Access to this data can be restricted in the InForm application. When users who do not have access to this data run a report with this report element, the resulting report displays a series of asterisks (*****) rather than the actual text.</p> <p>Data source: Replicated from the InForm transactional database to the Reporting and Analysis database.</p>
Rule RefName	<p>Data type: String</p> <p>Description: The name that uniquely identifies the rule in the study design code. This is the rule RefName.</p> <p>Data source: Replicated from the InForm transactional database to the Reporting and Analysis database.</p>

Report element	Description
Rule Description	<p>Data type: String</p> <p>Description: Description of the rule.</p> <p>Data source: Replicated from the InForm transactional database to the Reporting and Analysis database.</p>
Rule Type	<p>Data type: String</p> <p>Description: The type of rule. Valid values are:</p> <ul style="list-style-type: none"> • Server Rule—Executes on the server. • Browser Rule—Executes on the browser. Two browser-side rule activities are supported in the InForm application: <ul style="list-style-type: none"> ▪ Checks for text entries in a numeric field or numeric entries in an alphabetic field. ▪ Smart controls, which provide automatic selection of radio buttons and checkboxes when a user enters or selects a value in an associated text control or list. • Server Calc Rule—Provides the result for a calculated control whose value is based on the value of one or more other items. • Server conversion—Converts units from one standard to another standard. • Server Rand Rule—Determines the randomized drug kit number to assign in a calculated control. • Clintrialderivation—Used in a Clintrial study to provide the result for a derived data item whose value is based on the value of one or more other items in the Clintrial database. • Clintrialrule—Used in a Clintrial study. • Workflow—Determines the visit or form to which a subject progresses next. A workflow rule prevents study objects in the workflow from appearing until the rule is evaluated. • Global Condition—Determines whether a visit, form, or item appears for a subject. A global condition does not affect other study objects in the workflow. <p>Data source: Replicated from the InForm transactional database to the Reporting and Analysis database.</p>

Query report elements

Query report elements allow you to include information about the queries that have been issued against clinical data. Use these report elements to see query text and type, to gather counts on manual and automatic queries, and to see query status.

Queries

Query report items return identifying information about queries and status.

Report element	Description
Query Text	<p>Data type: String</p> <p>Description: The selected reason or entered text when a query was issued against an item.</p> <p>If the query state is Open, Answered, or Closed, this element returns the text that is associated with the last time the query was opened. If the query is a candidate query, this element returns the text that is associated with the last candidate query.</p> <p>For automatic queries, query text is defined in the rule that triggers the query. Therefore, query text for automatic queries will be consistent. For manual queries, the query text reflects what an InForm user entered when issuing the query. Therefore, query text for manual queries will vary.</p> <p>Access to this data can be restricted in the InForm application. When users who do not have access to this data run a report with this report element, the data is blinded in the resulting report.</p> <p>Data source: Derived for the report; not stored in the Reporting and Analysis database.</p>
Query Response	<p>Data type: String</p> <p>Description: The text for the most recent query response. This text is entered when the query is answered. If the query is reopened after it is answered, the resulting column is blank in the report.</p> <p>Access to this data can be restricted in the InForm application. When users who do not have access to this data run a report with this report element, the data is blinded in the resulting report.</p> <p>Data source: Derived for the report; not stored in the Reporting and Analysis database.</p>
Query Closure Text	<p>Data type: String</p> <p>Description: The text that was entered when the query was closed.</p> <p>Access to this data can be restricted in the InForm application. When users who do not have access to this data run a report with this report element, the data is blinded in the resulting report.</p> <p>Data source: Derived for the report; not stored in the Reporting and Analysis database.</p>

Report element	Description
Query Status	<p>Data type: String</p> <p>Description: The current status of the query. Valid values are:</p> <ul style="list-style-type: none"> • Open • Answered • Closed • Candidate • Deleted <p>Data source: Replicated from the InForm transactional database to the Reporting and Analysis database and decoded for display.</p>
Originating User	<p>Data type: String</p> <p>Description: The user name of the user who first entered the query. If the query has been reissued, this report element returns the user name of the user who reissued the query.</p> <p>Data source: Replicated from the InForm transactional database to the Reporting and Analysis database.</p>

Queries: Properties

Queries: Properties report elements let you report on different types of queries.

Report element	Description
Query Type	<p>Data type: String</p> <p>Description: The type of query. Valid values are:</p> <ul style="list-style-type: none"> • Automatic—An automatic query is a query that the InForm application automatically generates when a rule in the study design detects a discrepancy in entered data. • Manual—A manual query is a query that an InForm user enters. • Conflict—A conflict query is a query that the InForm application automatically generates when it detects a discrepancy between different copies of the same study when users synchronize them, or that is entered in the InForm Adapter query interface. This query type exists only when the InForm application is used with the CIS application. <p>Data source: Replicated from the InForm transactional database to the Reporting and Analysis database and decoded for display.</p>

Report element	Description
Is Automatic	<p>Data type: Y/N</p> <p>Description: Indicates whether the InForm application automatically generated the query. Valid values are:</p> <ul style="list-style-type: none"> • Y—The query is automatic. • N—The query is either a manual or conflict query. <p>Data source: Replicated from the InForm transactional database to the Reporting and Analysis database and decoded for display.</p>
Is Manual	<p>Data type: Y/N</p> <p>Description: Indicates whether an InForm user entered the query manually. Valid values are:</p> <ul style="list-style-type: none"> • Y—The query is manual. • N—The query is either an automatic or a conflict query. <p>Data source: Replicated from the InForm transactional database to the Reporting and Analysis database and decoded for display.</p>

Queries: Query Counts

Queries: Query Counts report elements return totals of different types of queries.

Report element	Description
Query Count	<p>Data type: Numeric</p> <p>Description: The number of unique queries, regardless of status or type.</p> <p>How calculated: Counts all queries that have ever been triggered, regardless of status and type.</p> <p>Data source: Derived and stored in the Reporting and Analysis database.</p>
Automatic	<p>Data type: Numeric</p> <p>Description: The number of queries that the InForm application automatically generates.</p> <p>How calculated: Counts all automatic queries that have ever been triggered, regardless of status. An automatic query is a query that the InForm application automatically generates when a rule in the study design detects a discrepancy in entered data.</p> <p>This calculation does not include manual or conflict queries.</p> <p>Data source: Derived and stored in the Reporting and Analysis database.</p>

Report element	Description
Manual	<p>Data type: Numeric</p> <p>Description: The number of queries entered manually by InForm users.</p> <p>How calculated: Counts all manual queries that have ever been triggered, regardless of status. A manual query is a query that an InForm user enters. This calculation does not include automatic or conflict queries.</p> <p>Data source: Derived and stored in the Reporting and Analysis database.</p>
Conflict	<p>Data type: Numeric</p> <p>Description: The number of conflict queries that have ever been triggered.</p> <p>How calculated: Counts all conflict queries that have ever been triggered, regardless of status. A conflict query is a query that the InForm application automatically generates when it detects a discrepancy between different copies of the same study when users synchronize them, or that is entered in the InForm Adapter query interface. This query type exists only when the InForm application is used with the CIS application.</p> <p>This calculation does not include automatic or manual queries.</p> <p>Data source: Derived and stored in the Reporting and Analysis database.</p>
Candidate	<p>Data type: Numeric</p> <p>Description: The number of queries with a current status of Candidate.</p> <p>How calculated: Counts queries with a current status of Candidate, regardless of query type.</p> <p>Data source: Derived and stored in the Reporting and Analysis database.</p>
Open	<p>Data type: Numeric</p> <p>Description: The number of queries with a current status of Open.</p> <p>How calculated: Counts queries with a current status of Open, regardless of query type. Note that this total includes queries that have been reissued and are currently open.</p> <p>Data source: Derived for the report; not stored in the Reporting and Analysis database.</p> <p>Note: To see the total number of newly opened queries, create a calculation that subtracts the number of reissued queries from the number of open queries.</p>

Report element	Description
Reissued	<p>Data type: Numeric</p> <p>Description: The number of currently open queries that were reissued.</p> <p>How calculated: Counts all reissued queries that are currently open. A query is reissued if it has been answered and then re-opened.</p> <p>Data source: Derived and stored in the Reporting and Analysis database.</p>
Answered	<p>Data type: Numeric</p> <p>Description: The number of queries with a current status of Answered.</p> <p>How calculated: Counts queries with a current status of Answered, regardless of query type.</p> <p>Data source: Derived for the report; not stored in the Reporting and Analysis database.</p>
Deleted	<p>Data type: Numeric</p> <p>Description: The number of queries with a current status of Deleted.</p> <p>How calculated: Counts queries with a current status of Deleted, regardless of query type.</p> <p>Data source: Derived for the report; not stored in the Reporting and Analysis database.</p>
Closed	<p>Data type: Numeric</p> <p>Description: The number of queries with a current status of Closed.</p> <p>How calculated: Counts queries with a current status of Closed, regardless of query type.</p> <p>Data source: Derived for the report; not stored in the Reporting and Analysis database.</p>
Status Changes	<p>Data type: Numeric</p> <p>Description: The number of state changes for a query.</p> <p>How calculated: Counts each status change for each triggered query. This count includes the initial entry of the query.</p> <p>Data source: Derived and stored in the Reporting and Analysis database.</p>

Queries: Query Dates

Query Dates report elements let you report query activity by date. You can also use this information to calculate how long queries have been in a particular state.

Report element	Description
----------------	-------------

Report element	Description
Query Status Date	<p>Data type: Date</p> <p>Description: The date when a query was assigned its current status in the InForm application.</p> <p>Date type: System date (GMT).</p>
First Candidate Date	<p>Data type: Date</p> <p>Description: The date when the query was first issued a Candidate status.</p> <p>Date type: System date (GMT).</p>
Last Candidate Date	<p>Data type: Date</p> <p>Description: The date when the query was last issued a Candidate status.</p> <p>Date type: System date (GMT).</p>
Opened Date	<p>Data type: Date</p> <p>Description: The date when the query was first opened in the InForm application.</p> <p>Date type: System date (GMT).</p>
First Reissued Date	<p>Data type: Date</p> <p>Description: The date when the query was first reissued.</p> <p>Date type: System date (GMT).</p>
Last Reissued Date	<p>Data type: Date</p> <p>Description: The date when the query was last reissued.</p> <p>Date type: System date (GMT).</p>
First Answered Date	<p>Data type: Date</p> <p>Description: The date when the query was first answered.</p> <p>Date type: System date (GMT).</p>
Last Answered Date	<p>Data type: Date</p> <p>Description: The date when the query was last answered.</p> <p>Date type: System date (GMT).</p>
Closed Date	<p>Data type: Date</p> <p>Description: The date when the query was closed.</p> <p>Date type: System date (GMT).</p>

Queries: Query Status by Month, Year

Queries: Query Status by Month, Year report elements let you create reports on query status by month. Use this report element with query counts to see the number of queries that were set to a

particular status each month.

If the report is sorted by one of the Month/Year report elements, the resulting report displays each month within a specified range. You can then add the Query Count element to see how many queries were assigned a particular status in each month.

Report element	Description
Query Status, Month, Year	<p>Data type: Date/Time</p> <p>Description: Each month/year combination within a specified range. Use with the Query Count report element to see how many queries were opened each month.</p> <p>Date type: System date (GMT), derived for display.</p>
Opened Month, Year	<p>Data type: Date/Time</p> <p>Description: Each month/year combination within a specified range. Use with the Query Count report element to see how many queries were opened each month.</p> <p>Date type: System date (GMT), derived for display.</p>
Answered Month, Year	<p>Data type: Date/Time</p> <p>Description: Each month/year combination within a specified range. Use with the Query Count report element to see how many queries were answered each month.</p> <p>Date type: System date (GMT), derived for display.</p>
Closed Month, Year	<p>Data type: Date/Time</p> <p>Description: Each month/year combination within a specified range. Use with the Query Count report element to see how many queries were closed each month.</p> <p>Date type: System date (GMT), derived for display.</p>

Queries: Cycle Times

Queries: Query Cycle Times report elements let you report on how long it takes for queries to move from one state to another.

Report element	Description
----------------	-------------

Report element	Description
Days Opened to Answered	<p>Data type: Numeric</p> <p>Description: The number of days from when a query was first opened to the last time it was answered.</p> <p>How calculated: The calculation begins on the first day when the status of a query was set to Open and ends on the most recent day when the status of a query was set to Answered. This value is calculated in multiples of 24 (hours) and is rounded down to the nearest whole number.</p> <p>For example, if a query is opened on day 1 at 10 AM and answered on day 3 at 9 AM, the Open to Answered value is 2 days.</p> <p>Data source: Derived and stored in the Reporting and Analysis database.</p>
Days Opened to Closed	<p>Data type: Numeric</p> <p>Description: The number of days from when a query was first opened to last time it was closed.</p> <p>How calculated: The calculation begins on the first day when the status of a query was set to Open and ends on the most recent day when the status of a query was set to Closed. This value is calculated in multiples of 24 (hours) and is rounded down to the nearest whole number.</p> <p>For example, if a query is opened on day 1 at 10 AM and closed on day 3 at 9 AM, the Answered to Closed value is 2 days.</p> <p>Data source: Derived and stored in the Reporting and Analysis database.</p>
Days Answered to Closed	<p>Data type: Numeric</p> <p>Description: The number of days from when a query was last answered to the last time it was closed.</p> <p>How calculated: The calculation begins on the first day when the status of a query was set to Answered and ends on the most recent day when the status of a query was set to Closed. This value is calculated in multiples of 24 (hours) and is rounded down to the nearest whole number.</p> <p>For example, if a query is answered on day 1 at 10 AM and closed on day 3 at 9 AM, the Answered to Closed value is 2 days.</p> <p>Data source: Derived and stored in the Reporting and Analysis database.</p>

Queries: Aging

Queries: Aging report elements let you report the length of time that queries have been in particular states.

Report element	Description
Days Candidate	<p>Data type: Numeric</p> <p>Description: The number of days a candidate query has been in the Candidate state.</p> <p>How calculated: This calculation only applies to queries that currently have a Candidate status. The returned value is either an exact count or an average, depending on other elements in the report.</p> <p>Data source: Derived for the report; not stored in the Reporting and Analysis database.</p>
Days Open	<p>Data type: Numeric</p> <p>Description: The number of days an open query has been in the Open state.</p> <p>How calculated: This calculation only applies to queries that currently have an Open status, including reissued queries. The returned value is either an exact count or an average, depending on other elements in your report. The calculation begins on the last date when a query had a status of Open and ends on the current date. The number of days is always rounded to the nearest whole number.</p> <p>Data source: Derived for the report; not stored in the Reporting and Analysis database.</p>
Days Answered	<p>Data type: Numeric</p> <p>Description: The number of days an answered query has been in the Answered state.</p> <p>How calculated: This report element returns values only for those queries that currently have an Answered status. The returned value is either an exact count or an average, depending on other elements in your report. The calculation begins on the last date when a query had a status of Answered, and ends on the current date. The number of days is always rounded to the nearest whole number.</p> <p>Data source: Derived for the report; not stored in the Reporting and Analysis database.</p>

Comment report elements

Comment report elements allow you to report on comments in your study. You can report on both item-level and form-level comments.

Comments

Report element	Description
Comment Date	<p>Data type: Date</p> <p>Description: The date when the comment was entered in the InForm application.</p> <p>Data source: Entered in the InForm application.</p>
Comment Text	<p>Data type: String</p> <p>Description: The comment text (limited to 255 characters).</p> <p>Data source: Replicated from the InForm transactional database to the Reporting and Analysis database.</p>
Comment Type	<p>Data type: Text</p> <p>Description: The comment type. Valid values are:</p> <ul style="list-style-type: none"> • Form—The comment is a form-level comment. • Item—The comment is an item-level comment. <p>Data source: Derived for the report; not stored in the Reporting and Analysis database. Database value decoded for display.</p>
Comment Count	<p>Data type: Numeric</p> <p>Description: The number of comments.</p> <p>How calculated: Counts all item-level and form-level comments.</p> <p>Data source: Derived and stored in the Reporting and Analysis database.</p>
Item Count	<p>Data type: Numeric</p> <p>Description: The number of item-level comments only. Item comments can be manually entered by an InForm user or automatically generated when an item is marked Incomplete.</p> <p>How calculated: Counts item-level comments only. Does not count form-level comments.</p> <p>Data source: Derived and stored in the Reporting and Analysis database.</p>
Form Count	<p>Data type: Numeric</p> <p>Description: The number of form-level comments only.</p> <p>How calculated: Counts form-level comments only. Does not count item-level comments.</p> <p>Data source: Derived and stored in the Reporting and Analysis database.</p>

User Info report elements

User Info: Users

User Info report elements allow you to gather information on your InForm users. Many of these elements are optional in your study design; report elements may return blank values.

Report element	Description
User Name	<p>Data type: String</p> <p>Description: The user name of the InForm user.</p> <p>Data source: Replicated from the InForm transactional database to the Reporting and Analysis database.</p>
First Name	<p>Data type: String</p> <p>Description: The first name of the InForm user.</p> <p>Data source: Replicated from the InForm transactional database to the Reporting and Analysis database.</p>
Last Name	<p>Data type: String</p> <p>Description: The last name of the InForm user.</p> <p>Data source: Replicated from the InForm transactional database to the Reporting and Analysis database.</p>
Title	<p>Data type: String</p> <p>Description: The job title of the InForm user.</p> <p>Data source: Replicated from the InForm transactional database to the Reporting and Analysis database.</p>
Description	<p>Data type: String</p> <p>Description: Text that describes details about the InForm user. If no description has been entered for the user, this column does not contain any data.</p> <p>Data source: Replicated from the InForm transactional database to the Reporting and Analysis database.</p>
Rights Group	<p>Data type: String</p> <p>Description: The InForm rights group to which the InForm user belongs.</p> <p>Data source: Replicated from the InForm transactional database to the Reporting and Analysis database.</p>
Email	<p>Data type: String</p> <p>Description: The email address of the InForm user.</p> <p>Data source: Replicated from the InForm transactional database to the Reporting and Analysis database.</p>

Report element	Description
Phone	<p>Data type: String</p> <p>Description: The phone number of the InForm user.</p> <p>Data source: Replicated from the InForm transactional database to the Reporting and Analysis database.</p>
User Count	<p>Data type: Numeric</p> <p>Description: The number of InForm users.</p> <p>Data source: Derived and stored in the Reporting and Analysis database.</p>
User Type	<p>Data type: String</p> <p>Description: The InForm user type.</p> <p>Data source: Replicated from the InForm transactional database to the Reporting and Analysis database and decoded for display.</p>
Creation Date	<p>Data type: Date/Time</p> <p>Description: The date the user record was created in the InForm application.</p> <p>Date type: System date (GMT).</p>
Activation Date	<p>Data type: Date/Time</p> <p>Description: The date the user was activated in the InForm application.</p> <p>Date type: System date (GMT).</p>
User Status	<p>Data type: String</p> <p>Description: The current status of the InForm user. Valid values are:</p> <ul style="list-style-type: none"> • Active • Inactive • Terminated <p>Data source: Replicated from the InForm transactional database to the Reporting and Analysis database.</p>
User Status Date	<p>Data type: String</p> <p>Description: The date when the current status was assigned to the InForm user.</p> <p>Data source: Replicated from the InForm transactional database to the Reporting and Analysis database.</p>

User Info: Group Associations

Group Associations report elements let you report on the InForm groups with which users are associated.

Report element	Description
Group Name	<p>Data type: String</p> <p>Description: The InForm rights group to which the user belongs.</p> <p>Data source: Replicated from the InForm transactional database to the Reporting and Analysis database.</p>
Group Type	<p>Data type: String</p> <p>Description: The type of the group with which the InForm user is associated. Valid values are:</p> <ul style="list-style-type: none"> • Query • Signature • Reporting • ItemGroup • ManageUser <p>Data source: Replicated from the InForm transactional database to the Reporting and Analysis database.</p>

User Info: Historical User Info

Historical User Info report elements allow you to see status information and group membership changes for users.

Note: To include the current first name, last name, and rights group for a user, use report elements from the User Info: Users folder.

There is also a standard report that shows the login history for a study within a selected date range.

For more information, see *Historical Login Report* (on page 319).

Report element	Description
User ID	<p>Data type: String</p> <p>Description: The user ID of the InForm user whose status or group membership changed.</p> <p>Data source: Replicated from the InForm transactional database to the Reporting and Analysis database.</p>

Report element	Description
Change Type	<p>Data type: String</p> <p>Description: Displays the following text, describing the type of change the user has undergone:</p> <ul style="list-style-type: none"> ▪ Group Change—The user has been added or removed from a group. ▪ Status Change—The user has been activated, deactivated, terminated, or reinstated. <p>Data source: Replicated from the InForm transactional database to the Reporting and Analysis database.</p>
Change Type Description	<p>Data type: String</p> <p>Description: Additional information about the type of change the user has undergone.</p> <ul style="list-style-type: none"> ▪ If the Change Type is Group Change, one of the following appears: <ul style="list-style-type: none"> ▪ Addition ▪ Deletion ▪ If the Change Type is Status Change, one of the following appears: <ul style="list-style-type: none"> ▪ Created ▪ Activated ▪ Deactivated ▪ Terminated ▪ Reinstated <p>Data source: Replicated from the InForm transactional database to the Reporting and Analysis database.</p>
Change Date	<p>Data type: Date/Time</p> <p>Description: Date and time when the user status or group membership change took place.</p> <p>Data source: Replicated from the InForm transactional database to the Reporting and Analysis database.</p>
Change Username	<p>Data type: String</p> <p>Description: User name of the user who updated the status or group membership information for the user whose status or group membership changed.</p> <p>Data source: Replicated from the InForm transactional database to the Reporting and Analysis database.</p>

Report element	Description
Reason for Change	<p>Data type: String</p> <p>Description: The reason for the user status or group membership change, as generated by the InForm application.</p> <p>Data source: Replicated from the InForm transactional database to the Reporting and Analysis database.</p>
Change Group Name	<p>Data type: String</p> <p>Description: For users whose group membership information changed, the group name to which the user was added or from which the user was removed.</p> <p>Data source: Replicated from the InForm transactional database to the Reporting and Analysis database.</p> <p>Note: If the user group membership information did not change, data does not appear in this column.</p>
Change Group Type	<p>Data type: String</p> <p>Description: For users whose group membership information changed, the group type of the group to which the user was added or from which the user was removed.</p> <p>Data source: Replicated from the InForm transactional database to the Reporting and Analysis database.</p> <p>Note: If the user group membership information did not change, data does not appear in this column.</p>

Predefined filters

Use predefined filters to narrow results in your ad hoc reports. These filters are shipped with the InForm application and can be used in all reports.

Note: You can also create filters to be used within reports. Each user-created filter is saved with the report in which it was created. The filter can be used only with that report and cannot be used globally across multiple reports.

Filters

Predefined filters let you limit your report to specific subjects, visits, and forms.

Filter	Description
--------	-------------

Filter	Description
All Enrolled Subjects	Limits the report to subjects who have been enrolled in the study. The resulting report includes all active subjects who were ever enrolled in any of these states: <ul style="list-style-type: none"> • Enrolled • Enroll Override • Randomized • Dropped Out • Complete
All Enrolled Subjects except Dropped	Limits the report to subjects who were ever enrolled in the study, excluding those subjects who dropped out. The resulting report includes data about subjects in any of these states: <ul style="list-style-type: none"> • Enrolled • Enroll Override • Randomized • Complete
Active Subjects	Limits the report to active subjects; that is, all subjects who have been enrolled in the study, excluding those who have dropped out or completed the study. The resulting report includes data about subjects in any of these states: <ul style="list-style-type: none"> • Enrolled • Enroll Override • Randomized
Clinical Visit	Limits the report to data about only clinical, or subject, visits. Use this filter to include information only about clinical visits in your report. This filter excludes data for these visit types: <ul style="list-style-type: none"> • Screening • Enrollment • Reg Docs • Visit Report
Clinical Form	Limits the report to information on clinical forms (forms whose type is CRF). This filter excludes these types of forms: <ul style="list-style-type: none"> • Enrollment • Monitor RegDoc • Monitor Visit Report
Expected Forms: Scheduled Visits	Limits the report to those clinical forms that are expected because they appear in scheduled visits.

Filter	Description
Expected Forms: Scheduled or Started Visits	Limits the report to expected forms that are expected because they appear in scheduled or started visits.
Expected Forms: Scheduled or Started Visits to Date	Limits the report to forms that are expected because they appear in visits that are scheduled to occur or have started by a particular date. (This filter prompts the report user to enter a date.)
Expected Forms: Scheduled Visits or Started Forms to Date	Limits the report to forms that have started by a given date or are expected because they appear in visits that are scheduled to occur by a given date. (This filter prompts the report user to enter a date.)
Data Complete (Queries Allowed)	Limits the report to forms that are data complete; that is, forms for which all required items have been completed. Note that this filter includes forms that have associated queries in any state.
Data Complete, No Open Queries	Limits the report to data for forms that are data complete; that is, forms for which all required items have been completed. This filter excludes forms that have associated open queries and candidate queries.
Data Clean: Complete and SV	<p>Limits the report to forms that are data complete and clean. This filter includes forms for which:</p> <ul style="list-style-type: none"> • All required items have been completed. • All SV Required items have been source verified using the InForm application. <p>The filter excludes forms with open and answered queries associated with them.</p>

Reporting on clinical data

Clinical data reports

You can use the Ad Hoc Reporting workspace to create reports that contain:

- **Study management data.**

The study management portion of the Ad Hoc Reporting tree allows you to create reports on the progress of your study.

- **Clinical data.**

The clinical portion of the Ad Hoc Reporting tree allows you to create reports that display entered values from the clinical forms in your study.

Reporting on clinical data

When you create reports using clinical data, keep in mind:

- Clinical data availability and organization are unique to each study; for this reason, reports that contain clinical data may not be validated to use across studies.
- Data that is entered on clinical forms can be changed several times during the course of a study. Although the InForm application captures audit trail data and stores it in the Reporting and Analysis database, the available clinical data elements in the Ad Hoc Reporting tree return only the most current values and revisions for any controls in clinical forms.
- A study is likely to go through many study versions. For example, forms and items might be added to or deleted from the original study design. The Clinical Data by Form folder contains data elements for every form and item that have ever been used in any version of the study.
- Your site associations and the display override settings on items determine the way reporting elements appear to you in the Ad Hoc Reporting workspace. For example, if an item is not visible to you in the InForm application, when you create a report that contains the item, the cells in the row that corresponds to the item contain the text **N/A**.
- When creating reports using clinical data, you must include a unique identifier for the study component on which to report. For example, to create a clinical report about a particular subject, you must use whatever identifiers uniquely identify the subject in your study. Depending on your study design, you may use:
 - Subject Number, if unique Subject Numbers are assigned for your study.
 - Subject Number and Subject Initials, if unique Subject Numbers are not assigned for your study.
 - SubjectID.
- When the same form is used in multiple visits, if a subject does not have any instances of the form, the resulting report may display extra rows that contain incomplete information. For more information, see *Reporting on multi-instance forms and visits* (on page 159).

Clinical reporting tree

The clinical portion of the Ad Hoc Reporting tree is built from the structure of the Reporting and Analysis database; report topics and elements are included for each form and control stored in the Reporting and Analysis database. The database structure is dependent on the study design.

The clinical portion of the Ad Hoc Reporting tree resides in the Clinical Data by Form and Clinical Data by Associated Form folders. The following image illustrates the structure of the Clinical Data by Form folder. The Clinical Data by Associated Form folder includes the same data that is in the Clinical Data by Form folder for each form that is part of an association.

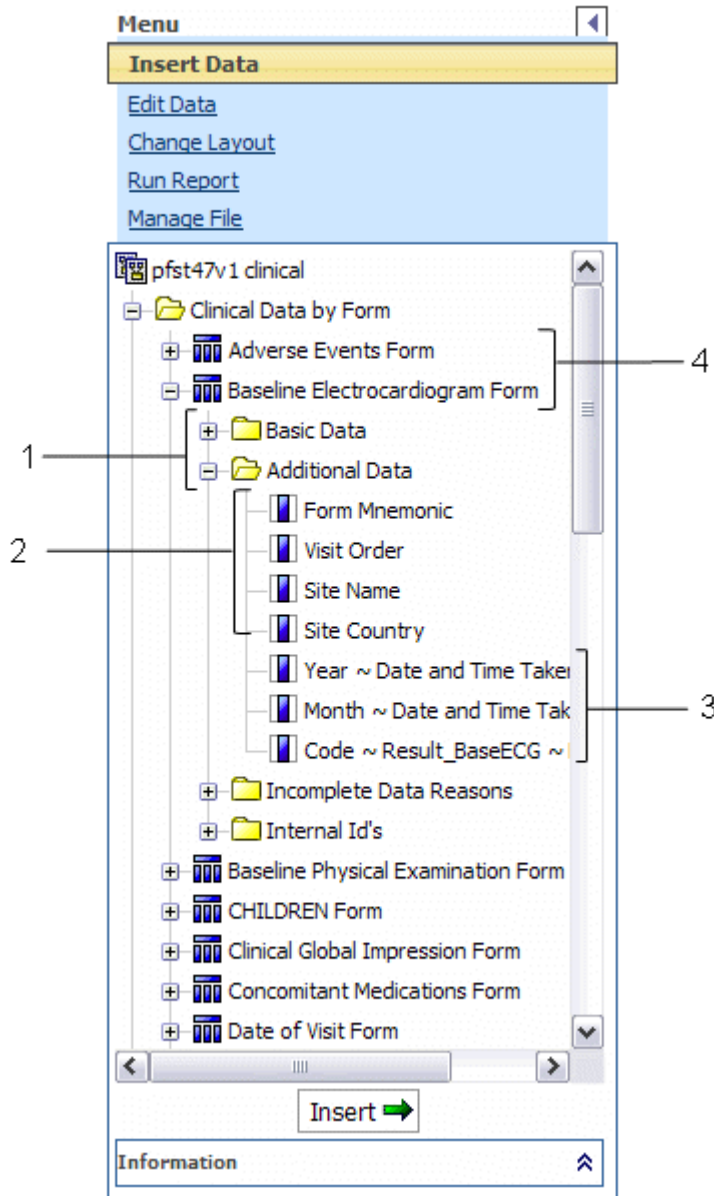

- **1**—(Points to the Basic Data and Additional Data folders for a clinical form.) The **report element folders** consist of clinical reporting elements.
- **2**—(Points to the study management report elements in the Additional Data folder.) To create reports with clinical data, include **study management report elements** that identify the study component (subject, visit, and so forth) on which you want to report. The Clinical Data by Form folder contains some report elements from the Trial Management package; you can use these elements to identify visit, subject, and site in your clinical reports, and to identify unique instances of repeating visits, forms, or itemsets.
- **3**—(Points to report topics for clinical forms.) **Clinical report topics** reflect the item questions that appear on the forms within your study. Labels for reporting elements may or may not have been customized for display in the Ad Hoc Reporting tree.
- **4**—(Points to the clinical form report topics in the Clinical Data by Form folder.) Each **clinical form report topic** corresponds to a form or an itemset within your study.

Clinical reporting elements

Each report topic includes the following sub-folders.

Clinical reporting element	Description
Basic Data	<p>The Basic Data folder provides easy access to frequently run reports. You can select the entire folder to create a basic report for a given form that includes easy-to-read, meaningful data and appropriate key elements to ensure report accuracy.</p> <p>The Basic Data folder contains:</p> <ul style="list-style-type: none"> • Clinical report elements that return clinical values that are associated with the form. • Text values of items rather than database codes, as well as most of the available date formats. • Several reporting elements you can use to identify site, subject, and visit. These elements also appear in the InForm Trial Management portion of the Ad Hoc Reporting tree.
Additional Data	Contains report elements that you can use for more advanced reports. Some of the included elements return database codes rather than text values for fields, normalized values, and unit codes.
Incomplete Data Reason	Contains reporting elements that return text explanations for incomplete items.
Internal IDs	Contains reporting elements that return values that uniquely identify a record in the database.

Note: When the study-specific clinical package is originally generated, the labels of each reporting element match the labels in the study design. Report topics are placed within default folders (Basic Data, Additional Data, Incomplete Data Reason, and Internal IDs).

Labels and folder locations for elements can be customized. This guide describes label naming conventions and element folder locations. Your clinical data model labels and folders may vary.

Creating reports with both clinical and study management data

If you create reports that use elements from both the clinical portion and the study management portion of the Ad Hoc Reporting tree, keep the following restrictions in mind:

- You can include data from only one clinical form in any report that combines both clinical and study management data.
- Do not use elements from the following study management report topics in reports that also contain clinical elements:
 - Sections
 - Items
 - Rules
 - Queries
 - Comments

Report results will be difficult to interpret if you include these report elements.

- For best results, include only one element from the study-specific clinical data model with no more than two elements from the Trial Management data model for each report that includes both clinical and study management data.

Note: This suggestion does not apply to DOV elements.

Clinical data in the Ad Hoc Reporting tree

Default labeling

Default labels for clinical report elements come from properties that are established in the study design code. Study designers specify different pieces of information to identify each form, itemset, or control in your study. The InForm application retrieves the text in these properties and uses it for default labeling of the clinical report elements.

The InForm application creates default labels for elements that appear in the Clinical Data by Forms folder as follows:

optional prefix~ control reference~ item reference

Note: You cannot customize report element names.

Report element label portion	Description
<i>optional prefix</i>	<p>The type of element:</p> <ul style="list-style-type: none"> • None • Code • Unit • Unit Code • Normalized • Date • Time • Month Yr • YYYY/MM/DD • HH24:MM:SS • Month • Year
<i>control reference</i>	<p>Text that identifies the specific control for the item.</p> <ul style="list-style-type: none"> • Controls other than checkboxes—The InForm application uses the following properties: <ul style="list-style-type: none"> ▪ Caption property for the control, if it exists. ▪ RefName property for the control, if no caption exists. • Checkboxes—The InForm application uses the following properties: <ul style="list-style-type: none"> ▪ Label property of the child control element, if it exists. ▪ Caption property of the child control element, if no label exists. ▪ RefName property for the child control element, if no label or caption exists.
<i>item reference</i>	<p>Text that identifies the item as it appears in the study. The InForm application uses the following properties:</p> <ul style="list-style-type: none"> • Itemset Column Header property for the item, if it exists and is not the default. • Question property for the item, if no itemset column header exists.

Note: Study designers should make sure that Itemset Column Header definitions (values of the Central Designer Short Question property on items in a repeating section) are unique within a study. If there are duplicate Itemset Column Header values in a study, the Reporting and Analysis module appends each value with a suffix to uniquely identify it. For example, if two itemsets share the Itemset Column Header **VSItemset**, the Reporting and Analysis module identifies them as **VSItemset** and **VSItemset~1**.

Clinical report elements: forms and itemsets

When the clinical portion of the Reporting and Analysis database is generated, database views are created for each form and itemset in your study. When the InForm application generates the study-specific clinical reporting package, each of these database views is represented as a report element.

Each report element that appears in the Clinical Data by Form folder corresponds to either a form, or an itemset on a form.

Note: Alternate forms are also represented by a report element.

Report elements are labeled with an appropriate suffix (Form or Itemset). In addition, the labels for itemset report topics begin with a prefix that identifies the form on which they appear.

Code report elements

Some clinical data is represented both by a text value and a code in the Reporting and Analysis database. The InForm application saves a unique, audited data record for the data (code) and a more readable display (text value) that can be adjusted if necessary. For example, a *Yes* answer to a question on a form is stored both as Yes and as 1 in the database.

Clinical report elements that appear in the Ad Hoc Reporting tree allow you to include either (or both) the text answer to a question or the code values in your reports. Text values are more readable in a report and are therefore included in the Basic Data folder for easy access. By default, the labels for report elements that return code values begin with the prefix **Code~** and appear in the Additional Data folder for any form in the Ad Hoc Reporting tree.

Data that require units of measure

Some answers to form questions are qualified by a unit of measurement. For example, the weight of a subject may be measured in kilograms or pounds.

For each question that requires a unit of measure qualifier, the following report elements appear in the Ad Hoc Reporting tree:

- Entered value.
- Unit of measure.
- Normalized value.

Itemsets, repeating visits, and repeating forms

Itemsets and repeating forms may capture data multiple times for a given subject. Forms may also appear in repeating visits. You can report on data that was collected at different iterations of itemsets, repeating forms, and repeating visits using index elements from the Ad Hoc Reporting tree to

identify specific itemset, form, and visit instances.

Note: The Internal IDs folders also contain the following report elements: Form Index, Itemset Index, and Visit Index. While these elements also identify specific instances of repeating forms, visits, or items, they return the actual database value that is assigned to these instances.

- **Form index**—The report topic for any repeating form contains a Form Index report element. Use this element to separate data from each instance of the repeating form.
- **Itemset index**—The report topic for any form with an itemset contains an Itemset Index report element. Use this element to separate data from each instance of the itemset.
- **Visit index**—The report topic for any form or itemset that appears within a repeating (unscheduled) visit contains a Visit Index report element. Use this element to identify the visit instance in which data was gathered.

Deleted itemset and form instances

InForm users can mark both Add Entry itemset instances and instances of repeating forms for deletion. (By marking a form or itemset for deletion, the InForm application removes the form or itemset from the case report book, but keeps a record of the form or itemset in the database.) The Ad Hoc Reporting tree allows you to report on itemset and form instances that have been marked for deletion.

The report topic for any itemset or repeating form instance contains an element, **IsDeleted**, which returns data on whether the form or itemset was deleted in the InForm application. When you create reports on forms and itemsets, you may want to include these report elements to identify instances that have been marked for deletion, and add a filter to show information for forms or itemsets.

Note: You cannot delete or undelete a Repeating Data itemset.

Date controls

Date controls in your study are represented in different ways in the Ad Hoc Reporting tree. Some dates are stored as numeric values, and others are string values. For example, for a start date for an adverse event, the date control could appear as Date ~ Start Date, Month Yr ~ Start Date, and so forth, depending on your study design. This format determines the data that appears in ad hoc reports.

In addition, the format for dates in the Reporting and Analysis module is determined by Cognos settings, and locale settings for your InForm study.

Incomplete Data Reasons

Each clinical report topic contains an Incomplete Data Reasons folder. Report elements that appear in the folder return a textual value with the reason why an item question is marked Incomplete or, for a Repeating Data itemset, the reason why an item is Blank.

Reference information for report elements

Report element (Default label)	Description	Default folder
-----------------------------------	-------------	----------------

Report element (Default label)	Description	Default folder
Code report elements		
[control reference] Example: Cardiovascular ~ Cardiovascular	Returns the text value that was entered during data entry.	Basic Data
Code~ [control reference] Example: Code ~ Cardiovascular ~ Cardiovascular	Returns the database code that corresponds to the value entered during data entry.	Additional Data
Data that require units of measure		
[control reference] Example: Weight	Returns the value that was entered during data entry. For instance, if the InForm user entered 135 on the form, the Weight element returns 135.	Basic Data
Unit~ [control reference] Example: Unit~ Weight	Returns the specific unit of measure that was selected at data entry. The label for this element has the prefix Unit ~ . For example, the Unit ~ Weight element might return these values: kg or lbs.	Basic Data
Normalized~ [control reference] Example: Normalized~ Weight	Returns the normalized value; the InForm application converts measurements to the same, or normalized, unit of measure, based on a base unit of measure that is defined for your study. For example, if the base unit of measure is kilograms, the InForm application converts all entered values to kilograms and stores that value as a normalized value.	Additional Data
Unit Code~ [control reference] Example: Unit Code ~ Weight	Returns the code value for the unit of measure, as it is stored in the database. The label for this element has the prefix Unit Code~ .	Additional Data
Date controls		
Date ~ [control label] Example: Date~ Start Date	Returns a date that includes Month, Day, and Year. If data is not entered, or is marked as Unknown in the InForm application, data does not appear for this report element.	Basic Data
Month Yr ~ [control label] Example: Month Yr ~ Start Date	Returns a date that includes Month and Year. If data is not entered, or is marked as Unknown in the InForm application, data does not appear for this report element.	Basic Data

Report element (Default label)	Description	Default folder
YYYYMMDD ~ [control label] Example: YYYYMMDD ~ Date Started	Returns a text string in YYYYMMDD format. Data displays here when a date control allows empty or unknown values.	Basic Data
Time ~ [control label] Example: Time ~ Date Taken	Returns a standard time (24-hour clock) in HH:MM:SS format. If data is not entered, or is marked as Unknown in the InForm application, data does not appear for this report element. This report element appears only for those InForm controls that collect the time portion of a date.	Basic Data
HH24:MM:SS ~ [control label] Example: HH24:MM:SS~ Date Taken	Returns a text value for time (24-hour clock). Data displays here when a date control allows empty or unknown values. This report element appears only for those InForm controls that collect the time portion of a date.	Basic Data
Year ~ [control label] Example: Year ~ Date Taken	Returns only the year portion of a date. If data is not entered, or is marked as Unknown in the InForm application, data does not appear for this report element.	Additional Data
Month ~ [control label] Example: Month ~ Date Taken	Returns only the Month portion of a date. If data is not entered, or is marked as Unknown in the InForm application, data does not appear for this report element.	Additional Data
Itemsets, repeating visits, and repeating forms		
Visit Index	Returns a numeric value that identifies an instance of a repeating visit.	Basic Data
Form Index	Returns a numeric value that identifies an instance of a repeating form.	Basic Data
Itemset Index	Returns a numeric value that identifies an instance of an itemset.	Basic Data
Deleted itemsets and form instances		

Report element (Default label)	Description	Default folder
Deleted form	Indicates whether the reported form instance was marked for deletion in the InForm application. Use this report element with the Form Index element to see form instances that are deleted. Values are: <ul style="list-style-type: none"> • Y—Form was marked for deletion. • N—Form was not marked for deletion. 	Basic Data
Deleted itemset	Indicates whether the reported Add Entry itemset was marked for deletion in the InForm application. Use this report element with the Itemset Index to see itemsets that are deleted. Values are: <ul style="list-style-type: none"> • Y—Itemset was marked for deletion. • N—Itemset was not marked for deletion. <p>Note: You cannot delete or undelete a Repeating Data itemset.</p>	Basic Data
Incomplete data reasons		
Not Done ~ [item label] Example: Not Done ~ Unit Dose	Returns a textual value that indicates why an item is marked Incomplete.	Incomplete Data Reasons
Blank~[item label] Example: Not Done~HeartRate	Indicates whether the reported item appears in a Repeating Data itemset, and is blank, as specified in the study design. <ul style="list-style-type: none"> • Y—Item is blank. • N—Item is not blank. 	Incomplete Data Reasons
Transactional data		
CREATEDBYUSERID	User ID of the user who started the form by entering data on the form or triggering a rule that entered data on the form. When the review schema is recreated, this column displays the system user ID.	Basic Data
CREATEDBYDATETIME	Date and time when the reported form was started; that is, when a user entered data on the form or triggered a rule that entered data on the form. When the review schema is recreated, this column displays the date and time when the review schema was recreated.	Basic Data

Report element (Default label)	Description	Default folder
MODIFIEDBYUSERID	User ID of the user who started or modified the form by entering or modifying data or triggering a rule that entered or modified data on the form. When the review schema is recreated, this column displays the system user ID.	Basic Data
MODIFIEDBYDATE TIME	Date and time when the reported form was most recently started or modified; that is, when a user entered or modified data on the form or triggered a rule that entered or modified data on the form. When the review schema is recreated, this column displays the date and time when the review schema was recreated.	Basic Data

Reporting on multi-instance forms and visits

About multi-instance forms and visits

Your study may include any number of multi-instance forms or items, including:

- Repeating forms.
- Non-repeating forms that occur within repeating visits.
- Itemsets.

When you create ad hoc reports, you can include data from more than one of these multi-instance forms, items, or visits on the same report.

A report can accurately provide data on the adverse events and concomitant medications for a subject. For example, it can accurately illustrate the relationships between:

- The subject and each adverse event.
- The subject and each medication.
- The adverse event and its associated concomitant medication.

Note: When the same form is used in multiple visits, if a subject does not have any instances of the form, the resulting report may display extra rows that contain incomplete information.

Filtering reports with more than one multi-instance form or itemset

You can apply filters to reports that contain data from more than one multi-instance form. However, results will vary depending on where you apply the filter. The following table describes how reporting behavior differs, depending on the filtered element.

You can filter on	For these results
-------------------	-------------------

You can filter on	For these results
A report element from a single-instance form	<p>Rows for filtered-out items are removed.</p> <p>Example: Report contains: SubjectID, Gender, Adverse events, and Concomitant Medications.</p> <p>Filter: Gender column = Male</p> <p>Results: Report removes all rows for female subjects.</p>
A report element from a multi-instance form	<p>Rows for filtered-out items contain the text N/A, but are not removed.</p> <p>Example: Report contains: SubjectID, Gender, Adverse events, and Concomitant Medications.</p> <p>Filter: Adverse event = Depression</p> <p>Results: Report does not remove rows for other adverse events. Instead, N/A appears in the Adverse Events column for all other adverse events.</p>

Reporting on forms with itemsets

For forms that contain a non-repeating section and an itemset, an association exists between the itemset and non-repeating section. You can create ad hoc reports to show the relationship between the data in a non-repeating section and its associated itemsets. The report output contains columns with data from the non-repeating section, and columns with data from each itemset.

For example, if an itemset exists on the Vital Signs form and the Demographics form, the itemset is associated with the non-repeating sections on each form.

- You can only create reports with data from a non-repeating section and itemsets that exist on the same form, and are therefore associated.
- You can create reports with data from a non-repeating section and itemsets that exist on non-repeating or repeating forms.
- For reports that contain a non-repeating section and multiple itemsets, there is no relationship between the itemsets.
- During study versioning:
 - If a non-repeating section with an associated itemset is deleted, the association between the non-repeating section and the itemset remains for subjects with data in the non-repeating section. You can still generate reports using the existing data from the deleted section for those subjects. For subjects that do not have data in the non-repeating section, the columns in the report do not contain data.
 - If an itemset with an associated non-repeating section is deleted, the association between the itemset and the non-repeating section remains for subjects with data in the itemset. You can still generate reports using the existing data from the deleted itemset for those subjects. For subjects that do not have data in the itemset, the columns in the report do not contain data.
 - An association is created between a non-repeating section and an itemset when:

- A non-repeating section is added to a form that contains an itemset.
- An itemset is added to a form that contains a non-repeating section.

Example 1: One non-repeating section and one itemset

This example shows the report output for subjects AAA and AAB. In this example, the non-repeating section appears on a repeating form. Therefore, more than one instance of the non-repeating section exists in the study.

Subject Number from Flat portion	Subject Initials	Form Index [▲]	Deleted Form	Treatment Name	Subject Initials from Itemset	Itemset Index [▲]	Deleted Itemset	Date ~ New Dose Start	New Dose
100	AAA	1	N	Treat1	AAA	1	N	Jan 13, 2006 12:00:00 AM	10
100	AAA	1	N	Treat1	AAA	2	N	Jan 27, 2006 12:00:00 AM	20
100	AAA	2	N	Treat2	AAA	1	N	Jan 26, 2006 12:00:00 AM	40
100	AAA	2	N	Treat2	AAA	2	N	Jan 25, 2006 12:00:00 AM	41
100	AAA	2	N	Treat2	AAA	3	N	Jan 26, 2006 12:00:00 AM	42
101	AAB	1	N	Treat6	AAB	1	N	Jan 12, 2006 12:00:00 AM	60
101	AAB	1	N	Treat6	AAB	2	N	Jan 27, 2006 12:00:00 AM	61

3
4

1
2

1—Data from the non-repeating section on each form for subjects AAA and AAB.

2—Data for the itemsets on each form for subjects AAA and AAB.

3—The Form Index column indicates that the non-repeating section appears on two forms for subject AAA, and one form for subject AAB.

4—The Itemset Index column indicates that:

- For subject AAA, the non-repeating section is associated with two itemset instances on Form 1 (rows 1 and 2), and three itemset instances on Form 2 (rows 3-5).
- For subject AAB, the non-repeating section is associated with two itemset instances on Form 1 only (rows 6 and 7).

Example 2: Incomplete non-repeating section and one itemset

This example shows the report output for subjects AAA, AAB, and AAC when the data in the non-repeating section is incomplete for subject AAC.

Subject Number from Flat portion<>	Subject Initials	Form Index<>	Deleted Form	Treatment Name	Subject Initials from Itemset	Itemset Index<>	Deleted Itemset	Date ~ New Dose Start	New Dose
100	AAA	1	N	Treat1	AAA	1	N	Jan 13, 2006 12:00:00 AM	10
100	AAA	1	N	Treat1	AAA	2	N	Jan 27, 2006 12:00:00 AM	20
100	AAA	2	N	Treat2	AAA	1	N	Jan 26, 2006 12:00:00 AM	40
100	AAA	2	N	Treat2	AAA	2	N	Jan 25, 2006 12:00:00 AM	41
100	AAA	2	N	Treat2	AAA	3	N	Jan 26, 2006 12:00:00 AM	42
101	AAB	1	N	Treat5	AAB	1	N	Jan 12, 2006 12:00:00 AM	60
101	AAB	1	N	Treat5	AAB	2	N	Jan 27, 2006 12:00:00 AM	61
					AAC	1	N	Jan 6, 2006 12:00:00 AM	80
					AAC	2	N	Jan 25, 2006 12:00:00 AM	81

1—The Form Index column indicates that the non-repeating section appears on two forms for subject AAA, and one form for subject AAB. For subject AAC, the non-repeating section does not contain data. However, its associated itemsets for subject AAC appear in rows 8 and 9.

2—The Itemset Index column indicates that:

- For subject AAA, the non-repeating section is associated with two itemset instances on Form 1 (rows 1 and 2), and three itemset instances on Form 2 (rows 3-5).
- For subject AAB, the non-repeating section is associated with two itemset instances on Form 1 (rows 6 and 7).
- For subject AAC, the non-repeating section is associated with two itemset instances (rows 8 and 9).

3—For subject AAC, the non-repeating section that is associated with Itemset Instance 1 and Itemset Instance 2 does not contain data. Therefore, blank cells appear for the columns that correspond to the data for the non-repeating section.

Example 3: Incomplete non-repeating section, one itemset, and an additional form

This example shows the report output for subjects AAA, AAB, and AAC when the data in the non-repeating section is incomplete for subject AAC, and data from the Subject Identification (SI) form is included in the report.

For subjects AAA and AAB, the itemset data is associated with the data in the non-repeating section, and the data in the non-repeating section is associated with the data on the SI form. Therefore, in this instance, the itemset data is associated with the data on the SI form for subjects AAA and AAB. Because data is not entered in the non-repeating section for subject AAC, the data that exists for subject AAC on the SI form is not associated with the itemset data, and therefore does not appear in the report, even if data for subject AAC exists on the SI form.

Subject Number from Flat section >	Subject Number from SI form	Subject Initials	Form Index <	Deleted Form	Treatment Name	Subject Initials from Itemset	Itemset Index <	Deleted Itemset	Date ~ New Dose Start	New Dose
100	AAA	AAA	1	N	Treat1	AAA	1	N	Jan 13, 2006 12:00:00 AM	10
100	AAA	AAA	1	N	Treat1	AAA	2	N	Jan 27, 2006 12:00:00 AM	20
100	AAA	AAA	2	N	Treat2	AAA	1	N	Jan 26, 2006 12:00:00 AM	40
100	AAA	AAA	2	N	Treat2	AAA	2	N	Jan 25, 2006 12:00:00 AM	41
100	AAA	AAA	2	N	Treat2	AAA	3	N	Jan 26, 2006 12:00:00 AM	42
101	AAB	AAB	1	N	Treat6	AAB	1	N	Jan 12, 2006 12:00:00 AM	60
101	AAB	AAB	1	N	Treat6	AAB	2	N	Jan 27, 2006 12:00:00 AM	61
						AAC	1	N	Jan 6, 2006 12:00:00 AM	80
						AAC	2	N	Jan 25, 2006 12:00:00 AM	81

1—Non-repeating section data.

2—SI form data.

3—Non-repeating section data, continued.

4—For subject AAC, the non-repeating section that is associated with Itemset Instance 1 and Itemset Instance 2 does not contain data. Therefore, blank cells appear for the columns that correspond to the data for the non-repeating section, and the columns that correspond to the data for the SI form. An association cannot be made between the itemset data and the data on the SI form without data in the non-repeating section.

5—The Itemset Index column indicates that:

- For subject AAA, the non-repeating section is associated with two itemset instances on Form 1 (rows 1 and 2), and three itemset instances on Form 2 (rows 3-5).
- For subject AAB, the non-repeating section is associated with two itemset instances on Form 1 (rows 6 and 7).
- For subject AAC, the non-repeating section is associated with two itemset instances (rows 8 and 9).

6—The Form Index column indicates that the non-repeating section appears on two forms for subject AAA, and one form for subject AAB. For subject AAC, the non-repeating section does not contain data. Therefore, data from the SI form does not appear for subject AAC; however, the itemset instances associated with the non-repeating section for subject AAC appear in rows 8 and 9.

Example 4: One non-repeating section with multiple itemsets

This example shows the report output for subject TTT when data in the non-repeating section is associated with multiple itemsets.

Note: No relationship exists between the itemsets.

Subject Number	Subject Initials	rdcSTDR ~ Is the subject currently on study drug Rivaroxaban Placebo	rdcSTDR2 ~ Is the subject currently on study drug Warfarin Placebo	Subject Initials	Itemset Index	Date ~ Stop date	Adverse Event Is this a serious Adverse Event ~ Reason	Subject Initials	Itemset Index	Date ~ Stop date	Is this a serious adverse event ~ Reason
200	TTT	Yes	Yes	TTT	1	Dec 28, 2010 12:00:00 AM	Yes. Bleeding or Non-Bleeding?	TTT	1	Dec 28, 2010 12:00:00 AM	Adverse Event
200	TTT	Yes	Yes	TTT	2	Dec 31, 2010 12:00:00 AM	Yes. Bleeding or Non-Bleeding?	TTT	2	Dec 29, 2010 12:00:00 AM	Adverse Event
200	TTT	Yes	Yes	TTT	3	Dec 17, 2010 12:00:00 AM	Yes. Bleeding or Non-Bleeding?				

1
2
3

1—Non-repeating section data.

2—Data for the first itemset that is associated with the non-repeating section. Three instances of the itemset exist in the study.

3—Data for the second itemset that is associated with the non-repeating section. Two instances of the itemset exist in the study.

Example 5: Incomplete non-repeating section with multiple itemsets

This example shows the report output for subjects BBA and AQW when data in a non-repeating section is complete for subject BBA, and incomplete for subject AQW.

- When the non-repeating section that is associated with an itemset is complete, the report contains the minimum number of rows required to display the data for each instance of each itemset.
- When the non-repeating section that is associated with an itemset does not contain data, or contains incomplete data, the report contains a separate row for each instance of each itemset.

Note: No relationship exists between the itemsets.

Subject Number	Subject Initials from flat portions	Accession 1 (flat portion items)	Subject Initials from Itemset1	Low	High	Itemset Index from Itemset1	Subject Initials from Itemset2	Low	High	Itemset Index from Itemset2
300	BBA	1	BBA	10	20	1	BBA	200	210	1
300	BBA	1	BBA	11	12	2	BBA	210	211	2
300	BBA	1					BBA	215	217	3
301	AQW		AQW	200	201	1				
301	AQW		AQW	202	203	2				
301	AQW		AQW	204	205	3				
301	AQW						AQW	300	301	1
301	AQW						AQW	302	303	2

1—For subject BBA, all three items from the non-repeating section that appear in the report are complete, and data for five instances appears for two itemsets. Three instances of Itemset 1 exist, and two instances of Itemset 2 exist.

Because data in the non-repeating section is complete for subject BBA, the data for all five itemset instances appears in three rows in the report output. The data for the two instances of Itemset 1 and the first two instances of Itemset 2 appears in the first two rows, and the data for the additional instance of Itemset 2 appears in the third row.

2—For subject AQW, at least one of the three items that appear in the non-repeating section for the report is incomplete.

3—For subject AQW, data for five itemset instances appears for two itemsets. Three instances of Itemset 1 exist, and two instances of Itemset 2 exist.

Because the data from the non-repeating section that appears in the report is incomplete for subject AQW, the data for all five itemset instances appears in five rows in the report output, with each row corresponding to an itemset instance. The data for the three instances of Itemset 1 appears in the first three rows, and the data for the two instances of Itemset 2 appears in the last two rows.

Note: If a non-repeating section contains incomplete data items, but the incomplete items are not included in the report, the report does not have a row for each instance of each itemset.

Reporting on associated forms

You can create an ad hoc report to show the relationship between data in two associated forms.

- The associated forms must be repeating.
- The forms must be marked as associated in the study design application (either the InForm Architect application or the Central Designer application).
- The report must only contain data from two associated forms.
- If the report topics in the report are not from associated forms, data does not display.
- If the report contains data from more than two associated forms, data does not display.

Use the report data in the Clinical Data by Associated Form package to create ad hoc reports with associated form data.

Note: You cannot create an ad hoc report that contains data from both the Clinical Data by Form report element and the Clinical Data by Associated Form package.

Example: Adverse Events and Concomitant Medications association

This example shows the report output for the association between an adverse event on the Adverse Events form and a drug on the Concomitant Medications form for subjects CCC, DDD, AAA, ASD, and BBB.

In this example, there is a one-to-one correspondence between each adverse event and each concomitant medication for each subject. If, for example, subject CCC reported two adverse events associated with Drug1, an additional row for subject CCC would exist with Event2 data in the Event column, and Drug1 data in the Drug name column.

Subject Initials	Event	Drug name	Site Mnemonic
PRE	Diabetes	Anacin	01

1 2

- **1**—(Points to the **Event** column.) The Event column contains adverse event data for each subject.
- **2**—(Points to the **Drug name** column.) The Drug name column contains concomitant medication data for each subject.

CHAPTER 3

InForm standard reports

In this chapter

Standard reports	168
InForm standard reports by category	169
Running and saving standard reports	170
Opening a standard report in the Report Studio application	172
Components of a standard report.....	173
Data in standard reports	178
Report folders.....	179
Report actions.....	180
Query reports.....	181
Case Report Form (CRF) reports.....	232
Item reports	287
Subject reports.....	301
Audit Trail reports	316

Standard reports

The InForm application includes a set of management reports that provide information about the progress of a study. These reports contain several categories of information, and several views of each report are available. For example, you can display the query status reports by site and by user; month by month or study-to-date; and in text or graphical formats. Standard reports are created using the Report Studio application and are validated and optimized for the InForm application.

There are five categories of standard reports:

- Query reports provide information about query aging, status, and cycle time.
- Case Report Form (CRF) reports provide information about the progress of data entry and query activity on started case books.
- Item reports provide information about the progress of item source verification, as well as listings of items on forms.
- Subject reports provide information on the progress of case book completion for individual subjects. These reports also provide subject enrollment and dropout counts, as well as subject enrollment status.
- Audit trail reports provide auditing and operational information such as audit trail information and log in history.

InForm standard reports by category

Folder	Available reports
Query Reports	<ul style="list-style-type: none"> • Outstanding Queries by Site and Visit • Query Aging by Site • Query Cycle Times by Site • Query Cycle Times by User • Query Performance Summary by Site • Query Performance Summary by User • Query Status by Site • Query Status by Site and Subject • Query Status by Site and Visit • Query Status by User • Query Volume by Month by Site • Query Volume by Rule • Subject Counts with Outstanding Queries
CRF Reports	<ul style="list-style-type: none"> • CRF Aging by Site • CRF Cycle Time Detail by Site • CRF Site Performance Summary by Site • CRF Status Detail by Site and Subject • CRF Status Detail by Visit and Site • CRF Status Summary by Site • CRF Status Summary by User
Item Reports	<ul style="list-style-type: none"> • CRF Item Listing • Source Verification Listing
Subject Reports	<ul style="list-style-type: none"> • Case Book Completion and Query Summary by Site • Cumulative Subject Enrollment by Month • Subject Dropout Count by Reason • Subject Enrollment Status by Site
Audit Trail Reports	<ul style="list-style-type: none"> • Audit Trail Report • Historical Login Report

Running and saving standard reports

Running a standard report from the Reporting and Analysis portal

- Click the link for the report.
- or
- 1 To specify additional options, click the **Run with Options** icon for the report.

Note: XML and CSV formats are *not* supported for standard reports.

- 2 Specify report parameters on the Selection Criteria page.
- 3 Click **Run Report**.

Note: For reports that contain a large amount of data, Oracle recommends that you save the report and open it from your local machine.

Running a standard report in a new window

- Right-click the link for any report to launch a new browser window in which to display the report.

Saving a standard report definition

When you save a report, the Reporting and Analysis module saves the report definition. A report definition includes the report elements and report topics that exist in the report you created, but does not include the report data. Each time you run a saved report, the Reporting and Analysis module creates a report with the report elements and report topics that exist in the report, and displays the most current data that exists in the Reporting and Analysis database.

- 1 Run the report.
- 2 Select **Keep this version > Save Report**.

The Reporting and Analysis module saves the report definition to the location from which you ran the report.

Saving a standard report as a report view

To save a report definition and the report data at the time when you ran the report, save the report as a report view. A report view allows you to save report data at specific times during the course of a study so that you can track study progress.

Note: To avoid overwriting report data, and to prevent confusion, save reports and report views with different names.

- 1 Run the report.
- 2 Select **Keep this version > Save as Report View**.

The **Save as report view** dialog box appears.

- 3 In the **Name** field, specify a name for the report view.
- 4 In the Location field, specify a location. By default, the home folder is specified.
 - To save the report view to a specific location:
 - 1 Click **Select another location**.
The Select a location (Navigate) dialog box appears.
 - 2 Specify the folder in which to save the report view.
 - 3 Click **OK**.
 - To save the report view to the My Folders page, click **Select My Folders**.

Opening a standard report in the Report Studio application

If you have access to the Report Studio application, you can open a standard report in the Report Studio application from the main Reporting and Analysis portal page. You can then use the Report Studio application to add advanced functionality to the report.

- For the report, click the **Open with Report Studio** icon ()

Components of a standard report

Report prompt page

On the report prompt page, you select criteria and choose sort options for your report. Prompt pages have three sections:

- Selection Criteria.
- Sort Options.
- Buttons (Run Report, More options, Cancel).

Selection Criteria section

In the Selection Criteria section of the prompt page, you can narrow the criteria for your report. This section might contain:

- Cascading prompts
- Checkboxes
- Drop-down lists
- Text boxes
- Calendars
- List boxes

Depending on the report, you can select one or more items to limit the report to your selections.

You can choose not to make any selections, which means no criteria are applied for a particular prompt to limit the reported data. Not making a selection often causes a report to run faster than selecting all values in the prompt list.

Cascading prompts

Cascading prompts allow you to select criteria in one category to narrow the selections that are offered in another category.

In the following example, the **Countries** and **Sites** list boxes are cascading prompts. You can select one or more countries from the **Countries** list, and click **Update** to see only sites for selected countries in the **Sites** list.

Note: If you change a selection in one prompt, be sure to click **Update** to update all cascading prompts.

The screenshot shows two selection lists. On the left, under 'Countries:', a list box contains 'MEXICO', 'USA' (highlighted), 'CANADA', 'ARGENTINA', '日本', 'Mexico', and 'Česká republi'. Below it are links for 'Select all' and 'Deselect all'. In the center is an 'Update >>' button. On the right, under 'Sites:', a list box contains '(01) Massachusetts General Hospital', '(02) Cleveland Clinic', '(03) Bellevue Hospital', '(04) Johns Hopkins Hospital', '(05) University of California Hospital', and '(06) Clinic of the University of Michigan'. Below it are links for 'Select all' and 'Deselect all'.

Checkboxes

Checkboxes allow you to select one or more options for narrowing report criteria.

The section is titled 'Limit to forms with:'. It contains a list box with four items, each with an unchecked checkbox: 'Required Items', 'SV Required Items', 'Outstanding Queries', and 'Comments'. Below the list box are links for 'Select all' and 'Deselect all'.

For some checkboxes, data must meet the criteria for **all** selected options to be contained in the report. For other checkboxes, data must meet criteria for at least one of the selected options to be contained in the report.

Drop-down lists

Drop-down lists allow you select only one option. To select an option, click the arrow on the drop-down list and move the cursor to the correct selection.

The section is titled 'Expected forms for:'. It contains a dropdown menu with 'Scheduled or Started Visits' selected and a downward-pointing arrow on the right.

Text boxes

You enter data in a text box by typing the value to use.

The section is titled 'Aging interval:'. It contains a text box with the number '7' entered.

Calendars

When you need to specify a date range, you can click the calendar icon and then select the From and To dates in the calendar instead of typing them.

Date range:

From: 

To: 

Then sort on:

Ascending

Descending

2009

Jan	Feb	Mar	Apr	May	Jun	
Jul	Aug	Sep	Oct	Nov	Dec	
Sun	Mon	Tue	Wed	Thu	Fri	Sat
					1	2
3	4	5	6	7	8	9
10	11	12	13	14	15	16
17	18	19	20	21	22	23
24	25	26	27	28	29	30
31						

List boxes

List boxes contain options that you can select.

- To select a single option, click the entry.
- To select more than one option at a time, hold down the **Ctrl** key while selecting each option.
- To select several options that appear together in the list, select the first option, and then press the **Shift** key while selecting the last option in the list to include.

Sites:

(01) Massachusetts General Hospital

(02) Cleveland Clinic

(03) Bellevue Hospital

(04) Johns Hopkins Hospital

(05) University of California Hospital

(06) Clinic of the University of Michigan

(10) 東京医科大学

(11) ザキングクリニック

(12) Hospital San Andrés

(13) Hospital General de México

[Select all](#) [Deselect all](#)

Sort Options section

In the Sort Options section of the prompt page, you can choose the columns on which to sort a report.

Drop-down lists appear at the bottom of each report prompt page. Default sorting selections are automatically selected. You can change these to create your own report definition.

Each sort drop-down list includes **Ascending** and **Descending** radio buttons. Ascending sorts are automatically selected by default. Use the radio buttons to change the sort type.

Reports that include groupings, such as organization by user or by site, are sorted at the detail level within the grouping, according to the selections made in the drop-down lists. The grouping sort order can be modified (ascending or descending) but will always take precedence over other sorting settings.

Buttons

The bottom-left corner of each prompt page contains buttons you can use to:

- Run the report.
- See more options (if available).
- Cancel the report.

Note: Some reports require you to make a selection before you can run the report. In this case, the Run Report button is grayed out, and red dashes indicate the field in which you must make a selection.

Summary page

The summary page for a report displays the selections you made on the report prompt page. This information is in report printouts to tell readers what criteria were used.

Report/Graph page

The Report/Graph page contains:

- Show/hide report selections.
- Graphs and columns.
- Report header and footer.

Show/hide report selections

A **Show/Hide Selections** link appears for all reports. Click this link to show or hide a list of the chosen selections on the prompt page, or to change the sort selections for the report.

Graphs and columns

Metrics or performance standard reports include graphs that represent the report results. When a graph is included in a report, it appears on the first page. Use the **Page Down** link to move down to

the report columns.

Report columns display data that is returned when the report is run. Some columns include totals and subtotals.

Report header and footer

The report header displays the report title and study name. The header can also display a logo.

The report footer contains the following data.

Footer label	Description
Run at	Date and time the report was run.
Page	Page number, centered in the footer. <ul style="list-style-type: none">• In HTML reports, only the page number appears.• In PDF reports, the page number and total page count appear.
Data as of	Date and time that data was last replicated to the Reporting and Analysis database.

Data in standard reports

Standard reports show data only for clinical visits and clinical form types.

- **Subtotals and totals**—Standard reports display subtotals and totals for numeric columns, unless the column displays a median value. For reports that include median calculations, subtotals and totals are blank.
 - CRA-oriented reports that have grand totals calculate those totals based on unique sites and count only unique data when a site is associated with more than one CRA. In these cases, the total on the report is clearly labeled, and the Prompt Page for that report warns you that site information is duplicated across CRAs sharing the same sites.
 - Minimum (Min), maximum (Max), and average values for subtotals and totals are calculated by taking the Min, Max, and Average of the sites.
- **Percentages**—When percentages are shown in a report, either the column head or a special footnote identifies what the number is a percentage of.

When percentages are shown in the same column as counts, sorting on that column is based on the percentage value and not the count value.

- **by User reports**—The *by User* reports in the Reporting and Analysis module are designed to provide information on the performance of primary monitors for your study. The reports provide performance statistics about all roles within a study. For sites with more than one person in a given role, you will see the same data multiple times, one row for each person. You can limit this by selecting specific individual users, such as primary CRAs, or establishing special rights groups that prohibit duplication by site.

To get the most out of the *by User* reports, follow these guidelines. When you can easily identify key rights groups and users, the *by User* reports will be manageable and will yield reliable results.

- Understand the rights group organization for your study, and know how primary monitors fit into this organization. All primary monitors can be assigned to a single rights group, or they can be scattered among several rights groups. To target only primary monitors and avoid producing unwieldy reports, you must know which rights group to select.
- Know how to identify your primary monitors. This information is especially important if your organization has not designated a single rights group for all primary monitors.
- **UUIDs**—Studies created using the Central Designer application automatically specify the Universal Unique Identifiers (UUIDs) that are required to populate columns in certain reports.
 - In this guide, the UUIDs are listed in the report descriptions where applicable.
 - If a column in a standard report does not contain any values, it is most likely the result of the InForm special fields not being specified when the study was created in the Central Designer application.

Report folders

All of the InForm standard reports appear on the Public Folders tab of the Reporting and Analysis portal.

Standard reports are organized into five folders. Click each folder name to access a complete list of standard reports for the chosen category.

- CRF Reports
- Item Reports
- Query Reports
- Subject Reports
- Audit Trail Reports

Note: You can display either a list view or a detail view of the standard reports folders.

Report actions

Each standard report folder lists Action icons. In the list view, these icons appear under the label **Actions**. In the details view, these icons appear under the report name and last run time information. Click **More** in either view to see a complete list of report actions.

For more information, see the Cognos documentation.

Report action	Description
Set properties	Specifies items such as the report name and screen tips for the report.
View most recent report in HTML	Displays the latest saved HTML view of the latest version of the report. If you click this link, the report runs based on the last saved prompt values for the report.
View report output versions	Displays a list of all output versions for the report, if report views have been saved. You can click these links to see each version. If you click this link, the report runs based on the last saved prompt values for the report.
Run with options	Allows you to specify the output version and delivery mechanism when you run the report. Use this option to change any prompt values that may have been previously set for the report.
	Note: Only users with Publisher rights or Report Administrator rights can access the following options.
New schedule	Allows you to schedule the report.
Alert me about new versions	Allows you to add yourself to an alert list for a report. Note: The report owner must enable the alert list before you can add yourself to it.
Do not alert any about new versions	Allows report authors to remove all users who are currently on the alert list.
View run history	Allows you to see the request time, start time, and completion time for each time the report was run.
Move	Allows you to move the report to another folder.
Copy	Allows you to copy the report to another folder.
Create shortcut to this entry	Allows you to create a shortcut to a report. You can specify any folder location (to which you have write access) for the shortcut.
Create report view of this report	Allows you to create a report view of the report.
Delete	Allows you to delete the report.

Query reports

Outstanding Queries by Site and Visit

This cross-tab report shows the number of open or answered queries for each visit (columns) and each site (rows). The report displays information only for countries that have sites with outstanding queries.

Use this report to quickly assess how clean current data is relative to visits or subjects.

Selection criteria: Outstanding Queries by Site and Visit

Use the report prompt page to select criteria and specify sort options for your report.

For general instructions about how to run a standard report, see:

- *Running a standard report from the Reporting and Analysis portal* (on page 170).
- *Running a standard report in a new window* (on page 170).

For information about data that appears on this report, such as the data source, how data is calculated, and how it is displayed, see *Report/Graph page: Outstanding Queries by Site and Visit* (on page 182).

Selection criteria

Selection criteria	Action
Countries	To report on specific countries, select their names from the list. Then, click Update to update the Sites list.
Sites	To report on specific sites, select the names of the sites from the list.
Visits	To report on one or more visits, select the visits from the list.
Query Type	To specify the type of queries to report on, select one of the following: <ul style="list-style-type: none"> • Auto—Automatic queries generated by the InForm application when a rule in the study design detects a discrepancy in the data that is entered. • Manual—Manual queries created by InForm users. <p>If you leave all checkboxes blank, the report will include both types of queries.</p>

Note: To include all available options in the report, leave the optional selection fields blank; that is, do not select any individual options from the drop-down lists. **For the best performance, do not select any optional filters.**

Sort options

Sort options are: None, Country, Site Mnemonic, Total Open, Total Answered, Total Outstanding.

Use the **Sort** drop-down lists to change any of the default selections.

Sort	Default selection
First level	Country
Second level	Site Mnemonic
Third level	None

Report/Graph page: Outstanding Queries by Site and Visit

Subtotals and totals

- **Subtotals**—By Country.
- **Totals**—Overall query count totals.

Column descriptions

Report element	Description
Country	<p>Data type: String</p> <p>Description: The country in which a site is located, as entered in the InForm Administration interface.</p> <p>Data source: Replicated from the InForm transactional database to the Reporting and Analysis database.</p>
Site Mnemonic	<p>Data type: String</p> <p>Description: An abbreviation that identifies a site, as entered in the InForm Administration interface.</p> <p>Data source: Replicated from the InForm transactional database to the Reporting and Analysis database.</p>
Visit Mnemonic	<p>Data type: String</p> <p>Description: An abbreviation of the visit title, as specified in the study design. For CRF visits, this title appears at the top of a collection of forms in the visit timeline and may not be a unique identifier.</p> <p>Data source: Replicated from the InForm transactional database to the Reporting and Analysis database.</p>

Report element	Description
Open query counts by visit	<p>Data type: Numeric</p> <p>Description: For each site and visit, the number of queries with a current status of Open.</p> <p>How calculated: Counts all open queries for each site and visit that are associated with items on any form in the visit. This calculation counts manual, automatic, or both types of open queries, based on your selection for the Query Type filter on the report prompt page. Note that this total includes queries that were opened, answered, and then reissued.</p> <p>Data source: Derived and stored in the Reporting and Analysis database.</p>
Answered query counts by visit	<p>Data type: Numeric</p> <p>Description: For each site and visit, the number of queries with a current status of Answered.</p> <p>How calculated: Counts all answered queries for each site and visit that are associated with items on any form in the visit. This calculation counts manual, automatic, or both types of answered queries, based on your selection for the Query Type filter on the report prompt page.</p> <p>Data source: Derived for the report; not stored in the Reporting and Analysis database.</p>
Total query counts by visit	<p>Data type: Numeric</p> <p>Description: For each site and visit, the total number of open and answered queries.</p> <p>How calculated: The sum of the values in the Open and Ans'd columns.</p> <p>Data source: Derived for the report; not stored in the Reporting and Analysis database.</p>
Totals - Open query counts by visit	<p>Data type: Numeric</p> <p>Description: For each site, the number of queries with a current status of Open.</p> <p>How calculated: The sum of the values for open queries for all visits at a given site.</p> <p>Data source: Derived for the report; not stored in the Reporting and Analysis database.</p>
Totals - Answered query counts by visit	<p>Data type: Numeric</p> <p>Description: For each site, the number of queries with a current status of Answered.</p> <p>How calculated: The sum of the values for answered queries for all visits at a given site.</p> <p>Data source: Derived for the report; not stored in the Reporting and Analysis database.</p>

Report element	Description
Totals - Total query counts by visit	<p>Data type: Numeric</p> <p>Description: For each site, the number of queries with a current status of Open or Answered.</p> <p>How calculated: The sum of the values for open or answered queries for all visits at a given site.</p> <p>Data source: Derived for the report; not stored in the Reporting and Analysis database.</p>

Query Aging by Site

This report shows the number of queries that are open, by site, for a given number of days.

Use this report to help identify sites that are falling behind.

Selection criteria: Query Aging by Site

Use the report prompt page to select criteria and specify sort options for your report.

For general instructions about how to run a standard report, see:

- *Running a standard report from the Reporting and Analysis portal* (on page 170).
- *Running a standard report in a new window* (on page 170).

For information about data that appears on this report, such as the data source, how data is calculated, and how it is displayed, see *Report/Graph page: Query Aging by Site* (on page 185).

Selection criteria

Selection criteria	Action
Country	To report on specific countries, select their names from the list. Then, click Update to update the Sites list.
Sites	To report on specific sites, select the names of the sites from the list.

Selection criteria	Action
Aging Interval	<p>Enter a time duration (in days) to be used as the aging interval. The resulting report uses the aging interval to show how many queries have been open for a specific number of days.</p> <p>For example, if you specify 7, the resulting report shows the number of queries that have been open for:</p> <ul style="list-style-type: none"> • Seven or fewer days. • More than 7 but equal to or fewer than 14 days. • More than 14 but equal to or fewer than 21 days. • More than 21 but equal to or fewer than 28 days. • More than 28 days. <p>Default: 7 (days)</p>

Sort options

Sort options are: None, Country, Site Mnemonic, Enrolled Subject Count, Total Open Query Count, Average Age of Open, % of Queries Open 1st Period, % of Queries Open 2nd Period, % of Queries Open 3d Period, % of Queries Open 4th Period, % of Queries Open 5th Period.

Use the **Sort** drop-down lists to change any of the default selections.

Sort	Default selection
First level	Country
Second level	Site Mnemonic
Third level	None

Report/Graph page: Query Aging by Site

Subtotals and totals

- **Subtotals**—By Country.
- **Totals**—Overall query aging totals.

Column descriptions

Column	Description
Country	<p>Data type: String</p> <p>Description: The country in which a site is located, as entered in the InForm Administration interface.</p> <p>Data source: Replicated from the InForm transactional database to the Reporting and Analysis database.</p>

Column	Description
Site Mnemonic	<p>Data type: String</p> <p>Description: An abbreviation that identifies a site, as entered in the InForm Administration interface.</p> <p>Data source: Replicated from the InForm transactional database to the Reporting and Analysis database.</p>
Subject Count	<p>Data type: Numeric</p> <p>Description: The number of subjects who enrolled at the site.</p> <p>How calculated: For each site, counts subjects who enrolled at the site, including subjects who are currently assigned other states.</p> <p>Note: The Enrollment form, designed according to InForm specifications, must be completed for the subject.</p> <p>UUID: PF_SC_COMPLETECTL</p> <p>Data source: Status is determined by the value on the Enrollment form, which is stored in the Reporting and Analysis database. Status is set to 1 when the subject is enrolled.</p>
Total Open	<p>Data type: Numeric</p> <p>Description: For each site, the number of queries with a current status of Open.</p> <p>How calculated: For each site, all queries with a current status of Open are counted, regardless of query type. Note that this total includes queries that were opened, answered, and then reissued.</p> <p>Data source: Derived and stored in the Reporting and Analysis database.</p>
Average Age of Open	<p>Data type: Numeric</p> <p>Description: For each site, the average number of days that a query is in the Open state.</p> <p>How calculated: This calculation only applies to queries with a current status of Open. The number of days is calculated by subtracting the date when a query was last opened from the current date.</p> <p>Data source: Derived for the report; not stored in the Reporting and Analysis database.</p>

Column	Description
Queries Open (% of Total Open for Country)	<p>Data type: Numeric (Percentage)</p> <p>Description: The number of open queries that have been open for specific intervals of time. You specify the aging interval (in days) on the report prompt page.</p> <p>For example, if you specify 7, the resulting report shows the number of queries that have been open for:</p> <ul style="list-style-type: none"> • Seven or fewer days. • More than 7 but equal to or fewer than 14 days. • More than 14 but equal to or fewer than 21 days. • More than 21 but equal to or fewer than 28 days. • More than 28 days. <p>How calculated: This value is calculated in multiples of 24 (hours). For example, if the query is opened at 10 AM on day 1 and the report is run 10 days later at 9 AM., the days open is 9.</p> <p>The number of queries in the date range is followed by a percentage of the total open query count per country. For each country, the percentage is calculated as follows:</p> $[\text{open queries within aging interval}] * 100 / [\text{total number of open queries}]$ <p>Data source: Derived and stored in the Reporting and Analysis database. Percentage derived for display.</p>

Query Cycle Times by Site

This report shows the minimum, maximum, and median number of days for queries to move from open to answered to closed. This report is grouped by site or sponsor. The report includes only sites that have queries.

Use this report to help you see whether a given site or sponsor is having issues resolving queries in a timely way.

Selection criteria: Query Cycle Times by Site

Use the report prompt page to select criteria and specify sort options for your report.

For general instructions about how to run a standard report, see:

- *Running a standard report from the Reporting and Analysis portal* (on page 170).
- *Running a standard report in a new window* (on page 170).

For information about data that appears on this report, such as the data source, how data is calculated, and how it is displayed, see *Report/Graph page: Query Cycle Times by Site* (on page 189).

Selection criteria

Selection criteria	Action
Countries	To report on specific countries, select their names from the list. Then, click Update to update the Sites list.
Sites	To report on specific sites, select the names of the sites from the list.
Query Types	<p>To specify the type of queries to report on, select one of the following:</p> <ul style="list-style-type: none"> • Auto—Automatic queries generated by the InForm application when a rule in the study design detects a discrepancy in the data that is entered. • Manual—Manual queries created by InForm users. <p>If you leave all checkboxes blank, the report will include both types of queries.</p>
Date Range	<p>To specify the date range, enter the From and To dates, or use the calendar icons to select the dates.</p> <p>Default From date: 2000-01-01</p> <p>Default To date: Current date</p>

Note: To include all available options in the report, leave the optional selection fields blank; that is, do not select any individual options from the drop-down lists. For the best performance, do not select any optional filters.

Sort options

Sort options are: None, Country, Site Mnemonic, Subject Count, Query Count, Open to Answered–Min, Open to Answered–Max, Open to Answered–Median, Answered to Closed–Min, Answered to Closed–Max, Answered to Closed–Median, Open to Closed–Min, Open to Closed–Max, Open to Closed–Median.

Use the **Sort** drop-down lists to change any of the default selections.

Sort	Default selection
------	-------------------

Sort	Default selection
First level	Country
Second level	Site Mnemonic
Third level	None

Report/Graph page: Query Cycle Times by Site

Graphs

A combination line/bar graph appears on the first page of the Query Cycle Times by Site report, plotting the median time from query open to answered, and the minimum time answered to closed, by sites within countries.

Subtotals and totals

- **Subtotals**—By country.
 - Min—Lowest minimum value for any site in the country.
 - Max—Highest maximum value for any site in the country.
 - Median—No value.
- **Totals**—Overall query cycle time totals.
 - Min—Lowest minimum value for any site in the country.
 - Max—Highest maximum value for any site in the country.
 - Median—No value.

Column descriptions

Column	Description
Country	<p>Data type: String</p> <p>Description: The country in which a site is located, as entered in the InForm Administration interface.</p> <p>Data source: Replicated from the InForm transactional database to the Reporting and Analysis database.</p>
Site Mnemonic	<p>Data type: String</p> <p>Description: An abbreviation that identifies a site, as entered in the InForm Administration interface.</p> <p>Data source: Replicated from the InForm transactional database to the Reporting and Analysis database.</p>

Column	Description
Subject Count	<p>Data type: Numeric</p> <p>Description: The number of subjects who enrolled at the site.</p> <p>How calculated: For each site, counts subjects who enrolled at the site, including subjects who are currently assigned other states.</p> <p>Note: The Enrollment form, designed according to InForm specifications, must be completed for the subject.</p> <p>UUID: PF_SC_COMPLETECTL</p> <p>Data source: Status is determined by the value on the Enrollment form, which is stored in the Reporting and Analysis database. Status is set to 1 when the subject is enrolled.</p>
Query Count	<p>Data type: Numeric</p> <p>Description: The total number of number of open, answered, and closed queries.</p> <p>How calculated: This calculation counts all open, closed, and answered queries, based on your selection in the Query Type filter on the report prompt page. This count does not include queries that have never been opened (candidate queries or deleted candidate queries).</p> <p>Data source: Derived and stored in the Reporting and Analysis database.</p>
Open to Answered (Days): Min, Max, Median	<p>Data type: Numeric</p> <p>Description: Data on the number of days from when queries are opened to when they are answered. For each site, columns display:</p> <ul style="list-style-type: none"> • Minimum—The fewest number of days for an opened query to be answered at the site. • Maximum—The greatest number of days for an opened query to be answered at the site. • Median—The median of the opened-to-answered range for all answered queries at the site. <p>How calculated: The calculation begins on the first day when the status of a query was set to Open and ends on the most recent day when the status of a query was set to Answered. This value is calculated in multiples of 24 (hours) and is rounded down to the nearest whole number.</p> <p>For example, if a query is opened on day 1 at 10 AM and answered on day 3 at 9 AM, the Open to Answered value is 2 days.</p> <p>Data source: Derived for the report; not stored in the Reporting and Analysis database.</p>

Column	Description
Answered to Closed (Days): Min, Max, Median	<p>Data type: Numeric</p> <p>Description: Data on the number of days from when queries are answered to when they are closed. For each site, columns display:</p> <ul style="list-style-type: none"> • Minimum—The fewest number of days for an answered query to be closed at the site. • Maximum—The greatest number of days for an answered query to be closed at the site. • Median—The median of the answered-to-closed range for all closed queries at the site. <p>How calculated: The calculation begins on the first day when the status of a query was set to Answered and ends on the most recent day when the status of a query was set to Closed. This value is calculated in multiples of 24 (hours) and is rounded down to the nearest whole number.</p> <p>For example, if a query is answered on day 1 at 10 AM and closed on day 3 at 9 AM, the Answered to Closed value is 2 days.</p> <p>Data source: Derived for the report; not stored in the Reporting and Analysis database.</p>
Open to Closed (Days): Min, Max, Median	<p>Data type: Numeric</p> <p>Description: Data on the number of days from when queries are opened to when they are closed. For each site, columns display:</p> <ul style="list-style-type: none"> • Minimum—The fewest number of days for an open query to be closed at the site. • Maximum—The greatest number of days for an open query to be closed at the site. • Median—The median of the opened-to-closed range for all closed queries at the site. <p>How calculated: The calculation begins on the first day when the status of a query was set to Open and ends on the most recent day when the status of a query was set to Closed. This value is calculated in multiples of 24 (hours) and is rounded down to the nearest whole number.</p> <p>For example, if a query is opened on day 1 at 10 AM and closed on day 3 at 9 AM, the Answered to Closed value is 2 days.</p> <p>Data source: Derived for the report; not stored in the Reporting and Analysis database.</p>

Query Cycle Times by User

This report shows the minimum, maximum, and median number of days for queries to move from open to answered to closed. This report is grouped by site or sponsor.

Use this report to help you see whether a given site or sponsor is having issues efficiently resolving queries.

Selection criteria: Query Cycle Times by User

Use the report prompt page to select criteria and specify sort options for your report.

For general instructions about how to run a standard report, see:

- *Running a standard report from the Reporting and Analysis portal* (on page 170).
- *Running a standard report in a new window* (on page 170).

For information about data that appears on this report, such as the data source, how data is calculated, and how it is displayed, see *Report/Graph page: Query Cycle Times by User* (on page 193).

Selection criteria

Selection criteria	Action
Rights groups	Select the rights group or groups used for CRAs that are primary in your study. Then, click Update to update the Users list.
Users	To report on specific users, select them from the drop-down list. Then, click Update to update the Sites list.
Sites	To report on specific sites, select the names of the sites from the list.
Query Types	To specify the type of queries to report on, select one of the following: <ul style="list-style-type: none"> • Auto—Automatic queries generated by the InForm application when a rule in the study design detects a discrepancy in the data that is entered. • Manual—Manual queries created by InForm users. If you leave all checkboxes blank, the report will include both types of queries.
Date Range	To specify the date range, enter the From and To dates, or use the calendar icons to select the dates. Default From date: 2000-01-01 Default To date: Current date

Note: To include all available options in the report, leave the optional selection fields blank; that is, do not select any individual options from the drop-down lists. **For the best performance, do not select any optional filters.**

Sort options

Sort options are: None, Group Name, User Name, Site Mnemonic, Subject Count, Query Count, Open to Answered–Min, Open to Answered–Max, Open to Answered–Median, Answered to Closed–Min, Answered to Closed–Max, Answered to Closed–Median, Open to Closed–Min, Open to Closed–Max, Open to Closed–Median.

Use the **Sort** drop-down lists to change any of the default selections.

Sort	Default selection
First level	Group Name
Second level	User Name
Third level	Site Mnemonic

Report/Graph page: Query Cycle Times by User

Subtotals and totals

- **Subtotals**—By User Name and Rights Group.
 - Min—Lowest minimum value for any site for this user.
 - Max—Highest maximum value for any site for this user.
 - Median—No value.
- **Totals**—Overall query cycle time totals.
 - Min—Lowest minimum value for any site for this user.
 - Max—Highest maximum value for any site for this user.
 - Median—No value.

Column descriptions

Column	Description
Rights Group	<p>Data type: String</p> <p>Description: The InForm rights group to which the user belongs.</p> <p>Data source: Replicated from the InForm transactional database to the Reporting and Analysis database.</p>
User Name	<p>Data type: String</p> <p>Description: The user name of the InForm user.</p> <p>Data source: Replicated from the InForm transactional database to the Reporting and Analysis database.</p>

Column	Description
Site Mnemonic	<p>Data type: String</p> <p>Description: An abbreviation that identifies a site, as entered in the InForm Administration interface.</p> <p>Data source: Replicated from the InForm transactional database to the Reporting and Analysis database.</p>
Subject Count	<p>Data type: Numeric</p> <p>Description: The number of subjects who enrolled at the site.</p> <p>How calculated: For each site, counts subjects who enrolled at the site, including subjects who are currently assigned other states.</p> <p>Note: The Enrollment form, designed according to InForm specifications, must be completed for the subject.</p> <p>UUID: PF_SC_COMPLETECTL</p> <p>Data source: Status is determined by the value on the Enrollment form, which is stored in the Reporting and Analysis database. Status is set to 1 when the subject is enrolled.</p>
Query Count	<p>Data type: Numeric</p> <p>Description: The total number of number of open, answered, and closed queries.</p> <p>How calculated: This calculation counts all open, closed, and answered queries, based on your selection in the Query Type filter on the report prompt page. This count does not include queries that have never been opened (candidate queries or deleted candidate queries).</p> <p>Data source: Derived and stored in the Reporting and Analysis database.</p>

Column	Description
Open to Answered (Days): Min, Max, Median	<p>Data type: Numeric</p> <p>Description: Data on the number of days from when queries are opened to when they are answered. For each user, columns display:</p> <ul style="list-style-type: none"> • Minimum—The fewest number of days for an opened query to be answered for this user. • Maximum—The greatest number of days for an opened query to be answered for this user. • Median—The median of the opened-to-answered range for all answered queries for this user. <p>How calculated: The calculation begins on the first day when the status of a query was set to Open and ends on the most recent day when the status of a query was set to Answered. This value is calculated in multiples of 24 (hours) and is rounded down to the nearest whole number.</p> <p>For example, if a query is opened on day 1 at 10 AM and answered on day 3 at 9 AM, the Open to Answered value is 2 days.</p> <p>Data source: Derived for the report; not stored in the Reporting and Analysis database.</p>
Answered to Closed (Days): Min, Max, Median	<p>Data type: Numeric</p> <p>Description: Data on the number of days from when queries are answered to when they are closed. For each user, columns display:</p> <ul style="list-style-type: none"> • Minimum—The fewest number of days for an answered query to be closed for this user. • Maximum—The greatest number of days for an answered query to be closed for this user. • Median—The median of the answered-to-closed range for all closed queries for this user. <p>How calculated: The calculation begins on the first day when the status of a query was set to Answered and ends on the most recent day when the status of a query was set to Closed. This value is calculated in multiples of 24 (hours) and is rounded down to the nearest whole number.</p> <p>For example, if a query is answered on day 1 at 10 AM and closed on day 3 at 9 AM, the Answered to Closed value is 2 days.</p> <p>Data source: Derived for the report; not stored in the Reporting and Analysis database.</p>

Column	Description
Open to Closed (Days): Min, Max, Median	<p>Data type: Numeric</p> <p>Description: Data on the number of days from when queries are opened to when they are closed. For each user, columns display:</p> <ul style="list-style-type: none"> • Minimum—The fewest number of days for an opened query to be closed for this user. • Maximum—The greatest number of days for an opened query to be closed for this user. • Median—The median of the opened- to-closed range for all closed queries for this user. <p>How calculated: The calculation begins on the first day when the status of a query was set to Open and ends on the most recent day when the status of a query was set to Closed. This value is calculated in multiples of 24 (hours) and is rounded down to the nearest whole number.</p> <p>For example, if a query is opened on day 1 at 10 AM and closed on day 3 at 9 AM, the Answered to Closed value is 2 days.</p> <p>Data source: Derived for the report; not stored in the Reporting and Analysis database.</p>

Query Performance Summary by Site

This report provides a summary collection of query statistics: the volume of queries by CRF and CRB, the average and range of days to resolve, and the current ages of unresolved queries. The report lists only sites that have open queries.

Study managers and lead CRAs use this report to review performance, track key metrics, and develop comprehensive action plans.

Selection criteria: Query Performance Summary by Site

Use the report prompt page to select criteria and specify sort options for your report.

For general instructions about how to run a standard report, see:

- *Running a standard report from the Reporting and Analysis portal* (on page 170).
- *Running a standard report in a new window* (on page 170).

For information about data that appears on this report, such as the data source, how data is calculated, and how it is displayed, see *Report/Graph page: Query Performance Summary by Site* (on page 198).

Selection criteria

Selection criteria	Action
--------------------	--------

Selection criteria	Action
Countries	To report on specific countries, select their names from the list. Then, click Update to update the Sites list.
Sites	If you updated the Sites list after selecting one or more countries and you want to report on specific sites, select the names of the sites from the list.
Query Types	<p>To specify the type of queries to report on, select one of the following:</p> <ul style="list-style-type: none"> • Auto—Automatic queries generated by the InForm application when a rule in the study design detects a discrepancy in the data that is entered. • Manual—Manual queries created by InForm users. <p>If you leave all checkboxes blank, the report will include both types of queries.</p>
Aging interval	<p>Enter a time duration (in days) to be used as the aging interval. The resulting report uses the aging interval to show how many queries have been open for a specific number of days.</p> <p>For example, if you specify 7, the resulting report shows the number of queries that have been open for:</p> <ul style="list-style-type: none"> • Seven or fewer days. • More than 7 but equal to or fewer than 14 days. • More than 14 but equal to or fewer than 21 days. • More than 21 but equal to or fewer than 28 days. • More than 28 days. <p>Default: 7 (days)</p>

Note: To include all available options in the report, leave the optional selection fields blank; that is, do not select any individual options from the drop-down lists. **For the best performance, do not select any optional filters.**

Sort options

Sort options are: None, Country, Site Mnemonic, Enrolled Count, Queries/CRB Max, Queries/CRB Median, Queries/CRF Max, Queries/CRF Median, Resolve Days Min, Resolve Days Max, Resolve Days Median, Days Period 1, Days Period 2, Days Period 3, Days Period 4, Days Period 5.

Use the **Sort** drop-down lists to change any of the default selections.

Sort	Default selection
First level	Country
Second level	Site Mnemonic
Third level	None

Report/Graph page: Query Performance Summary by Site

Graphs

- A bar graph appears on the first page of the Query Performance Summary by Site report, plotting the median query count for case books and forms, by site within country.
- A second graph shows the median days to resolve queries, by site within country.
- A third graph shows the median days queries have been open, by site within country.

Subtotals and totals

- **Subtotals**—By Country.
- **Totals**—Overall query count totals.

Column descriptions

Column	Description
Country	<p>Data type: String</p> <p>Description: The country in which a site is located, as entered in the InForm Administration interface.</p> <p>Data source: Replicated from the InForm transactional database to the Reporting and Analysis database.</p>
Site Mnemonic	<p>Data type: String</p> <p>Description: An abbreviation that identifies a site, as entered in the InForm Administration interface.</p> <p>Data source: Replicated from the InForm transactional database to the Reporting and Analysis database.</p>
Enrolled	<p>Data type: Numeric</p> <p>Description: The number of subjects who enrolled at the site.</p> <p>How calculated: For each site, counts subjects who enrolled at the site, including subjects who are currently assigned other states.</p> <p>Note: The Enrollment form, designed according to InForm specifications, must be completed for the subject.</p> <p>UUID: PF_SC_COMPLETECTL</p> <p>Data source: Status is determined by the value on the Enrollment form, which is stored in the Reporting and Analysis database. Status is set to 1 when the subject is enrolled.</p>

Column	Description
Queries per CRB	<p>Data type: Numeric</p> <p>Description: The maximum and median number of all queries per casebook for all enrolled subjects in each site.</p> <p>How calculated: For each site, counts manual, automatic, or both types of queries, based on your selection in the Query Type filter on the report prompt page. This count includes all queries, regardless of status, and all subjects who were ever enrolled, regardless of current status.</p> <p>For each site, columns display:</p> <ul style="list-style-type: none"> • Maximum—The maximum number of all queries per case book for all enrolled subjects at the site. • Median—The median number of all queries per case book for all enrolled subjects at the site. <p>Data source: Derived for the report; not stored in the Reporting and Analysis database.</p>
Queries per CRF	<p>Data type: Numeric</p> <p>Description: The maximum and median number of all queries per form for all started forms for all enrolled subjects in each site.</p> <p>How calculated: For each site, counts manual, automatic, or both types of queries, based on your selection in the Query Type filter on the report prompt page. This count includes all queries, regardless of status on all started clinical forms.</p> <p>For each site, columns display:</p> <ul style="list-style-type: none"> • Maximum—The maximum number of all queries per form for all started forms at the site. • Median—The median number of all queries per form for all started forms at the site. <p>Data source: Derived for the report; not stored in the Reporting and Analysis database.</p>

Column	Description
Days to Resolve (Open to Close)	<p>Data type: Numeric</p> <p>Description: The minimum, maximum, and median number of days for queries to be opened and closed.</p> <p>How calculated: For each query, the calculation starts on the first date when the status of the query was set to Open and ends on the most recent date when the status of the query was set to Closed. The number of days from the Open to the Closed state is rounded down to the nearest whole number.</p> <p>How calculated: The calculation begins on the first day when the status of a query was set to Open and ends on the most recent day when the status of a query was set to Closed. This value is calculated in multiples of 24 (hours) and is rounded down to the nearest whole number.</p> <p>For example, if a query is opened on day 1 at 10 AM and closed on day 3 at 9 AM, the Answered to Closed value is 2 days.</p> <p>For each site, columns display:</p> <ul style="list-style-type: none">• Minimum—The fewest number of days taken for a query to be opened and closed at the site.• Maximum—The maximum number of days taken for a query to be opened and closed at the site.• Median—The median number of days for all queries to be opened and closed at the site. <p>Data source: Derived for the report; not stored in the Reporting and Analysis database.</p>

Column	Description
Days Open	<p>Data type: Numeric</p> <p>Description: For each site, the number of queries that have been open for a specific number of days.</p> <p>How calculated: This calculation applies only to queries with a current status of Open. The calculation begins on the date when a query was last opened and ends on the current date.</p> <p>This value is calculated in multiples of 24 (hours). For example, if the query is opened at 10 a.m. on day 1 and the report is run 10 days later at 9 a.m., the days open is 9.</p> <p>You specify the aging interval (in days) on the report prompt page.</p> <p>For example, if you specify 7, the resulting report shows the number of queries that have been open for:</p> <ul style="list-style-type: none"> • Seven or fewer days. • More than 7 but equal to or fewer than 14 days. • More than 14 but equal to or fewer than 21 days. • More than 21 but equal to or fewer than 28 days. • More than 28 days. <p>Data source: Derived for the report; not stored in the Reporting and Analysis database.</p>

Query Performance Summary by User

This report provides a summary collection of query statistics: the volume of queries by CRF and CRB, the average and range of days to resolve, and the current ages of unresolved queries. The report lists only users that have open queries.

Study managers and lead CRAs use this report to filter by user and direct query-related inquiries to appropriate study personnel.

Selection criteria: Query Performance Summary by User

Use the report prompt page to select criteria and specify sort options for your report.

For general instructions about how to run a standard report, see:

- *Running a standard report from the Reporting and Analysis portal* (on page 170).
- *Running a standard report in a new window* (on page 170).

For information about data that appears on this report, such as the data source, how data is calculated, and how it is displayed, see *Report/Graph page: Query Performance Summary by User* (on page 203).

Selection criteria

Selection criteria	Action
Rights groups	Select the rights group or groups used for CRAs that are primary in your study. Then, click Update to update the Users list.
Users	To report on specific users, select them from the drop-down list. Then, click Update to update the Sites list.
Sites	To report on specific sites, select the names of the sites from the list.
Query Types	<p>To specify the type of queries to report on, select one of the following:</p> <ul style="list-style-type: none"> • Auto—Automatic queries generated by the InForm application when a rule in the study design detects a discrepancy in the data that is entered. • Manual—Manual queries created by InForm users. <p>If you leave all checkboxes blank, the report will include both types of queries.</p>
Aging Interval	<p>Enter a time duration (in days) to be used as the aging interval. The resulting report uses the aging interval to show how many queries have been open for a specific number of days.</p> <p>For example, if you specify 7, the resulting report shows the number of queries that have been open for:</p> <ul style="list-style-type: none"> • Seven or fewer days. • More than 7 but equal to or fewer than 14 days. • More than 14 but equal to or fewer than 21 days. • More than 21 but equal to or fewer than 28 days. • More than 28 days. <p>Default: 7 (days)</p>

Note: To include all available options in the report, leave the optional selection fields blank; that is, do not select any individual options from the drop-down lists. **For the best performance, do not select any optional filters.**

Sort options

Sort options are: None, Rights Group, User Name, Site Mnemonic, Enrolled Count, Queries/CRB Max, Queries/CRB Median, Queries/CRF Max, Queries/CRF Median, Resolve Days Min, Resolve Days Max, Resolve Days Median, Days Period 1, Days Period 2, Days Period 3, Days Period 4, Days Period 5.

Use the **Sort** drop-down lists to change any of the default selections.

Sort	Default selection
First level	Group Name
Second level	User Name
Third level	Site Mnemonic

Report/Graph page: Query Performance Summary by User

Subtotals and totals

- **Subtotals**—By User Name and Rights Group.
- **Totals**—Overall query count totals.

Column descriptions

Column	Description
Rights Group	<p>Data type: String</p> <p>Description: The InForm rights group to which the user belongs.</p> <p>Data source: Replicated from the InForm transactional database to the Reporting and Analysis database.</p>
User Name	<p>Data type: String</p> <p>Description: The user name of the InForm user.</p> <p>Data source: Replicated from the InForm transactional database to the Reporting and Analysis database.</p>
Site Mnemonic	<p>Data type: String</p> <p>Description: An abbreviation that identifies a site, as entered in the InForm Administration interface.</p> <p>Data source: Replicated from the InForm transactional database to the Reporting and Analysis database.</p>

Column	Description
Enrolled	<p>Data type: Numeric</p> <p>Description: The number of subjects who enrolled at the site.</p> <p>How calculated: For each site, counts subjects who enrolled at the site, including subjects who are currently assigned other states.</p> <p>Note: The Enrollment form, designed according to InForm specifications, must be completed for the subject.</p> <p>UUID: PF_SC_COMPLETECTL</p> <p>Data source: Status is determined by the value on the Enrollment form, which is stored in the Reporting and Analysis database. Status is set to 1 when the subject is enrolled.</p>
Queries per CRB	<p>Data type: Numeric</p> <p>Description: The maximum and median number of all queries per casebook for all enrolled subjects in each site.</p> <p>How calculated: For each site, counts manual, automatic, or both types of queries, based on your selection in the Query Type filter on the report prompt page. This count includes all queries, regardless of status, and all subjects who were ever enrolled, regardless of current status.</p> <p>For each site, columns display:</p> <ul style="list-style-type: none"> • Maximum—The maximum number of all queries per case book for all enrolled subjects at the site. • Median—The median number of all queries per case book for all enrolled subjects at the site. <p>Data source: Derived for the report; not stored in the Reporting and Analysis database.</p>
Queries per CRF	<p>Data type: Numeric</p> <p>Description: The maximum and median number of all queries per form for all started forms for all enrolled subjects in each site.</p> <p>How calculated: For each site, counts manual, automatic, or both types of queries, based on your selection in the Query Type filter on the report prompt page. This count includes all queries, regardless of status on all started clinical forms.</p> <p>For each site, columns display:</p> <ul style="list-style-type: none"> • Maximum—The maximum number of all queries per form for all started forms at the site. • Median—The median number of all queries per form for all started forms at the site. <p>Data source: Derived for the report; not stored in the Reporting and Analysis database.</p>

Column	Description
Days to Resolve (Open to Close)	<p>Data type: Numeric</p> <p>Description: The minimum, maximum, and median number of days for queries to be opened and closed.</p> <p>How calculated: For each query, the calculation starts on the first date when the status of the query was set to Open and ends on the most recent date when the status of the query was set to Closed. The number of days from the Open to the Closed state is rounded down to the nearest whole number.</p> <p>How calculated: The calculation begins on the first day when the status of a query was set to Open and ends on the most recent day when the status of a query was set to Closed. This value is calculated in multiples of 24 (hours) and is rounded down to the nearest whole number.</p> <p>For example, if a query is opened on day 1 at 10 AM and closed on day 3 at 9 AM, the Answered to Closed value is 2 days.</p> <p>For each site, columns display:</p> <ul style="list-style-type: none"> • Minimum—The fewest number of days taken for a query to be opened and closed at the site. • Maximum—The maximum number of days taken for a query to be opened and closed at the site. • Median—The median number of days for all queries to be opened and closed at the site. <p>Data source: Derived for the report; not stored in the Reporting and Analysis database.</p>

Column	Description
Days Open	<p>Data type: Numeric</p> <p>Description: For each site, the number of queries that have been open for a specific number of days.</p> <p>How calculated: This calculation applies only to queries with a current status of Open. The calculation begins on the date when a query was last opened and ends on the current date.</p> <p>This value is calculated in multiples of 24 (hours). For example, if the query is opened at 10 a.m. on day 1 and the report is run 10 days later at 9 a.m., the days open is 9.</p> <p>You specify the aging interval (in days) on the report prompt page.</p> <p>For example, if you specify 7, the resulting report shows the number of queries that have been open for:</p> <ul style="list-style-type: none"> • Seven or fewer days. • More than 7 but equal to or fewer than 14 days. • More than 14 but equal to or fewer than 21 days. • More than 21 but equal to or fewer than 28 days. • More than 28 days. <p>Data source: Derived for the report; not stored in the Reporting and Analysis database.</p>

Query Status by Site

This report shows the current total queries in each state for each site, with the option to drill down into the list of queries for visits or subjects for a specific site.

Sponsor personnel use this report to determine whether particular sites are generating many queries, which might indicate potential problems.

Selection criteria: Query Status by Site

Use the report prompt page to select criteria and specify sort options for your report.

For general instructions about how to run a standard report, see:

- *Running a standard report from the Reporting and Analysis portal* (on page 170).
- *Running a standard report in a new window* (on page 170).

For information about data that appears on this report, such as the data source, how data is calculated, and how it is displayed, see *Report/Graph page: Query Status by Site* (on page 208).

Selection criteria

Selection criteria	Action
--------------------	--------

Selection criteria	Action
Countries	To report on specific countries, select their names from the list. Then, click Update to update the Sites list.
Sites	To report on specific sites, select the names of the sites from the list.
Query type	<p>To specify the type of queries to report on, select one of the following:</p> <ul style="list-style-type: none"> • Auto—Automatic queries generated by the InForm application when a rule in the study design detects a discrepancy in the data that is entered. • Manual—Manual queries created by InForm users. <p>If you leave all checkboxes blank, the report will include both types of queries.</p>

Note: To include all available options in the report, leave the optional selection fields blank; that is, do not select any individual options from the drop-down lists. **For the best performance, do not select any optional filters.**

Sort options

Sort options are: None, Country, Site Mnemonic, Subject Count, Candidate Query Count, Deleted Query Count, Open Query Count, Answered Query Count, Closed Query Count, % Total within Country.

Use the **Sort** drop-down lists to change any of the default selections.

Sort	Default selection
First level	Country
Second level	Site Mnemonic
Third level	None

Report/Graph page: Query Status by Site

Subtotals and totals

- **Subtotals**—By Country
- **Totals**—Overall query count totals

Drill-through reports

This report contains links to two drill-through reports:

- Click the value in the **Site Mnemonic** column to drill down to the *Query Status by Site and Visit* (on page 215) report for the site.
- Click the value in the **Subject Count** column to drill down to the *Query Status by Site and Subject* (on page 210) report for the subject.

Column descriptions

Column	Description
Country	<p>Data type: String</p> <p>Description: The country in which a site is located, as entered in the InForm Administration interface.</p> <p>Data source: Replicated from the InForm transactional database to the Reporting and Analysis database.</p>
Site Mnemonic	<p>Data type: String</p> <p>Description: An abbreviation that identifies a site, as entered in the InForm Administration interface.</p> <p>Data source: Replicated from the InForm transactional database to the Reporting and Analysis database.</p>
Subject Count	<p>Data type: Numeric</p> <p>Description: The number of subjects who enrolled at the site.</p> <p>How calculated: For each site, counts subjects who enrolled at the site, including subjects who are currently assigned other states.</p> <p>Note: The Enrollment form, designed according to InForm specifications, must be completed for the subject.</p> <p>UUID: PF_SC_COMPLETECTL</p> <p>Data source: Status is determined by the value on the Enrollment form, which is stored in the Reporting and Analysis database. Status is set to 1 when the subject is enrolled.</p>

Column	Description
Avg Queries per Patient	<p>Data type: Numeric</p> <p>Description: The average number of queries associated with each subject at the site.</p> <p>How calculated: Counts the average number of unique queries per subject for the site, regardless of status, by dividing the number of queries for the site by the subject count for the site. This calculation counts manual, automatic, or both types of queries, based on your selection for the Query Types prompt.</p> <p>Data source: Derived for the report; not stored in the Reporting and Analysis database.</p>
Query Count: Candidate	<p>Data type: Numeric</p> <p>Description: For each site, the number of queries with a current status of Candidate.</p> <p>How calculated: Counts queries with the current status of Candidate. Counts manual, automatic, or both types of candidate queries, based on your selection in the Query Type filter on the report prompt page.</p> <p>Data source: Derived and stored in the Reporting and Analysis database.</p>
Query Count: Deleted	<p>Data type: Numeric</p> <p>Description: For each site, the number of queries with a current status of Deleted.</p> <p>How calculated: Counts queries with a current status of Deleted. Counts manual, automatic, or both types of deleted queries, based on your selection in the Query Type filter on the report prompt page.</p> <p>Data source: Derived and stored in the Reporting and Analysis database.</p>
Query Count: Open	<p>Data type: Numeric</p> <p>Description: For each site and visit, the number of queries with a current status of Open.</p> <p>How calculated: Counts all open queries for each site. Counts manual, automatic, or both, based on your selection in the Query Type filter on the report prompt page.</p> <p>Data source: Derived and stored in the Reporting and Analysis database.</p>

Column	Description
Query Count: Answered	<p>Data type: Numeric</p> <p>Description: For each site, the number of queries with a current status of Answered.</p> <p>How calculated: Counts all answered queries for each site. Counts manual, automatic, or both types of answered queries, based on your selection in the Query Type filter on the report prompt page.</p> <p>Data source: Derived and stored in the Reporting and Analysis database.</p>
Query Count: Closed	<p>Data type: Numeric</p> <p>Description: For each site, the number of queries with a current status of Closed.</p> <p>How calculated: Counts all closed queries for each site. Counts automatic, manual, or both types of closed queries, based on your selection in the Query Type filter on the report prompt page.</p> <p>Data source: Derived and stored in the Reporting and Analysis database.</p>
Query Count: Total (% of Total within Country)	<p>Data type: Numeric (Percentage)</p> <p>Description: The total number of queries at the site, regardless of status. For each site total, this column also displays the percentage of total queries for the country at the site.</p> <p>How calculated: Counts automatic, manual, or both types of closed queries, based on your selection in the Query Type filter on the report prompt page. The percentage is calculated as follows:</p> $[\% \text{ of total within country}] = [\text{query count for the site}] * 100 / [\text{query count for the country}]$ <p>Data source: Derived and stored in the Reporting and Analysis database. Percentage derived for display.</p>

Query Status by Site and Subject

This report is a drill-down report from the link in the Site Mnemonic column in the Query Status by Site and Query Status by User reports and can also be run as a stand-alone report.

This report shows CRAs and study managers the number of queries to date in each query state for one or more subjects within selected sites.

Selection criteria: Query Status by Site and Subject

Use the report prompt page to select criteria and specify sort options for your report.

For general instructions about how to run a standard report, see:

- *Running a standard report from the Reporting and Analysis portal* (on page 170).
- *Running a standard report in a new window* (on page 170).

For information about data that appears on this report, such as the data source, how data is calculated, and how it is displayed, see *Report/Graph page: Query Status by Site and Subject* (on page 212).

Selection criteria

Selection criteria	Action
Countries	To report on specific countries, select their names from the list. Then, click Update to update the Sites list.
Sites	To report on specific sites, select the names of the sites from the list. Then, click Update to update the Subjects list.
Subjects	To report on specific subjects, select the subjects from the list.
Query Type	To specify the type of queries to report on, select one of the following: <ul style="list-style-type: none"> • Auto—Automatic queries generated by the InForm application when a rule in the study design detects a discrepancy in the data that is entered. • Manual—Manual queries created by InForm users. If you leave all checkboxes blank, the report will include both types of queries.

Note: To include all available options in the report, leave the optional selection fields blank; that is, do not select any individual options from the drop-down lists. For the best performance, do not select any optional filters.

Sort options

Sort options are: None, Country, Site Mnemonic, Subject Number, Current Status, Started Visits Count, Candidate Query Count, Deleted Query Count, Open Query Count, Answered Query Count, Closed Query Count, % of all Queries.

Use the **Sort** drop-down lists to change any of the default selections.

Sort	Default selection
First level	Country
Second level	Site Mnemonic
Third level	Subject Number

Report/Graph page: Query Status by Site and Subject

Subtotals and totals

- **Subtotals**—By Site and Country.
- **Totals**—Overall query count totals.

Column descriptions

Column	Description
Country	<p>Data type: String</p> <p>Description: The country in which a site is located, as entered in the InForm Administration interface.</p> <p>Data source: Replicated from the InForm transactional database to the Reporting and Analysis database.</p>
Site Mnemonic	<p>Data type: String</p> <p>Description: An abbreviation that identifies a site, as entered in the InForm Administration interface.</p> <p>Data source: Replicated from the InForm transactional database to the Reporting and Analysis database.</p>
Subject Number	<p>Data type: String</p> <p>Description: The subject number, followed by the subject initials. The subject number identifies the subject. The subject number and subject initials can be changed post enrollment, if this is configured in the study.</p> <p>Note: Subject number might not be unique at your site.</p> <p>Data source: Replicated from the InForm transactional database to the Reporting and Analysis database.</p>

Column	Description
Current Status	<p>Data type: String</p> <p>Description: The current status of the subject. Subjects can be in only one state at a time.</p> <ul style="list-style-type: none"> • Screened—The Screening form for the subject was started, but the subject is not enrolled for one of the following reasons: <ul style="list-style-type: none"> ▪ The subject has been fully screened, but the enrollment form has not been started. ▪ The subject is fully screened and the enrollment process has started, but is not complete. • Screen Failed—The subject failed the InForm screening process. • Enroll Failed—The subject passed the InForm screening process, but failed the enrollment process. • Enrolled—The subject was properly enrolled in the InForm application, but has not reached the status of randomized, completed, or dropped out. • Randomized—The subject was enrolled and has been randomized in the InForm software, but is not yet completed or dropped out. • Complete—The subject has completed the study, as recorded in the Complete control of the Study Completion form for the subject. • Dropped out—The subject has dropped out of the study, as recorded in the Complete control of the Study Completion form for the subject. <p>Data source: Replicated from the InForm transactional database to the Reporting and Analysis database.</p>
Started Visits Count	<p>Data type: Numeric</p> <p>Description: For each subject, the number of visits that have a current status of Started.</p> <p>How calculated: For each subject, a visit is counted as started if at least one expected form in the visit is started. A form is started when any data, queries, or comments have been entered on the form.</p> <p>Data source: Derived and stored in the Reporting and Analysis database.</p>
Query Count: Candidate	<p>Data type: Numeric</p> <p>Description: For each site, the number of queries with a current status of Candidate.</p> <p>How calculated: Counts queries with the current status of Candidate. Counts manual, automatic, or both types of candidate queries, based on your selection in the Query Type filter on the report prompt page.</p> <p>Data source: Derived and stored in the Reporting and Analysis database.</p>

Column	Description
Query Count: Deleted	<p>Data type: Numeric</p> <p>Description: For each site, the number of queries with a current status of Deleted.</p> <p>How calculated: Counts queries with a current status of Deleted. Counts manual, automatic, or both types of deleted queries, based on your selection in the Query Type filter on the report prompt page.</p> <p>Data source: Derived and stored in the Reporting and Analysis database.</p>
Query Count: Open	<p>Data type: Numeric</p> <p>Description: For each site and visit, the number of queries with a current status of Open.</p> <p>How calculated: Counts all open queries for each site. Counts manual, automatic, or both, based on your selection in the Query Type filter on the report prompt page.</p> <p>Data source: Derived and stored in the Reporting and Analysis database.</p>
Query Count: Answered	<p>Data type: Numeric</p> <p>Description: For each site, the number of queries with a current status of Answered.</p> <p>How calculated: Counts all answered queries for each site. Counts manual, automatic, or both types of answered queries, based on your selection in the Query Type filter on the report prompt page.</p> <p>Data source: Derived and stored in the Reporting and Analysis database.</p>
Query Count: Closed	<p>Data type: Numeric</p> <p>Description: For each site, the number of queries with a current status of Closed.</p> <p>How calculated: Counts all closed queries for each site. Counts automatic, manual, or both types of closed queries, based on your selection in the Query Type filter on the report prompt page.</p> <p>Data source: Derived and stored in the Reporting and Analysis database.</p>

Column	Description
Total (% of Queries within Country)	<p>Data type: Numeric (Percentage)</p> <p>Description: The total number of queries at the site, regardless of status. This count is a sum of Candidate, Deleted, Open, Answered, and Closed queries plus the count of Conflict queries (which are not part of this report). For each site total, this column also displays the percentage of total queries for the country at the site.</p> <p>How calculated: Counts automatic, manual, or both types of closed queries, based on your selection in the Query Type filter on the report prompt page. The percentage is calculated as follows:</p> $[\% \text{ of total within country}] = [\text{query count for the site}] * 100 / [\text{query count for the country}]$ <p>Data source: Derived and stored in the Reporting and Analysis database. Percentage derived for display.</p> <p>Note: A conflict query is a query that the InForm application automatically generates when it detects a discrepancy between different copies of the same study when users synchronize them. This query type exists when the InForm application is used with the CIS application. Conflict queries can also be entered using the InForm Adapter query interface.</p>

Query Status by Site and Visit

This report is a drill-down report and uses the Subject Count as the link from the Query Status by Site and Query Status by User reports. It can also be run as a stand-alone report.

This report shows CRAs and study managers the number of queries to date in each query state for one or more visits for selected sites. CDMs use this report to review current query status by visit to help close out open queries in advance of an interim analysis or other study milestone.

Selection criteria: Query Status by Site and Visit

Use the report prompt page to select criteria and specify sort options for your report.

For general instructions about how to run a standard report, see:

- *Running a standard report from the Reporting and Analysis portal* (on page 170).
- *Running a standard report in a new window* (on page 170).

For information about data that appears on this report, such as the data source, how data is calculated, and how it is displayed, see *Report/Graph page: Query Status by Site and Visit* (on page 216).

Selection criteria

Selection criteria	Action
--------------------	--------

Selection criteria	Action
Countries	To report on specific countries, select their names from the list. Then, click Update to update the Sites list.
Sites	To report on specific sites, select the names of the sites from the list. Then, click Update to update the Visits list.
Visits	To report on one or more visits, select the visits from the list.
Query type	<p>To specify the type of queries to report on, select one of the following:</p> <ul style="list-style-type: none"> • Auto—Automatic queries generated by the InForm application when a rule in the study design detects a discrepancy in the data that is entered. • Manual—Manual queries created by InForm users. <p>If you leave all checkboxes blank, the report will include both types of queries.</p>

Note: To include all available options in the report, leave the optional selection fields blank; that is, do not select any individual options from the drop-down lists. For the best performance, do not select any optional filters.

Sort options

Sort options are: None, Country, Site Mnemonic, Visit Order, Subject Count, Candidate Query Count, Deleted Query Count, Open Query Count, Answered Query Count, Closed Query Count, % of all Queries.

Use the **Sort** drop-down lists to change any of the default selections.

Sort	Default selection
First level	Country
Second level	Site Mnemonic
Third level	Visit Order

Report/Graph page: Query Status by Site and Visit

Subtotals and totals

- **Subtotals**—By Site and Country.
- **Totals**—Overall query count totals.

Column descriptions

Column	Description
--------	-------------

Column	Description
Country	<p>Data type: String</p> <p>Description: The country in which a site is located, as entered in the InForm Administration interface.</p> <p>Data source: Replicated from the InForm transactional database to the Reporting and Analysis database.</p>
Site Mnemonic	<p>Data type: String</p> <p>Description: An abbreviation that identifies a site, as entered in the InForm Administration interface.</p> <p>Data source: Replicated from the InForm transactional database to the Reporting and Analysis database.</p>
Subject Count	<p>Data type: Numeric</p> <p>Description: The number of subjects who enrolled at the site.</p> <p>How calculated: For each site, counts subjects who enrolled at the site, including subjects who are currently assigned other states.</p> <p>Note: The Enrollment form, designed according to InForm specifications, must be completed for the subject.</p> <p>UUID: PF_SC_COMPLETECTL</p> <p>Data source: Status is determined by the value on the Enrollment form, which is stored in the Reporting and Analysis database. Status is set to 1 when the subject is enrolled.</p>
Visit Mnemonic	<p>Data type: String</p> <p>Description: An abbreviation of the visit title, as specified in the study design. For CRF visits, this title appears at the top of a collection of forms in the visit timeline and may not be a unique identifier.</p> <p>Data source: Replicated from the InForm transactional database to the Reporting and Analysis database.</p>
Query Count: Candidate	<p>Data type: Numeric</p> <p>Description: For each site, the number of queries with a current status of Candidate.</p> <p>How calculated: Counts queries with the current status of Candidate. Counts manual, automatic, or both types of candidate queries, based on your selection in the Query Type filter on the report prompt page.</p> <p>Data source: Derived and stored in the Reporting and Analysis database.</p>

Column	Description
Query Count: Deleted	<p>Data type: Numeric</p> <p>Description: For each site, the number of queries with a current status of Deleted.</p> <p>How calculated: Counts queries with a current status of Deleted. Counts manual, automatic, or both types of deleted queries, based on your selection in the Query Type filter on the report prompt page.</p> <p>Data source: Derived and stored in the Reporting and Analysis database.</p>
Query Count: Opened	<p>Data type: Numeric</p> <p>Description: For each site and visit, the number of queries with a current status of Open.</p> <p>How calculated: Counts all open queries for each site. Counts manual, automatic, or both, based on your selection in the Query Type filter on the report prompt page.</p> <p>Data source: Derived and stored in the Reporting and Analysis database.</p>
Query Count: Answered	<p>Data type: Numeric</p> <p>Description: For each site, the number of queries with a current status of Answered.</p> <p>How calculated: Counts all answered queries for each site. Counts manual, automatic, or both types of answered queries, based on your selection in the Query Type filter on the report prompt page.</p> <p>Data source: Derived and stored in the Reporting and Analysis database.</p>
Query Count: Closed	<p>Data type: Numeric</p> <p>Description: For each site, the number of queries with a current status of Closed.</p> <p>How calculated: Counts all closed queries for each site. Counts automatic, manual, or both types of closed queries, based on your selection in the Query Type filter on the report prompt page.</p> <p>Data source: Derived and stored in the Reporting and Analysis database.</p>

Column	Description
Query Count: Total (% Queries within Country)	<p>Data type: Numeric (Percentage)</p> <p>Description: The total number of queries at the site, regardless of status. This count is a sum of Candidate, Deleted, Open, Answered, and Closed queries plus the count of Conflict queries (which are not part of this report). For each site total, this column also displays the percentage of total queries for the country at the site.</p> <p>How calculated: Counts automatic, manual, or both types of closed queries, based on your selection in the Query Type filter on the report prompt page. The percentage is calculated as follows:</p> $[\% \text{ of total within country}] = [\text{query count for the site}] * 100 / [\text{query count for the country}]$ <p>Data source: Derived and stored in the Reporting and Analysis database. Percentage derived for display.</p> <p>Note: A conflict query is a query that the InForm application automatically generates when it detects a discrepancy between different copies of the same study when users synchronize them. This query type exists when the InForm application is used with the CIS application. Conflict queries can also be entered using the InForm Adapter query interface.</p>

Query Status by User

This report shows CRAs and study managers the raw numbers of queries to date in each query state for one or more sites, by user, with the option to drill down into the list of queries for visits or subjects for a specific site.

Selection criteria: Query Status by User

Use the report prompt page to select criteria and specify sort options for your report.

For general instructions about how to run a standard report, see:

- *Running a standard report from the Reporting and Analysis portal* (on page 170).
- *Running a standard report in a new window* (on page 170).

For information about data that appears on this report, such as the data source, how data is calculated, and how it is displayed, see *Report/Graph page: Query Status by User* (on page 220).

Selection criteria

Selection criteria	Action
Rights groups	Select one or more rights groups from the list. Then, click Update to update the Users list.
Users	To report on specific users, select them from the drop-down list. Then, click Update to update the Sites list.

Selection criteria	Action
Sites	To report on specific sites, select the names of the sites from the list.
Query types	<p>To specify the type of queries to report on, select one of the following:</p> <ul style="list-style-type: none"> • Auto—Automatic queries generated by the InForm application when a rule in the study design detects a discrepancy in the data that is entered. • Manual—Manual queries created by InForm users. <p>If you leave all checkboxes blank, the report will include both types of queries.</p>

Note: To include all available options in the report, leave the optional selection fields blank; that is, do not select any individual options from the drop-down lists. For the best performance, do not select any optional filters.

Sort options

Sort options are: None, Rights Group, User Name, Site Mnemonic, Subject Count, Candidate Query Count, Deleted Query Count, Open Query Count, Answered Query Count, Closed Query Count, % Total within Country.

Use the **Sort** drop-down lists to change any of the default selections.

Sort	Default selection
First level	Rights Group
Second level	User Name
Third level	Site Mnemonic

Report/Graph page: Query Status by User

Subtotals and totals

- **Subtotals**—None.
- **Totals**—Overall query count totals.

Drill-through reports

This report contains links to two drill-through reports:

- Click a value in the Site Mnemonic column to drill down to the Query Status by Site and Visit report for the selected site.
- Click a value in the Subject Count column to drill down to the Query Status by Site and Subject report for the subjects included in the count.

Column descriptions

Column	Description
Rights Group	<p>Data type: String</p> <p>Description: The InForm rights group to which the user belongs.</p> <p>Data source: Replicated from the InForm transactional database to the Reporting and Analysis database.</p>
User Name	<p>Data type: String</p> <p>Description: The user name of the InForm user.</p> <p>Data source: Replicated from the InForm transactional database to the Reporting and Analysis database.</p>
Site Mnemonic	<p>Data type: String</p> <p>Description: An abbreviation that identifies a site, as entered in the InForm Administration interface.</p> <p>Data source: Replicated from the InForm transactional database to the Reporting and Analysis database.</p>
Subject Count	<p>Data type: Numeric</p> <p>Description: The number of subjects who enrolled at the site.</p> <p>How calculated: For each site, counts subjects who enrolled at the site, including subjects who are currently assigned other states.</p> <p>Note: The Enrollment form, designed according to InForm specifications, must be completed for the subject.</p> <p>UUID: PF_SC_COMPLETECTL</p> <p>Data source: Status is determined by the value on the Enrollment form, which is stored in the Reporting and Analysis database. Status is set to 1 when the subject is enrolled.</p> <p>Note: You can use any of the predefined subject filters to further qualify this count.</p>
Avg Queries per Patient	<p>Data type: Numeric</p> <p>Description: The average number of queries associated with each subject at the site.</p> <p>How calculated: Counts the average number of unique queries per subject for the site, regardless of status, by dividing the number of queries for the site by the subject count for the site. This calculation counts manual, automatic, or both types of queries, based on your selection for the Query Types prompt.</p> <p>Data source: Derived for the report; not stored in the Reporting and Analysis database.</p>

Column	Description
Query Count: Candidate	<p>Data type: Numeric</p> <p>Description: For each site, the number of queries with a current status of Candidate.</p> <p>How calculated: Counts queries with the current status of Candidate. Counts manual, automatic, or both types of candidate queries, based on your selection in the Query Type filter on the report prompt page.</p> <p>Data source: Derived and stored in the Reporting and Analysis database.</p>
Query Count: Deleted	<p>Data type: Numeric</p> <p>Description: For each site, the number of queries with a current status of Deleted.</p> <p>How calculated: Counts queries with a current status of Deleted. Counts manual, automatic, or both types of deleted queries, based on your selection in the Query Type filter on the report prompt page.</p> <p>Data source: Derived and stored in the Reporting and Analysis database.</p>
Query Count: Open	<p>Data type: Numeric</p> <p>Description: For each site and visit, the number of queries with a current status of Open.</p> <p>How calculated: Counts all open queries for each site. Counts manual, automatic, or both, based on your selection in the Query Type filter on the report prompt page.</p> <p>Data source: Derived and stored in the Reporting and Analysis database.</p>
Query Count: Answered	<p>Data type: Numeric</p> <p>Description: For each site, the number of queries with a current status of Answered.</p> <p>How calculated: Counts all answered queries for each site. Counts manual, automatic, or both types of answered queries, based on your selection in the Query Type filter on the report prompt page.</p> <p>Data source: Derived and stored in the Reporting and Analysis database.</p>
Query Count: Closed	<p>Data type: Numeric</p> <p>Description: For each site, the number of queries with a current status of Closed.</p> <p>How calculated: Counts all closed queries for each site. Counts automatic, manual, or both types of closed queries, based on your selection in the Query Type filter on the report prompt page.</p> <p>Data source: Derived and stored in the Reporting and Analysis database.</p>

Column	Description
Query Count: Total (% of all Queries)	<p>Data type: Numeric (Percentage)</p> <p>Description: The total number of queries at the site, regardless of status. For each site total, this column also displays the percentage of total queries for the country at the site.</p> <p>How calculated: Counts automatic, manual, or both types of closed queries, based on your selection in the Query Type filter on the report prompt page. The percentage is calculated as follows:</p> $[\% \text{ of total within country}] = [\text{query count for the site}] * 100 / [\text{query count for the country}]$ <p>Data source: Derived and stored in the Reporting and Analysis database. Percentage derived for display.</p>

Query Volume by Month by Site

This report shows the number of queries opened, answered, and closed in each month for a range of months.

Site managers use this report to see if query volume or query handling is changing negatively over the course of a study.

Selection criteria: Query Volume by Month by Site

Use the report prompt page to select criteria and specify sort options for your report.

For general instructions about how to run a standard report, see:

- *Running a standard report from the Reporting and Analysis portal* (on page 170).
- *Running a standard report in a new window* (on page 170).

For information about data that appears on this report, such as the data source, how data is calculated, and how it is displayed, see *Report/Graph page: Query Volume by Month by Site* (on page 225).

Selection criteria

Selection criteria	Action
Countries	To report on specific countries, select their names from the list. Then, click Update to update the Sites list.
Sites	To report on specific sites, select the names of the sites from the list.

Selection criteria	Action
Query status	<p>To filter the report by query status, select one or more of the following options:</p> <ul style="list-style-type: none"> • Open—Query status is Open. • Answered—Query status is Answered. • Closed—Query status is Closed. <p>If you leave all checkboxes blank, the report will include all these options.</p>
Limited to Reissued	<p>To filter the report to include data for queries in the Reissued Queries state, select this option. The results will be limited to reissued queries only.</p>
Query type	<p>To specify the type of queries to report on, select one of the following:</p> <ul style="list-style-type: none"> • Auto—Automatic queries generated by the InForm application when a rule in the study design detects a discrepancy in the data that is entered. • Manual—Manual queries created by InForm users. <p>If you leave all checkboxes blank, the report will include both types of queries.</p>
Date range	<p>Choose one of these actions:</p> <ul style="list-style-type: none"> • To specify the date range, enter the From and To dates, or use the calendar icons to select the dates. • To automatically select the earliest and latest possible dates, use the Earliest Date and Latest Date radio buttons. <p>The resulting report shows query volume for the specified date range.</p>

Note: To include all available options in the report, leave the optional selection fields blank; that is, do not select any individual options from the drop-down lists. **For the best performance, do not select any optional filters.**

Sort options

Sort options are: None, Country, Site Mnemonic.

Use the **Sort** drop-down lists to change any of the default selections.

Sort	Default selection
First level	Country
Second level	Site Mnemonic
Third level	None

Report/Graph page: Query Volume by Month by Site

Graphs

A bar graph appears on the first page of the report, plotting the query volume by month and site.

Subtotals and totals

- **Subtotals**—By Country.
- **Totals**—Overall query count totals.

Column descriptions

Column	Description
Country	<p>Data type: String</p> <p>Description: The country in which a site is located, as entered in the InForm Administration interface.</p> <p>Data source: Replicated from the InForm transactional database to the Reporting and Analysis database.</p>
Site Mnemonic	<p>Data type: String</p> <p>Description: An abbreviation that identifies a site, as entered in the InForm Administration interface.</p> <p>Data source: Replicated from the InForm transactional database to the Reporting and Analysis database.</p>
Month, Year	<p>Data type: String</p> <p>Description: Month, Year for each month in which there is query activity (queries opened, answered, or closed).</p> <p>How calculated: For each query, extracts month and year portion of the date the query was first opened, first answered, and last closed.</p>
Open	<p>Data type: Numeric</p> <p>Description: The number of queries that were opened in a given month.</p> <p>How calculated: Counts queries that were opened in a given month, based on your selections in the Query Status, Query State, and Limit to Reissued prompts on the report prompt page.</p> <p>Data source: Derived for the report; not stored in the Reporting and Analysis database.</p>

Column	Description
Answered	<p>Data type: Numeric</p> <p>Description: The number of queries that were answered in a given month.</p> <p>How calculated: Counts queries that were answered in a given month, based on your selections in the Query Status, Query State, and Limit to Reissued prompts on the report prompt page.</p> <p>Data source: Derived for the report; not stored in the Reporting and Analysis database.</p>
Closed	<p>Data type: Numeric</p> <p>Description: For each site, the number of queries that were closed in a given month.</p> <p>How calculated: Counts queries that were closed in a given month, based on your selections in the Query Status, Query State, and Limit to Reissued prompts on the report prompt page.</p> <p>Data source: Derived for the report; not stored in the Reporting and Analysis database.</p>
Total	<p>Data type: Numeric</p> <p>Description: For each site and visit, the total number of open, answered, and closed queries in a given month.</p> <p>How calculated: The sum of the values in the Open, Ans'd, and Closed columns.</p> <p>Data source: Derived for the report; not stored in the Reporting and Analysis database.</p>

Query Volume by Rule

This report shows the number of times that each rule triggered a query.

Study designers use this report to help identify problem areas and find unnecessary query rules.

Selection criteria: Query Volume by Rule

Use the report prompt page to select criteria and specify sort options for your report.

For general instructions about how to run a standard report, see:

- *Running a standard report from the Reporting and Analysis portal* (on page 170).
- *Running a standard report in a new window* (on page 170).

For information about data that appears on this report, such as the data source, how data is calculated, and how it is displayed, see *Report/Graph page: Query Volume by Rule* (on page 228).

Selection criteria

Selection criteria	Action
Rule trigger count	<p>Select a trigger count range for your report. The trigger count is the number of times a rule triggered a query in the InForm application.</p> <p>Use the radio buttons to do the following:</p> <ul style="list-style-type: none"> • Specify From and To values. • Select the lowest and highest trigger counts in the study by using the data in the Lowest value and Highest value fields. <p>Default: Lowest to highest value</p> <p>Note: If no selection is made, the bar graph will be hard to read because rule names are very long. Oracle recommends that you specify From and To values.</p>

Sort options

Sort options are: None, Rule Name, Form Mnemonic, Item Name, Trigger Count, % of Total Trigger Count.

Use the **Sort** drop-down lists to change any of the default selections.

Sort	Default selection
First level	Trigger Count
Second level	Form Mnemonic
Third level	None

Report/Graph page: Query Volume by Rule

Graphs

A bar graph appears on the first page of the Query Volume by Rule report, illustrating the number of times each rule triggered a query.

Subtotals and totals

- **Subtotals**—By rule.
- **Totals**—Overall rule trigger count totals.

Column descriptions

Column	Description
Rule name	<p>Data type: String</p> <p>Description: The name that uniquely identifies the rule in the study design code. This is the rule RefName.</p> <p>Data source: Replicated from the InForm transactional database to the Reporting and Analysis database.</p>
Form Mnemonic	<p>Data type: String</p> <p>Description: A short name or abbreviation for the form, as specified in the study design code. This name appears in the Visit ruler and along the left side of certain pages for use with the form selectors, and is used to access a specific form in the InForm application.</p> <p>Data source: Replicated from the InForm transactional database to the Reporting and Analysis database.</p>
Item Name	<p>Data type: String</p> <p>Description: The name that uniquely identifies the item to which the rule is attached in the study design code. This corresponds to the Short Question in the Central Designer application or Itemset Column Header in the InForm application. Access to this data can be restricted in the InForm application. When users who do not have access to this data run a report with this report element, the resulting report displays a series of asterisks (*****) rather than the actual text.</p> <p>Data source: Replicated from the InForm transactional database to the Reporting and Analysis database.</p>
Trigger Count	<p>Data type: Text</p> <p>Description: The total number of times that the rule triggered a query.</p> <p>How calculated: Counts rules that have triggered a query.</p> <p>Data source: Derived and stored in the Reporting and Analysis database.</p>

Subject Counts with Outstanding Queries

This report shows the number of subjects at each site that have open or answered queries at a specified time. The report includes countries and sites regardless of whether they have subjects or queries.

Study managers and CDMs use this report to obtain detailed subject counts with outstanding queries in order to resolve queries and ensure site readiness.

Selection criteria: Subject Counts with Outstanding Queries

Use the report prompt page to select criteria and specify sort options for your report.

For general instructions about how to run a standard report, see:

- *Running a standard report from the Reporting and Analysis portal* (on page 170).
- *Running a standard report in a new window* (on page 170).

For information about data that appears on this report, such as the data source, how data is calculated, and how it is displayed, see *Report/Graph page: Subject Counts with Outstanding Queries* (on page 230).

Selection criteria

Selection criteria	Action
Countries	To report on specific countries, select their names from the list. Then, click Update to update the Sites list.
Sites	If you updated the Sites list after selecting one or more countries and you want to report on specific sites, select the names of the sites from the list.
Query Type	To specify the type of queries to report on, select one of the following: <ul style="list-style-type: none"> • Auto—Automatic queries generated by the InForm application when a rule in the study design detects a discrepancy in the data that is entered. • Manual—Manual queries created by InForm users. <p>If you leave all checkboxes blank, the report will include both types of queries.</p>
Minimum Days Open or Answered	Specify the minimum number of days a query must be opened or answered to be included in this report. Default: 0 (days)

Note: To include all available options in the report, leave the optional selection fields blank; that is, do not select any individual options from the drop-down lists. **For the best performance, do not select any optional filters.**

Sort options

Sort options are: None, Country, Site Mnemonic, Subject Count, Subjects w/Open Queries, Subjects w/Answered Queries.

Use the **Sort** drop-down lists to change any of the default selections.

Sort	Default selection
First level	Country
Second level	Site Mnemonic
Third level	None

Report/Graph page: Subject Counts with Outstanding Queries

Subtotals and totals

- **Subtotals**—By Country.
- **Totals**—Overall subject count totals.

Column descriptions

Column	Description
Country	<p>Data type: String</p> <p>Description: The country in which a site is located, as entered in the InForm Administration interface.</p> <p>Data source: Replicated from the InForm transactional database to the Reporting and Analysis database.</p>
Site Mnemonic	<p>Data type: String</p> <p>Description: An abbreviation that identifies a site, as entered in the InForm Administration interface.</p> <p>Data source: Replicated from the InForm transactional database to the Reporting and Analysis database.</p>
Subjects	<p>Data type: Numeric</p> <p>Description: The number of subjects who enrolled at the site.</p> <p>How calculated: For each site, counts subjects who enrolled at the site, including subjects who are currently assigned other states.</p> <p>Note: The Enrollment form, designed according to InForm specifications, must be completed for the subject.</p> <p>UUID: PF_SC_COMPLETECTL</p> <p>Data source: Status is determined by the value on the Enrollment form, which is stored in the Reporting and Analysis database. Status is set to 1 when the subject is enrolled.</p>

Column	Description
Subjects with Open Queries	<p>Data type: Numeric</p> <p>Description: The number of subjects with open queries.</p> <p>How calculated: Counts subjects with at least one open query against the entered data for the subject. The open query must have been open for at least the number of days that you specified in the Minimum Days Opened or Answered filter on the report prompt page. The calculation begins on the date when the query was last opened and ends on today's date. The number of days is rounded down to the nearest whole number.</p> <p>Data source: Derived for the report; not stored in the Reporting and Analysis database.</p>
Subjects with Answered Queries	<p>Data type: Numeric</p> <p>Description: The number of subjects with answered queries.</p> <p>How calculated: Counts subjects with at least one answered query against the entered data for the subject. The answered query must have been answered for at least the number of days that you specified in the Minimum Days Opened or Answered filter on the report prompt page. The calculation begins on the date when the query was last answered and ends on today's date. The number of days is rounded down to the nearest whole number.</p> <p>Data source: Derived for the report; not stored in the Reporting and Analysis database.</p>

Case Report Form (CRF) reports

CRF Aging by Site report

This report shows:

- The number of forms that are expected at any point in the study.
- The number of forms that are incomplete.
- The length of time that incomplete forms have been incomplete, beginning with the date of visit.

Note: This calculation relies on the use of the *DOV controls* (on page 21) specified in the form design.

CRAs use this report to stay current on the CRF activity within their site.

Selection criteria: CRF Aging by Site

Use the report prompt page to select criteria and specify sort options for your report.

For general instructions about how to run a standard report, see:

- *Running a standard report from the Reporting and Analysis portal* (on page 170).
- *Running a standard report in a new window* (on page 170).

For information about data that appears on this report, such as the data source, how data is calculated, and how it is displayed, see *Report/Graph page: CRF Aging by Site* (on page 234).

Selection criteria

Selection criteria	Action
Countries	To report on specific countries, select their names from the list. Then, click Update to update the Sites list.
Sites	To report on specific sites, select their names from the list.

Selection criteria	Action
Expected forms for	<p>Filter the report by expected forms. Choose one of these options from the drop-down list.</p> <ul style="list-style-type: none"> • All forms—All clinical forms (forms of type CRF) are considered. • Scheduled visits—All expected forms that are in scheduled visits are considered. • Scheduled or started visits—All clinical forms that are in either expected or started visits are considered. • Scheduled or started visits to date—All the expected forms that are in scheduled visits whose expected start date is earlier than the report run date, and all the expected forms that are present in started visits when the actual date of the visit is on or before the report run date are considered. • Scheduled visits or started forms to date—All the expected forms that are in scheduled visits whose expected start date is on or before the report run date, and all the expected forms that were started on or before the report run date are considered.
Aging Interval	<p>Enter a time duration (in days) to be used as the aging interval. The resulting report uses the aging interval to show how many forms have been incomplete during specific ranges of calendar days after the date of visit.</p> <p>For example, if you specify 7 here, the resulting report shows the number of forms that have been incomplete for:</p> <ul style="list-style-type: none"> • Seven or fewer days after the date of visit. • More than 7 days but equal to or fewer than 14 days after the DOV. • More than 14 days but equal to or fewer than 21 days after the DOV. • More than 21 days but equal to or fewer than 28 days after the DOV. • More than 28 days after the DOV. <p>Default: 7 (days)</p>

Selection criteria	Action
Limit to forms with	<p>To filter the report, select one or more of the following options:</p> <ul style="list-style-type: none"> • Required items—Forms that have items marked as required are considered. • SV required items—Forms that have items marked as source verification required are considered. • Outstanding queries—Forms that have open or answered queries against the forms items are considered. • Comments—Forms that have either form level or item level comments are considered. <p>If you leave all checkboxes blank, this prompt is not applied. In that case, the results are determined by your selections in the previous prompts.</p> <p>If one or more checkboxes are selected, the counts are limited by the selection(s) in this prompt. Most likely, this results in decreased counts. For example, selecting both Required items and SV required items limits the report results to only those forms that have both required items and SV required items.</p>

Sort options

Sort options are: None, Country, Site Mnemonic, Subject Count, Expected Forms Count, Completed Forms Count, Incomplete Forms Count, Not Started Forms Count, % of Incomplete Forms 1st Period, % of Incomplete Forms 2nd Period, % of Incomplete Forms 3rd Period, % of Incomplete Forms 4th Period, % of Incomplete Forms 5th Period.

Use the **Sort** drop-down lists to change any of the default selections.

Sort	Default selection
First level	Country
Second level	Site Mnemonic
Third level	None

Report/Graph page: CRF Aging by Site

Subtotals and totals

- **Subtotals**—By Country.
- **Totals**—Overall form count totals.

Column descriptions

Column	Description
--------	-------------

Column	Description
Country	<p>Data type: String</p> <p>Description: The country in which a site is located, as entered in the InForm Administration interface.</p> <p>Data source: Replicated from the InForm transactional database to the Reporting and Analysis database.</p>
Site Mnemonic	<p>Data type: String</p> <p>Description: An abbreviation that identifies a site, as entered in the InForm Administration interface.</p> <p>Data source: Replicated from the InForm transactional database to the Reporting and Analysis database.</p>
Subject Count	<p>Data type: Numeric</p> <p>Description: The number of subjects who enrolled at the site.</p> <p>How calculated: For each site, counts subjects who enrolled at the site, including subjects who are currently assigned other states.</p> <p>Note: The Enrollment form, designed according to InForm specifications, must be completed for the subject.</p> <p>UUID: PF_SC_COMPLETECTL</p> <p>Data source: Status is determined by the value on the Enrollment form, which is stored in the Reporting and Analysis database. Status is set to 1 when the subject is enrolled.</p>
Form Counts: Expected	<p>Data type: Numeric</p> <p>Description: The number of expected forms in the study.</p> <p>How calculated: This number reflects the number of expected forms for the site based on the option selected for the Expected forms for filter on the report prompt page. For more information, see <i>Selection criteria: CRF Aging by Site</i> (on page 232) and <i>Form elements and expected forms</i> (on page 91).</p> <p>Data source: Derived for the report; not stored in the Reporting and Analysis database.</p>

Column	Description
Form Counts: Complete	<p>Data type: Numeric (Percentage)</p> <p>Description: The number of completed forms, and the percentage of expected forms that are complete in the InForm application.</p> <p>How calculated: Counts forms that are expected and meet the following criteria:</p> <ul style="list-style-type: none"> • Are started. • Contain data for all required items. • For a repeating form, the form is not in a deleted state. • For an itemset form, the form is complete even if all the instances are deleted. <p>This value displays as a whole number and as a percentage of the total number of expected forms that are complete:</p> $[\text{completed, \% of expected}] = [\text{completed forms}] * 100 / [\text{expected forms}]$ <p>Data source: Replicated from the InForm transactional database to the Reporting and Analysis database. Percentage is derived for display.</p>
Form Counts: Incomplete	<p>Data type: Numeric</p> <p>Description: The number of expected forms that are started but not complete.</p> <p>How calculated: For each site, this calculation is:</p> $[\text{count of started forms}] - [\text{count of completed forms}]$ <p>Data source: Derived for the report; not stored in the Reporting and Analysis database.</p>
Form Counts: Not Started	<p>Data type: Numeric (Percentage)</p> <p>Description: The number (and percentage) of expected forms that are not started in the InForm application.</p> <p>How calculated: A form is started if any data, queries, or comments have been entered. Each instance of a repeating form counts as a separate started form. A dynamic form may be Activated, but not Started.</p> <p>This value displays as a whole number and as the percentage of expected forms that are not started:</p> $[\text{not started, \% of expected}] = [\text{not started forms count}] * 100 / [\text{expected forms count}]$ <p>Data source: Derived for the report; not stored in the Reporting and Analysis database.</p>

Column	Description
Incomplete (from DOV) Form Count (% of Incomplete)	<p>Data type: Numeric (Percentage)</p> <p>Description: The total count of all forms across all subjects that have been incomplete for specific ranges of calendar days after the date of visit. You specify the aging interval (in days) on the report prompt page. For example, if you specify 7, the resulting report shows the number of forms that have been incomplete for:</p> <ul style="list-style-type: none"> • Seven or fewer days. • More than 7 but equal to or fewer than 14 days. • More than 14 but equal to or fewer than 21 days. • More than 21 but equal to or fewer than 28 days. • More than 28 days. <p>How calculated: This value displays as a whole number, followed by a percentage of the total incomplete form count. The percentage is calculated as follows:</p> $\frac{[\text{count of incomplete forms within the aging interval}] * 100}{[\text{count of incomplete forms}]}$ <p>Note: This report element assumes that your study was developed using a specific design for the DOV controls. For more information, see <i>DOV controls</i> (on page 21).</p> <p>UUIDs:</p> <ul style="list-style-type: none"> • DateTimeControl—BD991BC0-B0A4-11D2-80E3-00A0C9AF7674 • Item—BD991BBF-B0A4-11D2-80E3-00A0C9AF7674 • Section—BD991BBE-B0A4-11D2-80E3-00A0C9AF7674 <p>Data source: Derived for the report; not stored in the Reporting and Analysis database.</p>

CRF Cycle Time Detail by Site

This report shows the measures of data-entry performance, by site and visit, by showing the number of days from:

- Date of visit to form started.
- Date of visit to form completed.
- Form completed to form source verified.
- Form completed to form locked.

Note: This calculation relies on the use of the *DOV controls* (on page 21) specified in the form design.

Selection criteria: CRF Cycle Time Detail by Site

Use the report prompt page to select criteria and specify sort options for your report.

For general instructions about how to run a standard report, see:

- *Running a standard report from the Reporting and Analysis portal* (on page 170).
- *Running a standard report in a new window* (on page 170).

For information about data that appears on this report, such as the data source, how data is calculated, and how it is displayed, see *Report/Graph page: CRF Cycle Time Detail by Site* (on page 239).

Selection criteria

Selection criteria	Action
Countries	To report on specific countries, select their names from the list. Then, click Update to update the Sites list.
Sites	If you updated the Sites list after selecting one or more countries and you want to report on specific sites, select the names of the sites from the list.
Visits	To report on one or more visits, select the visits from the list.

Note: To include all available options in the report, leave the optional selection fields blank; that is, do not select any individual options from the drop-down lists. For the best performance, do not select any optional filters.

Sort options

Sort options are: None, Country, Site Mnemonic, Visit Order, Started Forms Count, Completed Forms Count, Expected Forms Count, DOV to Form Started–Min, DOV to Form Started–Max, DOV to Form Completed–Min, DOV to Form Completed–Max, Form Completed to SDV Completed–Min, Form Completed to SDV Completed–Max, Form Completed to Form Locked–Min, Form Completed to Form Locked–Max.

Use the **Sort** drop-down lists to change any of the default selections.

Sort	Default selection
First level	Country
Second level	Site Mnemonic
Third level	Visit Order

Report/Graph page: CRF Cycle Time Detail by Site

Subtotals and totals

- **Subtotals**—By site and country.
 - Min—Lowest minimum value for any site in the country.
 - Max—Highest maximum value for any site in the country.
 - Median—No value.
- **Totals**—Overall form count totals.
 - Min—Lowest minimum value for any site in the country.
 - Max—Highest maximum value for any site in the country.
 - Median—No value.

Column descriptions

Column	Description
Country	<p>Data type: String</p> <p>Description: The country in which a site is located, as entered in the InForm Administration interface.</p> <p>Data source: Replicated from the InForm transactional database to the Reporting and Analysis database.</p>
Site Mnemonic	<p>Data type: String</p> <p>Description: An abbreviation that identifies a site, as entered in the InForm Administration interface.</p> <p>Data source: Replicated from the InForm transactional database to the Reporting and Analysis database.</p>
Visit Mnemonic	<p>Data type: String</p> <p>Description: An abbreviation of the visit title, as specified in the study design. For CRF visits, this title appears at the top of a collection of forms in the visit timeline and may not be a unique identifier.</p> <p>Data source: Replicated from the InForm transactional database to the Reporting and Analysis database.</p>
Form Counts: Expected	<p>Data type: Numeric</p> <p>Description: The total count of all forms that are expected across all subjects, by visit and by site.</p> <p>How calculated: This number reflects the number of expected forms for the site based on the definition of Expected forms. For more information, see <i>Form elements and expected forms</i> (on page 91).</p> <p>Data source: Derived for the report; not stored in the Reporting and Analysis database.</p>

Column	Description
Form Counts: Started	<p>Data type: Numeric</p> <p>Description: Total count of all forms that are started across all subjects, by visit and by site.</p> <p>How calculated: An expected form is considered started if any type of data entry activity (form data, queries, or comments) has started on the form.</p> <p>Data source: Replicated from the InForm transactional database to the Reporting and Analysis database.</p>
Form Counts: Completed	<p>Data type: Numeric</p> <p>Description: Total count of all forms that are complete across all subjects, by visit and by site.</p> <p>How calculated: Counts forms that are expected and meet the following criteria:</p> <ul style="list-style-type: none">• Are started.• Contain data for all required items.• For a repeating form, the form is not in a deleted state.• For an itemset form, the form is complete even if all the instances are deleted. <p>Data source: Derived and stored in the Reporting and Analysis database.</p>

Column	Description
DOV to Form Started (Days): Min, Max, Median	<p>Data type: Numeric</p> <p>Description: The number of days from the date entered on the DOV form to the first day on which any data entry activity (item data, comments, or queries) started. For each visit, this section displays:</p> <ul style="list-style-type: none"> • Minimum number of days taken by InForm users, across all forms and all subjects for each visit at every site, to start a form from the date entered in the DOV form. • Maximum number of days taken by InForm users, across all forms and all subjects for each visit at every site, to start a form from the date entered in the DOV form. • Median value for the number of days taken by InForm users, across all forms and all subjects for each visit at every site, to start a form from the date entered in the DOV form for all forms in the visit. <p>Note: This report element assumes that your study was developed using a specific design for the DOV controls.</p> <p>For more information, see <i>DOV controls</i> (on page 21).</p> <p>UUIDs:</p> <ul style="list-style-type: none"> • DateTimeControl—BD991BC0-B0A4-11D2-80E3-00A0C9AF7674 • Item—BD991BBF-B0A4-11D2-80E3-00A0C9AF7674 • Section—BD991BBE-B0A4-11D2-80E3-00A0C9AF7674 <p>Data source: Minimum, maximum, and median values are derived for the report, and are not stored in the Reporting and Analysis database.</p>

Column	Description
DOV to Form Completed (Days): Min, Max, Median	<p>Data type: Numeric</p> <p>Description: The number of days from the date entered on the DOV form to the most recent date on which all of the required items on the form contain data. For each visit, this section displays:</p> <ul style="list-style-type: none"> • Minimum number of days taken by InForm users, across all forms and all subjects for each visit at every site, to complete a form from the date entered in the DOV form. • Maximum number of days taken by InForm users, across all forms and all subjects for each visit at every site, to complete a form from the date entered in the DOV form. • Median value for the number of days taken by InForm users, across all forms and all subjects for each visit at every site, to complete a form from the date entered in the DOV form for all forms in the visit. <p>Note: This report element assumes that your study was developed using a specific design for the DOV controls.</p> <p>For more information, see <i>DOV controls</i> (on page 21).</p> <p>UUIDs:</p> <ul style="list-style-type: none"> • DateTimeControl—BD991BC0-B0A4-11D2-80E3-00A0C9AF7674 • Item—BD991BBF-B0A4-11D2-80E3-00A0C9AF7674 • Section—BD991BBE-B0A4-11D2-80E3-00A0C9AF7674 <p>Data source: Minimum, maximum, and median values are derived for the report, and are not stored in the Reporting and Analysis database.</p>

Column	Description
Form Completed to SV Complete (Days): Min, Max, Median	<p>Data type: Numeric</p> <p>Description: The number of days from the earliest date on which the form was complete to the most recent date when the form was marked Verified.</p> <p>A form is considered Verified if one of the following is true:</p> <ul style="list-style-type: none"> • The form does not contain critical items, and all items on the form that are marked SV Required are verified. • The form contains critical items, and all critical items on the form are verified. • The form is on the Critical Forms list, and all items on the form that are marked SV Required are verified. • The subject with which the form is associated is in the SV Pool, and all items marked SV Required are verified. • The subject with which the form is associated is not in the SV Pool, but an item on the form is marked critical for that subject, and all items marked SV Required are verified. <p>If none of the items on the form require source verification, the InForm application marks the form Verified.</p> <p>For each visit, this section displays:</p> <ul style="list-style-type: none"> • Minimum number of days, across all forms and all subjects for each visit at every site, to complete the source verification process from the date of form completion. • Maximum number of days, across all forms and all subjects for each visit at every site, to complete the source verification process from the date of form completion. • Median value of number of days, across all forms and all subjects for each visit at every site, to complete the source verification process from date of form completion. <p>Data source: Minimum, maximum, and median values are derived for the report, and are not stored in the Reporting and Analysis database.</p>

Column	Description
Form Completed to Form Locked (Days): Min, Max, Median	<p>Data type: Numeric</p> <p>Description: The number of days from the earliest date on which the form was complete to the most recent date on which the form was locked. For each visit, this section displays:</p> <ul style="list-style-type: none"> • Minimum number of days, across all forms and all subjects for each visit at every site, to lock the form from the date of form completion. • Maximum of days, across all forms and all subjects for each visit at every site, to lock the form from the date of form completion. • Median value of number of days, across all forms and all subjects for each visit at every site, to lock the form from the date of form completion. <p>Data source: Minimum, maximum, and median values are derived for the report, and are not stored in the Reporting and Analysis database.</p>

CRF Cycle Time Detail for a Site

This report shows the measures of data-entry performance, by site and visit, by showing the number of days from:

- Date of visit to form started.
- Date of visit to form completed.
- Form completed to form source verified.
- Form completed to form locked.

Note: This calculation relies on the use of the *DOV controls* (on page 21) specified in the form design.

Selection criteria: CRF Cycle Time Detail for a Site

Use the report prompt page to select criteria and specify sort options for your report.

For general instructions about how to run a standard report, see:

- *Running a standard report from the Reporting and Analysis portal* (on page 170).
- *Running a standard report in a new window* (on page 170).

For information about data that appears on this report, such as the data source, how data is calculated, and how it is displayed, see *Report/Graph page: CRF Cycle Time Detail for a Site* (on page 245).

Selection criteria

Selection criteria	Action
--------------------	--------

Selection criteria	Action
Countries	To report on specific countries, select their names from the list. Then, click Update to update the Sites list.
Sites	If you updated the Sites list after selecting one or more countries, select a site from the list.
Visits	To report on one or more visits, select the visits from the list.
<p>Note: To include all available options in the report, leave the optional selection fields blank; that is, do not select any individual options from the drop-down lists. For the best performance, do not select any optional filters.</p>	

Sort options

Sort options are: None, Country, Site Mnemonic, Visit Order, Started Forms Count, Completed Forms Count, Expected Forms Count, DOV to Form Started–Min, DOV to Form Started–Max, DOV to Form Completed–Min, DOV to Form Completed–Max, Form Completed to SDV Completed–Min, Form Completed to SDV Completed–Max, Form Completed to Form Locked–Min, Form Completed to Form Locked–Max.

Use the **Sort** drop-down lists to change any of the default selections.

Sort	Default selection
First level	Country
Second level	Site Mnemonic
Third level	Visit Order

Report/Graph page: CRF Cycle Time Detail for a Site

Graphs

A combination line/bar graph appears on the first page of the CRF Cycle Time Detail by Site report, plotting the median time from DOV to form complete against expected forms.

Subtotals and totals

- **Subtotals**—By site and country.
 - Min—Lowest minimum value for any site in the country.
 - Max—Highest maximum value for any site in the country.
 - Median—No value.
- **Totals**—Overall form count totals.
 - Min—Lowest minimum value for any site in the country.
 - Max—Highest maximum value for any site in the country.

- Median—No value.

Column descriptions

Column	Description
Country	<p>Data type: String</p> <p>Description: The country in which a site is located, as entered in the InForm Administration interface.</p> <p>Data source: Replicated from the InForm transactional database to the Reporting and Analysis database.</p>
Site Mnemonic	<p>Data type: String</p> <p>Description: An abbreviation that identifies a site, as entered in the InForm Administration interface.</p> <p>Data source: Replicated from the InForm transactional database to the Reporting and Analysis database.</p>
Visit Mnemonic	<p>Data type: String</p> <p>Description: An abbreviation of the visit title, as specified in the study design. For CRF visits, this title appears at the top of a collection of forms in the visit timeline and may not be a unique identifier.</p> <p>Data source: Replicated from the InForm transactional database to the Reporting and Analysis database.</p>
Form Counts: Expected	<p>Data type: Numeric</p> <p>Description: The total count of all forms that are expected across all subjects, by visit and by site.</p> <p>How calculated: This number reflects the number of expected forms for the site based on the definition of Expected forms. For more information, see <i>Form elements and expected forms</i> (on page 91).</p> <p>Data source: Derived for the report; not stored in the Reporting and Analysis database.</p>
Form Counts: Started	<p>Data type: Numeric</p> <p>Description: Total count of all forms that are started across all subjects, by visit and by site.</p> <p>How calculated: An expected form is considered started if any type of data entry activity (form data, queries, or comments) has started on the form.</p> <p>Data source: Replicated from the InForm transactional database to the Reporting and Analysis database.</p>

Column	Description
Form Counts: Completed	<p>Data type: Numeric</p> <p>Description: Total count of all forms that are complete across all subjects, by visit and by site.</p> <p>How calculated: Counts forms that are expected and meet the following criteria:</p> <ul style="list-style-type: none"> • Are started. • Contain data for all required items. • For a repeating form, the form is not in a deleted state. • For an itemset form, the form is complete even if all the instances are deleted. <p>Data source: Derived and stored in the Reporting and Analysis database.</p>
DOV to Form Started (Days): Min, Max, Median	<p>Data type: Numeric</p> <p>Description: The number of days from the date entered on the DOV form to the first day on which any data entry activity (item data, comments, or queries) started. For each visit, this section displays:</p> <ul style="list-style-type: none"> • Minimum number of days taken by InForm users, across all forms and all subjects for each visit at every site, to start a form from the date entered in the DOV form. • Maximum number of days taken by InForm users, across all forms and all subjects for each visit at every site, to start a form from the date entered in the DOV form. • Median value for the number of days taken by InForm users, across all forms and all subjects for each visit at every site, to start a form from the date entered in the DOV form for all forms in the visit. <p>Note: This report element assumes that your study was developed using a specific design for the DOV controls.</p> <p>For more information, see <i>DOV controls</i> (on page 21).</p> <p>UUIDs:</p> <ul style="list-style-type: none"> • DateTimeControl—BD991BC0-B0A4-11D2-80E3-00A0C9AF7674 • Item—BD991BBF-B0A4-11D2-80E3-00A0C9AF7674 • Section—BD991BBE-B0A4-11D2-80E3-00A0C9AF7674 <p>Data source: Minimum, maximum, and median values are derived for the report, and are not stored in the Reporting and Analysis database.</p>

Column	Description
DOV to Form Completed (Days): Min, Max, Median	<p>Data type: Numeric</p> <p>Description: The number of days from the date entered on the DOV form to the most recent date on which all of the required items on the form contain data. For each visit, this section displays:</p> <ul style="list-style-type: none"> • Minimum number of days taken by InForm users, across all forms and all subjects for each visit at every site, to complete a form from the date entered in the DOV form. • Maximum number of days taken by InForm users, across all forms and all subjects for each visit at every site, to complete a form from the date entered in the DOV form. • Median value for the number of days taken by InForm users, across all forms and all subjects for each visit at every site, to complete a form from the date entered in the DOV form for all forms in the visit. <p>Note: This report element assumes that your study was developed using a specific design for the DOV controls.</p> <p>For more information, see <i>DOV controls</i> (on page 21).</p> <p>UUIDs:</p> <ul style="list-style-type: none"> • DateTimeControl—BD991BC0-B0A4-11D2-80E3-00A0C9AF7674 • Item—BD991BBF-B0A4-11D2-80E3-00A0C9AF7674 • Section—BD991BBE-B0A4-11D2-80E3-00A0C9AF7674 <p>Data source: Minimum, maximum, and median values are derived for the report, and are not stored in the Reporting and Analysis database.</p>

Column	Description
Form Completed to SV Complete (Days): Min, Max, Median	<p>Data type: Numeric</p> <p>Description: The number of days from the earliest date on which the form was complete to the most recent date when the form was marked Verified.</p> <p>A form is considered Verified if one of the following is true:</p> <ul style="list-style-type: none"> • The form does not contain critical items, and all items on the form that are marked SV Required are verified. • The form contains critical items, and all critical items on the form are verified. • The form is on the Critical Forms list, and all items on the form that are marked SV Required are verified. • The subject with which the form is associated is in the SV Pool, and all items marked SV Required are verified. • The subject with which the form is associated is not in the SV Pool, but an item on the form is marked critical for that subject, and all items marked SV Required are verified. <p>If none of the items on the form require source verification, the InForm application marks the form Verified.</p> <p>For each visit, this section displays:</p> <ul style="list-style-type: none"> • Minimum number of days, across all forms and all subjects for each visit at every site, to complete the source verification process from the date of form completion. • Maximum number of days, across all forms and all subjects for each visit at every site, to complete the source verification process from the date of form completion. • Median value of number of days, across all forms and all subjects for each visit at every site, to complete the source verification process from date of form completion. <p>Data source: Minimum, maximum, and median values are derived for the report, and are not stored in the Reporting and Analysis database.</p>

Column	Description
Form Completed to Form Locked (Days): Min, Max, Median	<p>Data type: Numeric</p> <p>Description: The number of days from the earliest date on which the form was complete to the most recent date on which the form was locked. For each visit, this section displays:</p> <ul style="list-style-type: none"> • Minimum number of days, across all forms and all subjects for each visit at every site, to lock the form from the date of form completion. • Maximum of days, across all forms and all subjects for each visit at every site, to lock the form from the date of form completion. • Median value of number of days, across all forms and all subjects for each visit at every site, to lock the form from the date of form completion. <p>Data source: Minimum, maximum, and median values are derived for the report, and are not stored in the Reporting and Analysis database.</p>

CRF Site Performance Summary by Site

This report shows the average amount of time between study milestones, such as from visit start, to initial data entry, to form complete, and includes aging information for incomplete forms organized by site.

Selection criteria: CRF Site Performance Summary by Site

Use the report prompt page to select criteria and specify sort options for your report.

For general instructions about how to run a standard report, see:

- *Running a standard report from the Reporting and Analysis portal* (on page 170).
- *Running a standard report in a new window* (on page 170).

For information about data that appears on this report, such as the data source, how data is calculated, and how it is displayed, see *Report/Graph page: CRF Site Performance Summary by Site* (on page 252).

Selection criteria

Selection criteria	Action
Countries	To report on specific countries, select their names from the list. Then, click Update to update the Sites list.
Sites	If you updated the Sites list after selecting one or more countries and you want to report on specific sites, select the names of the sites from the list.

Selection criteria	Action
Aging Interval	<p>Enter a time duration (in days) to be used as the aging interval. The resulting report uses the aging interval to show how many forms have been incomplete during specific ranges of calendar days after the date of visit.</p> <p>For example, if you specify 7, the resulting report shows the number of forms that have been incomplete for:</p> <ul style="list-style-type: none"> • 7 or fewer days after the date of visit. • More than 7 days and 14 or fewer after the DOV. • More than 14 days and 21 or fewer days after the DOV. • More than 21 days and 28 or fewer days after the DOV. • More than 28 days after the DOV. <p>Default: 7 (days)</p>

Note: To include all available options in the report, leave the optional selection fields blank; that is, do not select any individual options from the drop-down lists. For the best performance, do not select any optional filters.

Sort options

Sort options are: None, Country, Site Mnemonic, DOV to Form Started–Min, DOV to Form Started–Max, DOV to Form Started–Median, DOV to Form Completed–Min, DOV to Form Completed–Max, DOV to Form Completed–Median, Form Completed to SDV Completed–Min, Form Completed to SDV Completed–Max, Form Completed to SDV Completed–Median, Form Completed to Form Locked–Min, Form Completed to Form Locked–Max, Form Completed to Form Locked–Median, Incomplete Forms–1st Period, Incomplete Forms–2nd Period, Incomplete Forms–3rd Period, Incomplete Forms–4th Period, Incomplete Forms–5th Period.

Use the **Sort** drop-down lists to change any of the default selections.

Sort	Default selection
First level	Country
Second level	Site Mnemonic
Third level	None

Report/Graph page: CRF Site Performance Summary by Site

Graphs

Two bar graphs appear on the first page of the CRF Site Performance Summary by Site report. The first graph plots, for the selected sites, the median number of days from DOV to form started and the median number of days from DOV to form completed. The second graph plots the number of incomplete forms, by time period, for the selected sites.

Subtotals and totals

- **Subtotals**—By Country.
 - Min—Lowest minimum value for any site in the country.
 - Max—Highest maximum value for any site in the country.
 - Median—No value.
- **Totals**—Overall cycle time totals.
 - Min—Lowest minimum value for any site in the country.
 - Max—Highest maximum value for any site in the country.
 - Median—No value.

Drill-down reports

You can click a value in the Site Mnemonic column to drill down to the *CRF Cycle Time Detail by Site* (on page 237) report.

Column descriptions

Column	Description
Country	<p>Data type: String</p> <p>Description: The country in which a site is located, as entered in the InForm Administration interface.</p> <p>Data source: Replicated from the InForm transactional database to the Reporting and Analysis database.</p>
Site Mnemonic	<p>Data type: String</p> <p>Description: An abbreviation that identifies a site, as entered in the InForm Administration interface.</p> <p>Data source: Replicated from the InForm transactional database to the Reporting and Analysis database.</p>

Column	Description
DOV to Forms Started (Days): Min, Max, Median	<p>Data type: Numeric</p> <p>Description: The number of days from the date entered on the DOV form to the first day on which any data entry activity (item data, comments, or queries) started. For each visit, this section displays:</p> <ul style="list-style-type: none"> • Minimum number of days taken by InForm users, across all forms and all subjects for each visit at every site, to start a form from the date entered in the DOV form. • Maximum number of days taken by InForm users, across all forms and all subjects for each visit at every site, to start a form from the date entered in the DOV form. • Median value for the number of days taken by InForm users, across all forms and all subjects for each visit at every site, to start a form from the date entered in the DOV form for all forms in the visit. <p>Note: This report element assumes that your study was developed using a specific design for the DOV controls.</p> <p>For more information, see <i>DOV controls</i> (on page 21).</p> <p>UUIDs:</p> <ul style="list-style-type: none"> • DateTimeControl—BD991BC0-B0A4-11D2-80E3-00A0C9AF7674 • Item—BD991BBF-B0A4-11D2-80E3-00A0C9AF7674 • Section—BD991BBE-B0A4-11D2-80E3-00A0C9AF7674 <p>Data source: Minimum, maximum, and median values are derived for the report, and are not stored in the Reporting and Analysis database.</p>

Column	Description
DOV to Forms Completed (Days): Min, Max, Median	<p>Data type: Numeric</p> <p>Description: The number of days from the date entered on the DOV form to the most recent date on which all of the required items on the form contain data. For each visit, this section displays:</p> <ul style="list-style-type: none"> • Minimum number of days taken by InForm users, across all forms and all subjects for each visit at every site, to complete a form from the date entered in the DOV form. • Maximum number of days taken by InForm users, across all forms and all subjects for each visit at every site, to complete a form from the date entered in the DOV form. • Median value for the number of days taken by InForm users, across all forms and all subjects for each visit at every site, to complete a form from the date entered in the DOV form for all forms in the visit. <p>Note: This report element assumes that your study was developed using a specific design for the DOV controls.</p> <p>For more information, see <i>DOV controls</i> (on page 21).</p> <p>UUIDs:</p> <ul style="list-style-type: none"> • DateTimeControl—BD991BC0-B0A4-11D2-80E3-00A0C9AF7674 • Item—BD991BBF-B0A4-11D2-80E3-00A0C9AF7674 • Section—BD991BBE-B0A4-11D2-80E3-00A0C9AF7674 <p>Data source: Minimum, maximum, and median values are derived for the report, and are not stored in the Reporting and Analysis database.</p>

Column	Description
Forms Completed to Forms SV Complete (Days): Min, Max, Median	<p>Data type: Numeric</p> <p>Description: The number of days from the earliest date on which the form was complete to the most recent date when the form was marked Verified.</p> <p>A form is considered Verified if one of the following is true:</p> <ul style="list-style-type: none"> • The form does not contain critical items, and all items on the form that are marked SV Required are verified. • The form contains critical items, and all critical items on the form are verified. • The form is on the Critical Forms list, and all items on the form that are marked SV Required are verified. • The subject with which the form is associated is in the SV Pool, and all items marked SV Required are verified. • The subject with which the form is associated is not in the SV Pool, but an item on the form is marked critical for that subject, and all items marked SV Required are verified. <p>If none of the items on the form require source verification, the InForm application marks the form Verified.</p> <p>For each visit, this section displays:</p> <ul style="list-style-type: none"> • Minimum number of days, across all forms and all subjects for each visit at every site, to complete the source verification process from the date of form completion. • Maximum number of days, across all forms and all subjects for each visit at every site, to complete the source verification process from the date of form completion. • Median value of number of days, across all forms and all subjects for each visit at every site, to complete the source verification process from date of form completion. <p>Data source: Minimum, maximum, and median values are derived for the report, and are not stored in the Reporting and Analysis database.</p>

Column	Description
Forms Completed to Forms Locked (Days): Min, Max, Median	<p>Data type: Numeric</p> <p>Description: The number of days from the earliest date on which the form was complete to the most recent date when the form was locked.</p> <p>For each visit, this section displays:</p> <ul style="list-style-type: none">• Minimum number of days, across all forms and all patients for each visit at every site, to lock the form from the date of form completion.• Maximum of days, across all forms and all patients for each visit at every site, to lock the form from the date of form completion.• Median value of number of days, across all forms and all patients for each visit at every site, to lock the form from the date of form completion. <p>Data source: Minimum, maximum, and median values are derived for the report, and are not stored in the Reporting and Analysis database.</p>

Column	Description
Incomplete (from DOV) Forms Count (Days)	<p>Data type: Numeric (Percentage)</p> <p>Description: The total count of all forms across all subjects that have been incomplete for specific ranges of calendar days after the date of visit. You specify the aging interval (in days) on the report prompt page. For example, if you specify 7, the resulting report shows the number of forms that have been incomplete for:</p> <ul style="list-style-type: none"> • Seven or fewer days. • More than 7 but equal to or fewer than 14 days. • More than 14 but equal to or fewer than 21 days. • More than 21 but equal to or fewer than 28 days. • More than 28 days. <p>How calculated: This value displays as a whole number, followed by a percentage of the total incomplete form count. The percentage is calculated as follows:</p> $\frac{[\text{count of incomplete forms within the aging interval}] * 100}{[\text{count of incomplete forms}]}$ <p>Note: This report element assumes that your study was developed using a specific design for the DOV controls. For more information, see <i>DOV controls</i> (on page 21).</p> <p>UUIDs:</p> <ul style="list-style-type: none"> • DateTimeControl—BD991BC0-B0A4-11D2-80E3-00A0C9AF7674 • Item—BD991BBF-B0A4-11D2-80E3-00A0C9AF7674 • Section—BD991BBE-B0A4-11D2-80E3-00A0C9AF7674 <p>Data source: Derived for the report; not stored in the Reporting and Analysis database.</p>

CRF Status Detail by Site and Subject

This report shows the number of forms in each possible status. Forms can be counted based on the definition selected for Expected.

Selection criteria: CRF Status Detail by Site and Subject

Use the report prompt page to select criteria and specify sort options for your report.

For general instructions about how to run a standard report, see:

- *Running a standard report from the Reporting and Analysis portal* (on page 170).
- *Running a standard report in a new window* (on page 170).

For information about data that appears on this report, such as the data source, how data is calculated, and how it is displayed, see *Report/Graph page: CRF Status Detail by Site and*

Subject (on page 260).

Selection criteria

Selection criteria	Action
Countries	To report on specific countries, select their names from the list. Then, click Update to update the Sites list.
Sites	To report on specific sites, select the sites from the list. Then, click Update to update the Subjects list with Subject IDs.
Subjects	To report on specific subjects, select the subjects from the list.
Expected forms for	<p>Filter the report by expected forms. Choose one of these options from the drop-down list.</p> <ul style="list-style-type: none"> • All forms—All clinical forms (forms of type CRF) are considered. • Scheduled visits—All expected forms that are in scheduled visits are considered. • Scheduled or started visits—All clinical forms that are in either expected or started visits are considered. • Scheduled or started visits to date—All the expected forms that are in scheduled visits whose expected start date is earlier than the report run date, and all the expected forms that are present in started visits when the actual date of the visit is on or before the report run date are considered. • Scheduled visits or started forms to date—All the expected forms that are in scheduled visits whose expected start date is on or before the report run date, and all the expected forms that were started on or before the report run date are considered. <p>Default: Scheduled or started visits</p>
Visits	To report on one or more visits, select the visits from the list.

Selection criteria	Action
Limit to forms with	<p>To filter the report, select one or more of the following options:</p> <ul style="list-style-type: none"> • Required items—Forms that have items marked as required are considered. • SV required items—Forms that have items marked as source verification required are considered. • Outstanding queries—Forms that have open or answered queries against the forms items are considered. • Comments—Forms that have either form level or item level comments are considered. <p>If you leave all checkboxes blank, this prompt is not applied. In that case, the results are determined by your selections in the previous prompts.</p> <p>If one or more checkboxes are selected, the counts are limited by the selection(s) in this prompt. Most likely, this results in decreased counts. For example, selecting both Required items and SV required items limits the report results to only those forms that have both required items and SV required items.</p>

Note: To include all available options in the report, leave the optional selection fields blank; that is, do not select any individual options from the drop-down lists. **For the best performance, do not select any optional filters.**

Sort options

Sort options are: None, Country, Site Mnemonic, Subject Number, Visit, Subject Count, Expected Forms Count, % of Not Started Forms, % of Incomplete Forms, % of Completed Forms, % of Frozen Forms, % of SV Partial Forms, % of SV Complete Forms, % of Signed Forms, % of Locked Forms, % of Forms with Comments, % of Forms with Queries.

Use the **Sort** drop-down lists to change any of the default selections.

Sort	Default selection
First level	Country
Second level	Site Mnemonic
Third level	Subject Number

Report/Graph page: CRF Status Detail by Site and Subject

Subtotals and totals

- **Subtotals**—By Subject, Site, and Country.
- **Totals**—Overall form count totals.

Column descriptions

Column	Description
Country	<p>Data type: String</p> <p>Description: The country in which a site is located, as entered in the InForm Administration interface.</p> <p>Data source: Replicated from the InForm transactional database to the Reporting and Analysis database.</p>
Site Mnemonic	<p>Data type: String</p> <p>Description: An abbreviation that identifies a site, as entered in the InForm Administration interface.</p> <p>Data source: Replicated from the InForm transactional database to the Reporting and Analysis database.</p>
Subject Number	<p>Data type: String</p> <p>Description: The subject number, followed by the subject initials. The subject number identifies the subject. The subject number and subject initials can be changed post enrollment, if this is configured in the study.</p> <p>Note: Subject number might not be unique at your site.</p> <p>Data source: Replicated from the InForm transactional database to the Reporting and Analysis database.</p>
Visit Mnemonic	<p>Data type: String</p> <p>Description: An abbreviation of the visit title, as specified in the study design. For CRF visits, this title appears at the top of a collection of forms in the visit timeline and may not be a unique identifier.</p> <p>Data source: Replicated from the InForm transactional database to the Reporting and Analysis database.</p>

Column	Description
DOV	<p>Data type: Date/Time</p> <p>Description: The date that is recorded in a standard Date of Visit control in the InForm application.</p> <p>Data type: Clinical</p> <p>Note: This report element assumes that your study was developed using a specific design for the DOV controls.</p> <p>UUIDs:</p> <ul style="list-style-type: none"> • DateTimeControl—BD991BC0-B0A4-11D2-80E3-00A0C9AF7674 • Item—BD991BBF-B0A4-11D2-80E3-00A0C9AF7674 • Section—BD991BBE-B0A4-11D2-80E3-00A0C9AF7674
Form Count (% of Expected): Expected	<p>Data type: Numeric</p> <p>Description: The number of expected forms in the study.</p> <p>How calculated: This number reflects the number of expected forms for the site based on the option selected for the Expected forms for filter on the report prompt page. For more information, see <i>Selection criteria: CRF Aging by Site</i> (on page 232) and <i>Form elements and expected forms</i> (on page 91).</p> <p>Data source: Derived for the report; not stored in the Reporting and Analysis database.</p>
Form Count (% of Expected): Not Started	<p>Data type: Numeric (Percentage)</p> <p>Description: The number (and percentage) of expected forms that are not started in the InForm application.</p> <p>How calculated: Calculated based on your selection in the Expected forms for filter on the report prompt page. The InForm application calculates the forms that are not started by taking the total number of expected forms, based on the filter you select, and then subtracting from that the number of all forms that have been started.</p> <p>A form is started if any data, queries or comments have been entered. Each instance of a repeating form counts as a separate started form. A deleted repeating form is also counted as a started form. A dynamic form may be Activated but not Started. This value displays as a whole number and as the percentage of expected forms that are not started:</p> $[not\ started,\ \%\ of\ expected] = [not\ started\ forms\ count] * 100 / [expected\ forms\ count]$ <p>Data source: Derived for the report; not stored in the Reporting and Analysis database.</p>

Column	Description
Form Count (% of Expected): Incomplete	<p>Data type: Numeric (Percentage)</p> <p>Description: The number of expected forms that are started but incomplete, and the percentage of expected forms that are incomplete.</p> <p>How calculated: For each site, calculates the following:</p> $[incomplete\ forms\ count] = [started\ forms\ count] - [completed\ forms\ count]$ $[incomplete,\ \%\ of\ expected] = [incomplete\ forms\ count] * 100 / [expected\ forms\ count]$ <p>Data source: Derived for the report; not stored in the Reporting and Analysis database.</p>
Form Count (% of Expected): Completed	<p>Data type: Numeric (Percentage)</p> <p>Description: The number of completed forms, and the percentage of expected forms that are complete in the InForm application.</p> <p>How calculated: Counts forms that are expected and meet the following criteria:</p> <ul style="list-style-type: none"> • Are started. • Contain data for all required items. • For a repeating form, the form is not in a deleted state. • For an itemset form, the form is complete even if all the instances are deleted. <p>This value displays as a whole number and as a percentage of the total number of expected forms that are complete:</p> $[completed,\ \%\ of\ expected] = [completed\ forms] * 100 / [expected\ forms]$ <p>Data source: Replicated from the InForm transactional database to the Reporting and Analysis database. Percentage is derived for display.</p>

Column	Description
Form Count (% of Expected): Frozen	<p>Data type: Numeric (Percentage)</p> <p>Description: The number of frozen forms, and the percentage of expected forms that are currently marked frozen in the InForm application.</p> <p>How calculated: Counts expected forms that have been frozen using any of these InForm features:</p> <ul style="list-style-type: none"> • Freeze CRF • Freeze CRB • Freeze Visit <p>This value displays as a whole number (number of frozen forms), followed by the percentage of expected forms that are currently marked frozen:</p> $[\text{frozen, \% of expected}] = [\text{frozen forms count}] * 100 / [\text{expected forms count}]$ <p>Data source: Replicated from the InForm transactional database to the Reporting and Analysis database. Percentage is derived for display.</p>
Form Count (% of Expected): SV Partial	<p>Data type: Numeric (Percentage)</p> <p>Description: The number of forms marked SV Partial, and the percentage of expected forms where source verification is not complete.</p> <p>How calculated: Counts partially verified forms.</p> <p>A form is considered SV Partial if one of the following is true:</p> <ul style="list-style-type: none"> • The form contains unverified critical items. • The form is on the Critical Forms list, and contains unverified items that are marked SV Required. • The subject with which the form is associated is in the SV Pool, and the form contains unverified items that are marked SV Required. • The subject with which the form is associated is not in the SV Pool, but an item on the form is marked critical for that subject, and the form contains unverified items that are marked SV Required. <p>This value is displayed as a whole number and as a percentage of the total number of expected forms that are marked SV Partial:</p> $[\text{SV Partial, \% expected}] = [\text{SV Partial forms count}] * 100 / [\text{expected forms count}]$ <p>Data source: Replicated from the InForm transactional database to the Reporting and Analysis database. Percentage is derived for display.</p>

Column	Description
Form Count (% of Expected) SV Complete	<p>Data type: Numeric (Percentage)</p> <p>Description: The number of verified forms, and the percentage of expected forms where source verification is complete.</p> <p>How calculated: Counts forms marked Verified.</p> <p>A form is considered Verified if one of the following is true:</p> <ul style="list-style-type: none"> • The form does not contain critical items, and all items on the form that are marked SV Required are verified. • The form contains critical items, and all critical items on the form are verified. • The form is on the Critical Forms list, and all items on the form that are marked SV Required are verified. • The subject with which the form is associated is in the SV Pool, and all items marked SV Required are verified. • The subject with which the form is associated is not in the SV Pool, but an item on the form is marked critical for that subject, and all items marked SV Required are verified. <p>If none of the items on the form require source verification, the InForm application marks the form Verified.</p> <p>This value displays as a whole number and as a percentage of the total number of expected forms that are marked Verified.</p> $[\textit{Verified, \% of expected}] = [\textit{Verified forms count}] * 100 / [\textit{expected forms count}]$ <p>Data source: Replicated from the InForm transactional database to the Reporting and Analysis database.</p>
Form Count (% of Expected): Signed	<p>Data type: Numeric (Percentage)</p> <p>Description: The number of signed forms and the percentage of expected forms that have been signed in the InForm application.</p> <p>How calculated: Counts forms that have been signed. This value displays as a whole number and as a percentage of the total number of expected forms that are signed.</p> $[\textit{signed, \% of expected}] = [\textit{signed forms count}] * 100 / [\textit{expected forms count}]$ <p>Data source: Replicated from the InForm transactional database to the Reporting and Analysis database. Percentage is derived for display.</p>

Column	Description
Form Count (% of Expected): Locked	<p>Data type: Numeric (Percentage)</p> <p>Description: The number of locked forms, and the percentage of expected forms that are locked.</p> <p>How calculated: Counts forms for which any of the following conditions is true:</p> <ul style="list-style-type: none"> • The form has been locked. • The form is contained within a case book that has been locked. • The form is contained within a visit that has been locked. <p>This value displays as a whole number and as a percentage:</p> $[\text{locked, \% of expected}] = [\text{locked forms count}] * 100 / [\text{expected forms count}]$ <p>Data source: Replicated from the InForm transactional database to the Reporting and Analysis database. Percentage is derived for display.</p>
Form Counts (% of Expected): Forms with Comments	<p>Data type: Numeric (Percentage)</p> <p>Description: The number of expected forms with form-level comments, and the percentage of expected forms that have form-level comments.</p> <p>How calculated: Counts forms that contain form-level comments. Does not count forms with item-level comments only. This value displays as a whole number and a percentage of the total number of expected forms that have comments:</p> $[\text{forms with comments, \% of expected}] = [\text{forms with comments}] * 100 / [\text{expected forms count}]$ <p>Data source: Replicated from the InForm transactional database to the Reporting and Analysis database. Percentage is derived for display.</p>
Form Counts (% of Expected): Forms with Queries	<p>Data type: Numeric (Percentage)</p> <p>Description: The number of forms with open queries, and the percentage of expected forms that contain open queries.</p> <p>How calculated: Counts forms that contain an item with an open query. This value displays as a whole number and a percentage of the total number of expected forms that have open queries:</p> $[\text{forms with open queries, \% of expected}] = [\text{forms with open queries}] * 100 / [\text{expected forms count}]$ <p>Data source: Replicated from the InForm transactional database to the Reporting and Analysis database. Percentage is derived for display.</p>

CRF Status Detail by Visit and Site

This report shows the number of forms in each possible status, organized by visit across sites. Use the report to help focus on cleaning specific visits.

Selection criteria: CRF Status Detail by Visit and Site report

Use the report prompt page to select criteria and specify sort options for your report.

For general instructions about how to run a standard report, see:

- *Running a standard report from the Reporting and Analysis portal* (on page 170).
- *Running a standard report in a new window* (on page 170).

For information about data that appears on this report, such as the data source, how data is calculated, and how it is displayed, see Report/Graph page: CRF Status Detail by Visit and Site.

Selection criteria

Selection criteria	Action
Countries	To report on specific countries, select their names from the list. Then, click Update to update the Sites list.
Sites	To report on specific sites, select the sites from the list. Then, click Update to update the Subjects list with Subject IDs.
Subjects	To report on specific subjects, select the subjects from the list.
Visits	To report on one or more visits, select the visits from the list.
Expected forms for	<p>Filter the report by expected forms. Choose one of these options from the drop-down list.</p> <ul style="list-style-type: none"> • All forms—All clinical forms (forms of type CRF) are considered. • Scheduled visits—All expected forms that are in scheduled visits are considered. • Scheduled or started visits—All clinical forms that are in either expected or started visits are considered. • Scheduled or started visits to date—All the expected forms that are in scheduled visits whose expected start date is earlier than the report run date, and all the expected forms that are present in started visits when the actual date of the visit is on or before the report run date are considered. • Scheduled visits or started forms to date—All the expected forms that are in scheduled visits whose expected start date is on or before the report run date, and all the expected forms that were started on or before the report run date are considered.

Selection criteria	Action
Limit to forms with	<p>To filter the report, select one or more of the following options:</p> <ul style="list-style-type: none"> • Required items—Forms that have items marked as required are considered. • SV required items—Forms that have items marked as source verification required are considered. • Outstanding queries—Forms that have open or answered queries against the forms items are considered. • Comments—Forms that have either form level or item level comments are considered. <p>If you leave all checkboxes blank, this prompt is not applied. In that case, the results are determined by your selections in the previous prompts.</p> <p>If one or more checkboxes are selected, the counts are limited by the selection(s) in this prompt. Most likely, this results in decreased counts. For example, selecting both Required items and SV required items limits the report results to only those forms that have both required items and SV required items.</p>

Note: To include all available options in the report, leave the optional selection fields blank; that is, do not select any individual options from the drop-down lists. For the best performance, do not select any optional filters.

Sort options

Sort options are: None, Country, Visit, Site Mnemonic, Subject Number, Expected Forms Count, % of Incomplete Forms, % of Completed Forms, % of Frozen Forms, % of SV Partial Forms, % of SV Complete Forms, % of Signed Forms, % of Locked Forms, % of Forms with Comments, % of Forms with Queries.

Use the **Sort** drop-down lists to change any of the default selections.

Sort	Default selection
First level	Country
Second level	Visit Order
Third level	Site Mnemonic

Report/Graph page: CRF Status Detail by Visit and Site

Subtotals and totals

- **Subtotals**—By Site, Visit, and Country.
- **Totals**—Overall form count totals.

Column descriptions

Column	Description
Country	<p>Data type: String</p> <p>Description: The country in which a site is located, as entered in the InForm Administration interface.</p> <p>Data source: Replicated from the InForm transactional database to the Reporting and Analysis database.</p>
Visit Mnemonic	<p>Data type: String</p> <p>Description: An abbreviation of the visit title, as specified in the study design. For CRF visits, this title appears at the top of a collection of forms in the visit timeline and may not be a unique identifier.</p> <p>Data source: Replicated from the InForm transactional database to the Reporting and Analysis database.</p>
Site Mnemonic	<p>Data type: String</p> <p>Description: An abbreviation that identifies a site, as entered in the InForm Administration interface.</p> <p>Data source: Replicated from the InForm transactional database to the Reporting and Analysis database.</p>
Subject Number	<p>Data type: String</p> <p>Description: The number that identifies the subject. This number can also be changed post-enrollment, if configured in the study.</p> <p>Note: Subject number might not be unique at your site.</p> <p>Data source: Replicated from the InForm transactional database to the Reporting and Analysis database.</p>

Column	Description
DOV	<p>Data type: Date/Time</p> <p>Description: The date that is recorded in a standard Date of Visit control in the InForm application.</p> <p>Data type: Clinical</p> <p>Note: This report element assumes that your study was developed using a specific design for the DOV controls.</p> <p>UUIDs:</p> <ul style="list-style-type: none"> • DateTimeControl—BD991BC0-B0A4-11D2-80E3-00A0C9AF7674 • Item—BD991BBF-B0A4-11D2-80E3-00A0C9AF7674 • Section—BD991BBE-B0A4-11D2-80E3-00A0C9AF7674
Form Count (% of Expected): Expected	<p>Data type: Numeric</p> <p>Description: The number of expected forms in the study.</p> <p>How calculated: This number reflects the number of expected forms for the site based on the option selected for the Expected forms for filter on the report prompt page. For more information, see <i>Selection criteria: CRF Aging by Site</i> (on page 232) and <i>Form elements and expected forms</i> (on page 91).</p> <p>Data source: Derived for the report; not stored in the Reporting and Analysis database.</p>
Form Count (% of Expected): Incomplete	<p>Data type: Numeric (Percentage)</p> <p>Description: The number of expected forms that are started but incomplete, and the percentage of expected forms that are incomplete.</p> <p>How calculated: For each site, calculates the following:</p> $[incomplete\ forms\ count] = [started\ forms\ count] - [completed\ forms\ count]$ $[incomplete,\ \%\ of\ expected] = [incomplete\ forms\ count] * 100 / [expected\ forms\ count]$ <p>Data source: Derived for the report; not stored in the Reporting and Analysis database.</p>

Column	Description
Form Count (% of Expected): Completed	<p>Data type: Numeric (Percentage)</p> <p>Description: The number of completed forms, and the percentage of expected forms that are complete in the InForm application.</p> <p>How calculated: Counts forms that are expected and meet the following criteria:</p> <ul style="list-style-type: none"> • Are started. • Contain data for all required items. • For a repeating form, the form is not in a deleted state. • For an itemset form, the form is complete even if all the instances are deleted. <p>This value displays as a whole number and as a percentage of the total number of expected forms that are complete:</p> $[\text{completed, \% of expected}] = [\text{completed forms}] * 100 / [\text{expected forms}]$ <p>Data source: Replicated from the InForm transactional database to the Reporting and Analysis database. Percentage is derived for display.</p>
Form Count (% of Expected): Frozen	<p>Data type: Numeric (Percentage)</p> <p>Description: The number of frozen forms, and the percentage of expected forms that are currently marked frozen in the InForm application.</p> <p>How calculated: Counts expected forms that have been frozen using any of these InForm features:</p> <ul style="list-style-type: none"> • Freeze CRF • Freeze CRB • Freeze Visit <p>This value displays as a whole number (number of frozen forms), followed by the percentage of expected forms that are currently marked frozen:</p> $[\text{frozen, \% of expected}] = [\text{frozen forms count}] * 100 / [\text{expected forms count}]$ <p>Data source: Replicated from the InForm transactional database to the Reporting and Analysis database. Percentage is derived for display.</p>

Column	Description
Form Count (% of Expected): SV Partial	<p>Data type: Numeric (Percentage)</p> <p>Description: The number of forms marked SV Partial, and the percentage of expected forms where source verification is not complete.</p> <p>How calculated: Counts partially verified forms.</p> <p>A form is considered SV Partial if one of the following is true:</p> <ul style="list-style-type: none"> • The form contains unverified critical items. • The form is on the Critical Forms list, and contains unverified items that are marked SV Required. • The subject with which the form is associated is in the SV Pool, and the form contains unverified items that are marked SV Required. • The subject with which the form is associated is not in the SV Pool, but an item on the form is marked critical for that subject, and the form contains unverified items that are marked SV Required. <p>This value is displayed as a whole number and as a percentage of the total number of expected forms that are marked SV Partial:</p> $[SV\ Partial, \% \ expected] = [SV\ Partial\ forms\ count] * 100 / [expected\ forms\ count]$ <p>Data source: Replicated from the InForm transactional database to the Reporting and Analysis database. Percentage is derived for display.</p>

Column	Description
Form Count (% of Expected): SV Completed	<p>Data type: Numeric (Percentage)</p> <p>Description: The number of verified forms, and the percentage of expected forms where source verification is complete.</p> <p>How calculated: Counts forms marked Verified.</p> <p>A form is considered Verified if one of the following is true:</p> <ul style="list-style-type: none"> • The form does not contain critical items, and all items on the form that are marked SV Required are verified. • The form contains critical items, and all critical items on the form are verified. • The form is on the Critical Forms list, and all items on the form that are marked SV Required are verified. • The subject with which the form is associated is in the SV Pool, and all items marked SV Required are verified. • The subject with which the form is associated is not in the SV Pool, but an item on the form is marked critical for that subject, and all items marked SV Required are verified. <p>If none of the items on the form require source verification, the InForm application marks the form Verified.</p> <p>This value displays as a whole number and as a percentage of the total number of expected forms that are marked Verified.</p> $[Verified, \% \text{ of expected}] = [Verified \text{ forms count}] * 100 / [expected \text{ forms count}]$ <p>Data source: Replicated from the InForm transactional database to the Reporting and Analysis database.</p>
Form Count (% of Expected): Signed	<p>Data type: Numeric (Percentage)</p> <p>Description: The number of signed forms and the percentage of expected forms that have been signed in the InForm application.</p> <p>How calculated: Counts forms that have been signed. This value displays as a whole number and as a percentage of the total number of expected forms that are signed.</p> $[signed, \% \text{ of expected}] = [signed \text{ forms count}] * 100 / [expected \text{ forms count}]$ <p>Data source: Replicated from the InForm transactional database to the Reporting and Analysis database. Percentage is derived for display.</p>

Column	Description
Form Count (% of Expected): Locked	<p>Data type: Numeric (Percentage)</p> <p>Description: The number of locked forms, and the percentage of expected forms that are locked.</p> <p>How calculated: Counts forms for which any of the following conditions is true:</p> <ul style="list-style-type: none"> • The form has been locked. • The form is contained within a case book that has been locked. • The form is contained within a visit that has been locked. <p>This value displays as a whole number and as a percentage:</p> $[\textit{locked, \% of expected}] = [\textit{locked forms count}] * 100 / [\textit{expected forms count}]$ <p>Data source: Replicated from the InForm transactional database to the Reporting and Analysis database. Percentage is derived for display.</p>
Form Counts (% of Expected): Forms with Comments	<p>Data type: Numeric (Percentage)</p> <p>Description: The number of expected forms with form-level comments, and the percentage of expected forms that have form-level comments.</p> <p>How calculated: Counts forms that contain form-level comments. Does not count forms with item-level comments only. This value displays as a whole number and a percentage of the total number of expected forms that have comments:</p> $[\textit{forms with comments, \% of expected}] = [\textit{forms with comments}] * 100 / [\textit{expected forms count}]$ <p>Data source: Replicated from the InForm transactional database to the Reporting and Analysis database. Percentage is derived for display.</p>
Form Counts (% of Expected): Forms with Queries	<p>Data type: Numeric (Percentage)</p> <p>Description: The number of forms with open queries, and the percentage of expected forms that contain open queries.</p> <p>How calculated: Counts forms that contain an item with an open query. This value displays as a whole number and a percentage of the total number of expected forms that have open queries:</p> $[\textit{forms with open queries, \% of expected}] = [\textit{forms with open queries}] * 100 / [\textit{expected forms count}]$ <p>Data source: Replicated from the InForm transactional database to the Reporting and Analysis database. Percentage is derived for display.</p>

CRF Status Summary by Site

This report shows, by site, the number and percentage of expected forms that are incomplete, complete, frozen, and locked.

Selection criteria: CRF Status Summary by Site

Use the report prompt page to select criteria and specify sort options for your report.

For general instructions about how to run a standard report, see:

- *Running a standard report from the Reporting and Analysis portal* (on page 170).
- *Running a standard report in a new window* (on page 170).

For information about data that appears on this report, such as the data source, how data is calculated, and how it is displayed, see *Report/Graph page: CRF Status Summary by Site* (on page 276).

Selection criteria

Selection criteria	Action
Countries	To report on specific countries, select their names from the list. Then, click Update to update the Sites list.
Sites	If you updated the Sites list after selecting one or more countries and you want to report on specific sites, select the names of the sites from the list.
Expected forms for	<p>Select the clinical forms (forms that have a type of CRF) that are expected to appear.</p> <ul style="list-style-type: none"> • All forms—All expected forms are considered. • Scheduled visits—Expected forms that appear in scheduled visits are considered. • Scheduled or started visits—Expected forms that appear in scheduled or started visits are considered. A started visit is a visit in which at least one non-common expected form is started. • Scheduled or started visits to date—Expected forms that appear in visits that are scheduled to start or have been started by the date the report is run are considered. • Scheduled visits or started forms to date—Expected forms for which either of the following is true are considered: <ul style="list-style-type: none"> ▪ The forms appear in visits that are scheduled to occur by the date the report is run. ▪ The forms have been started by the date the report is run.

Selection criteria	Action
Limit to forms with	<p>To filter the report, select one or more of the following options:</p> <ul style="list-style-type: none"> • Required items—Forms that have items marked as required are considered. • SV required items—Forms that have items marked as source verification required are considered. • Outstanding queries—Forms that have open or answered queries against the forms items are considered. • Comments—Forms that have either form level or item level comments are considered. <p>If you leave all checkboxes blank, this prompt is not applied. In that case, the results are determined by your selections in the previous prompts.</p> <p>If one or more checkboxes are selected, the counts are limited by the selection(s) in this prompt. Most likely, this results in decreased counts. For example, selecting both Required items and SV required items limits the report results to only those forms that have both required items and SV required items.</p>

Note: To include all available options in the report, leave the optional selection fields blank; that is, do not select any individual options from the drop-down lists. For the best performance, do not select any optional filters.

Sort options

Sort options are: None, Country, Site Mnemonic, Subject Count, Expected Forms Count, % of Not Started Forms, % of Incomplete Forms, % of Completed Forms, % of Frozen Forms, % of SV Complete Forms, % of Signed Forms, % of Locked Forms.

Use the **Sort** drop-down lists to change any of the default selections.

Sort	Default selection
First level	Country
Second level	Site Mnemonic
Third level	None

Report/Graph page: CRF Status Summary by Site

Graphs

A bar graph appears on the first page of the CRF Status Summary by Site report, plotting a summary of form completion status across all subjects, visits, and sites in each country.

Subtotals and totals

- **Subtotals**—By Country.
- **Totals**—Overall form count totals.

Drill-through reports

- Click a value in the Site Mnemonic column to drill through to the CRF Status Detail by Visit and Site report for the selected site.
- Click a value in the Subject Count column to drill through to the *CRF Status Detail by Site and Subject* (on page 257) report for the subjects included in the subject count.

Column descriptions

Column	Description
Country	<p>Data type: String</p> <p>Description: The country in which a site is located, as entered in the InForm Administration interface.</p> <p>Data source: Replicated from the InForm transactional database to the Reporting and Analysis database.</p>
Site Mnemonic	<p>Data type: String</p> <p>Description: An abbreviation that identifies a site, as entered in the InForm Administration interface.</p> <p>Data source: Replicated from the InForm transactional database to the Reporting and Analysis database.</p>
Subject Count	<p>Data type: Numeric</p> <p>Description: The number of subjects who enrolled at the site.</p> <p>How calculated: For each site, counts subjects who enrolled at the site, including subjects who are currently assigned other states.</p> <p>Note: The Enrollment form, designed according to InForm specifications, must be completed for the subject.</p> <p>UUID: PF_SC_COMPLETECTL</p> <p>Data source: Status is determined by the value on the Enrollment form, which is stored in the Reporting and Analysis database. Status is set to 1 when the subject is enrolled.</p>

Column	Description
Form Count (% of Expected): Expected	<p>Data type: Numeric</p> <p>Description: The number of expected forms in the study.</p> <p>How calculated: This number reflects the number of expected forms for the site based on the option selected for the Expected forms for filter on the report prompt page. For more information, see <i>Selection criteria: CRF Aging by Site</i> (on page 232) and <i>Form elements and expected forms</i> (on page 91).</p> <p>Data source: Derived for the report; not stored in the Reporting and Analysis database.</p>
Form Count (% of Expected): Not Started	<p>Data type: Numeric (Percentage)</p> <p>Description: The number (and percentage) of expected forms that are not started in the InForm application.</p> <p>How calculated: A form is started if any data, queries, or comments have been entered. Each instance of a repeating form counts as a separate started form. A dynamic form may be Activated, but not Started.</p> <p>This value displays as a whole number and as the percentage of expected forms that are not started:</p> $[\text{not started, \% of expected}] = [\text{not started forms count}] * 100 / [\text{expected forms count}]$ <p>Data source: Derived for the report; not stored in the Reporting and Analysis database.</p>
Form Count (% of Expected): Incomplete	<p>Data type: Numeric (Percentage)</p> <p>Description: The number of expected forms that are started but incomplete, and the percentage of expected forms that are incomplete.</p> <p>How calculated: For each site, calculates the following:</p> $[\text{incomplete forms count}] = [\text{started forms count}] - [\text{completed forms count}]$ $[\text{incomplete, \% of expected}] = [\text{incomplete forms count}] * 100 / [\text{expected forms count}]$ <p>Data source: Derived for the report; not stored in the Reporting and Analysis database.</p>

Column	Description
Form Count (% of Expected): Completed	<p>Data type: Numeric (Percentage)</p> <p>Description: The number of completed forms, and the percentage of expected forms that are complete in the InForm application.</p> <p>How calculated: Counts forms that are expected and meet the following criteria:</p> <ul style="list-style-type: none"> • Are started. • Contain data for all required items. • For a repeating form, the form is not in a deleted state. • For an itemset form, the form is complete even if all the instances are deleted. <p>This value displays as a whole number and as a percentage of the total number of expected forms that are complete:</p> $[\text{completed, \% of expected}] = [\text{completed forms}] * 100 / [\text{expected forms}]$ <p>Data source: Replicated from the InForm transactional database to the Reporting and Analysis database. Percentage is derived for display.</p>
Form Count (% of Expected): Frozen	<p>Data type: Numeric (Percentage)</p> <p>Description: The number of frozen forms, and the percentage of expected forms that are currently marked frozen in the InForm application.</p> <p>How calculated: Counts expected forms that have been frozen using any of these InForm features:</p> <ul style="list-style-type: none"> • Freeze CRF • Freeze CRB • Freeze Visit <p>This value displays as a whole number (number of frozen forms), followed by the percentage of expected forms that are currently marked frozen:</p> $[\text{frozen, \% of expected}] = [\text{frozen forms count}] * 100 / [\text{expected forms count}]$ <p>Data source: Replicated from the InForm transactional database to the Reporting and Analysis database. Percentage is derived for display.</p>

Column	Description
Form Count (% of Expected): SV Complete	<p>Data type: Numeric (Percentage)</p> <p>Description: The number of verified forms, and the percentage of expected forms where source verification is complete.</p> <p>How calculated: Counts verified forms.</p> <p>A form is considered Verified if one of the following is true:</p> <ul style="list-style-type: none"> • The form does not contain critical items, and all items on the form that are marked SV Required are verified. • The form contains critical items, and all critical items on the form are verified. • The form is on the Critical Forms list, and all items on the form that are marked SV Required are verified. • The subject with which the form is associated is in the SV Pool, and all items marked SV Required are verified. • The subject with which the form is associated is not in the SV Pool, but an item on the form is marked critical for that subject, and all items marked SV Required are verified. <p>If none of the items on the form require source verification, the InForm application marks the form Verified.</p> <p>This value displays as a whole number and as a percentage of the total number of expected forms that are marked Verified:</p> $[\textit{Verified, \% of expected}] = [\textit{Verified forms count}] * 100 / [\textit{expected forms count}]$ <p>Data source: Replicated from the InForm transactional database to the Reporting and Analysis database.</p>
Form Count (% of Expected): Signed	<p>Data type: Numeric</p> <p>Description: The number of signed forms and the percentage of expected forms that are currently signed in the InForm application.</p> <p>How calculated: Counts forms that have been signed by all groups that are required to sign the form. This value appears as a whole number and as a percentage of expected forms that are signed:</p> $[\textit{signed, \% of expected}] = [\textit{signed forms count}] * 100 / [\textit{expected forms count}]$ <p>Data source: Replicated from the InForm transactional database to the Reporting and Analysis database.</p>

Column	Description
Form Count (% of Expected): Locked	<p>Data type: Numeric</p> <p>Description: The number of locked forms and the percentage of expected forms that are locked in the InForm application.</p> <p>How calculated: Counts forms that meet one of the following criteria:</p> <ul style="list-style-type: none"> • Have been locked. • Are contained within a case book that has been locked. • Are contained within a visit that has been locked. <p>This value displays as a whole number and as a percentage:</p> $[\text{locked, \% of expected}] = [\text{locked forms count}] * 100 / [\text{expected forms count}]$ <p>Data source: Replicated from the InForm transactional database to the Reporting and Analysis database.</p>

CRF Status Summary by User

This report shows the total number and percentage of expected forms that are incomplete, complete, frozen, locked, SV complete, and signed. This report is grouped by user within a rights group.

Selection criteria: CRF Status Summary by User

Use the report prompt page to select criteria and specify sort options for your report.

For general instructions about how to run a standard report, see:

- *Running a standard report from the Reporting and Analysis portal* (on page 170).
- *Running a standard report in a new window* (on page 170).

For information about data that appears on this report, such as the data source, how data is calculated, and how it is displayed, see *Report/Graph page: CRF Status Summary by User* (on page 282).

Selection criteria

Selection criteria	Action
Rights Groups	Select the rights group or groups used for CRAs that are primary in your study. Then, click Update to update the Users list.
Users	To report on specific users, select them from the drop-down list. Then, click Update to update the Sites list.
Sites	To report on specific sites, select the names of the sites from the list.

Selection criteria	Action
Expected forms for	<p>Select the clinical forms (forms that have a type of CRF) that are expected to appear.</p> <ul style="list-style-type: none"> • All forms—All expected forms are considered. • Scheduled visits—Expected forms that appear in scheduled visits are considered. • Scheduled or started visits—Expected forms that appear in scheduled or started visits are considered. A started visit is a visit in which at least one non-common expected form is started. • Scheduled or started visits to date—Expected forms that appear in visits that are scheduled to start or have been started by the date the report is run are considered. • Scheduled visits or started forms to date—Expected forms for which either of the following is true are considered: <ul style="list-style-type: none"> ▪ The forms appear in visits that are scheduled to occur by the date the report is run. ▪ The forms have been started by the date the report is run.
Limit to forms with	<p>Select one or more options to filter the report to include only forms with:</p> <ul style="list-style-type: none"> • Required items—Forms that have items that are marked required are considered. • SV required items—Forms that have items for which source verification is required are considered. • Outstanding queries—Forms that have open or answered queries against the form items are considered. • Comments—Forms that have either form level or item level comments are considered. <p>If you leave all checkboxes blank, this prompt is not applied. In that case, the results are determined by your selections in the previous prompts.</p> <p>If one or more checkboxes are selected, the counts are limited by the selection(s) in this prompt. Most likely, this results in decreased counts. For example, selecting both Required items and SV required items limits the report results to only those forms that have both required items and SV required items.</p>

Note: To include all available options in the report, leave the optional selection fields blank; that is, do not select any individual options from the drop-down lists. **For the best performance, do not select any optional filters.**

Sort options

Sort options are: None, Rights Group, User Name, Site Mnemonic, Subject Count, Expected Forms

Count, % of Not Started Forms, % of Incomplete Forms, % of Completed Forms, % of Frozen Forms, % of SV Complete Forms, % of Signed Forms, % of Locked Forms.

Use the **Sort** drop-down lists to change any of the default selections.

Sort	Default selection
First level	Rights Group
Second level	User Name
Third level	Site Mnemonic

Report/Graph page: CRF Status Summary by User

Subtotals and totals

- **Subtotals**—None.
- **Totals**—Overall form count totals.

Drill-down reports

- Click a value in the Site Mnemonic column to drill down to the CRF Status Detail by Visit and Site report for the selected site.
- Click a value in the Subject Count column to drill down to the *CRF Status Detail by Site and Subject* (on page 260) report for the selected user.

Column descriptions

Column	Description
Rights Group	<p>Data type: String</p> <p>Description: The InForm rights group to which the InForm user belongs.</p> <p>Data source: Replicated from the InForm transactional database to the Reporting and Analysis database.</p>
User Name	<p>Data type: String</p> <p>Description: The user name of the InForm user.</p> <p>Data source: Replicated from the InForm transactional database to the Reporting and Analysis database.</p>
Site Mnemonic	<p>Data type: String</p> <p>Description: An abbreviation that identifies a site, as entered in the InForm Administration interface.</p> <p>Data source: Replicated from the InForm transactional database to the Reporting and Analysis database.</p>

Column	Description
Subject Count	<p>Data type: Numeric</p> <p>Description: The number of subjects who enrolled at the site.</p> <p>How calculated: For each site, counts subjects who enrolled at the site, including subjects who are currently assigned other states.</p> <p>Note: The Enrollment form, designed according to InForm specifications, must be completed for the subject.</p> <p>UUID: PF_SC_COMPLETECTL</p> <p>Data source: Status is determined by the value on the Enrollment form, which is stored in the Reporting and Analysis database. Status is set to 1 when the subject is enrolled.</p>
Form Count (% of Expected): Expected	<p>Data type: Numeric</p> <p>Description: The number of expected forms in the study.</p> <p>How calculated: This number reflects the number of expected forms for the site based on the option selected for the Expected forms for filter on the report prompt page. For more information, see <i>Selection criteria: CRF Aging by Site</i> (on page 232) and <i>Form elements and expected forms</i> (on page 91).</p> <p>Data source: Derived for the report; not stored in the Reporting and Analysis database.</p>
Form Count (% of Expected): Not Started	<p>Data type: Numeric (Percentage)</p> <p>Description: The number (and percentage) of expected forms that are not started in the InForm application.</p> <p>How calculated: A form is started if any data, queries, or comments have been entered. Each instance of a repeating form counts as a separate started form. A dynamic form may be Activated, but not Started.</p> <p>This value displays as a whole number and as the percentage of expected forms that are not started:</p> $[not\ started,\ \%\ of\ expected] = [not\ started\ forms\ count] * 100 / [expected\ forms\ count]$ <p>Data source: Derived for the report; not stored in the Reporting and Analysis database.</p>

Column	Description
Form Count (% of Expected): Incomplete	<p>Data type: Numeric (Percentage)</p> <p>Description: The number of expected forms that are started but incomplete, and the percentage of expected forms that are incomplete.</p> <p>How calculated: For each site, calculates the following:</p> $[incomplete\ forms\ count] = [started\ forms\ count] - [completed\ forms\ count]$ $[incomplete,\ \%\ of\ expected] = [incomplete\ forms\ count] * 100 / [expected\ forms\ count]$ <p>Data source: Derived for the report; not stored in the Reporting and Analysis database.</p>
Form Count (% of Expected): Completed	<p>Data type: Numeric (Percentage)</p> <p>Description: The number of completed forms, and the percentage of expected forms that are complete in the InForm application.</p> <p>How calculated: Counts forms that are expected and meet the following criteria:</p> <ul style="list-style-type: none"> • Are started. • Contain data for all required items. • For a repeating form, the form is not in a deleted state. • For an itemset form, the form is complete even if all the instances are deleted. <p>This value displays as a whole number and as a percentage of the total number of expected forms that are complete:</p> $[completed,\ \%\ of\ expected] = [completed\ forms] * 100 / [expected\ forms]$ <p>Data source: Replicated from the InForm transactional database to the Reporting and Analysis database. Percentage is derived for display.</p>

Column	Description
Form Count (% of Expected): Frozen	<p>Data type: Numeric (Percentage)</p> <p>Description: The number of frozen forms, and the percentage of expected forms that are currently marked frozen in the InForm application.</p> <p>How calculated: Counts expected forms that have been frozen using any of these InForm features:</p> <ul style="list-style-type: none"> • Freeze CRF • Freeze CRB • Freeze Visit <p>This value displays as a whole number (number of frozen forms), followed by the percentage of expected forms that are currently marked frozen:</p> $[\text{frozen, \% of expected}] = [\text{frozen forms count}] * 100 / [\text{expected forms count}]$ <p>Data source: Replicated from the InForm transactional database to the Reporting and Analysis database. Percentage is derived for display.</p>
Form Count (% of Expected): SV Complete	<p>Data type: Numeric (Percentage)</p> <p>Description: The number of verified forms, and the percentage of expected forms where source verification is complete.</p> <p>How calculated: Counts verified forms.</p> <p>A form is considered Verified if one of the following is true:</p> <ul style="list-style-type: none"> • The form does not contain critical items, and all items on the form that are marked SV Required are verified. • The form contains critical items, and all critical items on the form are verified. • The form is on the Critical Forms list, and all items on the form that are marked SV Required are verified. • The subject with which the form is associated is in the SV Pool, and all items marked SV Required are verified. • The subject with which the form is associated is not in the SV Pool, but an item on the form is marked critical for that subject, and all items marked SV Required are verified. <p>If none of the items on the form require source verification, the InForm application marks the form Verified.</p> <p>This value displays as a whole number and as a percentage of the total number of expected forms that are marked Verified:</p> $[\text{Verified, \% of expected}] = [\text{Verified forms count}] * 100 / [\text{expected forms count}]$ <p>Data source: Replicated from the InForm transactional database to the Reporting and Analysis database.</p>

Column	Description
Form Count (% of Expected): Signed	<p>Data type: Numeric (Percentage)</p> <p>Description: The number of signed forms and the percentage of expected forms that have been signed in the InForm application.</p> <p>How calculated: Counts forms that have been signed. This value displays as a whole number and as a percentage of the total number of expected forms that are signed.</p> $[\text{signed, \% of expected}] = [\text{signed forms count}] * 100 / [\text{expected forms count}]$ <p>Data source: Replicated from the InForm transactional database to the Reporting and Analysis database. Percentage is derived for display.</p>
Form Count (% of Expected): Locked	<p>Data type: Numeric (Percentage)</p> <p>Description: The number of locked forms, and the percentage of expected forms that are locked.</p> <p>How calculated: Counts forms for which any of the following conditions is true:</p> <ul style="list-style-type: none"> • The form has been locked. • The form is contained within a case book that has been locked. • The form is contained within a visit that has been locked. <p>This value displays as a whole number and as a percentage:</p> $[\text{locked, \% of expected}] = [\text{locked forms count}] * 100 / [\text{expected forms count}]$ <p>Data source: Replicated from the InForm transactional database to the Reporting and Analysis database. Percentage is derived for display.</p>

Item reports

CRF Item Listing

This report shows a list of form items that are in a given state or that entered a given state as of a specified point in time. The report is organized by site, subject, visit, and form. You can filter for missing items or for items that were changed after a given time.

Selection criteria: CRF Item Listing

Use the report prompt page to select criteria and specify sort options for your report.

For general instructions about how to run a standard report, see:

- *Running a standard report from the Reporting and Analysis portal* (on page 170).
- *Running a standard report in a new window* (on page 170).

Note: You must make a selection from the Visits drop-down list before you can access the More Options page or run the report.

For information about data that appears on this report, such as the data source, how data is calculated, and how it is displayed, see *Report/Graph page: CRF Item Listing* (on page 290).

Selection criteria

Selection criteria	Action
Countries	To report on specific countries, select their names from the list. Then, click Update to update the Sites list.
Sites	To report on specific sites, select their names from the list. Then, click Update to update the Visits list.
Visits	Select a visit from the list.

Selection criteria	Action
Limit to forms that are	<p>To filter the report to include only items in specific states, select one or more of the following options:</p> <ul style="list-style-type: none"> • SV Ready—Forms are considered if they are marked SV Ready, and are selected for source verification. • Not SV Complete—Forms are considered if they are neither source verified nor partially source verified. • Partially SV Complete—Forms are considered if they are marked partially source verified. • SV Complete—Forms are considered if they are marked source verified. • Frozen—Forms in a frozen state are considered. • Signed—Forms that are signed are considered. • Locked—Forms that are locked are considered. • SV Selected—Forms that are selected for source verification are considered. <p>For all states related to source verification:</p> <p>A form has been selected for source verification if one of the following is true:</p> <ul style="list-style-type: none"> • The form contains one or more critical items. • The form is on the Critical Forms list. • The subject with which the form is associated is in the SV Pool. • The subject with which the form is associated is not in the SV Pool, but an item on the form is marked critical for that subject. <p>The resulting report includes items in all form states you select. If you leave all checkboxes blank, the report includes all applicable forms.</p>

Selection criteria	Action
Limit to items that are	<p>Select one or more options to filter the report to include only items that are:</p> <ul style="list-style-type: none"> • Required—Items that are marked required are considered. • SV required—Items marked SV Required are considered. • With queries—Items that have open queries against them are considered. • With comments—Items that have comments against them are considered. • Unverified—Items that are not yet source verified are considered. • Verified—Items that are source verified are considered. • No longer verified—Items that were modified after source verification was done and for which the source verification for the changes is not complete are considered. • Empty—Items that have no data are considered. • Modified—Items that were modified after initial data entry are considered. • Filled—Items that have data are considered. • SV Selected—Items that are selected for source verification. An item has been selected for source verification if one of the following is true: <ul style="list-style-type: none"> ▪ The item is marked SV Required and SV Critical. ▪ The form on which the item exists is on the Critical Forms list. ▪ The subject with which the item is associated is part of the SV Pool. ▪ The subject with which the item is associated is not part of the SV Pool, but the item is marked critical for that subject. <p>The resulting report includes data for only the types of items you select. If you leave all checkboxes blank, the report will include all applicable items.</p>
Date last modified date range	<p>Specify a From and To date by entering dates or by using the calendar icons to select the date range to include in your report.</p> <p>The resulting report includes data for items that were last modified within the specified date range.</p> <p>Default: Current date</p>

Note: To include all available options in the report, leave the optional selection fields blank; that is, do not select any individual options from the drop-down lists. **For the best performance, do not select any optional filters.**

Sort options

Sort options are: None, Site, Subject Number, Visit, Form, Item Question, Form Dates–SV Ready, Form Dates–Frozen, Form Dates–SV Complete, Form Dates–Signed, Form Dates–Locked, Item-Verified, Item–SV Required, Item–Required, Item–Has Query, Item–Has Comment, Item–Original Value Date, Item–Data Change User, Item–Data Last Modified.

Use the **Sort** drop-down lists to change any of the default selections.

Sort	Default selection
First level	Site
Second level	Subject Number
Third level	Visit
Fourth level	Form

Report/Graph page: CRF Item Listing

Link to form items

Click the value in the **Form** column to link directly to the form in the InForm application.

Column descriptions

Column	Description
Site	<p>Data type: String</p> <p>Description: An abbreviation that identifies a site, as entered in the InForm Administration interface.</p> <p>Data source: Replicated from the InForm transactional database to the Reporting and Analysis database.</p>
Subject Number/Initials	<p>Data type: String</p> <p>Description: The subject number, followed by the subject initials. The subject number identifies the subject. The subject number and subject initials can be changed post enrollment, if this is configured in the study.</p> <p>Note: Subject number might not be unique at your site.</p> <p>Data source: Replicated from the InForm transactional database to the Reporting and Analysis database.</p>
Visit	<p>Data type: String</p> <p>Description: An abbreviation of the visit title, as specified in the study design. For CRF visits, this title appears at the top of a collection of forms in the visit timeline and may not be a unique identifier.</p> <p>Data source: Replicated from the InForm transactional database to the Reporting and Analysis database.</p>

Column	Description
DOV	<p>Data type: Date/Time</p> <p>Description: The date that is recorded in a standard Date of Visit control in the InForm application.</p> <p>Data type: Clinical</p> <p>Note: This report element assumes that your study was developed using a specific design for the DOV controls.</p> <p>UUIDs:</p> <ul style="list-style-type: none"> • DateTimeControl—BD991BC0-B0A4-11D2-80E3-00A0C9AF7674 • Item—BD991BBF-B0A4-11D2-80E3-00A0C9AF7674 • Section—BD991BBE-B0A4-11D2-80E3-00A0C9AF7674
Form	<p>Data type: String</p> <p>Description: A short name or abbreviation for the form, as specified in the study design code. This name appears in the Visit ruler and along the left side of certain pages for use with the form selectors, and is used to access a specific form in the InForm application.</p> <p>Data source: Replicated from the InForm transactional database to the Reporting and Analysis database.</p>
Form index	<p>Data type: Numeric</p> <p>Description: For repeating forms, a numeric ordinal value that identifies an iteration of a form. For non-repeating forms, the value is 1.</p> <p>Data source: Derived for the report; not stored in the Reporting and Analysis database.</p>
Item Question	<p>Data type: String</p> <p>Description: Text of the question or prompt that instructs the user to enter specific clinical data.</p> <p>Data source: Replicated from the InForm transactional database to the Reporting and Analysis database.</p>

Column	Description
Form State Dates: SV Ready	<p>Data type: Date/Time</p> <p>Description: The most recent date on which the status of the form was set to SV Ready.</p> <p>A form is considered SV Ready if it has a status of SV Ready, and is selected for source verification.</p> <p>A form has been selected for source verification if one of the following is true:</p> <ul style="list-style-type: none"> • The form contains one or more critical items. • The form is on the Critical Forms list. • The subject with which the form is associated is in the SV Pool. • The subject with which the form is associated is not in the SV Pool, but an item on the form is marked critical for that subject. <p>Date type: System date (GMT).</p>
Form State Dates: Frozen	<p>Data type: Date/Time</p> <p>Description: The most recent date on which the status of the form was set to Frozen in the InForm application. Note that a value displays here only if the form has a current status of Frozen.</p> <p>Date type: System date (GMT).</p>
Form State Dates: SV Complete	<p>Data type: Date/Time</p> <p>Description: The most recent date on which the form was marked Verified.</p> <p>A form is considered Verified if one of the following is true:</p> <ul style="list-style-type: none"> • The form does not contain critical items, and all items on the form that are marked SV Required are verified. • The form contains critical items, and all critical items on the form are verified. • The form is on the Critical Forms list, and all items on the form that are marked SV Required are verified. • The subject with which the form is associated is in the SV Pool, and all items marked SV Required are verified. • The subject with which the form is associated is not in the SV Pool, but an item on the form is marked critical for that subject, and all items marked SV Required are verified. <p>If none of the items on the form require source verification, the InForm application marks the form Verified.</p> <p>Date type: System date (GMT).</p>

Column	Description
Form State Dates: Signed	<p>Data type: Date/Time</p> <p>Description: The most recent date on which the form was signed in the InForm application. Note that a value displays here only if the form has a current status of Signed.</p> <p>Date type: System date (GMT).</p>
Form State Dates: Locked	<p>Data type: Date/Time</p> <p>Description: The most recent date on which the form was locked in the InForm application. Note that a value displays here only if the form has a current status of Locked.</p> <p>Date type: System date (GMT).</p>
Item Properties: Required	<p>Data type: Y/N</p> <p>Description: Indicates whether the item requires a value for the form to be considered data entry complete. Valid values are:</p> <ul style="list-style-type: none"> • Y—The item is required. • N—The item is not required. <p>Note: Itemset items cannot be required.</p> <p>Data source: Replicated from the InForm transactional database to the Reporting and Analysis database and decoded for display.</p>
Item Properties: SV Selected	<p>Data type: Y/N</p> <p>Description: Indicates whether the item has been selected for source verification.</p> <ul style="list-style-type: none"> • Y—The item has been selected for source verification. • N—The item has not been selected for source verification. <p>An item has been selected for source verification if one of the following is true:</p> <ul style="list-style-type: none"> • The item is marked SV Required and SV Critical. • The form on which the item exists is on the Critical Forms list. • The subject with which the item is associated is part of the SV Pool. • The subject with which the item is associated is not part of the SV Pool, but the item is marked critical for that subject. <p>Data source: Replicated from the InForm transactional database to the Reporting and Analysis database and decoded for display.</p>

Column	Description
Item Properties: SV Required	<p>Data type: Y/N</p> <p>Description: Indicates whether the item requires source verification.</p> <ul style="list-style-type: none"> • Y—The item requires InForm source verification. • N—The item does not require source verification. <p>An item is considered SV Required only if it is marked SV Required.</p> <p>Data source: Replicated from the InForm transactional database to the Reporting and Analysis database and decoded for display.</p>
Item Properties: Verified	<p>Data type: Y/N</p> <p>Description: Indicates whether the item is source verified.</p> <ul style="list-style-type: none"> • Y—The item is source verified. • N—The item is not source verified. <p>An item is considered source verified if it is in the Verified state.</p> <p>Data source: Replicated from the InForm transactional database to the Reporting and Analysis database and decoded for display.</p>
Item Properties: Has Query	<p>Data type: Y/N</p> <p>Description: Indicates whether the item has an open query associated with it.</p> <ul style="list-style-type: none"> • Y—The item has an open query. • N—The item has no open queries. <p>Note: This field is not supported in itemsets.</p> <p>Data source: Replicated from the InForm transactional database to the Reporting and Analysis database and decoded for display.</p>
Item Properties: Has Comment	<p>Data type: Y/N</p> <p>Description: Indicates whether the item has a comment associated with it.</p> <ul style="list-style-type: none"> • Y—The item has a comment. • N—The item does not have a comment. <p>Note: This field is not supported in itemsets.</p> <p>Data source: Replicated from the InForm transactional database to the Reporting and Analysis database and decoded for display.</p>
Item Properties: Data Modified	<p>Data type: Date</p> <p>Description: The date on which data was most recently modified.</p> <p>Date type: System date (GMT).</p>

Column	Description
Item Properties: Original Value Date	<p>Data type: Date</p> <p>Description: The date on which data was originally entered into the item.</p> <p>Date type: System date (GMT).</p>
Item Properties: Data Change User	<p>Data type: String</p> <p>Description: The user name of the InForm user who made the most recent change to the item.</p> <p>Data source: Replicated from the InForm transactional database to the Reporting and Analysis database.</p>

Source Verification Listing

This report shows form items for which the SV status changed within a date range.

CRA's use this report to compile a list of items to source verify when visiting a site, or to view those items that were source verified in a given time period.

Selection criteria: Source Verification Listing

Use the report prompt page to select criteria and specify sort options for your report.

For general instructions about how to run a standard report, see:

- *Running a standard report from the Reporting and Analysis portal* (on page 170).
- *Running a standard report in a new window* (on page 170).

For information about data that appears on this report, such as the data source, how data is calculated, and how it is displayed, see *Report/Graph page: Source Verification Listing* (on page 297).

Selection criteria

Selection criteria	Action
Countries	To report on specific countries, select their names from the list. Then, click Update to update the Sites list.
Sites	To report on specific sites, select their names from the list. Then, click Update to update the Subjects list.
Subjects	To report on specific subjects, select their names from the list. Then, click Update to update the Visits list.
Visit	To report on a visit, select it from the list. You can only select one visit at a time. Note: You must select a visit.

Selection criteria	Action
Forms	<p>To report on specific forms, select one or more forms from the list of form mnemonics.</p> <p>Note: You must select at least one form.</p>
Data entry completion status	<p>To filter the report by data entry completion status, select one of the following options:</p> <ul style="list-style-type: none"> • Any Forms—Both complete and incomplete forms are considered. • Only Incomplete Forms—Forms for which data entry has started but not all of the required items are entered, or completed forms that have an open query against any item are considered. • Only Complete Forms—Forms that contain data in all required items and that have no open queries against any items are considered. For repeating forms, the form cannot be in a deleted state. <p>The resulting report includes data for the form completion status selected.</p> <p>Default: Any Forms</p>
Visit start date range	<p>Select a date range for the visit start date. Use the calendar icons to select the date range to include in your report. The resulting report will include data for all visits that were started within the selected range.</p> <p>Default start date: 01-JAN-2009</p> <p>Default end date: Report run date</p>
Limit to	<p>To report based on item type, select from the following options:</p> <ul style="list-style-type: none"> • Items with queries—Items that have open queries against them are considered. • Items with comments—Items that have comments against them are considered. • Unverified items—Items that are not yet source verified are considered. • Verified items—Items that are source verified are considered. • No longer verified items—Items that were modified after source verification was done and for which the source verification for the changes is not complete are considered. • SV Selected—Items that are selected for source verification are considered. <p>The resulting report displays data items that have all of the selected criteria. If you leave all checkboxes blank, the report will include all applicable forms.</p>

Sort options

Sort options are: None, Site, Subject Number, Visit, Form, Item Question, Verified, Status Change User, Last Verified, Data Change User, Data Last Modified.

Use the **Sort** drop-down lists to change any of the default selections.

Sort	Default selection
First level	Site
Second level	Subject Number
Third level	Visit
Fourth level	Form

Report/Graph page: Source Verification Listing

Link to form items

Click the value in the **Form** column to link directly to the form in the InForm application. From there, you can see the data entered for the item.

Column descriptions

Column	Description
Site	<p>Data type: String</p> <p>Description: An abbreviation that identifies a site, as entered in the InForm Administration interface.</p> <p>Data source: Replicated from the InForm transactional database to the Reporting and Analysis database.</p>
Subject Number	<p>Data type: String</p> <p>Description: The number that identifies the subject. This number can also be changed post-enrollment, if configured in the study.</p> <p>Note: Subject number might not be unique at your site.</p> <p>Data source: Replicated from the InForm transactional database to the Reporting and Analysis database.</p>
Visit	<p>Data type: String</p> <p>Description: An abbreviation of the visit title, as specified in the study design. For CRF visits, this title appears at the top of a collection of forms in the visit timeline and may not be a unique identifier.</p> <p>Data source: Replicated from the InForm transactional database to the Reporting and Analysis database.</p>

Column	Description
DOV	<p>Data type: Date</p> <p>Description: The date that is recorded in a standard Date of Visit control in the InForm application.</p> <p>Data type: Clinical</p> <p>Note: This report element assumes that your study was developed using a specific design for the DOV controls.</p> <p>UUIDs:</p> <ul style="list-style-type: none"> • DateTimeControl—BD991BC0-B0A4-11D2-80E3-00A0C9AF7674 • Item—BD991BBF-B0A4-11D2-80E3-00A0C9AF7674 • Section—BD991BBE-B0A4-11D2-80E3-00A0C9AF7674
Form	<p>Data type: String</p> <p>Description: A short name or abbreviation for the form, as specified in the study design code. This name appears in the Visit ruler and along the left side of certain pages for use with the form selectors, and is used to access a specific form in the InForm application.</p> <p>Data source: Replicated from the InForm transactional database to the Reporting and Analysis database.</p>
Form Index	<p>Data type: Numeric</p> <p>Description: For repeating forms, a numeric ordinal value that identifies an iteration of a form. For non-repeating forms, the value is 1.</p> <p>Data source: Derived for the report; not stored in the Reporting and Analysis database.</p>
Item Question	<p>Data type: String</p> <p>Description: Text of the question or prompt that instructs the user to enter specific clinical data. Access to this data can be restricted in the InForm application. When users who do not have access to this data run a report with this report element, the resulting report displays a series of asterisks (*****) rather than the actual item question.</p> <p>InForm items that have never contained data will not appear on reports that pair Item Question with Form Name or Form Mnemonic.</p> <p>Data source: Replicated from the InForm transactional database to the Reporting and Analysis database.</p>
Status Change User	<p>Data type: String</p> <p>Description: The user name of the InForm user who made the most recent change to the status of the item. A change to the SV status of the item is considered a status change for the item.</p> <p>Data source: Replicated from the InForm transactional database to the Reporting and Analysis database.</p>

Column	Description
Verified	<p>Data type: Y/N</p> <p>Description: Indicates whether the item is source verified.</p> <ul style="list-style-type: none"> • Y—The item is source verified. • N—The item is not source verified. <p>An item is considered source verified if it is in the Verified state.</p> <p>Data source: Replicated from the InForm transactional database to the Reporting and Analysis database and decoded for display.</p>
Last Verified	<p>Data type: Date</p> <p>Description: The most recent date on which the item was source verified. An item is considered source verified if it is in the Verified state.</p> <p>Date type: System date (GMT).</p>
Data Change User	<p>Data type: String</p> <p>Description: The user name of the InForm user who made the most recent change to the item.</p> <p>Data source: Replicated from the InForm transactional database to the Reporting and Analysis database.</p>
Data Last Modified	<p>Data type: Date</p> <p>Description: The date on which data was most recently entered into the item.</p> <p>Date type: System date (GMT).</p>
Is SV Selected	<p>Data type: Y/N</p> <p>Description: Indicates whether the item has been selected for source verification.</p> <ul style="list-style-type: none"> • Y—The item has been selected for source verification. • N—The item has not been selected for source verification. <p>An item has been selected for source verification if one of the following is true:</p> <ul style="list-style-type: none"> • The item is marked SV Required and SV Critical. • The form on which the item exists is on the Critical Forms list. • The subject with which the item is associated is part of the SV Pool. • The subject with which the item is associated is not part of the SV Pool, but the item is marked critical for that subject. <p>Data source: Replicated from the InForm transactional database to the Reporting and Analysis database and decoded for display.</p>

Column	Description
Source Verified Targeted	<p>Data type: Numeric</p> <p>How calculated: Counts items that have been source verified and have been selected for source verification.</p> <p>An item has been selected for source verification if one of the following is true:</p> <ul style="list-style-type: none">• The item is marked SV Required and SV Critical.• The form on which the item exists is on the Critical Forms list.• The subject with which the item is associated is part of the SV Pool.• The subject with which the item is associated is not part of the SV Pool, but the item is marked critical for that subject. <p>Data source: Derived and stored in the Reporting and Analysis database.</p>

Subject reports

Case Book Completion and Query Summary by Site

This report shows how many case books are complete and how many have no outstanding queries.

Selection criteria: Case Book Completion and Query Summary by Site

Use the report prompt page to select criteria and specify sort options for your report.

For general instructions about how to run a standard report, see:

- *Running a standard report from the Reporting and Analysis portal* (on page 170).
- *Running a standard report in a new window* (on page 170).

For information about data that appears on this report, such as the data source, how data is calculated, and how it is displayed, see *Report/Graph page: Case Book Completion and Query Summary by Site* (on page 302).

Selection criteria

Selection criteria	Action
Countries	To report on specific countries, select their names from the list. Then, click Update to update the Sites list.
Sites	If you updated the Sites list after selecting one or more countries and you want to report on specific sites, select the names of the sites from the list.
Expected forms	<p>Select the clinical forms (forms that have a type of CRF) that are expected to appear.</p> <ul style="list-style-type: none"> • All forms—All expected forms are considered. • Scheduled visits—Expected forms that appear in scheduled visits are considered. • Scheduled or started visits—Expected forms that appear in scheduled or started visits are considered. A started visit is a visit in which at least one non-common expected form is started. • Scheduled or started visits to date—Expected forms that appear in visits that are scheduled to start or have been started by the date the report is run are considered. • Scheduled visits or started forms to date—Expected forms for which either of the following is true are considered: <ul style="list-style-type: none"> ▪ The forms appear in visits that are scheduled to occur by the date the report is run. ▪ The forms have been started by the date the report is run. <p>Default: Scheduled or started visits</p>

Note: To include all available options in the report, leave the optional selection fields blank; that is, do not select any individual options from the drop-down lists. **For the best performance, do not select any optional filters.**

Sort options

Sort options are: None, Country, Site Mnemonic, Enrolled Subject Count, Count of Incomplete CRBs, % of Incomplete CRBs, Count of Incomplete CRBs with Queries, % of Incomplete CRBs with Queries, Count of Incomplete CRBs without Queries, % of Incomplete CRBs without Queries, Count of Completed CRBs, % of Completed CRBs, Count of Completed CRBs with Queries, % of Completed CRBs with Queries, Count of Completed CRBs without Queries, % of Completed CRBs without Queries.

Use the **Sort** drop-down lists to change any of the default selections.

Sort	Default selection
First level	Country
Second level	Site Mnemonic
Third level	None

Report/Graph page: Case Book Completion and Query Summary by Site

Subtotals and totals

- **Subtotals**—By Country.
 - Numeric columns—Total for each country.
 - % columns—Percent for each country.
- **Totals**—Overall subject count totals.
 - Numeric columns—Total for all countries.
 - % columns—Percent for all countries.

Column descriptions

Column	Description
Country	<p>Data type: String</p> <p>Description: The country in which a site is located, as entered in the InForm Administration interface.</p> <p>Data source: Replicated from the InForm transactional database to the Reporting and Analysis database.</p>

Column	Description
Site Mnemonic	<p>Data type: String</p> <p>Description: An abbreviation that identifies a site, as entered in the InForm Administration interface.</p> <p>Data source: Replicated from the InForm transactional database to the Reporting and Analysis database.</p>
Enrolled Subject Count	<p>Data type: Numeric</p> <p>Description: The number of subjects with started CRBs who have enrolled at the site and have not dropped out.</p> <p>How calculated: For each site, counts subjects with started CRBs who have been enrolled in the InForm application and have not dropped out of the study.</p> <p>UUID: PF_SC_COMPLETECTL</p> <p>Data source: Derived for the report; not stored in the Reporting and Analysis database.</p>
Incomplete CRBs (% of Incomplete CRBs)	<p>Data type: Numeric</p> <p>Description: The number of started CRBs that are not complete.</p> <p>How calculated: Counts Case Report Books that have been started and have at least one expected form without a status of Data Entry Completed.</p> <p>This value displays as both a total and a percentage of all started CRBs for subjects that have not dropped out:</p> $[\% \text{ incomplete CRBs}] = [\text{incomplete CRBs}] * 100 / [\text{started CRBs}]$ <p>Data source: Derived for the report; not stored in the Reporting and Analysis database.</p>

Column	Description
Incomplete CRBs with Queries (% of Incomplete CRBs with Queries)	<p>Data type: Numeric</p> <p>Description: The number of started CRBs that are not complete and that have open queries.</p> <p>How calculated: Counts Case Report Books that meet all of the following criteria:</p> <ul style="list-style-type: none"> • Have been started. • Have at least one expected form without a status of Data Entry Completed. • Have at least one expected form with at least one open or answered query. <p>This value displays as both a total and a percentage of all started CRBs for subjects that have not dropped out:</p> $\frac{[\% \text{ incomplete CRBs with queries}]}{[\text{started CRBs}]} = \frac{[\text{incomplete CRBs with queries}] * 100}{[\text{started CRBs}]}$ <p>Data source: Derived for the report; not stored in the Reporting and Analysis database.</p>
Incomplete CRBs without Queries (% of Incomplete CRBs without Queries)	<p>Data type: Numeric</p> <p>Description: The number of started CRBs that are not complete and that have no outstanding queries.</p> <p>How calculated: Counts Case Report Books that meet all of the following criteria:</p> <ul style="list-style-type: none"> • Have been started. • Have at least one expected form without a status of Data Entry Completed. • Do not have any expected forms with any open or answered queries. <p>This value displays as both a total and a percentage of all started CRBs for subjects that have not dropped out:</p> $[\text{incomplete CRBs without queries}] = [\text{incomplete CRBs}] - [\text{incomplete CRBs with queries}]$ $\frac{[\% \text{ incomplete CRBs without queries}]}{[\text{started CRBs}]} = \frac{[\text{incomplete CRBs without queries}] * 100}{[\text{started CRBs}]}$ <p>Data source: Derived for the report; not stored in the Reporting and Analysis database.</p>

Column	Description
Completed CRBs (% of Completed CRBs)	<p>Data type: Numeric</p> <p>Description: The number of started CRBs that are complete.</p> <p>How calculated: Counts Case Report Books that meet all of the following criteria:</p> <ul style="list-style-type: none"> • Have been started. • Have all expected forms with a status of Data Entry Completed. <p>This value displays as both a total and a percentage of all started CRBs for subjects that have not dropped out:</p> $[\text{complete CRBs}] = [\text{CRB count}] - [\text{incomplete CRBs}]$ $[\% \text{ complete CRBs}] = [\text{complete CRBs}] * 100 / [\text{started CRBs}]$ <p>Data source: Derived for the report; not stored in the Reporting and Analysis database.</p>
Completed CRBs with Queries (% of Completed CRBs with Queries)	<p>Data type: Numeric</p> <p>Description: The number of started CRBs that are complete and that have open or answered queries.</p> <p>How calculated: Counts Case Report Books that meet all of the following criteria:</p> <ul style="list-style-type: none"> • Have been started. • Have all expected forms with a status of Data Entry Completed. • Have at least one expected form with at least one open or answered query. <p>This value displays as both a total and a percentage of all started CRBs for subjects that have not dropped out:</p> $[\text{completed CRBs with queries}] = [\text{total CRBs with queries}] - [\text{incomplete CRBs with queries}]$ $[\% \text{ complete CRBs with queries}] = [\text{complete CRBs with queries}] * 100 / [\text{started CRBs}]$ <p>Data source: Derived for the report; not stored in the Reporting and Analysis database.</p>

Column	Description
Completed CRBs without Queries	<p>Data type: Numeric</p> <p>Description: The number of started CRBs that are complete and that have no open or answered queries.</p> <p>How calculated: Counts Case Report Books that meet all of the following criteria:</p> <ul style="list-style-type: none"> • Have been started. • Have all expected forms with a status of Data Entry Completed. • Do not have any expected forms with any open or answered queries. <p>This value displays as both a total and a percentage of all started CRBs for subjects that have not dropped out:</p> $[\text{complete CRBs without queries}] = [\text{complete CRBs}] - [\text{complete CRBs with queries}]$ $[\% \text{ complete CRBs without queries}] = [\text{complete CRBs without queries}] * 100 / [\text{started CRBs}]$ <p>Data source: Derived for the report; not stored in the Reporting and Analysis database.</p>

Cumulative Subject Enrollment by Month

This report charts the cumulative counts of enrolled, dropped, and completed subjects at each site over time.

Selection criteria: Cumulative Subject Enrollment by Month

Use the report prompt page to select criteria and specify sort options for your report.

For general instructions about how to run a standard report, see:

- *Running a standard report from the Reporting and Analysis portal* (on page 170).
- *Running a standard report in a new window* (on page 170).

For information about data that appears on this report, such as the data source, how data is calculated, and how it is displayed, see *Report/Graph page: Cumulative Subject Enrollment by Month* (on page 307).

Selection criteria

Selection criteria	Action
Countries	To report on specific countries, select their names from the list. Then, click Update to update the Sites list.

Selection criteria	Action
Sites	If you updated the Sites list after selecting one or more countries and you want to report on specific sites, select the names of the sites from the list.
Date range	To specify the date range, enter the From and To dates, or use the calendar icons to select the dates. Default From date: 2000-01-01 Default To date: Current date

Note: To include all available options in the report, leave the optional selection fields blank; that is, do not select any individual options from the drop-down lists. For the best performance, do not select any optional filters.

Sort options

Sort options are: None, Site Mnemonic, Date.

Use the **Sort** drop-down lists to change any of the default selections.

Sort	Default selection
First level	Site Mnemonic
Second level	Date

Report/Graph page: Cumulative Subject Enrollment by Month

Graphs

A bar graph appears on the first page of the Cumulative Subject Enrollment by Month report, illustrating the enrolled, dropped, and completed subject count by month.

Subtotals and totals

- **Subtotals**—None.
- **Totals**—Overall subject count totals.

Column descriptions

Column	Description
Site Mnemonic	Data type: String Description: An abbreviation that identifies a site, as entered in the InForm Administration interface. Data source: Replicated from the InForm transactional database to the Reporting and Analysis database.

Column	Description
Enrolled count by month	<p>Data type: Numeric</p> <p>Description: The number of subjects who were enrolled at the site within a given month.</p> <p>How calculated: For each site, counts the number of enrolled subjects for the month. If no new subjects are enrolled during a particular month, the count is the same as the previous month.</p> <p>UUID: PF_SC_COMPLETECTL</p> <p>Data source: Derived for the report; not stored in the Reporting and Analysis database.</p>
Dropped count by month	<p>Data type: Numeric</p> <p>Description: The number of subjects in each site who dropped out of the study during a given month.</p> <p>How calculated: For each site, counts the number of subjects who dropped out of the study during the month. If no subjects drop out during a particular month, the count is the same as the previous month.</p> <p>UUID: PF_SC_COMPLETECTL</p> <p>Data source: Derived for the report; not stored in the Reporting and Analysis database.</p>
Completed count by month	<p>Data type: Numeric</p> <p>Description: The number of subjects at the site who completed the study during a given month.</p> <p>How calculated: For each site, counts the number of subjects who complete the study in a particular month. If no subjects complete the study in a given month, the count is the same as the previous month.</p> <p>UUID: PF_SC_COMPLETECTL</p> <p>Data source: Replicated from the InForm transactional database to the Reporting and Analysis database.</p>

Subject Dropout Count by Reason

This report shows the number of subjects who have left the study for each reason used in the study design.

Selection criteria: Subject Dropout Count by Reason

Use the report prompt page to select criteria and specify sort options for your report.

For general instructions about how to run a standard report, see:

- *Running a standard report from the Reporting and Analysis portal* (on page 170).
- *Running a standard report in a new window* (on page 170).

For information about data that appears on this report, such as the data source, how data is

calculated, and how it is displayed, see *Report/Graph page: Subject Dropout Count by Reason* (on page 309).

Selection criteria

Selection criteria	Action
Countries	To report on specific countries, select their names from the list. Then, click Update to update the Sites list.
Sites	To report on specific sites, select the names of the sites from the list.
Date range	To specify the date range, enter the From and To dates, or use the calendar icons to select the dates. Default From date: 2000-01-01 Default To date: Current date

Sort options

Sort options are: None, Country, Site Mnemonic, Enrolled Count, Total Dropouts.

Use the **Sort** drop-down lists to change any of the default selections.

Sort	Default selection
First level	Country
Second level	Site Mnemonic
Third level	None

Report/Graph page: Subject Dropout Count by Reason

Graphs

A bar graph appears on the first page of the Subject Dropout Count by Reason report, illustrating how many subjects dropped out, organized by drop out reason.

Subtotals and totals

- **Subtotals**—By Country and Site.
- **Totals**—Overall subject count totals.

Column descriptions

Column	Description
--------	-------------

Column	Description
Country	<p>Data type: String</p> <p>Description: The country in which a site is located, as entered in the InForm Administration interface.</p> <p>Data source: Replicated from the InForm transactional database to the Reporting and Analysis database.</p>
Site Mnemonic	<p>Data type: String</p> <p>Description: An abbreviation that identifies a site, as entered in the InForm Administration interface.</p> <p>Data source: Replicated from the InForm transactional database to the Reporting and Analysis database.</p>
Enrolled	<p>Data type: Numeric</p> <p>Description: The number of subjects that were enrolled at the site in the InForm application during the specified date range.</p> <p>UUID: PF_SC_COMPLETECTL</p> <p>Data source: Replicated from the InForm transactional database to the Reporting and Analysis database.</p>
Dropout Reason	<p>Data type: String</p> <p>Description: Text that indicates why the subject dropped out of the study. The dropout reason is clinical data that is specified on the Study Completion form for the subject.</p> <p>Note: This report displays only those reasons that were specified when a subject dropped out of the study. If a dropout reason was never used, the reason does not appear in this report.</p> <p>UUIDs: PF_SC_COMPLETECTL, PF_SC_REASONCTL_ <i>internal_reason_value</i></p> <p>Data source: Replicated from the InForm transactional database to the Reporting and Analysis database.</p>
Total Dropouts	<p>Data type: Numeric</p> <p>Description: The total number of subjects that dropped out of the study, by site. This total is a sum of all dropout counts in the row plus the count of subjects who dropped out but for whom the reason was not specified.</p> <p>UUID: PF_SC_COMPLETECTL</p> <p>Data source: Replicated from the InForm transactional database to the Reporting and Analysis database.</p>

Subject Enrollment Status by Site

This report shows the number and percentage of subjects screened, enrolled, randomized, active, completed, or dropped by site.

Selection criteria: Subject Enrollment Status by Site

Use the report prompt page to select criteria and specify sort options for your report.

For general instructions about how to run a standard report, see:

- *Running a standard report from the Reporting and Analysis portal* (on page 170).
- *Running a standard report in a new window* (on page 170).

For information about data that appears on this report, such as the data source, how data is calculated, and how it is displayed, see *Report/Graph page: Subject Enrollment Status by Site* (on page 312).

Selection criteria

Selection criteria	Action
Countries	To report on specific countries, select their names from the list. Then, click Update to update the Sites list.
Sites	To report on specific sites, select the names of the sites from the list.
Date range	To specify the date range, enter the From and To dates, or use the calendar icons to select the dates. Default From date: 2000-01-01 Default To date: Current date

Sort options

Sort options are: None, Country, Site Mnemonic, Screened, Screen Failed, % Enrolled, Enroll Failure, Screen Override, Enroll Override, % Randomized, % Active, % Completed, % Dropped.

Use the **Sort** drop-down lists to change any of the default selections.

Sort	Default selection
First level	Country
Second level	Site Mnemonic
Third level	None

Report/Graph page: Subject Enrollment Status by Site

Graphs

A bar graph appears on the first page of the Subject Enrollment Status by Site report, illustrating the number of screened, enrolled, and dropped subjects at each site.

Subtotals and totals

- **Subtotals**—By Country.
- **Totals**—Overall subject count totals.

Column descriptions

Column	Description
Country	<p>Data type: String</p> <p>Description: The country in which a site is located, as entered in the InForm Administration interface.</p> <p>Data source: Replicated from the InForm transactional database to the Reporting and Analysis database.</p>
Site Mnemonic	<p>Data type: String</p> <p>Description: An abbreviation that identifies a site, as entered in the InForm Administration interface.</p> <p>Data source: Replicated from the InForm transactional database to the Reporting and Analysis database.</p>
Screened	<p>Data type: Numeric</p> <p>Description: The number of subjects who have been successfully screened in the InForm application without a screen failure during the screening process.</p> <p>How calculated: For each site, counts each subject who was successfully screened without a screen failure during the screening process and who meets one of the following conditions:</p> <ul style="list-style-type: none"> • The enrollment process was not started. • The enrollment process was started but not completed because either an enrollment failure occurred or the user completed the enrollment form but chose not to enroll the subject. • The enrollment process was completed successfully and the subject moved on to another state (Enrolled, Randomized, Dropped Out, or Incomplete). <p>UUID: PF_SC_COMPLETECTL</p> <p>Data source: Derived for the report; not stored in the Reporting and Analysis database.</p>

Column	Description
Screen Failure	<p>Data type: Numeric</p> <p>Description: The number of subjects who failed the screening process in the InForm application. These subjects have screen failure text generated.</p> <p>How calculated: For each site, counts the number of subjects that were failed during the InForm screening process. This count excludes the Screen Override values.</p> <p>Data source: Replicated from the InForm transactional database to the Reporting and Analysis database.</p>
Enroll Failure	<p>Data type: Numeric</p> <p>Description: The number of subjects who were successfully screened (no screen failure reason generated), but failed the enrollment process by entering an invalid character (hyphen or a slash). The failure generates the enroll failure reason in the InForm application.</p> <p>How calculated: For each site, counts the number of subjects who failed the InForm enrollment process. This count excludes the Enroll Override values.</p> <p>Data source: Replicated from the InForm transactional database to the Reporting and Analysis database.</p>
Screen Override	<p>Data type: Numeric</p> <p>Description: For each site, the number of subjects who have been screened in the InForm application due to the screening override process.</p> <p>How calculated: For each site, counts the number of subjects who failed the InForm screening process and subsequently were screened through the InForm screening override process. This count includes subjects who may have moved on to other states (such as Enrolled, Randomized, Dropped out, or Complete).</p> <p>Subjects screened and enrolled through PF Admin Import: Subjects who were added to the study through PF Admin Import are not counted in Screen/Enroll Override counts, even if they initially failed screening or enrollment.</p> <p>Data source: Replicated from the InForm transactional database to the Reporting and Analysis database.</p>

Column	Description
Enroll Override	<p>Data type: Numeric</p> <p>Description: For each site, the number of subjects who have been enrolled in the InForm application due to the enrollment override process within the specified date range on the report prompt page.</p> <p>How calculated: For each site, counts subjects who have ever failed the InForm enrollment process, but have subsequently been enrolled through the InForm enroll override process. This count includes subjects who may have moved on to other states (such as Randomized, Dropped out, or Complete).</p> <p>Subjects screened and enrolled through PF Admin Import: Subjects who were added to the study through PF Admin Import are not counted in Screen/Enroll Override counts, even if they initially failed screening or enrollment.</p> <p>Data source: Replicated from the InForm transactional database to the Reporting and Analysis database.</p>
Enrolled	<p>Data type: Numeric</p> <p>Description: The number of subjects that were ever enrolled at the site.</p> <p>How calculated: For each site, the count includes subjects who were initially screen failed or enroll failed but subsequently enrolled or moved from the Enrolled state to other states (Randomized, Dropped out, or Completed).</p> <p>Subjects screened and enrolled through PF Admin Import: Subjects who were added to the study via PF Admin Import are not counted in Screen/Enroll Override counts, even if they initially failed screening or enrollment.</p> <p>UUID: PF_SC_COMPLETECTL</p> <p>Data source: Replicated from the InForm transactional database to the Reporting and Analysis database. Percentage is derived for display.</p>
Randomized	<p>Data type: Numeric</p> <p>Description: The number of enrolled subjects who have been randomized in the InForm application.</p> <p>How calculated: For each site, counts subjects who have ever been in the randomized state.</p> <p>UUID: PF_SC_COMPLETECTL</p> <p>Data source: Replicated from the InForm transactional database to the Reporting and Analysis database. Percentage is derived for display.</p>

Column	Description
Active in Trial	<p>Data type: Numeric</p> <p>Description: For each site, the number of subjects currently participating in the study as of the report run date.</p> <p>How calculated: For each site, counts every subject in the Enrolled or Randomized state within the specified date range. Excludes subjects in the Completed or Dropped out state.</p> <p>Data source: Replicated from the InForm transactional database to the Reporting and Analysis database.</p>
Completed	<p>Data type: Numeric</p> <p>Description: The number of enrolled subjects who have completed the study.</p> <p>How calculated: For each site, counts subjects who have completed the study, as recorded on the Subject Completion in the InForm application.</p> <p>UUIDs: PF_SC_COMPLETECTL, PF_SC_STUDY_COMPLETE, PF_SC_STUDY_INCOMPLETE</p> <p>Data source: Replicated from the InForm transactional database to the Reporting and Analysis database. Percentage is derived for display.</p>
Dropped	<p>Data type: Numeric</p> <p>Description: The number of enrolled subjects who have dropped out of the study.</p> <p>How calculated: For each site, counts subjects who have dropped out of the study, as recorded on the Subject Completion form in the InForm application.</p> <p>UUID: PF_SC_COMPLETECTL</p> <p>Data source: Replicated from the InForm transactional database to the Reporting and Analysis database. Percentage is derived for display.</p>

Audit Trail reports

Audit Trail Report

This report shows the fields for which data was entered, modified, or cleared within a selected date range.

Selection criteria: Audit Trail Report

Use the report prompt page to select criteria and specify sort options for your report.

For general instructions about how to run a standard report, see:

- *Running a standard report from the Reporting and Analysis portal* (on page 170).
- *Running a standard report in a new window* (on page 170).

For information about data that appears on this report, such as the data source, how data is calculated, and how it is displayed, see *Report/Graph page: Audit Trail Report* (on page 317).

Selection criteria

Selection criteria	Action
Sites	To report on specific sites, select the names of the sites from the list.
Subjects	To report on specific subjects, select the subjects from the list.
Visits	To report on one or more visits, select the visits from the list.
Forms	To report on specific forms, select one or more forms from the list of form mnemonics.
Item Questions	To report on items, select one or more item questions from the list.
Initial Entry or Modification	Select whether to narrow the report by initial data entered, modified data, deleted or undeleted itemset data, or deleted or undeleted form data.
Rights Groups	To report on rights groups, select one or more rights groups from the list. Then, click Update to update the Users list.
Username	To report on users, select specific user names from the list.
User Types	Select specific user types from the list.
Current Value Date/Time range	To specify the date range, enter the From and To dates, or use the calendar icons to select the dates. Default From date: 2000-01-01 Default To date: Current date

Sort options

None. Automatically sorted by Site Mnemonic, Subject Number, Visit Mnemonic, Visit Index, Form

Mnemonic, Form Index, Itemset Index, Item Question, Control RefName, Audit Order.

Report/Graph page: Audit Trail Report

Column descriptions

Column	Description
Study Name	<p>Data type: String</p> <p>Description: Name associated with the study, as specified in the study design code.</p> <p>Data source: Replicated from the InForm transactional database to the Reporting and Analysis database.</p>
Site Mnemonic	<p>Data type: String</p> <p>Description: Abbreviation used to identify a site, as entered in the InForm Administration interface.</p> <p>Data source: Replicated from the InForm transactional database to the Reporting and Analysis database.</p>
Subject Number	<p>Data type: String</p> <p>Description: Number that identifies the subject. This number may be changed after the subject is enrolled, if the study is configured to require a unique subject ID for a study or site.</p> <p>Data source: Replicated from the InForm transactional database to the Reporting and Analysis database.</p>
Visit Mnemonic	<p>Data type: String</p> <p>Description: Abbreviation of the visit title, as specified in study design code. For CRF visits, this name appears at the top of a collection of forms in the visit timeline. The visit mnemonic may not be a unique identifier.</p> <p>Data source: Replicated from the InForm transactional database to the Reporting and Analysis database.</p>
Visit Index	<p>Data type: Numeric</p> <p>Description: Value that identifies the instance of the visit in which data was entered for the form.</p> <p>Data source: Replicated from the InForm transactional database to the Reporting and Analysis database.</p>
Form Mnemonic	<p>Data type: String</p> <p>Description: Short name or abbreviation for the form, as specified in the study design code. This name appears on the Visit Navigation tab and is used to access a specific form in the InForm application.</p> <p>Data source: Replicated from the InForm transactional database to the Reporting and Analysis database.</p>

Column	Description
Form Index	<p>Data type: Numeric</p> <p>Description: For repeating forms, a numeric ordinal value that identifies the instance of the form. For non-repeating forms, the value is 1.</p> <p>Data source: Replicated from the InForm transactional database to the Reporting and Analysis database.</p>
Itemset Index	<p>Data type: Numeric</p> <p>Description: Value that identifies an instance of an itemset.</p> <p>Data source: Replicated from the InForm transactional database to the Reporting and Analysis database.</p>
Item Question	<p>Data type: String</p> <p>Description: Text of the question or prompt that instructs the user to enter specific clinical data.</p> <p>Items that have never contained data will not appear on reports that pair Item Question with Form Name or Form Mnemonic.</p> <p>Data source: Replicated from the InForm transactional database to the Reporting and Analysis database.</p>
Changed Control RefName	<p>Data type: String</p> <p>Description: Name of the modified field.</p> <p>Data source: Replicated from the InForm transactional database to the Reporting and Analysis database.</p>
Audit Order	<p>Data type: Numeric</p> <p>Description: Value that indicates the audit order for item changes from the earliest to the latest.</p> <p>Data source: Replicated from the InForm transactional database to the Reporting and Analysis database.</p>
Initial Entry or Modification	<p>Data type: String</p> <p>Description: Text that explains whether the clinical data is an initial entry, a modification, or a deletion.</p> <p>Data source: Replicated from the InForm transactional database to the Reporting and Analysis database.</p>
Entered Reason	<p>Data type: String</p> <p>Description: Text that explains the reason for the most recent clinical data change (if any) for the item. Text appears here only when the clinical data for the item has been changed after initial entry.</p> <p>Data source: Replicated from the InForm transactional database to the Reporting and Analysis database.</p>

Column	Description
Current Value	<p>Data type: String</p> <p>Description: Current value of the item.</p> <p>Data source: Replicated from the InForm transactional database to the Reporting and Analysis database.</p>
Current Value Date/Time	<p>Data type: String</p> <p>Description: Current date/time value for the item.</p> <p>Data source: Replicated from the InForm transactional database to the Reporting and Analysis database.</p>
Previous Value	<p>Data type: String</p> <p>Description: Value of the item before it was modified.</p> <p>Data source: Replicated from the InForm transactional database to the Reporting and Analysis database.</p>
Previous Value Date/Time	<p>Data type: String</p> <p>Description: Date/time value of the item before it was modified.</p> <p>Data source: Replicated from the InForm transactional database to the Reporting and Analysis database.</p>
Rights Group	<p>Data type: String</p> <p>Description: Rights group to which the user who entered or modified the data belongs.</p> <p>Data source: Replicated from the InForm transactional database to the Reporting and Analysis database.</p>
Username	<p>Data type: String</p> <p>Description: User name of the user who entered or modified the data.</p> <p>Data source: Replicated from the InForm transactional database to the Reporting and Analysis database.</p>
User Type	<p>Data type: String</p> <p>Description: User type. For example, Sponsor.</p> <p>Data source: Replicated from the InForm transactional database to the Reporting and Analysis database.</p>

Historical Login Report

This report shows the login history within a selected date range.

Note: There are also ad hoc report topics that you can use to create a report that shows user status and group membership information.

For more information, see *User Info: Historical User Info* (on page 144).

Selection criteria: Historical Login Report

Use the report prompt page to select criteria and specify sort options for your report.

For general instructions about how to run a standard report, see:

- *Running a standard report from the Reporting and Analysis portal* (on page 170).
- *Running a standard report in a new window* (on page 170).

For information about data that appears on this report, such as the data source, how data is calculated, and how it is displayed, see *Report/Graph page: Historical Login Report* (on page 320).

Selection criteria

Selection criteria	Action
Rights Group	Select one or more rights groups.
Username	Select specific user names from the group.
User Type	Select specific user types from the list.
Login Date/Time	<ul style="list-style-type: none"> • To specify the date range, enter the From and To dates, or use the calendar icons to select the dates. • To automatically select the earliest and latest possible dates, use the Earliest Date and Latest Date radio buttons.

Sort options

None. Automatically sorted by the Login Date/Time in descending order.

Report/Graph page: Historical Login Report

Column descriptions

Column	Description
Login Date/Time	<p>Data type: String</p> <p>Description: Login date/time value.</p> <p>Data source: Replicated from the InForm transactional database to the Reporting and Analysis database.</p>
Username	<p>Data type: String</p> <p>Description: User name of the user.</p> <p>Data source: Replicated from the InForm transactional database to the Reporting and Analysis database.</p>

Column	Description
First name	<p>Data type: String</p> <p>Description: First name of the user.</p> <p>Data source: Replicated from the InForm transactional database to the Reporting and Analysis database.</p>
Last name	<p>Data type: String</p> <p>Description: Last name of the user.</p> <p>Data source: Replicated from the InForm transactional database to the Reporting and Analysis database.</p>
Country	<p>Data type: String</p> <p>Description: Country in which a user is located, as entered in the InForm Administration interface.</p> <p>Data source: Replicated from the InForm transactional database to the Reporting and Analysis database.</p>
Rights Group	<p>Data type: String</p> <p>Description: Rights group to which the user belongs.</p> <p>Data source: Replicated from the InForm transactional database to the Reporting and Analysis database.</p>
User Type	<p>Data type: String</p> <p>Description: User type. For example, Sponsor.</p> <p>Data source: Replicated from the InForm transactional database to the Reporting and Analysis database.</p>

About the documentation

Where to find the product documentation

The product documentation is available from the following locations:

- **My Oracle Support** (<https://support.oracle.com>)—*Release Notes* and *Known Issues*.
- **Oracle Technology Network** (<http://www.oracle.com/technetwork/documentation/hsgbu-154445.html>)—The most current documentation set, excluding the *Release Notes* and *Known Issues*.

If the software is available for download, the complete documentation set is available from the Oracle Software Delivery Cloud (<https://edelivery.oracle.com>).

All documents may not be updated for every InForm release. Therefore, the version numbers for the documents in a release may differ.

Documentation accessibility

For information about Oracle's commitment to accessibility, visit the Oracle Accessibility Program website at <http://www.oracle.com/pls/topic/lookup?ctx=acc&id=docacc>.

Access to Oracle Support

Oracle customers that have purchased support have access to electronic support through My Oracle Support. For information, visit <http://www.oracle.com/pls/topic/lookup?ctx=acc&id=info> or visit <http://www.oracle.com/pls/topic/lookup?ctx=acc&id=trs> if you are hearing impaired.

Documentation

Document	Description	Part number	Last updated
<i>Release Notes</i>	The <i>Release Notes</i> document describes enhancements and issues fixed in the current release, and other late-breaking information.	E61316-01	6.1.1
<i>Known Issues</i>	The <i>Known Issues</i> document provides detailed information about the known issues in this release, along with workarounds, if available.	E61318-01	6.1.1

Document	Description	Part number	Last updated
<i>Secure Configuration Guide</i>	The <i>Secure Configuration Guide</i> provides an overview of the security features provided with the Oracle® Health Sciences InForm application, including details about the general principles of application security, and how to install, configure, and use the InForm application securely.	E61320-01	6.1.1
<i>Upgrade and Migration Guide</i>	The <i>Upgrade and Migration Guide</i> provides instructions for upgrading and migrating the InForm software and InForm Portal software to the current InForm release, and for upgrading the Cognos software for use with the Reporting and Analysis module.	E61321-01	6.1.1
<i>Installation Guide</i>	The <i>Installation Guide</i> describes how to install the software and configure the environment for the InForm application and Cognos software.	E61322-01	6.1.1
<i>Study and Reporting Setup Guide</i>	The <i>Study and Reporting Setup Guide</i> describes how to perform the tasks that are required to set up an InForm study and configure the Reporting and Analysis module for the study.	E61323-01	6.1.1
<i>User Guide</i>	The <i>User Guide</i> provides an overview of the InForm application including details on multilingual studies, how to navigate through the user interface, how to manage a study-specific Home page with the InForm Portal application, and how to accomplish typical tasks you perform while running a clinical study. This document is also available from the user interface.	E61324-01	6.1.1
<i>Reporting and Analysis Guide</i>	The <i>Reporting and Analysis Guide</i> provides an overview of the Reporting and Analysis module. It includes a brief overview of the Reporting and Analysis interface, illustrates how to access the Ad Hoc Reporting workspace, and describes the study management and clinical data packages available for creating reports. It also provides detailed descriptions of each standard report that is included with your installation.	E61326-01	6.1.1
<i>Reporting Database Schema Guide</i>	The <i>Reporting Database Schema Guide</i> describes the Reporting and Analysis database schema, and provides information on creating Reporting Database Extracts (RDEs).	E61327-01	6.1.1

Document	Description	Part number	Last updated
<i>Utilities Guide</i>	<p>The <i>Utilities Guide</i> provides information about and step-by-step instructions for using the following utilities:</p> <ul style="list-style-type: none"> • PFConsole utility • MedML Installer utility • InForm Data Import utility • InForm Data Export utility • InForm Performance Monitor utility • InForm Report Folder Maintenance utility <p>This guide also provides reference information for the MedML elements and scripting objects that are used to import and export data to and from the InForm application, as well as sample data import XML.</p>	E61328-01	6.1.1
MedML Installer utility online Help	<p>The MedML Installer utility online Help provides information about, and step-by-step instructions for using, the MedML Installer utility, which is used to load XML that defines study components into the InForm database.</p> <p>This guide also provides reference information for the MedML elements and scripting objects that are used to import and export data to and from the InForm application, as well as sample data import XML.</p> <p>This document is also available from the user interface.</p>	NA	NA
InForm Data Export utility online Help	<p>The InForm Data Export utility online Help provides information about and step-by-step instructions for using the InForm Data Export utility, which is used to export data from the InForm application to the following output formats:</p> <ul style="list-style-type: none"> • Customer-defined database (CDD) • Name value pairs <p>This document is also available from the user interface.</p>	NA	NA

Document	Description	Part number	Last updated
InForm Data Import utility online Help	The InForm Data Import utility online Help provides information about and step-by-step instructions for using the InForm Data Import utility, which is used to import data into the InForm application. This document is also available from the user interface.	NA	NA
<i>Clinical Data API Guide</i>	The <i>Clinical Data API Guide</i> provides information about submitting data to the InForm application in InForm ODM format.	E61329-01	6.1.1
<i>Third Party Licenses and Notices</i>	The <i>Third Party Licenses and Notices</i> document includes third party technology that may be included in or distributed with this product.	E61330-01	6.1.1
<i>Secure Development Guide</i>	The <i>Secure Development Guide</i> provides an overview of common security risks for developers using Application Programming Interfaces (APIs) with the Oracle® Health Sciences InForm application, and information on how to address those risks.	E72493-01	6.1.1

Index

A

- ad hoc report
 - accessing • 32, 41
 - ad hoc reports - itemsets • 154, 155, 160, 161, 162, 163, 164
 - automatic summarization • 45
 - creating • 34, 35, 37
 - deleted report elements • 155
 - drill up, drill down, drill through settings • 46
 - editing • 41, 44, 45, 47
 - element descriptions • 61, 63
 - filters • 42, 43, 44
 - identifying deleted data • 48
 - lineage information • 46
 - overview • 31
 - previewing • 38, 39
 - report options • 11, 13, 14, 45
 - running • 37
 - saving • 37
 - workspace • 33
- Audit Trail Report
 - description • 316
 - Report/Graph page • 317
 - selection criteria • 316
- audit trail reports
 - Audit Trail Report • 316
 - Historical Login Report • 319

C

- calculations
 - calculations - date time elements • 51, 52, 54
 - creating • 52
 - numeric elements • 53
 - overview • 51
 - string elements • 53
- Case Book Completion and Query Summary by Site report
 - description • 301
 - Report/Graph page • 302
 - selection criteria • 301
- Case Report Form (CRF) reports
 - CRF Aging by Site • 232
 - CRF Cycle Time Detail by Site • 237
 - CRF Cycle Time Detail for a Site • 244
 - CRF Site Performance Summary by Site • 250
 - CRF Status Detail by Site and Subject • 257
 - CRF Status Detail by Visit and Site • 265
 - CRF Status Summary by Site • 273
 - CRF Status Summary by User • 280
- chart report
 - developing • 56

- overview • 56
- clinical data reports
 - associated forms • 166
 - clinical and study management data • 152
 - code report elements • 154
 - date controls • 155
 - default labeling • 152
 - deleted itemsets and form instances • 155
 - form index • 154
 - forms and add-entry forms • 154
 - incomplete data reasons • 155
 - itemset index • 154
 - itemsets, repeating visits, and repeating forms • 154, 155, 160, 161, 162, 163, 164
 - multi-instance forms and visits • 159
 - overview • 149
 - reporting elements • 151
 - units of measure • 154
 - visit index • 154
- comment report elements • 140, 141
- CRF Aging by Site report
 - description • 232
 - Report/graph page • 234
 - selection criteria • 232
- CRF Cycle Time Detail by Site report
 - description • 237
 - Report/Graph page • 239
 - selection criteria • 238
- CRF Cycle Time Detail for a Site report
 - description • 244
 - Report/Graph page • 245
 - selection criteria • 244
- CRF Item Listing report
 - description • 287
 - Report/Graph page • 290
 - selection criteria • 287
- CRF Site Performance Summary by Site report
 - description • 250
 - Report/Graph page • 252
 - selection criteria • 250
- CRF Status Detail by Site and Subject report
 - description • 257
 - Report/Graph page • 260
 - selection criteria • 257
- CRF Status Detail by Visit and Site report
 - description • 265
 - selection criteria • 266
- CRF Status Summary by Site
 - description • 273
 - Report/Graph page • 276
 - selection criteria • 274
- CRF Status Summary by User report

- description • 280
- Report/Graph page • 282
- selection criteria • 280
- crosstab report
 - developing • 55
 - overview • 55
- Cumulative Subject Enrollment by Month report
 - description • 306
 - Report/Graph page • 307
 - selection criteria • 306
- custom groups
 - date time elements • 58
 - defining • 58
 - numeric elements • 59
 - overview • 58
 - string elements • 59

D

- database columns
 - default values • 152

F

- forms report elements
 - Aging • 115
 - Cycle Times • 115
 - description • 90, 92
 - expected forms • 91
 - Form Dates • 108
 - Form Status Counts • 99

H

- Historical Login Report
 - description • 319
 - Report/Graph page • 320
 - selection criteria • 320

I

- item report elements
 - description • 122, 123
 - Item Counts by Property • 126
 - Item Dates • 129
 - Item Properties • 124
 - Item Status Counts • 127
- item reports
 - Item Listing • 287
 - Source Verification Listing • 295

O

- Outstanding Queries by Site and Visit report
 - description • 181
 - Report/Graph page • 182
 - selection criteria • 181

P

- passwords
 - changing • 9
- predefined filters • 42, 43, 44, 146

Q

- Query Aging by Site report
 - description • 184
 - Query Aging by Site report - Report/Graph page • 185
 - selection criteria • 184
- Query Cycle Times by Site report
 - description • 187
 - Report/Graph page • 189
 - selection criteria • 188
- Query Cycle Times by User report
 - description • 192
 - Report/Graph page • 193
 - selection criteria • 192
- Query Performance Summary by Site report
 - description • 196
 - Report/Graph page • 198
 - selection criteria • 196
- Query Performance Summary by User report
 - description • 201
 - Report/Graph page • 203
 - selection criteria • 202
- query report elements
 - Aging • 140
 - Cycle Times • 138
 - description • 131, 132
 - properties • 133
 - Query Counts • 134
 - Query Dates • 136
 - Query Status by Month, Year • 137
- query reports
 - Outstanding Queries by Site and Visit • 181
 - Query Aging by Site • 184
 - Query Cycle Times by Site • 187
 - Query Cycle Times by User • 192
 - Query Performance Summary by Site • 196
 - Query Performance Summary by User • 201
 - Query Status by Site • 206
 - Query Status by Site and Subject • 210
 - Query Status by Site and Visit • 215
 - Query Status by User • 219
 - Query Volume by Month by Site • 223
 - Query Volume by Rule • 226
 - Subject Counts with Outstanding Queries • 229
- Query Status by Site and Subject report
 - description • 210
 - Report/Graph page • 212
 - selection criteria • 211
- Query Status by Site and Visit report
 - description • 215
 - Report/Graph page • 216
 - selection criteria • 215
- Query Status by Site report
 - Report/Graph page • 208
 - selection criteria • 206
- Query Status by User report
 - description • 219
 - Report/Graph page • 220
 - selection criteria • 219

Query Volume by Month by Site report
description • 223
Report/Graph page • 225
selection criteria • 223

Query Volume by Rule report
description • 226
Report/Graph page • 228
selection criteria • 227

R

report

ad hoc • 15, 30
components • 173, 176
custom • 16
data • 178
overview • 16
standard • 16

Report prompt page

buttons • 176
calendars • 175
cascading prompts • 173
checkboxes • 174
drop-down lists • 174
list boxes • 175
overview • 173
selection criteria • 173
sort options • 176
text boxes • 174

report summary page • 176

Report/Graph page

graphs and columns • 176
report header and footer • 177
show/hide report selections • 176

Reporting and Analysis module

Configuring browser settings • 26, 27

Reporting and Analysis portal

icons • 7, 8
overview • 7
personal pages • 10
report folders • 7
tools • 8

reporting database

columns • 152
data models • 4, 5
InForm Trial Management package • 5
internal IDs • 49
overview • 2, 3
packages • 5
reporting tree • 34, 62, 150
study-specific clinical package • 5

reports, working with

adding comments • 18, 19
enabling comments • 19
opening • 40, 172
overview • 15, 16, 30
previewing • 38, 39
report options • 11, 12, 13, 14, 45
running • 37, 170
scheduling • 17, 18

rule report elements • 130

S

section report elements • 122
properties • 122

sites report elements • 68

Source Verification Listing report

description • 295
Report/Graph page • 297
selection criteria • 295

standard report

actions • 180
components • 173
data • 178
folders • 179
overview • 168, 169
report options • 12, 13, 14
Report prompt page • 173
running • 170
saving • 170
Summary page • 176

study design and reports

DOV controls • 21
labels for clinical report elements • 21
optional study elements • 21
subject status requirements • 20

study info report elements

sponsor • 64
study • 66
study versions • 67

study management data reports

comment report elements • 140
forms report elements • 90
item report elements • 122
predefined filters • 146
query report elements • 131
rule report elements • 130
section report elements • 122
sites report elements • 68
study info report elements • 64
subject report elements • 71
user info report elements • 142, 144
visit report elements • 83

Subject Counts with Outstanding Queries report

description • 229
Report/Graph page • 230
selection criteria • 229

Subject Dropout Count by Reason report

description • 308
Report/Graph page • 309
selection criteria • 308

Subject Enrollment Status by Site report

description • 310
Report/Graph page • 312
selection criteria • 311

subject report elements

CRB StatusCounts • 78
description • 71, 72
Subject Status (text) • 73
Subject Status Counts • 75
Subject Status Dates • 80

subject reports

- Case Book Completion and Query Summary by Site • 301
- Cumulative Subject Enrollment by Month • 306
- Subject Dropout Count by Reason • 308
- Subject Enrollment Status by Site • 310

summary page • 176

U

user info report elements • 142, 144

V

visit report elements

- description • 83, 84
- Visit Counts by Property • 87
- Visit Dates • 90
- Visit Properties • 84
- Visit Status Counts • 87