

**Oracle® Communications**  
**EAGLE**

Database Administration - GWS User's Guide

Release 46.4

**E79798 Revision 1**

December 2016

This software and related documentation are provided under a license agreement containing restrictions on use and disclosure and are protected by intellectual property laws. Except as expressly permitted in your license agreement or allowed by law, you may not use, copy, reproduce, translate, broadcast, modify, license, transmit, distribute, exhibit, perform, publish, or display any part, in any form, or by any means. Reverse engineering, disassembly, or decompilation of this software, unless required by law for interoperability, is prohibited.

The information contained herein is subject to change without notice and is not warranted to be error-free. If you find any errors, please report them to us in writing.

If this is software or related documentation that is delivered to the U.S. Government or anyone licensing it on behalf of the U.S. Government, then the following notice is applicable:

U.S. GOVERNMENT END USERS: Oracle programs, including any operating system, integrated software, any programs installed on the hardware, and/or documentation, delivered to U.S. Government end users are "commercial computer software" pursuant to the applicable Federal Acquisition Regulation and agency-specific supplemental regulations. As such, use, duplication, disclosure, modification, and adaptation of the programs, including any operating system, integrated software, any programs installed on the hardware, and/or documentation, shall be subject to license terms and license restrictions applicable to the programs. No other rights are granted to the U.S. Government.

This software or hardware is developed for general use in a variety of information management applications. It is not developed or intended for use in any inherently dangerous applications, including applications that may create a risk of personal injury. If you use this software or hardware in dangerous applications, then you shall be responsible to take all appropriate fail-safe, backup, redundancy, and other measures to ensure its safe use. Oracle Corporation and its affiliates disclaim any liability for any damages caused by use of this software or hardware in dangerous applications.

Oracle and Java are registered trademarks of Oracle and/or its affiliates. Other names may be trademarks of their respective owners.

Intel and Intel Xeon are trademarks or registered trademarks of Intel Corporation. All SPARC trademarks are used under license and are trademarks or registered trademarks of SPARC International, Inc. AMD, Opteron, the AMD logo, and the AMD Opteron logo are trademarks or registered trademarks of Advanced Micro Devices. UNIX is a registered trademark of The Open Group.

This software or hardware and documentation may provide access to or information about content, products, and services from third parties. Oracle Corporation and its affiliates are not responsible for and expressly disclaim all warranties of any kind with respect to third-party content, products, and services unless otherwise set forth in an applicable agreement between you and Oracle. Oracle Corporation and its affiliates will not be responsible for any loss, costs, or damages incurred due to your access to or use of third-party content, products, or services, except as set forth in an applicable agreement between you and Oracle.

# Table of Contents

<b>Chapter 1: Introduction.....</b>	<b>16</b>
Overview.....	17
Scope and Audience.....	17
Documentation Admonishments.....	17
Manual Organization.....	18
My Oracle Support (MOS).....	19
Emergency Response.....	19
Related Specifications.....	20
Customer Training.....	20
Locate Product Documentation on the Oracle Help Center Site.....	20
Maintenance and Administration Subsystem.....	21
EAGLE Database Partitions.....	22
<b>Chapter 2: Gateway Screening (GWS) Overview.....</b>	<b>25</b>
Introduction.....	26
TUP Message Screening.....	28
Gateway Screening States.....	28
Linkset Parameters.....	29
Gateway Screening Attributes.....	30
Use of the Character “ c ” for the NI, NC, NCM, ZONE, AREA, ID, NPC, MSA, SSA, and SP Parameters.....	33
Specifying a Range of Values for Gateway Screening Parameters.....	34
Use of the Asterisk “ * ” for the ZONE, AREA, ID, MSA, SSA, and SP Parameters.....	36
User Interface Requirements.....	38
Command Summary.....	38
Enter Commands.....	39
Change Commands.....	39
Delete Commands.....	40
Retrieve Commands.....	40
14-Bit ITU National Point Code Formats.....	44
Converting Single Number 14-Bit ITU National Point Codes.....	44
Converting Multiple Part 14-Bit ITU National Point Codes.....	45
Gateway Screening Using Duplicate ITU National Point Codes.....	46

Gateway Screening Configuration.....	47
Gateway Screening Configuration Examples.....	51
Adding a GLS Card.....	61
Removing a GLS Card.....	71
E5-OAM Integrated GLS Feature Activation Procedure.....	75
Configuring Gateway Screening Stop Action Sets.....	75
Configuring TLNP Gateway Screening Stop Action Sets.....	88
Removing Gateway Screening Stop Action Sets.....	102
Setting the Threshold for Reporting Gateway Screening Activity.....	106
Setting the Maximum Number of Gateway Screening Rejected Messages.....	110
Activating the MTP Routed GWS Stop Action Feature.....	113
Turning Off the MTP Routed GWS Stop Action Feature .....	122

### **Chapter 3: Allowed Affected Point Code (AFTPC) Screen**

<b>Configuration.....</b>	<b>125</b>
Introduction.....	126
Gateway Screening Actions.....	126
Allowed AFTPC Screening Actions.....	126
Adding an Allowed Affected Point Code Screen.....	129
Removing an Allowed Affected Point Code Screen.....	139
Changing an Allowed Affected Point Code Screen.....	143

### **Chapter 4: Allowed Called Party (CDPA) Screen Configuration.....153**

Introduction.....	154
Gateway Screening Actions.....	154
Allowed CDPA Screening Actions.....	154
Adding an Allowed Called Party Address Screen.....	159
Removing an Allowed Called Party Address Screen.....	171
Changing an Allowed Called Party Address Screen.....	176

### **Chapter 5: Allowed Translation Type (TT) Screen Configuration...188**

Introduction.....	189
Gateway Screening Actions.....	189
Allowed TT Screening Actions.....	189
Adding an Allowed Translation Type Screen.....	194
Removing an Allowed Translation Type Screen.....	201
Changing an Allowed Translation Type Screen.....	204



## **Chapter 6: Allowed Calling Party (CGPA) Screen Configuration...211**

Introduction.....	212
Gateway Screening Actions.....	212
Allowed CGPA Screening Actions.....	213
Adding an Allowed Calling Party Address Screen.....	218
Removing an Allowed Calling Party Address Screen .....	229
Changing an Allowed Calling Party Address Screen.....	234

## **Chapter 7: Allowed Affected Destination Field (DESTFLD) Screen**

### **Configuration.....247**

Introduction.....	248
Gateway Screening Actions.....	248
Allowed Affected Destination Screening Actions.....	249
Adding an Allowed Affected Destination Field Screen.....	252
Removing an Allowed Affected Destination Field Screen.....	261
Changing an Allowed Affected Destination Field Screen.....	266

## **Chapter 8: Blocked Destination Point Code (BLKDPC) Screen**

### **Configuration.....276**

Introduction.....	277
Gateway Screening Actions.....	277
Blocked DPC Screening Actions.....	277
Adding a Blocked DPC Screen.....	281
Removing a Blocked DPC Screen.....	294
Changing a Blocked DPC Screen.....	299

## **Chapter 9: Allowed Destination Point Code (DPC) Screen**

### **Configuration.....311**

Introduction.....	312
Gateway Screening Actions.....	312
Allowed DPC Screening Actions.....	312
Adding an Allowed DPC Screen.....	316
Removing an Allowed DPC Screen.....	330
Changing an Allowed DPC Screen.....	334

## **Chapter 10: Allowed Signaling Information Octet (SIO) Screen**

<b>Configuration.....</b>	<b>348</b>
Introduction.....	349
Gateway Screening Actions.....	349
Allowed SIO Screening Actions.....	349
Adding an Allowed SIO Screen.....	354
Removing an Allowed SIO Screen.....	365
Changing an Allowed SIO Screen.....	369

## **Chapter 11: Blocked Originating Point Code (BLKOPC) Screen**

<b>Configuration.....</b>	<b>378</b>
Introduction.....	379
Gateway Screening Actions.....	379
Blocked OPC Screening Actions.....	379
Adding a Blocked OPC Screen.....	383
Removing a Blocked OPC Screen.....	397
Changing a Blocked OPC Screen.....	401

## **Chapter 12: Allowed Originating Point Code (OPC) Screen**

<b>Configuration.....</b>	<b>413</b>
Introduction.....	414
Gateway Screening Actions.....	414
Allowed OPC Screening Actions.....	414
Adding an Allowed OPC Screen.....	418
Removing an Allowed OPC Screen.....	432
Changing an Allowed OPC Screen.....	435

## **Chapter 13: Screen Set Configuration.....449**

Introduction.....	450
Automatic Destination Field Screening.....	450
Adding a Screen Set.....	450
Removing a Screen Set.....	459
Changing a Screen Set.....	462

<b>Chapter 14: Calling Name Conversion Facility (CNCF)</b>	
<b>Configuration.....</b>	<b>470</b>
Introduction.....	471
Configuring the EAGLE for the CNCF Feature.....	473
<b>Chapter 15: Allowed ISUP Message Type Screen Configuration....</b>	<b>489</b>
Introduction.....	490
Gateway Screening Actions.....	490
TUP Message Screening.....	490
Allowed ISUP Message Type Screening Actions.....	491
Adding an Allowed ISUP Message Type Screen.....	495
Removing an Allowed ISUP Message Type Screen.....	503
Changing an Allowed ISUP Message Type Screen.....	507
<b>Glossary.....</b>	<b>513</b>

# List of Figures

Figure 1: EAGLE Database Partitions (E5-Based Control Cards).....	23
Figure 2: Sample Network Showing Gateway Screening Using Duplicate ITU National Point Codes.....	46
Figure 3: The Gateway Screening Process.....	50
Figure 4: Gateway Screening Configuration - Example 1.....	52
Figure 5: Gateway Screening Configuration - Example 2.....	54
Figure 6: Gateway Screening Configuration - Example 3.....	55
Figure 7: Gateway Screening Configuration - Example 4.....	57
Figure 8: Gateway Screening Configuration - Example 5.....	58
Figure 9: Gateway Screening Configuration - Example 6.....	59
Figure 10: Gateway Screening Configuration - Example 7.....	61
Figure 11: Adding a GLS Card to the Database.....	66
Figure 12: Removing a GLS Card.....	74
Figure 13: Configuring Gateway Screening Stop Action Sets.....	84
Figure 14: Configuring TLNP Gateway Screening Stop Action Sets.....	95
Figure 15: Removing Gateway Screening Stop Action Sets.....	105
Figure 16: Setting the Threshold for Reporting Gateway Screening Activity.....	109
Figure 17: Setting the Maximum Number of Gateway Screening Rejected Messages.....	112
Figure 18: Activating the MTP Routed GWS Stop Action Feature.....	118
Figure 19: Turning Off the MTP Routed GWS Stop Action Feature .....	124
Figure 20: Allowed AFTPC Screening Actions.....	127
Figure 21: Allowed Affected Point Code Screening Function.....	129

Figure 22: Adding an Allowed Affected Point Code Screen .....	136
Figure 23: Removing an Allowed Affected Point Code Screen.....	142
Figure 24: Changing an Allowed Affected Point Code Screen.....	148
Figure 25: Allowed CDPA Screening Actions.....	155
Figure 26: Allowed Called Party Address Screening Function.....	158
Figure 27: Adding an Allowed Called Party Address Screen.....	167
Figure 28: Removing an Allowed Called Party Address Screen .....	174
Figure 29: Changing an Allowed Called Party Address Screen.....	182
Figure 30: Allowed TT Screening Actions.....	190
Figure 31: Allowed Translation Type Screening Function.....	193
Figure 32: Adding an Allowed Translation Type Screen .....	198
Figure 33: Removing an Allowed Translation Type Screen .....	203
Figure 34: Changing an Allowed Translation Type Screen .....	207
Figure 35: Allowed CGPA Screening Actions.....	214
Figure 36: Allowed Calling Party Address Screening Function.....	217
Figure 37: Adding an Allowed Calling Party Address Screen.....	225
Figure 38: Removing an Allowed Calling Party Address Screen .....	232
Figure 39: Changing an Allowed Calling Party Address Screen.....	241
Figure 40: Allowed Affected Destination Screening Actions.....	249
Figure 41: Allowed Affected Destination Field Screening Function.....	252
Figure 42: Adding an Allowed Affected Destination Field Screen .....	258
Figure 43: Removing an Allowed Affected Destination Field Screen.....	264
Figure 44: Changing an Allowed Affected Destination Field Screen.....	271
Figure 45: Blocked DPC Screening Actions.....	278
Figure 46: Blocked DPC Screening Functions.....	281

Figure 47: Adding a Blocked DPC Screen.....	289
Figure 48: Removing a Blocked DPC Screen.....	297
Figure 49: Changing a Blocked DPC Screen.....	305
Figure 50: Allowed DPC Screening Actions.....	313
Figure 51: Allowed DPC Screening Functions.....	316
Figure 52: Adding an Allowed DPC Screen.....	325
Figure 53: Removing an Allowed DPC Screen .....	333
Figure 54: Changing an Allowed DPC Screen .....	341
Figure 55: Allowed SIO Screening Actions.....	351
Figure 56: Allowed SIO Screening Function.....	354
Figure 57: Adding an Allowed SIO Screen.....	362
Figure 58: Removing an Allowed SIO Screen .....	368
Figure 59: Changing an Allowed SIO Screen .....	374
Figure 60: Blocked OPC Screening Actions.....	380
Figure 61: Blocked OPC Screening Functions.....	383
Figure 62: Adding a Blocked OPC Screen.....	392
Figure 63: Removing a Blocked OPC Screen.....	400
Figure 64: Changing a Blocked OPC Screen.....	407
Figure 65: Allowed OPC Screening Actions.....	415
Figure 66: Allowed OPC Screening Functions.....	418
Figure 67: Adding an Allowed OPC Screen.....	427
Figure 68: Removing an Allowed OPC Screen.....	434
Figure 69: Changing an Allowed OPC Screen .....	442
Figure 70: Adding a Screen Set.....	456
Figure 71: Removing a Screen Set.....	461

Figure 72: Changing a Screen Set.....	466
Figure 73: PIP/GN Parameter Conversion.....	471
Figure 74: CNCF Gateway Screening Configuration - Example 1.....	474
Figure 75: CNCF Gateway Screening Configuration - Example 2.....	475
Figure 76: CNCF Gateway Screening Configuration - Example 3.....	476
Figure 77: CNCF Gateway Screening Configuration - Example 4.....	477
Figure 78: Calling Name Conversion Facility Configuration .....	484
Figure 79: Allowed ISUP Message Type Screening Actions .....	492
Figure 80: Allowed ISUP Message Type Screening Function.....	495
Figure 81: Adding an Allowed ISUP Message Type Screen .....	500
Figure 82: Removing an Allowed ISUP Message Type Screen.....	506
Figure 83: Changing an Allowed ISUP Message Type Screen.....	510

# List of Tables

Table 1: Admonishments.....18

Table 2: Valid Value Combinations for ANSI Point Code Parameters .....34

Table 3: Valid Value Combinations for H0 and H1 Parameters.....35

Table 4: Valid Parameter Combinations for ANSI Point Code Parameters.....35

Table 5: Valid Value Combinations for ITU-I Point Code Parameters .....36

Table 6: Valid Value Combinations for 24-Bit ITU-N Point Code Parameters .....37

Table 7: Valid Parameter Combinations for ITU-I Point Code Parameters.....37

Table 8: Valid Parameter Combinations for 24-bit ITU-N Point Code Parameters.....37

Table 9: Gateway Screening Process and Provisioning Order.....49

Table 10: GLS Card Types.....62

Table 11: Gateway Screening Stop Action Definitions If the CNCF Feature Is Off.....77

Table 12: Gateway Screening Stop Action Set Parameter Combinations.....78

Table 13: Sample TLNP Gateway Screening Stop Action Set Configuration.....89

Table 14: Gateway Screening Retrieve Commands.....93

Table 15: Example Gateway Screening Allowed AFTPC Configuration Table.....130

Table 16: Valid Value Combinations for ANSI Point Code Parameters.....130

Table 17: Valid Value Combinations for ITU-I Point Code Parameters.....131

Table 18: Valid Value Combinations for 24-Bit ITU-N Point Code Parameters.....131

Table 19: Valid Value Combinations for ANSI Point Code Parameters.....143

Table 20: Valid Value Combinations for ITU-I Point Code Parameters .....144

Table 21: Valid Value Combinations for 24-Bit ITU-N Point Code Parameters .....144

Table 22: Example Gateway Screening Allowed CDPA Configuration Table.....159



Table 23: Valid Value Combinations for ANSI Point Code Parameters.....	160
Table 24: Valid Value Combinations for ITU-I Point Code Parameters.....	160
Table 25: Valid Value Combinations for 24-Bit ITU-N Point Code Parameters.....	160
Table 26: CDPA Parameter Combinations.....	164
Table 27: Valid Value Combinations for ANSI Point Code Parameters .....	177
Table 28: Valid Value Combinations for ITU-I Point Code Parameters .....	177
Table 29: Valid Value Combinations for 24-Bit ITU-N Point Code Parameters .....	177
Table 30: CDPA Parameter Combinations.....	180
Table 31: Example Gateway Screening Allowed TT Configuration Table.....	194
Table 32: Valid Parameter Combinations for the Allowed CGPA Screening Function.....	213
Table 33: Example Gateway Screening Allowed CGPA Configuration Table.....	218
Table 34: Valid Value Combinations for ANSI Point Code Parameters.....	219
Table 35: Valid Value Combinations for ITU-I Point Code Parameters.....	219
Table 36: Valid Value Combinations for 24-Bit ITU-N Point Code Parameters.....	220
Table 37: Valid Value Combinations for ANSI Point Code Parameters.....	235
Table 38: Valid Value Combinations for ITU-I Point Code Parameters.....	235
Table 39: Valid Value Combinations for 24-Bit ITU-N Point Code Parameters.....	235
Table 40: CGPA Parameter Combinations.....	238
Table 41: Example Gateway Screening Allowed DESTFLD Configuration Table.....	253
Table 42: Valid Value Combinations for ANSI Point Code Parameters.....	253
Table 43: Valid Value Combinations for ITU-I Point Code Parameters.....	254
Table 44: Valid Value Combinations for 24-Bit ITU-N Point Code Parameters.....	254
Table 45: Valid Value Combinations for ANSI Point Code Parameters.....	266
Table 46: Valid Value Combinations for ITU-I Point Code Parameters .....	267
Table 47: Valid Value Combinations for 24-Bit ITU-N Point Code Parameters .....	267

Table 48: Example Gateway Screening Blocked DPC Configuration Table.....	282
Table 49: Valid Value Combinations for ANSI Point Code Parameters.....	283
Table 50: Valid Value Combinations for ITU-I Point Code Parameters.....	283
Table 51: Valid Value Combinations for 24-Bit ITU-N Point Code Parameters.....	284
Table 52: Valid Value Combinations for ANSI Point Code Parameters.....	300
Table 53: Valid Value Combinations for ITU-I Point Code Parameters.....	301
Table 54: Valid Value Combinations for 24-Bit ITU-N Point Code Parameters.....	301
Table 55: Example Gateway Screening Allowed DPC Configuration Table.....	317
Table 56: Valid Value Combinations for ANSI Point Code Parameters.....	318
Table 57: Valid Value Combinations for ITU-I Point Code Parameters.....	318
Table 58: Valid Value Combinations for 24-Bit ITU-N Point Code Parameters.....	319
Table 59: Valid Value Combinations for ANSI Point Code Parameters.....	335
Table 60: Valid Value Combinations for ITU-I Point Code Parameters .....	335
Table 61: Valid Value Combinations for 24-Bit ITU-N Point Code Parameters .....	336
Table 62: Valid Parameter Combinations for the Allowed SIO Screening Function.....	350
Table 63: Example Gateway Screening Allowed SIO Configuration Table.....	355
Table 64: Valid Value Combinations for H0 and H1 Parameters.....	356
Table 65: Valid Value Combinations for H0 and H1 Parameters.....	370
Table 66: Example Gateway Screening Blocked OPC Configuration Table.....	383
Table 67: Valid Value Combinations for ANSI Point Code Parameters.....	385
Table 68: Valid Value Combinations for ITU-I Point Code Parameters .....	386
Table 69: Valid Value Combinations for 24-Bit ITU-N Point Code Parameters .....	386
Table 70: Valid Value Combinations for ANSI Point Code Parameters.....	402
Table 71: Valid Value Combinations for ITU-I Point Code Parameters.....	403
Table 72: Valid Value Combinations for 24-Bit ITU-N Point Code Parameters.....	403

Table 73: Example Gateway Screening Allowed OPC Configuration Table.....	419
Table 74: Valid Value Combinations for ANSI Point Code Parameters.....	420
Table 75: Valid Value Combinations for ITU-I Point Code Parameters.....	420
Table 76: Valid Value Combinations for 24-Bit ITU-N Point Code Parameters.....	421
Table 77: Valid Value Combinations for ANSI Point Code Parameters.....	436
Table 78: Valid Value Combinations for ITU-I Point Code Parameters.....	436
Table 79: Valid Value Combinations for 24-Bit ITU-N Point Code Parameters.....	437
Table 80: Example Gateway Screening Screen Set Configuration Table.....	451
Table 81: ISUP IAM Message Conversion Examples.....	472
Table 82: Example Gateway Screening Allowed DPC Configuration Table for the CNCF Feature.....	479
Table 83: Example Gateway Screening Allowed SIO Configuration Table for the CNCF Feature.....	480
Table 84: Example Gateway Screening Allowed OPC Configuration Table for the CNCF Feature.....	481
Table 85: Example Gateway Screening Screen Set Configuration Table for the CNCF Feature.....	482
Table 86: Linkset Configuration Table for the CNCF Feature.....	483
Table 87: Example Gateway Screening Allowed ISUP Configuration Table.....	496

# Chapter 1

## Introduction

---

### Topics:

- *Overview.....17*
- *Scope and Audience.....17*
- *Documentation Admonishments.....17*
- *Manual Organization.....18*
- *My Oracle Support (MOS).....19*
- *Emergency Response.....19*
- *Related Specifications.....20*
- *Customer Training.....20*
- *Locate Product Documentation on the Oracle Help Center Site.....20*
- *Maintenance and Administration Subsystem.....21*
- *EAGLE Database Partitions.....22*

Chapter 1, Introduction, contains general information about the gateway screening feature, the database, and the organization of this manual.

## Overview

The *Database Administration – GWS User’s Guide* describes the procedures used to configure the EAGLE and its database to implement the Gateway Screening Feature.

The Gateway Screening (GWS) feature examines a Message Signaling Unit (MSU) attempting to enter the EAGLE against predefined criteria in the EAGLE database to determine whether the MSU should be allowed to enter. The screening functions are defined by using screening tables or screen sets containing a set of rules. Each screen set is uniquely identified by a screen set name. Each rule in the screen set is identified by a screening reference name. Each screening reference belongs to a specific category, which indicates the criteria used to either accept or reject an incoming MSU. Gateway screening tables provide screening of MTP messages on Link Interface Modules (LIMs) and SCCP messages on the service modules.

**Note:** Database administration privileges are password restricted. Only those persons with access to the command class “Database Administration” can execute the administrative functions. Refer to *Commands User’s Guide* for more information on command classes and commands allowed by those classes.

It is possible for two or more users to make changes to the same database element at any time during their database administration sessions. It is strongly recommended that only one user at a time make any changes to the database.

Throughout this manual, these terms are used to refer to either the original card or the EPM-B version or other replacement version of the card unless one of the card types is specifically required.

- E5-ENET - the original E5-ENET or the E5-ENET-B card
- E5-E1T1 - the original E5-E1T1 or the E5-E1T1-B card
- E5-ATM - the original E5-ATM or the E5-ATM-B card
- E5-IPSM - the original E5-IPSM or the E5-ENET-B card that is running the IPSHC GPL
- E5-SM4G - the original E5-SM4G or the E5-SM8G-B card (not an EPM-B card)
- MCPM - the original MCPM or the E5-MCPM-B card





## Scope and Audience

This manual is intended for database administration personnel or translations personnel responsible for configuring the EAGLE and its database to implement the Gateway Screening feature.

## Documentation Admonishments

Admonishments are icons and text throughout this manual that alert the reader to assure personal safety, to minimize possible service interruptions, and to warn of the potential for equipment damage.

Table 1: Admonishments

Icon	Description
 DANGER	Danger: (This icon and text indicate the possibility of <i>personal injury</i> .)
 WARNING	Warning: (This icon and text indicate the possibility of <i>equipment damage</i> .)
 CAUTION	Caution: (This icon and text indicate the possibility of <i>service interruption</i> .)
 TOPPLE	Topple: (This icon and text indicate the possibility of <i>personal injury and equipment damage</i> .)

## Manual Organization

Throughout this document, the terms database and system software are used. Database refers to all data that can be administered by the user, including shelves, cards, links, routes, global title translation tables, and gateway screening tables. System software refers to data that cannot be administered by the user, including generic program loads (GPLs).

This document is organized into the following sections.

[Introduction](#) contains general information about the gateway screening feature, the database, and the organization of this manual.

[Gateway Screening \(GWS\) Overview](#) contains an overview of the Gateway screening feature and the procedures for provisioning the GLS card, gateway screening stop action sets, the threshold for gateway screening activity, and the maximum number of gateway screening rejected messages.

[Allowed Affected Point Code \(AFTPC\) Screen Configuration](#) contains the procedures necessary to configure allowed affected point code screens.

[Allowed Called Party \(CDPA\) Screen Configuration](#) contains the procedures necessary to configure allowed called party address screens.

[Allowed Translation Type \(TT\) Screen Configuration](#) contains the procedures necessary to configure allowed translation type screens.

[Allowed Calling Party \(CGPA\) Screen Configuration](#) contains the procedures necessary to configure allowed calling party address screens.

*Allowed Affected Destination Field (DESTFLD) Screen Configuration* contains the procedures necessary to configure allowed affected destination field screens.

*Blocked Destination Point Code (BLKDPC) Screen Configuration* contains the procedures necessary to configure blocked destination point code screens.

*Allowed Destination Point Code (DPC) Screen Configuration* contains the procedures necessary to configure allowed destination point code screens.

*Allowed Signaling Information Octet (SIO) Screen Configuration* contains the procedures necessary to configure allowed signaling information octet screens.

*Blocked Originating Point Code (BLKOPC) Screen Configuration* contains the procedures necessary to configure blocked originating point code screens.

*Allowed Originating Point Code (OPC) Screen Configuration* contains the procedures necessary to configure allowed originating point code screens.

*Screen Set Configuration* contains the procedures necessary to configure screen sets.

*Calling Name Conversion Facility (CNCF) Configuration* contains a description of the Calling Name Conversion Facility feature the procedure necessary to configure this feature.

*Allowed ISUP Message Type Screen Configuration* contains the procedures necessary to configure allowed ISUP message type screens.

## My Oracle Support (MOS)

MOS (<https://support.oracle.com>) is your initial point of contact for all product support and training needs. A representative at Customer Access Support (CAS) can assist you with MOS registration.

Call the CAS main number at 1-800-223-1711 (toll-free in the US), or call the Oracle Support hotline for your local country from the list at <http://www.oracle.com/us/support/contact/index.html>. When calling, make the selections in the sequence shown below on the Support telephone menu:

1. Select **2** for New Service Request
2. Select **3** for Hardware, Networking and Solaris Operating System Support
3. Select one of the following options:
  - For Technical issues such as creating a new Service Request (SR), Select **1**
  - For Non-technical issues such as registration or assistance with MOS, Select **2**

You will be connected to a live agent who can assist you with MOS registration and opening a support ticket.

MOS is available 24 hours a day, 7 days a week, 365 days a year.

## Emergency Response

In the event of a critical service situation, emergency response is offered by the Customer Access Support (CAS) main number at 1-800-223-1711 (toll-free in the US), or by calling the Oracle Support hotline for your local country from the list at <http://www.oracle.com/us/support/contact/index.html>. The

emergency response provides immediate coverage, automatic escalation, and other features to ensure that the critical situation is resolved as rapidly as possible.

A critical situation is defined as a problem with the installed equipment that severely affects service, traffic, or maintenance capabilities, and requires immediate corrective action. Critical situations affect service and/or system operation resulting in one or several of these situations:

- A total system failure that results in loss of all transaction processing capability
- Significant reduction in system capacity or traffic handling capability
- Loss of the system's ability to perform automatic system reconfiguration
- Inability to restart a processor or the system
- Corruption of system databases that requires service affecting corrective actions
- Loss of access for maintenance or recovery operations
- Loss of the system ability to provide any required critical or major trouble notification

Any other problem severely affecting service, capacity/traffic, billing, and maintenance capabilities may be defined as critical by prior discussion and agreement with Oracle.

## Related Specifications

For information about additional publications that are related to this document, refer to the Oracle Help Center site. See [Locate Product Documentation on the Oracle Help Center Site](#) for more information on related product publications.

## Customer Training

Oracle University offers training for service providers and enterprises. Visit our web site to view, and register for, Oracle Communications training:

<http://education.oracle.com/communication>

To obtain contact phone numbers for countries or regions, visit the Oracle University Education web site:

[www.oracle.com/education/contacts](http://www.oracle.com/education/contacts)

## Locate Product Documentation on the Oracle Help Center Site

Oracle Communications customer documentation is available on the web at the Oracle Help Center (OHC) site, <http://docs.oracle.com>. You do not have to register to access these documents. Viewing these files requires Adobe Acrobat Reader, which can be downloaded at <http://www.adobe.com>.

1. Access the Oracle Help Center site at <http://docs.oracle.com>.
2. Click **Industries**.
3. Under the Oracle Communications subheading, click the **Oracle Communications documentation** link.



The Communications Documentation page appears. Most products covered by these documentation sets will appear under the headings “Network Session Delivery and Control Infrastructure” or “Platforms.”

4. Click on your Product and then the Release Number.  
A list of the entire documentation set for the selected product and release appears.
5. To download a file to your location, right-click the **PDF** link, select **Save target as** (or similar command based on your browser), and save to a local folder.

## Maintenance and Administration Subsystem

The Maintenance and Administration Subsystem (MAS) is the central management point for the EAGLE. The MAS provides user interface, maintenance communication, peripheral services, alarm processing, system disk interface, and measurements. Management and redundancy are provided by use of two separate subsystem processors.

The MAS resides on two separate sets of Maintenance and Administration Subsystem Processor (MASP) cards and a Maintenance Disk and Alarm card (collectively referred to as control cards). The control cards are located in slots 1113 through 1118 of the EAGLE control shelf. The control cards must be E5-based cards.

### E5-based Control Cards

The E5-based set of EAGLE control cards consists of the following cards:

- Two Maintenance and Administration Subsystem Processor cards (E5-MASP) cards. Each dual-slot E5-MASP card is made up of the following two modules:
  - Maintenance Communication Application Processor (E5-MCAP) card
  - Terminal Disk Module (E5-TDM) card
- One Maintenance Disk and Alarm card (E5-MDAL card)

### Maintenance Communication Application Processor (E5-MCAP) Card

The E5-MCAP card contains the Communications Processor and Applications Processor and provides connections to the IMT bus. The card controls the maintenance and database administration activity and performs both application and communication processing. E5-MCAP cards are located in slots 1113 and 1115 of the control shelf.

Each E5-MCAP card contains two USB ports. One latched USB port is used with removable flash media (“thumb drives”), and one flush-mounted USB port is used with a plug-in flash drive. The removable media drive in the latched USB port is used to install and back up customer data. The flush-mounted USB port is used for upgrade and could be used for disaster recovery.

### Terminal Disk Module (E5-TDM) Card

The E5-TDM card provides the Terminal Processor for the 16 I/O ports, and interfaces to the Maintenance Disk and Alarm (E5-MDAL) card and fixed disk storage. The E5-TDM card also distributes Composite Clocks and High Speed Master clocks throughout the EAGLE, and distributes Shelf ID to the EAGLE. Each E5-TDM card contains one fixed SATA drive that is used to store primary and backup system databases, measurements, and Generic Program Loads (GPLs). E5-TDM cards are located in slots 1114 and 1116 of the control shelf.

### Maintenance Disk and Alarm (E5-MDAL) Card

The E5-MDAL card processes alarm requests and provides fan control. There is only one E5-MDAL card in a control card set. Critical, major, and minor system alarms are provided for up to 6 individual frames. In addition to the 3 system alarms, the E5-MDAL card provides the system audible alarm.

The E5-MDAL card provides control of fans on a per-frame basis, and allows for each fan relay to be set individually. The E5-MDAL card is located in slots 1117 and 1118 of the control shelf.

## EAGLE Database Partitions

The data that the EAGLE uses to perform its functions are stored in two separate areas: the fixed disk drives, and the removable media. The following sections describe these areas and data that is stored on them. These areas and their partitions are shown in [Figure 1: EAGLE Database Partitions \(E5-Based Control Cards\)](#).

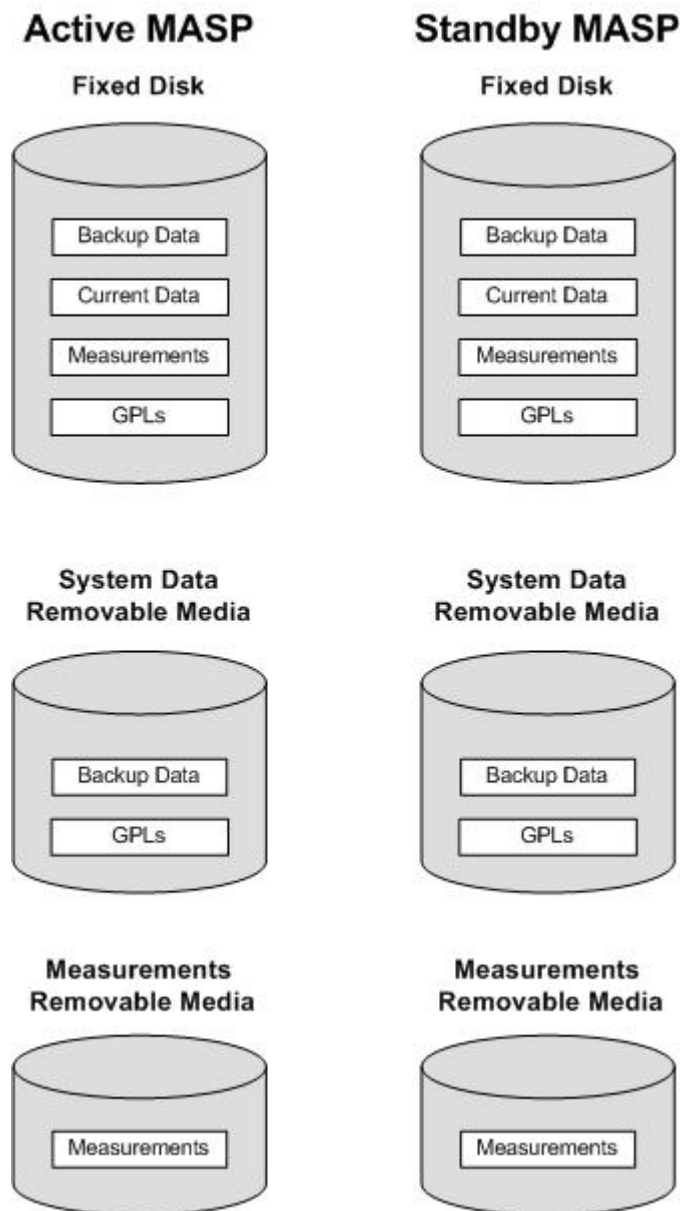

Figure 1: EAGLE Database Partitions (E5-Based Control Cards)

#### Fixed Disk Drive

There are two fixed disk drives on the EAGLE. The fixed disk drives contain the “master” set of data and programs for the EAGLE. The two fixed disk drives are located on the terminal disk modules (E5-TDMs). Both disks have the same files. The data stored on the fixed disks is partially replicated on the various cards in the EAGLE. Changes made during database administration sessions are sent to the appropriate cards.

The data on the fixed disks can be viewed as four partitions.

- Current partition

- Backup partition
- Measurements partition
- Generic program loads (GPLs) partition

The data which can be administered by users is stored in two partitions on the fixed disk, a current database partition which has the tables which are changed by on-line administration, and a backup database partition which is a user-controlled copy of the current partition.

All of the on-line data administration commands affect the data in the current partition. The purpose of the backup partition is to provide the users with a means of rapidly restoring the database to a known good state if there has been a problem while changing the current partition.

A full set of GPLs is stored on the fixed disk, in the GPL partition. There is an approved GPL and a trial GPL for each type of GPL in this set and a utility GPL, which has only an approved version. Copies of these GPLs are downloaded to the EAGLE cards. The GPL provides each card with its functionality. For example, the `ss7ansi` GPL provides MTP functionality for link interface modules (LIMs).

Measurement tables are organized as a single partition on the fixed disk. These tables are used as holding areas for the measurement counts.

### Removable Media

The removable media is used with the E5-MCAP card portion of the E5-MASP in card locations 1113 and 1115.

The removable media is used for two purposes.

- To hold an off-line backup copy of the administered data and system GPLs
- To hold a copy of the measurement tables

Because of the size of the data stored on the fixed disk drives on the E5-TDMs, a single removable media cannot store all of the data in the database, GPL and measurements partitions.

To use a removable media to hold the system data, it must be formatted for system data. To use a removable media to hold measurements data, it must be formatted for measurements data. The EAGLE provides the user the ability to format a removable media for either of these purposes. A removable media can be formatted on the EAGLE by using the `format-disk` command. More information on the `format-disk` command can be found in *Commands User's Guide*. More information on the removable media drives can be found in *Hardware Guide*.

Additional and preformatted removable media are available from the [My Oracle Support \(MOS\)](#).

## Gateway Screening (GWS) Overview

---

**Topics:**

- *Introduction.....26*
- *Gateway Screening States.....28*
- *Gateway Screening Attributes.....30*
- *User Interface Requirements.....38*
- *14-Bit ITU National Point Code Formats.....44*
- *Gateway Screening Using Duplicate ITU National Point Codes.....46*
- *Gateway Screening Configuration.....47*
- *Adding a GLS Card.....61*
- *Removing a GLS Card.....71*
- *E5-OAM Integrated GLS Feature Activation Procedure.....75*
- *Configuring Gateway Screening Stop Action Sets.....75*
- *Configuring TLNP Gateway Screening Stop Action Sets.....88*
- *Removing Gateway Screening Stop Action Sets.....102*
- *Setting the Threshold for Reporting Gateway Screening Activity.....106*
- *Setting the Maximum Number of Gateway Screening Rejected Messages.....110*
- *Activating the MTP Routed GWS Stop Action Feature.....113*
- *Turning Off the MTP Routed GWS Stop Action Feature .....122*

Chapter 2, Gateway Screening (GWS) Overview, contains an overview of the Gateway Screening feature and the procedures for provisioning the GLS card, gateway screening stop action sets, the threshold for gateway screening activity, and the maximum number of gateway screening rejected messages.

## Introduction

This chapter provides an overview of the gateway screening feature and procedures for provisioning these items in the database:

- GLS cards
- Gateway screening stop action sets
- The threshold for gateway screening activity
- Setting the maximum number of gateway screening rejected messages

The gateway screening tables are loaded onto Link Interface Modules (LIMs) or service modules. Service modules can be any of these cards:

- EAGLE-Service Module 4 GB (E5-SM4G or E5-SM8G-B cards)

The use of the service modules in the EAGLE is dependent on the combination of global title translation features that are being used in the EAGLE. For more information on the global title translation features, go to *Database Administration - GTT User's Guide*.

The gateway screening tables provide screening of MTP (LIMs) and SCCP (service modules) messages.

MTP Screening consists of the following items:

- Allowed Originating Point Code (OPC)
- Blocked Originating Point Code (BLKOPC)
- Allowed Signaling Information Octet (SIO)
- Allowed Destination Point Code (DPC)
- Blocked Destination Point Code (BLKDPC)
- Allowed Affected Destination Field (DESTFLD)
- Allowed ISUP Message Type (ISUP) - ISUP and TUP messages can be screened by the allowed ISUP message type screen.

SCCP Screening consists of the following items:

- Allowed Calling Party Address (CGPA)
- Allowed Translation Type (TT)
- Allowed Called Party Address (CDPA)
- Allowed Affected Point Code (AFTPC).

The procedures shown in this manual use a variety of commands. If more information than what is shown in these procedures is needed, go to *Commands User's Guide* to find the required information.

The EAGLE's role in the SS7 network is to provide SS7 message transport between originating and destination signaling points. EAGLEs that route messages to and from other networks also perform gateway screening. The screening process results in a message being accepted into the network or rejected. The criteria for message screening depends on the type of message received by the EAGLE, and the contents of the EAGLE screening tables.

Gateway screening functions on the EAGLE reside within the LIM and the service modules and are defined using screening tables or screen sets which contain a set of rules. Each screen set is uniquely identified by a screen set name. Each rule in the screen set is identified by a screening reference name. Each screening reference belongs to a specific category, which indicates the criteria that is used to either accept or reject an incoming MSU. For example, the category `blkopc` rejects all MSUs with the

OPCs specified in the screening reference. The screening parameters (point codes, routing indicator, subsystem number, etc.) are used to match information in the SS7 message. The screening data is defined by the attributes discussed in the [Gateway Screening Attributes](#) section.

Each group of screening references is referred to as a screen set and is identified by a particular screen set name (`scrn`). The screen set is applied to a particular linkset. This allows the capability, for example, for specific OPCs with particular SIOs and DPCs to be allowed into the network.

With the SEAS interface, the screen set function is performed by a gateway linkset. A gateway linkset combines the functions of a gateway screening screen set and an SS7 linkset specifying the `gwsa=on` and `scrn` parameters. Like an EAGLE gateway screening screen set, a gateway linkset defines the screening references that are to be used to screen the messages on the linkset. It also defines the linkset whose messages are to be screened. A gateway linkset can only be configured from a SEAS terminal and not from an EAGLE terminal. The linkset attributes of a gateway linkset can be displayed on an EAGLE terminal with the `rtrv-ls` command. A gateway linkset is shown by the entry SEAS in the SCRN field of the `rtrv-ls` command output. The gateway screening portion of the gateway linkset can only be displayed on the SEAS interface.

There are two basic functions, allow and block. In an allowed screen (for example, allowed DPC), if a match is found and the next screening function identifier (`nsfi`) is equal to anything but `stop`, the next screening reference (`nsr`) is identified and the screening process continues to the next screen identified by the `nsfi` and `nsr` parameters. If the next screening function identifier is `stop`, the message is processed and no further screening takes place. If no match is found, the message is rejected.

In a blocked screen (for example, blocked DPC), if a match is found and the next screening function identifier is `fail`, the message is rejected and no further screening takes place. If no match is found and the next screening function identifier is equal to anything but `stop`, the next screening reference is identified and the screening process continues to the next screen identified by the `nsfi` and `nsr` parameters. If the next screening function identifier is equal to `stop`, the message is processed and no further screening takes place.

When the screening process stops, other actions can be assigned to the screen set. These actions, called gateway screening stop actions, define the actions the EAGLE can perform on the MSU that passes gateway screening. For more information on configuring gateway screening stop actions, go to the [Configuring Gateway Screening Stop Action Sets](#) procedure. The EAGLE currently uses these gateways screening stop actions.

- COPY – copy the MSU for the STPLAN feature
- RDCT – redirect the MSU for the DTA feature
- CNCF – convert the PIP parameter with the GN parameter or the GN parameter with the PIP parameter in the ISUPIAM message for the Calling Name Conversion Facility feature.
- TLNP – ISUPIAMs that pass gateway screening are processed either by the ISUPNP with EPAP feature (if the ISUPNP with EPAP feature is enabled and turned on) or by the Triggerless LNP feature (if the Triggerless LNP feature is turned on).
- TINP – ISUP IAMs that pass gateway screening are intercepted by the Triggerless ISUP based Number Portability (TINP) feature and converted to include the routing number (RN) if the call is to a ported number. This gateway screening stop action can be specified only if the TINP feature is enabled.

The allowed OPC and DPC screens are useful in the gateway screening process when specifying particular sets of point codes that are allowed to send messages to another network or receive messages from another network. The blocked OPC and DPC screens are useful in the gateway screening process specifying particular sets of point codes that are not allowed to send SS7 messages to another network or receive SS7 messages from another network.

## TUP Message Screening

TUP messages are screened using the Allowed ISUP Message Type screen. The TUP protocol is an obsolete predecessor to the ISUP protocol that remains in use in some areas. To screen for TUP messages, a screen set must be defined to screen for messages containing the service indicator value of 4. This is accomplished by defining an allowed SIO screen in the screen set containing the `si=4` parameter.

Since both ISUP and TUP messages are screened using the allowed ISUP message type screen, it is recommended that the screen set contain an allowed SIO screen to screen for ISUP messages, messages containing the service indicator value of 5. Each of these entries in the allowed SIO screen should have separate next screening functions. This allows the screening rules after the allowed SIO screen to have two separate streams, one that ends with screening ISUP messages, the other that ends with screening TUP messages.

The TUP messages can be screened for point codes before the allowed SIO screen with the allowed and blocked OPC screens, and after the SIO screen with the allowed and blocked DPC screens. However, if the screen set does not contain an allowed SIO screen that screens for TUP messages (messages with the service indicator value of 4), the message will be treated by the allowed ISUP message type screen as an ISUP message.

The following commands show how a screen set can be provisioned to screen for TUP and ISUP messages.

```
ent-scr-isup:sr=is01:isupmt=10:nsfi=stop
ent-scr-isup:sr=tu01:tupmt=1:nsfi=stop
ent-scr-dpc:sr=dpc4:ni=1:nc=2:ncm=3:nsfi=isup:nsr=tu01
ent-scr-dpc:sr=dpc5:ni=7:nc=1:ncm=0:nsfi=isup:nsr=is01
ent-scr-sio:sr=si02:nic=2:pri=0:si=4:nsfi=dpc:nsr=dpc4
ent-scr-sio:sr=si02:nic=2:pri=0:si=5:nsfi=dpc:nsr=dpc5
ent-scrset:scrn=ist2:nsr=si02:nsfi=sio
```

In this example screen set configuration, messages are screened by the allowed SIO screen `si02` for either ISUP or TUP messages. ISUP messages are further screened by the allowed DPC screen `dpc5` and TUP messages are screened by the allowed DPC screen `dpc4`. The ISUP messages containing the ANSI point code 001-002-003 are passed onto the allowed ISUP screen `is01`. The TUP messages containing the ANSI point code 007-001-000 are passed onto the allowed ISUP screen `tu01`.

**Note:** The gateway screening rules are entered in reverse of the order that the screening process takes place.

## Gateway Screening States

Gateway screening on a particular linkset can be set to function in one of four states:

**NO SCREENING** – Screening is not performed. All message signaling units (MSUs) are passed. This state is set by the `gwsa=off` and `gws=off` parameters of the `ent-ls` or `chg-ls` commands.



**SCREEN AND REPORT** – Screening is performed. When an MSU fails screening it is discarded, an output message is generated, and measurements are pegged. This state is set by the `gwsa=on` and `gws=on` parameters of the `ent-ls` or `chg-ls` commands.

**SCREEN AND DON'T REPORT** – Screening is performed. When an MSU fails screening it is discarded and measurements are pegged, but no output message is generated. This state is set by the `gwsa=on` and `gws=off` parameters of the `ent-ls` or `chg-ls` commands.

**SCREEN TEST MODE** – Screening is performed, but all MSUs are passed. When an MSU fails screening, an output message is generated, but the MSU is still passed. This state is set by the `gwsa=off` and `gws=on` parameters of the `ent-ls` or `chg-ls` commands.



**Caution:** When Gateway Screening is in the screen test mode, any action in the gateway screening stop action set specified by the `actname` parameter at the end of the gateway screening process will be performed.

CAUTION

The `gwsa` and `gws` parameters are described in the [Linkset Parameters](#) section.

## Linkset Parameters

Optional parameters of the enter linkset (`ent-ls`) command or the change linkset (`chg-ls`) command are used to set the screening state. These parameters are:

**SCRN** – the name of the gateway screening screen set that is associated with the linkset.

**GWSA** – Gateway screening action – The value `on` allows gateway screening to be performed on the linkset. The value `off`, does not allow gateway screening to be performed on the linkset. This parameter can only be specified if the `scrn` parameter is specified.

**GWSM** – Gateway screening messaging – The value `on` allows output messages to be generated. The value `off` does not allow output messages to be generated. This parameter can only be specified if the `scrn` parameter is specified.

**GWSD** – Gateway screening MSU discard – If gateway screening cannot be performed and the `gwsd` parameter is set to `on`, all MSUs on the linkset are discarded. These are two examples of why gateway screening could not be performed.

- No GLS cards are configured and installed in the EAGLE.
- The screen set is too big to be loaded onto the LIM or service module.

The value `off` does not allow messages to be discarded. This parameter can only be specified if the `scrn` and `gwsa=on` parameters are specified.

**Note:** Discarding all MSUs on a linkset will not allow any MSUs on the linkset to be routed. It is recommended that the value specified for the `gwsd` parameter is `off`. The `gwsd` parameter should only set to `on` if you wish screen MSUs for gateway screening rather than routing MSUs through the EAGLE.

Refer to *Commands User's Guide* for more information on the `ent-ls` or `chg-ls` commands.

## Gateway Screening Attributes

Each screen has attributes which hold information required to perform a particular screening function. The following attributes are required in order to implement all of the screening functions.

The screen set name(`scrn`) is a four character (one alpha and up to three alphanumeric) value that specifies the name of the screen set.

The screening reference (`sr`) is a four character (one alpha and up to three alphanumeric) value. Combined with the next screening function identifier (`nsfi`), it uniquely defines a screening table.

The network identifier for ANSI point codes (`ni`) is an integer between 0 and 255, the asterisk "\*", or the character "c".

The network cluster for ANSI point codes (`nc`) is an integer between 0 and 255, the asterisk "\*", or the character "c".

The network cluster member for ANSI point codes (`ncm`) is an integer between 0 and 255, the asterisk "\*", or the character "c".

The zone for ITU international point codes (`zone`) is an integer between 0 and 7, the asterisk "\*", or the character "c".

The area for ITU international point codes (`area`) is an integer between 0 and 255, the asterisk "\*", or the character "c".

The ID for ITU international point codes (`id`) is an integer between 0 and 7, the asterisk "\*", or the character "c".

The 14-bit ITU national point code (`npc`) is an integer between 1 and 16383, the asterisk "\*", or the character "c". The EAGLE supports different formats for 14-bit ITU national point codes as defined by the `npcfmti` parameter of the `chg-stpopts` command. No matter what format is defined by the `npcfmti` parameter, the 14-bit ITU national point code must be entered as an integer for gateway screening. If the format of the 14-bit ITU national point code that you wish to enter for gateway screening is not a single integer, the point code value must be converted into a single integer value. For more information on converting 14-bit ITU national point code values, see the [14-Bit ITU National Point Code Formats](#) section. For more information on the different ITU national point code formats, see the 14-Bit ITU National Point Code Formats section in Chapter 2, Configuring Destination Tables in *Database Administration - SS7 User's Guide*.

Gateway Screening supports using ITU international spare point codes in addition to ITU international point codes, and 14-bit ITU national spare point codes in addition to 14-bit ITU national point codes. The `pcst` parameter is used to specify the whether or not the ITU international and 14-bit ITU national point codes are spare point codes (`pcst=s` parameter) or not (`pcst=none` parameter). For more information about ITU international and 14-bit ITU national spare point codes, see Chapter 2, Configuring Destination Tables in *Database Administration - SS7 User's Guide*. Gateway Screening does not support using private point codes.

The main signaling area value for 24-bit ITU national point codes (`msa`) is an integer between 0 and 255, the asterisk "\*", or the character "c".

The sub-signaling area value for 24-bit ITU national point codes (`ssa`) is an integer between 0 and 255, the asterisk "\*", or the character "c".

The signaling point value for 24-bit ITU national point codes (*sp*) is an integer between 0 and 255, the asterisk "\*", or the character "c".

The ISUP message type (*isupmt*)/TUP message type (*tupmt*) is an integer between 0 and 255, or the character "\*". This parameter specifies either an ISUP message type or a TUP message type for the ISUP screening reference specified in the *sr* parameter.

The service indicator (*si*) is an integer between 0 and 15. This parameter specifies a service indicator for the SIO screening reference specified in the *sr* parameter. The service indicator is the first 4 bits of an SIO.

The network indicator code (*nic*) is an integer between 0 and 3 or an "\*" (asterisk). This parameter specifies a network indicator code for the SIO screening reference specified in the *sr* parameter. The network indicator code is the last 2 bits of an SIO.

The H0 heading code (*h0*) is an integer between 0 and 15, or an "\*" (asterisk). This parameter specifies the first four bits of a message type for the SIO screening reference.

The H1 heading code (*h1*) is an integer between 0 and 15, or an "\*" (asterisk). This parameter specifies last four bits of a message type for the SIO screening reference.

The message priority (*pri*) is an integer between 0 and 3. This parameter specifies the message priorities for the SIO screening reference.

The subsystem number (*ssn*) is an integer between 0 and 255 or an "\*" (asterisk). This parameter identifies the SCP application that should receive the message.

The routing indicator (*ri*) is destination point code (DPC), global title translation (GT), or "\*" (asterisk). This parameter indicates whether a subsequent global title translation is required.

- *gt* – indicates that a subsequent translation is required.
- *dpc* – indicates that no further translation is required.
- \* (asterisk) – indicates all possible values (DPC and GT).

The translation type (*type*) is an integer between 0 and 255 or a "\*" (asterisk). Identifies the type of global title translation. It is the decimal representation of the 1-byte field used in SS7.

The SCCP message type (*sccpmt*) is an integer with the values 9 (UDT messages), 10 (UDTS messages), 17 (XUDT messages), 18 (XUDTS messages), or "\*" (asterisk). This parameter specifies one of these message types and is part of the calling party address screen.

The SCCP management (SCMG) format ID (*scmgfid*) is an integer from 1 to 255 or "\*" (asterisk). This parameter specifies the function and format of an SCMG message and is part of the called party address screen.

The next screening function identifier (*nsfi*) is the screen function that is required to continue processing the message. It is the next step in processing the message. The values for this attribute are: *opc*, *blkopc*, *sio*, *dpc*, *blkdpc*, *destfld*, *isupcgpa*, *tt*, *cdpa*, *aftpc*, *stop*, and *fail*.

The next screening reference (*nsr*) is a four character (one alpha and up to three alphanumeric) value. Combined with the next screening function identifier (*nsfi*), it uniquely defines the next screening table to be used in the gateway screening process.

The gateway screening stop action set name (*actname*) is a six character (one alpha and up to five alphanumeric characters) value. Specified only with the *nsfi=stop* parameter, the gateway screening stop action set defines the additional actions the EAGLE can perform on MSUs that pass gateway screening.

The asterisk, or "\*", is a single entry that indicates all possible values for that parameter.

These attributes are not used on all screens. The following list shows which attributes are required for each screening function. There are two types of attributes, search keys and results. The search keys are used to match fields in the SS7 message in order to determine the screening function result. The result is determined by matching a search key with information in the current SS7 message. The result indicates the next step in the screening process.

- Screen Set screening function
  - Search Key - SCRN
  - Result - NSFI, NSR, ACTNAME
- Allowed OPC screening function
  - Search Key - SR, NI, NC, NCM,,ZONE, AREA, ID, NPC, MSA, SSA, SP, PCST
  - Result - NSFI, NSR, ACTNAME
- Blocked OPC screening function
  - Search Key - SR, NI, NC, NCM,,ZONE, AREA, ID, NPC, MSA, SSA, SP, PCST
  - Result - NSFI, NSR, ACTNAME
- Allowed SIO screening function
  - Search Key - SR, NIC, SI, H0, H1, PRI
  - Result - NSFI, NSR, ACTNAME
- Allowed DPC screening function
  - Search Key - SR, NI, NC, NCM,,ZONE, AREA, ID, NPC, MSA, SSA, SP, PCST
  - Result - NSFI, NSR, ACTNAME
- Blocked Allowed DPC screening function
  - Search Key - SR, NI, NC, NCM,,ZONE, AREA, ID, NPC, MSA, SSA, SP, PCST
  - Result - NSFI, NSR, ACTNAME
- Allowed DESTFLD screening function
  - Search Key - SR, NI, NC, NCM,,ZONE, AREA, ID, NPC, MSA, SSA, SP, PCST
  - Result - NSFI, ACTNAME
- Allowed ISUP screening function
  - Search Key - SR, ISUPMT, TUPMT
  - Result - NSFI, ACTNAME

**Note:** The Allowed ISUP Screening function table contains both the ISUP message type (ISUPMT) and TUP message type (TUPMT). Only one of these parameters can be specified for an allowed ISUP screen. The parameter value to be used is dependent on the service indicator (SI) value specified in the allowed SIO screen: SI=5 for an ISUP message type, SI=4 for a TUP message type.
- Allowed CGPA screening function
  - Search Key - SR, NI, NC, NCM,,ZONE, AREA, ID, NPC, MSA, SSA, SP, RI, SSN, SCCPMT, PCST
  - Result - NSFI, NSR, ACTNAME
- Allowed TT screening function

- Search Key - SR, TYPE
- Result - NSFI, NSR, ACTNAME
- Allowed CDPA screening function
  - Search Key - SR, NI, NC, NCM,,ZONE, AREA, ID, NPC, MSA, SSA, SP, SSN, SCMGFID, PCST
  - Result - NSFI, NSR, ACTNAME
- Allowed AFTPC screening function
  - Search Key - SR, NI, NC, NCM,,ZONE, AREA, ID, NPC, MSA, SSA, SP, SSN, PCST
  - Result - NSFI, ACTNAME

**Note:** The NSR attribute can only be specified when the NSFI is not STOP. The NSR cannot be specified with the ACTNAME attribute. The ACTNAME attribute can only be specified when the NSFI is STOP. The ACTNAME parameter cannot be specified with the NSR parameter. NSFI and NSR can only be defined once per screening table.

### Use of the Character “c” for the NI, NC, NCM, ZONE, AREA, ID, NPC, MSA, SSA, and SP Parameters

The character “c” is used in the blocked OPC or DPC screens (for parameters *ni*, *nc*, *ncm*, *zone*, *area*, *id*, *npc*, *msa*, *ssa*, and *sp*) to allow the screening process to continue for messages with point codes that do not match any point codes in the blocked OPC or DPC screens. The character “c” is used this way. When screening for a blocked OPC or DPC and the point code being screened does not match any of the point codes in the blocked OPC or DPC screens, the message is not rejected and the screening process continues. To allow the screening process to continue, the blocked OPC and blocked DPC screens must have at least one entry consisting of a screening reference, a point code, a next screening function identifier, and a next screening reference. The point code is in the form of *ni=c*, *nc=c*, *ncm=c* (for ANSI point codes), *zone=c*, *area=c*, *id=c* (for ITU international point codes), *npc=c* (for 14-bit ITU national point codes), and *msa=c*, *ssa=c*, *sp=c* (for 24-bit ITU national point codes). When the character “c” is specified, the next screening function identifier and next screening reference must be specified, unless the next screening function identifier is *stop* (*nsfi=stop*). Then the next screening reference cannot be specified.

When the point code does not match any entries in the blocked OPC or DPC screens, the screening process is directed to the screening reference with the point code *c-c-c* or *npc=c*. The next screening function identifier and next screening reference in this entry are examined to determine the next step in the screening process.

When a blocked OPC or DPC screen is created, the first entry for the *ni-nc-ncm*, *zone-area-id*, or *msa-ssa-sp* must be *c-c-c*, or the *npc* must “c.” Subsequent entries can be specific point codes.

If the character “c” is specified for any parameters *ni*, *nc*, *ncm*, *zone*, *area*, *id*, *msa*, *ssa*, or *sp*, it must be specified for all three parameters. No other values can be used. For example, a point code *c-c-255* is not allowed. The point code must be *c-c-c*. The “\*” (asterisk) value cannot be used with the character “c” (for example, a point code *c-c-\** is not allowed).

ANSI, ITU international, or 24-bit ITU national point codes using the value “c” can be entered by specifying only the *ni=c* parameter (for ANSI point codes), *zone=c* parameter (for ITU international point codes), or *msa=c* parameter (for 24-bit ITU national point codes), and the *nc*, *ncm*, *area*, *id*, *ssa*, and *sp* parameters can be omitted.

The `pcst` and `npcst` parameters, for specifying the ITU international and 14-bit ITU national spare point codes, cannot be used with point codes containing the character “c”.

## Specifying a Range of Values for Gateway Screening Parameters

The values of these gateway screening parameters can be specified as a range of values.

`ni` – the network identifier for an ANSI point code

`nc` – the network cluster for an ANSI point code

`ncm` – the network cluster member for an ANSI point code

`pri` – the message priority in the SIO field of an MSU

`h0` – the H0 heading code in the SIF field of an MSU

`h1` – the H1 heading code in the SIF field of an MSU

`type` – the translation type in the called party address field of an MSU

`isupmt` – the ISUP message type

`tupmt` – the TUP message type

A range of values is specified with the values that define the range separated by two ampersands (&&), for example, `:ni=025&&100` specifies all network indicators for ANSI point codes from 25 to 100.

A range of values for an ANSI point code parameter can be specified with asterisks (\*) or single values for other point code parameters. [Table 2: Valid Value Combinations for ANSI Point Code Parameters](#) shows the valid combinations of these parameter values.

**Table 2: Valid Value Combinations for ANSI Point Code Parameters**

NI	NC	NCM
Single Value	Single Value	Single Value
Single Value	Single Value	Range of Values
Single Value	Single Value	Asterisk
Single Value	Range of Values	Asterisk
Single Value	Asterisk	Asterisk
Range of Values	Asterisk	Asterisk
Asterisk	Asterisk	Asterisk

A range of values for the H0 and H1 heading codes can be specified with asterisks (\*) or single values for other heading code parameter. [Table 3: Valid Value Combinations for H0 and H1 Parameters](#) shows the valid combinations of these parameter values.

**Table 3: Valid Value Combinations for H0 and H1 Parameters**

H0	H1
Single Value	Single Value
Single Value	Range of Values
Single Value	Asterisk
Range of Values	Asterisk
Asterisk	Asterisk

When changing or removing an existing gateway screening entry, the ANSI point code values, priority values, H0 and H1 heading code values, translation type, ISUP message type, or TUP message type values specified with the command must match the values configured in the database for the specified screening reference. If a command is specified with a parameter value that is part of a range of values for that parameter already configured for that screening reference, the command is rejected.

For example, the database contains a gateway screening entry for the range of allowed OPCs 010-010-010 to 010-010-100 in Allowed OPC screening reference `opc1`. If an attempt is made to remove or change Allowed OPC screening reference `opc1` and the ANSI point code 010-010-025 is specified. The command is rejected because point code 010-010-025 is a part of the point code range configured in the database. To remove or change Allowed OPC screening reference `opc1`, these point code parameters must be specified with the command, `ni=010, nc=010, ncm=010&&100`.

If the ANSI point code, priority value, H0 and H1 heading code values, or translation type values specified with an enter command is within the range of values already configured for the specified screening reference, the command is rejected. For example, the `ent-scr-opc` command is entered with the point code 010-010-050 assigned to screening reference `opc1`. If the database contains the range of point codes 010-010-010 to 010-010-100, specified as `ni=010, nc=010, ncm=010&&100`, the command is rejected. If the database contains an entry for all point codes with the network identifier of 010 and network cluster of 010, `ni=010, nc=010, ncm=*`, the command is rejected.

A range of values can be specified when displaying gateway screening entries. The range of values does not have to match the values configured in the database. The range of values specified with a retrieve command is used to limit the number of entries to search for. There are some restrictions for using ANSI point code values with retrieve commands. [Table 4: Valid Parameter Combinations for ANSI Point Code Parameters](#) shows the valid combinations of the ANSI point code parameters.

**Table 4: Valid Parameter Combinations for ANSI Point Code Parameters**

NI	NC	NCM
Single value	Single value	Single value, a range of values, an asterisk, or the NCM value not specified
Single value	A range of values, an asterisk, or the NC value is not specified	the NCM value is not specified
A range of NI values, an asterisk, or the NI value is not specified	the NC value is not specified	the NCM value is not specified

The range of values are displayed in the output of the retrieve commands the same way as they were entered. The following are examples of outputs containing ranges of values.

```
rtrv-scr-blkdpc:sr=iec:ni=240:nc=001:ncm=010&&018
```

```
rlghncxa03w 06-10-25 15:25:30 GMT EAGLE5 36.0.0
SCREEN = BLOCKED DPC
SR      NI      NC      NCM      NSF1      NSR/ACT
IEC    240      001      010&&020 STOP      -----
```

```
rtrv-scr-sio:sr=iec:nic=1:si=1
```

```
rlghncxa03w 06-10-25 15:25:30 GMT EAGLE5 36.0.0
SCREEN = ALLOWED SIO
SR      NIC     PRI  SI  H0      H1      NSF1      NSR/ACT
IEC    2      0&&2  1   08&&11 *      BLKDPC  WDB2
IEC    2      1     1   11     03&&07 DPC     ABC2
```

```
rtrv-scr-tt:all=yes
```

```
rlghncxa03w 06-10-25 15:25:30 GMT EAGLE5 36.0.0
SCREEN = ALLOWED TT
SR      TYPE     NSF1      NSR/ACT
IEC    005&&010 STOP      -----
IEC    012      STOP      -----
IEC    016      CDPA     IEC
WRD2   243      STOP      -----
WRD4   *        STOP      -----
```

### Use of the Asterisk “ \* ” for the ZONE, AREA, ID, MSA, SSA, and SP Parameters

A range of values for an ITU-I or 24-bit ITU-N point code parameter can be specified using a combination of asterisks (\*) and single values for the point code parameters. [Table 5: Valid Value Combinations for ITU-I Point Code Parameters](#) shows the valid combinations of the ITU-I parameter values. [Table 6: Valid Value Combinations for 24-Bit ITU-N Point Code Parameters](#) shows the valid combinations of the 24-bit ITU-N parameter values.

**Table 5: Valid Value Combinations for ITU-I Point Code Parameters**

ZONE	AREA	ID
Single Value	Single Value	Single Value
Single Value	Single Value	Asterisk
Single Value	Asterisk	Asterisk
Asterisk	Asterisk	Asterisk



**Table 6: Valid Value Combinations for 24-Bit ITU-N Point Code Parameters**

MSA	SSA	SP
Single Value	Single Value	Single Value
Single Value	Single Value	Asterisk
Single Value	Asterisk	Asterisk
Asterisk	Asterisk	Asterisk

*Table 7: Valid Parameter Combinations for ITU-I Point Code Parameters* shows the valid combinations of the ITU-I point code parameters used with the retrieve commands when displaying ITU-I gateway screening entries.

**Table 7: Valid Parameter Combinations for ITU-I Point Code Parameters**

ZONE	AREA	ID
Single value	Single value	Single value, an asterisk, or the ID value not specified
Single value	An asterisk, or the AREA value is not specified	the ID value is not specified
An asterisk, or the ZONE value is not specified	the AREA value is not specified	the ID value is not specified

*Table 8: Valid Parameter Combinations for 24-bit ITU-N Point Code Parameters* shows the valid combinations of the 24-bit ITU-N point code parameters used with the retrieve commands when displaying 24-bit ITU-N gateway screening entries.

**Table 8: Valid Parameter Combinations for 24-bit ITU-N Point Code Parameters**

MSA	SSA	SP
Single value	Single value	Single value, an asterisk, or the SP value not specified
Single value	An asterisk, or the SSA value is not specified	the SP value is not specified
An asterisk, or the MSA value is not specified	the SSA value is not specified	the SP value is not specified

## User Interface Requirements

A screening table is created, modified, displayed and removed using these on-line commands. For more information on these commands, go to *Commands User's Guide*.

- Screen Set – ent-scrset, chg-scrset, dlt-scrset, rtrv-scrset
- Allowed Originating Point Code – ent-scr-opc, chg-scr-opc, dlt-scr-opc, rtrv-scr-opc
- Blocked Originating Point Code – ent-scr-blkopc, chg-scr-blkopc, dlt-scr-blkopc, rtrv-scr-blkopc
- Allowed Service Information Octet – ent-scr-sio, chg-scr-sio, dlt-scr-sio, rtrv-scr-sio
- Allowed Destination Point Code – ent-scr-dpc, chg-scr-dpc, dlt-scr-dpc, rtrv-scr-dpc
- Blocked Destination Point Code – ent-scr-blkdpc, chg-scr-blkdpc, dlt-scr-blkdpc, rtrv-scr-blkdpc
- Allowed Affected Destination Field – ent-scr-destfld, chg-scr-destfld, dlt-scr-destfld, rtrv-scr-destfld
- Allowed ISUP/TUP Message Type – ent-scr-isup, chg-scr-isup, dlt-scr-isup, rtrv-scr-isup
- Allowed Calling Party Address – ent-scr-cgpa, chg-scr-cgpa, dlt-scr-cgpa, rtrv-scr-cgpa
- Allowed Called Party Address – ent-scr-cdpa, chg-scr-cdpa, dlt-scr-cdpa, rtrv-scr-cdpa
- Allowed Translation Type – ent-scr-tt, chg-scr-tt, dlt-scr-tt, rtrv-scr-tt
- Allowed Affected Point Code – ent-scr-aftpc, chg-scr-aftpc, dlt-scr-aftpc, rtrv-scr-aftpc
- Gateway Screening Stop Action Sets – chg-gws-actset, rtrv-gws-actset

## Command Summary

This section briefly describes each type of command used in this chapter. There are four commands for each screening function. One to enter the screening information (ent), one to change the screening information after it has been entered (chg), one to delete screening information (dlt), and one to display the screening information (rtrv).

If the command is not accepted, a “Command Rejected” message is displayed. If the command is accepted, a time stamp and a “Command Completed” message is displayed. For example:

```
E2361 Cmd Rej: Screen set name not defined
```

or

```
rlghncxa03w 06-10-25 15:25:30 GMT EAGLE5 36.0.0
ENT-SCR-OPC: MASP A - COMPLTD
```

Any time a screen set is affected by a command (for example, an entry is added to, removed from, or changed in the screen set) a “Screen Set Affected” message is displayed indicating the percentage of memory that screen set occupies (100% = the maximum space available). This information is useful

in determining how “full” the screen set is at any given time. The percentages are calculated after the command is executed. For example, the output message, ENT-SCR-OPC: SCREEN SET AFFECTED - SS01 25% FULL, indicates that after an entry was added to screen set SS01 by the `ent-scr-opc` command, it occupied 25% of the maximum space available. The following is an example of the output that can be received when a screen set is affected.

```
Extended Processing Time Required -- Please Wait
Notice: The number of screensets affected is 2.
ENT-SCR-OPC: SCREEN SET AFFECTED - ss01 25% FULL
ENT-SCR-OPC: SCREEN SET AFFECTED - ss04 35% FULL
ENT-SCR-OPC: MASP A - COMPLTD
```

When a new screen set is created it immediately occupies space which may or may not be over the allowed limit. The user must know how much space has been occupied by the new screen set. For example, if the screen set SCR1 is created, the output of the `ent-scrset` command has the following format:

```
Extended Processing Time Required -- Please Wait
Notice: The number of screensets affected is 1.
ENT-SCRSET: SCREEN SET AFFECTED - scr1 95% FULL
ENT-SCRSET: MASP A - COMPLTD
```

**Note:** A screen set can be over 100% full, but it is not recommended that the screen set remain in this condition. The gateway screening process will not function properly using a screen set that is over 100% full. Some entries must be removed from the screen set to reduce the screen set capacity to 100% or below.

## Enter Commands

All of the parameters in the enter command are mandatory. If the enter command contains a screening reference that does not exist, a new screening table is created. If the screening reference exists, and an entry that matches the specified parameters does not already exist, a new entry is added to the screening table. If an entry exists already, the command is rejected.

## Change Commands

At least one parameter must be changed in the change commands. Parameters that are considered part of the search key must be specified in every `chg` command (for example, the `ni`, `nc`, `ncm`, `zone`, `area`, `id`, `npc`, `msa`, `ssa`, and `sp` parameters for the `chg-scr-opc` command). Each of these parameters has a corresponding “new” parameter (for example, `nni`, `nnc`, `nncm`, `nzone`, `narea`, `nid`, `nnpc`, `nmsa`, `nssa`, `nsp`) which may be specified in order to change the entry in the screening table. Parameters that are not part of the search key may be specified, but do not have “new” values. For example, the `nsfi`, `nsr`, `ri`, and `actname` parameters do not have “new” parameters (for example, `nnsfi`, `nnsr`, `nri`, or `nactname`). If a “new” parameter is not specified, it assumes the value of the corresponding search key parameter. For example, if the `nni` parameter is not specified, then the `ni` parameter does not change since the `nni` parameter assumes the value of the `ni` parameter. If, however, a “new” parameter is specified, it must follow the same rules as the search keys. For example, if the `nni` and `nncm` parameters are not specified, and the `nnc` parameter is specified as an “\*” (asterisk), then the `ncm` parameter must be an “\*” (asterisk). The new data must not already exist in the screening table. If an entry already exists which matches the new data, the command is rejected.

## Delete Commands

The use of the asterisk value in a delete command implies the deletion of a specific entry containing that asterisk value, not the deletion of multiple entries whose values may be in the range implied by the asterisk. For example, entering `dlt-scr-opc:sr=opc1:ni=*:nc=*:ncm=*` cannot be used to remove all entries in `opc1`.

When the last entry is deleted from a screening table, the entire table is deleted, unless it is referenced by another screening table. If a screening table is referenced and an attempt is made to delete the last entry in the screening table, an error message is displayed.

## Retrieve Commands

The retrieve commands for each screening function have the same parameters as the enter commands with an additional parameter called `all`. The `all` parameter defaults to `no`, and can only be specified if no other parameters are specified. If the `all` parameter is specified and is `yes`, then a detailed output consisting of every entry in each rule of the indicated screening function type is displayed. There are no rules associated with parameter combinations (for example, if the `nc` parameter is equal to `*` then the `ncm` parameter must be `""`). If an entry is specified using a `""`, then only the entries where that parameter is a `""` is output.

If the NSFI has a value other than STOP or FAIL, then the name of the screening reference to be used in the next step of the gateway screening process (NSR) must be specified. The value of the NSR is shown in the NSR/ACT field.

If the NSFI is STOP, no NSR value can be specified. The gateway screening stop action sets can be specified with the `actname` parameter if the NSFI is STOP. If a gateway screening stop set has been assigned to the screen, the NSR/ACT field shows the name of the gateway screening stop action set. For more information on the gateway screening stop action sets, go to the [Configuring Gateway Screening Stop Action Sets](#) procedure.

If the NSFI is FAIL or STOP and no NSR or ACTNAME value is assigned to the screen, the entry `-----` is shown in the NSR/ACT field.

The following is an example of a detailed output using the `rtrv-scr-opc` command with the `all=yes` parameter specified.

```
rlghncxa03w 06-10-25 15:25:30 GMT EAGLE5 36.0.0
SCREEN = ALLOWED OPC
SR      NI      NC      NCM      NSFI      NSR/ACT
IEC     240      001      010&&200 STOP     -----
IEC     241      *        *        CGPA      cg04
SR      ZONE    AREA    ID      NSFI      NSR/ACT
IEC     1       003     4       BLKOPC    blk1
IEC     1       003     5       STOP      COPY
SR      NPC
IEC     00235
IEC     00240
SR      NI      NC      NCM      NSFI      NSR/ACT
WRD2    243      015&&075 *        STOP      RDCT
WRD3    243      105     002     CGPA      WRD4
SR      NPC
WRD4    00245
WRD4    00247
                NSFI      NSR/ACT
                BLKOPC    blk3
                STOP      CR
```

For the `rtrv-scrset:all=yes` command, the output consists of every screen set and every screening table in each screen set, in addition to the fields displayed from the `rtrv-scrset` command with no parameters. The following is an example of the detailed output of the `rtrv-scrset:all=yes` command.

```
rlghncxa03w 06-10-25 15:25:30 GMT EAGLE5 36.0.0

SCRN  NSFI      NSR/ACT  RULES  DESTFLD
SS01  OPC        IEC      120    Y
      DPC        GOOP     33
      SIO        WRD1     5
SS02  STOP      -----  0      Y
SS03  DPC        WRD1     56     Y
      SIO        WRD2     10
      BLKDPC    WRD5     30
```

Parameters that are not specified default to “all possible values” for that parameter. If no parameters are specified (except for the `rtrv-scrset` command), a summary output is displayed. A summary output consists of three columns of information, the screening references for the specified screen (SR), and an indicator of whether the screen table is referenced or not (REF), and the number of entries in the screening reference (RULES). The following is an example of a summary output using the `rtrv-scr-opc` command with no parameters.

```
rlghncxa03w 06-10-25 15:25:30 GMT EAGLE5 36.0.0
SCREEN = ALLOWED OPC

SR    REF  RULES
IEC   YES   2
WRD2  YES   1
WRD3  NO    4
WRD4  YES   9
```

For the `rtrv-scrset` command, if no parameters are specified, the output displays the following information.

- The capacity of the gateway screening database, as a percentage of the maximum capacity
- The percentage of the maximum number of the CDPA and AFTPC tables
- The total number of screen sets in the database with the percentage of the screen set capacity
- The number of SEAS and EAGLE screen sets being used
- The screen set name (SCRN)
- The next screening function that should be used in the gateway screening process (NSFI)
- The next screening reference or the gateway screening stop action set name (NSR/ACT)
- The memory capacity (percentage) of each screen set (FULL)
- The number of entries (rules) in the screen set (RULES)
- The number of tables in the screen set (TABLES)
- Whether the automatic allowed affected destination screening (DESTFLD) for network management messages is applied against the routing table, self point codes, and capability point codes. When this parameter is on, the automatic screening is applied at the end of the provisioned screen set.

The following is an example of the output of the `rtrv-scrset` command with no parameters.

```
rlghncxa03w 06-10-25 15:25:30 GMT EAGLE5 36.0.0
```

```

ENTIRE GWS DATABASE IS 1% FULL
CDPA + AFTPC TABLES ARE 1% FULL
SCREEN SET TABLE IS ( 7 OF 255) 2% FULL
THERE ARE 0 SEAS SCREEN SETS USED ( prefix 00nn )
THERE ARE 7 EAGLE SCREEN SETS USED

```

SCRN	NSFI	NSR/ACT	FULL	RULES	TABLES	DESTFLD
ss01	OPC	opc1	51%	2075	22	Y
ss02	OPC	opc2	2%	75	22	Y
ss03	OPC	opc3	2%	75	22	Y
ss04	OPC	opc1	51%	2075	22	N
ss07	OPC	opc1	51%	2075	22	Y
ss09	OPC	opc1	51%	2075	22	N
ss28	OPC	opc1	51%	2075	22	Y

The outputs of the retrieve commands contains the following fields. There are certain fields that are used with specific commands and these are noted in the description of the field.

**AREA** – The area value of an ITU international point code, expressed as zone-area-id. This field is used with all screening functions except screen set, allowed SIO, and allowed TT screening functions.

**DESTFLD** – Whether the automatic allowed affected destination screening for network management messages is applied against the routing table, self point codes, and capability point codes. When this parameter is on, the automatic screening is applied at the end of the provisioned screen set. This field is only used with the screen set function.

**FULL** – The capacity of allowed memory a given screen set occupies, expressed as percentage. This field is only used with the screen set function.

**H0** – The H0 heading code in the service information field. The H0 field shows the first four bits of the message type indicator in the SIO field. This field is only used with the allowed SIO screening function.

**H1** – The H1 heading code in the service information field. The H1 field shows the last four bits of the message type indicator in the SIO field. This field is only used with the allowed SIO screening function.

**ID** – The ID value of an ITU international point code, expressed as zone-area-id. This field is used with all screening functions except screen set, allowed SIO, and allowed TT screening functions.

**ISUPMT/TUPMT** – The ISUP message type ( **ISUPMT** ) in the service information field of an ISUP message or the TUP message type ( **TUPMT** ) in the service information field of a TUP message. This field is used only with allowed ISUP screening functions.

**MSA** – The main signaling area value of a 24-bit ITU national point code, expressed as msa-ssa-sp. This field is used with all screening functions except screen set, allowed SIO, and allowed TT screening functions.

**NC** – The network cluster of an ANSI point code, expressed as ni-nc-ncm. This field is used with all screening functions except screen set, allowed SIO, and allowed TT screening functions.

**NCM** – The network cluster member of an ANSI point code, expressed as ni-nc-ncm. This field is used with all screening functions except screen set, allowed SIO, and allowed TT screening functions.

**NI** – The network identifier of an ANSI point code, expressed as ni-nc-ncm. This field is used with all screening functions except screen set, allowed SIO, and allowed TT screening functions.

**NIC** – The network indicator code in the service information octet. This field is only used with the allowed SIO screening function.

**NPC** – The ITU national point code. This field is used with all screening functions except screen set, allowed SIO, and allowed TT screening functions.

**NSFI** – The next screening function identifier. The next screening function identifier specifies the next screening function that should be used in the gateway screening process. This field is used with all screening functions.

**NSR/ACT** – The next screening reference or the gateway screening stop action set name. The next screening reference is the name of the of the next gateway screening entity that should be used in the screening process. The gateway screening stop action set name is the name of the gateway screening stop action set assigned to the screen defining the additional action to be performed on the MSU that passes gateway screening. This field is used with all screening functions.

**PRI** – The priority of a message in the service information octet. This field is only used with the allowed SIO screening function.

**REF** – An indicator of whether the specified screening table is referenced by another screening table. This field is used with the summary outputs of all retrieve commands except the retrieve screen set (*rtrv-scrset*) command.

**RI** – The routing indicator in the called party address (CDPA). This field is only used with the allowed CGPA screening function.

**RULES** – The number of entries in the screen. This field is only used with the screen set function.

**SCCPMT** – The SCCP message type. This field is only used with the allowed calling party address function.

**SCMGFID** – The SCCP management (SCMG) format ID, which defines the function and format of each SCMG message. This field is only used with the allowed called party address function.

**SCRN** – The name of the screen set. This field is only used with the screen set function.

**SI** – The service indicator for the service information octet, which are the last two bits of the subservice field. This field is only used with the allowed SIO screening function.

**SP** – The signaling point value of a 24-bit ITU national point code, expressed as *msa-ssa-sp*. This field is used with all screening functions except screen set, allowed SIO, and allowed TT screening functions.

**SR** – The name of the screening reference. This field is used with all screening functions except the screen set screening function.

**SSA** – The sub-signaling area value of a 24-bit ITU national point code, expressed as *msa-ssa-sp*. This field is used with all screening functions except screen set, allowed SIO, and allowed TT screening functions.

**SSN** – The subsystem number of a given point code. This field is only used with the allowed CGPA, allowed CDPA, and allowed AFTPC screening functions.

**TABLES** – The number of tables in the screen. This field is only used with the screen set function.

**TYPE** – The translation type that is allowed for global title translation. This field is only used with the allowed TT screening function.

**ZONE** – The zone value of an ITU international point code, expressed as *zone-area-id*. This field is used with all screening functions except screen set, allowed SIO, and allowed TT screening functions.

The ITU international and 14-bit ITU national spare point codes are displayed in the output of the Gateway Screening retrieve commands with the spare point code subtype prefix "s-".

## 14-Bit ITU National Point Code Formats

Gateway screening only allows 14-bit ITU national point codes to be provisioned in the database by the enter, delete, or change gateway screening commands, and displayed by the gateway screening retrieve commands as a single number. If a format other than a single number (14-0-0-0) for the 14-bit ITU national point code has been defined by the `npcfmt i` parameter of the `chg-stpopts` command, the 14-bit ITU national point code must be converted into a single number so that it can be used by gateway screening.

For example, the format of the 14-bit ITU national point code is 4-4-4-2 and the user would like to add point code value 7-7-7-1 into the allowed OPC screen. The point code value 7-7-7-1 would have to be converted to a single number so that the point code can be added to the allowed OPC screen. To determine what multiple part 14-bit ITU national point code is represented by the single number 14-bit ITU national point code in the gateway screening table, the single number point code must be converted to a multiple part point code.

To convert a single number 14-bit ITU national point code to a multiple part point code, perform the [Converting Single Number 14-Bit ITU National Point Codes](#) procedure.

To convert a multiple part 14-bit ITU national point code to a single number point code, perform the [Converting Multiple Part 14-Bit ITU National Point Codes](#) procedure.

For a definition of the different formats that can be used for 14-bit ITU national point codes, see the 14-Bit ITU National Point Code Formats section in Chapter 2, Configuring Destination Tables in the *Database Administration Manual - SS7*.

### Converting Single Number 14-Bit ITU National Point Codes

To convert a single number 14-bit ITU national point code to a multiple part 14-bit ITU national point code, perform these steps. To make this conversion, you will need to know the format of the 14-bit ITU national point code. This can be verified in the `NPCFMTI` field of the `rtrv-stpopts` command output. For this example, the 14-bit ITU national point codes 14781 and 695 are converted to point codes using the 3-8-3-0 format.

1. The point code is converted to a binary number.

This can be done with most scientific calculators.

- a) The number 14781 converts to the binary number 11100110111101.
- b) The number 695 converts to the binary number 1010110111.

**Note:** Make sure the binary number contains 14 digits. If it does not, add leading zeros to the binary number to bring the total number of digits in the number to 14.

In this example, the binary equivalent for the decimal number 695 (1010110111) contains 10 digits, so four zeros must be added to the beginning of the binary number. The resulting binary number is now 00001010110111.

2. Divide the binary number into the number of parts required by the format of the 14-bit ITU national point code.

For this example, the format is 3-8-3-0. Since the last part of the point code format is 0, the point code format contains only three parts. Divide the point code into three parts, the first part of the



point code contains the first three digits of the 14-digit binary number, the second part of the point code contains the next eight digits of the 14-digit binary number, and the third part of the point code contains the last three digits of the 14-digit binary number.

For this example, the binary numbers would be divided like this:

- a) 11100110111101 = 111 00110111 101
- b) 00001010110111 = 000 01010110 111

3. Convert each part of the point code into a decimal number using the same scientific calculator used in step 1 and separate each part of the point code with dashes.

The results are as follows.

- a) 111 00110111 101 = 7-55-5
- b) 000 01010110 111 = 0-86-7

When the 14-bit ITU national point codes are converted from single numbers to multiple part point codes, the resulting value of the multiple part point code depends on the point code format specified by the `npcfmt i` parameter of the `chg-stpopts` command. When converting the single number point code 14781 to the point code format 3-8-3-0, the resulting point code value is 7-55-5. If point code 14781 is converted to the point code format 4-4-4-2, the resulting point code value is 14-6-15-1.

## Converting Multiple Part 14-Bit ITU National Point Codes

To convert multiple part 14-bit ITU national point codes to a single number, perform these steps. To make this conversion, you will need to know the format of the 14-bit ITU national point code. This can be verified in the `NPCFMTI` field of the `rtrv-stpopts` command output. For this example, the 14-bit ITU national point codes 7-55-5 and 0-86-7, using the 3-8-3-0 point code format, are converted into a single number.

1. Convert each part of the point code into a binary number using a scientific calculator.

The results are as follows.

- a) 7-55-5 = 111 00110111 101
- b) 0-86-7 = 000 01010110 111

2. Combine each part of the point code into a single binary number as follows.

- a) 111 00110111 101 = 11100110111101
- b) 000 01010110 111 = 00001010110111

**Note:** If the binary number has any zeros at the beginning of the number, remove these zeros as they are not necessary.

In this example, the binary equivalent for the point code 0-86-7 (00001010110111) contains four zeros at the beginning of the binary number. When the leading zeros are removed from the binary number, the resulting binary number is now 1010110111.

3. Convert the binary number to a decimal number using the same scientific calculator used in step 1.
  - a) The binary number 11100110111101 converts to the decimal number 14781.
  - b) The binary number 1010110111 converts to the decimal number 695.

## Gateway Screening Using Duplicate ITU National Point Codes

**Note:** The Duplicate ITU National Point Code feature applies only to 14-bit ITU national point codes.

Gateway screening does not support the Duplicate ITU National Point Code Support feature. The point code value specified with the `npc` parameter can only be a 5-digit number and cannot contain any group code values. However, by assigning a different screenset to the linksets that have different group codes, you can screen on ITU national point codes that have group codes assigned to them. The screenset is assigned to the linkset with the `scrn` parameter of either the `ent -1s` or `chg -1s` command.

For example, in the network in *Figure 2: Sample Network Showing Gateway Screening Using Duplicate ITU National Point Codes*, if you want to screen out MSUs coming from OPC 6217 in group GE, but allow MSUs coming from OPC 6217 in group FR, you could assign different screensets to linksets LSB1 and LSB2. The screenset assigned to linkset LSB1 would allow MSUs from OPC 6217. The screenset assigned to linkset LSB2 would block MSUs from OPC 6217.

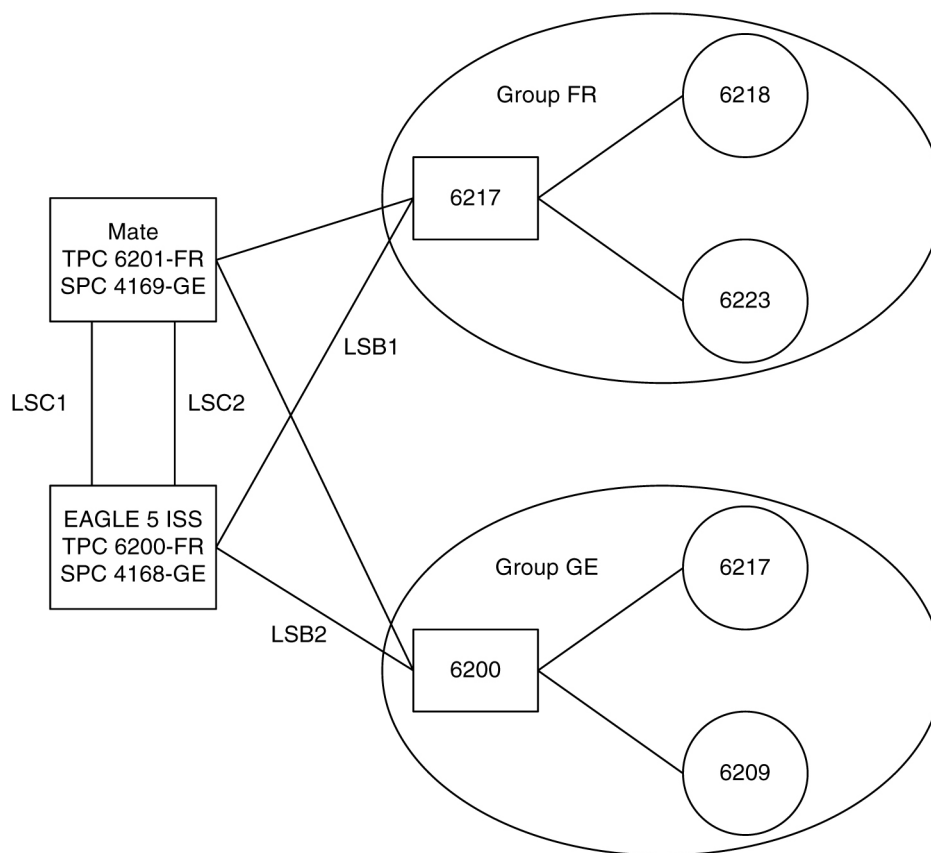

Figure 2: Sample Network Showing Gateway Screening Using Duplicate ITU National Point Codes

## Gateway Screening Configuration

Gateway screening can be configured in a variety of ways, depending on the criteria you wish to screen the messages for. The examples used in these procedures are based on seven example configurations ([Figure 4: Gateway Screening Configuration - Example 1](#) through [Figure 10: Gateway Screening Configuration - Example 7](#)). Each example configuration shows the screening order used by the EAGLE, with the screening criteria for each screen, and the order that these screens are added to the database to achieve the screening order, with the command entry required to enter the screening criteria into the database.

Each procedure adding a gateway screening entity to the database contains a table showing the parameters and the data used for the command examples.

**Note:** The gateway screening rules table can contain a maximum of 362,700 rules.

The EAGLE can contain a maximum of 255 screen sets.

Each screen set can contain a maximum of 4,000 rules, however the total number of rules contained in all the screen sets cannot exceed 362,700.

These general rules apply to configuring gateway screening entities in the database. Each procedure contains any rules that are specific to that procedure.

1. The gateway screening feature must be turned on before gateway screening entities can be added to the database.

Verify this by entering the `rtrv-feat` command. If the gateway screening feature is off, it can be turned on by entering the `chg-feat:gws=on` command.

**Note:** Once the gateway screening feature is turned on with the `chg-feat` command, it cannot be turned off

2. A TSM running the GLS application `GPL` must be configured in the database with the `ent-card:type=tsm:appl=gl:loc=<TSM Card Location>` command.

Verify this with the `rtrv-card` command.

3. Changing or removing an existing gateway screening entity will change the screening order for the messages on the linkset.

Verify the new screening order before changing or removing any gateway screening entities.

4. If the screen set being added to the database includes existing screening references, messages in the linkset being screened will be screened against all entries in those screening references.

This could allow a message into the EAGLE that was not supposed to be allowed in, or a message blocked from the EAGLE that is supposed to be allowed in. Verify the contents of existing screening references to make sure that you want all messages in the linkset screened against all entries in the existing screening references.

5. The gateway screening entity specified by the `nsfi` and `nsr` parameters must be in the database.
6. If the `nsfi` and `nsr` parameters do not reference an existing screening entity, the `nsfi` parameter must be set to `stop` and the `nsr` parameter cannot be specified.

When the `nsfi` parameter is set to `stop`, the gateway screening process stops at the specified screen.

- The `actname` parameter, specifying the gateway screening stop action set assigned to the screen, can only be specified with the `nsfi=stop` parameter.



**Caution:** When Gateway Screening is in the screen test mode, as defined by the linkset parameters `gwsa=off` and `gws=on`, any action in the gateway screening stop action set specified by the `actname` parameter at the end of the gateway screening process will be performed.

- The word `SEAS` cannot be used as a value for the `scrn` parameter of the `ent-scrset`, `dlt-scrset`, and `chg-scrset` commands.

The word `SEAS` is used in the `rtrv-ls` command output, in the `SCRN` field, to show gateway linksets created on the `SEAS` interface. A gateway linkset can only be configured from a `SEAS` terminal and not from an `EAGLE` terminal. Gateway linksets can only be displayed from the `SEAS` interface.

- When removing gateway screening entities from the database, the specified entity cannot be removed if it is referenced by other gateway screening entities.

If it is referenced by other gateway screening entities, either the `nsfi` parameter in those gateway screening entities must be changed to `stop`, or the `nsfi` and `nsr` parameters in the those gateway screening entities must be changed to reference other gateway screening entities.

- Point code values containing all zeros, shown in the following list, cannot be specified for any gateway screening command:

- ANSI Point Code - 000-000-000
- ITU-I Point Code - 0-000-0

- A screening reference may contain both 14-bit and 24-bit ITU national point codes, only if the internal values of these point codes are not the same.

For example, the 14-bit ITU national point code 1 (`npc=1`) and the 24-bit ITU national point code 000-000-001 (`msa=0`, `ssa=0`, `sp=1`) cannot be specified for the same screening reference as both of these point codes have the same internal value. This would also apply to using the asterisk as a point code value. The `npc=*` and the `msa=*`, `ssa=*`, `sp=*` parameters cannot be specified in the same screening reference.

- If the last entry in the specified screening reference is removed from the database, the screening reference is removed from the database.

If an attempt is made to display that specified screening reference name (for example, entering the `rtrv-scr-opc:sr=iec` command after removing the last entry in the allowed OPC screen IEC), the output shows that the specified screening reference name is not in the database, as shown in this example. The following error message is displayed showing that the specified screening reference name could not be found in the database.

```
E2573 Cmd Rej: SR or NSR does not reference an existing SR
```

- The `EAGLE` screens messages in a hierarchical fashion.

For example, allowed OPC screens are checked before blocked OPC screens; blocked OPC screens are checked before allowed SIO screens, and so on. The gateway screening entities must be entered in reverse of the order that the screening process takes place (see [Figure 3: The Gateway Screening](#)

*Process*). To add gateway screening entities into the database, the first entity to be entered must be the entity that you want to stop screening the message on. The other entities follow in the proper order and the screen set is the last entity to be added into the database. The screen set entity must be in the database for gateway screening to take place. *Table 9: Gateway Screening Process and Provisioning Order* The following lists shows the order of the MTP gateway screening process and the SCCP gateway screening process and the order that these gateway screening entities must be entered into the database.

**Table 9: Gateway Screening Process and Provisioning Order**

MTPGateway Screening Order		SCCPGateway Screening Order	
Screening Order	Order of Entry into the Database	Screening Order	Order of Entry into the Database
1. Screen Set	1. Allowed DESTFLD	1. Screen Set	1. Allowed AFTPC
2. Allowed OPC	or Allowed ISUP*	2. Allowed OPC	2. Allowed CDPA
3. Blocked OPC	2. Blocked DPC	3. Blocked OPC	3. Allowed TT
4. Allowed SIO	3. Allowed DPC	4. Allowed SIO	4. Allowed CGPA
5. Allowed DPC	4. Allowed SIO	5. Allowed DPC	5. Blocked DPC
6. Blocked DPC	5. Blocked OPC	6. Blocked DPC	6. Allowed DPC
7. Allowed DESTFLD	6. Allowed OPC	7. Allowed CGPA	7. Allowed SIO
or Allowed ISUP*	7. Screen Set	8. Allowed TT	8. Blocked OPC
		9. Allowed CDPA	9. Allowed OPC
		10. Allowed AFTPC	10. Screen Set
* The allowed ISUP screen can contain ISUP and TUP message types.			

Using the `ent-ls` or `chg-ls` commands, the screen set can then be assigned to a linkset and all messages on that linkset are screened for acceptance into the network.

When the `copy-disk` or `copy-tbl` commands are issued, the database on disk is locked. A DB Timeout alarm is generated due to the LIM cards inability to download GWS data. Once the command completes, the LIM card is able to download the dataset.

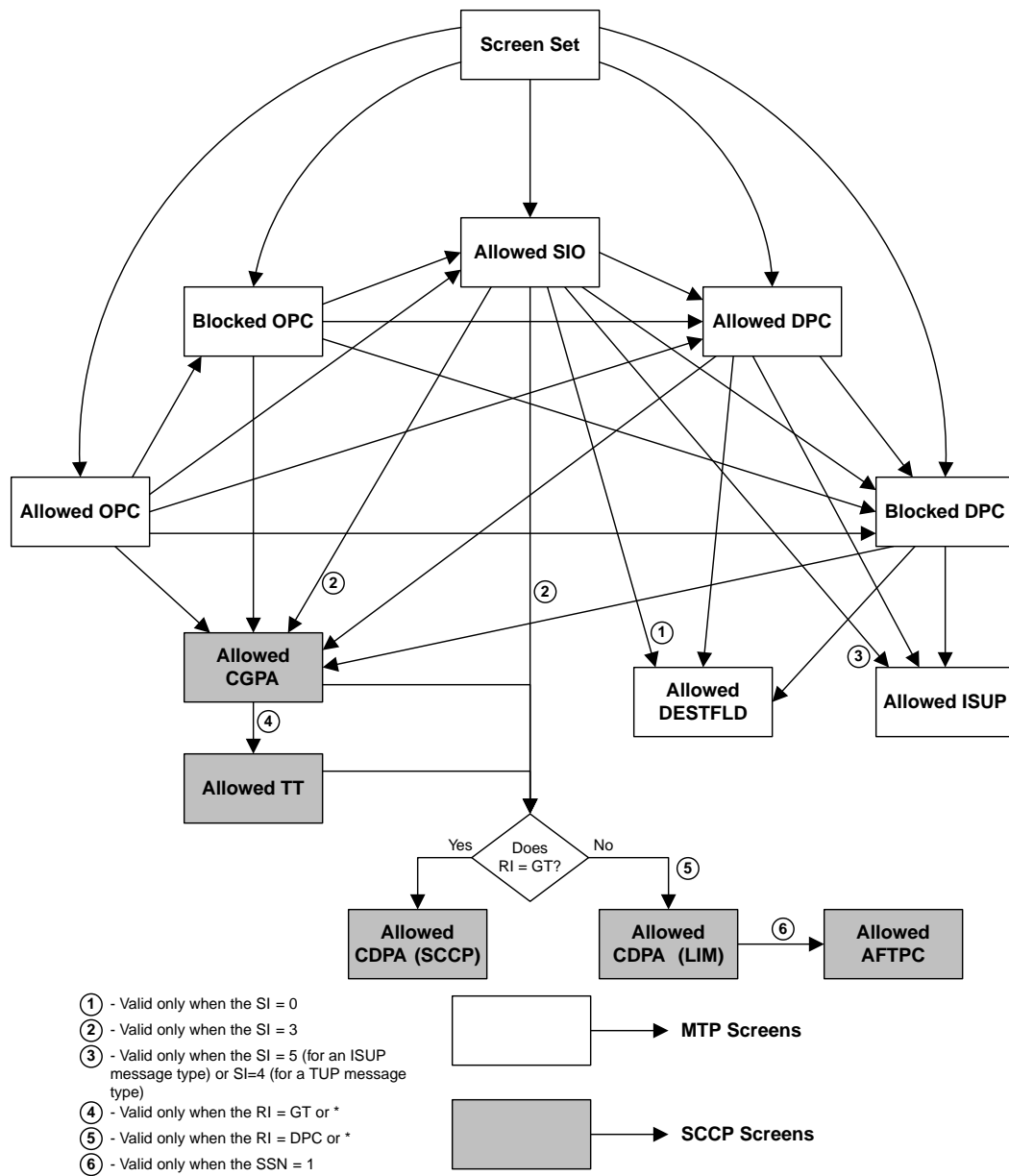

Figure 3: The Gateway Screening Process

## Gateway Screening Configuration Examples

### Example 1

Example 1 screens the messages in a linkset for the following criteria. [Figure 4: Gateway Screening Configuration - Example 1](#) shows the screening order the EAGLE uses and the order that the screens must be entered into the database.

- Allow into the EAGLE messages containing the following items
  - The OPC 001-001-001
  - The DPC 003-003-003
  - The calling party address (CGPA) 006-006-006, with the subsystem number of 253 and the routing indicator (*ri*) of *dpc* and the SCCP message type of UDT
  - The called party address (CDPA) 003-003-003 with the subsystem number of 001, and the SCMG format ID of 050
  - The allowed affected point code (AFTPC) of 008-008-008 with the subsystem number of 250
- Block from the EAGLE messages containing these items
  - The OPC 001-002-002
  - The DPC 004-004-004
- The message that passes the gateway screening criteria is copied for the STPLAN application (specified with the *actname* parameter and the name of the gateway screening stop action set containing the *COPY* gateway screening stop action).

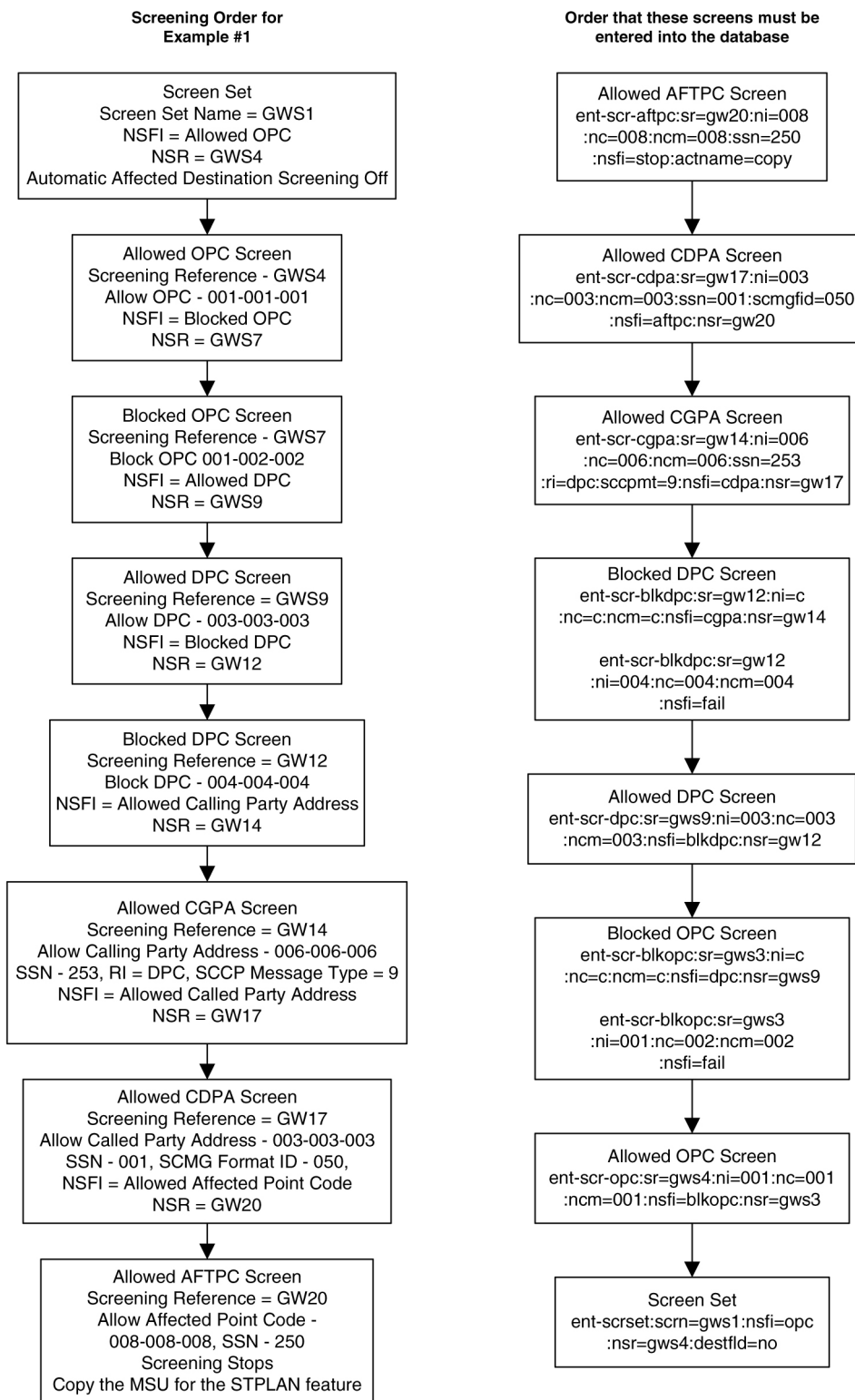

Figure 4: Gateway Screening Configuration - Example 1



## Example 2

Example 2 screens the messages in a linkset for the following criteria. [Figure 5: Gateway Screening Configuration - Example 2](#) shows the screening order the EAGLE uses and the order that the screens must be entered into the database.

- Allow messages containing the following items into the EAGLE

The following SIO information:

- The network indicator code of 2 (`nic=2`)
- The service indicator of 3 (`si=3`)
- Message priorities ranging from 1 to 3 (`:pri=1&&3`)

The calling party address (CGPA) 7-100-4, with the subsystem number of 254 and the routing indicator (`ri`) of \*, and the SCCP message type of UDTS

The called party address (CDPA) 5-117-2 with the subsystem number of 254

- Block messages containing the OPC 4-250-3 from the EAGLE

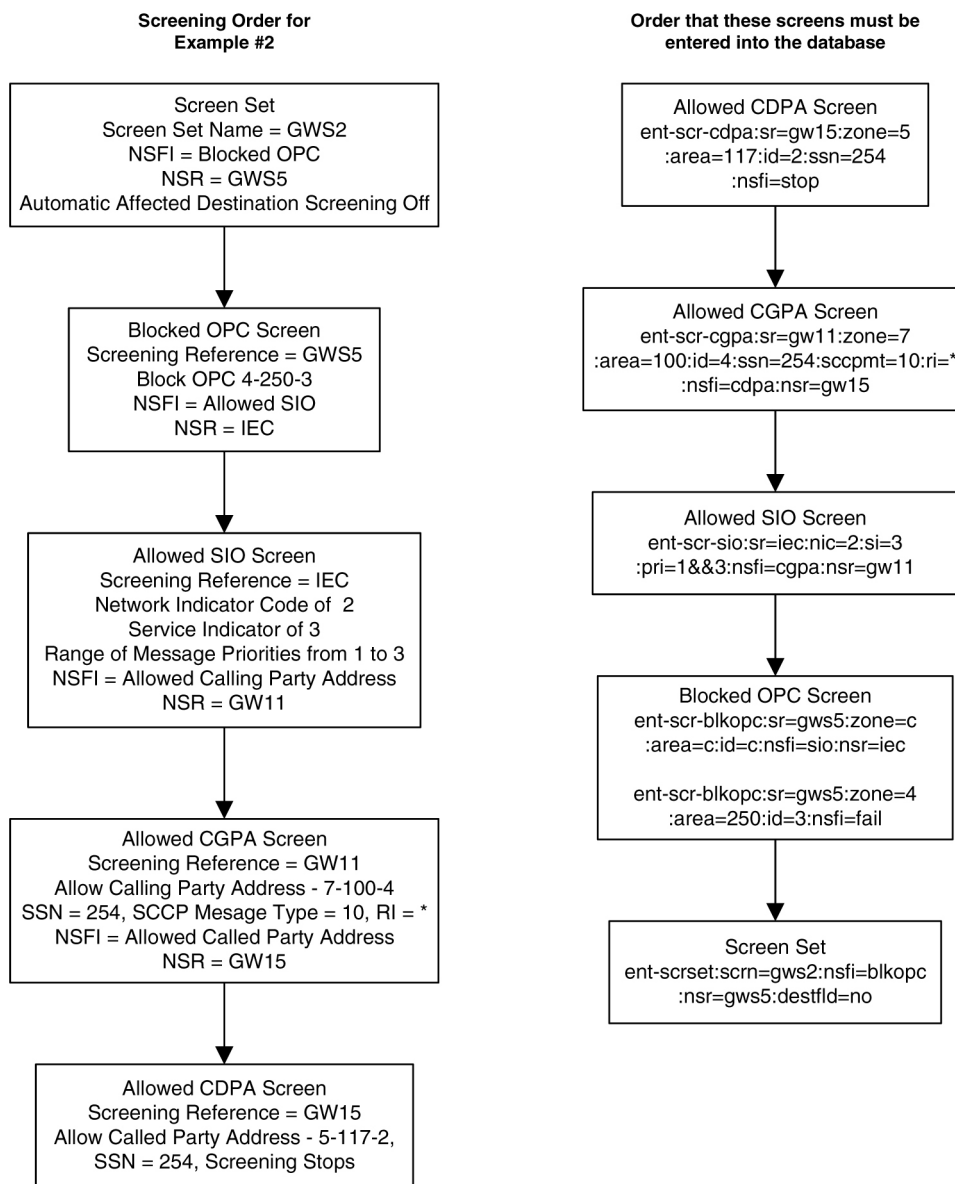

Figure 5: Gateway Screening Configuration - Example 2

### Example 3

Example 3 screens the messages in a linkset for the following criteria. [Figure 6: Gateway Screening Configuration - Example 3](#) shows the screening order the EAGLE uses and the order that the screens must be entered into the database.

- Allow into the EAGLE messages containing the following items

The DPCs from 070-070-025 to 070-070-135

The calling party address (CGPA) 007-007-007, with the subsystem number of 250 and the routing indicator (ri) of gt and the SCCP Message type of XUDT

The translation type (TT) 250

The called party address (CDPA) 006-006-006 with the subsystem number of 253

- Block messages containing the DPC 005-005-005 from the EAGLE
- Automatic Destination Field screening is on.

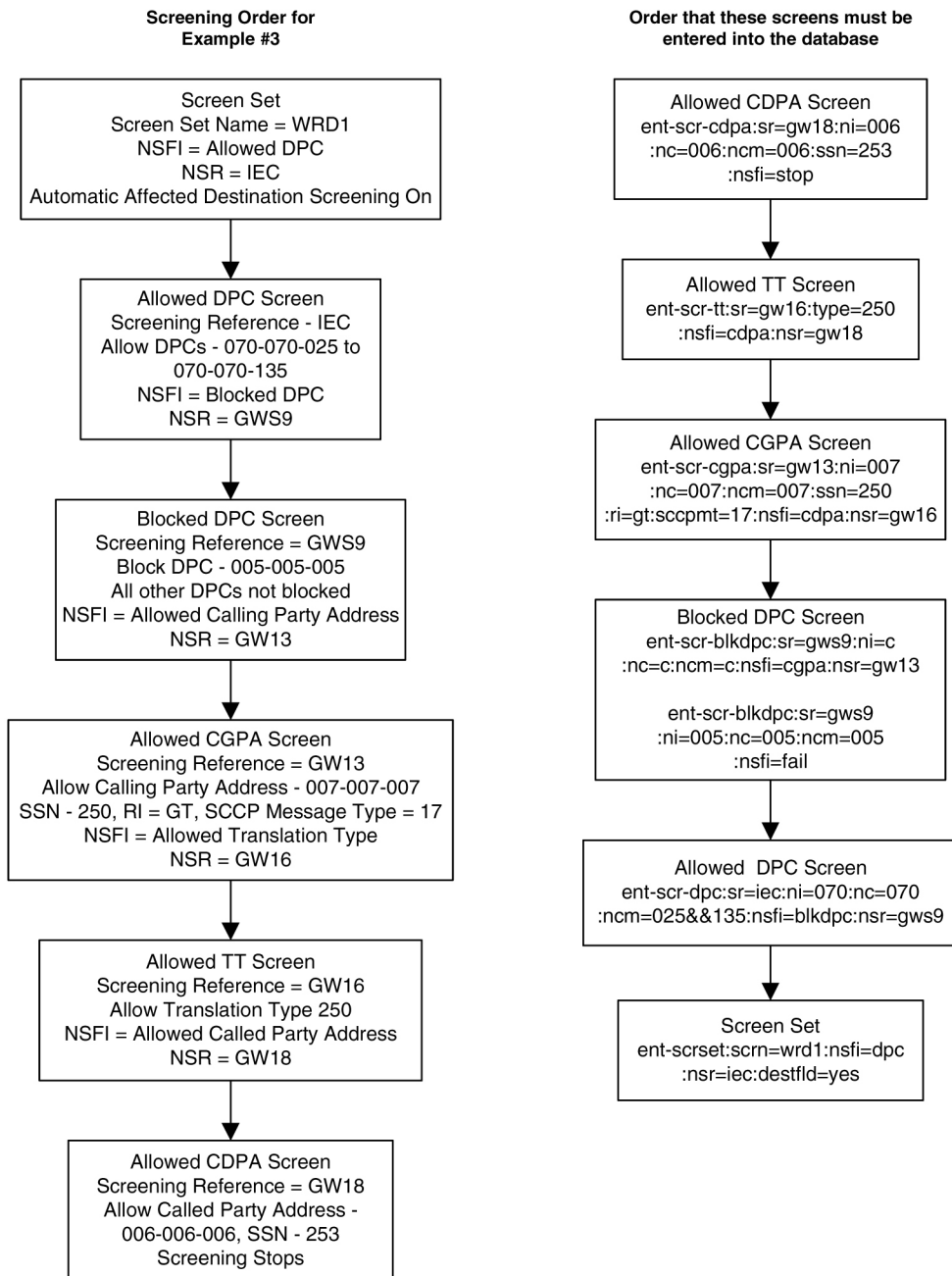

Figure 6: Gateway Screening Configuration - Example 3

### Example 4

Example 4 screens the messages in a linkset for the following criteria. [Figure 7: Gateway Screening Configuration - Example 4](#) shows the screening order the EAGLE uses and the order that the screens must be entered into the database.

- Allow messages containing the following items into the EAGLE

The following SIO information:

- The network indicator code of 2 (`nic=2`)
- The service indicator of 3 (`si=3`)
- Message priority of 3 (`pri=3`)

The called party address (CDPA) 007-007-007 with the subsystem number of 001 and SCMG format ID of 100

The allowed affected point code (AFTPC) of 010-010-010 with the subsystem number of 015

- The message that passes the gateway screening criteria is copied for the STPLAN application (specified with the `actname` parameter and the name of the gateway screening stop action set containing the `COPY` gateway screening stop action).
- Automatic Destination Field screening is on.

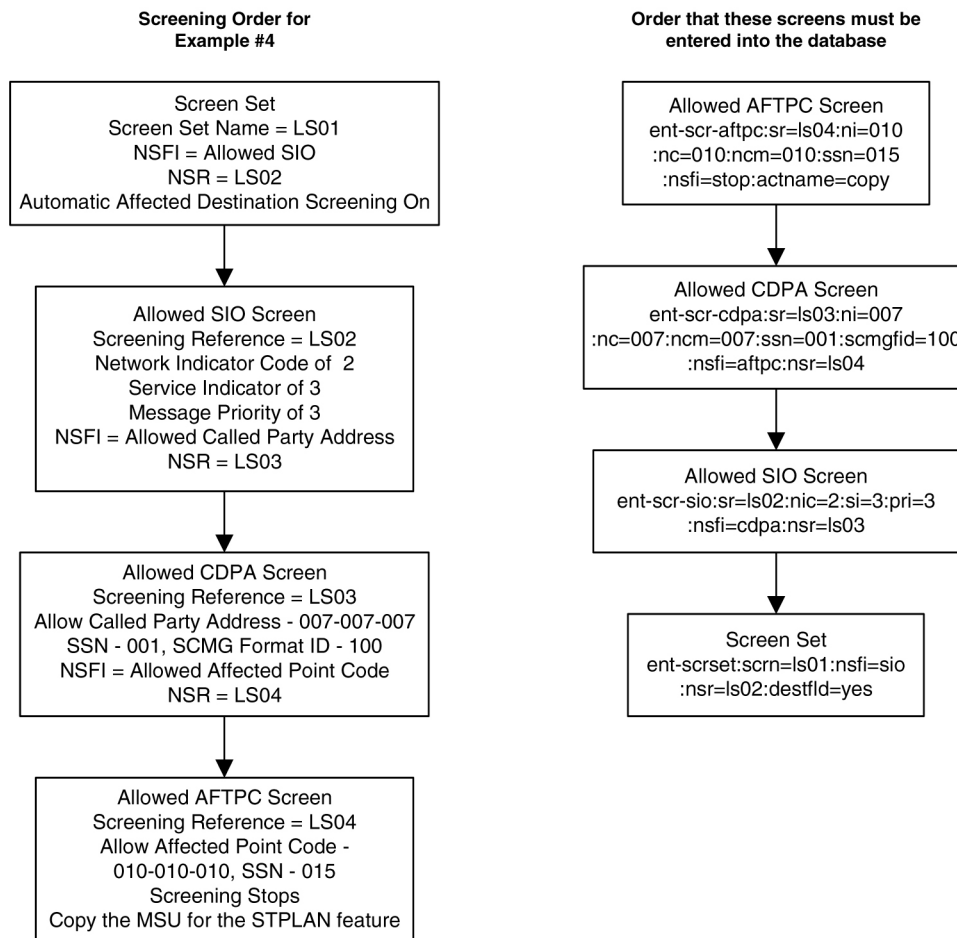

Figure 7: Gateway Screening Configuration - Example 4

### Example 5

Example 5 screens the messages in a linkset for the following criteria. [Figure 8: Gateway Screening Configuration - Example 5](#) shows the screening order the EAGLE uses and the order that the screens must be entered into the database.

- Allow into the EAGLE messages containing the following items
  - The OPC 010-010-010
  - The following SIO information:
    - The network indicator code of 2 (*nic=2*)
    - The service indicator of 0 (*si=0*)
    - Heading code 0 of 4 (*h0=4*)
    - Heading code 1 of 5 (*h1=5*)
    - Message priority of 3 (*pri=3*)
  - The allowed affected destination field (DESTFLD) of 100-100-100
- Block messages containing the OPC 020-020-020 from the EAGLE

- The message that passes the gateway screening criteria is copied for the STPLAN application and is redirected for the gateway screening redirect function (specified with the actname parameter and the name of the gateway screening stop action set containing the COPY and RDCT gateway screening stop actions).

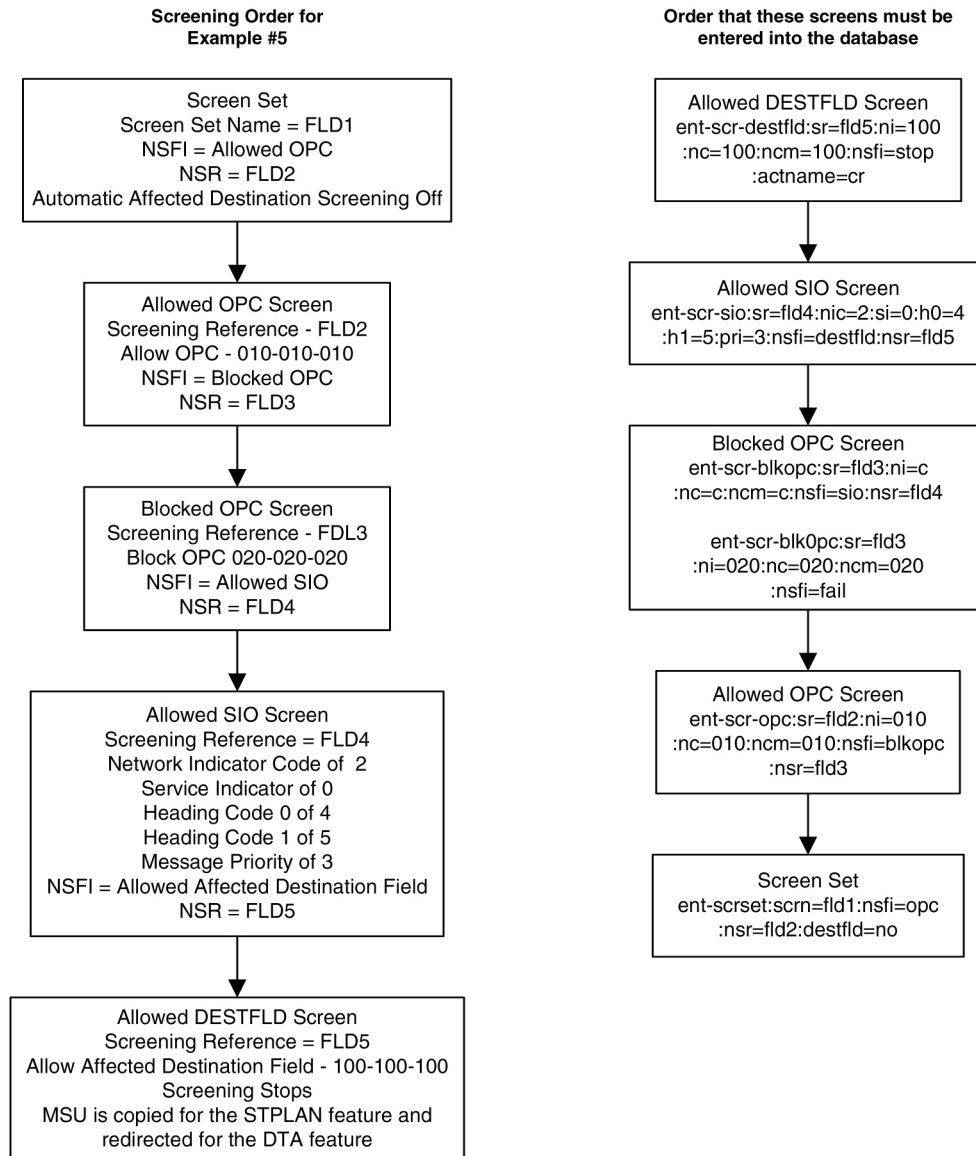

Figure 8: Gateway Screening Configuration - Example 5

### Example 6

Example 6 screens the messages in a linkset for the following criteria. [Figure 9: Gateway Screening Configuration - Example 6](#) shows the screening order the EAGLE uses and the order that the screens must be entered into the database.

- Allow into the EAGLE messages containing the following items

The OPC 015-015-015

The following SIO information:

- The network indicator code of 2 (*nic=2*)
- The service indicator of 5 (*si=5*)
- Message priority of 3 (*pri=3*)

The allowed ISUP message type (ISUP) of 135

- Block messages containing the OPC 025-025-025 from the EAGLE
- The message that passes the gateway screening criteria is copied for the STPLAN application and is redirected for the gateway screening redirect function (specified with the *actname* parameter and the name of the gateway screening stop action set containing the COPY and RDCT gateway screening stop actions).

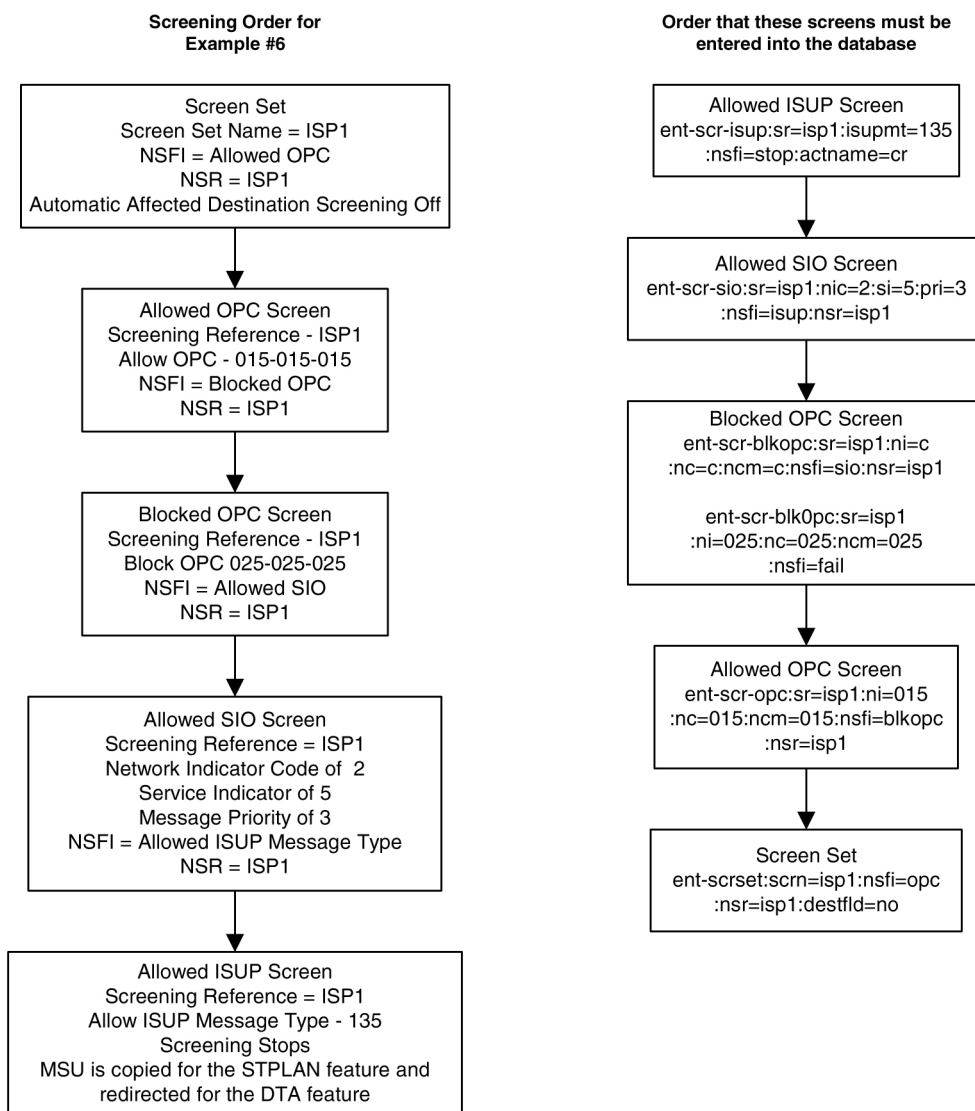

Figure 9: Gateway Screening Configuration - Example 6

### Example 7

Example 7 screens the messages in a linkset for the following criteria. *Figure 10: Gateway Screening Configuration - Example 7* shows the screening order the EAGLE uses and the order that the screens must be entered into the database.

- Allow into the EAGLE messages containing the following items:
  - TUP messages containing these items:
    - The OPC 017-017-017
    - The DPC 050-034-049
    - The following SIO information:
      - The network indicator code of 2 (`nic=2`)
      - The service indicator of 4 (`si=4`)
      - Message priority of 3 (`pri=3`)
    - The allowed TUP message type of 100
  - ISUP messages containing these items:
    - The OPC 017-017-017
    - The DPC 073-200-059
    - The following SIO information:
      - The network indicator code of 2 (`nic=2`)
      - The service indicator of 5 (`si=5`)
      - Message priority of 3 (`pri=3`)
    - The allowed ISUP message type of 139
- The messages, both TUP and ISUP, that pass the gateway screening criteria are copied for the STPLAN application and are redirected for the gateway screening redirect function (specified with the `actname` parameter and the name of the gateway screening stop action set containing the COPY and RDCT gateway screening stop actions).



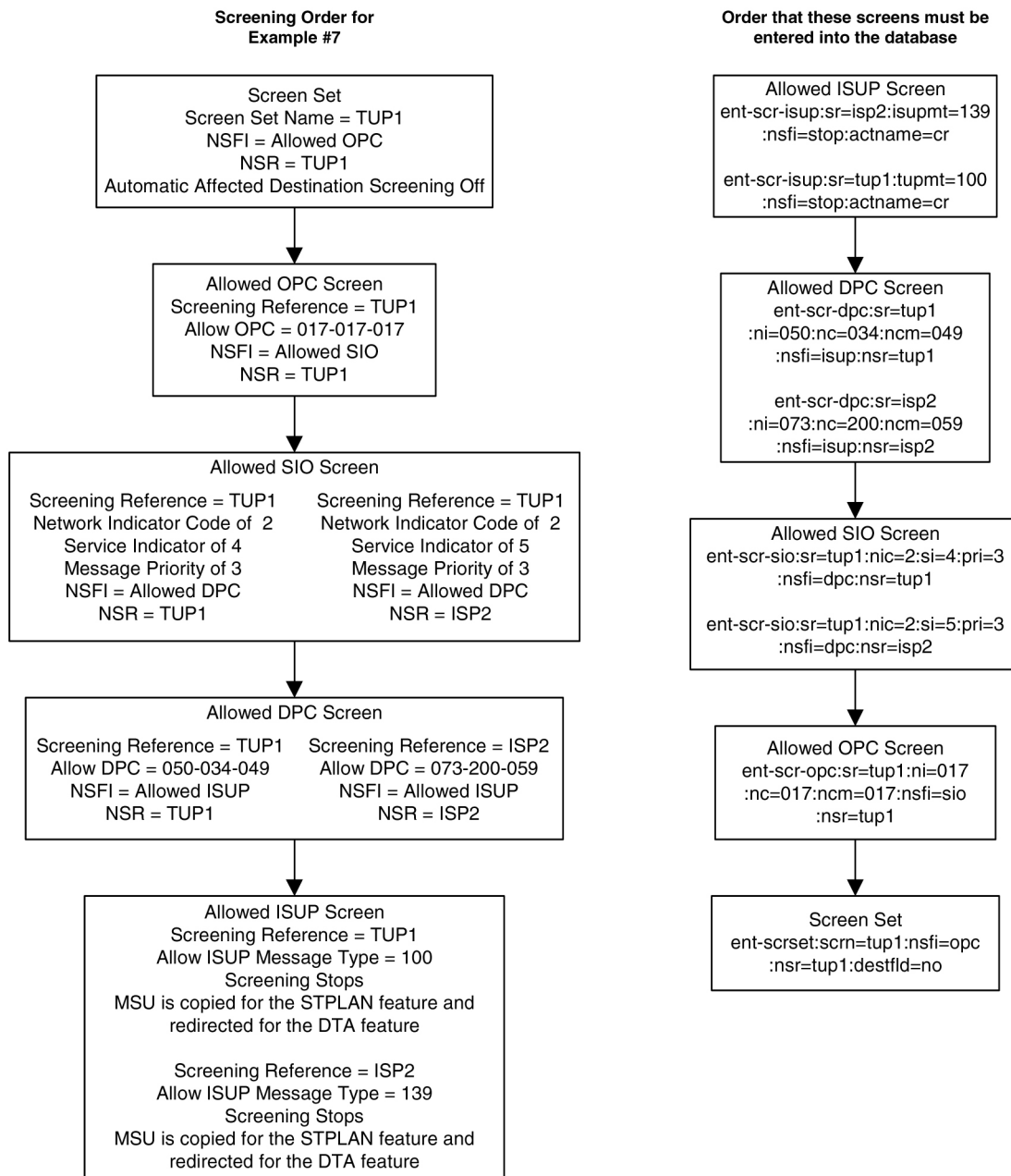

Figure 10: Gateway Screening Configuration - Example 7

## Adding a GLS Card

This procedure is used to add a card to support the gateway screening feature (a GLS card), shown in [Table 10: GLS Card Types](#), using the ent-card command.

Table 10: GLS Card Types

Card Type	Part Number
E5-TSM	870-2943-01

The `ent-card` command uses these parameters.

`:loc` – The location of the card being added to the database.

`:type` – The type of card being added to the database. For this procedure, the value of this parameter is `tsm`.

`:appl` – The application software that is assigned to the card. For this procedure, the value of this parameter is `gls`.

`:force` – Allow the LIM to be added to the database even if there are not enough service modules to support the number of LIMs in the EAGLE 5. This parameter is obsolete and is no longer used.

The shelf to which the card is to be added, must already be in the database. This can be verified with the `rtrv-shlf` command. If the shelf is not in the database, see the Adding a Shelf procedure in *Database Administration – System Management User's Guide*.

The card cannot be added to the database if the specified card location already has a card assigned to it.

Before the card can be configured in the database for the gateway screening feature, the gateway screening feature must be turned on with the `chg-feat` command. The `rtrv-feat` command can verify that the gateway screening feature is on.

**Note:** After the Gateway Screening feature is turned on with the `chg-feat` command, the feature cannot be turned off.

The E5-TSM requires two HIPR2 cards in the shelf where it is installed.

The EAGLE can contain a maximum of eight GLS cards. The examples in this procedure are used to add a GLS card in card slot 1212 to the database.

### Adding a GLS Card

1. Display the cards in the EAGLE using the `rtrv-card` command.

This is an example of the possible output. Cards should be distributed throughout the EAGLE for proper power distribution. Refer to *Installation Guide* for the shelf power distribution. This is an example of the possible output.

```
rlghncxa03w 13-06-17 09:58:31 GMT EAGLE5 45.0.0
CARD  TYPE      APPL      LSET NAME      LINK SLC  LSET NAME      LINK SLC
1101  DSM          VSCCP
1102  TSM          GLS
1113  E5MCAP       OAMHC
1114  E5TDM-A
1115  E5MCAP       OAMHC
1116  E5TDM-B
1117  E5MDAL
1201  LIMDS0       SS7ANSI      sp2           A         0         sp1           B         0
1203  LIMDS0       SS7ANSI      sp3           A         0
1204  LIMDS0       SS7ANSI      sp3           A         1
1206  LIMDS0       SS7ANSI      nsp3         A         1         nsp4           B         1
```

1211	TSM	GLS							
1216	DCM	STPLAN							
1308	LIMDS0	SS7ANSI	sp6	A	1	sp7	B	0	
1314	LIMDS0	SS7ANSI	sp7	A	1	sp5	B	1	
1317	DCM	STPLAN							

If the APPL field of the `rtrv-card` command output shows no cards assigned to the GLS application continue the procedure with [Step 2](#).

- Verify that the gateway screening feature is on, by entering the `rtrv-feat` command.

If the gateway screening feature is on, the GWS field should be set to on. For this example, the gateway screening feature is off.

**Note:** The `rtrv-feat` command output contains other fields that are not used by this procedure. If you wish to see all the fields displayed by the `rtrv-feat` command, see the `rtrv-feat` command description in *Commands User's Guide*.

If the Gateway Screening feature is on, continue the procedure with [Step 4](#)

If the Gateway Screening feature is not on, continue the procedure with [Step 3](#).

- If the gateway screening feature is not on, shown by the `GWS = off` entry in the `rtrv-feat` command output in [Step 2](#), turn the gateway screening feature on by entering this command.

```
chg-feat:gws=on
```

**Note:** After the Gateway Screening feature is turned on with the `chg-feat` command, it cannot be turned off.

When the `chg-feat` has successfully completed, this message should appear.

```
rlghncxa03w 06-10-25 15:27:30 GMT EAGLE5 36.0.0
CHG-FEAT: MASP A - COMPLTD
```

Continue the procedure with [Step 4](#).

- Display the GLS cards that are in the database by entering this command.

```
rept-stat-card:appl=glS
```

This is an example of the possible output.

```
rlghncxa03w 08-11-01 16:07:48 GMT EAGLE5 40.0.0
CARD   VERSION      TYPE      GPL          PST          SST          AST
1102   131-010-000    TSM       GLS          IS-NR        Active       -----
1211   131-010-000    TSM       GLSHC        IS-NR        Active       -----
```

Command Completed.

E5-TSMs are shown by the entry GLSHC in the GPL column of the `rept-stat-gpl` output. TSMs are shown by the entry GLS in the GPL column of the `rept-stat-gpl` output. Continue the procedure by performing one of these actions.

- If E5-TSMs are shown in the `rept-stat-card` output, and an E5-TSM is being added to the same shelf as the E5-TSMs shown in the `rept-stat-card` output, continue the procedure with [Step 6](#).

- If E5-TSMs are shown in the `rept-stat-card` output, and an E5-TSM is being added to a different shelf as the E5-TSMs shown in the `rept-stat-card` output, continue the procedure with [Step 5](#).
  - If E5-TSMs are not shown in the `rept-stat-card` output, and an E5-TSM is being added, continue the procedure with [Step 5](#).
5. Verify that HIPR2 cards are installed at card locations 9 and 10 in the shelf where the E5-TSM will be installed. Enter this command.

```
rept-stat-gpl:gpl=hipr2
```

This is an example of the possible output.

```
rlghncxa03w 09-07-01 11:40:26 GMT EAGLE5 41.1.0
GPL          CARD          RUNNING          APPROVED          TRIAL
HIPR2        1109          126-002-000     126-002-000     126-003-000
HIPR2        1110          126-002-000     126-002-000     126-003-000
HIPR2        1209          126-002-000     126-002-000     126-003-000
HIPR2        1210          126-002-000     126-002-000     126-003-000
HIPR2        1309          126-002-000     126-002-000     126-003-000
HIPR2        1310          126-002-000     126-002-000     126-003-000
HIPR2        2109          126-002-000     126-002-000     126-003-000
HIPR2        2110          126-002-000     126-002-000     126-003-000
Command Completed
```

If HIPR2 cards are installed at card locations 9 and 10 in the shelf where the E5-TSM will be installed, continue the procedure with [Step 6](#).

If HIPR2 cards are not installed in the shelf where the E5-TSM will be installed, refer to *Installation Guide* to install the HIPR2 cards. Once the HIPR2 cards have been installed, continue the procedure with [Step 6](#).

6. Verify that the GLS card has been physically installed into the proper location.

If the GLS card is in the required card location, continue the procedure with [Step 7](#).

If the GLS card is not in the required card location, continue with [Step 7](#).



**Caution:** If the versions of the flashGPLs on the E5-TSM do not match the flashGPL versions in the database when the E5-TSM is inserted into the card slot, UAM 0002 is generated indicating that these GPL versions do not match. If UAM 0002 has been generated, perform the alarm clearing procedure for UAM 0002 in *Unsolicited Alarm and Information Messages Reference* before proceeding with this procedure.

7. Add the GLS card to the database using the `ent-card` command.

For this example, enter this command.

```
ent-card:loc=1212:type=tsm:appl=glS
```

When this command has successfully completed, this message should appear.

```
rlghncxa03w 06-10-25 15:28:30 GMT EAGLE5 36.0.0
ENT-CARD: MASP A - COMPLTD
```

8. Verify the changes using the `rtrv-card` command with the card location specified.

For this example, enter this command.

```
rtrv-card:loc=1212
```

This is an example of the possible output.

```
rlghncxa03w 06-10-25 15:29:30 GMT EAGLE5 36.0.0
CARD   TYPE      APPL      LSET NAME      LINK SLC  LSET NAME      LINK SLC
1212   TSM          GLS
```

- Put the card in service using the `rst-card` command with the card location specified in [Step 7](#). For this example, enter this command.

```
rst-card:loc=1212
```

When this command has successfully completed, this message should appear.

```
rlghncxa03w 06-10-28 08:21:07 GMT EAGLE5 36.0.0
Card has been allowed.
```

- Backup the new changes using the `chg-db:action=backup:dest=fixed` command.

These messages should appear, the active Maintenance and Administration Subsystem Processor (MASP) appears first.

```
BACKUP (FIXED) : MASP A - Backup starts on active MASP.
BACKUP (FIXED) : MASP A - Backup on active MASP to fixed disk complete.
BACKUP (FIXED) : MASP A - Backup starts on standby MASP.
BACKUP (FIXED) : MASP A - Backup on standby MASP to fixed disk complete.
```

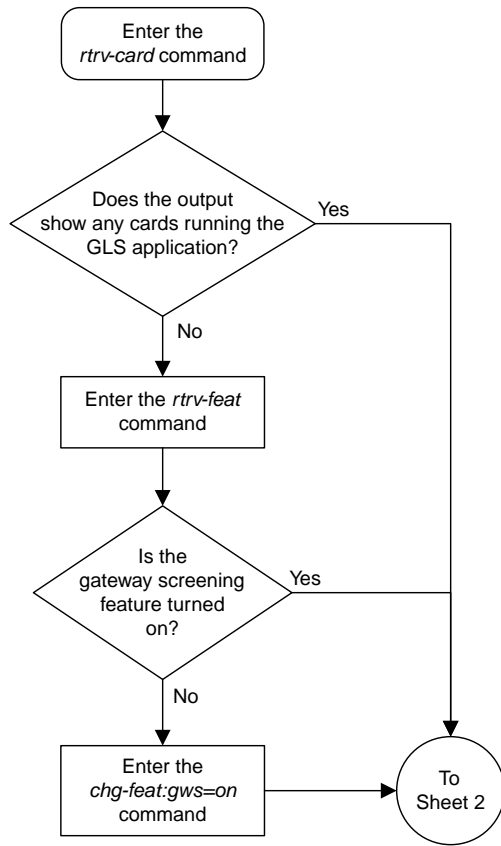

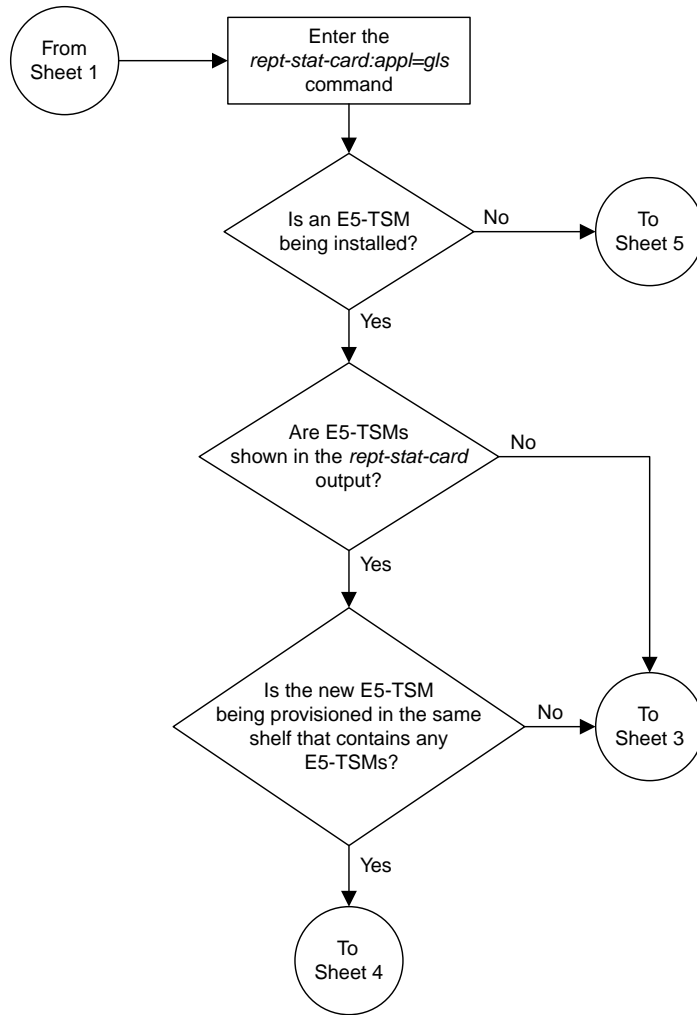

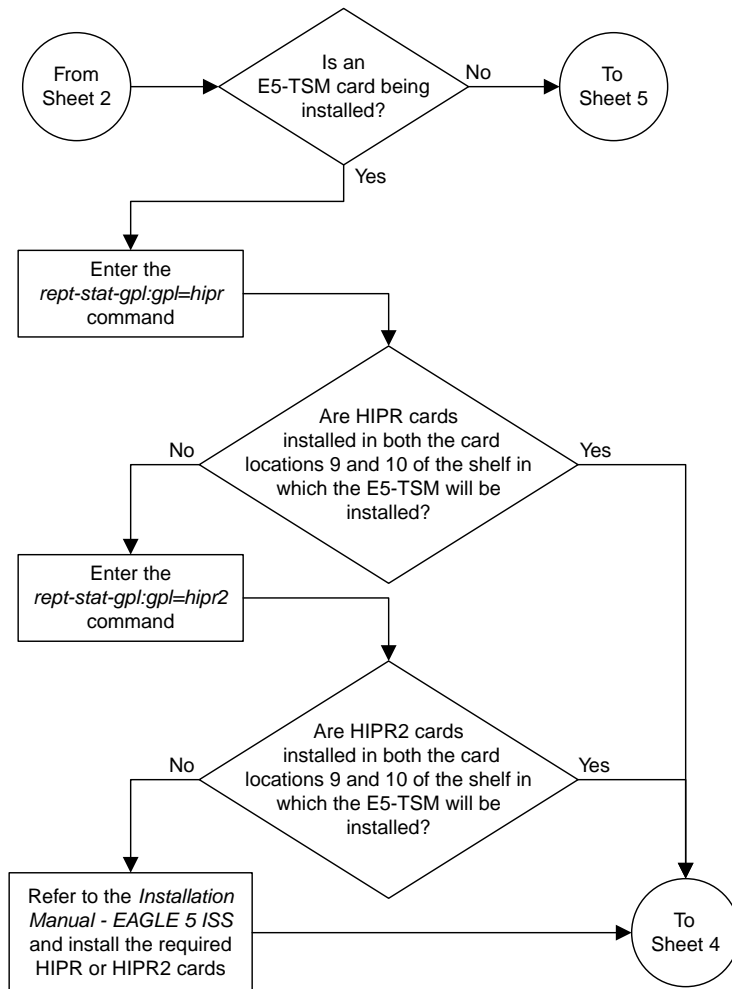



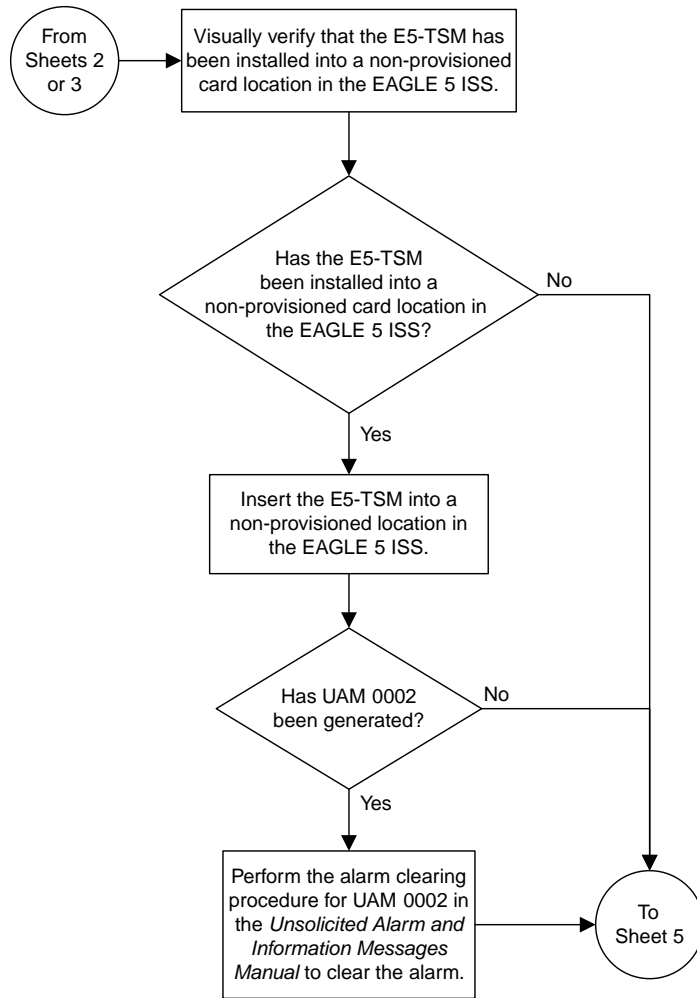

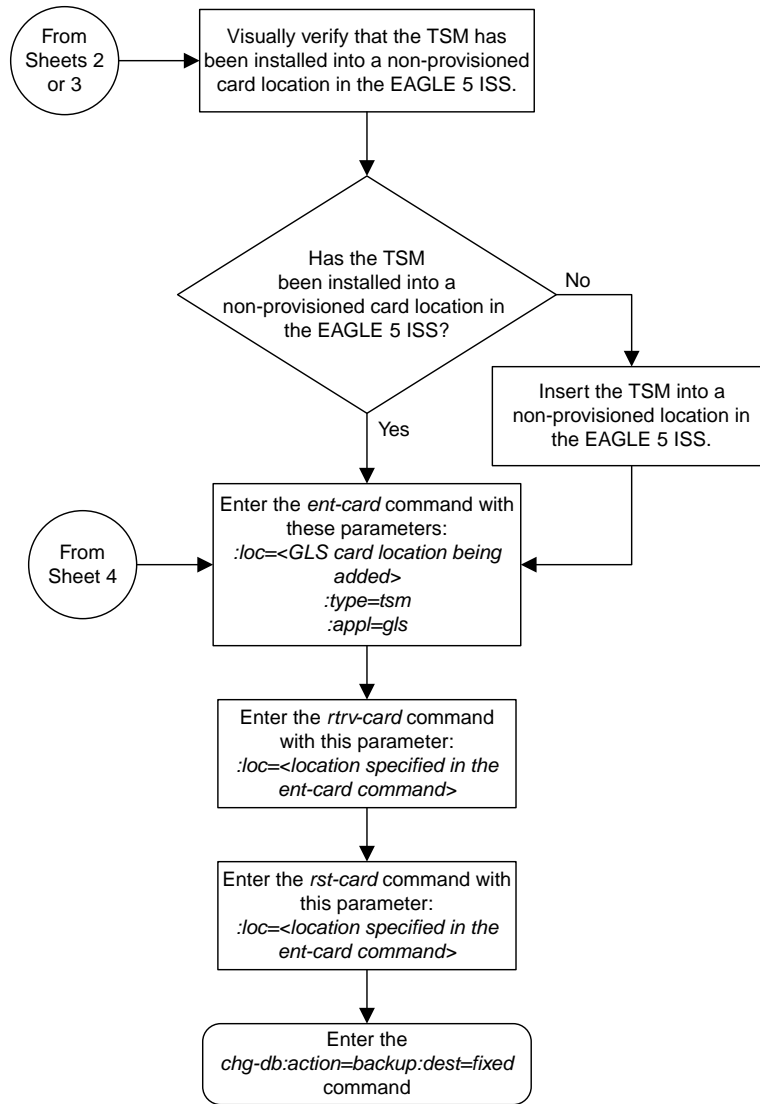

Sheet 5 of 5

Figure 11: Adding a GLS Card to the Database

## Removing a GLS Card

This procedure is used to remove GLS cards, used by gateway screening, from the database using the `dlt-card` command. The card cannot be removed if it does not exist in the database.



**Caution:** If the GLS card is the last GLS card in service, removing this card from the database will disable the Gateway Screening feature.

### CAUTION

The examples in this procedure are used to remove the GLS card in card location 1205.

### Canceling the `REPT-STAT-CARD` Command

Because the `rept-stat-card` command used in this procedure can output information for a long period of time, the `rept-stat-card` command can be canceled and the output to the terminal stopped. There are three ways that the `rept-stat-card` command can be canceled.

- Press the F9 function key on the keyboard at the terminal where the `rept-stat-card` command was entered.
- Enter the `canc-cmd` without the `trm` parameter at the terminal where the `rept-stat-card` command was entered.
- Enter the `canc-cmd:trm=<xx>`, where `<xx>` is the terminal where the `rept-stat-card` command was entered, from another terminal other than the terminal where the `rept-stat-card` command was entered. To enter the `canc-cmd:trm=<xx>` command, the terminal must allow Security Administration commands to be entered from it and the user must be allowed to enter Security Administration commands. The terminal's permissions can be verified with the `rtrv-secu-trm` command. The user's permissions can be verified with the `rtrv-user` or `rtrv-secu-user` commands.

For more information about the `canc-cmd` command, go to *Commands User's Guide*.

1. Display the cards in the database using the `rtrv-card` command.

This is an example of the possible output.

```
rlghncxa03w 13-06-17 09:58:31 GMT EAGLE5 45.0.0
CARD  TYPE      APPL      LSET NAME      LINK SLC  LSET NAME      LINK SLC
1101  DSM          VSCCP
1102  TSM          GLS
1103  DCM          STPLAN
1104  DCM          STPLAN
1113  E5MCAP       OAMHC
1114  E5TDM-A
1115  E5MCAP       OAMHC
1116  E5TDM-B
1117  E5MDAL
1201  LIMDS0      SS7ANSI   lsn1          A    0    lsn2          B    1
1203  LIMDS0      SS7ANSI   lsn2          A    0    lsn1          B    1
1205  TSM          GLS
```

2. Display the cards that are in service with the `rept-stat-card:stat=nr` command.

```
rept-stat-card:stat=nr
```

This is an example of the possible output.

```
rlghncxa03w 09-05-25 15:26:30 GMT EAGLE5 41.0.0
CARD  VERSION      TYPE   GPL      PST      SST      AST
1101  110-003-000    DSM    VS CCP   IS-NR    Active   -----
1102  110-003-000    TSM    GLS      IS-NR    Active   -----
1103  110-002-000    DCM    STPLAN  IS-NR    Active   -----
1104  110-002-000    DCM    STPLAN  IS-NR    Active   -----
1109  109-003-000    HMUX   BPHMUX  IS-NR    Active   -----
1110  109-003-000    HMUX   BPHMUX  IS-NR    Active   -----
1113  110-003-000    E5MCAP OAMHC   IS-NR    Active   -----
1114  -----        E5TDM          IS-NR    Active   -----
1115  110-003-000    E5MCAP OAMHC   IS-NR    Standby  -----
1116  -----        E5TDM          IS-NR    Active   -----
1117  -----        E5MDAL         IS-NR    Active   -----
1201  110-003-000    LIMDS0 SS7ANSI  IS-NR    Active   -----
1203  110-003-000    LIMDS0 SS7ANSI  IS-NR    Active   -----
1205  110-003-000    TSM    GLS      IS-NR    Active   -----
1209  109-003-000    HMUX   BPHMUX  IS-NR    Active   -----
1210  109-003-000    HMUX   BPHMUX  IS-NR    Active   -----
```

3. An GLS card is identified by the entry GLS in the APPL fields in the outputs in steps 1 and 2.

Remove the card from service using the `rmv-card` command and specifying the card location. If the GLS card to be inhibited is the only GLS card in service, shown in step 2, the `force=yes` parameter must also be specified. For this example, enter this command.

```
rmv-card:loc=1205
```

When this command has successfully completed, this message should appear.

```
rlghncxa03w 06-10-25 15:27:30 GMT EAGLE5 36.0.0
Card has been inhibited.
```

4. Remove the card from the database using the `dlt-card` command.

The `dlt-card` command has only one parameter, `loc`, which is the location of the card. For this example, enter this command.

```
dlt-card:loc=1205
```

When this command has successfully completed, this message should appear.

```
rlghncxa03w 06-10-25 15:28:30 GMT EAGLE5 36.0.0
DLT-CARD: MASP A - COMPLTD
```

5. Verify the changes using the `rtrv-card` command specifying the card that was removed in step 4.

For this example, enter this command.

```
rtrv-card:loc=1205
```

When this command has successfully completed, this message should appear.

```
E2144 Cmd Rej: Location invalid for hardware configuration
```

6. Backup the new changes using the `chg-db:action=backup:dest=fixed` command.

These messages should appear, the active Maintenance and Administration Subsystem Processor (MASP) appears first.

```
BACKUP (FIXED) : MASP A - Backup starts on active MASP.  
BACKUP (FIXED) : MASP A - Backup on active MASP to fixed disk complete.  
BACKUP (FIXED) : MASP A - Backup starts on standby MASP.  
BACKUP (FIXED) : MASP A - Backup on standby MASP to fixed disk complete.
```

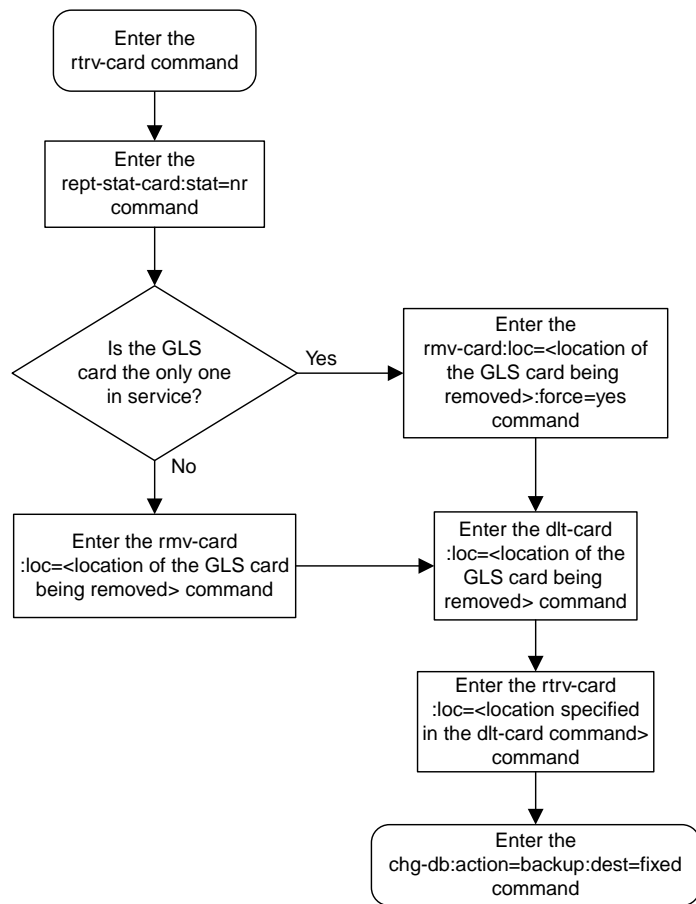

Figure 12: Removing a GLS Card

## E5-OAM Integrated GLS Feature Activation Procedure

This procedure is used to activate the integrated generic loading services (GLS) feature.

Before this feature can be enabled, the Eagle must have an E5 maintenance and administration subsystem processor (MASP) and the GWS feature must be activated. The GWS feature is unaffected by this feature being enabled and turned on.

The integrated GLS feature can be turned off after the feature is turned on; however, it cannot be disabled once the feature is enabled.

The Integrated GLS feature cannot be enabled with a temporary Feature Access Key (FAK).

For details about the commands used in this procedure, refer to *Commands User's Guide*.

When the integrated GLS feature is turned on:

- The E5-MASPs support GLS functionality. That means the E5-MASPs are able to accept the binding requests for GWS screen sets from network cards, bind the requested screen sets successfully, and load the screen sets to the requested network cards.
- The GLS cards shall remain in IS-NR state but will not serve any new binding requests from network cards.
- When Eagle is running in duplex mode, both active and standby E5-MASPs handle the binding request. The screenset binding load is dynamically distributed between Active and Standby E5 MASP. In simplex mode, active E5-MASP handles all binding requests from network cards.

When the integrated GLS feature is turned off (enabled or not), the E5-MASPs will not serve requests for binding screen sets. The GLS cards will handle new screenset binding requests.

When the integrated GLS feature activation procedure is completed, all GLS functionality automatically migrates from E5-TSM cards to E5-MASPs.

### Activating the Integrated GLS Feature

Complete these steps to activate the integrated GLS feature.

1. Verify that the GWS feature is activated using the `rtrv-feat` command.
2. If the GWS feature is not activated, activate the GWS feature using the instructions provided in [Gateway Screening Configuration](#) before proceeding.
3. Enter the `enable-ctrl-feat` command to enable the integrated GLS feature:  
`enable-ctrl-feat:partnum=89305601:fak=<Feature Access Key>`.
4. Enter `chg-ctrl-feat:partnum=8935601:status=on`

## Configuring Gateway Screening Stop Action Sets

This procedure is used to add a gateway screening stop action set to the database or change an existing gateway screening stop action set using the `chg-gws-actset` command.

The gateway screening stop action sets define the actions that are performed on the MSU when the gateway screening process has stopped. These gateway screening stop action sets replace the `copy`

and `redirect` parameters that have been used with the gateway screening commands when the gateway screening process stops.

The database can contain a maximum of 16 gateway screening stop action sets, with each set containing a maximum of 10 gateway screening stop actions. These are the current gateway screening stop actions.

- COPY – copy the MSU for the STPLAN feature
  - RDCT – redirect the MSU for the DTA feature
  - CNCF – convert the PIP parameter with the GN parameter or the GN parameter with the PIP parameter in the ISUPIAM message for the Calling Name Conversion Facility feature.
  - TLNP – ISUPIAMs that pass gateway screening are processed either by the ISUPNP with EPAP feature or by the Triggerless LNP feature. This gateway screening stop action is discussed in more detail in the [Configuring TLNP Gateway Screening Stop Action Sets](#) procedure.
  - TINP – ISUP IAMs that pass gateway screening are intercepted by the Triggerless ISUP based Number Portability (TINP) feature and converted to include the routing number (RN) if the call is to a ported number. This gateway screening stop action can be specified only if the TINP stop action is assigned to a stop action set. If the TINP feature is enabled and turned on, the ISUP NP with EPAP feature (if the ISUP NP with EPAP feature is enabled) is overridden.
  - TIF, TIF2, TIF3 - TIF processing is applied to the messages that pass Gateway Screening. These gateway screening stop actions can be specified only if the `tinp`, `tif`, `tif2`, or `tif3` stop action is already assigned to a gateway screening stop action set, or if any of these features are enabled.
    - TIF Number Portability
    - TIF SCS Forwarding
    - TIF Simple Number Substitution
  - SCCP - This gateway screening stop action is associated with the MTP Routed GWS Stop Action feature (part number 893035601) and can be specified only if this feature is enabled. If this stop action is configured and the MTP Routed GWS Stop Action feature is turned on, MTP routed SCCP UDT/XUDT messages that pass Gateway Screening are forwarded to the service modules for further processing.
- Note:** The MTP Msgs for SCCP Apps feature (part number 893017401) takes precedence over the MTP Routed GWS Stop Action feature. If the MTP Msgs for SCCP Apps feature is enabled and turned on, all MTP routed SCCP messages are forwarded to the service modules for further processing whether or not the SCCP gateway screening stop action is specified.
- NONE – no action is performed on the MSU.
  - DUP - This gateway screening stop action is used to duplicate the incoming MSU without affecting the processing of the original MSU. The duplicated MSU will be routed to a point code specified in the STPOPTS table under the GDPC parameter. The duplicated MSU is a priority 0 message.
  - STRIP - This gateway screening stop action is used to de-capsulate the MSU that was encapsulated by the REDIRECT stop action.



**Caution:** When Gateway Screening is in the screen test mode, as defined by the linkset parameters `gwsa=off` and `gws=on`, any action in the gateway screening stop action sets created in this procedure will be performed.

The `chg-gws-actset` command uses these parameters.

`:actid` – The ID number of the gateway screening stop action set. The value of this parameter is from 4 to 16.



:actname – The name of the gateway screening stop action set consisting of 1 alphabetic character followed by up to 5 alphanumeric characters.

:force=yes – The force=yes parameter must be specified when changing the gateway screening stop actions of an existing gateway screening stop action set.

:all=none – sets the value of each gateway screening stop action in the gateway screening stop action set to none. Refer to the procedure [Removing Gateway Screening Stop Action Sets](#) for information about using this parameter.

:act1 to :act10 – The ten gateway screening stop actions for each gateway screening stop action set. Gateway screening stop action 1 (act1) is the first stop action to be performed and gateway screening stop action 10 (act10) is the last stop action to be performed on the MSU.

The first three gateway screening stop action sets (actid=1, actid=2, and actid=3) are already defined with the existing gateway screening stop actions shown in [Table 11: Gateway Screening Stop Action Definitions If the CNCF Feature Is Off](#).

**Table 11: Gateway Screening Stop Action Definitions If the CNCF Feature Is Off**

Gateway Screening Stop Action ID	Gateway Screening Stop Action Set Name	Stop Action 1	Stop Action 2	Action Performed by the EAGLE
1	copy	copy	—	copy the MSU for the STPLAN feature
2	rdct	rdct	—	redirect the MSU for the DTA feature
3	cr	copy	rdct	copy the MSU for the STPLAN feature and redirect the MSU for the DTA feature

The word none cannot be used for the actname parameter.

The force=yes parameter must be specified when changing an existing gateway screening stop action set.

If the copy gateway screening action is specified with the chg-gws-actset command, it must be specified with the act1 parameter.

A specific gateway screening stop action can only be specified once in a specific gateway screening stop action set. For example, the chg-gws-actset command cannot be executed if the copy gateway screening stop action is specified for gateway screening stop action parameters act1 and act2 as shown in this command example.

```
chg-gws-actset:actid=4:act1=copy:act2=copy
```

The value of the actname parameter must be unique. The value of this parameter is used by the actname parameter in the gateway screening commands and is shown in the NSR/ACT field of the outputs of the retrieve gateway screening commands to define the action that is performed on the MSU that passes gateway screening.

When a gateway screening stop action set is being entered in to the database for the first time, the name of the gateway screening stop action set (actname) must be added to the database before any gateway screening stop actions are assigned to the gateway screening stop action set.

*Table 12: Gateway Screening Stop Action Set Parameter Combinations* shows the combinations of parameter values that can be specified for act1, act2, and act3 parameters for gateway screening stop action sets 4 through 16.

**Table 12: Gateway Screening Stop Action Set Parameter Combinations**

ACT1	ACT2	ACT3
cncf		
copy	cncf	
copy	cncf	rdct
cncf	rdct	
tinp		
copy	tinp	
tif		
copy	tif	
copy	cncf	tif
cncf	tif	
tif2		
copy	tif2	
copy	cncf	tif2
cncf	tif2	
tif3		
copy	tif3	
copy	cncf	tif3
cncf	tif3	
sccp		
copy	sccp	
<p>A blank entry in this table means that the ACT2 or ACT3 parameter has no value.</p> <p>The cncf stop action can be specified only if the CNCF feature is turned on.</p> <p>The tinp stop action can be specified only if the tinp stop action is assigned to a stop action set.</p> <p>The tif, tif2, or tif3 stop actions can be specified only if one or more of these features are enabled.</p> <ul style="list-style-type: none"> <li>• TIF Number Portability</li> <li>• TIF SCS Forwarding</li> <li>• TIF Simple Number Substitution</li> </ul> <p>The sccp stop action can be specified only if the MTP Routed GWS Stop Action feature is enabled.</p>		

1. Verify that the gateway screening feature is turned on, by entering the `rtrv-feat` command.

If the gateway screening feature is turned on, the GWS field should be set to `on`. In this example, the gateway screening feature is off.

**Note:** The `rtrv-feat` command output contains other fields that are not used by this procedure. If you wish to see all the fields displayed by the `rtrv-feat` command, see the `rtrv-feat` command description in *Commands User's Guide*.

If the gateway screening feature is turned on, go to [Step 3](#).

2. If the gateway screening feature is not turned on, shown by the `GWS = off` entry in the `rtrv-feat` command output in [Step 1](#), turn it on by entering this command.

```
chg-feat:gws=on
```

**Note:** Once the gateway screening feature is turned on with the `chg-feat` command, it cannot be turned off.

When this command has successfully completed, this message should appear.

```
rlghncxa03w 06-10-25 15:26:30 GMT EAGLE5 36.0.0
CHG-FEAT: MASP A - COMPLTD
```

3. Display the gateway screening stop action sets in the database with the `rtrv-gws-actset` command.

Action IDs 1, 2, and 3 are predefined and cannot be changed. Action ID 1 contains only the COPY stop action. Action ID 2 contains the RDCT stop action. Action ID 3 contains the COPY and the RDCT stop action as shown in this output example.

```
rlghncxa03w 06-10-25 15:27:30 GMT EAGLE5 36.0.0
ACT  ACT      ACT  ACT  ACT  ACT  ACT  ACT  ACT  ACT  ACT  ACT
ID   NAME      1    2    3    4    5    6    7    8    9    10
---  ---
1    copy      copy
2    rdct      rdct
3    cr        copy rdct

GWS action set table is (3 of 16) 19% full
```

Continue the procedure by performing one of these steps.

- The TINP stop action can be specified only if a gateway screening stop action set containing the TINP stop action must be shown in the `rtrv-gws-actset` output. Only two gateway screening stop action sets can contain the TINP stop action.
  - If only one gateway screening stop action contains the TINP stop action, continue the procedure with [Step 7](#) to specify the TINP stop action for a gateway screening stop action set.
  - If no gateway screening stop action sets contain the TINP stop action, or two gateway screening stop action sets contain the TINP stop action, the TINP stop action cannot be specified for a gateway screening stop action set. Continue the procedure by specifying another stop action.
- The SCCP stop action can be specified if the MTP Routed GWS Stop Action feature is enabled, or if the SCCP stop action is shown in the `rtrv-gws-actset` output.

- If only one gateway screening stop action contains the SCCP stop action, continue the procedure with [Step 7](#) to specify the SCCP stop action for a gateway screening stop action set.
  - If no gateway screening stop action sets contain the SCCP stop action, continue the procedure with [Step 4](#) to verify that the MTP Routed GWS Stop Action feature is enabled.
  - Only two gateway screening stop action sets can contain the SCCP stop action. If two gateway screening stop action sets contain the SCCP stop action, the SCCP stop action cannot be specified for a gateway screening stop action set. Continue the procedure by specifying another stop action.
  - The CNCF, TIF, TIF2, or TIF3 stop actions or combinations of these stop actions can be specified for a gateway screening stop action set. Refer to [Table 12: Gateway Screening Stop Action Set Parameter Combinations](#) for the combinations that can be used. If the CNCF stop action will be specified for a gateway screening stop action set, continue the procedure with [Step 5](#). If only the TIF, TIF2, or TIF3 stop actions will be specified for a gateway screening stop action set, continue the procedure with [Step 6](#).
4. Enter this command to verify whether or not the MTP Routed GWS Stop Action feature is enabled.

```
rtrv-ctrl-feat:partnum=893035601
```

This is an example of the possible output.

```
rlghncxa03w 09-07-28 21:15:37 GMT EAGLE5 41.1.0
The following features have been permanently enabled:

Feature Name          Partnum    Status  Quantity
MTPRTD GWS Stop Action 893035601  on      ----

The following features have been temporarily enabled:

Feature Name          Partnum    Status  Quantity    Trial Period Left
Zero entries found.

The following features have expired temporary keys:

Feature Name          Partnum
Zero entries found.
```

If the MTP Routed GWS Stop Action feature is not enabled, perform the [Activating the MTP Routed GWS Stop Action Feature](#) procedure to enable the MTP Routed GWS Stop Action feature.

After the [Activating the MTP Routed GWS Stop Action Feature](#) procedure has been performed, or if the `rtrv-ctrl-feat` output shows that the MTP Routed GWS Stop Action feature is enabled, continue the procedure with [Step 7](#).

5. To specify the CNCF gateway screening stop action, the Calling Name Conversion Facility (CNCF) feature must be turned on. If the CNCF gateway screening stop action is shown in [Step 3](#), or if the `rtrv-feat` output in [Step 1](#) shows that the CNCF feature is on, continue the procedure with [Step 6](#). If the CNCF feature is not turned on, shown by the `CNCF = off` entry in the `rtrv-feat` command output in [Step 1](#), turn it on by entering this command.

```
chg-feat:cncf=on
```

**Note:** Once the calling name conversion facility feature is turned on with the `chg-feat` command, it cannot be turned off.

When this command has successfully completed, this message should appear.

```
rlghncxa03w 06-10-25 15:29:30 GMT EAGLE5 36.0.0
CHG-FEAT: MASP A - COMPLTD
```

Continue this procedure by performing one of these steps.

- If the TIF, TIF2, or TIF3 stop actions will not be specified for the gateway screening stop action set, continue the procedure with [Step 7](#).
  - If the TIF, TIF2, or TIF3 stop actions will be specified for the gateway screening stop action set, and either the TIF, TIF2, or TIF3 stop actions are shown the `rtrv-ctrl-feat` output in [Step 3](#), continue the procedure with [Step 7](#).
  - If the TIF, TIF2, or TIF3 stop actions will be specified for the gateway screening stop action set, and either the TIF, TIF2, or TIF3 stop actions are not shown the `rtrv-ctrl-feat` output in [Step 3](#), continue the procedure with [Step 6](#).
6. Display the features that are enabled by entering the `rtrv-ctrl-feat` command. The following is an example of the possible output.

```
rlghncxa03w 07-05-30 21:15:37 GMT EAGLE5 37.2.0
The following features have been permanently enabled:
```

Feature Name	Partnum	Status	Quantity
Command Class Management	893005801	off	----
Intermed GTT Load Sharing	893006901	off	----
XGTT Table Expansion	893006101	off	----
XMAP Table Expansion	893007710	on	3000
Large System # Links	893005910	on	2000
Routesets	893006401	on	6000
GSM MAP SRI Redirect	893014001	on	----
ISUP NP with EPAP	893013801	on	----
HC-MIM SLK Capacity	893012707	on	64

The following features have been temporarily enabled:

Feature Name	Partnum	Status	Quantity	Trial Period	Left
Zero entries found.					

The following features have expired temporary keys:

Feature Name	Partnum
Zero entries found.	

If you wish to specify the TIF, TIF2, or TIF3 stop actions, one or more of these features must be enabled.

- TIF Number Portability
- TIF SCS Forwarding
- TIF Simple Number Substitution

If the TIF Number Portability, TIF SCS Forwarding, or TIF Simple Number Substitution features are enabled, the TIF, TIF2, and TIF3 stop actions can be specified. Continue the procedure with [Step 7](#).

The TIF Number Portability, TIF SCS Forwarding, or TIF Simple Number Substitution features must be enabled. If these features are not enabled, perform the procedures in *Number Plan Processor Guide* to enable at least one of these features. After the TIF Number Portability, TIF SCS Forwarding,

or TIF Simple Number Substitution features have been enabled, continue the procedure with [Step 7](#).

7. Add the gateway screening stop action to the database by using the `chg-gws-actset` command.

[Table 12: Gateway Screening Stop Action Set Parameter Combinations](#) shows the parameter combinations that can be used for the stop action parameters (act1 - act10).

```
chg-gws-actset:actid=4:actname=cncf:act1=cncf
```

```
chg-gws-actset:actid=5:actname=cpcncf:act1=copy:act2=cncf
```

```
chg-gws-actset:actid=6:actname=cncfrd:act1=cncf:act2=rdct
```

```
chg-gws-actset:actid=7:actname=cpcfrd:act1=copy:act2=cncf:act3=rdct
```

```
chg-gws-actset:actid=8:actname=cptinp:act1=copy:act2=tinp
```

```
chg-gws-actset:actid=9:actname=tinp:act1=tinp
```

```
chg-gws-actset:actid=10:actname=tif1:act1=tif
```

```
chg-gws-actset:actid=11:actname=tif2:act1=copy:act2=tif2
```

```
chg-gws-actset:actid=12:actname=tif3:act1=copy:act2=tif3
```

```
chg-gws-actset:actid=13:actname=sccpa:act1=sccp
```

```
chg-gws-actset:actid=14:actname=sccpb:act1=copy:act2=sccp
```

If an existing gateway screening stop action set is being changed, the `force=yes` parameter must be specified with the `chg-gws-actset` command.

The `force=yes` parameter can be specified with the `chg-gws-actset` command if a new GWS stop action set is being created, but is not necessary.

The `actname` parameter must be specified for a new GWS stop action set. The `actname` parameter is not required, but can be specified, if an existing stop action set is being changed.

If the `actname` parameter value is different from what is shown in the `rtrv-gws-actset` output for the GWS stop action set being changed, the name of the GWS stop action set will be changed to the new `actname` parameter value (see the first Caution).



**CAUTION**

**Caution:**

Changing the name of an existing GWS stop action set will prevent the actions defined in the GWS stop action set from being used to process the MSUs that pass gateway screening. If the name of the GWS stop action set is changed, enter the gateway screening retrieve commands (`rtrv-scrset`, `rtrv-scr-opc`, `rtrv-scr-blkopc`, `rtrv-scr-sio`, `rtrv-scr-dpc`, `rtrv-scr-blkdpc`, `rtrv-scr-destfld`, `rtrv-scr-isup`, `rtrv-scr-cgpa`, `rtrv-scr-tt`, `rtrv-scr-cdpa`, and `rtrv-scr-aftpc`) with the `actname` parameter and the old GWS stop action set name to identify the screens that need to be changed to use the new GWS stop action set name. To change these screens, perform the appropriate procedures in this user's guide.



**CAUTION**

**Caution:**

Caution must be used when changing the stop actions in existing gateway screening stop action sets because these gateway screening stop action sets may be used by one

or more gateway screening rules. Changes in the existing gateway screening stop action sets will change how MSUs that pass gateway screening are processed.



**Caution:**

Caution must be used when specifying the RDCT stop action in an existing GWS stop action set. Specifying the RDCT stop action for Allowed OPC screens containing the adjacent point code of a linkset, for Allowed SIO screens containing the service indicator values 1 (SI=1) or 2 (SI=2), or for Allowed DPC screens containing the EAGLE's point code can cause signaling link failures. To verify whether or not the GWS stop action set name used in this procedure is referenced by these screens, enter the `rtrv-scr-opc`, `rtrv-scr-sio`, or `rtrv-scr-dpc` commands, with the `actname` parameter and the GWS stop action set name used in this procedure.

When each of these commands have successfully completed, this message should appear.

```
rlghncxa03w 06-10-25 15:30:30 GMT EAGLE5 36.0.0
CAUTION: GWS action set may be referenced by one or more GWS rules
CHG-GWS-ACTSET: MASP A - COMPLTD
```

- Verify the changes using the `rtrv-gws-actset` command.

This is an example of the possible output.

```
rlghncxa03w 09-07-25 15:31:30 GMT EAGLE5 41.1.0
ACT  ACT  ACT  ACT  ACT  ACT  ACT  ACT  ACT  ACT  ACT  ACT
ID   NAME  1    2    3    4    5    6    7    8    9    10
---  ---  ---  ---  ---  ---  ---  ---  ---  ---  ---  ---
1    copy  copy
2    rdct  rdct
3    cr    copy rdct
4    cncf  cncf
5    cpcncf copy cncf
6    cncfrd cncf rdct
7    cpcfrd copy cncf rdct
8    cptinp copy tinp
9    tinp  tinp
10   tif1  tif
11   tif2  copy tif2
12   tif3  copy tif3
13   sccpa sccp
14   sccpb copy sccp

GWS action set table is (14 of 16) 88% full
```

- Backup the new changes using the `chg-db:action=backup:dest=fixed` command.

These messages should appear, the active Maintenance and Administration Subsystem Processor (MASP) appears first.

```
BACKUP (FIXED) : MASP A - Backup starts on active MASP.
BACKUP (FIXED) : MASP A - Backup on active MASP to fixed disk complete.
BACKUP (FIXED) : MASP A - Backup starts on standby MASP.
BACKUP (FIXED) : MASP A - Backup on standby MASP to fixed disk complete.
```

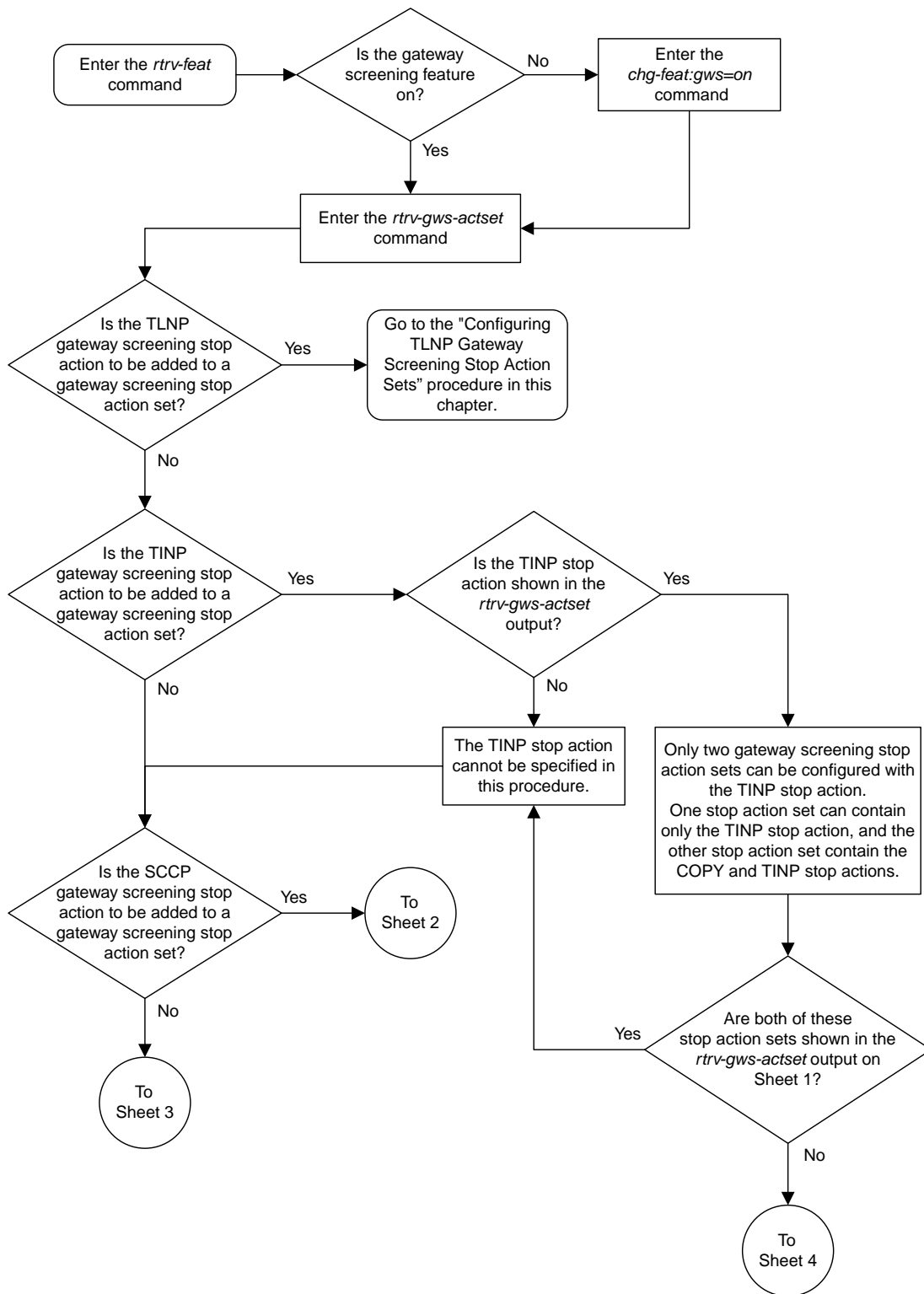



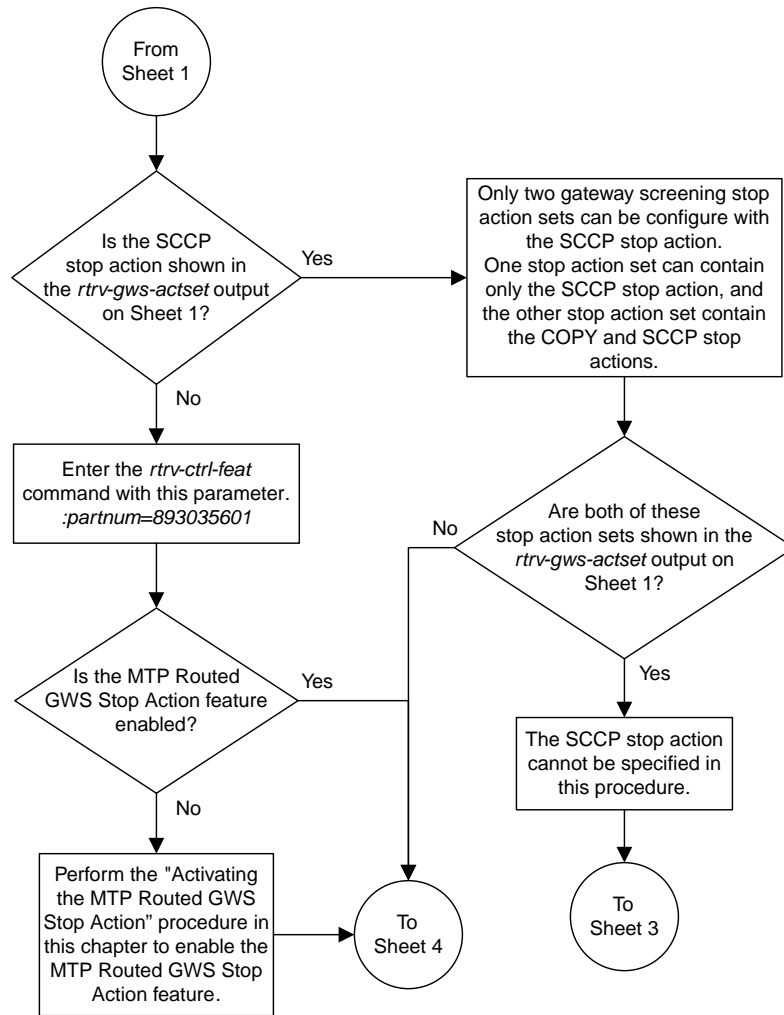

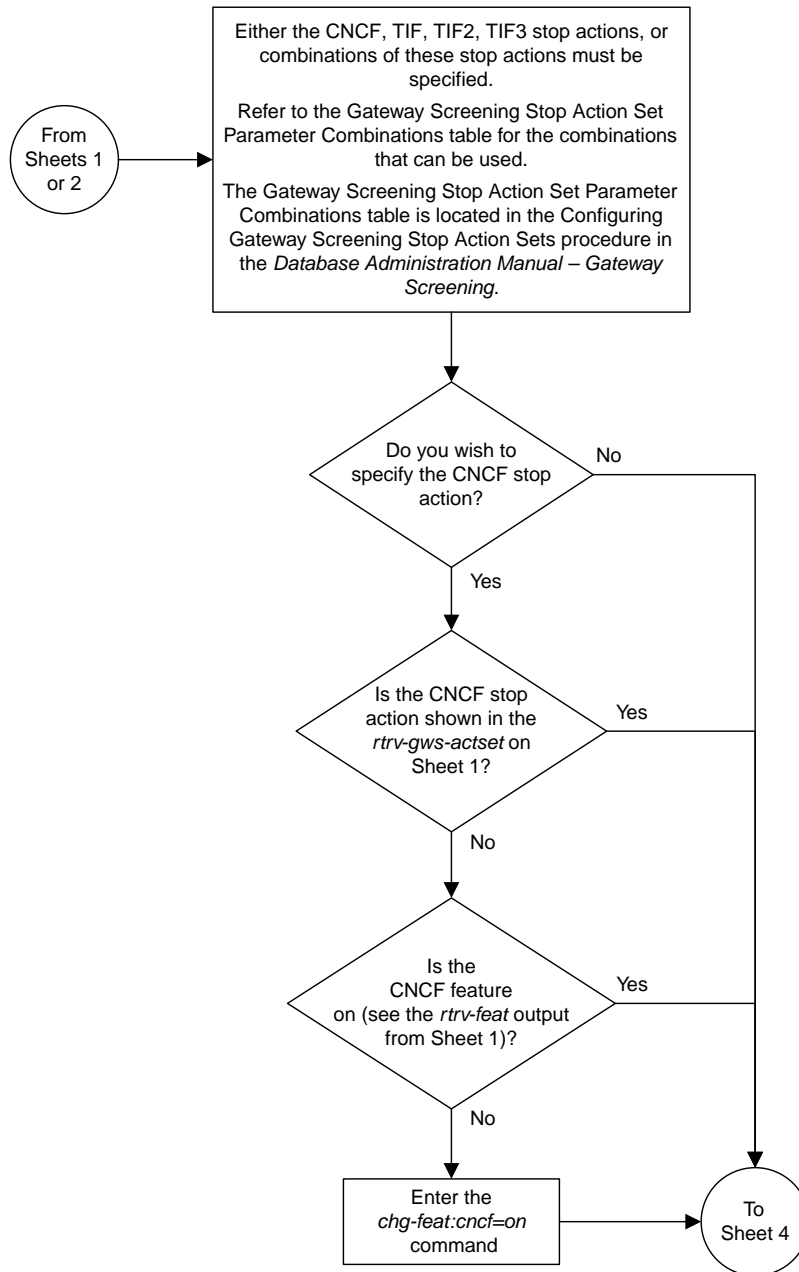

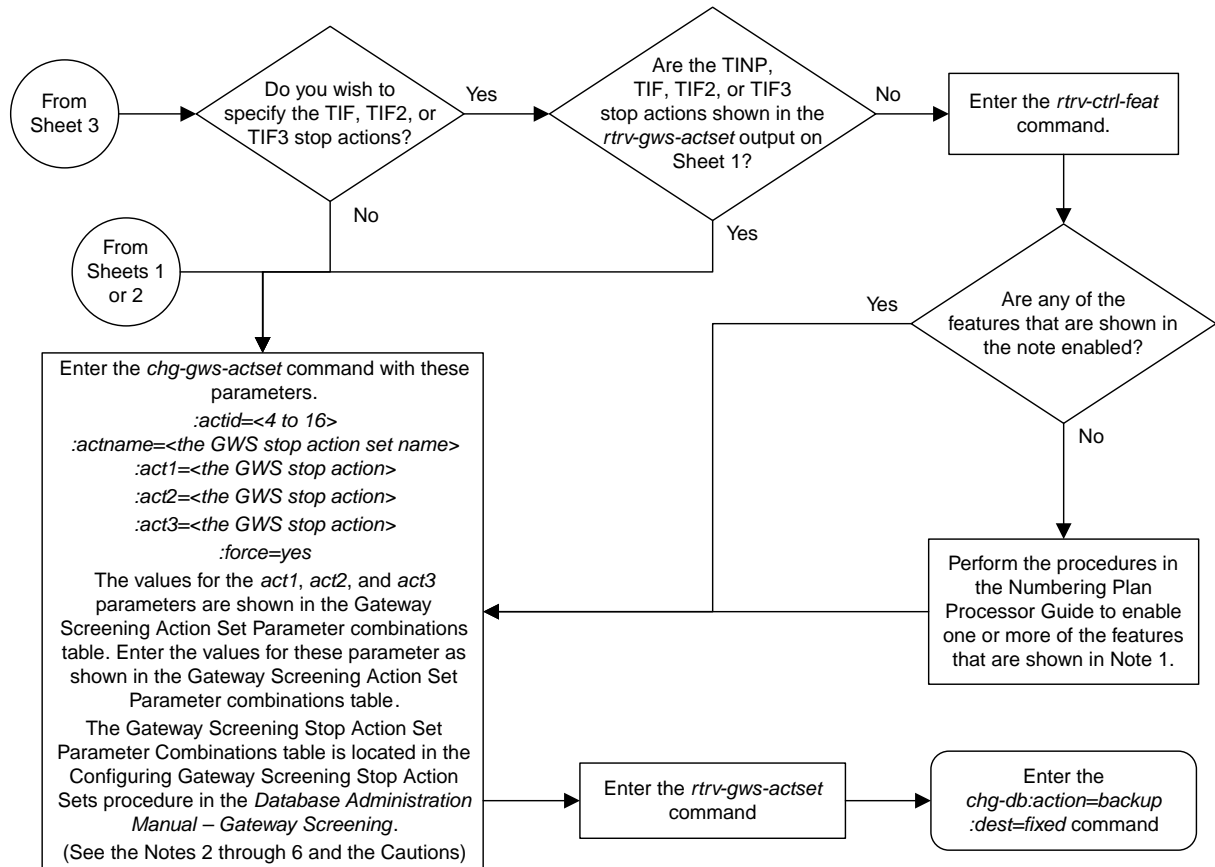

Notes:

- The features that must be enabled to specify the TIF, TIF2, or TIF3 stop actions in this procedure are:
  - 893018901 – TIF Number Portability
  - 893022202 – TIF SCS Forwarding
  - 893024001 – TIF Simple Number Substitution.
- The *force=yes* parameter must be specified with the *chg-gws-actset* command if an existing GWS stop action set is being changed.
- The *force=yes* parameter can be specified with the *chg-gws-actset* command if a new GWS stop action set is being created, but is not necessary.
- The *actname* parameter must be specified for a new GWS stop action set.
- The *actname* parameter is not required, but can be specified, if an existing stop action set is being changed.
- If the *actname* parameter value is different from what is shown in the *rtrv-gws-actset* output for the GWS stop action set being changed, the name of the GWS stop action set will be changed to the new *actname* parameter value (see Caution 1).

Cautions:

- Changing the name of an existing GWS stop action set will prevent the actions defined in the GWS stop action set from being used to process the MSUs that pass gateway screening. If the name of the GWS stop action set is changed, enter the gateway screening retrieve commands (*rtrv-scrset*, *rtrv-scr-opc*, *rtrv-scr-blkopc*, *rtrv-scr-sio*, *rtrv-scr-dpc*, *rtrv-scr-blkdpc*, *rtrv-scr-destfld*, *rtrv-scr-isup*, *rtrv-scr-cgpa*, *rtrv-scr-rt*, *rtrv-scr-cdpa*, and *rtrv-scr-aftpc*) with the *actname* parameter and the old GWS stop action set name to identify the screens that need to be changed to use the new GWS stop action set name. To change these screens, perform the appropriate procedures in this chapter.
- Caution must be used when changing the stop actions in existing gateway screening stop action sets because these gateway screening stop action sets may be used by one or more gateway screening rules. Changes in the existing gateway screening stop action sets will change how MSUs that pass gateway screening are processed.
- Caution must be used when specifying the RDCT stop action in an existing GWS stop action set. Specifying the RDCT stop action for Allowed OPC screens containing the adjacent point code of a linkset, for Allowed SIO screens containing the service indicator values 1 (SI=1) or 2 (SI=2), or for Allowed DPC screens containing the Eagle's point code can cause signaling link failures.

To verify whether or not the GWS stop action set name used in this procedure is referenced by these screens, enter the *rtrv-scr-opc*, *rtrv-scr-sio*, or *rtrv-scr-dpc* commands, with the *actname* parameter and the GWS stop action set name used in this procedure.

Sheet 4 of 4

Figure 13: Configuring Gateway Screening Stop Action Sets

## Configuring TLNP Gateway Screening Stop Action Sets

This procedure is used to add a gateway screening stop action set containing the TLNP gateway screening stop action to the database using the `chg-gws-actset` command.

The gateway screening stop action sets define the actions that are performed on the MSU when the gateway screening process has stopped.

The database can contain a maximum of 16 gateway screening stop action sets, with each set containing a maximum of 10 gateway screening stop actions. For this procedure only two gateway screening stop actions can be used.

- COPY – copy the MSU for the STPLAN feature
- TLNP – ISUPIAMs that pass gateway screening are processed either by the ISUP NP with EPAP feature (if the ISUP NP with EPAP feature is enabled and turned on) or by the Triggerless LNP feature (if the LNP feature is enabled and the Triggerless LNP feature is turned on). The ISUP NP with EPAP feature is discussed in more detail in *G-Port User's Guide*. The Triggerless LNP feature is discussed in more detail in *ELAP Administration and LNP Feature Activation Guide*.

The status of the ISUP NP with EPAP feature can be verified with the `rtrv-ctrl-feat` command. The ISUP NP with EPAP feature also requires that the G-Port feature is enabled and that Gateway Screening feature is turned on. The status of the G-Port feature can be verified with the `rtrv-ctrl-feat` command. The status of the Gateway Screening feature can be verified with the `rtrv-feat` command. Enabling the G-Port feature is discussed in more detail in *G-Port User's Guide*.



**Caution:** When Gateway Screening is in the screen test mode, as defined by the linkset parameters `gwsa=off` and `gws=on`, any action in the gateway screening stop action sets created in this procedure will be performed.

The `chg-gws-actset` command in this procedure uses these parameters.

`:actid` – The ID number of the gateway screening stop action set. The value of this parameter is from 4 to 16.

`:actname` – The name of the gateway screening stop action set consisting of 1 alphabetic character followed by up to 5 alphanumeric characters. The word `none` cannot be used for the `actname` parameter.

`:force` – The `force=yes` parameter must be specified when changing the gateway screening stop actions of an existing gateway screening stop action set.

`:act1` and `:act2` – Only two gateway screening stop action sets can be defined with the TLNP gateway screening stop action:

- One set with only the TLNP gateway Screening stop action (defined with the `act1=tlnp` parameter).
- Another set with the COPY and TLNP gateway screening stop action (defined by the `act1=copy` and `act2=tlnp` parameters).

The value of the `actname` parameter must be unique. The value of this parameter is used by the `actname` parameter in the gateway screening commands and is shown in the `NSR/ACT` field of the outputs of the retrieve gateway screening commands to define the action that is performed on the MSU that passes gateway screening.

When a gateway screening stop action set is being entered into the database for the first time, the name of the gateway screening stop action set (`actname`) must be added to the database before any gateway screening stop actions are assigned to the gateway screening stop action set.

The `tlnp` gateway screening stop action cannot be specified with either the `cncf` (calling name conversion facility) or `rdct` (redirect) gateway screening actions in the same gateway screening action set.

**Table 13: Sample TLNP Gateway Screening Stop Action Set Configuration**

ACTID	ACTNAME	ACT1	ACT2	ACT3
4	TLNP	tlnp	—	—
5	CPNP	copy	tlnp	—

1. Verify that the gateway screening feature is turned on, by entering the `rtrv-feat` command.

If the gateway screening feature is turned on, the `GWS` field should be set to `on`. In this example, the gateway screening feature is off.

**Note:** The `rtrv-feat` command output contains other fields that are not used by this procedure. If you wish to see all the fields displayed by the `rtrv-feat` command, see the `rtrv-feat` command description in *Commands User's Guide*.

If the gateway screening feature is turned on, go to step 3.

2. If the gateway screening feature is not turned on, shown by the `GWS = off` entry in the `rtrv-feat` command output in step 1, turn it on by entering this command.

```
chg-feat:gws=on
```

**Note:** Once the gateway screening feature is turned on with the `chg-feat` command, it cannot be turned off.

When this command has successfully completed, this message should appear.

```
rlghncxa03w 06-10-25 15:26:30 GMT EAGLE5 36.0.0
CHG-FEAT: MASP A - COMPLTD
```

3. Display the gateway screening stop action sets in the database with the `rtrv-gws-actset` command.

Action IDs 1, 2, and 3 are predefined and cannot be changed. Action ID 1 contains only the `COPY` stop action. Action ID 2 contains the `RDCT` stop action. Action ID 3 contains the `COPY` and the `RDCT` stop actions as shown in the following output example.

```
rlghncxa03w 06-10-25 15:27:30 GMT EAGLE5 36.0.0
ACT ACT ACT ACT ACT ACT ACT ACT ACT ACT ACT ACT
```

```

ID   NAME   1     2     3     4     5     6     7     8     9     10
--   ---   -     -     -     -     -     -     -     -     -     -
1    copy   copy
2    rdct   rdct
3    cr     copy rdct

GWS action set table is (3 of 16) 19% full
    
```

If the `rtrv-gws-actset` output shows that these gateway screening stop action sets: one with `ACT1=tlnp` and the other with `ACT1=copy` and `ACT2=tlnp`, this procedure cannot be performed.

If only one of these gateway screening stop action sets are shown, skip steps 4 through 11, and go to step 12.

If neither of these gateway screening stop action sets are shown, go to step 4.

4. Verify whether or not the LNP or ISUPNP with EPAP features are enabled, using the `rtrv-ctrl-feat` command.

If the LNP feature is enabled, the `LNP TNS` field with a telephone number quantity greater than zero is shown in the `rtrv-ctrl-feat` output. If the ISUP NP with EPAP feature is enabled, the `ISUP NP with EPAP Active` field is shown in the `rtrv-ctrl-feat` output.

This is an example of the possible output.

```

rlghncxa03w 06-10-30 21:15:37 GMT EAGLE5 36.0.0
The following features have been permanently enabled:

Feature Name                Partnum    Status    Quantity
Command Class Management   893005801  off      ----
Intermed GTT Load Sharing   893006901  off      ----
XGTT Table Expansion        893006101  off      ----
XMAP Table Expansion        893007710  on       3000
Large System # Links        893005910  on       2000
Routesets                   893006401  on       6000
GSM MAP SRI Redirect        893014001  on       ----
ISUP NP with EPAP Active    893013801  on       ----
HC-MIM SLK Capacity         893012707  on       64

The following features have been temporarily enabled:

Feature Name                Partnum    Status    Quantity    Trial Period Left
Zero entries found.

The following features have expired temporary keys:

Feature Name                Partnum
Zero entries found.
    
```

If the ISUP NP with EPAP feature is enabled, skip steps 5 through 10, and go to step 11.

If the LNP feature is enabled, perform the “Configuring the Triggerless LNP Feature” procedure in *ELAP Administration and LNP Feature Activation Guide*.

If neither the ISUP NP with EPAP or the LNP features are enabled, perform the “Configuring the Triggerless LNP Feature” procedure in *ELAP Administration and LNP Feature Activation Guide* to use the `tlnp` gateway screening stop action for the Triggerless LNP feature.

To use the `tlnp` gateway screening stop action for the ISUP NP with EPAP feature, and neither the ISUP NP with EPAP or the LNP features are enabled, verify that the G-Port feature is enabled.

If the G-Port feature is enabled, the entry GPORT is shown in the `rtrv-ctrl-feat` output. If the G-Port feature is not enabled, go to *G-Port User's Guide* and enable the G-Port feature. Then go to step 5.

If the G-Port feature is enabled, go to step 5.

**Note:** If the `rtrv-ctrl-feat` output in step 4 shows any controlled features, skip steps 5, 6, 7, and 8, and go to step 9.

**Note:** If the `rtrv-ctrl-feat` output shows only the HC-MIMSLK Capacity feature with a quantity of 64, then no other features are enabled. Steps 5, 6, 7, and 8 must be performed.

5. Display the serial number in the database with the `rtrv-serial-num` command.

This is an example of the possible output.

```
rlghncxa03w 06-10-30 21:15:37 GMT EAGLE5 36.0.0
System serial number = ntxxxxxxxxxxxxxxx

System serial number is not locked.

rlghncxa03w 06-10-30 21:15:37 GMT EAGLE5 36.0.0
Command Completed
```

**Note:** If the serial number is locked, skip step 6 and go to step 7.

**Note:** If the serial number is correct and locked, skip steps 6, 7, and 8, and go to step 9. If the serial number is correct but not locked, skip steps 6 and 7, and go to step 8. If the serial number is not correct, but is locked, the ISUP NP with EPAP feature cannot be enabled and the remainder of this procedure cannot be performed. Contact the Customer Care Center to get an incorrect and locked serial number changed. Refer to *My Oracle Support (MOS)* for the contact information. The serial number can be found on a label affixed to the control shelf (shelf 1100).

6. Enter the correct serial number into the database using the `ent-serial-num` command with the `serial` parameter.

For this example, enter this command.

```
ent-serial-num:serial=<EAGLE's correct serial number>
```

When this command has successfully completed, the following message should appear.

```
rlghncxa03w 06-10-28 21:15:37 GMT EAGLE5 36.0.0
ENT-SERIAL-NUM: MASP A - COMPLTD
```

7. Verify that the serial number entered into step 6 was entered correctly using the `rtrv-serial-num` command.

This is an example of the possible output.

```
rlghncxa03w 06-10-28 21:15:37 GMT EAGLE5 36.0.0
System serial number = nt00001231

System serial number is not locked.
rlghncxa03w 06-10-28 21:15:37 GMT EAGLE5 36.0.0
Command Completed
```

If the serial number was not entered correctly, repeat steps 6 and 7 and re-enter the correct serial number.

- Lock the serial number in the database by entering the `ent-serial-num` command with the serial number shown in step 5, if the serial number shown in step 5 is correct, or with the serial number shown in step 7, if the serial number was changed in step 6, and with the `lock=yes` parameter.

For this example, enter this command.

```
ent-serial-num:serial=<EAGLE's serial number>:lock=yes
```

When this command has successfully completed, the following message should appear.

```
rlghncxa03w 06-10-28 21:15:37 GMT EAGLE5 36.0.0
ENT-SERIAL-NUM: MASP A - COMPLTD
```

- Enable the ISUP NP with EPAP feature by entering the `enable-ctrl-feat` command.

For this example, enter this command.

```
enable-ctrl-feat:partnum=893013801:fak=<feature access key>
```

**Note:** The values for the feature access key (the `fak` parameter) are provided by Oracle. If you do not have the controlled feature part number or the feature access key for the feature you wish to enable, contact your Oracle Sales Representative or Account Representative.

When the `enable-ctrl-feat` command has successfully completed, this message should appear.

```
rlghncxa03w 06-10-30 21:15:37 GMT EAGLE5 36.0.0
ENABLE-CTRL-FEAT: MASP B - COMPLTD
```

- Verify the changes by entering the `rtrv-ctrl-feat` command with the part number specified in step 9.

```
rtrv-ctrl-feat:partnum=893013801
```

The following is an example of the possible output.

```
rlghncxa03w 06-10-30 21:16:37 GMT EAGLE5 36.0.0
The following features have been permanently enabled:
```

Feature Name	Partnum	Status	Quantity
ISUP NP with EPAP	893013801	off	----

**Note:** If the TLNP feature is on, shown in the `rtrv-feat` output in step 1, skip this step and step 12, and go to step 13.

- Turn the TLNP feature on by entering this command.

```
chg-feat:tlnp=on
```

**Note:** Once the TLNP feature is turned on with the `chg-feat` command, it cannot be turned off.



When this command has successfully completed, this message should appear.

```
rlghncxa03w 06-10-25 15:26:30 GMT EAGLE5 36.0.0
CHG-FEAT: MASP A - COMPLTD
```

12. Add the TLNP gateway screening stop action to the database by using the `chg-gws-actset` command.

For this example, enter these commands based on the sample configuration shown in [Table 13: Sample TLNP Gateway Screening Stop Action Set Configuration](#).

```
chg-gws-actset:actid=4:actname=tlnp:act1=tlnp
```

```
chg-gws-actset:actid=5:actname=cpnp:act1=copy:act2=tlnp
```

If an existing gateway screening stop action set is being changed, the `force=yes` parameter must be specified with the `chg-gws-actset` command.

The `force=yes` parameter can be specified with the `chg-gws-actset` command if a new GWS stop action set is being created, but is not necessary.

The `actname` parameter must be specified for a new GWS stop action set.

The `actname` parameter is not required, but can be specified, if an existing stop action set is being changed.

If the `actname` parameter value is different from what is shown in the `rtrv-gws-actset` output for the GWS stop action set being changed, the name of the GWS stop action set will be changed to the new `actname` parameter value (see the first Caution).



CAUTION

**Caution:** Changing the name of an existing GWS stop action set will prevent the actions defined in the GWS stop action set from being used to process the MSUs that pass gateway screening. If the name of GWS stop action set is changed, enter the gateway screening retrieve commands shown in [Table 14: Gateway Screening Retrieve Commands](#) with the `actname` parameter and the old GWS stop action set name to identify the screens that need to be changed to use the new GWS stop action set name. To change these screens, perform the appropriate procedures in this manual.

**Table 14: Gateway Screening Retrieve Commands**

<code>rtrv-scrset</code>	<code>rtrv-scr-opc</code>	<code>rtrv-scr-blkopc</code>	<code>rtrv-scr-sio</code>
<code>rtrv-scr-dpc</code>	<code>rtrv-scr-blkdpc</code>	<code>rtrv-scr-destfld</code>	<code>rtrv-scr-isup</code>
<code>rtrv-scr-cgpa</code>	<code>rtrv-scr-tt</code>	<code>rtrv-scr-cdpa</code>	<code>rtrv-scr-aftpc</code>



CAUTION

**Caution:** Caution must be used when changing the stop actions in existing gateway screening stop action sets because these gateway screening stop action sets may be used by one or more gateway screening rules. Changes in the existing gateway screening stop action sets will change how MSUs that pass gateway screening are processed.

When each of these commands have successfully completed, this message should appear.

```
rlghncxa03w 06-10-25 15:30:30 GMT EAGLE5 36.0.0
CAUTION: GWS action set may be referenced by one or more GWS rules
CHG-GWS-ACTSET: MASP A - COMPLTD
```

**13. Verify the changes using the `rtrv-gws-actset` command.**

This is an example of the possible output.

```
rlghncxa03w 06-10-25 15:31:30 GMT EAGLE5 36.0.0
ACT  ACT      ACT  ACT  ACT  ACT  ACT  ACT  ACT  ACT  ACT  ACT
ID   NAME      1    2    3    4    5    6    7    8    9    10
--   -
1    copy      copy
2    rdct      rdct
3    cr        copy rdct
4    tlnp      tlnp
5    cpnp      copy tlnp

GWS action set table is (5 of 16) 31% full
```

**14. Backup the new changes using the `chg-db:action=backup:dest=fixed` command.**

These messages should appear, the active Maintenance and Administration Subsystem Processor (MASP) appears first.

```
BACKUP (FIXED) : MASP A - Backup starts on active MASP.
BACKUP (FIXED) : MASP A - Backup on active MASP to fixed disk complete.
BACKUP (FIXED) : MASP A - Backup starts on standby MASP.
BACKUP (FIXED) : MASP A - Backup on standby MASP to fixed disk complete.
```

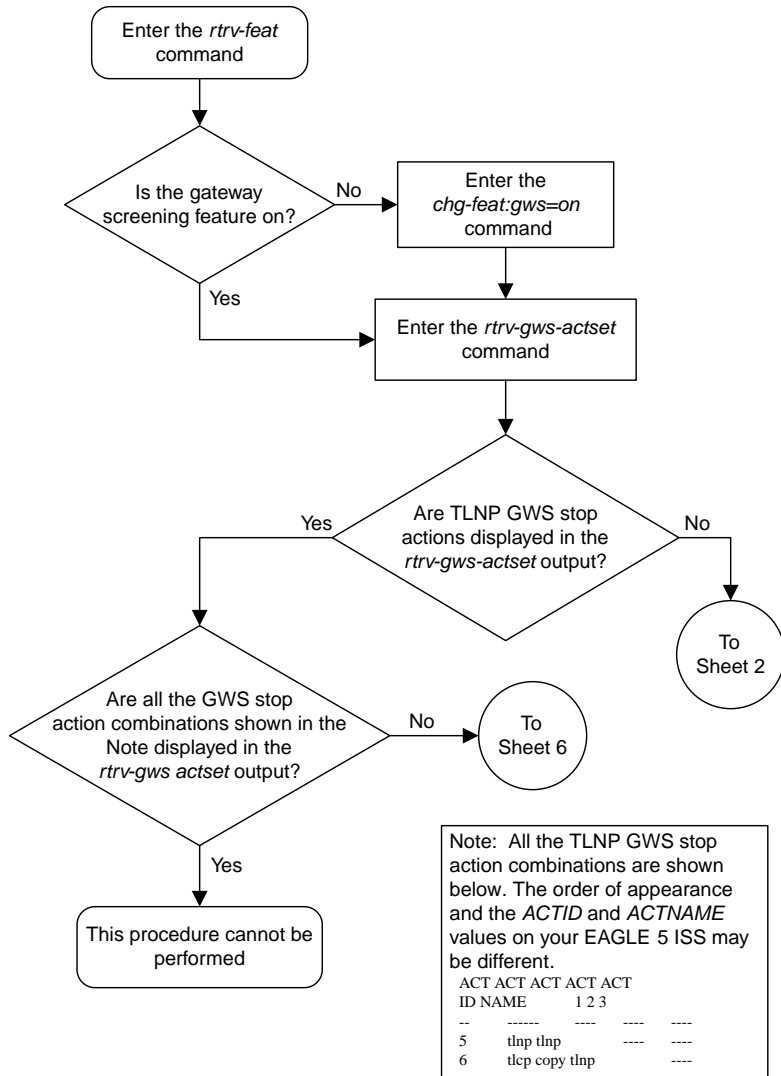

Note: All the TLNP GWS stop action combinations are shown below. The order of appearance and the *ACTID* and *ACTNAME* values on your EAGLE 5 ISS may be different.

ACT ID	ACT NAME	ACT 1	ACT 2	ACT 3	ACT 4
5	tlnp tlnp	----	----	----	----
6	tlcp copy tlnp	----	----	----	----

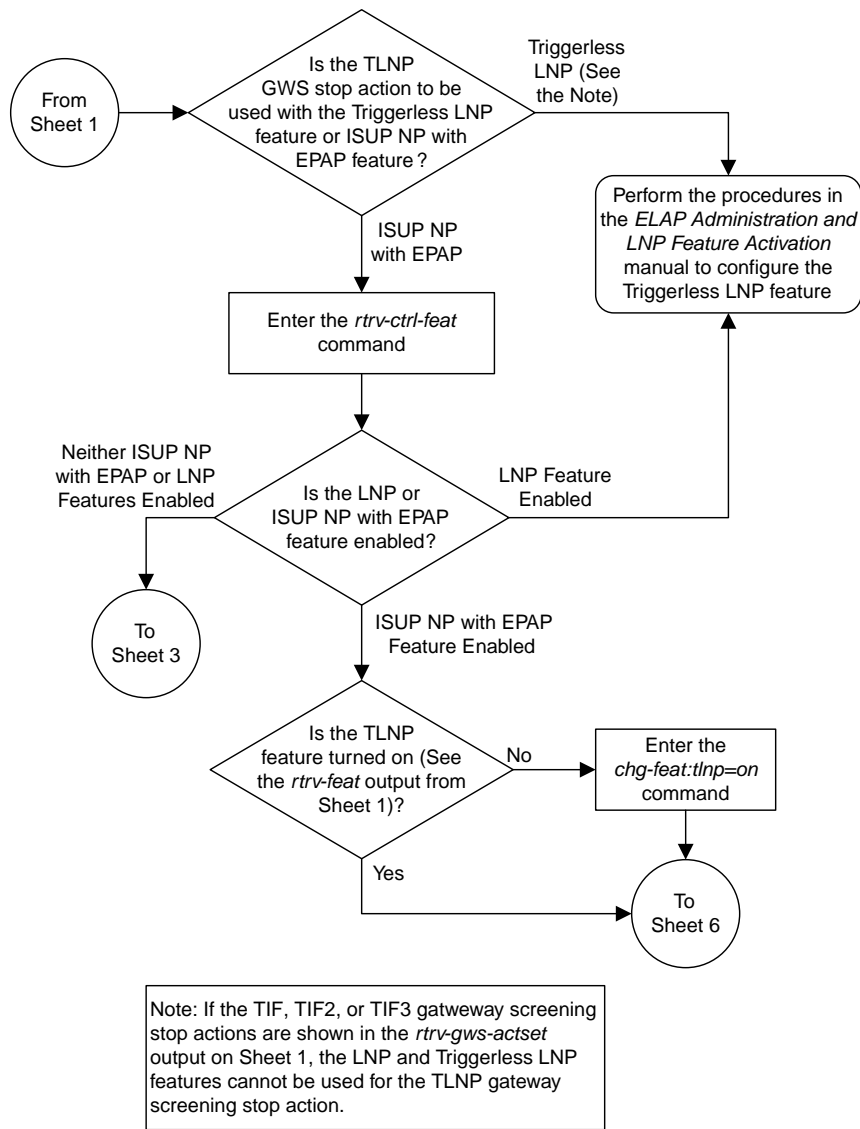

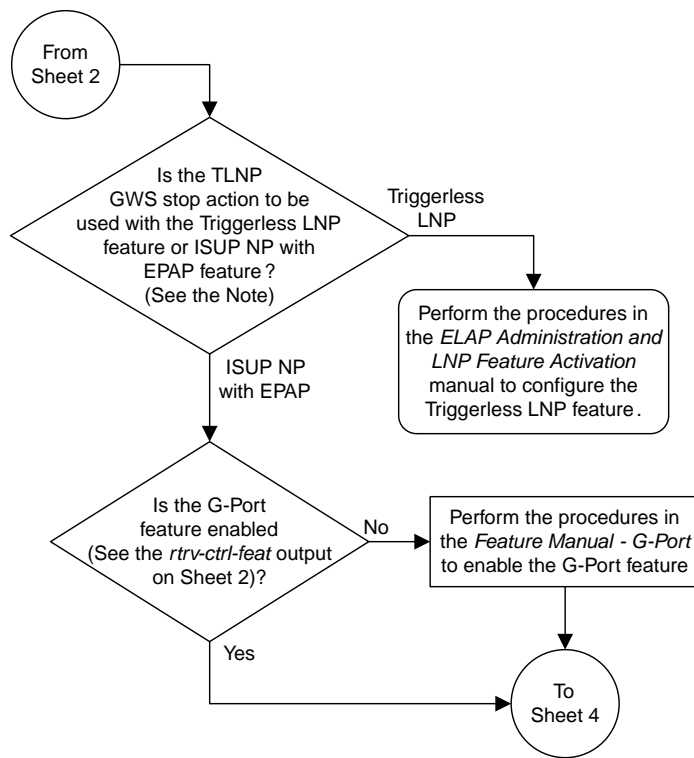

Note: If the TIF Number Portability, TIF SCS Forwarding, or TIF Simple Number Substitution features are shown in the *rtrv-ctrl-feat* output on Sheet 2 as enabled, the LNP and Triggerless LNP features cannot be used for the TLNP gateway screening stop action.

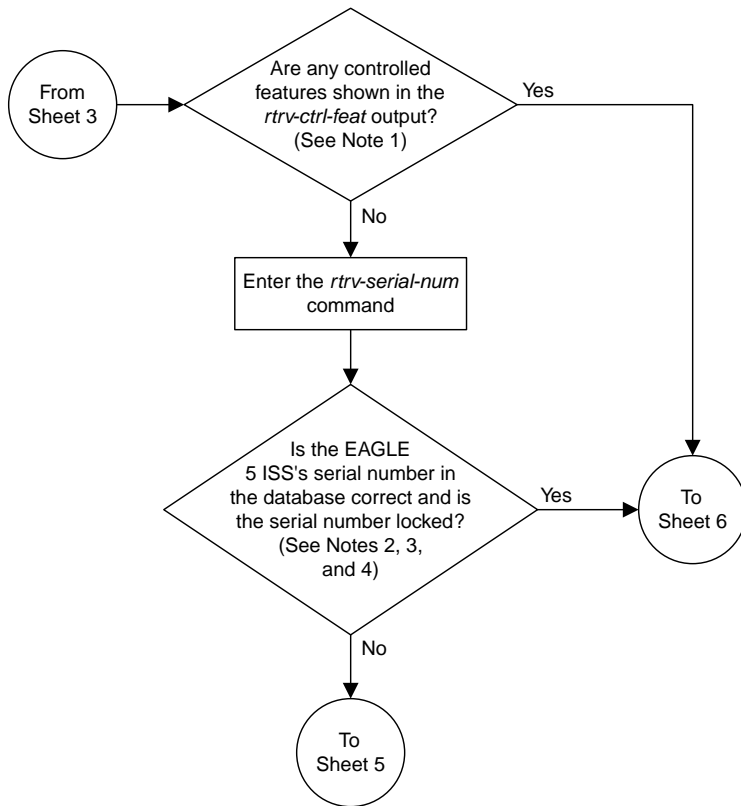

Notes:

1. If the *rtrv-ctrl-feat* output shows only the HC -MIM SLK Capacity feature with a quantity of 64, the answer to this question is no and the Eagle 5 ISS's serial number must be verified. This is the default entry for the *rtrv-ctrl-feat* output. This entry is shown whether or not the Eagle 5 ISS's serial number is in the database.
2. If the serial number is locked, it cannot be changed.
3. If the serial number is not locked, the controlled feature cannot be enabled.
4. The serial number can be found on a label affixed to the control shelf (shelf 1100).

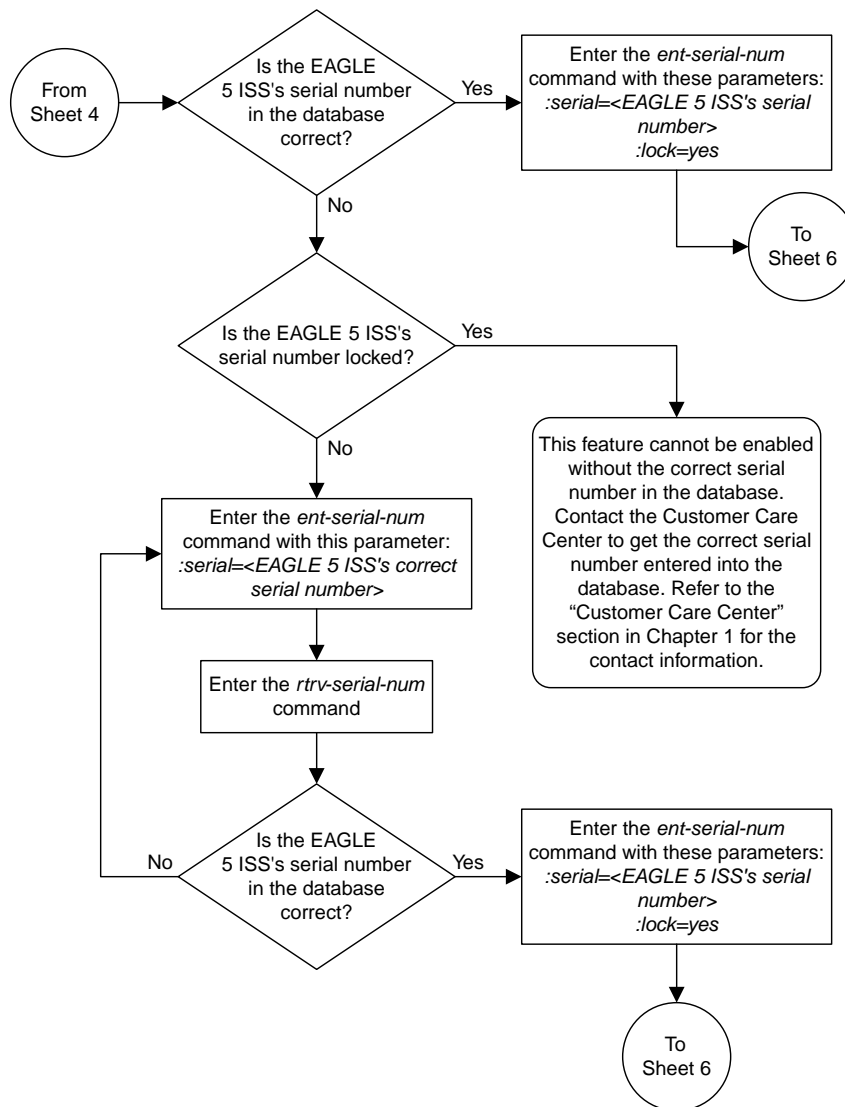

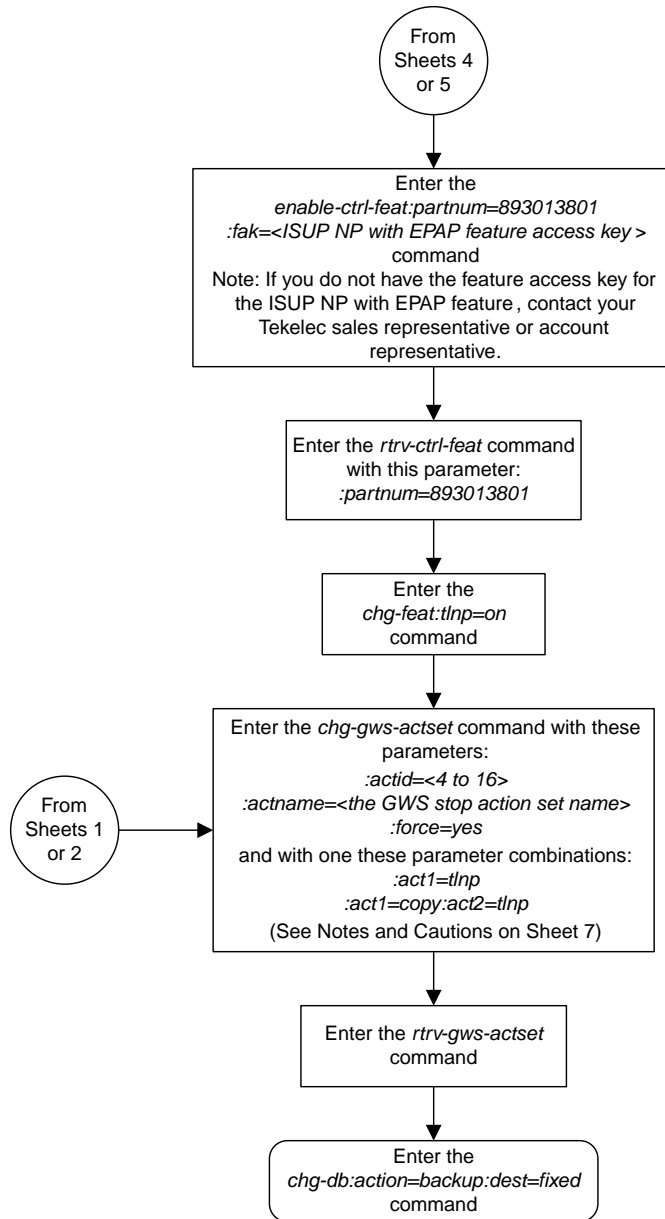



**Notes:**

1. The *force=yes* parameter must be specified with the *chg-gws-actset* command if an existing GWS stop action set is being changed.
2. The *force=yes* parameter can be specified with the *chg-gws-actset* command if a new GWS stop action set is being created, but is not necessary.
3. The TLNP GWS stop action cannot be in the same GWS stop action set with either the CNCF or RDCT GWS stop actions.
4. The *actname* parameter must be specified for a new GWS stop action set.
5. The *actname* parameter is not required, but can be specified, if an existing stop action set is being changed.
6. If the *actname* parameter value is different from what is shown in the *rtrv-gws-actset* output for the GWS stop action set being changed, the name of the GWS stop action set will be changed to the new *actname* parameter value (see Caution 1).

**Cautions:**

1. **Changing the name of an existing GWS stop action set will prevent the actions defined in the GWS stop action set from being used to process the MSUs that pass gateway screening. If the name of the GWS stop action set is changed, enter the gateway screening retrieve commands (*rtrv-scrset*, *rtrv-scr-opc*, *rtrv-scr-blkopc*, *rtrv-scr-sio*, *rtrv-scr-dpc*, *rtrv-scr-blkdpc*, *rtrv-scr-destfld*, *rtrv-scr-isup*, *rtrv-scr-cgpa*, *rtrv-scr-tt*, *rtrv-scr-cdpa*, and *rtrv-scr-aftpc*) with the *actname* parameter and the old GWS stop action set name to identify the screens that need to be changed to use the new GWS stop action set name. To change these screens, perform the appropriate procedures in Chapters 3 through 15 in this manual.**
2. **Caution must be used when changing the stop actions in existing gateway screening stop action sets because these gateway screening stop action sets may be used by one or more gateway screening rules. Changes in the existing gateway screening stop action sets will change how MSUs that pass gateway screening are processed.**

Sheet 7 of 7

Figure 14: Configuring TLNP Gateway Screening Stop Action Sets

## Removing Gateway Screening Stop Action Sets

This procedure is used to remove a gateway screening stop action set from the database or a gateway screening stop action from a gateway screening stop action set from the database using the `chg-gws-actset` command.

The database can contain a maximum of 16 gateway screening stop action sets, with each set containing a maximum of 10 gateway screening stop actions. Five gateway screening stop actions have been defined.

The `chg-gws-actset` command uses these parameters in this procedure.

`:actid` – The ID number of the gateway screening stop action set. The value of this parameter is from 4 to 16.

`:force` – The `force=yes` parameter must be specified when changing the gateway screening stop actions of an existing gateway screening stop action set.

`:all=none` – Sets the value of each gateway screening stop action in the gateway screening stop action set to none.

`:act1` to `:act10` – One of ten gateway screening stop actions being removed from the gateway screening stop action set.

The first three gateway screening stop action sets (`actid=1`, `actid=2`, and `actid=3`) cannot be changed or removed.

No other optional parameters can be specified `all=none` parameter.

The `force=yes` parameter must be specified when changing an existing gateway screening stop action set.

1. Display the gateway screening stop action sets in the database with the `rtrv-gws-actset` command.

This is an example of the possible output.

```

rlghncxa03w 06-10-25 15:27:30 GMT EAGLE5 36.0.0
ACT  ACT      ACT  ACT  ACT  ACT  ACT  ACT  ACT  ACT  ACT
ID   NAME     1    2    3    4    5    6    7    8    9    10
--   -
1    copy     copy
2    rdct     rdct
3    cr       copy rdct
4    cncf     cncf
5    cpnf     copy cncf
6    cfrd     copy cncf rdct
7    cnrd     cncf rdct
8    tlnp     tlnp
9    tlcp     copy tlnp

GWS action set table is (9 of 16) 56% full

```

2. Either remove a gateway screening stop action set from the database or remove a gateway screening stop action from a gateway screening stop action set from the database by entering the `chg-gws-actset` command.

If you wish to remove the gateway screening stop actions from an existing gateway screening stop action set (stop action sets 4 through 16), enter the `chg-gws-actset` command with the `all=none`, `actid`, and `force=yes` parameters, as shown in this command example.

```
chg-gws-actset:actid=4:all=none:force=yes
```

If you wish to remove individual gateway screening stop actions from an existing gateway screening stop action set (stop action sets 4 through 16), enter the `chg-gws-actset` command with the `stop` action parameter (`act1` through `act10`) value equal to `none` and the `force=yes` parameter, as shown in this command example.

```
chg-gws-actset:actid=5:act2=none:force=yes
```



**CAUTION**

**Caution:** Caution must be used when changing the stop actions in existing gateway screening stop action sets because these gateway screening stop action sets may be used by one or more gateway screening rules. Changes in the existing gateway screening stop action sets will change how MSUs that pass gateway screening are processed.

When each of these commands have successfully completed, this message should appear.

```
rlghncxa03w 06-10-25 15:30:30 GMT EAGLE5 36.0.0
CAUTION: GWS action set may be referenced by one or more GWS rules
CHG-GWS-ACTSET: MASP A - COMPLTD
```

3. Verify the changes using the `rtrv-gws-actset` command.

This is an example of the possible output.

```
rlghncxa03w 06-10-25 15:31:30 GMT EAGLE5 36.0.0
ACT  ACT  ACT  ACT  ACT  ACT  ACT  ACT  ACT  ACT  ACT
ID   NAME  1    2    3    4    5    6    7    8    9    10
--   -
1    copy  copy
2    rdct  rdct
3    cr    copy rdct
4    ----  ----
5    cpcncf copy
6    cncfrd cncf rdct
7    cpcfrd copy cncf rdct
8    tlnp  tlnp
9    cpnp  copy tlnp

GWS action set table is (8 of 16) 50% full
```

4. Backup the new changes using the `chg-db:action=backup:dest=fixed` command.

These messages should appear, the active Maintenance and Administration Subsystem Processor (MASP) appears first.

```
BACKUP (FIXED) : MASP A - Backup starts on active MASP.
```

```
BACKUP (FIXED) : MASP A - Backup on active MASP to fixed disk complete.  
BACKUP (FIXED) : MASP A - Backup starts on standby MASP.  
BACKUP (FIXED) : MASP A - Backup on standby MASP to fixed disk complete.
```

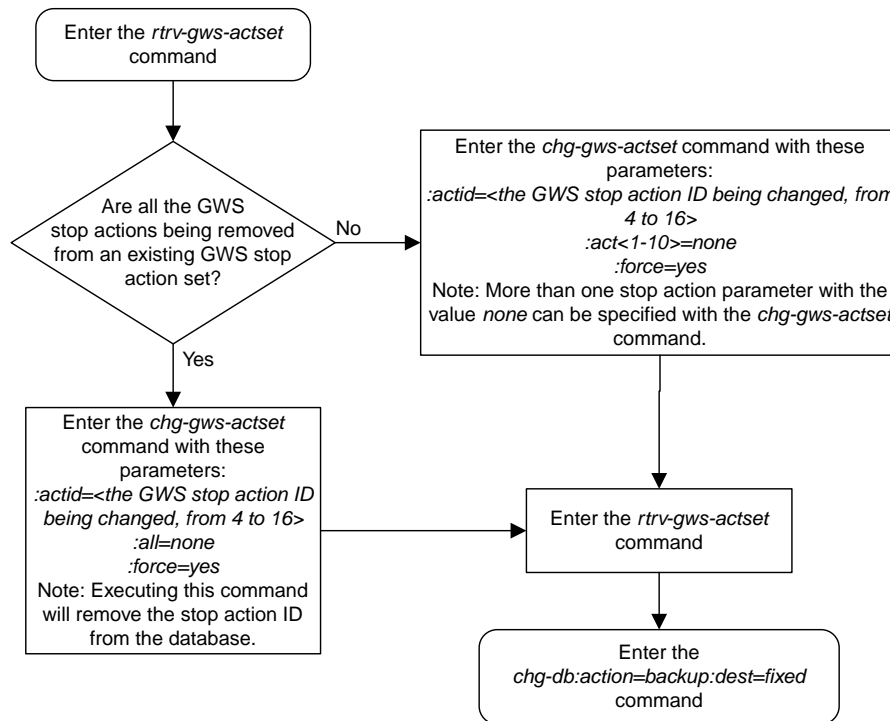

Figure 15: Removing Gateway Screening Stop Action Sets

## Setting the Threshold for Reporting Gateway Screening Activity

This procedure is used to set the threshold for reporting these gateway screening activities using the `set-gtwy-acthresh` command.

- The threshold for MSUs received on a gateway link set.
- The threshold for MSUs rejected on a gateway link set because of screening.

These thresholds are set on a linkset basis. These gateway screening activities are reported only if the threshold is set and only if the threshold is reached.

The `set-gtwy-acthresh` command uses these parameters.

`:intrvl` – The examination period, in minutes, during which the gateway screening activity thresholds are to be tested.

`:lsn` – The name of the linkset that the thresholds are assigned to.

`:recv` – The threshold for MSUs received on the gateway link set.

`:rej` – The threshold for MSUs rejected on the gateway link set because of screening.

### Canceling the `RTRV-LS` Command

Because the `rtrv-ls` command used in this procedure can output information for a long period of time, the `rtrv-ls` command can be canceled and the output to the terminal stopped. There are three ways that the `rtrv-ls` command can be canceled.

- Press the F9 function key on the keyboard at the terminal where the `rtrv-ls` command was entered.
- Enter the `canc-cmd` without the `trm` parameter at the terminal where the `rtrv-ls` command was entered.
- Enter the `canc-cmd:trm=<xx>`, where `<xx>` is the terminal where the `rtrv-ls` command was entered, from another terminal other than the terminal where the `rtrv-ls` command was entered. To enter the `canc-cmd:trm=<xx>` command, the terminal must allow Security Administration commands to be entered from it and the user must be allowed to enter Security Administration commands. The terminal's permissions can be verified with the `rtrv-secu-trm` command. The user's permissions can be verified with the `rtrv-user` or `rtrv-secu-user` commands.

For more information about the `canc-cmd` command, go to *Commands User's Guide*.

1. Display the gateway screening thresholds in the database using the `rtrv-gtwy-acthresh` command.

The following is an example of the possible output.

```
rlghncxa03w 06-10-25 15:25:30 GMT EAGLE5 36.0.0
LSN      REJ      RECV      INTRVL
WY644368 10       1000      10
WY234456 25       2000      20
LN123556 25       2500      30
OP239900 -         5         5
```

2. Display the current linkset configuration using the `rtrv-ls` command.

The following is an example of the possible output.

```

rlghncxa03w 09-05-25 15:26:30 GMT EAGLE5 41.0.0
                                     L3T SLT                               GWS GWS GWS
LSN      APCA  (SS7)  SCRNL  SET  SET  BEI  LST  LNKS  ACT  MES  DIS  SLSCI  NIS
lsa1     240-020-000  ss01  1   1  yes  A   1   off  off  off  no   off
lsa2     240-030-000  ss02  1   2  no   C   3   on  on  on  yes  off
lsa3     240-040-000  ss03  1   3  yes  C   5   off  off  off  yes  off
ln123556 240-050-000  ss01  1   8  yes  C   5   on  on  on  yes  off
op239900 240-060-000  ss01  1   7  yes  C   5   on  on  on  yes  off
wy234456 240-070-000  ss01  1   6  yes  C   5   on  on  on  yes  off
wy644368 240-080-000  ss01  1   5  yes  C   5   on  on  on  yes  off

                                     L3T SLT                               GWS GWS GWS
LSN      APCI  (SS7)  SCRNL  SET  SET  BEI  LST  LNKS  ACT  MES  DIS  SLSCI  NIS
lsi1     1-111-1    ss01  1   1  yes  A   1   off  off  off  ---  ---
lsi2     1-111-2    ss02  1   2  no   C   3   on  on  on  ---  ---
lsi3     1-111-3    ss03  1   3  yes  C   5   off  off  off  ---  ---

                                     L3T SLT                               GWS GWS GWS
LSN      APCN  (SS7)  SCRNL  SET  SET  BEI  LST  LNKS  ACT  MES  DIS  SLSCI  NIS
lsn1     11111    ss01  1   1  yes  A   1   off  off  off  ---  off
lsn2     11112    ss02  1   2  no   C   3   on  on  on  ---  off
lsn3     11113    ss03  1   3  yes  C   5   off  off  off  ---  off

Link set table is ( 9 of 1024) 1% full

```

If the GWSA value of the linkset is no, shown in the GWSACT column of the `rtrv-ls` output, perform the "Changing an SS7 Linkset" procedure in *Database Administration - SS7 User's Guide* to change the GWSA value of the linkset. Continue the procedure with [Step 3](#).

If the GWSA value of the linkset is yes, continue the procedure with [Step 3](#).

3. Set the gateway screening thresholds for a linkset using the `set-gtwy-acthresh` command. For this example, enter this command.

```
set-gtwy-acthresh:lsn=lsa2:intrvl=20:rej=30:rcv=2500
```

When this command has successfully completed, a message similar to the following should appear.

```

rlghncxa03w 06-10-25 15:29:30 GMT EAGLE5 36.0.0
SET-GTWY-TRSHLD: MASP A - COMPLTD

```

4. Verify the changes using the `rtrv-gtwy-acthresh` command with the linkset name specified in step 3.

For this example, enter this command.

```
rtrv-gtwy-acthresh:lsn=lsa2
```

The following is an example of the possible output.

```

rlghncxa03w 06-10-25 15:30:30 GMT EAGLE5 36.0.0
LSN      REJ      RECV      INTRVL
LSA2     30        2500      20

```

5. Backup the new changes using the `chg-db:action=backup:dest=fixed` command.

The following messages should appear, the active Maintenance and Administration Subsystem Processor (MASP) appears first.

```
BACKUP (FIXED) : MASP A - Backup starts on active MASP.  
BACKUP (FIXED) : MASP A - Backup on active MASP to fixed disk complete.  
BACKUP (FIXED) : MASP A - Backup starts on standby MASP.  
BACKUP (FIXED) : MASP A - Backup on standby MASP to fixed disk complete.
```



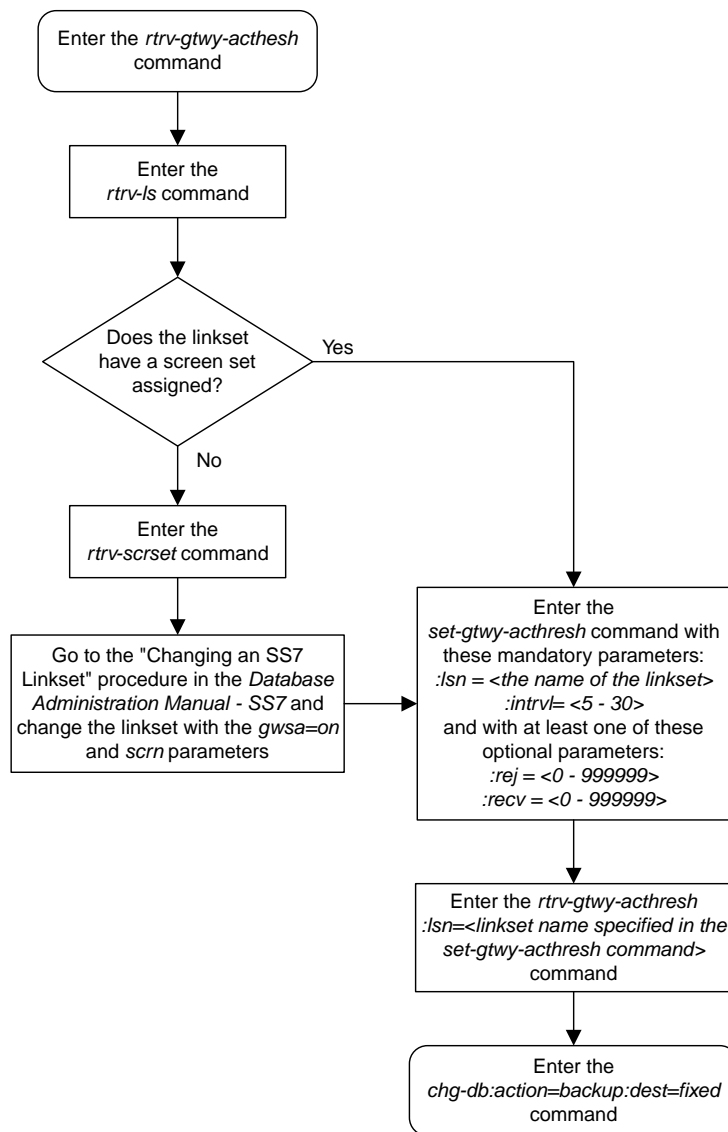

Figure 16: Setting the Threshold for Reporting Gateway Screening Activity

## Setting the Maximum Number of Gateway Screening Rejected Messages

When an MSU is rejected because of gateway screening, a UIM is sent to the terminal alerting the user that the MSU has been rejected. The EAGLE allows the user to configure the maximum number of these UIMs that can be sent to the terminal for a specified time period. This procedure is used to configure the maximum number of UIMs sent to the terminal and the time period using the `set-scrrej-prmtrs` command.

The `set-scrrej-prmtrs` command uses these parameters.

`:limit` – the number of UIMs to be sent to the EAGLE terminals during the time period specified by the `intrvl` parameter. The values for this parameter range from 0 to 9999.

`:intrvl` – the amount of time, in minutes, that the maximum number of UIMs, defined by the `limit` parameter, can be sent to the EAGLE terminals.

The examples in this procedure are used to set the number of UIMs to 500 and the time period to 20 minutes.

1. Display the current gateway screening rejected UIM limit in the database using the `rtrv-gtwy-prmtrs` command.

The following is an example of the possible output.

```
rlghncxa03w 06-10-25 15:25:30 GMT EAGLE5 36.0.0
LIMIT INTRVL
1000 15
```

2. Set the gateway screening rejected UIM limit using the `set-scrrej-prmtrs` command.

For this example, enter this command.

```
set-scrrej-prmtrs:limit=500:intrvl=20
```

When this command has successfully completed, a message similar to the following should appear.

```
rlghncxa03w 06-10-25 15:26:30 GMT EAGLE5 36.0.0
SET-SCRREJ-PRMTRS: MASP A - COMPLTD
```

3. Verify the changes using the `rtrv-gtwy-prmtrs` command.

The following is an example of the possible output.

```
rlghncxa03w 06-10-25 15:27:30 GMT EAGLE5 36.0.0
LIMIT INTRVL
500 20
```

4. Backup the new changes using the `chg-db:action=backup:dest=fixed` command.

The following messages should appear, the active Maintenance and Administration Subsystem Processor (MASP) appears first.

```
BACKUP (FIXED) : MASP A - Backup starts on active MASP.  
BACKUP (FIXED) : MASP A - Backup on active MASP to fixed disk complete.  
BACKUP (FIXED) : MASP A - Backup starts on standby MASP.  
BACKUP (FIXED) : MASP A - Backup on standby MASP to fixed disk complete.
```

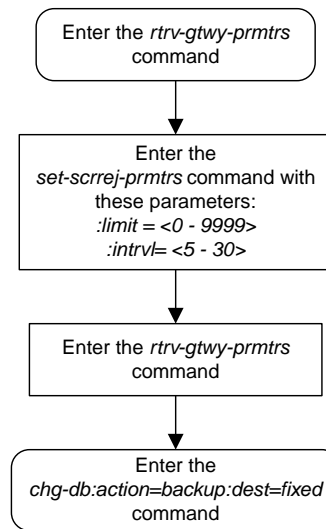

Figure 17: Setting the Maximum Number of Gateway Screening Rejected Messages

## Activating the MTP Routed GWS Stop Action Feature

This procedure is used to enable and turn on the MTP Routed GWS Stop Action feature using the feature's part number and a feature access key.

**Note:** As of Release 46.3, the fak parameter is no longer required. This parameter is only used for backward compatibility.

The feature access key for the MTP Routed GWS Stop Action feature is based on the feature's part number and the serial number of the EAGLE, making the feature access key site-specific.

The `enable-ctrl-feat` command enables the feature by inputting the feature's access key and the feature's part number with these parameters:

`: fak` – The feature access key provided by Oracle. The feature access key contains 13 alphanumeric characters and is not case sensitive.

`: partnum` – The Oracle-issued part number of the MTP Routed GWS Stop Action feature, 893035601.

The `enable-ctrl-feat` command requires that the database contain a valid serial number for the EAGLE, and that this serial number is locked. This can be verified with the `rtrv-serial-num` command. The EAGLE is shipped with a serial number in the database, but the serial number is not locked. The serial number can be changed, if necessary, and locked once the EAGLE is on-site, with the `ent-serial-num` command. The `ent-serial-num` command uses these parameters.

`: serial` – The serial number assigned to the EAGLE. The serial number is not case sensitive.

`: lock` – Specifies whether or not the serial number is locked. This parameter has only one value, `yes`, which locks the serial number. Once the serial number is locked, it cannot be changed.

**Note:** To enter and lock the EAGLE's serial number, the `ent-serial-num` command must be entered twice, once to add the correct serial number to the database with the `serial` parameter, then again with the `serial` and the `lock=yes` parameters to lock the serial number. You should verify that the serial number in the database is correct before locking the serial number. The serial number can be found on a label affixed to the control shelf (shelf 1100).

This feature cannot be temporarily enabled (with the temporary feature access key).

Once this feature is enabled, provisioning for this feature can be performed, but the feature will not work until the feature is turned on with the `chg-ctrl-feat` command. The `chg-ctrl-feat` command uses these parameters.

`: partnum` – The Oracle-issued part number of the MTP Routed GWS Stop Action feature, 893035601.

`: status=on` – used to turn the MTP Routed GWS Stop Action feature on.

Once the MTP Routed GWS Stop Action feature has been turned on, it can be turned off. For more information on turning the MTP Routed GWS Stop Action feature off, refer to the [Turning Off the MTP Routed GWS Stop Action Feature](#) procedure.

The status of the features in the EAGLE is shown with the `rtrv-ctrl-feat` command.

When the MTP Routed GWS Stop Action feature is turned on, MTP routed SCCP UDT/XUDT messages that pass gateway screening are forwarded to the service modules for further processing.

1. Display the status of the controlled features by entering the `rtrv-ctrl-feat` command. The following is an example of the possible output.

```
tklcl1110501 15-06-24 16:53:12 EST EAGLE5 46.2.0-65.53.1
The following features have been permanently enabled:
```

Feature Name	Partnum	Status	Quantity
Large System # Links	893005910	on	2000
XGTT Table Expansion	893006110	on	1000000
Routesets	893006403	on	8000
LNP Short Message Serv.	893006601	on	----
Intermed GTT Load Sharing	893006901	on	----
Command Class Management	893005801	on	----
Telnet	893005701	on	----
EAGLE5 Product	893007101	on	----
XMAP Table Expansion	893007710	on	3000
LNP ported NPANXXs	893009403	on	350000
LNP ported LRNs	893010506	on	200000
LNP ELAP Configuration	893010901	on	----
LNP ported TNS	893011036	on	384000000
SCCP Conversion	893012001	on	----
HC-MIM SLK Capacity	893012707	on	64
EAGLE OA&M IP Security	893400001	off	----
Flexible GTT Load Sharing	893015401	on	----
Origin-Based MTP Routing	893014201	on	----
Origin Based SCCP Routing	893014301	on	----
GPORT	893017201	on	----
INP	893017901	on	----
E5-SM4G Throughput Cap	893019101	on	5000
Multiple Linkset to APC	893019701	on	----
6-Way LS on Routesets	893019801	on	----
Proxy Point Code	893018710	on	100
AMGTT	893021801	on	----
VGTT with 16 GTT lengths	893024801	on	----
ITU TCAP LRN QUERY(LRNQT)	893026301	on	----
ISLSBR	893026501	on	----
GTT Action - DISCARD	893027501	on	----
GTT Action - DUPLICATE	893027601	on	----
GTT Action - FORWARD	893037501	on	----
Flex Lset Optnl Based Rtg	893027701	on	----
TCAP Opcode Based Routing	893027801	on	----
TOBR Opcode Quantity	893027907	on	1000000
ST-HSL-A SLK Capacity	893027301	on	4
3 Links per E5-ATM card	893039104	on	20
Integrated GLS	893038901	on	----
EPAP Data Split	893039801	on	----
Dual ExAP Config	893040501	on	----

```
The following features have been temporarily enabled:
```

Feature Name	Partnum	Status	Quantity	Trial Period Left
Zero entries found.				

```
The following features have expired temporary keys:
```

Feature Name	Partnum
Zero entries found.	

If the MTP Routed GWS Stop Action feature is enabled and turned on, no further action is necessary. This procedure does not need to be performed.

If the MTP Routed GWS Stop Action feature is enabled and but not turned on, continue the procedure with [Step 8](#).

If the MTP Routed GWS Stop Action feature is not enabled, continue the procedure with [Step 2](#).

- To enable the MTP Routed GWS Stop Action feature, the GTT feature must be turned on. Enter the `rtrv-feat` command to verify whether or not the GTT feature is on. If the GTT feature is on, the `GTT` field should be set to `on`.

**Note:** The `rtrv-feat` command output contains other fields that are not used by this procedure. If you wish to see all the fields displayed by the `rtrv-feat` command, refer to the `rtrv-feat` command description in *Commands User's guide*.

If the GTT feature is off, perform the "Adding a Service Module" procedure in *Database Administration - GTT* to turn the GTT feature on. Add any required service modules according to the Service Module and Feature Combination table in the "Adding a Service Module" procedure.

After the "Adding a Service Module" procedure has been performed, or if the GTT feature is on, continue the procedure by performing one of these steps.

- If the `rtrv-ctrl-feat` output shows the HC-MIM SLK Capacity feature with a quantity of 64 and other features, continue the procedure with [Step 7](#).
- If the `rtrv-ctrl-feat` output shows only the HC-MIM SLK Capacity feature with a quantity of 64, continue the procedure with [Step 3](#).

- Display the serial number in the database with the `rtrv-serial-num` command. This is an example of the possible output.

```
rlghncxa03w 09-07-28 21:15:37 GMT EAGLE5 41.1.0
System serial number = nt00001231

System serial number is not locked.

rlghncxa03w 09-07-28 21:15:37 GMT EAGLE5 41.1.0
Command Completed
```

**Note:** If the serial number is correct and locked, continue the procedure with [Step 7](#). If the serial number is correct but not locked, continue the procedure with [Step 6](#). If the serial number is not correct, but is locked, this feature cannot be enabled and the remainder of this procedure cannot be performed. Contact the Customer Care Center to get an incorrect and locked serial number changed. Refer to [My Oracle Support \(MOS\)](#) for the contact information. The serial number can be found on a label affixed to the control shelf (shelf 1100).

- Enter the correct serial number into the database using the `ent-serial-num` command with the `serial` parameter.

For this example, enter this command.

```
ent-serial-num:serial=<EAGLE's correct serial number>
```

When this command has successfully completed, the following message should appear.

```
rlghncxa03w 09-07-28 21:15:37 GMT EAGLE5 41.1.0
ENT-SERIAL-NUM: MASP A - COMPLTD
```

- Verify that the serial number entered into [Step 4](#) was entered correctly using the `rtrv-serial-num` command. This is an example of the possible output.

```
rlghncxa03w 09-07-28 21:15:37 GMT EAGLE5 41.1.0
System serial number = nt00001231

System serial number is not locked.

rlghncxa03w 09-07-28 21:15:37 GMT EAGLE5 41.1.0
Command Completed
```

If the serial number was not entered correctly, repeat [Step 4](#) and [Step 5](#) and re-enter the correct serial number.

- Lock the serial number in the database by entering the `ent-serial-num` command with the serial number shown in [Step 3](#), if the serial number shown in [Step 3](#) is correct, or with the serial number shown in [Step 5](#), if the serial number was changed in [Step 4](#), and with the `lock=yes` parameter.

For this example, enter this command.

```
ent-serial-num:serial=<EAGLE's serial number>:lock=yes
```

When this command has successfully completed, the following message should appear.

```
rlghncxa03w 09-07-28 21:15:37 GMT EAGLE5 41.1.0
ENT-SERIAL-NUM: MASP A - COMPLTD
```

- Enable the MTP Routed GWS Stop Action feature with the `enable-ctrl-feat` command specifying the part number for the MTP Routed GWS Stop Action feature and the feature access key. Enter this command.

```
enable-ctrl-feat:partnum=893035601:fak=<MTP Routed GWS Stop Action feature
access key>
```

The MTP Routed GWS Stop Action feature cannot be enabled with a temporary feature access key.

The value for the feature access key (the `fak` parameter) is provided by Oracle. If you do not have the feature access key for the MTP Routed GWS Stop Action feature, contact your Oracle Sales Representative or Account Representative.

When the `enable-ctrl-feat` command has successfully completed, this message should appear.

```
rlghncxa03w 09-07-28 21:15:37 GMT EAGLE5 41.1.0
ENABLE-CTRL-FEAT: MASP B - COMPLTD
```



**CAUTION**

**Caution:** Once the MTP Routed GWS Stop Action feature is enabled, the SCCP gateway screening stop action can be provisioned for Gateway Screening rules. MTP routed SCCP UDT/XUDT messages that pass gateway screening will not be forwarded to the service modules for further processing until the MTP Routed GWS Stop Action is turned on in [Step 8](#).

- Turn the MTP Routed GWS Stop Action feature on with the `chg-ctrl-feat` command specifying the part number for the MTP Routed GWS Stop Action feature and the `status=on` parameter. Enter this command.



```
chg-ctrl-feat:partnum=893035601:status=on
```

When the `chg-crtl-feat` command has successfully completed, this message should appear.

```
rlghncxa03w 09-07-28 21:15:37 GMT EAGLE5 41.1.0
CHG-CTRL-FEAT: MASP B - COMPLTD
```

- Verify the changes by entering the `rtrv-ctrl-feat` command with the MTP Routed GWS Stop Action feature part number. Enter this command.

```
rtrv-ctrl-feat:partnum=893035601
```

The following is an example of the possible output.

```
rlghncxa03w 09-07-28 21:15:37 GMT EAGLE5 41.1.0
The following features have been permanently enabled:

Feature Name          Partnum    Status    Quantity
MTPRTD GWS Stop Action 893035601  on       ----

The following features have been temporarily enabled:

Feature Name          Partnum    Status    Quantity    Trial Period Left
Zero entries found.

The following features have expired temporary keys:

Feature Name          Partnum
Zero entries found.
```

- Backup the new changes using the `chg-db:action=backup:dest=fixed` command. These messages should appear, the active Maintenance and Administration Subsystem Processor (MASP) appears first.

```
BACKUP (FIXED) : MASP A - Backup starts on active MASP.
BACKUP (FIXED) : MASP A - Backup on active MASP to fixed disk complete.
BACKUP (FIXED) : MASP A - Backup starts on standby MASP.
BACKUP (FIXED) : MASP A - Backup on standby MASP to fixed disk complete.
```

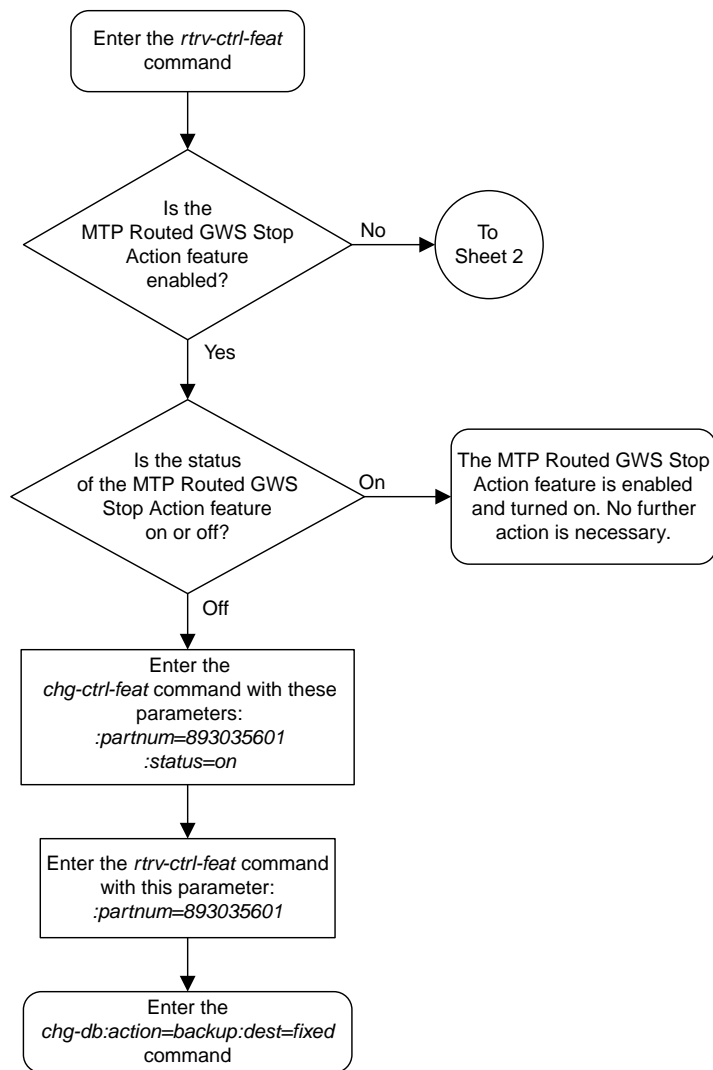

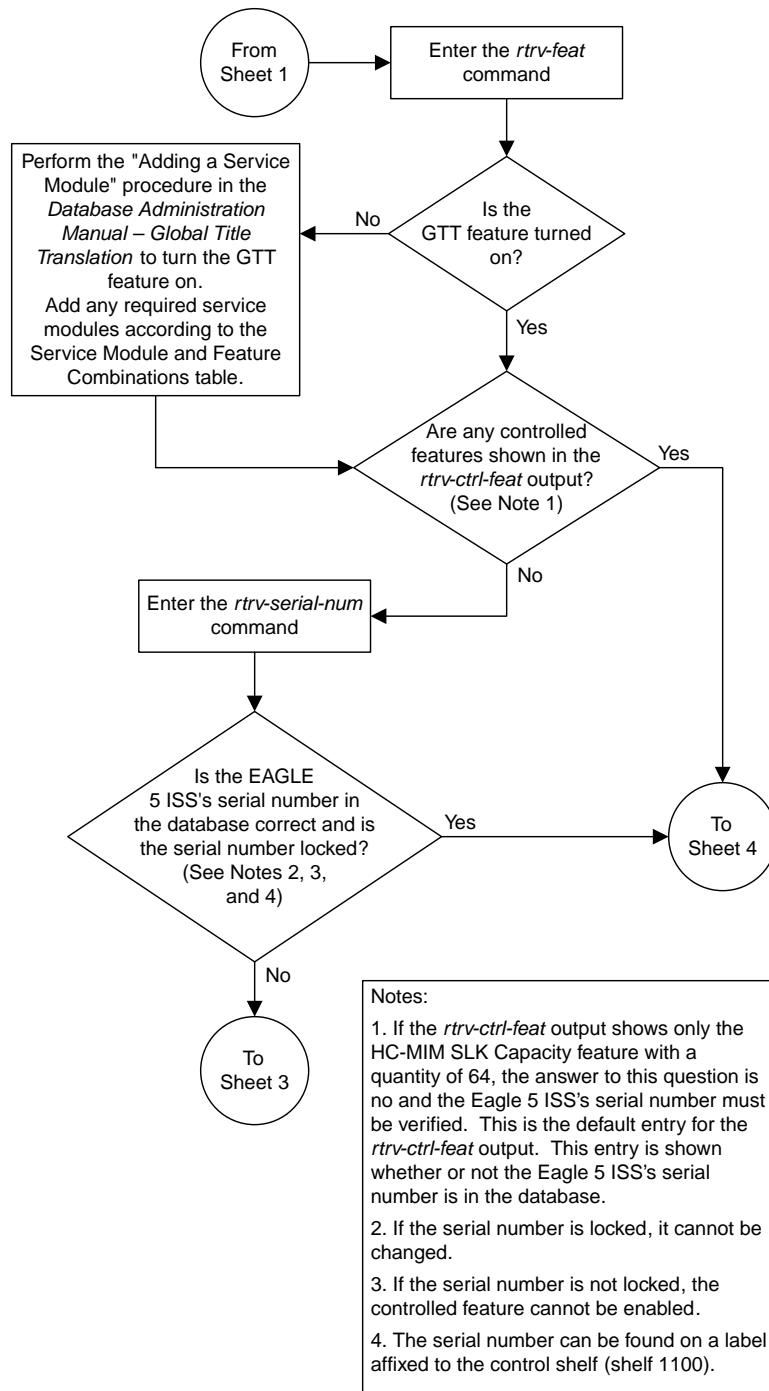

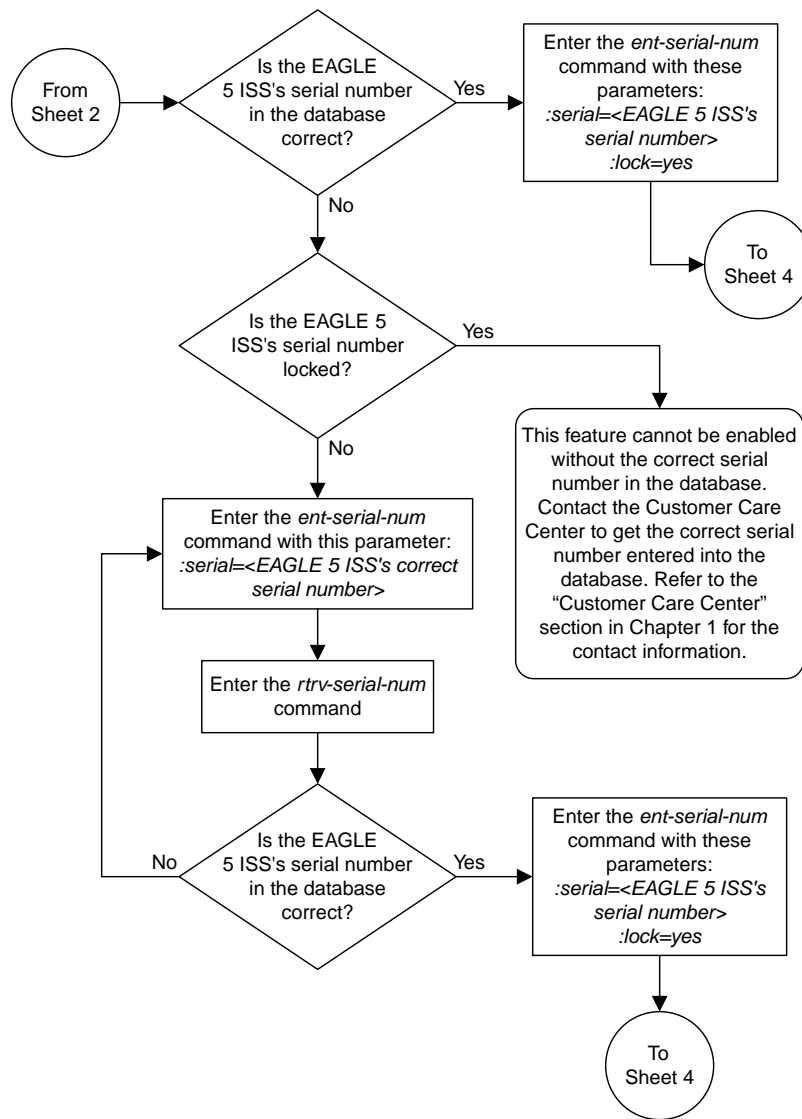

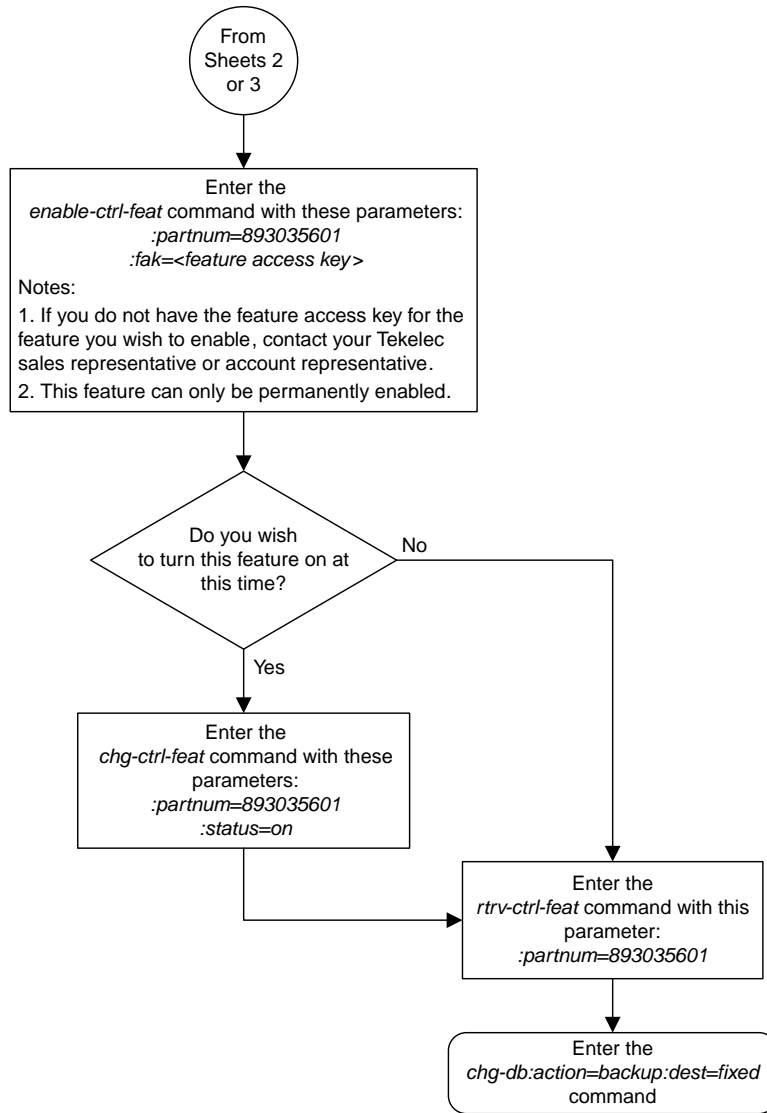

Sheet 4 of 4

**Figure 18: Activating the MTP Routed GWS Stop Action Feature**

## Turning Off the MTP Routed GWS Stop Action Feature

This procedure is used to turn off the MTP Routed GWS Stop Action feature, using the `chg-ctrl-feat` command.

The `chg-ctrl-feat` command uses the following parameters:

`:partnum` - The part number of the MTP Routed GWS Stop Action feature, 893035601.

`:status=off` - used to turn off the MTP Routed GWS Stop Action feature.

The status of the MTP Routed GWS Stop Action feature must be on and is shown with the `rtrv-ctrl-feat` command.



**Caution:** If the MTP Routed GWS Stop Action feature is turned off, MTP routed SCCP UDT/XUDT messages that pass gateway screening will not be forwarded to the service modules for further processing.

1. Display the status of the MTP Routed GWS Stop Action feature by entering the `rtrv-ctrl-feat:partnum=893035601` command.

The following is an example of the possible output.

```
rlghncxa03w 09-07-28 21:15:37 GMT EAGLE5 41.1.0
The following features have been permanently enabled:

Feature Name           Partnum    Status    Quantity
MTPRTD GWS Stop Action 893035601  on       ----

The following features have been temporarily enabled:

Feature Name           Partnum    Status    Quantity    Trial Period Left
Zero entries found.

The following features have expired temporary keys:

Feature Name           Partnum
Zero entries found.
```

If the status of the MTP Routed GWS Stop Action feature is off, or if the MTP Routed GWS Stop Action feature is not enabled, this procedure cannot be performed.

2. Turn off the MTP Routed GWS Stop Action feature by entering the `chg-ctrl-feat` command with the `status=off` parameter.

For example, enter this command.

```
chg-ctrl-feat:partnum=893035601:status=off
```

When this command has successfully completed, the following message should appear.

```
rlghncxa03w 09-07-28 21:16:37 GMT EAGLE5 41.1.0
CHG-CTRL-FEAT: MASP A - COMPLTD
```

3. Verify that the MTP Routed GWS Stop Action feature has been turned off by using the `rtrv-ctrl-feat:partnum=893035601` command. The following is an example of the possible output.

```
rlghncxa03w 09-07-28 21:15:37 GMT EAGLE5 41.1.0
The following features have been permanently enabled:

Feature Name           Partnum   Status   Quantity
MTPRTD GWS Stop Action 893035601 off      ----

The following features have been temporarily enabled:

Feature Name           Partnum   Status   Quantity   Trial Period Left
Zero entries found.

The following features have expired temporary keys:

Feature Name           Partnum
Zero entries found.
```

4. Backup the new changes using the `chg-db:action=backup:dest=fixed` command. These messages should appear, the active Maintenance and Administration Subsystem Processor (MASP) appears first.

```
BACKUP (FIXED) : MASP A - Backup starts on active MASP.
BACKUP (FIXED) : MASP A - Backup on active MASP to fixed disk complete.
BACKUP (FIXED) : MASP A - Backup starts on standby MASP.
BACKUP (FIXED) : MASP A - Backup on standby MASP to fixed disk complete.
```

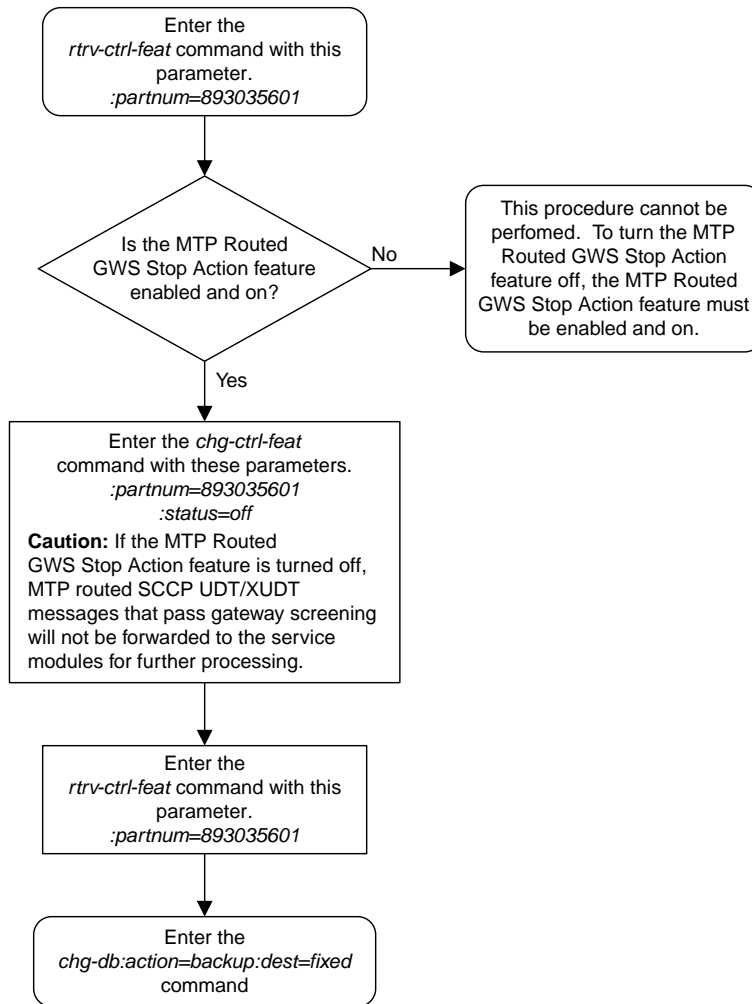

Figure 19: Turning Off the MTP Routed GWS Stop Action Feature



# Chapter 3

## Allowed Affected Point Code (AFTPC) Screen Configuration

---

### Topics:

- *Introduction.....126*
- *Adding an Allowed Affected Point Code Screen.....129*
- *Removing an Allowed Affected Point Code Screen.....139*
- *Changing an Allowed Affected Point Code Screen.....143*

Chapter 3, Allowed Affected Point Code (AFTPC) Screen Configuration, contains the procedures necessary to configure allowed affected point code screens.

## Introduction

The allowed affected point code (AFTPC) screen is used to identify affected point codes. Messages containing the allowed affected point code in the AFTPC screen are allowed into the EAGLE for further processing. The gray shaded areas in [Figure 21: Allowed Affected Point Code Screening Function](#) shows the fields of the SS7 message that are checked by the AFTPC screening function. Affected point codes are found in subsystem-prohibited (SSP), subsystem-status-test (SST) and subsystem-allowed (SSA) SCCP management messages. This is the last screen in the gateway screening process.

## Gateway Screening Actions

The Gateway Screening process stops with this screen. The `nsfi` parameter value can only be `stop`. If a match is not found, the message is discarded.

If a match is found, the message is processed. If a gateway screening stop action set is specified with the screen, shown by the `actname` parameter value, the message is processed according to the gateway screening stop actions that are assigned to the gateway screening stop action set.

- If the `copy` gateway screening stop action is specified, the message is processed and a copy of the message is sent by the STPLAN feature to an external application.
- If the `rdct` (redirect) gateway screening stop action is specified, the message is diverted from the original destination and sent to another destination with the Database Transport Access feature, specified by global title translation, for further processing.
- If the `cncf` gateway screening stop action is specified, the PIP parameter in the incoming ISUP IAM message is converted to the GN parameter. The GN parameter in the incoming ISUP IAM message is converted to the PIP parameter. The message is then sent to the node specified by the DPC in the routing label in the message. For more information on the Calling Name Conversion Facility feature, see [Calling Name Conversion Facility \(CNCF\) Configuration](#).
- If the `tlnp` gateway screening stop action is specified, ISUP IAMs that pass gateway screening are processed either by the ISUP NP with EPAP feature (if the ISUP NP with EPAP feature is enabled and turned on) or by the Triggerless LNP feature (if the Triggerless LNP feature is turned on). The ISUP NP with EPAP feature is discussed in more detail in *G-Port User's Guide*. The Triggerless LNP feature is discussed in more detail in *ELAP Administration and LNP Feature Activation Guide*.
- If the `tinp` gateway screening stop action is specified, ISUP IAMs that pass gateway screening are intercepted by the Triggerless ISUP based Number Portability (TINP) feature and converted to include the routing number (RN) if the call is to a ported number. The TINP feature is discussed in more detail in *G-Port User's Guide*.
- If the `tif`, `tif2`, or `tif3` gateway screening stop actions are specified, TIF processing is applied to the message.
- If the `sccp` gateway screening stop action is specified, MTP routed SCCP UDT/XUDT are forwarded to the service modules for further processing.

## Allowed AFTPC Screening Actions

[Figure 20: Allowed AFTPC Screening Actions](#) shows the screening actions of the allowed AFTPC screen.

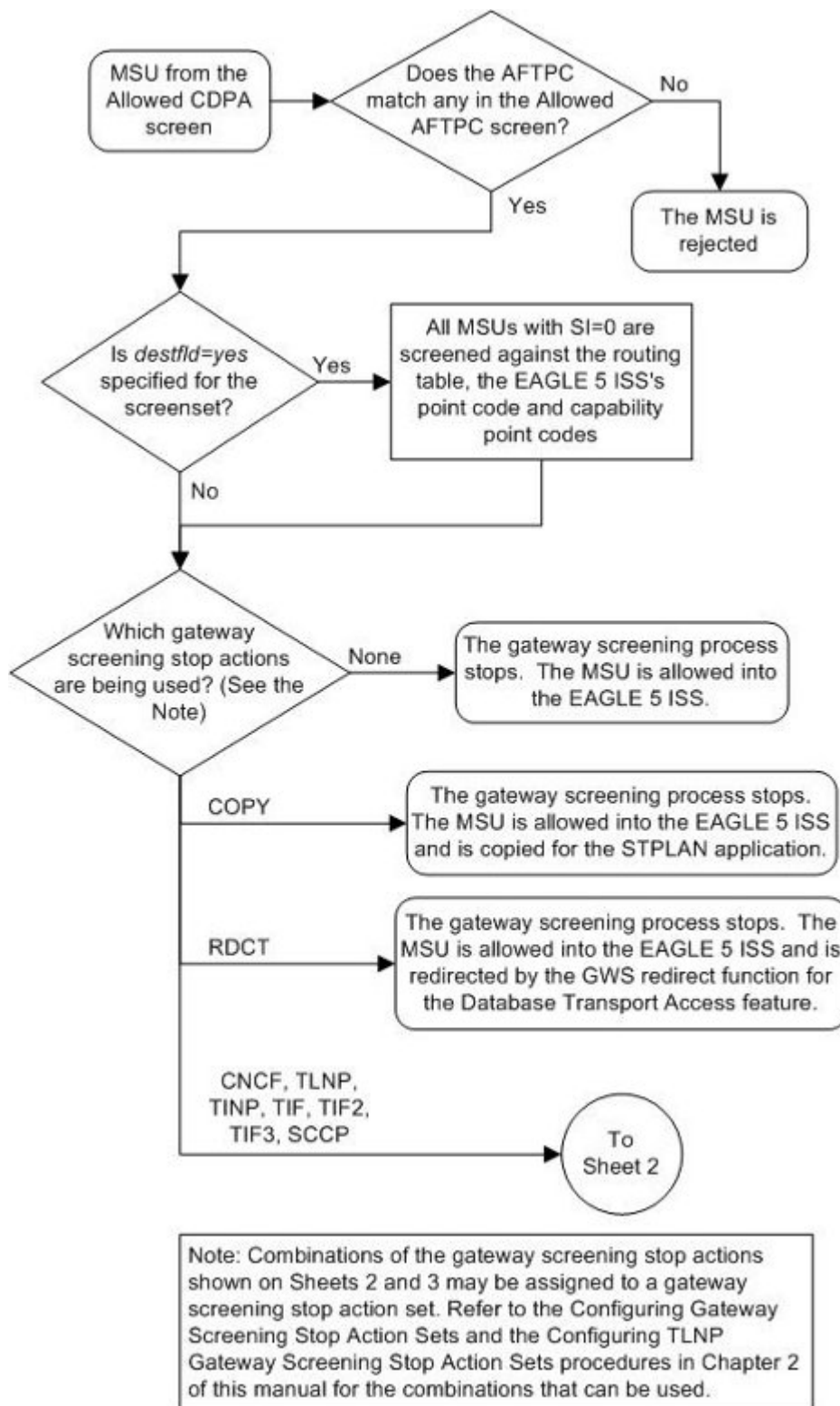

Sheet 1 of 2

Figure 20: Allowed AFTPC Screening Actions

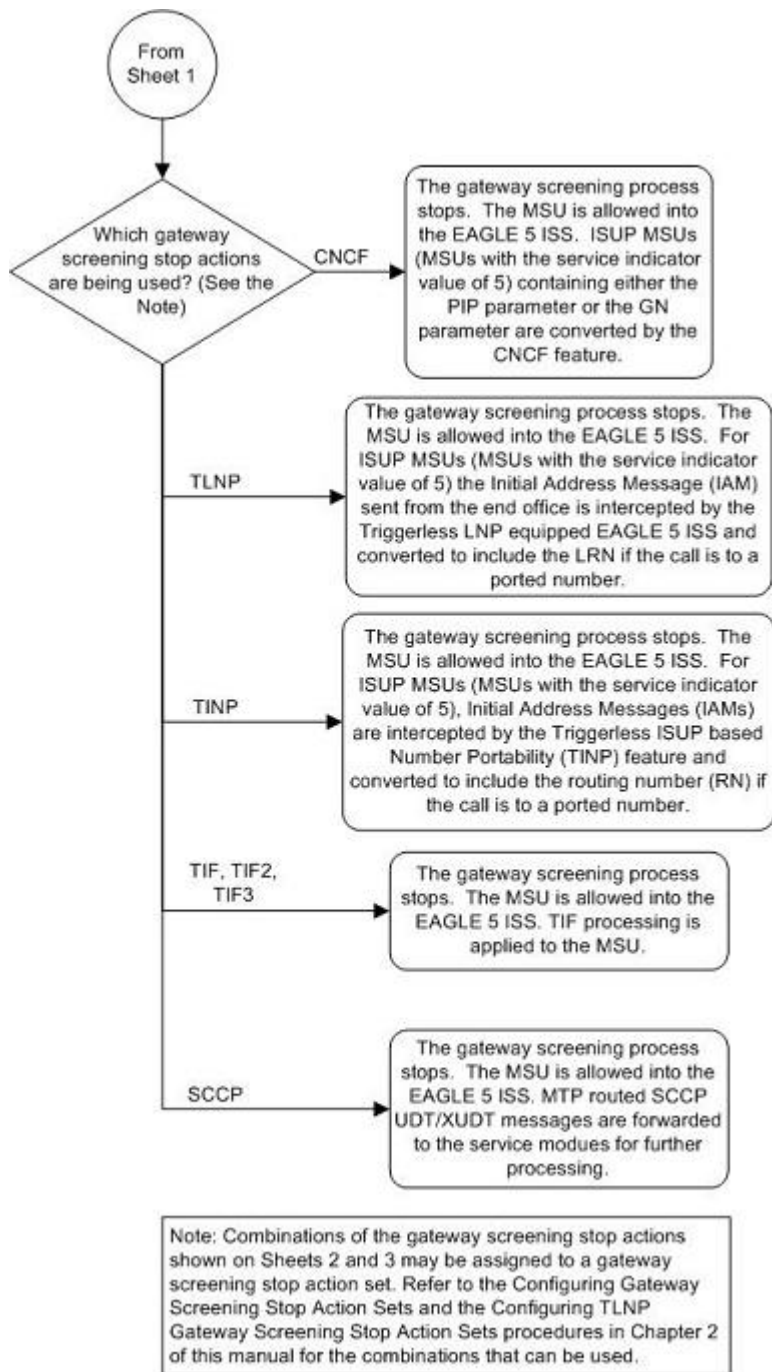

ANSI MSU (ANSI Message Signal Unit)

BSN FSN LI	SIO xx xx xxxx NIC PRI SI	SIF					
		DPC NCM NC NI	Routing Label OPC NCM NC NI	SLS xx	CGPA	CDPA	SCMG Data Length Message Type\ (SSA, SSP, SST) Affected Subsystem Affected Point Code (NCM NC NI) Subsystem Multiplicity

ITU-I MSU (ITU International Message Signal Unit)

BSN FSN LI	SIO xx xx xxxx NIC PRI SI	SIF					
		DPC ID AREA ZONE	Routing Label OPC ID AREA ZONE	SLS xx	CGPA	CDPA	SCMG Data Length Message Type\ (SSA, SSP, SST) Affected Subsystem Affected Point Code (ID AREA ZONE) Subsystem Multiplicity

14-Bit ITU-N MSU (14-Bit ITU National Message Signal Unit)

BSN FSN LI	SIO xx xx xxxx NIC PRI SI	SIF					
		DPC NPC	Routing Label OPC NPC	SLS xx	CGPA	CDPA	SCMG Data Length Message Type\ (SSA, SSP, SST) Affected Subsystem Affected Point Code (NPC) Subsystem Multiplicity

24-Bit ITU-N MSU (24-Bit ITU National Message Signal Unit)

BSN FSN LI	SIO xx xx xxxx NIC PRI SI	SIF					
		DPC SP SSA MSA	Routing Label OPC SP SSA MSA	SLS xx	CGPA	CDPA	SCMG Data Length Message Type\ (SSA, SSP, SST) Affected Subsystem Affected Point Code (SP SSA MSA) Subsystem Multiplicity

Figure 21: Allowed Affected Point Code Screening Function

## Adding an Allowed Affected Point Code Screen

This procedure is used to add an allowed affected point code (AFTPC) screen to the database using the `ent-scr-aftpc` command. The parameters used by the `ent-scr-aftpc` command are shown in the [Gateway Screening Attributes](#) section. The general rules that apply to configuring gateway screening entities are shown in the [Gateway Screening Configuration](#) section.

The examples in this procedure are used to add the allowed AFTPC screen data shown in [Table 15: Example Gateway Screening Allowed AFTPC Configuration Table](#) and based on the example configurations

shown in [Figure 4: Gateway Screening Configuration - Example 1](#) and [Figure 7: Gateway Screening Configuration - Example 4](#).

**Table 15: Example Gateway Screening Allowed AFTPC Configuration Table**

Screening Reference	NI	NC	NCM	SSN	NSFI	ACTNAME
gw20	008	008	008	250	stop	COPY
ls04	010	010	010	015	stop	COPY

**Note:** If you using multiple-part ITU national point codes with gateway screening, see the [14-Bit ITU National Point Code Formats](#) section.

### Specifying a Range of Values

A range of values can be specified for the point code parameters `ni`, `nc`, or `ncm`.

If a range of values is specified for any of these parameters, and the value of the other parameters match existing values for the screening reference name, the range of values for the point code parameter cannot include any values for that parameter that are currently provisioned for the screening reference name.

For example, screening reference name `scr1` contains these entries:

SR	NI	NC	NCM	SSN	NSFI	NSR/ACT
SCR1	240	001	010	012	STOP	-----
SCR1	241	010	020	015	STOP	-----

Another entry for screening reference `scr1` with the `ni` value of 240 and the `nc` value of 001 cannot be specified if the range of values for the `ncm` parameter includes the value 010.

The ANSI point code parameter values can be specified as a single value, a range of values, or with an asterisk (\*). The asterisk specifies all possible values for the `ni`, `nc`, and `ncm` parameters. [Table 16: Valid Value Combinations for ANSI Point Code Parameters](#) shows the valid combinations of these parameter values.

**Table 16: Valid Value Combinations for ANSI Point Code Parameters**

NI	NC	NCM
Single Value	Single Value	Single Value
Single Value	Single Value	Range of Values
Single Value	Single Value	Asterisk
Single Value	Range of Values	Asterisk
Single Value	Asterisk	Asterisk
Range of Values	Asterisk	Asterisk
Asterisk	Asterisk	Asterisk

A range of values can also be specified for an ITU-I or 24-bit ITU-N point code parameter using a combination of asterisks (\*) and single values for the point code parameters. [Table 17: Valid Value Combinations for ITU-I Point Code Parameters](#) shows the valid combinations of the ITU-I parameter values. [Table 18: Valid Value Combinations for 24-Bit ITU-N Point Code Parameters](#) shows the valid combinations of the 24-bit ITU-N parameter values.

**Table 17: Valid Value Combinations for ITU-I Point Code Parameters**

ZONE	AREA	ID
Single Value	Single Value	Single Value
Single Value	Single Value	Asterisk
Single Value	Asterisk	Asterisk
Asterisk	Asterisk	Asterisk

**Table 18: Valid Value Combinations for 24-Bit ITU-N Point Code Parameters**

MSA	SSA	SP
Single Value	Single Value	Single Value
Single Value	Single Value	Asterisk
Single Value	Asterisk	Asterisk
Asterisk	Asterisk	Asterisk

1. Verify that the gateway screening feature is on, by entering the `rtrv-feat` command.

If the gateway screening feature is on, the `GWS` field is set to `on`.

**Note:** The `rtrv-feat` command output contains other fields that are not used by this procedure. If you wish to see all the fields displayed by the `rtrv-feat` command, see the `rtrv-feat` command description in *Commands User's Guide*.

If the gateway screening feature is on, shown by the entry `GWS = on` in the `rtrv-feat` command output, skip step 2, and go to step 3.

2. Turn the gateway screening feature on by entering this command.

```
chg-feat:gws=on
```

**Note:** Once the gateway screening feature is turned on with the `chg-feat` command, it cannot be turned off.

The gateway screening feature must be purchased before you turn this feature on with the `chg-feat` command. If you are not sure if you have purchased the gateway screening feature, contact your Oracle Sales Representative or Account Representative.

When the `chg-feat` has successfully completed, this message should appear.

```
rlghncxa03w 06-10-28 11:43:04 GMT EAGLE5 36.0.0
CHG-FEAT: MASP A - COMPLTD
```

3. Display all allowed AFTPC screens in the database using the `rtrv-scr-aftpc` command.

The following is an example of the possible output.

```
rlghncxa03w 06-10-25 15:25:30 GMT EAGLE5 36.0.0
SCREEN = ALLOWED AFTPC
SR      REF  RULES
IEC     YES   2
WRD2    YES   1
WRD4    YES   9
```

If the screening reference names that you wish to add with this procedure are not shown in the `rtrv-scr-aftpc` command output, go to step 4. For this example, the screening reference names are not shown. If these screening reference names are shown in the `rtrv-scr-aftpc` command output, make sure the screening data you wish to enter is not already in the database by entering the `rtrv-scr-aftpc` command with the screening reference name. For example, enter the `rtrv-scr-aftpc:sr=iec` command. The following is an example of the possible output.

```
rlghncxa03w 06-10-25 15:26:30 GMT EAGLE5 36.0.0
SCREEN = ALLOWED AFTPC
SR      NI      NC      NCM      SSN      NSF1      NSR/ACT
IEC     010     010     011     012     STOP     -----
IEC     010     010     013     012     STOP     -----
```

If a gateway screening stop action set is to be assigned to the allowed AFTPC screen being added to the database, go to step 4. Otherwise, go to step 5.

4. Display the gateway screening stop action sets in the database with the `rtrv-gws-actset` command.

This is an example of the possible output.

```
rlghncxa03w 06-10-25 15:26:30 GMT EAGLE5 36.0.0
ACT  ACT  ACT  ACT  ACT  ACT  ACT  ACT  ACT  ACT  ACT  ACT
ID   NAME  1    2    3    4    5    6    7    8    9    10
--   -
1    copy  copy
2    rdct  rdct
3    cr    copy rdct
4    cncf  cncf
5    cpcncf copy cncf
6    cncfrd cncf rdct
7    cpcfrd copy cncf rdct
```

GWS action set table is (7 of 16) 44% full

If the required gateway screening stop action set is not in the database, perform the [Configuring Gateway Screening Stop Action Sets](#) procedure to configure the required gateway screening stop action set.

**Note:** If the point code being added in this procedure is not anITU-I or 14-bitITU-N spare point code, skip step 5 and to step 6.

**Note:** If the point code being added in this procedure is anITU-I or 14-bitITU-N spare point code and the screening reference containsITU-I or 14-bitITU-N spare point codes, skip step 5 and go to step 6.



5. Display the status of the ITU National and International Spare Point Code Support feature by entering the `rtrv-ctrl-feat` command with the ITU National and International Spare Point Code Support feature part number.

Enter this command.

```
rtrv-ctrl-feat:partnum=893013601
```

This is an example of the possible output.

```
rlghncxa03w 06-10-25 15:25:30 GMT EAGLE5 36.0.0
The following features have been permanently enabled:

Feature Name          Partnum   Status Quantity
Spare Point Code Support 893013601 on      ----

The following features have been temporarily enabled:

Feature Name          Partnum   Status Quantity   Trial Period Left
Zero entries found.

The following features have expired temporary keys:

Feature Name          Partnum
Zero entries found.
```

If the ITU National and International Spare Point Code Support feature is enabled, go to step 6.

If the ITU National and International Spare Point Code Support feature is not enabled, perform the “Activating the ITU National and International Spare Point Code Support Feature” procedure in *Database Administration - SS7 User’s Guide* to enable the ITU National and International Spare Point Code Support feature as required. After the feature has been enabled, go to step 6.

6. Add the new allowed AFTPC screen to the database using the `ent-scr-aftpc` command.



**CAUTION**

**Caution:** The EAGLE does not support redirecting MSUs for the DTA feature or intercepting ISUPIAM messages for the Calling Name Conversion Facility feature from the allowed AFTPC screen. Gateway screening stop action sets containing either the RDCT (redirect) or CNCF (calling name conversion facility) stop actions should not be assigned to the allowed AFTPC screen. If a gateway screening stop action set containing the RDCT or CNCF stop actions is specified with the `ent-scr-aftpc` command, unsolicited information message (UIM) 1127 is generated when the attempt is made to redirect MSUs from the allowed AFTPC screen. Unsolicited information message (UIM) 1217 is generated when ISUP IAMMSUs are intercepted from the allowed AFTPC screen. For more information on UIMs 1127 and 1217, go to *Unsolicited Alarm and Information Messages Reference*.

If a gateway screening stop action is to be assigned to the allowed AFTPC screen being changed, enter the `ent-scr-aftpc` command with the `nsfi=stop` parameter and the `actname` parameter with the name of a gateway screening stop action set shown in the output of the `rtrv-gws-actset` command executed in step 4.

The following list contains the values for `ni`, `nc`, `ncm`, `zone`, `area`, `id`, `npc`, `msa`, `ssa`, `sp`, and `ssn` parameters:

- `ni` – 0 - 255 or an asterisk (\*)
- `nc` – 0 - 255 or an asterisk (\*)

- ncm – 0 - 255 or an asterisk (\*)
- zone – 0 - 7 or an asterisk (\*)
- area – 0 - 255 or an asterisk (\*)
- id – 0 - 7 or an asterisk (\*)
- npc – 1 - 16383 or an asterisk (\*)
- msa – 0 - 255 or an asterisk (\*)
- ssa – 0 - 255 or an asterisk (\*)
- sp – 0 - 255 or an asterisk (\*)
- ssn – 0 - 255 or an asterisk (\*)

A range of values can be specified for the ni, nc, and ncm parameters. See the [“Specifying a Range of Values”](#) section for more information on how the asterisk and a range of values are used for the ni, nc, and ncm parameters.

To add a spare point code to the allowed AFTPC screen, the pcst=s parameter must be specified. To add a non-spare point code to the allowed AFTPC screen, the pcst parameter does not have to be specified. If the pcst parameter is specified for a screen containing an ITU-I or 14-bit ITU-N non-spare point code, the value must be none. For this example, enter these commands.

```
ent-scr-aftpc:sr=gw20:ni=008:nc=008:ncm=008:ssn=250:nsfi=stop :actname=copy
```

A message similar to the following should appear.

```
rlghncxa03w 06-10-25 15:27:30 GMT EAGLE5 36.0.0
ENT-SCR-AFTPC: SCREEN SET AFFECTED - GW20 1% FULL
ENT-SCR-AFTPC: MASP A - COMPLTD
```

```
ent-scr-aftpc:sr=ls04:ni=010:nc=010:ncm=010:ssn=015:nsfi=stop :actname=copy
```

A message similar to the following should appear.

```
rlghncxa03w 06-10-25 15:28:30 GMT EAGLE5 36.0.0
ENT-SCR-AFTPC: SCREEN SET AFFECTED - LS04 1% FULL
ENT-SCR-AFTPC: MASP A - COMPLTD
```

7. Verify the changes using the rtrv-scr-aftpc command with the screening reference name used in step 6.

For this example, enter these commands.

```
rtrv-scr-aftpc:sr=gw20
```

The following is an example of the possible output.

```
rlghncxa03w 06-10-25 15:29:30 GMT EAGLE5 36.0.0
SCREEN = ALLOWED AFTPC
SR   NI   NC   NCM   SSN   NSFI   NSR/ACT
GW20 008   008   008   250   STOP   COPY
```

```
rtrv-scr-aftpc:sr=ls04
```

The following is an example of the possible output.

```
rlghncxa03w 06-10-25 15:30:30 GMT EAGLE5 36.0.0
SCREEN = ALLOWED AFTPC
SR      NI      NC      NCM      SSN      NSFI     NSR/ACT
LS04   010      010      010      015      STOP     COPY
```

8. Backup the new changes using the `chg-db:action=backup:dest=fixed` command.

The following messages should appear, the active Maintenance and Administration Subsystem Processor (MASP) appears first.

```
BACKUP (FIXED) : MASP A - Backup starts on active MASP.
BACKUP (FIXED) : MASP A - Backup on active MASP to fixed disk complete.
BACKUP (FIXED) : MASP A - Backup starts on standby MASP.
BACKUP (FIXED) : MASP A - Backup on standby MASP to fixed disk complete.
```

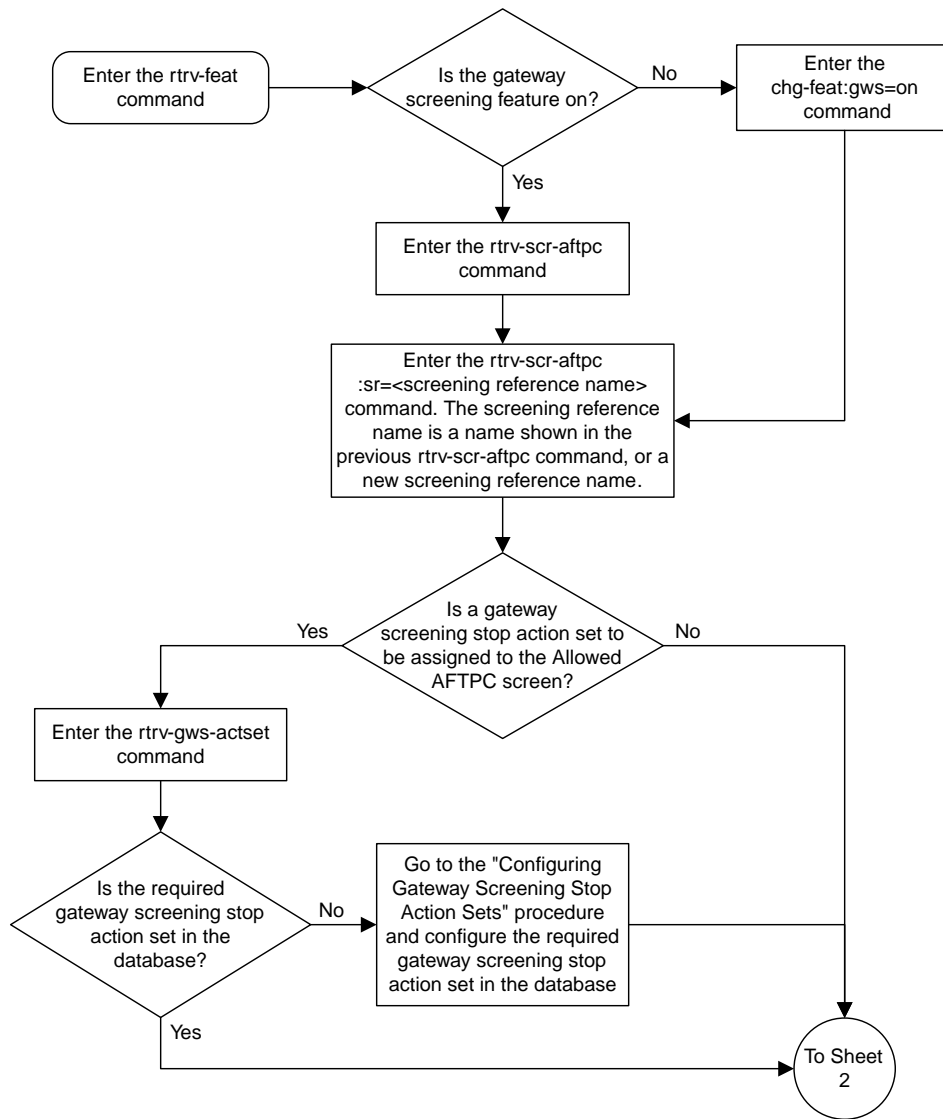

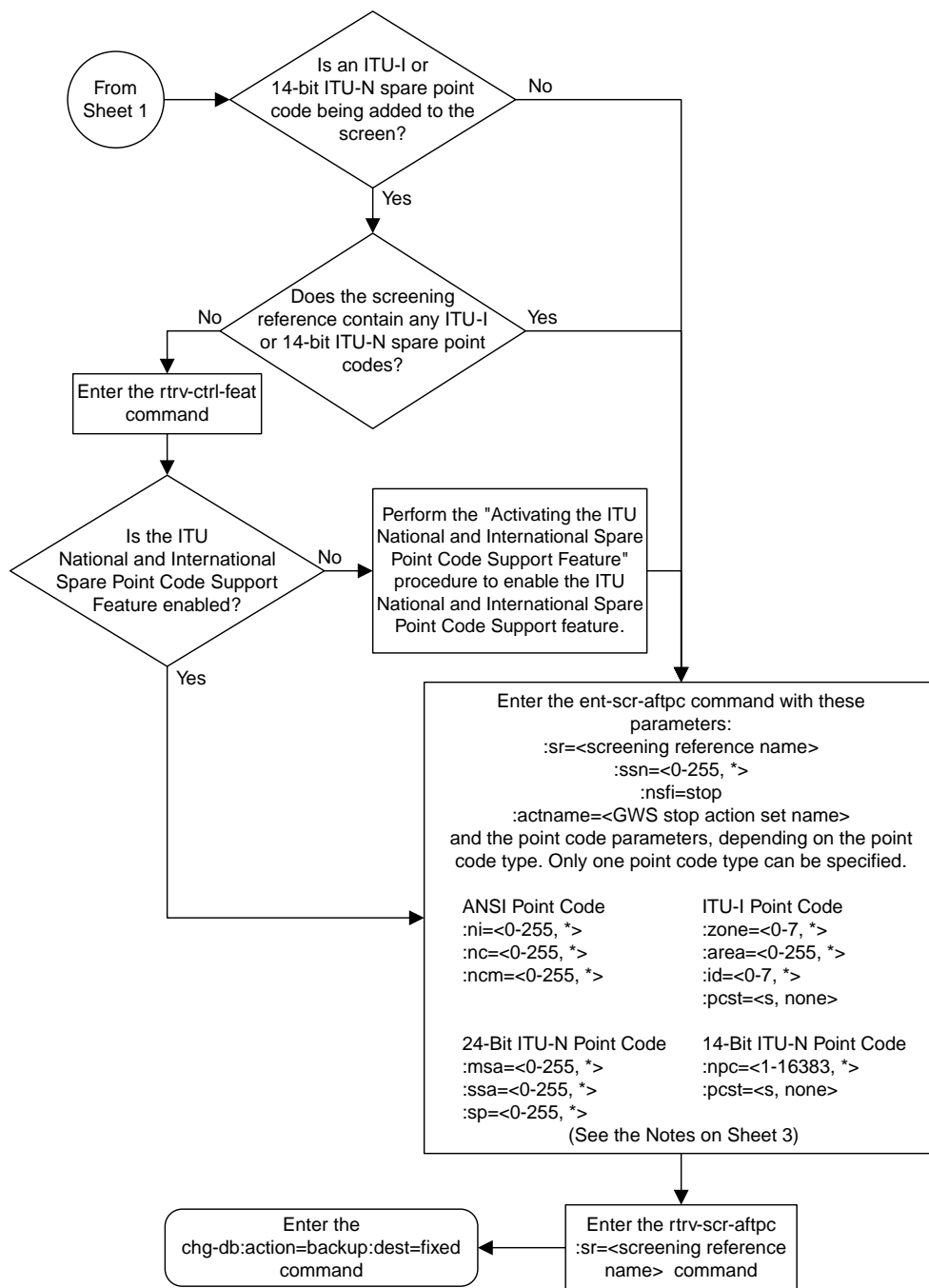

## Notes:

1. A range of values can be specified for the ni, nc, or ncm parameters by inserting double ampersands (&&) between the parameter values defining the range. For example, to specify the range 025 to 200 for the ni parameter, enter 025&&200 for the ni parameter value.

2. The asterisk (\*) specifies the entire range of values for that parameter.

For more information about specifying a range of values and about using the asterisk, see the "Gateway Screening Attributes" section and the "Specifying a Range of Values" section. The "Gateway Screening Attributes" section is in the *Database Administration Manual - Gateway Screening*. The "Specifying a Range of Values" section is in the "Adding an Allowed Affected Point Code Screen" procedure in the *Database Administration Manual - Gateway Screening*.

3. The actname parameter is optional. If the actname parameter is specified, the actname parameter value is one of the gateway screening stop action set names shown in the rtrv-gws-actset output on Sheet 1.

4. To add a non-spare point code, the pcst parameter does not have to be specified. If the pcst parameter is specified for a screen containing an ITU-I or 14-bit ITU-N non-spare point code, the value must be none.

5. To add a spare point code, the pcst=s parameter must be specified.

Sheet 3 of 3

Figure 22: Adding an Allowed Affected Point Code Screen

## Removing an Allowed Affected Point Code Screen

This procedure is used to remove an allowed affected point code (AFTPC) screen from the database using the `dlt-scr-aftpc` command. The parameters used by the `dlt-scr-aftpc` command are shown in the [Gateway Screening Attributes](#) section. The general rules that apply to configuring gateway screening entities are shown in the [Gateway Screening Configuration](#) section.

The example in this procedure removes the allowed AFTPC screen `wrd0` from the database.

**Note:** If you are using multiple-part ITU national point codes with gateway screening, see the [14-Bit ITU National Point Code Formats](#) section.

1. Display the allowed AFTPC screens in the database using the `rtrv-scr-aftpc` command.

The following is an example of the possible output.

```
rlghncxa03w 06-10-25 15:25:30 GMT EAGLE5 36.0.0
SCREEN = ALLOWED AFTPC
SR   REF  RULES
GW20 YES   1
IEC  YES   2
LS04 YES   1
WRD0 YES   1
WRD2 YES   1
WRD4 YES   9
```

From the `rtrv-scr-aftpc` output, display the allowed AFTPC screen you wish to remove using the `rtrv-scr-aftpc` command with the screening reference name. For this example, enter the `rtrv-scr-aftpc:sr=wrd0` command. The following is an example of the possible output.

```
rlghncxa03w 06-10-25 15:25:30 GMT EAGLE5 36.0.0
SCREEN = ALLOWED AFTPC
SR   ZONE  AREA  ID      SSN      NSFI      NSR/ACT
WRD0 1       004   6       023      STOP      -----
```

2. An allowed AFTPC screen can only be referenced by an allowed CDPA screen.

Verify any references to the allowed AFTPC screen being removed from the database using the `rtrv-scr-cdpa:nsfi=aftpc` command. The following is an example of the possible output.

```
rlghncxa03w 06-10-25 15:26:30 GMT EAGLE5 36.0.0
SCREEN = ALLOWED CDPA
SR   ZONE  AREA  ID      SSN      SCMGFID  NSFI      NSR/ACT
IEC  1       134   *       001      002      AFTPC     IEC

SR   ZONE  AREA  ID      SSN      SCMGFID  NSFI      NSR/ACT
WRD1 1       004   6       001      005      AFTPC     WRD0
```

SR	NPC	SSN	SCMGFID	NSFI	NSR/ACT
WRD4	12345	001	100	AFTPC	IEC

If the screen being removed is referenced by any CDPA screens, perform the [Changing an Allowed Called Party Address Screen](#) procedure to change the NSFI of those CDPA screens to reference other AFTPC screens or change the NSFI of these screens to STOP.

- Remove the allowed AFTPC screen from the database using the `dlt-scr-aftpc` command with the screening reference name shown in the `rtrv-scr-aftpc` output in step 1 and with the point code parameter values (`ni`, `nc`, `ncm`, or `zone`, `area`, `id`, or `npc`, or `msa`, `ssa`, `sp`) and the `ssn` parameter value of the screen being removed from the database.

The values for these parameters must be entered exactly as shown in the `rtrv-scr-aftpc` output.

To remove an entry containing either an ITU-I or a 14-bit ITU-N spare point code, the `pcst=s` parameter must be specified with the `dlt-scr-aftpc` command.

To remove an entry containing either an ITU-I or a 14-bit ITU-N non-spare point code, the `pcst` parameter does not have to be specified with the `dlt-scr-aftpc` command. If the `pcst` parameter is specified, the value must be `none`.

For this example, enter this command.

```
dlt-scr-aftpc:sr=wrd0:zone=1:area=004:id=6:ssn=023
```

A message similar to the following should appear.

```
rlghncxa03w 06-10-25 15:29:30 GMT EAGLE5 36.0.0
DLT-SCR-AFTPC: SCREEN SET AFFECTED - WRD0 0% FULL
DLT-SCR-AFTPC: MASP A - COMPLTD
```

- Verify the changes using the `rtrv-scr-aftpc` command with screening reference name used in step 3.

For this example, enter this command.

```
rtrv-scr-aftpc:sr=wrd0
```

The following message should appear.

```
E2573 Cmd Rej: SR or NSR does not reference an existing SR
```

This message shows that the specified screening reference name is not in the database and the action of the `dlt-scr-aftpc` command in step 5 was successful. If the specified screening reference name contained more than one entry when the `dlt-scr-aftpc` command was executed in step 4, the `rtrv-scr-aftpc:sr=` command output would show the remaining entries in the screening reference instead of error message E2573.

- Backup the new changes using the `chg-db:action=backup:dest=fixed` command.

The following messages should appear, the active Maintenance and Administration Subsystem Processor (MASP) appears first.

```
BACKUP (FIXED) : MASP A - Backup starts on active MASP.
```



```
BACKUP (FIXED) : MASP A - Backup on active MASP to fixed disk complete.  
BACKUP (FIXED) : MASP A - Backup starts on standby MASP.  
BACKUP (FIXED) : MASP A - Backup on standby MASP to fixed disk complete.
```

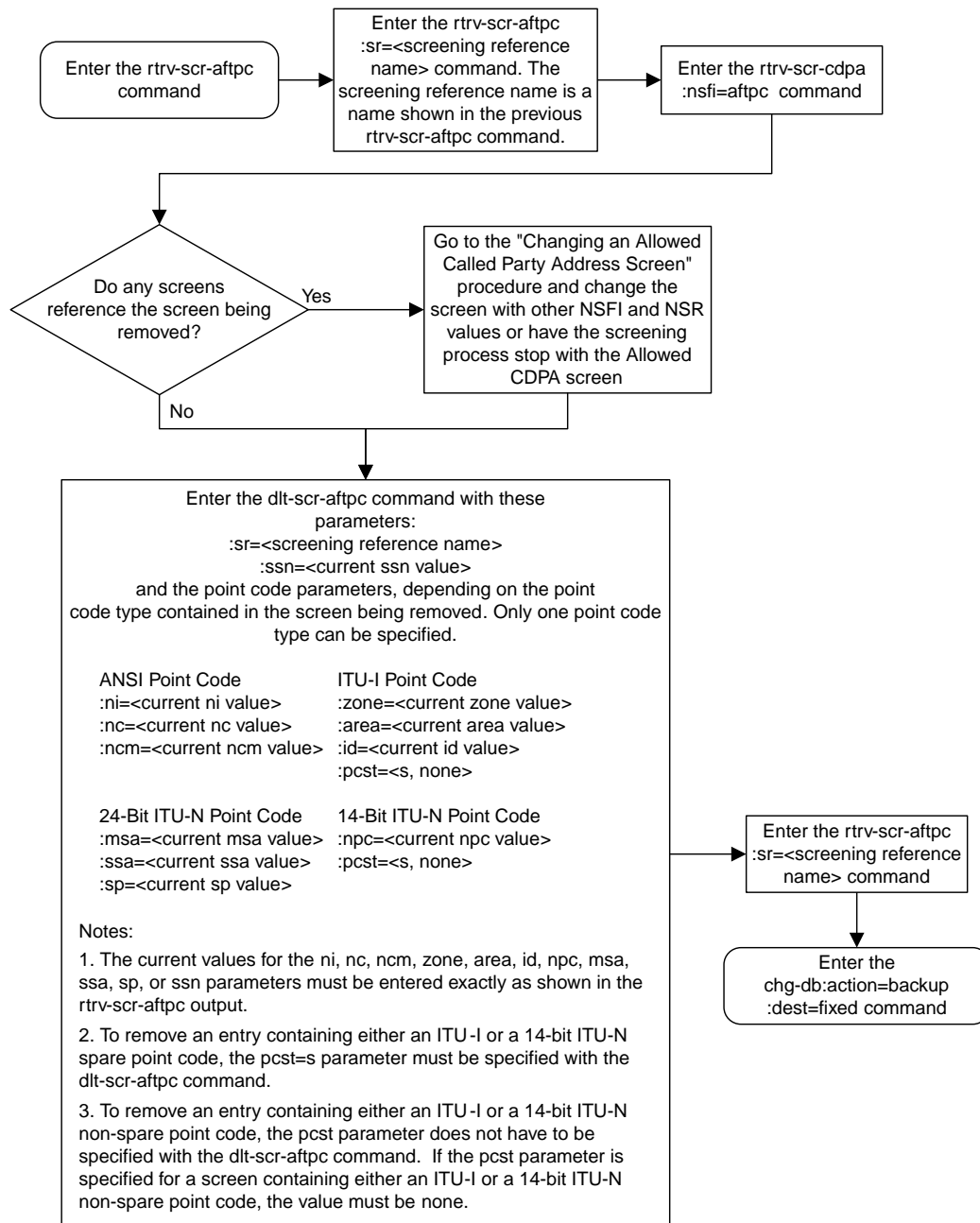

Figure 23: Removing an Allowed Affected Point Code Screen

## Changing an Allowed Affected Point Code Screen

This procedure is used to change the attributes of an allowed affected point code (AFTPC) screen in the database using the `chg-scr-aftpc` command. The parameters used by the `chg-scr-aftpc` command are shown in the [Gateway Screening Attributes](#) section. The general rules that apply to configuring gateway screening entities are shown in the [Gateway Screening Configuration](#) section.

The example in this procedure is used to change the point code 009-009-009 for the allowed AFTPC screen `gw21` to 100-100-100, and the subsystem number from 253 to 150.

**Note:** If you are using multiple-part ITU national point codes with gateway screening, see the [14-Bit ITU National Point Code Formats](#) section.

### Specifying a Range of Values

A range of values can be specified for the point code parameters `ni`, `nc`, or `ncm`.

If a range of values is specified for any of these parameters, and the value of the other parameters match existing values for the screening reference name, the range of values for the point code parameter cannot include any values for that parameter that are currently provisioned for the screening reference name.

For example, screening reference name `scr1` contains these entries:

SR	NI	NC	NCM	SSN	NSFI	NSR/ACT
SCR1	240	001	010	012	STOP	-----
SCR1	241	010	020	015	STOP	-----

Another entry for screening reference `scr1` with the `ni` value of 240 and the `nc` value of 001 cannot be specified if the range of values for the `ncm` parameter includes the value 010.

The ANSI point code parameter values can be specified as a single value, a range of values, or with an asterisk (\*). The asterisk specifies all possible values for the `ni`, `nc`, and `ncm` parameters. [Table 19: Valid Value Combinations for ANSI Point Code Parameters](#) shows the valid combinations of these parameter values.

**Table 19: Valid Value Combinations for ANSI Point Code Parameters**

NI	NC	NCM
Single Value	Single Value	Single Value
Single Value	Single Value	Range of Values
Single Value	Single Value	Asterisk
Single Value	Range of Values	Asterisk
Single Value	Asterisk	Asterisk
Range of Values	Asterisk	Asterisk
Asterisk	Asterisk	Asterisk

A range of values can also be specified for an ITU-I or 24-bit ITU-N point code parameter using a combination of asterisks (\*) and single values for the point code parameters. [Table 20: Valid Value Combinations for ITU-I Point Code Parameters](#) shows the valid combinations of the ITU-I parameter values. [Table 21: Valid Value Combinations for 24-Bit ITU-N Point Code Parameters](#) shows the valid combinations of the 24-bit ITU-N parameter values.

**Table 20: Valid Value Combinations for ITU-I Point Code Parameters**

ZONE	AREA	ID
Single Value	Single Value	Single Value
Single Value	Single Value	Asterisk
Single Value	Asterisk	Asterisk
Asterisk	Asterisk	Asterisk

**Table 21: Valid Value Combinations for 24-Bit ITU-N Point Code Parameters**

MSA	SSA	SP
Single Value	Single Value	Single Value
Single Value	Single Value	Asterisk
Single Value	Asterisk	Asterisk
Asterisk	Asterisk	Asterisk

1. Display the allowed AFTPC screens in the database using the `rtrv-scr-aftpc` command.

The following is an example of the possible output.

```
rlghncxa03w 06-10-25 15:25:30 GMT EAGLE5 36.0.0
SCREEN = ALLOWED AFTPC
SR   REF  RULES
GW20 YES   1
GW21 YES   1
IEC  YES   2
LS04 YES   1
WRD0 YES   1
WRD2 YES   1
WRD4 YES   9
```

From the `rtrv-scr-aftpc` output, display the allowed AFTPC screen you wish to change using the `rtrv-scr-aftpc` command with the screening reference name. For this example, enter this command.

```
rtrv-scr-aftpc:sr=gw21
```

The following is an example of the possible output.

```
rlghncxa03w 06-10-25 15:25:30 GMT EAGLE5 36.0.0
SCREEN = ALLOWED AFTPC
SR   NI       NC       NCM       SSN       NSFI       NSR/ACT
GW21 009       009       009       253       STOP       -----
```

If a gateway screening stop action set is to be assigned to the allowed AFTPC screen being changed in this procedure, go to step 2. Otherwise, skip step 2 and go to step 3.

2. Display the gateway screening stop action sets in the database with the `rtrv-gws-actset` command.

This is an example of the possible output.

```
rlghncxa03w 06-10-25 15:26:30 GMT EAGLE5 36.0.0
ACT  ACT      ACT  ACT  ACT  ACT  ACT  ACT  ACT  ACT  ACT  ACT
ID   NAME     1    2    3    4    5    6    7    8    9    10
---  -
1    copy     copy
2    rdct     rdct
3    cr       copy rdct
4    cncf     cncf
5    cpcncf   copy cncf
6    cncfrd   cncf rdct
7    cpcfird  copy cncf rdct

GWS action set table is (7 of 16) 44% full
```

If the required gateway screening stop action set is not in the database, perform the [Configuring Gateway Screening Stop Action Sets](#) procedure to configure the required gateway screening stop action set.

3. Display the status of the ITU National and International Spare Point Code Support feature by entering the `rtrv-ctrl-feat` command with the ITU National and International Spare Point Code Support feature part number.

**Note:** If any of these conditions apply to this procedure, skip this step and go to step 4:

- The point code in the screen is not being changed.
- The screen being changed contains either an ANSI or 24-bit ITU-N point code.
- The ITU-I or 14-bit ITU-N non-spare point code in the screen is not being changed to an ITU-I or 14-bit ITU-N spare point code.
- The point code in the screen is an ITU-I or 14-bit ITU-N spare point code or the screening reference contains other screens with ITU-I or 14-bit ITU-N spare point codes.

Enter this command.

```
rtrv-ctrl-feat:partnum=893013601
```

This is an example of the possible output.

```
rlghncxa03w 06-10-25 15:25:30 GMT EAGLE5 36.0.0
The following features have been permanently enabled:

Feature Name                Partnum  Status  Quantity
```

```

Spare Point Code Support 893013601 on ----

The following features have been temporarily enabled:

Feature Name          Partnum  Status Quantity  Trial Period Left
Zero entries found.

The following features have expired temporary keys:

Feature Name          Partnum
Zero entries found.

```

If the ITU National and International Spare Point Code Support feature is enabled, go to step 4.

If the ITU National and International Spare Point Code Support feature is not enabled, perform the “Activating the ITU National and International Spare Point Code Support Feature” procedure in *Database Administration - SS7 User’s Guide* to enable the ITU National and International Spare Point Code Support feature as required. After the feature has been enabled, go to step 4.

#### 4. Change the attributes of an allowed AFTPC screen using the `chg-scr-aftpc` command.

If a gateway screening stop action is to be assigned to the allowed AFTPC screen being changed, enter the `chg-scr-aftpc` command with the `nsfi=stop` parameter and the `actname` parameter with the name of a gateway screening stop action set shown in the output of the `rtrv-gws-actset` command executed in step 2.

The current values for the `ni`, `nc`, `ncm`, `zone`, `area`, `id`, `npc`, `msa`, `ssa`, `sp`, and `ssn` parameters must be entered exactly as shown in the `rtrv-scr-aftpc` output in step 1.

The following list contains the values for the `nni`, `nnc`, `nncm`, `nzone`, `narea`, `nid`, `nnpc`, `nmsa`, `nssa`, `nsp`, and `nssn` parameters:

- `nni` - 0-255 or an asterisk (\*)
- `nnc` - 0-255 or an asterisk (\*)
- `nncm` - 0-255 or an asterisk (\*)
- `nzone` - 0-7 or an asterisk (\*)
- `narea` - 0-255 or an asterisk (\*)
- `nid` - 0-7 or an asterisk (\*)
- `nnpc` - 1 - 16383 or an asterisk (\*)
- `nmsa` - 0-255 or an asterisk (\*)
- `nssa` - 0-255 or an asterisk (\*)
- `nsp` - 0-255 or an asterisk (\*)
- `nssn` - 0 - 255 or an asterisk (\*)

A range of values can be specified for the `nni`, `nnc`, and `nncm` parameters. See the [“Specifying a Range of Values”](#) section for more information on how the asterisk and a range of values are used for the `nni`, `nnc`, and `nncm` parameters.

To change an ITU-I or 14-bit ITU-N spare point code to a non-spare point code, both the `pcst=s` and `npcst=none` parameters must be specified with the `chg-scr-aftpc` command.

To change an ITU-I or 14-bit ITU-N non-spare point code to a spare point code, the `npcst=s` parameter must be specified with the `chg-scr-aftpc` command. The `pcst` parameter does not have to be specified.

If the current point code in the screen being changed is either an ITU-I or 14-bit ITU-N spare point code, the `pcst=s` parameter must be specified with the `chg-scr-aftpc` command.

If the current point code in the screen being changed is either an ITU-I or 14-bit ITU-N non-spare point code, the `pcst` parameter does not have to be specified with the `chg-scr-aftpc` command. If the `pcst` parameter is specified for a screen containing either an ITU-I or 14-bit ITU-N non-spare point code, the `pcst` parameter value must be `none`.

For this example, enter this command.

```
chg-scr-aftpc:sr=gw21:ni=009:nc=009:ncm=009:ssn=253:nni=100
:nnc=100:nncm=100:nssn=150
```



**Caution:** The EAGLE does not support redirecting MSUs for the DTA feature or intercepting ISUPIAM messages for the Calling Name Conversion Facility feature from the allowed AFTPC screen. Gateway screening stop action sets containing either the RDCT (redirect) or CNCF (calling name conversion facility) stop actions should not be assigned to the allowed AFTPC screen. If a gateway screening stop action set containing the RDCT or CNCF stop actions is specified with the `chg-scr-aftpc` command, unsolicited information message (UIM) 1127 is generated when the attempt is made to redirect MSUs from the allowed AFTPC screen. Unsolicited information message (UIM) 1217 is generated when ISUPIAM MSUs are intercepted from the allowed AFTPC screen. For more information on UIMs 1127 and 1217, go to *Unsolicited Alarm and Information Messages Reference*.

A message similar to the following should appear.

```
rlghncxa03w 06-10-25 15:27:30 GMT EAGLE5 36.0.0
CHG-SCR-AFTPC: SCREEN SET AFFECTED - GW21 1% FULL
CHG-SCR-AFTPC: MASP A - COMPLTD
```

5. Verify the changes using the `rtrv-scr-aftpc` command with screening reference name used in step 4.

For this example, enter this command.

```
rtrv-scr-aftpc:sr=gw21
```

The following is an example of the possible output.

```
rlghncxa03w 06-10-25 15:28:30 GMT EAGLE5 36.0.0
SCREEN = ALLOWED AFTPC
SR   NI   NC   NCM   SSN   NSF1   NSR/ACT
GW21 100   100  100   150   STOP   -----
```

6. Backup the new changes using the `chg-db:action=backup:dest=fixed` command.

The following messages should appear, the active Maintenance and Administration Subsystem Processor (MASP) appears first.

```
BACKUP (FIXED) : MASP A - Backup starts on active MASP.
BACKUP (FIXED) : MASP A - Backup on active MASP to fixed disk complete.
BACKUP (FIXED) : MASP A - Backup starts on standby MASP.
BACKUP (FIXED) : MASP A - Backup on standby MASP to fixed disk complete.
```

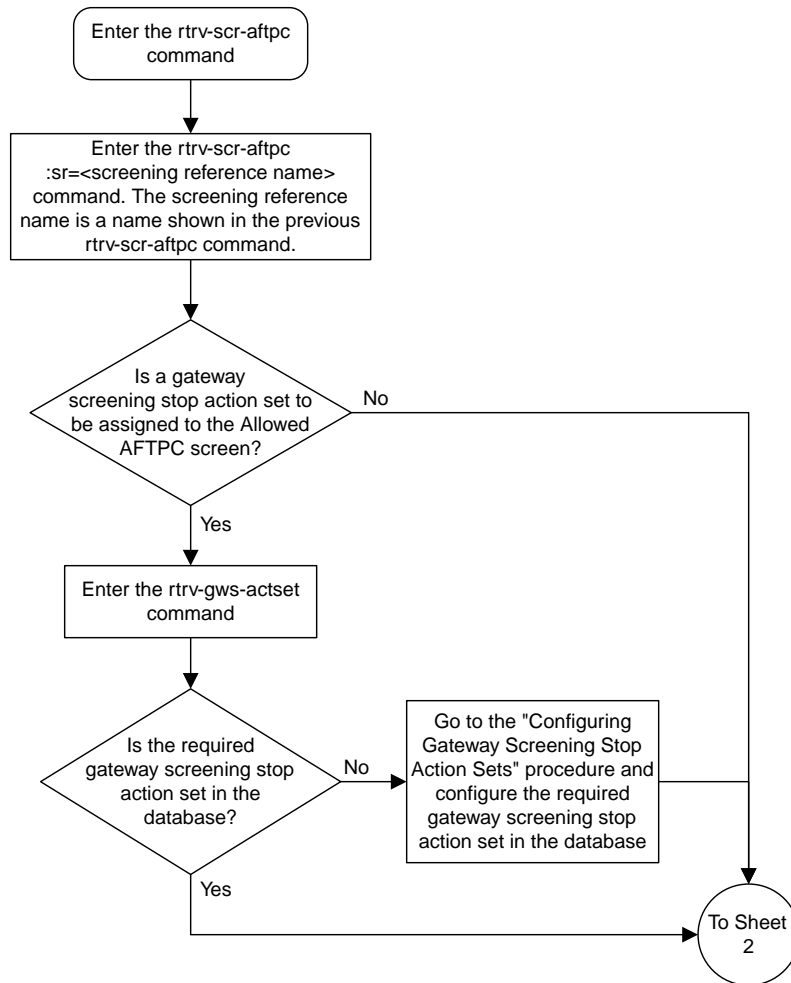



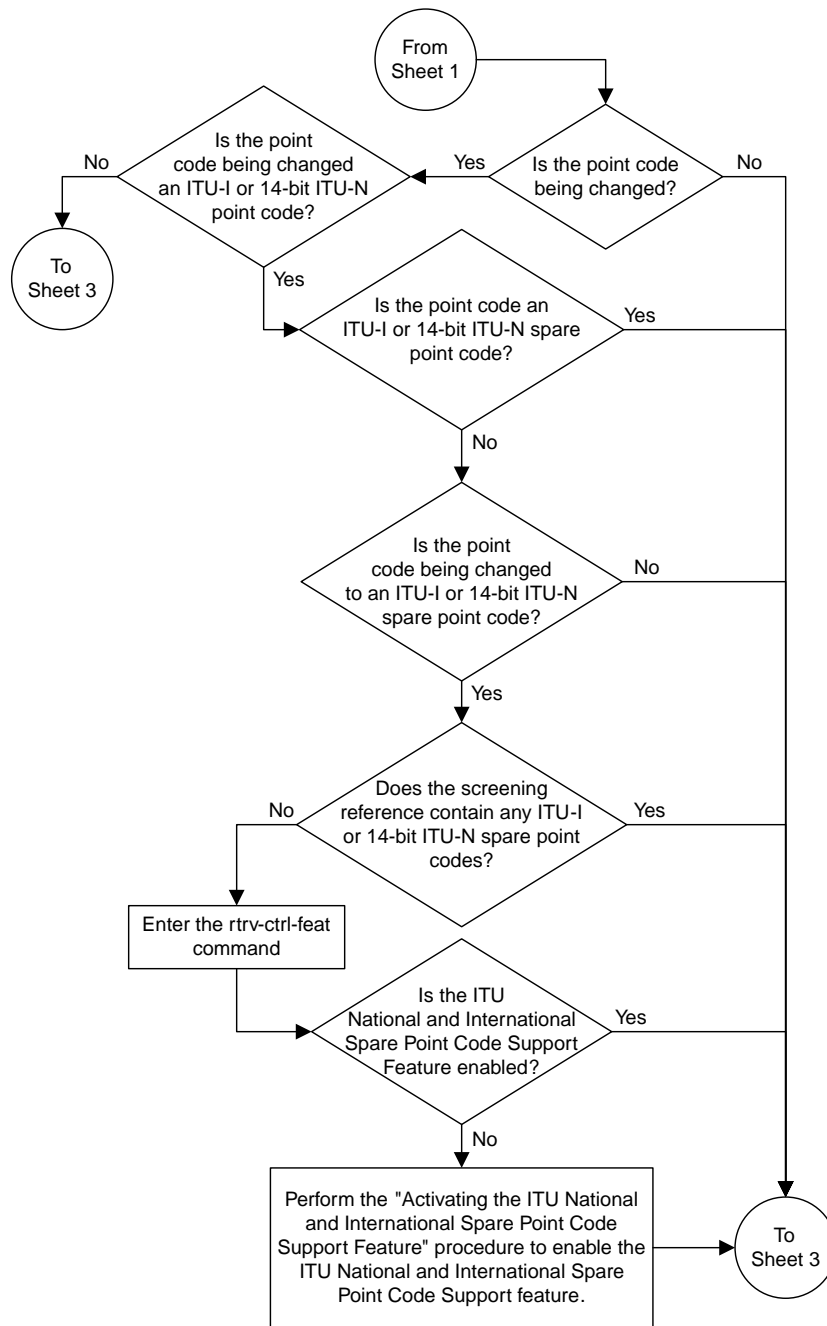

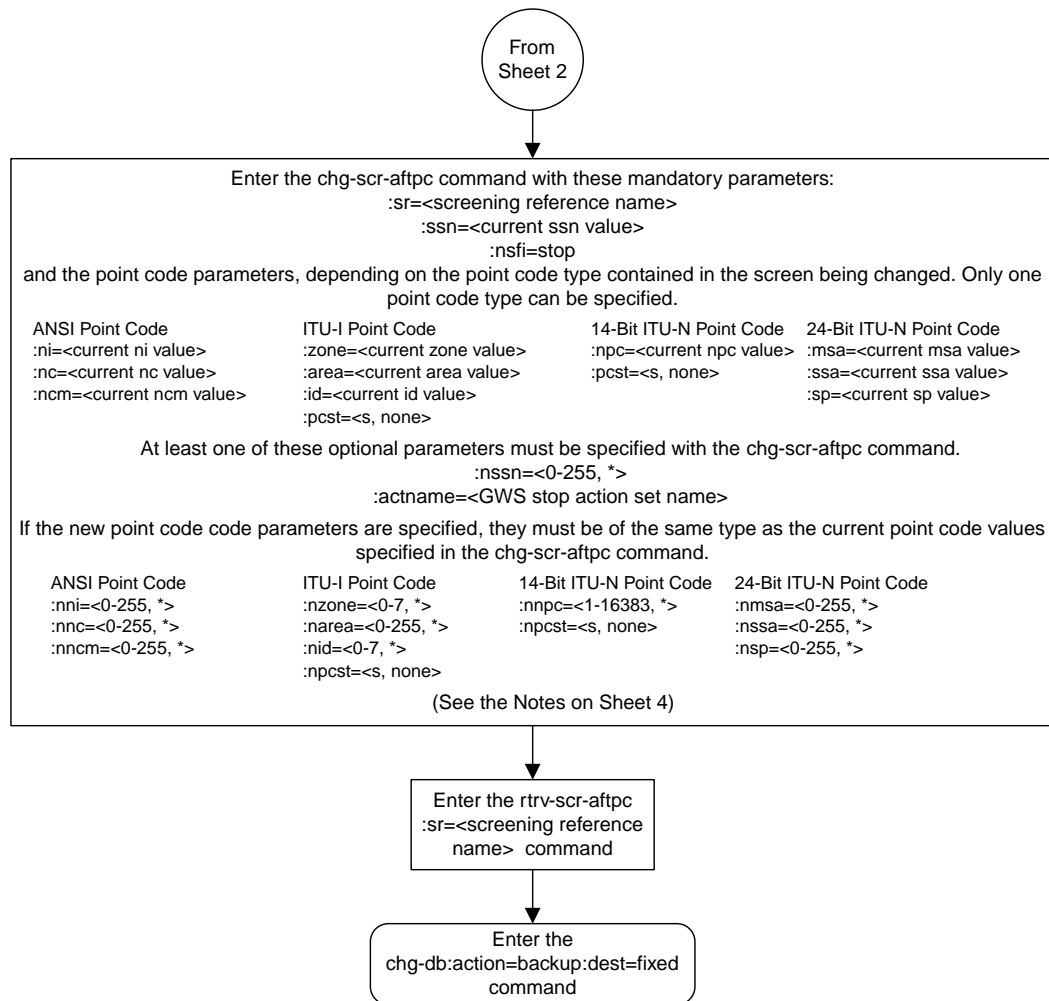

**Notes:**

1. A range of values can be specified for the ni, nc, or ncm parameters by inserting double ampersands (&&) between the parameter values defining the range. For example, to specify the range 025 to 200 for the ni parameter, enter 025&&200 for the ni parameter value.
2. The current values for the ni, nc, ncm, zone, area, id, or ssn parameters must be entered exactly as shown in the rtrv-scr-aftpc output.
3. The asterisk (\*) specifies the entire range of values for that parameter.  
For more information about specifying a range of values and about using the asterisk, see the "Gateway Screening Attributes" section and the "Specifying a Range of Values" section. The "Gateway Screening Attributes" section is in the *Database Administration Manual - Gateway Screening*. The "Specifying a Range of Values" section is in the "Changing an Allowed Affected Point Code Screen" procedure in the *Database Administration Manual - Gateway Screening*.
4. The actname parameter is optional. If the actname parameter is specified, the actname parameter value is one of the gateway screening stop action set names shown in the rtrv-gws-actset output on Sheet 1.
5. To change an ITU-I or 14-bit ITU-N spare point code to a non-spare point code, both the pcst=s and npcst=none parameters must be specified with the chg-scr-aftpc command.
6. To change an ITU-I or 14-bit ITU-N non-spare point code to a spare point code, the npcst=s parameter must be specified with the chg-scr-aftpc command. The pcst parameter does not have to be specified.
7. If the current point code in the screen being changed is either an ITU-I or 14-bit ITU-N spare point code, the pcst=s parameter must be specified with the chg-scr-aftpc command.
8. If the current point code in the screen being changed is either an ITU-I or 14-bit ITU-N non-spare point code, the pcst parameter does not have to be specified with the chg-scr-aftpc command. If the pcst parameter is specified for a screen containing either an ITU-I or 14-bit ITU-N non-spare point code, the pcst parameter value must be none.

Sheet 4 of 4

**Figure 24: Changing an Allowed Affected Point Code Screen**

## Allowed Called Party (CDPA) Screen Configuration

---

### Topics:

- *Introduction.....154*
- *Adding an Allowed Called Party Address Screen.....159*
- *Removing an Allowed Called Party Address Screen.....171*
- *Changing an Allowed Called Party Address Screen.....176*

Chapter 4, Allowed Called Party (CDPA) Screen Configuration, contains the procedures necessary to configure allowed called party address screens.

## Introduction

The allowed called party address (CDPA) screen is used to screen SCCP messages for a DPC in the routing label and a subsystem number in the called party address. The gray shaded areas in [Figure 26: Allowed Called Party Address Screening Function](#) shows the fields of the SS7 message that are checked by the CDPA screening function. The screening reference contains a list of point codes and subsystem number combinations.

## Gateway Screening Actions

If a match is not found, the message is discarded.

If a match is found, the `nsfi` is examined to determine the next step in the screening process. If the `nsfi` value is any value other than `stop`, the next screening reference (`nsr`) is identified and the screening process continues to the next screen identified by the `nsfi` and `nsr` parameter values.

If the `nsfi` is equal to `stop`, the screening process stops and the message is processed. If a gateway screening stop action set is specified with the screen, shown by the `actname` parameter value, the message is processed according to the gateway screening stop actions that are assigned to the gateway screening stop action set.

- If the `copy` gateway screening stop action is specified, the message is processed and a copy of the message is sent by the STPLAN feature to an external application.
- If the `rdct` (redirect) gateway screening stop action is specified, the message is diverted from the original destination and sent to another destination with the Database Transport Access feature, specified by global title translation, for further processing.
- If the `cncf` gateway screening stop action is specified, the PIP parameter in the incoming ISUP IAM message is converted to the GN parameter. The GN parameter in the incoming ISUP IAM message is converted to the PIP parameter. The message is then sent to the node specified by the DPC in the routing label in the message. For more information on the Calling Name Conversion Facility feature, see [Calling Name Conversion Facility \(CNCF\) Configuration](#).
- If the `tlnp` gateway screening stop action is specified, ISUP IAMs that pass gateway screening are processed either by the ISUP NP with EPAP feature (if the ISUP NP with EPAP feature is enabled and turned on) or by the Triggerless LNP feature (if the Triggerless LNP feature is turned on). The ISUP NP with EPAP feature is discussed in more detail in *G-Port User's Guide*. The Triggerless LNP feature is discussed in more detail in *ELAP Administration and LNP Feature Activation Guide*.
- If the `tinp` gateway screening stop action is specified, ISUP IAMs that pass gateway screening are intercepted by the Triggerless ISUP based Number Portability (TINP) feature and converted to include the routing number (RN) if the call is to a ported number. The TINP feature is discussed in more detail in *G-Port User's Guide*.
- If the `tif`, `tif2`, or `tif3` gateway screening stop actions are specified, TIF processing is applied to the message.
- If the `sccp` gateway screening stop action is specified, MTP routed SCCP UDT/XUDT are forwarded to the service modules for further processing.

## Allowed CDPA Screening Actions

[Figure 25: Allowed CDPA Screening Actions](#) shows the screening actions of the allowed CDPA screen.

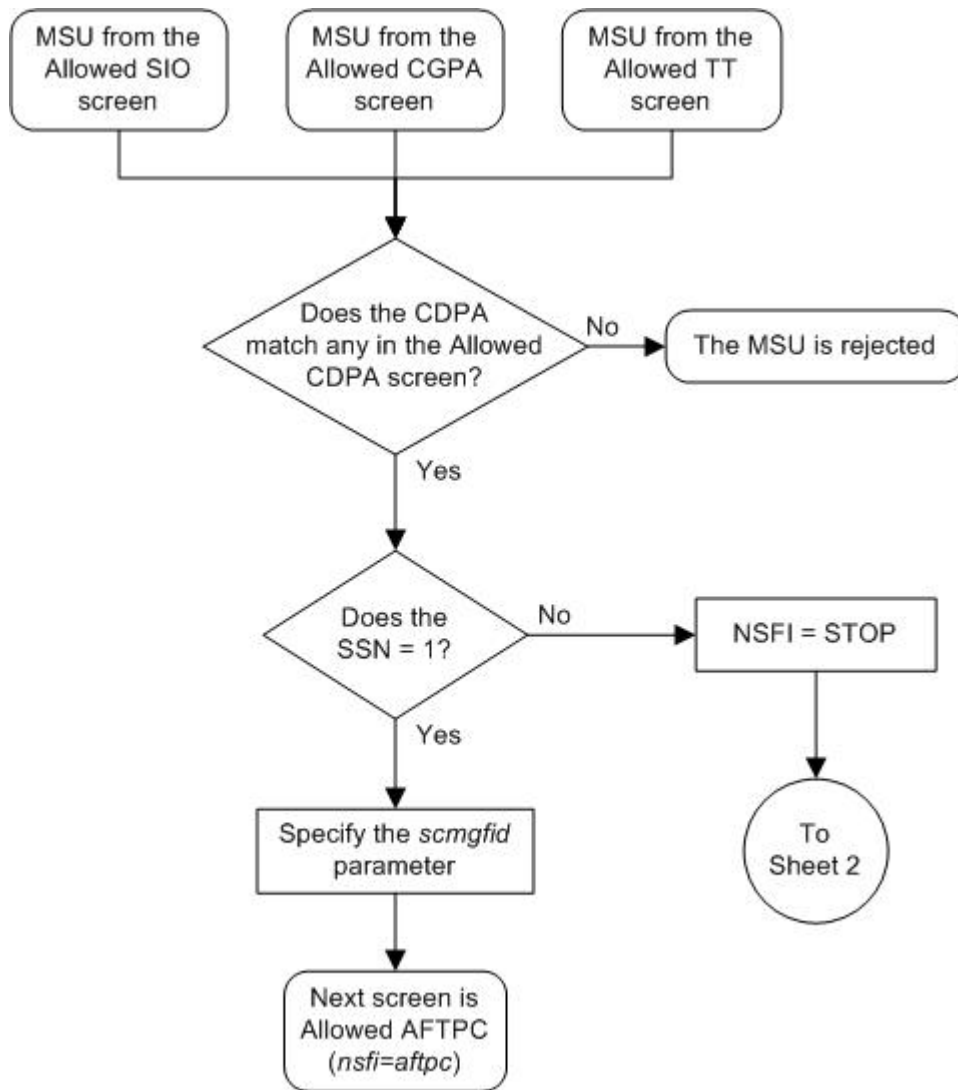

Sheet 1 of 3

Figure 25: Allowed CDPA Screening Actions

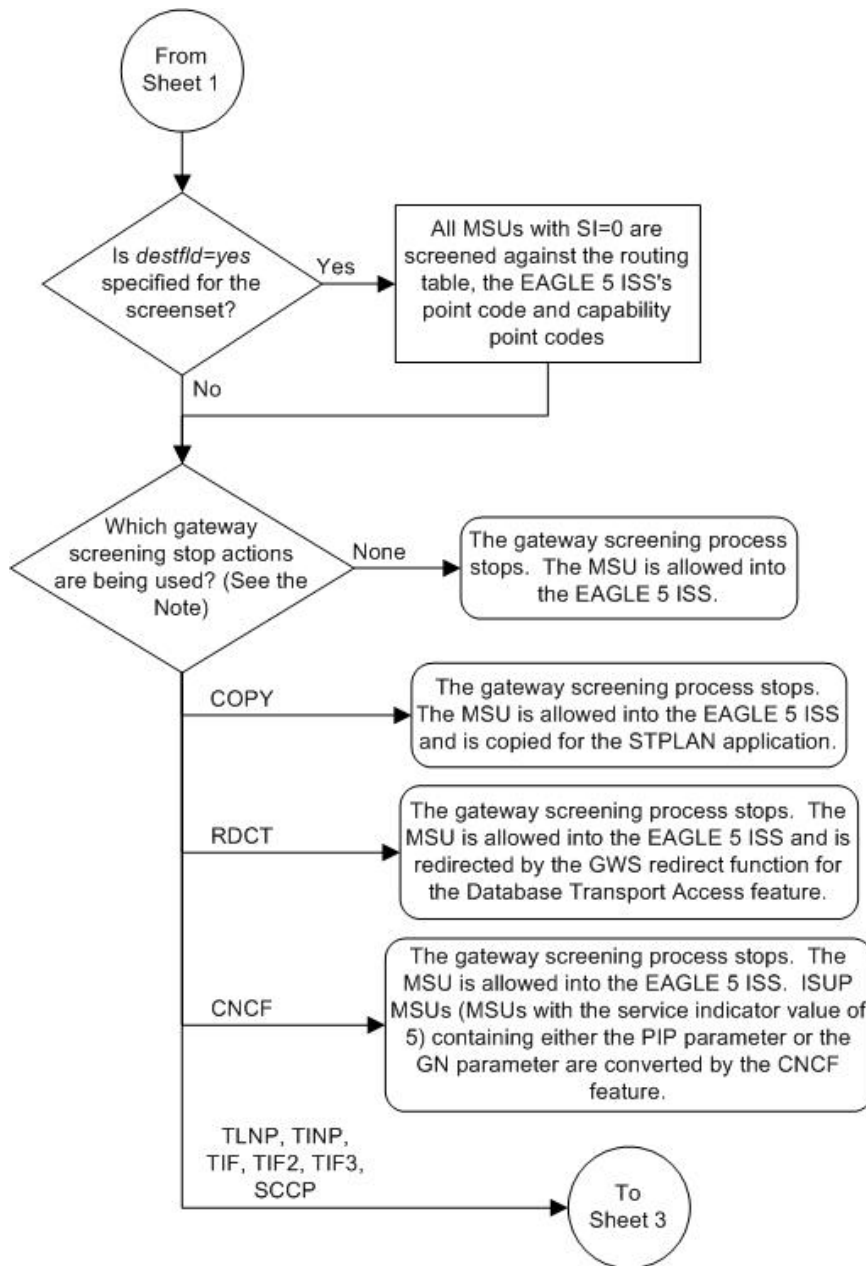

Note: Combinations of the gateway screening stop actions shown on Sheets 2 and 3 may be assigned to a gateway screening stop action set. Refer to the Configuring Gateway Screening Stop Action Sets and the Configuring TLNP Gateway Screening Stop Action Sets procedures in Chapter 2 of this manual for the combinations that can be used.



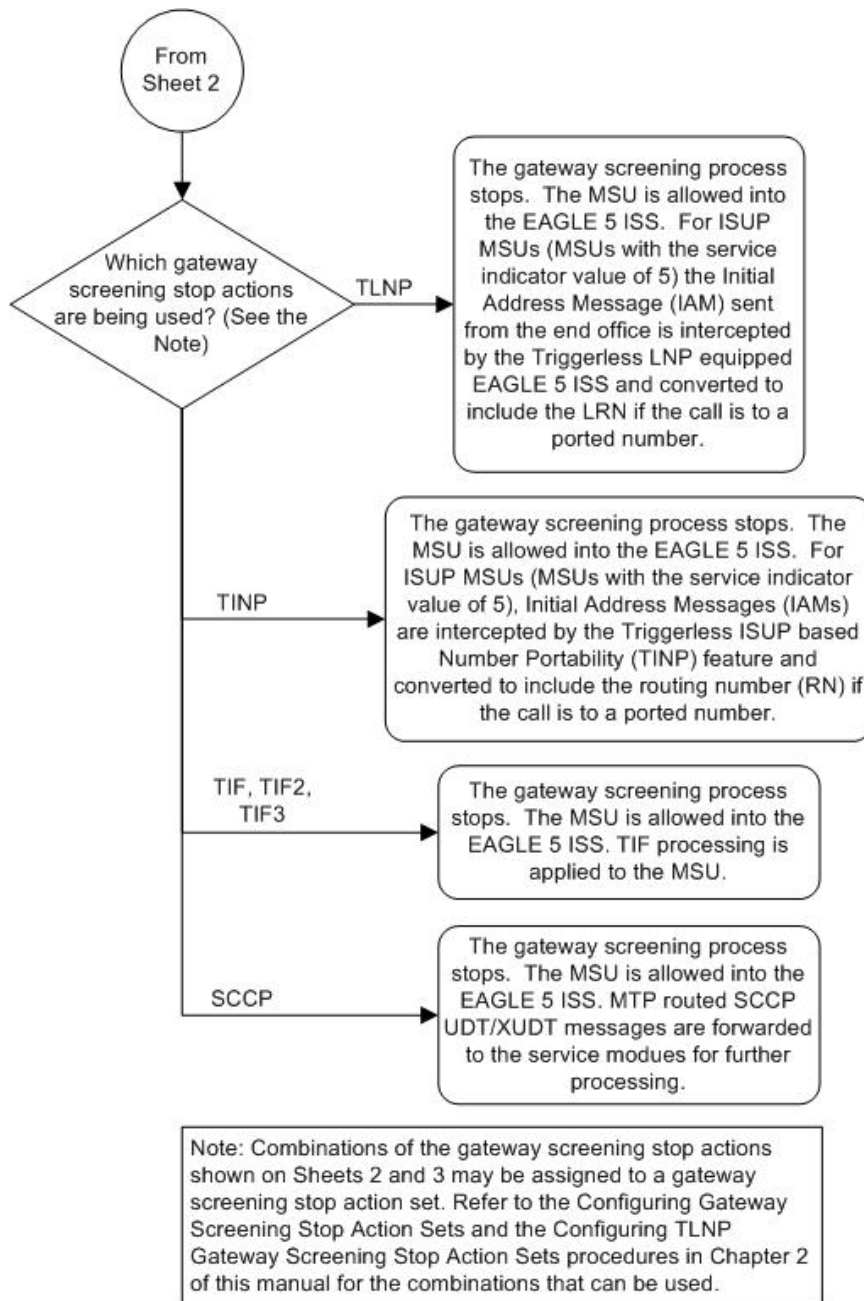

Sheet 3 of 3

ANSI MSU (ANSI Message Signal Unit)

BSN FSN LI	SIO xx xx xxxx NIC PRI SI	SIF			
		Routing Label DPC OPC SLS NCM NC NI NCM NC NI xx	CGPA Length Address Indicator Subsystem Point Code (NCM NC NI)	CDPA Length Address Indicator (x x xxxx xx) (x RI xxxx xx) Subsystem Point Code (NCM NC NI)	SCMG Data Length SCMG Format (xxxx xxxx) Point Code (NCM NC NI) Subsystem

ITU-I MSU (ITU International Message Signal Unit)

BSN FSN LI	SIO xx xx xxxx NIC PRI SI	SIF			
		Routing Label DPC OPC SLS ID AREA ZONE ID AREA ZONE xx	CGPA Length Address Indicator Subsystem Point Code (ID AREA ZONE)	CDPA Length Address Indicator (x x xxxx xx) (x RI xxxx xx) Subsystem Point Code (ID AREA ZONE)	SCMG Data Length SCMG Format (xxxx xxxx) Point Code (ID AREA ZONE) Subsystem

14-Bit ITU-N MSU (14-Bit ITU National Message Signal Unit)

BSN FSN LI	SIO xx xx xxxx NIC PRI SI	SIF			
		Routing Label DPC OPC SLS NPC NPC xx	CGPA Length Address Indicator Subsystem Point Code (NPC)	CDPA Length Address Indicator (x x xxxx xx) (x RI xxxx xx) Subsystem Point Code (NPC)	SCMG Data Length SCMG Format (xxxx xxxx) Point Code (NPC) Subsystem

24-Bit ITU-N MSU (24-bit ITU National Message Signal Unit)

BSN FSN LI	SIO xx xx xxxx NIC PRI SI	SIF			
		Routing Label DPC OPC SLS SP SSA MSA SP SSA MSA xx	CGPA Length Address Indicator Subsystem Point Code (SP SSA MSA)	CDPA Length Address Indicator (x x xxxx xx) (x RI xxxx xx) Subsystem Point Code (SP SSA MSA)	SCMG Data Length SCMG Format (xxxx xxxx) Point Code (SP SSA MSA) Subsystem

Figure 26: Allowed Called Party Address Screening Function

## Adding an Allowed Called Party Address Screen

This procedure is used to add an allowed called party address (CDPA) screen to the database using the `ent-scr-cdpa` command. The parameters used by the `ent-scr-cdpa` command are shown in the [Gateway Screening Attributes](#) section. The general rules that apply to configuring gateway screening entities are shown in the [Gateway Screening Configuration](#) section.

The examples in this procedure are used to add the allowed CDPA screen data shown in [Table 22: Example Gateway Screening Allowed CDPA Configuration Table](#) and based on the example configurations shown in [Figure 4: Gateway Screening Configuration - Example 1](#) through [Figure 7: Gateway Screening Configuration - Example 4](#).

**Table 22: Example Gateway Screening Allowed CDPA Configuration Table**

Screening Reference	ZONE	AREA	ID	SSN	SCMGFID	NSFI	NSR
gw15	5	117	2	254	----	stop	----
Screening Reference	NI	NC	NCM	SSN	SCMGFID	NSFI	NSR
gw17	003	003	003	001	050	aftpc	gw20
gw18	006	006	006	253	----	stop	----
ls03	007	007	007	001	100	aftpc	ls04

**Note:** If you are using multiple-part ITU national point codes with gateway screening, see the [14-Bit ITU National Point Code Formats](#) section.

The allowed CDPA screen can only reference an allowed AFTPC screen and the allowed AFTPC screen being referenced must be in the database. This can be verified using the `rtrv-scr-aftpc:all=yes` command. If the desired allowed AFTPC screen is not in the database, perform one of these procedures to add the required screen to the database or change an existing screen in the database.

- [Adding an Allowed Affected Point Code Screen](#)
- [Changing an Allowed Affected Point Code Screen](#)

### Specifying a Range of Values

A range of values can be specified for the point code parameters `ni`, `nc`, or `ncm`.

If a range of values is specified for any of these parameters, and the value of the other parameters match existing values for the screening reference name, the range of values for the point code parameter cannot include any values for that parameter that are currently provisioned for the screening reference name.

For example, screening reference name `scr1` contains these entries:

SR	NI	NC	NCM	SSN	SCMGFID	NSFI	NSR/ACT
SCR1	240	001	010	012	-----	STOP	-----
SCR1	241	010	020	001	002	AFTPC	SCR1

Another entry for screening reference `scr1` with the `ni` value of 240 and the `nc` value of 001 cannot be specified if the range of values for the `ncm` parameter includes the value 010.

The ANSI point code parameter values can be specified as a single value, a range of values, or with an asterisk (\*). The asterisk specifies all possible values for the `ni`, `nc`, and `ncm` parameters. [Table 23: Valid Value Combinations for ANSI Point Code Parameters](#) shows the valid combinations of these parameter values.

**Table 23: Valid Value Combinations for ANSI Point Code Parameters**

NI	NC	NCM
Single Value	Single Value	Single Value
Single Value	Single Value	Range of Values
Single Value	Single Value	Asterisk
Single Value	Range of Values	Asterisk
Single Value	Asterisk	Asterisk
Range of Values	Asterisk	Asterisk
Asterisk	Asterisk	Asterisk

A range of values can also be specified for an ITU-I or 24-bit ITU-N point code parameter using a combination of asterisks (\*) and single values for the point code parameters. [Table 24: Valid Value Combinations for ITU-I Point Code Parameters](#) shows the valid combinations of the ITU-I parameter values. [Table 25: Valid Value Combinations for 24-Bit ITU-N Point Code Parameters](#) shows the valid combinations of the 24-bit ITU-N parameter values.

**Table 24: Valid Value Combinations for ITU-I Point Code Parameters**

ZONE	AREA	ID
Single Value	Single Value	Single Value
Single Value	Single Value	Asterisk
Single Value	Asterisk	Asterisk
Asterisk	Asterisk	Asterisk

**Table 25: Valid Value Combinations for 24-Bit ITU-N Point Code Parameters**

MSA	SSA	SP
Single Value	Single Value	Single Value
Single Value	Single Value	Asterisk
Single Value	Asterisk	Asterisk
Asterisk	Asterisk	Asterisk

1. Verify that the gateway screening feature is on, by entering the `rtrv-feat` command.

If the gateway screening feature is on, the GWS field is set to on.

**Note:** The `rtrv-feat` command output contains other fields that are not used by this procedure. If you wish to see all the fields displayed by the `rtrv-feat` command, see the `rtrv-feat` command description in *Commands User's Guide*.

If the gateway screening feature is on, shown by the entry `GWS = on` in the `rtrv-feat` command output, skip step 2, and go to step 3.

- Turn the gateway screening feature on by entering this command.

```
chg-feat:gws=on
```

**Note:** Once the gateway screening feature is turned on with the `chg-feat` command, it cannot be turned off.

The gateway screening feature must be purchased before you turn this feature on with the `chg-feat` command. If you are not sure if you have purchased the gateway screening feature, contact your Oracle Sales Representative or Account Representative.

When the `chg-feat` has successfully completed, this message should appear.

```
rlghncxa03w 06-10-28 11:43:04 GMT EAGLE5 36.0.0
CHG-FEAT: MASP A - COMPLTD
```

- Display all allowed CDPA screens in the database using the `rtrv-scr-cdpa` command.

The following is an example of the possible output.

```
rlghncxa03w 06-10-25 15:25:30 GMT EAGLE5 36.0.0
SCREEN = ALLOWED CDPA
SR   REF  RULES
IEC  YES   2
WRD2 YES   1
WRD4 YES   9
```

If the screening reference names that you wish to add with this procedure are not shown in the `rtrv-scr-cdpa` command output, go to step 4. For this example, the screening reference names are not shown. If these screening reference names are shown in the `rtrv-scr-cdpa` command output, make sure the screening data you wish to enter is not already in the database by entering the `rtrv-scr-cdpa` command with the screening reference name. For example, enter the `rtrv-scr-cdpa:sr=iec` command.

The following is an example of the possible output.

```
rlghncxa03w 06-10-25 15:26:30 GMT EAGLE5 36.0.0
SCREEN = ALLOWED CDPA
SR   NI      NC      NCM      SSN      SCMGFID  NSFI      NSR/ACT
IEC  240      001     010     012     -----  STOP     -----
SR   ZONE    AREA    ID       SSN      SCMGFID  NSFI      NSR/ACT
IEC  1        134     *       001     002     AFTPC    IEC
```

If a gateway screening stop action set is to be assigned to the allowed CDPA screen being added to the database, go to step 4.

Step 4 verifies the gateway screening stop action set names in the database. The gateway screening stop action set names are assigned only if the NSFI of the screen being added in this procedure is STOP. If the NSFI of the new screen will be STOP, but a gateway screening stop action set name will not be assigned to the new screen, skip steps 4 and 5 and go to step 6. If the NSFI of the new screen is AFTPC, skip step 4 and go to step 5.

4. Display the gateway screening stop action sets in the database with the `rtrv-gws-actset` command.

This is an example of the possible output.

```
rlghncxa03w 06-10-25 15:27:30 GMT EAGLE5 36.0.0
ACT  ACT  ACT  ACT  ACT  ACT  ACT  ACT  ACT  ACT  ACT
ID   NAME  1    2    3    4    5    6    7    8    9    10
--   -
1    copy  copy
2    rdct  rdct
3    cr    copy rdct
4    cncf  cncf
5    cpcncf copy cncf
6    cncfrd cncf rdct
7    cpcfrd copy cncf rdct

GWS action set table is (7 of 16) 44% full
```

If the required gateway screening stop action set is not in the database, perform the [Configuring Gateway Screening Stop Action Sets](#) procedure to configure the required gateway screening stop action set.

**Note:** If the NSFI of the screen being added in this procedure is STOP, skip step 5 and go to step 6.

5. Enter the `rtrv-scr-aftpc` command to verify that the screen that will be specified by the NSFI/NSR parameter combination in step 7 is in the database.

If the desired screen is not in the database, perform one of these procedures to add the desired screen to the database or change an existing screen in the database.

- [Adding an Allowed Affected Point Code Screen](#)
- [Changing an Allowed Affected Point Code Screen.](#)

**Note:** If the point code being added in this procedure is not an ITU-I or 14-bit ITU-N spare point code, skip step 6 and to step 7.

**Note:** If the point code being added in this procedure is an ITU-I or 14-bit ITU-N spare point code and the screening reference contains ITU-I or 14-bit ITU-N spare point codes, skip step 6 and go to step 7.

6. Display the status of the ITU National and International Spare Point Code Support feature by entering the `rtrv-ctrl-feat` command with the ITU National and International Spare Point Code Support feature part number.

Enter this command.

```
rtrv-ctrl-feat:partnum=893013601
```

This is an example of the possible output.

```
rlghncxa03w 06-10-25 15:25:30 GMT EAGLE5 36.0.0
The following features have been permanently enabled:

Feature Name          Partnum  Status Quantity
Spare Point Code Support 893013601 on    ----

The following features have been temporarily enabled:

Feature Name          Partnum  Status Quantity  Trial Period Left
Zero entries found.

The following features have expired temporary keys:

Feature Name          Partnum
Zero entries found.
```

If the ITU National and International Spare Point Code Support feature is enabled, go to step 7.

If the ITU National and International Spare Point Code Support feature is not enabled, perform the “Activating the ITU National and International Spare Point Code Support Feature” procedure in *Database Administration - SS7 User’s Guide* to enable the ITU National and International Spare Point Code Support feature as required. After the feature has been enabled, go to step 7.

7. Add a new allowed CDPA screen to the database using the `ent-scr-cdpa` command.

If a gateway screening stop action is to be assigned to the allowed CDPA screen being added to the database, enter the `ent-scr-cdpa` command with the `nsfi=stop` parameter and the `actname` parameter with the name of a gateway screening stop action set shown in the output of the `rtrv-gws-actset` command executed in step 4.



**Caution:** TheEAGLE does not support redirectingMSUs for theDTA feature or intercepting ISUPIAM messages for theCalling Name Conversion Facility feature from the allowedCDPA screen. Gateway screening stop action sets containing either theRDCT (redirect) orCNCF (calling name conversion facility) stop actions should not be assigned to the allowedCDPA screen. If a gateway screening stop action set containing theRDCT orCNCF stop actions is specified with the`ent-scr-cdpa` command, unsolicited information message (UIM) 1125 is generated when the attempt is made to redirectMSUs from the allowedCDPA screen. Unsolicited information message (UIM) 1215 is generated whenISUP IAMMSUs are intercepted from the allowedCDPA screen. For more information onUIMs 1125 and 1215, go to the*Unsolicited Alarm and Information Messages Reference*.

The following list contains the values for `ni`, `nc`, `ncm`, `zone`, `area`, `id`, `npc`, `msa`, `ssa`, `sp`, `ssn`, and `scmgfid` parameters:

- `ni` – 0 - 255 or an asterisk (\*)
- `nc` – 0 - 255 or an asterisk (\*)
- `ncm` – 0 - 255 or an asterisk (\*)
- `zone` – 0 - 7 or an asterisk (\*)
- `area` – 0 - 255 or an asterisk (\*)
- `id` – 0 - 7 or an asterisk (\*)
- `npc` – 1 - 16383 or an asterisk (\*)
- `msa` – 0 - 255 or an asterisk (\*)

- ssa – 0 - 255 or an asterisk (\*)
- sp – 0 - 255 or an asterisk (\*)
- ssn – 0 - 255 or an asterisk (\*)
- scmgfid – 1 - 255 or an asterisk (\*)

**Note:** The `scmgfid`, `ssn`, `nsfi`, and `nsr` parameters can be specified only as shown in [Table 26: CDPA Parameter Combinations](#).

**Table 26: CDPA Parameter Combinations**

SSN	SCMGFID	NSFI	NSR
1	1 - 255, *	AFTPC	Must be specified
0, 2-255, *	Cannot be specified	STOP	Cannot be specified

A range of values can be specified for the `ni`, `nc`, and `ncm` parameters. See the [“Specifying a Range of Values”](#) section for more information on how the asterisk and a range of values are used for the `ni`, `nc`, and `ncm` parameters.

To add a spare point code to the allowed CDPA screen, the `pcst=s` parameter must be specified. To add a non-spare point code to the allowed CDPA screen, the `pcst` parameter does not have to be specified. If the `pcst` parameter is specified for a screen containing an ITU-I or 14-bit ITU-N non-spare point code, the value must be `none`.

For this example, enter these commands.

```
ent-scr-cdpa:sr=gw15:zone=5:area=117:id=2:ssn=254:nsfi=stop
```

A message similar to the following should appear.

```
rlghncxa03w 06-10-25 15:28:30 GMT EAGLE5 36.0.0
ENT-SCR-CDPA: SCREEN SET AFFECTED - GW15 1% FULL
ENT-SCR-CDPA: MASP A - COMPLTD
```

```
ent-scr-cdpa:sr=gw17:ni=003:nc=003:ncm=003:ssn=001:scmgfid=050
:nsfi=aftpc:nsr=gw20
```

A message similar to the following should appear.

```
rlghncxa03w 06-10-25 15:29:30 GMT EAGLE5 36.0.0
ENT-SCR-CDPA: SCREEN SET AFFECTED - GW17 1% FULL
ENT-SCR-CDPA: MASP A - COMPLTD
```

```
ent-scr-cdpa:sr=gw18:ni=006:nc=006:ncm=006:ssn=253:nsfi=stop
```

A message similar to the following should appear.

```
rlghncxa03w 06-10-25 15:30:30 GMT EAGLE5 36.0.0
ENT-SCR-CDPA: SCREEN SET AFFECTED - GW18 1% FULL
ENT-SCR-CDPA: MASP A - COMPLTD
```

```
ent-scr-cdpa:sr=ls03:ni=007:nc=007:ncm=007:ssn=001:scmgfid=100
:nsfi=aftpc:nsr=ls04
```



A message similar to the following should appear.

```
rlghncxa03w 06-10-25 15:31:30 GMT EAGLE5 36.0.0
ENT-SCR-CDPA: SCREEN SET AFFECTED - LS03 1% FULL
ENT-SCR-CDPA: MASP A - COMPLTD
```

- Verify the changes using the `rtrv-scr-cdpa` command with the screening reference name used in step 7.

For this example, enter these commands.

```
rtrv-scr-cdpa:sr=gw15
```

The following is an example of the possible output.

```
rlghncxa03w 06-10-25 15:32:30 GMT EAGLE5 36.0.0
SCREEN = ALLOWED CDPA
SR      ZONE  AREA  ID      SSN      SCMGFID  NSFI      NSR/ACT
GW15    5       117   2       254     -----  STOP     -----
```

```
rtrv-scr-cdpa:sr=gw17
```

The following is an example of the possible output.

```
rlghncxa03w 06-10-25 15:33:30 GMT EAGLE5 36.0.0
SCREEN = ALLOWED CDPA
SR  NI      NC      NCM      SSN      SCMGFID  NSFI      NSR/ACT
GW17 003     003     003     001     050     AFTPC     GW20
```

```
rtrv-scr-cdpa:sr=gw18
```

The following is an example of the possible output.

```
rlghncxa03w 06-10-25 15:34:30 GMT EAGLE5 36.0.0
SCREEN = ALLOWED CDPA
SR  NI      NC      NCM      SSN      SCMGFID  NSFI      NSR/ACT
GW18 006     006     006     253     -----  STOP     -----
```

```
rtrv-scr-cdpa:sr=ls03
```

The following is an example of the possible output.

```
rlghncxa03w 06-10-25 15:35:30 GMT EAGLE5 36.0.0
SCREEN = ALLOWED CDPA
SR  NI      NC      NCM      SSN      SCMGFID  NSFI      NSR/ACT
LS03 007     007     007     001     100     AFTPC     -----
```

- Backup the new changes using the `chg-db:action=backup:dest=fixed` command.

The following messages should appear, the active Maintenance and Administration Subsystem Processor (MASP) appears first.

```
BACKUP (FIXED) : MASP A - Backup starts on active MASP.
```

```
BACKUP (FIXED) : MASP A - Backup on active MASP to fixed disk complete.  
BACKUP (FIXED) : MASP A - Backup starts on standby MASP.  
BACKUP (FIXED) : MASP A - Backup on standby MASP to fixed disk complete.
```

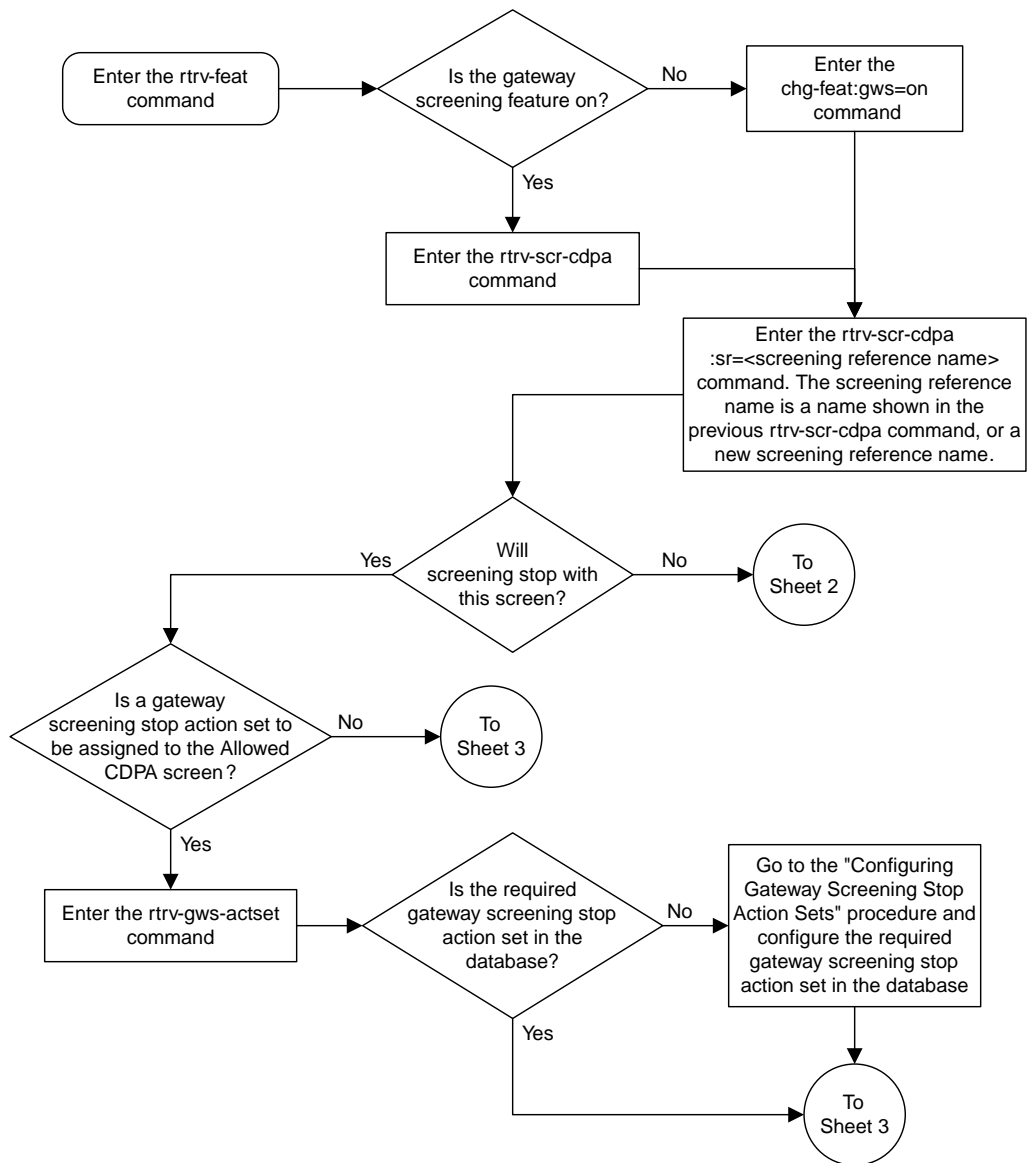

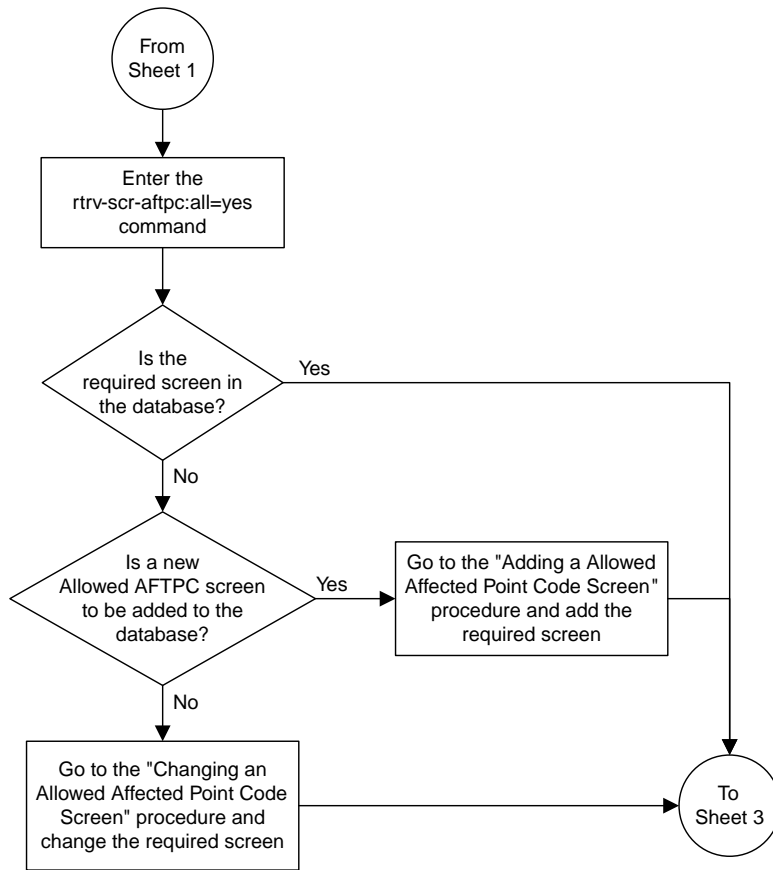

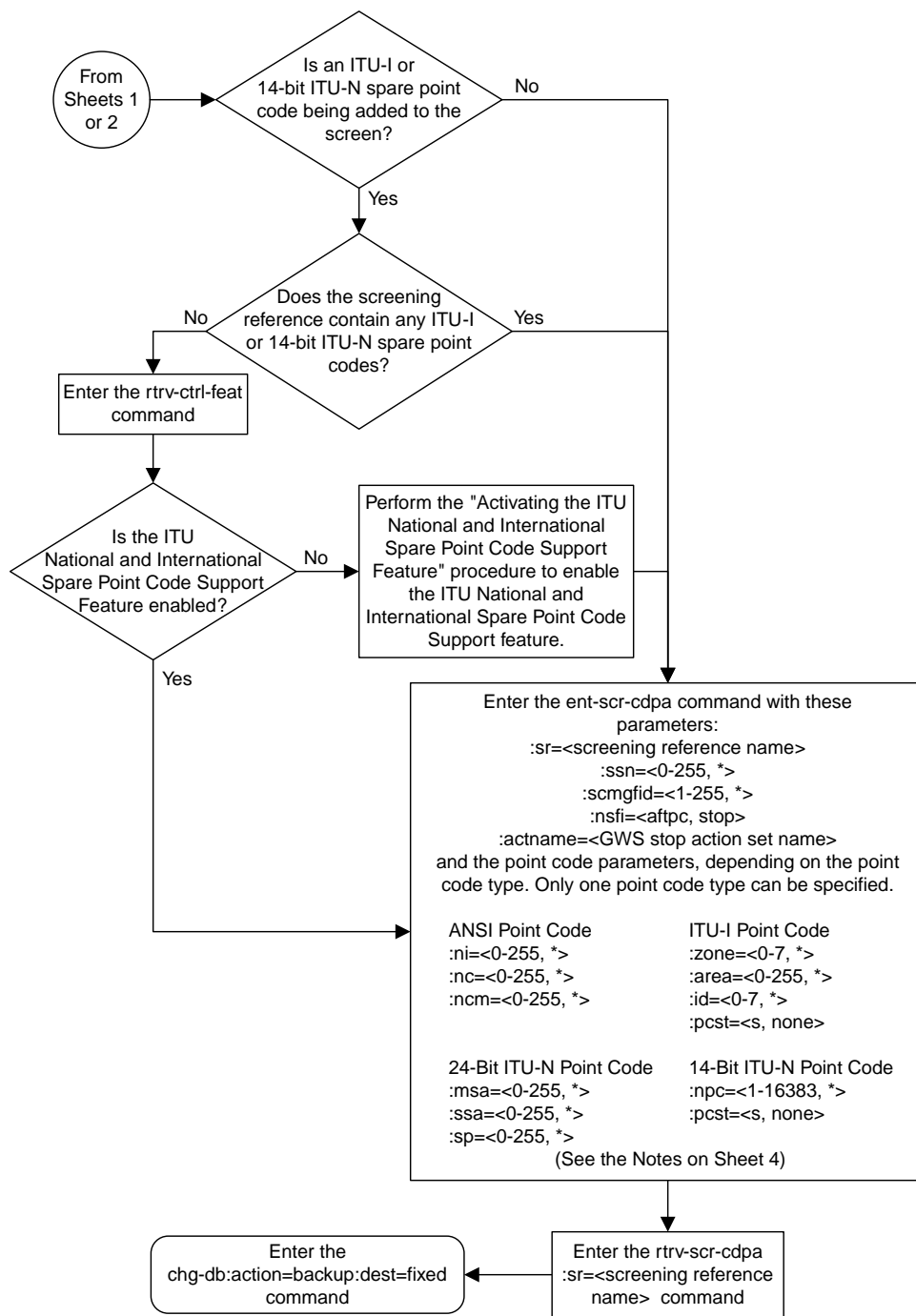

**Notes:**

1. A range of values can be specified for the *ni*, *nc*, or *ncm* parameters by inserting double ampersands (&&) between the parameter values defining the range. For example, to specify the range 025 to 200 for the *ni* parameter, enter 025&&200 for the *ni* parameter value.
2. The asterisk (\*) specifies the entire range of values for that parameter.  
For more information about specifying a range of values and about using the asterisk, see the "Gateway Screening Attributes" section and the "Specifying a Range of Values" section. The "Gateway Screening Attributes" section is in the *Database Administration Manual - Gateway Screening*. The "Specifying a Range of Values" section is in the "Adding an Allowed Called Party Address Screen" procedure in the *Database Administration Manual - Gateway Screening*.
3. The *scmgfid* parameter can be specified only if the *ssn=1* parameter is specified. If either the *ssn=1* or *scmgfid* parameter is specified, the other parameter must be specified. The *scmgfid* parameter cannot be specified if the *ssn* parameter value is 0, 2 through 255, or \*.
4. To specify the *nsfi=atpc* parameter, the *ssn* parameter value must be 1.
5. If the *ssn* parameter value is 0, 2 through 255, or \*, the *nsfi* parameter value must be *stop*.
6. If the *ssn* parameter value is 1, the *nsfi* parameter value can be *atpc* or *stop*.
7. The *nsr* parameter can be specified only, and must be specified, if the *nsfi=atpc* parameter is specified.
8. The *actname* parameter can be specified only if the *nsfi=stop* parameter is specified. The *actname* parameter is optional. If the *actname* parameter is specified, the *actname* parameter value is one of the gateway screening stop action set names shown in the *rtrv-gws-actset* output on Sheet 1.
9. To add a non-spare point code, the *pcst* parameter does not have to be specified. If the *pcst* parameter is specified for a screen containing an ITU-I or 14-bit ITU-N non-spare point code, the value must be *none*.
10. To add a spare point code, the *pcst=s* parameter must be specified.

Sheet 4 of 4

**Figure 27: Adding an Allowed Called Party Address Screen**

## Removing an Allowed Called Party Address Screen

This procedure is used to remove an allowed called party address (CDPA) screen from the database using the `dlt-scr-cdpa` command. The parameters used by the `dlt-scr-cdpa` command are shown in the [Gateway Screening Attributes](#) section. The general rules that apply to configuring gateway screening entities are shown in the [Gateway Screening Configuration](#) section.

The example in this procedure removes the allowed CDPA screen `gw17` from the database.

**Note:** If you are using multiple-part ITU national point codes with gateway screening, see the [14-Bit ITU National Point Code Formats](#) section.

The allowed CDPA screen can be referenced by one of the following screens.

- Allowed SIO
- Allowed CGPA
- Allowed TT

### Verifying the Gateway Screening Configuration

Enter the following commands to verify that none of these screens reference the allowed CDPA screen being removed from the database.

- `rtrv-scr-sio:nsfi=cdpa`
- `rtrv-scr-cgpa:nsfi=cdpa`
- `rtrv-scr-tt:nsfi=cdpa`

### Gateway Screening Configuration Procedures

To change the NSFI of any of these screens, perform one of these procedures.

- [Changing an Allowed Translation Type Screen](#)
- [Changing an Allowed Calling Party Address Screen](#)
- [Changing an Allowed SIO Screen](#)

1. Display the allowed CDPA screens in the database using the `rtrv-scr-cdpa` command.

The following is an example of the possible output.

```
rlghncxa03w 06-10-25 15:25:30 GMT EAGLE5 36.0.0
SCREEN = ALLOWED CDPA
SR   REF  RULES
GW15 YES   1
GW17 YES   1
GW18 YES   1
IEC  YES   2
LS03 YES   1
WRD2 YES   1
WRD4 YES   9
```

From the `rtrv-scr-cdpa` output, display the allowed CDPA screen you wish to remove using the `rtrv-scr-cdpa` command with the screening reference name. For this example, enter the `rtrv-scr-cdpa:sr=gw17` command. The following is an example of the possible output.

The following is an example of the possible output.

```
rlghncxa03w 06-10-25 15:25:30 GMT EAGLE5 36.0.0
SCREEN = ALLOWED CDPA
SR      NI      NC      NCM      SSN      SCMGFID  NSFI      NSR/ACT
GW17   003      003      003      001      050      AFTPC     GW20
```

2. Enter the commands in the [Verifying the Gateway Screening Configuration](#) section to verify that the screen being removed is not referenced by other screens in the database.

If the screen being removed is referenced by other screens, perform the procedures shown in the [Gateway Screening Configuration Procedures](#) section to change the NSFI of those screens to reference other screens or change the NSFI of these screens to STOP.

3. Remove the allowed CDPA screen from the database using the `dlt-scr-cdpa` command.

The current values for the `ni`, `nc`, `ncm`, `zone`, `area`, `id`, `npc`, `msa`, `ssa`, `sp`, and `ssn` parameters must be entered exactly as shown in the `rtrv-scr-cdpa` output in [Step 1](#).

To remove an entry containing either an ITU-I or a 14-bit ITU-N spare point code, the `pcst=s` parameter must be specified with the `dlt-scr-cdpa` command.

To remove an entry containing either an ITU-I or a 14-bit ITU-N non-spare point code, the `pcst` parameter does not have to be specified with the `dlt-scr-cdpa` command. If the `pcst` parameter is specified, the value must be none.

For this command, enter this command:

```
dlt-scr-cdpa:sr=gw17:ni=003:nc=003:ncm=003:ssn=001
```

A message similar to the following should appear.

```
rlghncxa03w 06-10-25 15:26:30 GMT EAGLE5 36.0.0
DLT-SCR-CDPA: SCREEN SET AFFECTED - GW17 0% FULL
DLT-SCR-CDPA: MASP A - COMPLTD
```

4. Verify the changes using the `rtrv-scr-cdpa` command with the screening reference name used in [Step 3](#).

For this example, enter this command.

```
rtrv-scr-cdpa:sr=gw17
```

The following is an example of the possible output.

```
E2573 Cmd Rej: SR or NSR does not reference an existing SR
```

This message shows that the specified screening reference name is not in the database and the action of the `dlt-scr-cdpa` command in [Step 3](#) was successful. If the specified screening reference name contained more than one entry when the `dlt-scr-cdpa` command was executed in [Step 3](#), the `rtrv-scr-cdpa:sr=` command output would show the remaining entries in the screening reference instead of error message E2573.



5. Backup the new changes using the `chg-db:action=backup:dest=fixed` command.

The following messages should appear, the active Maintenance and Administration Subsystem Processor (MASP) appears first.

```
BACKUP (FIXED) : MASP A - Backup starts on active MASP.  
BACKUP (FIXED) : MASP A - Backup on active MASP to fixed disk complete.  
BACKUP (FIXED) : MASP A - Backup starts on standby MASP.  
BACKUP (FIXED) : MASP A - Backup on standby MASP to fixed disk complete.
```

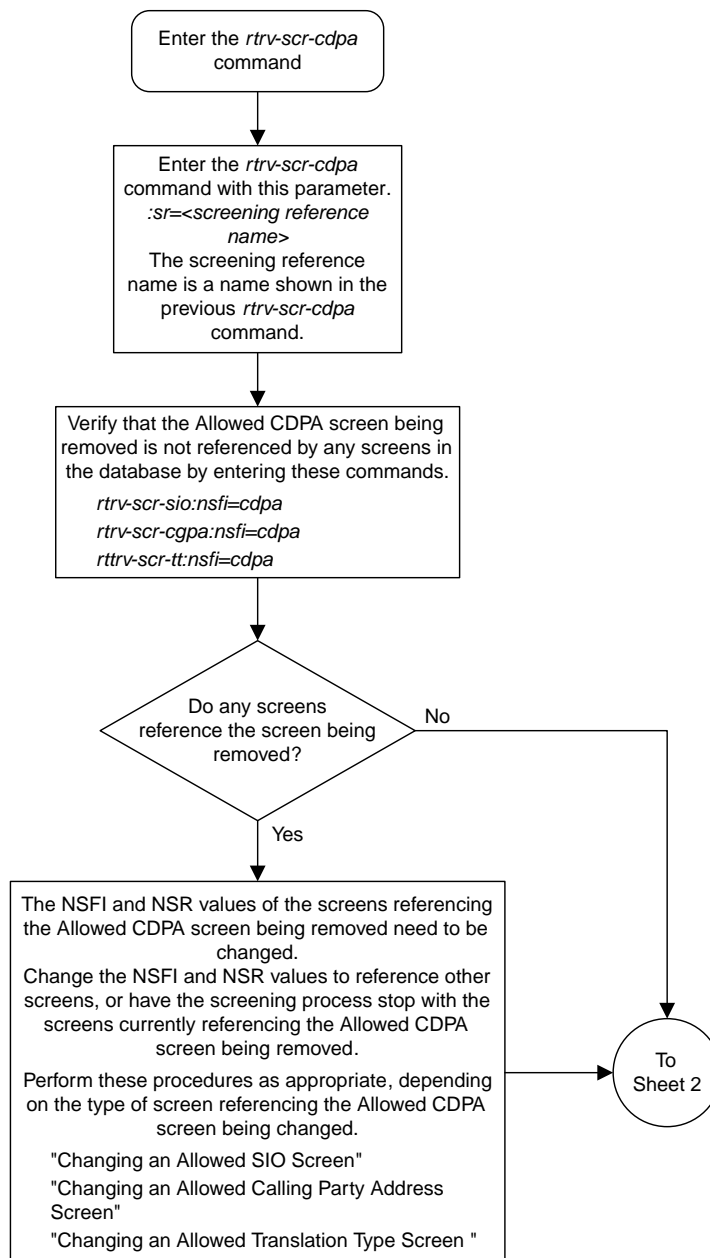

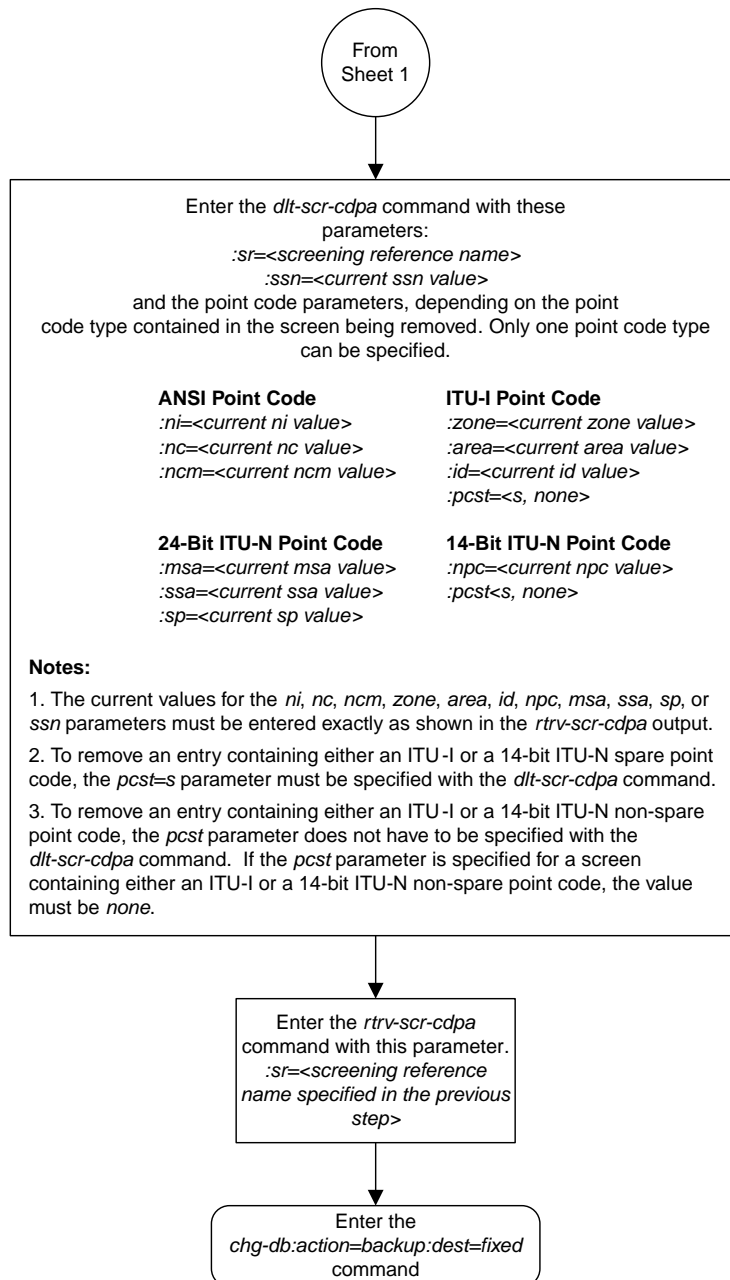

Sheet 2 of 2

**Figure 28: Removing an Allowed Called Party Address Screen**

## Changing an Allowed Called Party Address Screen

This procedure is used to change the attributes of an allowed called party address (CDPA) screen in the database using the `chg-scr-cdpa` command. The parameters used by the `chg-scr-cdpa` command are shown in the [Gateway Screening Attributes](#) section. The general rules that apply to configuring gateway screening entities are shown in the [Gateway Screening Configuration](#) section.

The example in this procedure is used to change the point code 5-117-2 for the allowed CDPA screen `gw15` to 2-230-7, the subsystem number from 254 to 001, the NSFI to `aftpc`, the NSR of `itu1`, and the new SCMG format ID of 150.

**Note:** If you using multiple-part ITU national point codes with gateway screening, see the [14-Bit ITU National Point Code Formats](#) section.

The allowed CDPA screen can only reference an allowed AFTPC screen. This can be verified using the `rtrv-scr-aftpc:all=yes` command. If the desired allowed AFTPC screen is not in the database, perform one of these procedures to add the required screen to the database or change an existing screen in the database.

- [Adding an Allowed Affected Point Code Screen](#)
- [Changing an Allowed Affected Point Code Screen](#)

### Specifying a Range of Values

A range of values can be specified for the point code parameters `ni`, `nc`, or `ncm`.

If a range of values is specified for any of these parameters, and the value of the other parameters match existing values for the screening reference name, the range of values for the point code parameter cannot include any values for that parameter that are currently provisioned for the screening reference name.

For example, screening reference name `scr1` contains these entries:

SR	NI	NC	NCM	SSN	SCMGFID	NSFI	NSR/ACT
SCR1	240	001	010	012	-----	STOP	-----
SCR1	241	010	020	001	002	AFTPC	SCR1

Another entry for screening reference `scr1` with the `ni` value of 240 and the `nc` value of 001 cannot be specified if the range of values for the `ncm` parameter includes the value 010.

The ANSI point code parameter values can be specified as a single value, a range of values, or with an asterisk (\*). The asterisk specifies all possible values for the `ni`, `nc`, and `ncm` parameters. [Table 27: Valid Value Combinations for ANSI Point Code Parameters](#) shows the valid combinations of these parameter values.

**Table 27: Valid Value Combinations for ANSI Point Code Parameters**

NI	NC	NCM
Single Value	Single Value	Single Value
Single Value	Single Value	Range of Values
Single Value	Single Value	Asterisk
Single Value	Range of Values	Asterisk
Single Value	Asterisk	Asterisk
Range of Values	Asterisk	Asterisk
Asterisk	Asterisk	Asterisk

A range of values can also be specified for an ITU-I or 24-bit ITU-N point code parameter using a combination of asterisks (\*) and single values for the point code parameters. [Table 28: Valid Value Combinations for ITU-I Point Code Parameters](#) shows the valid combinations of the ITU-I parameter values. [Table 29: Valid Value Combinations for 24-Bit ITU-N Point Code Parameters](#) shows the valid combinations of the 24-bit ITU-N parameter values.

**Table 28: Valid Value Combinations for ITU-I Point Code Parameters**

ZONE	AREA	ID
Single Value	Single Value	Single Value
Single Value	Single Value	Asterisk
Single Value	Asterisk	Asterisk
Asterisk	Asterisk	Asterisk

**Table 29: Valid Value Combinations for 24-Bit ITU-N Point Code Parameters**

MSA	SSA	SP
Single Value	Single Value	Single Value
Single Value	Single Value	Asterisk
Single Value	Asterisk	Asterisk
Asterisk	Asterisk	Asterisk

1. Display the allowed CDPA screens in the database using the `rtrv-scr-cdpa` command.

The following is an example of the possible output.

```
rlghncxa03w 06-10-25 15:25:30 GMT EAGLE5 36.0.0
SCREEN = ALLOWED CDPA
SR    REF  RULES
GW15  YES   1
GW17  YES   1
GW18  YES   1
IEC   YES   2
LS03  YES   1
WRD2  YES   1
WRD4  YES   9
```

From the `rtrv-scr-cdpa` output, display the allowed CDPA screen you wish to change using the `rtrv-scr-cdpa` command with the screening reference name. For this example, enter this command.

```
rtrv-scr-cdpa:sr=gw15
```

The following is an example of the possible output.

```
rlghncxa03w 06-10-25 15:25:30 GMT EAGLE5 36.0.0
SCREEN = ALLOWED CDPA
SR    ZONE  AREA  ID      SSN      SCMGFID  NSFI    NSR/ACT
GW15  5       117   2       254      -----  STOP    -----
```

If a gateway screening stop action set is to be assigned to the allowed CDPA screen being changed in this procedure, go to step 2.

Step 2 verifies the gateway screening stop action set names in the database. The gateway screening stop action set names are assigned only if the NSFI of the screen being changed in this procedure is STOP. If the NSFI of the screen will be changed to STOP, but a gateway screening stop action set name will not be assigned to the screen, skip steps 2 and 3 and go to step 4. If the NSFI of the screen will not be STOP, skip step 2 and go to step 3.

2. Display the gateway screening stop action sets in the database with the `rtrv-gws-actset` command.

This is an example of the possible output.

```
rlghncxa03w 06-10-25 15:26:30 GMT EAGLE5 36.0.0
ACT  ACT    ACT  ACT  ACT  ACT  ACT  ACT  ACT  ACT  ACT  ACT
ID   NAME    1    2    3    4    5    6    7    8    9    10
--   -----
1    copy    copy
2    rdct    rdct
3    cr      copy  rdct
4    cncf    cncf
5    cpcncf  copy  cncf
6    cncfrd  cncf  rdct
7    cpcfrd  copy  cncf  rdct

GWS action set table is (7 of 16) 44% full
```

If the required gateway screening stop action set is not in the database, perform the [Configuring Gateway Screening Stop Action Sets](#) procedure and configure the required gateway screening stop action set.

**Note:** If the NSFI of the screen being added in this procedure is STOP, skip step 3 and go to step 4.

3. Enter the `rtrv-scr-aftpc` command to verify that the screen that will be specified by the NSFI/NSR parameter combination in step 5 is in the database.

If the desired screen is not in the database, perform one of these procedures to add the desired screen to the database or change an existing screen in the database.

- [Adding an Allowed Affected Point Code Screen](#)
- [Changing an Allowed Affected Point Code Screen.](#)

**Note:** If any of these conditions apply to this procedure, skip step 4 and go to step 5:

- The point code in the screen is not being changed.
- The screen being changed contains either an ANSI or 24-bit ITU-N point code.
- The ITU-I or 14-bit ITU-N non-spare point code in the screen is not being changed to an ITU-I or 14-bit ITU-N spare point code.
- The point code in the screen is an ITU-I or 14-bit ITU-N spare point code or the screening reference contains other screens with ITU-I or 14-bit ITU-N spare point codes.

4. Display the status of the ITU National and International Spare Point Code Support feature by entering the `rtrv-ctrl-feat` command with the ITU National and International Spare Point Code Support feature part number.

Enter this command.

```
rtrv-ctrl-feat:partnum=893013601
```

This is an example of the possible output.

```
rlghncxa03w 06-10-25 15:25:30 GMT EAGLE5 36.0.0
The following features have been permanently enabled:

Feature Name          Partnum   Status  Quantity
Spare Point Code Support 893013601 on      ----

The following features have been temporarily enabled:

Feature Name          Partnum   Status  Quantity  Trial Period Left
Zero entries found.

The following features have expired temporary keys:

Feature Name          Partnum
Zero entries found.
```

If the ITU National and International Spare Point Code Support feature is enabled, go to step 5.

If the ITU National and International Spare Point Code Support feature is not enabled, perform the “Activating the ITU National and International Spare Point Code Support Feature” procedure in *Database Administration - SS7 User’s Guide* to enable the ITU National and International Spare Point Code Support feature as required. After the feature has been enabled, go to step 5.

5. Change the attributes for the allowed CDPA screen using the `chg-scr-cdpa` command.

If a gateway screening stop action is to be assigned to the allowed CDPA screen being changed, enter the `chg-scr-cdpa` command with the `nsfi=stop` parameter and the `actname` parameter with the name of a gateway screening stop action set shown in the output of the `rtrv-gws-actset` command executed in step 2.



**CAUTION**

**Caution:** TheEAGLE does not support redirectingMSUs for theDTA feature or interceptingISUPIAM messages for theCalling Name Conversion Facility feature from the allowedCDPA screen. Gateway screening stop action sets containing either theRDCT (redirect) orCNCF (calling name conversion facility) stop actions should not be assigned to the allowedCDPA screen. If a gateway screening stop action set containing theRDCT orCNCF stop actions is specified with the`chg-scr-cdpa` command, unsolicited information message (UIM) 1125 is generated when the attempt is made to redirectMSUs from the allowedCDPA screen. Unsolicited information message (UIM) 1215 is generated whenISUPIAMMSUs are intercepted from the allowedCDPA screen. For more information onUIMs 1125 and 1215, go to*Unsolicited Alarm and Information Messages Reference*.

The current values for the `ni`, `nc`, `ncm`, `zone`, `area`, `id`, `npc`, `msa`, `ssa`, and `sp`, `ssn`, and `scmgfid` parameters must be entered exactly as shown in the `rtrv-scr-cdpa` output in step 1. If the `scmgfid` value is shown as dashes, the `scmgfid` parameter cannot be specified.

The following list contains the values for `nni`, `nnc`, `nncm`, `nzone`, `narea`, `nid`, `nnpc`, `nmsa`, `nssa`, `nsp`, `nssn`, and `nscmgfid` parameters:

- `nni` – 0 - 255 or an asterisk (\*)
- `nnc` – 0 - 255 or an asterisk (\*)
- `nncm` – 0 - 255 or an asterisk (\*)
- `nzone` – 0 - 7 or an asterisk (\*)
- `narea` – 0 - 255 or an asterisk (\*)
- `nid` – 0 - 7 or an asterisk (\*)
- `nnpc` – 1 - 16383 or an asterisk (\*)
- `nmsa` – 0 - 255 or an asterisk (\*)
- `nssa` – 0 - 255 or an asterisk (\*)
- `nsp` – 0 - 255 or an asterisk (\*)
- `nssn` – 0 - 255 or an asterisk (\*)
- `nscmgfid` – 1 - 255 or an asterisk (\*)

**Note:** The `nsfi=aftpc` parameter can be specified only if the `ssn` value (new or current) is 1. [Table 30: CDPA Parameter Combinations](#) shows the valid parameter combinations for the `ssn`, `scmgfid`, `nsfi`, and `nsr` parameter values.

**Table 30: CDPA Parameter Combinations**

New or Current SSN Value	New or Current SCMGFID Value	NSFI	NSR
1	1 - 255, *	AFTPC or STOP	Must be specified if NSFI=AFTPC
0, 2-255, *	Cannot be specified	STOP	Cannot be specified



A range of values can be specified for the `nni`, `nnc`, and `nncm` parameters. See the [“Specifying a Range of Values”](#) section for more information on how the asterisk and a range of values are used for the `nni`, `nnc`, and `nncm` parameters.

To change an ITU-I or 14-bit ITU-N spare point code to a non-spare point code, both the `pcst=s` and `npcst=none` parameters must be specified with the `chg-scr-cdpa` command.

To change an ITU-I or 14-bit ITU-N non-spare point code to a spare point code, the `npcst=s` parameter must be specified with the `chg-scr-cdpa` command. The `pcst` parameter does not have to be specified.

If the current point code in the screen being changed is either an ITU-I or 14-bit ITU-N spare point code, the `pcst=s` parameter must be specified with the `chg-scr-cdpa` command.

If the current point code in the screen being changed is either an ITU-I or 14-bit ITU-N non-spare point code, the `pcst` parameter does not have to be specified with the `chg-scr-cdpa` command. If the `pcst` parameter is specified for a screen containing either an ITU-I or 14-bit ITU-N non-spare point code, the `pcst` parameter value must be `none`.

For this example, enter this command.

```
chg-scr-cdpa:sr=gw15:zone=5:area=117:id=2:ssn=254:nzone=2
:narea=230:nid=7:nssn=001:nscmgfid=150:nsfi=aftpc:nsr=it1
```

A message similar to the following should appear.

```
rlghncxa03w 06-10-25 15:27:30 GMT EAGLE5 36.0.0
CHG-SCR-CDPA: SCREEN SET AFFECTED - GW15 1% FULL
CHG-SCR-CDPA: MASP A - COMPLTD
```

- Verify the changes using the `rtrv-scr-cdpa` command with the screening reference name used in step 5.

For this example, enter this command.

```
rtrv-scr-cdpa:sr=gw15
```

The following is an example of the possible output.

```
rlghncxa03w 06-10-25 15:28:30 GMT EAGLE5 36.0.0
SCREEN = ALLOWED CDPA
SR      ZONE  AREA  ID      SSN      SCMGFID  NSFI     NSR/ACT
GW15    2      230   7       001      150     AFTPC    ITU1
```

- Backup the new changes using the `chg-db:action=backup:dest=fixed` command.

The following messages should appear, the active Maintenance and Administration Subsystem Processor (MASP) appears first.

```
BACKUP (FIXED) : MASP A - Backup starts on active MASP.
BACKUP (FIXED) : MASP A - Backup on active MASP to fixed disk complete.
BACKUP (FIXED) : MASP A - Backup starts on standby MASP.
BACKUP (FIXED) : MASP A - Backup on standby MASP to fixed disk complete.
```

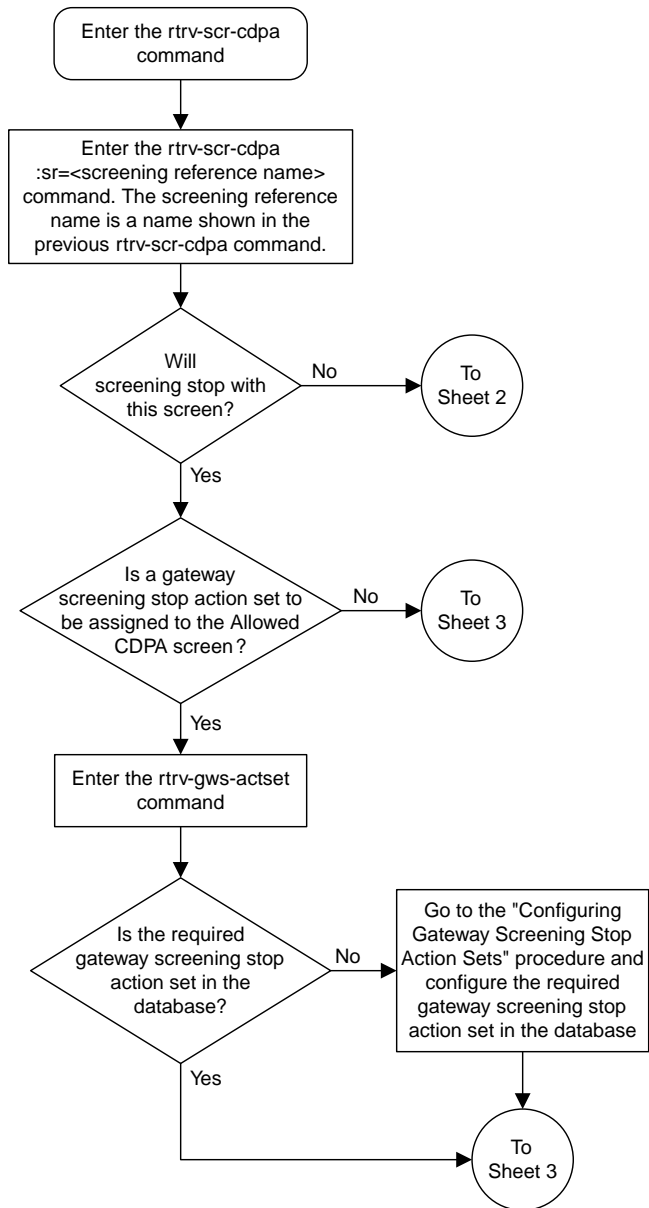

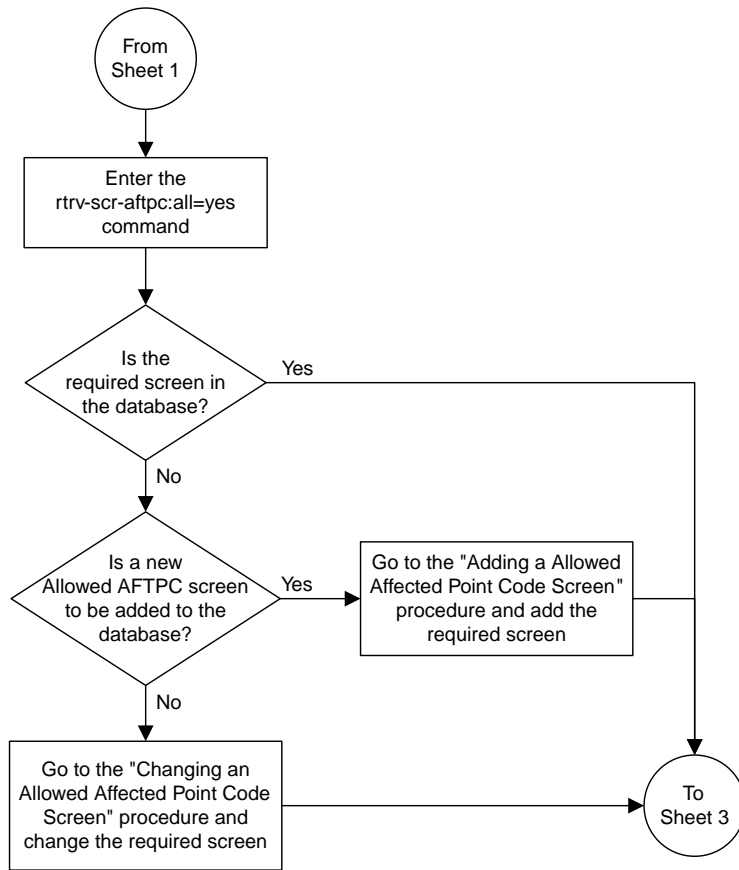

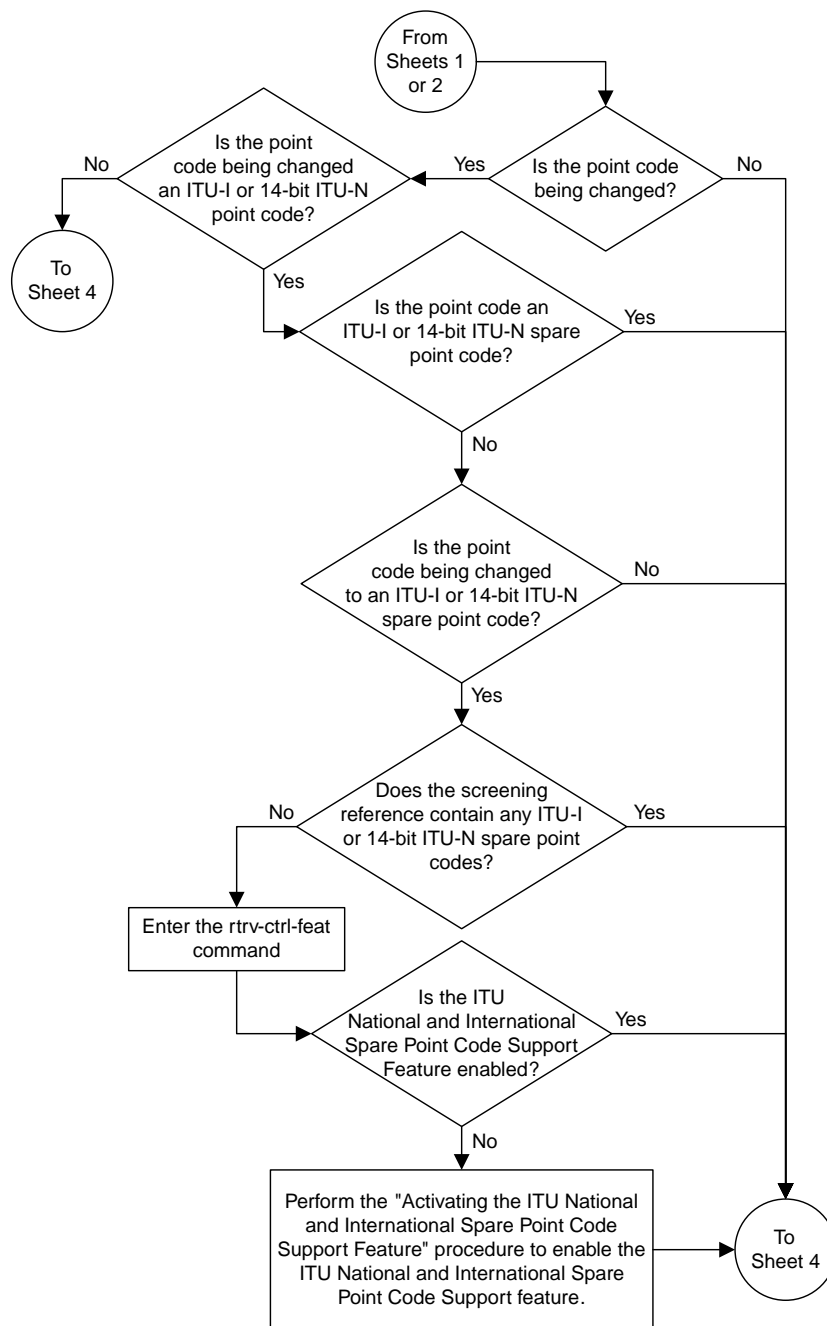

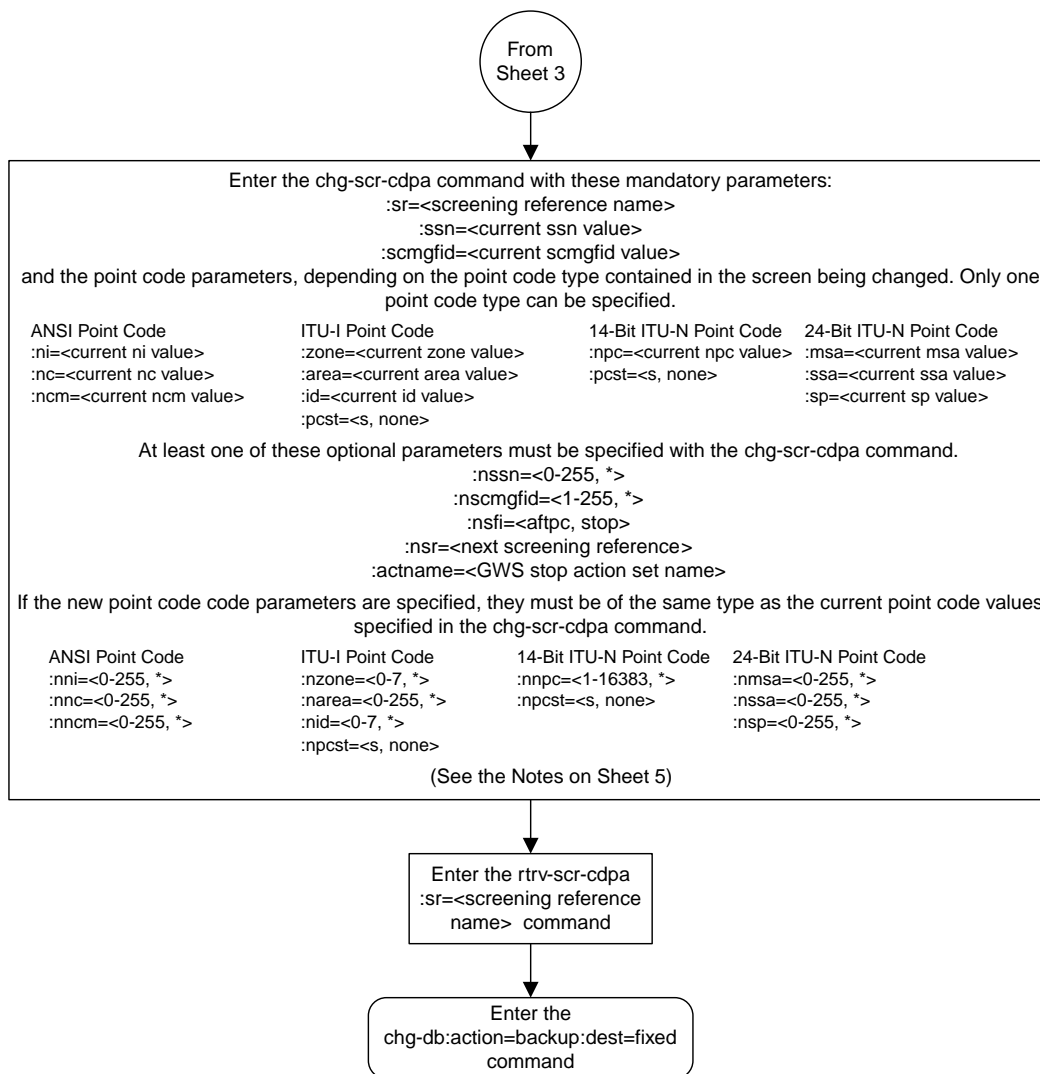

**Notes:**

1. A range of values can be specified for the *nni*, *nnc*, or *nncm* parameters by inserting double ampersands (&&) between the parameter values defining the range. For example, to specify the range 025 to 200 for the *nni* parameter, enter 025&&200 for the *nni* parameter value.
2. The asterisk (\*) specifies the entire range of values for that parameter.  
  
For more information about specifying a range of values and about using the asterisk, see the "Gateway Screening Attributes" section and the "Specifying a Range of Values" section. The "Gateway Screening Attributes" section is in the *Database Administration Manual - Gateway Screening*. The "Specifying a Range of Values" section is in the "Changing an Allowed Called Party Address Screen" procedure in the *Database Administration Manual - Gateway Screening*.
3. The *nscmgfid* parameter can be specified only if the *ssn* parameter value (if unchanged) or the *nssn* parameter value is 1. If either the *nssn=1* or *nscmgfid* parameter is specified, the other parameter must be specified. The *nscmgfid* parameter cannot be specified if the *ssn* parameter value is 0, 2 through 255, or \*.
4. To specify the *nsfi=afipc* parameter, the *ssn* parameter value (if unchanged) or the *nssn* parameter value must be 1.
5. If the *ssn* parameter value (if unchanged) or the *nssn* parameter value is 0, 2 through 255, or \*, the *nsfi* parameter value must be *stop*.
6. If the *ssn* parameter value (if unchanged) or the *nssn* parameter value is 1, the *nsfi* parameter value can be either *afipc* or *stop*.
7. The *nsr* parameter can be specified only, and must be specified, if the *nsfi=afipc* parameter is specified.
8. The *actname* parameter can be specified only if the *nsfi* value is *stop* (either the current *nsfi* value is *stop* and not being changed, or the *nsfi* value is being changed to *stop*). The *actname* parameter is optional. If the *actname* parameter is specified, the *actname* parameter value is one of the gateway screening stop action set names shown in the *rtrv-gws-actset* output on Sheet 1.
9. The current values for the *ni*, *nc*, *nncm*, *zone*, *area*, *id*, *npc*, *msa*, *ssa*, *sp*, or *ssn* parameters must be entered exactly as shown in the *rtrv-scr-cdpa* output. If dashes are shown for the *scmgfid* parameter, the *scmgfid* parameter cannot be specified with the *chg-scr-cdpa* command.
10. To change an ITU-I or 14-bit ITU-N spare point code to a non-spare point code, both the *pcst=s* and *npcst=none* parameters must be specified with the *chg-scr-cdpa* command.
11. To change an ITU-I or 14-bit ITU-N non-spare point code to a spare point code, the *npcst=s* parameter must be specified with the *chg-scr-cdpa* command. The *pcst* parameter does not have to be specified.
12. If the current point code in the screen being changed is either an ITU-I or 14-bit ITU-N spare point code, the *pcst=s* parameter must be specified with the *chg-scr-cdpa* command.
13. If the current point code in the screen being changed is either an ITU-I or 14-bit ITU-N non-spare point code, the *pcst* parameter does not have to be specified with the *chg-scr-cdpa* command. If the *pcst* parameter is specified for a screen containing either an ITU-I or 14-bit ITU-N non-spare point code, the *pcst* parameter value must be *none*.

Sheet 5 of 5

**Figure 29: Changing an Allowed Called Party Address Screen**

# Chapter 5

## Allowed Translation Type (TT) Screen Configuration

---

### Topics:

- [Introduction.....189](#)
- [Adding an Allowed Translation Type Screen...194](#)
- [Removing an Allowed Translation Type Screen.....201](#)
- [Changing an Allowed Translation Type Screen.....204](#)

Chapter 5, Allowed Translation Type (TT) Screen Configuration, contains the procedures necessary to configure allowed translation type screens.



## Introduction

The allowed translation type (TT) screen is used to screen all SCCP messages which have the specified translation type value in the called party address. The gray shaded areas in [Figure 31: Allowed Translation Type Screening Function](#) shows the fields of the SS7 message that are checked by the TT screening function.

## Gateway Screening Actions

If a match is not found, the message is discarded.

If a match is found, the `nsfi` is examined to determine the next step in the screening process. If the `nsfi` value is any value other than `stop`, the next screening reference (`nsr`) is identified and the screening process continues to the next screen identified by the `nsfi` and `nsr` parameter values.

If the `nsfi` is equal to `stop`, the screening process stops and the message is processed. If a gateway screening stop action set is specified with the screen, shown by the `actname` parameter value, the message is processed according to the gateway screening stop actions that are assigned to the gateway screening stop action set.

- If the `copy` gateway screening stop action is specified, the message is processed and a copy of the message is sent by the STPLAN feature to an external application.
- If the `rdct` (redirect) gateway screening stop action is specified, the message is diverted from the original destination and sent to another destination with the Database Transport Access feature, specified by global title translation, for further processing.
- If the `cncf` gateway screening stop action is specified, the PIP parameter in the incoming ISUP IAM message is converted to the GN parameter. The GN parameter in the incoming ISUP IAM message is converted to the PIP parameter. The message is then sent to the node specified by the DPC in the routing label in the message. For more information on the Calling Name Conversion Facility feature, see [Calling Name Conversion Facility \(CNCF\) Configuration](#).
- If the `tlnp` gateway screening stop action is specified, ISUP IAMs that pass gateway screening are processed either by the ISUP NP with EPAP feature (if the ISUP NP with EPAP feature is enabled and turned on) or by the Triggerless LNP feature (if the Triggerless LNP feature is turned on). The ISUP NP with EPAP feature is discussed in more detail in *G-Port User's Guide*. The Triggerless LNP feature is discussed in more detail in *ELAP Administration and LNP Feature Activation Guide*.
- If the `tinp` gateway screening stop action is specified, ISUP IAMs that pass gateway screening are intercepted by the Triggerless ISUP based Number Portability (TINP) feature and converted to include the routing number (RN) if the call is to a ported number. The TINP feature is discussed in more detail in *G-Port User's Guide*.
- If the `tif`, `tif2`, or `tif3` gateway screening stop actions are specified, TIF processing is applied to the message.
- If the `sccp` gateway screening stop action is specified, MTP routed SCCP UDT/XUDT are forwarded to the service modules for further processing.

## Allowed TT Screening Actions

[Figure 30: Allowed TT Screening Actions](#) shows the screening actions of the allowed TT screen.

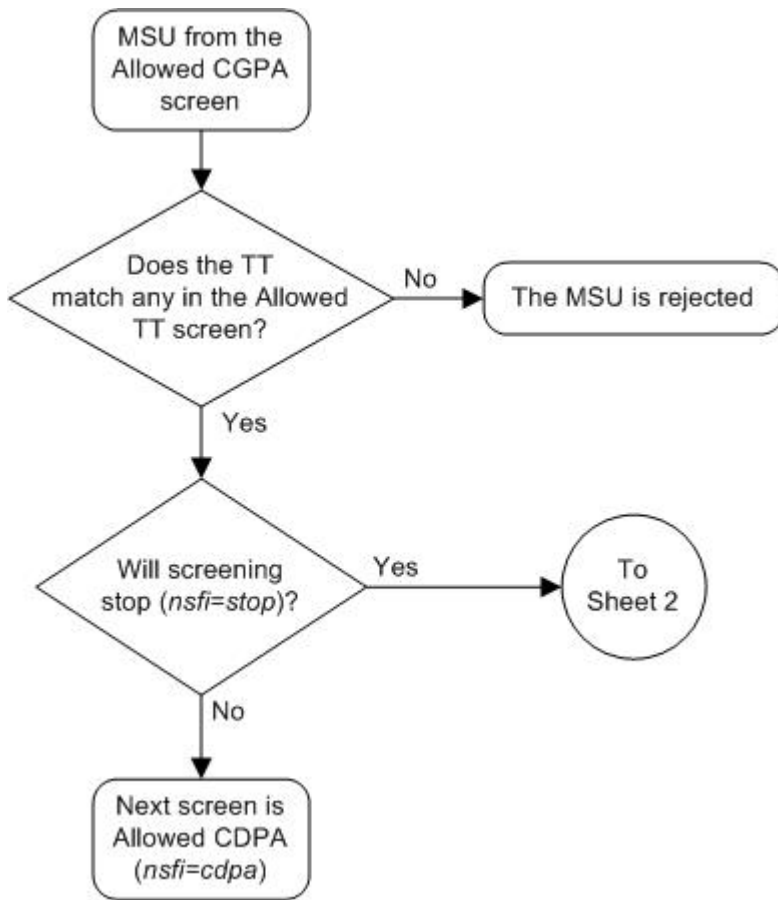

Sheet 1 of 3

Figure 30: Allowed TT Screening Actions

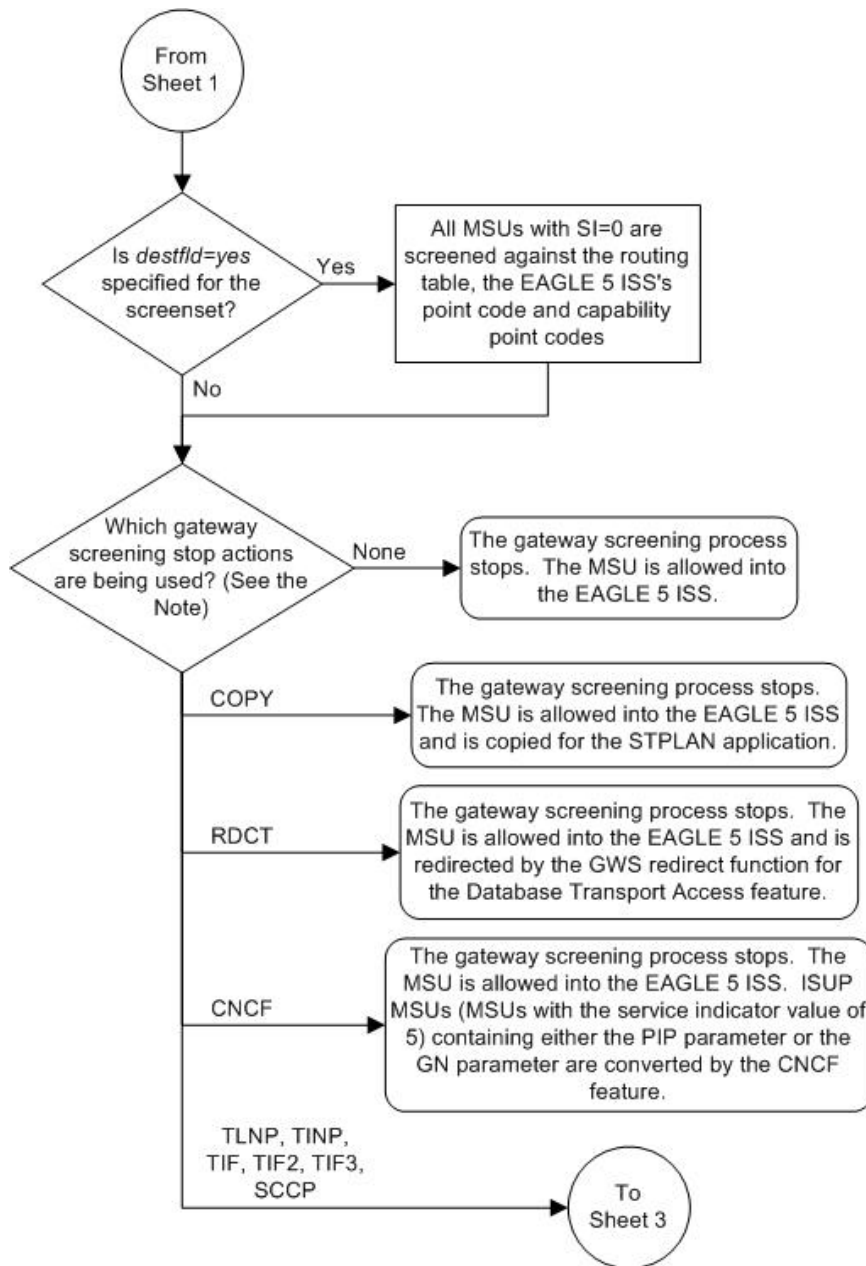

Note: Combinations of the gateway screening stop actions shown on Sheets 2 and 3 may be assigned to a gateway screening stop action set. Refer to the Configuring Gateway Screening Stop Action Sets and the Configuring TLNP Gateway Screening Stop Action Sets procedures in Chapter 2 of this manual for the combinations that can be used.

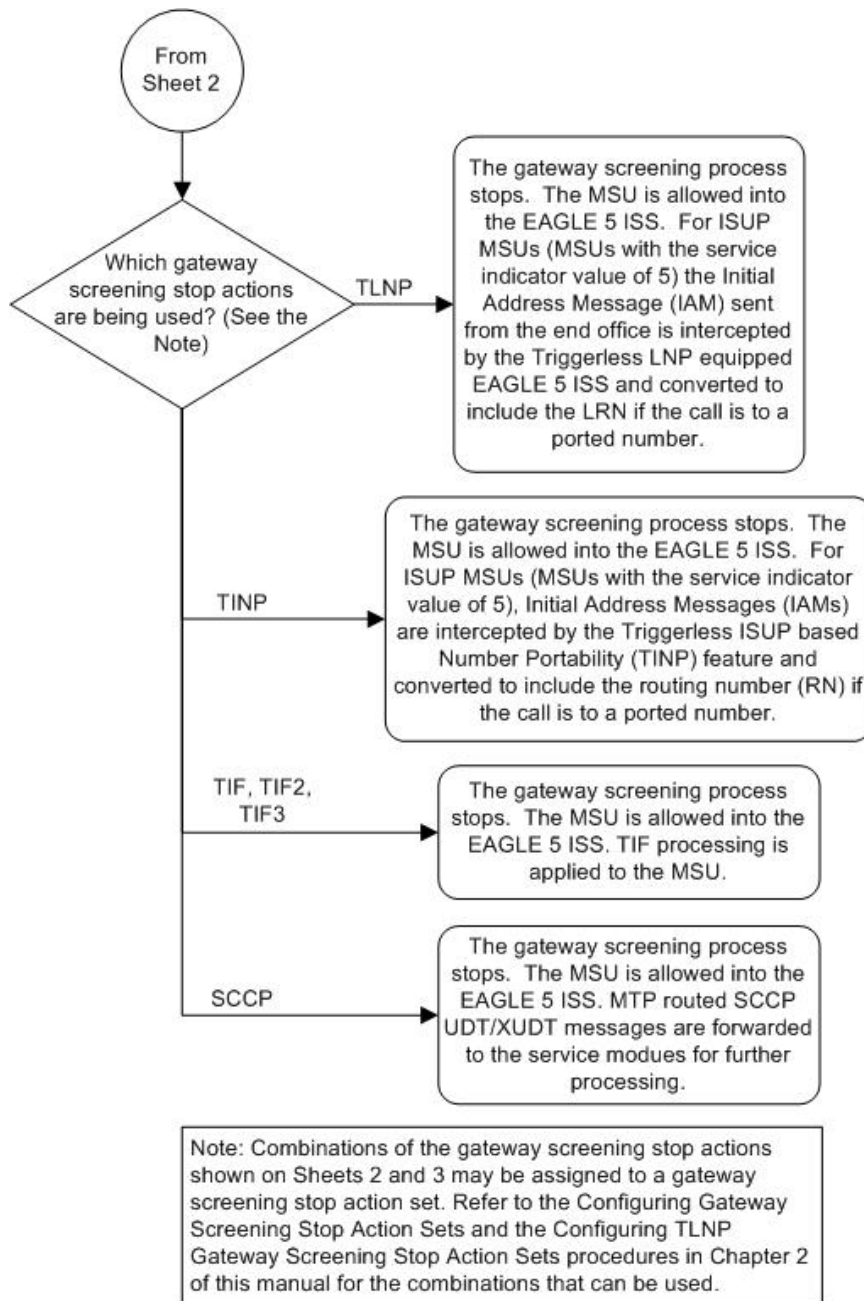

Sheet 3 of 3

ANSI MSU (ANSI Message Signal Unit)

BSN FSN LI	SIO xx xx xxxx NIC PRI SI	SIF			
		Routing Label DPC            OPC            SLS NCM NC NI    NCM NC NI    xx		CGPA Length Address Indicator Subsystem Point Code (NCM NC NI)	CDPA Length Address Indicator (x x xxxx xx) (x RI xxxx xx) Subsystem Point Code (NCM NC NI) Address (Translation Type) (Digits )

ITU-I MSU (ITU International Message Signal Unit)

BSN FSN LI	SIO xx xx xxxx NIC PRI SI	SIF			
		Routing Label DPC            OPC            SLS ID AREA ZONE ID AREA ZONE xx		CGPA Length Address Indicator Subsystem Point Code (ID AREA ZONE)	CDPA Length Address Indicator (x x xxxx xx) (x RI xxxx xx) Subsystem Point Code (ID AREA ZONE) Address (Translation Type) (Digits )

14-Bit ITU-N MSU (14-Bit ITU National Message Signal Unit)

BSN FSN LI	SIO xx xx xxxx NIC PRI SI	SIF			
		Routing Label DPC            OPC            SLS NPC            NPC            xx		CGPA Length Address Indicator Subsystem Point Code (NPC)	CDPA Length Address Indicator (x x xxxx xx) (x RI xxxx xx) Subsystem Point Code (NPC) Address (Translation Type) (Digits )

24-Bit ITU-N MSU (24-Bit ITU National Message Signal Unit)

BSN FSN LI	SIO xx xx xxxx NIC PRI SI	SIF			
		Routing Label DPC            OPC            SLS SP SSA MSA SP SSA MSA xx		CGPA Length Address Indicator Subsystem Point Code (SP SSA MSA)	CDPA Length Address Indicator (x x xxxx xx) (x RI xxxx xx) Subsystem Point Code (SP SSA MSA) Address (Translation Type) (Digits )

Figure 31: Allowed Translation Type Screening Function

## Adding an Allowed Translation Type Screen

This procedure is used to add an allowed translation type (TT) screen to the database using the `ent-scr-tt` command. The parameters used by the `ent-scr-tt` command are shown in the [Gateway Screening Attributes](#) section. The general rules that apply to configuring gateway screening entities are shown in the [Gateway Screening Configuration](#) section.

The examples in this procedure are used to add the allowed TT screen data shown in [Table 31: Example Gateway Screening Allowed TT Configuration Table](#) and based on the example configuration shown in [Figure 6: Gateway Screening Configuration - Example 3](#).

**Table 31: Example Gateway Screening Allowed TT Configuration Table**

Screening Reference	TYPE	NSFI	NSR
gw16	250	cdpa	gw18

The allowed TT screen can only reference an allowed CDPA screen and the allowed CDPA screen being referenced must be in the database. This can be verified using the `rtrv-scr-cdpa:all=yes` command. If the desired allowed CDPA screen is not in the database, perform one of these procedures to add the required screen to the database or change an existing screen in the database.

- [Adding an Allowed Called Party Address Screen](#)
- [Changing an Allowed Called Party Address Screen](#)

### Specifying a Range of Values

A range of values can be specified for the `type` parameter. The range of values specified for the `type` parameter cannot include any values currently provisioned for the screen reference name.

For example, screening reference name `scr1` contains these entries:

```
SR   TYPE   NSFI   NSR/ACT
scr1 110     STOP   -----
scr1 125     STOP   -----
```

Another entry for screening reference `scr1` cannot contain a range of values that would include the `type` parameter values 110 or 125.

1. Verify that the gateway screening feature is on, by entering the `rtrv-feat` command.

If the gateway screening feature is on, the `GWS` field is set to `on`.

**Note:** The `rtrv-feat` command output contains other fields that are not used by this procedure. If you wish to see all the fields displayed by the `rtrv-feat` command, see the `rtrv-feat` command description in *Commands User's Guide*.

If the gateway screening feature is on, shown by the entry `GWS = on` in the `rtrv-feat` command output, skip step 2, and go to step 3.

2. Turn the gateway screening feature on by entering this command.

```
chg-feat:gws=on
```

**Note:** Once the gateway screening feature is turned on with the `chg-feat` command, it cannot be turned off.

The gateway screening feature must be purchased before you turn this feature on with the `chg-feat` command. If you are not sure if you have purchased the gateway screening feature, contact your Oracle Sales Representative or Account Representative.

When the `chg-feat` has successfully completed, this message should appear.

```
rlghncxa03w 06-10-28 11:43:04 GMT EAGLE5 36.0.0
CHG-FEAT: MASP A - COMPLTD
```

3. Display all allowed TT screens in the database using the `rtrv-scr-tt` command.

The following is an example of the possible output.

```
rlghncxa03w 06-10-25 15:25:30 GMT EAGLE5 36.0.0
SCREEN = ALLOWED TT
SR    REF  RULES
IEC   YES   2
WRD2  YES   1
WRD4  YES   9
```

If the screening reference names that you wish to add with this procedure are not shown in the `rtrv-scr-tt` command output, go to step 4. For this example, the screening reference names are not shown. If these screening reference names are shown in the `rtrv-scr-tt` command output, make sure the screening data you wish to enter is not already in the database by entering the `rtrv-scr-tt` command with the screening reference name. For example, enter the `rtrv-scr-tt:sr=iec` command.

The following is an example of the possible output.

```
rlghncxa03w 06-10-25 15:26:30 GMT EAGLE5 36.0.0
SCREEN = ALLOWED TT
SR    TYPE  NSFI  NSR/ACT
IEC   005&&010 STOP  -----
IEC   012    STOP  -----
IEC   016    CDPA  IEC
WRD2  243    STOP  -----
WRD4  *      STOP  -----
```

If a gateway screening stop action set is to be assigned to the allowed TT screen being added to the database, go to step 4.

Step 4 verifies the gateway screening stop action set names in the database. The gateway screening stop action set names are assigned only if the NSFI of the screen being added in this procedure is STOP. If the NSFI of the new screen will be STOP, but a gateway screening stop action set name will not be assigned to the new screen, skip steps 4 and 5 and go to step 6. If the NSFI of the new screen is CDPA, skip step 4 and go to step 5.

4. Display the gateway screening stop action sets in the database with the `rtrv-gws-actset` command.

This is an example of the possible output.

```

rlghncxa03w 06-10-25 15:27:30 GMT EAGLE5 36.0.0
ACT ACT ACT ACT ACT ACT ACT ACT ACT ACT ACT
ID NAME 1 2 3 4 5 6 7 8 9 10
--
1 copy copy
2 rdct rdct
3 cr copy rdct
4 cncf cncf
5 cpcncf copy cncf
6 cncfrd cncf rdct
7 cpcfrd copy cncf rdct

GWS action set table is (7 of 16) 44% full

```

If the required gateway screening stop action set is not in the database, perform the [Configuring Gateway Screening Stop Action Sets](#) procedure to configure the required gateway screening stop action set.

**Note:** If the NSFI of the screen being added in this procedure is STOP, skip step 5 and go to step 6.

5. Enter the `rtrv-scr-cdpa` command to verify that the screen that will be specified by the NSFI/NSR parameter combination in step 6 is in the database.

If the desired screen is not in the database, perform one of these procedures to add the desired screen to the database or change an existing screen in the database.

- [Adding an Allowed Called Party Address Screen](#)
- [Changing an Allowed Called Party Address Screen.](#)

6. Add a new allowed TT screen to the database using the `ent-scr-tt` command.

If a gateway screening stop action is to be assigned to the allowed TT screen being changed, enter the `ent-scr-tt` command with the `nsfi=stop` parameter and the `actname` parameter with the name of a gateway screening stop action set shown in the output of the `rtrv-gws-actset` command executed in step 4.



**Caution:** The EAGLE does not support redirecting MSUs for the DTA feature or intercepting ISUPIAM messages for the Calling Name Conversion Facility feature from the allowed TT screen. Gateway screening stop action sets containing either the RDCT (redirect) or CNCF (calling name conversion facility) stop actions should not be assigned to the allowed TT screen. If a gateway screening stop action set containing the RDCT or CNCF stop actions is specified with the `ent-scr-tt` command, unsolicited information message (UIM) 1128 is generated when the attempt is made to redirect MSUs from the allowed TT screen. Unsolicited information message (UIM) 1218 is generated when ISUP IAMMSUs are intercepted from the allowed TT screen. For more information on UIMs 1128 and 1218, go to the [Unsolicited Alarm and Information Messages Reference](#).

The value of the `type` parameter can be from 0 to 255 or an asterisk (\*).

A range of values can be specified for the `type` parameter. See the [“Specifying a Range of Values”](#) section for more information on how a range of values is used for the `type` parameter.

For this example, enter this command.



```
ent-scr-tt:sr=gw16:type=250:nsfi=cdpa:nsr=gw18
```

A message similar to the following should appear.

```
rlghncxa03w 06-10-25 15:28:30 GMT EAGLE5 36.0.0
ENT-SCR-TT: SCREEN SET AFFECTED - GW16 1% FULL
ENT-SCR-TT: MASP A - COMPLTD
```

7. Verify the changes using the `rtrv-scr-tt` command with the screening reference name used in step 6.

For this example, enter this command.

```
rtrv-scr-tt:sr=gw16
```

The following is an example of the possible output.

```
rlghncxa03w 06-10-25 15:29:30 GMT EAGLE5 36.0.0
SCREEN = ALLOWED TT
SR      TYPE      NSFI      NSR/ACT
GW16   250          CDPA      GW18
```

8. Backup the new changes using the `chg-db:action=backup:dest=fixed` command.

The following messages should appear, the active Maintenance and Administration Subsystem Processor (MASP) appears first.

```
BACKUP (FIXED) : MASP A - Backup starts on active MASP.
BACKUP (FIXED) : MASP A - Backup on active MASP to fixed disk complete.
BACKUP (FIXED) : MASP A - Backup starts on standby MASP.
BACKUP (FIXED) : MASP A - Backup on standby MASP to fixed disk complete.
```

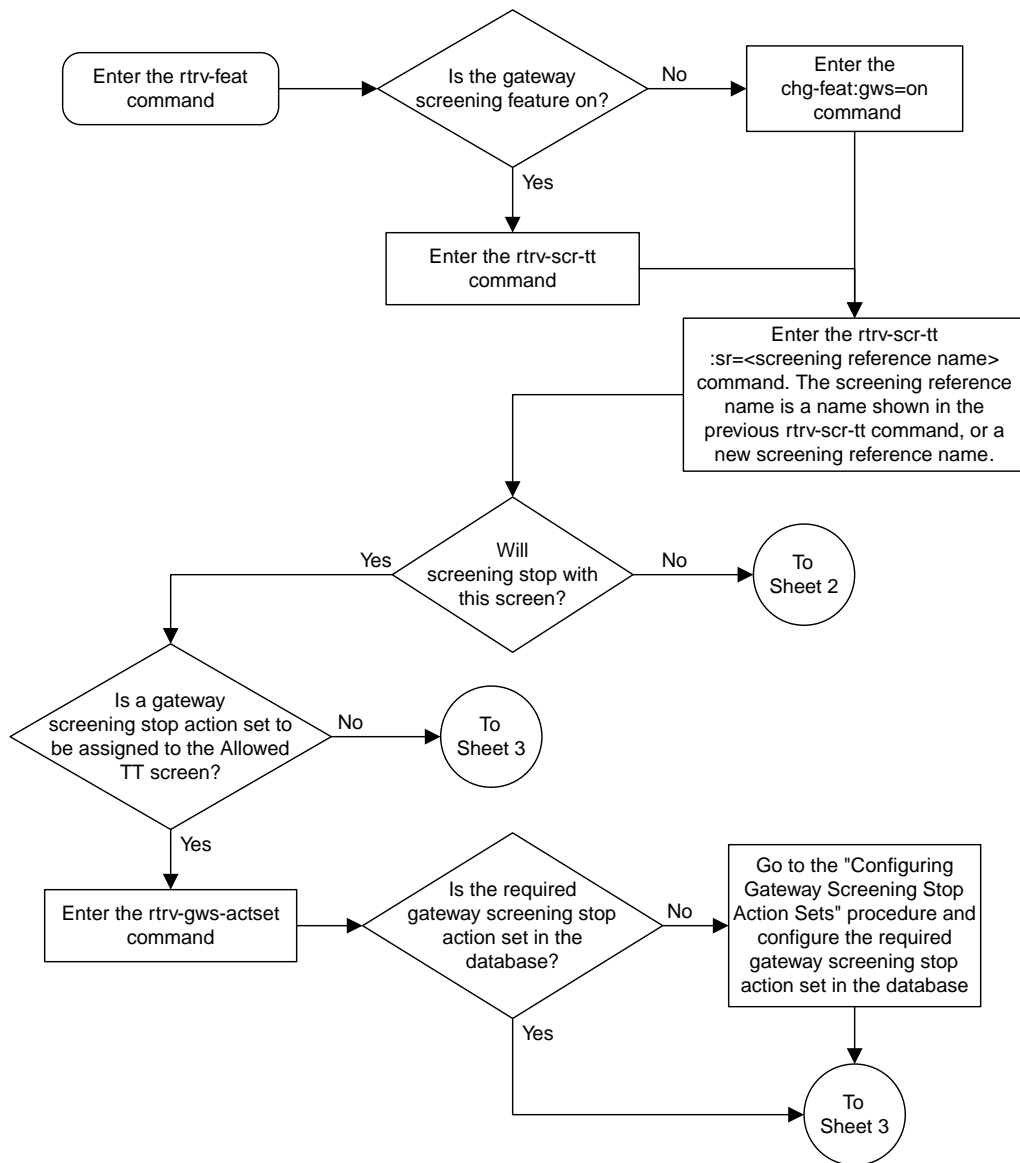

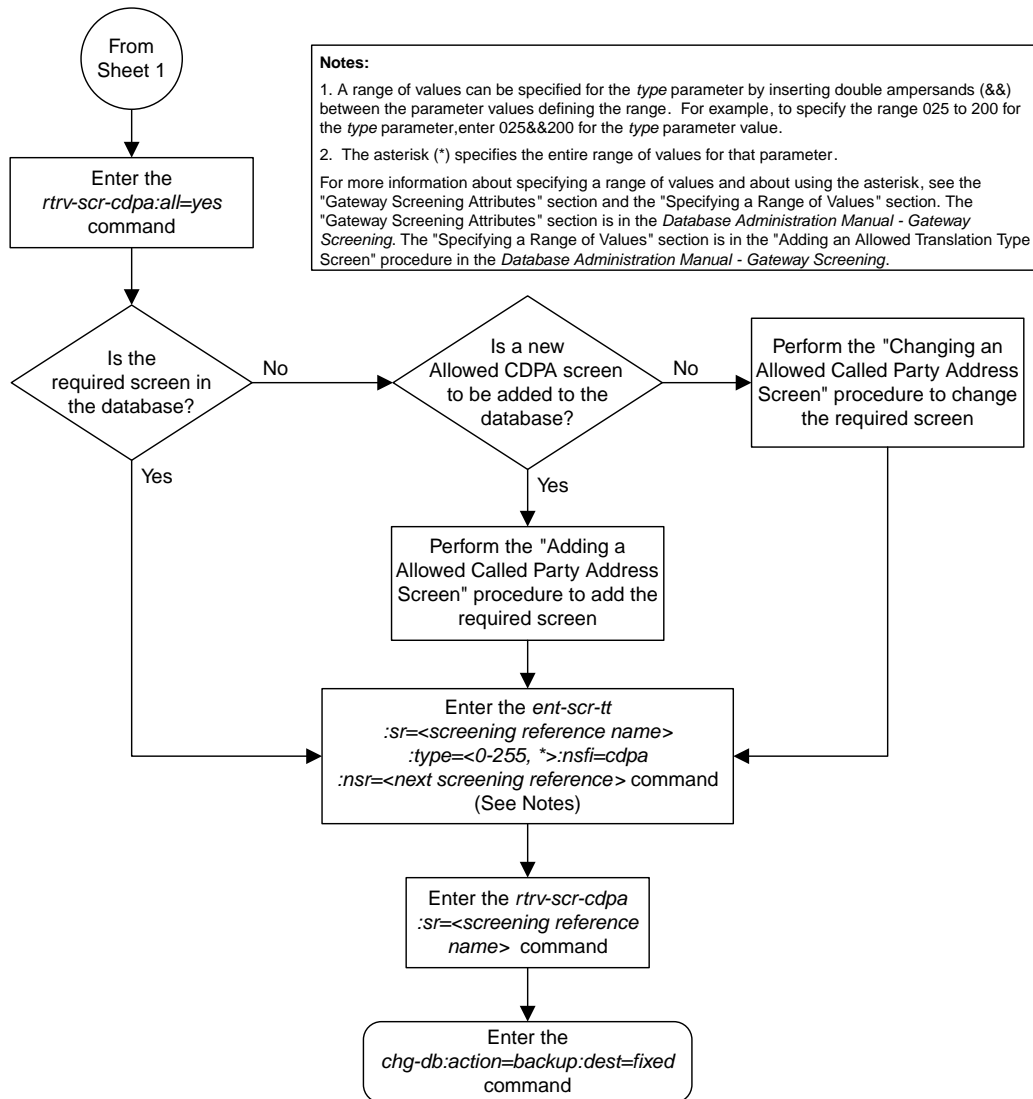

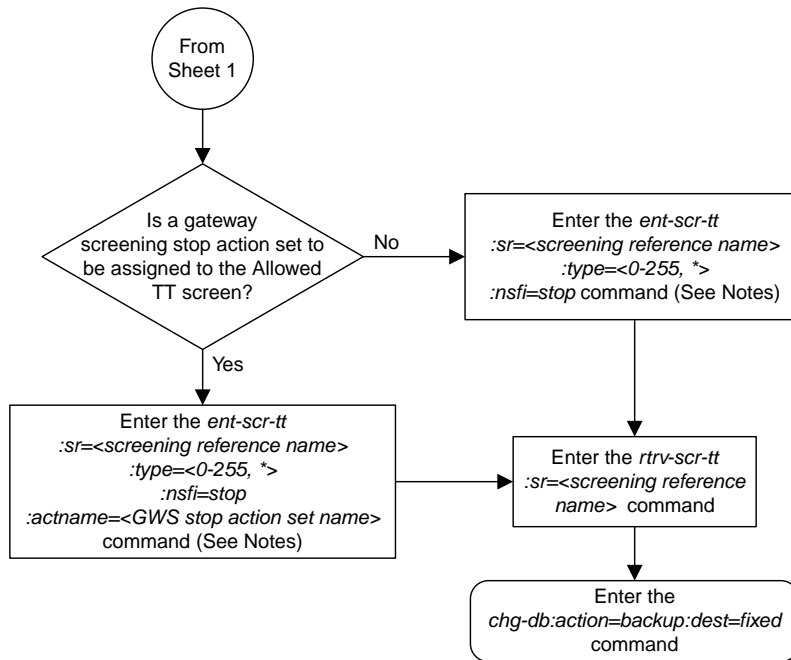

**Notes:**

1. A range of values can be specified for the *type* parameter by inserting double ampersands (&&) between the parameter values defining the range. For example, to specify the range 025 to 200 for the *type* parameter, enter 025&&200 for the *type* parameter value.
2. The asterisk (\*) specifies the entire range of values for that parameter.

For more information about specifying a range of values and about using the asterisk, see the "Gateway Screening Attributes" section and the "Specifying a Range of Values" section. The "Gateway Screening Attributes" section is in the *Database Administration Manual - Gateway Screening*. The "Specifying a Range of Values" section is in the "Adding an Allowed Translation Type Screen" procedure in the *Database Administration Manual - Gateway Screening*.

Sheet 3 of 3

**Figure 32: Adding an Allowed Translation Type Screen**

## Removing an Allowed Translation Type Screen

This procedure is used to remove an allowed translation type (TT) screen from the database using the `dlt-scr-tt` command. The parameters used by the `dlt-scr-tt` command are shown in the [Gateway Screening Attributes](#) section. The general rules that apply to configuring gateway screening entities are shown in the [Gateway Screening Configuration](#) section.

The example in this procedure removes the allowed TT screen `iec`, with the translation type 016 from the database.

The allowed TT screen can be referenced by the Allowed CGPA screen. Enter the `rtrv-scr-cgpa:nsfi=tt` command to verify that this screen does not reference the allowed TT screen being removed from the database.

To change the NSFI of any of these screens, perform the [Changing an Allowed Calling Party Address Screen](#) procedure.

1. Display the allowed TT screens in the database using the `rtrv-scr-tt` command.

The following is an example of the possible output.

```
r1ghncxa03w 06-10-25 15:26:30 GMT EAGLE5 36.0.0
SCREEN = ALLOWED TT
SR   REF   RULES
GW16 YES    1
IEC  YES    3
WRD2 YES    1
WRD4 YES    1
```

From the `rtrv-scr-tt` output, display the allowed TT screen you wish to remove using the `rtrv-scr-tt` command with the screening reference name. For this example, enter the `rtrv-scr-tt:sr=iec` command. The following is an example of the possible output. The following is an example of the possible output.

```
r1ghncxa03w 06-10-25 15:26:30 GMT EAGLE5 36.0.0
SCREEN = ALLOWED TT
SR   TYPE     NSFI   NSR/ACT
IEC  005&&010  STOP   -----
IEC  012       STOP   -----
IEC  016       CDPA   IEC
```

2. Enter the `rtrv-scr-cgpa:nsfi=tt` command to verify that the screen being removed is not referenced by other screens in the database.

If the screen being removed is referenced by other screens, perform the [Changing an Allowed Calling Party Address Screen](#) procedure and change the NSFI of those screens to reference other screens or change the NSFI of these screens to STOP.

3. Remove the allowed TT screen from the database using the `dlt-scr-tt` command.

The current value of the type parameter must be entered exactly as shown in the `rtrv-scr-tt` output. For this example, enter this command.

```
dlt-scr-tt:sr=iec:type=016
```

A message similar to the following should appear.

```
rlghncxa03w 06-10-25 15:26:30 GMT EAGLE5 36.0.0
DLT-SCR-TT: SCREEN SET AFFECTED - IEC 2% FULL
DLT-SCR-TT: MASP A - COMPLTD
```

4. Verify the changes using the `rtrv-scr-tt` command with the screening reference name used in step 3.

For this example, enter this command.

```
rtrv-scr-tt:sr=iec
```

The following is an example of the possible output.

```
rlghncxa03w 06-10-25 15:26:30 GMT EAGLE5 36.0.0
SCREEN = ALLOWED TT
SR   TYPE      NSFI   NSR/ACT
IEC  005&&010  STOP   -----
IEC  012       STOP   -----
```

5. Backup the new changes using the `chg-db:action=backup:dest=fixed` command.

The following messages should appear, the active Maintenance and Administration Subsystem Processor (MASP) appears first.

```
BACKUP (FIXED) : MASP A - Backup starts on active MASP.
BACKUP (FIXED) : MASP A - Backup on active MASP to fixed disk complete.
BACKUP (FIXED) : MASP A - Backup starts on standby MASP.
BACKUP (FIXED) : MASP A - Backup on standby MASP to fixed disk complete.
```

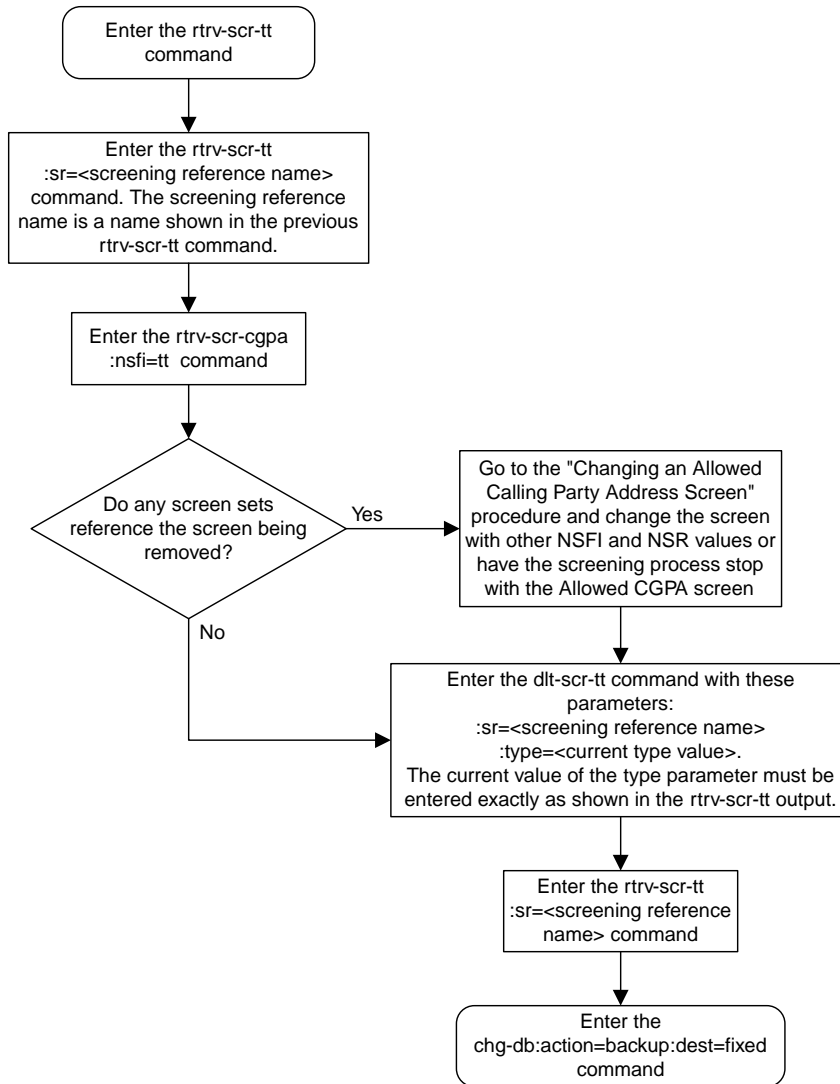

Figure 33: Removing an Allowed Translation Type Screen

## Changing an Allowed Translation Type Screen

This procedure is used to change the attributes of an allowed translation type (TT) screen in the database using the `chg-scr-tt` command. The parameters used by the `chg-scr-tt` command are shown in the [Gateway Screening Attributes](#) section. The general rules that apply to configuring gateway screening entities are shown in the [Gateway Screening Configuration](#) section.

The example in this procedure is used to change the translation type 016 for the allowed CGPA screen `iec` to 210 and change the NSFI to `stop`.

The allowed TT screen can only reference an allowed CDPA screen. This can be verified using the `rtrv-scr-cdpa:all=yes` command. If the desired allowed CDPA screen is not in the database, perform one of these procedures to add the required screen to the database or change an existing screen in the database.

- [Adding an Allowed Called Party Address Screen](#)
- [Changing an Allowed Called Party Address Screen](#)

### Specifying a Range of Values

A range of values can be specified for the `type` parameter. The range of values specified for the `type` parameter cannot include any values currently provisioned for the screen reference name.

For example, screening reference name `scr1` contains these entries:

SR	TYPE	NSFI	NSR/ACT
scr1	110	STOP	-----
scr1	125	STOP	-----

Another entry for screening reference `scr1` cannot contain a range of values that would include the `type` parameter values 110 or 125.

1. Display the allowed TT screens in the database using the `rtrv-scr-tt` command.

The following is an example of the possible output.

```
rlghncxa03w 06-10-25 15:26:30 GMT EAGLE5 36.0.0
SCREEN = ALLOWED TT
SR   REF  RULES
GW16 YES   1
IEC  YES   3
WRD2 YES   1
WRD4 YES   1
```

From the `rtrv-scr-tt` output, display the allowed TT screen you wish to remove using the `rtrv-scr-tt` command with the screening reference name. For this example, enter the `rtrv-scr-tt:sr=iec` command.

The following is an example of the possible output.

```
rlghncxa03w 06-10-25 15:26:30 GMT EAGLE5 36.0.0
SCREEN = ALLOWED TT
SR   TYPE  NSFI  NSR/ACT
```



```
IEC 005&&010 STOP -----
IEC 012 STOP -----
IEC 016 CDPA IEC
```

If a gateway screening stop action set is to be assigned to the allowed TT screen being added to the database, go to step 2.

Step 2 verifies the gateway screening stop action set names in the database. The gateway screening stop action set names are assigned only if the NSFI of the screen being changed in this procedure is STOP. If the NSFI of the screen will be changed to STOP, but a gateway screening stop action set name will not be assigned to the screen, skip steps 2 and 3 and go to step 4. If the NSFI of the screen will not be STOP, skip step 2 and go to step 3.

2. Display the gateway screening stop action sets in the database with the `rtrv-gws-actset` command.

This is an example of the possible output.

```
rlghncxa03w 06-10-25 15:26:30 GMT EAGLE5 36.0.0
ACT ACT ACT ACT ACT ACT ACT ACT ACT ACT ACT
ID NAME 1 2 3 4 5 6 7 8 9 10
--
1 copy copy
2 rdct rdct
3 cr copy rdct
4 cncf cncf
5 cpcncf copy cncf
6 cncfrd cncf rdct
7 cpcfrd copy cncf rdct

GWS action set table is (7 of 16) 44% full
```

If the required gateway screening stop action set is not in the database, perform the [Configuring Gateway Screening Stop Action Sets](#) procedure to configure the required gateway screening stop action set.

**Note:** If the NSFI of the screen being added in this procedure is STOP, skip step 3 and go to step 4.

3. Enter the `rtrv-scr-cdpa` command to verify that the screen that will be specified by the NSFI/NSR parameter combination in step 4 is in the database.

If the desired screen is not in the database, perform one of these procedures to add the desired screen to the database or change an existing screen in the database.

- [Adding an Allowed Called Party Address Screen](#)
- [Changing an Allowed Called Party Address Screen.](#)

4. Change the attributes of an allowed TT screen using the `chg-scr-tt` command.

If a gateway screening stop action is to be assigned to the allowed TT screen being changed, enter the `chg-scr-tt` command with the `nsfi=stop` parameter and the `actname` parameter with the name of a gateway screening stop action set shown in the output of the `rtrv-gws-actset` command executed in step 2.



**Caution:** TheEAGLE does not support redirectingMSUs for theDTA feature or interceptingISUPIAM messages for theCalling Name Conversion Facility feature from the allowedTT screen. Gateway screening stop action sets containing either theRDCT (redirect) orCNCNF (calling name conversion facility) stop actions should not be assigned to the allowedTT screen. If a gateway screening stop action set containing theRDCT orCNCNF stop actions is specified with thechg-scr-tt command, unsolicited information message (UIM) 1128 is generated when the attempt is made to redirectMSUs from the allowedTT screen. Unsolicited information message (UIM) 1218 is generated whenISUPIAMMSUs are intercepted from the allowedTT screen. For more information onUIMs 1128 and 1218, go to*Unsolicited Alarm and Information Messages Reference*.

The value of the ntype parameter can be from 0 to 255 or an asterisk (\*). The current value of the type parameter must be entered exactly as shown in the rtrv-scr-tt output in step 1.

A range of values can be specified for the ntype parameter. See the *“Specifying a Range of Values”* section for more information on how a range of values is used for the ntype parameter.

For this example, enter this command.

```
chg-scr-tt:sr=iec:type=016:ntype=210:nsfi=stop
```

A message similar to the following should appear.

```
rlghncxa03w 06-10-25 15:27:30 GMT EAGLE5 36.0.0
CHG-SCR-TT: SCREEN SET AFFECTED - IEC 4% FULL
CHG-SCR-TT: MASP A - COMPLTD
```

5. Verify the changes using the rtrv-scr-tt command with the screening reference name used in step 4.

For this example, enter this command.

```
rtrv-scr-tt:sr=iec
```

The following is an example of the possible output.

```
rlghncxa03w 06-10-25 15:26:30 GMT EAGLE5 36.0.0
SCREEN = ALLOWED TT
SR      TYPE      NSFI      NSR/ACT
IEC     005&&010    STOP      -----
IEC     012          STOP      -----
IEC     210          STOP      -----
```

6. Backup the new changes using the chg-db:action=backup:dest=fixed command.

The following messages should appear, the active Maintenance and Administration Subsystem Processor (MASP) appears first.

```
BACKUP (FIXED) : MASP A - Backup starts on active MASP.
BACKUP (FIXED) : MASP A - Backup on active MASP to fixed disk complete.
BACKUP (FIXED) : MASP A - Backup starts on standby MASP.
BACKUP (FIXED) : MASP A - Backup on standby MASP to fixed disk complete.
```

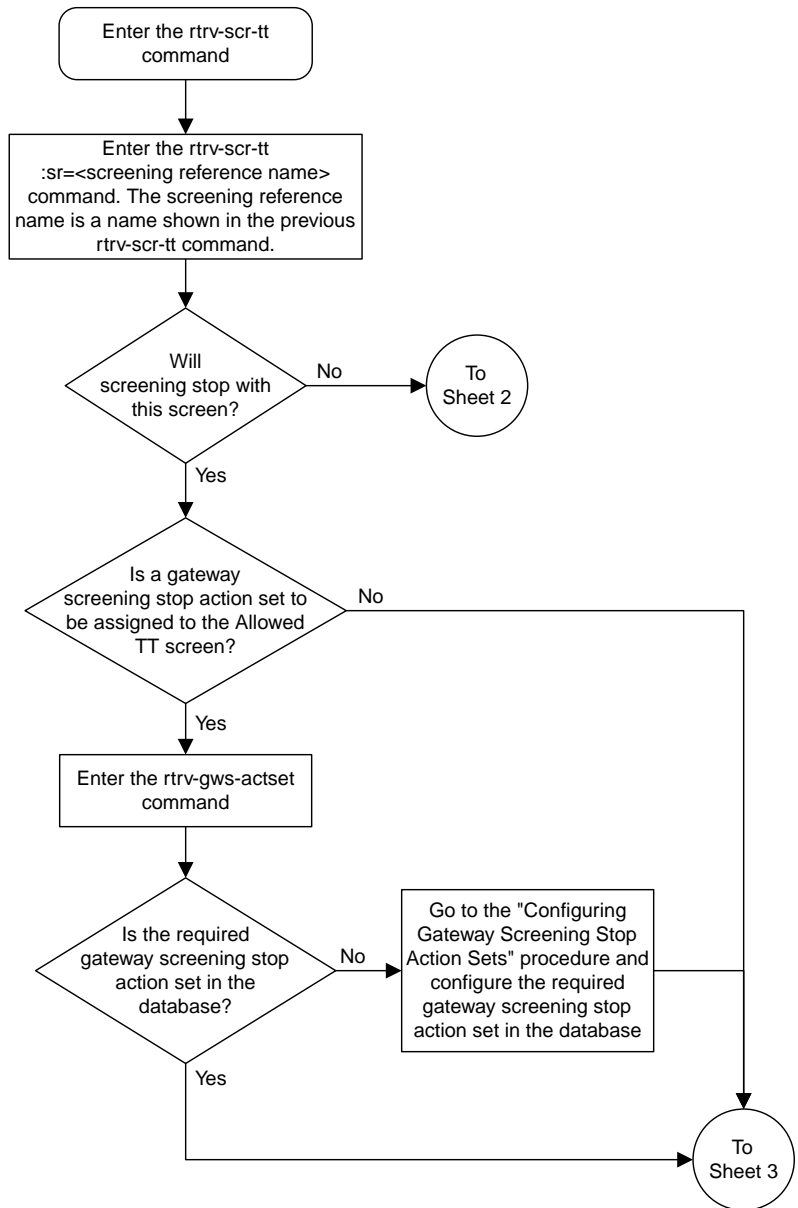

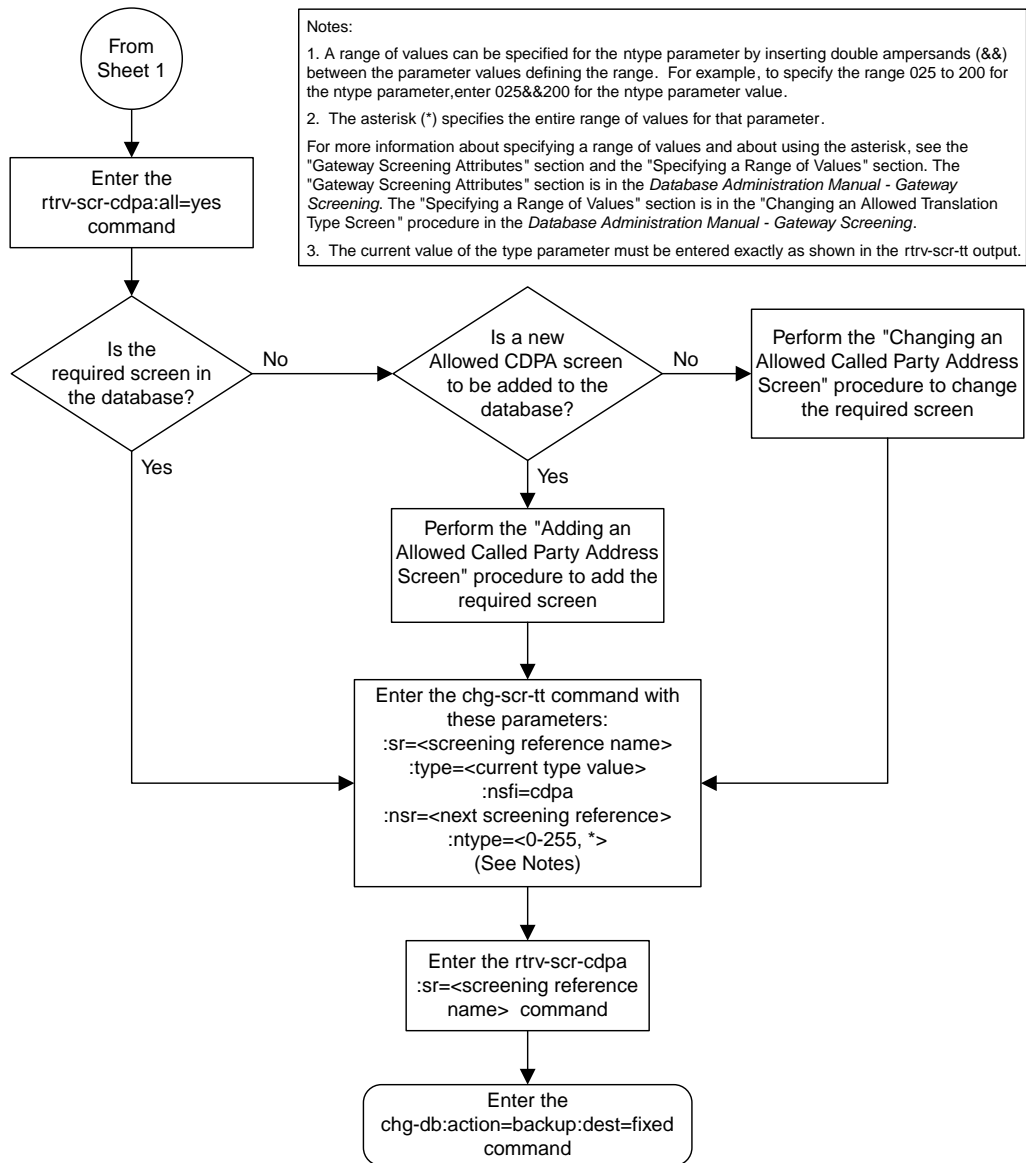

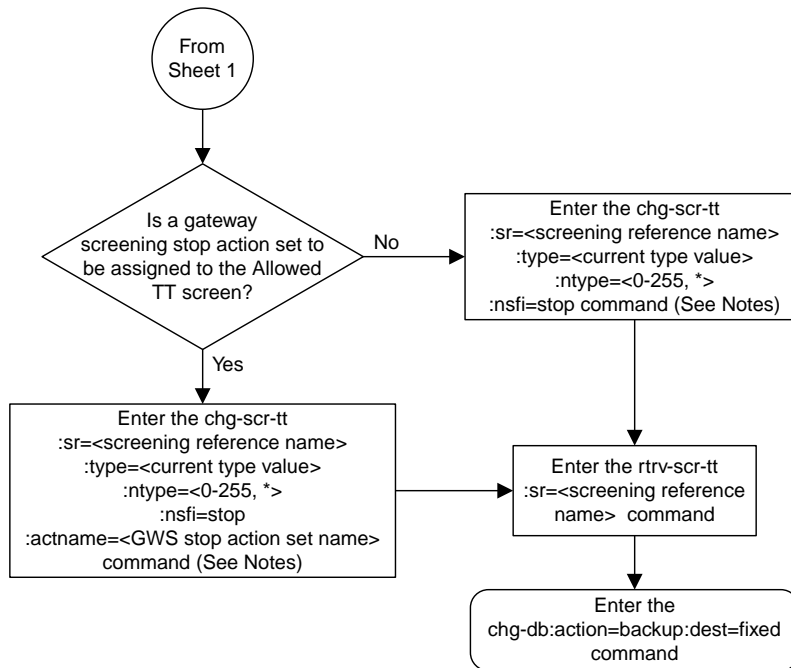

**Notes:**

1. A range of values can be specified for the *ntype* parameter by inserting double ampersands (&&) between the parameter values defining the range. For example, to specify the range 025 to 200 for the *ntype* parameter, enter 025&&200 for the *ntype* parameter value.
2. The asterisk (\*) specifies the entire range of values for that parameter.

For more information about specifying a range of values and about using the asterisk, see the "Gateway Screening Attributes" section and the "Specifying a Range of Values" section. The "Gateway Screening Attributes" section is in the *Database Administration Manual - Gateway Screening*. The "Specifying a Range of Values" section is in the "Changing an Allowed Translation Type Screen" procedure in the *Database Administration Manual - Gateway Screening*.

3. The current value of the *type* parameter must be entered exactly as shown in the *rtrv-scr-tt* output.

Sheet 3 of 3

**Figure 34: Changing an Allowed Translation Type Screen**

# Chapter 6

## Allowed Calling Party (CGPA) Screen Configuration

---

### Topics:

- *Introduction.....212*
- *Adding an Allowed Calling Party Address Screen.....218*
- *Removing an Allowed Calling Party Address Screen .....229*
- *Changing an Allowed Calling Party Address Screen.....234*

Chapter 6, Allowed Calling Party (CGPA) Screen Configuration, contains the procedures necessary to configure allowed calling party address screens.

## Introduction

The allowed calling party address (CGPA) screen is used to screen SCCP messages from another network. The gray shaded areas in [Figure 36: Allowed Calling Party Address Screening Function](#) shows the fields of the SS7 message that are checked by the CGPA screening function. The screening reference contains a list of point codes and subsystem number combinations.

## Gateway Screening Actions

If a match is not found, the message is discarded.

If a match is found, the `nsfi` is examined to determine the next step in the screening process. If the `nsfi` value is any value other than `stop`, the next screening reference (`nsr`) is identified and the screening process continues to the next screen identified by the `nsfi` and `nsr` parameter values.

If the `nsfi` is equal to `stop`, the screening process stops and the message is processed. If a gateway screening stop action set is specified with the screen, shown by the `actname` parameter value, the message is processed according to the gateway screening stop actions that are assigned to the gateway screening stop action set.

- If the `copy` gateway screening stop action is specified, the message is processed and a copy of the message is sent by the STPLAN feature to an external application.
- If the `rdct` (redirect) gateway screening stop action is specified, the message is diverted from the original destination and sent to another destination with the Database Transport Access feature, specified by global title translation, for further processing.
- If the `cncf` gateway screening stop action is specified, the PIP parameter in the incoming ISUP IAM message is converted to the GN parameter. The GN parameter in the incoming ISUP IAM message is converted to the PIP parameter. The message is then sent to the node specified by the DPC in the routing label in the message. For more information on the Calling Name Conversion Facility feature, see [Calling Name Conversion Facility \(CNCF\) Configuration](#).
- If the `tlnp` gateway screening stop action is specified, ISUP IAMs that pass gateway screening are processed either by the ISUP NP with EPAP feature (if the ISUP NP with EPAP feature is enabled and turned on) or by the Triggerless LNP feature (if the Triggerless LNP feature is turned on). The ISUP NP with EPAP feature is discussed in more detail in *G-Port User's Guide*. The Triggerless LNP feature is discussed in more detail in *ELAP Administration and LNP Feature Activation Guide*.
- If the `tinp` gateway screening stop action is specified, ISUP IAMs that pass gateway screening are intercepted by the Triggerless ISUP based Number Portability (TINP) feature and converted to include the routing number (RN) if the call is to a ported number. The TINP feature is discussed in more detail in *G-Port User's Guide*.
- If the `tif`, `tif2`, or `tif3` gateway screening stop actions are specified, TIF processing is applied to the message.
- If the `sccp` gateway screening stop action is specified, MTP routed SCCP UDT/XUDT are forwarded to the service modules for further processing.



## Allowed CGPA Screening Actions

Any MSU that does not contain a service indicator of 3 in the SIO field and does not contain the SCCP message types 9, 10, 17, or 18 and reaches this screen in the gateway screening process automatically passes gateway screening and is allowed into the EAGLE.

The value of the `nsfi` parameter is based on the value of the routing indicator (`ri`) parameter. [Table 32: Valid Parameter Combinations for the Allowed CGPA Screening Function](#) shows the valid combinations of `nsfi` values and routing indicator values.

**Table 32: Valid Parameter Combinations for the Allowed CGPA Screening Function**

Routing Indicator (RI) Values	Nest Screening Function Identifier (NSFI) Values
GT	TT
DPC	CDPA
* (asterisk)	TT, CDPA

[Figure 35: Allowed CGPA Screening Actions](#) shows the screening actions of the allowed CGPA screen.

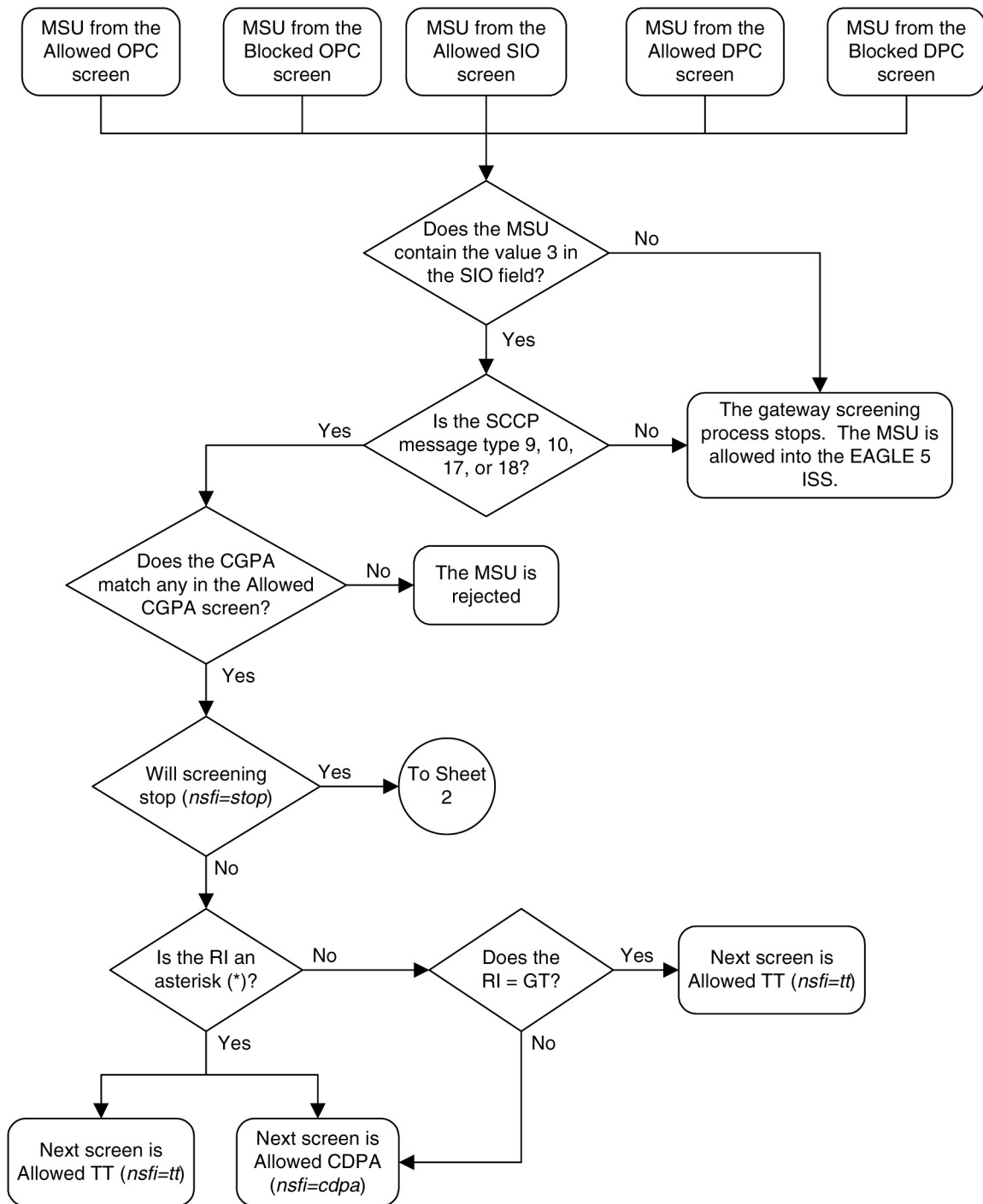

Sheet 1 of 3

Figure 35: Allowed CGPA Screening Actions

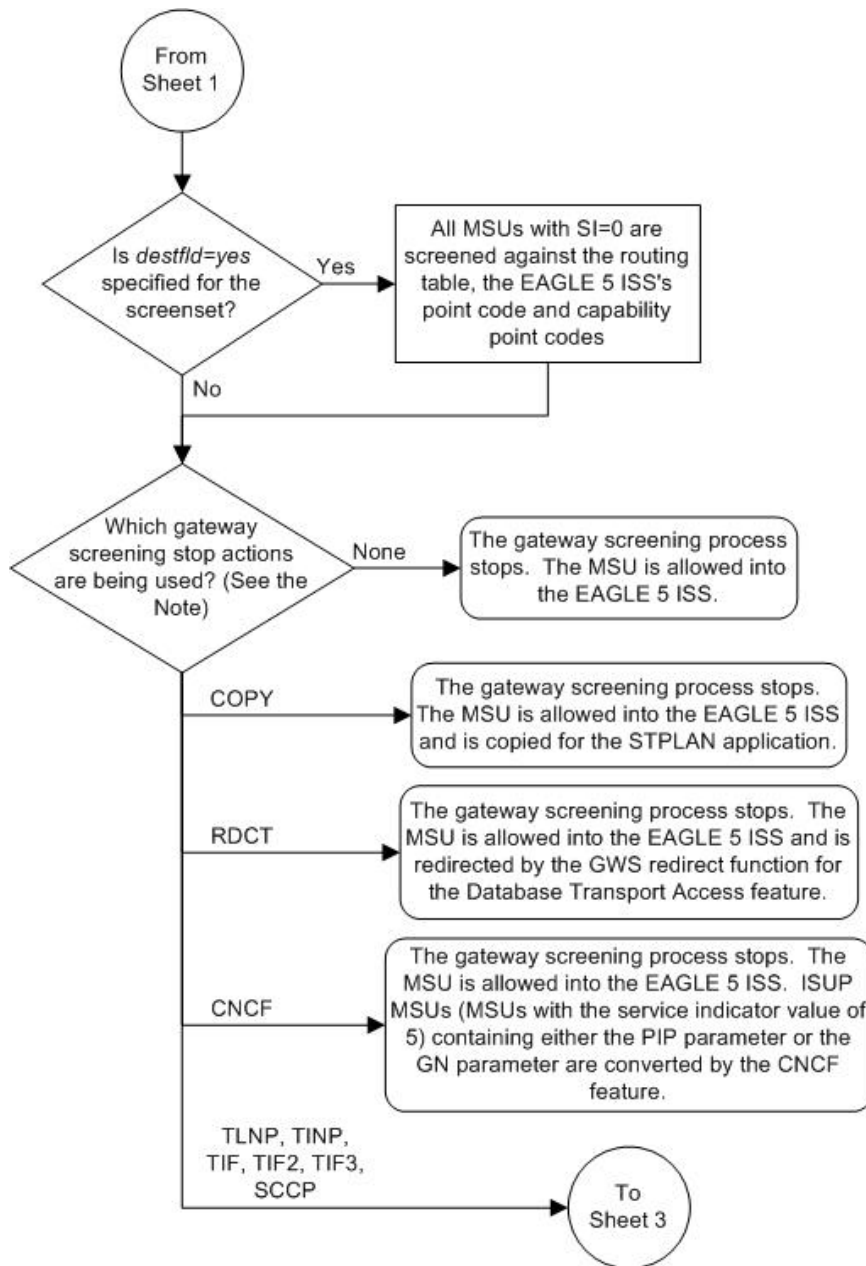

Note: Combinations of the gateway screening stop actions shown on Sheets 2 and 3 may be assigned to a gateway screening stop action set. Refer to the Configuring Gateway Screening Stop Action Sets and the Configuring TLNP Gateway Screening Stop Action Sets procedures in Chapter 2 of this manual for the combinations that can be used.

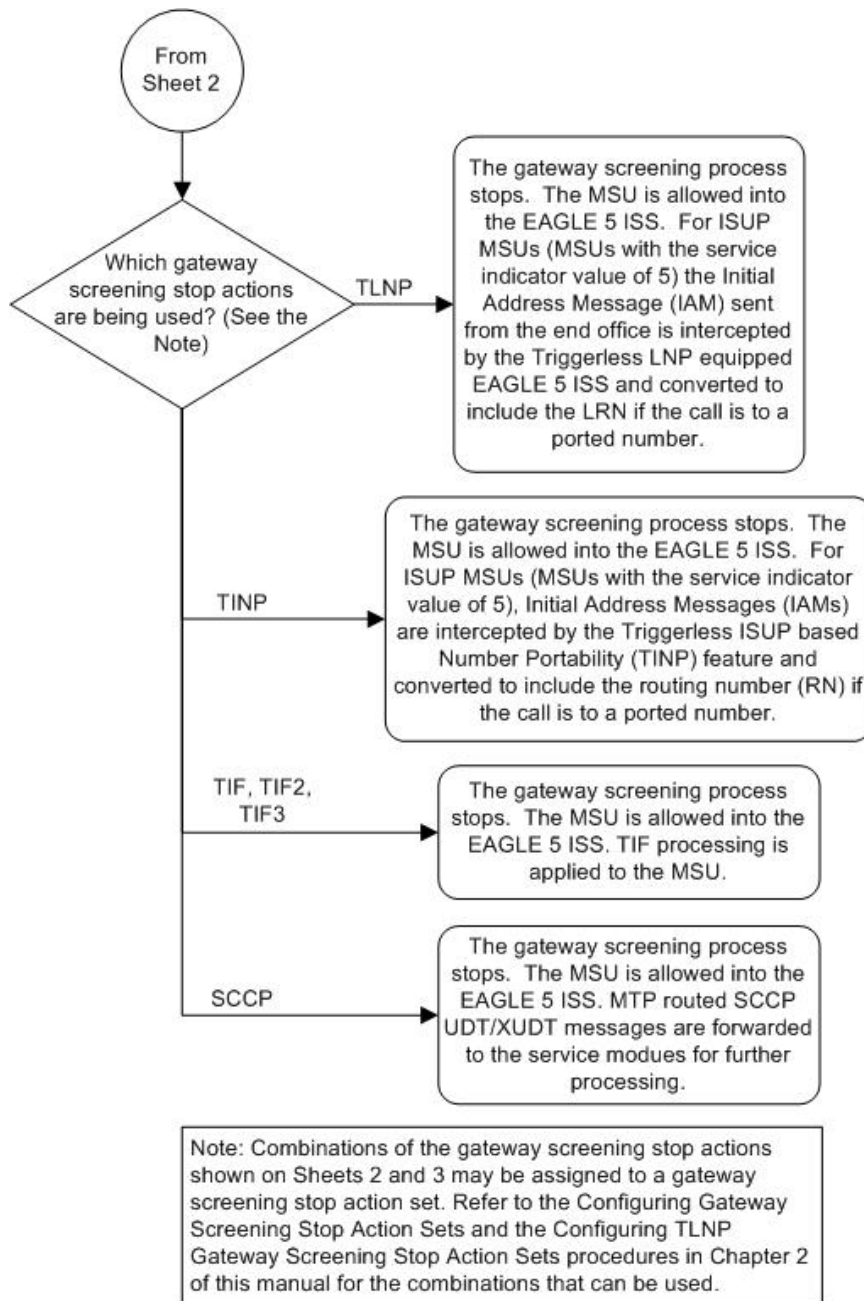

Sheet 3 of 3

ANSI MSU (ANSI Message Signal Unit)

BSN FSN LI	SIO xx xx xxxx NIC PRI SI	SIF					
		Routing Label DPC OPC SLS NCM NC NI NCM NC NI xx			SCCP Message Type xxxx xxxx	CGPA Length Address Indicator Subsystem Point Code (NCM NC NI)	CDPA Length Address Indicator (x x xxxx xx) (x RI xxxx xx) Subsystem Point Code (NCM NC NI)

ITU-I MSU (ITU International Message Signal Unit)

BSN FSN LI	SIO xx xx xxxx NIC PRI SI	SIF					
		Routing Label DPC OPC SLS ID AREA ZONE ID AREA ZONE xx			SCCP Message Type xxxx xxxx	CGPA Length Address Indicator Subsystem Point Code (ID AREA ZONE)	CDPA Length Address Indicator (x x xxxx xx) (x RI xxxx xx) Subsystem Point Code (ID AREA ZONE)

14-Bit ITU-N MSU (14-Bit ITU National Message Signal Unit)

BSN FSN LI	SIO xx xx xxxx NIC PRI SI	SIF					
		Routing Label DPC OPC SLS NPC NPC xx			SCCP Message Type xxxx xxxx	CGPA Length Address Indicator Subsystem Point Code (NPC)	CDPA Length Address Indicator (x x xxxx xx) (x RI xxxx xx) Subsystem Point Code (NPC)

24-Bit ITU-N MSU (24-Bit ITU National Message Signal Unit)

BSN FSN LI	SIO xx xx xxxx NIC PRI SI	SIF					
		Routing Label DPC OPC SLS SP SSA MSA SP SSA MSA xx			SCCP Message Type xxxx xxxx	CGPA Length Address Indicator Subsystem Point Code (SP SSA MSA)	CDPA Length Address Indicator (x x xxxx xx) (x RI xxxx xx) Subsystem Point Code (SP SSA MSA)

Figure 36: Allowed Calling Party Address Screening Function

## Adding an Allowed Calling Party Address Screen

This procedure is used to add an allowed calling party address (CGPA) screen to the database using the `ent-scr-cgpa` command. The parameters used by the `ent-scr-cgpa` command are shown in the [Gateway Screening Attributes](#) section. The general rules that apply to configuring gateway screening entities are shown in the [Gateway Screening Configuration](#) section.

The examples in this procedure are used to add the allowed CGPA screen data shown in [Table 33: Example Gateway Screening Allowed CGPA Configuration Table](#) and based on the example configurations shown in [Figure 4: Gateway Screening Configuration - Example 1](#) through [Figure 6: Gateway Screening Configuration - Example 3](#).

**Table 33: Example Gateway Screening Allowed CGPA Configuration Table**

Screening Reference	ZONE	AREA	ID	SSN	RI	SCCPMT	NSFI	NSR
gw11	7	100	4	254	*	010	cdpa	gw15
Screening Reference	NI	NC	NCM	SSN	RI	SCCPMT	NSFI	NSR
gw13	007	007	007	250	gt	017	tt	gw16
gw14	006	006	006	253	dpc	009	cdpa	gw17

**Note:** If you using multiple-part ITU national point codes with gateway screening, see the [14-Bit ITU National Point Code Formats](#) section.

The allowed CGPA screen can reference one of the following screens.

- Allowed TT
- Allowed CDPA

### Verifying the Gateway Screening Configuration

Enter the following commands to verify that these screens are in the database.

- `rtrv-scr-tt:all=yes`
- `rtrv-scr-cdpa:all=yes`

### Gateway Screening Configuration Procedures

If the desired screen is not in the database, perform one of the following procedures to add the desired screen to the database or change an existing screen in the database.

- [Adding an Allowed Translation Type Screen](#)
- [Adding an Allowed Called Party Address Screen](#)
- [Changing an Allowed Translation Type Screen](#)
- [Changing an Allowed Called Party Address Screen](#)

### Specifying a Range of Values

A range of values can be specified for the point code parameters `ni`, `nc`, or `ncm`.

If a range of values is specified for any of these parameters, and the value of the other parameters match existing values for the screening reference name, the range of values for the point code parameter cannot include any values for that parameter that are currently provisioned for the screening reference name.

For example, screening reference name `scr1` contains these entries:

SR	NI	NC	NCM	SSN	RI	SCCPMT	NSFI	NSR/ACT
SCR1	240	001	010	012	DPC	009	STOP	-----
SCR1	241	010	020	*	GT	017	TT	SCR1

Another entry for screening reference `scr1` with the `ni` value of 240 and the `nc` value of 001 cannot be specified if the range of values for the `ncm` parameter includes the value 010.

The ANSI point code parameter values can be specified as a single value, a range of values, or with an asterisk (\*). The asterisk specifies all possible values for the `ni`, `nc`, and `ncm` parameters. [Table 34: Valid Value Combinations for ANSI Point Code Parameters](#) shows the valid combinations of these parameter values.

**Table 34: Valid Value Combinations for ANSI Point Code Parameters**

NI	NC	NCM
Single Value	Single Value	Single Value
Single Value	Single Value	Range of Values
Single Value	Single Value	Asterisk
Single Value	Range of Values	Asterisk
Single Value	Asterisk	Asterisk
Range of Values	Asterisk	Asterisk
Asterisk	Asterisk	Asterisk

A range of values can also be specified for an ITU-I or 24-bit ITU-N point code parameter using a combination of asterisks (\*) and single values for the point code parameters. [Table 35: Valid Value Combinations for ITU-I Point Code Parameters](#) shows the valid combinations of the ITU-I parameter values. [Table 36: Valid Value Combinations for 24-Bit ITU-N Point Code Parameters](#) shows the valid combinations of the 24-bit ITU-N parameter values.

**Table 35: Valid Value Combinations for ITU-I Point Code Parameters**

ZONE	AREA	ID
Single Value	Single Value	Single Value
Single Value	Single Value	Asterisk
Single Value	Asterisk	Asterisk
Asterisk	Asterisk	Asterisk

Table 36: Valid Value Combinations for 24-Bit ITU-N Point Code Parameters

MSA	SSA	SP
Single Value	Single Value	Single Value
Single Value	Single Value	Asterisk
Single Value	Asterisk	Asterisk
Asterisk	Asterisk	Asterisk

1. Verify that the gateway screening feature is on, by entering the `rtrv-feat` command.

If the gateway screening feature is on, the `GWS` field is set to `on`.

**Note:** The `rtrv-feat` command output contains other fields that are not used by this procedure. If you wish to see all the fields displayed by the `rtrv-feat` command, see the `rtrv-feat` command description in *Commands User's Guide*.

If the gateway screening feature is on, shown by the entry `GWS = on` in the `rtrv-feat` command output, skip step 2, and go to step 3.

2. Turn the gateway screening feature on by entering this command.

```
chg-feat:gws=on
```

**Note:** Once the gateway screening feature is turned on with the `chg-feat` command, it cannot be turned off.

The gateway screening feature must be purchased before you turn this feature on with the `chg-feat` command. If you are not sure if you have purchased the gateway screening feature, contact your Oracle Sales Representative or Account Representative.

When the `chg-feat` has successfully completed, this message should appear.

```
rlghncxa03w 06-10-28 11:43:04 GMT EAGLE5 36.0.0
CHG-FEAT: MASP A - COMPLTD
```

3. Display all allowed CGPA screens in the database using the `rtrv-scr-cgpa` command.

The following is an example of the possible output.

```
rlghncxa03w 06-10-25 15:25:30 GMT EAGLE5 36.0.0
SCREEN = ALLOWED CGPA
SR    REF  RULES
IEC   YES   2
WRD2  YES   1
WRD4  YES   9
```

If the screening reference names that you wish to add with this procedure are not shown in the `rtrv-scr-cgpa` command output, go to step 2. For this example, the screening reference names are not shown. If these screening reference names are shown in the `rtrv-scr-cgpa` command output, make sure the screening data you wish to enter is not already in the database by entering



the `rtrv-scr-cgpa` command with the screening reference name. For example, enter the `rtrv-scr-cgpa:sr=iec` command. The following is an example of the possible output.

```
rlghncxa03w 06-10-25 15:26:30 GMT EAGLE5 36.0.0
SCREEN = ALLOWED CGPA
SR   NI      NC      NCM      SSN      RI      SCCPMT  NSFI     NSR/ACT
IEC  240     001     010     012     DPC    009     STOP     -----
IEC  241     010     *       *       *      GT     017     TT       TT1
```

If a gateway screening stop action set is to be assigned to the allowed CGPA screen being added to the database, go to step 4.

Step 4 verifies the gateway screening stop action set names in the database. The gateway screening stop action set names are assigned only if the NSFI of the screen being added in this procedure is STOP. If the NSFI of the new screen will be STOP, but a gateway screening stop action set name will not be assigned to the new screen, skip steps 4 and 5 and go to step 6. If the NSFI of the new screen is not STOP, skip step 4 and go to step 5.

4. Display the gateway screening stop action sets in the database with the `rtrv-gws-actset` command.

This is an example of the possible output.

```
rlghncxa03w 06-10-25 15:27:30 GMT EAGLE5 36.0.0
ACT  ACT      ACT  ACT  ACT  ACT  ACT  ACT  ACT  ACT  ACT  ACT
ID   NAME     1    2    3    4    5    6    7    8    9    10
--   -
1    copy     copy
2    rdct     rdct
3    cr       copy rdct
4    cncf     cncf
5    cpcncf   copy cncf
6    cncfrd   cncf rdct
7    cpcfrd   copy cncf rdct
```

GWS action set table is (7 of 16) 44% full

If the required gateway screening stop action set is not in the database, perform the [Configuring Gateway Screening Stop Action Sets](#) procedure to configure the required gateway screening stop action set.

**Note:** If the NSFI of the screen being added in this procedure is STOP, skip step 5 and go to step 6.

5. Enter the commands in the [Verifying the Gateway Screening Configuration](#) section to verify that the screen that will be specified by the NSFI/NSR parameter combination in step 7 is in the database.

If the desired screen is not in the database, perform one of the procedures shown in the [Gateway Screening Configuration Procedures](#) section to add the desired screen to the database or change an existing screen in the database.

**Note:** If the point code being added in this procedure is not an ITU-I or 14-bit ITU-N spare point code, skip step 6 and go to step 7.

**Note:** If the point code being added in this procedure is an ITU-I or 14-bit ITU-N spare point code and the screening reference contains ITU-I or 14-bit ITU-N spare point codes, skip step 6 and go to step 7.

6. Display the status of the ITU National and International Spare Point Code Support feature by entering the `rtrv-ctrl-feat` command with the ITU National and International Spare Point Code Support feature part number.

Enter this command.

```
rtrv-ctrl-feat:partnum=893013601
```

This is an example of the possible output.

```
rlghncxa03w 06-10-25 15:25:30 GMT EAGLE5 36.0.0
The following features have been permanently enabled:

Feature Name          Partnum   Status Quantity
Spare Point Code Support 893013601 on      ----

The following features have been temporarily enabled:

Feature Name          Partnum   Status Quantity   Trial Period Left
Zero entries found.

The following features have expired temporary keys:

Feature Name          Partnum
Zero entries found.
```

If the ITU National and International Spare Point Code Support feature is enabled, go to step 7.

If the ITU National and International Spare Point Code Support feature is not enabled, perform the “Activating the ITU National and International Spare Point Code Support Feature” procedure in *Database Administration - SS7 User’s Guide* to enable the ITU National and International Spare Point Code Support feature as required. After the feature has been enabled, go to step 7.

7. Add a new allowed CGPA screen to the database using the `ent-scr-cgpa` command.

If a gateway screening stop action is to be assigned to the allowed CGPA screen being changed, enter the `ent-scr-cgpa` command with the `nsfi=stop` parameter and the `actname` parameter with the name of a gateway screening stop action set shown in the output of the `rtrv-gws-actset` command executed in step 4.



**CAUTION**

**Caution:** TheEAGLE does not support redirectingMSUs for theDTA feature or intercepting ISUPIAM messages for theCalling Name Conversion Facility feature from the allowedCGPA screen. Gateway screening stop action sets containing either theRDCT (redirect) orCNCF (calling name conversion facility) stop actions should not be assigned to the allowedCGPA screen. If a gateway screening stop action set containing theRDCT orCNCF stop actions is specified with the`ent-scr-cgpa` command, unsolicited information message (UIM) 1126 is generated when the attempt is made to redirectMSUs from the allowedCGPA screen. Unsolicited information message (UIM) 1216 is generated whenISUP IAM MSUs are intercepted from the allowedCGPA screen. For more information onUIMs 1126 and 1216, go to*Unsolicited Alarm and Information Messages Reference*.

The following list contains the values for `ni`, `nc`, `ncm`, `zone`, `area`, `id`, `npc`, `msa`, `ssa`, `sp`, `ssn`, `ri`, and `scpmt` parameters:

- `ni` – 0 - 255 or an asterisk (\*)
- `nc` – 0 - 255 or an asterisk (\*)

- ncm – 0 - 255 or an asterisk (\*)
- zone – 0 - 7 or an asterisk (\*)
- area – 0 - 255 or an asterisk (\*)
- id – 0 - 7 or an asterisk (\*)
- npc – 1 - 16383 or an asterisk (\*)
- msa – 0 - 255 or an asterisk (\*)
- ssa – 0 - 255 or an asterisk (\*)
- sp – 0 - 255 or an asterisk (\*)
- ssn – 0 - 255 or an asterisk (\*)
- ri – gt, dpc or an asterisk (\*)
- sccpmt – 9, 10, 17, 18 or an asterisk (\*)

**Note:** If either the `ri=gt` or `nsfi=tt` parameter is specified, the other parameter must be specified. If either the `ri=dpc` or `nsfi=cdpa` parameter is specified, the other parameter must be specified. If the `ri=*` parameter is specified, either the `nsfi=gt` or `nsfi=dpc` parameters can be specified.

**Note:** If the `sccpmt` parameter is not specified, an asterisk will be entered as the value of the `sccpmt` parameter.

A range of values can be specified for the `ni`, `nc`, and `ncm` parameters. See the [“Specifying a Range of Values”](#) section for more information on how the asterisk and a range of values are used for the `ni`, `nc`, and `ncm` parameters.

To add a spare point code to the allowed CGPA screen, the `pcst=s` parameter must be specified. To add a non-spare point code to the allowed CGPA screen, the `pcst` parameter does not have to be specified. If the `pcst` parameter is specified for a screen containing an ITU-I or 14-bit ITU-N non-spare point code, the value must be `none`.

For this example, enter these commands.

```
ent-scr-cgpa:sr=gw11:zone=7:area=100:id=4:ssn=254:ri=*
:sccpmt=010:nsfi=cdpa:nsr=gw15
```

A message similar to the following should appear.

```
rlghncxa03w 06-10-25 15:28:30 GMT EAGLE5 36.0.0
ENT-SCR-CGPA: SCREEN SET AFFECTED - GW11 1% FULL
ENT-SCR-CGPA: MASP A - COMPLTD
```

```
ent-scr-cgpa:sr=gw13:ni=007:nc=007:ncm=007:ssn=250:ri=gt
:sccpmt=017:nsfi=tt:nsr=gw16
```

A message similar to the following should appear.

```
rlghncxa03w 06-10-25 15:29:30 GMT EAGLE5 36.0.0
ENT-SCR-CGPA: SCREEN SET AFFECTED - GW13 1% FULL
ENT-SCR-CGPA: MASP A - COMPLTD
```

```
ent-scr-cgpa:sr=gw14:ni=006:nc=006:ncm=006:ssn=253:ri=dpc
:sccpmt=009:nsfi=cdpa:nsr=gw17
```

A message similar to the following should appear.

```
rlghncxa03w 06-10-25 15:30:30 GMT EAGLE5 36.0.0
ENT-SCR-CGPA: SCREEN SET AFFECTED - GW14 1% FULL
ENT-SCR-CGPA: MASP A - COMPLTD
```

- Verify the changes using the `rtrv-scr-cgpa` command with the screening reference name used in step 7.

For this example, enter these commands.

```
rtrv-scr-cgpa:sr=gw11
```

The following is an example of the possible output.

```
rlghncxa03w 06-10-25 15:32:30 GMT EAGLE5 36.0.0
SCREEN = ALLOWED CGPA
SR      ZONE  AREA  ID      SSN      RI  SCCPMT  NSF1  NSR/ACT
GW11    7      100   4       254     *   010    CDPA  GW15
```

```
rtrv-scr-cgpa:sr=gw13
```

The following is an example of the possible output.

```
rlghncxa03w 06-10-25 15:33:30 GMT EAGLE5 36.0.0
SCREEN = ALLOWED CGPA
SR  NI  NC  NCM  SSN  RI  SCCPMT  NSF1  NSR/ACT
GW13 007 007 007 250  SSN 017  CDPA  GW16
```

```
rtrv-scr-cgpa:sr=gw14
```

The following is an example of the possible output.

```
rlghncxa03w 06-10-25 15:34:30 GMT EAGLE5 36.0.0
SCREEN = ALLOWED CGPA
SR  NI  NC  NCM  SSN  RI  SCCPMT  NSF1  NSR/ACT
GW14 006 006 006 253  GT  009  TT  GW17
```

- Backup the new changes using the `chg-db:action=backup:dest=fixed` command.

The following messages should appear, the active Maintenance and Administration Subsystem Processor (MASP) appears first.

```
BACKUP (FIXED) : MASP A - Backup starts on active MASP.
BACKUP (FIXED) : MASP A - Backup on active MASP to fixed disk complete.
BACKUP (FIXED) : MASP A - Backup starts on standby MASP.
BACKUP (FIXED) : MASP A - Backup on standby MASP to fixed disk complete.
```

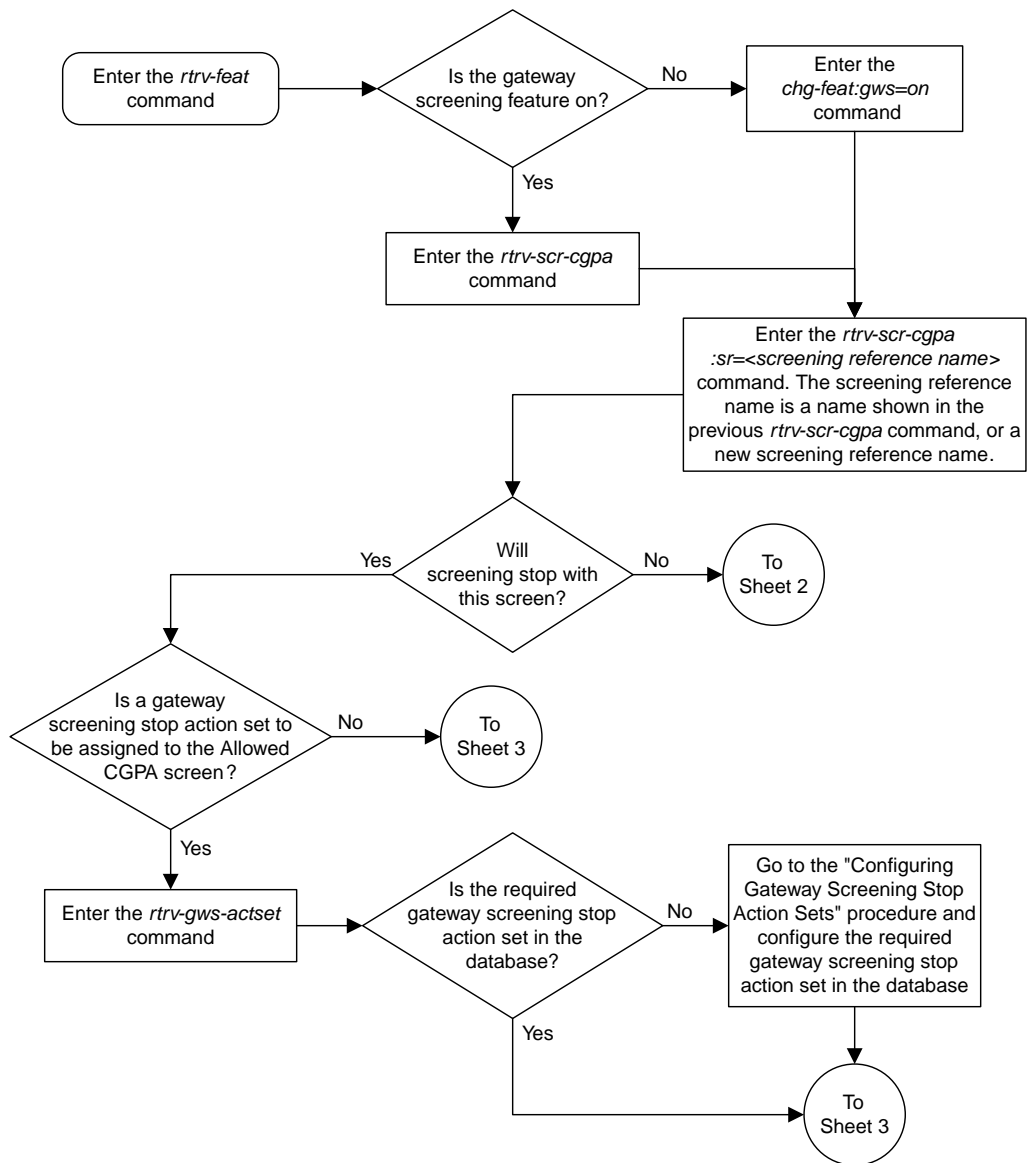

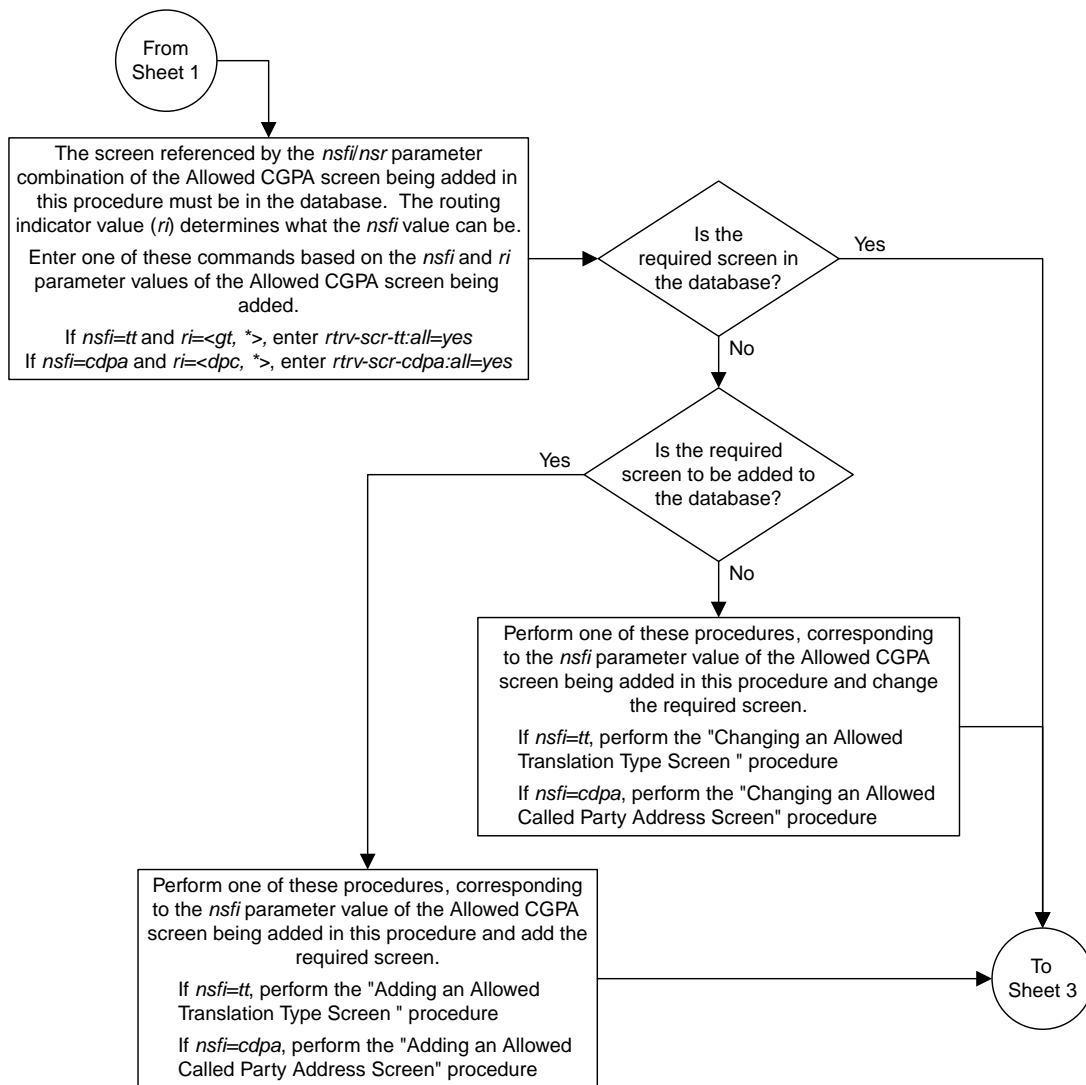

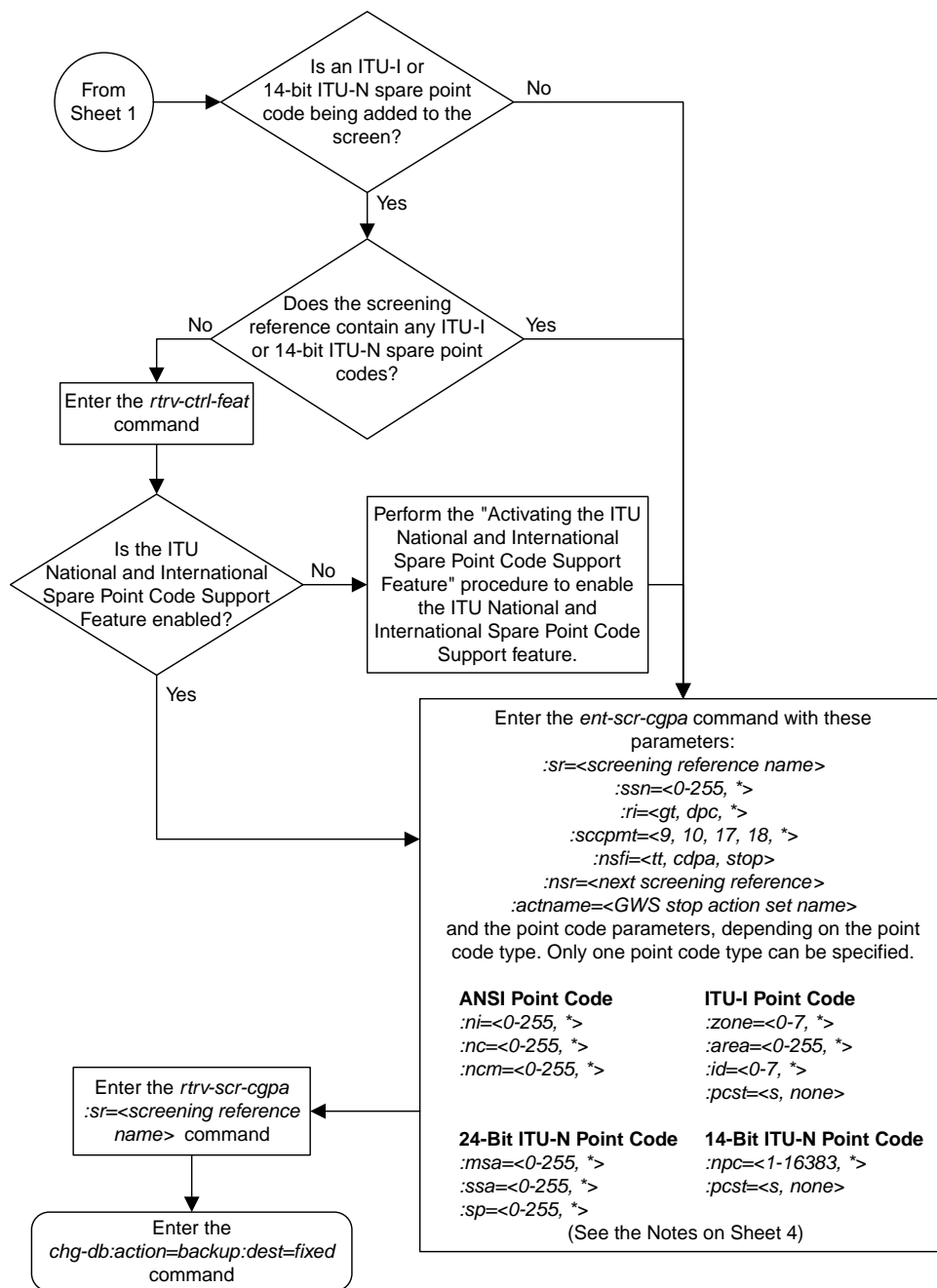

**Notes:**

1. A range of values can be specified for the *ni*, *nc*, or *ncm* parameters by inserting double ampersands (&&) between the parameter values defining the range. For example, to specify the range 025 to 200 for the *ni* parameter, enter 025&&200 for the *ni* parameter value.

2. The asterisk (\*) specifies the entire range of values for that parameter.

For more information about specifying a range of values and about using the asterisk, see the "Gateway Screening Attributes" section and the "Specifying a Range of Values" section. The "Gateway Screening Attributes" section is in the *Database Administration Manual - Gateway Screening*. The "Specifying a Range of Values" section is in the "Adding an Allowed Calling Party Address Screen" procedure in the *Database Administration Manual - Gateway Screening*.

3. If the *sccpmt* parameter is not specified, an asterisk will be entered as the value for the *sccpmt* parameter.

4. To specify the *nsfi=tt* parameter, the *ri* parameter value must be *gt* or \*.

5. To specify the *nsfi=cdpa* parameter, the *ri* parameter value must be *dpc* or \*.

6. The *nsr* parameter can be specified only, and must be specified, if the *nsfi=tt* or *nsfi=cdpa* parameters are specified.

7. The *actname* parameter can be specified only if the *nsfi=stop* parameter is specified. The *actname* parameter is optional. If the *actname* parameter is specified, the *actname* parameter value is one of the gateway screening stop action set names shown in the *rtv-gws-actset* output on Sheet 1.

8. To add a non-spare point code, the *pcst* parameter does not have to be specified. If the *pcst* parameter is specified for a screen containing an ITU-I or 14-bit ITU-N non-spare point code, the value must be *none*.

9. To add a spare point code, the *pcst=s* parameter must be specified.



Sheet 4 of 4

**Figure 37: Adding an Allowed Calling Party Address Screen**

## Removing an Allowed Calling Party Address Screen

This procedure is used to remove an allowed calling party address (CGPA) screen from the database using the `dlt-scr-cgpa` command. The parameters used by the `dlt-scr-cgpa` command are shown in the [Gateway Screening Attributes](#) section. The general rules that apply to configuring gateway screening entities are shown in the [Gateway Screening Configuration](#) section.

The example in this procedure removes the allowed CGPA screen `gw14` from the database.

**Note:** If you are using multiple-part ITU national point codes with gateway screening, see the [14-Bit ITU National Point Code Formats](#) section.

The allowed CGPA screen can be referenced by one of the following screens.

- Allowed OPC
- Blocked OPC
- Allowed SIO
- Allowed DPC
- Blocked DPC

### Verifying the Gateway Screening Configuration

Enter the following commands to verify that none of these screens reference the allowed CGPA screen being removed from the database.

- `rtrv-scr-opc:nsfi=cgpa`
- `rtrv-scr-blkopc:nsfi=cgpa`
- `rtrv-scr-sio:nsfi=cgpa`
- `rtrv-scr-dpc:nsfi=cgpa`
- `rtrv-scr-blkdpc:nsfi=cgpa`

### Gateway Screening Configuration Procedures

To change the NSFI of any of these screens, perform one of these procedures.

- [Changing a Blocked DPC Screen](#)
- [Changing an Allowed DPC Screen](#)
- [Changing an Allowed SIO Screen](#)
- [Changing a Blocked OPC Screen](#)
- [Changing an Allowed OPC Screen](#)

1. Display the allowed CGPA screens in the database using the `rtrv-scr-cgpa` command.

The following is an example of the possible output.

```
rlghncxa03w 06-10-25 15:25:30 GMT EAGLE5 36.0.0
SCREEN = ALLOWED CGPA
SR      REF  RULES
GW11   YES   1
```

```
GW13  YES    1
GW14  YES    1
IEC   YES    2
WRD2  YES    1
WRD4  YES    9
```

From the `rtrv-scr-cgpa` output, display the allowed CGPA screen you wish to remove using the `rtrv-scr-cgpa` command with the screening reference name. For this example, enter the `rtrv-scr-cgpa:sr=gw14` command. The following is an example of the possible output.

```
rtrv-scr-cgpa:sr=gw14
```

The following is an example of the possible output.

```
rlghncxa03w 06-10-25 15:25:30 GMT  EAGLE5 36.0.0
SCREEN = ALLOWED CGPA
SR   NI      NC      NCM      SSN      RI      SCCPMT  NSF1  NSR/ACT
GW14 003      003      003      253      GT      009     TT   GW17
```

2. Enter the commands in the [Verifying the Gateway Screening Configuration](#) section to verify that the screen being removed is not referenced by other screens in the database.

If the screen being removed is referenced by other screens, perform the procedures shown in the [Gateway Screening Configuration Procedures](#) section to change the NSF1 of those screens to reference other screens or change the NSF1 of these screens to STOP.

3. Remove the allowed CGPA screen from the database using the `dlt-scr-cgpa` command.

The current values for the `ni`, `nc`, `ncm`, `zone`, `area`, `id`, `npc`, `msa`, `ssa`, `sp`, `ri`, `ssn`, or `sccpmt` parameters must be entered exactly as shown in the `rtrv-scr-cgpa` output.

To remove an entry containing either an ITU-I or a 14-bit ITU-N spare point code, the `pcst=s` parameter must be specified with the `dlt-scr-cgpa` command.

To remove an entry containing either an ITU-I or a 14-bit ITU-N non-spare point code, the `pcst` parameter does not have to be specified with the `dlt-scr-cgpa` command. If the `pcst` parameter is specified, the value must be `none`.

For this example, enter this command.

```
dlt-scr-cgpa:sr=gw14:ni=003:nc=003:ncm=003:ssn=253:sccpmt=009
```

A message similar to the following should appear.

```
rlghncxa03w 06-10-25 15:26:30 GMT  EAGLE5 36.0.0
DLT-SCR-CGPA: SCREEN SET AFFECTED - GW14  0% FULL
DLT-SCR-CGPA: MASP A - COMPLTD
```

4. Verify the changes using the `rtrv-scr-cgpa` command with the screening reference name used in step 3.

For this example, enter this command.

```
rtrv-scr-cgpa:sr=gw14
```

The following is an example of the possible output.

```
E2573 Cmd Rej: SR or NSR does not reference an existing SR
```

This message shows that the specified screening reference name is not in the database and the action of the `dlt-scr-cgpa` command in step 3 was successful. If the specified screening reference name contained more than one entry when the `dlt-scr-cgpa` command was executed in step 3, the `rtrv-scr-cgpa:sr=` command output would show the remaining entries in the screening reference instead of error message E2573.

5. Backup the new changes using the `chg-db:action=backup:dest=fixed` command.

The following messages should appear, the active Maintenance and Administration Subsystem Processor (MASP) appears first.

```
BACKUP (FIXED) : MASP A - Backup starts on active MASP.  
BACKUP (FIXED) : MASP A - Backup on active MASP to fixed disk complete.  
BACKUP (FIXED) : MASP A - Backup starts on standby MASP.  
BACKUP (FIXED) : MASP A - Backup on standby MASP to fixed disk complete.
```

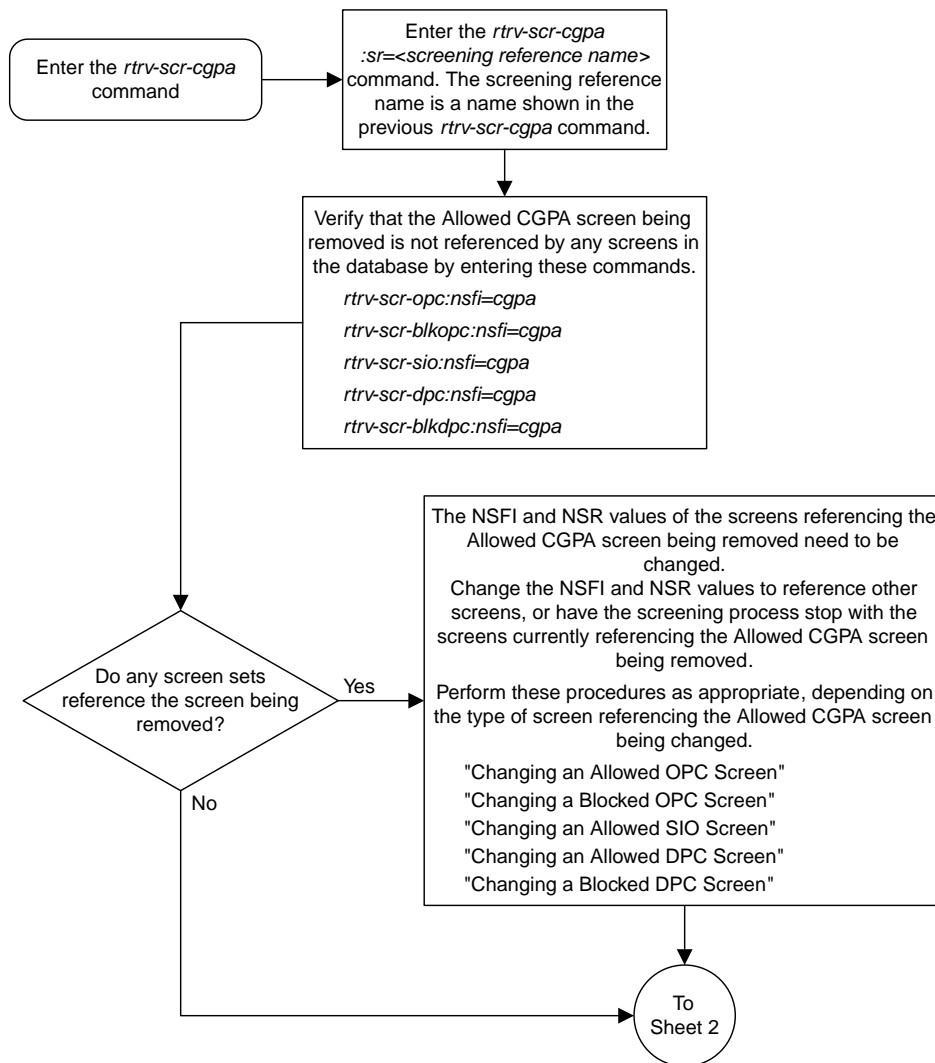

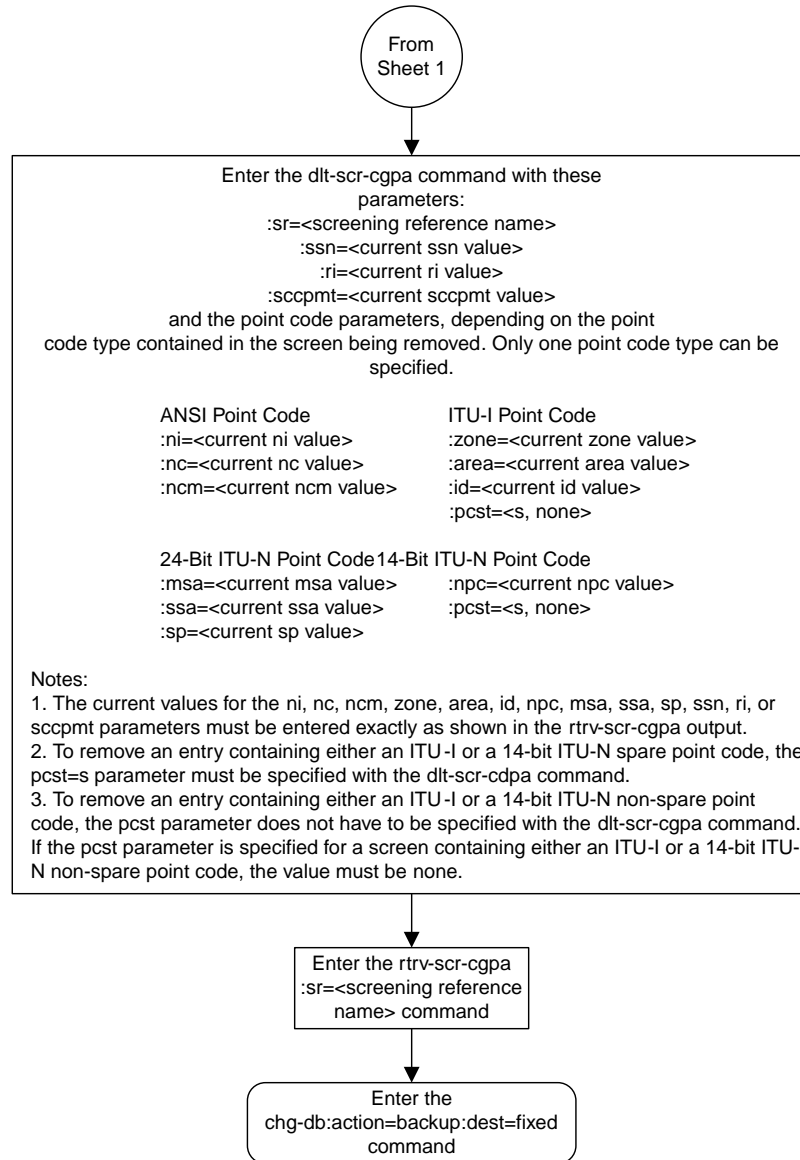

Sheet 2 of 2

**Figure 38: Removing an Allowed Calling Party Address Screen**

## Changing an Allowed Calling Party Address Screen

This procedure is used to change the attributes of an allowed calling party address (CGPA) screen in the database using the `chg-scr-cgpa` command. The parameters used by the `chg-scr-cgpa` command are shown in the [Gateway Screening Attributes](#) section. The general rules that apply to configuring gateway screening entities are shown in the [Gateway Screening Configuration](#) section.

The example in this procedure is used to change the point code 003-003-003 for the allowed CGPA screen `gw14` to 230-230-230 and change the subsystem number from 253 to 150.

**Note:** If you are using multiple-part ITU national point codes with gateway screening, see the [14-Bit ITU National Point Code Formats](#) section.

The allowed CGPA screen can reference one of the following screens.

- Allowed TT
- Allowed CDPA

### Verifying the Gateway Screening Configuration

Enter the following commands to verify that these screens are in the database.

- `rtrv-scr-tt:all=yes`
- `rtrv-scr-cdpa:all=yes`

### Gateway Screening Configuration Procedures

If the desired screen is not in the database, perform one of these procedures to add the desired screen to the database or change an existing screen in the database.

- [Adding an Allowed Translation Type Screen](#)
- [Adding an Allowed Called Party Address Screen](#)
- [Changing an Allowed Translation Type Screen](#)
- [Changing an Allowed Called Party Address Screen](#)

### Specifying a Range of Values

A range of values can be specified for the point code parameters `ni`, `nc`, or `ncm`.

If a range of values is specified for any of these parameters, and the value of the other parameters match existing values for the screening reference name, the range of values for the point code parameter cannot include any values for that parameter that are currently provisioned for the screening reference name.

For example, screening reference name `scr1` contains these entries:

SR	NI	NC	NCM	SSN	RI	SCCPMT	NSFI	NSR/ACT
SCR1	240	001	010	012	DPC	009	STOP	-----
SCR1	241	010	020	*	GT	017	TT	SCR1

Another entry for screening reference `scr1` with the `ni` value of 240 and the `nc` value of 001 cannot be specified if the range of values for the `ncm` parameter includes the value 010.

The ANSI point code parameter values can be specified as a single value, a range of values, or with an asterisk (\*). The asterisk specifies all possible values for the `ni`, `nc`, and `ncm` parameters. [Table 37: Valid Value Combinations for ANSI Point Code Parameters](#) shows the valid combinations of these parameter values.

**Table 37: Valid Value Combinations for ANSI Point Code Parameters**

NI	NC	NCM
Single Value	Single Value	Single Value
Single Value	Single Value	Range of Values
Single Value	Single Value	Asterisk
Single Value	Range of Values	Asterisk
Single Value	Asterisk	Asterisk
Range of Values	Asterisk	Asterisk
Asterisk	Asterisk	Asterisk

A range of values can also be specified for an ITU-I or 24-bit ITU-N point code parameter using a combination of asterisks (\*) and single values for the point code parameters. [Table 38: Valid Value Combinations for ITU-I Point Code Parameters](#) shows the valid combinations of the ITU-I parameter values. [Table 39: Valid Value Combinations for 24-Bit ITU-N Point Code Parameters](#) shows the valid combinations of the 24-bit ITU-N parameter values.

**Table 38: Valid Value Combinations for ITU-I Point Code Parameters**

ZONE	AREA	ID
Single Value	Single Value	Single Value
Single Value	Single Value	Asterisk
Single Value	Asterisk	Asterisk
Asterisk	Asterisk	Asterisk

**Table 39: Valid Value Combinations for 24-Bit ITU-N Point Code Parameters**

MSA	SSA	SP
Single Value	Single Value	Single Value
Single Value	Single Value	Asterisk
Single Value	Asterisk	Asterisk

MSA	SSA	SP
Asterisk	Asterisk	Asterisk

1. Display the allowed CGPA screens in the database using the `rtrv-scr-cgpa` command.

The following is an example of the possible output.

```
rlghncxa03w 06-10-25 15:25:30 GMT EAGLE5 36.0.0
SCREEN = ALLOWED CGPA
SR   REF  RULES
GW11 YES    1
GW13 YES    1
GW14 YES    1
IEC  YES    2
WRD2 YES    1
WRD4 YES    9
```

From the `rtrv-scr-cgpa` output, display the allowed CGPA screen you wish to change using the `rtrv-scr-cgpa` command with the screening reference name. For this example, enter this command.

```
rtrv-scr-cgpa:sr=gw14
```

The following is an example of the possible output.

```
rlghncxa03w 06-10-25 15:25:30 GMT EAGLE5 36.0.0
SCREEN = ALLOWED CGPA
SR  NI      NC      NCM      SSN      RI      SCCPMT  NSFI      NSR/ACT
GW14 003      003      003      253      GT      009      TT        GW17
```

If a gateway screening stop action set is to be assigned to the allowed CGPA screen being added to the database, go to step 2.

Step 2 verifies the gateway screening stop action set names in the database. The gateway screening stop action set names are assigned only if the NSFI of the screen being changed in this procedure is STOP. If the NSFI of the screen will be changed to STOP, but a gateway screening stop action set name will not be assigned to the screen, skip steps 2 and 3 and go to step 4. If the NSFI of the screen will not be STOP, skip step 2 and go to step 3.

2. Display the gateway screening stop action sets in the database with the `rtrv-gws-actset` command.

This is an example of the possible output.

```
rlghncxa03w 06-10-25 15:26:30 GMT EAGLE5 36.0.0
ACT  ACT    ACT  ACT  ACT  ACT  ACT  ACT  ACT  ACT  ACT  ACT
ID   NAME    1    2    3    4    5    6    7    8    9    10
--   -
1    copy    copy
2    rdct    rdct
3    cr      copy rdct
4    cncf    cncf
5    cpncf   copy cncf
6    cncfrd  cncf rdct
```



```
7    cpcfird copy cncf rdct
GWS action set table is (7 of 16) 44% full
```

If the required gateway screening stop action set is not in the database, perform the [Configuring Gateway Screening Stop Action Sets](#) procedure to configure the required gateway screening stop action set.

**Note:** If the NSFI of the screen being changed in this procedure will be STOP, or if the NSFI of the screen is not being changed, skip step 3 and go to step 4.

3. Enter the commands in the [Verifying the Gateway Screening Configuration](#) section to verify that the screen that will be specified by the NSFI/NSR parameter combination in step 5 is in the database.

If the desired screen is not in the database, perform one of the procedures shown in the [Gateway Screening Configuration Procedures](#) section to add the desired screen to the database or change an existing screen in the database.

**Note:** If any of these conditions apply to this procedure, skip this step and go to step 5:

- The point code in the screen is not being changed.
- The screen being changed contains either an ANSI or 24-bit ITU-N point code.
- The ITU-I or 14-bit ITU-N non-spare point code in the screen is not being changed to an ITU-I or 14-bit ITU-N spare point code.
- The point code in the screen is an ITU-I or 14-bit ITU-N spare point code or the screening reference contains other screens with ITU-I or 14-bit ITU-N spare point codes.

4. Display the status of the ITU National and International Spare Point Code Support feature by entering the `rtrv-ctrl-feat` command with the ITU National and International Spare Point Code Support feature part number.

Enter this command.

```
rtrv-ctrl-feat:partnum=893013601
```

This is an example of the possible output.

```
rlghncxa03w 06-10-25 15:25:30 GMT EAGLE5 36.0.0
The following features have been permanently enabled:

Feature Name           Partnum   Status  Quantity
Spare Point Code Support 893013601 on      ----

The following features have been temporarily enabled:

Feature Name           Partnum   Status  Quantity  Trial Period Left
Zero entries found.

The following features have expired temporary keys:

Feature Name           Partnum
Zero entries found.
```

If the ITU National and International Spare Point Code Support feature is enabled, go to step 5.

If the ITU National and International Spare Point Code Support feature is not enabled, perform the “Activating the ITU National and International Spare Point Code Support Feature” procedure

in *Database Administration - SS7 User's Guide* to enable the ITU National and International Spare Point Code Support feature as required. After the feature has been enabled, go to step 5.

5. Change the attributes of an allowed CGPA screen using the `chg-scr-cgpa` command.

If a gateway screening stop action is to be assigned to the allowed CGPA screen being changed, enter the `chg-scr-cgpa` command with the `nsfi=stop` parameter and the `actname` parameter with the name of a gateway screening stop action set shown in the output of the `rtrv-gws-actset` command executed in step 2.



**CAUTION**

**Caution:** The EAGLE does not support redirecting MSUs for the DTA feature or intercepting ISUPIAM messages for the Calling Name Conversion Facility feature from the allowed CGPA screen. Gateway screening stop action sets containing either the RDCT (redirect) or CNCF (calling name conversion facility) stop actions should not be assigned to the allowed CGPA screen. If a gateway screening stop action set containing the RDCT or CNCF stop actions is specified with the `chg-scr-cgpa` command, unsolicited information message (UIM) 1126 is generated when the attempt is made to redirect MSUs from the allowed CGPA screen. Unsolicited information message (UIM) 1216 is generated when ISUPIAM MSUs are intercepted from the allowed CGPA screen. For more information on UIMs 1126 and 1216, go to *Unsolicited Alarm and Information Messages Reference*.

The current values for the `ni`, `nc`, `ncm`, `zone`, `area`, `id`, `npc`, `msa`, `ssa`, `sp`, `ssn`, `ri`, and `sccpmt` parameters must be entered exactly as shown in the `rtrv-scr-cgpa` output in step 1.

The following list contains the values for `nni`, `nnc`, `nncm`, `nzone`, `narea`, `nid`, `nnpc`, `nssn`, `nmsa`, `nssa`, `nsp`, `nri`, and `nsccpmt` parameters:

- `nni` – 0 - 255 or an asterisk (\*)
- `nnc` – 0 - 255 or an asterisk (\*)
- `nncm` – 0 - 255 or an asterisk (\*)
- `nzone` – 0 - 7 or an asterisk (\*)
- `narea` – 0 - 255 or an asterisk (\*)
- `nid` – 0 - 7 or an asterisk (\*)
- `nnpc` – 1 - 16383 or an asterisk (\*)
- `nmsa` – 0 - 255 or an asterisk (\*)
- `nssa` – 0 - 255 or an asterisk (\*)
- `nsp` – 0 - 255 or an asterisk (\*)
- `nssn` – 0 - 255 or an asterisk (\*)
- `nri` – `gt`, `dpc` or an asterisk (\*)
- `nsccpmt` – 9, 10, 17, 18 or an asterisk (\*)

**Note:** The `nri`, `nsfi`, and `nsr` parameters can be specified only as shown in [Table 40: CGPA Parameter Combinations](#).

**Table 40: CGPA Parameter Combinations**

New or Current RI Value	NSFI	NSR
GT	TT, STOP	Must be specified if NSFI=TT

New or Current RI Value	NSFI	NSR
DPC	CDPA, STOP	Must be specified if NSFI=CDPA
*	TT, CDPA, STOP	Must be specified if NSFI=TT or NSFI=CDPA

A range of values can be specified for the `nri`, `nnc`, and `nncm` parameters. See the [“Specifying a Range of Values”](#) section for more information on how the asterisk and a range of values are used for the `nri`, `nnc`, and `nncm` parameters.

To change an ITU-I or 14-bit ITU-N spare point code to a non-spare point code, both the `pcst=s` and `npcst=none` parameters must be specified with the `chg-scr-cgpa` command.

To change an ITU-I or 14-bit ITU-N non-spare point code to a spare point code, the `npcst=s` parameter must be specified with the `chg-scr-cgpa` command. The `pcst` parameter does not have to be specified.

If the current point code in the screen being changed is either an ITU-I or 14-bit ITU-N spare point code, the `pcst=s` parameter must be specified with the `chg-scr-cgpa` command.

If the current point code in the screen being changed is either an ITU-I or 14-bit ITU-N non-spare point code, the `pcst` parameter does not have to be specified with the `chg-scr-cgpa` command. If the `pcst` parameter is specified for a screen containing either an ITU-I or 14-bit ITU-N non-spare point code, the `pcst` parameter value must be none.

For this example, enter this command.

```
chg-scr-cgpa:sr=gw14:ni=003:nc=003:ncc=003:ssn=253:sccpmt=009
:nri=230:nnc=230:nncm=230:nssn=150
```

A message similar to the following should appear.

```
rlghncxa03w 06-10-25 15:27:30 GMT EAGLE5 36.0.0
CHG-SCR-CGPA: SCREEN SET AFFECTED - GW14 1% FULL
CHG-SCR-CGPA: MASP A - COMPLTD
```

- Verify the changes using the `rtrv-scr-cgpa` command with the screening reference name used in step 5.

For this example, enter this command.

```
rtrv-scr-cgpa:sr=gw14
```

The following is an example of the possible output.

```
rlghncxa03w 06-10-25 15:28:30 GMT EAGLE5 36.0.0
SCREEN = ALLOWED CGPA
SR  NI  NC  NCM  SSN  RI  SCCPMT  NSFI  NSR/ACT
GW14 230 230 230 150  GT  009  TT  GW17
```

- Backup the new changes using the `chg-db:action=backup:dest=fixed` command.

The following messages should appear, the active Maintenance and Administration Subsystem Processor (MASP) appears first.

```
BACKUP (FIXED) : MASP A - Backup starts on active MASP.  
BACKUP (FIXED) : MASP A - Backup on active MASP to fixed disk complete.  
BACKUP (FIXED) : MASP A - Backup starts on standby MASP.  
BACKUP (FIXED) : MASP A - Backup on standby MASP to fixed disk complete.
```

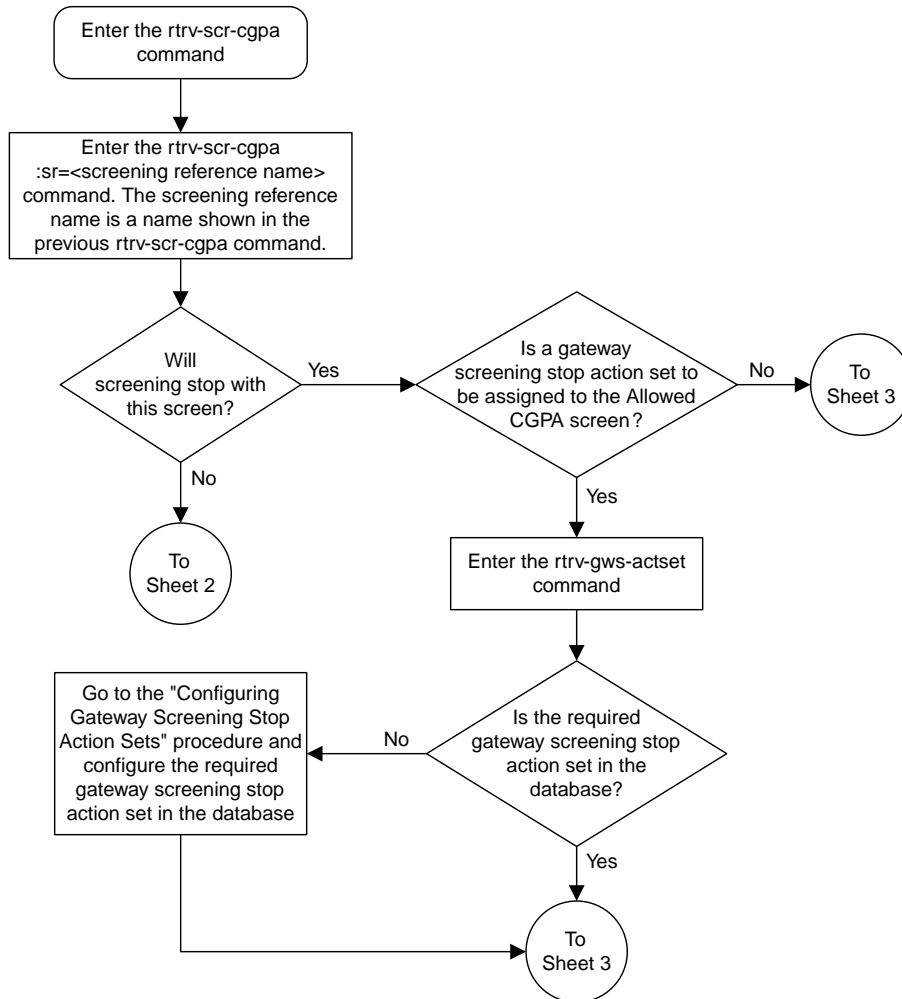

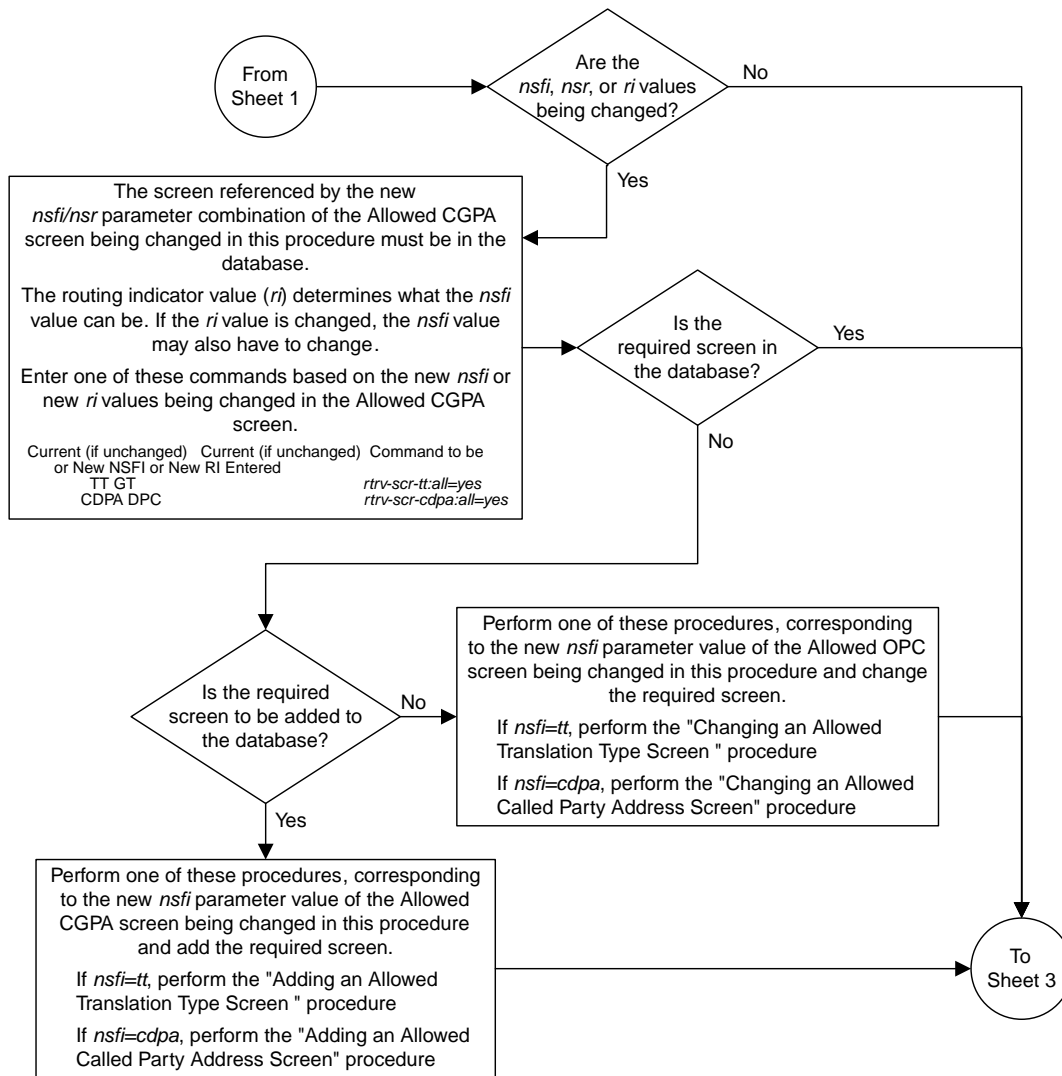

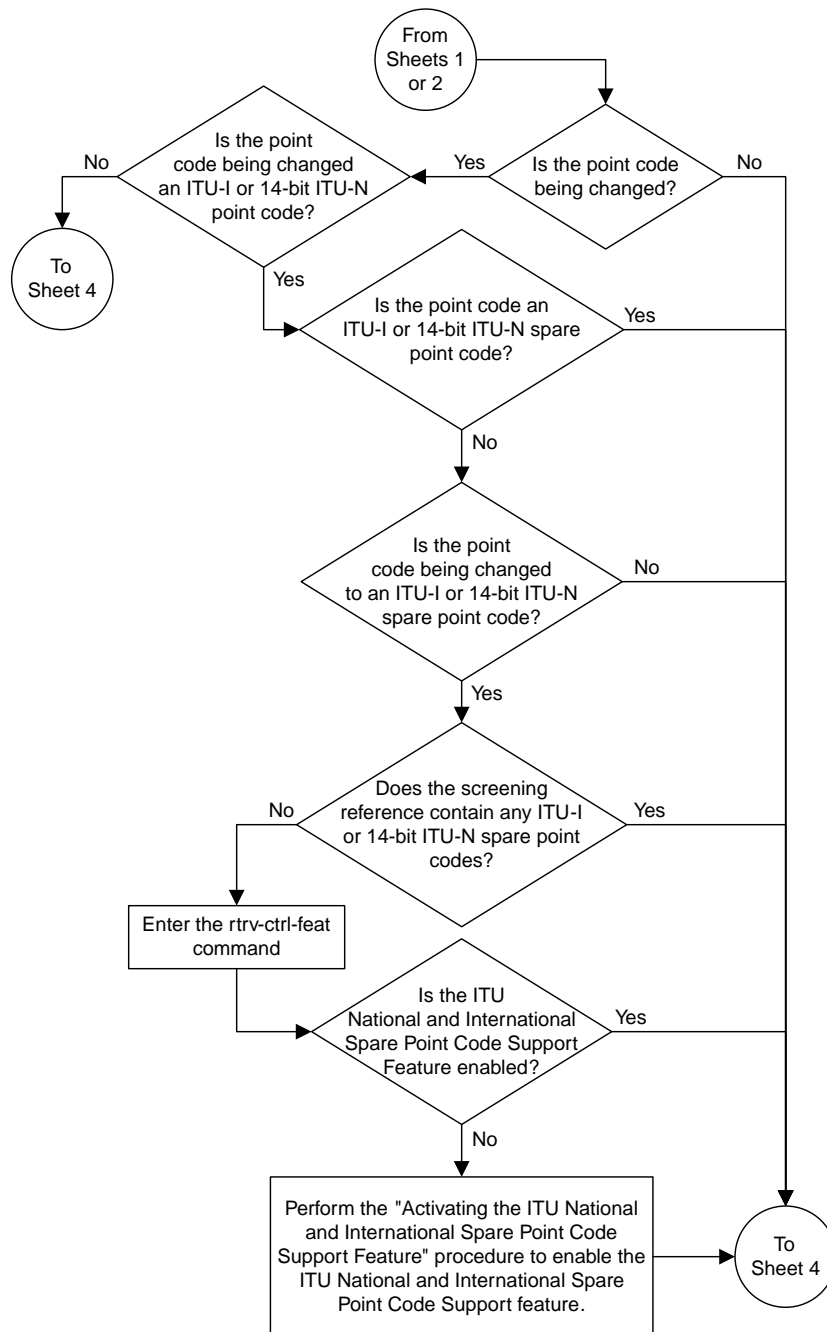

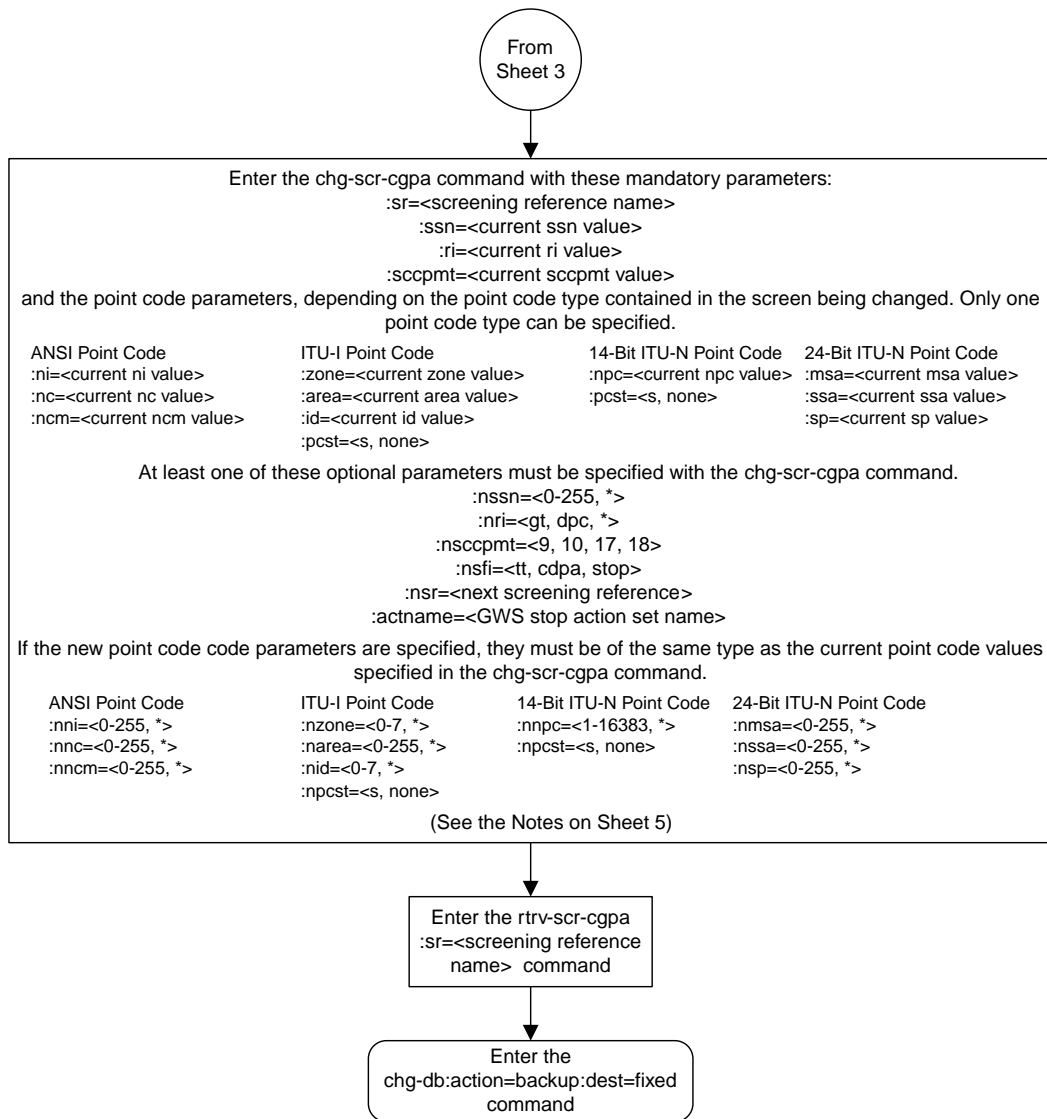



**Notes:**

1. A range of values can be specified for the *nri*, *nc*, or *nncm* parameters by inserting double ampersands (&&) between the parameter values defining the range. For example, to specify the range 025 to 200 for the *nri* parameter, enter 025&&200 for the *nri* parameter value.
2. The asterisk (\*) specifies the entire range of values for that parameter.  
For more information about specifying a range of values and about using the asterisk, see the "Gateway Screening Attributes" section and the "Specifying a Range of Values" section. The "Gateway Screening Attributes" section is in the *Database Administration Manual - Gateway Screening*. The "Specifying a Range of Values" section is in the "Changing an Allowed Calling Party Address Screen" procedure in the *Database Administration Manual - Gateway Screening*.
3. If either the *nsfi=<tt or cdpa>* or *nsr* parameters are specified, the other parameter must be specified.
4. If the *nsfi=stop* parameter is specified, or if the current *nsfi* value is stop and is not being changed, the *nsr* parameter cannot be specified.
5. The *actname* parameter can be specified only when the *nsfi* value is stop (either the current *nsfi* value is stop and not being changed, or if the *nsfi* value is being changed to stop). The *actname* parameter is optional. If the *actname* parameter is specified, the *actname* parameter value is one of the gateway screening stop action set names shown in the *rtrv-gws-actset* output on Sheet 1.
6. The *nri=gt* parameter can be specified only if the *nsfi* value is TT. If the *nsfi=tt* parameter is specified, the *ri* value must be GT or \*.
7. The *nri=dpc* parameter can be specified only if the *nsfi* value is CDPA. If the *nsfi=cdpa* parameter is specified, the *ri* value must be DPC or \*.
8. The current values for the *ni*, *nc*, *nncm*, *zone*, *area*, *id*, *npc*, *ssn*, *ri*, and *scopmt* parameters must be entered exactly as shown in the *rtrv-scr-cgpa* output.
9. To change an ITU-I or 14-bit ITU-N spare point code to a non-spare point code, both the *pcst=s* and *npcst=none* parameters must be specified with the *chg-scr-cgpa* command.
10. To change an ITU-I or 14-bit ITU-N non-spare point code to a spare point code, the *npcst=s* parameter must be specified with the *chg-scr-cgpa* command. The *pcst* parameter does not have to be specified.
11. If the current point code in the screen being changed is either an ITU-I or 14-bit ITU-N spare point code, the *pcst=s* parameter must be specified with the *chg-scr-cgpa* command.
12. If the current point code in the screen being changed is either an ITU-I or 14-bit ITU-N non-spare point code, the *pcst* parameter does not have to be specified with the *chg-scr-cgpa* command. If the *pcst* parameter is specified for a screen containing either an ITU-I or 14-bit ITU-N non-spare point code, the *pcst* parameter value must be none.

Sheet 5 of 5

**Figure 39: Changing an Allowed Calling Party Address Screen**

## Allowed Affected Destination Field (DESTFLD) Screen Configuration

---

### Topics:

- *Introduction.....248*
- *Adding an Allowed Affected Destination Field Screen.....252*
- *Removing an Allowed Affected Destination Field Screen.....261*
- *Changing an Allowed Affected Destination Field Screen.....266*

Chapter 7, Allowed Affected Destination Field (DESTFLD) Screen Configuration, contains the procedures necessary to configure allowed affected destination field screens.

## Introduction

The Affected Destination Field screen identifies the point code in the affected destination field, the concerned signaling point code of incoming MTP network management messages from another network that are allowed into the EAGLE. The gray shaded areas in [Figure 41: Allowed Affected Destination Field Screening Function](#) shows the fields of the SS7 message that are checked by the Affected Destination Field screening function.

Network management messages contain the entry 0 in the service indicator field of the SIO. This is the last screen in the MTP portion of the gateway screening process. This `nsfi` for this screen has only one value, `stop`.

**Note:** Screening of the affected destination field can also be performed without configuring an allowed affected destination field screen by specifying the `destfld=yes` parameter when configuring a screen set. For more information on the screen set `destfld=yes` parameter, see the section [Automatic Destination Field Screening](#).

## Gateway Screening Actions

The Gateway Screening process stops with this screen. The `nsfi` parameter value can only be `stop`. If a match is not found, the message is discarded.

If a match is found, the message is processed. If a gateway screening stop action set is specified with the screen, shown by the `actname` parameter value, the message is processed according to the gateway screening stop actions that are assigned to the gateway screening stop action set.

- If the `copy` gateway screening stop action is specified, the message is processed and a copy of the message is sent by the STPLAN feature to an external application.
- If the `rdct` (redirect) gateway screening stop action is specified, the message is diverted from the original destination and sent to another destination with the Database Transport Access feature, specified by global title translation, for further processing.
- If the `cncf` gateway screening stop action is specified, the PIP parameter in the incoming ISUP IAM message is converted to the GN parameter. The GN parameter in the incoming ISUP IAM message is converted to the PIP parameter. The message is then sent to the node specified by the DPC in the routing label in the message. For more information on the Calling Name Conversion Facility feature, see [Calling Name Conversion Facility \(CNCF\) Configuration](#).
- If the `tlnp` gateway screening stop action is specified, ISUP IAMs that pass gateway screening are processed either by the ISUP NP with EPAP feature (if the ISUP NP with EPAP feature is enabled and turned on) or by the Triggerless LNP feature (if the Triggerless LNP feature is turned on). The ISUP NP with EPAP feature is discussed in more detail in *G-Port User's Guide*. The Triggerless LNP feature is discussed in more detail in *ELAP Administration and LNP Feature Activation Guide*.
- If the `tinp` gateway screening stop action is specified, ISUP IAMs that pass gateway screening are intercepted by the Triggerless ISUP based Number Portability (TINP) feature and converted to include the routing number (RN) if the call is to a ported number. The TINP feature is discussed in more detail in *G-Port User's Guide*.
- If the `tif`, `tif2`, or `tif3` gateway screening stop actions are specified, TIF processing is applied to the message.
- If the `sccp` gateway screening stop action is specified, MTP routed SCCP UDT/XUDT are forwarded to the service modules for further processing.

### Allowed Affected Destination Screening Actions

These network management messages are screened by the Allowed Affected Destination Field: TFP, TFA, TFR, TFC, UPU, and SRST (RSP, RSR). Any MSU that is not one of these network management message types, or does not contain a service indicator of 0 in the SIO field and reaches this screen in the gateway screening process automatically passes gateway screening and is allowed into the EAGLE.

Figure 40: Allowed Affected Destination Screening Actions shows the screening actions of the allowed affected destination field screen.

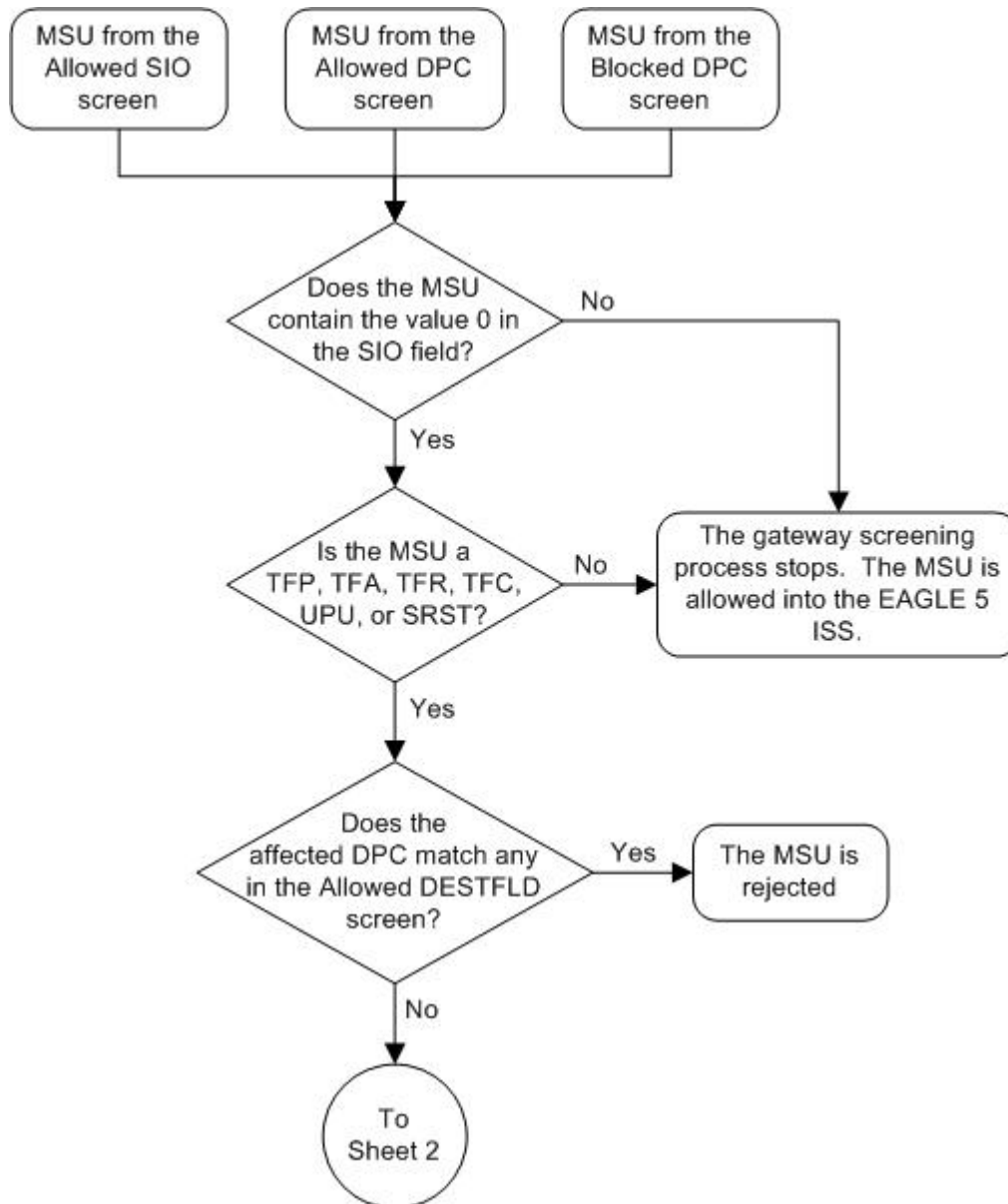

Sheet 1 of 3

Figure 40: Allowed Affected Destination Screening Actions

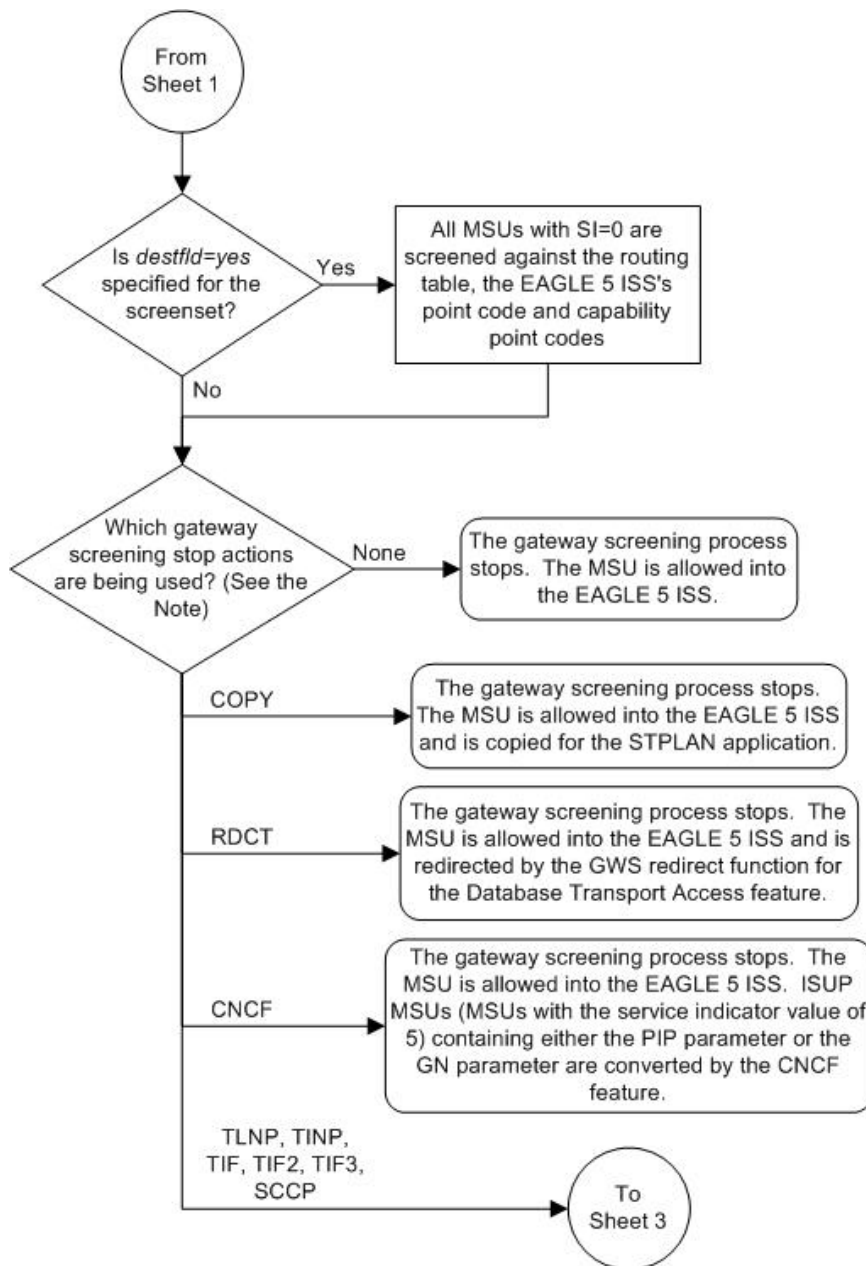

Note: Combinations of the gateway screening stop actions shown on Sheets 2 and 3 may be assigned to a gateway screening stop action set. Refer to the Configuring Gateway Screening Stop Action Sets and the Configuring TLNP Gateway Screening Stop Action Sets procedures in Chapter 2 of this manual for the combinations that can be used.

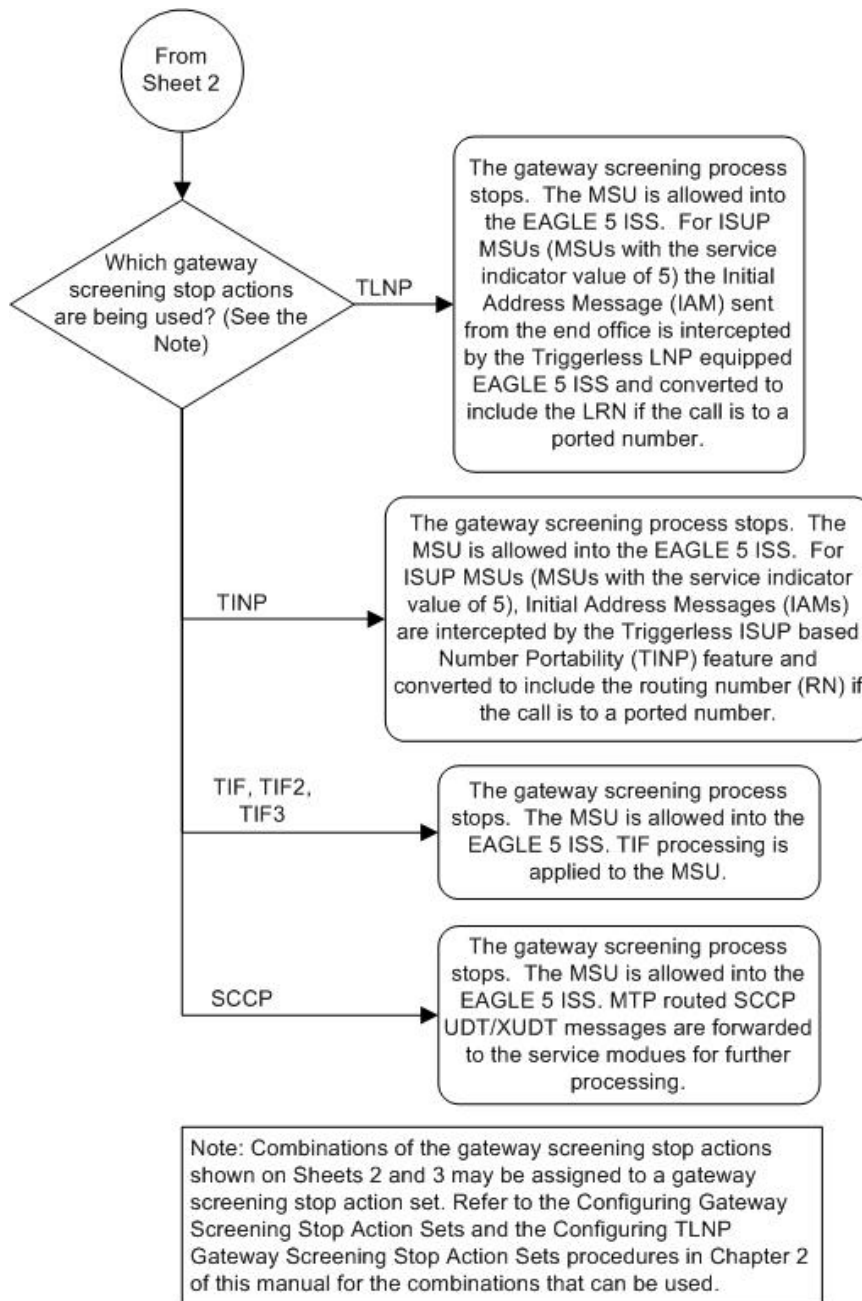

Sheet 3 of 3

ANSI MSU (ANSI Message Signal Unit)

BSN FSN LI	SIO xx xx xxxx NIC PRI SI	SIF			
		DPC NCM NC NI	Routing Label OPC NCM NC NI	SLS xx	H1 H0

ITU-I MSU (ITU International Message Signal Unit)

BSN FSN LI	SIO xx xx xxxx NIC PRI SI	SIF			
		DPC ID AREA ZONE	Routing Label OPC ID AREA ZONE	SLS xx	H1 H0

14-Bit ITU-N MSU (14-Bit ITU National Message Signal Unit)

BSN FSN LI	SIO xx xx xxxx NIC PRI SI	SIF			
		DPC NPC	Routing Label NPC	SLS xx	H1 H0

24-Bit ITU-N MSU (24-Bit ITU National Message Signal Unit)

BSN FSN LI	SIO xx xx xxxx NIC PRI SI	SIF			
		DPC SP SSA MSA	Routing Label SP SSA MSA	SLS xx	H1 H0

Figure 41: Allowed Affected Destination Field Screening Function

## Adding an Allowed Affected Destination Field Screen

This procedure is used to add an allowed affected destination field (DESTFLD) screen to the database using the `ent-scr-destfld` command. The parameters used by the `ent-scr-destfld` command are shown in the [Gateway Screening Attributes](#) section. The general rules that apply to configuring gateway screening entities are shown in the [Gateway Screening Configuration](#) section.

The examples in this procedure are used to add the allowed DESTFLD screen data shown in [Table 41: Example Gateway Screening Allowed DESTFLD Configuration Table](#) and based on the example configuration shown in [Figure 8: Gateway Screening Configuration - Example 5](#).



Table 41: Example Gateway Screening Allowed DESTFLD Configuration Table

Screening Reference	NI	NC	NCM	NSFI	ACTNAME
fld5	100	100	100	stop	CR

**Note:** If you using multiple-part ITU national point codes with gateway screening, see the [14-Bit ITU National Point Code Formats](#) section.

### Specifying a Range of Values

A range of values can be specified for the point code parameters `ni`, `nc`, or `ncm`.

If a range of values is specified for any of these parameters, and the value of the other parameters match existing values for the screening reference name, the range of values for the point code parameter cannot include any values for that parameter that are currently provisioned for the screening reference name.

For example, screening reference name `scr1` contains these entries:

SR	NI	NC	NCM	NSFI	NSR/ACT
SCR1	240	001	010	STOP	-----
SCR1	241	010	020	STOP	-----

Another entry for screening reference `scr1` with the `ni` value of 240 and the `nc` value of 001 cannot be specified if the range of values for the `ncm` parameter includes the value 010.

The ANSI point code parameter values can be specified as a single value, a range of values, or with an asterisk (\*). The asterisk specifies all possible values for the `ni`, `nc`, and `ncm` parameters. [Table 42: Valid Value Combinations for ANSI Point Code Parameters](#) shows the valid combinations of these parameter values.

Table 42: Valid Value Combinations for ANSI Point Code Parameters

NI	NC	NCM
Single Value	Single Value	Single Value
Single Value	Single Value	Range of Values
Single Value	Single Value	Asterisk
Single Value	Range of Values	Asterisk
Single Value	Asterisk	Asterisk
Range of Values	Asterisk	Asterisk
Asterisk	Asterisk	Asterisk

A range of values can also be specified for an ITU-I or 24-bit ITU-N point code parameter using a combination of asterisks (\*) and single values for the point code parameters. [Table 43: Valid Value Combinations for ITU-I Point Code Parameters](#) shows the valid combinations of the ITU-I parameter values. [Table 44: Valid Value Combinations for 24-Bit ITU-N Point Code Parameters](#) shows the valid combinations of the 24-bit ITU-N parameter values.

Table 43: Valid Value Combinations for ITU-I Point Code Parameters

ZONE	AREA	ID
Single Value	Single Value	Single Value
Single Value	Single Value	Asterisk
Single Value	Asterisk	Asterisk
Asterisk	Asterisk	Asterisk

Table 44: Valid Value Combinations for 24-Bit ITU-N Point Code Parameters

MSA	SSA	SP
Single Value	Single Value	Single Value
Single Value	Single Value	Asterisk
Single Value	Asterisk	Asterisk
Asterisk	Asterisk	Asterisk

1. Verify that the gateway screening feature is on, by entering the `rtrv-feat` command.

If the gateway screening feature is on, the `GWS` field is set to `on`.

**Note:** The `rtrv-feat` command output contains other fields that are not used by this procedure. If you wish to see all the fields displayed by the `rtrv-feat` command, see the `rtrv-feat` command description in *Commands User's Guide*.

If the gateway screening feature is on, shown by the entry `GWS = on` in the `rtrv-feat` command output, skip step 2, and go to step 3.

2. Turn the gateway screening feature on by entering this command.

```
chg-feat:gws=on
```

**Note:** Once the gateway screening feature is turned on with the `chg-feat` command, it cannot be turned off.

The gateway screening feature must be purchased before you turn this feature on with the `chg-feat` command. If you are not sure if you have purchased the gateway screening feature, contact your Oracle Sales Representative or Account Representative.

When the `chg-feat` has successfully completed, this message should appear.

```
rlghncxa03w 06-10-28 11:43:04 GMT EAGLE5 36.0.0
CHG-FEAT: MASP A - COMPLTD
```

3. Display all allowed DESTFLD screens in the database using the `rtrv-scr-destfld` command.

The following is an example of the possible output.

```
rlghncxa03w 06-10-25 15:25:30 GMT EAGLE5 36.0.0
SCREEN = ALLOWED DESTFLD
```

SR	REF	RULES
IEC	YES	2
WRD2	YES	1
WRD4	YES	9

If the screening reference names that you wish to add with this procedure are not shown in the `rtrv-scr-destfld` command output, go to step 4. For this example, the screening reference names are not shown. If these screening reference names are shown in the `rtrv-scr-destfld` command output, make sure the screening data you wish to enter is not already in the database by entering the `rtrv-scr-destfld` command with the screening reference name. For example, enter the `rtrv-scr-destfld:sr=iec` command.

The following is an example of the possible output.

```
rlghncxa03w 06-10-25 15:26:30 GMT EAGLE5 36.0.0
SCREEN = ALLOWED DESTFLD
SR  NI      NC      NCM      NSF1  NSR/ACT
IEC 240     001     010     STOP  -----
IEC 241     010     *       STOP  COPY
```

If a gateway screening stop action set is to be assigned to the allowed DESTFLD screen being added to the database, go to step 4. Otherwise, go to step 5.

4. Display the gateway screening stop action sets in the database with the `rtrv-gws-actset` command.

This is an example of the possible output.

```
rlghncxa03w 06-10-25 15:28:30 GMT EAGLE5 36.0.0
ACT ACT ACT ACT ACT ACT ACT ACT ACT ACT ACT
ID  NAME 1 2 3 4 5 6 7 8 9 10
--  ---  - - - - - - - - - - - - - - - - - - - - - -
1  copy copy
2  rdct rdct
3  cr copy rdct
4  cncf cncf
5  cpcncf copy cncf
6  cncfrd cncf rdct
7  cpcfrd copy cncf rdct

GWS action set table is (7 of 16) 44% full
```

If the required gateway screening stop action set is not in the database, perform the [Configuring Gateway Screening Stop Action Sets](#) procedure to configure the required gateway screening stop action set.

**Note:** If the point code being added in this procedure is not an ITU-I or 14-bit ITU-N spare point code, skip this step and to step 6.

**Note:** If the point code being added in this procedure is an ITU-I or 14-bit ITU-N spare point code and the screening reference contains ITU-I or 14-bit ITU-N spare point codes, skip this step and go to step 6.

5. Display the status of the ITU National and International Spare Point Code Support feature by entering the `rtrv-ctrl-feat` command with the ITU National and International Spare Point Code Support feature part number.

Enter this command.

```
rtrv-ctrl-feat:partnum=893013601
```

This is an example of the possible output.

```
rlghncxa03w 06-10-25 15:25:30 GMT EAGLE5 36.0.0
The following features have been permanently enabled:

Feature Name          Partnum  Status Quantity
Spare Point Code Support 893013601 on    ----

The following features have been temporarily enabled:

Feature Name          Partnum  Status Quantity  Trial Period Left
Zero entries found.

The following features have expired temporary keys:

Feature Name          Partnum
Zero entries found.
```

If the ITU National and International Spare Point Code Support feature is enabled, go to step 6.

If the ITU National and International Spare Point Code Support feature is not enabled, perform the “Activating the ITU National and International Spare Point Code Support Feature” procedure in *Database Administration - SS7 User’s Guide* to enable the ITU National and International Spare Point Code Support feature as required. After the feature has been enabled, go to step 6.

6. Add a new allowed DESTFLD screen to the database using the `ent-scr-destfld` command.

If a gateway screening stop action is to be assigned to the allowed DESTFLD screen being changed, enter the `ent-scr-destfld` command with the `nsfi=stop` parameter and the `actname` parameter with the name of a gateway screening stop action set shown in the output of the `rtrv-gws-actset` command executed in step 4.

The following list contains the values for `ni`, `nc`, `ncm`, `zone`, `area`, `id`, `npc`, `msa`, `ssa`, and `sp` parameters:

- `ni` – 0 - 255 or an asterisk (\*)
- `nc` – 0 - 255 or an asterisk (\*)
- `ncm` – 0 - 255 or an asterisk (\*)
- `zone` – 0 - 7 or an asterisk (\*)
- `area` – 0 - 255 or an asterisk (\*)
- `id` – 0 - 7 or an asterisk (\*)
- `npc` – 1 - 16383 or an asterisk (\*)
- `msa` – 0 - 255 or an asterisk (\*)
- `ssa` – 0 - 255 or an asterisk (\*)
- `sp` – 0 - 255 or an asterisk (\*)

A range of values can be specified for the `ni`, `nc`, and `ncm` parameters. See the [“Specifying a Range of Values”](#) section for more information on how the asterisk and a range of values are used for the `ni`, `nc`, and `ncm` parameters.

To add a spare point code to the allowed DESTFLD screen, the `pcst=s` parameter must be specified. To add a non-spare point code to the allowed DESTFLD screen, the `pcst` parameter does not have

to be specified. If the `pcst` parameter is specified for a screen containing an ITU-I or 14-bit ITU-N non-spare point code, the value must be none.

For this example, enter this command.

```
ent-scr-destfld:sr=fld5:ni=100:nc=100:ncm=100:nsfi=stop :actname=cr
```

A message similar to the following should appear.

```
rlghncxa03w 06-10-25 15:29:30 GMT EAGLE5 36.0.0
ENT-SCR-DESTFLD: SCREEN SET AFFECTED - FLD5 1% FULL
ENT-SCR-DESTFLD: MASP A - COMPLTD
```

7. Verify the changes using the `rtrv-scr-destfld` command with the screening reference name used in step 6. For this example, enter this command.

```
rtrv-scr-destfld:sr=fld5
```

The following is an example of the possible output.

```
rlghncxa03w 06-10-25 15:30:30 GMT EAGLE5 36.0.0
SCREEN = ALLOWED DESTFLD
SR      NI      NC      NCM      NSFI     NSR/ACT
FLD5   100     100     100     STOP     CR
```

8. Backup the new changes using the `chg-db:action=backup:dest=fixed` command.

The following messages should appear, the active Maintenance and Administration Subsystem Processor (MASP) appears first.

```
BACKUP (FIXED) : MASP A - Backup starts on active MASP.
BACKUP (FIXED) : MASP A - Backup on active MASP to fixed disk complete.
BACKUP (FIXED) : MASP A - Backup starts on standby MASP.
BACKUP (FIXED) : MASP A - Backup on standby MASP to fixed disk complete.
```

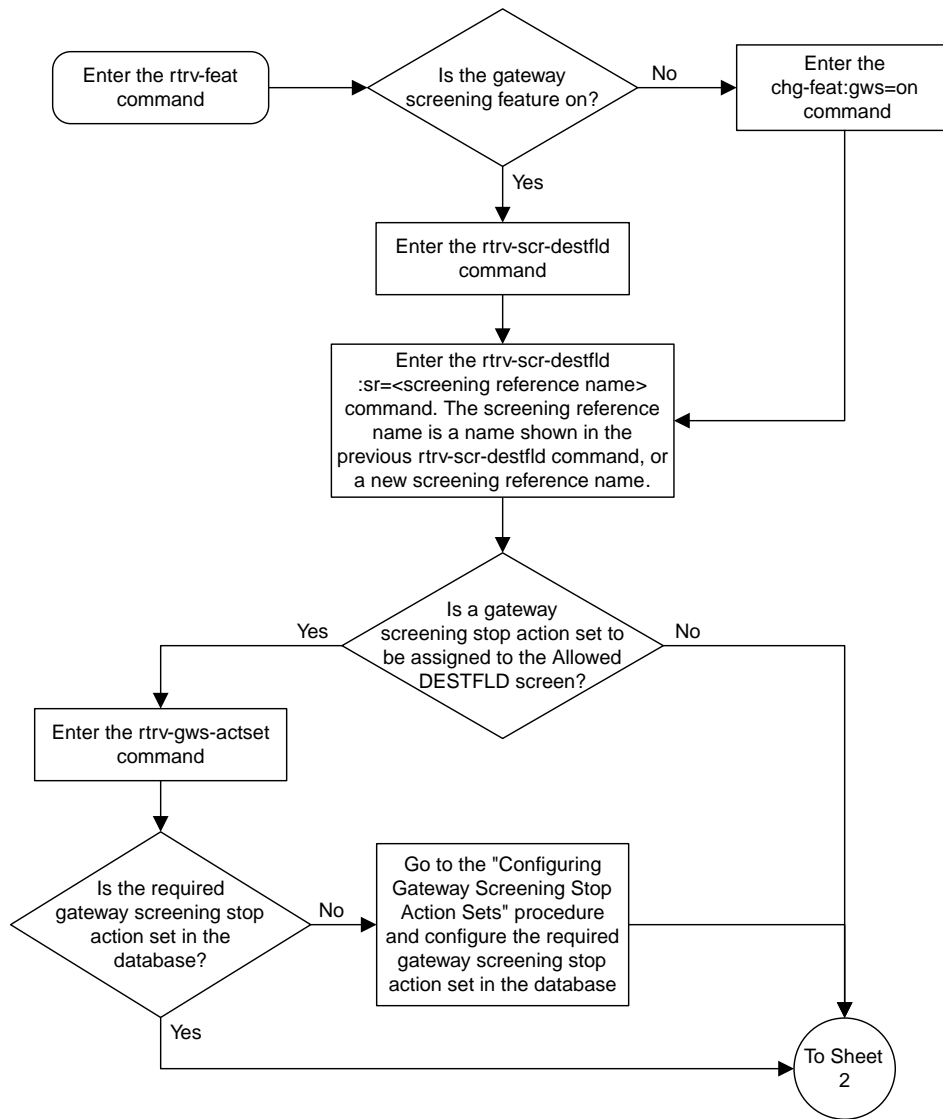

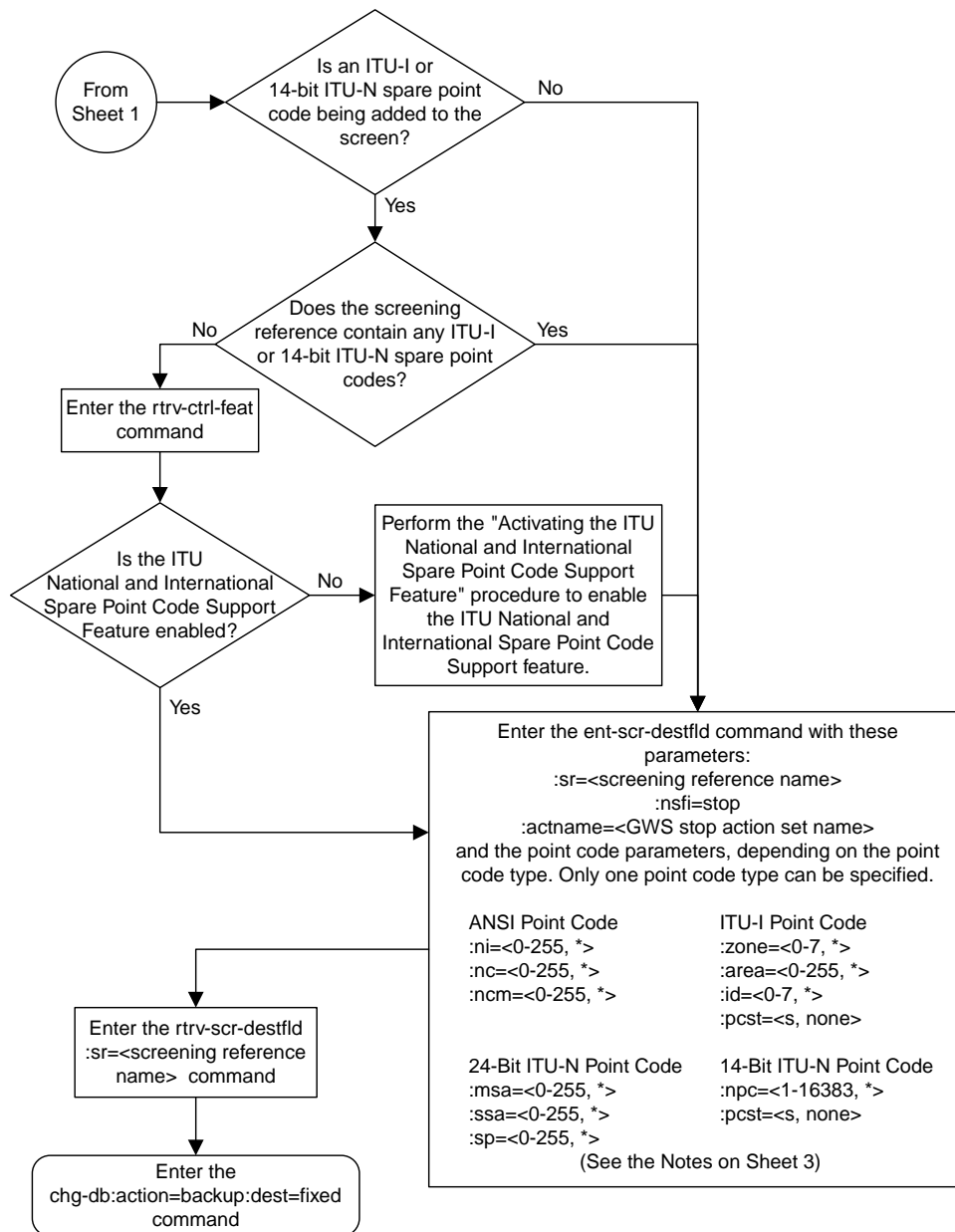

**Notes:**

1. A range of values can be specified for the *ni*, *nc*, or *ncm* parameters by inserting double ampersands (&&) between the parameter values defining the range. For example, to specify the range 025 to 200 for the *ni* parameter, enter 025&&200 for the *ni* parameter value.

2. The asterisk (\*) specifies the entire range of values for that parameter.

For more information about specifying a range of values and about using the asterisk, see the "Gateway Screening Attributes" section and the "Specifying a Range of Values" section. The "Gateway Screening Attributes" section is in the *Database Administration Manual - Gateway Screening*. The "Specifying a Range of Values" section is in the "Adding an Allowed Affected Destination Field Screen" procedure in the *Database Administration Manual - Gateway Screening*.

3. The *actname* parameter is optional. If the *actname* parameter is specified, the *actname* parameter value is one of the gateway screening stop action set names shown in the *rtrv-gws-actset* output on Sheet 1.

4. To add a non-spare point code, the *pcst* parameter does not have to be specified. If the *pcst* parameter is specified for a screen containing an ITU-I or 14-bit ITU-N non-spare point code, the value must be *none*.

5. To add a spare point code, the *pcst=s* parameter must be specified.



Sheet 3 of 3

Figure 42: Adding an Allowed Affected Destination Field Screen

## Removing an Allowed Affected Destination Field Screen

This procedure is used to remove an allowed affected destination field (DESTFLD) screen from the database using the `dlt-scr-destfld` command. The parameters used by the `dlt-scr-destfld` command are shown in the [Gateway Screening Attributes](#) section. The general rules that apply to configuring gateway screening entities are shown in the [Gateway Screening Configuration](#) section.

The example in this procedure removes the allowed DESTFLD screen `fld5` from the database.

**Note:** If you are using multiple-part ITU national point codes with gateway screening, see the [14-Bit ITU National Point Code Formats](#) section.

The allowed DESTFLD screen can be referenced by one of the following screens.

- Allowed SIO
- Allowed DPC
- Blocked DPC

### Verifying the Gateway Screening Configuration

Enter the following commands to verify that none of these screens reference the allowed CGPA screen being removed from the database.

- `rtrv-scr-sio:nsfi=destfld`
- `rtrv-scr-dpc:nsfi=destfld`
- `rtrv-scr-blkdpc:nsfi=destfld`

### Gateway Screening Configuration Procedures

To change the NSFI of any of these screens, perform one of these procedures.

- [Changing an Allowed SIO Screen](#)
- [Changing an Allowed DPC Screen](#)
- [Changing a Blocked DPC Screen](#)

1. Display the allowed DESTFLD screens in the database using the `rtrv-scr-destfld` command.

The following is an example of the possible output.

```
rlghncxa03w 06-10-25 15:25:30 GMT EAGLE5 36.0.0
SCREEN = ALLOWED DESTFLD
SR    REF  RULES
FLD5  YES   1
IEC   YES   6
WRD2  YES   1
WRD4  YES   9
```

From the `rtrv-scr-destfld` output, display the allowed DESTFLD screen you wish to remove using the `rtrv-scr-destfld` command with the screening reference name. For this example, enter this command.

```
rtrv-scr-destfld:sr=fld5
```

The following is an example of the possible output.

```
rlghncxa03w 06-10-25 15:25:30 GMT EAGLE5 36.0.0
SCREEN = ALLOWED DESTFLD
SR      NI      NC      NCM      NSF1     NSR/ACT
fld5   100     100     100     STOP     cr
```

2. Enter the commands in the [Verifying the Gateway Screening Configuration](#) section to verify that the screen being removed is not referenced by other screens in the database.

If the screen being removed is referenced by other screens, perform the procedures shown in the [Gateway Screening Configuration Procedures](#) section to change the NSF1 of those screens to reference other screens or change the NSF1 of these screens to STOP.

3. Remove the allowed DESTFLD screen from the database using the `dlt-scr-destfld` command with the screening reference name shown in the `rtrv-scr-destfld` output in step 1 and with the point code parameter values (`ni`, `nc`, `ncm`, or `zone`, `area`, `id`, `npc`, `msa`, `ssa`, or `sp`) of the screen being removed from the database.

The values for these parameters must be entered exactly as shown in the `rtrv-scr-destfld` output.

To remove an entry containing either an ITU-I or a 14-bit ITU-N spare point code, the `pcst=s` parameter must be specified with the `dlt-scr-destfld` command.

To remove an entry containing either an ITU-I or a 14-bit ITU-N non-spare point code, the `pcst` parameter does not have to be specified with the `dlt-scr-destfld` command. If the `pcst` parameter is specified, the value must be none.

For this example, enter this command.

```
dlt-scr-destfld:sr=fld5:ni=100:nc=100:ncm=100
```

A message similar to the following should appear.

```
rlghncxa03w 06-10-25 15:26:30 GMT EAGLE5 36.0.0
DLT-SCR-DESTFLD: SCREEN SET AFFECTED - FLD5 0% FULL
DLT-SCR-DESTFLD: MASP A - COMPLTD
```

4. Verify the changes using the `rtrv-scr-destfld` command with the screening reference name used in step 3.

For this example, enter this command.

```
rtrv-scr-destfld:sr=fld5
```

The following is an example of the possible output.

```
E2573 Cmd Rej: SR or NSR does not reference an existing SR
```

This message shows that the specified screening reference name is not in the database and the action of the `dlt-scr-destfld` command in step 3 was successful. If the specified screening reference name contained more than one entry when the `dlt-scr-destfld` command was

executed in step 3, the `rtrv-scr-destfld:sr=` command output would show the remaining entries in the screening reference instead of error message E2573.

5. Backup the new changes using the `chg-db:action=backup:dest=fixed` command.

The following messages should appear, the active Maintenance and Administration Subsystem Processor (MASP) appears first.

```
BACKUP (FIXED) : MASP A - Backup starts on active MASP.  
BACKUP (FIXED) : MASP A - Backup on active MASP to fixed disk complete.  
BACKUP (FIXED) : MASP A - Backup starts on standby MASP.  
BACKUP (FIXED) : MASP A - Backup on standby MASP to fixed disk complete.
```

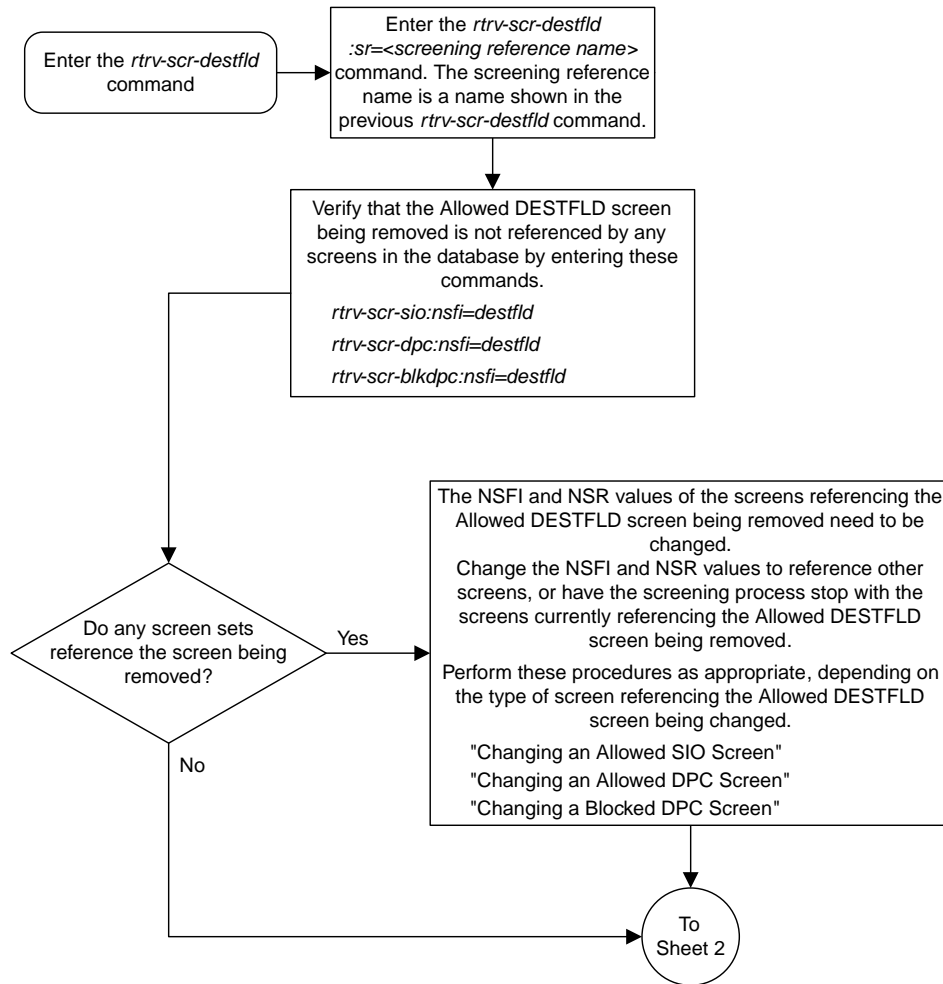

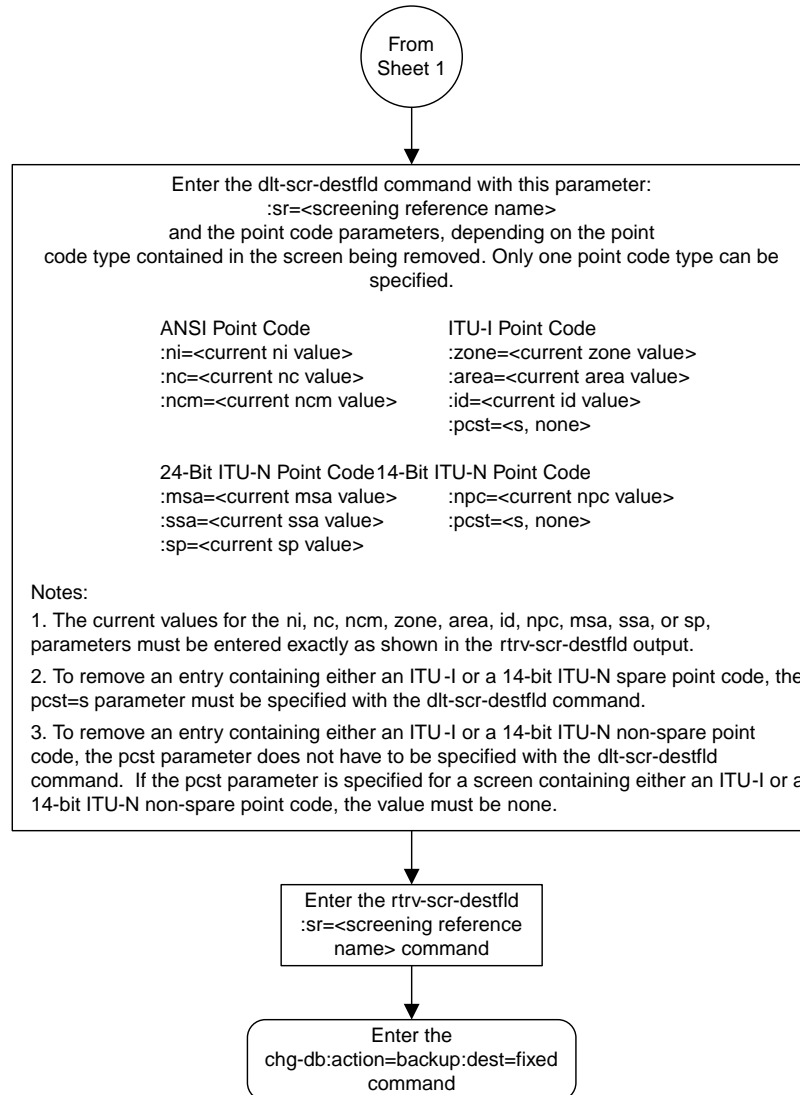

Sheet 2 of 2

**Figure 43: Removing an Allowed Affected Destination Field Screen**

## Changing an Allowed Affected Destination Field Screen

This procedure is used to change the attributes of an allowed affected destination field (DESTFLD) screen in the database using the `chg-scr-destfld` command. The parameters used by the `chg-scr-destfld` command are shown in the [Gateway Screening Attributes](#) section. The general rules that apply to configuring gateway screening entities are shown in the [Gateway Screening Configuration](#) section.

The example in this procedure is used to change the point code 100-100-100 for the allowed DESTFLD screen `fld5` to 030-030-030 and to redirect the MSU for the DTA feature.

**Note:** If you using multiple-part ITU national point codes with gateway screening, see the [14-Bit ITU National Point Code Formats](#) section.

### Specifying a Range of Values

A range of values can be specified for the point code parameters `ni`, `nc`, or `ncm`.

If a range of values is specified for any of these parameters, and the value of the other parameters match existing values for the screening reference name, the range of values for the point code parameter cannot include any values for that parameter that are currently provisioned for the screening reference name.

For example, screening reference name `scr1` contains these entries:

SR	NI	NC	NCM	NSFI	NSR/ACT
SCR1	240	001	010	STOP	-----
SCR1	241	010	020	STOP	-----

Another entry for screening reference `scr1` with the `ni` value of 240 and the `nc` value of 001 cannot be specified if the range of values for the `ncm` parameter includes the value 010.

The ANSI point code parameter values can be specified as a single value, a range of values, or with an asterisk (\*). The asterisk specifies all possible values for the `ni`, `nc`, and `ncm` parameters. [Table 45: Valid Value Combinations for ANSI Point Code Parameters](#) shows the valid combinations of these parameter values.

**Table 45: Valid Value Combinations for ANSI Point Code Parameters**

NI	NC	NCM
Single Value	Single Value	Single Value
Single Value	Single Value	Range of Values
Single Value	Single Value	Asterisk
Single Value	Range of Values	Asterisk

NI	NC	NCM
Single Value	Asterisk	Asterisk
Range of Values	Asterisk	Asterisk
Asterisk	Asterisk	Asterisk

A range of values can also be specified for an ITU-I or 24-bit ITU-N point code parameter using a combination of asterisks (\*) and single values for the point code parameters. [Table 46: Valid Value Combinations for ITU-I Point Code Parameters](#) shows the valid combinations of the ITU-I parameter values. [Table 47: Valid Value Combinations for 24-Bit ITU-N Point Code Parameters](#) shows the valid combinations of the 24-bit ITU-N parameter values.

**Table 46: Valid Value Combinations for ITU-I Point Code Parameters**

ZONE	AREA	ID
Single Value	Single Value	Single Value
Single Value	Single Value	Asterisk
Single Value	Asterisk	Asterisk
Asterisk	Asterisk	Asterisk

**Table 47: Valid Value Combinations for 24-Bit ITU-N Point Code Parameters**

MSA	SSA	SP
Single Value	Single Value	Single Value
Single Value	Single Value	Asterisk
Single Value	Asterisk	Asterisk
Asterisk	Asterisk	Asterisk

1. Display the allowed DESTFLD screens in the database using the `rtrv-scr-destfld` command.  
The following is an example of the possible output.

```
rlghncxa03w 06-10-25 15:25:30 GMT EAGLE5 36.0.0
SCREEN = ALLOWED DESTFLD
SR    REF  RULES
FLD5  YES   1
IEC   YES   6
WRD2  YES   1
WRD4  YES   9
```

From the `rtrv-scr-destfld` output, display the allowed DESTFLD screen you wish to change using the `rtrv-scr-destfld` command with the screening reference name. For this example, enter this command.

```
rtrv-scr-destfld:sr=fld5
```

The following is an example of the possible output.

```
rlghncxa03w 06-10-25 15:25:30 GMT EAGLE5 36.0.0
SCREEN = ALLOWED DESTFLD
SR   NI      NC      NCM      NSF1     NSR/ACT
fld5 100      100     100     STOP     cr
```

If a gateway screening stop action set is to be assigned to the allowed DESTFLD screen being added to the database, go to step 2. Otherwise, go to step 3.

2. Display the gateway screening stop action sets in the database with the `rtrv-gws-actset` command.

This is an example of the possible output.

```
rlghncxa03w 06-10-25 15:26:30 GMT EAGLE5 36.0.0
ACT  ACT      ACT  ACT  ACT  ACT  ACT  ACT  ACT  ACT  ACT  ACT
ID   NAME     1    2    3    4    5    6    7    8    9    10
---  ---
1    copy     copy
2    rdct     rdct
3    cr       copy rdct
4    cncf     cncf
5    cpcncf   copy cncf
6    cncfrd   cncf rdct
7    cpcfrd   copy cncf rdct

GWS action set table is (7 of 16) 44% full
```

If the required gateway screening stop action set is not in the database, perform the [Configuring Gateway Screening Stop Action Sets](#) procedure to configure the required gateway screening stop action set.

3. Display the status of the ITU National and International Spare Point Code Support feature by entering the `rtrv-ctrl-feat` command with the ITU National and International Spare Point Code Support feature part number.

**Note:** If any of these conditions apply to this procedure, skip this step and go to step 4:

- The point code in the screen is not being changed.
- The screen being changed contains either an ANSI or 24-bit ITU-N point code.
- The ITU-I or 14-bit ITU-N non-spare point code in the screen is not being changed to an ITU-I or 14-bit ITU-N spare point code.
- The point code in the screen is an ITU-I or 14-bit ITU-N spare point code or the screening reference contains other screens with ITU-I or 14-bit ITU-N spare point codes.

Enter this command.

```
rtrv-ctrl-feat:partnum=893013601
```

This is an example of the possible output.

```
rlghncxa03w 06-10-25 15:25:30 GMT EAGLE5 36.0.0
The following features have been permanently enabled:
```



```

Feature Name          Partnum  Status Quantity
Spare Point Code Support 893013601 on      ----

```

The following features have been temporarily enabled:

```

Feature Name          Partnum  Status Quantity  Trial Period Left
Zero entries found.

```

The following features have expired temporary keys:

```

Feature Name          Partnum
Zero entries found.

```

If the ITU National and International Spare Point Code Support feature is enabled, go to step 4.

If the ITU National and International Spare Point Code Support feature is not enabled, perform the “Activating the ITU National and International Spare Point Code Support Feature” procedure in *Database Administration - SS7 User’s Guide* to enable the ITU National and International Spare Point Code Support feature as required. After the feature has been enabled, go to step 4.

#### 4. Change the attributes of an allowed DESTFLD screen using the `chg-scr-destfld` command.

If a gateway screening stop action is to be assigned to the allowed DESTFLD screen being changed, enter the `chg-scr-destfld` command with the `actname` parameter with the name of a gateway screening stop action set shown in the output of the `rtrv-gws-actset` command executed in step 2.

The current values for the `ni`, `nc`, `ncm`, `zone`, `area`, `id`, `npc`, `msa`, `ssa`, and `sp` parameters must be entered exactly as shown in the `rtrv-scr-destfld` output in step 1.

The following list contains the values for the `nni`, `nnc`, `nncm`, `nzone`, `narea`, `nid`, `nnpc`, `nmsa`, `nssa`, and `nsp` parameters:

- `nni` - 0-255 or an asterisk (\*)
- `nnc` - 0-255 or an asterisk (\*)
- `nncm` - 0-255 or an asterisk (\*)
- `nzone` - 0-7 or an asterisk (\*)
- `narea` - 0-255 or an asterisk (\*)
- `nid` - 0-7 or an asterisk (\*)
- `nnpc` - 1 - 16383 or an asterisk (\*)
- `nmsa` - 0-255 or an asterisk (\*)
- `nssa` - 0-255 or an asterisk (\*)
- `nsp` - 0-255 or an asterisk (\*)

```

chg-scr-destfld:sr=fld5:ni=100:nc=100:ncm=100:nni=030:nnc=030
:nncm=030:actname=rdct

```

The following messages appear.

```

rlghncxa03w 06-10-25 15:27:30 GMT EAGLE5 36.0.0
CHG-SCR-DESTFLD: SCREEN SET AFFECTED - FLD5 1% FULL
CHG-SCR-DESTFLD: MASP A - COMPLTD

```

5. Verify the changes using the `rtrv-scr-destfld` command with screening reference name used in step 4.

For this example, enter this command.

```
rtrv-scr-destfld:sr=fld5
```

The following is an example of the possible output.

```
rlghncxa03w 06-10-25 15:28:30 GMT EAGLE5 36.0.0
SCREEN = ALLOWED DESTFLD
SR      NI      NC      NCM      NSF1     NSR/ACT
fld5   030      030      030      STOP     rdct
```

6. Backup the new changes using the `chg-db:action=backup:dest=fixed` command.

The following messages should appear, the active Maintenance and Administration Subsystem Processor (MASP) appears first.

```
BACKUP (FIXED) : MASP A - Backup starts on active MASP.
BACKUP (FIXED) : MASP A - Backup on active MASP to fixed disk complete.
BACKUP (FIXED) : MASP A - Backup starts on standby MASP.
BACKUP (FIXED) : MASP A - Backup on standby MASP to fixed disk complete.
```

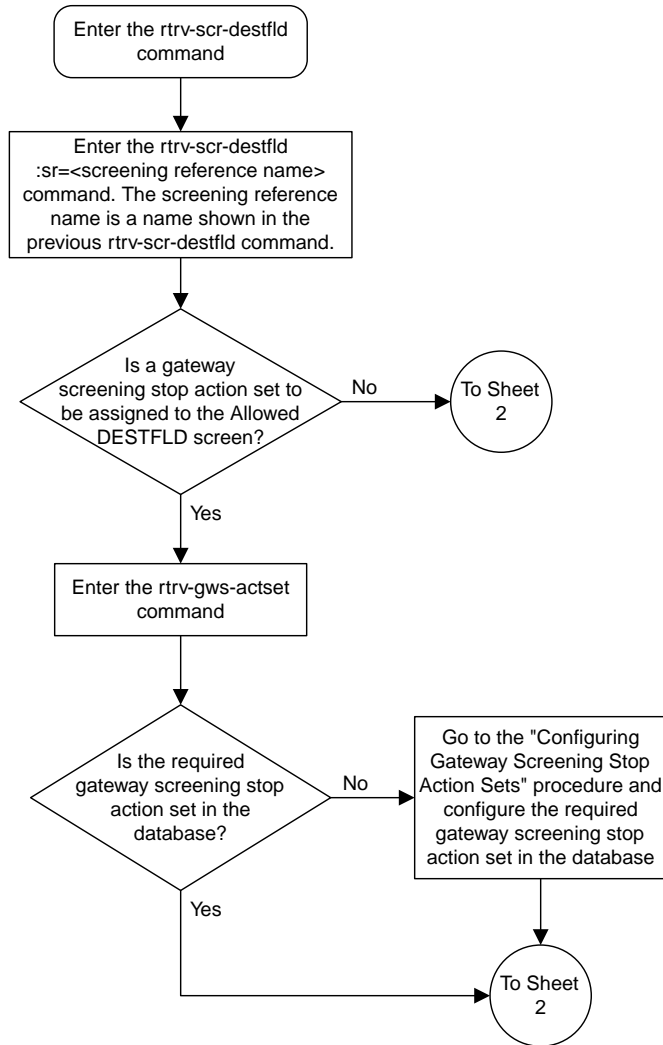

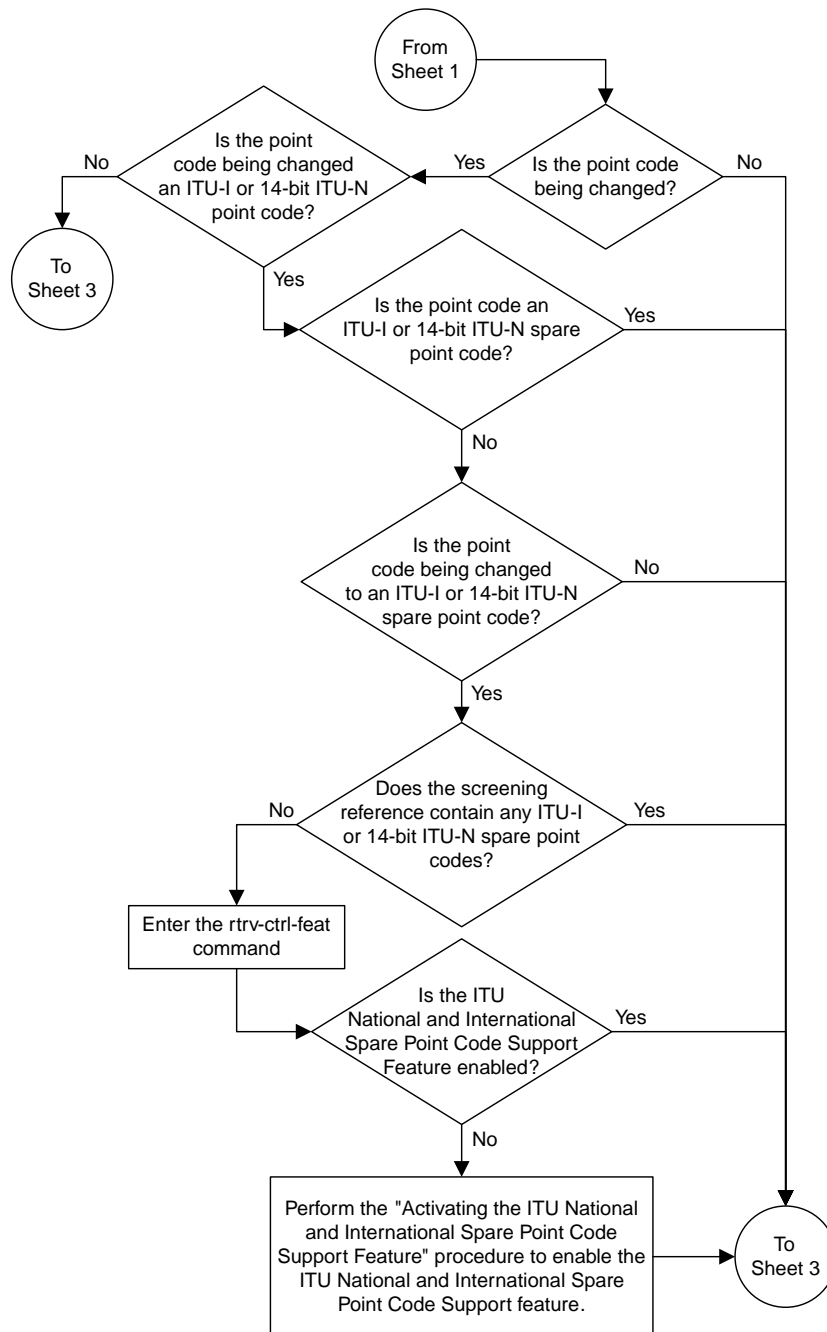

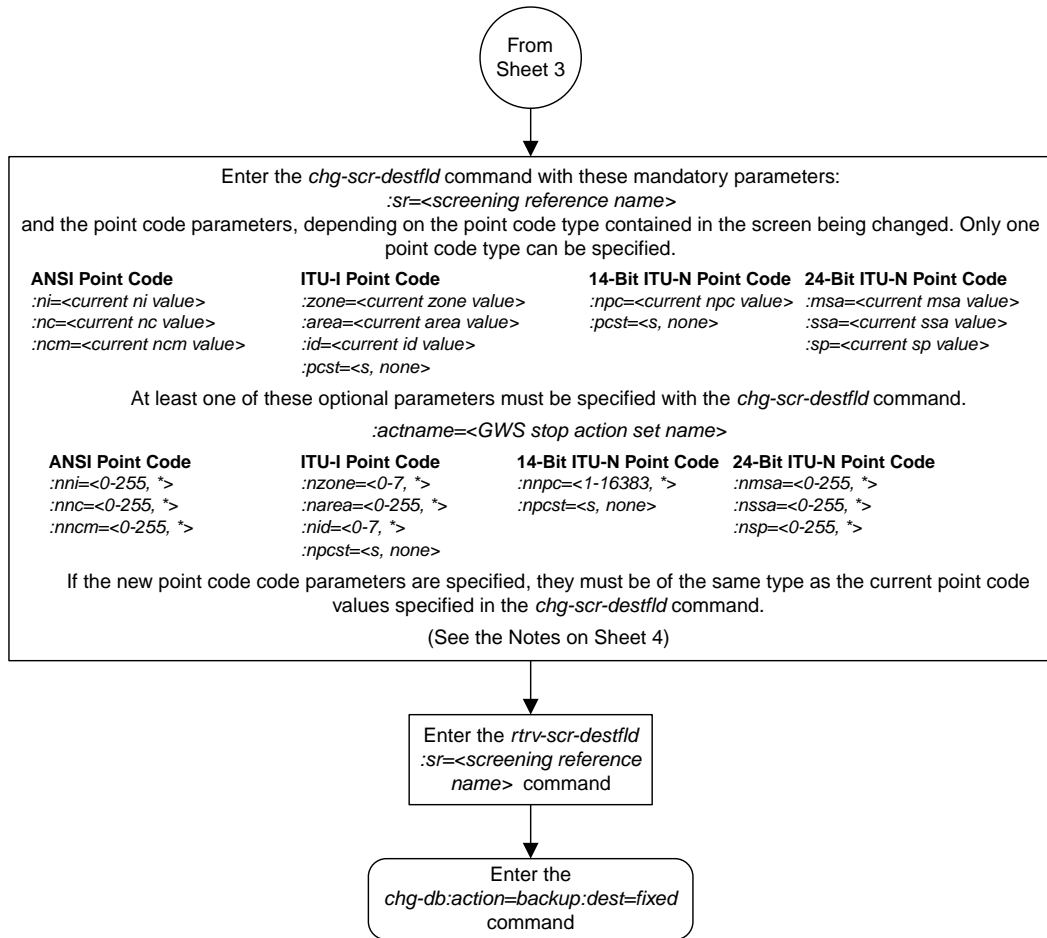

**Notes:**

1. A range of values can be specified for the *nni*, *nnc*, or *nncm* parameters by inserting double ampersands (&&) between the parameter values defining the range. For example, to specify the range 025 to 200 for the *nni* parameter, enter 025&&200 for the *nni* parameter value.
2. The asterisk (\*) specifies the entire range of values for that parameter.  
  
For more information about specifying a range of values and about using the asterisk, see the "Gateway Screening Attributes" section and the "Specifying a Range of Values" section. The "Gateway Screening Attributes" section is in the *Database Administration Manual - Gateway Screening*. The "Specifying a Range of Values" section is in the "Changing an Allowed Affected Destination Field Screen" procedure in the *Database Administration Manual - Gateway Screening*.
3. The *actname* parameter is optional. If the *actname* parameter is specified, the *actname* parameter value is one of the gateway screening stop action set names shown in the *rtrv-gws-actset* output on Sheet 1.
4. The current values for the *ni*, *nc*, *nncm*, *zone*, *area*, *id*, *npc*, *msa*, *ssa*, and *sp* parameters must be entered exactly as shown in the *rtrv-scr-destfld* output.
5. To change an ITU-I or 14-bit ITU-N spare point code to a non-spare point code, both the *pcst=s* and *npcst=none* parameters must be specified with the *chg-scr-destfld* command.
6. To change an ITU-I or 14-bit ITU-N non-spare point code to a spare point code, the *npcst=s* parameter must be specified with the *chg-scr-destfld* command. The *pcst* parameter does not have to be specified.
7. If the current point code in the screen being changed is either an ITU-I or 14-bit ITU-N spare point code, the *pcst=s* parameter must be specified with the *chg-scr-destfld* command.
8. If the current point code in the screen being changed is either an ITU-I or 14-bit ITU-N non-spare point code, the *pcst* parameter does not have to be specified with the *chg-scr-destfld* command. If the *pcst* parameter is specified for a screen containing either an ITU-I or 14-bit ITU-N non-spare point code, the *pcst* parameter value must be *none*.

Sheet 4 of 4

**Figure 44: Changing an Allowed Affected Destination Field Screen**

# Chapter 8

## Blocked Destination Point Code (BLKDPC) Screen Configuration

---

### Topics:

- [Introduction.....277](#)
- [Adding a Blocked DPC Screen.....281](#)
- [Removing a Blocked DPC Screen.....294](#)
- [Changing a Blocked DPC Screen.....299](#)

Chapter 8, Blocked Destination Point Code (BLKDPC) Screen Configuration, contains the procedures necessary to configure blocked destination point code screens.



## Introduction

The blocked DPC screen identifies DPC's that are not allowed to receive SS7 messages from another network. The gray shaded areas in [Figure 46: Blocked DPC Screening Functions](#) shows the fields of the SS7 message that are checked by the blocked DPC screening function.

## Gateway Screening Actions

If a match is found, the `nsfi` is equal to `fail`, the message is discarded and no further screening takes place.

If a match is not found, the `nsfi` is examined to determine the next step in the screening process. If the `nsfi` value is any value other than `stop`, the next screening reference (`nsr`) is identified and the screening process continues to the next screen identified by the `nsfi` and `nsr` parameter values.

If the `nsfi` is equal to `stop`, the screening process stops and the message is processed. If a gateway screening stop action set is specified with the screen, shown by the `actname` parameter value, the message is processed according to the gateway screening stop actions that are assigned to the gateway screening stop action set.

- If the `copy` gateway screening stop action is specified, the message is processed and a copy of the message is sent by the STPLAN feature to an external application.
- If the `rdct` (redirect) gateway screening stop action is specified, the message is diverted from the original destination and sent to another destination with the Database Transport Access feature, specified by global title translation, for further processing.
- If the `cncf` gateway screening stop action is specified, the PIP parameter in the incoming ISUP IAM message is converted to the GN parameter. The GN parameter in the incoming ISUP IAM message is converted to the PIP parameter. The message is then sent to the node specified by the DPC in the routing label in the message. For more information on the Calling Name Conversion Facility feature, see [Calling Name Conversion Facility \(CNCF\) Configuration](#).
- If the `tlnp` gateway screening stop action is specified, ISUP IAMs that pass gateway screening are processed either by the ISUP NP with EPAP feature (if the ISUP NP with EPAP feature is enabled and turned on) or by the Triggerless LNP feature (if the Triggerless LNP feature is turned on). The ISUP NP with EPAP feature is discussed in more detail in the *Feature Manual - G-Port*. The Triggerless LNP feature is discussed in more detail in the *ELAP Administration and LNP Feature Activation* manual.
- If the `tinp` gateway screening stop action is specified, ISUP IAMs that pass gateway screening are intercepted by the Triggerless ISUP based Number Portability (TINP) feature and converted to include the routing number (RN) if the call is to a ported number. The TINP feature is discussed in more detail in the *Feature Manual - G-Port*.
- If the `tif`, `tif2`, or `tif3` gateway screening stop actions are specified, TIF processing is applied to the message.
- If the `sccp` gateway screening stop action is specified, MTP routed SCCP UDT/XUDT are forwarded to the service modules for further processing.

## Blocked DPC Screening Actions

[Figure 45: Blocked DPC Screening Actions](#) shows the screening actions of the blocked DPC screen.

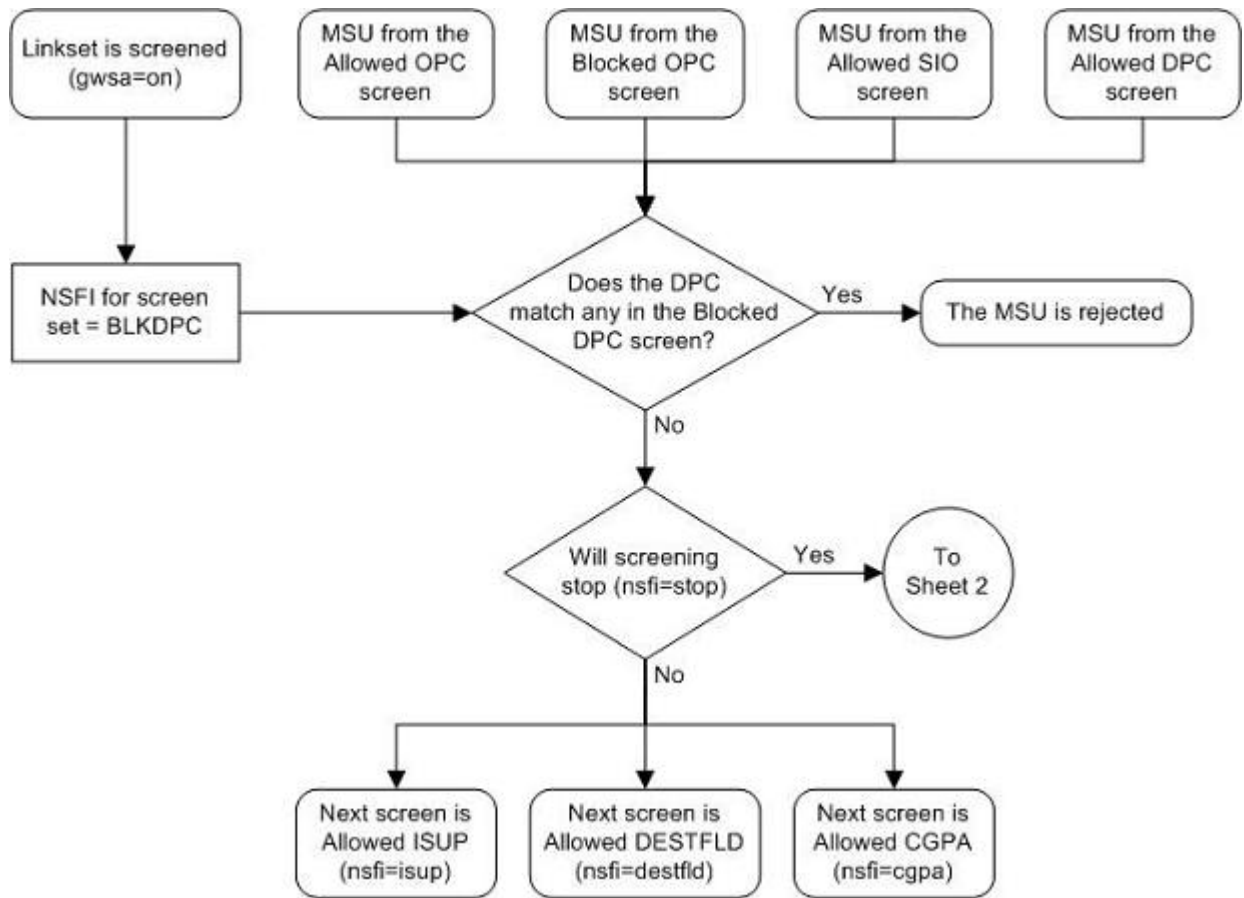

Sheet 1 of 3

Figure 45: Blocked DPC Screening Actions

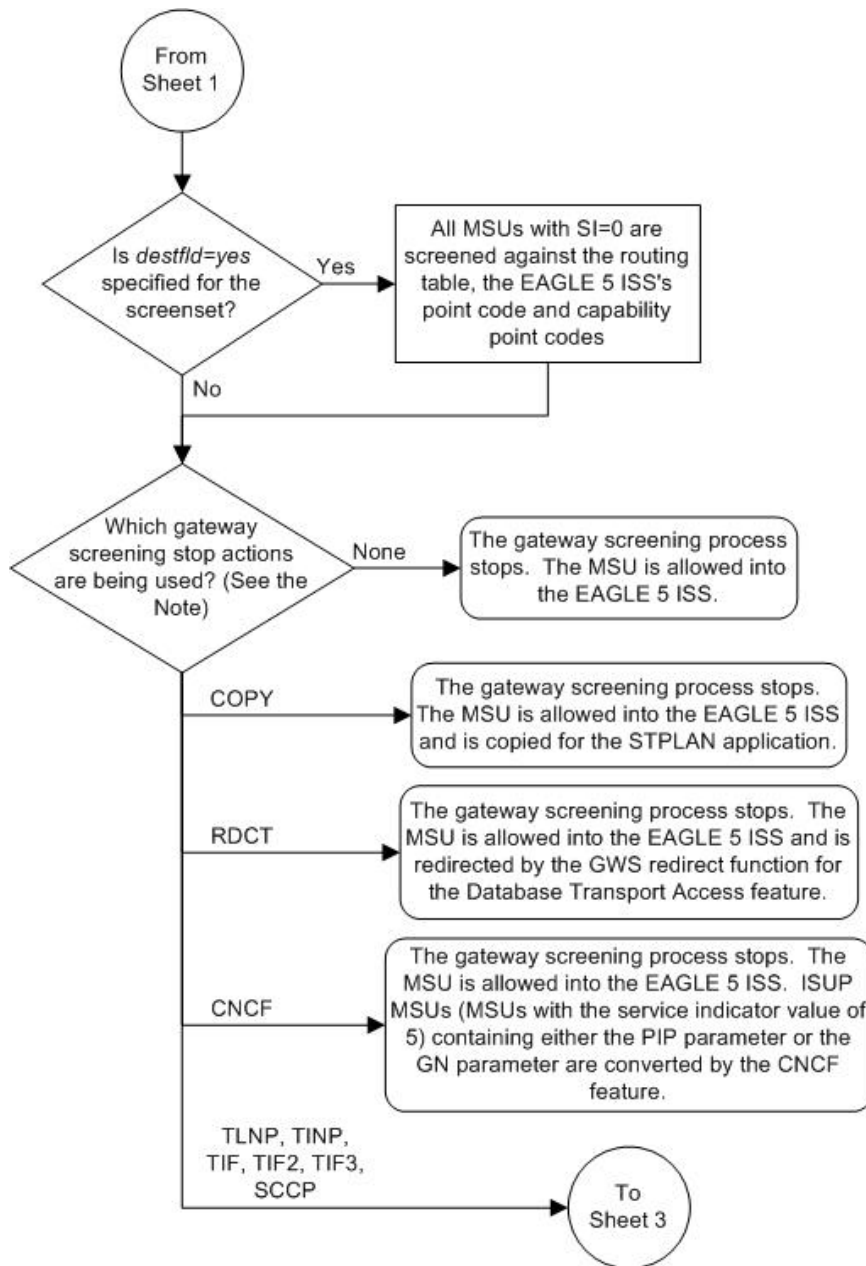

Note: Combinations of the gateway screening stop actions shown on Sheets 2 and 3 may be assigned to a gateway screening stop action set. Refer to the Configuring Gateway Screening Stop Action Sets and the Configuring TLNP Gateway Screening Stop Action Sets procedures in Chapter 2 of this manual for the combinations that can be used.

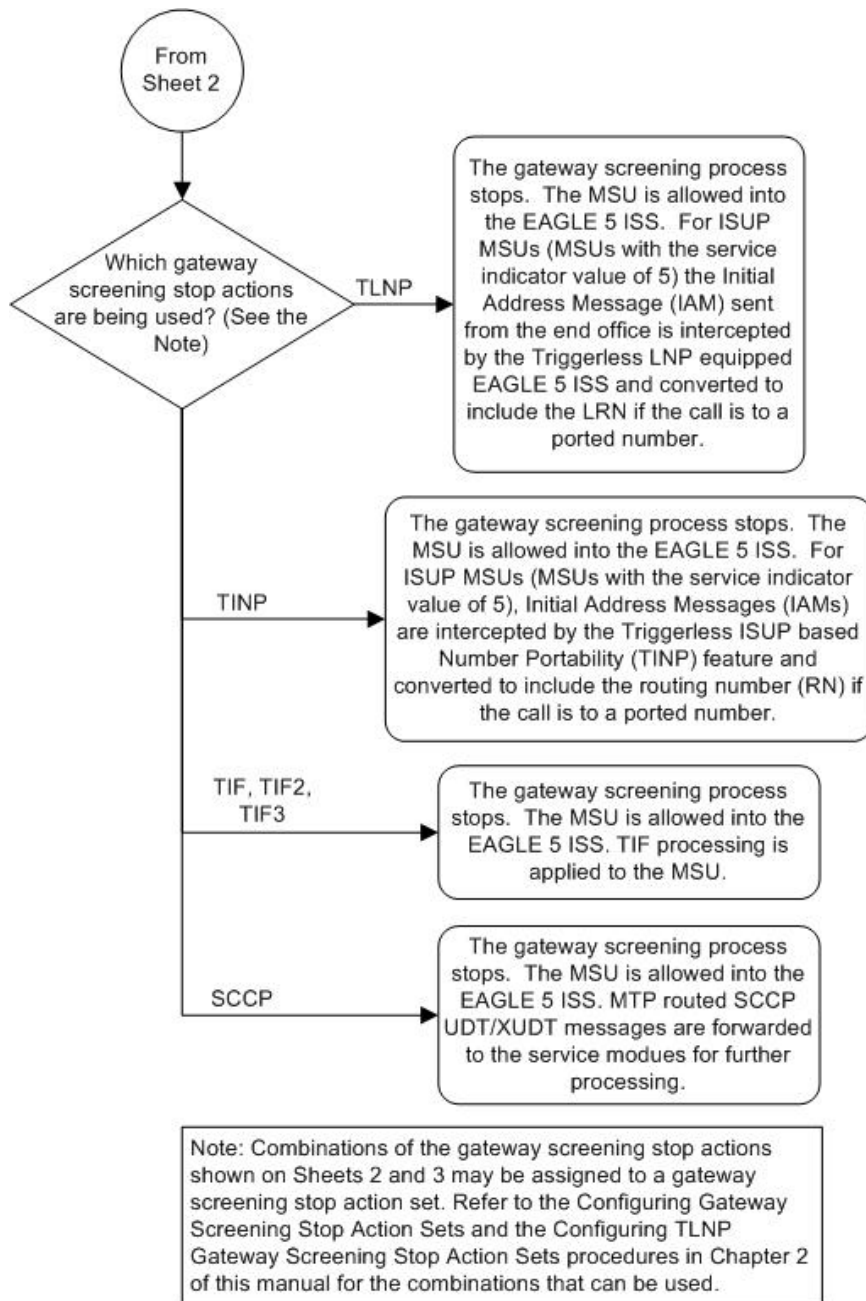

Sheet 3 of 3

ANSI MSU (ANSI Message Signal Unit)

BSN FSN LI	SIO xx xx xxxx NIC PRI SI	SIF		
		DPC NCM NC NI	Routing Label OPC NCM NC NI	SLS xx

ITU-I MSU (ITU International Message Signal Unit)

BSN FSN LI	SIO xx xx xxxx NIC PRI SI	SIF		
		DPC ID AREA ZONE	Routing Label OPC ID AREA ZONE	SLS xx

14-Bit ITU-N MSU (14-Bit ITU National Message Signal Unit)

BSN FSN LI	SIO xx xx xxxx NIC PRI SI	SIF		
		DPC NPC	Routing Label OPC NPC	SLS xx

24-Bit ITU-N MSU (24-Bit ITU National Message Signal Unit)

BSN FSN LI	SIO xx xx xxxx NIC PRI SI	SIF		
		DPC SP SSA MSA	Routing Label OPC SP SSA MSA	SLS xx

Figure 46: Blocked DPC Screening Functions

## Adding a Blocked DPC Screen

This procedure is used to add a blocked destination point code (DPC) screen to the database using the `ent-scr-blkdpc` command. The parameters used by the `ent-scr-blkdpc` command are shown in the [Gateway Screening Attributes](#) section. The general rules that apply to configuring gateway screening entities are shown in the [Gateway Screening Configuration](#) section.

The examples in this procedure are used to add the blocked DPC screen data shown in [Table 48: Example Gateway Screening Blocked DPC Configuration Table](#) and based on the example configurations shown in [Figure 4: Gateway Screening Configuration - Example 1](#) and [Figure 6: Gateway Screening Configuration - Example 3](#).

Table 48: Example Gateway Screening Blocked DPC Configuration Table

Screening Reference	NI	NC	NCM	NSFI	NSR
gws9	C	C	C	cgpa	gw13
gws9	005	005	005	fail	----
gw12	C	C	C	cgpa	gw14
gw12	004	004	004	fail	----

**Note:** If you using multiple-part ITU national point codes with gateway screening, see the [14-Bit ITU National Point Code Formats](#) section.

The blocked DPC screen can reference one of the following screens.

- Allowed Affected Destination Field
- Allowed CGPA
- Allowed ISUP

#### Verifying Gateway Screening Configuration

Enter the following commands to verify that these screens are in the database.

- `rtrv-scr-destfld:all=yes`
- `rtrv-scr-cgpa:all=yes`
- `rtrv-scr-isup:all=yes`

#### Gateway Screening Configuration Procedures

If the desired screen is not in the database, perform one of the following procedures to add the desired screen to the database or change an existing screen in the database.

- [Adding an Allowed Affected Destination Field Screen](#)
- [Adding an Allowed Calling Party Address Screen](#)
- [Adding an Allowed ISUP Message Type Screen](#)
- [Changing an Allowed Affected Destination Field Screen](#)
- [Changing an Allowed Calling Party Address Screen](#)
- [Changing an Allowed ISUP Message Type Screen](#)

For the first entry for a specific screening reference, the value for the point code must be `c`, and the NSFI must be either `stop` or `cgpa`. If the NSFI is `stop`, the screening of the message will stop at the specified blocked DPC screen. If the NSFI is `cgpa`, then any message containing a point code that is not listed in the blocked DPC screen with a NSFI equal to `fail`, will continue to be screened with the allowed CGPA screen. All subsequent entries for that screening reference must contain a numeric point code value, the NSFI must be equal to `fail`, and the `nsr` parameter cannot be specified. Any message that contains a DPC in the blocked DPC screen with the NSFI equal to `fail` will be rejected from the network and the screening process is stopped.

The `pcst` parameter, specifying whether or not the ITU-I or 14-bit ITU-N point code is a spare point code, cannot be used with the `zone=c` or `npc=c` parameters.

#### Specifying a Range of Values

A range of values can be specified for the point code parameters `ni`, `nc`, or `ncm`.

If a range of values is specified for any of these parameters, and the value of the other parameters match existing values for the screening reference name, the range of values for the point code parameter cannot include any values for that parameter that are currently provisioned for the screening reference name.

For example, screening reference name `scr1` contains these entries:

SR	NI	NC	NCM	NSFI	NSR/ACT
SCR1	C	C	C	CGPA	cg01
SCR1	240	001	010	FAIL	-----
SCR1	241	010	020	FAIL	-----

Another entry for screening reference `scr1` with the `ni` value of 240 and the `nc` value of 001 cannot be specified if the range of values for the `ncm` parameter includes the value 010.

The ANSI point code parameter values can be specified as a single value, a range of values, or with an asterisk (\*). The asterisk specifies all possible values for the `ni`, `nc`, and `ncm` parameters. [Table 49: Valid Value Combinations for ANSI Point Code Parameters](#) shows the valid combinations of these parameter values.

**Table 49: Valid Value Combinations for ANSI Point Code Parameters**

NI	NC	NCM
Single Value	Single Value	Single Value
Single Value	Single Value	Range of Values
Single Value	Single Value	Asterisk
Single Value	Range of Values	Asterisk
Single Value	Asterisk	Asterisk
Range of Values	Asterisk	Asterisk
Asterisk	Asterisk	Asterisk

A range of values can also be specified for an ITU-I or 24-bit ITU-N point code parameter using a combination of asterisks (\*) and single values for the point code parameters. [Table 50: Valid Value Combinations for ITU-I Point Code Parameters](#) shows the valid combinations of the ITU-I parameter values. [Table 51: Valid Value Combinations for 24-Bit ITU-N Point Code Parameters](#) shows the valid combinations of the 24-bit ITU-N parameter values.

**Table 50: Valid Value Combinations for ITU-I Point Code Parameters**

ZONE	AREA	ID
Single Value	Single Value	Single Value
Single Value	Single Value	Asterisk
Single Value	Asterisk	Asterisk
Asterisk	Asterisk	Asterisk

Table 51: Valid Value Combinations for 24-Bit ITU-N Point Code Parameters

MSA	SSA	SP
Single Value	Single Value	Single Value
Single Value	Single Value	Asterisk
Single Value	Asterisk	Asterisk
Asterisk	Asterisk	Asterisk

1. Verify that the gateway screening feature is on, by entering the `rtrv-feat` command.

If the gateway screening feature is on, the `GWS` field is set to `on`.

**Note:** The `rtrv-feat` command output contains other fields that are not used by this procedure. If you wish to see all the fields displayed by the `rtrv-feat` command, see the `rtrv-feat` command description in *Commands User's Guide*.

If the gateway screening feature is on, shown by the entry `GWS = on` in the `rtrv-feat` command output, skip step 2, and go to step 3.

2. Turn the gateway screening feature on by entering this command.

```
chg-feat:gws=on
```

**Note:** Once the gateway screening feature is turned on with the `chg-feat` command, it cannot be turned off.

The gateway screening feature must be purchased before you turn this feature on with the `chg-feat` command. If you are not sure if you have purchased the gateway screening feature, contact your Oracle Sales Representative or Account Representative.

When the `chg-feat` has successfully completed, this message should appear.

```
rlghncxa03w 06-10-28 11:43:04 GMT EAGLE5 36.0.0
CHG-FEAT: MASP A - COMPLTD
```

3. Display all blocked DPC screens in the database using the `rtrv-scr-blkdpc` command. The following is an example of the possible output.

```
rlghncxa03w 06-10-25 15:25:30 GMT EAGLE5 36.0.0
SCREEN = BLOCKED DPC
SR    REF  RULES
IEC   YES   6
WRD2  YES   1
WRD3  NO    4
WRD4  YES   9
```

If the screening reference names that you wish to add with this procedure are not shown in the `rtrv-scr-blkdpc` command output, go to step 4. For this example, the screening reference names are not shown. If these screening reference names are shown in the `rtrv-scr-blkdpc` command output, make sure the screening data you wish to enter is not already in the database by entering



the `rtrv-scr-blkdpc` command with the screening reference name. For example, enter the `rtrv-scr-blkdpc:sr=iec` command. The following is an example of the possible output.

```
rlghncxa03w 06-10-25 15:26:30 GMT EAGLE5 36.0.0
SCREEN = BLOCKED DPC
SR      NI      NC      NCM      NSFI      NSR/ACT
IEC     240      001      010      FAIL      -----
IEC     241      010      *        FAIL      -----

SR      NPC
IEC     00235
NSFI    NSR/ACT
FAIL    -----

SR      ZONE  AREA  ID      NSFI    NSR/ACT
IEC     1     003   4       FAIL    -----
IEC     1     003   5       FAIL    -----
IEC     C     C     C       CGPA    cg01
```

If a gateway screening stop action set is to be assigned to the blocked DPC screen being added to the database, go to step 4.

Step 4 verifies the gateway screening stop action set names in the database. The gateway screening stop action set names are assigned only if the NSFI of the screen being added in this procedure is STOP. If the NSFI of the new screen will be STOP, but a gateway screening stop action set name will not be assigned to the new screen, skip steps 4 and 5 and go to step 6. If the NSFI of the new screen is not STOP, skip step 4 and go to step 5.

4. Display the gateway screening stop action sets in the database with the `rtrv-gws-actset` command.

This is an example of the possible output.

```
rlghncxa03w 06-10-25 15:27:30 GMT EAGLE5 36.0.0
ACT  ACT  ACT  ACT  ACT  ACT  ACT  ACT  ACT  ACT  ACT
ID   NAME  1    2    3    4    5    6    7    8    9    10
---  ---
1    copy  copy
2    rdct  rdct
3    cr    copy rdct
4    cncf  cncf
5    cpcncf copy cncf
6    cncfrd cncf rdct
7    cpcfrd copy cncf rdct

GWS action set table is (7 of 16) 44% full
```

If the required gateway screening stop action set is not in the database, perform the [Configuring Gateway Screening Stop Action Sets](#) procedure to configure the required gateway screening stop action set.

**Note:** If the NSFI of the screen being added in this procedure is STOP or FAIL, skip step 5 and go to step 6.

5. Enter the commands in the [Verifying the Gateway Screening Configuration](#) section to verify that the screen that will be specified by the NSFI/NSR parameter combination in step 7 is in the database.

If the desired screen is not in the database, perform one of the procedures shown in the [Gateway Screening Configuration Procedures](#) section to add the desired screen to the database or change an existing screen in the database.

**Note:** If the point code being added in this procedure is not an ITU-I or 14-bit ITU-N spare point code, skip this step and go to step 7.

**Note:** If the point code being added in this procedure is an ITU-I or 14-bit ITU-N spare point code and the screening reference contains ITU-I or 14-bit ITU-N spare point codes, skip this step and go to step 7.

6. Display the status of the ITU National and International Spare Point Code Support feature by entering the `rtrv-ctrl-feat` command with the ITU National and International Spare Point Code Support feature part number.

Enter this command.

```
rtrv-ctrl-feat:partnum=893013601
```

This is an example of the possible output.

```
rlghncxa03w 06-10-25 15:25:30 GMT EAGLE5 36.0.0
The following features have been permanently enabled:

Feature Name          Partnum   Status  Quantity
Spare Point Code Support 893013601 on      ----

The following features have been temporarily enabled:

Feature Name          Partnum   Status  Quantity   Trial Period Left
Zero entries found.

The following features have expired temporary keys:

Feature Name          Partnum
Zero entries found.
```

If the ITU National and International Spare Point Code Support feature is enabled, go to step 7.

If the ITU National and International Spare Point Code Support feature is not enabled, perform the “Activating the ITU National and International Spare Point Code Support Feature” procedure in *Database Administration - SS7 User’s Guide* to enable the ITU National and International Spare Point Code Support feature as required. After the feature has been enabled, go to step 7.

7. Add a new blocked DPC screen to the database using the `ent-scr-blkdpc` command.

If a gateway screening stop action is to be assigned to the blocked DPC screen being added, enter the `ent-scr-blkdpc` command with the `nsfi=stop` parameter and the `actname` parameter with the name of a gateway screening stop action set shown in the output of the `rtrv-gws-actset` command executed in step 4.

The following list contains the values for `ni`, `nc`, `ncm`, `zone`, `area`, `id`, `npc`, `msa`, `ssa`, and `sp` parameters:

- `ni` - 0-255, c, or an asterisk (\*)
- `nc` - 0-255, c, or an asterisk (\*)
- `ncm` - 0-255, c, or an asterisk (\*)
- `zone` - 0-7, c, or an asterisk (\*)
- `area` - 0-255, c, or an asterisk (\*)
- `id` - 0-7, c, or an asterisk (\*)
- `npc` - 1 - 16383, c, or an asterisk (\*)

- msa - 0-255, c, or an asterisk (\*)
- ssa - 0-255, c, or an asterisk (\*)
- sp - 0-255, c, or an asterisk (\*)

A range of values can be specified for the `ni`, `nc`, and `ncm` parameters. See the [“Specifying a Range of Values”](#) section for more information on how the asterisk and a range of values are used for the `ni`, `nc`, and `ncm` parameters.

To add a spare point code to the blocked DPC screen, the `pcst=s` parameter must be specified. To add a non-spare point code to the blocked DPC screen, the `pcst` parameter does not have to be specified. If the `pcst` parameter is specified for a screen containing an ITU-I or 14-bit ITU-N non-spare point code, the value must be none. The `pcst` parameter cannot be used with the `zone=c` or `npc=c` parameters.

For this example, enter these commands.

```
ent-scr-blkdpc:sr=gws9:ni=c:nc=c:ncm=c:nsfi=cgpa:nsr=gw13
```

A message similar to the following should appear.

```
rlghncxa03w 06-10-25 15:28:30 GMT EAGLE5 36.0.0
ENT-SCR-BLKDPC: SCREEN SET AFFECTED - GWS9 1% FULL
ENT-SCR-BLKDPC: MASP A - COMPLTD
```

```
ent-scr-blkdpc:sr=gws9:ni=005:nc=005:ncm=005:nsfi=fail
```

A message similar to the following should appear.

```
rlghncxa03w 06-10-25 15:29:30 GMT EAGLE5 36.0.0
ENT-SCR-BLKDPC: SCREEN SET AFFECTED - GWS9 1% FULL
ENT-SCR-BLKDPC: MASP A - COMPLTD
```

```
ent-scr-blkdpc:sr=gw12:ni=c:nc=c:ncm=c:nsfi=cgpa:nsr=gw14
```

A message similar to the following should appear.

```
rlghncxa03w 06-10-25 15:30:30 GMT EAGLE5 36.0.0
ENT-SCR-BLKDPC: SCREEN SET AFFECTED - GW12 1% FULL
ENT-SCR-BLKDPC: MASP A - COMPLTD
```

```
ent-scr-blkdpc:sr=gw12:ni=004:nc=004:ncm=004:nsfi=fail
```

A message similar to the following should appear.

```
rlghncxa03w 06-10-25 15:31:30 GMT EAGLE5 36.0.0
ENT-SCR-BLKDPC: SCREEN SET AFFECTED - GW12 1% FULL
ENT-SCR-BLKDPC: MASP A - COMPLTD
```

8. Verify the changes using the `rtrv-scr-blkdpc` command with the screening reference name used in step 7. For this example, enter these commands.

```
rtrv-scr-blkdpc:sr=gws9
```

The following is an example of the possible output.

```
rlghncxa03w 06-10-25 15:32:30 GMT EAGLE5 36.0.0
SCREEN = BLOCKED DPC
SR      NI      NC      NCM      NSF1     NSR/ACT
GWS9   C        C        C        CGPA     GW13
GWS9   005      005      005      FAIL     -----
```

```
rtrv-scr-blkdpc:sr=gw12
```

The following is an example of the possible output.

```
rlghncxa03w 06-10-25 15:33:30 GMT EAGLE5 36.0.0
SCREEN = BLOCKED DPC
SR      NI      NC      NCM      NSF1     NSR/ACT
GW12   C        C        C        CGPA     GW14
GW12   004      004      004      FAIL     -----
```

9. Backup the new changes using the `chg-db:action=backup:dest=fixed` command.

The following messages should appear, the active Maintenance and Administration Subsystem Processor (MASP) appears first.

```
BACKUP (FIXED) : MASP A - Backup starts on active MASP.
BACKUP (FIXED) : MASP A - Backup on active MASP to fixed disk complete.
BACKUP (FIXED) : MASP A - Backup starts on standby MASP.
BACKUP (FIXED) : MASP A - Backup on standby MASP to fixed disk complete.
```

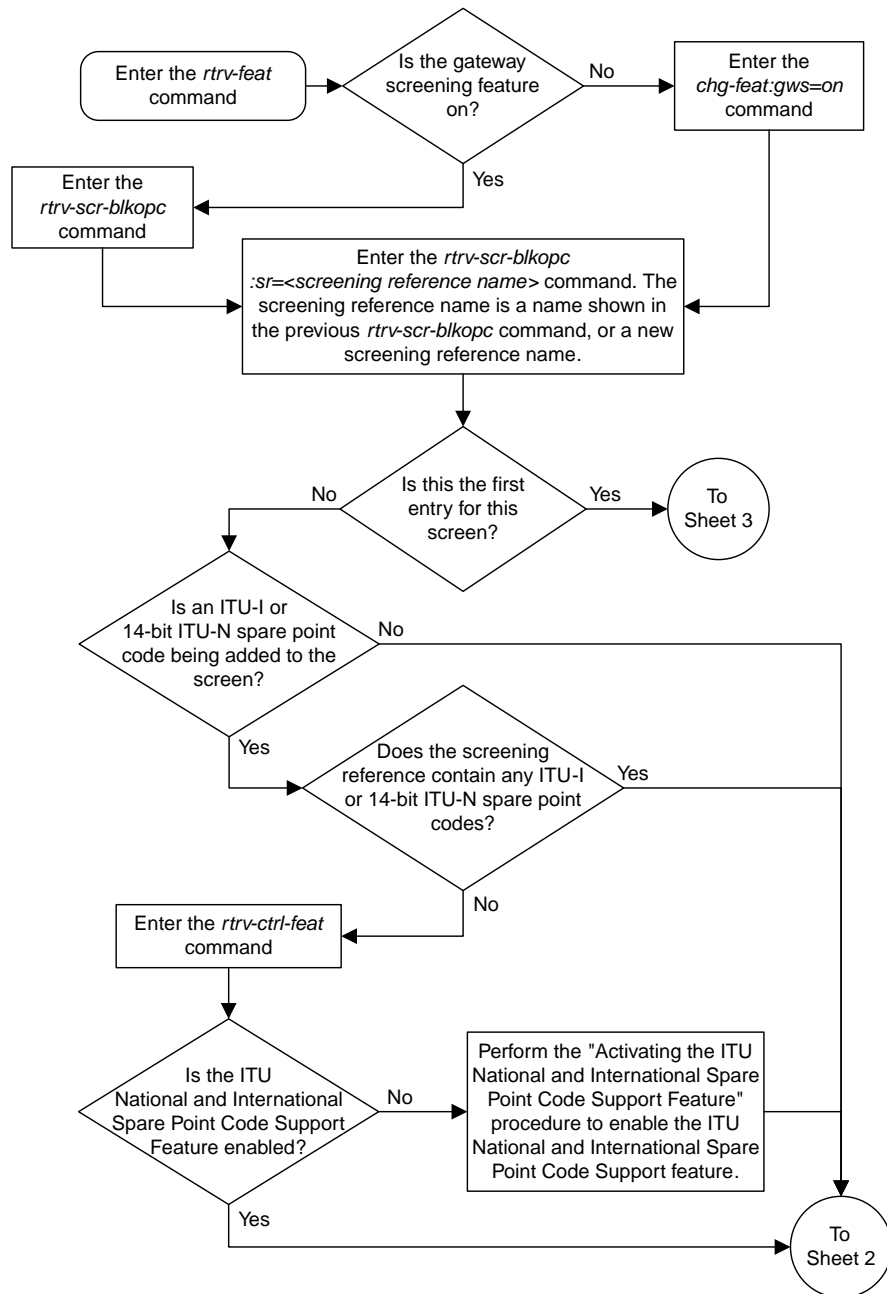

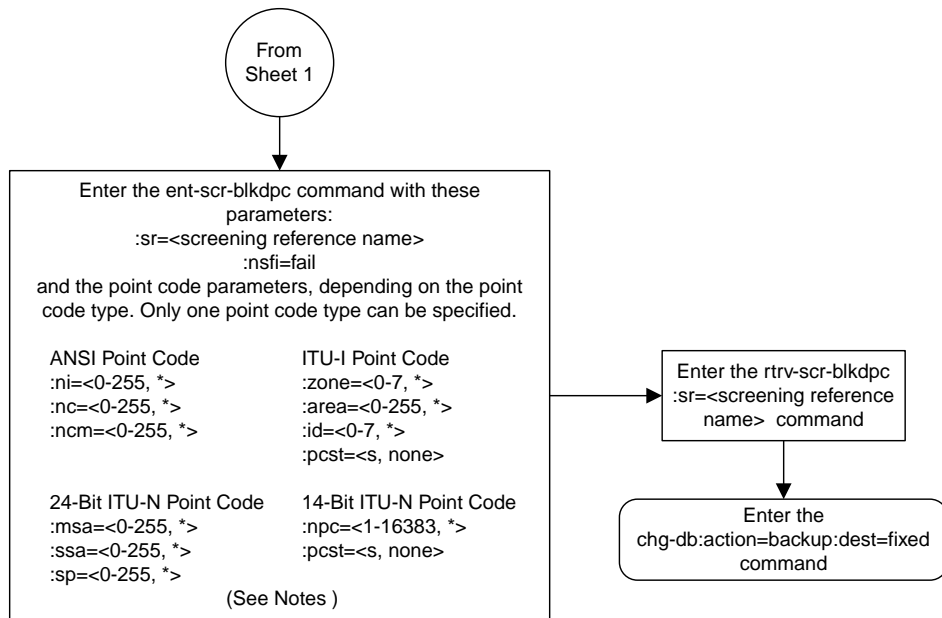

Notes:

1. A range of values can be specified for the ni, nc, or ncm parameters by inserting double ampersands (&&) between the parameter values defining the range. For example, to specify the range 025 to 200 for the ni parameter, enter 025&&200 for the ni parameter value.
2. The asterisk (\*) specifies the entire range of values for that parameter.

For more information about specifying a range of values and about using the asterisk, see the "Gateway Screening Attributes" section and the "Specifying a Range of Values" section. The "Gateway Screening Attributes" section is in the *Database Administration Manual - Gateway Screening*. The "Specifying a Range of Values" section is in the "Adding a Blocked DPC Screen" procedure in the *Database Administration Manual - Gateway Screening*.

3. To add a non-spare point code, the pcst parameter does not have to be specified. If the pcst parameter is specified for a screen containing an ITU-I or 14-bit ITU-N non-spare point code, the value must be none.
4. To add a spare point code, the pcst=s parameter must be specified.

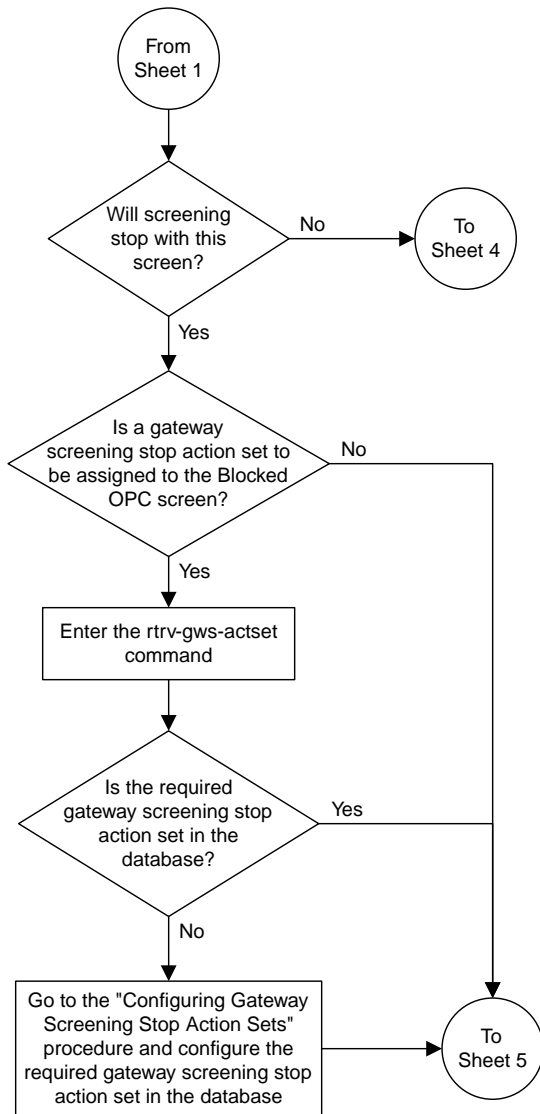

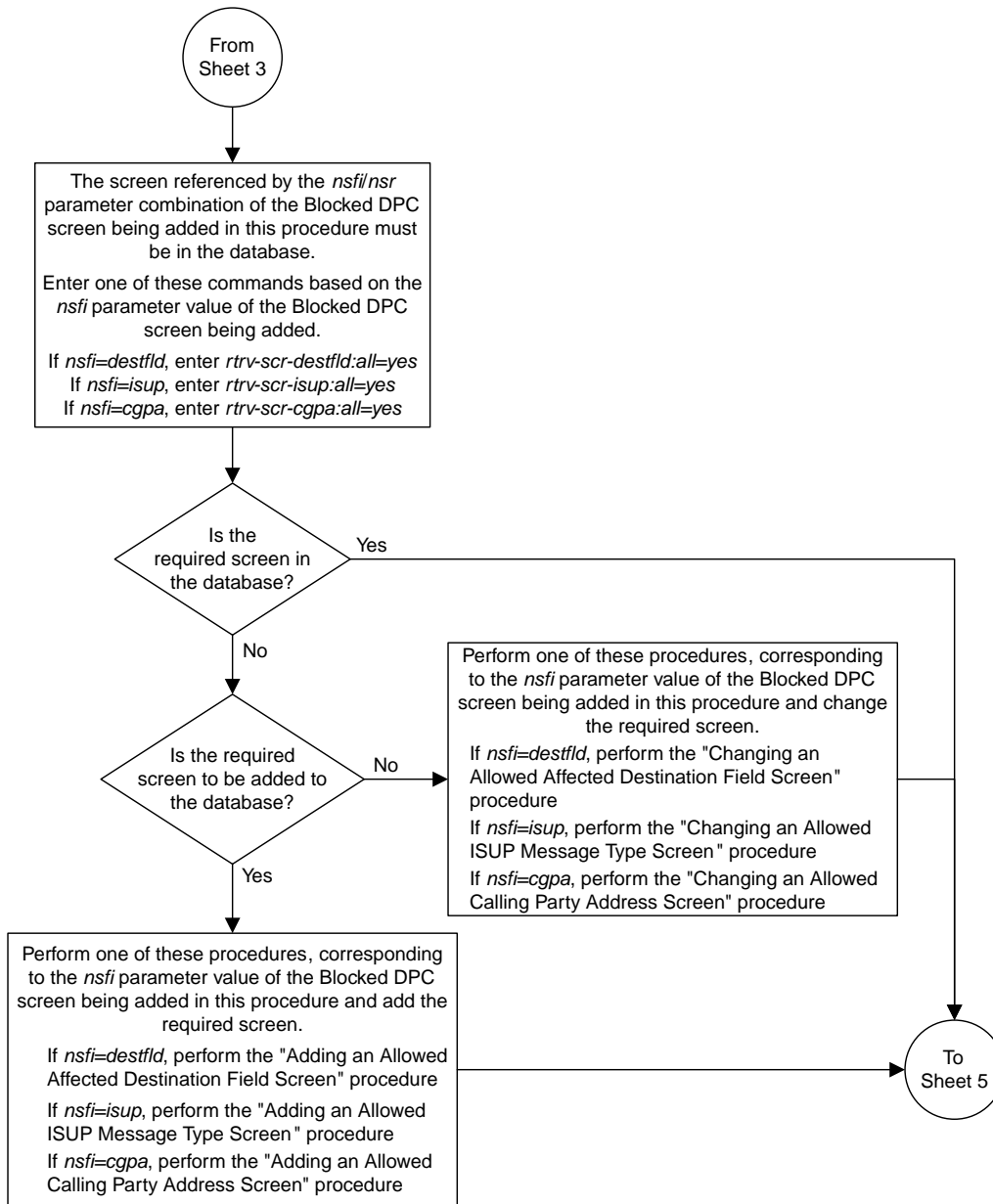



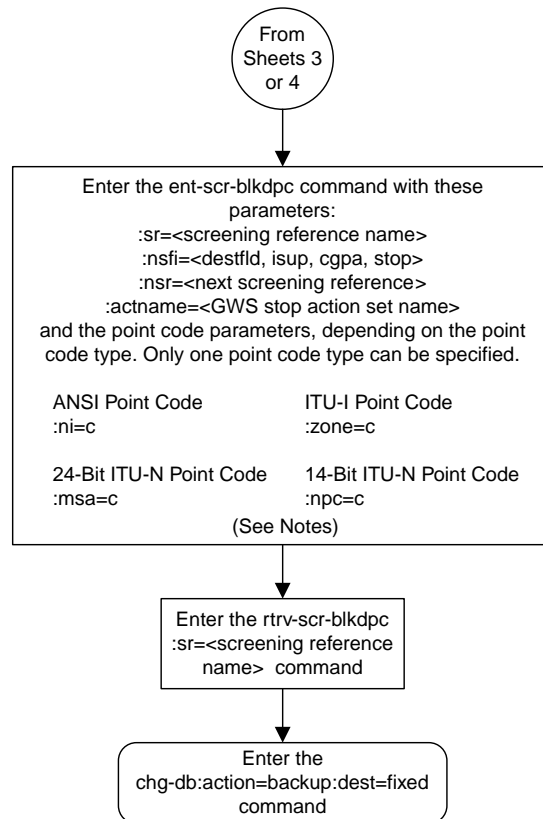

## Notes:

1. The nsr parameter can be specified only, and must be specified, if the nsfi parameter value is either destfld, isup, or cgpa.
2. The actname parameter is optional and can be specified only with the nsfi=stop parameter. If the actname parameter is specified, the actname parameter value is one of the gateway screening stop action set names shown in the rtrv-gws-actset output on Sheet 3.

Sheet 5 of 5

Figure 47: Adding a Blocked DPC Screen

## Removing a Blocked DPC Screen

This procedure is used to remove a blocked destination point code (DPC) screen from the database using the `dlt-scr-blkdp` command. The parameters used by the `dlt-scr-blkdp` command are shown in the [Gateway Screening Attributes](#) section. The general rules that apply to configuring gateway screening entities are shown in the [Gateway Screening Configuration](#) section.

The example in this procedure removes the blocked DPC screen `iec` with the point code 240-001-010 from the database.

**Note:** If you are using multiple-part ITU national point codes with gateway screening, see the [14-Bit ITU National Point Code Formats](#) section.

The `c-c-c` entry cannot be removed from the blocked DPC screen unless all other entries in the blocked DPC screen have been removed. The `c-c-c` entry cannot be removed from the blocked DPC screen if other screens reference the blocked DPC screen. If the last entry (`c-c-c`) in the blocked DPC screen is removed, the blocked DPC screen is removed. The blocked DPC screen can be referenced by one of the following screens.

- Screen Set
- Allowed OPC
- Blocked OPC
- Allowed SIO
- Allowed DPC

### Verifying the Gateway Screening Configuration

Enter the following commands to verify that none of these screens reference the blocked DPC screen being removed from the database.

- `rtrv-scrset:nsfi=blkdp`
- `rtrv-scr-opc:nsfi=blkdp`
- `rtrv-scr-blkopc:nsfi=blkdp`
- `rtrv-scr-sio:nsfi=blkdp`
- `rtrv-scr-dpc:nsfi=blkdp`

### Gateway Screening Configuration Procedures

To change the NSFI of any of these screens, perform one of these procedures.

- [Changing a Screen Set](#)
- [Changing an Allowed OPC Screen](#)
- [Changing a Blocked OPC Screen](#)
- [Changing an Allowed SIO Screen](#)
- [Changing an Allowed DPC Screen](#)

1. Display the blocked DPC screens in the database using the `rtrv-scr-blkdp` command.

The following is an example of the possible output.

```
rlghncxa03w 06-10-25 15:25:30 GMT EAGLE5 36.0.0
SCREEN = BLOCKED DPC

SR   REF  RULES
IEC  YES   6
WRD2 YES   1
WRD3 NO    4
WRD4 YES   9
```

From the `rtrv-scr-blkdpc` output, display the blocked DPC screen you wish to remove using the `rtrv-scr-blkdpc` command with the screening reference name. For this example, enter this command.

```
rtrv-scr-blkdpc:sr=iec
```

The following is an example of the possible output.

```
rlghncxa03w 06-10-25 15:25:30 GMT EAGLE5 36.0.0
SCREEN = BLOCKED DPC
SR   NI      NC      NCM      NSF1     NSR/ACT
IEC  240     001    010     FAIL     -----
IEC  241     010    *       FAIL     -----
SR   NPC
IEC  00235
SR   ZONE   AREA   ID      NSF1     NSR/ACT
IEC  1       003    4       FAIL     -----
IEC  1       003    5       FAIL     -----
IEC  C       C      C       CGPA     cg01
```

2. Enter the commands in the [Verifying the Gateway Screening Configuration](#) section to verify that the screen being removed is not referenced by other screens in the database.

If the screen being removed is referenced by other screens, perform the procedures shown in the [Gateway Screening Configuration Procedures](#) section to change the NSF1 of those screens to reference other screens or change the NSF1 of these screens to STOP.

3. Remove the blocked DPC screen from the database using the `dlt-scr-blkdpc` command with the screening reference name shown in the `rtrv-scr-blkdpc` output in step 1 and with the point code parameter values (`ni`, `nc`, `ncm`, or `zone`, `area`, `id`, `npc`, `msa`, `ssa`, or `sp`) of the screen being removed from the database. The values for these parameters must be entered exactly as shown in the `rtrv-scr-blkdpc` output.

To remove an entry containing either an ITU-I or a 14-bit ITU-N spare point code, the `pcst=s` parameter must be specified with the `dlt-scr-blkdpc` command.

To remove an entry containing either an ITU-I or a 14-bit ITU-N non-spare point code, the `pcst` parameter does not have to be specified with the `dlt-scr-blkdpc` command. If the `pcst` parameter is specified, the value must be `none`.

The `pcst` parameter cannot be used with the `zone=c` or the `npc=c` parameters.

For this example, enter this command.

```
dlt-scr-blkdpc:sr=iec:ni=240:nc=001:ncm=010
```

A message similar to the following should appear.

```
rlghncxa03w 06-10-25 15:26:30 GMT EAGLE5 36.0.0
DLT-SCR-BLKDPC: SCREEN SET AFFECTED - IEC 25% FULL
DLT-SCR-BLKDPC: MASP A - COMPLTD
```

4. Verify the changes using the `rtrv-scr-blkdpc` command with the screening reference name used in step 3.

For this example, enter this command.

```
rtrv-scr-blkdpc:sr=iec
```

The following is an example of the possible output.

```
rlghncxa03w 06-10-25 15:27:30 GMT EAGLE5 36.0.0
SCREEN = BLOCKED DPC
SR      NI      NC      NCM      NSF1      NSR/ACT
IEC     241      010      *        FAIL      -----

SR      NPC
IEC     00235
                NSF1      NSR/ACT
                FAIL      -----

SR      ZONE   AREA   ID      NSF1      NSR/ACT
IEC     1      003   4        FAIL      -----
IEC     1      003   5        FAIL      -----
IEC     C      C      C        CGPA      cg01
```

If the screen removed in step 3 was the last screen contained in the specified screening reference, the screening reference is removed from the database. The following message is displayed.

```
E2573 Cmd Rej: SR or NSR does not reference an existing SR
```

5. Backup the new changes using the `chg-db:action=backup:dest=fixed` command.

The following messages should appear, the active Maintenance and Administration Subsystem Processor (MASP) appears first.

```
BACKUP (FIXED) : MASP A - Backup starts on active MASP.
BACKUP (FIXED) : MASP A - Backup on active MASP to fixed disk complete.
BACKUP (FIXED) : MASP A - Backup starts on standby MASP.
BACKUP (FIXED) : MASP A - Backup on standby MASP to fixed disk complete.
```

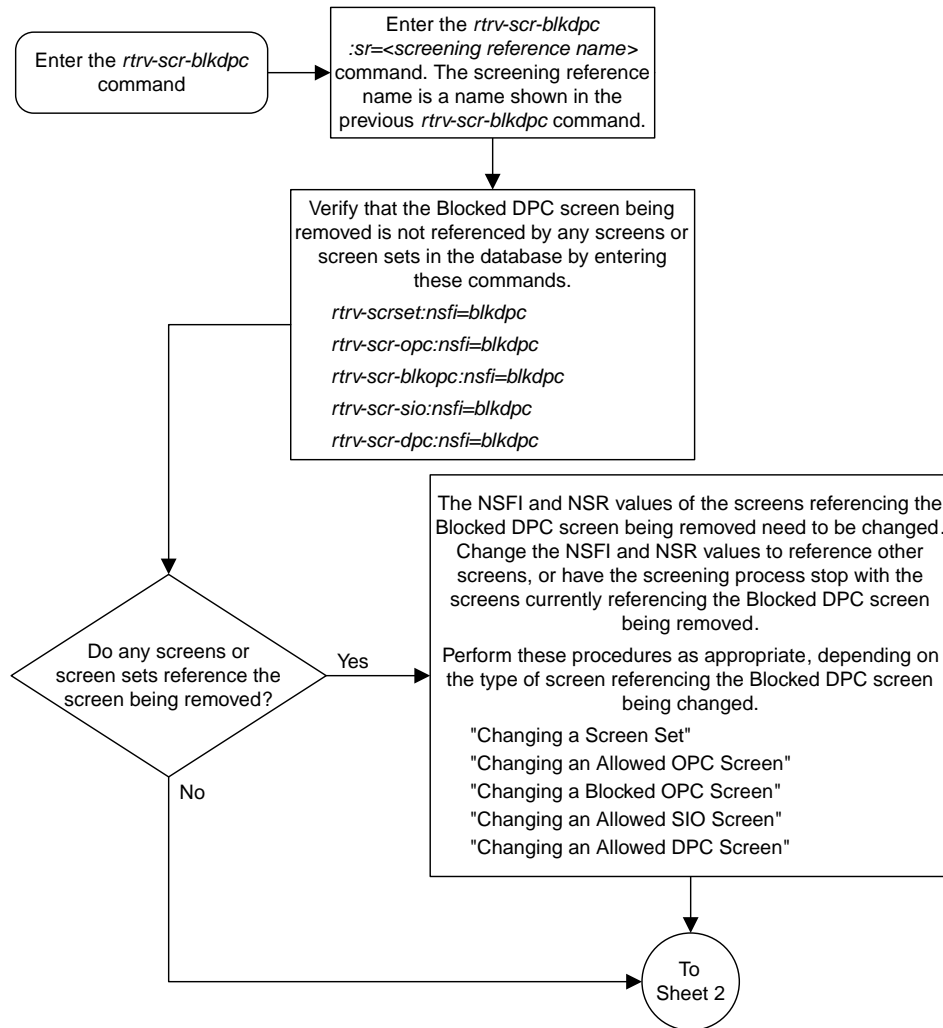

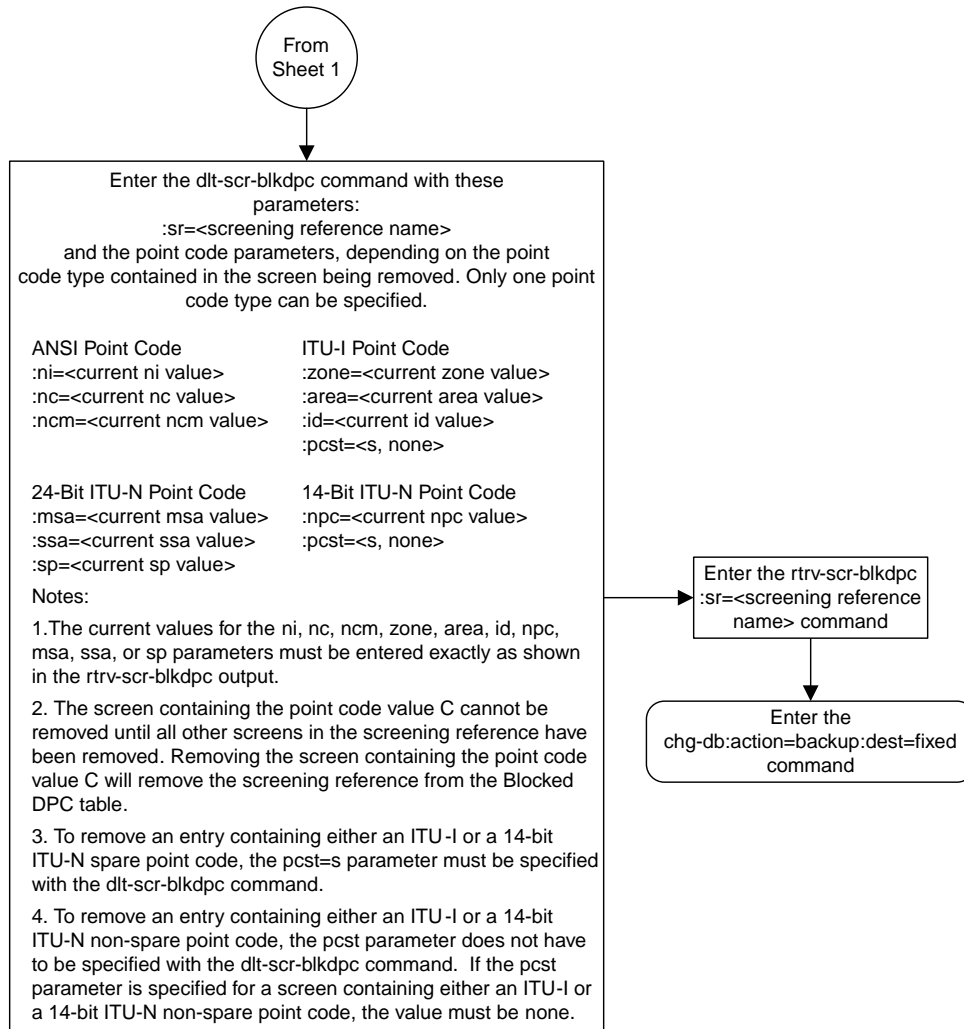

Sheet 2 of 2

**Figure 48: Removing a Blocked DPC Screen**

## Changing a Blocked DPC Screen

This procedure is used to change the attributes of a blocked destination point code (DPC) screen in the database using the `chg-scr-blkdpc` command. The parameters used by the `chg-scr-blkdpc` command are shown in the [Gateway Screening Attributes](#) section. The general rules that apply to configuring gateway screening entities are shown in the [Gateway Screening Configuration](#) section.

The example in this procedure is used to change the point code 003-003-003 for the blocked DPC screen `gw12` to 230-230-230.

**Note:** If you are using multiple-part ITU national point codes with gateway screening, see the [14-Bit ITU National Point Code Formats](#) section.

If the current `ni`, `nc`, and `ncm` are equal to the character "c", only the next screening function identifier and next screening reference can be changed. The next screening function identifier cannot be equal to `fail`. If the next screening function identifier is not equal to `stop`, the next screening reference must be specified. Otherwise, only the blocked DPC can be changed.

The blocked DPC screen can reference one of the following screens.

- Allowed Affected Destination Field
- Allowed CGPA
- Allowed ISUP

### Verifying the Gateway Screening Configuration

Enter the following commands to verify that these screens are in the database.

- `rtrv-scr-destfld:all=yes`
- `rtrv-scr-cgpa:all=yes`
- `rtrv-scr-isup:all=yes`

### Gateway Screening Configuration Procedures

If the desired screen is not in the database, perform one of these procedures to add the desired screen to the database or change an existing screen in the database.

- [Adding an Allowed Affected Destination Field Screen](#)
- [Adding an Allowed Calling Party Address Screen](#)
- [Adding an Allowed ISUP Message Type Screen](#)
- [Changing an Allowed Affected Destination Field Screen](#)
- [Changing an Allowed Calling Party Address Screen](#)
- [Changing an Allowed ISUP Message Type Screen](#)

If the NSFI is `stop`, the screening of the message will stop at the specified blocked DPC screen. If the NSFI is either `cgpa`, `destfld`, or `isup`, then any message containing a point code that is not listed in the blocked DPC screen with a NSFI equal to `fail`, will continue to be screened with either the allowed CGPA, allowed DESTFLD, or allowed ISUP screen. All subsequent entries for that screening reference must contain a numeric point code value, the NSFI must be equal to `fail`, and the `nsr`

parameter cannot be specified. Any message that contains a DPC in the blocked DPC screen with the NSFI equal to `fail` will be rejected from the network and the screening process is stopped.

The `pcst` or `npcst` parameters, specifying whether or not the ITU-I or 14-bit ITU-N point code is a spare point code, cannot be used with the `zone=c` or `npc=c` parameters.

### Specifying a Range of Values

A range of values can be specified for the point code parameters `ni`, `nc`, or `ncm`.

If a range of values is specified for any of these parameters, and the value of the other parameters match existing values for the screening reference name, the range of values for the point code parameter cannot include any values for that parameter that are currently provisioned for the screening reference name.

For example, screening reference name `scr1` contains these entries:

SR	NI	NC	NCM	NSFI	NSR/ACT
SCR1	C	C	C	CGPA	cg01
SCR1	240	001	010	FAIL	-----
SCR1	241	010	020	FAIL	-----

Another entry for screening reference `scr1` with the `ni` value of 240 and the `nc` value of 001 cannot be specified if the range of values for the `ncm` parameter includes the value 010.

The ANSI point code parameter values can be specified as a single value, a range of values, or with an asterisk (\*). The asterisk specifies all possible values for the `ni`, `nc`, and `ncm` parameters. [Table 52: Valid Value Combinations for ANSI Point Code Parameters](#) shows the valid combinations of these parameter values.

**Table 52: Valid Value Combinations for ANSI Point Code Parameters**

NI	NC	NCM
Single Value	Single Value	Single Value
Single Value	Single Value	Range of Values
Single Value	Single Value	Asterisk
Single Value	Range of Values	Asterisk
Single Value	Asterisk	Asterisk
Range of Values	Asterisk	Asterisk
Asterisk	Asterisk	Asterisk

A range of values can also be specified for an ITU-I or 24-bit ITU-N point code parameter using a combination of asterisks (\*) and single values for the point code parameters. [Table 53: Valid Value Combinations for ITU-I Point Code Parameters](#) shows the valid combinations of the ITU-I parameter values. [Table 54: Valid Value Combinations for 24-Bit ITU-N Point Code Parameters](#) shows the valid combinations of the 24-bit ITU-N parameter values.



Table 53: Valid Value Combinations for ITU-I Point Code Parameters

ZONE	AREA	ID
Single Value	Single Value	Single Value
Single Value	Single Value	Asterisk
Single Value	Asterisk	Asterisk
Asterisk	Asterisk	Asterisk

Table 54: Valid Value Combinations for 24-Bit ITU-N Point Code Parameters

MSA	SSA	SP
Single Value	Single Value	Single Value
Single Value	Single Value	Asterisk
Single Value	Asterisk	Asterisk
Asterisk	Asterisk	Asterisk

1. Display the blocked DPC screens in the database using the `rtrv-scr-blkdpc` command.

The following is an example of the possible output.

```
rlghncxa03w 06-10-25 15:25:30 GMT EAGLE5 36.0.0
SCREEN = BLOCKED DPC
SR   REF  RULES
GW12 YES   2
IEC  YES   6
WRD2 YES   1
WRD3 NO    4
WRD4 YES   9
```

From the `rtrv-scr-blkdpc` output, display the blocked DPC screen you wish to change using the `rtrv-scr-blkdpc` command with the screening reference name. For this example, enter this command.

```
rtrv-scr-blkdpc:sr=gw12
```

The following is an example of the possible output.

```
rlghncxa03w 06-10-25 15:25:30 GMT EAGLE5 36.0.0
SCREEN = BLOCKED DPC
SR  NI      NC      NCM      NSF1     NSR/ACT
GW12 C        C        C        CGPA     GW14
GW12 003     003     003     FAIL     -----
```

If a gateway screening stop action set is to be assigned to the blocked DPC screen being changed in the database, go to step 2.

Step 2 verifies the gateway screening stop action set names in the database. The gateway screening stop action set names are assigned only if the NSFI of the screen being changed in this procedure is STOP. If the NSFI of the screen will be changed to STOP, but a gateway screening stop action set name will not be assigned to the screen, skip steps 2 and 3 and go to step 4. If the NSFI of the screen will not be STOP, skip step 2 and go to step 3.

2. Display the gateway screening stop action sets in the database with the `rtrv-gws-actset` command.

This is an example of the possible output.

```
rlghncxa03w 06-10-25 15:26:30 GMT EAGLE5 36.0.0
ACT  ACT  ACT  ACT  ACT  ACT  ACT  ACT  ACT  ACT  ACT
ID   NAME  1    2    3    4    5    6    7    8    9    10
--   -
1    copy  copy
2    rdct  rdct
3    cr    copy rdct
4    cncf  cncf
5    cpcncf copy cncf
6    cncfrd cncf rdct
7    cpcf rd copy cncf rdct

GWS action set table is (7 of 16) 44% full
```

If the required gateway screening stop action set is not in the database, perform the [Configuring Gateway Screening Stop Action Sets](#) procedure to configure the required gateway screening stop action set.

**Note:** If the NSFI of the screen being changed in this procedure will be STOP or FAIL, or if the NSFI of the screen is not being changed, skip step 3 and go to step 4.

3. Enter the commands in the [Verifying the Gateway Screening Configuration](#) section to verify that the screen that will be specified by the NSFI/NSR parameter combination in step 5 is in the database.

If the desired screen is not in the database, go to one of the procedures shown in the [Gateway Screening Configuration Procedures](#) section to add the desired screen to the database or change an existing screen in the database.

**Note:** If any of these conditions apply to this procedure, skip this step and go to step 5:

- The point code in the screen is not being changed.
- The screen being changed contains either an ANSI or 24-bit ITU-N point code.
- The ITU-I or 14-bit ITU-N non-spare point code in the screen is not being changed to an ITU-I or 14-bit ITU-N spare point code.
- The point code in the screen is an ITU-I or 14-bit ITU-N spare point code or the screening reference contains other screens with ITU-I or 14-bit ITU-N spare point codes.

4. Display the status of the ITU National and International Spare Point Code Support feature by entering the `rtrv-ctrl-feat` command with the ITU National and International Spare Point Code Support feature part number.

Enter this command.

```
rtrv-ctrl-feat:partnum=893013601
```

This is an example of the possible output.

```
rlghncxa03w 06-10-25 15:25:30 GMT EAGLE5 36.0.0
The following features have been permanently enabled:

Feature Name          Partnum   Status Quantity
Spare Point Code Support 893013601 on      ----

The following features have been temporarily enabled:

Feature Name          Partnum   Status Quantity   Trial Period Left
Zero entries found.

The following features have expired temporary keys:

Feature Name          Partnum
Zero entries found.
```

If the ITU National and International Spare Point Code Support feature is enabled, go to step 5.

If the ITU National and International Spare Point Code Support feature is not enabled, perform the “Activating the ITU National and International Spare Point Code Support Feature” procedure in the *Database Administration Manual - SS7* to enable the ITU National and International Spare Point Code Support feature as required. After the feature has been enabled, go to step 5.

5. Change the attributes of a blocked DPC screen using the `chg-scr-blkdpc` command.

If a gateway screening stop action is to be assigned to the blocked DPC screen being changed, enter the `chg-scr-blkdpc` command with the `nsfi=stop` parameter and the `actname` parameter with the name of a gateway screening stop action set shown in the output of the `rtrv-gws-actset` command executed in step 2.

The current values for the `ni`, `nc`, `ncm`, `zone`, `area`, `id`, `npc`, `msa`, `ssa`, and `sp` parameters must be entered exactly as shown in the `rtrv-scr-blkdpc` output in step 1.

The following list contains the values for the `nni`, `nnc`, `nncm`, `nzone`, `narea`, `nid`, `nnpc`, `nmsa`, `nssa`, and `nsp` parameters:

- `nni` – 0 - 255, c, or an asterisk (\*)
- `nnc` – 0 - 255, c, or an asterisk (\*)
- `nncm` – 0 - 255, c, or an asterisk (\*)
- `nzone` – 0 - 7, c, or an asterisk (\*)
- `narea` – 0 - 255, c, or an asterisk (\*)
- `nid` – 0 - 7, c, or an asterisk (\*)
- `nnpc` – 1 - 16383, c, or an asterisk (\*)
- `nmsa` – 0 - 255, c, or an asterisk (\*)
- `nssa` – 0 - 255, c, or an asterisk (\*)
- `nsp` – 0 - 255, c, or an asterisk (\*)

A range of values can be specified for the `nni`, `nnc`, and `nncm` parameters. See the “[Specifying a Range of Values](#)” section for more information on how the asterisk and a range of values are used for the `nni`, `nnc`, and `nncm` parameters.

To change an ITU-I or 14-bit ITU-N spare point code to a non-spare point code, both the `pcst=s` and `npcst=none` parameters must be specified with the `chg-scr-blkdpc` command.

To change an ITU-I or 14-bit ITU-N non-spare point code to a spare point code, the `npcst=s` parameter must be specified with the `chg-scr-blkdpc` command. The `pcst` parameter does not have to be specified.

If the current point code in the screen being changed is either an ITU-I or 14-bit ITU-N spare point code, the `pcst=s` parameter must be specified with the `chg-scr-blkdpc` command.

If the current point code in the screen being changed is either an ITU-I or 14-bit ITU-N non-spare point code, the `pcst` parameter does not have to be specified with the `chg-scr-blkdpc` command. If the `pcst` parameter is specified for a screen containing either an ITU-I or 14-bit ITU-N non-spare point code, the `pcst` parameter value must be none.

The `pcst` or `npcst` parameters cannot be used with the `zone=c` or `npc=c` parameters.

For this example, enter this command.

```
chg-scr-blkdpc:sr=gw12:ni=003:nc=003:ncm=003:nni=230:nnc=230 :nncm=230
```

The following messages appear.

```
rlghncxa03w 06-10-25 15:27:30 GMT EAGLE5 36.0.0
CHG-SCR-BLKDPC: SCREEN SET AFFECTED - GW12 1% FULL
CHG-SCR-BLKDPC: MASP A - COMPLTD
```

6. Verify the changes using the `rtrv-scr-blkdpc` command with the screening reference name used in step 5.

For this example, enter this command.

```
rtrv-scr-blkdpc:sr=gw12
```

The following is an example of the possible output.

```
rlghncxa03w 06-10-25 15:28:30 GMT EAGLE5 36.0.0
SCREEN = BLOCKED DPC
SR   NI      NC      NCM      NSF1     NSR/ACT
GW12 C         C       C        CGPA     GW14
GW12 230      230     230     FAIL     -----
```

7. Backup the new changes using the `chg-db:action=backup:dest=fixed` command.

The following messages should appear, the active Maintenance and Administration Subsystem Processor (MASP) appears first.

```
BACKUP (FIXED) : MASP A - Backup starts on active MASP.
BACKUP (FIXED) : MASP A - Backup on active MASP to fixed disk complete.
BACKUP (FIXED) : MASP A - Backup starts on standby MASP.
BACKUP (FIXED) : MASP A - Backup on standby MASP to fixed disk complete.
```

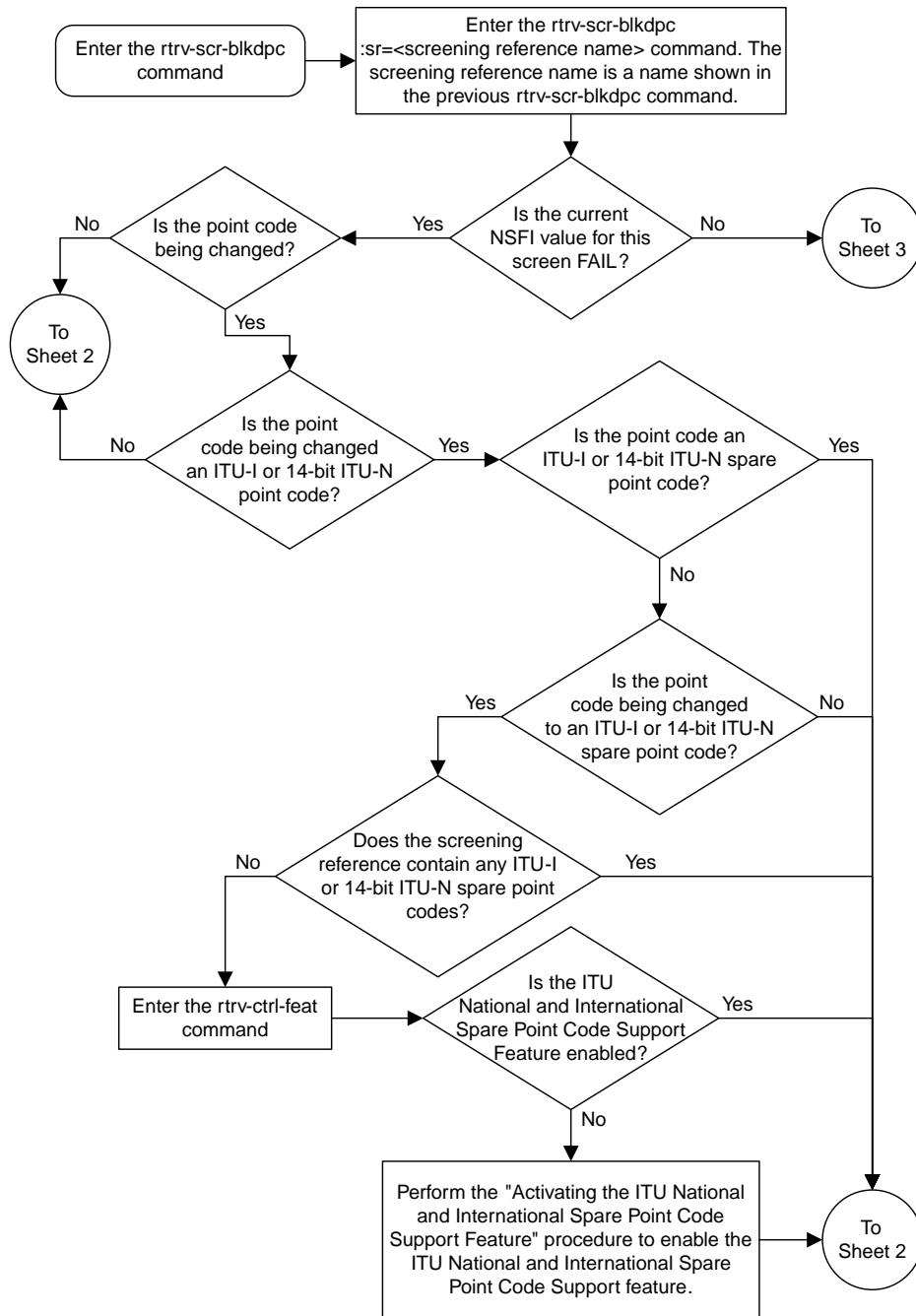

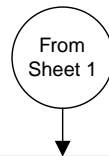

Enter the chg-scr-blkdpc command with this mandatory parameter:  
:sr=<screening reference name>  
and the point code parameters, depending on the point code type contained in the screen being changed. Only one point code type can be specified.

ANSI Point Code	ITU-I Point Code	14-Bit ITU-N Point Code	24-Bit ITU-N Point Code
:ni=<current ni value>	:zone=<current zone value>	:npc=<current npc value>	:msa=<current msa value>
:nc=<current nc value>	:area=<current area value>	:pcst=<s, none>	:ssa=<current ssa value>
:ncm=<current ncm value>	:id=<current id value>		:sp=<current sp value>
	:pcst=<s, none>		

At least one of these optional point code parameters must be specified with the chg-scr-blkdpc command.

ANSI Point Code	ITU-I Point Code	14-Bit ITU-N Point Code	24-Bit ITU-N Point Code
:nni=<0-255, *>	:nzone=<0-7, *>	:nnpc=<1-16383, *>	:nmsa=<0-255, *>
:nnc=<0-255, *>	:narea=<0-255, *>	:npcst=<s, none>	:nssa=<0-255, *>
:nncm=<0-255, *>	:nid=<0-7, *>		:nsp=<0-255, *>
	:npcst=<s, none>		

The new point code code parameters must be of the same type as the current point code values specified in the chg-scr-blkdpc command  
(See Notes )

Enter the rtrv-scr-blkdpc  
:sr=<screening reference  
name> command

Enter the  
chg-db:action=backup:dest=fixed  
command

- Notes:
1. A range of values can be specified for the nni, nnc, or nncm parameters by inserting double ampersands (&&) between the parameter values defining the range. For example, to specify the range 025 to 200 for the nni parameter, enter 025&&200 for the nni parameter value.
  2. The current values for the ni, nc, ncm, zone, area, id, npc, msa, ssa, or sp parameters must be entered exactly as shown in the rtrv-scr-blkdpc output. The current point code value cannot be C.
  3. The asterisk (\*) specifies the entire range of values for that parameter.
- For more information about specifying a range of values and about using the asterisk, see the "Gateway Screening Attributes" section and the "Specifying a Range of Values" section. The "Gateway Screening Attributes" section is in the *Database Administration Manual - Gateway Screening*. The "Specifying a Range of Values" section is in the "Changing a Blocked DPC Screen" procedure in the *Database Administration Manual - Gateway Screening*.
4. To change an ITU-I or 14-bit ITU-N spare point code to a non-spare point code, both the pcst=s and npcst=none parameters must be specified with the chg-scr-blkdpc command.
  5. To change an ITU-I or 14-bit ITU-N non-spare point code to a spare point code, the npcst=s parameter must be specified with the chg-scr-blkdpc command. The pcst parameter does not have to be specified.
  6. If the current point code in the screen being changed is either an ITU-I or 14-bit ITU-N spare point code, the pcst=s parameter must be specified with the chg-scr-blkdpc command.
  7. If the current point code in the screen being changed is either an ITU-I or 14-bit ITU-N non-spare point code, the pcst parameter does not have to be specified with the chg-scr-blkdpc command. If the pcst parameter is specified for a screen containing either an ITU-I or 14-bit ITU-N non-spare point code, the pcst parameter value must be none.

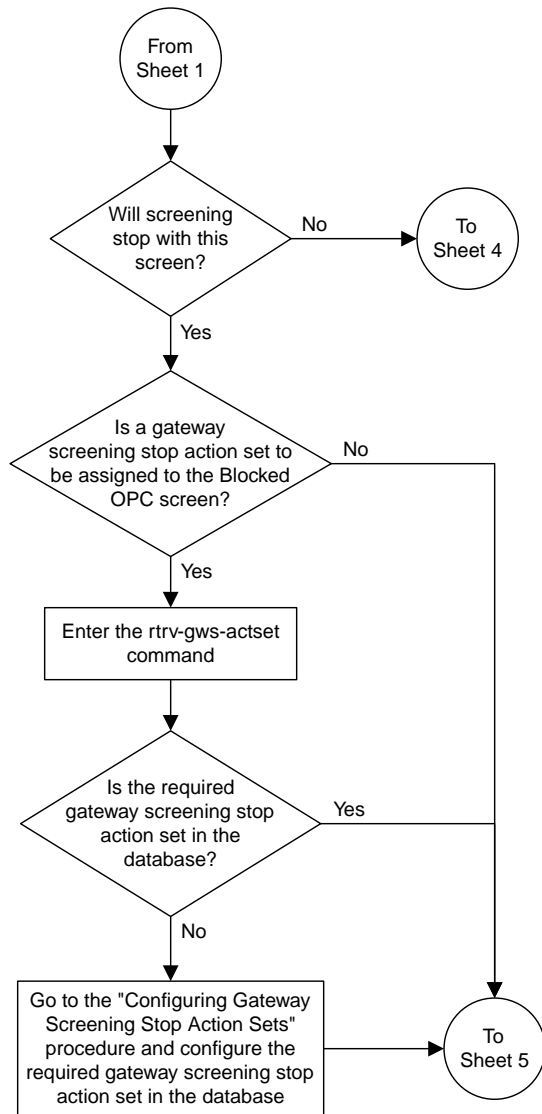

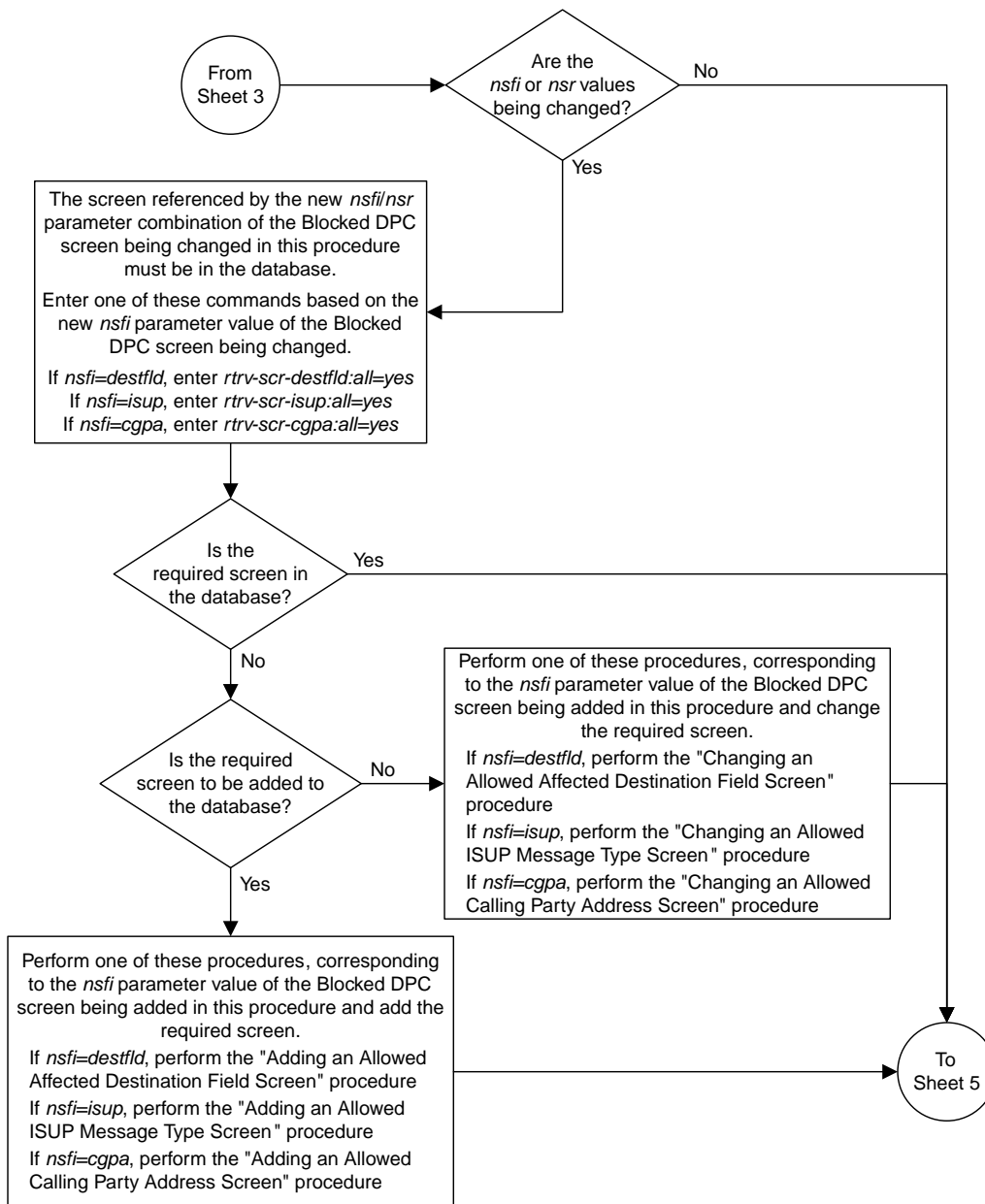



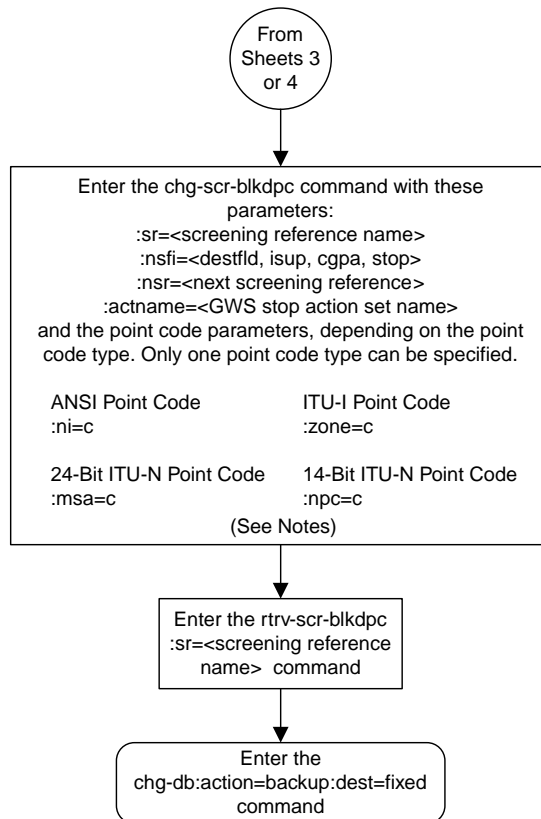

Notes:

1. The nsr parameter can be specified only, and must be specified, if the nsfi parameter value is either destfld, isup, or cgpa.
2. The actname parameter is optional and can be specified only with the nsfi=stop parameter. If the actname parameter is specified, the actname parameter value is one of the gateway screening stop action set names shown in the rtrv-gws-actset output on Sheet 3.

Sheet 5 of 5

**Figure 49: Changing a Blocked DPC Screen**

## Allowed Destination Point Code (DPC) Screen Configuration

---

### Topics:

- [Introduction.....312](#)
- [Adding an Allowed DPC Screen.....316](#)
- [Removing an Allowed DPC Screen.....330](#)
- [Changing an Allowed DPC Screen.....334](#)

Chapter 9, Allowed Destination Point Code (DPC) Screen Configuration, contains the procedures necessary to configure allowed destination point code screens.

## Introduction

The allowed destination point code (DPC) screen identifies a set of DPC's that are allowed to receive SS7 messages from another network. The gray shaded areas in [Figure 51: Allowed DPC Screening Functions](#) shows the fields of the SS7 message that are checked by the allowed DPC screening function.

## Gateway Screening Actions

If a match is not found, the message is discarded.

If a match is found, the `nsfi` is examined to determine the next step in the screening process. If the `nsfi` value is any value other than `stop`, the next screening reference (`nsr`) is identified and the screening process continues to the next screen identified by the `nsfi` and `nsr` parameter values.

If the `nsfi` is equal to `stop`, the screening process stops and the message is processed. If a gateway screening stop action set is specified with the screen, shown by the `actname` parameter value, the message is processed according to the gateway screening stop actions that are assigned to the gateway screening stop action set.

- If the `copy` gateway screening stop action is specified, the message is processed and a copy of the message is sent by the STPLAN feature to an external application.
- If the `rdct` (redirect) gateway screening stop action is specified, the message is diverted from the original destination and sent to another destination with the Database Transport Access feature, specified by global title translation, for further processing.
- If the `cncf` gateway screening stop action is specified, the PIP parameter in the incoming ISUP IAM message is converted to the GN parameter. The GN parameter in the incoming ISUP IAM message is converted to the PIP parameter. The message is then sent to the node specified by the DPC in the routing label in the message. For more information on the Calling Name Conversion Facility feature, see [Calling Name Conversion Facility \(CNCF\) Configuration](#).
- If the `tlnp` gateway screening stop action is specified, ISUP IAMs that pass gateway screening are processed either by the ISUP NP with EPAP feature (if the ISUP NP with EPAP feature is enabled and turned on) or by the Triggerless LNP feature (if the Triggerless LNP feature is turned on). The ISUP NP with EPAP feature is discussed in more detail in *G-Port User's Guide*. The Triggerless LNP feature is discussed in more detail in *ELAP Administration and LNP Feature Activation Guide*.
- If the `tinp` gateway screening stop action is specified, ISUP IAMs that pass gateway screening are intercepted by the Triggerless ISUP based Number Portability (TINP) feature and converted to include the routing number (RN) if the call is to a ported number. The TINP feature is discussed in more detail in *G-Port User's Guide*.
- If the `tif`, `tif2`, or `tif3` gateway screening stop actions are specified, TIF processing is applied to the message.
- If the `sccp` gateway screening stop action is specified, MTP routed SCCP UDT/XUDT are forwarded to the service modules for further processing.

## Allowed DPC Screening Actions

[Figure 50: Allowed DPC Screening Actions](#) shows the screening actions of the allowed DPC screen.

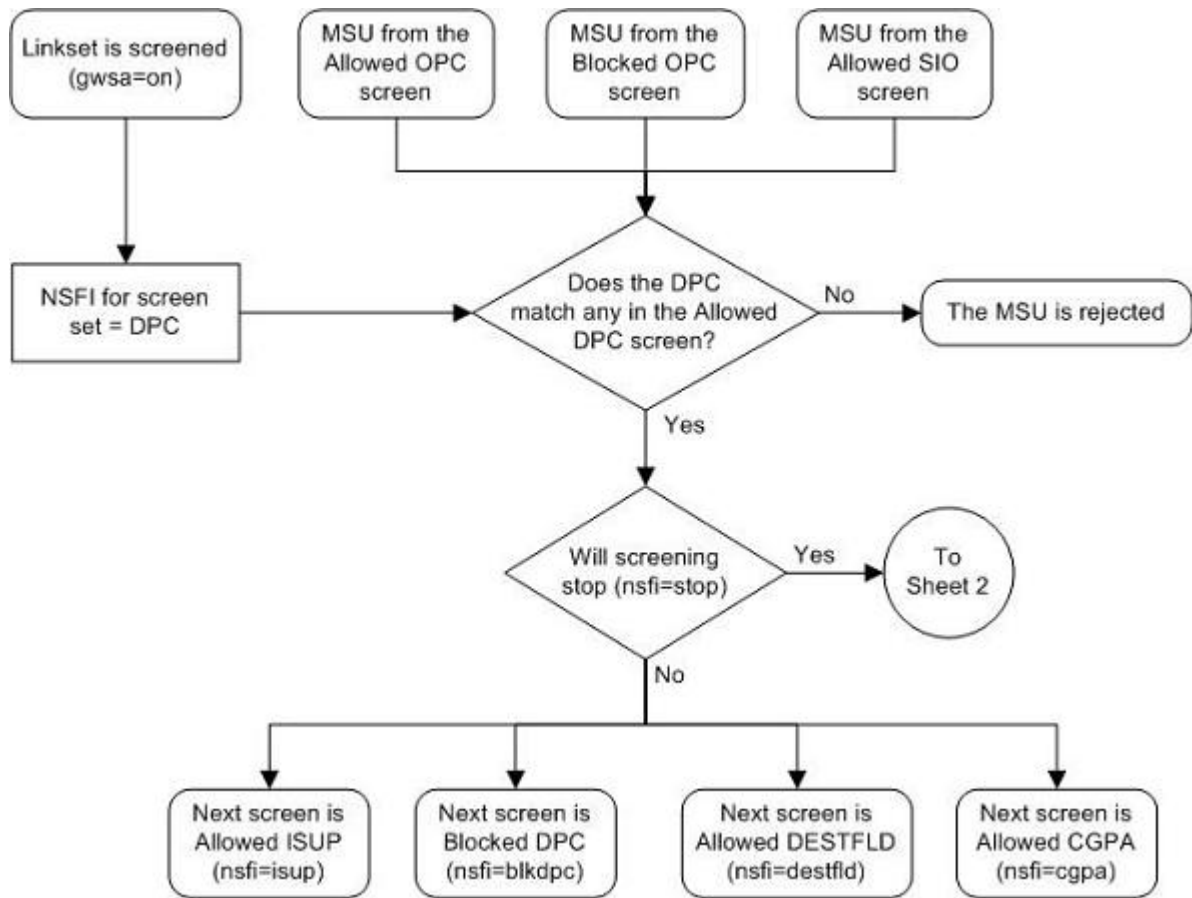

Sheet 1 of 3

Figure 50: Allowed DPC Screening Actions

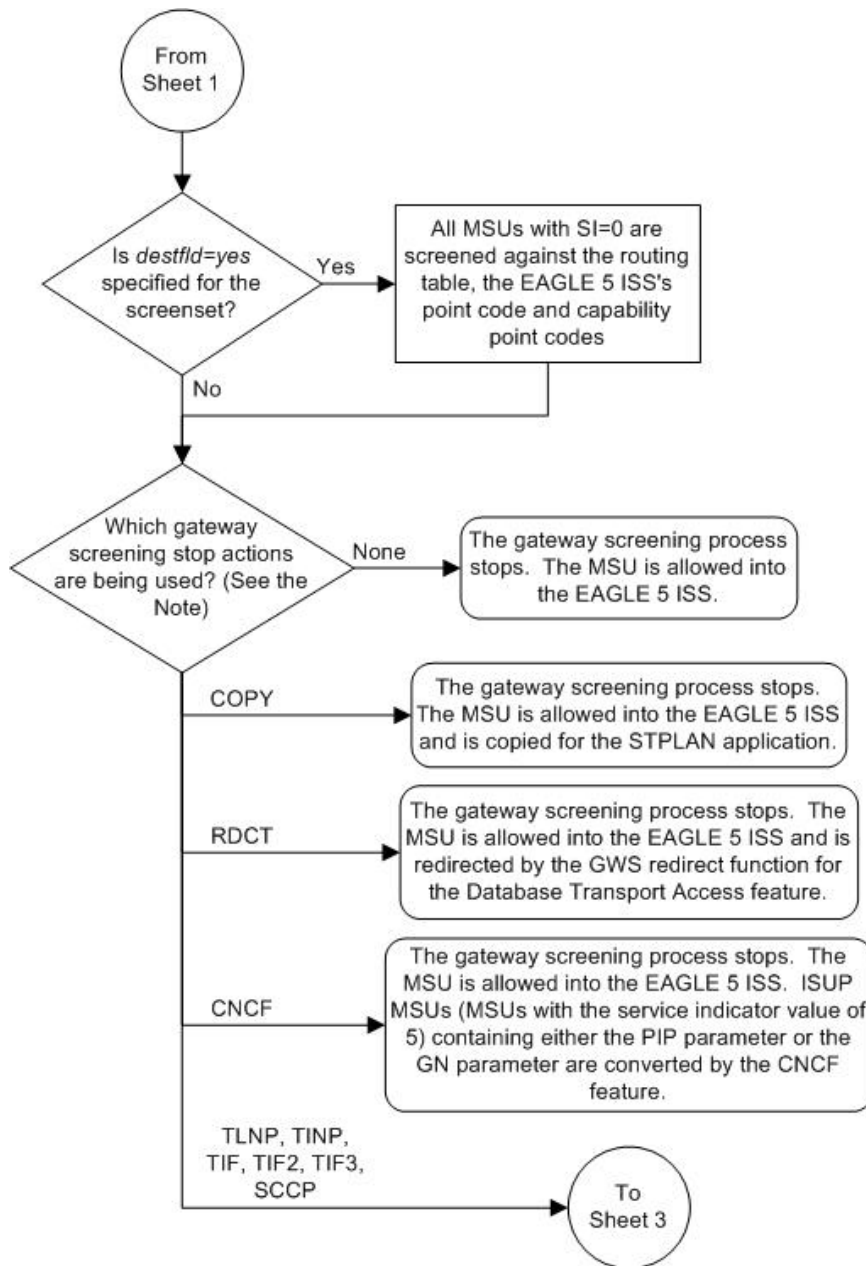

Note: Combinations of the gateway screening stop actions shown on Sheets 2 and 3 may be assigned to a gateway screening stop action set. Refer to the Configuring Gateway Screening Stop Action Sets and the Configuring TLNP Gateway Screening Stop Action Sets procedures in Chapter 2 of this manual for the combinations that can be used.

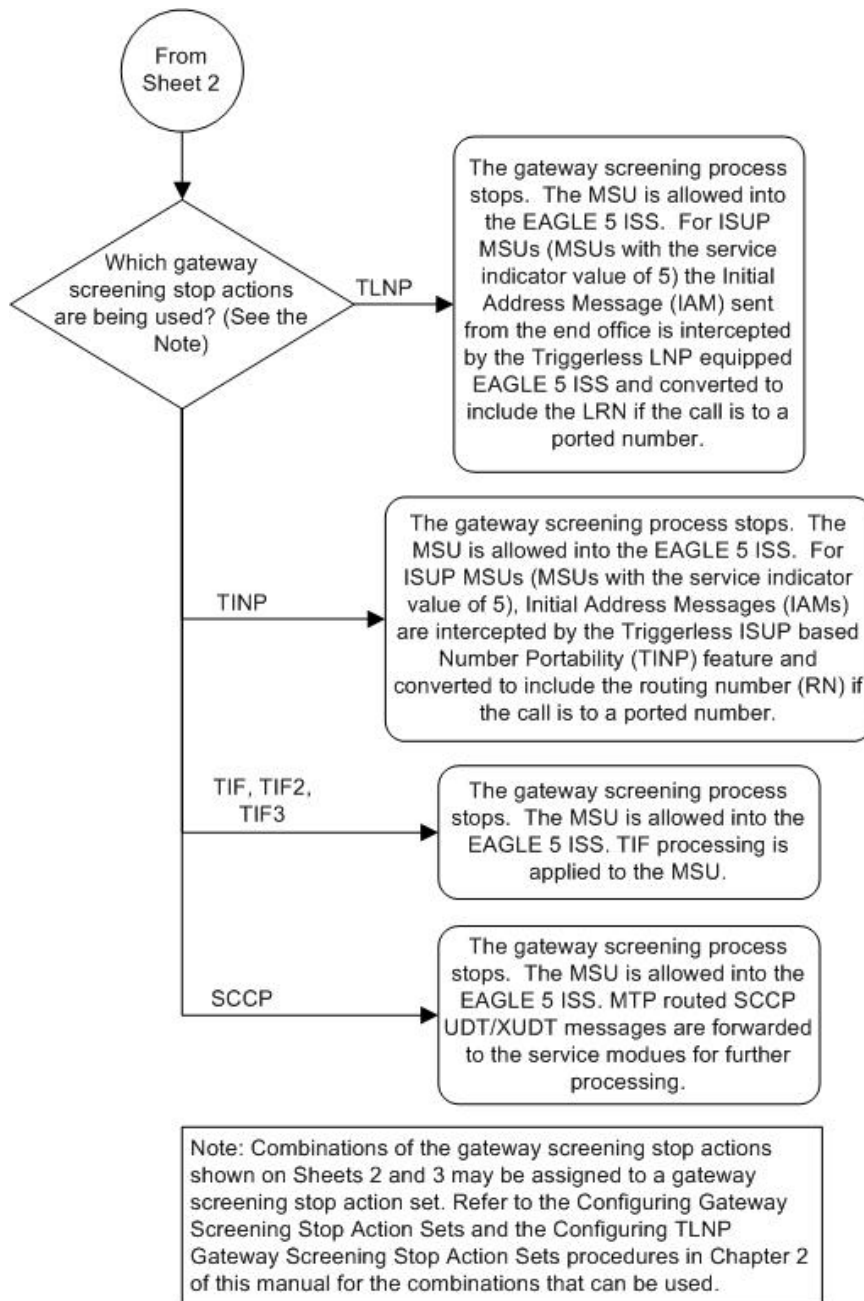

Sheet 3 of 3

ANSI MSU (ANSI Message Signal Unit)

BSN FSN LI	SIO xx xx xxxx NIC PRI SI	SIF		
		DPC NCM NC NI	Routing Label OPC NCM NC NI	SLS xx

ITU-I MSU (ITU International Message Signal Unit)

BSN FSN LI	SIO xx xx xxxx NIC PRI SI	SIF		
		DPC ID AREA ZONE	Routing Label OPC ID AREA ZONE	SLS xx

14-Bit ITU-N MSU (14-Bit ITU National Message Signal Unit)

BSN FSN LI	SIO xx xx xxxx NIC PRI SI	SIF		
		DPC NPC	Routing Label OPC NPC	SLS xx

24-Bit ITU-N MSU (24-Bit ITU National Message Signal Unit)

BSN FSN LI	SIO xx xx xxxx NIC PRI SI	SIF		
		DPC SP SSA MSA	Routing Label OPC SP SSA MSA	SLS xx

Figure 51: Allowed DPC Screening Functions

## Adding an Allowed DPC Screen

This procedure is used to add an allowed destination point code (DPC) screen to the database using the `ent-scr-dpc` command. The parameters used by the `ent-scr-dpc` command are shown in the [Gateway Screening Attributes](#) section. The general rules that apply to configuring gateway screening entities are shown in the [Gateway Screening Configuration](#) section.

The examples in this procedure are used to add the allowed DPC screen data shown in [Table 55: Example Gateway Screening Allowed DPC Configuration Table](#) and based on the example configurations shown in [Figure 4: Gateway Screening Configuration - Example 1](#), [Figure 6: Gateway Screening Configuration - Example 3](#), and [Figure 10: Gateway Screening Configuration - Example 7](#).



Table 55: Example Gateway Screening Allowed DPC Configuration Table

Screening Reference	NI	NC	NCM	NSFI	NSR
gws9	003	003	003	blkdpc	gw12
iec	070	070	025&&135	blkdpc	gws9
isp2	073	200	059	isup	isp2
tup1	050	034	049	isup	tup1

**Note:** If you using multiple-part ITU national point codes with gateway screening, see the [14-Bit ITU National Point Code Formats](#) section.

The allowed DPC screen can reference one of the following screens.

- Blocked DPC
- Allowed Affected Destination Field
- Allowed CGPA
- Allowed ISUP

#### Verifying the Gateway Screening Configuration

Enter the following commands to verify that these screens are in the database.

- `rtrv-scr-blkdpc:all=yes`
- `rtrv-scr-destfld:all=yes`
- `rtrv-scr-cgpa:all=yes`
- `rtrv-scr-isup:all=yes`

#### Gateway Screening Configuration Procedures

If the desired screen is not in the database, perform one of these procedures to add the desired screen to the database or change an existing screen in the database.

- [Adding a Blocked DPC Screen](#)
- [Adding an Allowed Affected Destination Field Screen](#)
- [Adding an Allowed Calling Party Address Screen](#)
- [Adding an Allowed ISUP Message Type Screen](#)
- [Changing a Blocked DPC Screen](#)
- [Changing an Allowed Affected Destination Field Screen](#)
- [Changing an Allowed Calling Party Address Screen](#)
- [Changing an Allowed ISUP Message Type Screen](#)

#### Specifying a Range of Values

A range of values can be specified for the point code parameters `ni`, `nc`, or `ncm`.

If a range of values is specified for any of these parameters, and the value of the other parameters match existing values for the screening reference name, the range of values for the point code parameter cannot include any values for that parameter that are currently provisioned for the screening reference name.

For example, screening reference name `scr1` contains these entries:

SR	NI	NC	NCM	NSFI	NSR/ACT
SCR1	240	001	010	CGPA	-----
SCR1	241	010	020	STOP	-----

Another entry for screening reference `scr1` with the `ni` value of 240 and the `nc` value of 001 cannot be specified if the range of values for the `ncm` parameter includes the value 010.

The ANSI point code parameter values can be specified as a single value, a range of values, or with an asterisk (\*). The asterisk specifies all possible values for the `ni`, `nc`, and `ncm` parameters. [Table 56: Valid Value Combinations for ANSI Point Code Parameters](#) shows the valid combinations of these parameter values.

**Table 56: Valid Value Combinations for ANSI Point Code Parameters**

NI	NC	NCM
Single Value	Single Value	Single Value
Single Value	Single Value	Range of Values
Single Value	Single Value	Asterisk
Single Value	Range of Values	Asterisk
Single Value	Asterisk	Asterisk
Range of Values	Asterisk	Asterisk
Asterisk	Asterisk	Asterisk

A range of values can also be specified for an ITU-I or 24-bit ITU-N point code parameter using a combination of asterisks (\*) and single values for the point code parameters. [Table 57: Valid Value Combinations for ITU-I Point Code Parameters](#) shows the valid combinations of the ITU-I parameter values. [Table 58: Valid Value Combinations for 24-Bit ITU-N Point Code Parameters](#) shows the valid combinations of the 24-bit ITU-N parameter values.

**Table 57: Valid Value Combinations for ITU-I Point Code Parameters**

ZONE	AREA	ID
Single Value	Single Value	Single Value
Single Value	Single Value	Asterisk
Single Value	Asterisk	Asterisk
Asterisk	Asterisk	Asterisk

Table 58: Valid Value Combinations for 24-Bit ITU-N Point Code Parameters

MSA	SSA	SP
Single Value	Single Value	Single Value
Single Value	Single Value	Asterisk
Single Value	Asterisk	Asterisk
Asterisk	Asterisk	Asterisk

1. Verify that the gateway screening feature is on, by entering the `rtrv-feat` command.

If the gateway screening feature is on, the `GWS` field is set to `on`.

**Note:** The `rtrv-feat` command output contains other fields that are not used by this procedure. If you wish to see all the fields displayed by the `rtrv-feat` command, see the `rtrv-feat` command description in *Commands User's Guide*.

If the gateway screening feature is on, shown by the entry `GWS = on` in the `rtrv-feat` command output, skip step 2, and go to step 3.

2. Turn the gateway screening feature on by entering this command.

```
chg-feat:gws=on
```

**Note:** Once the gateway screening feature is turned on with the `chg-feat` command, it cannot be turned off.

**Note:** The gateway screening feature must be purchased before you turn this feature on with the `chg-feat` command. If you are not sure if you have purchased the gateway screening feature, contact your Oracle Sales Representative or Account Representative.

When the `chg-feat` has successfully completed, this message should appear.

```
rlghncxa03w 06-10-28 11:43:04 GMT EAGLE5 36.0.0
CHG-FEAT: MASP A - COMPLTD
```

3. Display all allowed DPC screens in the database using the `rtrv-scr-dpc` command.

The following is an example of the possible output.

```
rlghncxa03w 06-10-25 15:25:30 GMT EAGLE5 36.0.0
SCREEN = ALLOWED DPC
SR    REF  RULES
IEC   YES   6
WRD2  YES   1
WRD4  YES   9
```

If the screening reference names that you wish to add with this procedure are not shown in the `rtrv-scr-dpc` command output, go to step 2. For this example, the screening reference names are not shown. If these screening reference names are shown in the `rtrv-scr-dpc` command output, make sure the screening data you wish to enter is not already in the database by entering

the `rtrv-scr-dpc` command with the screening reference name. For example, enter the `rtrv-scr-dpc:sr=iec` command.

The following is an example of the possible output.

```
rlghncxa03w 06-10-25 15:26:30 GMT EAGLE5 36.0.0
SCREEN = ALLOWED DPC
SR      NI          NC          NCM          NSFI          NSR/ACT
IEC     240          001          010          STOP          -----
IEC     241          010          *            CGPA          cg04
SR      NPC
IEC     00235
IEC     00240
SR      ZONE       AREA       ID           NSFI          NSR/ACT
IEC     1           003       4           BLKDPC       blk1
IEC     1           003       5           STOP          -----
```

If a gateway screening stop action set is to be assigned to the allowed DPC screen being added to the database, go to step 4.

Step 4 verifies the gateway screening stop action set names in the database. The gateway screening stop action set names are assigned only if the NSFI of the screen being added in this procedure is STOP. If the NSFI of the new screen will be STOP, but a gateway screening stop action set name will not be assigned to the new screen, skip steps 4, 5, and 6 and go to step 7. If the NSFI of the new screen is not STOP, skip step 4 and 5, and go to step 6.

4. Display the gateway screening stop action sets in the database with the `rtrv-gws-actset` command.

This is an example of the possible output.

```
rlghncxa03w 06-10-25 15:27:30 GMT EAGLE5 36.0.0
ACT  ACT    ACT  ACT  ACT  ACT  ACT  ACT  ACT  ACT  ACT  ACT
ID   NAME   1    2    3    4    5    6    7    8    9    10
--   -
1    copy   copy
2    rdct   rdct
3    cr     copy rdct
4    cncf   cncf
5    cpcncf copy cncf
6    cncfrd cncf rdct
7    cpcfrd copy cncf rdct
```

GWS action set table is (7 of 16) 44% full

If the required gateway screening stop action set is not in the database, perform the [Configuring Gateway Screening Stop Action Sets](#) procedure to configure the required gateway screening stop action set.

**Note:** If the gateway screening stop action set being assigned to the Allowed DPC screen does not contain the redirect stop action, skip step 5 and go to step 6.

5. Verify the EAGLE's point code by entering the `rtrv-sid` command.

The following is an example of the possible output.

```

rlghncxa03w 06-10-10 11:43:04 GMT EAGLE5 36.0.0
PCA          PCI          PCN          CLLI          PCTYPE
100-100-100  3-75-7         7-9-8-1     rlghncxa03w  OTHER

CPCA
002-002-002  002-002-003   002-002-004 002-002-005
002-002-006  002-002-007   002-002-008 002-002-009
004-002-001  004-003-003   050-060-070

CPCA (LNP)
005-005-002  005-005-004   005-005-005 006-006-006

CPCI
1-002-1      1-002-2       1-002-3      1-002-4
2-001-1      7-222-7

CPCN
2-0-10-3    2-0-11-0     2-0-11-2     2-0-12-1
2-2-3-3     2-2-4-0     10-14-10-1

```



**CAUTION**

**Caution:** Redirecting SLTA/SLTM messages prevents SLTA/SLTM messages from being returned to the EAGLE. The signaling link carrying these messages will fail if these messages are not returned to the EAGLE. To prevent SLTA/SLTM messages from being redirected, gateway screening stop action sets containing the redirect stop action should not be assigned to Allowed DPC screens containing the EAGLE's point code.

**Note:** If the NSFI of the screen being added in this procedure is STOP, skip step 6 and go to step 7.

6. Enter the commands in the [Verifying the Gateway Screening Configuration](#) section to verify that the screen that will be specified by the NSFI/NSR parameter combination in step 8 is in the database.

If the desired screen is not in the database, perform one of the procedures shown in the [Gateway Screening Configuration Procedures](#) section to add the desired screen to the database or change an existing screen in the database.

**Note:** If the point code being added in this procedure is not an ITU-I or 14-bit ITU-N spare point code, continue the procedure with step 8.

**Note:** If the point code being added in this procedure is an ITU-I or 14-bit ITU-N spare point code and the screening reference contains ITU-I or 14-bit ITU-N spare point codes, continue the procedure with step 8.

7. Display the status of the ITU National and International Spare Point Code Support feature by entering the `rtrv-ctrl-feat` command with the ITU National and International Spare Point Code Support feature part number.

Enter this command.

```
rtrv-ctrl-feat:partnum=893013601
```

This is an example of the possible output.

```

rlghncxa03w 06-10-25 15:25:30 GMT EAGLE5 36.0.0
The following features have been permanently enabled:

```

```

Feature Name      Partnum  Status Quantity
Spare Point Code Support  893013601 on      ----

```

The following features have been temporarily enabled:

```

Feature Name      Partnum  Status Quantity  Trial Period Left
Zero entries found.

```

The following features have expired temporary keys:

```

Feature Name      Partnum
Zero entries found.

```

If the ITU National and International Spare Point Code Support feature is enabled, go to step 8.

If the ITU National and International Spare Point Code Support feature is not enabled, perform the “Activating the ITU National and International Spare Point Code Support Feature” procedure in *Database Administration - SS7 User’s Guide* to enable the ITU National and International Spare Point Code Support feature as required. After the feature has been enabled, go to step 8.

8. Add a new allowed DPC screen to the database using the `ent-scr-dpc` command.

If a gateway screening stop action is to be assigned to the allowed DPC screen being added, enter the `ent-scr-dpc` command with the `nsfi=stop` parameter and the `actname` parameter with the name of a gateway screening stop action set shown in the output of the `rtrv-gws-actset` command executed in step 4.



**CAUTION**

**Caution:** Redirecting SLTA/SLTM messages prevents SLTA/SLTM messages from being returned to the EAGLE. The signaling link carrying these messages will fail if these messages are not returned to the EAGLE. To prevent SLTA/SLTM messages from being redirected, gateway screening stop action sets containing the redirect stop action should not be assigned to Allowed DPC screens containing the EAGLE’s point code, shown in step 5.

The following list contains the values for `ni`, `nc`, `ncm`, `zone`, `area`, `id`, `npc`, `msa`, `ssa`, and `sp` parameters:

- `ni` – 0 - 255 or an asterisk (\*)
- `nc` – 0 - 255 or an asterisk (\*)
- `ncm` – 0 - 255 or an asterisk (\*)
- `zone` – 0 - 7 or an asterisk (\*)
- `area` – 0 - 255 or an asterisk (\*)
- `id` – 0 - 7 or an asterisk (\*)
- `npc` – 1 - 16383 or an asterisk (\*)
- `msa` – 0 - 255 or an asterisk (\*)
- `ssa` – 0 - 255 or an asterisk (\*)
- `sp` – 0 - 255 or an asterisk (\*)

A range of values can be specified for the `ni`, `nc`, and `ncm` parameters. See the [“Specifying a Range of Values”](#) section for more information on how the asterisk and a range of values are used for the `ni`, `nc`, and `ncm` parameters. To add a spare point code to the allowed DPC screen, the `pcst=s` parameter must be specified.

To add a non-spare point code to the allowed DPC screen, the `pcst` parameter does not have to be specified. If the `pcst` parameter is specified for a screen containing an ITU-I or 14-bit ITU-N non-spare point code, the value must be none.

For this example, enter these commands.

```
ent-scr-dpc:sr=gws9:ni=003:nc=003:ncm=003:nsfi=blkdpc:nsr=gw12
```

A message similar to the following should appear.

```
rlghncxa03w 06-10-25 15:28:30 GMT EAGLE5 36.0.0
ENT-SCR-DPC: SCREEN SET AFFECTED - GWS9 1% FULL
ENT-SCR-DPC: MASP A - COMPLTD
```

```
ent-scr-dpc:sr=isp2:ni=073:nc=200:ncm=059:nsfi=isup:nsr=isp2
```

A message similar to the following should appear.

```
rlghncxa03w 06-10-25 15:29:30 GMT EAGLE5 36.0.0
ENT-SCR-DPC: SCREEN SET AFFECTED - ISP2 1% FULL
ENT-SCR-DPC: MASP A - COMPLTD
```

```
ent-scr-dpc:sr=tup1:ni=050:nc=034:ncm=059:nsfi=isup:nsr=tup1
```

A message similar to the following should appear.

```
rlghncxa03w 06-10-25 15:29:30 GMT EAGLE5 36.0.0
ENT-SCR-DPC: SCREEN SET AFFECTED - TUP1 1% FULL
ENT-SCR-DPC: MASP A - COMPLTD
```

```
ent-scr-dpc:sr=iec:ni=070:nc=070:ncm=025&&135:nsfi=blkdpc :nsr=gws9
```

A message similar to the following should appear.

```
rlghncxa03w 06-10-25 15:29:30 GMT EAGLE5 36.0.0
ENT-SCR-DPC: SCREEN SET AFFECTED - IEC 1% FULL
ENT-SCR-DPC: MASP A - COMPLTD
```

9. Verify the changes using the `rtrv-scr-dpc` command with the screening reference name used in step 8.

For this example, enter these commands.

```
rtrv-scr-dpc:sr=gws9
```

The following is an example of the possible output.

```
rlghncxa03w 06-10-25 15:30:30 GMT EAGLE5 36.0.0
SCREEN = ALLOWED DPC
SR      NI      NC      NCM      NSFI      NSR/ACT
GWS9   003      003      003      BLKDPC   GW12
```

```
rtrv-scr-dpc:sr=iec
```

The following is an example of the possible output.

```
rlghncxa03w 06-10-25 15:31:30 GMT EAGLE5 36.0.0
SCREEN = ALLOWED DPC
SR      NI      NC      NCM      NSF1     NSR/ACT
IEC     070      070      025&&135 BLKDPC   GWS9
```

```
rtrv-scr-dpc:sr=isp2
```

The following is an example of the possible output.

```
rlghncxa03w 06-10-25 15:31:30 GMT EAGLE5 36.0.0
SCREEN = ALLOWED DPC
SR      NI      NC      NCM      NSF1     NSR/ACT
ISP2    073      200      059      ISUP     ISP2
```

```
rtrv-scr-dpc:sr=tup1
```

The following is an example of the possible output.

```
rlghncxa03w 06-10-25 15:31:30 GMT EAGLE5 36.0.0
SCREEN = ALLOWED DPC
SR      NI      NC      NCM      NSF1     NSR/ACT
TUP1    050      034      049      ISUP     TUP1
```

**10. Backup the new changes using the `chg-db:action=backup:dest=fixed` command.**

The following messages should appear, the active Maintenance and Administration Subsystem Processor (MASP) appears first.

```
BACKUP (FIXED) : MASP A - Backup starts on active MASP.
BACKUP (FIXED) : MASP A - Backup on active MASP to fixed disk complete.
BACKUP (FIXED) : MASP A - Backup starts on standby MASP.
BACKUP (FIXED) : MASP A - Backup on standby MASP to fixed disk complete.
```



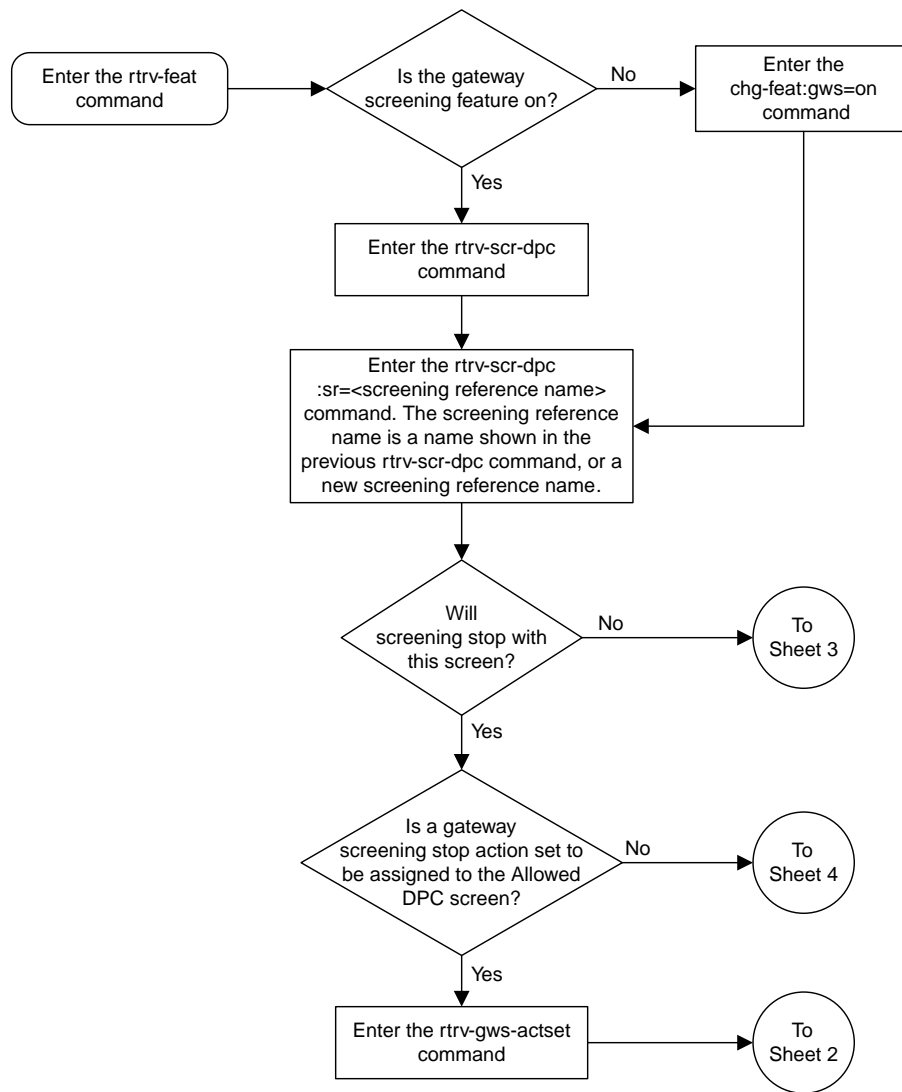

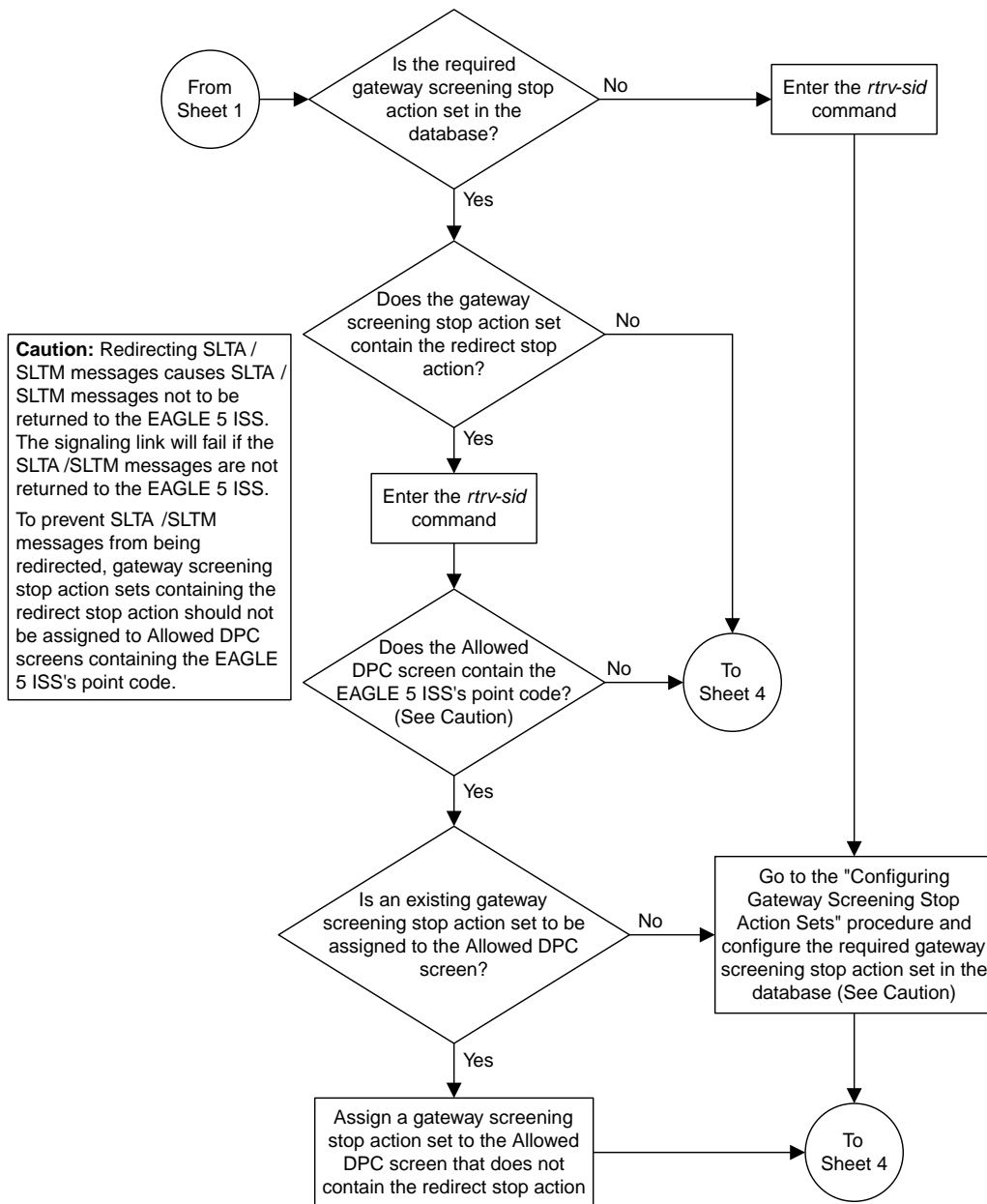

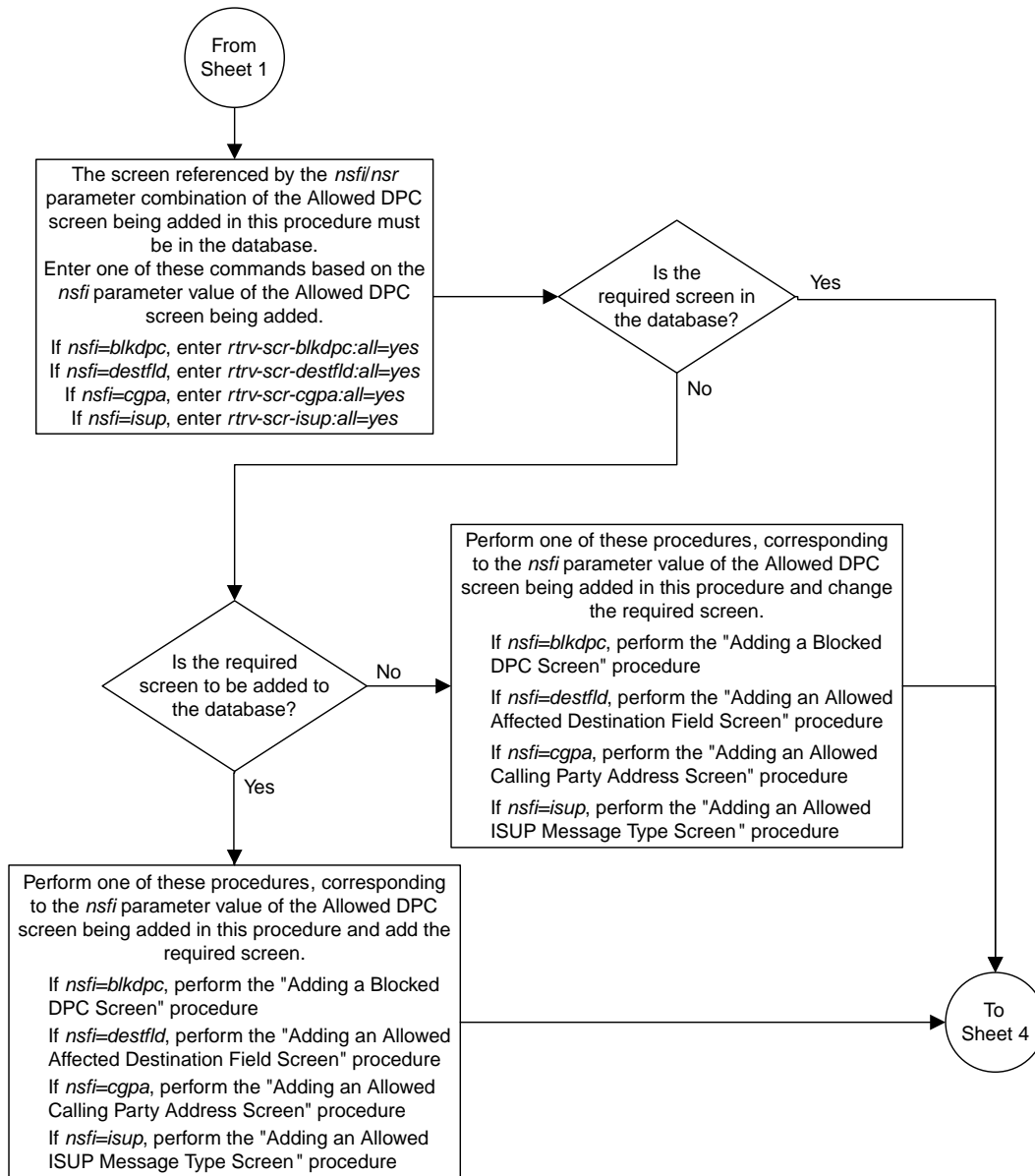

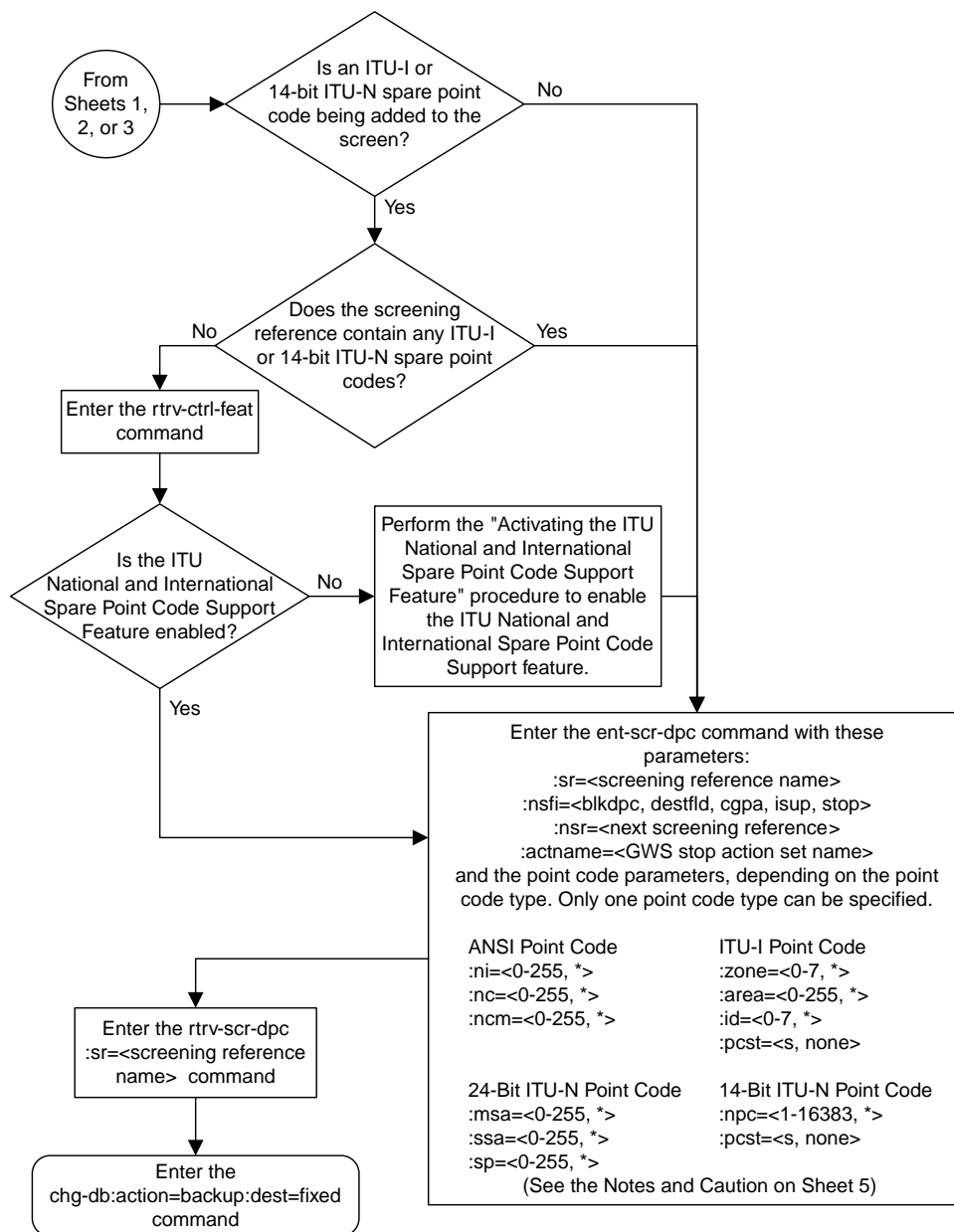

**Notes:**

1. A range of values can be specified for the *ni*, *nc*, or *ncm* parameters by inserting double ampersands (&&) between the parameter values defining the range. For example, to specify the range 025 to 200 for the *ni* parameter, enter 025&&200 for the *ni* parameter value.

2. The asterisk (\*) specifies the entire range of values for that parameter.

For more information about specifying a range of values and about using the asterisk, see the "Gateway Screening Attributes" section and the "Specifying a Range of Values" section. The "Gateway Screening Attributes" section is in the *Database Administration Manual - Gateway Screening*. The "Specifying a Range of Values" section is in the "Adding an Allowed DPC Screen" procedure in the *Database Administration Manual - Gateway Screening*.

3. The *nsr* parameter can be specified only, and must be specified, if the *nsfi* parameter value is either *blkdpc*, *destfld*, *cgpa*, or *isup*.

4. The *actname* parameter is optional and can be specified only with the *nsfi=stop* parameter. If the *actname* parameter is specified, the *actname* parameter value is one of the gateway screening stop action set names shown in the *rtrv-gws-actset* output on Sheet 1.

5. To add a non-spare point code, the *pcst* parameter does not have to be specified. If the *pcst* parameter is specified for a screen containing an ITU-I or 14-bit ITU-N non-spare point code, the value must be *none*.

6. To add a spare point code, the *pcst=s* parameter must be specified.

**Caution:** Redirecting SLTA /SLTM messages causes SLTA /SLTM messages not to be returned to the EAGLE 5 ISS. The signaling link will fail if the SLTA /SLTM messages are not returned to the EAGLE 5 ISS.

To prevent SLTA /SLTM messages from being redirected, gateway screening stop action sets containing the redirect stop action should not be assigned to Allowed DPC screens containing the EAGLE 5 ISS's point code.

Sheet 5 of 5

**Figure 52: Adding an Allowed DPC Screen**

## Removing an Allowed DPC Screen

This procedure is used to remove an allowed destination point code (DPC) screen from the database using the `dlt-scr-dpc` command. The parameters used by the `dlt-scr-dpc` command are shown in the [Gateway Screening Attributes](#) section. The general rules that apply to configuring gateway screening entities are shown in the [Gateway Screening Configuration](#) section.

The example in this procedure removes the allowed DPC screen `gws9` from the database.

**Note:** If you are using multiple-part ITU national point codes with gateway screening, see the [14-Bit ITU National Point Code Formats](#) section.

The allowed DPC screen can be referenced by one of the following screens.

- Screen Set
- Allowed OPC
- Blocked OPC
- Allowed SIO

### Verifying the Gateway Screening Configuration

Enter the following commands to verify that none of these screens reference the allowed DPC screen being removed from the database.

- `rtrv-scrset:nsfi=dpc`
- `rtrv-scr-opc:nsfi=dpc`
- `rtrv-scr-blkopc:nsfi=dpc`
- `rtrv-scr-sio:nsfi=dpc`

### Gateway Screening Configuration Procedures

To change the NSFI of any of these screens, perform one of these procedures.

- [Changing a Screen Set](#)
- [Changing an Allowed OPC Screen](#)
- [Changing a Blocked OPC Screen](#)
- [Changing an Allowed SIO Screen](#)

1. Display the allowed DPC screens in the database using the `rtrv-scr-dpc` command.

The following is an example of the possible output.

```
rlghncxa03w 06-10-25 15:25:30 GMT EAGLE5 36.0.0
SCREEN = ALLOWED DPC

SR      REF  RULES
GWS9   YES    1
IEC    YES    6
ISP2   YES    1
TUP1   YES    1
```

```
WRD2 YES 1
WRD4 YES 9
```

From the `rtrv-scr-dpc` output, display the allowed DPC screen you wish to remove using the `rtrv-scr-dpc` command with the screening reference name. For this example, enter this command.

```
rtrv-scr-dpc:sr=gws9
```

The following is an example of the possible output.

```
rlghncxa03w 06-10-25 15:25:30 GMT EAGLE5 36.0.0
SCREEN = ALLOWED DPC
SR NI NC NCM NSFI NSR/ACT
GWS9 003 003 003 BLKDPC GW12
```

2. Enter the commands in the [Verifying the Gateway Screening Configuration](#) section to verify that the screen being removed is not referenced by other screens in the database.

If the screen being removed is referenced by other screens, perform the procedures shown in the [Gateway Screening Configuration Procedures](#) section to change the NSFI of those screens to reference other screens or change the NSFI of these screens to STOP.

3. Remove the allowed DPC screen from the database using the `dlt-scr-dpc` command with the screening reference name shown in the `rtrv-scr-dpc` output in step 1 and with the point code parameter values (`ni`, `nc`, `ncm`, or `zone`, `area`, `id`, or `npc`, or `msa`, `ssa`, `sp`) of the screen being removed from the database.

The values for these parameters must be entered exactly as shown in the `rtrv-scr-dpc` output.

To remove an entry containing either an ITU-I or a 14-bit ITU-N spare point code, the `pcst=s` parameter must be specified with the `dlt-scr-dpc` command.

To remove an entry containing either an ITU-I or a 14-bit ITU-N non-spare point code, the `pcst` parameter does not have to be specified with the `dlt-scr-dpc` command. If the `pcst` parameter is specified, the value must be none.

For this example, enter this command.

```
dlt-scr-dpc:sr=gws9:ni=003:nc=003:ncm=003
```

A message similar to the following should appear.

```
rlghncxa03w 06-10-25 15:26:30 GMT EAGLE5 36.0.0
DLT-SCR-DPC: SCREEN SET AFFECTED - GWS9 0% FULL
DLT-SCR-DPC: MASP A - COMPLTD
```

4. Verify the changes using the `rtrv-scr-dpc` command with the screening reference name used in step 3.

For this example, enter this command.

```
rtrv-scr-dpc:sr=gws9
```

The following is an example of the possible output.

```
E2573 Cmd Rej: SR or NSR does not reference an existing SR
```

This message shows that the specified screening reference name is not in the database and the action of the `dlt-scr-dpc` command in step 3 was successful. If the specified screening reference name contained more than one entry when the `dlt-scr-dpc` command was executed in step 3, the `rtrv-scr-dpc:sr=` command output would show the remaining entries in the screening reference instead of error message E2573.

5. Backup the new changes using the `chg-db:action=backup:dest=fixed` command.

The following messages should appear, the active Maintenance and Administration Subsystem Processor (MASP) appears first.

```
BACKUP (FIXED) : MASP A - Backup starts on active MASP.  
BACKUP (FIXED) : MASP A - Backup on active MASP to fixed disk complete.  
BACKUP (FIXED) : MASP A - Backup starts on standby MASP.  
BACKUP (FIXED) : MASP A - Backup on standby MASP to fixed disk complete.
```



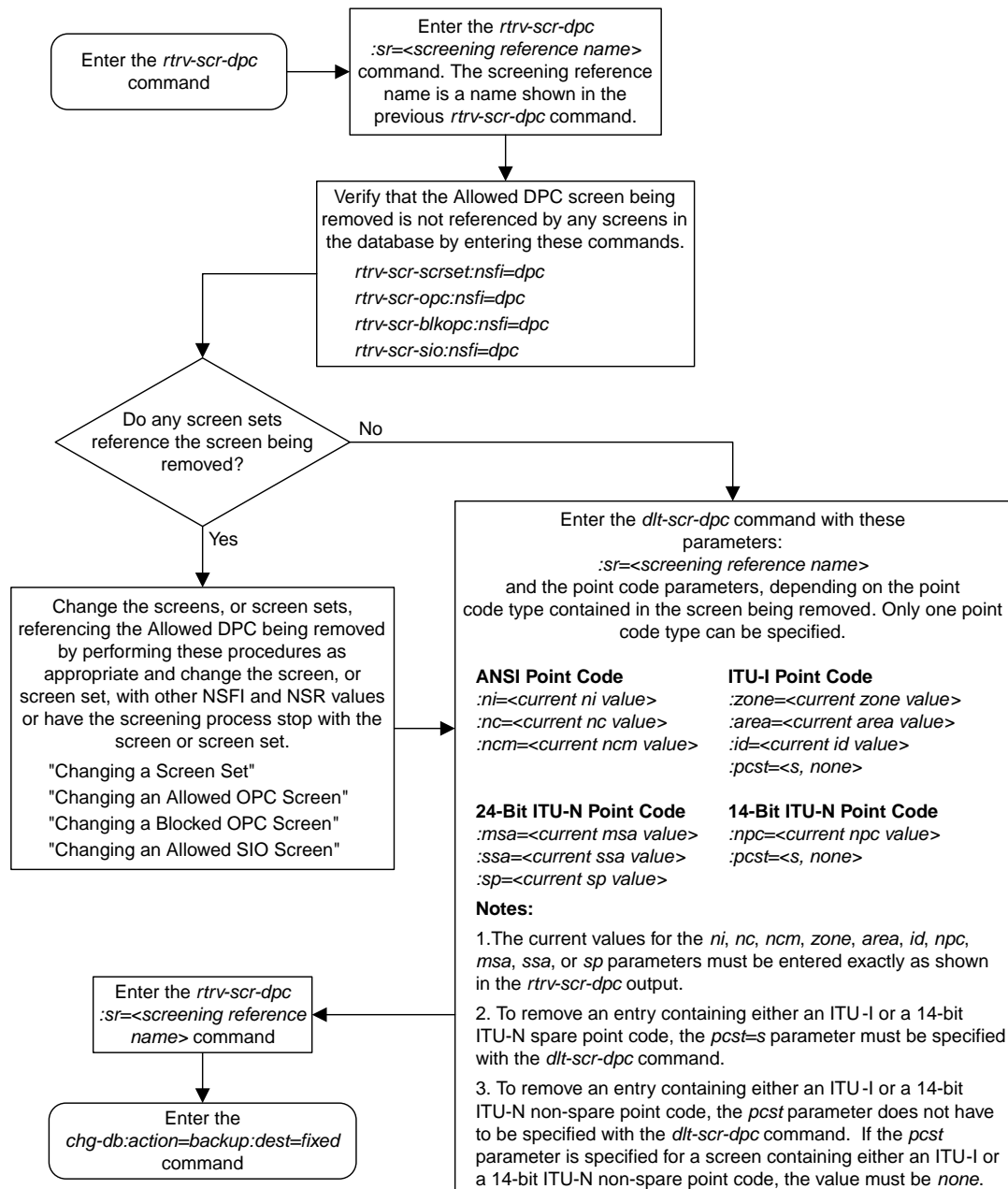

Figure 53: Removing an Allowed DPC Screen

## Changing an Allowed DPC Screen

This procedure is used to change the attributes of an allowed destination point code (DPC) screen in the database using the `chg-scr-dpc` command. The parameters used by the `chg-scr-dpc` command are shown in the [Gateway Screening Attributes](#) section. The general rules that apply to configuring gateway screening entities are shown in the [Gateway Screening Configuration](#) section.

The example in this procedure change point code in the allowed DPC screen `gws9` to `009-009-009` and change the `nsfi` to `stop`.

**Note:** If you using multiple-part ITU national point codes with gateway screening, see the [14-Bit ITU National Point Code Formats](#) section.

The allowed DPC screen can reference one of the following screens.

- Blocked DPC
- Allowed Affected Destination Field
- Allowed CGPA
- Allowed ISUP Message Type

### Verifying the Gateway Screening Configuration

Enter the following commands to verify that these screens are in the database.

- `rtrv-scr-blkdpc:all=yes`
- `rtrv-scr-destfld:all=yes`
- `rtrv-scr-cgpa:all=yes`
- `rtrv-scr-isup:all=yes`

### Gateway Screening Configuration Procedures

If the desired screen is not in the database, perform one of these procedures to add the desired screen to the database or change an existing screen in the database.

- [Adding a Blocked DPC Screen](#)
- [Adding an Allowed Affected Destination Field Screen](#)
- [Adding an Allowed Calling Party Address Screen](#)
- [Adding an Allowed ISUP Message Type Screen](#)
- [Changing a Blocked DPC Screen](#)
- [Changing an Allowed Affected Destination Field Screen](#)
- [Changing an Allowed Calling Party Address Screen](#)
- [Changing an Allowed ISUP Message Type Screen](#)

### Specifying a Range of Values

A range of values can be specified for the point code parameters `ni`, `nc`, or `ncm`.

If a range of values is specified for any of these parameters, and the value of the other parameters match existing values for the screening reference name, the range of values for the point code parameter cannot include any values for that parameter that are currently provisioned for the screening reference name.

For example, screening reference name `scr1` contains these entries:

SR	NI	NC	NCM	NSFI	NSR/ACT
SCR1	240	001	010	CGPA	-----
SCR1	241	010	020	STOP	-----

Another entry for screening reference `scr1` with the `ni` value of 240 and the `nc` value of 001 cannot be specified if the range of values for the `ncm` parameter includes the value 010.

The ANSI point code parameter values can be specified as a single value, a range of values, or with an asterisk (\*). The asterisk specifies all possible values for the `ni`, `nc`, and `ncm` parameters. [Table 59: Valid Value Combinations for ANSI Point Code Parameters](#) shows the valid combinations of these parameter values.

**Table 59: Valid Value Combinations for ANSI Point Code Parameters**

NI	NC	NCM
Single Value	Single Value	Single Value
Single Value	Single Value	Range of Values
Single Value	Single Value	Asterisk
Single Value	Range of Values	Asterisk
Single Value	Asterisk	Asterisk
Range of Values	Asterisk	Asterisk
Asterisk	Asterisk	Asterisk

A range of values can also be specified for an ITU-I or 24-bit ITU-N point code parameter using a combination of asterisks (\*) and single values for the point code parameters. [Table 60: Valid Value Combinations for ITU-I Point Code Parameters](#) shows the valid combinations of the ITU-I parameter values. [Table 61: Valid Value Combinations for 24-Bit ITU-N Point Code Parameters](#) shows the valid combinations of the 24-bit ITU-N parameter values.

**Table 60: Valid Value Combinations for ITU-I Point Code Parameters**

ZONE	AREA	ID
Single Value	Single Value	Single Value
Single Value	Single Value	Asterisk
Single Value	Asterisk	Asterisk
Asterisk	Asterisk	Asterisk

Table 61: Valid Value Combinations for 24-Bit ITU-N Point Code Parameters

MSA	SSA	SP
Single Value	Single Value	Single Value
Single Value	Single Value	Asterisk
Single Value	Asterisk	Asterisk
Asterisk	Asterisk	Asterisk

1. Display the allowed DPC screens in the database using the `rtrv-scr-dpc` command.

The following is an example of the possible output.

```
rlghncxa03w 06-10-25 15:25:30 GMT EAGLE5 36.0.0
SCREEN = ALLOWED DPC
SR   REF  RULES
GWS9 YES   1
IEC  YES   6
ISP2 YES   1
TUP1 YES   1
WRD2 YES   1
WRD4 YES   9
```

From the `rtrv-scr-dpc` output, display the allowed DPC screen you wish to remove using the `rtrv-scr-dpc` command with the screening reference name. For this example, enter this command.

```
rtrv-scr-dpc:sr=gws9
```

The following is an example of the possible output.

```
rlghncxa03w 06-10-25 15:25:30 GMT EAGLE5 36.0.0
SCREEN = ALLOWED DPC
SR   NI      NC      NCM      NSFI      NSR/ACT
GWS9 003      003      003      BLKDPC    GW12
```

If a gateway screening stop action set is to be assigned to the allowed DPC screen being changed in the database, go to step 2.

Step 2 verifies the gateway screening stop action set names in the database. The gateway screening stop action set names are assigned only if the NSFI of the screen being changed in this procedure is STOP. If the NSFI of the screen will be changed to STOP, but a gateway screening stop action set name will not be assigned to the screen, skip steps 2, 3, and 4, and go to step 5. If the NSFI of the screen will not be STOP, skip step 2 and 3, and go to step 4.

2. Display the gateway screening stop action sets in the database with the `rtrv-gws-actset` command.

This is an example of the possible output.

```
rlghncxa03w 06-10-25 15:26:30 GMT EAGLE5 36.0.0
ACT ACT   ACT ACT  ACT ACT  ACT ACT  ACT ACT  ACT ACT
```

ID	NAME	1	2	3	4	5	6	7	8	9	10
1	copy	copy									
2	rdct	rdct									
3	cr	copy	rdct								
4	cncf	cncf									
5	cpcncf	copy	cncf								
6	cncfrd	cncf	rdct								
7	cpcfcd	copy	cncf	rdct							

GWS action set table is (7 of 16) 44% full

If the required gateway screening stop action set is not in the database, perform the [Configuring Gateway Screening Stop Action Sets](#) procedure to configure the required gateway screening stop action set.

**Note:** If the gateway screening stop action set being assigned to the Allowed DPC screen does not contain the redirect stop action, skip step 3 and go to step 4.

3. Verify the EAGLE's point code by entering the `rtrv-sid` command.

The following is an example of the possible output.

```

rlghncxa03w 06-10-10 11:43:04 GMT EAGLE5 36.0.0
PCA          PCI          PCN          CLLI          PCTYPE
100-100-100  3-75-7        7-9-8-1     rlghncxa03w  OTHER

CPCA
002-002-002      002-002-003      002-002-004      002-002-005
002-002-006      002-002-007      002-002-008      002-002-009
004-002-001      004-003-003      050-060-070

CPCA (LNP)
005-005-002      005-005-004      005-005-005      006-006-006

CPCI
1-002-1          1-002-2          1-002-3          1-002-4
2-001-1          7-222-7

CPCN
2-0-10-3        2-0-11-0        2-0-11-2        2-0-12-1
2-2-3-3        2-2-4-0        10-14-10-1
    
```



**Caution:** Redirecting SLTA/SLTM messages prevents SLTA/SLTM messages from being returned to the EAGLE. The signaling link carrying these messages will fail if these messages are not returned to the EAGLE. To prevent SLTA/SLTM messages from being redirected, gateway screening stop action sets containing the redirect stop action should not be assigned to Allowed DPC screens containing the EAGLE's point code.

**Note:** If the NSFI of the screen being changed in this procedure will be STOP, or if the NSFI of the screen is not being changed, skip step 4 and go to step 5.

4. Enter the commands in the [Verifying the Gateway Screening Configuration](#) section to verify that the screen that will be specified by the NSFI/NSR parameter combination in step 6 is in the database.

If the desired screen is not in the database, perform one of the procedures shown in the [Gateway Screening Configuration Procedures](#) section to add the desired screen to the database or change an existing screen in the database.

**Note:** If any of these conditions apply to this procedure, skip step 5 and go to step 6:

- The point code in the screen is not being changed.
  - The screen being changed contains either an ANSI or 24-bit ITU-N point code.
  - The ITU-I or 14-bit ITU-N non-spare point code in the screen is not being changed to an ITU-I or 14-bit ITU-N spare point code.
  - The point code in the screen is an ITU-I or 14-bit ITU-N spare point code or the screening reference contains other screens with ITU-I or 14-bit ITU-N spare point codes.
5. Display the status of the ITU National and International Spare Point Code Support feature by entering the `rtrv-ctrl-feat` command with the ITU National and International Spare Point Code Support feature part number.

Enter this command.

```
rtrv-ctrl-feat:partnum=893013601
```

This is an example of the possible output.

```
rlghncxa03w 06-10-25 15:25:30 GMT EAGLE5 36.0.0
The following features have been permanently enabled:

Feature Name          Partnum   Status  Quantity
Spare Point Code Support 893013601 on      ----

The following features have been temporarily enabled:

Feature Name          Partnum   Status  Quantity  Trial Period Left
Zero entries found.

The following features have expired temporary keys:

Feature Name          Partnum
Zero entries found.
```

If the ITU National and International Spare Point Code Support feature is enabled, go to step 6.

If the ITU National and International Spare Point Code Support feature is not enabled, perform the “Activating the ITU National and International Spare Point Code Support Feature” procedure in *Database Administration - SS7 User’s Guide* to enable the ITU National and International Spare Point Code Support feature as required. After the feature has been enabled, go to step 6.

6. Change the attributes of an allowed DPC screen using the `chg-scr-dpc` command.

If a gateway screening stop action is to be assigned to the allowed DPC screen being changed, enter the `chg-scr-dpc` command with the `nsfi=stop` parameter and the `actname` parameter with the name of a gateway screening stop action set shown in the output of the `rtrv-gws-actset` command executed in step 2.



**Caution:** Redirecting SLTA/SLTM messages prevents SLTA/SLTM messages from being returned to the EAGLE. The signaling link carrying these messages will fail if these messages are not returned to the EAGLE. To prevent SLTA/SLTM messages from being redirected, gateway screening stop action sets containing the redirect stop

action should not be assigned to Allowed DPC screens containing the EAGLE's point code, shown in step 3.

The current values for the `ni`, `nc`, `ncm`, `zone`, `area`, `id`, `npc`, `msa`, `ssa`, and `sp` parameters must be entered exactly as shown in the `rtrv-scr-dpc` output in step 1.

The following list contains the values for the `nni`, `nnc`, `nncm`, `nzone`, `narea`, `nid`, `nnpc`, `nmsa`, `nssa`, and `nsp` parameters:

- `nni` - 0-255 or an asterisk (\*)
- `nnc` - 0-255 or an asterisk (\*)
- `nncm` - 0-255 or an asterisk (\*)
- `nzone` - 0-7 or an asterisk (\*)
- `narea` - 0-255 or an asterisk (\*)
- `nid` - 0-7 or an asterisk (\*)
- `nnpc` - 1 - 16383 or an asterisk (\*)
- `nmsa` - 0-255 or an asterisk (\*)
- `nssa` - 0-255 or an asterisk (\*)
- `nsp` - 0-255 or an asterisk (\*)

A range of values can be specified for the `nni`, `nnc`, and `nncm` parameters. See the [“Specifying a Range of Values”](#) section for more information on how the asterisk and a range of values are used for the `nni`, `nnc`, and `nncm` parameters.

To change an ITU-I or 14-bit ITU-N spare point code to a non-spare point code, both the `pcst=s` and `npcst=none` parameters must be specified with the `chg-scr-dpc` command.

To change an ITU-I or 14-bit ITU-N non-spare point code to a spare point code, the `npcst=s` parameter must be specified with the `chg-scr-dpc` command. The `pcst` parameter does not have to be specified.

If the current point code in the screen being changed is either an ITU-I or 14-bit ITU-N spare point code, the `pcst=s` parameter must be specified with the `chg-scr-dpc` command.

If the current point code in the screen being changed is either an ITU-I or 14-bit ITU-N non-spare point code, the `pcst` parameter does not have to be specified with the `chg-scr-dpc` command. If the `pcst` parameter is specified for a screen containing either an ITU-I or 14-bit ITU-N non-spare point code, the `pcst` parameter value must be `none`.

For this example, enter this command.

```
chg-scr-dpc:sr=gws9:ni=003:nc=003:ncm=003:nni=009:nnc=009
:nncm=009:nsfi=stop
```

A message similar to the following should appear.

```
rlghncxa03w 06-10-25 15:27:30 GMT EAGLE5 36.0.0
CHG-SCR-DPC: SCREEN SET AFFECTED - GWS9 1% FULL
CHG-SCR-DPC: MASP A - COMPLTD
```

7. Verify the changes using the `rtrv-scr-dpc` command with the screening reference name used in step 6.

For this example, enter this command.

```
rtrv-scr-dpc:sr=gws9
```

The following is an example of the possible output.

```
rlghncxa03w 06-10-25 15:28:30 GMT EAGLE5 36.0.0
SCREEN = ALLOWED DPC
SR      NI      NC      NCM      NSF1     NSR/ACT
GWS9   009      009      009      STOP     -----
```

8. Backup the new changes using the `chg-db:action=backup:dest=fixed` command.

The following messages should appear, the active Maintenance and Administration Subsystem Processor (MASP) appears first.

```
BACKUP (FIXED) : MASP A - Backup starts on active MASP.
BACKUP (FIXED) : MASP A - Backup on active MASP to fixed disk complete.
BACKUP (FIXED) : MASP A - Backup starts on standby MASP.
BACKUP (FIXED) : MASP A - Backup on standby MASP to fixed disk complete.
```



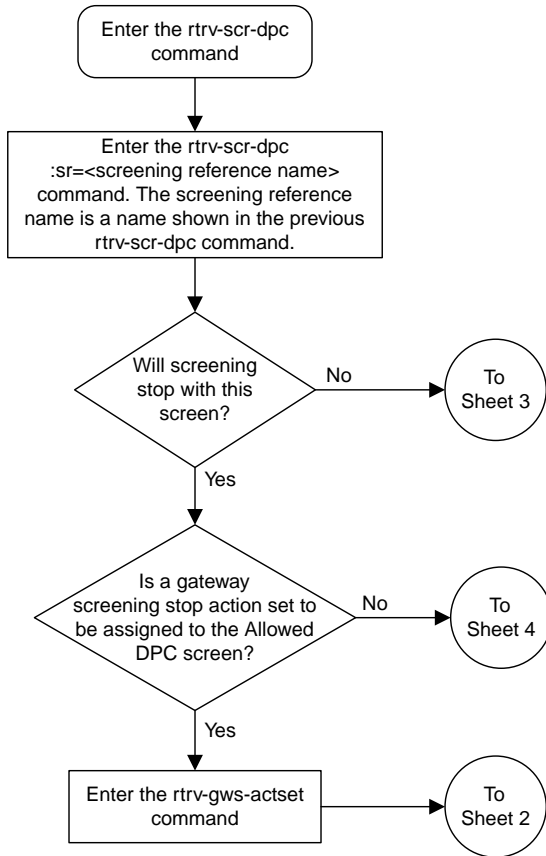

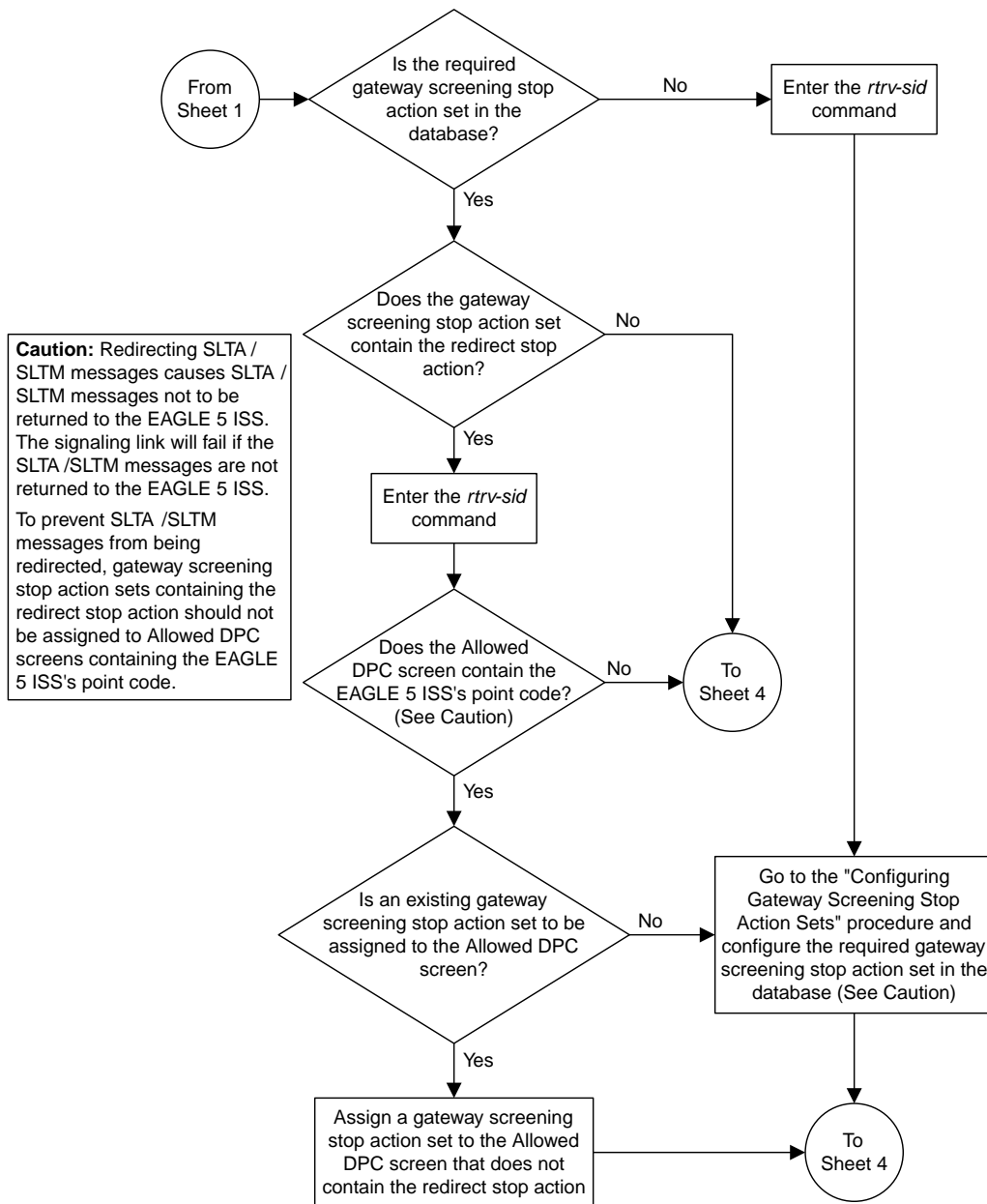

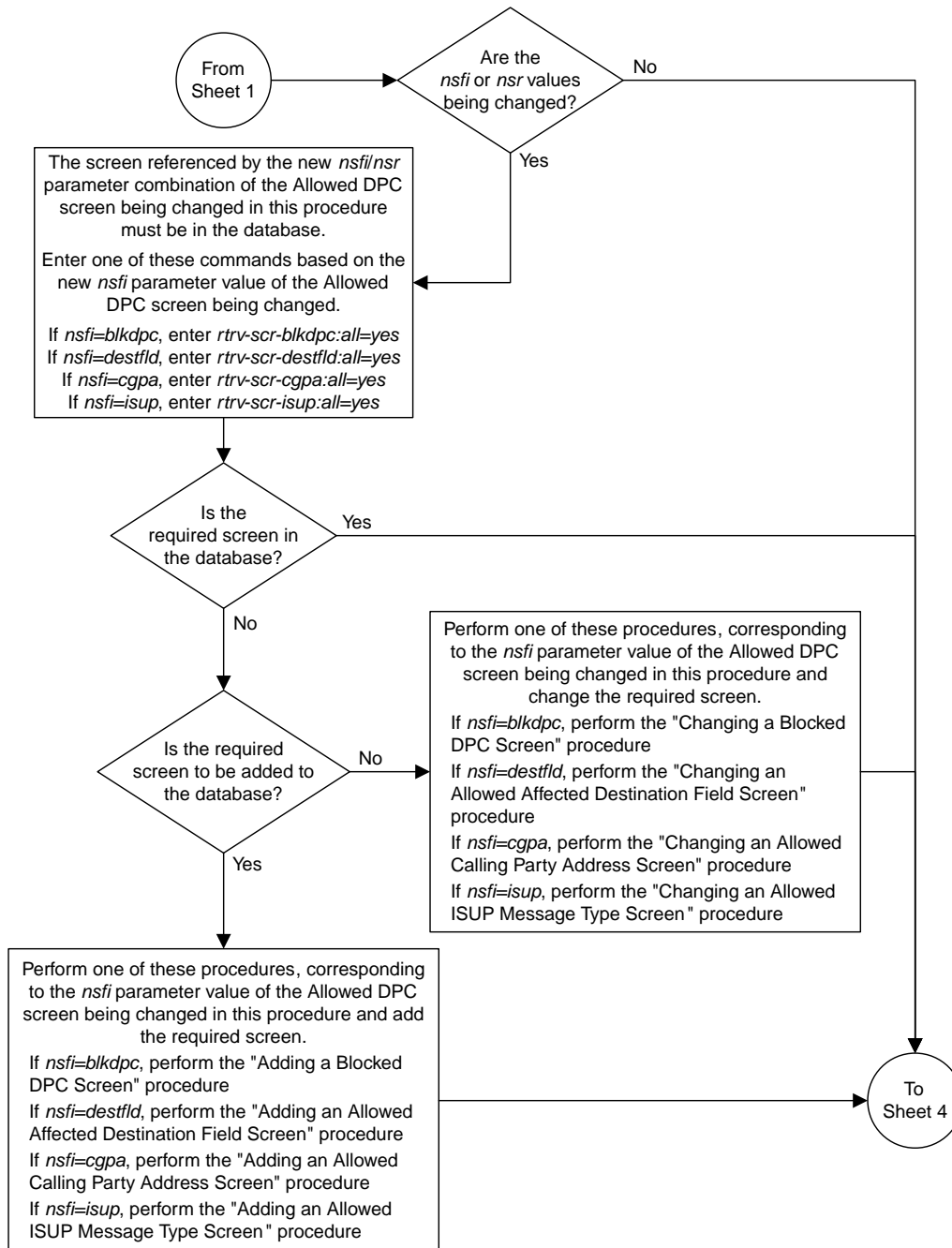

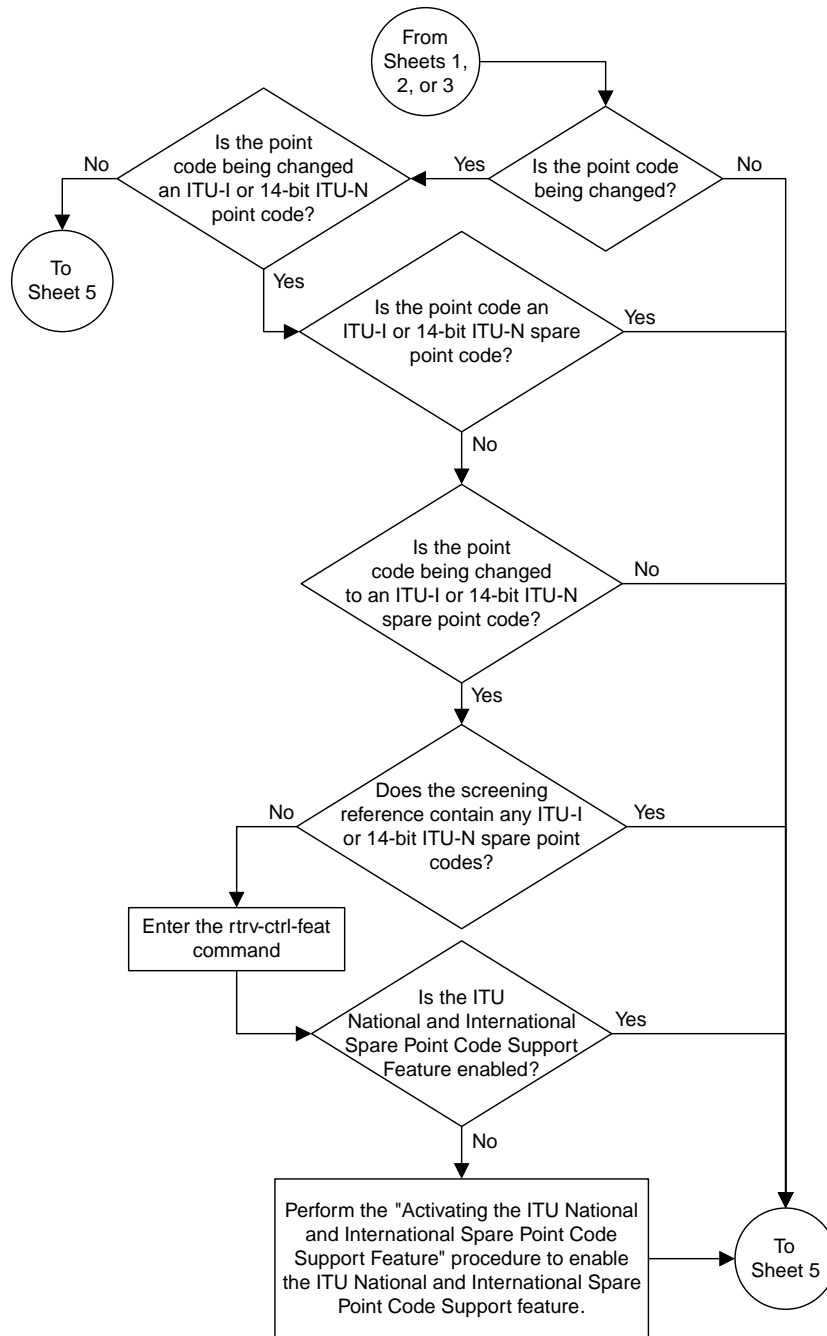

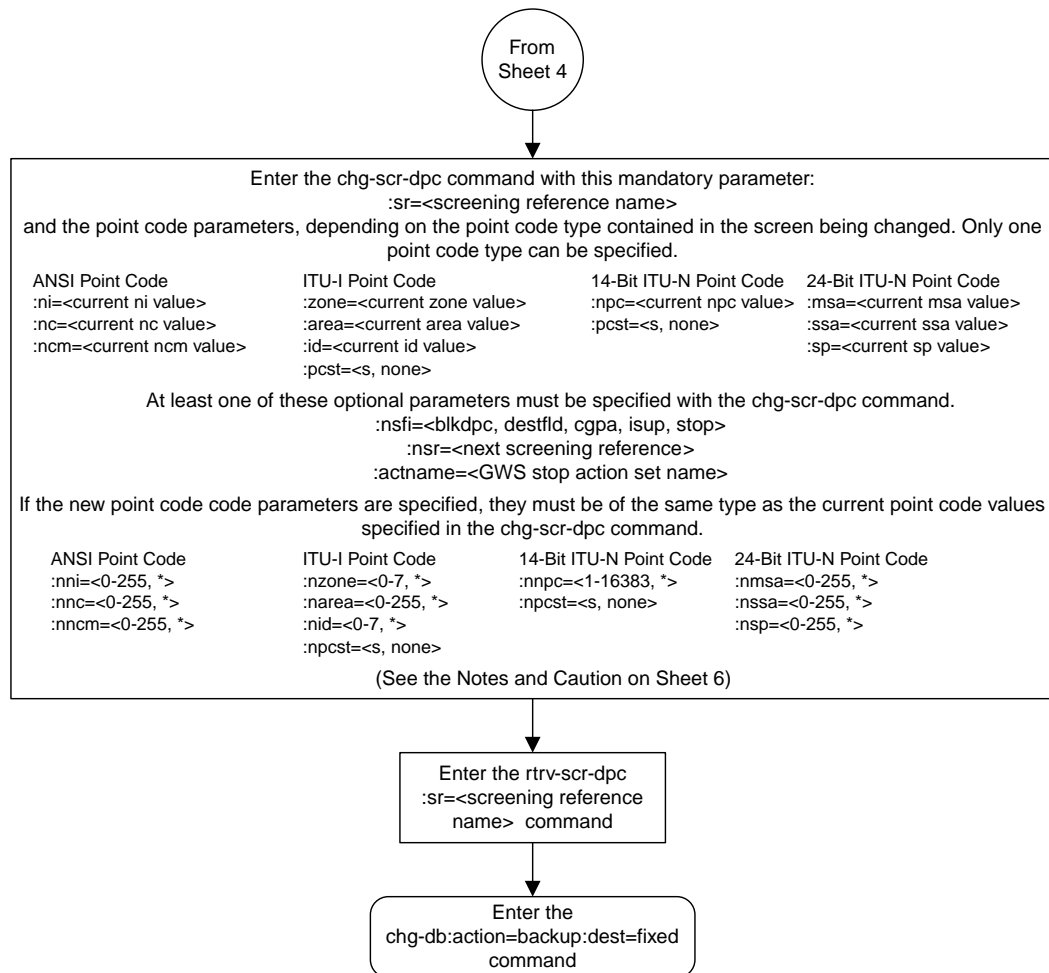

**Notes:**

1. A range of values can be specified for the *ni*, *nc*, or *ncm* parameters by inserting double ampersands (&&) between the parameter values defining the range. For example, to specify the range 025 to 200 for the *ni* parameter, enter 025&&200 for the *ni* parameter value.

2. The asterisk (\*) specifies the entire range of values for that parameter.

For more information about specifying a range of values and about using the asterisk, see the "Gateway Screening Attributes" section and the "Specifying a Range of Values" section. The "Gateway Screening Attributes" section is in the *Database Administration Manual - Gateway Screening*. The "Specifying a Range of Values" section is in the "Changing an Allowed DPC Screen" procedure in the *Database Administration Manual - Gateway Screening*.

3. The *nsr* parameter can be specified, and must be specified, if the *nsfi* parameter value is either *blkdpc*, *destfld*, *cgpa*, or *isup*.

4. The *actname* parameter is optional and can be specified only with the *nsfi=stop* parameter. If the *actname* parameter is specified, the *actname* parameter value is one of the gateway screening stop action set names shown in the *rtrv-gws-actset* output on Sheet 1.

5. To change an ITU-I or 14-bit ITU-N spare point code to a non-spare point code, both the *pcst=s* and *npcst=none* parameters must be specified with the *chg-scr-dpc* command.

6. To change an ITU-I or 14-bit ITU-N non-spare point code to a spare point code, the *npcst=s* parameter must be specified with the *chg-scr-dpc* command. The *pcst* parameter does not have to be specified.

7. If the current point code in the screen being changed is either an ITU-I or 14-bit ITU-N spare point code, the *pcst=s* parameter must be specified with the *chg-scr-dpc* command.

8. If the current point code in the screen being changed is either an ITU-I or 14-bit ITU-N non-spare point code, the *pcst* parameter does not have to be specified with the *chg-scr-dpc* command. If the *pcst* parameter is specified for a screen containing either an ITU-I or 14-bit ITU-N non-spare point code, the *pcst* parameter value must be *none*.

**Caution:** Redirecting SLTA /SLTM messages causes SLTA /SLTM messages not to be returned to the EAGLE 5 ISS. The signaling link will fail if the SLTA /STM messages are not returned to the EAGLE 5 ISS.

To prevent SLTA /SLTM messages from being redirected, gateway screening stop action sets containing redirect stop action should not be assigned to Allowed DPC screens containing the EAGLE 5 ISS's point code.

Sheet 6 of 6

**Figure 54: Changing an Allowed DPC Screen**

# Chapter 10

## Allowed Signaling Information Octet (SIO) Screen Configuration

---

### Topics:

- [Introduction.....349](#)
- [Adding an Allowed SIO Screen.....354](#)
- [Removing an Allowed SIO Screen.....365](#)
- [Changing an Allowed SIO Screen.....369](#)

Chapter 10, Allowed Signaling Information Octet (SIO) Screen Configuration, contains the procedures necessary to configure allowed signaling information octet screens.



## Introduction

The allowed signaling information octet (SIO) screen identifies the type of MSUs (ISUP, TCAP, etc.) that are allowed into the network. The gray shaded areas in [Figure 56: Allowed SIO Screening Function](#) shows the fields of the SS7 message that are checked by the allowed SIO screening function.

## Gateway Screening Actions

If a match is not found, the message is discarded.

If a match is found, the `nsfi` is examined to determine the next step in the screening process. If the `nsfi` value is any value other than `stop`, the next screening reference (`nsr`) is identified and the screening process continues to the next screen identified by the `nsfi` and `nsr` parameter values.

If the `nsfi` is equal to `stop`, the screening process stops and the message is processed. If a gateway screening stop action set is specified with the screen, shown by the `actname` parameter value, the message is processed according to the gateway screening stop actions that are assigned to the gateway screening stop action set.

- If the `copy` gateway screening stop action is specified, the message is processed and a copy of the message is sent by the STPLAN feature to an external application.
- If the `rdct` (redirect) gateway screening stop action is specified, the message is diverted from the original destination and sent to another destination with the Database Transport Access feature, specified by global title translation, for further processing.
- If the `cncf` gateway screening stop action is specified, the PIP parameter in the incoming ISUP IAM message is converted to the GN parameter. The GN parameter in the incoming ISUP IAM message is converted to the PIP parameter. The message is then sent to the node specified by the DPC in the routing label in the message. For more information on the Calling Name Conversion Facility feature, see [Calling Name Conversion Facility \(CNCF\) Configuration](#).
- If the `tlnp` gateway screening stop action is specified, ISUP IAMs that pass gateway screening are processed either by the ISUP NP with EPAP feature (if the ISUP NP with EPAP feature is enabled and turned on) or by the Triggerless LNP feature (if the Triggerless LNP feature is turned on). The ISUP NP with EPAP feature is discussed in more detail in *G-Port User's Guide*. The Triggerless LNP feature is discussed in more detail in *ELAP Administration and LNP Feature Activation Guide*.
- If the `tinp` gateway screening stop action is specified, ISUP IAMs that pass gateway screening are intercepted by the Triggerless ISUP based Number Portability (TINP) feature and converted to include the routing number (RN) if the call is to a ported number. The TINP feature is discussed in more detail in *G-Port User's Guide*.
- If the `tif`, `tif2`, or `tif3` gateway screening stop actions are specified, TIF processing is applied to the message.
- If the `sccp` gateway screening stop action is specified, MTP routed SCCP UDT/XUDT are forwarded to the service modules for further processing.

## Allowed SIO Screening Actions

The value of the `nsfi` parameter is based on the value of the service indicator (`si`) parameter. [Table 62: Valid Parameter Combinations for the Allowed SIO Screening Function](#) shows the valid combinations of `nsfi` values and service indicator values.

**Table 62: Valid Parameter Combinations for the Allowed SIO Screening Function**

Service Indicator (SI) Values	Nest Screening Function Identifier (NSFI) Values
0	DPC, BLKDPC, DESTFLD
3	DPC, BLKDPC, CGPA, CDPA
4, 5	DPC, BLKDPC, ISUP
All other values (1, 2, 6-15)	DPC, BLKDPC

Messages containing the service indicator value 4 are TUP messages, and messages containing the service indicator value 5 are ISUP messages. Both types of messages are screened using the allowed ISUP screen. TUP messages can be screened for point codes, after the SIO screen, with the allowed and blocked DPC screens. However, if the screen set does not contain an allowed SIO screen that screens for TUP messages (messages with the service indicator value of 4), the message will be treated by the allowed ISUP message type screen as an ISUP message, even if the message contains the service indicator value of 4.

*Figure 55: Allowed SIO Screening Actions* shows the screening actions of the allowed SIO screen.

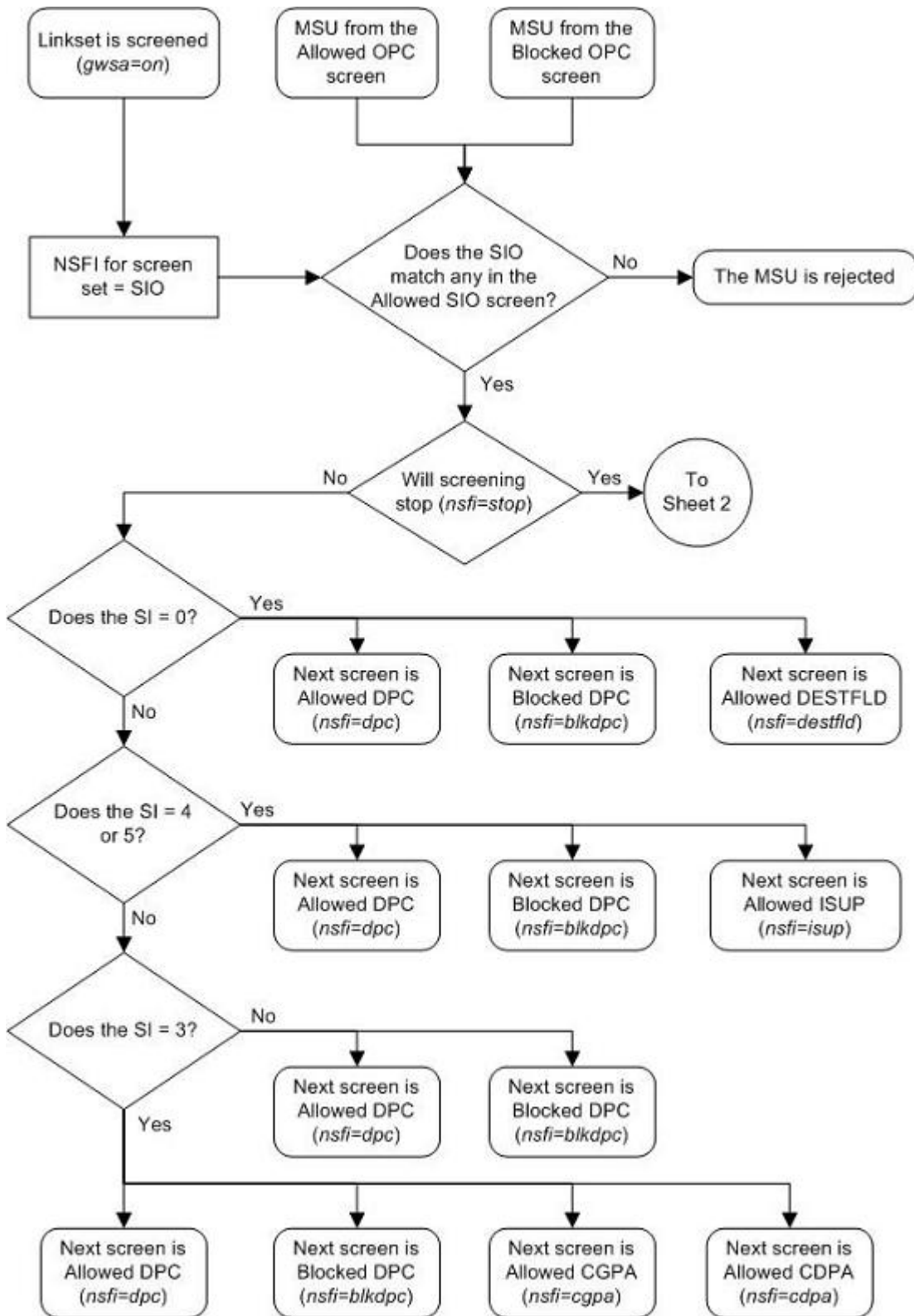

Sheet 1 of 3

Figure 55: Allowed SIO Screening Actions

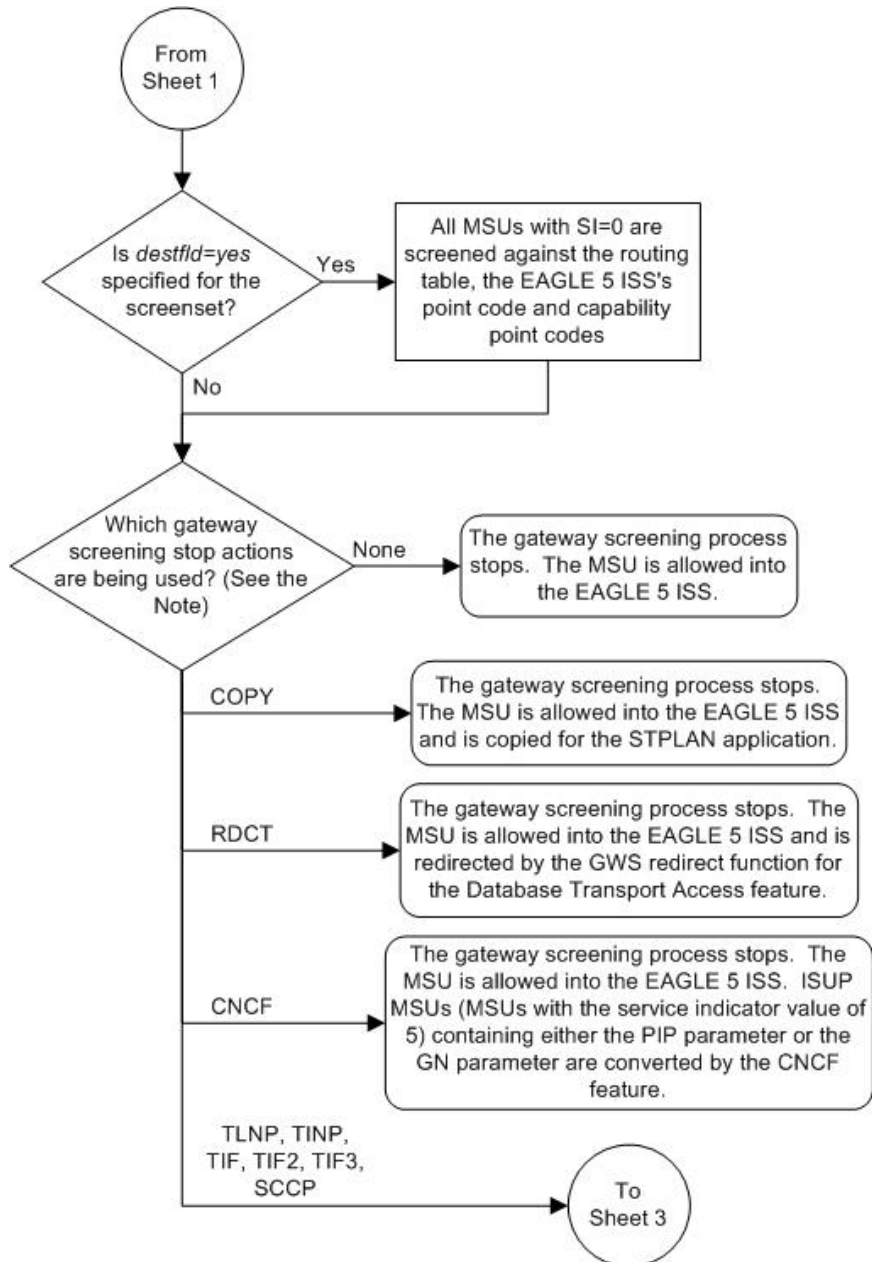

Note: Combinations of the gateway screening stop actions shown on Sheets 2 and 3 may be assigned to a gateway screening stop action set. Refer to the Configuring Gateway Screening Stop Action Sets and the Configuring TLNP Gateway Screening Stop Action Sets procedures in Chapter 2 of this manual for the combinations that can be used.

Sheet 2 of 3

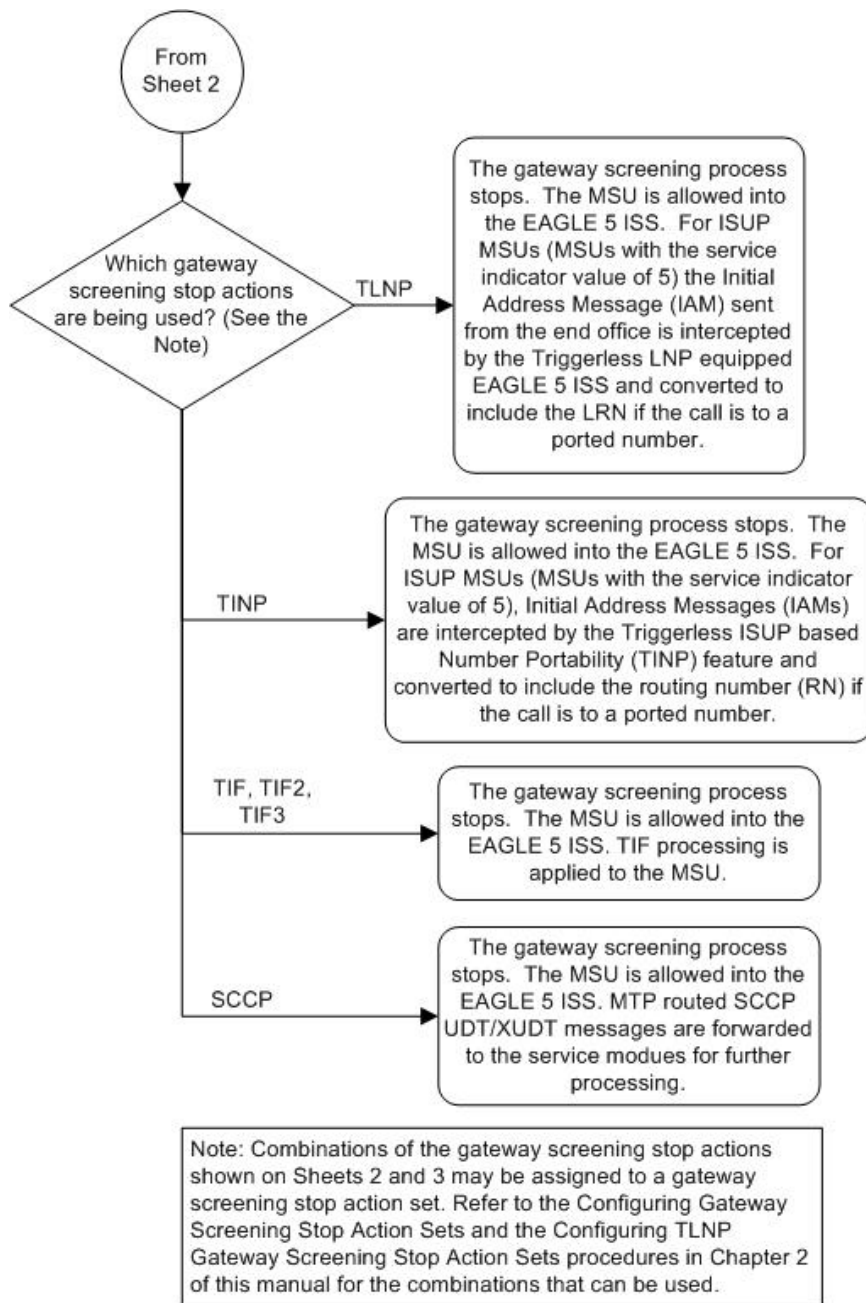

Sheet 3 of 3

ANSI MSU (ANSI Message Signal Unit)

BSN FSN LI	SIO xx xx xxxx NIC PRI SI	SIF			
		Routing Label DPC OPC SLS NCM NC NI NCM NC NI xx			H1 H0

ITU-I MSU (ITU International Message Signal Unit)

BSN FSN LI	SIO xx xx xxxx NIC PRI SI	SIF			
		Routing Label DPC OPC SLS ID AREA ZONE ID AREA ZONE xx			H1 H0

14-Bit ITU-N MSU (14-Bit ITU National Message Signal Unit)

BSN FSN LI	SIO xx xx xxxx NIC PRI SI	SIF			
		Routing Label DPC OPC SLS NPC NPC xx			H1 H0

24-Bit ITU-N MSU (24-Bit ITU National Message Signal Unit)

BSN FSN LI	SIO xx xx xxxx NIC PRI SI	SIF			
		Routing Label DPC OPC SLS SP SSA MSA SP SSA MSA xx			H1 H0

Figure 56: Allowed SIO Screening Function

## Adding an Allowed SIO Screen

This procedure is used to add an allowed signaling information octet (SIO) screen to the database using the `ent-scr-sio` command. The parameters used by the `ent-scr-sio` command are shown in the [Gateway Screening Attributes](#) section. The general rules that apply to configuring gateway screening entities are shown in the [Gateway Screening Configuration](#) section.

The examples in this procedure are used to add the allowed SIO screen data shown in [Table 63: Example Gateway Screening Allowed SIO Configuration Table](#) and based on the example configurations shown in [Figure 5: Gateway Screening Configuration - Example 2](#), [Figure 7: Gateway Screening Configuration - Example 4](#), [Figure 8: Gateway Screening Configuration - Example 5](#), [Figure 9: Gateway Screening Configuration - Example 6](#), and [Figure 10: Gateway Screening Configuration - Example 7](#).

Table 63: Example Gateway Screening Allowed SIO Configuration Table

Screening Reference	NIC	SI	H0	H1	PRI	NSFI	NSR
fld4	2	0	4	5	3	destfld	fld5
iec	2	3	--	--	1&&3	cgpa	gw11
ls02	2	3	--	--	3	cdpa	ls03
isp1	2	5	--	--	3	isup	isp1
tup1	2	4	--	--	3	dpc	tup1
tup1	2	5	--	--	3	dpc	isp2

The allowed SIO screen can reference one of the following screens.

- Allowed DPC
- Blocked DPC
- Allowed Affected Destination Field
- Allowed ISUP Message Type
- Allowed CGPA
- Allowed CDPA

### Verifying the Gateway Screening Configuration

Enter the following commands to verify that these screens are in the database.

- `rtrv-scr-dpc:all=yes`
- `rtrv-scr-blkdpc:all=yes`
- `rtrv-scr-destfld:all=yes`
- `rtrv-scr-isup:all=yes`
- `rtrv-scr-cgpa:all=yes`
- `rtrv-scr-cdpa:all=yes`

### Gateway Screening Configuration Procedures

If the desired screen is not in the database, perform one of these procedures to add the desired screen to the database or change an existing screen in the database.

- [Adding an Allowed DPC Screen](#)
- [Adding a Blocked DPC Screen](#)
- [Adding an Allowed Affected Destination Field Screen](#)
- [Adding an Allowed ISUP Message Type Screen](#)
- [Adding an Allowed Calling Party Address Screen](#)
- [Adding an Allowed Called Party Address Screen](#)
- [Changing an Allowed DPC Screen](#)
- [Changing a Blocked DPC Screen](#)
- [Changing an Allowed Affected Destination Field Screen](#)
- [Changing an Allowed ISUP Message Type Screen](#)
- [Changing an Allowed Calling Party Address Screen](#)

- [Changing an Allowed Called Party Address Screen](#)

### Specifying a Range of Values

A range of values can be specified for the `pri`, `h0`, and `h1` parameters. If a range of values is specified for any of these parameters and the `nic` and `si` values in the screening reference name are not changed, the range of values for the `pri`, `h0`, or `h1` parameters cannot include any values that are currently provisioned for the screening reference name.

For example, screening reference name `scr1` contains these entries:

SR	NIC	PRI	SI	H0	H1	NSFI	NSR/ACT
SCR1	2	3	1	4	5	DPC	LS03
SCR1	2	2	1	2	7	BLKDPC	LS04

Another entry for screening reference `scr1` with the same `nic` and `si` values cannot be specified if:

- The range of values for the `pri` parameter includes the values 2 or 3
- The range of values for the `h0` parameter includes the values 2 or 4
- The range of values for the `h1` parameter includes the values 5 or 7.

### Specifying H0 and H1 Values

The `h0` and `h1` values must be specified if the `si` value is 0, 1, or 2. If the `si` value is 3 through 15, the `h0` and `h1` parameters cannot be specified.

The `h0` and `h1` parameters must be specified if either parameter is specified.

The H0 and H1 heading code values can be a single value, a range of values with the beginning and end of the range separated by double ampersands (for example, a range of values from 2 to 9, 2&&9), or with an asterisk (\*). The asterisk specifies all possible values for the `h0` and `h1` parameters. [Table 64: Valid Value Combinations for H0 and H1 Parameters](#) shows the valid combinations of these parameter values.

**Table 64: Valid Value Combinations for H0 and H1 Parameters**

H0	H1
Single Value	Single Value
Single Value	Range of Values
Single Value	Asterisk
Range of Values	Asterisk
Asterisk	Asterisk

1. Verify that the gateway screening feature is on, by entering the `rtrv-feat` command.

If the gateway screening feature is on, the `GWS` field is set to `on`.

**Note:** The `rtrv-feat` command output contains other fields that are not used by this procedure. If you wish to see all the fields displayed by the `rtrv-feat` command, see the `rtrv-feat` command description in *Commands Reference*.



If the gateway screening feature is on, shown by the entry `GWS = on` in the `rtrv-feat` command output, skip step 2, and go to step 3.

- Turn the gateway screening feature on by entering this command.

```
chg-feat:gws=on
```

**Note:** Once the gateway screening feature is turned on with the `chg-feat` command, it cannot be turned off.

The gateway screening feature must be purchased before you turn this feature on with the `chg-feat` command. If you are not sure if you have purchased the gateway screening feature, contact your Oracle Sales Representative or Account Representative.

When the `chg-feat` has successfully completed, this message should appear.

```
rlghncxa03w 06-10-28 11:43:04 GMT EAGLE5 36.0.0
CHG-FEAT: MASP A - COMPLTD
```

- Display all allowed SIO screens in the database using the `rtrv-scr-sio` command.

The following is an example of the possible output.

```
rlghncxa03w 06-10-25 15:25:30 GMT EAGLE5 36.0.0
SCREEN = ALLOWED SIO
SR   REF  RULES
IEC  YES   5
WRD2 YES   1
WRD4 YES   9
```

If the screening reference names that you wish to add with this procedure are not shown in the `rtrv-scr-sio` command output, go to either steps 4 or 5.

Step 4 verifies the gateway screening stop action set names in the database. The gateway screening stop action set names are assigned only if the NSFI of the screen being added in this procedure is STOP. If the NSFI of the new screen will be STOP, but a gateway screening stop action set name will not be assigned to the new screen, skip steps 4 and 5 and go to step 6. If the NSFI of the new screen is not STOP, skip step 4 and go to step 5.

If these screening reference names are shown in the `rtrv-scr-sio` command output, make sure the screening data you wish to enter is not already in the database by entering the `rtrv-scr-sio` command with the screening reference name. In this example, screen `iec` will have new data added to it. For this example, enter the `rtrv-scr-sio:sr=iec` command. The following is an example of the possible output.

```
rlghncxa03w 06-10-25 15:26:30 GMT EAGLE5 36.0.0
SCREEN = ALLOWED SIO
SR   NIC  PRI  SI  H0    H1    NSFI    NSR/ACT
IEC  2     0&&3 0    0      0     BLKDPC  WDB2
IEC  2     0&&2 0    1      1     DPC     WDB3
IEC  2     0&&1 0    2      2     STOP    -----
IEC  2     0&&3 4    --     --     STOP    -----
IEC  2     0&&2 1    *      *     DPC     WDB3
```

4. Display the gateway screening stop action sets in the database with the `rtrv-gws-actset` command.

This is an example of the possible output.

```
rlghncxa03w 06-10-25 15:27:30 GMT EAGLE5 36.0.0
ACT ACT ACT ACT ACT ACT ACT ACT ACT ACT
ID NAME 1 2 3 4 5 6 7 8 9 10
-----
1 copy copy
2 rdct rdct
3 cr copy rdct
4 cncf cncf
5 cpcncf copy cncf
6 cncfrd cncf rdct
7 cpcfrd copy cncf rdct

GWS action set table is (7 of 16) 44% full
```

If the required gateway screening stop action set is not in the database, perform the [Configuring Gateway Screening Stop Action Sets](#) procedure to configure the required gateway screening stop action set.

**Note:** If the NSFI of the screen being added in this procedure is STOP, skip step 5 and go to step 6.

5. Enter the commands in the [Verifying the Gateway Screening Configuration](#) section to verify that the screen that will be specified by the NSFI/NSR parameter combination in step 6 is in the database.

If the desired screen is not in the database, perform one of the procedures shown in the [Gateway Screening Configuration Procedures](#) section to add the desired screen to the database or change an existing screen in the database.

6. Add a new allowed SIO screen to the database using the `ent-scr-sio` command.

If a gateway screening stop action set is to be assigned to the new allowed SIO screen, enter the `ent-scr-sio` command with the `nsfi=stop` parameter and the `actname` parameter with the name of a gateway screening stop action set shown in the output of the `rtrv-gws-actset` command executed in step 4.



**CAUTION**

**Caution:** Redirecting SLTA/SLTM messages prevents SLTA/SLTM messages from being returned to the EAGLE. The signaling link carrying these messages will fail if these messages are not returned to the EAGLE. To prevent SLTA/SLTM messages from being redirected, gateway screening stop action sets containing the redirect stop action should not be assigned to Allowed SIO screens containing the service indicator values 1 (SI=1) or 2 (SI=2).

The following list contains the values for `nic`, `si`, `pri`, `h0` and `h1` parameters:

- `nic` – 0 - 3, or an asterisk (\*)
- `si` – 0 - 15
- `pri` – 0 - 3, or an asterisk (\*)
- `h0` – 0 - 15, or an asterisk (\*)
- `h1` – 0 - 15, or an asterisk (\*)

A range of values can be specified for the `pri`, `h0`, and `h1` parameters. See the [“Specifying a Range of Values”](#) section for more information. See the [“Specifying H0 and H1 Values”](#) section for information on how the asterisk and a range of values are used for the `h0` and `h1` parameters.

The value of the `nsfi` parameter is based on the value of the service indicator (`si`) parameter. [Table 62: Valid Parameter Combinations for the Allowed SIO Screening Function](#) shows the valid combinations of `nsfi` values and service indicator values. For this example, enter these commands.

```
ent-scr-sio:sr=fld4:nic=2:si=0:h0=4:h1=5:pri=3:nsfi=destfld :nsr=fld5
```

A message similar to the following should appear.

```
rlghncxa03w 06-10-25 15:28:30 GMT EAGLE5 36.0.0
ENT-SCR-SIO: MASP A - COMPLTD
```

```
ent-scr-sio:sr=iec:nic=2:si=3:pri=1&&3:nsfi=cgpa:nsr=gw11
```

A message similar to the following should appear.

```
rlghncxa03w 06-10-25 15:29:30 GMT EAGLE5 36.0.0
ENT-SCR-SIO: MASP A - COMPLTD
```

```
ent-scr-sio:sr=ls02:nic=2:si=3:pri=3:nsfi=cdpa:nsr=ls03
```

A message similar to the following should appear.

```
rlghncxa03w 06-10-25 15:30:30 GMT EAGLE5 36.0.0
ENT-SCR-SIO: MASP A - COMPLTD
```

```
ent-scr-sio:sr=isp1:nic=2:si=5:pri=3:nsfi=isup:nsr=isp1
```

A message similar to the following should appear.

```
rlghncxa03w 06-10-25 15:30:30 GMT EAGLE5 36.0.0
ENT-SCR-SIO: MASP A - COMPLTD
```

```
ent-scr-sio:sr=tup1:nic=2:si=4:pri=3:nsfi=dpc:nsr=tup1
```

A message similar to the following should appear.

```
rlghncxa03w 06-10-25 15:30:30 GMT EAGLE5 36.0.0
ENT-SCR-SIO: MASP A - COMPLTD
```

```
ent-scr-sio:sr=tup1:nic=2:si=5:pri=3:nsfi=dpc:nsr=isp2
```

A message similar to the following should appear.

```
rlghncxa03w 06-10-25 15:30:30 GMT EAGLE5 36.0.0
ENT-SCR-SIO: MASP A - COMPLTD
```

- Verify the changes using the `rtrv-scr-sio` command with the screening reference name used in step 6.

For this example, enter these commands.

```
rtrv-scr-sio:sr=iec
```

The following is an example of the possible output.

```
rlghncxa03w 06-10-25 15:31:30 GMT EAGLE5 36.0.0
SCREEN = ALLOWED SIO
SR   NIC  PRI  SI  H0    H1    NSF1  NSR/ACT
IEC  2    0&&3 0   0     0     BLKDPC WDB2
IEC  2    0&&2 0   1     1     DPC    WDB3
IEC  2    0&&1 0   2     2     STOP   -----
IEC  2    0&&3 4   --    --    STOP   -----
IEC  2    0&&2 1   *     *     DPC    WDB3
IEC  2    1&&3 3   --    --    CGPA   GW11
```

```
rtrv-scr-sio:sr=ls02
```

The following is an example of the possible output.

```
rlghncxa03w 06-10-25 15:32:30 GMT EAGLE5 36.0.0
SCREEN = ALLOWED SIO
SR   NIC  PRI  SI  H0    H1    NSF1  NSR/ACT
LS02 2    3    3   --    --    CDPA   LS03
```

```
rtrv-scr-sio:sr=fld4
```

The following is an example of the possible output.

```
rlghncxa03w 06-10-25 15:33:30 GMT EAGLE5 36.0.0
SCREEN = ALLOWED SIO
SR   NIC  PRI  SI  H0    H1    NSF1  NSR/ACT
FLD4 2    3    0   4     5     DESTFLD FDL5
```

```
rtrv-scr-sio:sr=ispl
```

The following is an example of the possible output.

```
rlghncxa03w 06-10-25 15:33:30 GMT EAGLE5 36.0.0
SCREEN = ALLOWED SIO
SR   NIC  PRI  SI  H0    H1    NSF1  NSR/ACT
ispl 2    3    5   --    --    ISUP   ispl
```

```
rtrv-scr-sio:sr=tup1
```

The following is an example of the possible output.

```
rlghncxa03w 06-10-25 15:33:30 GMT EAGLE5 36.0.0
SCREEN = ALLOWED SIO
SR   NIC  PRI  SI  H0    H1    NSF1  NSR/ACT
tup1 2    3    4   --    --    DPC    tup1
tup1 2    3    5   --    --    ISUP   isp2
```

8. Backup the new changes using the `chg-db:action=backup:dest=fixed` command.

The following messages should appear, the active Maintenance and Administration Subsystem Processor (MASP) appears first.

```
BACKUP (FIXED) : MASP A - Backup starts on active MASP.  
BACKUP (FIXED) : MASP A - Backup on active MASP to fixed disk complete.  
BACKUP (FIXED) : MASP A - Backup starts on standby MASP.  
BACKUP (FIXED) : MASP A - Backup on standby MASP to fixed disk complete.
```

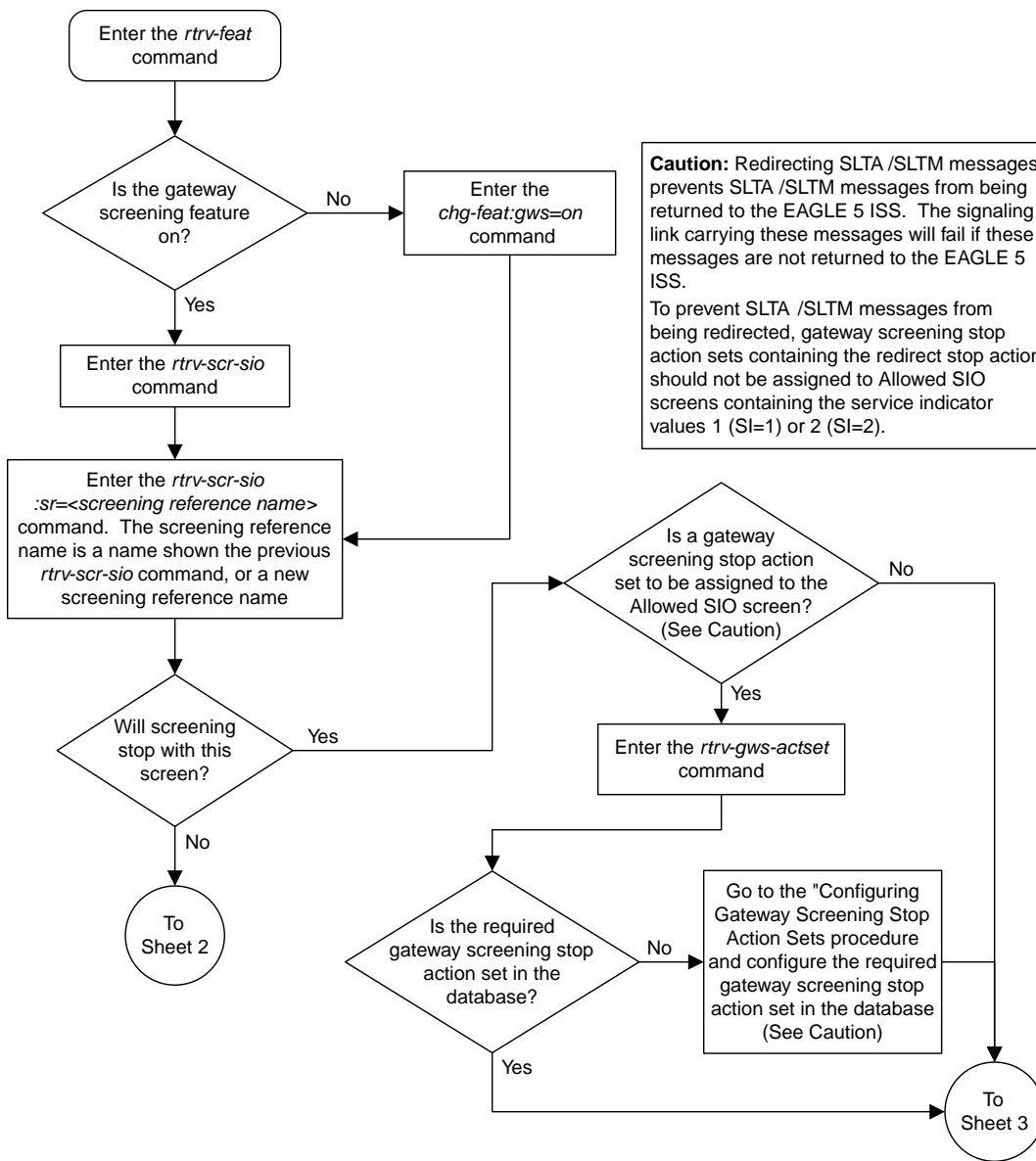

**Caution:** Redirecting SLTA /SLTM messages prevents SLTA /SLTM messages from being returned to the EAGLE 5 ISS. The signaling link carrying these messages will fail if these messages are not returned to the EAGLE 5 ISS.

To prevent SLTA /SLTM messages from being redirected, gateway screening stop action sets containing the redirect stop action should not be assigned to Allowed SIO screens containing the service indicator values 1 (SI=1) or 2 (SI=2).

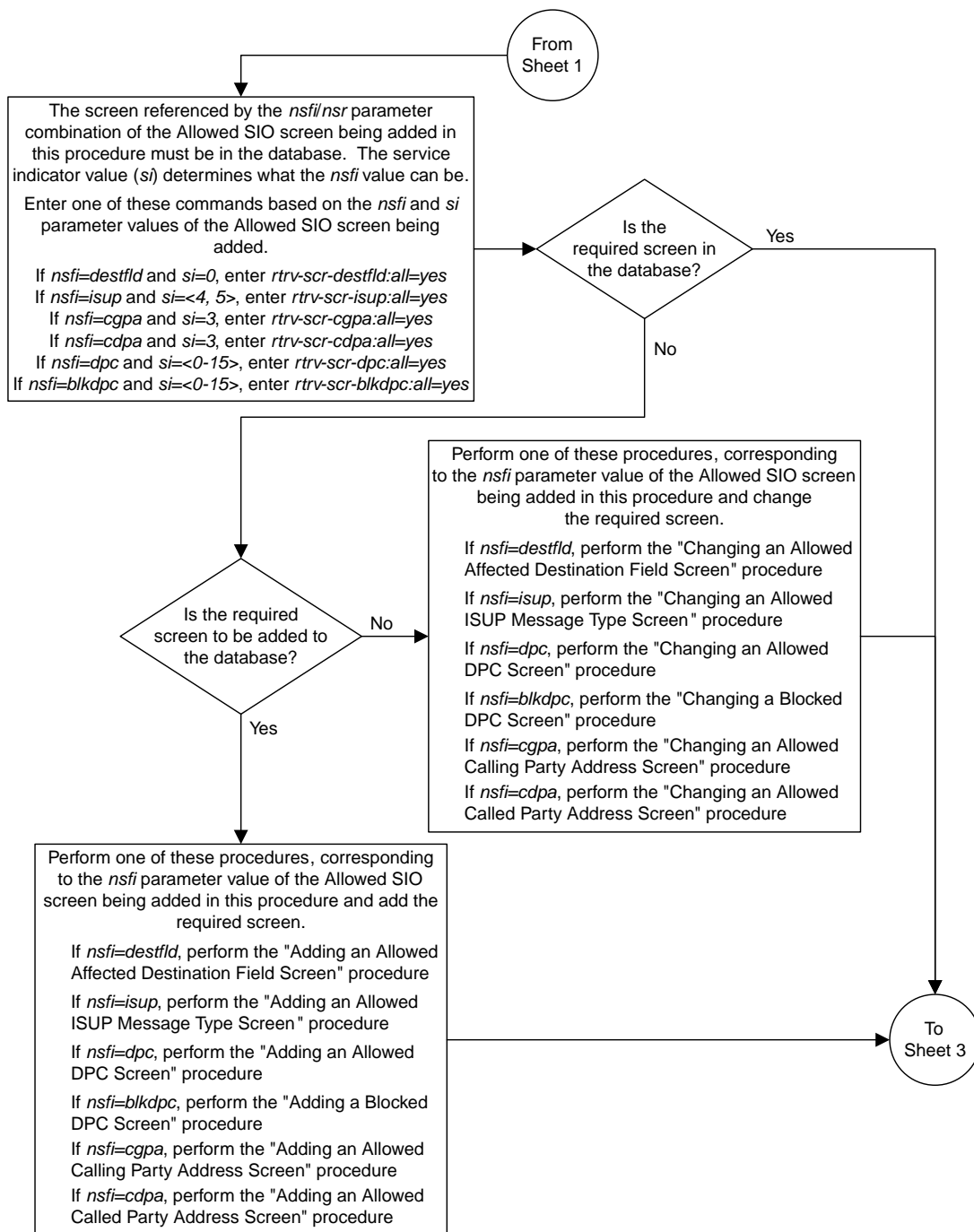

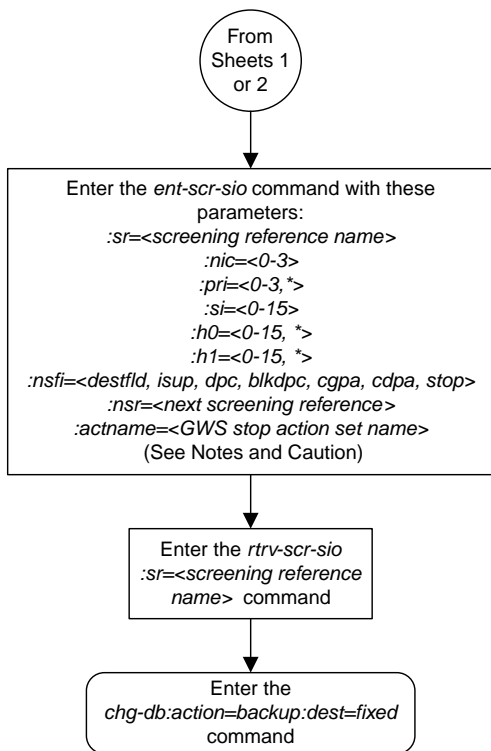

**Notes:**

1. A range of values can be specified for the *pri*, *h0*, or *h1* parameters by inserting double ampersands (&&) between the parameter values defining the range. For example, to specify the range 0 to 3 for the *pri* parameter, enter 0&&3 for the *pri* parameter value.
2. The asterisk (\*) specifies the entire range of values for that parameter.

For more information about specifying a range of values and about using the asterisk, see the "Gateway Screening Attributes" section in Chapter 2 and the "Specifying a Range of Values" and "Specifying H0 and H1 Values" sections in this procedure.

3. The *nsr* parameter can be specified only, and must be specified, if the *nsfi* parameter value is either *destfld*, *isup*, *dpc*, *blkdpc*, *cgpa*, or *cdpa*.
4. The *actname* parameter is optional and can be specified only with the *nsfi=stop* parameter. If the *actname* parameter is specified, the *actname* parameter value is one of the gateway screening stop action set names shown in the *rtrv-gws-actset* output on Sheet 1.
5. The NSFI and service indicator values can be entered only in the following combinations:

SI Value	NSFI Value
0	destfld, dpc, blkdpc
3	cgpa, cdpa, dpc, blkdpc
4, 5	isup, dpc, blkdpc
1, 2, 6-15	dpc, blkdpc

6. The *h0* and *h1* parameters can be specified, and must be specified, only if the *si* values are either 0, 1, or 2.

**Caution:** Redirecting SLTA /SLTM messages prevents SLTA /SLTM messages from being returned to the EAGLE 5 ISS. The signaling link carrying these messages will fail if these messages are not returned to the EAGLE 5 ISS.

To prevent SLTA /SLTM messages from being redirected, gateway screening stop action sets containing the redirect stop action should not be assigned to Allowed SIO screens containing the service indicator values 1 (SI=1) or 2 (SI=2).



Sheet 3 of 3

Figure 57: Adding an Allowed SIO Screen

## Removing an Allowed SIO Screen

This procedure is used to remove an allowed signaling information octet (SIO) screen from the database using the `dlt-scr-sio` command. The parameters used by the `dlt-scr-sio` command are shown in the [Gateway Screening Attributes](#) section. The general rules that apply to configuring gateway screening entities are shown in the [Gateway Screening Configuration](#) section.

The example in this procedure removes the allowed SIO screen `ls02` from the database.

The allowed SIO screen can be referenced by one of the following screens.

- Screen Set
- Allowed OPC
- Blocked OPC

### Verifying the Gateway Screening Configuration

Enter the following commands to verify that none of these screens reference the allowed SIO screen being removed from the database.

- `rtrv-scrset:nsfi=sio`
- `rtrv-scr-opc:nsfi=sio`
- `rtrv-scr-blkopc:nsfi=sio`

### Gateway Screening Configuration Procedures

To change the NSFI of any of these screens, perform one of these procedures.

- [Changing a Screen Set](#)
- [Changing an Allowed OPC Screen](#)
- [Changing a Blocked OPC Screen](#)

1. Display the allowed SIO screens in the database using the `rtrv-scr-sio` command.

The following is an example of the possible output.

```
rlghncxa03w 06-10-25 15:25:30 GMT EAGLE5 36.0.0
SCREEN = ALLOWED SIO

SR    REF  RULES
IEC   YES   6
ISP1  YES   1
WRD2  YES   1
WRD4  YES   9
LS02  YES   1
TUP1  YES   2
```

From the `rtrv-scr-sio` output, display the allowed SIO screen you wish to remove using the `rtrv-scr-sio` command with the screening reference name. For this example, enter this command.

```
rtrv-scr-sio:sr=ls02
```

The following is an example of the possible output.

```
rlghncxa03w 06-10-25 15:25:30 GMT EAGLE5 36.0.0
SCREEN = ALLOWED SIO
SR      NIC  PRI  SI  H0      H1      NSF1    NSR/ACT
LS02   2    3    3   --      --      CDPA    LS03
```

2. Enter the commands in the [Verifying the Gateway Screening Configuration](#) section to verify that the screen being removed is not referenced by other screens in the database.

If the screen being removed is referenced by other screens, perform the procedures shown in the [Gateway Screening Configuration Procedures](#) to change the NSF1 of those screens to reference other screens or change the NSF1 of these screens to STOP.

3. Remove the allowed SIO to the database using the `dlt-scr-sio` command.

The `dlt-scr-sio` command must be entered with these parameters: `sr, nic, si, pri`. The values for these parameters must be entered exactly as shown in the `rtrv-scr-sio` output in step 1. If the screen being removed has values for the `h0` and `h1` parameters, these values must be entered with the other parameter values. If the screen being removed contains dashes for the `h0` and `h1` parameters, the `h0` and `h1` parameters cannot be specified with the `dlt-scr-sio` command. For this example, enter this command.

```
dlt-scr-sio:sr=ls02:nic=2:si=3:pri=3
```

A message similar to the following should appear.

```
rlghncxa03w 06-10-25 15:26:30 GMT EAGLE5 36.0.0
DLT-SCR-SIO: SCREEN SET AFFECTED - LS02 0% FULL
DLT-SCR-SIO: MASP A - COMPLTD
```

4. Verify the changes using the `rtrv-scr-sio` command with the screening reference name used in step 3.

For this example, enter this command.

```
rtrv-scr-sio:sr=ls02
```

The following is an example of the possible output.

```
E2573 Cmd Rej: SR or NSR does not reference an existing SR
```

This message shows that the specified screening reference name is not in the database and the action of the `dlt-scr-sio` command in step 3 was successful. If the specified screening reference name contained more than one entry when the `dlt-scr-sio` command was executed in step 3, the `rtrv-scr-sio:sr=` command output would show the remaining entries in the screening reference instead of error message E2573.

5. Backup the new changes using the `chg-db:action=backup:dest=fixed` command.

The following messages should appear, the active Maintenance and Administration Subsystem Processor (MASP) appears first.

```
BACKUP (FIXED) : MASP A - Backup starts on active MASP.  
BACKUP (FIXED) : MASP A - Backup on active MASP to fixed disk complete.  
BACKUP (FIXED) : MASP A - Backup starts on standby MASP.  
BACKUP (FIXED) : MASP A - Backup on standby MASP to fixed disk complete.
```

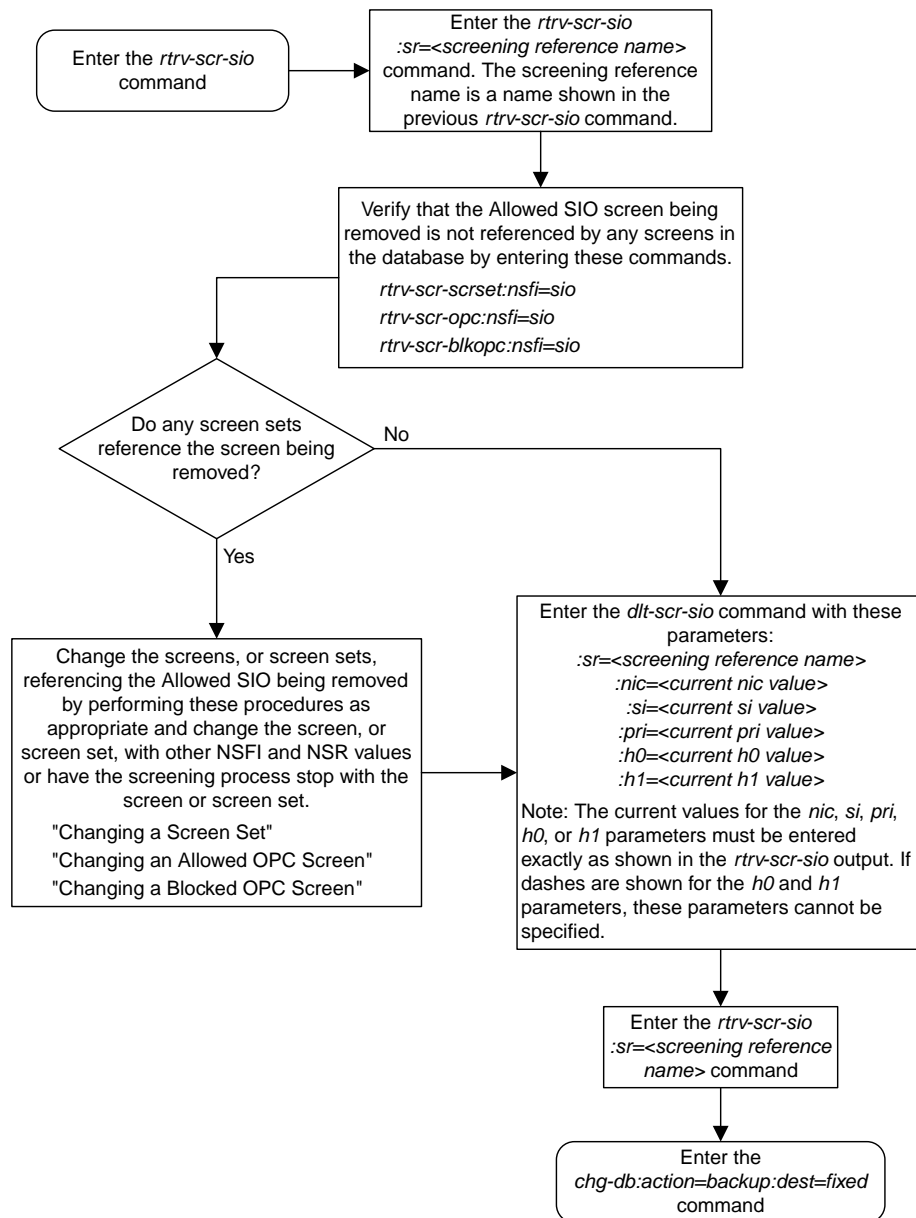

Figure 58: Removing an Allowed SIO Screen

## Changing an Allowed SIO Screen

This procedure is used to change the attributes of an allowed signaling information octet (SIO) screen in the database using the `chg-scr-sio` command. The parameters used by the `chg-scr-sio` command are shown in the [Gateway Screening Attributes](#) section. The general rules that apply to configuring gateway screening entities are shown in the [Gateway Screening Configuration](#) section.

The example in this procedure change the allowed SIO screen `1s02` to an `nic` of 2, an `si` of 14, and an `nsfi` is stop.

The allowed SIO screen can reference one of the following screens.

- Allowed DPC
- Blocked DPC
- Allowed Affected Destination Field
- Allowed ISUP
- Allowed CGPA
- Allowed CDPA

### Verifying the Gateway Screening Configuration

Enter the following commands to verify that these screens are in the database.

- `rtrv-scr-dpc:all=yes`
- `rtrv-scr-blkdpc:all=yes`
- `rtrv-scr-destfld:all=yes`
- `rtrv-scr-isup:all=yes`
- `rtrv-scr-cgpa:all=yes`
- `rtrv-scr-cdpa:all=yes`

### Gateway Screening Configuration Procedures

If the desired screen is not in the database, perform one of these procedures to add the desired screen to the database or change an existing screen in the database.

- [Adding an Allowed DPC Screen](#)
- [Adding a Blocked DPC Screen](#)
- [Adding an Allowed Affected Destination Field Screen](#)
- [Adding an Allowed ISUP Message Type Screen](#)
- [Adding an Allowed Calling Party Address Screen](#)
- [Adding an Allowed Called Party Address Screen](#)
- [Changing an Allowed DPC Screen](#)
- [Changing a Blocked DPC Screen](#)
- [Changing an Allowed Affected Destination Field Screen](#)
- [Changing an Allowed ISUP Message Type Screen](#)
- [Changing an Allowed Calling Party Address Screen](#)
- [Changing an Allowed Called Party Address Screen](#)

The new values for the network indicator code, service indicator, priority, and heading codes being changed in the allowed SIO screen cannot be in that screen.

### Specifying a Range of Values

A range of values can be specified for the `pri`, `h0`, and `h1` parameters. If a range of values is specified for any of these parameters and the `nic` and `si` values in the screening reference name are not changed, the range of values for the `pri`, `h0`, or `h1` parameters cannot include any values that are currently provisioned for the screening reference name.

For example, screening reference name `scr1` contains these entries:

SR	NIC	PRI	SI	H0	H1	NSFI	NSR/ACT
SCR1	2	3	1	4	5	DPC	LS03
SCR1	2	2	1	2	7	BLKDPC	LS04

Another entry for screening reference `scr1` with the same `nic` and `si` values cannot be specified if:

- The range of values for the `pri` parameter includes the values 2 or 3
- The range of values for the `h0` parameter includes the values 2 or 4
- The range of values for the `h1` parameter includes the values 5 or 7.

### Changing H0 and H1 Values

The `h0` and `h1` values must be specified if the `si` value is 0, 1, or 2. If the `si` value is 3 through 15, the `h0` and `h1` parameters cannot be specified.

The `nh0` and `nh1` values must be specified if the `nsi` value is 0, 1, or 2. If the `nsi` value is 3 through 15, the `nh0` and `nh1` parameters cannot be specified.

The `h0` and `h1` parameters must be specified if either parameter is specified.

The `nh0` and `nh1` parameters must be specified if either parameter is specified.

The H0 and H1 heading code values can be a single value, a range of values with the beginning and end of the range separated by double ampersands (for example, a range of values from 2 to 9, 2&&9), or with an asterisk (\*). The asterisk specifies all possible values for the `h0` and `h1` parameters. [Table 65: Valid Value Combinations for H0 and H1 Parameters](#) shows the valid combinations of these parameter values.

**Table 65: Valid Value Combinations for H0 and H1 Parameters**

H0	H1
Single Value	Single Value
Single Value	Range of Values
Single Value	Asterisk
Range of Values	Asterisk
Asterisk	Asterisk

1. Display the allowed SIO screens in the database using the `rtrv-scr-sio` command.

The following is an example of the possible output.

```
r1ghncxa03w 06-10-25 15:25:30 GMT EAGLE5 36.0.0
SCREEN = ALLOWED SIO
```

```
SR    REF  RULES
IEC   YES   6
ISP1  YES   1
WRD2  YES   1
WRD4  YES   9
LS02  YES   1
TUP1  YES   2
```

From the `rtrv-scr-sio` output, display the allowed SIO screen you wish to change using the `rtrv-scr-sio` command with the screening reference name. For this example, enter this command.

```
rtrv-scr-sio:sr=ls02
```

The following is an example of the possible output.

```
rlghncxa03w 06-10-25 15:25:30 GMT EAGLE5 36.0.0
SCREEN = ALLOWED SIO
SR    NIC  PRI  SI  H0      H1      NSFI   NSR/ACT
LS02  2     3   3   --     --     CDPA   LS03
```

If a gateway screening stop action set is to be assigned to the allowed SIO screen being changed in the database, go to step 2.

Step 2 verifies the gateway screening stop action set names in the database. The gateway screening stop action set names are assigned only if the NSFI of the screen being changed in this procedure is STOP. If the NSFI of the screen will be changed to STOP, but a gateway screening stop action set name will not be assigned to the screen, skip steps 2 and 3 and go to step 4. If the NSFI of the screen will not be STOP, skip step 2 and go to step 3.

2. Display the gateway screening stop action sets in the database with the `rtrv-gws-actset` command.

This is an example of the possible output.

```
rlghncxa03w 06-10-25 15:26:30 GMT EAGLE5 36.0.0
ACT  ACT   ACT  ACT  ACT  ACT  ACT  ACT  ACT  ACT  ACT  ACT
ID   NAME   1    2    3    4    5    6    7    8    9    10
--   ---   - - - - - - - - - - - - - - - - - - - - - - - - - - - - - - - -
1    copy   copy
2    rdct   rdct
3    cr     copy rdct
4    cncf   cncf
5    cpcncf copy cncf
6    cncfrd cncf rdct
7    cpcfrd copy cncf rdct
```

```
GWS action set table is (7 of 16) 44% full
```

If the required gateway screening stop action set is not in the database, perform the [Configuring Gateway Screening Stop Action Sets](#) procedure to configure the required gateway screening stop action set.

**Note:** If the NSFI of the screen being changed in this procedure will be STOP, or if the NSFI of the screen is not being changed, skip step 3 and go to step 4.

3. Enter the commands in the [Verifying the Gateway Screening Configuration](#) section to verify that the screen that will be specified by the NSFI/NSR parameter combination in step 4 is in the database.

If the desired screen is not in the database, perform one of the procedures shown in the [Gateway Screening Configuration Procedures](#) section to add the desired screen to the database or change an existing screen in the database.

4. Change the attributes of an allowed SIO screen using the `chg-scr-sio` command.

If a gateway screening stop action is to be assigned to the allowed SIO screen being changed, enter the `chg-scr-sio` command with the `nsfi=stop` parameter and the `actname` parameter with the name of a gateway screening stop action set shown in the output of the `rtrv-gws-actset` command executed in step 2.



**CAUTION**

**Caution:** Redirecting SLTA/SLTM messages prevents SLTA/SLTM messages from being returned to the EAGLE. The signaling link carrying these messages will fail if these messages are not returned to the EAGLE. To prevent SLTA/SLTM messages from being redirected, gateway screening stop action sets containing the redirect stop action should not be assigned to Allowed SIO screens containing the service indicator values 1 (SI=1) or 2 (SI=2).

The current values for the `nic`, `si`, `pri`, `h0` and `h1` parameters must be entered in the `chg-scr-sio` command exactly as shown in the `rtrv-scr-sio` output in step 1.

The following list contains the values for `nnic`, `nsi`, `npri`, `nh0` and `nh1` parameters:

- `nnic` – 0 - 3, or an asterisk (\*)
- `nsi` – 0 - 15
- `npri` – 0 - 3, or an asterisk (\*)
- `nh0` – 0 - 15, or an asterisk (\*)
- `nh1` – 0 - 15, or an asterisk (\*)

A range of values can be specified for the `npri`, `nh0`, and `nh1` parameters. See the [“Specifying a Range of Values”](#) section for more information. See the [“Changing H0 and H1 Values”](#) section for information on how the asterisk and a range of values are used for the `nh0` and `nh1` parameters.

The value of the `nsfi` parameter is based on the value of the service indicator (`si`) parameter. [Table 62: Valid Parameter Combinations for the Allowed SIO Screening Function](#) shows the valid combinations of `nsfi` values and service indicator values.

For this example, enter this command.

```
chg-scr-sio:sr=ls02:nic=2:si=3:pri=3:nsi=14:nsfi=stop
```

A message similar to the following should appear.

```
rlghncxa03w 06-10-25 15:27:30 GMT EAGLE5 36.0.0
CHG-SCR-SIO: SCREEN SET AFFECTED - LS02 1% FULL
CHG-SCR-SIO: MASP A - COMPLTD
```

5. Verify the changes using the `rtrv-scr-sio` command with the screening reference name used in step 4.

For this example, enter this command.

```
rtrv-scr-sio:sr=ls02
```



The following is an example of the possible output.

```
rlghncxa03w 06-10-25 15:28:30 GMT EAGLE5 36.0.0
SCREEN = ALLOWED SIO
SR      NIC  PRI  SI  H0      H1      NSF1      NSR/ACT
LS02   2    3    14  --      --      STOP      -----
```

6. Backup the new changes using the `chg-db:action=backup:dest=fixed` command.

The following messages should appear, the active Maintenance and Administration Subsystem Processor (MASP) appears first.

```
BACKUP (FIXED) : MASP A - Backup starts on active MASP.
BACKUP (FIXED) : MASP A - Backup on active MASP to fixed disk complete.
BACKUP (FIXED) : MASP A - Backup starts on standby MASP.
BACKUP (FIXED) : MASP A - Backup on standby MASP to fixed disk complete.
```

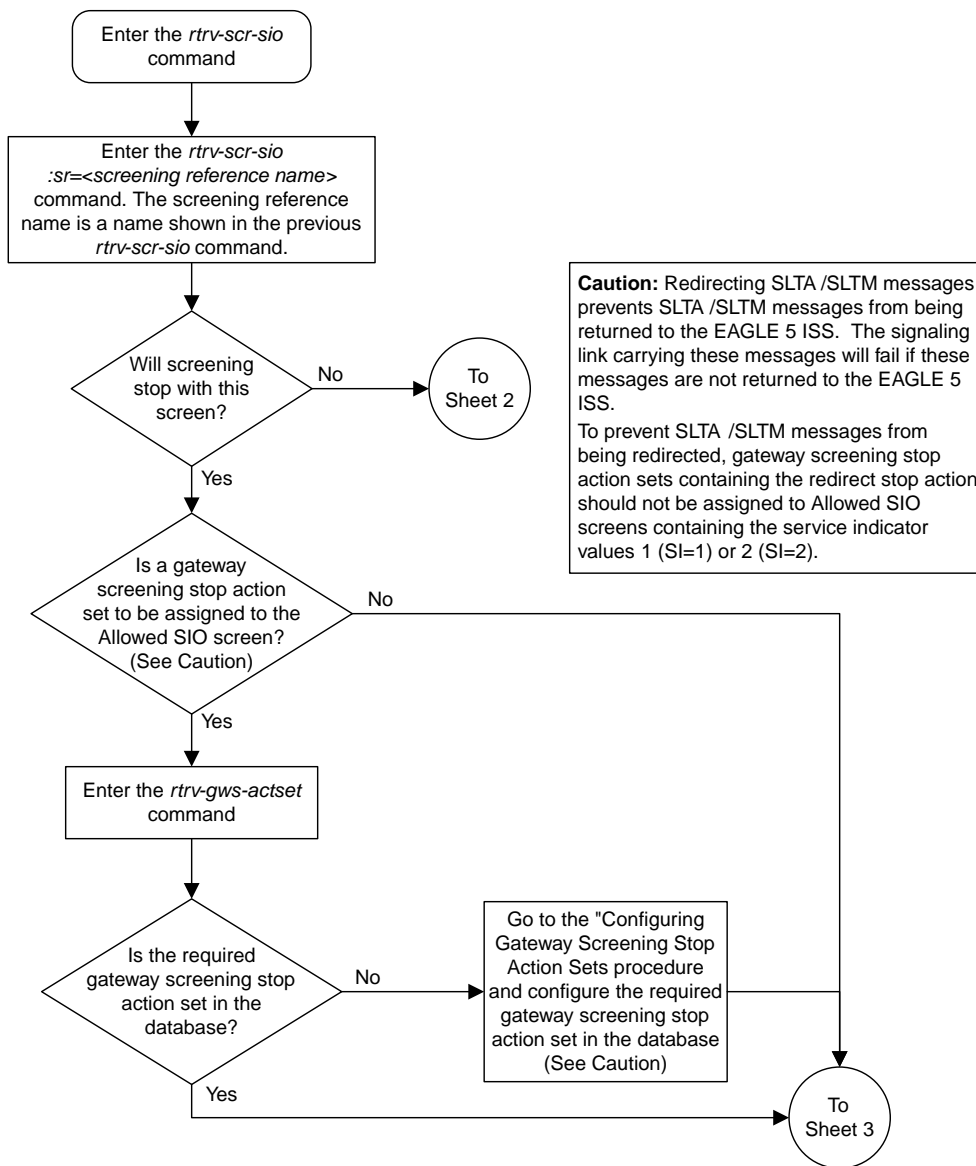

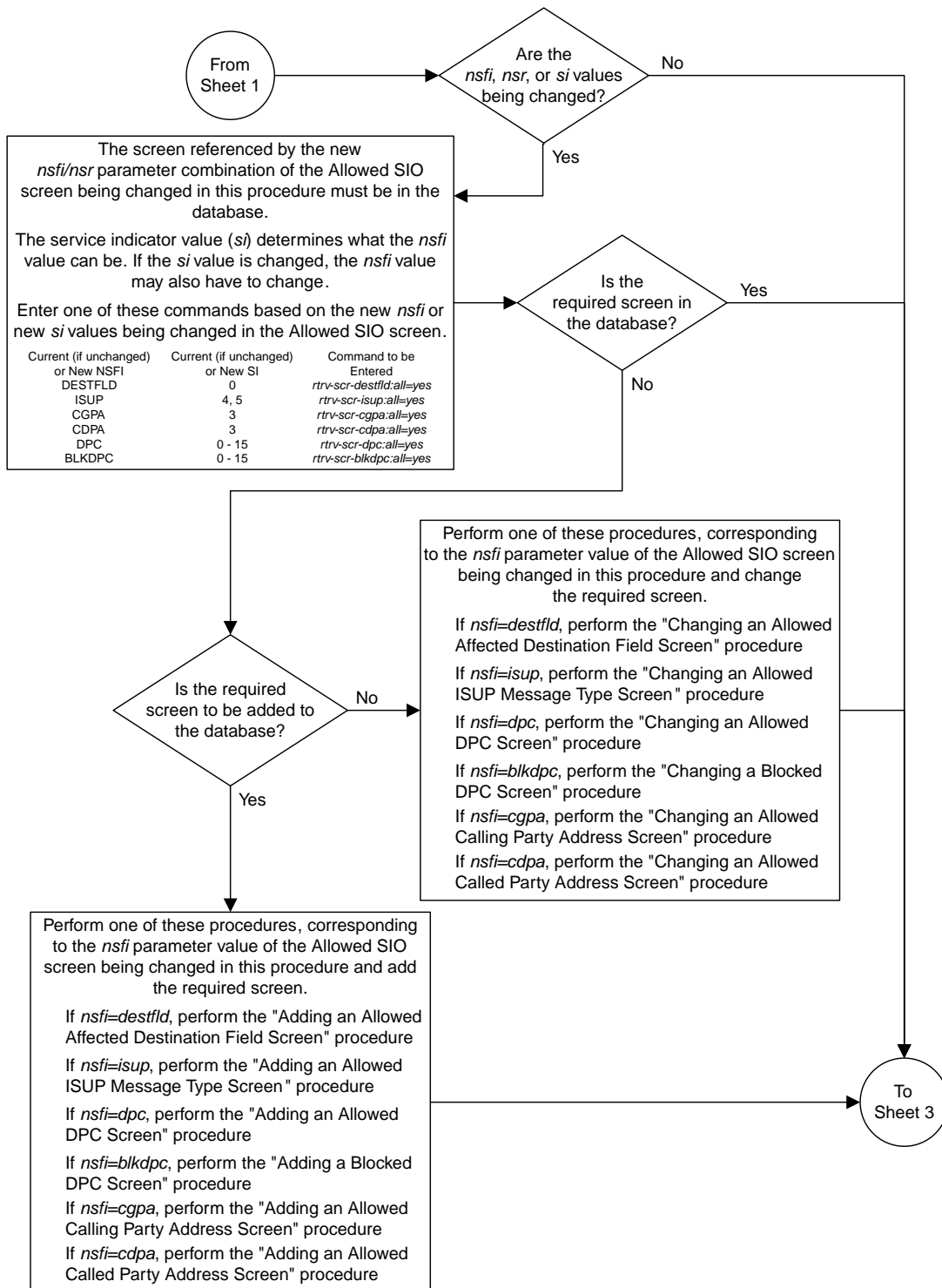

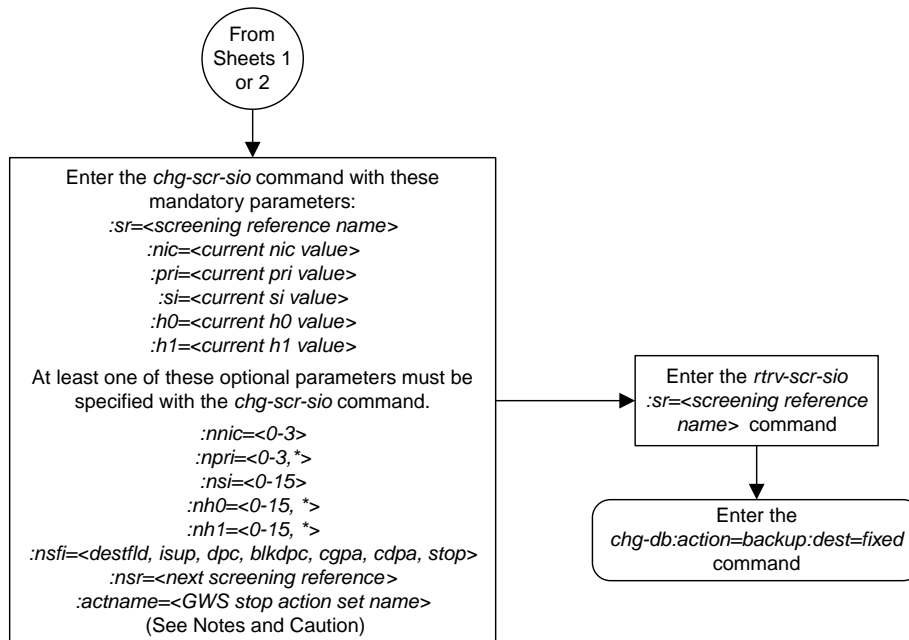

**Notes:**

1. A range of values can be specified for the *npri*, *nh0*, or *nh1* parameters by inserting double ampersands (&&) between the parameter values defining the range. For example, to specify the range 0 to 3 for the *npri* parameter, enter 0&&3 for the *npri* parameter value.
2. The asterisk (\*) specifies the entire range of values for that parameter.

For more information about specifying a range of values and about using the asterisk, see the "Gateway Screening Attributes" section and the "Specifying a Range of Values" and "Specifying H0 and H1 Values" sections. The "Gateway Screening Attributes" section is in the *Database Administration Manual - Gateway Screening*. The "Specifying a Range of Values" and "Specifying H0 and H1 Values" sections are in the "Changing an Allowed SIO Screen" procedure in the *Database Administration Manual - Gateway Screening*.

3. The current values for the *nic*, *si*, *pri*, *h0*, or *h1* parameters must be entered exactly as shown in the *rtvr-scr-sio* output. If dashes are shown for the *h0* and *h1* parameters, these parameters cannot be specified.
4. The *nsr* parameter can be specified only, and must be specified, if the *nsfi* parameter is specified and its value is either *destfld*, *isup*, *dpc*, *blkdpc*, *cgpa*, or *cdpa*.
5. The *actname* parameter is optional and can be specified only if the current *nsfi* parameter is *stop*, or the new *nsfi* parameter value is *stop*. If the *actname* parameter is specified, the *actname* parameter value is one of the gateway screening stop action set names shown in the *rtvr-gws-actset* output on Sheet 1.
6. If the *si* parameter value is 0, 1, or 2, the *h0* and *h1* parameters must be specified. If the *si* parameter value is 3 through 15, the *h0* and *h1* parameters cannot be specified.
7. If the *nsi* parameter value is 0, 1, or 2, the *nh0* and *nh1* parameters must be specified. If the *nsi* parameter value is 3 through 15, the *nh0* and *nh1* parameters cannot be specified.
8. The NSFI and service indicator values can be entered only in the following combinations:

Current (if unchanged) or New SI Value	Current (if unchanged) or New NSFI Value
0	destfld, dpc, blkdpc
3	cgpa, cdpa, dpc, blkdpc
4, 5	isup, dpc, blkdpc
1, 2, 6 - 15	dpc, blkdpc

**Caution:** Redirecting SLTA /SLTM messages prevents SLTA /SLTM messages from being returned to the EAGLE 5 ISS. The signaling link carrying these messages will fail if these messages are not returned to the EAGLE 5 ISS. To prevent SLTA /SLTM messages from being redirected, gateway screening stop action sets containing the redirect stop action should not be assigned to Allowed SIO screens containing the service indicator values 1 (SI=1) or 2 (SI=2).

Sheet 3 of 3

**Figure 59: Changing an Allowed SIO Screen**

# Chapter 11

## Blocked Originating Point Code (BLKOPC) Screen Configuration

---

### Topics:

- [Introduction.....379](#)
- [Adding a Blocked OPC Screen.....383](#)
- [Removing a Blocked OPC Screen.....397](#)
- [Changing a Blocked OPC Screen.....401](#)

Chapter 11, Blocked Originating Point Code (BLKOPC) Screen Configuration, contains the procedures necessary to configure blocked originating point code screens.

## Introduction

The blocked OPC screen identifies OPC's that are not allowed to send SS7 messages into the network. The gray shaded areas in [Figure 61: Blocked OPC Screening Functions](#) shows the fields of the SS7 message that are checked by the blocked OPC screening function.

## Gateway Screening Actions

If a match is found, the `nsfi` is equal to `fail`, the message is discarded and no further screening takes place.

If a match is not found, the `nsfi` is examined to determine the next step in the screening process. If the `nsfi` value is any value other than `stop`, the next screening reference (`nsr`) is identified and the screening process continues to the next screen identified by the `nsfi` and `nsr` parameter values.

If the `nsfi` is equal to `stop`, the screening process stops and the message is processed. If a gateway screening stop action set is specified with the screen, shown by the `actname` parameter value, the message is processed according to the gateway screening stop actions that are assigned to the gateway screening stop action set.

- If the `copy` gateway screening stop action is specified, the message is processed and a copy of the message is sent by the STPLAN feature to an external application.
- If the `rdct` (redirect) gateway screening stop action is specified, the message is diverted from the original destination and sent to another destination with the Database Transport Access feature, specified by global title translation, for further processing.
- If the `cncf` gateway screening stop action is specified, the PIP parameter in the incoming ISUP IAM message is converted to the GN parameter. The GN parameter in the incoming ISUP IAM message is converted to the PIP parameter. The message is then sent to the node specified by the DPC in the routing label in the message. For more information on the Calling Name Conversion Facility feature, see [Calling Name Conversion Facility \(CNCF\) Configuration](#).
- If the `tlnp` gateway screening stop action is specified, ISUP IAMs that pass gateway screening are processed either by the ISUP NP with EPAP feature (if the ISUP NP with EPAP feature is enabled and turned on) or by the Triggerless LNP feature (if the Triggerless LNP feature is turned on). The ISUP NP with EPAP feature is discussed in more detail in the *Feature Manual - G-Port*. The Triggerless LNP feature is discussed in more detail in the *ELAP Administration and LNP Feature Activation* manual.
- If the `tinp` gateway screening stop action is specified, ISUP IAMs that pass gateway screening are intercepted by the Triggerless ISUP based Number Portability (TINP) feature and converted to include the routing number (RN) if the call is to a ported number. The TINP feature is discussed in more detail in the *Feature Manual - G-Port*.
- If the `tif`, `tif2`, or `tif3` gateway screening stop actions are specified, TIF processing is applied to the message.
- If the `sccp` gateway screening stop action is specified, MTP routed SCCP UDT/XUDT are forwarded to the service modules for further processing.

## Blocked OPC Screening Actions

[Figure 60: Blocked OPC Screening Actions](#) shows the screening actions of the blocked OPC screen.

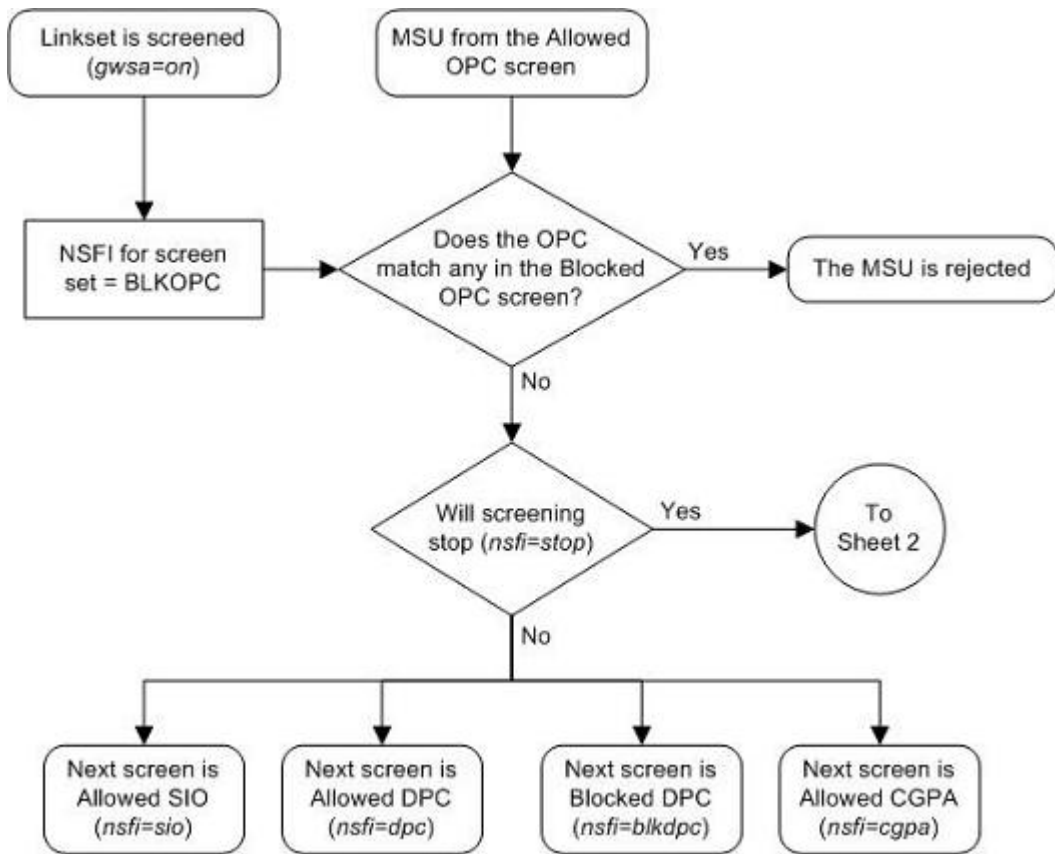

Sheet 1 of 3

Figure 60: Blocked OPC Screening Actions



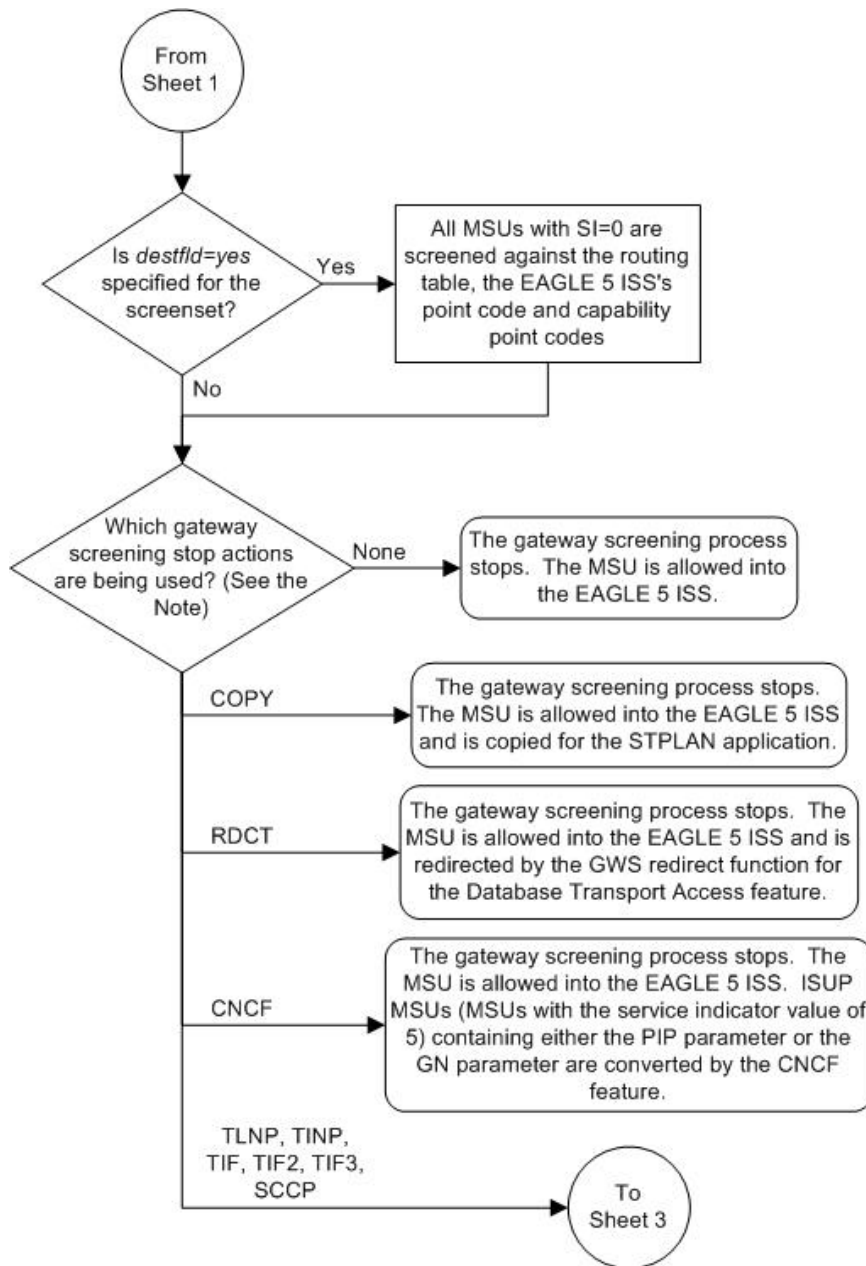

Note: Combinations of the gateway screening stop actions shown on Sheets 2 and 3 may be assigned to a gateway screening stop action set. Refer to the Configuring Gateway Screening Stop Action Sets and the Configuring TLNP Gateway Screening Stop Action Sets procedures in Chapter 2 of this manual for the combinations that can be used.

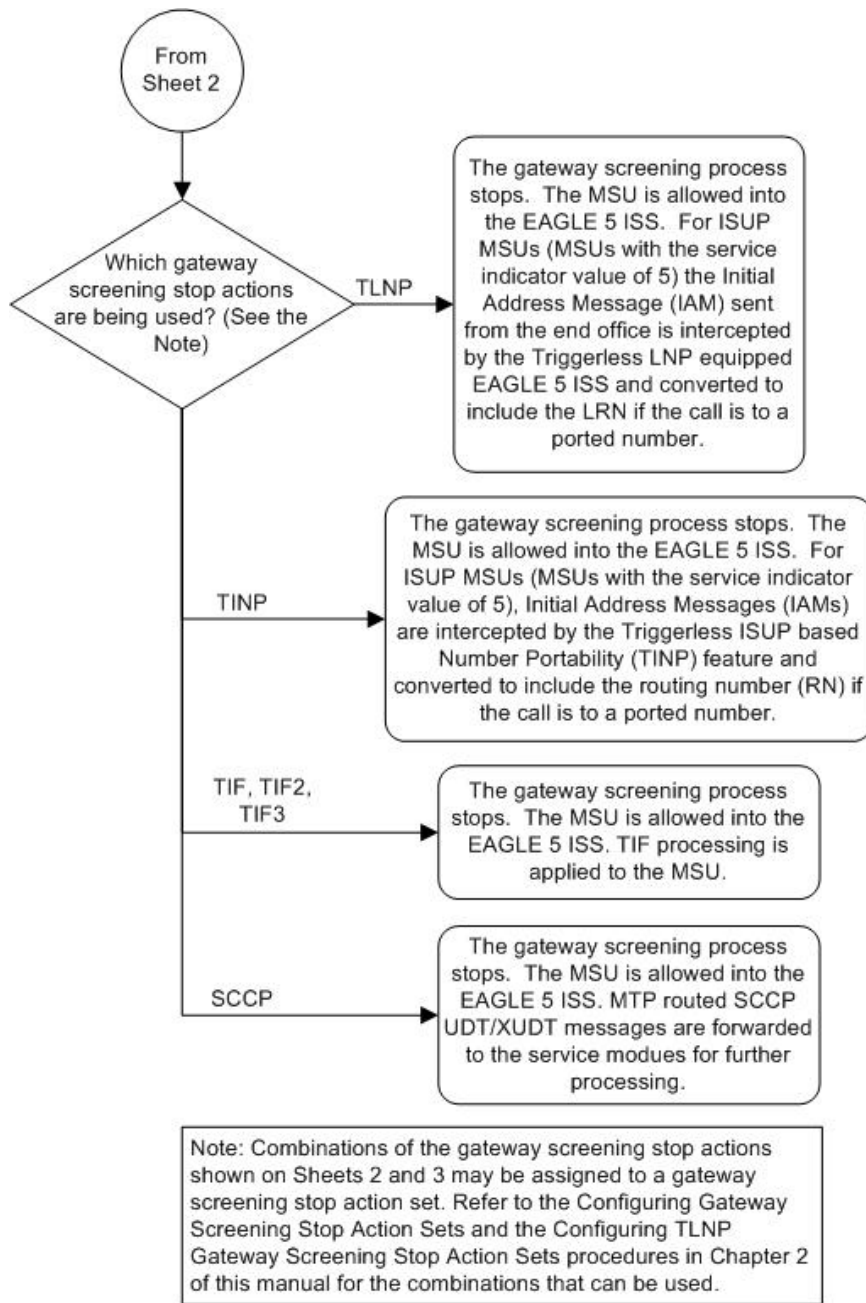

Sheet 3 of 3

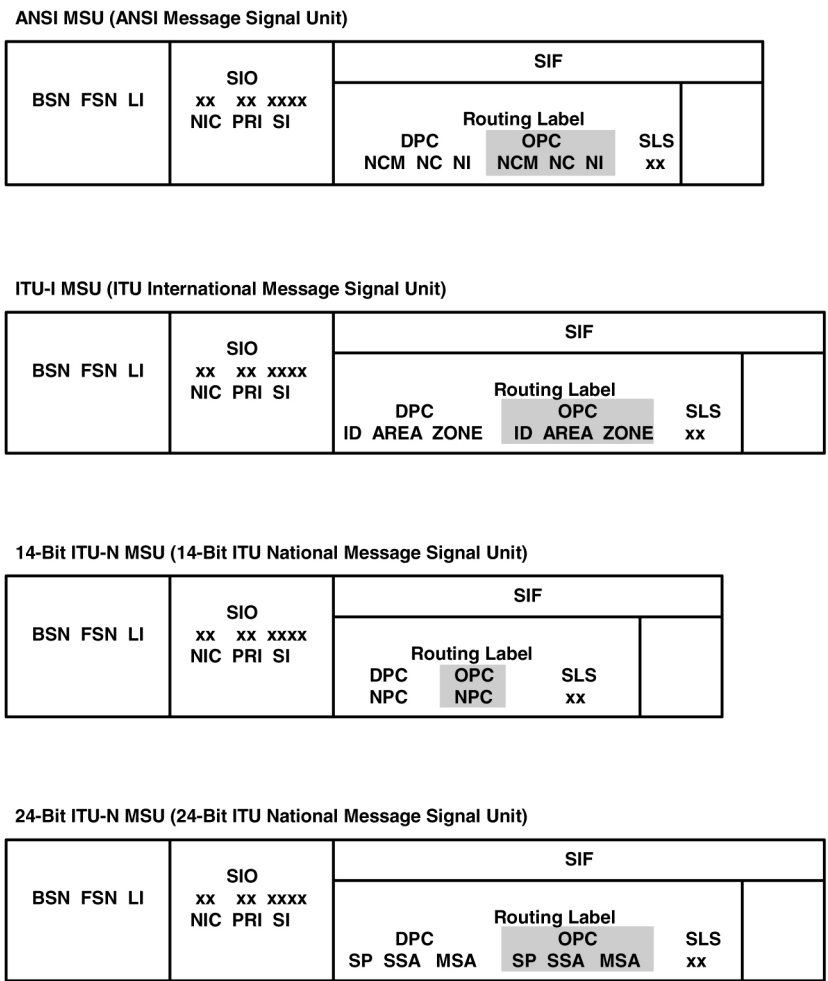

Figure 61: Blocked OPC Screening Functions

### Adding a Blocked OPC Screen

This procedure is used to add a blocked originating point code (OPC) screen to the database using the `ent-scr-blkopc` command. The parameters used by the `ent-scr-blkopc` command are shown in the [Gateway Screening Attributes](#) section. The general rules that apply to configuring gateway screening entities are shown in the [Gateway Screening Configuration](#) section.

The examples in this procedure are used to add the blocked OPC screen data shown in [Table 66: Example Gateway Screening Blocked OPC Configuration Table](#) and based on the example configurations shown in [Figure 4: Gateway Screening Configuration - Example 1](#), [Figure 5: Gateway Screening Configuration - Example 2](#), and [Figure 8: Gateway Screening Configuration - Example 5](#).

Table 66: Example Gateway Screening Blocked OPC Configuration Table

Screening Reference	ZONE	AREA	ID	NSFI	NSR
---------------------	------	------	----	------	-----

gws5	C	C	C	sio	iec
gws5	4	250	3	fail	----
<b>Screening Reference</b>	<b>NI</b>	<b>NC</b>	<b>NCM</b>	<b>NSFI</b>	<b>NSR</b>
fld3	C	C	C	sio	fld4
fld3	020	020	020	fail	----
gws3	C	C	C	dpc	gws9
gws3	001	002	002	fail	----
isp1	C	C	C	sio	isp1
isp1	025	025	025	fail	----

**Note:** If you using multiple-part ITU national point codes with gateway screening, see the [14-Bit ITU National Point Code Formats](#) section.

The blocked OPC screen can reference one of the following screens.

- Allowed SIO
- Allowed DPC
- Blocked DPC
- Allowed CGPA

### Verifying the Gateway Screening Configuration

Enter the following commands to verify that these screens are in the database.

- `rtrv-scr-sio:all=yes`
- `rtrv-scr-dpc:all=yes`
- `rtrv-scr-blkdpc:all=yes`
- `rtrv-scr-cgpa:all=yes`

### Gateway Screening Configuration Procedures

If the desired screen is not in the database, perform one of the following procedures to add the desired screen to the database or change an existing screen in the database.

- [Adding an Allowed SIO Screen](#)
- [Adding an Allowed DPC Screen](#)
- [Adding a Blocked DPC Screen](#)
- [Adding an Allowed Calling Party Address Screen](#)
- [Changing an Allowed SIO Screen](#)
- [Changing an Allowed DPC Screen](#)
- [Changing a Blocked DPC Screen](#)
- [Changing an Allowed Calling Party Address Screen](#)

For the first entry for a specific screening reference, the value for the point code must be `c`, and the NSFI must be either `stop`, `sio`, `dpc`, `blkdpc`, or `cgpa`. If the NSFI is `stop`, the screening of the message will stop at the specified blocked OPC screen. If the NSFI is either `sio`, `dpc`, `blkdpc`, or `cgpa`, then any message containing a point code that is not listed in the blocked OPC screen with a

NSFI equal to `fail`, will continue to be screened with either the allowed SIO, allowed DPC, blocked DPC, or the allowed CGPA screen.

All subsequent entries for that screening reference must contain a numeric point code value, the NSFI must be equal to `fail`, and the `nsr` parameter cannot be specified. Any message that contains an OPC in the blocked OPC screen with the NSFI equal to `fail` will be rejected from the network and the screening process is stopped.

The `pcst` parameter, specifying whether or not the ITU-I or 14-bit ITU-N point code is a spare point code, cannot be used with the `zone=c` or `npc=c` parameters.

### Specifying a Range of Values

A range of values can be specified for the point code parameters `ni`, `nc`, or `ncm`.

If a range of values is specified for any of these parameters, and the value of the other parameters match existing values for the screening reference name, the range of values for the point code parameter cannot include any values for that parameter that are currently provisioned for the screening reference name.

For example, screening reference name `scr1` contains these entries:

SR	NI	NC	NCM	NSFI	NSR/ACT
SCR1	240	001	010	FAIL	-----
SCR1	241	010	020	FAIL	-----

Another entry for screening reference `scr1` with the `ni` value of 240 and the `nc` value of 001 cannot be specified if the range of values for the `ncm` parameter includes the value 010.

The ANSI point code parameter values can be specified as a single value, a range of values, or with an asterisk (\*). The asterisk specifies all possible values for the `ni`, `nc`, and `ncm` parameters. [Table 67: Valid Value Combinations for ANSI Point Code Parameters](#) shows the valid combinations of these parameter values.

**Table 67: Valid Value Combinations for ANSI Point Code Parameters**

NI	NC	NCM
Single Value	Single Value	Single Value
Single Value	Single Value	Range of Values
Single Value	Single Value	Asterisk
Single Value	Range of Values	Asterisk
Single Value	Asterisk	Asterisk
Range of Values	Asterisk	Asterisk
Asterisk	Asterisk	Asterisk

A range of values can also be specified for an ITU-I or 24-bit ITU-N point code parameter using a combination of asterisks (\*) and single values for the point code parameters. [Table 68: Valid Value Combinations for ITU-I Point Code Parameters](#) shows the valid combinations of the ITU-I parameter values. [Table 69: Valid Value Combinations for 24-Bit ITU-N Point Code Parameters](#) shows the valid combinations of the 24-bit ITU-N parameter values.

Table 68: Valid Value Combinations for ITU-I Point Code Parameters

ZONE	AREA	ID
Single Value	Single Value	Single Value
Single Value	Single Value	Asterisk
Single Value	Asterisk	Asterisk
Asterisk	Asterisk	Asterisk

Table 69: Valid Value Combinations for 24-Bit ITU-N Point Code Parameters

MSA	SSA	SP
Single Value	Single Value	Single Value
Single Value	Single Value	Asterisk
Single Value	Asterisk	Asterisk
Asterisk	Asterisk	Asterisk

1. Verify that the gateway screening feature is on, by entering the `rtrv-feat` command.

If the gateway screening feature is on, the `GWS` field is set to `on`.

**Note:** The `rtrv-feat` command output contains other fields that are not used by this procedure. If you wish to see all the fields displayed by the `rtrv-feat` command, see the `rtrv-feat` command description in *Commands User's Guide*.

If the gateway screening feature is on, shown by the entry `GWS = on` in the `rtrv-feat` command output, skip step 2, and go to step 3.

2. Turn the gateway screening feature on by entering this command.

```
chg-feat:gws=on
```

**Note:** Once the gateway screening feature is turned on with the `chg-feat` command, it cannot be turned off.

The gateway screening feature must be purchased before you turn this feature on with the `chg-feat` command. If you are not sure if you have purchased the gateway screening feature, contact your Oracle Sales Representative or Account Representative.

When the `chg-feat` has successfully completed, this message should appear.

```
rlghncxa03w 06-10-28 11:43:04 GMT EAGLE5 36.0.0
CHG-FEAT: MASP A - COMPLTD
```

3. Display all blocked OPC screens in the database using the `rtrv-scr-blkopc` command.

The following is an example of the possible output.

```
rlghncxa03w 06-10-25 15:25:30 GMT EAGLE5 36.0.0
SCREEN = BLOCKED OPC
SR      REF  RULES
```

```
IEC   YES   2
WRD2  YES   1
WRD4  YES   9
```

If the screening reference names that you wish to add with this procedure are not shown in the `rtrv-scr-blkopc` command output, go to step 4. For this example, the screening reference names are not shown. If these screening reference names are shown in the `rtrv-scr-blkopc` command output, make sure the screening data you wish to enter is not already in the database by entering the `rtrv-scr-blkopc` command with the screening reference name. For example, enter the `rtrv-scr-blkopc:sr=iec` command. The following is an example of the possible output.

```
rlghncxa03w 06-10-25 15:26:30 GMT EAGLE5 36.0.0
SCREEN = BLOCKED OPC
SR   NI      NC      NCM      NSFI      NSR/ACT
IEC  240      001      010      FAIL      -----
IEC  241      010      *        FAIL      -----

SR      ZONE   AREA   ID      NSFI      NSR/ACT
IEC     1     003    4       FAIL      -----
IEC     1     003    5       FAIL      -----

SR   NI      NC      NCM      NSFI      NSR/ACT
IEC  C       C       C       STOP     CR
SR      NPC
IEC   00235
      NSFI      NSR
      FAIL      -----

SR   NI      NC      NCM      NSFI      NSR/ACT
WRD2 243      015      001      STOP     -----
WRD2 243      105      002      FAIL     -----
WRD2 C       C       C       STOP     -----
```

If a gateway screening stop action set is to be assigned to the blocked OPC screen being added to the database, go to step 4.

Step 4 verifies the gateway screening stop action set names in the database. The gateway screening stop action set names are assigned only if the NSFI of the screen being added in this procedure is STOP. If the NSFI of the new screen will be STOP, but a gateway screening stop action set name will not be assigned to the new screen, skip steps 4 and 5 and go to step 6. If the NSFI of the new screen is not STOP, skip step 4 and go to step 5.

4. Display the gateway screening stop action sets in the database with the `rtrv-gws-actset` command.

This is an example of the possible output.

```
rlghncxa03w 06-10-25 15:28:30 GMT EAGLE5 36.0.0
ACT  ACT      ACT  ACT  ACT  ACT  ACT  ACT  ACT  ACT  ACT  ACT
ID   NAME      1    2    3    4    5    6    7    8    9    10
--   -
1    copy      copy
2    rdct      rdct
3    cr        copy rdct
4    cncf      cncf
5    cpcncf    copy cncf
6    cncfrd    cncf rdct
7    cpcfrd    copy cncf rdct
```

```
GWS action set table is (7 of 16) 44% full
```

If the required gateway screening stop action set is not in the database, perform the [Configuring Gateway Screening Stop Action Sets](#) procedure to configure the required gateway screening stop action set.

**Note:** If the NSFI of the screen being added in this procedure is STOP or FAIL, skip step 5 and go to step 6.

5. Enter the commands in the [Verifying the Gateway Screening Configuration](#) section to verify that the screen that will be specified by the NSFI/NSR parameter combination in step 7 is in the database.

If the desired screen is not in the database, perform one of the procedures shown in the [Gateway Screening Configuration Procedures](#) section to add the desired screen to the database or change an existing screen in the database.

6. Display the status of the ITU National and International Spare Point Code Support feature by entering the `rtrv-ctrl-feat` command with the ITU National and International Spare Point Code Support feature part number.

**Note:** If the point code being added in this procedure is not an ITU-I or 14-bit ITU-N spare point code, skip this step and go to step 7.

**Note:** If the point code being added in this procedure is an ITU-I or 14-bit ITU-N spare point code and the screening reference contains ITU-I or 14-bit ITU-N spare point codes, skip this step and go to step 7.

Enter this command.

```
rtrv-ctrl-feat:partnum=893013601
```

This is an example of the possible output.

```
rlghncxa03w 06-10-25 15:25:30 GMT EAGLE5 36.0.0
The following features have been permanently enabled:

Feature Name          Partnum   Status  Quantity
Spare Point Code Support  893013601 on      ----

The following features have been temporarily enabled:

Feature Name          Partnum   Status  Quantity  Trial Period Left
Zero entries found.

The following features have expired temporary keys:

Feature Name          Partnum
Zero entries found.
```

If the ITU National and International Spare Point Code Support feature is enabled, go to step 7.

If the ITU National and International Spare Point Code Support feature is not enabled, perform the “Activating the ITU National and International Spare Point Code Support Feature” procedure in *Database Administration - SS7 User’s Guide* to enable the ITU National and International Spare Point Code Support feature as required. After the feature has been enabled, go to step 7.

7. Add a new blocked OPC screen to the database using the `ent-scr-blkopc` command.



If a gateway screening stop action is to be assigned to the blocked OPC screen being changed, enter the `ent-scr-blkopc` command with the `nsfi=stop` parameter and the `actname` parameter with the name of a gateway screening stop action set shown in the output of the `rtrv-gws-actset` command executed in step 4. The following list contains the values for `ni`, `nc`, `ncm`, `zone`, `area`, `id`, `npc`, `msa`, `ssa`, and `sp` parameters:

- `ni` – 0 - 255, `c`, or an asterisk (\*)
- `nc` – 0 - 255, `c`, or an asterisk (\*)
- `ncm` – 0 - 255, `c`, or an asterisk (\*)
- `zone` – 0 - 7, `c`, or an asterisk (\*)
- `area` – 0 - 255, `c`, or an asterisk (\*)
- `id` – 0 - 7, `c`, or an asterisk (\*)
- `npc` – 1 - 16383, `c`, or an asterisk (\*)
- `msa` – 0 - 255, `c`, or an asterisk (\*)
- `ssa` – 0 - 255, `c`, or an asterisk (\*)
- `sp` – 0 - 255, `c`, or an asterisk (\*)

A range of values can be specified for the `ni`, `nc`, and `ncm` parameters. See the [“Specifying a Range of Values”](#) section for more information on how the asterisk and a range of values are used for the `ni`, `nc`, and `ncm` parameters.

To add a spare point code to the blocked OPC screen, the `pcst=s` parameter must be specified. To add a non-spare point code to the blocked OPC screen, the `pcst` parameter does not have to be specified. If the `pcst` parameter is specified for a screen containing an ITU-I or 14-bit ITU-N non-spare point code, the value must be none. The `pcst` parameter cannot be used with the `zone=c` or `npc=c` parameters.

For this example, enter these commands.

```
ent-scr-blkopc:sr=gws5:zone=c:area=c:id=c:nsfi=sio:nsr=iec
```

A message similar to the following should appear.

```
rlghncxa03w 06-10-25 15:29:30 GMT EAGLE5 36.0.0
ENT-SCR-BLKOPC: SCREEN SET AFFECTED - GWS5 1% FULL
ENT-SCR-BLKOPC: MASP A - COMPLTD
```

```
ent-scr-blkopc:sr=gws5:zone=4:area=250:id=3:nsfi=fail
```

A message similar to the following should appear.

```
rlghncxa03w 06-10-25 15:30:30 GMT EAGLE5 36.0.0
ENT-SCR-BLKOPC: SCREEN SET AFFECTED - GWS5 1% FULL
ENT-SCR-BLKOPC: MASP A - COMPLTD
```

```
ent-scr-blkopc:sr=gws3:ni=c:nc=c:ncm=c:nsfi=dpc:nsr=gws9
```

A message similar to the following should appear.

```
rlghncxa03w 06-10-25 15:31:30 GMT EAGLE5 36.0.0
ENT-SCR-BLKOPC: SCREEN SET AFFECTED - GWS7 1% FULL
ENT-SCR-BLKOPC: MASP A - COMPLTD
```

```
ent-scr-blkopc:sr=gws3:ni=001:nc=002:ncm=002:nsfi=fail
```

A message similar to the following should appear.

```
rlghncxa03w 06-10-25 15:32:30 GMT EAGLE5 36.0.0
ENT-SCR-BLKOPC: SCREEN SET AFFECTED - GWS7 1% FULL
ENT-SCR-BLKOPC: MASP A - COMPLTD
```

```
ent-scr-blkopc:sr=fld3:ni=c:nc=c:ncm=c:nsfi=sio:nsr=fld4
```

A message similar to the following should appear.

```
rlghncxa03w 06-10-25 15:33:30 GMT EAGLE5 36.0.0
ENT-SCR-BLKOPC: SCREEN SET AFFECTED - FLD3 1% FULL
ENT-SCR-BLKOPC: MASP A - COMPLTD
```

```
ent-scr-blkopc:sr=fld3:ni=020:nc=020:ncm=020:nsfi=fail
```

A message similar to the following should appear.

```
rlghncxa03w 06-10-25 15:34:30 GMT EAGLE5 36.0.0
ENT-SCR-BLKOPC: SCREEN SET AFFECTED - FLD3 1% FULL
ENT-SCR-BLKOPC: MASP A - COMPLTD
```

```
ent-scr-blkopc:sr=isp1:ni=c:nc=c:ncm=c:nsfi=sio:nsr=isp1
```

A message similar to the following should appear.

```
rlghncxa03w 06-10-25 15:33:30 GMT EAGLE5 36.0.0
ENT-SCR-BLKOPC: SCREEN SET AFFECTED - ISP1 1% FULL
ENT-SCR-BLKOPC: MASP A - COMPLTD
```

```
ent-scr-blkopc:sr=isp1:ni=025:nc=025:ncm=025:nsfi=fail
```

A message similar to the following should appear.

```
rlghncxa03w 06-10-25 15:34:30 GMT EAGLE5 36.0.0
ENT-SCR-BLKOPC: SCREEN SET AFFECTED - ISP1 1% FULL
ENT-SCR-BLKOPC: MASP A - COMPLTD
```

- Verify the changes using the `rtrv-scr-blkopc` command with the screening reference name used in step 7. For this example, enter these commands.

```
rtrv-scr-blkopc:sr=gws5
```

The following is an example of the possible output.

```
rlghncxa03w 06-10-25 15:35:30 GMT EAGLE5 36.0.0
SCREEN = BLOCKED OPC
SR      ZONE  AREA  ID      NSFI    NSR/ACT
GWS5    4      250   3       FAIL    -----
GWS5    C      C     C       SIO     IEC
```

```
rtrv-scr-blkopc:sr=gws3
```

The following is an example of the possible output.

```
rlghncxa03w 06-10-25 15:25:30 GMT EAGLE5 36.0.0
SCREEN = BLOCKED OPC
SR   NI       NC       NCM       NSF1      NSR/ACT
GWS3 002       002       002       FAIL      -----
GWS3 C         C         C         DPC       GWS9
```

```
rtrv-scr-blkopc:sr=fld3
```

The following is an example of the possible output.

```
rlghncxa03w 06-10-25 15:36:30 GMT EAGLE5 36.0.0
SCREEN = BLOCKED OPC
SR   NI       NC       NCM       NSF1      NSR/ACT
FLD3 020       020       020       FAIL      -----
FLD3 C         C         C         DPC       FLD4
```

```
rtrv-scr-blkopc:sr=isp1
```

The following is an example of the possible output.

```
rlghncxa03w 06-10-25 15:36:30 GMT EAGLE5 36.0.0
SCREEN = BLOCKED OPC
SR   NI       NC       NCM       NSF1      NSR/ACT
ISP1 025       025       025       FAIL      -----
ISP1 C         C         C         SIO       ISP1
```

9. Backup the new changes using the `chg-db:action=backup:dest=fixed` command.

The following messages should appear, the active Maintenance and Administration Subsystem Processor (MASP) appears first.

```
BACKUP (FIXED) : MASP A - Backup starts on active MASP.
BACKUP (FIXED) : MASP A - Backup on active MASP to fixed disk complete.
BACKUP (FIXED) : MASP A - Backup starts on standby MASP.
BACKUP (FIXED) : MASP A - Backup on standby MASP to fixed disk complete.
```

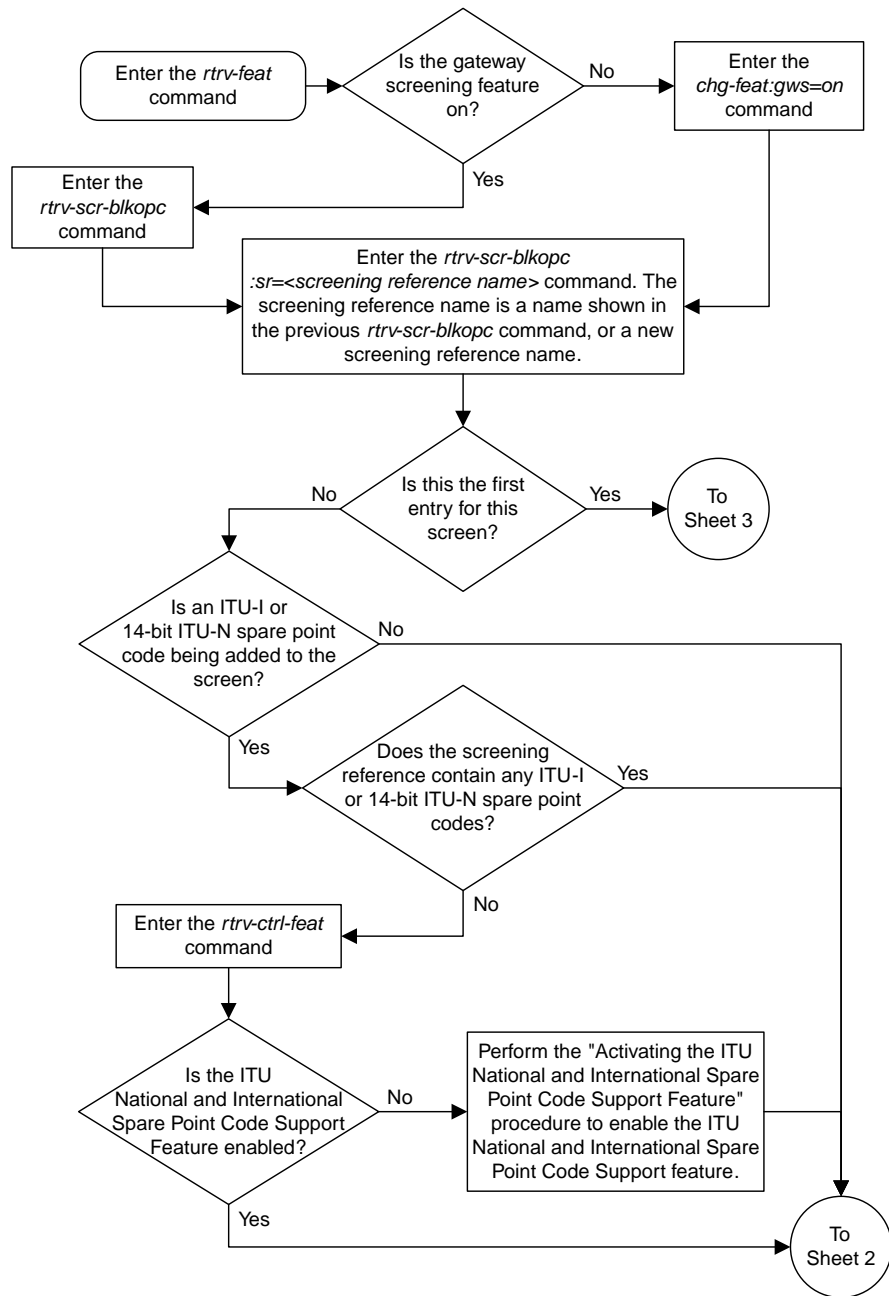

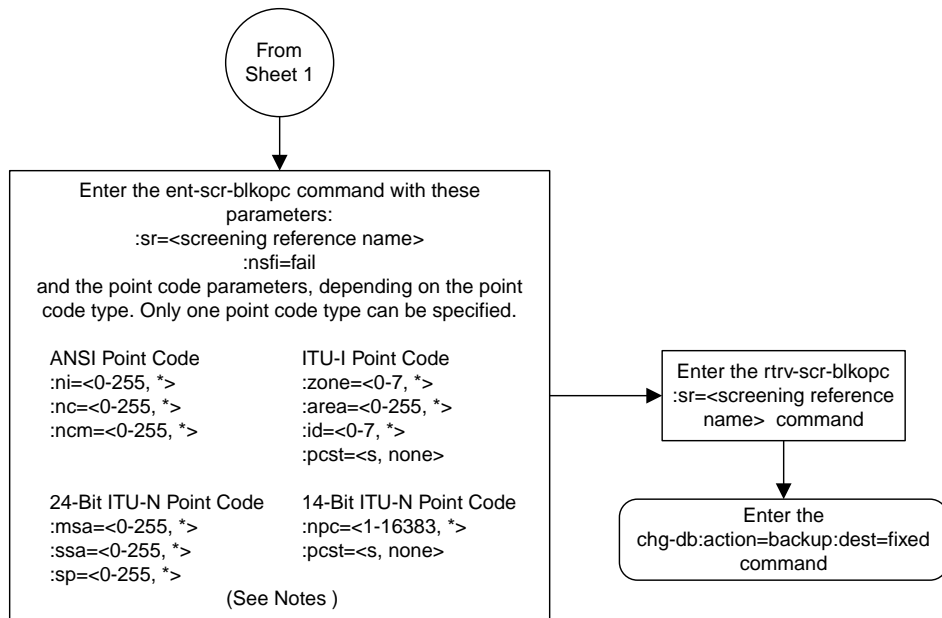

Notes:

1. A range of values can be specified for the ni, nc, or ncm parameters by inserting double ampersands (&&) between the parameter values defining the range. For example, to specify the range 025 to 200 for the ni parameter, enter 025&&200 for the ni parameter value.
2. The asterisk (\*) specifies the entire range of values for that parameter.

For more information about specifying a range of values and about using the asterisk, see the "Gateway Screening Attributes" section and the "Specifying a Range of Values" section. The "Gateway Screening Attributes" section is in the *Database Administration Manual - Gateway Screening*. The "Specifying a Range of Values" section is in the "Adding a Blocked OPC Screen" procedure in the *Database Administration Manual - Gateway Screening*.

3. To add a non-spare point code, the pcst parameter does not have to be specified. If the pcst parameter is specified for a screen containing an ITU-I or 14-bit ITU-N non-spare point code, the value must be none.
4. To add a spare point code, the pcst=s parameter must be specified.

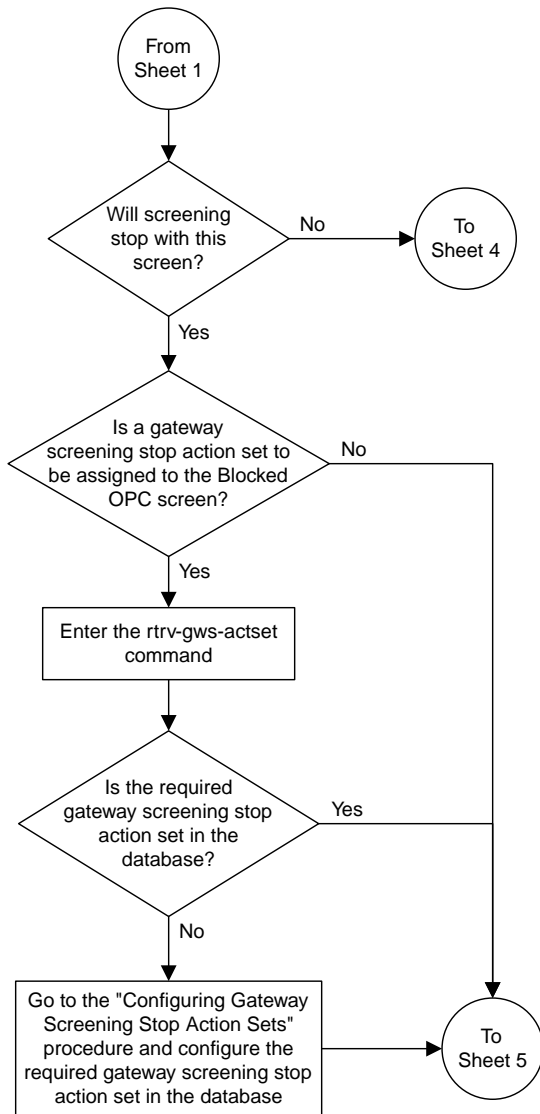

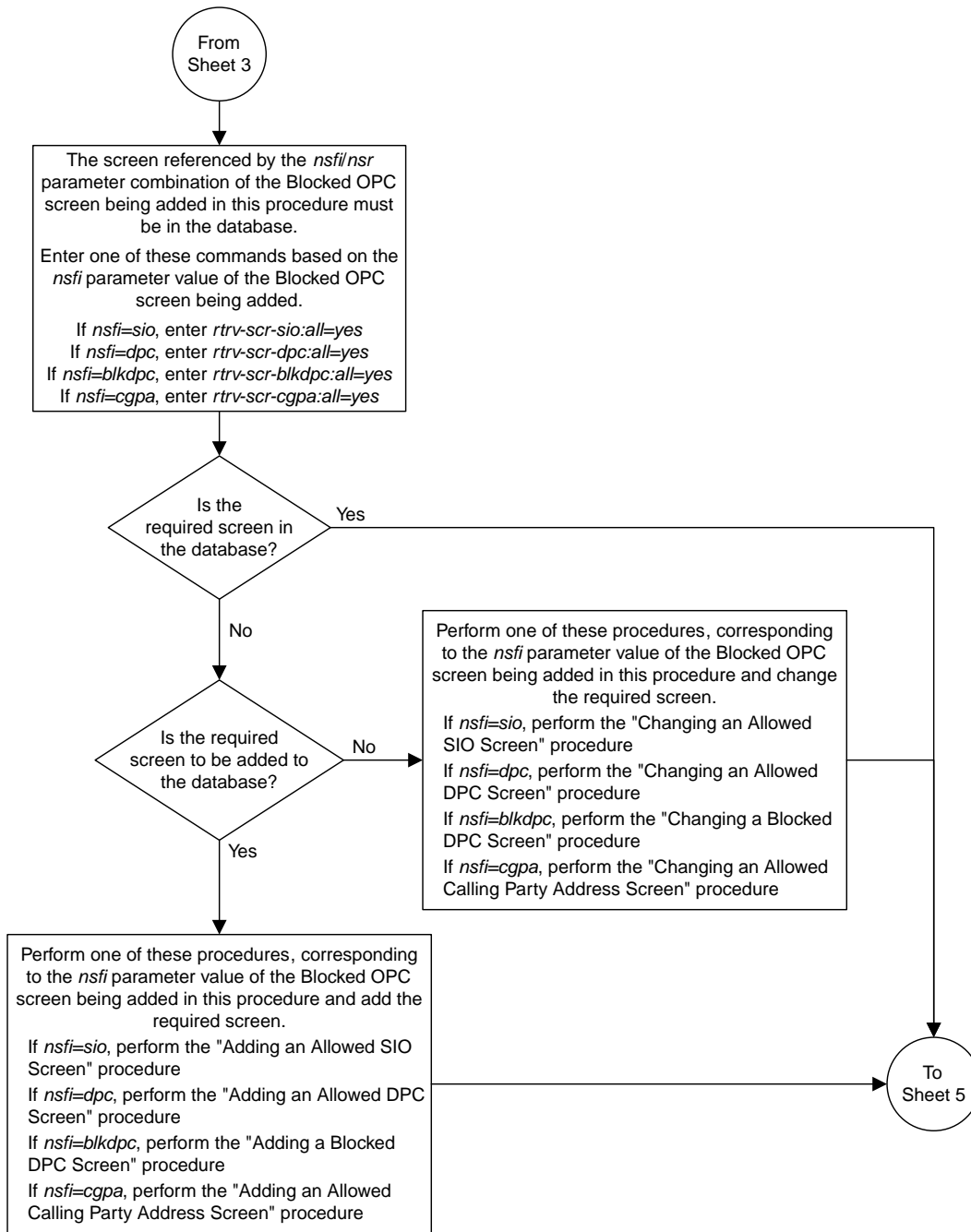

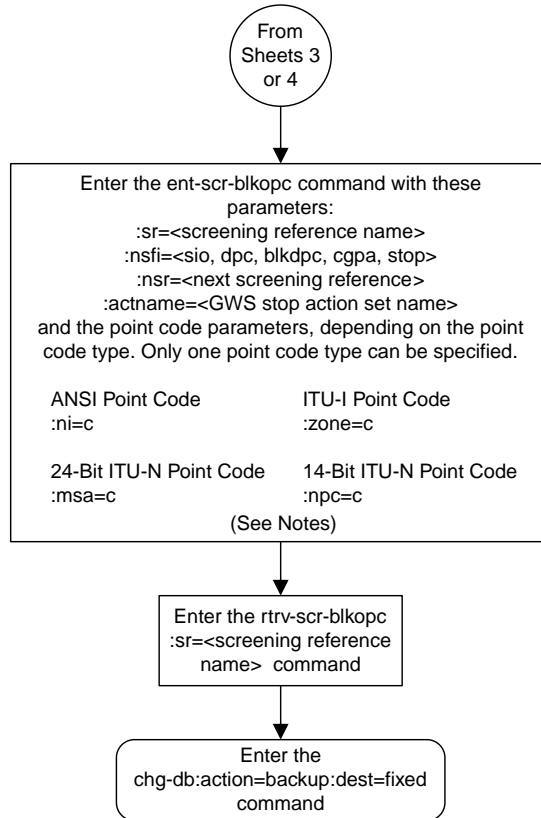

Notes:

1. The nsr parameter can be specified only, and must be specified, if the nsfi parameter value is either sio, dpc, blkdpc, cgpa, or isup.
2. The actname parameter is optional and can be specified only with the nsfi=stop parameter. If the actname parameter is specified, the actname parameter value is one of the gateway screening stop action set names shown in the rtrv-gws-actset output on Sheet 3.



Sheet 5 of 5

Figure 62: Adding a Blocked OPC Screen

## Removing a Blocked OPC Screen

This procedure is used to remove a blocked originating point code (OPC) screen from the database using the `dlt-scr-blkopc` command. The parameters used by the `dlt-scr-blkopc` command are shown in the [Gateway Screening Attributes](#) section. The general rules that apply to configuring gateway screening entities are shown in the [Gateway Screening Configuration](#) section.

The example in this procedure removes the blocked OPC screen `iec` with the point code 240-001-010 from the database.

**Note:** If you are using multiple-part ITU national point codes with gateway screening, see the [14-Bit ITU National Point Code Formats](#) section.

The `c-c-c` entry cannot be removed from the blocked OPC screen unless all other entries in the blocked OPC screen have been removed. The `c-c-c` entry cannot be removed from the blocked OPC screen if other screens reference the blocked OPC screen. If the last entry (`c-c-c`) in the blocked OPC screen is removed, the blocked OPC screen is removed. The blocked OPC screen can be referenced by one of the following screens.

- Screen Set
- Allowed OPC

### Verifying the Gateway Screening Configuration

Enter the following commands to verify that none of these screens reference the blocked OPC screen being removed from the database.

- `rtrv-scrset:nsfi=blkopc`
- `rtrv-scr-opc:nsfi=blkopc`

### Gateway Screening Configuration Procedures

To change the NSFI of any of these screens, perform one of these procedures.

- [Changing a Screen Set](#)
- [Changing an Allowed OPC Screen](#)

1. Display the blocked OPC screens in the database using the `rtrv-scr-blkopc` command.

The following is an example of the possible output.

```
rlghncxa03w 06-10-25 15:25:30 GMT EAGLE5 36.0.0
SCREEN = BLOCKED DPC

SR      REF  RULES
IEC     YES   6
ISP1    YES   2
WRD2    YES   2
WRD3    NO    4
WRD4    YES   9
```

From the `rtrv-scr-blkopc` output, display the blocked OPC screen you wish to remove using the `rtrv-scr-blkopc` command with the screening reference name. For this example, enter this command.

```
rtrv-scr-blkopc:sr=iec
```

The following is an example of the possible output.

```
rlghncxa03w 06-10-25 15:25:30 GMT EAGLE5 36.0.0
SCREEN = BLOCKED OPC
SR  NI      NC      NCM      NSFI     NSR/ACT
IEC 240     001     010     FAIL     -----
IEC 241     010     *       FAIL     -----
SR  ZONE    AREA    ID      NSFI     NSR/ACT
IEC  1      003     4       FAIL     -----
IEC  1      003     5       FAIL     -----
SR  NI      NC      NCM      NSFI     NSR/ACT
IEC  C      C      C      CGPA     cg01
SR  NPC
IEC  00235     NSFI     NSR
IEC  00235     FAIL     -----
```

2. Enter the commands in the [Verifying the Gateway Screening Configuration](#) section to verify that the screen being removed is not referenced by other screens in the database.

If the screen being removed is referenced by other screens, perform the procedures shown in the [Gateway Screening Configuration Procedures](#) section to change the NSFI of those screens to reference other screens or change the NSFI of these screens to STOP.

3. Remove the blocked OPC screen from the database using the `dlt-scr-blkopc` command with the screening reference name shown in the `rtrv-scr-blkopc` output in step 1 and with the point code parameter values (`ni`, `nc`, `ncm`, or `zone`, `area`, `id`, or `npc`, `msa`, `ssa`, `sp`) of the screen being removed from the database.

The values for these parameters must be entered exactly as shown in the `rtrv-scr-blkopc` output.

To remove an entry containing either an ITU-I or a 14-bit ITU-N spare point code, the `pcst=s` parameter must be specified with the `dlt-scr-blkopc` command.

To remove an entry containing either an ITU-I or a 14-bit ITU-N non-spare point code, the `pcst` parameter does not have to be specified with the `dlt-scr-blkopc` command. If the `pcst` parameter is specified, the value must be none.

The `pcst` parameter cannot be used with the `zone=c` or the `npc=c` parameters.

For this example, enter this command.

```
dlt-scr-blkopc:sr=iec:ni=240:nc=001:ncm=010
```

A message similar to the following should appear.

```
rlghncxa03w 06-10-25 15:26:30 GMT EAGLE5 36.0.0
DLT-SCR-BLKOPC: SCREEN SET AFFECTED - IEC 2% FULL
DLT-SCR-BLKOPC: MASP A - COMPLTD
```

4. Verify the changes using the `rtrv-scr-blkopc` command with the screening reference name used in step 3.

For this example, enter this command.

```
rtrv-scr-blkopc:sr=iec
```

The following is an example of the possible output.

```
rlghncxa03w 06-10-25 15:27:30 GMT EAGLE5 36.0.0
SCREEN = BLOCKED OPC
SR      NI      NC      NCM      NSF1      NSR/ACT
IEC     241      010      *        FAIL      -----
SR      ZONE    AREA    ID       NSF1      NSR/ACT
IEC     1        003     4        FAIL      -----
IEC     1        003     5        FAIL      -----
SR      NI      NC      NCM      NSF1      NSR/ACT
IEC     C        C        C        CGPA     cg01
SR      NPC
IEC     00235      NSF1      NSR
IEC     00235      FAIL      -----
```

If the screen removed in step 3 was the last screen contained in the specified screening reference, the screening reference is removed from the database. The following message is displayed.

```
E2573 Cmd Rej: SR or NSR does not reference an existing SR
```

5. Backup the new changes using the `chg-db:action=backup:dest=fixed` command.

The following messages should appear, the active Maintenance and Administration Subsystem Processor (MASP) appears first.

```
BACKUP (FIXED) : MASP A - Backup starts on active MASP.
BACKUP (FIXED) : MASP A - Backup on active MASP to fixed disk complete.
BACKUP (FIXED) : MASP A - Backup starts on standby MASP.
BACKUP (FIXED) : MASP A - Backup on standby MASP to fixed disk complete.
```

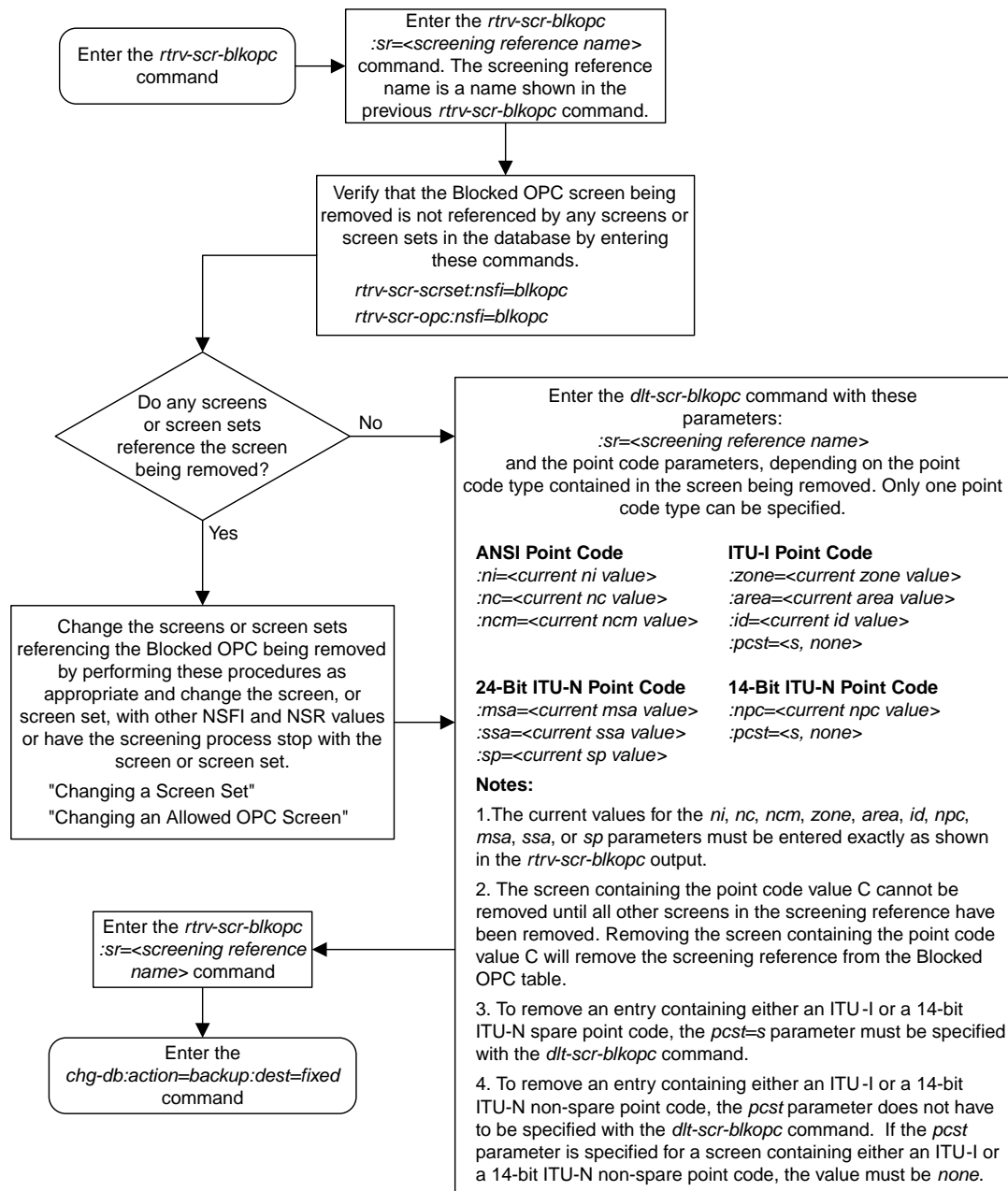

Figure 63: Removing a Blocked OPC Screen

## Changing a Blocked OPC Screen

This procedure is used to change the attributes of a blocked originating point code (OPC) screen in the database using the `chg-scr-blkopc` command. The parameters used by the `chg-scr-blkopc` command are shown in the [Gateway Screening Attributes](#) section. The general rules that apply to configuring gateway screening entities are shown in the [Gateway Screening Configuration](#) section.

The example in this procedure is used to change the point code 002-002-002 for the blocked OPC screen `gws7` to 230-230-230.

**Note:** If you are using multiple-part ITU national point codes with gateway screening, [14-Bit ITU National Point Code Formats](#) section.

If the current `ni`, `nc`, and `ncm` are equal to the character "c", only the next screening function identifier and next screening reference can be changed. The next screening function identifier cannot be equal to `fail`. If the next screening function identifier is not equal to `stop`, the next screening reference must be specified. Otherwise, only the point code can be changed.

The blocked OPC screen can reference one of the following screens.

- Allowed SIO
- Allowed DPC
- Blocked DPC
- Allowed CGPA

### Verifying the Gateway Screening Configuration

Enter the following commands to verify that these screens are in the database.

- `rtrv-scr-sio:all=yes`
- `rtrv-scr-dpc:all=yes`
- `rtrv-scr-blkdpc:all=yes`
- `rtrv-scr-cgpa:all=yes`

### Gateway Screening Configuration Procedures

If the desired screen is not in the database, perform one of these procedures to add the desired screen to the database.

- [Adding an Allowed SIO Screen](#)
- [Adding an Allowed DPC Screen](#)
- [Adding a Blocked DPC Screen](#)
- [Adding an Allowed Calling Party Address Screen](#)
- [Changing an Allowed SIO Screen](#)
- [Changing an Allowed DPC Screen](#)
- [Changing a Blocked DPC Screen](#)
- [Changing an Allowed Calling Party Address Screen](#)

For the first entry for a specific screening reference, the value for the point code must be `c`, and the NSFI must be either `stop`, `sio`, `dpc`, `blkdpc`, or `cgpa`. If the NSFI is `stop`, the screening of the message will stop at the specified blocked OPC screen. If the NSFI is either `sio`, `dpc`, `blkdpc`, or `cgpa`, then any message containing a point code that is not listed in the blocked OPC screen with a

NSFI equal to `fail`, will continue to be screened with either the allowed SIO, allowed DPC, blocked DPC, or the allowed CGPA screen.

All subsequent entries for that screening reference must contain a numeric point code value, the NSFI must be equal to `fail`, and the `nsr` parameter cannot be specified. Any message that contains an OPC in the blocked OPC screen with the NSFI equal to `fail` will be rejected from the network and the screening process is stopped.

The `pcst` or `npcst` parameters, specifying whether or not the ITU-I or 14-bit ITU-N point code is a spare point code, cannot be used with the `zone=c` or `npc=c` parameters.

### Specifying a Range of Values

A range of values can be specified for the point code parameters `ni`, `nc`, or `ncm`.

If a range of values is specified for any of these parameters, and the value of the other parameters match existing values for the screening reference name, the range of values for the point code parameter cannot include any values for that parameter that are currently provisioned for the screening reference name.

For example, screening reference name `scr1` contains these entries:

SR	NI	NC	NCM	NSFI	NSR/ACT
SCR1	240	001	010	FAIL	-----
SCR1	241	010	020	FAIL	-----

Another entry for screening reference `scr1` with the `ni` value of 240 and the `nc` value of 001 cannot be specified if the range of values for the `ncm` parameter includes the value 010.

The ANSI point code parameter values can be specified as a single value, a range of values, or with an asterisk (\*). The asterisk specifies all possible values for the `ni`, `nc`, and `ncm` parameters. [Table 70: Valid Value Combinations for ANSI Point Code Parameters](#) shows the valid combinations of these parameter values.

**Table 70: Valid Value Combinations for ANSI Point Code Parameters**

NI	NC	NCM
Single Value	Single Value	Single Value
Single Value	Single Value	Range of Values
Single Value	Single Value	Asterisk
Single Value	Range of Values	Asterisk
Single Value	Asterisk	Asterisk
Range of Values	Asterisk	Asterisk
Asterisk	Asterisk	Asterisk

A range of values can also be specified for an ITU-I or 24-bit ITU-N point code parameter using a combination of asterisks (\*) and single values for the point code parameters. [Table 71: Valid Value Combinations for ITU-I Point Code Parameters](#) shows the valid combinations of the ITU-I parameter

values. [Table 72: Valid Value Combinations for 24-Bit ITU-N Point Code Parameters](#) shows the valid combinations of the 24-bit ITU-N parameter values.

**Table 71: Valid Value Combinations for ITU-I Point Code Parameters**

ZONE	AREA	ID
Single Value	Single Value	Single Value
Single Value	Single Value	Asterisk
Single Value	Asterisk	Asterisk
Asterisk	Asterisk	Asterisk

**Table 72: Valid Value Combinations for 24-Bit ITU-N Point Code Parameters**

MSA	SSA	SP
Single Value	Single Value	Single Value
Single Value	Single Value	Asterisk
Single Value	Asterisk	Asterisk
Asterisk	Asterisk	Asterisk

1. Display the blocked OPC screens in the database using the `rtrv-scr-blkopc` command.

The following is an example of the possible output.

```
rlghncxa03w 06-10-25 15:25:30 GMT EAGLE5 36.0.0
SCREEN = BLOCKED OPC
SR   REF  RULES
GWS7 YES   2
IEC  YES   6
ISP1 YES   2
WRD2 YES   2
WRD3 NO    4
WRD4 YES  10
```

From the `rtrv-scr-blkopc` output, display the blocked OPC screen you wish to change using the `rtrv-scr-blkopc` command with the screening reference name. For this example, enter this command.

```
rtrv-scr-blkopc:sr=gws7
```

The following is an example of the possible output.

```
rlghncxa03w 06-10-25 15:25:30 GMT EAGLE5 36.0.0
SCREEN = BLOCKED OPC
SR   NI      NC      NCM      NSF1     NSR/ACT
GWS7 002      002      002      FAIL     -----
GWS7 C        C        C        DPC      GWS9
```

If a gateway screening stop action set is to be assigned to the blocked OPC screen being changed in the database, go to step 2.

Step 2 verifies the gateway screening stop action set names in the database. The gateway screening stop action set names are assigned only if the NSFI of the screen being changed in this procedure is STOP. If the NSFI of the screen will be changed to STOP, but a gateway screening stop action set name will not be assigned to the screen, skip steps 2 and 3 and go to step 4. If the NSFI of the screen will not be STOP, skip step 2 and go to step 3.

2. Display the gateway screening stop action sets in the database with the `rtrv-gws-actset` command.

This is an example of the possible output.

```
rlghncxa03w 06-10-25 15:26:30 GMT EAGLE5 36.0.0
ACT  ACT      ACT  ACT  ACT  ACT  ACT  ACT  ACT  ACT  ACT  ACT
ID   NAME      1    2    3    4    5    6    7    8    9    10
--   -
1    copy      copy
2    rdct      rdct
3    cr        copy rdct
4    cncf      cncf
5    cpcncf    copy cncf
6    cncfrd    cncf rdct
7    cpcfrd    copy cncf rdct

GWS action set table is (7 of 16) 44% full
```

If the required gateway screening stop action set is not in the database, perform the [Configuring Gateway Screening Stop Action Sets](#) procedure to configure the required gateway screening stop action set.

**Note:** If the NSFI of the screen being changed in this procedure will be STOP or FAIL, or if the NSFI of the screen is not being changed, skip step 3 and go to step 4.

3. Enter the commands in the [Verifying the Gateway Screening Configuration](#) section to verify that the screen that will be specified by the NSFI/NSR parameter combination in step 5 is in the database.

If the desired screen is not in the database, perform one of the procedures shown in the [Gateway Screening Configuration Procedures](#) section to add the desired screen to the database or change an existing screen in the database.

**Note:** If any of these conditions apply to this procedure, skip this step and go to step 5:

- The point code in the screen is not being changed.
- The screen being changed contains either an ANSI or 24-bit ITU-N point code.
- The ITU-I or 14-bit ITU-N non-spare point code in the screen is not being changed to an ITU-I or 14-bit ITU-N spare point code.
- The point code in the screen is an ITU-I or 14-bit ITU-N spare point code or the screening reference contains other screens with ITU-I or 14-bit ITU-N spare point codes.

4. Display the status of the ITU National and International Spare Point Code Support feature by entering the `rtrv-ctrl-feat` command with the ITU National and International Spare Point Code Support feature part number.

Enter this command.



```
rtrv-ctrl-feat:partnum=893013601
```

This is an example of the possible output.

```
rlghncxa03w 06-10-25 15:25:30 GMT EAGLE5 36.0.0
The following features have been permanently enabled:

Feature Name          Partnum   Status Quantity
Spare Point Code Support 893013601 on      ----

The following features have been temporarily enabled:

Feature Name          Partnum   Status Quantity   Trial Period Left
Zero entries found.

The following features have expired temporary keys:

Feature Name          Partnum
Zero entries found.
```

If the ITU National and International Spare Point Code Support feature is enabled, go to step 5.

If the ITU National and International Spare Point Code Support feature is not enabled, perform the “Activating the ITU National and International Spare Point Code Support Feature” procedure in *Database Administration - SS7 User’s Guide* to enable the ITU National and International Spare Point Code Support feature as required. After the feature has been enabled, go to step 5.

5. Change the attributes of the blocked OPC screen using the `chg-scr-blkopc` command.

If a gateway screening stop action is to be assigned to the blocked OPC screen being changed, enter the `chg-scr-blkopc` command with the `nsfi=stop` parameter and the `actname` parameter with the name of a gateway screening stop action set shown in the output of the `rtrv-gws-actset` command executed in step 2.

The current values for the `ni`, `nc`, `nncm`, `zone`, `area`, `id`, `npc`, `msa`, `ssa`, and `sp` parameters must be entered exactly as shown in the `rtrv-scr-blkopc` output in step 1.

The following list contains the values for the `nni`, `nnc`, `nncm`, `nzone`, `narea`, `nid`, `nnpc`, `nmsa`, `nssa`, and `nsp` parameters:

- `nni` – 0 - 255, c, or an asterisk (\*)
- `nnc` – 0 - 255, c, or an asterisk (\*)
- `nncm` – 0 - 255, c, or an asterisk (\*)
- `nzone` – 0 - 7, c, or an asterisk (\*)
- `narea` – 0 - 255, c, or an asterisk (\*)
- `nid` – 0 - 7, c, or an asterisk (\*)
- `nnpc` – 1 - 16383, c, or an asterisk (\*)
- `nmsa` – 0 - 255, c, or an asterisk (\*)
- `nssa` – 0 - 255, c, or an asterisk (\*)
- `nsp` – 0 - 255, c, or an asterisk (\*)

A range of values can be specified for the `nni`, `nnc`, and `nncm` parameters. See the “[Specifying a Range of Values](#)” section for more information on how the asterisk and a range of values are used for the `nni`, `nnc`, and `nncm` parameters.

To change an ITU-I or 14-bit ITU-N spare point code to a non-spare point code, both the `pcst=s` and `npcst=none` parameters must be specified with the `chg-scr-blkopc` command.

To change an ITU-I or 14-bit ITU-N non-spare point code to a spare point code, the `npcst=s` parameter must be specified with the `chg-scr-blkopc` command. The `pcst` parameter does not have to be specified.

If the current point code in the screen being changed is either an ITU-I or 14-bit ITU-N spare point code, the `pcst=s` parameter must be specified with the `chg-scr-blkopc` command.

If the current point code in the screen being changed is either an ITU-I or 14-bit ITU-N non-spare point code, the `pcst` parameter does not have to be specified with the `chg-scr-blkopc` command. If the `pcst` parameter is specified for a screen containing either an ITU-I or 14-bit ITU-N non-spare point code, the `pcst` parameter value must be none.

The `pcst` or `npcst` parameters cannot be used with the `zone=c` or `npc=c` parameters.

For this example, enter this command.

```
chg-scr-blkopc:sr=gws7:ni=002:nc=002:ncm=002:nni=230:nnc=230 :nncm=230
```

The following messages appear.

```
rlghncxa03w 06-10-25 15:27:30 GMT EAGLE5 36.0.0
CHG-SCR-BLKOPC: SCREEN SET AFFECTED - GWS7 1% FULL
CHG-SCR-BLKOPC: MASP A - COMPLTD
```

**Note:** Verify the changes using the `rtrv-scr-blkopc` command with the screening reference name used in step 5. For this example, enter this command.

```
rtrv-scr-blkopc:sr=gws7
```

The following is an example of the possible output.

```
rlghncxa03w 06-10-25 15:28:30 GMT EAGLE5 36.0.0
SCREEN = BLOCKED OPC
SR      NI      NC      NCM      NSF1      NSR/ACT
GWS7   230     230     230     FAIL     -----
GWS7   C       C       C       DPC     GWS9
```

#### 6. Backup the new changes using the `chg-db:action=backup:dest=fixed` command.

The following messages should appear, the active Maintenance and Administration Subsystem Processor (MASP) appears first.

```
BACKUP (FIXED) : MASP A - Backup starts on active MASP.
BACKUP (FIXED) : MASP A - Backup on active MASP to fixed disk complete.
BACKUP (FIXED) : MASP A - Backup starts on standby MASP.
BACKUP (FIXED) : MASP A - Backup on standby MASP to fixed disk complete.
```

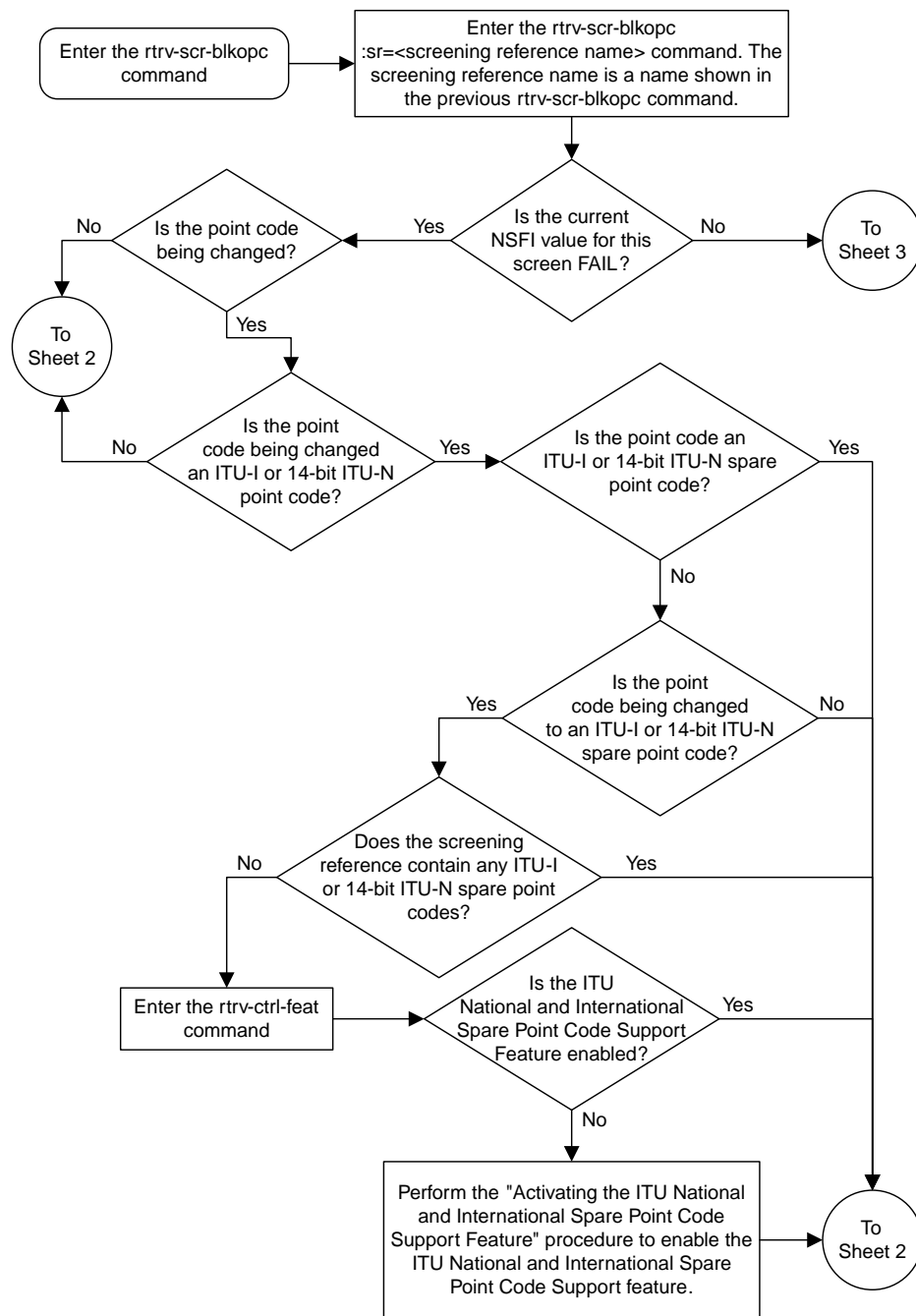

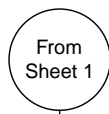

Enter the chg-scr-blkopc command with this mandatory parameter:  
 :sr=<screening reference name>  
 and the point code parameters, depending on the point code type contained in the screen being changed. Only one point code type can be specified.

ANSI Point Code	ITU-I Point Code	14-Bit ITU-N Point Code	24-Bit ITU-N Point Code
:ni=<current ni value>	:zone=<current zone value>	:npc=<current npc value>	:msa=<current msa value>
:nc=<current nc value>	:area=<current area value>	:pcst=<s, none>	:ssa=<current ssa value>
:ncm=<current ncm value>	:id=<current id value>		:sp=<current sp value>
	:pcst=<s, none>		

At least one of these optional point code parameters must be specified with the chg-scr-blkopc command.

ANSI Point Code	ITU-I Point Code	14-Bit ITU-N Point Code	24-Bit ITU-N Point Code
:nni=<0-255, *>	:nzone=<0-7, *>	:nnpc=<1-16383, *>	:nmsa=<0-255, *>
:nnc=<0-255, *>	:narea=<0-255, *>	:npcst=<s, none>	:nssa=<0-255, *>
:nncm=<0-255, *>	:nid=<0-7, *>		:nsp=<0-255, *>
	:npcst=<s, none>		

The new point code code parameters must be of the same type as the current point code values specified in the chg-scr-blkopc command  
 (See Notes )

Enter the rtrv-scr-blkopc  
 :sr=<screening reference  
 name> command

Enter the  
 chg-db:action=backup:dest=fixed  
 command

- Notes:
1. A range of values can be specified for the nni, nnc, or nncm parameters by inserting double ampersands (&&) between the parameter values defining the range. For example, to specify the range 025 to 200 for the nni parameter, enter 025&&200 for the nni parameter value.
  2. The current values for the ni, nc, ncm, zone, area, id, npc, msa, ssa, or sp parameters must be entered exactly as shown in the rtrv-scr-blkopc output. The current point code value cannot be C.
  3. The asterisk (\*) specifies the entire range of values for that parameter.
- For more information about specifying a range of values and about using the asterisk, see the "Gateway Screening Attributes" section and the "Specifying a Range of Values" section. The "Gateway Screening Attributes" section is in the Database Administration Manual - Gateway Screening. The "Specifying a Range of Values" section is in the "Changing a Blocked OPC Screen" procedure in the Database Administration Manual - Gateway Screening.
4. To change an ITU-I or 14-bit ITU-N spare point code to a non-spare point code, both the pcst=s and npcst=none parameters must be specified with the chg-scr-blkopc command.
  5. To change an ITU-I or 14-bit ITU-N non-spare point code to a spare point code, the npcst=s parameter must be specified with the chg-scr-blkopc command. The pcst parameter does not have to be specified.
  6. If the current point code in the screen being changed is either an ITU-I or 14-bit ITU-N spare point code, the pcst=s parameter must be specified with the chg-scr-blkopc command.
  7. If the current point code in the screen being changed is either an ITU-I or 14-bit ITU-N non-spare point code, the pcst parameter does not have to be specified with the chg-scr-blkopc command. If the pcst parameter is specified for a screen containing either an ITU-I or 14-bit ITU-N non-spare point code, the pcst parameter value must be none.

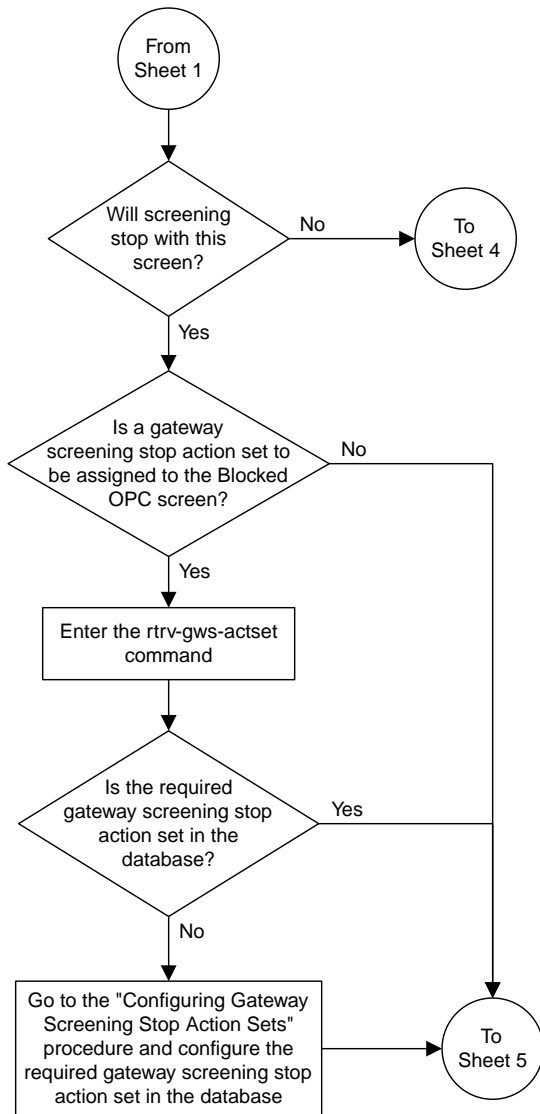

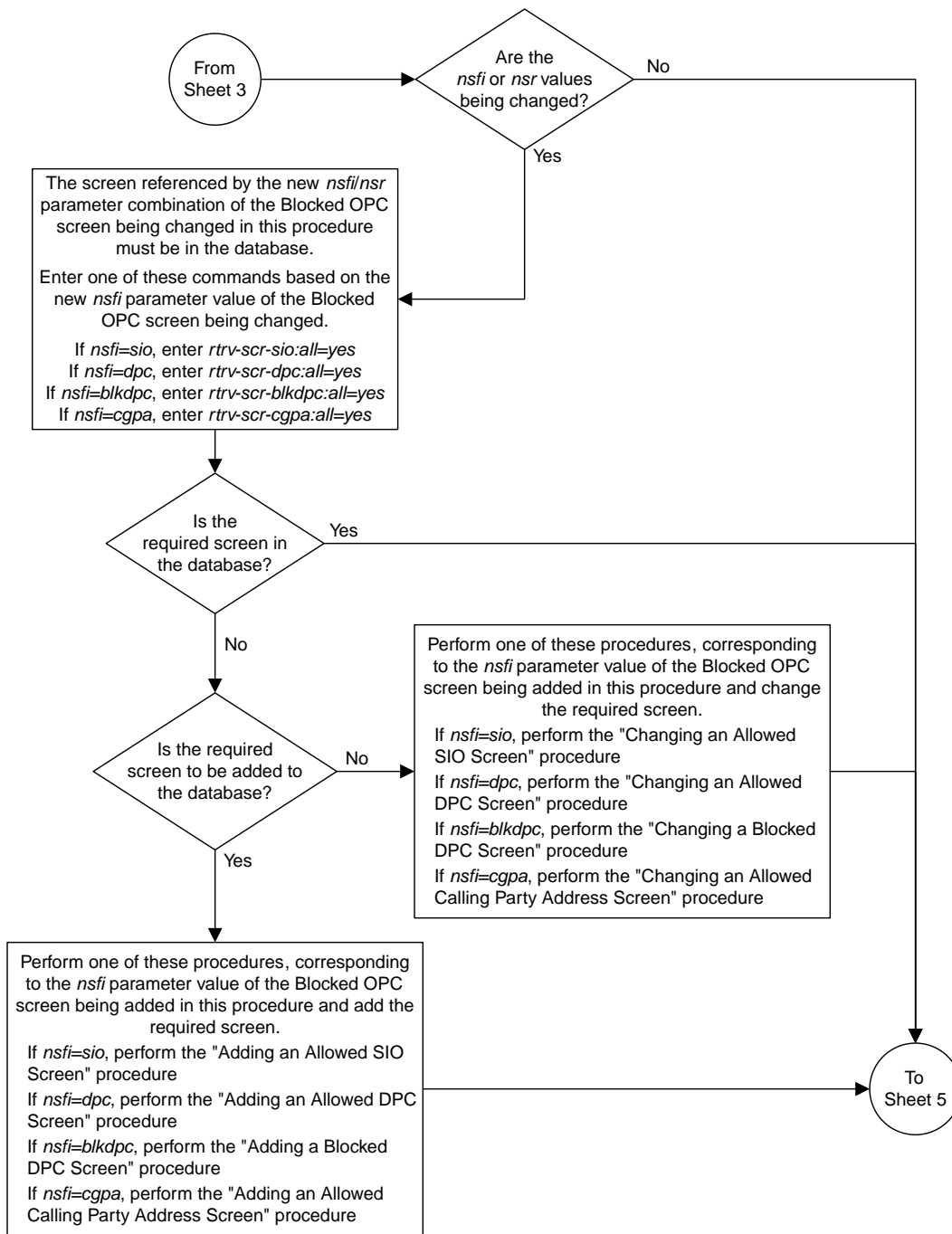

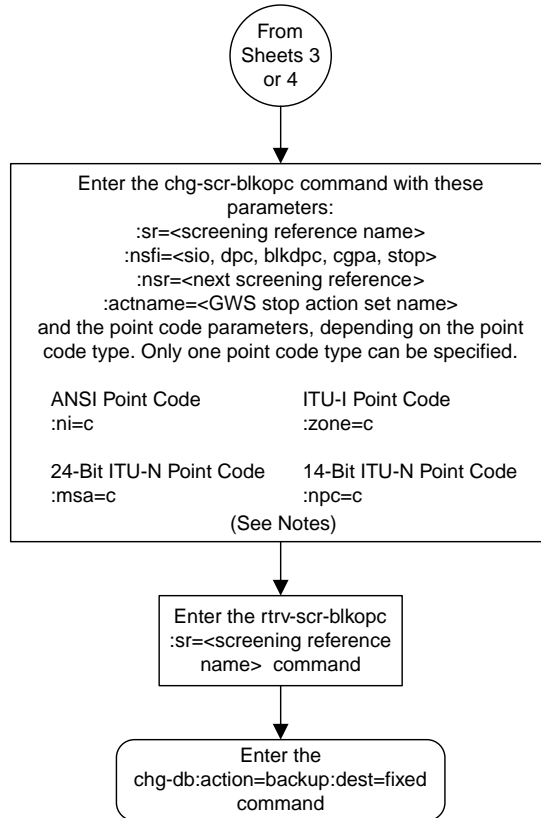

Notes:

1. The nsr parameter can be specified only, and must be specified, if the nsfi parameter value is either sio, dpc, blkdpc, or cgpa.
2. The actname parameter is optional and can be specified only with the nsfi=stop parameter. If the actname parameter is specified, the actname parameter value is one of the gateway screening stop action set names shown in the rtrv-gws-actset output on Sheet 3.

Sheet 5 of 5

**Figure 64: Changing a Blocked OPC Screen**



# Chapter 12

## Allowed Originating Point Code (OPC) Screen Configuration

---

### Topics:

- [Introduction.....414](#)
- [Adding an Allowed OPC Screen.....418](#)
- [Removing an Allowed OPC Screen.....432](#)
- [Changing an Allowed OPC Screen.....435](#)

Chapter 12, Allowed Originating Point Code (OPC) Screen Configuration, contains the procedures necessary to configure allowed originating point code screens.

## Introduction

The allowed originating point code (OPC) screen identifies a set of OPC's that are allowed to send SS7 messages into the network. The gray shaded areas in [Figure 66: Allowed OPC Screening Functions](#) shows the fields of the SS7 message that are checked by the allowed OPC screening function.

## Gateway Screening Actions

If a match is not found, the message is discarded.

If a match is found, the `nsfi` is examined to determine the next step in the screening process. If the `nsfi` value is any value other than `stop`, the next screening reference (`nsr`) is identified and the screening process continues to the next screen identified by the `nsfi` and `nsr` parameter values.

If the `nsfi` is equal to `stop`, the screening process stops and the message is processed. If a gateway screening stop action set is specified with the screen, shown by the `actname` parameter value, the message is processed according to the gateway screening stop actions that are assigned to the gateway screening stop action set.

- If the `copy` gateway screening stop action is specified, the message is processed and a copy of the message is sent by the STPLAN feature to an external application.
- If the `rdct` (redirect) gateway screening stop action is specified, the message is diverted from the original destination and sent to another destination with the Database Transport Access feature, specified by global title translation, for further processing.
- If the `cncf` gateway screening stop action is specified, the PIP parameter in the incoming ISUP IAM message is converted to the GN parameter. The GN parameter in the incoming ISUP IAM message is converted to the PIP parameter. The message is then sent to the node specified by the DPC in the routing label in the message. For more information on the Calling Name Conversion Facility feature, see [Calling Name Conversion Facility \(CNCF\) Configuration](#).
- If the `tlnp` gateway screening stop action is specified, ISUP IAMs that pass gateway screening are processed either by the ISUP NP with EPAP feature (if the ISUP NP with EPAP feature is enabled and turned on) or by the Triggerless LNP feature (if the Triggerless LNP feature is turned on). The ISUP NP with EPAP feature is discussed in more detail in *G-Port User's Guide*. The Triggerless LNP feature is discussed in more detail in *ELAP Administration and LNP Feature Activation Guide*.
- If the `tinp` gateway screening stop action is specified, ISUP IAMs that pass gateway screening are intercepted by the Triggerless ISUP based Number Portability (TINP) feature and converted to include the routing number (RN) if the call is to a ported number. The TINP feature is discussed in more detail in *G-Port User's Guide*.
- If the `tif`, `tif2`, or `tif3` gateway screening stop actions are specified, TIF processing is applied to the message.
- If the `sccp` gateway screening stop action is specified, MTP routed SCCP UDT/XUDT are forwarded to the service modules for further processing.

## Allowed OPC Screening Actions

[Figure 65: Allowed OPC Screening Actions](#) shows the screening actions of the allowed OPC screen.

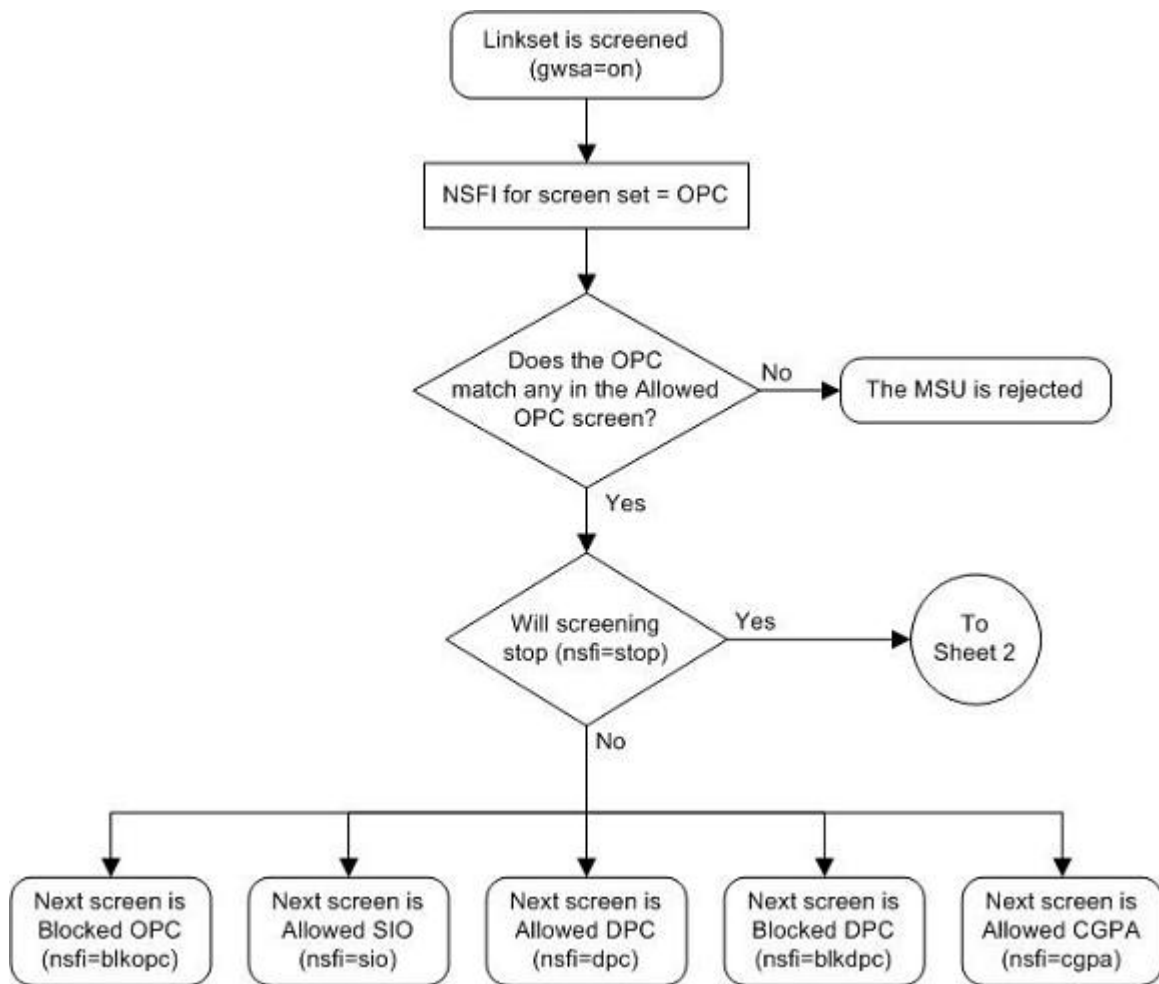

Sheet 1 of 3

Figure 65: Allowed OPC Screening Actions

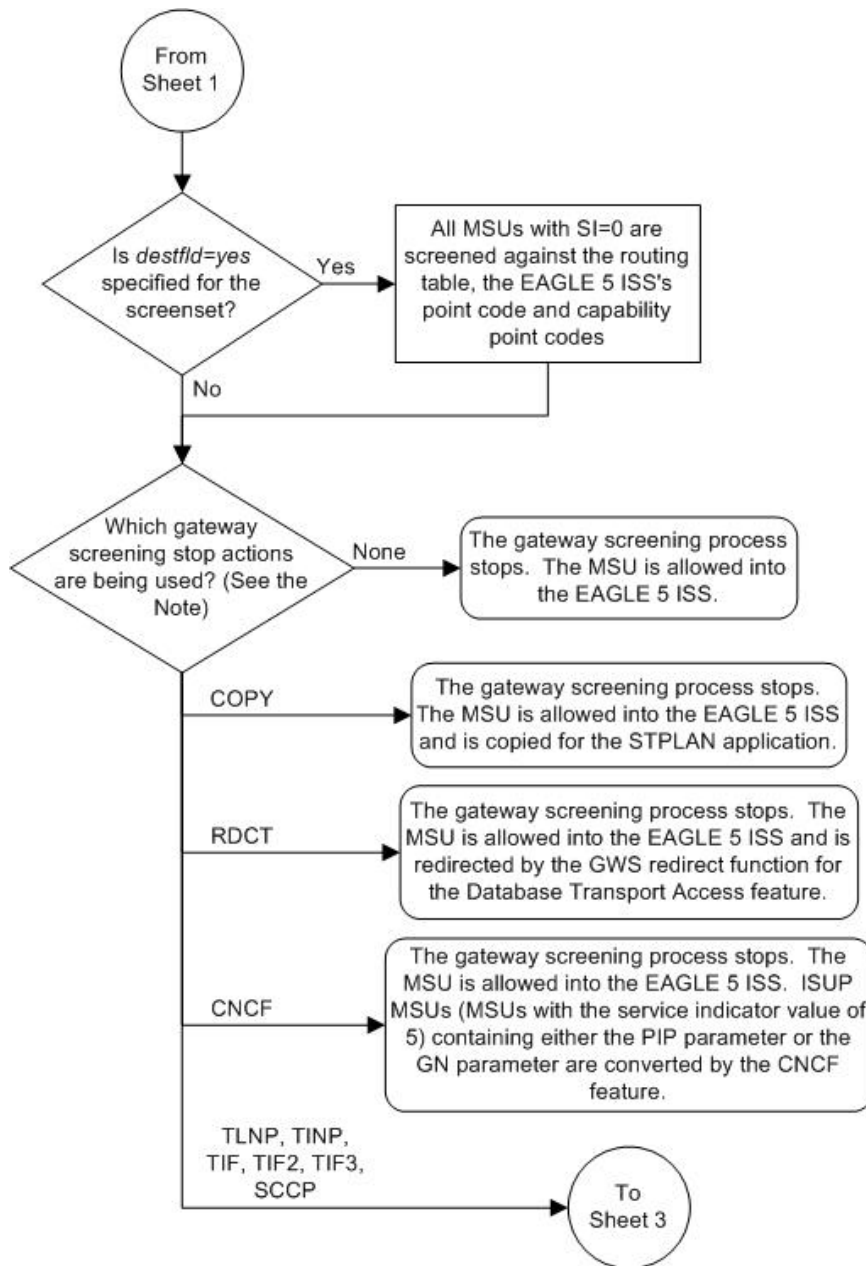

Note: Combinations of the gateway screening stop actions shown on Sheets 2 and 3 may be assigned to a gateway screening stop action set. Refer to the Configuring Gateway Screening Stop Action Sets and the Configuring TLNP Gateway Screening Stop Action Sets procedures in Chapter 2 of this manual for the combinations that can be used.

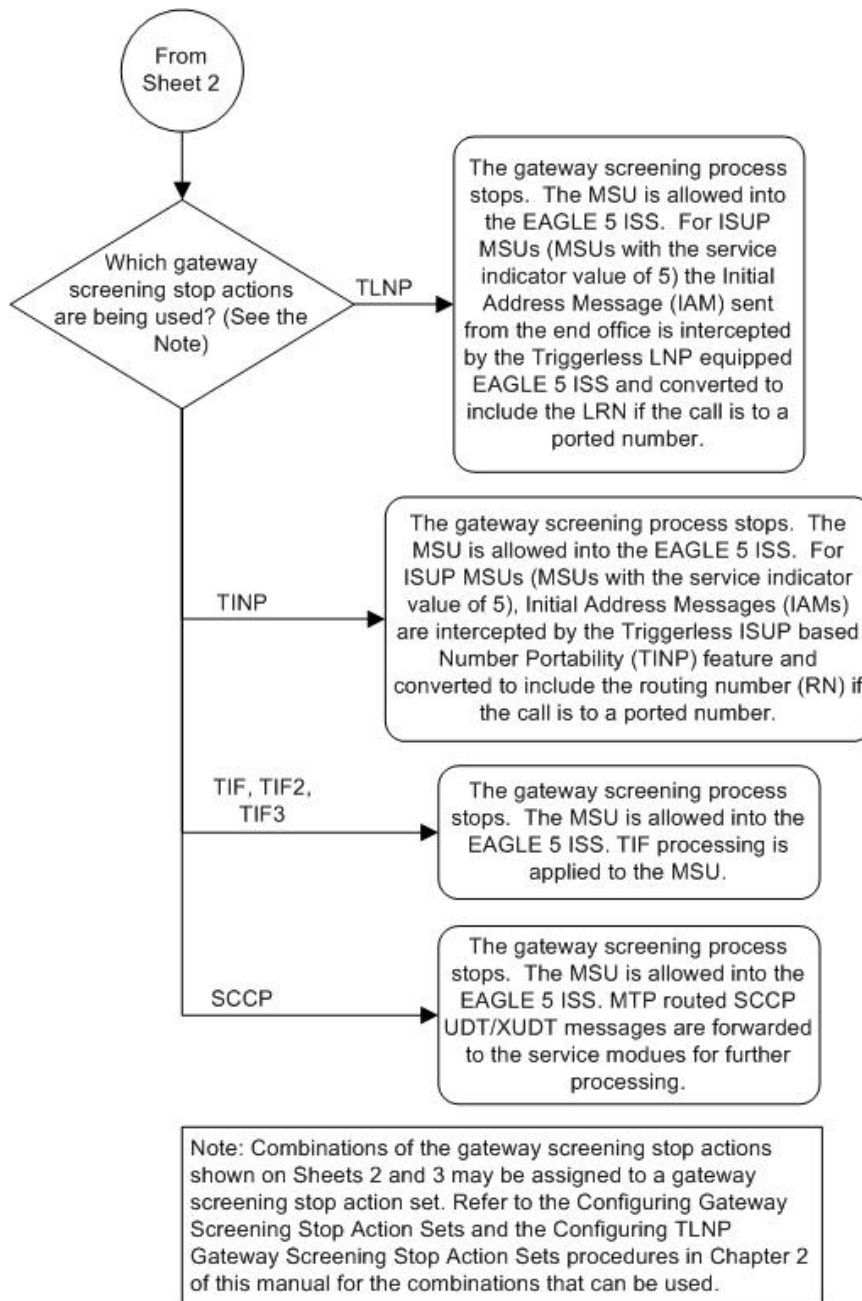

Sheet 3 of 3

ANSI MSU (ANSI Message Signal Unit)

BSN FSN LI	SIO xx xx xxxx NIC PRI SI	SIF		
		DPC NCM NC NI	Routing Label OPC NCM NC NI	SLS xx

ITU-I MSU (ITU International Message Signal Unit)

BSN FSN LI	SIO xx xx xxxx NIC PRI SI	SIF		
		DPC ID AREA ZONE	Routing Label OPC ID AREA ZONE	SLS xx

14-Bit ITU-N MSU (14-Bit ITU National Message Signal Unit)

BSN FSN LI	SIO xx xx xxxx NIC PRI SI	SIF	
		DPC NPC	Routing Label OPC NPC

24-Bit ITU-N MSU (24-Bit ITU National Message Signal Unit)

BSN FSN LI	SIO xx xx xxxx NIC PRI SI	SIF		
		DPC SP SSA MSA	Routing Label OPC SP SSA MSA	SLS xx

Figure 66: Allowed OPC Screening Functions

## Adding an Allowed OPC Screen

This procedure is used to add an allowed originating point code (OPC) screen to the database using the `ent-scr-opc` command. The parameters used by the `ent-scr-opc` command are shown in the [Gateway Screening Attributes](#) section. The general rules that apply to configuring gateway screening entities are shown in the [Gateway Screening Configuration](#) section.

The examples in this procedure are used to add the allowed OPC screen data shown in [Table 73: Example Gateway Screening Allowed OPC Configuration Table](#) and based on the example configurations shown in [Figure 4: Gateway Screening Configuration - Example 1](#), [Figure 8: Gateway Screening Configuration - Example 5](#), and [Figure 10: Gateway Screening Configuration - Example 7](#).

Table 73: Example Gateway Screening Allowed OPC Configuration Table

Screening Reference	NI	NC	NCM	NSFI	NSR
gws4	001	001	001	blkopc	gws3
fld2	010	010	010	blkopc	fld3
isp1	015	015	015	blkopc	isp1
tup1	017	017	017	sio	tup1

**Note:** If you using multiple-part ITU national point codes with gateway screening, see the [14-Bit ITU National Point Code Formats](#) section.

The allowed OPC screen can reference one of the following screens.

- Blocked OPC
- Allowed SIO
- Allowed DPC
- Blocked DPC
- Allowed CGPA

#### Verifying the Gateway Screening Configuration

Enter the following commands to verify that these screens are in the database.

- `rtrv-scr-blkopc:all=yes`
- `rtrv-scr-sio:all=yes`
- `rtrv-scr-dpc:all=yes`
- `rtrv-scr-blkdpc:all=yes`
- `rtrv-scr-cgpa:all=yes`

#### Gateway Screening Configuration Procedures

If the desired screen is not in the database, perform one of these procedures to add the desired screen to the database or change an existing screen in the database.

- [Adding a Blocked OPC Screen](#)
- [Adding an Allowed SIO Screen](#)
- [Adding an Allowed DPC Screen](#)
- [Adding a Blocked DPC Screen](#)
- [Adding an Allowed Calling Party Address Screen](#)
- [Changing a Blocked OPC Screen](#)
- [Changing an Allowed SIO Screen](#)
- [Changing an Allowed DPC Screen](#)
- [Changing a Blocked DPC Screen](#)
- [Changing an Allowed Calling Party Address Screen](#)

#### Specifying a Range of Values

A range of values can be specified for the point code parameters `ni`, `nc`, or `ncm`.

If a range of values is specified for any of these parameters, and the value of the other parameters match existing values for the screening reference name, the range of values for the point code parameter cannot include any values for that parameter that are currently provisioned for the screening reference name.

For example, screening reference name `scr1` contains these entries:

SR	NI	NC	NCM	NSFI	NSR/ACT
SCR1	240	001	010	CGPA	-----
SCR1	241	010	020	STOP	-----

Another entry for screening reference `scr1` with the `ni` value of 240 and the `nc` value of 001 cannot be specified if the range of values for the `ncm` parameter includes the value 010.

The ANSI point code parameter values can be specified as a single value, a range of values, or with an asterisk (\*). The asterisk specifies all possible values for the `ni`, `nc`, and `ncm` parameters. [Table 74: Valid Value Combinations for ANSI Point Code Parameters](#) shows the valid combinations of these parameter values.

**Table 74: Valid Value Combinations for ANSI Point Code Parameters**

NI	NC	NCM
Single Value	Single Value	Single Value
Single Value	Single Value	Range of Values
Single Value	Single Value	Asterisk
Single Value	Range of Values	Asterisk
Single Value	Asterisk	Asterisk
Range of Values	Asterisk	Asterisk
Asterisk	Asterisk	Asterisk

A range of values can also be specified for an ITU-I or 24-bit ITU-N point code parameter using a combination of asterisks (\*) and single values for the point code parameters. [Table 75: Valid Value Combinations for ITU-I Point Code Parameters](#) shows the valid combinations of the ITU-I parameter values. [Table 76: Valid Value Combinations for 24-Bit ITU-N Point Code Parameters](#) shows the valid combinations of the 24-bit ITU-N parameter values.

**Table 75: Valid Value Combinations for ITU-I Point Code Parameters**

ZONE	AREA	ID
Single Value	Single Value	Single Value
Single Value	Single Value	Asterisk
Single Value	Asterisk	Asterisk



ZONE	AREA	ID
Asterisk	Asterisk	Asterisk

Table 76: Valid Value Combinations for 24-Bit ITU-N Point Code Parameters

MSA	SSA	SP
Single Value	Single Value	Single Value
Single Value	Single Value	Asterisk
Single Value	Asterisk	Asterisk
Asterisk	Asterisk	Asterisk

1. Verify that the gateway screening feature is on, by entering the `rtrv-feat` command.

If the gateway screening feature is on, the `GWS` field is set to `on`.

**Note:** The `rtrv-feat` command output contains other fields that are not used by this procedure. If you wish to see all the fields displayed by the `rtrv-feat` command, see the `rtrv-feat` command description in *Commands User's Guide*.

If the gateway screening feature is on, shown by the entry `GWS = on` in the `rtrv-feat` command output, skip step 2, and go to step 3.

2. Turn the gateway screening feature on by entering this command.

```
chg-feat:gws=on
```

**Note:** Once the gateway screening feature is turned on with the `chg-feat` command, it cannot be turned off.

**Note:** The gateway screening feature must be purchased before you turn this feature on with the `chg-feat` command. If you are not sure if you have purchased the gateway screening feature, contact your Oracle Sales Representative or Account Representative.

When the `chg-feat` has successfully completed, this message should appear.

```
r1ghncxa03w 06-10-28 11:43:04 GMT EAGLE5 36.0.0
CHG-FEAT: MASP A - COMPLTD
```

3. Display all allowed OPC screens in the database using the `rtrv-scr-opc` command.

The following is an example of the possible output.

```
r1ghncxa03w 06-10-25 15:25:30 GMT EAGLE5 36.0.0
SCREEN = ALLOWED OPC
SR   REF  RULES
IEC  YES   2
WRD2 YES   1
WRD4 YES   9
```

If the screening reference names that you wish to add with this procedure are not shown in the `rtrv-scr-opc` command output, go to step 4. For this example, the screening reference names are not shown. If these screening reference names are shown in the `rtrv-scr-opc` command output, make sure the screening data you wish to enter is not already in the database by entering the `rtrv-scr-opc` command with the screening reference name. For example, enter the `rtrv-scr-opc:sr=iec` command. The following is an example of the possible output.

```
rlghncxa03w 06-10-25 15:26:30 GMT EAGLE5 36.0.0
SCREEN = ALLOWED OPC
SR      NI      NC      NCM      NSF1     NSR/ACT
IEC     240     001     010     STOP     -----
IEC     241     010     *       CGPA     cg04

SR      NPC
IEC     00235
IEC     00240

SR      ZONE   AREA   ID      NSF1     NSR/ACT
IEC     1      003   4      BLKOPC  blk1
IEC     1      003   5      STOP     -----
```

If a gateway screening stop action set is to be assigned to the allowed OPC screen being added to the database, go to step 4.

Step 4 verifies the gateway screening stop action set names in the database. The gateway screening stop action set names are assigned only if the NSF1 of the screen being added in this procedure is STOP. If the NSF1 of the new screen will be STOP, but a gateway screening stop action set name will not be assigned to the new screen, skip steps 4, 5, and 6, and go to step 7. If the NSF1 of the new screen is not STOP, skip steps 4 and 5, and go to step 6.

4. Display the gateway screening stop action sets in the database with the `rtrv-gws-actset` command.

This is an example of the possible output.

```
rlghncxa03w 06-10-25 15:27:30 GMT EAGLE5 36.0.0
ACT ACT  ACT ACT  ACT ACT  ACT ACT  ACT ACT  ACT ACT
ID  NAME  1  2  3  4  5  6  7  8  9  10
--  ---  -  -  -  -  -  -  -  -  -  -
1   copy  copy
2   rdct  rdct
3   cr    copy rdct
4   cncf  cncf
5   cpcncf copy cncf
6   cncfrd cncf rdct
7   cpcfrd copy cncf rdct

GWS action set table is (7 of 16) 44% full
```

If the required gateway screening stop action set is not in the database, perform the [Configuring Gateway Screening Stop Action Sets](#) procedure to configure the required gateway screening stop action set.

**Note:** If the gateway screening stop action set being assigned to the Allowed OPC screen does not contain the redirect stop action, skip step 5 and go to step 6.

5. Verify the point codes of adjacent nodes by entering the `rtrv-ls` command.

The following is an example of the possible output.

```
rlghncxa03w 06-10-10 11:43:04 GMT EAGLE5 36.0.0
                                L3T SLT
LSN      APCA  (SS7)  SCRN  SET  SET  BEI  LST  LNKS  ACT  MES  DIS  SLSCI  NIS
ele2     001-207-000  none  1   1   no  B   6   off  off  off  no   off
ls1305   000-005-000  none  1   1   no  A   1   off  off  off  no   off
ls1307   000-007-000  none  1   1   no  A   1   off  off  off  no   off
elm1s1   001-001-001  none  1   1   no  A   7   off  off  off  no   off
elm1s2   001-001-002  none  1   1   no  A   7   off  off  off  no   off

                                L3T SLT
LSN      APCI  (SS7)  SCRN  SET  SET  BEI  LST  LNKS  ACT  MES  DIS  SLSCI  NIS
ele2i    1-207-0    none  1   1   no  B   4   off  off  off  ---  on
ls1315   0-015-0    none  1   1   no  A   1   off  off  off  ---  off
ls1317   0-017-0    none  1   1   no  A   1   off  off  off  ---  on
elm2s1   1-011-1    none  1   1   no  A   7   off  off  off  ---  off
elm2s2   1-011-2    none  1   1   no  A   7   off  off  off  ---  off

Link set table is (10 of 1024) 1% full.
```



**CAUTION**

**Caution:** RedirectingSLTA/SLTMmessages preventsSLTA/SLTMmessages from being returned to theEAGLE. The signaling link carrying these messages will fail if these messages are not returned to theEAGLE. To preventSLTA/SLTMmessages from being redirected, gateway screening stop action sets containing the redirect stop action should not be assigned toAllowed OPC screens containing the adjacent point code of a linkset.

**Note:** If theNSFI of the screen being added in this procedure isSTOP, skip step 6 and go to step 7.

6. Enter the commands in the [Verifying the Gateway Screening Configuration](#) section to verify that the screen that will be specified by the NSFI/NSR parameter combination in step 8 is in the database.

If the desired screen is not in the database, perform one of the procedures shown in the [Gateway Screening Configuration Procedures](#) section to add the desired screen to the database or change an existing screen in the database.

**Note:** If the point code being added in this procedure is not anITU-I or 14-bitITU-N spare point code, skip step 7 and to step 8.

**Note:** If the point code being added in this procedure is anITU-I or 14-bitITU-N spare point code and the screening reference containsITU-I or 14-bitITU-N spare point codes, skip step 7 and go to step 8.

7. Display the status of the ITU National and International Spare Point Code Support feature by entering the `rtrv-ctrl-feat` command with the ITU National and International Spare Point Code Support feature part number.

Enter this command.

```
rtrv-ctrl-feat:partnum=893013601
```

This is an example of the possible output.

```
rlghncxa03w 06-10-25 15:25:30 GMT EAGLE5 36.0.0
The following features have been permanently enabled:
```

```

Feature Name          Partnum  Status  Quantity
Spare Point Code Support  893013601  on      ----

```

The following features have been temporarily enabled:

```

Feature Name          Partnum  Status  Quantity  Trial Period Left
Zero entries found.

```

The following features have expired temporary keys:

```

Feature Name          Partnum
Zero entries found.

```

If the ITU National and International Spare Point Code Support feature is enabled, go to step 8.

If the ITU National and International Spare Point Code Support feature is not enabled, perform the “Activating the ITU National and International Spare Point Code Support Feature” procedure in *Database Administration - SS7 User’s Guide* to enable the ITU National and International Spare Point Code Support feature as required. After the feature has been enabled, go to step 8.

8. Add a new allowed OPC screen to the database using the `ent-scr-opc` command.

If a gateway screening stop action is to be assigned to the allowed OPC screen being changed, enter the `ent-scr-opc` command with the `nsfi=stop` parameter and the `actname` parameter with the name of a gateway screening stop action set shown in the output of the `rtrv-gws-actset` command executed in step 4.



**Caution:** Redirecting SLTA/SLTM messages prevents SLTA/SLTM messages from being returned to the EAGLE. The signaling link carrying these messages will fail if these messages are not returned to the EAGLE. To prevent SLTA/SLTM messages from being redirected, gateway screening stop action sets containing the redirect stop action should not be assigned to Allowed OPC screens containing the adjacent point code of a linkset, shown in step 5.

The following list contains the values for `ni`, `nc`, `ncm`, `zone`, `area`, `id`, `npc`, `msa`, `ssa`, and `sp` parameters:

- `ni` – 0 - 255 or an asterisk (\*)
- `nc` – 0 - 255 or an asterisk (\*)
- `ncm` – 0 - 255 or an asterisk (\*)
- `zone` – 0 - 7 or an asterisk (\*)
- `area` – 0 - 255 or an asterisk (\*)
- `id` – 0 - 7 or an asterisk (\*)
- `npc` – 1 - 16383 or an asterisk (\*)
- `msa` – 0 - 255 or an asterisk (\*)
- `ssa` – 0 - 255 or an asterisk (\*)
- `sp` – 0 - 255 or an asterisk (\*)

A range of values can be specified for the `ni`, `nc`, and `ncm` parameters. See the “[Specifying a Range of Values](#)” section for more information on how the asterisk and a range of values are used for the `ni`, `nc`, and `ncm` parameters.

To add a spare point code to the allowed OPC screen, the `pcst=s` parameter must be specified. To add a non-spare point code to the allowed OPC screen, the `pcst` parameter does not have to

be specified. If the `pcst` parameter is specified for a screen containing an ITU-I or 14-bit ITU-N non-spare point code, the value must be none.

For this example, enter these commands.

```
ent-scr-opc:sr=gws4:ni=001:nc=001:ncm=001:nsfi=blkopc:nsr=gws3
```

A message similar to the following should appear.

```
rlghncxa03w 06-10-25 15:28:30 GMT EAGLE5 36.0.0
ENT-SCR-OPC: SCREEN SET AFFECTED - GWS4 1% FULL
ENT-SCR-OPC: MASP A - COMPLTD
```

```
ent-scr-opc:sr=fld2:ni=010:nc=010:ncm=010:nsfi=blkopc:nsr=fld3
```

A message similar to the following should appear.

```
rlghncxa03w 06-10-25 15:29:30 GMT EAGLE5 36.0.0
ENT-SCR-OPC: SCREEN SET AFFECTED - FLD2 1% FULL
ENT-SCR-OPC: MASP A - COMPLTD
```

```
ent-scr-opc:sr=isp1:ni=015:nc=015:ncm=015:nsfi=blkopc:nsr=isp1
```

A message similar to the following should appear.

```
rlghncxa03w 06-10-25 15:29:30 GMT EAGLE5 36.0.0
ENT-SCR-OPC: SCREEN SET AFFECTED - ISP1 1% FULL
ENT-SCR-OPC: MASP A - COMPLTD
```

```
ent-scr-opc:sr=tup1:ni=017:nc=017:ncm=017:nsfi=sio:nsr=tup1
```

A message similar to the following should appear.

```
rlghncxa03w 06-10-25 15:29:30 GMT EAGLE5 36.0.0
ENT-SCR-OPC: SCREEN SET AFFECTED - TUP1 1% FULL
ENT-SCR-OPC: MASP A - COMPLTD
```

9. Verify the changes using the `rtrv-scr-opc` command with the screening reference name used in step 8.

For this example, enter these commands.

```
rtrv-scr-opc:sr=gws4
```

The following is an example of the possible output.

```
rlghncxa03w 06-10-25 15:30:30 GMT EAGLE5 36.0.0
SCREEN = ALLOWED OPC
SR   NI      NC      NCM      NSFI      NSR/ACT
GWS4 001      001      001      BLKOPC    GWS3
```

```
rtrv-scr-opc:sr=fld2
```

The following is an example of the possible output.

```
rlghncxa03w 06-10-25 15:31:30 GMT EAGLE5 36.0.0
SCREEN = ALLOWED OPC
SR   NI       NC       NCM       NSF1     NSR/ACT
FLD2 010       010       010       BLKOPC  FLD3
```

```
rtrv-scr-opc:sr=isp1
```

The following is an example of the possible output.

```
rlghncxa03w 06-10-25 15:31:30 GMT EAGLE5 36.0.0
SCREEN = ALLOWED OPC
SR   NI       NC       NCM       NSF1     NSR/ACT
ISP1 015       015       015       BLKOPC  ISP1
```

```
rtrv-scr-opc:sr=tup1
```

The following is an example of the possible output.

```
rlghncxa03w 06-10-25 15:31:30 GMT EAGLE5 36.0.0
SCREEN = ALLOWED OPC
SR   NI       NC       NCM       NSF1     NSR/ACT
TUP1 017       017       017       SIO      TUP1
```

**10. Backup the new changes using the `chg-db:action=backup:dest=fixed` command.**

The following messages should appear, the active Maintenance and Administration Subsystem Processor (MASP) appears first.

```
BACKUP (FIXED) : MASP A - Backup starts on active MASP.
BACKUP (FIXED) : MASP A - Backup on active MASP to fixed disk complete.
BACKUP (FIXED) : MASP A - Backup starts on standby MASP.
BACKUP (FIXED) : MASP A - Backup on standby MASP to fixed disk complete.
```

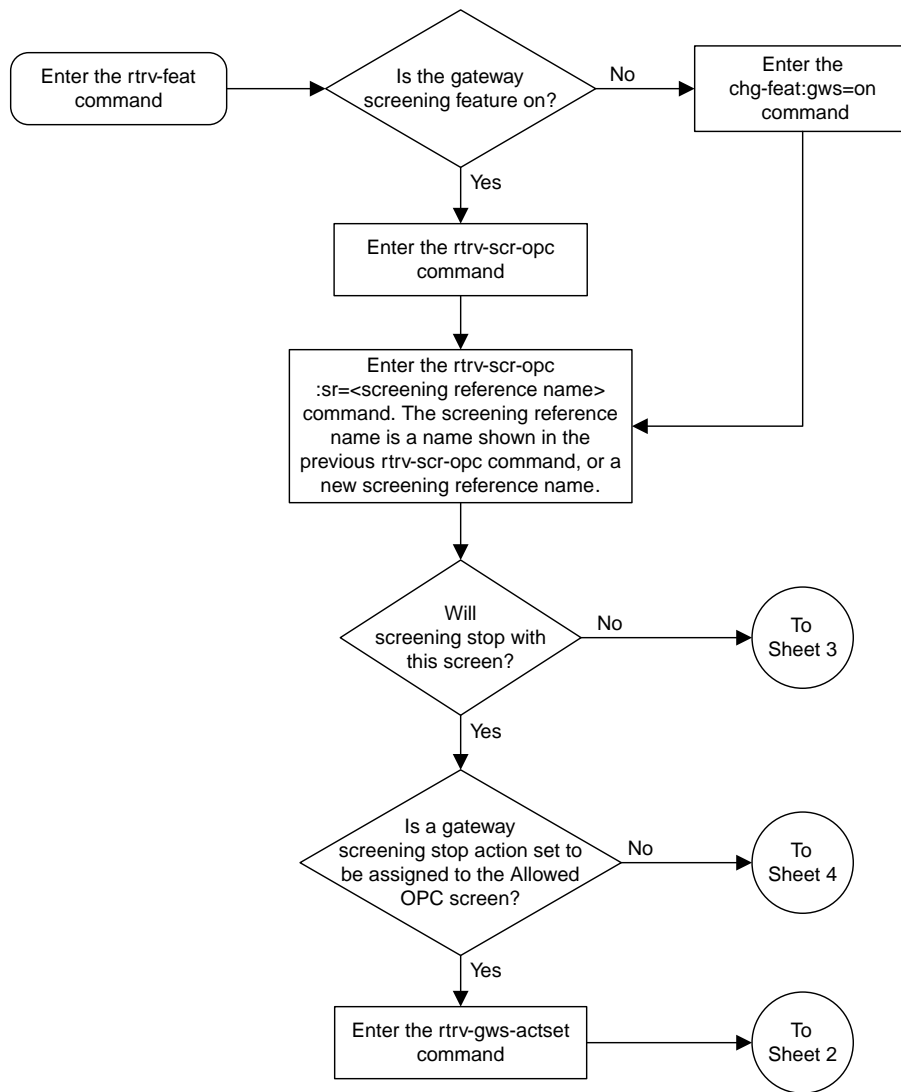

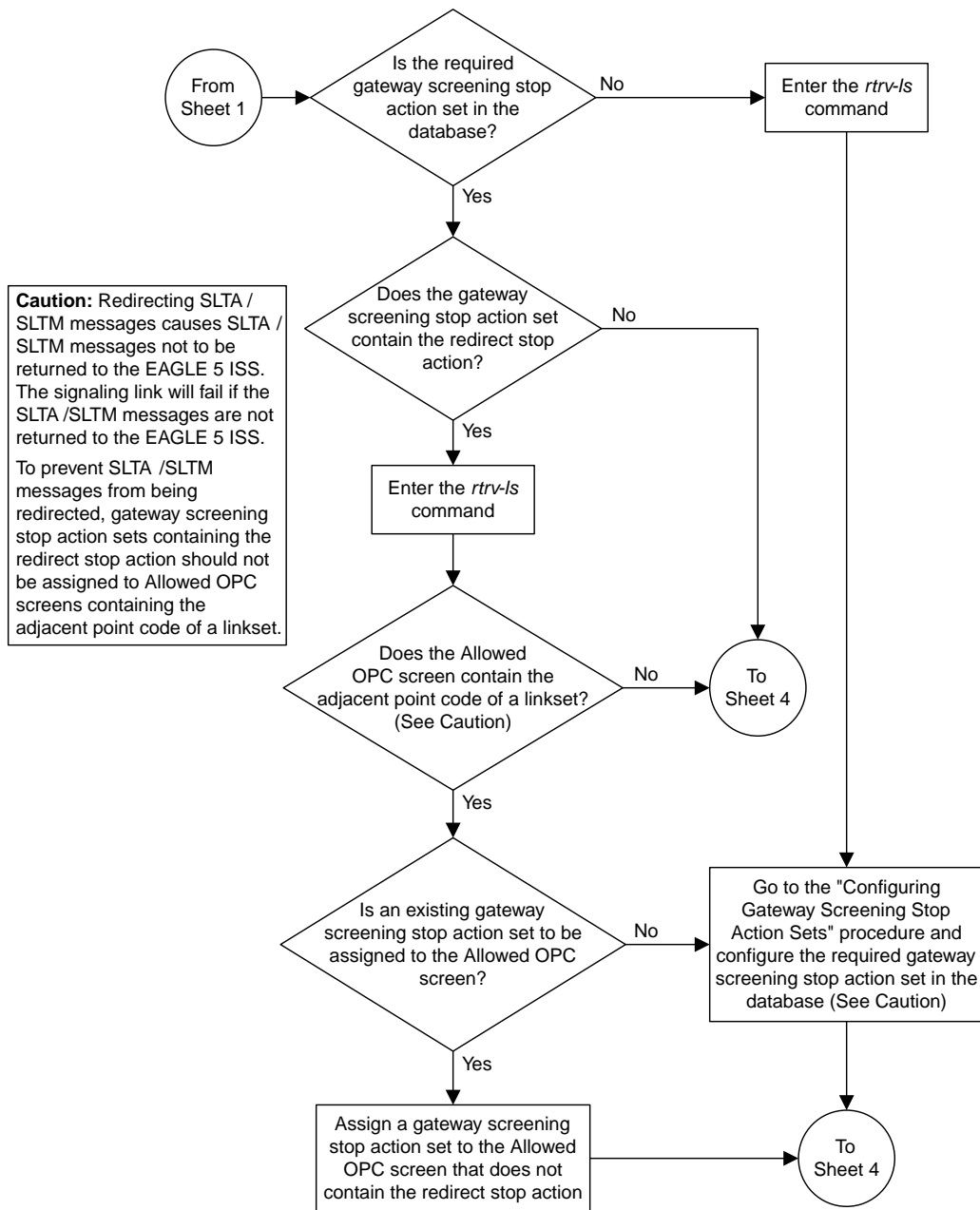



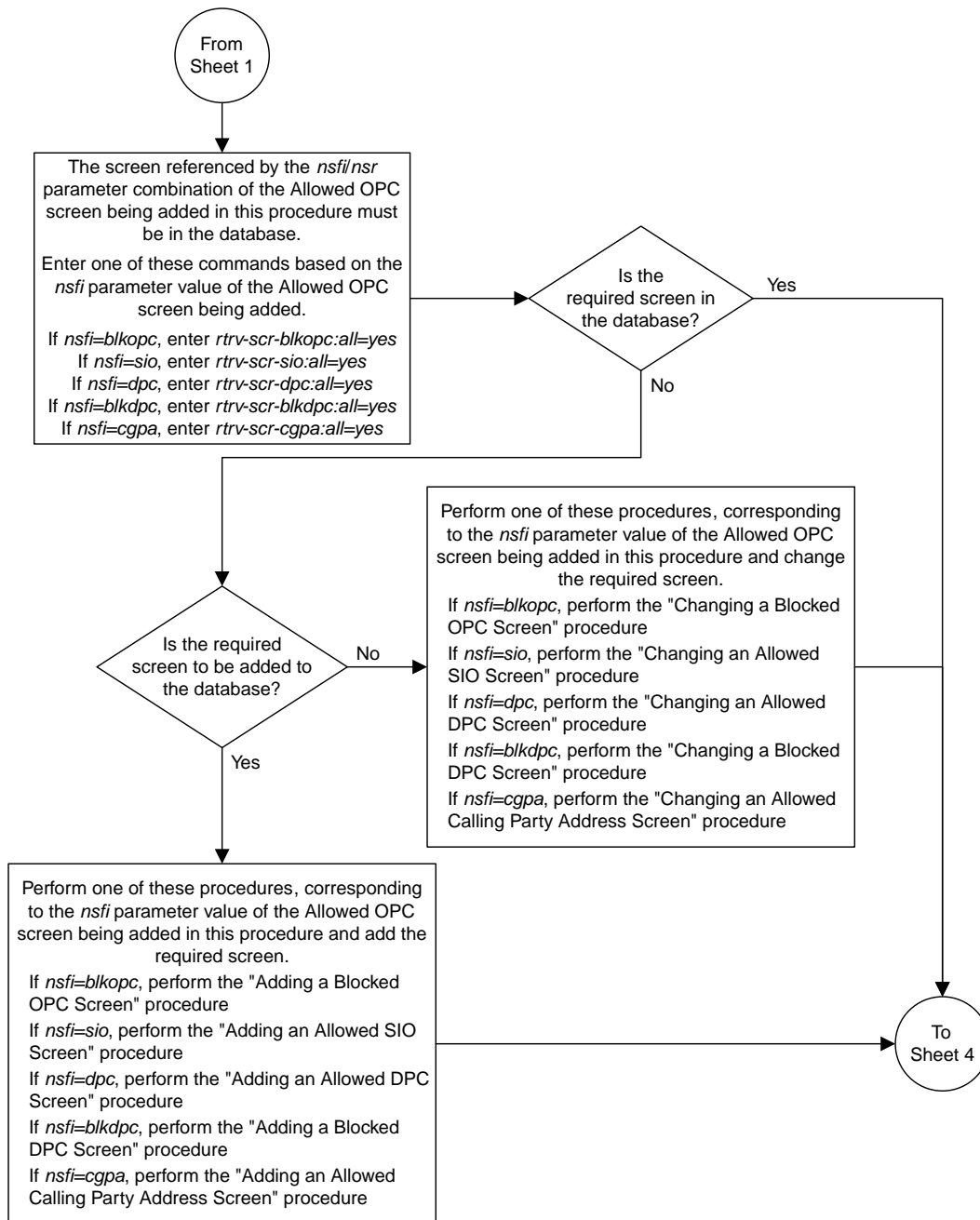

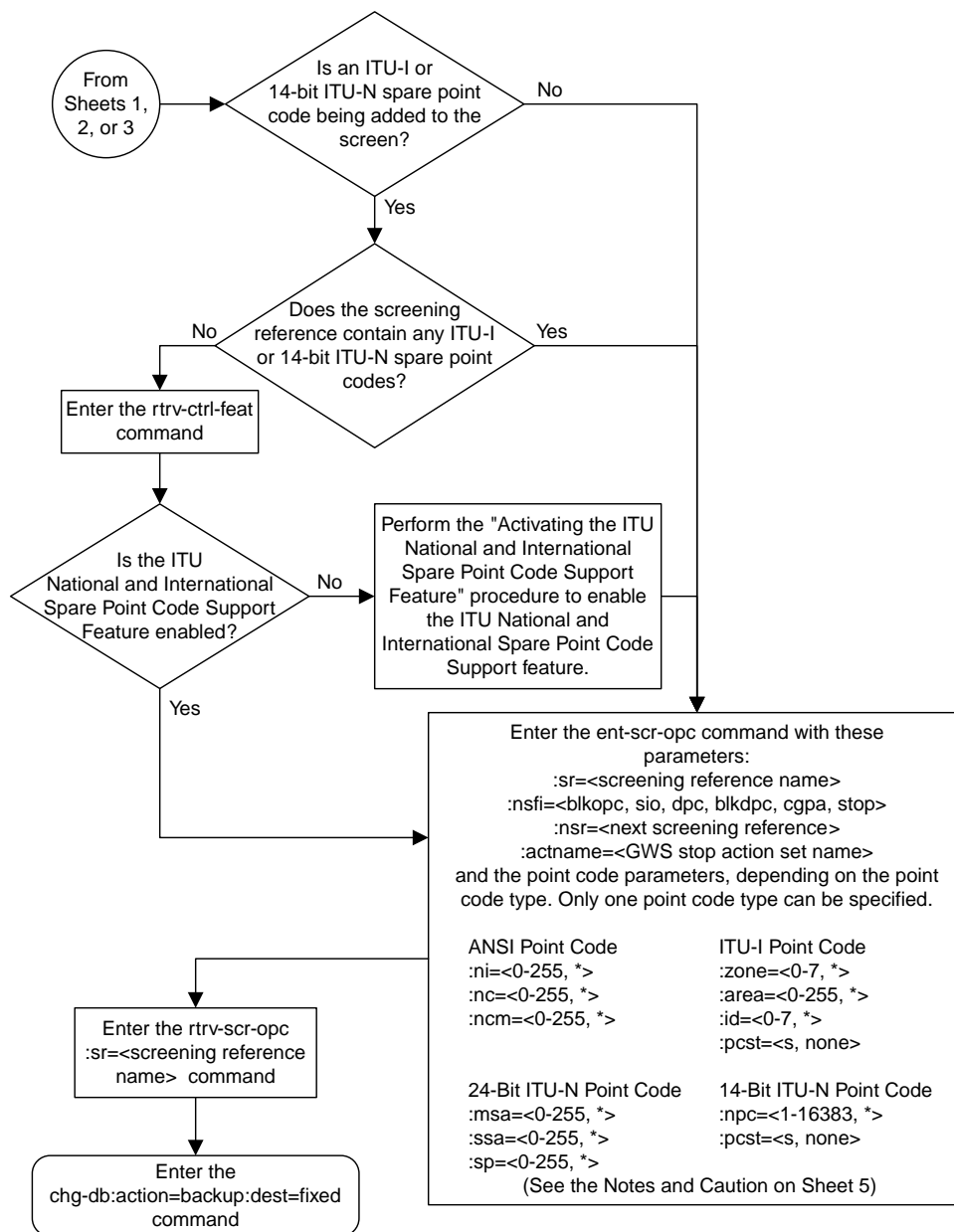

**Notes:**

1. A range of values can be specified for the *ni*, *nc*, or *ncm* parameters by inserting double ampersands (&&) between the parameter values defining the range. For example, to specify the range 025 to 200 for the *ni* parameter, enter 025&&200 for the *ni* parameter value.

2. The asterisk (\*) specifies the entire range of values for that parameter.

For more information about specifying a range of values and about using the asterisk, see the "Gateway Screening Attributes" section and the "Specifying a Range of Values" section. The "Gateway Screening Attributes" section is in the *Database Administration Manual - Gateway Screening*. The "Specifying a Range of Values" section is in the "Adding an Allowed OPC Screen" procedure in the *Database Administration Manual - Gateway Screening*.

3. The *nsr* parameter can be specified only, and must be specified, if the *nsfi* parameter value is either *blkopc*, *sio*, *dpc*, *blkdpc*, or *cgpa*.

4. The *actname* parameter is optional and can be specified only with the *nsfi=stop* parameter. If the *actname* parameter is specified, the *actname* parameter value is one of the gateway screening stop action set names shown in the *rtrv-gws-actset* output on Sheet 1.

5. To add a non-spare point code, the *pcst* parameter does not have to be specified. If the *pcst* parameter is specified for a screen containing an ITU-I or 14-bit ITU-N non-spare point code, the value must be *none*.

6. To add a spare point code, the *pcst=s* parameter must be specified.

**Caution:** Redirecting SLTA /SLTM messages causes SLTA /SLTM messages not to be returned to the EAGLE 5 ISS. The signaling link will fail if the SLTA /SLTM messages are not returned to the EAGLE 5 ISS.

To prevent SLTA /SLTM messages from being redirected, gateway screening stop action sets containing the redirect stop action should not be assigned to Allowed OPC screens containing the adjacent point code of a linkset.

Sheet 5 of 5

Figure 67: Adding an Allowed OPC Screen

## Removing an Allowed OPC Screen

This procedure is used to remove an allowed originating point code (OPC) screen from the database using the `dlt-scr-opc` command. The parameters used by the `dlt-scr-opc` command are shown in the [Gateway Screening Attributes](#) section. The general rules that apply to configuring gateway screening entities are shown in the [Gateway Screening Configuration](#) section.

The example in this procedure removes the allowed OPC screen `gws4` from the database.

**Note:** If you are using multiple-part ITU national point codes with gateway screening, see the [14-Bit ITU National Point Code Formats](#) section.

The allowed OPC screen can only be referenced by a screen set.

Enter the `rtrv-scrset:nsfi=opc` command to verify that none of the screen sets reference the allowed OPC screen being removed from the database.

To change the NSFI of any of the screen sets, perform the [Changing a Screen Set](#) procedure.

1. Display the allowed OPC screens in the database using the `rtrv-scr-opc` command.

The following is an example of the possible output.

```
rlghncxa03w 06-10-25 15:25:30 GMT EAGLE5 36.0.0
SCREEN = ALLOWED OPC

SR    REF  RULES
GWS4  YES   1
IEC   YES   6
ISP1  YES   1
TUP1  YES   1
WRD2  YES   1
WRD4  YES   9
```

From the `rtrv-scr-opc` output, display the allowed OPC screen you wish to remove using the `rtrv-scr-opc` command with the screening reference name. For this example, enter this command.

```
rtrv-scr-opc:sr=gws4
```

The following is an example of the possible output.

```
rlghncxa03w 06-10-25 15:25:30 GMT EAGLE5 36.0.0
SCREEN = ALLOWED OPC
SR  NI      NC      NCM      NSFI     NSR/ACT
GWS4 001      001      001      BLKOPC  GWS7
```

2. Enter the `rtrv-scrset:nsfi=opc` command to verify that none of the screen sets reference the allowed OPC screen being removed from the database.

To change the NSFI of any of the screen sets, perform the [Changing a Screen Set](#) procedure.

- Remove the allowed OPC screen from the database using the `dlt-scr-opc` command with the screening reference name shown in the `rtrv-scr-opc` output in step 1 and with the point code parameter values (`ni`, `nc`, `ncm`, or `zone`, `area`, `id`, or `npc`, or `msa`, `ssa`, `sp`) of the screen being removed from the database. The values for these parameters must be entered exactly as shown in the `rtrv-scr-opc` output.

To remove an entry containing either an ITU-I or a 14-bit ITU-N spare point code, the `pcst=s` parameter must be specified with the `dlt-scr-opc` command.

To remove an entry containing either an ITU-I or a 14-bit ITU-N non-spare point code, the `pcst` parameter does not have to be specified with the `dlt-scr-opc` command. If the `pcst` parameter is specified, the value must be `none`.

For this example, enter this command.

```
dlt-scr-opc:sr=gws4:ni=001:nc=001:ncm=001
```

A message similar to the following should appear.

```
rlghncxa03w 06-10-25 15:26:30 GMT EAGLE5 36.0.0
DLT-SCR-OPC: SCREEN SET AFFECTED - GWS4 0% FULL
DLT-SCR-OPC: MASP A - COMPLTD
```

- Verify the changes using the `rtrv-scr-opc` command with the screening reference name used in step 3.

For this example, enter this command.

```
rtrv-scr-opc:sr=gws4
```

The following is an example of the possible output.

```
E2573 Cmd Rej: SR or NSR does not reference an existing SR
```

This message shows that the specified screening reference name is not in the database and the action of the `dlt-scr-opc` command in step 3 was successful. If the specified screening reference name contained more than one entry when the `dlt-scr-opc` command was executed in step 3, the `rtrv-scr-opc:sr=` command output would show the remaining entries in the screening reference instead of error message E2573.

- Backup the new changes using the `chg-db:action=backup:dest=fixed` command.

The following messages should appear, the active Maintenance and Administration Subsystem Processor (MASP) appears first.

```
BACKUP (FIXED) : MASP A - Backup starts on active MASP.
BACKUP (FIXED) : MASP A - Backup on active MASP to fixed disk complete.
BACKUP (FIXED) : MASP A - Backup starts on standby MASP.
BACKUP (FIXED) : MASP A - Backup on standby MASP to fixed disk complete.
```

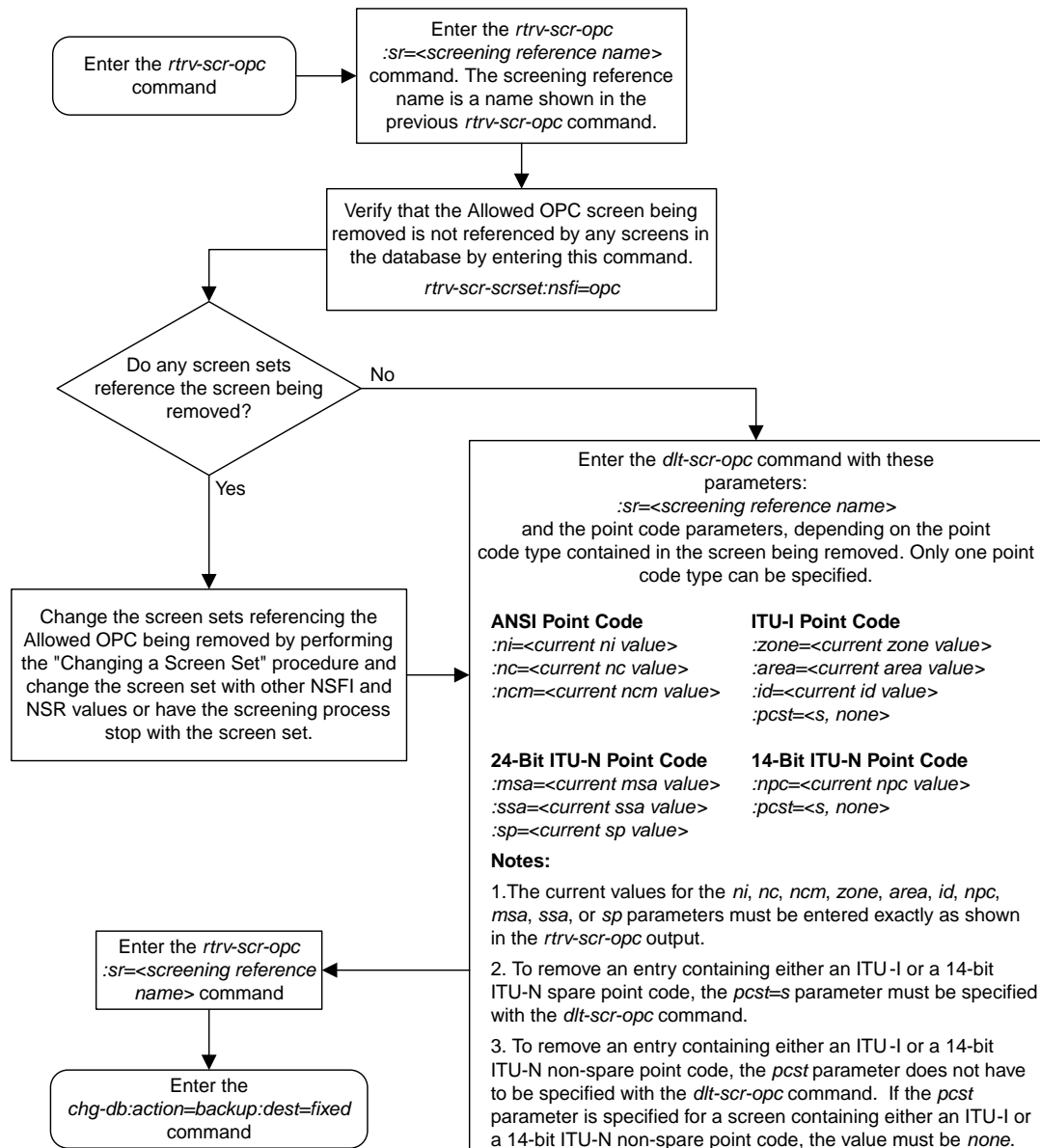

Figure 68: Removing an Allowed OPC Screen

## Changing an Allowed OPC Screen

This procedure is used to change the attributes of an allowed originating point code (OPC) screen in the database using the `chg-scr-opc` command. The parameters used by the `chg-scr-opc` command are shown in the [Gateway Screening Attributes](#) section. The general rules that apply to configuring gateway screening entities are shown in the [Gateway Screening Configuration](#) section.

The example in this procedure is used to change the point code for the allowed OPC screen `wrd2` to `230-230-230`, the NSFI to `blkopc`, and the NSR to `wrd6`.

**Note:** If you are using multiple-part ITU national point codes with gateway screening, see the [14-Bit ITU National Point Code Formats](#) section.

The allowed OPC screen can reference one of the following screens.

- Blocked OPC
- Allowed SIO
- Allowed DPC
- Blocked DPC
- Allowed CGPA

### Verifying the Gateway Screening Configuration

Enter the following commands to verify that these screens are in the database.

- `rtrv-scr-blkopc:all=yes`
- `rtrv-scr-sio:all=yes`
- `rtrv-scr-dpc:all=yes`
- `rtrv-scr-blkdpc:all=yes`
- `rtrv-scr-cgpa:all=yes`

### Gateway Screening Configuration Procedures

If the desired screen is not in the database, perform one of these procedures to add the desired screen to the database or change an existing screen in the database.

- [Adding a Blocked OPC Screen](#)
- [Adding an Allowed SIO Screen](#)
- [Adding an Allowed DPC Screen](#)
- [Adding a Blocked DPC Screen](#)
- [Adding an Allowed Calling Party Address Screen](#)
- [Changing a Blocked OPC Screen](#)
- [Changing an Allowed SIO Screen](#)
- [Changing an Allowed DPC Screen](#)
- [Changing a Blocked DPC Screen](#)
- [Changing an Allowed Calling Party Address Screen](#)

### Specifying a Range of Values

A range of values can be specified for the point code parameters `ni`, `nc`, or `ncm`.

If a range of values is specified for any of these parameters, and the value of the other parameters match existing values for the screening reference name, the range of values for the point code parameter

cannot include any values for that parameter that are currently provisioned for the screening reference name.

For example, screening reference name `scr1` contains these entries:

SR	NI	NC	NCM	NSFI	NSR/ACT
SCR1	240	001	010	CGPA	-----
SCR1	241	010	020	STOP	-----

Another entry for screening reference `scr1` with the `ni` value of 240 and the `nc` value of 001 cannot be specified if the range of values for the `ncm` parameter includes the value 010.

The ANSI point code parameter values can be specified as a single value, a range of values, or with an asterisk (\*). The asterisk specifies all possible values for the `ni`, `nc`, and `ncm` parameters. [Table 77: Valid Value Combinations for ANSI Point Code Parameters](#) shows the valid combinations of these parameter values.

**Table 77: Valid Value Combinations for ANSI Point Code Parameters**

NI	NC	NCM
Single Value	Single Value	Single Value
Single Value	Single Value	Range of Values
Single Value	Single Value	Asterisk
Single Value	Range of Values	Asterisk
Single Value	Asterisk	Asterisk
Range of Values	Asterisk	Asterisk
Asterisk	Asterisk	Asterisk

A range of values can also be specified for an ITU-I or 24-bit ITU-N point code parameter using a combination of asterisks (\*) and single values for the point code parameters. [Table 78: Valid Value Combinations for ITU-I Point Code Parameters](#) shows the valid combinations of the ITU-I parameter values. [Table 79: Valid Value Combinations for 24-Bit ITU-N Point Code Parameters](#) shows the valid combinations of the 24-bit ITU-N parameter values.

**Table 78: Valid Value Combinations for ITU-I Point Code Parameters**

ZONE	AREA	ID
Single Value	Single Value	Single Value
Single Value	Single Value	Asterisk
Single Value	Asterisk	Asterisk
Asterisk	Asterisk	Asterisk



Table 79: Valid Value Combinations for 24-Bit ITU-N Point Code Parameters

MSA	SSA	SP
Single Value	Single Value	Single Value
Single Value	Single Value	Asterisk
Single Value	Asterisk	Asterisk
Asterisk	Asterisk	Asterisk

1. Display the allowed OPC screens in the database using the `rtrv-scr-opc` command.

The following is an example of the possible output.

```
rlghncxa03w 06-10-25 15:25:30 GMT EAGLE5 36.0.0
SCREEN = ALLOWED DPC
SR    REF  RULES
GWS4  YES   1
IEC   YES   6
ISP1  YES   1
TUP1  YES   1
WRD2  YES   1
WRD4  YES   9
```

From the `rtrv-scr-opc` output, display the allowed OPC screen you wish to remove using the `rtrv-scr-opc` command with the screening reference name. For this example, enter this command.

```
rtrv-scr-opc:sr=wr2
```

The following is an example of the possible output.

```
rlghncxa03w 06-10-25 15:25:30 GMT EAGLE5 36.0.0
SCREEN = ALLOWED OPC
SR  NI      NC      NCM      NSF1      NSR/ACT
WRD2 243      015      001      STOP      -----
```

If a gateway screening stop action set is to be assigned to the allowed OPC screen being changed in the database, go to step 2.

Step 2 verifies the gateway screening stop action set names in the database. The gateway screening stop action set names are assigned only if the NSF1 of the screen being changed in this procedure is STOP. If the NSF1 of the screen will be changed to STOP, but a gateway screening stop action set name will not be assigned to the screen, skip steps 2, 3, and 4 and go to step 5. If the NSF1 of the screen will not be STOP, skip step 2 and 3, and go to step 4.

2. Display the gateway screening stop action sets in the database with the `rtrv-gws-actset` command.

This is an example of the possible output.

```
rlghncxa03w 06-10-25 15:26:30 GMT EAGLE5 36.0.0
ACT ACT  ACT ACT  ACT ACT  ACT ACT  ACT ACT  ACT
```

ID	NAME	1	2	3	4	5	6	7	8	9	10
1	copy	copy									
2	rdct	rdct									
3	cr	copy	rdct								
4	cncf	cncf									
5	cpcncf	copy	cncf								
6	cncfrd	cncf	rdct								
7	cpcfrd	copy	cncf	rdct							

GWS action set table is (7 of 16) 44% full

If the required gateway screening stop action set is not in the database, perform the [Configuring Gateway Screening Stop Action Sets](#) procedure to configure the required gateway screening stop action set.

**Note:** If the gateway screening stop action set being assigned to the Allowed OPC screen does not contain the redirect stop action, skip step 3 and go to step 4.

- Verify the point codes of adjacent nodes by entering the `rtrv-ls` command.

The following is an example of the possible output.

```
rlghncxa03w 06-10-10 11:43:04 GMT EAGLE5 36.0.0
                                L3T SLT
LSN          APCA  (SS7)  SCRN  SET  SET  BEI  LST  LNKS  ACT  MES  DIS  SLSCI  NIS
ele2         001-207-000  none  1   1   no  B   6   off  off  off  no   off
ls1305      000-005-000  none  1   1   no  A   1   off  off  off  no   off
ls1307      000-007-000  none  1   1   no  A   1   off  off  off  no   off
elm1s1      001-001-001  none  1   1   no  A   7   off  off  off  no   off
elm1s2      001-001-002  none  1   1   no  A   7   off  off  off  no   off

                                L3T SLT
LSN          APCI  (SS7)  SCRN  SET  SET  BEI  LST  LNKS  ACT  MES  DIS  SLSCI  NIS
ele2i       1-207-0    none  1   1   no  B   4   off  off  off  ---  on
ls1315      0-015-0    none  1   1   no  A   1   off  off  off  ---  off
ls1317      0-017-0    none  1   1   no  A   1   off  off  off  ---  on
elm2s1      1-011-1    none  1   1   no  A   7   off  off  off  ---  off
elm2s2      1-011-2    none  1   1   no  A   7   off  off  off  ---  off
```

Link set table is (10 of 1024) 1% full.



**CAUTION**

**Caution:** Redirecting SLTA/SLTM messages prevents SLTA/SLTM messages from being returned to the EAGLE. The signaling link carrying these messages will fail if these messages are not returned to the EAGLE. To prevent SLTA/SLTM messages from being redirected, gateway screening stop action sets containing the redirect stop action should not be assigned to Allowed OPC screens containing the adjacent point code of a linkset.

**Note:** If the NSFI of the screen being changed in this procedure will be STOP, or if the NSFI of the screen is not being changed, skip step 4 and go to step 5.

- Enter the commands in the [Verifying the Gateway Screening Configuration](#) section to verify that the screen that will be specified by the NSFI/NSR parameter combination in step 6 is in the database.

If the desired screen is not in the database, perform one of the procedures shown in the [Gateway Screening Configuration Procedures](#) section to add the desired screen to the database or change an existing screen in the database.

**Note:** If any of these conditions apply to this procedure, skip this step and go to step 6:

- The point code in the screen is not being changed.
  - The screen being changed contains either an ANSI or 24-bit ITU-N point code.
  - The ITU-I or 14-bit ITU-N non-spare point code in the screen is not being changed to an ITU-I or 14-bit ITU-N spare point code.
  - The point code in the screen is an ITU-I or 14-bit ITU-N spare point code or the screening reference contains other screens with ITU-I or 14-bit ITU-N spare point codes.
5. Display the status of the ITU National and International Spare Point Code Support feature by entering the `rtrv-ctrl-feat` command with the ITU National and International Spare Point Code Support feature part number.

Enter this command.

```
rtrv-ctrl-feat:partnum=893013601
```

This is an example of the possible output.

```
rlghncxa03w 06-10-25 15:25:30 GMT EAGLE5 36.0.0
The following features have been permanently enabled:

Feature Name                Partnum   Status Quantity
Spare Point Code Support    893013601 on      ----

The following features have been temporarily enabled:

Feature Name                Partnum   Status Quantity   Trial Period Left
Zero entries found.

The following features have expired temporary keys:

Feature Name                Partnum
Zero entries found.
```

If the ITU National and International Spare Point Code Support feature is enabled, go to step 6.

If the ITU National and International Spare Point Code Support feature is not enabled, perform the “Activating the ITU National and International Spare Point Code Support Feature” procedure in *Database Administration - SS7 User’s Guide* to enable the ITU National and International Spare Point Code Support feature as required. After the feature has been enabled, go to step 6.

6. Change the attributes for the allowed OPC using the `chg-scr-opc` command.

If a gateway screening stop action is to be assigned to the allowed OPC screen being changed, enter the `chg-scr-opc` command with the `nsfi=stop` parameter and the `actname` parameter with the name of a gateway screening stop action set shown in the output of the `rtrv-gws-actset` command executed in step 2.



**Caution:** Redirecting SLTA/SLTM messages prevents SLTA/SLTM messages from being returned to the EAGLE. The signaling link carrying these messages will fail if these messages are not returned to the EAGLE. To prevent SLTA/SLTM messages from being redirected, gateway screening stop action sets containing the redirect stop action should not be assigned to Allowed OPC screens containing the adjacent point code of a linkset, shown in step 3.

The current values for the `ni`, `nc`, `ncm`, `zone`, `area`, `id`, `npc`, `msa`, `ssa`, and `sp` parameters must be entered exactly as shown in the `rtrv-scr-opc` output in step 1.

The following list contains the values for the `nni`, `nnc`, `nncm`, `nzone`, `narea`, `nid`, and `nnpc` parameters:

- `nni` – 0 - 255 or an asterisk (\*)
- `nnc` – 0 - 255 or an asterisk (\*)
- `nncm` – 0 - 255 or an asterisk (\*)
- `nzone` – 0 - 7 or an asterisk (\*)
- `narea` – 0 - 255 or an asterisk (\*)
- `nid` – 0 - 7 or an asterisk (\*)
- `nnpc` – 1 - 16383 or an asterisk (\*)
- `nmsa` – 0 - 255 or an asterisk (\*)
- `nssa` – 0 - 255 or an asterisk (\*)
- `nsp` – 0 - 255 or an asterisk (\*)

A range of values can be specified for the `nni`, `nnc`, and `nncm` parameters. See the [“Specifying a Range of Values”](#) section for more information on how the asterisk and a range of values are used for the `nni`, `nnc`, and `nncm` parameters.

To change an ITU-I or 14-bit ITU-N spare point code to a non-spare point code, both the `pcst=s` and `npcst=none` parameters must be specified with the `chg-scr-opc` command.

To change an ITU-I or 14-bit ITU-N non-spare point code to a spare point code, the `npcst=s` parameter must be specified with the `chg-scr-opc` command. The `pcst` parameter does not have to be specified.

If the current point code in the screen being changed is either an ITU-I or 14-bit ITU-N spare point code, the `pcst=s` parameter must be specified with the `chg-scr-opc` command.

If the current point code in the screen being changed is either an ITU-I or 14-bit ITU-N non-spare point code, the `pcst` parameter does not have to be specified with the `chg-scr-opc` command. If the `pcst` parameter is specified for a screen containing either an ITU-I or 14-bit ITU-N non-spare point code, the `pcst` parameter value must be `none`.

For this example, enter this command.

```
chg-scr-opc:sr=wrld2:ni=243:nc=015:ncm=001:nni=230:nc=230
:ncm=230:nsfi=blkopc:nsr=wrld6
```

A message similar to the following should appear.

```
rlghncxa03w 06-10-25 15:27:30 GMT EAGLE5 36.0.0
CHG-SCR-OPC: SCREEN SET AFFECTED - WRD2 1% FULL
CHG-SCR-OPC: MASP A - COMPLTD
```

7. Verify the changes using the `rtrv-scr-opc` command with the screening reference name used in step 6.

For this example, enter this command.

```
rtrv-scr-opc:sr=wrld2
```

The following is an example of the possible output.

```
rlghncxa03w 06-10-25 15:28:30 GMT EAGLE5 36.0.0
SCREEN = ALLOWED OPC
SR      NI      NC      NCM      NSF1      NSR/ACT
WRD2   230      230      230      BLKOPC   WRD6
```

8. Backup the new changes using the `chg-db:action=backup:dest=fixed` command.

The following messages should appear, the active Maintenance and Administration Subsystem Processor (MASP) appears first.

```
BACKUP (FIXED) : MASP A - Backup starts on active MASP.
BACKUP (FIXED) : MASP A - Backup on active MASP to fixed disk complete.
BACKUP (FIXED) : MASP A - Backup starts on standby MASP.
BACKUP (FIXED) : MASP A - Backup on standby MASP to fixed disk complete.
```

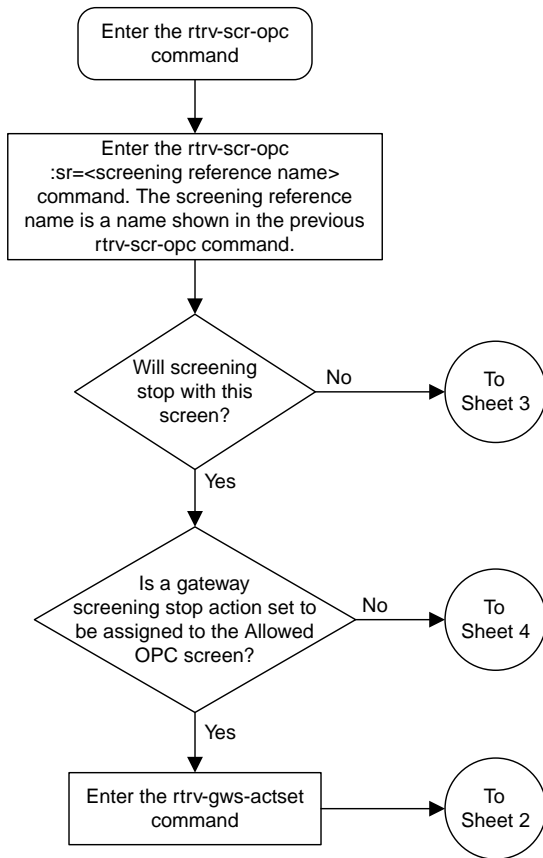

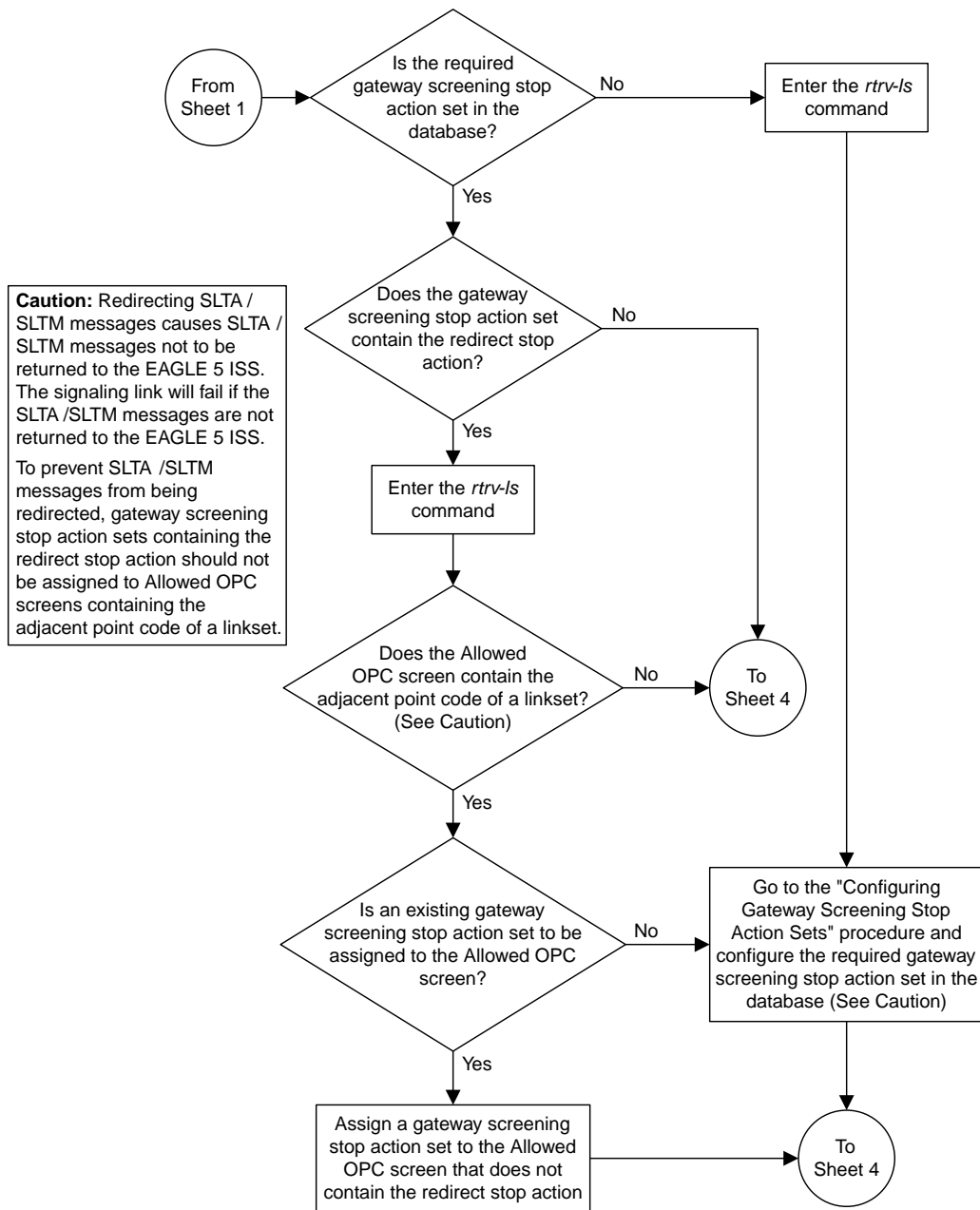

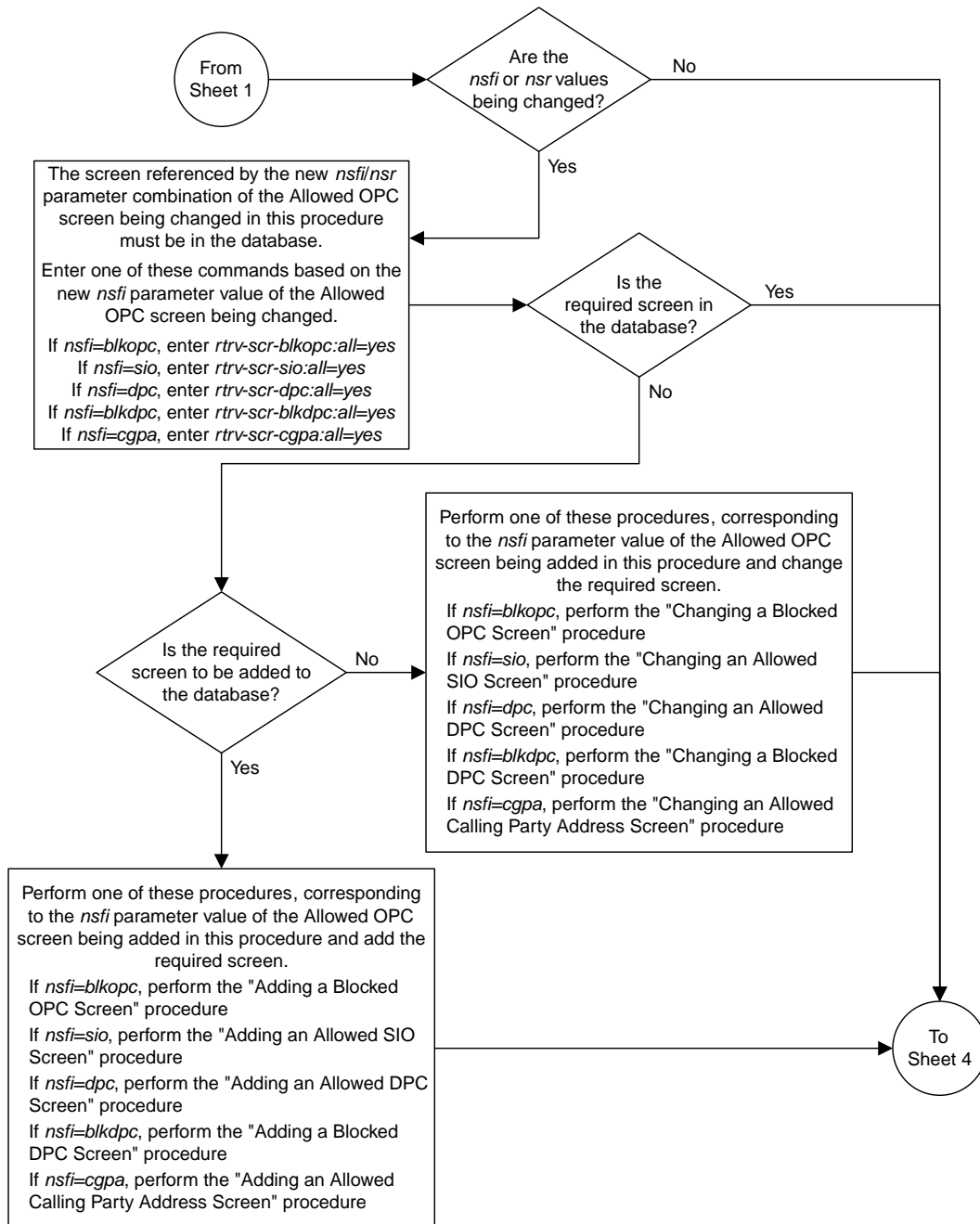



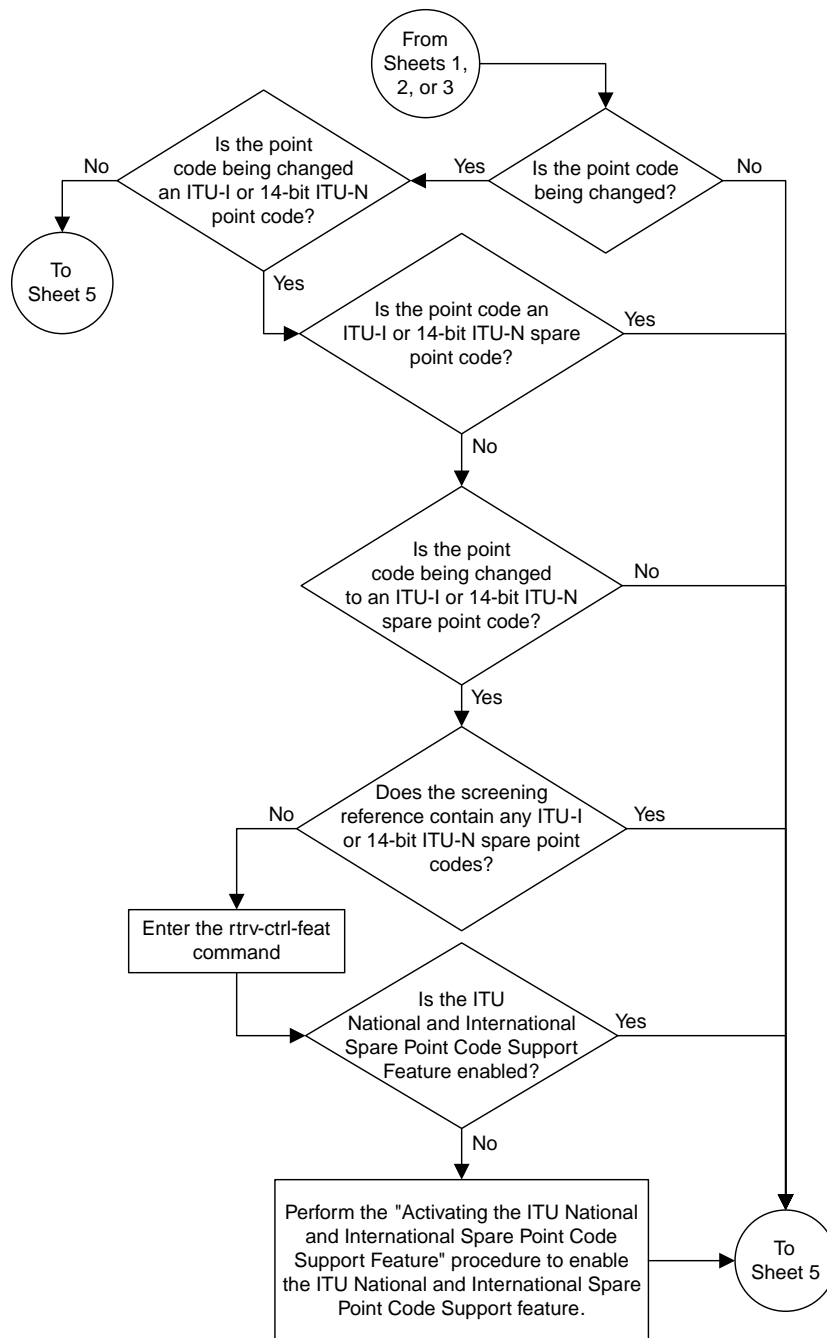

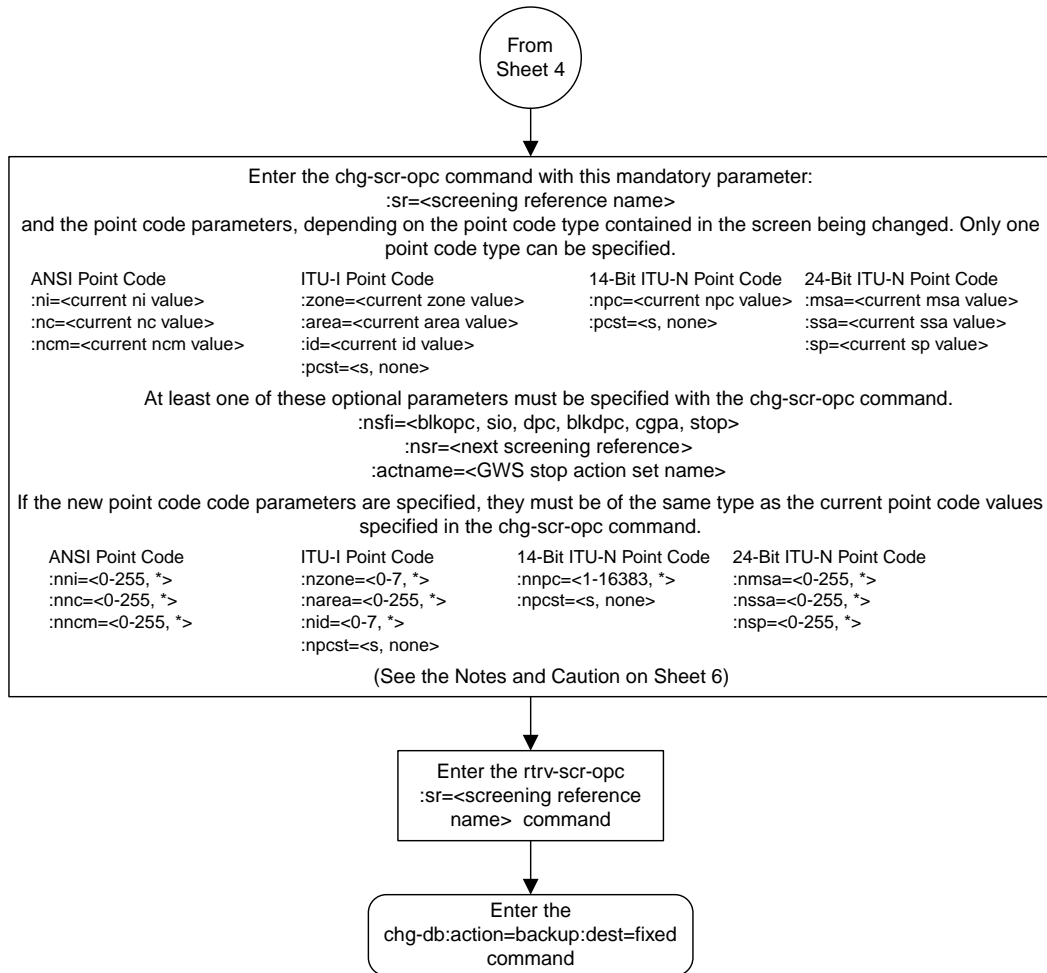

**Notes:**

1. A range of values can be specified for the *ni*, *nc*, or *ncm* parameters by inserting double ampersands (&&) between the parameter values defining the range. For example, to specify the range 025 to 200 for the *ni* parameter, enter 025&&200 for the *ni* parameter value.

2. The asterisk (\*) specifies the entire range of values for that parameter.

For more information about specifying a range of values and about using the asterisk, see the "Gateway Screening Attributes" section and the "Specifying a Range of Values" section. The "Gateway Screening Attributes" section is in the *Database Administration Manual - Gateway Screening*. The "Specifying a Range of Values" section is in the "Changing an Allowed OPC Screen" procedure in the *Database Administration Manual - Gateway Screening*.

3. The *nsr* parameter can be specified, and must be specified, if the *nsfi* parameter value is either *blkopc*, *sio*, *dpc*, *blkdpc*, or *cgpa*.

4. The *actname* parameter is optional and can be specified only with the *nsfi=stop* parameter. If the *actname* parameter is specified, the *actname* parameter value is one of the gateway screening stop action set names shown in the *rtrv-gws-actset* output on Sheet 1.

5. To change an ITU-I or 14-bit ITU-N spare point code to a non-spare point code, both the *pcst=s* and *npcst=none* parameters must be specified with the *chg-scr-opc* command.

6. To change an ITU-I or 14-bit ITU-N non-spare point code to a spare point code, the *npcst=s* parameter must be specified with the *chg-scr-opc* command. The *pcst* parameter does not have to be specified.

7. If the current point code in the screen being changed is either an ITU-I or 14-bit ITU-N spare point code, the *pcst=s* parameter must be specified with the *chg-scr-opc* command.

8. If the current point code in the screen being changed is either an ITU-I or 14-bit ITU-N non-spare point code, the *pcst* parameter does not have to be specified with the *chg-scr-opc* command. If the *pcst* parameter is specified for a screen containing either an ITU-I or 14-bit ITU-N non-spare point code, the *pcst* parameter value must be *none*.

**Caution:** Redirecting SLTA /SLTM messages causes SLTA /SLTM messages not to be returned to the EAGLE 5 ISS. The signaling link will fail if the SLTA /STM messages are not returned to the EAGLE 5 ISS.

To prevent SLTA /SLTM messages from being redirected, gateway screening stop action sets containing redirect stop action should not be assigned to Allowed OPC screens containing the adjacent point code of a linkset.

Sheet 6 of 6

**Figure 69: Changing an Allowed OPC Screen**

# Chapter 13

## Screen Set Configuration

---

### Topics:

- *Introduction.....450*
- *Automatic Destination Field Screening.....450*
- *Adding a Screen Set.....450*
- *Removing a Screen Set.....459*
- *Changing a Screen Set.....462*

Chapter 13, Screen Set Configuration, contains the procedures necessary to configure screen sets.

## Introduction

A screen set is a gateway screening table containing a list of rules, or screening references. The screening references indicate the screening action that is to be performed on a message in a specific linkset. These screening references are configured in *Allowed Affected Point Code (AFTPC) Screen Configuration* through *Allowed Originating Point Code (OPC) Screen Configuration*. The screen set is assigned to a linkset. When the `gwsa=on` linkset parameter is specified for a specific linkset, all the messages on that linkset will be screened by the gateway screening feature based on the screening references contained in the screen set. For more information of the linkset parameters used for the gateway screening feature, go to the *Gateway Screening States* section, or to the `ent-1s` or `chg-1s` command descriptions in *Commands User's Guide*.

## Automatic Destination Field Screening

Network management messages can be screened automatically by gateway screening without configuring an Allowed Affected Destination Field screen. The `destfld=yes` parameter specified with the `ent-scrset` or `chg-scrset` commands turns on automatic screening of the affected destination point code (see *Figure 41: Allowed Affected Destination Field Screening Function*) in the network management messages. Network management messages contain the value 0 in the service indicator field of the SIO. The network management messages are screened against the routing table, the EAGLE's point code, and capability point codes. If the affected destination point code matches the EAGLE's point code, capability point codes, or point codes in the routing table, the message is allowed into the EAGLE. The automatic screening is applied after the last screen in the screening process, containing the `nsfi=stop` parameter, for that screen set.

These network management messages are automatically screened by gateway screening: TFP, TFA, TFR, TFC, UPU, SRST (RSP, RSR). All other network management messages are allowed into the EAGLE.

## Adding a Screen Set

This procedure is used to add a screen set to the database using the `ent-scrset` command. The parameters used by the `ent-scrset` command are shown in the *Gateway Screening Attributes* section. The general rules that apply to configuring gateway screening entities are shown in the *Gateway Screening Configuration* section.

A maximum of 255 screen sets can be configured in the database. If the database contains 255 screen sets, any attempt to add another screen set with the `ent-scrset` command will be rejected. If the database contains 255 screen sets, and you wish to add another screen set, a current screen set must be removed or changed. To remove a screen set, perform the *Removing a Screen Set* procedure. To change an existing screen set, perform the *Changing a Screen Set* procedure.

The examples in this procedure are used to add the screen set data shown in *Table 80: Example Gateway Screening Screen Set Configuration Table* and based on the example configurations shown in *Figure 4*:

*Gateway Screening Configuration - Example 1 through Figure 10: Gateway Screening Configuration - Example 7.*

**Table 80: Example Gateway Screening Screen Set Configuration Table**

Screen Set Name	Next Screening Function Identifier	Next Screening Reference	DESTFLD
gws1	opc	gws4	No
gws2	blkopc	gws5	No
ls01	sio	ls02	Yes
wrd1	dpc	iec	Yes
fld1	opc	fld2	No
isp1	opc	isp1	No
tup1	opc	tup1	No

The screen set can reference one of the following screens.

- Allowed OPC
- Blocked OPC
- Allowed SIO
- Allowed DPC
- Blocked DPC

#### Verifying the Gateway Screening Configuration

Enter the following commands to verify that these screens are in the database.

- `rtrv-scr-opc:all=yes`
- `rtrv-scr-blkopc:all=yes`
- `rtrv-scr-sio:all=yes`
- `rtrv-scr-dpc:all=yes`
- `rtrv-scr-blkdpc:all=yes`

#### Gateway Screening Configuration Procedures

If the desired screen is not in the database, perform one of these procedures to add the desired screen to the database or change an existing screen in the database.

- *Adding an Allowed OPC Screen*
- *Adding a Blocked OPC Screen*
- *Adding an Allowed SIO Screen*
- *Adding an Allowed DPC Screen*
- *Adding a Blocked DPC Screen*
- *Changing an Allowed OPC Screen*
- *Changing a Blocked OPC Screen*
- *Changing an Allowed SIO Screen*
- *Changing an Allowed DPC Screen*
- *Changing a Blocked DPC Screen*

1. Verify that the gateway screening feature is on, by entering the `rtrv-feat` command.

If the gateway screening feature is on, the `GWS` field is set to `on`.

**Note:** The `rtrv-feat` command output contains other fields that are not used by this procedure. If you wish to see all the fields displayed by the `rtrv-feat` command, see the `rtrv-feat` command description in *Commands User's Guide*.

If the gateway screening feature is on, shown by the entry `GWS = on` in the `rtrv-feat` command output, skip step 2, and go to step 3.

2. Turn the gateway screening feature on by entering this command.

```
chg-feat:gws=on
```

**Note:** Once the gateway screening feature is turned on with the `chg-feat` command, it cannot be turned off.

The gateway screening feature must be purchased before you turn this feature on with the `chg-feat` command. If you are not sure if you have purchased the gateway screening feature, contact your Oracle Sales Representative or Account Representative.

When the `chg-feat` has successfully completed, this message should appear.

```
rlghncxa03w 06-10-28 11:43:04 GMT EAGLE5 36.0.0
CHG-FEAT: MASP A - COMPLTD
```

3. Display all the screen sets in the database using the `rtrv-scrset` command.

The following is an example of the possible output.

```
rlghncxa03w 06-10-25 15:25:30 GMT EAGLE5 36.0.0
ENTIRE GWS DATABASE IS 1% FULL
CDPA + AFTPC TABLES ARE 1% FULL
THERE ARE 248 SCREEN SETS AVAILABLE

THE FOLLOWING ARE OVER 80% FULL:
SCRN  NSFI      NSR/ACT  FULL  RULES  TABLES  DESTFLD
-----
SCRN  NSFI      NSR/ACT  FULL  RULES  TABLES  DESTFLD
ss01  OPC       opc1     51%   2075   22       YES
ss02  OPC       opc2      2%     75     22       YES
ss03  OPC       opc3      2%     75     22       YES
ss04  OPC       opc1     51%   2075   22       NO
ss07  OPC       opc1     51%   2075   22       YES
ss09  OPC       opc1     51%   2075   22       NO
ss28  OPC       opc1     51%   2075   22       YES
```

If a gateway screening stop action set is to be assigned to the screen set being added to the database, go to step 4.

Step 4 verifies the gateway screening stop action set names in the database. The gateway screening stop action set names are assigned only if the NSFI of the screen set being added in this procedure is `STOP`. If the NSFI of the new screen set will be `STOP`, but a gateway screening stop action set name will not be assigned to the new screen set, skip steps 4 and 5 and go to step 6. If the NSFI of the new screen set is not `STOP`, skip step 4 and go to step 5.



4. Display the gateway screening stop action sets in the database with the `rtrv-gws-actset` command.

This is an example of the possible output.

```
rlghncxa03w 06-10-25 15:26:30 GMT EAGLE5 36.0.0
ACT ACT ACT ACT ACT ACT ACT ACT ACT ACT
ID NAME 1 2 3 4 5 6 7 8 9 10
-----
1 copy copy
2 rdct rdct
3 cr copy rdct
4 cncf cncf
5 cpcncf copy cncf
6 cncfrd cncf rdct
7 cpcfrd copy cncf rdct
GWS action set table is (7 of 16) 44% full
```

If the required gateway screening stop action set is not in the database, perform the [Configuring Gateway Screening Stop Action Sets](#) procedure to configure the required gateway screening stop action set.

**Note:** If the NSFI of the screen set being added in this procedure is STOP, skip step 5 and go to step 6.

5. Enter the commands in the [Verifying the Gateway Screening Configuration](#) section to verify that the screen that will be specified by the NSFI/NSR parameter combination in step 6 is in the database.

If the desired screen is not in the database, perform one of the procedures shown in the [Gateway Screening Configuration Procedures](#) section to add the desired screen to the database or change an existing screen in the database.

6. Add a new screen set to the database using the `ent-scrset` command.

If a gateway screening stop action is to be assigned to the screen set being added, enter the `ent-scrset` command with the `nsfi=stop` parameter and the `actname` parameter with the name of a gateway screening stop action set shown in the output of the `rtrv-gws-actset` command executed in step 4.

For this example, enter these commands.

```
ent-scrset:scrn=gws1:nsfi=opc:nsr=gws4:destfld=no
```

A message similar to the following should appear.

```
rlghncxa03w 06-10-25 15:27:30 GMT EAGLE5 36.0.0
ENT-SCRSET: SCREEN SET AFFECTED - GWS1 1% FULL
ENT-SCRSET: MASP A - COMPLTD
```

```
ent-scrset:scrn=gws2:nsfi=blkopc:nsr=gws5:destfld=no
```

A message similar to the following should appear.

```
rlghncxa03w 06-10-25 15:28:30 GMT EAGLE5 36.0.0
ENT-SCRSET: SCREEN SET AFFECTED - GWS2 1% FULL
ENT-SCRSET: MASP A - COMPLTD
```

```
ent-scrset:scrn=ls01:nsfi=sio:nsr=ls02:destfld=yes
```

A message similar to the following should appear.

```
rlghncxa03w 06-10-25 15:29:30 GMT EAGLE5 36.0.0
ENT-SCRSET: SCREEN SET AFFECTED - LS01 1% FULL
ENT-SCRSET: MASP A - COMPLTD
```

```
ent-scrset:scrn=wr01:nsfi=dpc:nsr=iec:destfld=yes
```

A message similar to the following should appear.

```
rlghncxa03w 06-10-25 15:30:30 GMT EAGLE5 36.0.0
ENT-SCRSET: SCREEN SET AFFECTED - WRD1 1% FULL
ENT-SCRSET: MASP A - COMPLTD
```

```
ent-scrset:scrn=fld1:nsfi=opc:nsr=fld2:destfld=no
```

A message similar to the following should appear.

```
rlghncxa03w 06-10-25 15:31:30 GMT EAGLE5 36.0.0
ENT-SCRSET: SCREEN SET AFFECTED - FLD1 1% FULL
ENT-SCRSET: MASP A - COMPLTD
```

```
ent-scrset:scrn=ispl:nsfi=opc:nsr=ispl:destfld=no
```

A message similar to the following should appear.

```
rlghncxa03w 06-10-25 15:31:30 GMT EAGLE5 36.0.0
ENT-SCRSET: SCREEN SET AFFECTED - ISP1 1% FULL
ENT-SCRSET: MASP A - COMPLTD
```

```
ent-scrset:scrn=tup1:nsfi=opc:nsr=tup1:destfld=no
```

A message similar to the following should appear.

```
rlghncxa03w 06-10-25 15:31:30 GMT EAGLE5 36.0.0
ENT-SCRSET: SCREEN SET AFFECTED - TUP1 1% FULL
ENT-SCRSET: MASP A - COMPLTD
```

## 7. Verify the changes using the `rtrv-scrset` command.

The following is an example of the possible output.

```
rlghncxa03w 06-10-25 15:32:30 GMT EAGLE5 36.0.0
ENTIRE GWS DATABASE IS 1% FULL
CDPA + AFTPC TABLES ARE 1% FULL
THERE ARE 242 SCREEN SETS AVAILABLE

THE FOLLOWING ARE OVER 80% FULL:
SCRN  NSFI      NSR/ACT  FULL  RULES  TABLES  DESTFLD
SCRN  NSFI      NSR/ACT  FULL  RULES  TABLES  DESTFLD
```

fld1	OPC	fld2	1%	5	4	NO
gws1	OPC	gws4	1%	9	7	NO
gws2	BLKOPC	gws5	1%	5	4	NO
isp1	OPC	isp1	1%	6	4	NO
ls01	SIO	ls02	1%	3	3	YES
ss01	OPC	opc1	51%	2075	22	YES
ss02	OPC	opc2	2%	75	22	YES
ss03	OPC	opc3	2%	75	22	YES
ss04	OPC	opc1	51%	2075	22	NO
ss07	OPC	opc1	51%	2075	22	YES
ss09	OPC	opc1	51%	2075	22	NO
ss28	OPC	opc1	51%	2075	22	YES
tup1	OPC	tup1	1%	8	5	NO
wrd1	DPC	iec	1%	6	5	YES

- Backup the new changes using the `chg-db:action=backup:dest=fixed` command.

The following messages should appear, the active Maintenance and Administration Subsystem Processor (MASP) appears first.

```
BACKUP (FIXED) : MASP A - Backup starts on active MASP.
BACKUP (FIXED) : MASP A - Backup on active MASP to fixed disk complete.
BACKUP (FIXED) : MASP A - Backup starts on standby MASP.
BACKUP (FIXED) : MASP A - Backup on standby MASP to fixed disk complete.
```

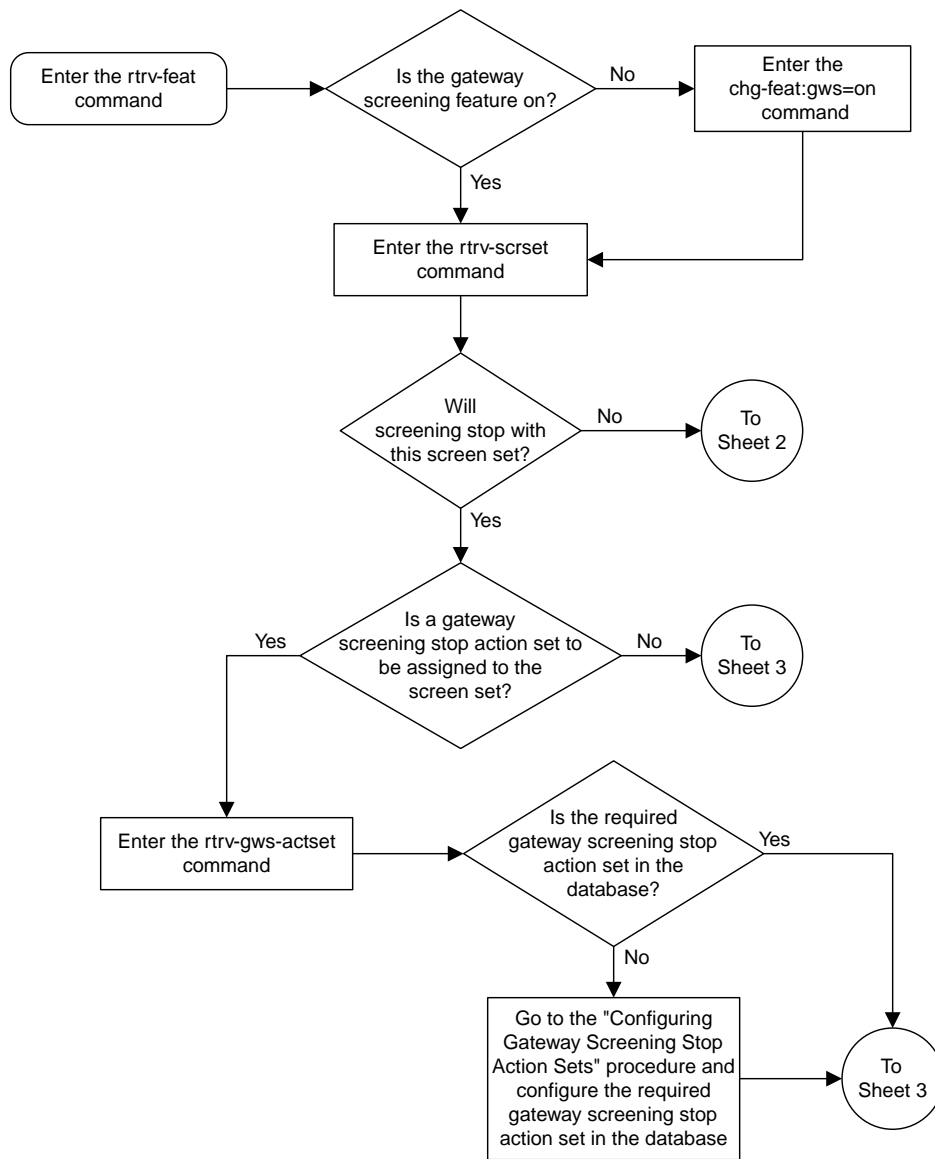

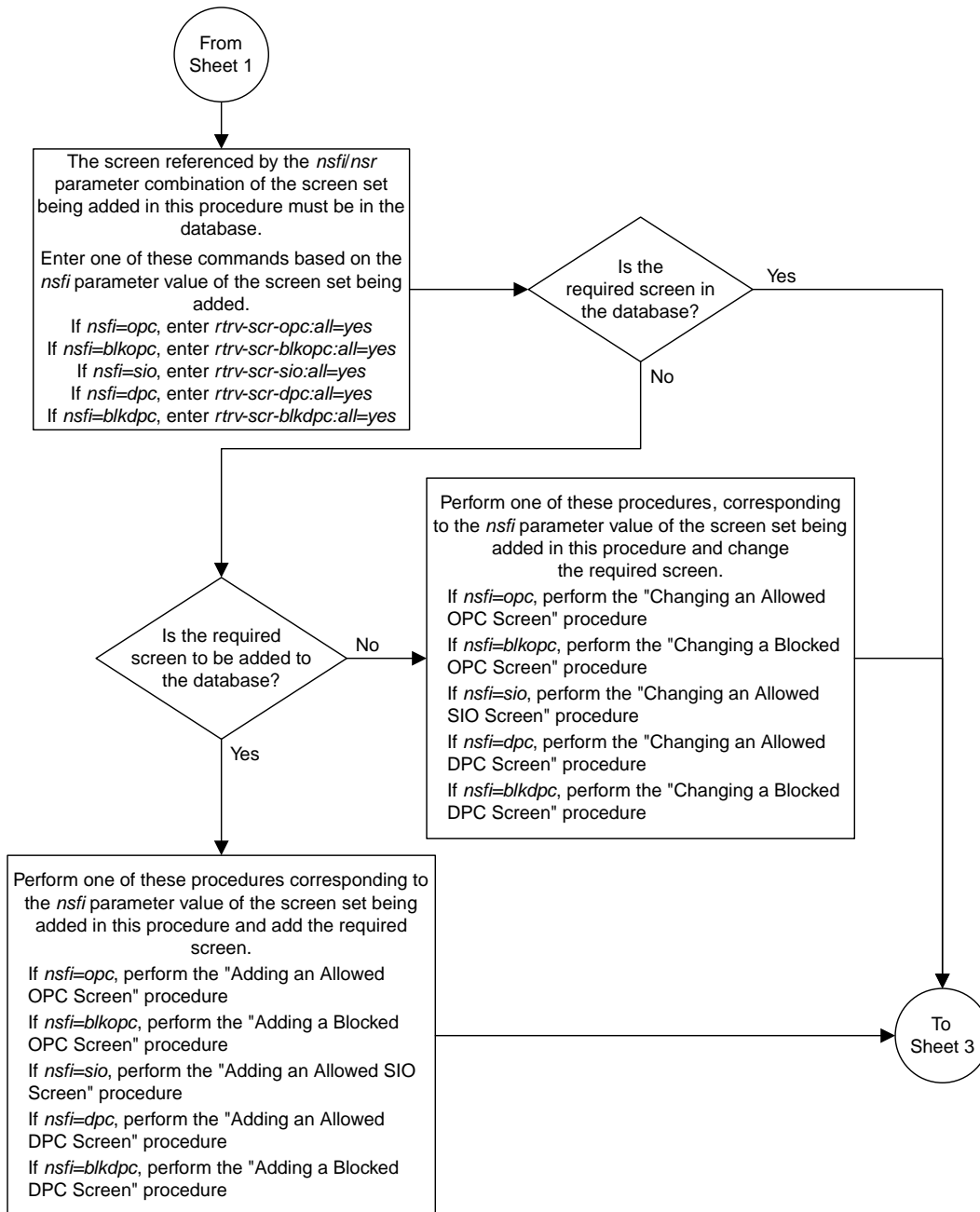

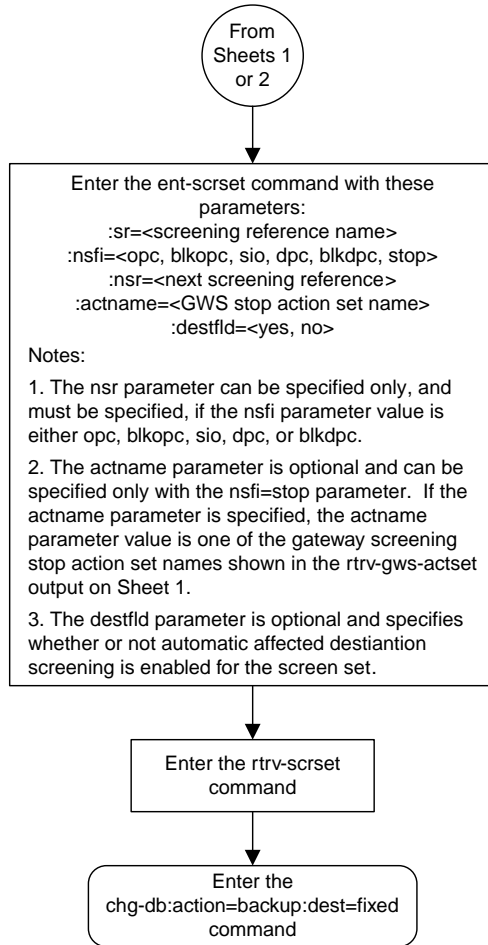

Sheet 3 of 3

Figure 70: Adding a Screen Set

## Removing a Screen Set

This procedure is used to remove a screen set from the database using the `dlt-scrset` command. The parameters used by the `dlt-scrset` command are shown in the [Gateway Screening Attributes](#) section. The general rules that apply to configuring gateway screening entities are shown in the [Gateway Screening Configuration](#) section.

The example in this procedure removes the screen set `gws1` from the database.

1. Display all screen sets in the database using the `rtrv-scrset` command.

The following is an example of the possible output.

```
rlghncxa03w 06-10-25 15:25:30 GMT EAGLE5 36.0.0
ENTIRE GWS DATABASE IS 1% FULL
CDPA + AFTPC TABLES ARE 1% FULL
THERE ARE 242 SCREEN SETS AVAILABLE

THE FOLLOWING ARE OVER 80% FULL:
SCRN  NSFI      NSR/ACT  FULL  RULES  TABLES  DESTFLD
-----
SCRN  NSFI      NSR/ACT  FULL  RULES  TABLES  DESTFLD
fld1  OPC       fld2     1%    5      4        NO
gws1  OPC       gws4     1%    9      7        NO
gws2  BLKOPC   gws5     1%    5      4        NO
isp1  OPC       isp1     1%    6      4        NO
ls01  SIO      ls02     1%    3      3        YES
ss01  OPC      opc1     51%   2075   22       YES
ss02  OPC      opc2     2%    75     22       YES
ss03  OPC      opc3     2%    75     22       YES
ss04  OPC      opc1     51%   2075   22       NO
ss07  OPC      opc1     51%   2075   22       YES
ss09  OPC      opc1     51%   2075   22       NO
ss28  OPC      opc1     51%   2075   22       YES
tup1  OPC      tup1     1%    8      5        NO
wrld1 DPC      iec      1%    6      5        YES
```

2. The screen set to be removed cannot be referenced by a linkset.

To verify this, enter the `rtrv-ls` command. If the output shows a reference to the screen set to be removed, perform the Changing an SS7 Linkset procedure in the *Database Administration Manual – SS7* and change the `scrn` parameter to reference another screen set, or to none to remove the reference to the screen set.

3. Remove the screen set from the database using the `dlt-scrset` command.

For this example, enter this command.

```
dlt-scrset:scrn=gws1
```

A message similar to the following should appear.

```
rlghncxa03w 06-10-25 15:26:30 GMT EAGLE5 36.0.0
DLT-SCRSET: SCREEN SET AFFECTED - GWS1 0% FULL
DLT-SCRSET: MASP A - COMPLTD
```

4. Verify the changes using the `rtrv-scrset` command with the screen set name used in step 3.

For this example, enter this command.

```
rtrv-scrset:scrn=gws1
```

The following is an example of the possible output.

```
E2573 Cmd Rej: SR or NSR does not reference an existing SR
```

This message shows that the specified screen set name is not in the database and the action of the `dlt-scrset` command in step 3 was successful.

5. Backup the new changes using the `chg-db:action=backup:dest=fixed` command.

The following messages should appear, the active Maintenance and Administration Subsystem Processor (MASP) appears first.

```
BACKUP (FIXED) : MASP A - Backup starts on active MASP.
BACKUP (FIXED) : MASP A - Backup on active MASP to fixed disk complete.
BACKUP (FIXED) : MASP A - Backup starts on standby MASP.
BACKUP (FIXED) : MASP A - Backup on standby MASP to fixed disk complete.
```



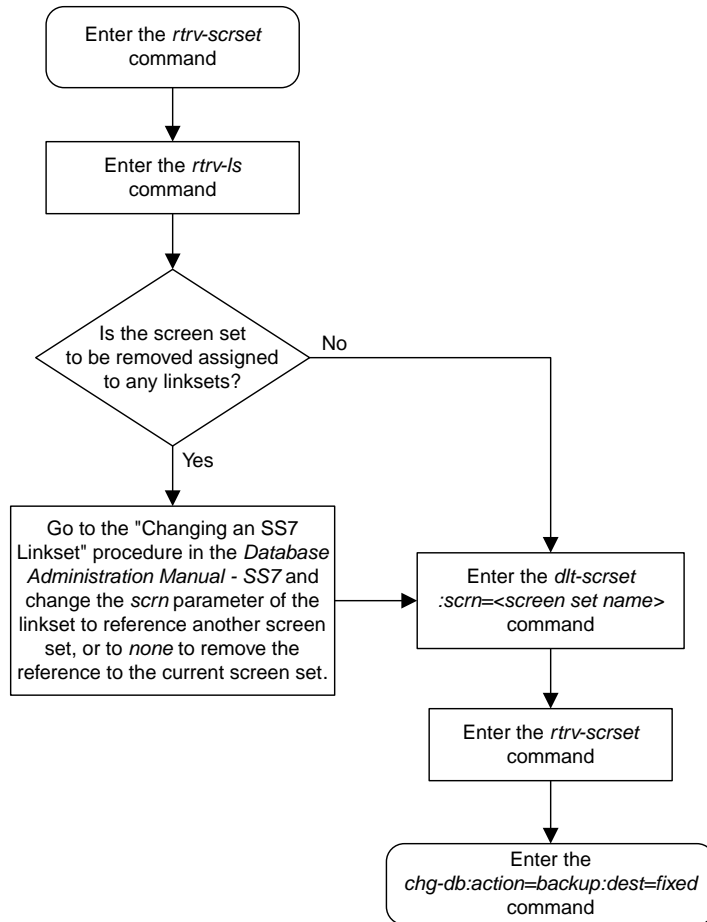

Figure 71: Removing a Screen Set

## Changing a Screen Set

This procedure is used to change the attributes of a screen set in the database using the `chg-scrset` command. The parameters used by the `chg-scrset` command are shown in the [Gateway Screening Attributes](#) section. The general rules that apply to configuring gateway screening entities are shown in the [Gateway Screening Configuration](#) section.

The example in this procedure is used to change screen set `1s01` to screen set `1s05` with the `nsfi=blkopc` and `nsr=1s08`.

If the screen set name is being changed, the new screen set name cannot already exist in the database.

The screen set can reference one of the following screens.

- Allowed OPC
- Blocked OPC
- Allowed SIO
- Allowed DPC
- Blocked DPC

### Verifying the Gateway Screening Configuration

Enter the following commands to verify that these screens are in the database.

- `rtrv-scr-opc:all=yes`
- `rtrv-scr-blkopc:all=yes`
- `rtrv-scr-sio:all=yes`
- `rtrv-scr-dpc:all=yes`
- `rtrv-scr-blkdpc:all=yes`

### Gateway Screening Configuration Procedures

If the desired screen is not in the database, perform one of the following procedures to add the desired screen to the database or change an existing screen in the database.

- [Adding an Allowed OPC Screen](#)
- [Adding a Blocked OPC Screen](#)
- [Adding an Allowed SIO Screen](#)
- [Adding an Allowed DPC Screen](#)
- [Adding a Blocked DPC Screen](#)
- [Changing an Allowed OPC Screen](#)
- [Changing a Blocked OPC Screen](#)
- [Changing an Allowed SIO Screen](#)
- [Changing an Allowed DPC Screen](#)
- [Changing a Blocked DPC Screen](#)

1. Display all screen sets in the database using the `rtrv-scrset` command.

The following is an example of the possible output.

```
r1ghncxa03w 06-10-25 15:25:30 GMT EAGLE5 36.0.0
ENTIRE GWS DATABASE IS 1% FULL
```

```

CDPA + AFTPC TABLES ARE 1% FULL
THERE ARE 242 SCREEN SETS AVAILABLE

THE FOLLOWING ARE OVER 80% FULL:
SCRN  NSFI      NSR/ACT  FULL  RULES  TABLES  DESTFLD

SCRN  NSFI      NSR/ACT  FULL  RULES  TABLES  DESTFLD
fld1  OPC       fld2      1%    5      4        NO
gws1  OPC       gws4      1%    9      7        NO
gws2  BLKOPC    gws5      1%    5      4        NO
isp1  OPC       isp1      1%    6      4        NO
ls01  SIO       ls02      1%    3      3        YES
ss01  OPC       opc1      51%   2075   22       YES
ss02  OPC       opc2      2%    75     22       YES
ss03  OPC       opc3      2%    75     22       YES
ss04  OPC       opc1      51%   2075   22       NO
ss07  OPC       opc1      51%   2075   22       YES
ss09  OPC       opc1      51%   2075   22       NO
ss28  OPC       opc1      51%   2075   22       YES
tup1  OPC       tup1      1%    8      5        NO
wrđ1  DPC       iec       1%    6      5        YES

```

- The screen set being changed cannot be referenced by a linkset.

To verify this, enter the `rtrv-ls` command. If the output shows a reference to the screen set to be removed, perform the Changing an SS7 Linkset procedure in *Database Administration - SS7 User's Guide* and change the `scrn` parameter to reference another screen set, or to none to remove the reference to the screen set.

**Note:** If a new gateway screening stop action set will not be assigned to the screen set being changed, skip step 3 and go to step 4.

- Display the gateway screening stop action sets in the database with the `rtrv-gws-actset` command.

This is an example of the possible output.

```

rlghncxa03w 06-10-25 15:26:30 GMT EAGLE5 36.0.0
ACT  ACT    ACT  ACT  ACT  ACT  ACT  ACT  ACT  ACT  ACT  ACT
ID   NAME   1    2    3    4    5    6    7    8    9    10
---  ---
1    copy   copy
2    rdct   rdct
3    cr     copy rdct
4    cnf    cnf
5    cpcnf  copy cnf
6    cnf    cnf rdct
7    cpcnf  copy cnf rdct

GWS action set table is (7 of 16) 44% full

```

If the required gateway screening stop action set is not in the database, go to the [Configuring Gateway Screening Stop Action Sets](#) procedure and configure the required gateway screening stop action set.

**Note:** If the NSFI of the screen set being changed in this procedure will be STOP, or if the NSFI of the screen set is not being changed, skip step 4 and go to step 5.

- Enter the commands in the [Verifying the Gateway Screening Configuration](#) section to verify that the screen that will be specified by the NSFI/NSR parameter combination in step 5 is in the database.

If the desired screen is not in the database, perform one of the procedures shown in the [Gateway Screening Configuration Procedures](#) section to add the desired screen to the database or change an existing screen in the database.

5. Change the attributes of a screen set using the `chg-scrset` command.

If a gateway screening stop action is to be assigned to the screen set being changed, enter the `chg-scrset` command with the `nsfi=stop` parameter and the `actname` parameter with the name of a gateway screening stop action set shown in the output of the `rtrv-gws-actset` command executed in step 2.

For this example, enter this command.

```
chg-scrset:scrn=ls01:nscrn=ls05:nsfi=blkopc:nsr=ls08
```

A message similar to the following should appear.

```
rlghncxa03w 06-10-25 15:27:30 GMT EAGLE5 36.0.0
CHG-SCRSET: SCREEN SET AFFECTED - LS01 1% FULL
CHG-SCRSET: MASP A - COMPLTD
```

6. Verify the changes using the `rtrv-scrset` command.

The following is an example of the possible output.

```
rlghncxa03w 06-10-25 15:28:30 GMT EAGLE5 36.0.0
ENTIRE GWS DATABASE IS 1% FULL
CDPA + AFTPC TABLES ARE 1% FULL
THERE ARE 242 SCREEN SETS AVAILABLE

THE FOLLOWING ARE OVER 80% FULL:
SCRN  NSFI      NSR/ACT  FULL  RULES  TABLES  DESTFLD

SCRN  NSFI      NSR/ACT  FULL  RULES  TABLES  DESTFLD
fld1  OPC       fld2     1%    5      4        NO
gws1  OPC       gws4     1%    9      7        NO
gws2  BLKOPC    gws5     1%    5      4        NO
isp1  OPC       isp1     1%    6      4        NO
ls05  BLKOPC    ls08     3%    45     14       YES
ss01  OPC       opc1     51%   2075   22       YES
ss02  OPC       opc2     2%    75     22       YES
ss03  OPC       opc3     2%    75     22       YES
ss04  OPC       opc1     51%   2075   22       NO
ss07  OPC       opc1     51%   2075   22       YES
ss09  OPC       opc1     51%   2075   22       NO
ss28  OPC       opc1     51%   2075   22       YES
tup1  OPC       tup1     1%    8      5        NO
wrld1 DPC       iec      1%    6      5        YES
```

7. Backup the new changes using the `chg-db:action=backup:dest=fixed` command.

The following messages should appear, the active Maintenance and Administration Subsystem Processor (MASP) appears first.

```
BACKUP (FIXED) : MASP A - Backup starts on active MASP.
BACKUP (FIXED) : MASP A - Backup on active MASP to fixed disk complete.
```

```
BACKUP (FIXED) : MASP A - Backup starts on standby MASP.  
BACKUP (FIXED) : MASP A - Backup on standby MASP to fixed disk complete.
```

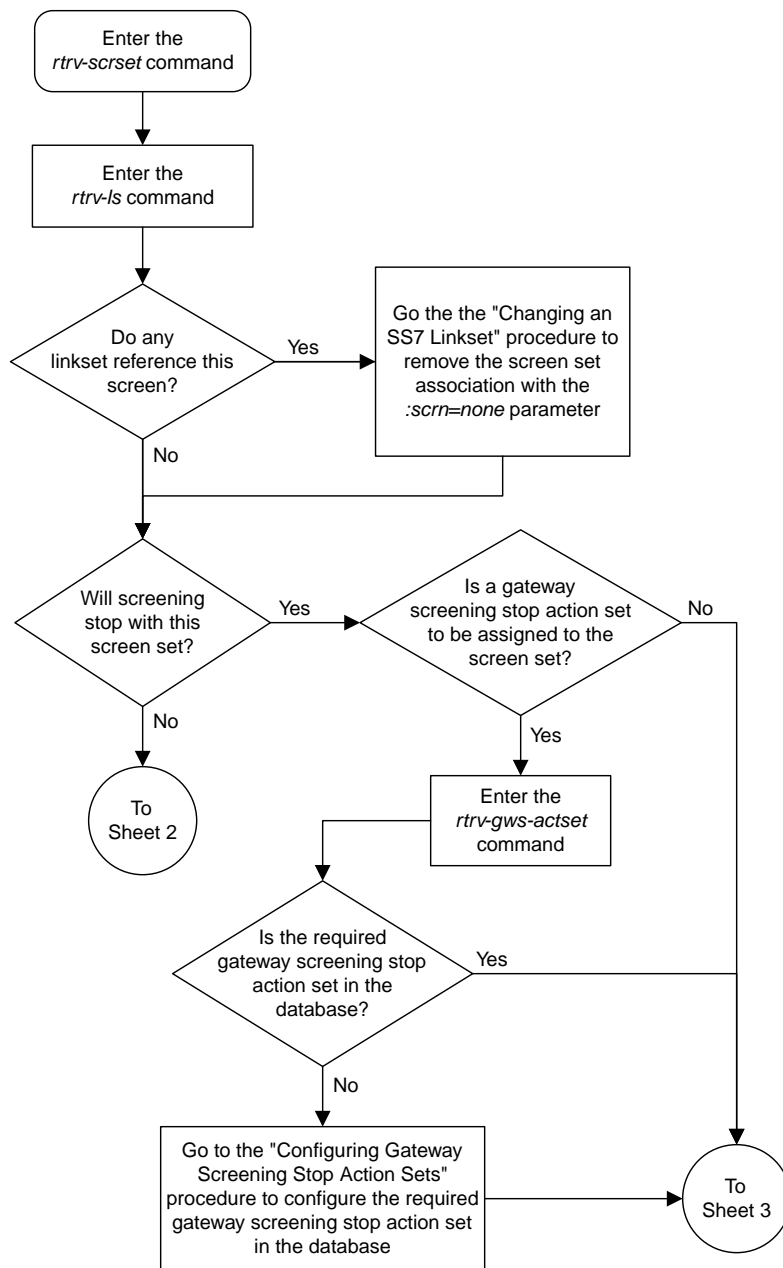

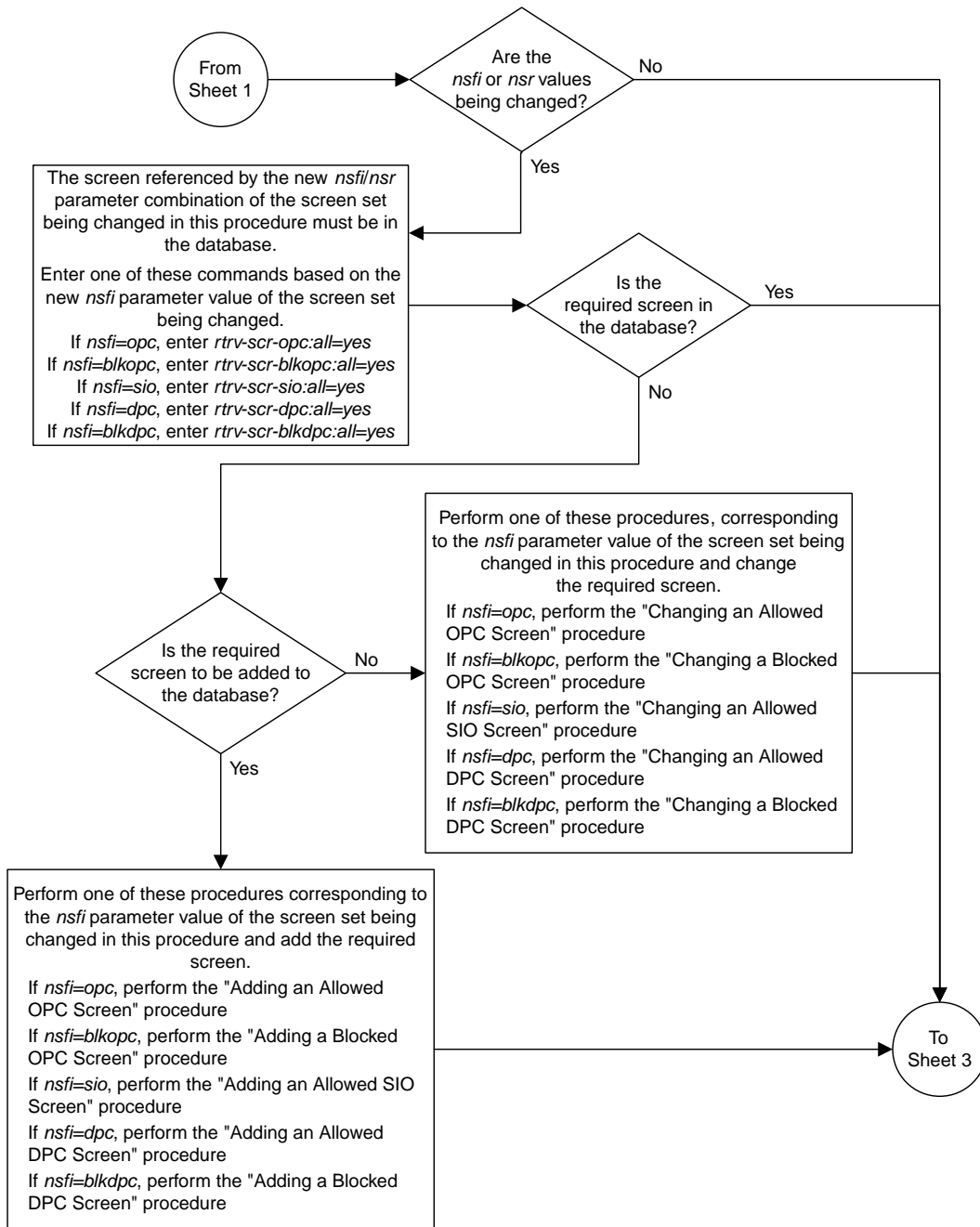

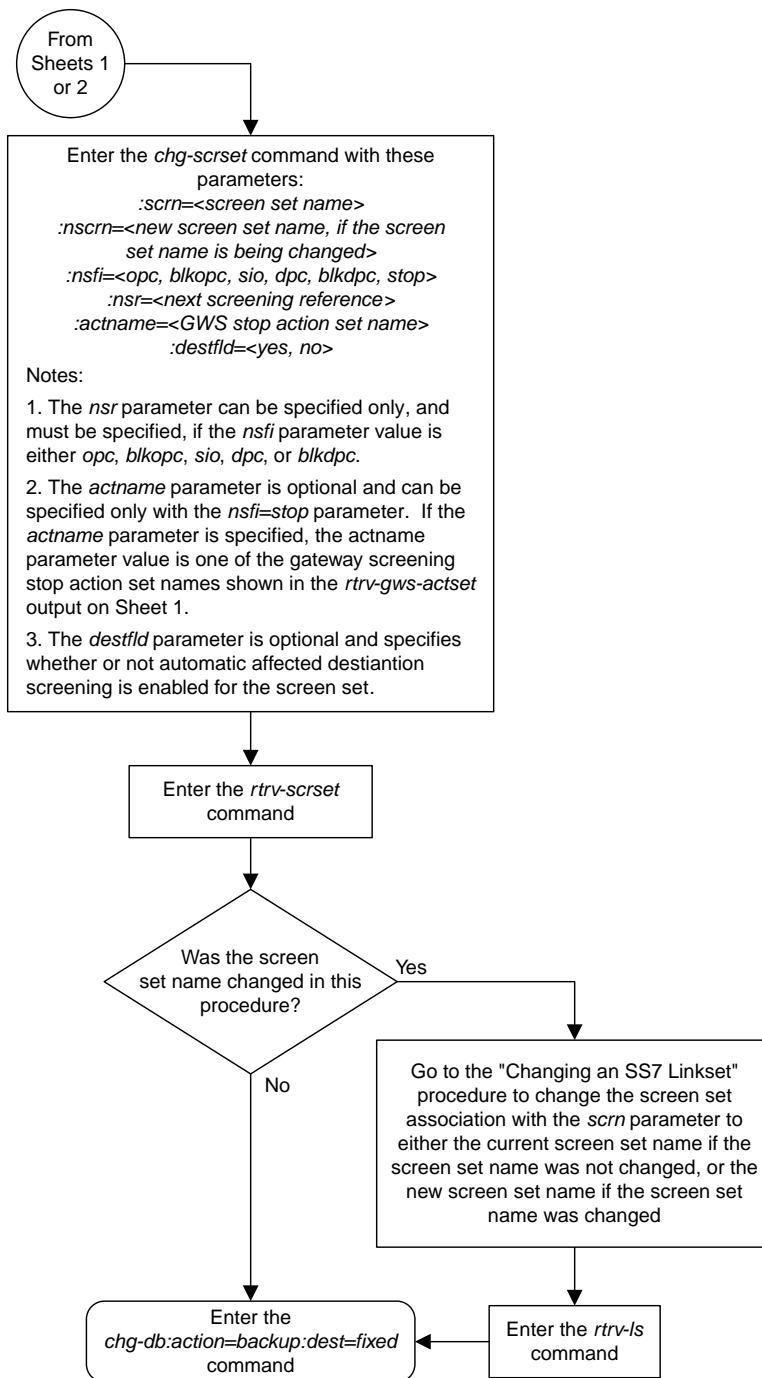



Sheet 3 of 3

**Figure 72: Changing a Screen Set**

# Chapter 14

## Calling Name Conversion Facility (CNCF) Configuration

### Topics:

- [Introduction.....471](#)
- [Configuring the EAGLE for the CNCF Feature.....473](#)

Chapter 14, Calling Name Conversion Facility (CNCF) Configuration, contains a description of the Calling Name Conversion Facility feature the procedure necessary to configure this feature.

## Introduction

This feature provides a conversion of ISUP IAM messages using two versions of calling name identification presentation (CNIP) for calling name information delivery. One version of the CNIP uses the non-standard proprietary ISUP party information (PIP) parameter. The other version uses the ANSI standard ISUP generic name (GN) parameter. The conversion will either replace the PIP parameter with the GN parameter or the GN parameter with the PIP parameter in the ISUP IAM message.

The gateway screening feature is used to select the ISUP messages that are converted. The incoming messages are selected based on the OPC and DPC in the routing label of the message, and the message type in the service information octet. The message type is defined by the value of the service indicator (SI) field of the SIO. ISUP messages contain the value 5 in the service indicator field of the SIO. Screening rules for Allowed OPC, Allowed DPC, and the Allowed SIO entities must be configured in the database for this feature.

This feature is an optional feature and must be turned on with the `chg-feat` command and the `cncf=on` parameter. The `rtrv-feat` command can be used to verify if this feature is on or not. This feature applies to only ANSI networks.

*Figure 73: PIP/GN Parameter Conversion* shows an example network which contains these two separate ISUP versions. Based on this example, *Table 81: ISUP IAM Message Conversion Examples* shows when the ISUP IAM message conversion by the CNCF feature occurs.

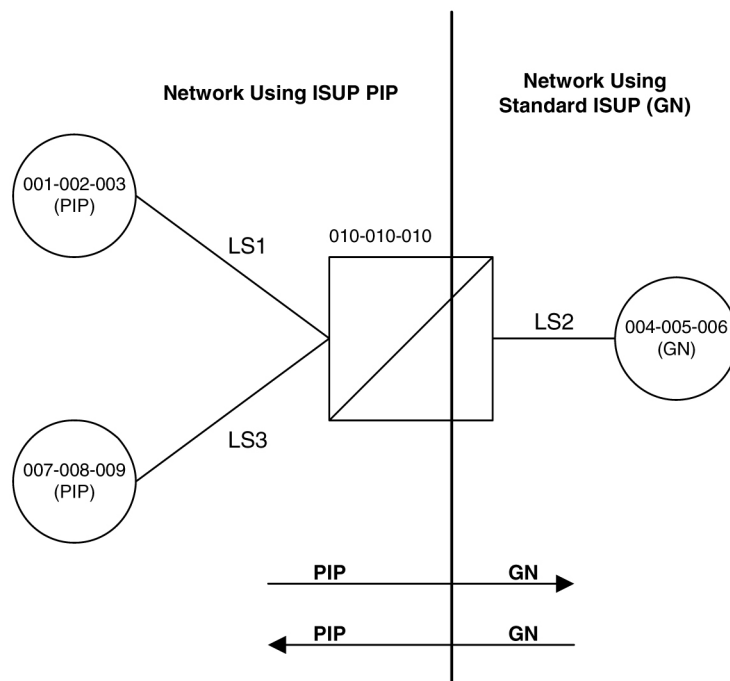

**Figure 73: PIP/GN Parameter Conversion**

Table 81: ISUP IAM Message Conversion Examples

Origination Point Code	Destination Point Code	ISUP IAM Message Conversion
001-002-003	004-005-006	Yes
001-002-003	007-008-009	No
004-005-006	001-002-003	Yes
004-005-006	007-008-009	Yes
007-008-009	001-002-003	No
007-008-009	004-005-006	Yes

Great care must be taken when configuring the gateway screening rules for this feature. The CNCF feature has no way to validate the gateway screening rules to detect errors in converting messages between compatible networks. For example, using the example network in [Figure 73: PIP/GN Parameter Conversion](#), the ISUP IAM message traffic from node 001-002-003 to node 007-008-009 does not need to be converted because they are using the same calling name delivery parameter, PIP. If the gateway screening rules are not carefully configured, these messages could be converted when they do not need to be.

No measurements are collected showing the number of MSUs converted by this feature.

If both the COPY and CNCF gateway screening stop actions are specified as the stop actions for the gateway screening process, the MSU is converted by the CNCF feature, then copied for the STPLAN feature.

If both the RDCT and CNCF gateway screening stop actions are specified as the stop actions for the gateway screening process, the MSU is converted by the CNCF feature, then redirected for the DTA feature.

If there are multiple PIP parameters or GN parameters with calling name information within a single ISUP IAM, only the first occurrence of the parameter in the ISUP IAM message is converted.

Only GN IAM messages containing calling name information (Type of Name = Calling Name, Presentation = Allowed, Parameter Length >1) are converted to PIP IAM messages.

Only PIP IAM messages containing Calling Name Information (Sub-Parameter Code = Name Information, Name Element Indicator = Calling Party) are converted to GN IAM messages.

If the received IAM message contains both a GN and a PIP parameter with calling name information, the GN parameter is retransmitted and the PIP parameter is deleted.

Any MSU that is not converted is simply retransmitted. These MSUs include non-ISUP MSUs, non-IAM MSUs, and any IAM MSU received that doesn't contain either a GN or PIP parameter.

If the PIP parameter contains other information in addition to the calling party name information, only a GN parameter containing calling party name information is generated.

The linkset being screened for this feature should not contain C links (1st=c parameter of the ent-1s and chg-1s commands). This would result in the double conversion of the ISUP IAM messages.

## Configuring the EAGLE for the CNCF Feature

To configure the EAGLE for the CNCF feature, gateway screening rules for Allowed OPC, Allowed DPC, and the Allowed SIO entities must be configured in the database for this feature. The last entity in the screening process (`nsfi=stop`) must have a gateway screening stop action set containing the CNCF gateway screening stop action.

The allowed OPC screening rules must contain the OPCs that the ISUP IAM messages are being sent from.

The allowed DPC screening rules must contain the DPCs that the ISUP IAM messages are being sent to.

The allowed SIO screening rules must contain the ISUP message type, defined by the `si=5` parameter.

The CNCF feature must be turned on. Before the CNCF feature can be turned on, the gateway screening feature must be on. This can be verified with the `rtv-feat` command.

The examples in this procedure are based on these figures and tables.

- [Figure 74: CNCF Gateway Screening Configuration - Example 1](#)
- [Figure 75: CNCF Gateway Screening Configuration - Example 2](#)
- [Figure 76: CNCF Gateway Screening Configuration - Example 3](#)
- [Figure 77: CNCF Gateway Screening Configuration - Example 4](#)
- [Table 81: ISUP IAM Message Conversion Examples](#)
- [Table 82: Example Gateway Screening Allowed DPC Configuration Table for the CNCF Feature](#)
- [Table 83: Example Gateway Screening Allowed SIO Configuration Table for the CNCF Feature](#)
- [Table 84: Example Gateway Screening Allowed OPC Configuration Table for the CNCF Feature](#)
- [Table 85: Example Gateway Screening Screen Set Configuration Table for the CNCF Feature](#)
- [Table 86: Linkset Configuration Table for the CNCF Feature](#)

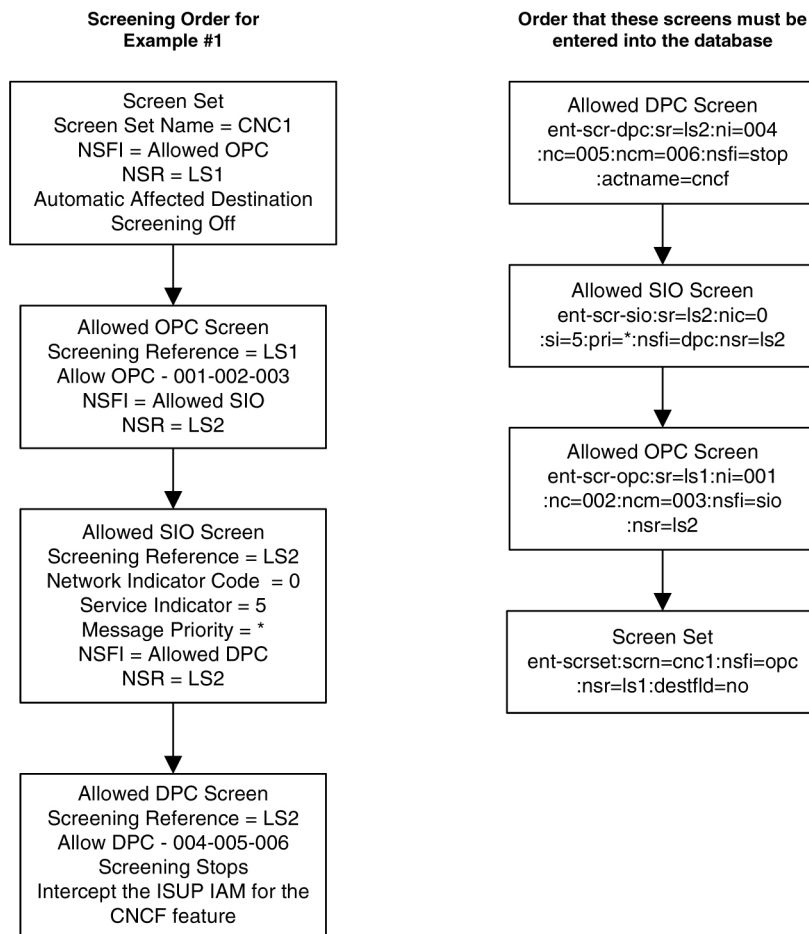

Figure 74: CNCF Gateway Screening Configuration - Example 1

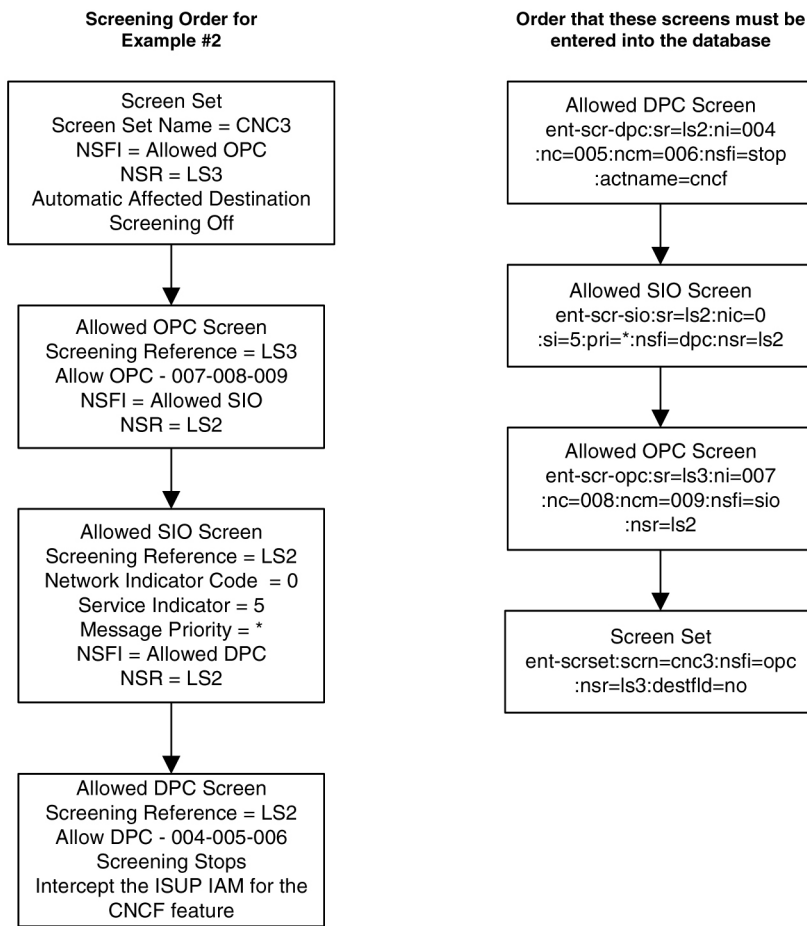

Figure 75: CNCF Gateway Screening Configuration - Example 2

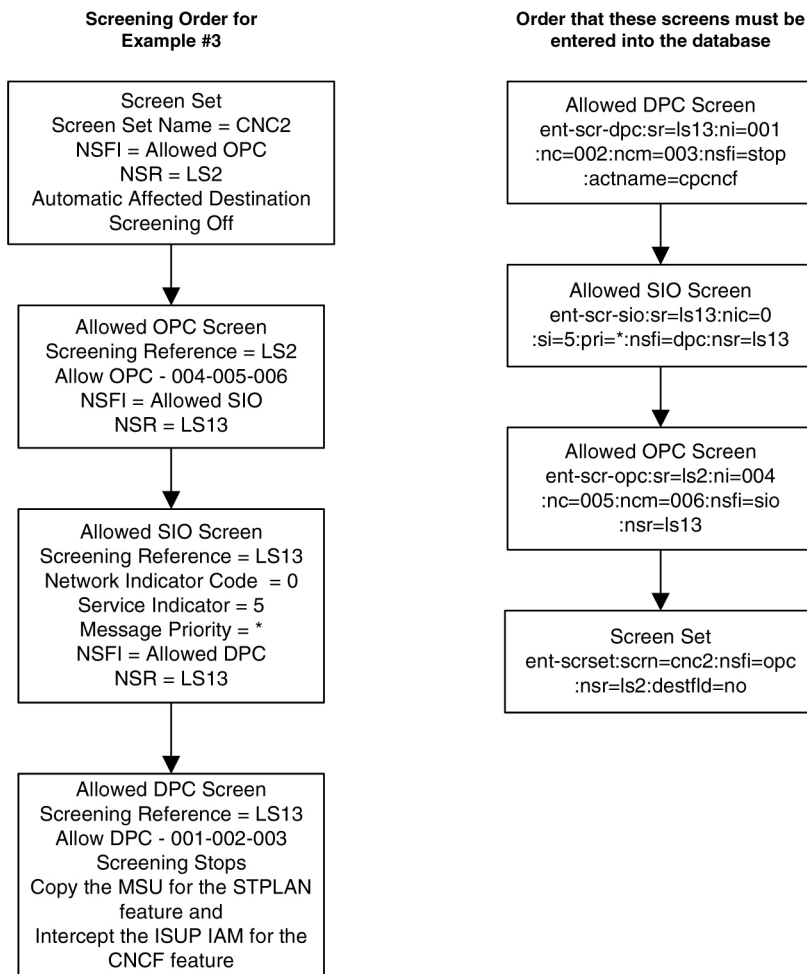

Figure 76: CNCF Gateway Screening Configuration - Example 3



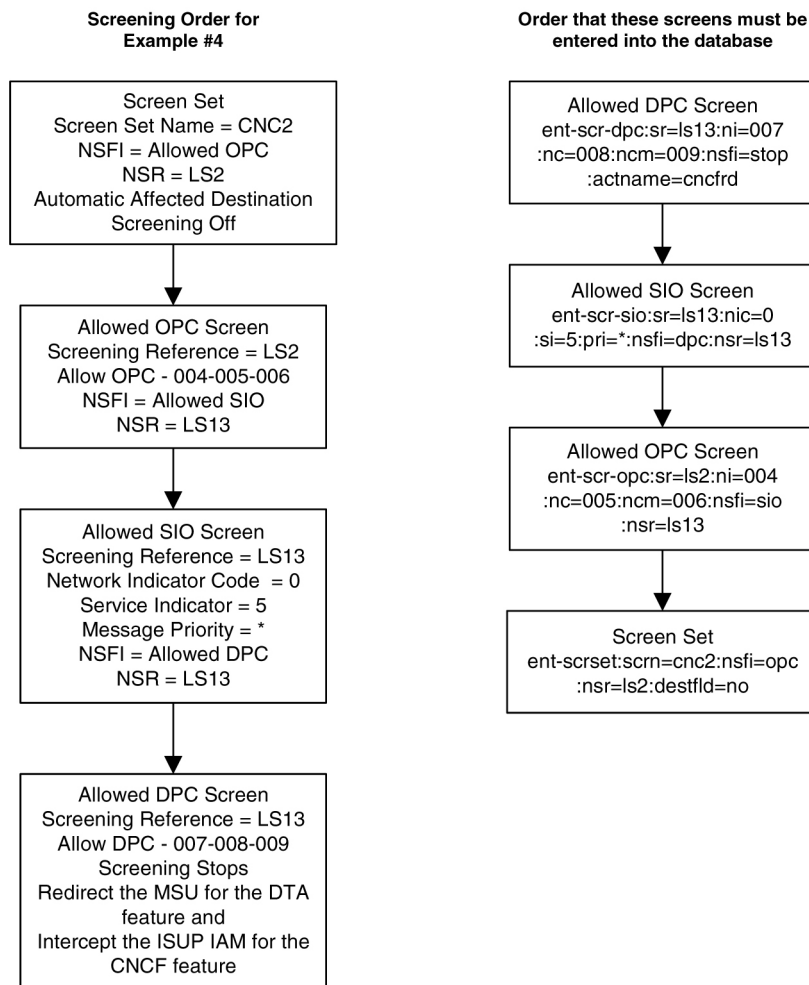

Figure 77: CNCF Gateway Screening Configuration - Example 4

### Canceling the RTRV-LS Command

Because the `rtrv-ls` command used in this procedure can output information for a long period of time, the `rtrv-ls` command can be canceled and the output to the terminal stopped. There are three ways that the `rtrv-ls` command can be canceled.

- Press the F9 function key on the keyboard at the terminal where the `rtrv-ls` command was entered.
- Enter the `canc-cmd` without the `trm` parameter at the terminal where the `rtrv-ls` command was entered.
- Enter the `canc-cmd:trm=<xx>`, where `<xx>` is the terminal where the `rtrv-ls` command was entered, from another terminal other than the terminal where the `rtrv-ls` command was entered. To enter the `canc-cmd:trm=<xx>` command, the terminal must allow Security Administration commands to be entered from it and the user must be allowed to enter Security Administration commands. The terminal's permissions can be verified with the `rtrv-secu-trm` command. The user's permissions can be verified with the `rtrv-user` or `rtrv-secu-user` commands.

For more information about the `canc-cmd` command, go to *Commands User's Guide*.

1. Verify that the gateway screening and the calling name conversion facility features are on, by entering the `rtrv-feat` command.

If the gateway screening feature is on, the `GWS` field should be set to `on`. If the calling name conversion facility feature is on, the `CNCF` field should be set to `on`. For this example, the gateway screening and the calling name conversion facility features are off.

**Note:** The `rtrv-feat` command output contains other fields that are not used by this procedure. If you wish to see all the fields displayed by the `rtrv-feat` command, see the `rtrv-feat` command description in *Commands User's Guide*.

If both features are on, go to step 4. If the gateway screening feature is on, but the calling name conversion facility feature is off, go to step 3. If the gateway screening feature is off, go to step 2.

2. If the gateway screening feature is not on, shown by the `GWS = off` entry in the `rtrv-feat` command output in step 1, turn the gateway screening feature on by entering this command.

```
chg-feat:gws=on
```

**Note:** Once the gateway screening feature is turned on with the `chg-feat` command, it cannot be turned off.

When the `chg-feat` has successfully completed, this message should appear.

```
rlghncxa03w 06-10-25 15:26:30 GMT EAGLE5 36.0.0
CHG-FEAT: MASP A - COMPLTD
```

3. If the calling name conversion facility feature is not on, shown by the `CNCF = off` entry in the `rtrv-feat` command output in step 1, turn the calling name conversion facility feature on by entering this command.

```
chg-feat:cncf=on
```

**Note:** Once the calling name conversion facility feature is turned on with the `chg-feat` command, it cannot be turned off.

When the `chg-feat` has successfully completed, this message should appear.

```
rlghncxa03w 06-10-25 15:27:30 GMT EAGLE5 36.0.0
CHG-FEAT: MASP A - COMPLTD
```

4. Display the gateway screening stop action sets in the database with the `rtrv-gws-actset` command.

This is an example of the possible output.

```
rlghncxa03w 06-10-25 15:28:30 GMT EAGLE5 36.0.0
ACT  ACT  ACT  ACT  ACT  ACT  ACT  ACT  ACT  ACT  ACT  ACT
ID   NAME  1    2    3    4    5    6    7    8    9    10
--   -
1    copy  copy
2    rdct  rdct
3    cr    copy rdct
4    cncf  cncf
5    cpcncf copy cncf
6    cncfrd cncf rdct
```

```
7    cpcf rd copy cncf rdct
GWS action set table is (7 of 16) 44% full
```

If the `cncf` gateway screening stop action is not shown in the `rtrv-gws-actset` command output, perform the [Configuring Gateway Screening Stop Action Sets](#) procedure to create a new gateway screening stop action set containing the `cncf` gateway screening stop action, or change an existing gateway screening stop action set to contain the `cncf` gateway screening stop action.

5. Display all allowed DPC screens in the database using the `rtrv-scr-dpc` command.

The following is an example of the possible output.

```
rlghncxa03w 06-10-25 15:29:30 GMT EAGLE5 36.0.0
SCREEN = ALLOWED DPC
SR    REF    RULES
IEC   YES    2
WRD2  YES    1
WRD4  YES    9
```

If the necessary screening reference name is shown in the `rtrv-scr-dpc` command output, make sure the screening data you wish to enter is not already in the database by entering the `rtrv-scr-dpc` command with the screening reference name. For example, enter the `rtrv-scr-dpc:sr=iec` command.

The following is an example of the possible output.

```
rlghncxa03w 06-10-25 15:30:30 GMT EAGLE5 36.0.0
SCREEN = ALLOWED DPC
SR    NI      NC      NCM      NSFI     NSR/ACT
IEC   240     001    010     STOP    -----
IEC   241     010    *        CGPA    cg04
SR    NPC
IEC   00235
IEC   00240
SR    ZONE   AREA   ID      NSFI     NSR/ACT
IEC   1      003   4       BLKDPC  blk1
IEC   1      003   5       STOP    -----
```

6. If the required screen is not in the database, perform the [Adding an Allowed DPC Screen](#) procedure to add the required allowed DPC screen.

For this example, enter the screening information in [Table 82: Example Gateway Screening Allowed DPC Configuration Table for the CNCF Feature](#).

**Table 82: Example Gateway Screening Allowed DPC Configuration Table for the CNCF Feature**

Screening Reference	NI	NC	NCM	NSFI	ACTNAME*
ls2	004	005	006	Stop	CNCF
ls13	001	002	003	Stop	CPCNCF
ls13	007	008	009	Stop	CNCFRD

Screening Reference	NI	NC	NCM	NSFI	ACTNAME*
* The value of the actname parameter is shown in the <code>rtrv-gws-actset</code> command output example shown in step 4.					

If you wish to change an existing allowed DPC screen, instead of adding a new allowed DPC screen, perform the [Changing an Allowed DPC Screen](#) procedure to change an existing allowed DPC screen. For this example, change the screens with the screening information in [Table 82: Example Gateway Screening Allowed DPC Configuration Table for the CNCF Feature](#).

7. Display all allowed SIO screens in the database using the `rtrv-scr-sio` command.

The following is an example of the possible output.

```
r1ghncxa03w 06-10-25 15:31:30 GMT EAGLE5 36.0.0
SCREEN = ALLOWED SIO
SR  REF  RULES
IEC  YES   2
WRD2 YES   1
WRD4 YES   9
```

If the necessary screening reference name is shown in the `rtrv-scr-sio` command output, make sure the screening data you wish to enter is not already in the database by entering the `rtrv-scr-sio` command with the screening reference name. For example, enter the `rtrv-scr-sio:sr=iec` command.

The following is an example of the possible output.

```
r1ghncxa03w 06-10-25 15:32:30 GMT EAGLE5 36.0.0
SCREEN = ALLOWED SIO
SR  NIC  PRI  SI  H0  H1  NSFI  NSR/ACT
IEC  2    0&&3  0   0   0   BLKDPC WDB2
IEC  2    0&&2  0   1   1   DPC    WDB3
IEC  2    0&&1  0   2   2   STOP   -----
IEC  2    0&&3  4   --  --   STOP   -----
IEC  2    0&&2  1   *   *   DPC    WDB3
```

8. If the required screen is not in the database, perform the [Adding an Allowed SIO Screen](#) procedure to add the required allowed SIO screen.

For this example, enter the screening information in [Table 83: Example Gateway Screening Allowed SIO Configuration Table for the CNCF Feature](#).

**Table 83: Example Gateway Screening Allowed SIO Configuration Table for the CNCF Feature**

Screening Reference	NIC	SI	H0	H1	PRI	NSFI	NSR
ls2	0	5	--	--	*	dpc	ls2
ls13	0	5	--	--	*	dpc	ls13

If you wish to change an existing allowed SIO screen, instead of adding a new allowed SIO screen, perform the [Changing an Allowed SIO Screen](#) procedure to change an existing allowed SIO screen. For this example, change the screens with the screening information in [Table 83: Example Gateway Screening Allowed SIO Configuration Table for the CNCF Feature](#).

9. Display all allowed OPC screens in the database using the `rtrv-scr-opc` command.

The following is an example of the possible output.

```
rlghncxa03w 06-10-25 15:33:30 GMT EAGLE5 36.0.0
SCREEN = ALLOWED OPC
SR    REF  RULES
IEC   YES   2
WRD2  YES   1
WRD4  YES   9
```

If the necessary screening reference name is shown in the `rtrv-scr-opc` command output, make sure the screening data you wish to enter is not already in the database by entering the `rtrv-scr-opc` command with the screening reference name. For example, enter the `rtrv-scr-opc:sr=iec` command.

The following is an example of the possible output.

```
rlghncxa03w 06-10-25 15:34:30 GMT EAGLE5 36.0.0
SCREEN = ALLOWED OPC
SR    NI      NC      NCM      NSF1     NSR/ACT
IEC   240      001     010     STOP     -----
IEC   241      010     *       CGPA     cg04
SR    NPC
IEC   00235
IEC   00240
SR    ZONE    AREA    ID      NSF1     NSR/ACT
IEC   1       003     4      BLKOPC  blk1
IEC   1       003     5      STOP     -----
```

10. If the required screen is not in the database, perform the [Adding an Allowed OPC Screen](#) procedure to add the required allowed OPC screen.

For this example, enter the screening information in [Table 84: Example Gateway Screening Allowed OPC Configuration Table for the CNCF Feature](#).

**Table 84: Example Gateway Screening Allowed OPC Configuration Table for the CNCF Feature**

Screening Reference	NI	NC	NCM	NSF1	NSR
ls1	001	002	003	sio	ls2
ls2	004	005	006	sio	ls13
ls3	007	008	009	sio	ls2

If you wish to change an existing allowed OPC screen, instead of adding a new allowed OPC screen, perform the [Changing an Allowed OPC Screen](#) procedure to change an existing allowed OPC screen. For this example, change the screens with the screening information in [Table 84: Example Gateway Screening Allowed OPC Configuration Table for the CNCF Feature](#).

11. Display all the screen sets in the database using the `rtrv-scrset` command.

The following is an example of the possible output.

```
rlghncxa03w 06-10-25 15:35:30 GMT EAGLE5 36.0.0
ENTIRE GWS DATABASE IS 1% FULL
CDPA + AFTPC TABLES ARE 1% FULL
THERE ARE 248 SCREEN SETS AVAILABLE

THE FOLLOWING ARE OVER 80% FULL:
SCRN  NSFI      NSR/ACT  FULL  RULES  TABLES  DESTFLD

SCRN  NSFI      NSR/ACT  FULL  RULES  TABLES  DESTFLD
ss01  OPC       opc1     51%  2075   22       YES
ss02  OPC       opc2      2%    75     22       YES
ss03  OPC       opc3      2%    75     22       YES
ss04  OPC       opc1     51%  2075   22       NO
ss07  OPC       opc1     51%  2075   22       YES
ss09  OPC       opc1     51%  2075   22       NO
ss28  OPC       opc1     51%  2075   22       YES
```

12. If the required screen set is not in the database, perform the [Adding a Screen Set](#) procedure to add the required screen set.

For this example, enter the screening information in [Table 85: Example Gateway Screening Screen Set Configuration Table for the CNCF Feature](#).

**Table 85: Example Gateway Screening Screen Set Configuration Table for the CNCF Feature**

Screen Set Name	Next Screening Function Identifier	Next Screening Reference	DESTFLD
cnc1	opc	ls1	No
cnc2	opc	ls2	No
cnc3	opc	ls3	No

If you wish to change an existing screen set, instead of adding a new screen set, perform the [Changing a Screen Set](#) procedure to change an existing screen set. For this example, change the screen sets with the screening information in [Table 85: Example Gateway Screening Screen Set Configuration Table for the CNCF Feature](#).

13. Display the current linkset configuration using the `rtrv-ls` command.

This is an example of the possible output.

```
rlghncxa03w 09-05-25 15:36:30 GMT EAGLE5 41.0.0

LSN          APCA  (SS7)  SCRN  L3T  SLT          GWS  GWS  GWS
lsa1         240-020-000  scr1  1    1  yes A    1    off off off no  off
lsa2         240-030-000  scr2  1    2  no  C    3    on  on  on yes off
lsa3         240-040-000  scr3  1    3  yes C    5    off off off yes off

L3T  SLT          GWS  GWS  GWS
```

```

LSN          APCI  (SS7)  SCRNL3T SLT  GWS GWS GWS
lsi1         1-111-1  scr1  1  1  yes A  1  off off off --- ---
lsi2         1-111-2  scr2  1  2  no  C  3  on  on  on  --- ---
lsi3         1-111-3  scr3  1  3  yes C  5  off off off --- ---

LSN          APCN  (SS7)  SCRNL3T SLT  GWS GWS GWS
lsn1         11111  scr1  1  1  yes A  1  off off off --- off
lsn2         11112  scr2  1  2  no  C  3  on  on  on  --- off
lsn3         11113  scr3  1  3  yes C  5  off off off --- off

Link set table is ( 9 of 1024) 1% full

```

14. If the required linkset is not in the database, perform the Adding an SS7 Linkset in *Database Administration - SS7 User's Guide* to add the required linkset.

For this example, enter the linkset information in [Table 86: Linkset Configuration Table for the CNCF Feature](#).

**Table 86: Linkset Configuration Table for the CNCF Feature**

Linkset Name	Linkset APC	# LINKS	LST	GWSA	GWSM	SCRN
ls1	001-002-003	2	B	on	off	cnc1
ls2	004-005-006	2	B	on	off	cnc2
ls3	007-008-009	2	B	on	off	cnc3

If you wish to change an existing linkset, instead of adding a new linkset, perform the Changing an SS7 Linkset procedure in *Database Administration - SS7 User's Guide* to change an existing linkset. For this example, change the linksets with the information in [Table 86: Linkset Configuration Table for the CNCF Feature](#).

15. Backup the new changes using the `chg-db:action=backup:dest=fixed` command.

The following messages should appear, the active Maintenance and Administration Subsystem Processor (MASP) appears first.

```

BACKUP (FIXED) : MASP A - Backup starts on active MASP.
BACKUP (FIXED) : MASP A - Backup on active MASP to fixed disk complete.
BACKUP (FIXED) : MASP A - Backup starts on standby MASP.
BACKUP (FIXED) : MASP A - Backup on standby MASP to fixed disk complete.

```

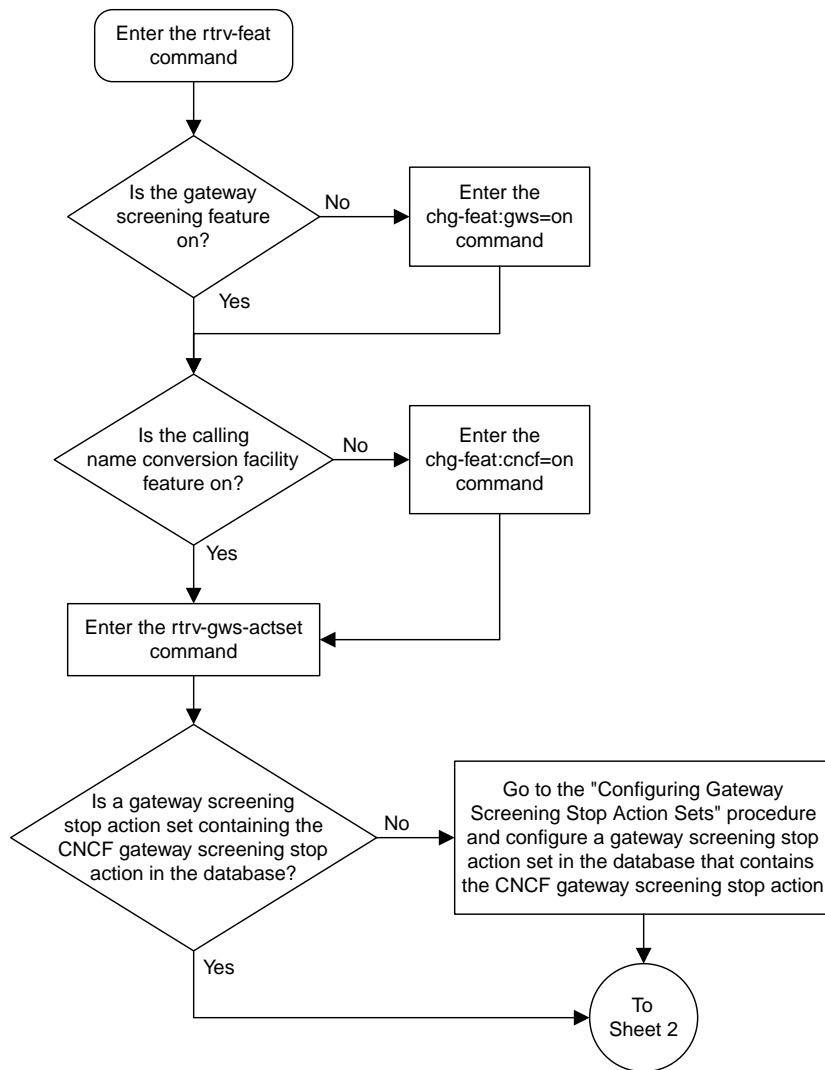



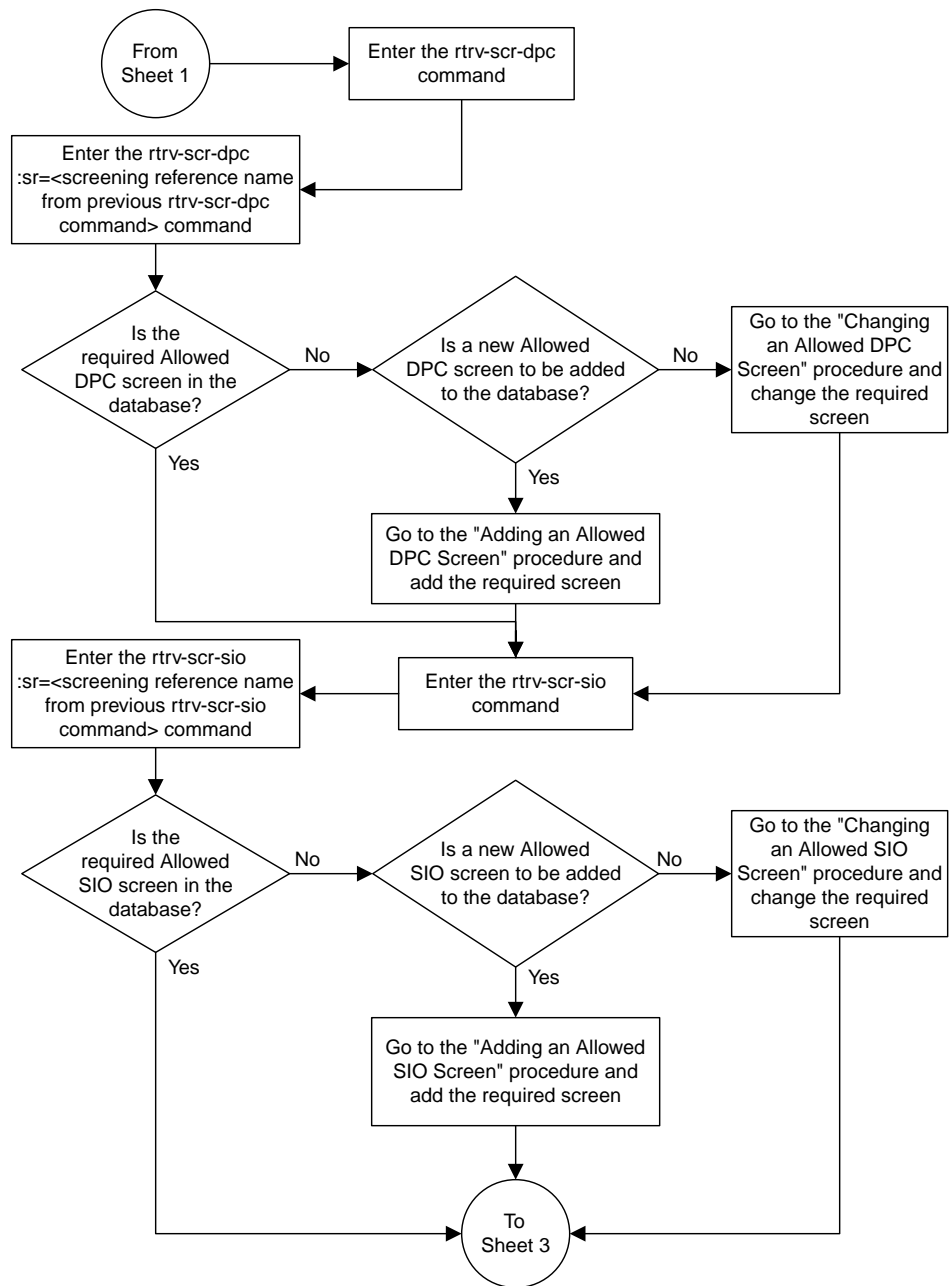

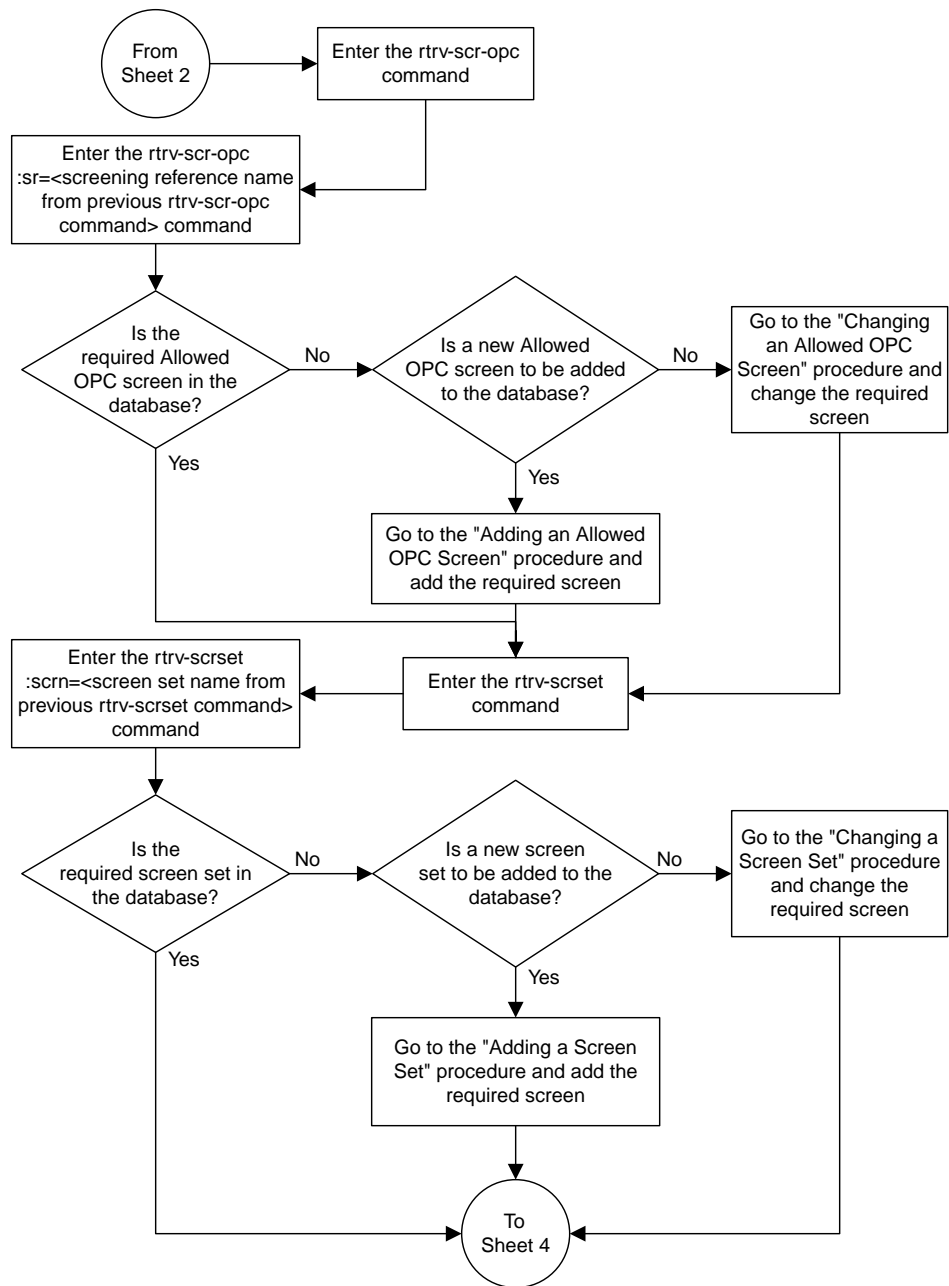

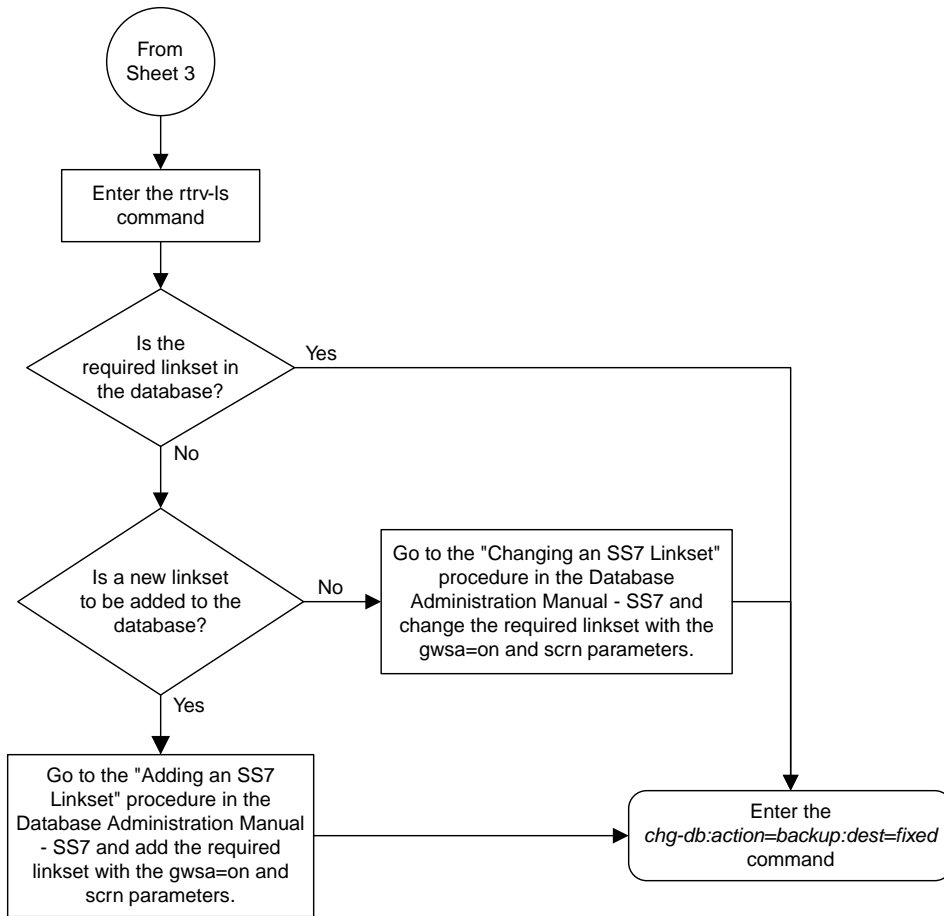

Sheet 4 of 4

**Figure 78: Calling Name Conversion Facility Configuration**

# Chapter 15

## Allowed ISUP Message Type Screen Configuration

---

### Topics:

- *Introduction.....490*
- *Adding an Allowed ISUP Message Type Screen.....495*
- *Removing an Allowed ISUP Message Type Screen.....503*
- *Changing an Allowed ISUP Message Type Screen.....507*

Chapter 15, Allowed ISUP Message Type Screen Configuration, contains the procedures necessary to configure allowed ISUP message type screens.

## Introduction

The ISUP Message Type screen identifies which ISUP messages, using the ISUP message type, that are allowed into the EAGLE. The gray shaded areas in [Figure 80: Allowed ISUP Message Type Screening Function](#) shows the fields of the SS7 message that are checked by the ISUP Message Type screening function.

## Gateway Screening Actions

The Gateway Screening process stops with this screen. The `nsfi` parameter value can only be `stop`. If a match is not found, the message is discarded.

If a match is found, the message is processed. If a gateway screening stop action set is specified with the screen, shown by the `actname` parameter value, the message is processed according to the gateway screening stop actions that are assigned to the gateway screening stop action set.

- If the `copy` gateway screening stop action is specified, the message is processed and a copy of the message is sent by the STPLAN feature to an external application.
- If the `rdct` (redirect) gateway screening stop action is specified, the message is diverted from the original destination and sent to another destination with the Database Transport Access feature, specified by global title translation, for further processing.
- If the `cncf` gateway screening stop action is specified, the PIP parameter in the incoming ISUP IAM message is converted to the GN parameter. The GN parameter in the incoming ISUP IAM message is converted to the PIP parameter. The message is then sent to the node specified by the DPC in the routing label in the message. For more information on the Calling Name Conversion Facility feature, see [Calling Name Conversion Facility \(CNCF\) Configuration](#).
- If the `tlnp` gateway screening stop action is specified, ISUP IAMs that pass gateway screening are processed either by the ISUP NP with EPAP feature (if the ISUP NP with EPAP feature is enabled and turned on) or by the Triggerless LNP feature (if the Triggerless LNP feature is turned on). The ISUP NP with EPAP feature is discussed in more detail in *G-Port User's Guide*. The Triggerless LNP feature is discussed in more detail in *ELAP Administration and LNP Feature Activation Guide*.
- If the `tinp` gateway screening stop action is specified, ISUP IAMs that pass gateway screening are intercepted by the Triggerless ISUP based Number Portability (TINP) feature and converted to include the routing number (RN) if the call is to a ported number. The TINP feature is discussed in more detail in *G-Port User's Guide*.
- If the `tif`, `tif2`, or `tif3` gateway screening stop actions are specified, TIF processing is applied to the message.
- If the `sccp` gateway screening stop action is specified, MTP routed SCCP UDT/XUDT are forwarded to the service modules for further processing.

## TUP Message Screening

TUP messages are screened using the Allowed ISUP Message Type screen. The TUP protocol is an obsolete predecessor to the ISUP protocol that remains in use in some areas. To screen for TUP messages, a screen set must be defined to screen for messages containing the service indicator value of 4. This is accomplished by defining an allowed SIO screen in the screen set containing the `si=4` parameter.

Since both ISUP and TUP messages are screened using the allowed ISUP message type screen, it is recommended that the screen set contain an allowed SIO screen to screen for ISUP messages, messages containing the service indicator value of 5. Each of these entries in the allowed SIO screen should have separate next screening functions. This allows the screening rules after the allowed SIO screen to have two separate streams, one that ends with screening ISUP messages, the other that ends with screening TUP messages.

The TUP messages can be screened for point codes before the allowed SIO screen with the allowed and blocked OPC screens, and after the SIO screen with the allowed and blocked DPC screens. However, if the screen set does not contain an allowed SIO screen that screens for TUP messages (messages with the service indicator value of 4), the message will be treated by the allowed ISUP message type screen as an ISUP message.

The following commands show how a screen set can be provisioned to screen for TUP and ISUP messages.

```
ent-scr-isup:sr=is01:isupmt=10:nsfi=stop
ent-scr-isup:sr=tu01:tupmt=1:nsfi=stop
ent-scr-dpc:sr=dpc4:ni=1:nc=2:ncm=3:nsfi=isup:nsr=tu01
ent-scr-dpc:sr=dpc5:ni=7:nc=1:ncm=0:nsfi=isup:nsr=is01
ent-scr-sio:sr=si02:nic=2:pri=0:si=4:nsfi=dpc:nsr=dpc4
ent-scr-sio:sr=si02:nic=2:pri=0:si=5:nsfi=dpc:nsr=dpc5
ent-scrset:scrn=ist2:nsr=si02:nsfi=sio
```

In this example screen set configuration, messages are screened by the allowed SIO screen `si02` for either ISUP or TUP messages. ISUP messages are further screened by the allowed DPC screen `dpc5` and TUP messages are screened by the allowed DPC screen `dpc4`. The ISUP messages containing the ANSI point code 001-002-003 are passed onto the allowed ISUP screen `is01`. The TUP messages containing the ANSI point code 007-001-000 are passed onto the allowed ISUP screen `tu01`.

**Note:** The gateway screening rules are entered in reverse of the order that the screening process takes place.

## Allowed ISUP Message Type Screening Actions

*Figure 79: Allowed ISUP Message Type Screening Actions* shows the screening actions of the allowed ISUP message type screen.

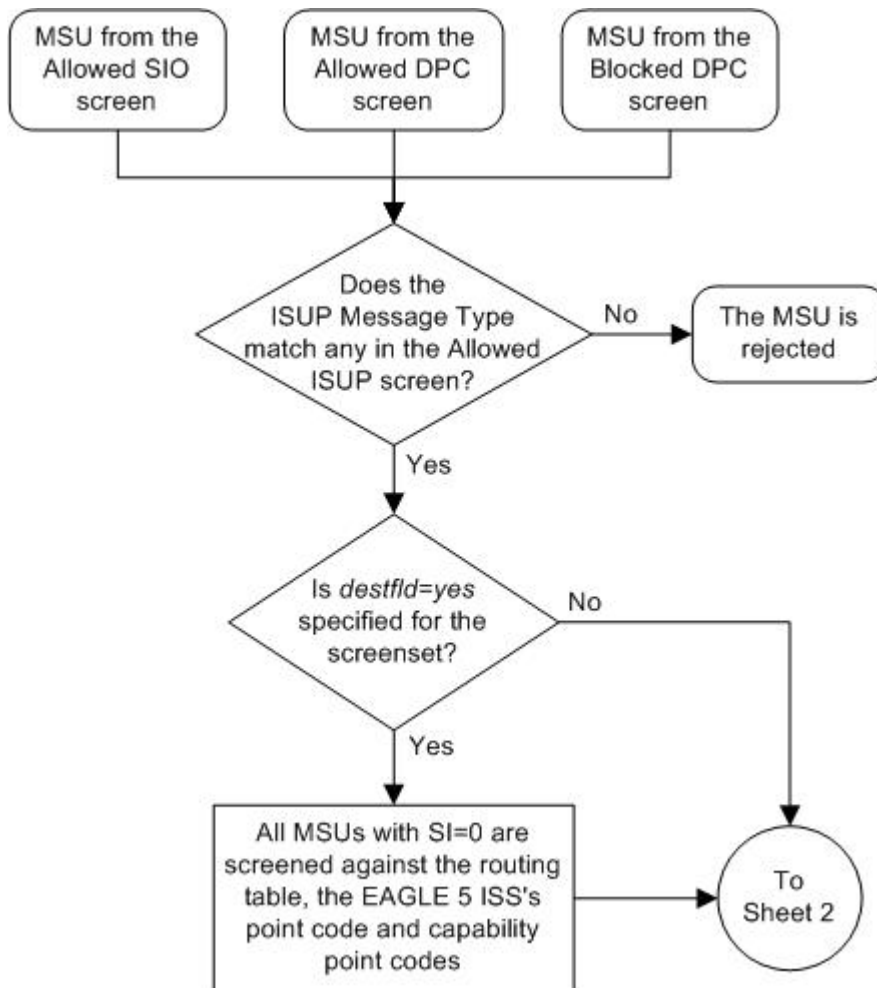

Sheet 1 of 3

Figure 79: Allowed ISUP Message Type Screening Actions



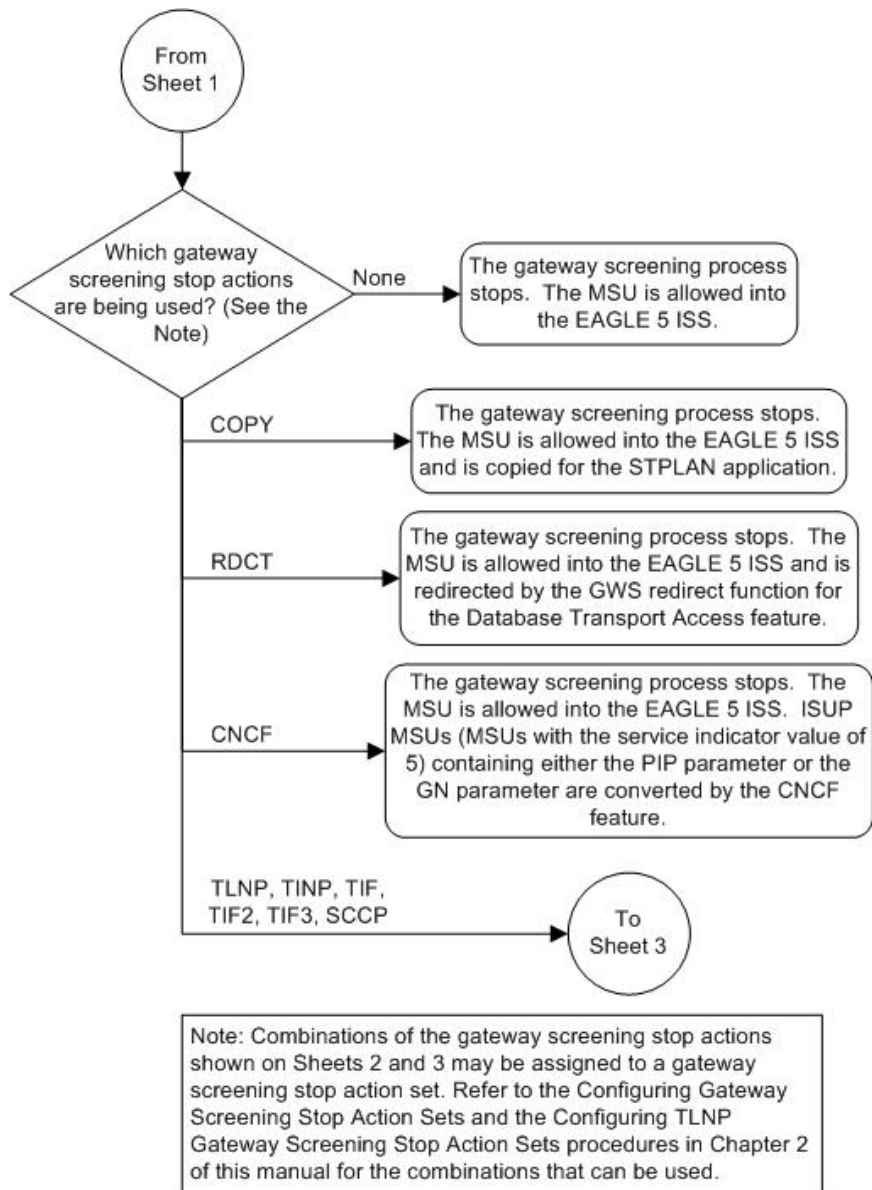

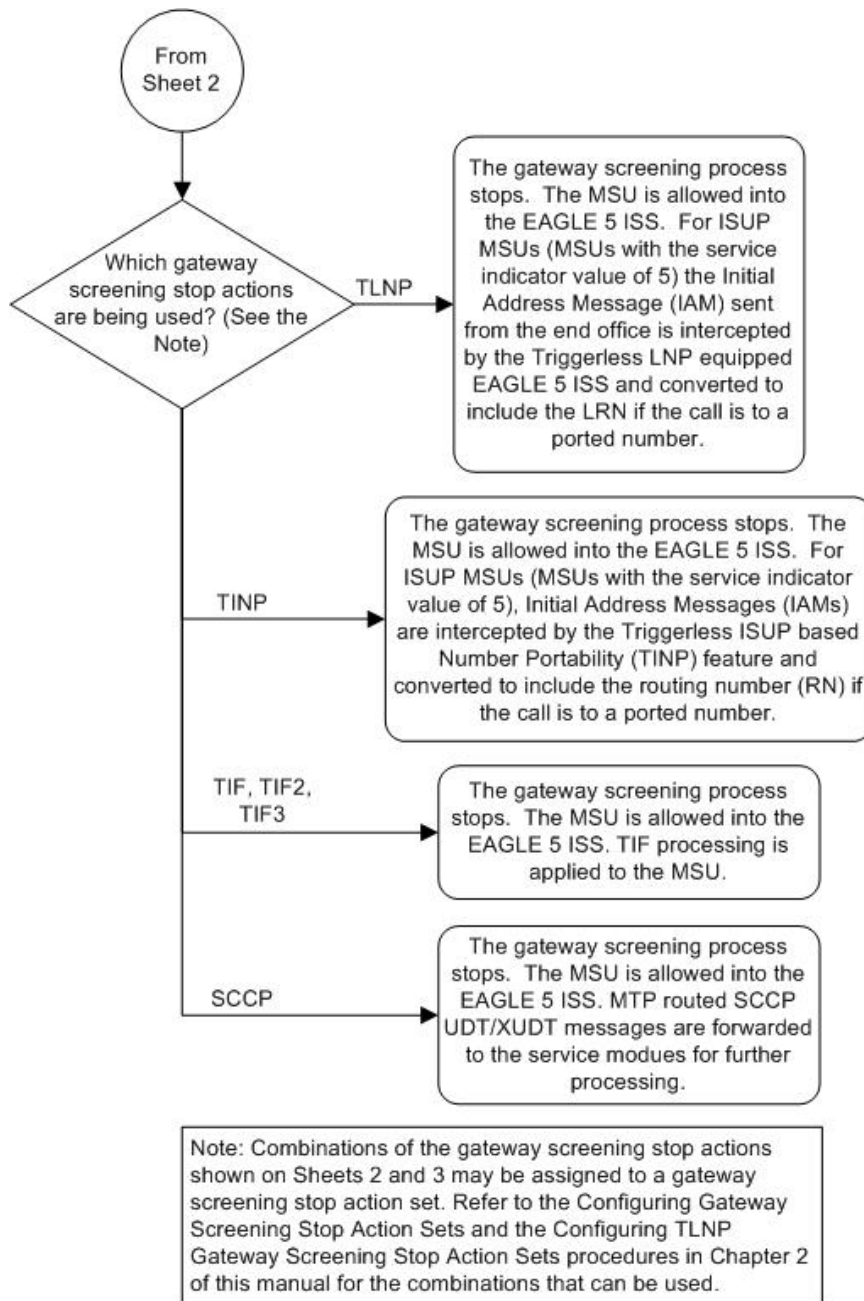

Sheet 3 of 3

ANSI MSU (ANSI Message Signal Unit)									
BSN FSN LI	SIO xx xx xxxx NIC PRI SI	SIF							
		DPC NCM NC NI		Routing Label OPC NCM NC NI		SLS xx	CIC Code	ISUP Message Type	ISUP Data

ITU-I MSU (ITU International Message Signal Unit)									
BSN FSN LI	SIO xx xx xxxx NIC PRI SI	SIF							
		DPC ID AREA ZONE		Routing Label OPC ID AREA ZONE		SLS xx	CIC Code	ISUP Message Type	ISUP Data

14-Bit ITU-N MSU (14-Bit ITU National Message Signal Unit)									
BSN FSN LI	SIO xx xx xxxx NIC PRI SI	SIF							
		DPC NPC		Routing Label OPC NPC		SLS xx	CIC Code	ISUP Message Type	ISUP Data

24-Bit ITU-N MSU (24-Bit ITU National Message Signal Unit)									
BSN FSN LI	SIO xx xx xxxx NIC PRI SI	SIF							
		DPC SP SSA MSA		Routing Label OPC SP SSA MSA		SLS xx	CIC Code	ISUP Message Type	ISUP Data

Figure 80: Allowed ISUP Message Type Screening Function

## Adding an Allowed ISUP Message Type Screen

This procedure is used to add an allowed ISUP message type (ISUP) screen to the database using the `ent-scr-isup` command. The parameters used by the `ent-scr-isup` command are shown in the [Gateway Screening Attributes](#) section. The general rules that apply to configuring gateway screening entities are shown in the [Gateway Screening Configuration](#) section.

Since both ISUP and TUP messages are screened by the allowed ISUP message type screen, the `ent-scr-isup` command contains a parameter for the ISUP message type (`isupmt`) and a parameter for the TUP message type (`tupmt`). Only one of these parameters can be specified for the allowed ISUP screen being entered into the database. The `isupmt` parameter should be specified in screen sets that contain allowed SIO screens that are screening messages for the service indicator value of 5 (SI=5). The `tupmt` parameter should be specified in screen sets that contain allowed SIO screens that are screening messages for the service indicator value of 4 (SI=4). If you wish to screen for TUP messages, make sure that the screen set being configured contains an allowed SIO screen that screens messages for the service indicator value of 4 (SI=4). If you do not do this, the EAGLE will treat the message as an ISUP message, even if the message contains the service indicator value of 4.

The examples in this procedure are used to add the allowed ISUP screen data shown in [Table 87: Example Gateway Screening Allowed ISUP Configuration Table](#) and based on the example configuration

shown in [Figure 9: Gateway Screening Configuration - Example 6](#) and [Figure 10: Gateway Screening Configuration - Example 7](#).

**Table 87: Example Gateway Screening Allowed ISUP Configuration Table**

Screening Reference	ISUPMT	NSFI	ACTNAME
isp1	135	stop	CR
isp2	139	stop	CR
Screening Reference	TUPMT	NSFI	ACTNAME
tup1	100	stop	CR

1. Verify that the gateway screening feature is on, by entering the `rtrv-feat` command.

If the gateway screening feature is on, the `GWS` field is set to `on`.

**Note:** The `rtrv-feat` command output contains other fields that are not used by this procedure. If you wish to see all the fields displayed by the `rtrv-feat` command, see the `rtrv-feat` command description in *Commands User's Guide*.

If the gateway screening feature is on, shown by the entry `GWS = on` in the `rtrv-feat` command output, skip step 2, and go to step 3.

2. Turn the gateway screening feature on by entering this command.

```
chg-feat:gws=on
```

**Note:** Once the gateway screening feature is turned on with the `chg-feat` command, it cannot be turned off.

The gateway screening feature must be purchased before you turn this feature on with the `chg-feat` command. If you are not sure if you have purchased the gateway screening feature, contact your Oracle Sales Representative or Account Representative.

When the `chg-feat` has successfully completed, this message should appear.

```
rlghncxa03w 06-10-28 11:43:04 GMT EAGLE5 36.0.0
CHG-FEAT: MASP A - COMPLTD
```

3. Display all allowed ISUP screens in the database using the `rtrv-scr-isup` command.

The following is an example of the possible output.

```
rlghncxa03w 06-10-25 15:25:30 GMT EAGLE5 36.0.0
SCREEN = ALLOWED ISUP
SR    REF  RULES
IEC   YES   2
WRD2  YES   1
WRD4  YES   1
```

If the screening reference names that you wish to add with this procedure are not shown in the `rtrv-scr-isup` command output, go to step 4. For this example, the screening reference names

are not shown. If these screening reference names are shown in the `rtrv-scr-isup` command output, make sure the screening data you wish to enter is not already in the database by entering the `rtrv-scr-isup` command with the screening reference name. For example, enter the `rtrv-scr-isup:sr=iec` command. The following is an example of the possible output.

```
rlghncxa03w 06-10-25 15:26:30 GMT EAGLE5 36.0.0
SCREEN = ALLOWED ISUP
SR  ISUPMT/  NSFI  NSR/ACT
    TUPMT
iec 100      STOP  cr
iec 197      STOP  cr
```

If a gateway screening stop action set is to be assigned to the allowed ISUP screen being added to the database, go to step 4. Otherwise, go to step 5.

4. Display the gateway screening stop action sets in the database with the `rtrv-gws-actset` command.

This is an example of the possible output.

```
rlghncxa03w 06-10-25 15:28:30 GMT EAGLE5 36.0.0
ACT ACT ACT ACT ACT ACT ACT ACT ACT ACT
ID  NAME  1    2    3    4    5    6    7    8    9    10
--  -----
1   copy  copy
2   rdct  rdct
3   cr    copy rdct
4   cncf  cncf
5   cpcncf copy cncf
6   cncfrd cncf rdct
7   cpcfrd copy cncf rdct
```

GWS action set table is (7 of 16) 44% full

If the required gateway screening stop action set is not in the database, perform the [Configuring Gateway Screening Stop Action Sets](#) procedure to configure the required gateway screening stop action set.

5. Add a new allowed ISUP screen to the database using the `ent-scr-isup` command.

For this example, enter this command.

```
ent-scr-isup:sr=isp1:isupmt=135:nsfi=stop:actname=cr
```

A message similar to the following should appear.

```
rlghncxa03w 06-10-25 15:29:30 GMT EAGLE5 36.0.0
ENT-SCR-ISUP: SCREEN SET AFFECTED - ISP1 1% FULL
ENT-SCR-ISUP: MASP A - COMPLTD
```

```
ent-scr-isup:sr=isp2:isupmt=139:nsfi=stop:actname=cr
```

A message similar to the following should appear.

```
rlghncxa03w 06-10-25 15:29:30 GMT EAGLE5 36.0.0
```

```
ENT-SCR-ISUP: SCREEN SET AFFECTED - ISP2 1% FULL
ENT-SCR-ISUP: MASP A - COMPLTD
```

```
ent-scr-isup:sr=tup1:tupmt=100:nsfi=stop:actname=cr
```

A message similar to the following should appear.

```
rlghncxa03w 06-10-25 15:29:30 GMT EAGLE5 36.0.0
ENT-SCR-ISUP: SCREEN SET AFFECTED - TUP1 1% FULL
ENT-SCR-ISUP: MASP A - COMPLTD
```

If a gateway screening stop action is to be assigned to the allowed ISUP screen being changed, enter the `ent-scr-isup` command with the `nsfi=stop` parameter and the `actname` parameter with the name of a gateway screening stop action set shown in the output of the `rtrv-gws-actset` command executed in step 4. The `isupmt` or `tupmt` parameters can have these values: 0 - 255, or an asterisk (\*). A range of ISUP or TUP message types can be specified with the `ent-scr-isup` command. If a range of ISUP message types is specified, the range of ISUP message types cannot include any ISUP message types that are currently provisioned for the screening reference name. If a range of TUP message types is specified, the range of TUP message types cannot include any TUP message types that are currently provisioned for the screening reference name. For example, screening reference name `scr1` contains these entries:

SR	ISUPMT/ TUPMT	NSFI	NSR/ACT
scr1	115	STOP	cr
scr1	203	STOP	cr

Another entry for screening reference `scr1` cannot be specified if the range of ISUP message types includes the values 115 and 203.

- Verify the changes using the `rtrv-scr-isup` command with the screening reference name used in step 5.

For this example, enter this command.

```
rtrv-scr-isup:sr=isp1
```

The following is an example of the possible output.

```
rlghncxa03w 06-10-25 15:30:30 GMT EAGLE5 36.0.0
SCREEN = ALLOWED ISUP
SR  ISUPMT/  NSFI  NSR/ACT
    TUPMT
isp1 135      STOP  cr
```

```
rtrv-scr-isup:sr=isp2
```

The following is an example of the possible output.

```
rlghncxa03w 06-10-25 15:30:30 GMT EAGLE5 36.0.0
SCREEN = ALLOWED ISUP
SR  ISUPMT/  NSFI  NSR/ACT
```

```
      TUPMT
isp2 139      STOP      cr
```

```
rtrv-scr-isup:sr=tup1
```

The following is an example of the possible output.

```
rlghncxa03w 06-10-25 15:30:30 GMT  EAGLE5 36.0.0
SCREEN = ALLOWED ISUP
SR  ISUPMT/  NSFI  NSR/ACT
      TUPMT
tup1 100      STOP      cr
```

7. Backup the new changes using the `chg-db:action=backup:dest=fixed` command.

The following messages should appear, the active Maintenance and Administration Subsystem Processor (MASP) appears first.

```
BACKUP (FIXED) : MASP A - Backup starts on active MASP.
BACKUP (FIXED) : MASP A - Backup on active MASP to fixed disk complete.
BACKUP (FIXED) : MASP A - Backup starts on standby MASP.
BACKUP (FIXED) : MASP A - Backup on standby MASP to fixed disk complete.
```

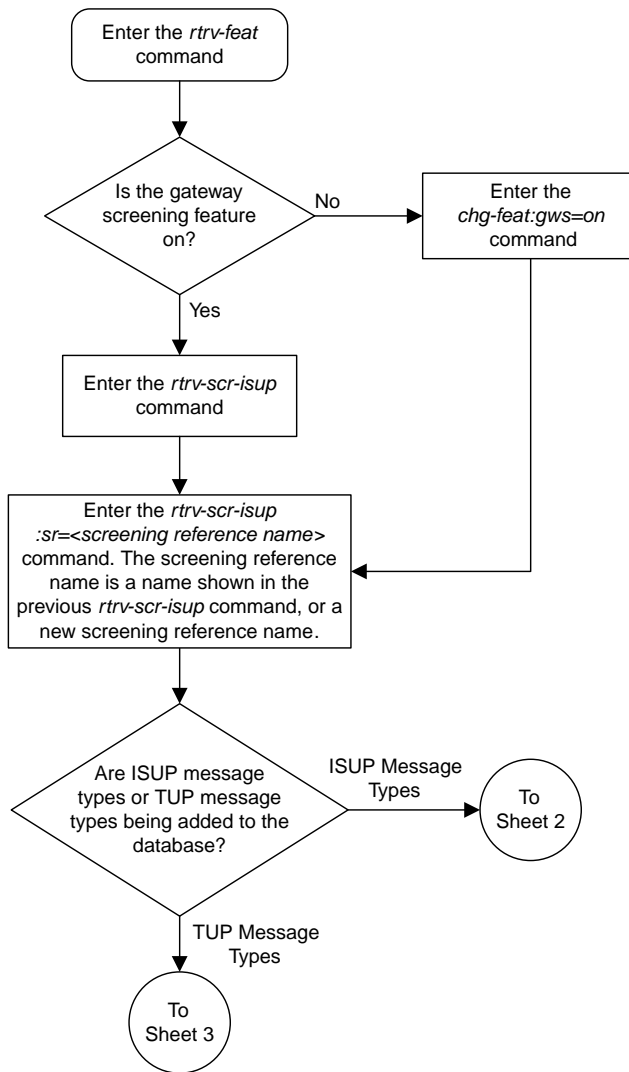



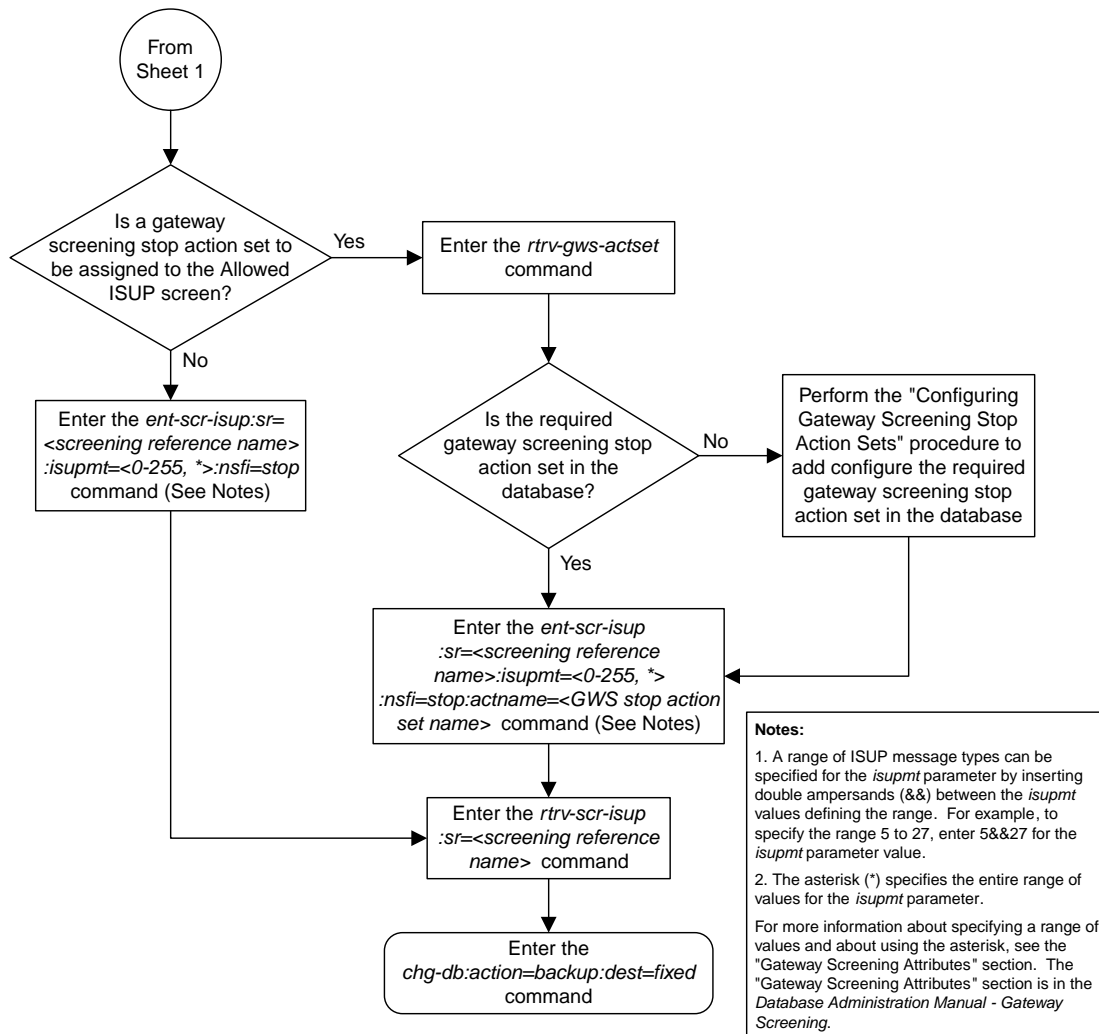

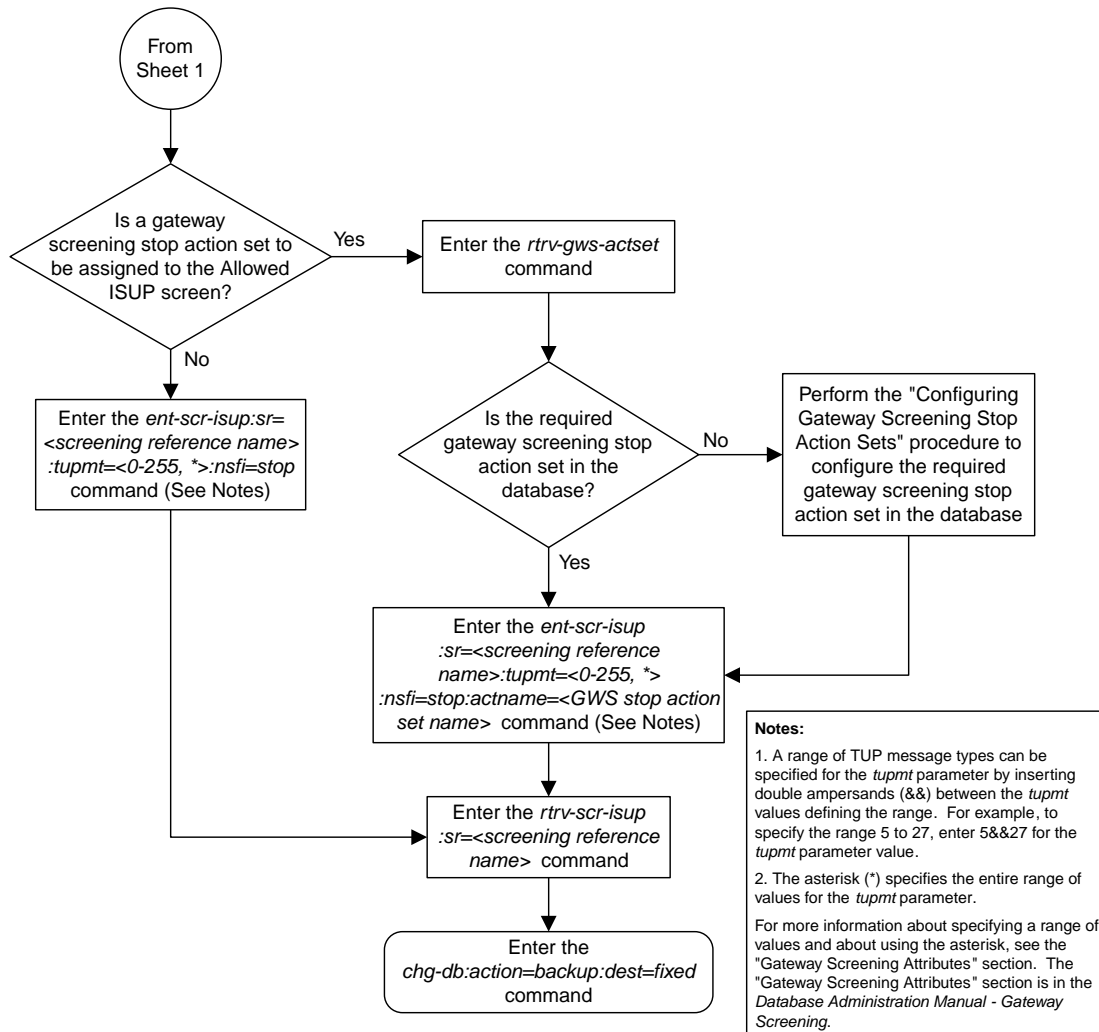

Sheet 3 of 3

**Figure 81: Adding an Allowed ISUP Message Type Screen**

## Removing an Allowed ISUP Message Type Screen

This procedure is used to remove an allowed ISUP message type (ISUP) screen from the database using the `dlt-scr-isup` command. The parameters used by the `dlt-scr-isup` command are shown in the [Gateway Screening Attributes](#) section. The general rules that apply to configuring gateway screening entities are shown in the [Gateway Screening Configuration](#) section.

Since both ISUP and TUP messages are screened by the allowed ISUP message type screen, the `dlt-scr-isup` command contains a parameter for the ISUP message type (`isupmt`) and a parameter for the TUP message type (`tupmt`). Only one of these parameters can be specified for the allowed ISUP screen being removed from the database.

The example in this procedure removes the allowed ISUP screen `isp2` from the database.

The allowed ISUP screen can be referenced by one of the following screens.

- Allowed SIO
- Allowed DPC
- Blocked DPC

### Verifying the Gateway Screening Configuration

Enter the following commands to verify that none of these screens reference the allowed ISUP screen being removed from the database.

- `rtrv-scr-sio:nsfi=isup`
- `rtrv-scr-dpc:nsfi=isup`
- `rtrv-scr-blkdpc:nsfi=isup`

### Gateway Screening Configuration Procedures

To change the NSFI of any of these screens, perform to one of these procedures.

- [Changing an Allowed SIO Screen](#)
- [Changing an Allowed DPC Screen](#)
- [Changing a Blocked DPC Screen](#)

1. Display the allowed ISUP screens in the database using the `rtrv-scr-isup` command.

The following is an example of the possible output.

```
rlghncxa03w 06-10-25 15:25:30 GMT EAGLE5 36.0.0
SCREEN = ALLOWED ISUP
SR    REF  RULES
IEC   YES   2
ISP1  YES   1
ISP2  YES   2
TUP1  YES   1
WRD2  YES   1
WRD4  YES   1
```

From the `rtrv-scr-isup` output, display the allowed ISUP screen you wish to remove using the `rtrv-scr-isup` command with the screening reference name. For this example, enter this command.

```
rtrv-scr-isup:sr=isp2
```

The following is an example of the possible output.

```
rlghncxa03w 06-10-25 15:30:30 GMT EAGLE5 36.0.0
SCREEN = ALLOWED ISUP
SR   ISUPMT/   NSFI   NSR/ACT
      TUPMT
isp2 055       STOP   cr
```

2. Enter the commands in the [Verifying the Gateway Screening Configuration](#) section to verify that the screen being removed is not referenced by other screens in the database.

If the screen being removed is referenced by other screens, perform the procedures shown in the [Gateway Screening Configuration Procedures](#) section to change the NSFI of those screens to reference other screens or change the NSFI of these screens to STOP.

3. Remove the allowed ISUP screen from the database using the `dlt-scr-isup` command.

The current value of the `isupmt` parameter must be entered exactly as shown in the `rtrv-scr-isup` output in step 1. For this example, enter this command.

```
dlt-scr-isup:sr=isp2:isupmt=055
```

A message similar to the following should appear.

```
rlghncxa03w 06-10-25 15:26:30 GMT EAGLE5 36.0.0
DLT-SCR-ISUP: SCREEN SET AFFECTED - FLD5 0% FULL
DLT-SCR-ISUP: MASP A - COMPLTD
```

4. Verify the changes using the `rtrv-scr-isup` command with the screening reference name used in step 3.

For this example, enter this command.

```
rtrv-scr-isup:sr=isp2
```

The following is an example of the possible output.

```
E2573 Cmd Rej: SR or NSR does not reference an existing SR
```

This message shows that the specified screening reference name is not in the database and the action of the `dlt-scr-isup` command in step 3 was successful. If the specified screening reference name contained more than one entry when the `dlt-scr-isup` command was executed in step 3, the `rtrv-scr-isup:sr=` command output would show the remaining entries in the screening reference instead of error message E2573.

5. Backup the new changes using the `chg-db:action=backup:dest=fixed` command.

The following messages should appear, the active Maintenance and Administration Subsystem Processor (MASP) appears first.

```
BACKUP (FIXED) : MASP A - Backup starts on active MASP.  
BACKUP (FIXED) : MASP A - Backup on active MASP to fixed disk complete.  
BACKUP (FIXED) : MASP A - Backup starts on standby MASP.  
BACKUP (FIXED) : MASP A - Backup on standby MASP to fixed disk complete.
```

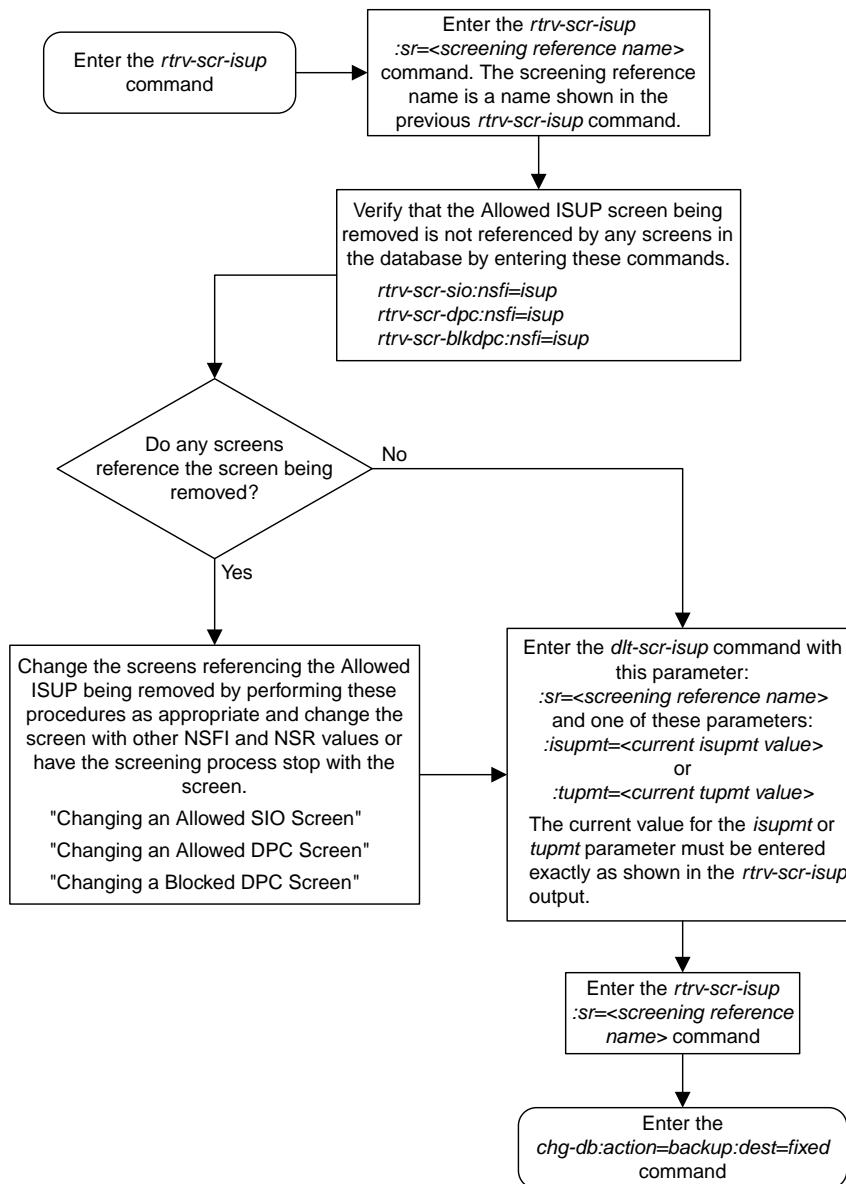

Figure 82: Removing an Allowed ISUP Message Type Screen

## Changing an Allowed ISUP Message Type Screen

This procedure is used to change the attributes of an allowed ISUP message type (ISUP) screen in the database using the `chg-scr-isup` command. The parameters used by the `chg-scr-isup` command are shown in the [Gateway Screening Attributes](#) section. The general rules that apply to configuring gateway screening entities are shown in the [Gateway Screening Configuration](#) section.

The example in this procedure is used to change the ISUP message type 135 for the allowed ISUP screen `isp1` to 075 and to redirect the MSU for the DTA feature.

1. Display the allowed ISUP screens in the database using the `rtrv-scr-isup` command.

The following is an example of the possible output.

```
rlghncxa03w 06-10-25 15:25:30 GMT EAGLE5 36.0.0
SCREEN = ALLOWED ISUP
SR      REF  RULES
IEC     YES   2
ISP1    YES   3
ISP2    YES   2
TUP1    YES   1
WRD2    YES   1
WRD4    YES   1
```

From the `rtrv-scr-isup` output, display the allowed ISUP screen you wish to remove using the `rtrv-scr-isup` command with the screening reference name. For this example, enter this command.

```
rtrv-scr-isup:sr=isp1
```

The following is an example of the possible output.

```
rlghncxa03w 06-10-25 15:30:30 GMT EAGLE5 36.0.0
SCREEN = ALLOWED ISUP
SR      ISUPMT/  NSFI      NSR/ACT
        TUPMT
isp1 002          STOP      copy
isp1 089          STOP      -----
isp1 135          STOP      cr
```

If a gateway screening stop action set is to be assigned to the allowed ISUP screen being changed in the database, go to step 2.

Step 2 verifies the gateway screening stop action set names in the database. If a gateway screening stop action set name will not be assigned to the screen, skip step 2 and go to step 3.

2. Display the gateway screening stop action sets in the database with the `rtrv-gws-actset` command.

This is an example of the possible output.

```
rlghncxa03w 06-10-25 15:26:30 GMT EAGLE5 36.0.0
ACT ACT    ACT ACT  ACT ACT  ACT ACT  ACT ACT  ACT
```

ID	NAME	1	2	3	4	5	6	7	8	9	10
1	copy	copy									
2	rdct	rdct									
3	cr	copy	rdct								
4	cncf	cncf									
5	cpcncf	copy	cncf								
6	cncfrd	cncf	rdct								
7	cpcfrd	copy	cncf	rdct							

GWS action set table is (7 of 16) 44% full

If the required gateway screening stop action set is not in the database, perform the [Configuring Gateway Screening Stop Action Sets](#) procedure to configure the required gateway screening stop action set.

3. Change the attributes of an allowed ISUP screen using the `chg-scr-isup` command.

If a gateway screening stop action is to be assigned to the allowed ISUP screen being changed, enter the `chg-scr-isup` command with the `nsfi=stop` parameter and the `actname` parameter with the name of a gateway screening stop action set shown in the output of the `rtrv-gws-actset` command executed in step 2.

The value of the `isupmt` or `tupmt` parameter must be entered exactly as shown in the `rtrv-scr-isup` output in step 1.

The `nisupmt` or `ntupmt` parameter can have these values: 0 - 255, or an asterisk (\*).

A range of ISUP or TUP message types can be specified with the `chg-scr-isup` command. If a range of ISUP message types is specified, the range of ISUP message types cannot include any ISUP message types that are currently provisioned for the screening reference name. If a range of TUP message types is specified, the range of TUP message types cannot include any TUP message types that are currently provisioned for the screening reference name.

For example, screening reference name `scr1` contains these entries:

SR	ISUPMT/ TUPMT	NSFI	NSR/ACT
scr1	115	STOP	cr
scr1	203	STOP	cr

Another entry for screening reference `scr1` cannot be specified if the range of ISUP message types includes the values 115 and 203. For this example, enter this command.

```
chg-scr-isup:sr=isp1:isupmt=135:nisupmt=075:actname=rdct
```

The following messages appear.

```
rlghncxa03w 06-10-25 15:27:30 GMT EAGLE5 36.0.0
CHG-SCR-ISUP: SCREEN SET AFFECTED - ISP1 1% FULL
CHG-SCR-ISUP: MASP A - COMPLTD
```

4. Verify the changes using the `rtrv-scr-isup` command with screening reference name used in step 3.

For this example, enter this command.



```
rtrv-scr-isup:sr=ispl
```

The following is an example of the possible output.

```
rlghncxa03w 06-10-25 15:30:30 GMT EAGLE5 36.0.0
SCREEN = ALLOWED ISUP
SR   ISUPMT/   NSFI   NSR/ACT
     TUPMT
ispl 002       STOP   copy
ispl 075       STOP   rdct
ispl 089       STOP   -----
```

5. Backup the new changes using the `chg-db:action=backup:dest=fixed` command.

The following messages should appear, the active Maintenance and Administration Subsystem Processor (MASP) appears first.

```
BACKUP (FIXED) : MASP A - Backup starts on active MASP.
BACKUP (FIXED) : MASP A - Backup on active MASP to fixed disk complete.
BACKUP (FIXED) : MASP A - Backup starts on standby MASP.
BACKUP (FIXED) : MASP A - Backup on standby MASP to fixed disk complete.
```

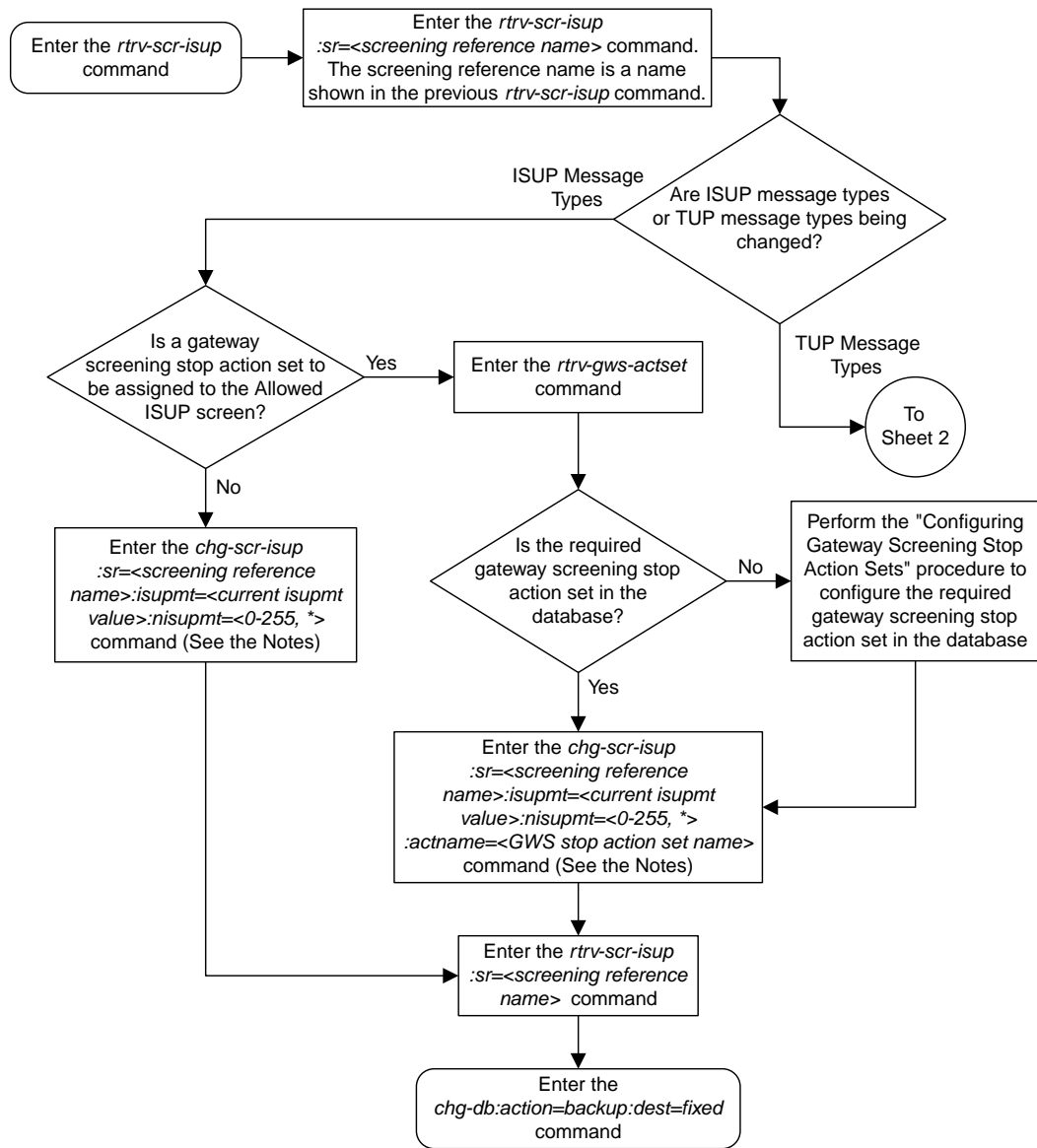

**Notes:**

1. A range of ISUP message types can be specified for the *nisupmt* parameter by inserting double ampersands (&&) between the *isupmt* values defining the range. For example, to specify the range 5 to 27, enter 5&&27 for the *nisupmt* parameter value.
2. The current *isupmt* value must be specified exactly as it is shown in the *rtrv-scr-isup* output.
3. The asterisk (\*) specifies the entire range of values for the *nisupmt* parameter.

For more information about specifying a range of values and about using the asterisk, see the "Gateway Screening Attributes" section in the *Database Administration Manual – Gateway Screening*.

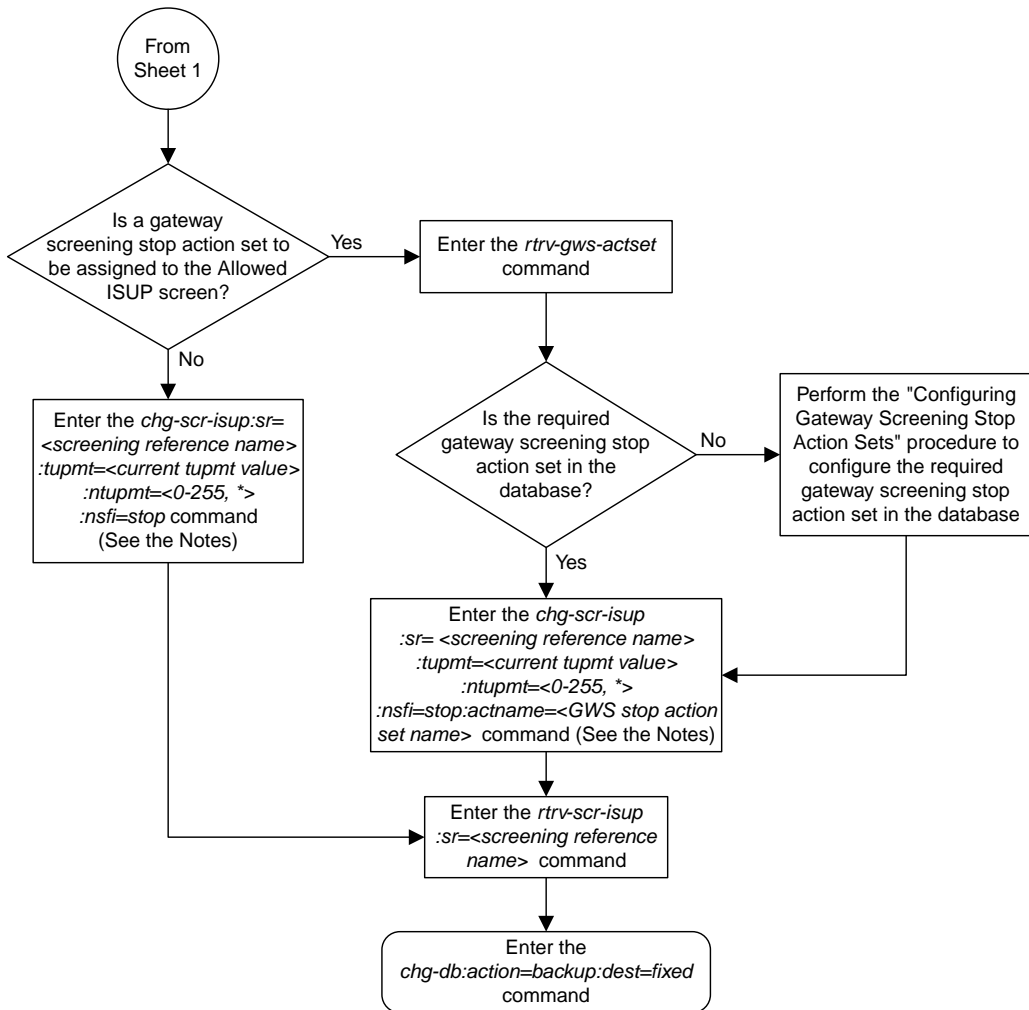

**Notes:**

1. A range of TUP message types can be specified for the *ntupmt* parameter by inserting double ampersands (&&) between the *tupmt* values defining the range. For example, to specify the range 5 to 27, enter 5&&27 for the *ntupmt* parameter value.
2. The current *tupmt* value must be specified exactly as it is shown in the *rtrv-scr-isup* output.
3. The asterisk (\*) specifies the entire range of values for the *ntupmt* parameter.

For more information about specifying a range of values and about using the asterisk, see the "Gateway Screening Attributes" section in the *Database Administration Manual - Gateway Screening*.

Sheet 2 of 2

**Figure 83: Changing an Allowed ISUP Message Type Screen**

## A

ACT	Activate
AFTPC	Affected Point Code The point code in subsystem-prohibited (SSP), subsystem-status-test (SST), and subsystem-allowed (SSA) SCCP management messages used by gateway screening to determine if the messages containing these point codes are allowed in to the network. This point code is in the SCMG Data (SCCP Management) portion of the signaling information field in the MSU.
Allowed Affected Destination Field	The gateway screening entity that identifies the point code in the affected destination field (the concerned signaling point code) of incoming MTP network management messages from another network that are allowed into the EAGLE. Messages containing the specified point code are allowed into the network.
Allowed AFTPC	The gateway screening entity that identifies the messages containing a specific affected point code. Messages containing the specified affected point code are allowed into the network.
Allowed DPC	The gateway screening entity that identifies the destination point codes that are allowed to receive

## A

SS7 messages from the EAGLE. Messages containing the specified destination point codes go on to the next step in the gateway screening process, or are allowed into the network if the gateway screening process stops with this entity.

Allowed ISUP

The gateway screening entity that identifies the ISUP or TUP message types that are allowed into the network.

Allowed OPC

The gateway screening entity that identifies the originating point codes that are allowed to send SS7 messages into the network. Messages containing the specified originating point codes go on to the next step in the gateway screening process, or are allowed into the network if the gateway screening process stops with this entity.

Allowed SIO

The gateway screening entity that identifies the type of MSUs (ISUP, TUP, TCAP, and so forth) that are allowed into the network. The message type is determined by the network indicator code (NIC), priority (PRI), and service indicator (SI) fields of the signaling information octet (SIO) field in the MSU, and the H0 and H1 heading codes of the signaling information field of the MSU. Messages containing the specified message type go on to the next step in the gateway screening process, or are allowed into the network if the gateway screening process stops with this entity.

**A**

Allowed TT	The gateway screening entity that identifies the SCCP messages that have a specified translation type value in the called party address. SCCP messages containing specified translation type in the called party address go on to the next step in the gateway screening process, or are allowed into the network if the gateway screening process stops with this entity.
ANSI	American National Standards Institute An organization that administers and coordinates the U.S. voluntary standardization and conformity assessment system. ANSI develops and publishes standards. ANSI is a non-commercial, non-government organization which is funded by more than 1000 corporations, professional bodies, and enterprises.
APC	Adjacent Point Code The point code that identifies a node adjacent to the EAGLE. This term is used in link sets and routes. Application Processing Chassis

**B**

BLKDPC	Blocked Destination Point Code - The point code that the gateway screening uses to keep MSUs bound for a specific point code out of the network where the EAGLE is located. This point code is in the routing label portion of the signaling information field in the MSU. Messages that do not contain the specified destination point code go on to the next step in the gateway screening process, or are
--------	---

**B**

allowed into the network if the gateway screening process stops with this entity.

BLKOPC

Blocked Originating Point Code -  
The point code that gateway screening uses to keep MSUs coming from a specific point code out of the network where the EAGLE is located. This point code is in the routing label portion of the signaling information field in the MSU. Messages that do not contain the specified originating point code go on to the next step in the gateway screening process, or are allowed into the network if the gateway screening process stops with this entity.

**C**

CNCF

Calling Name Conversion Facility  
CNCF provides a conversion of ISUP IAM messages using calling name identification presentation (CNIP) for calling name information delivery. CNIP uses either non-standard proprietary ISUP party information (PIP) parameter or ANSI standard ISUP generic name (GN) parameter.

CNIP

Calling Name Identification  
Presentation

control cards

Cards that occupy slots 1113 through 1118 of the control shelf on an EAGLE and perform OAM, TDM, and database functions for the EAGLE. The legacy set consists of the single-slot GPSM-II card running the OAM application and EOAM GPL, the single-slot TDM



## C

card, and the dual-slot MDAL card. The E5-based set consists of the dual-slot E5-MASP card (the E5-MCAP module and the E5-TDM module) and the dual-slot E5-MDAL card.

Cards that occupy slots 1113 through 1118 of the control shelf control cards on an EAGLE and perform basic OAM. The E5-based set consists of the dual-slot E5-MASP card (the E5-MCAP module and the E5-TDM module) and the dual-slot E5-MDAL card.

CR

Cluster Routing  
Connection Request

## D

Database

All data that can be administered by the user, including cards, destination point codes, gateway screening tables, global title translation tables, links, LNP services, LNP service providers, location routing numbers, routes, shelves, subsystem applications, and 10-digit telephone numbers.

DESTFLD

The point code in the affected destination field (the concerned signaling point code) of incoming MTP network management messages from another network that are allowed into the EAGLE.

Destination

The node to which the signaling link traffic is routed. This destination is identified by a point code, either a full point code or a cluster point code.

## D

DPC

Destination Point Code - DPC refers to the scheme in SS7 signaling to identify the receiving signaling point. In the SS7 network, the point codes are numeric addresses which uniquely identify each signaling point. This point code can be adjacent to the EAGLE, but does not have to be.

DTA

Database Transport Access - A feature in the EAGLE that encapsulates specific MSUs into the data portion of SCCP within a new SS7 MSU and sends the new MSU to the destination using global title translation. The EAGLE uses gateway screening to determine which MSUs are used by the DTA feature.

## E

E5-MASP card

E5-based dual-slot card that consists of the E5-MCAP module (occupies slot 1113 and slot 1115) and the E5-TDM module (occupies slot 1114 and slot 1116) in an EAGLE control shelf. Used when the E5-MDAL card is used.

E5-MCAP card

The module contains the Communications Processor and Applications Processor and provides connections to the IMT bus. Controls the maintenance and database administration activity and performs both application and communication processing. Runs the OAM application and OAMHC GPL. Occupies slot 1113 and slot 1115 in an EAGLE control shelf. Used when the E5-MDAL card is used. Contains two USB ports.

**E**

E5-MDAL card	The E5 MDAL card processes alarm requests, provides general purpose relays, and provides fan control. Occupies slots 1117 and 1118 in an EAGLE Control Shelf. Used with E5-MASP cards. Does NOT contain a drive for removable cartridges.
E5-TDM card	The E5-TDM card provides the EAGLE with 16 ports for user terminals, contains fixed disk storage and distributes Composite Clocks and High Speed Master clocks throughout the EAGLE. Occupies slot 1114 and slot 1116 in an EAGLE Control Shelf. Used when the E5-MDAL card is used.
EPAP	EAGLE Application Processor

**F**

flush-mounted USB port	USB port on the E5-MCAP card; used with credit card flash memory drives for upgrades and could be used for disaster recovery.
FR	Family of Requirement

**G**

GLS	Generic Loading Services An application that is used by the TSM cards for downloading gateway screening to LIM cards.
GN	Generic Name
GPL	Generic Program Load

## G

Software that allows the various features in the system to work. GPLs and applications are not the same software.

G-Port

GSM Mobile Number Portability

A feature that provides mobile subscribers the ability to change the GSM subscription network within a portability cluster, while retaining their original MSISDN(s).

GT

Global Title Routing Indicator

GTT

Global Title Translation

A feature of the signaling connection control part (SCCP) of the SS7 protocol that the EAGLE uses to determine which service database to send the query message when an MSU enters the EAGLE and more information is needed to route the MSU. These service databases also verify calling card numbers and credit card numbers. The service databases are identified in the SS7 network by a point code and a subsystem number.

GWS

Gateway Screening

Used at gateway STPs to limit access into the network to authorized users. A gateway STP performs inter-network routing and gateway screening functions. GWS controls access to nonhome SS7 networks. Only an MSU that matches predefined criteria in the EAGLE database is allowed to enter the EAGLE.

**G**

GWSA	Gateway Screening Action Gateway Screening Application
GWSD	Gateway Screening Message Discard
GWSM	Gateway Screening Messages Gateway Screening Mode

**H**

HC-MIM	High Capacity Multi-Channel Interface Module  A card that provides access to eight E1/T1 ports residing on backplane connectors A and B. Each data stream consists of 24 T1 or 31 E1 DS0 signaling links assigned in a time-division multiplex (TDM) manner. Each channel occupies a unique timeslot in the data stream and can be selected as a local signaling link on the interface card. Each card has 8 E1 or 8 T1 port interfaces with a maximum of 64 signaling links provisioned among the 8 E1/T1 ports.
--------	--

**I**

IAM	Initial Address Message  Ensures the services offered are compatible with the reception devices, and can be used. For example, IAM prevents a phone being connected to a facsimile.
ID	Identity Identifier
IEC	Inter-Exchange Carrier

**I**

International Escape Code

ISUP

ISDN User Part

The ISDN-specific part of the transmission with additional information via a signaling channel between exchanges.

ITU

International Telecommunications Union

An organization that operates worldwide to allow governments and the private telecommunications sector to coordinate the deployment and operating of telecommunications networks and services. The ITU is responsible for regulating, coordinating and developing international telecommunications, and for harmonizing national political interests.

**L**

latched USB port

On the E5-MCAP card, a USB port with a lockable latch. Used with removable media (flash memory "thumb" drives) to install and back up customer data.

LIM

Link Interface Module

Provides access to remote SS7, IP, and other network elements such as a Signaling Control Point (SCP) through a variety of signaling interfaces (DS0, MPL, E1/T1 MIM, LIM-ATM, E1-ATM, IPLIMx, IPGWx). The LIMs consist of a main assembly and possibly, an interface appliqué board. These appliqué provide level one and

**L**

some level two functionality on SS7 signaling links.

Link

Signaling Link

Carries signaling within a Link Set using a specific Association. A Link can belong to only one Link Set and one Association. There is generally one Link per Association in a Link Set.

LNP

Local Number Portability

The ability of subscribers to switch local or wireless carriers and still retain the same phone number.

LST

Link Set Type

**M**

MAS

Maintenance and Administration Subsystem

A set of cards located in the Control Shelf, used to provide a central management point for the EAGLE. The MAS provides user interface, maintenance communication, peripheral services, alarm processing, system disk interface, and measurements using the following three subassemblies: GPSM-II, TDM, and MDAL.

MASP

Maintenance and Administration Subsystem Processor

The Maintenance and Administration Subsystem Processor (MASP) function is a logical pairing of the GPSM-II card and the TDM card. The GPSM-II card is connected to the TDM card

## M

by means of an Extended Bus Interface (EBI) local bus.

The MDAL card contains the removable cartridge drive and alarm logic. There is only one MDAL card in the Maintenance and Administration Subsystem (MAS) and it is shared between the two MASPs.

MSA

Metropolitan Statistical Areas  
Main Signaling Area

MSU

Message Signal Unit

The SS7 message that is sent between signaling points in the SS7 network with the necessary information to get the message to its destination and allow the signaling points in the network to set up either a voice or data connection between themselves. The message contains the following information:

- The forward and backward sequence numbers assigned to the message which indicate the position of the message in the traffic stream in relation to the other messages.
- The length indicator which indicates the number of bytes the message contains.
- The type of message and the priority of the message in the signaling information octet of the message.
- The routing information for the message, shown in the routing label of the message, with the identification of the node that sent message (originating point code), the identification of the node receiving the message



## M

(destination point code), and the signaling link selector which the EAGLE uses to pick which link set and signaling link to use to route the message.

MTP

Message Transfer Part

The levels 1, 2, and 3 of the SS7 protocol that control all the functions necessary to route an SS7 MSU through the network

Module Test Plan

## N

NC

Network Cluster

Network Code

Not Compliant

North Carolina

NCM

Network Cluster Member

NI

Network Indicator

NIC

Network Identifier Code

Network Information Center

Network Interface Card

Computer hardware that enables computers to communicate with one another over a computer network. Also called a network card or a network adapter.

NP

Number Plan

Numbering Plan

Number Portability

A capability that permits telecommunications users to maintain the same telephone access

**N**

number as they change telecommunication suppliers.

NPC

National Point Code

NSR

Next Screening Reference

**O**

OPC

Within an SS7 network, the point codes are numeric addresses which uniquely identify each signaling point. The OPC identifies the sending signaling point.

**P**

PIP

Party Information Parameter

PRI

Primary Rate Interface  
Primary Rate ISDN  
Priority

**R**

removable media

Flash memory or "thumb" drives used in the latched USB port on an E5-MCAP card for installation and backup of customer data.

RI

Routing Indicator

RN

Routing Number

The number provided by the Freephone Service Provider (FSP) to the Access Service Provider (ASP) to enable a pre-determined routing of traffic to a specific network/carrier/customer.

**R**

RSP

Route Set Test

Prohibited message.

Remote Signaling Point

Represents an SS7 network node (point code) that signaling must be sent to. An RSP has an SS7 domain (ANSI, ITUI, ITUN), a point code, and an optional Adjacent Server Group.

Remote Signaling Point

A logical element that represents a unique point code within a particular SS7 domain with which the SS7 application's Local Signaling Point interacts.

RSR

Reset Request

Route Set Test

Restricted message.

**S**

SCCP

Signaling Connection Control Part

The signaling connection control part with additional functions for the Message Transfer Part (MTP) in SS7 signaling. Messages can be transmitted between arbitrary nodes in the signaling network using a connection-oriented or connectionless approach.

SCMG

SCCP Management

SCMG manages the status of subsystems and SCCP-capable signaling points (SPs). It maintains the status of remote SCCP SPs and that of local subsystems.

## S

SCP	<p>Secure Copy</p> <p>Service Control Point</p> <p>SCPs are network intelligence centers where databases or call processing information is stored. The primary function of SCPs is to respond to queries from other SPs by retrieving the requested information from the appropriate database, and sending it back to the originator of the request.</p>
SCR	<p>service-configuration request</p>
Screen Set	<p>A gateway screening table containing a list of rules, or screening references. The screening references indicate the screening action that is to be performed on a message in a specific linkset.</p>
Screening Reference	<p>The name of each entry in the gateway screening tables. Combined with the next screening function identifier (NSFI), it uniquely defines a screening table. This field is used with all screening functions except the screen set screening function.</p>
SCRN	<p>Screen Set Name</p>
SEAS	<p>Signaling Engineering and Administration System</p> <p>An interface defined by Bellcore and used by the Regional Bell Operating Companies (RBOCs), as well as other Bellcore Client Companies (BCCs), to remotely administer and monitor the</p>

## S

signaling points in their network from a central location.

SI

Service Indicator

SIF

Service Information Field

MTP Service Information Field is the payload field of an SS7 MSU header. The first byte of the SIF is the start of the MTP3 routing label. For MTP3-variant networks, the maximum SIF size is 272 bytes. For MTP3b-variant networks, the maximum SIF size is 4095 bytes.

SIO

Service Information Octet

The network indicator code (NIC), priority (PRI), and service indicator (SI) in the SIO field in the message signaling unit (MSU). This information identifies the type of MSU (ISUP, TCAP, and so forth) that is allowed in the network where the EAGLE is located.

SLTA

Signaling Link Test  
Acknowledgment

SLTM

Signal Link Test Message

SP

Service Provider

Signaling Point

A set of signaling equipment represented by a unique point code within an SS7 domain.

Spare Point Code

The EAGLE ITU  
International/National Spare Point

## S

Code feature allows a network operator to use the same Point Codes across two networks (either ITU-I or ITU-N). The feature also enables National and National Spare traffic to be routed over the same linkset. The EAGLE uses the MSU Network Indicator (NI) to differentiate the same point code of one network from the other. In accordance with the SS7 standard, unique Network Indicator values are defined for Point Code types ITU-I, ITU-N, ITU-I Spare, and ITU-N Spare.

SR

Screening Reference

SS7

Signaling System #7

A communications protocol that allows signaling points in a network to send messages to each other so that voice and data connections can be set up between these signaling points. These messages are sent over its own network and not over the revenue producing voice and data paths. The EAGLE is an STP, which is a device that routes these messages through the network.

SSA

Subsystem Allowed

SSN

SS7 Subsystem Number

The subsystem number of a given point code. The subsystem number identifies the SCP application that should receive the message, or the subsystem number of the destination point code to be assigned to the LNP subsystem of the EAGLE.

## S

## Subsystem Number

A value of the routing indicator portion of the global title translation data commands indicating that no further global title translation is required for the specified entry.

## Subsystem Number

Used to update the CdPA.

## SSP

Subsystem Prohibited network management message

Subsystem Prohibited SCCP (SCMG) management message. (CER)

Service Switching Point (SS7 Network)

Signal Switching Point

Signal Switching Points are switches that originate, terminate, or tandem calls. An SSP sends signaling messages to other SSPs to setup, manage, and release voice circuits required to complete a call.

## SST

Secondary State

The secondary state of the specified entity.

Subsystem Status Test

Subsystem Status Test network management message.

Subsystem Status Test SCCP (SCMG) management message. (CER)

## STPLAN

Signaling Transfer Point Local Area Network

The application used by the SLAN card and E5-SLAN card to support the STP LAN feature. This

## S

application does not support 24-bit ITU-N point codes.

## T

TCAP

Transaction Capabilities  
Application Part

A protocol in the SS7 protocol suite that enables the deployment of advanced intelligent network services by supporting non-circuit related information exchange between signaling points using the Signaling Connection Control Part connectionless service. TCAP also supports remote control - ability to invoke features in another remote network switch.

TFA

TransFer Allowed (Msg)

TFC

Transfer Control  
TransFer Controlled (Msg)  
Transfer Congested

TFP

TransFer Prohibited (Msg)  
A procedure included in the signaling route management (functionality) used to inform a signaling point of the unavailability of a signaling route.

TFR

Transfer Restricted

TIF

Triggerless ISUP Framework

TINP

Triggerless ISUP based Number  
Portability



**T**

TLNP	Triggerless LNP
Translation Type	See TT.
Triggerless LNP	A feature that gives service providers a method to route calls to ported numbers without having to upgrade their signaling switch (end office or mobile switching center) software. This feature uses the gateway screening stop action TLNP to intercept through-switched ISUP messages on the LIM.
TSM	Translation Services Module Provides translation capability and Global Title Translation (GTT) implementation for the Local Number Portability (LNP) function and is used for downloading gateway screening tables to link interface modules (LIMs).
TT	Translation Type Resides in the Called Party Address (CdPA) field of the MSU and determines which service database is to receive query messages. The translation type indicates which Global Title Translation table determines the routing to a particular service database.
TUP	Telephone User Part

**U**

UAM	Unsolicited Alarm Message
-----	---------------------------

## U

A message sent to a user interface whenever there is a fault that is service-affecting or when a previous problem is corrected. Each message has a trouble code and text associated with the trouble condition.

UDT

Unitdata Transfer

UDTS

Unitdata Transfer Service

An error response to a UDT message.

UIM

Unsolicited Information Message

A message sent to a user interface whenever there is a fault that is not service-affecting or when a previous problem is corrected. Each message has a trouble code and text associated with the trouble condition.

Unified Inventory Management

UPU

User Part Unavailable

An MTP3 management message.

USB port

Receptacle for flash memory drives on personal computers. On the E5-MDAL card, a flush-mounted USB port used with credit card flash memory drives for upgrade. On the E5-MCAP card, a latched USB port for use with flash memory "thumb" drives for installation and backup of customer data.

## X

X

XUDT

Extended Unit Data  
Extended User Data

XUDTS

Extended Unitdata Service message  
An error response to an XUDT message.