

**Oracle® Communications
EAGLE**

TIF User's Guide

Release 46.4

E79829 Revision 1

December 2016

Oracle Communications EAGLE TIF User's Guide, Release 46.4

Copyright © 1993, 2016, Oracle and/or its affiliates. All rights reserved.

This software and related documentation are provided under a license agreement containing restrictions on use and disclosure and are protected by intellectual property laws. Except as expressly permitted in your license agreement or allowed by law, you may not use, copy, reproduce, translate, broadcast, modify, license, transmit, distribute, exhibit, perform, publish, or display any part, in any form, or by any means. Reverse engineering, disassembly, or decompilation of this software, unless required by law for interoperability, is prohibited.

The information contained herein is subject to change without notice and is not warranted to be error-free. If you find any errors, please report them to us in writing.

If this is software or related documentation that is delivered to the U.S. Government or anyone licensing it on behalf of the U.S. Government, then the following notice is applicable:

U.S. GOVERNMENT END USERS: Oracle programs, including any operating system, integrated software, any programs installed on the hardware, and/or documentation, delivered to U.S. Government end users are "commercial computer software" pursuant to the applicable Federal Acquisition Regulation and agency-specific supplemental regulations. As such, use, duplication, disclosure, modification, and adaptation of the programs, including any operating system, integrated software, any programs installed on the hardware, and/or documentation, shall be subject to license terms and license restrictions applicable to the programs. No other rights are granted to the U.S. Government.

This software or hardware is developed for general use in a variety of information management applications. It is not developed or intended for use in any inherently dangerous applications, including applications that may create a risk of personal injury. If you use this software or hardware in dangerous applications, then you shall be responsible to take all appropriate fail-safe, backup, redundancy, and other measures to ensure its safe use. Oracle Corporation and its affiliates disclaim any liability for any damages caused by use of this software or hardware in dangerous applications.

Oracle and Java are registered trademarks of Oracle and/or its affiliates. Other names may be trademarks of their respective owners.

Intel and Intel Xeon are trademarks or registered trademarks of Intel Corporation. All SPARC trademarks are used under license and are trademarks or registered trademarks of SPARC International, Inc. AMD, Opteron, the AMD logo, and the AMD Opteron logo are trademarks or registered trademarks of Advanced Micro Devices. UNIX is a registered trademark of The Open Group.

This software or hardware and documentation may provide access to or information about content, products, and services from third parties. Oracle Corporation and its affiliates are not responsible for and expressly disclaim all warranties of any kind with respect to third-party content, products, and services unless otherwise set forth in an applicable agreement between you and Oracle. Oracle Corporation and its affiliates will not be responsible for any loss, costs, or damages incurred due to your access to or use of third-party content, products, or services, except as set forth in an applicable agreement between you and Oracle.

Table of Contents

Chapter 1: Introduction.....	10
Overview.....	11
Scope and Audience.....	11
Documentation Admonishments.....	11
Manual Organization.....	12
My Oracle Support (MOS).....	13
Emergency Response.....	13
Related Specifications.....	14
Customer Training.....	14
Locate Product Documentation on the Oracle Help Center Site.....	14
Chapter 2: Triggerless ISUP Framework (TIF).....	15
TIF Description.....	16
TIF Features.....	18
TIF Configuration Options.....	19
TIF Services That Call NPP.....	23
NPP Conditioning Actions.....	23
NPP Service Actions.....	25
NPP Formatting Actions.....	29
Protocol Handling.....	30
TIF Post-NPP Processing.....	36
RTDB Lookup.....	38
IAM/SAM Splitting.....	42
MSU Sequencing.....	43
ISUP Decode and Encode Errors.....	43
Hardware Requirements.....	44
MPS/EPAP Platform.....	44
Chapter 3: TIF Features.....	45
TIF Number Portability Feature.....	46
TIF NP Message Flows.....	46
TIF NP Configuration Options.....	51
TIF NP Protocol Handling.....	51

TIF Pre-NPP Processing for TIF NP.....	51
TIF NP Service Action Handlers.....	51
TIF Post-NPP Processing for TIF NP	63
TIF Number Substitution Feature.....	63
TIF NS Message Flows.....	64
TIF NS Basic Use Cases.....	64
TIF NS Configuration Options.....	66
TIF NS Handling of IAM Message.....	66
TIF NS Protocol Handling.....	66
TIF Pre-NPP Processing for TIF NS.....	67
TIF NS Service Action Handlers.....	67
TIF Post-NPP Processing for TIF NS	70
TIF Simple Number Substitution Feature	70
TIF SNS Message Flows.....	70
TIF SNS Basic Use Cases.....	71
TIF SNS Configuration Option.....	72
TIF SNS Protocol Handling.....	72
TIF SNS Service Action Handlers.....	73
TIF SCS Forwarding Feature.....	74
TIF Additional Subscriber Data Feature	75
TIF ASD Message Flows.....	77
TIF ASD Service Action Handlers.....	78
TIF Generic Routing Number Feature	80
TIF GRN Message Flows.....	82
TIF GRN Service Action Handlers.....	83
TIF Blacklist Features.....	85
NPP Service Action Data.....	86
TIF Blacklist Message Flow.....	87
TIF Subscr CgPN Blacklist Feature.....	87
TIF Range CgPN Blacklist Feature.....	89
TIF Selective Screening Feature.....	91
TIF Blacklist Post-NPP Processing.....	95

Chapter 4: EAGLE TIF Commands.....96

EAGLE Commands for TIF Features.....	97
--------------------------------------	----

Chapter 5: TIF Feature Configuration.....100

Introduction.....	101
EPAP Entity Provisioning.....	101
System Prerequisites.....	101

TIF Feature Prerequisites and Considerations.....	102
TIF Configuration Procedure.....	103
Enabling TIF Features.....	103
Enabling the Service Portability Feature.....	105
Provisioning the TIF and SCCP Options.....	106
Provisioning the Destination-based Options for TIF.....	106
Provisioning NPP for TIF.....	107
Turning On TIF Features.....	108
Turning On the Service Portability Feature.....	109
Turning Off TIF Features.....	110
Turning Off the Service Portability Feature.....	110
TIF Test Tool.....	111
Chapter 6: Measurements.....	113
TIF Measurements.....	114
Chapter 7: Maintenance	117
Alarms.....	118
TIF UIMs.....	118
Maintenance Commands.....	119
rept-stat-sccp.....	120
Debug Commands.....	120
Status Reporting and Problem Identification.....	121
EPAP Status and Alarm Reporting.....	123
Glossary.....	125

List of Figures

Figure 1: TIF Overview.....	17
Figure 2: TIF Stop Action Processing.....	31
Figure 3: SCRC Processing of TIF Messages.....	33
Figure 4: TIF Service Module Processing Main Flow.....	34
Figure 5: Basic NPP Processing.....	36
Figure 6: TIF Post-NPP Results Handler.....	38
Figure 7: ISUP Message Flows for TIF NP CdPN Relay.....	46
Figure 8: ISUP Message Flows for TIF NP CdPN Relay, with Optional NM Bits.....	47
Figure 9: ISUP Message Flows for TIF NP CgPN Portability.....	47
Figure 10: ISUP Message Flows for TIF NP CgPN with NPRELAY and CGPNNP.....	48
Figure 11: ISUP Message Flows for TIF NP Release.....	48
Figure 12: ISUP Message Flows for TIF NP Release, with Optional NM bits.....	49
Figure 13: ISUP Message Flows for TIF CRP.....	50
Figure 14: ISUP Message Flows for Service Portability.....	50
Figure 15: ISUP Message Flows for NPRLS + NPRELAY.....	51
Figure 16: NP Service Action Precedence.....	52
Figure 17: ISUP RELAY with TIF NS.....	64
Figure 18: ISUP RELAY with TIF NS - No CgPN Substitution.....	64
Figure 19: ISUP RELAY with TIF NS - No CdPN Substitution.....	64
Figure 20: TIF NS Basic Operation for TIF CdPN Service.....	65
Figure 21: TIF NS Basic Operation for TIF CgPN Service.....	66
Figure 22: ISUP Message Flows for TIF SNS.....	71

Figure 23: TIF SNS Basic Operation for TIF CdPN Service.....	71
Figure 24: TIF SNS Basic Operation for TIF CgPN Service.....	72
Figure 25: ISUP IAM Message Flows for TIF ASD for TIF CdPN Service.....	77
Figure 26: ISUP REL Message Flow for TIF ASD for TIF CdPN Service with NPRLS and NPNRLS SAs.....	77
Figure 27: ISUP IAM Message Flow for TIF ASD for CgPN Service.....	78
Figure 28: ISUP IAM Message Flows for TIF GRN for TIF CdPN Service.....	82
Figure 29: ISUP REL Message Flow for TIF GRN for TIF CdPN Service with NPRSL and NPNRLS.....	83
Figure 30: ISUP IAM Message Flows for TIF GRN for TIF CgPN Service.....	83
Figure 31: TIF Blacklist Basic Message Flow.....	87

List of Tables

Table 1: Admonishments.....	12
Table 2: TIF Features.....	18
Table 3: TIF Configuration Options.....	19
Table 4: SCCOPTS Configuration Option used by TIF.....	22
Table 5: Destination-based Configuration Options.....	23
Table 6: GWS Stop Action Mapping to CdPN Service Name to CgPN Service Name.....	23
Table 7: TIF ACCgPN Conditioning Action.....	24
Table 8: TIF ACCgPNx Conditioning Actions.....	24
Table 9: Service Actions used by TIF Features.....	25
Table 10: Mutually Exclusive TIF Service Actions.....	27
Table 11: Unusual Service Action Behavior.....	28
Table 12: Formatting Actions Provided by TIF CdPN Services.....	29
Table 13: Formatting Actions - TIF Selective Screening.....	30
Table 14: TIF Stop Action Rules.....	31
Table 15: Portability Types Relevant to NP Lookups.....	39
Table 16: Possible Lookup Results.....	39
Table 17: RTDB Success Criteria for NP Type with MATCHSEQ=NPTYPE.....	40
Table 18: RTDB Success Criteria for NP Type with MATCHSEQ=DN.....	41
Table 19: Summary of TIF NP Service Actions.....	52
Table 20: Rules for Determining Outbound RN and SP	54
Table 21: NM Bits Values.....	54
Table 22: TIF NP Service Portability Digit Formatting Scenarios.....	56

Table 23: Scenarios for Combining the NPRELAY and NPRLS Service Actions.....	57
Table 24: Summary of TIF NS Service Actions.....	67
Table 25: NPP Service Actions used by TIF ASD.....	78
Table 26: NPP Service Actions used by TIF GRN.....	83
Table 27: NPP Service Actions that Support SA Data.....	86
Table 28: Summary of TIF Subscr CgPN Blacklist Service Actions.....	88
Table 29: Summary of TIF Range CgPN Blacklist Service Actions.....	90
Table 30: Summary of TIF Selective Screening Service Actions.....	92
Table 31: Commands used for TIF Features.....	97
Table 32: System Prerequisites.....	101
Table 33: TIF Feature Prerequisite.....	102
Table 34: TIF Test Tool Parameters.....	112
Table 35: TIF IAM Measurements.....	114
Table 36: TIF UIMs.....	118
Table 37: Existing ISUP Decode Errors.....	118
Table 38: Maintenance Commands.....	119
Table 39: Status Reporting for EPAP-Related Features.....	121

Chapter 1

Introduction

Topics:

- *Overview.....11*
- *Scope and Audience.....11*
- *Documentation Admonishments.....11*
- *Manual Organization.....12*
- *My Oracle Support (MOS).....13*
- *Emergency Response.....13*
- *Related Specifications.....14*
- *Customer Training.....14*
- *Locate Product Documentation on the Oracle Help Center Site.....14*

This chapter contains a brief description of the Triggerless ISUP Framework (TIF) and the features that use TIF. The chapter also includes the scope, audience, and organization of the manual; how to find related publications; and how to contact Oracle for assistance.

Overview

The Triggerless ISUP Framework (TIF) and the Oracle Communications EAGLE features that use TIF (see [TIF Features](#)), along with the Numbering Plan Processor (NPP), provide the following capabilities to support ISUP Number Portability:

- Complex prefix usage, where prefixes can be used to customize actions
- Non-NAI-compliant digit handling
- Complex outgoing digit formats
- Called Number Portability
- Calling Number Portability
- Concurrent Release and Relay support
- Circular route prevention
- Calling Party Number Substitution
- Called Party Number Substitution
- Simple Called Number Substitution
- Message Forwarding to SCS
- Calling Party Blacklisting
- Called Party Blacklisting
- TIF Selective Screening

The Service Portability feature also extends number portability to allow a subscriber to move from one technology to another within the same provider.

Most of the TIF features require Oracle Communications EAGLE Application Processor Provisioning (EPAP) provisioning data from the Real Time Database (RTDB). Subscriber data is transferred from customer databases to the EPAP. The EPAP formats the RTDB and loads the RTDB to each Service Module card on the EAGLE. The RTDB data is used in obtaining Number Portability information and in determining how to correctly format the outgoing message.





Scope and Audience

This manual is intended for anyone responsible for installing, maintaining, and using the features of the Oracle Communications EAGLE that use the Triggerless ISUP Framework (TIF). Users of this manual and the other manuals in the EAGLE family of documents must have a working knowledge of telecommunications and network installations.

Documentation Admonishments

Admonishments are icons and text throughout this manual that alert the reader to assure personal safety, to minimize possible service interruptions, and to warn of the potential for equipment damage.

Table 1: Admonishments

Icon	Description
 DANGER	Danger: (This icon and text indicate the possibility of <i>personal injury</i> .)
 WARNING	Warning: (This icon and text indicate the possibility of <i>equipment damage</i> .)
 CAUTION	Caution: (This icon and text indicate the possibility of <i>service interruption</i> .)
 TOPPLE	Topple: (This icon and text indicate the possibility of <i>personal injury and equipment damage</i> .)

Manual Organization

This document is organized into the following chapters:

- [Introduction](#) contains general information about the TIF documentation, the organization of this manual, and how to get technical assistance.
- [Triggerless ISUP Framework \(TIF\)](#) provides a functional description of the Triggerless ISUP Framework, including configuration options, protocol handling, ISUP IAM message decoding and encoding, IAM/SAM splitting, and NPP Services.
- [TIF Features](#) describes the functions and use of the Oracle Communications EAGLE features that use TIF.
- [EAGLE TIF Commands](#) describes the EAGLE configuration and test commands that are used for the TIF features.
- [TIF Feature Configuration](#) describes EAGLE provisioning for the TIF features, and the TIF Test Tool that is used to verify provisioning without affecting live traffic.
- [Measurements](#) describes TIF-related measurements, measurements reports, and methods of collection.
- [Maintenance](#) describes TIF-related UAMs and UIMs; commands that can be used for maintenance functions; and status and alarm reporting for the EAGLE, Oracle Communications EAGLE Application Processor Provisioning (EPAP), Service Module cards, and services.

My Oracle Support (MOS)

MOS (<https://support.oracle.com>) is your initial point of contact for all product support and training needs. A representative at Customer Access Support (CAS) can assist you with MOS registration.

Call the CAS main number at 1-800-223-1711 (toll-free in the US), or call the Oracle Support hotline for your local country from the list at <http://www.oracle.com/us/support/contact/index.html>. When calling, make the selections in the sequence shown below on the Support telephone menu:

1. Select **2** for New Service Request
2. Select **3** for Hardware, Networking and Solaris Operating System Support
3. Select one of the following options:
 - For Technical issues such as creating a new Service Request (SR), Select **1**
 - For Non-technical issues such as registration or assistance with MOS, Select **2**

You will be connected to a live agent who can assist you with MOS registration and opening a support ticket.

MOS is available 24 hours a day, 7 days a week, 365 days a year.

Emergency Response

In the event of a critical service situation, emergency response is offered by the Customer Access Support (CAS) main number at 1-800-223-1711 (toll-free in the US), or by calling the Oracle Support hotline for your local country from the list at <http://www.oracle.com/us/support/contact/index.html>. The emergency response provides immediate coverage, automatic escalation, and other features to ensure that the critical situation is resolved as rapidly as possible.

A critical situation is defined as a problem with the installed equipment that severely affects service, traffic, or maintenance capabilities, and requires immediate corrective action. Critical situations affect service and/or system operation resulting in one or several of these situations:

- A total system failure that results in loss of all transaction processing capability
- Significant reduction in system capacity or traffic handling capability
- Loss of the system's ability to perform automatic system reconfiguration
- Inability to restart a processor or the system
- Corruption of system databases that requires service affecting corrective actions
- Loss of access for maintenance or recovery operations
- Loss of the system ability to provide any required critical or major trouble notification

Any other problem severely affecting service, capacity/traffic, billing, and maintenance capabilities may be defined as critical by prior discussion and agreement with Oracle.

Related Specifications

For information about additional publications that are related to this document, refer to the Oracle Help Center site. See [Locate Product Documentation on the Oracle Help Center Site](#) for more information on related product publications.

Customer Training

Oracle University offers training for service providers and enterprises. Visit our web site to view, and register for, Oracle Communications training:

<http://education.oracle.com/communication>

To obtain contact phone numbers for countries or regions, visit the Oracle University Education web site:

www.oracle.com/education/contacts

Locate Product Documentation on the Oracle Help Center Site

Oracle Communications customer documentation is available on the web at the Oracle Help Center (OHC) site, <http://docs.oracle.com>. You do not have to register to access these documents. Viewing these files requires Adobe Acrobat Reader, which can be downloaded at <http://www.adobe.com>.

1. Access the Oracle Help Center site at <http://docs.oracle.com>.
2. Click **Industries**.
3. Under the Oracle Communications subheading, click the **Oracle Communications documentation** link.
The Communications Documentation page appears. Most products covered by these documentation sets will appear under the headings "Network Session Delivery and Control Infrastructure" or "Platforms."
4. Click on your Product and then the Release Number.
A list of the entire documentation set for the selected product and release appears.
5. To download a file to your location, right-click the **PDF** link, select **save target as** (or similar command based on your browser), and save to a local folder.

Triggerless ISUP Framework (TIF)

Topics:

- *TIF Description.....16*
- *TIF Features.....18*
- *TIF Configuration Options.....19*
- *TIF Services That Call NPP.....23*
- *Protocol Handling.....30*
- *RTDB Lookup.....38*
- *IAM/SAM Splitting.....42*
- *MSU Sequencing.....43*
- *ISUP Decode and Encode Errors.....43*
- *Hardware Requirements.....44*
- *MPS/EPAP Platform.....44*

This chapter describes the functions provided by the Triggerless ISUP Framework, including ISUP IAM protocol handling, NPP processing for TIF, Service Portability, and response message formatting.

The chapter includes an overview of the EAGLE Provisioning Application Processor (EPAP). EPAP provides the Real Time Database (RTDB) that is used in the database lookup functions.

TIF Description

For TIF features, TIF provides an overall structure that allows the EAGLE 5 ISS to intercept ISUP messages that would normally be through-switched and apply special processing to them. For example, an IAM message could be intercepted and have the called number prefix replaced based on portability information.

At least one TIF feature must be enabled and turned on before TIF functions are available in the system.

TIF processing consists of two main sections:

- On the LIM cards, TIF uses Gateway Screening (GWS) to select an ISUP MSU for processing, and forwards the MSU to Service Module cards for processing.
- On the Service Module cards, TIF decodes the MSU, invokes the Numbering Plan Processor (NPP), and encodes the results.

TIF features provide NPP with Service Action Handlers to perform database access, data evaluation, and any feature-specific handling for the MSU.

A high-level overview of TIF processing is shown in [Figure 1: TIF Overview](#).

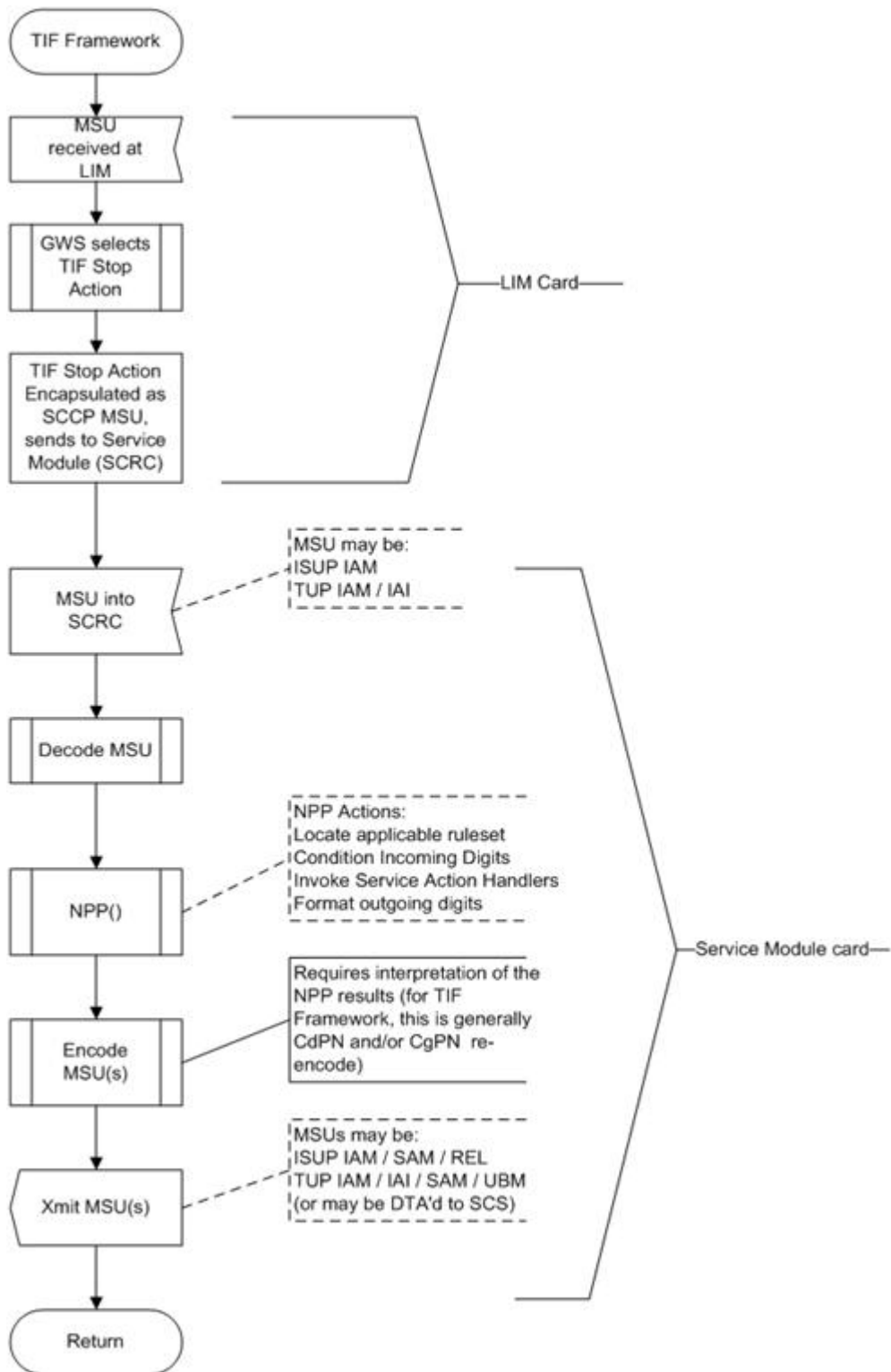

Figure 1: TIF Overview

TIF Features

All of the features that are listed in [Table 2: TIF Features](#) use TIF ("TIF features"). Chapter 3 in this manual describes each TIF feature.

The GTT feature and the Gateway Screening feature (GWS) must be turned on before a TIF feature can be enabled in the system.

Table 2: TIF Features

Part Number	Description	Other Dependencies/Notes
893-0189-01	TIF Number Portability (TIF NP)	Requires EPAP for RTDB lookup; Mutually exclusive with ELAP, unless the Dual ExAP Configuration feature is enabled
893-0222-01	TIF SCS Forwarding (TIF SCS)	Does not require RTDB for lookup; Can be enabled with EPAP or ELAP in the system
893-0225-01	TIF Number Substitution (TIF NS)	Requires EPAP for RTDB lookup; Mutually exclusive with ELAP, unless the Dual ExAP Configuration feature is enabled
893-0240-01	TIF Simple Number Substitution (TIF SNS)	Does not require RTDB for lookup; Can be enabled with EPAP or ELAP in the system
893-0245-01	TIF Additional Subscriber Data (TIF ASD)	Requires EPAP for RTDB lookup; Mutually exclusive with ELAP, unless the Dual ExAP Configuration feature is enabled
893-0255-01	TIF Generic Routing Number (TIF GRN)	Requires EPAP for RTDB lookup; Mutually exclusive with ELAP, unless the Dual ExAP Configuration feature is enabled
893-0376-01	TIF Subscr CgPN Blacklist	Requires EPAP for RTDB lookup; Mutually exclusive with ELAP, unless the Dual ExAP Configuration feature is enabled

Part Number	Description	Other Dependencies/Notes
893-0377-01	TIF Range CgPN Blacklist	Does not require RTDB lookup; Can be enabled with EPAP or ELAP in the system.
893-0402-01	TIF Selective Screening	Requires EPAP for RTDB lookup; Mutually exclusive with ELAP, unless the Dual ExAP Configuration feature is enabled, and with the TIF Number Substitution feature

TIF Configuration Options

The following types of configuration options are used with TIF features:

- TIF configuration option values in the TIFOPTS table influence number conditioning, response message formatting and generation, and Service Portability processing.
- The SCCP ACLEN option value in the SCCPOPTS table can be used to indicate the length of the Area Code in the Calling Party Number (CgPN).
- Destination-based options can be used with or instead of the TIFOPTS configuration options for outgoing message formatting.

TIFOPTS Configuration Options

The TIFOPTS data is loaded to the LIM cards and to Service Module cards that contain the Real Time Database (RTDB). The options described in [Table 3: TIF Configuration Options](#) are used for the following functions:

- Specify the conditioning that is needed before CdPN or CgPN lookup.
- Specify the conditions that indicate a successful RTDB lookup.
- Specify Service Portability processing that can be performed for IAM messages.
- Specify the cause for a Release message.
- Indicate when to split the IAM message into an IAM message and a SAM message.
- Specify the digits to substitute for the Calling Party Number in Simple Number Substitution.
- Indicate the Calling Party's Category value for the Public DN for the network in Number Substitution.
- Specify the format and contents of fields in the outgoing message (CgPN digits, NM bits, delimiter digits, Area Code, Release Cause, Default RN).

Table 3: TIF Configuration Options

Parameter	Range	Description	Used by TIF Feature
IAMCGPN	dn, rn, rndn	Indicates the format of the outgoing CgPN digits, if they were modified by a feature	Any TIF feature

Parameter	Range	Description	Used by TIF Feature
DLMA	1-16 hexadecimal digits, none	Digits used for Delimiter A (DLMA) in NPP Formatting Action Note: If a TIF service has DLMA-DLMC values provisioned in NPP Formatting Actions and in the TIFOPTS table, the values from the TIFOPTS table will be used in NPP processing.	Any TIF feature
DLMB	1-16 hexadecimal digits, none	Digits used for Delimiter B (DLMB) in NPP Formatting Action Note: If a TIF service has DLMA-DLMC values provisioned in NPP Formatting Actions and in the TIFOPTS table, the values from the TIFOPTS table will be used in NPP processing.	Any TIF feature
DLMC	1-16 hexadecimal digits, none	Digits used for Delimiter C (DLMC) in NPP Formatting Action Note: If a TIF service has DLMA-DLMC values provisioned in NPP Formatting Actions and in the TIFOPTS table, the values from the TIFOPTS table will be used in NPP processing.	Any TIF feature
SPLITIAM	15-31, none	Determines when to split the IAM message into 1 IAM message + 1 SAM message. This option is used only if the splitiam option in the Destination table for the associated DPC is set to none.	Any TIF feature
CONDCGPN	addcc, none	Indicates the preconditioning required when a CgPN lookup is needed.	Any TIF feature
DFLTRN	1-15 hexadecimal digits	Digits to substitute for anSP. Used for CdPN and CgPN	Any TIF feature
NPFLAG	nm, none	Specifies whether the NM bits are modified in the IAM message to show that RTDB lookup has been performed. (The NM bits exist only in incoming and outgoing IAM messages.) Note: See the related nprst option (NP Reset flag) for point codes in the Destination table.	TIF Number Portability (893-0189-01)
RCAUSENP	0-127	Specifies the value to be used for the Release Cause field in a REL message sent in the number-ported case. Note: See the related rcause option for point codes in the Destination table.	TIF Number Portability (893-0189-01)

Parameter	Range	Description	Used by TIF Feature
RCAUSEPFX	0-127	Specifies the value to be used for the Release Cause field in a REL message sent in the number-not-portable case. Note: See the related rcause option for point codes in the Destination table.	TIF Number Portability (893-0189-01)
RLCOPC	on, off	Indicates if the per-OPC rcause option value should be used to override the TIFOPTS rcausenp or rcausepfx option values	TIF Number Portability (893-0189-01)
NPTYPEPRLS	rnspdn, rn,sp, rnsp, any, all	NP entity type. Specifies the entity type of the DN that is used to indicate that a successful RTDB lookup occurred for the NPRLS Service Action and NPNRLS Service Action. RTDB lookup will result in an unsuccessful match and Service Portability processing is skipped if this value is rn.	TIF Number Portability (893-0189-01)
NPTYPEPRLY	rnspdn, rn, sp, rnsp, any, all	NP entity type. Specifies the entity type of the DN that is used to indicate that a successful RTDB lookup occurred for the NPRELAY Service Action. RTDB lookup will result in an unsuccessful match and Service Portability processing is skipped if this value is rn.	TIF Number Portability (893-0189-01)
NPTYPECGPN	rnspdn, any, sp, rn, sprn, all	NP entity type of the CgPN. Specifies the entity type of the DN that is used to indicate that a successful RTDB lookup occurred.	TIF Number Portability (893-0189-01)
CRPREL	0-255	Provides the ISUP Release Cause for messages that are determined to be Circular Routed	TIF Number Portability (893-0189-01)
RNRQD	yes, no	Indicates if the Redirection Number parameter shall be included in the Release message when Release handling is indicated	TIF Number Portability (893-0189-01)
NSADDLDATA	yes, no	Indicates that the Calling Party's Category data value must match the value of the NSPUBLIC option value before Calling Party number substitution can occur.	TIF Number Substitution (893-0225-01)
NSPUBLIC	0-255	Non-zero value indicates that a Calling Party number is Public. Indicates the Calling Party Category value for :public DN" for the network.	TIF Number Substitution (893-0225-01)
SNSCGPNDFLT	1-32 hexadecimal digits, none	Digits to used in Calling Number Simple Number Substitution	TIF Simple Number Substitution (893-0240-01)
MATCHSEQ	dn, nptype	Determines the RTDB lookup mechanism. See RTDB Lookup .	TIF features requiring RTDB lookup:

Parameter	Range	Description	Used by TIF Feature
		TIF ASD and TIF GRN support only matchseq=dn. TIF NS supports only matchseq=dn. Note: Used only during upgrade, for backward compatibility.	TIF Number Portability (893-0189-01) TIF Additional Subscriber Data (893-0245-01) TIF Generic Routing Number (893-0255-01) TIF Number Substitution (893-0225-01) TIF Subscr CgPN Blacklist (893-0376-01)
SPORTRLS	none, gsm, is41, all	Service Portability configuration option for the NPRLS Service Action	TIF Number Portability (893-0189-01) Service Portability (893-0343-01)
SPORTRELAY	none, gsm, is41, all	Service Portability configuration option for the NPRELAY Service Action	TIF Number Portability (893-0189-01) Service Portability (893-0343-01)
SPFILL	on, off	Indicates whether SP should be populated when DFLTRN or GRN is used for RN	TIF Number Portability (893-0189-01)

SCCPOPTS Option

The SCCPOPTS table contains the ACLEN option value, described in [Table 4: SCCPOPTS Configuration Option used by TIF](#), that can be used to indicate the length of the Area Code in the Calling Party Number.

Table 4: SCCPOPTS Configuration Option used by TIF

Parameter	Range	Description	Used by TIF Feature
ACLEN	0-8	Length of Area Code (used for CgPN handling)	Any TIF feature

Destination-based Options

The destination-based options for TIF, described in [Table 5: Destination-based Configuration Options](#), are used with or instead of the TIFOPTS configuration options for the following functions:

- Indicate the setting of the NM Bits in ITU IAM messages when the TIFOPTS npflag option indicates that NM Bits are used.
- Specify the release cause for a Release message when the TIFOPTS rlcopc option is on.
- Indicate when and how to split the IAM message into an IAM message and a SAM message.

Table 5: Destination-based Configuration Options

Parameter	Range	Description	Used by TIF Feature
npnst	on, off	Indicates whether the NM Bits should be set to 00 in ITU IAM messages when the TIFOPTS npflag option value is NM.	TIF Number Portability
rcause	0-127, none	Specifies the value to be used for the Release Cause field in a REL message instead of the TIFOPTS rcausenp option value (ported case) or the TIFOPTS rcausenpfx option value (not-ported case).	TIF Number Portability
splitiam	15-31, none	Determines when and how to split the IAM into 1 IAM message + 1 SAM message for ITU IAM message, instead of using the TIFOPTS SPLITIAM option value.	Any TIF feature

TIF Services That Call NPP

For TIF services, NPP processes traffic filtered by the corresponding Gateway Screening Stop Action, as shown in [Table 6: GWS Stop Action Mapping to CdPN Service Name to CgPN Service Name](#).

The services for TIF features allow NPP Rules to be defined for handling different types of traffic, such as inter-carrier traffic and local traffic.

NPP processing for a TIF CdPN service can invoke the corresponding TIF CgPN service, depending on the value of the INVKSERV parameter in the TIF CdPN Service Rule.

For example, if the MSU was filtered by the TIF2 GWS Stop Action, the TIF2 NPP service is invoked using the CdPN in the message. If the INVKSERV value in the matched TIF2 NPP Service Rule is TIFCGPN2, then the TIFCGPN2 NPP service is invoked using the CgPN in the message.

Refer to *Numbering Plan Processor (NPP) User's Guide* for more information about NPP components and processing.

Table 6: GWS Stop Action Mapping to CdPN Service Name to CgPN Service Name

GWS Stop Action	NPP CdPN Service Name	NPP CgPN Service Name
TIF	TIF	TIFCGPN
TIF2	TIF2	TIFCGPN2
TIF3	TIF3	TIFCGPN3

NPP Conditioning Actions

TIF supports all Conditioning Actions that are provided by NPP.

TIF ACCgPN Conditioning Action

TIF provides the ACCgPN Conditioning Action to extract the Area Code from the CgPN while processing CdPN services. The ACCgPN Conditioning Action skips over any country code digits (matching DefCC or Multiple CC) and removes the number of digits specified in the SCCPOPTS ACLEN configuration option from the beginning of the CgPN. These digits will be used as the Area Code (AC) to condition the Called Party digits for any subsequent Service Action or Formatting Action.

If the ACCgPN Conditioning Action is invoked, but the Calling Party is not present or has fewer digits than the SCCPOPTS ACLEN option value (after any CC digits), then no change to Area Code will be made.

The ACCgPN Conditioning Action can be provisioned with the TIF, TIF2, and TIF3 services. The ACCGPN Conditioning Action is mutually exclusive with the ACCgPNx Conditioning Actions and with any other Conditioning Action that is used to populate the AC (Area Code) Formatting Action value for NPP.

Table 7: TIF ACCgPN Conditioning Action

Conditioning Action	Description
ACCgPN	Area Code from Calling Party Area code needs to be extracted from the Calling Party Number

TIF ACCgPN1 through ACCgPN8 Conditioning Actions

TIF uses the ACCgPN1 - ACCgPN8 (ACCgPNx) Conditioning Actions to extract the Area Code from the CgPN while processing CdPN services. The length of the Area Code to be extracted from the CgPN is not specified by SCCPOPTS:ACLEN configuration parameter. Instead, the digit suffix "x" of the Conditioning Action parameter name specifies the length of the Area Code to be extracted. For example, the Conditioning Action ACCgPN4 will extract an Area Code of 4 digits from the CgPN. The ACCgPNx Conditioning Actions skip over any Country Code digits (matching DefCC or Multiple CC) and remove the specified "x" number of Area Code digits.

If an ACCgPNx Conditioning Action is invoked, but the Calling Party is not present or has fewer digits than the specified "x" number of digits (after any CC digits), then no change to Area Code will be made.

The ACCgPNx Conditioning Actions can be provisioned with the TIF, TIF2, and TIF3 services. The ACCGPNx Conditioning Actions are mutually exclusive with each other, with the ACCgPN Conditioning Action, and with any other Conditioning Action that is used to populate the AC (Area Code) Formatting Action value for NPP.

Table 8: TIF ACCgPNx Conditioning Actions

Conditioning Action	Description
ACCgPN1	Area Code from Calling Party One-digit Area Code needs to be extracted from the Calling Party Number.
ACCgPN2	Area Code from Calling Party

Conditioning Action	Description
	Two-digit Area Code needs to be extracted from the Calling Party Number.
ACCgPN3	Area Code from Calling Party Three-digit Area Code needs to be extracted from the Calling Party Number.
ACCgPN4	Area Code from Calling Party Four-digit Area Code needs to be extracted from the Calling Party Number
ACCgPN5	Area Code from Calling Party Five-digit Area Code needs to be extracted from the Calling Party Number.
ACCgPN6	Area Code from Calling Party Six-digit Area Code needs to be extracted from the Calling Party Number.
ACCgPN7	Area Code from Calling Party Seven-digit Area Code needs to be extracted from the Calling Party Number.
ACCgPN8	Area Code from Calling Party Eight-digit Area Code needs to be extracted from the Calling Party Number.

NPP Service Actions

The NPP Service Actions listed in [Table 9: Service Actions used by TIF Features](#) are used by the indicated TIF features. Before an NPP Rule can be provisioned with an Action Set containing a Service Action for a TIF feature, the TIF feature must be turned on. The precedence indicates the sequence of execution if more than one Service Action is used by a service; services are executed in high-to-low precedence.

Table 9: Service Actions used by TIF Features

Service Action	Description	Required Feature	Precedence	CdPN	CgPN
CRP	Circular Route Prevention	893018901 TIF Number Portability	92	X	
FPFXRLS	Matched NPP rule prefix; always release (no RTDB lookup)	893037701 TIF Range CgPN Blacklist (CgPN) 893040201 TIF Selective Screening (CdPN)	92	X	X

Service Action	Description	Required Feature	Precedence	CdPN	CgPN
BLRLS	Release because Blacklist Flag Set in RTDB	893037601 TIF Subscr CgPN Blacklist 893040201 TIF Selective Screening (CdPN)	91	X	X
BLNFNDRLS	Release because Blacklist Record not found in RTDB	893037601 TIF Subscr CgPN Blacklist 893040201 TIF Selective Screening (CdPN)	91	X	X
NPNRLS	Number Portability Release on No Match	893018901 TIF Number Portability	91	X	
SELSCR	Selective Screening	893040201 TIF Selective Screening	91	X	
ASDLKUP	Use of CdPN Additional Subscriber Data when formatting CdPN	89302450 TIF Additional Subscriber Data	90	X	X
CgPNASDRqd	Use of CgPN Additional Subscriber Data when formatting CdPN	89302450 TIF Additional Subscriber Data	90	X	
GRNLKUP	Use of CdPN Generic Routing Number when formatting CdPN	89302550 TIF Generic Routing Number	90	X	X
CgPNGRNRqd	Use of CgPN Generic Routing Number when formatting CdPN	89302550 TIF Generic Routing Number	90	X	
CGPNNP	Calling Number Portability	893018901 TIF Number Portability	80		X
CGPNSVCRQD	Calling Number Lookup	893018901 TIF Number Portability	80	X	
NOCGPNRLS	Release if no CgPN data exists	893037701 TIF Range CgPN Blacklist	80	X	
NPRELAY	Number Portability Relay	893018901 TIF Number Portability	80	X	
NPRLS	Number Portability Release on Match	893018901 TIF Number Portability	80	X	
NSCdPN	Called Number Substitution	893022501 TIF Number Substitution	80	X	
NSCgPN	Calling Number Substitution	893022501 TIF Number Substitution	75		X

Service Action	Description	Required Feature	Precedence	CdPN	CgPN
SNSCgPN	Simple Number Substitution	893024001 TIF Simple Number Substitution	75	X	X
CDIAL	Corrective Dialing	NPP basic functions; no TIF feature is required	10	X	X
FWDSCS	Forward to SCS	893022201 TIF SCS Forwarding	5	X	

TIF Service Action Interactions

Service Actions (SAs) that are mutually exclusive ([Table 10: Mutually Exclusive TIF Service Actions](#)) cannot be provisioned together.

Table 10: Mutually Exclusive TIF Service Actions

Provisioned NPP Services	Mutually Exclusive SAs	Conflict
TIF, TIF2, or TIF3	ASDLKUP, CgPNASDRqd	Both process ASD.
TIF, TIF2, or TIF3	GRNLKUP, CgPNGRNRqd	Both process GRN.
TIF, TIF2, or TIF3	CgPNSVCRqd, NPRLS	CgPNSVCRqd applies NP on the CgPN with intent to relay the IAM, whereas NPRLS applies NP on the CdPN with intent to send REL.
TIF, TIF2, or TIF3, and TIFCGPN, TIFCGPN2, or TIFCGPN3	SNSCgPN, NSCgPN	The outgoing digit string resulting from SNSCgPN could be modified by NSCgPN.
TIF, TIF2, or TIF3, and INVKSERV=TIFCGPN, TIFCGPN2, or TIFCGPN3	TIF:SA=FPFXRLS / CgPNASDRqd / CgPNGRNRqd / CgPNSVCRqd / NSCgPN / SNSCgPN	These TIF SAs use CgPN digits that have not undergone NPP number conditioning, and therefore are not allowed to be provisioned if a TIF CgPN service is also provisioned.
TIF, TIF2, or TIF3, and TIFCGPN, TIFCGPN2, or TIFCGPN3	FPFXRLS and any supported SA for this service shown in Table 9: Service Actions used by TIF Features	REL must be sent.
TIF, TIF2, or TIF3	SA=SELSCR and NSCdPN / NSCgPN	SELSCR uses Number Substitution DN as a set of Call Types for the DN.

Unusual Service Action Behavior

[Table 11: Unusual Service Action Behavior](#) describes unusual behavior exhibited by some combinations of Service Actions.

Table 11: Unusual Service Action Behavior

Provisioned NPP Services	Provisioned SAs	Unusual Behavior
TIF, TIF2, or TIF3	CgPNSVCRqd, NSCgPN	<p>The outgoing CgPN digit string set by CgPNSVCRqd can be modified by NSCgPN based on the value of the TIFOPTS IAMCGPN option.</p> <p>This combination would work only if IAMCGPN=RNDN, CgPNSVCRqd sets the RN digits and NSCgPN would set the DN digits, but:</p> <ul style="list-style-type: none"> • If IAMCGPN=RN, then NSCgPN is ignored. • If IAMCGPN=DN, the CgPNSVCRqd is ignored.
TIF, TIF2, or TIF3	CgPNSVCRqd, SNSCgPN	<p>The outgoing CgPN digit string is set by CgPNSVCRqd.</p> <p>If the TIFOPTS SNSCGPNDFLT option is NONE, then the outgoing CgPN digit string is not read.</p>
TIF, TIF2, or TIF3	NPNRLS, NPRELAY	<p>There can be cases where the combination of the values of the TIFOPTS NPTYPEPERLS and NPTYPEPERLY option and the entity type from RTDB lookup of CdPN digits can cause the original IAM to be relayed. For example:</p> <ul style="list-style-type: none"> • Entity=RN; NPNRLS reads NPTYPEPERLS=RN, SPRN, ALL, RNSPDN, ANY; NPRELAY reads NPTYPEPERLY=SP • Entity=SP; NPNRLS reads NPTYPEPERLS=SP, SPRN, ALL, RNSPDN, ANY; NPRELAY reads NPTYPEPERLY=RN
TIF, TIF2, or TIF3	NPNRLS, NPRLS	<p>Because both of these SAs use the same TIFOPTS NPTYPEPERLS option value, final outcome is always release. REL due to NPNRLS does not include a</p>

Provisioned NPP Services	Provisioned SAs	Unusual Behavior
		Redirection Number. REL due to NPRLS may include a Redirection Number depending on the value of the TIFOPTS RNRQD option.
TIF, TIF2, or TIF3	NPRLS, NPRELAY	<p>There can be cases where the combination of the values of the TIFOPTS NPTYPEPERLS and NPTYPEPERLY option and the entity type from RTDB lookup of CdPN digits can cause the original IAM to be relayed. For example:</p> <ul style="list-style-type: none"> Entity=RN; NPRLS reads NPTYPEPERLS=SP, NPRELAY reads NPTYPEPERLY=SP Entity=SP; NPRLS reads NPTYPEPERLS=RN; NPRELAY reads NPTYPEPERLY=RN

NPP Formatting Actions

All of the Formatting Actions that are provided by NPP are supported for TIF CdPN NPP services and TIF CgPN NPP services.

TIF CdPN services provide the Formatting Actions shown in [Table 12: Formatting Actions Provided by TIF CdPN Services](#), to be used with the TIF ASD and TIF GRN features.

Table 12: Formatting Actions Provided by TIF CdPN Services

Formatting Action	Name	Description
ASDOTHER	Additional Subscriber Data (ASD) from Other NPP Service	If ASD is supplied from the Calling Party Service, then the ASD will be formatted into the Called Party digits.
GRNOTHER	Generic Routing Number (GRN) from Other NPP Service	If a GRN is supplied from the Calling Party Service, then the GRN will be formatted into the Called Party digits.

The ASDOTHER and GRNOTHER Formatting Action values can be populated only if another NPP service is invoked. If the Action Set in the NPP Service Rule contains either the ASDOTHER or GRNOTHER Formatting Action, then the value of the INVKSERV parameter must not be NONE in the Service Rule.

TIF provides the Formatting Actions shown in [Table 13: Formatting Actions - TIF Selective Screening](#) to facilitate CdPN and CgPN digit formatting when a message is relayed by the TIF Selective Screening feature.

Table 13: Formatting Actions - TIF Selective Screening

Formatting Action	Description
FASCRCDD	Formatting action list to format ISUP CdPN digits when the Called Party Number is screened by the TIF Selective Screening process.
FASCRCG	Formatting action list to format ISUP CgPN digits when the Called Party Number is screened by TIF Selective Screening process.

Protocol Handling

TIF protocol processing consists of the following functions:

- Gateway Screening of the MSU received by a LIM card selects a TIF Stop Action, encapsulating the MSU as SCCP data, and forwarding the MSU to Service Module cards for processing.
- On the Service Module card, TIF decodes the message, passes information to NPP services for processing, and formats and sends the resulting message.

LIM Card Processing

When a LIM card receives an MSU, the following TIF processing occurs (see the LIM processing shown in [Figure 1: TIF Overview](#)):

- The Gateway Screening (GWS) feature filters messages for ISUP, and ISUP messages with SI=5 are screened for selection of a TIF Stop Action.
- Selected ISUP IAM messages are marked for sequencing, encapsulated as SCCP messages, and forwarded to Service Modules for processing. TIF supports proper sequencing of IAM/SAM messages. See [IAM/SAM Splitting](#) for details.

All other ISUP MSUs delivered to TIF for processing are marked for sequencing and routed.

MSUs that are TUP or not ISUP (SI=5) are routed without modification. UIM 1407 Unexpected SI in TIF Stop Action is generated.

The TIF Stop Action processing flow is shown in [Figure 2: TIF Stop Action Processing](#).

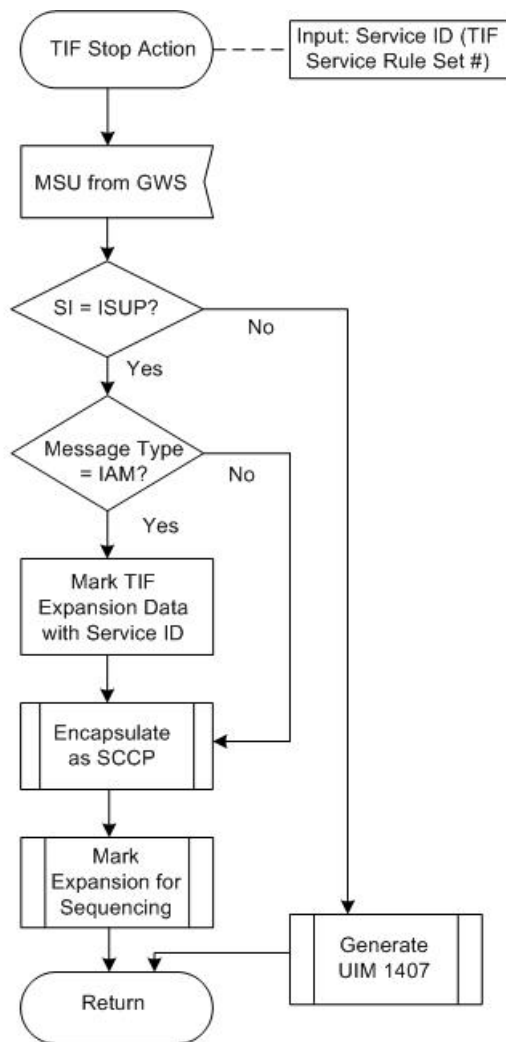

Figure 2: TIF Stop Action Processing

Gateway Screening supports the following TIF Stop Actions: TIF, TIF2, and TIF3. Existing GWS rules are used to separate ISUP traffic for TIF processing. The GWS rule must end with a Stop Action that contains TIF, TIF2, or TIF3.

The DTA, TIF, TIF2, and TIF3 Stop Actions are all mutually exclusive in Stop Action Sets, and each of these Stop Actions must be the last Stop Action for the set.

Table 14: TIF Stop Action Rules defines the processing of messages within TIF Stop Actions.

Table 14: TIF Stop Action Rules

Protocol	Message Type	Encapsulate	Sequence	Action
ISUP	IAM	Yes	Yes	Send to Service Module card
	Other	No	Yes	Send to sequencer
Other	N/A	No	No	Route Message

Each TIF Stop Action encapsulates the incoming MSU as SCCP data and forwards the new MSU to a Service Module card for processing. The expanded data portion of the MSU is marked with the TIF Stop Action number so that the appropriate Service Rule Set can be invoked on the Service Module card.

Each TIF Stop Action is associated with a different NPP Service Rule Set, so that different actions can be taken on identically formatted messages that encounter different Gateway Screening rules. This allows for customized handling based on the incoming linkset, OPC, DPC, or other GWS criteria.

Each Stop Action is assigned to the corresponding NPP Service: TIF > TIF, TIF2 > TIF2, TIF3 > TIF3.

Although TIF will not impose any size limitations on the incoming MSU size, the FWDSCS Service Action Handler for the TIF SCS Forwarding feature does have some encapsulation limits imposed by DTA processing of the message. Refer to *Database Administration - Features User's Guide* for information about DTA, and see [TIF SCS Forwarding Feature](#) for a description of the FWDSCS Service Action Handler processing.

Service Module Card Processing

As shown in [Figure 3: SCRC Processing of TIF Messages](#), SCRC provides a common entry point on Service Module cards to process SCCP messages. In LIM handling, TIF Stop Actions forward only ISUP IAM messages to Service Module cards. Because the messages from TIF are actually ISUP messages encapsulated within an SCCP header, the messages are sent to a TIF handler instead of normal SCRC processing (normally GTT or Local Subsystem handling).

[Figure 3: SCRC Processing of TIF Messages](#) shows the basic SCRC processing for ISUP messages from TIF.

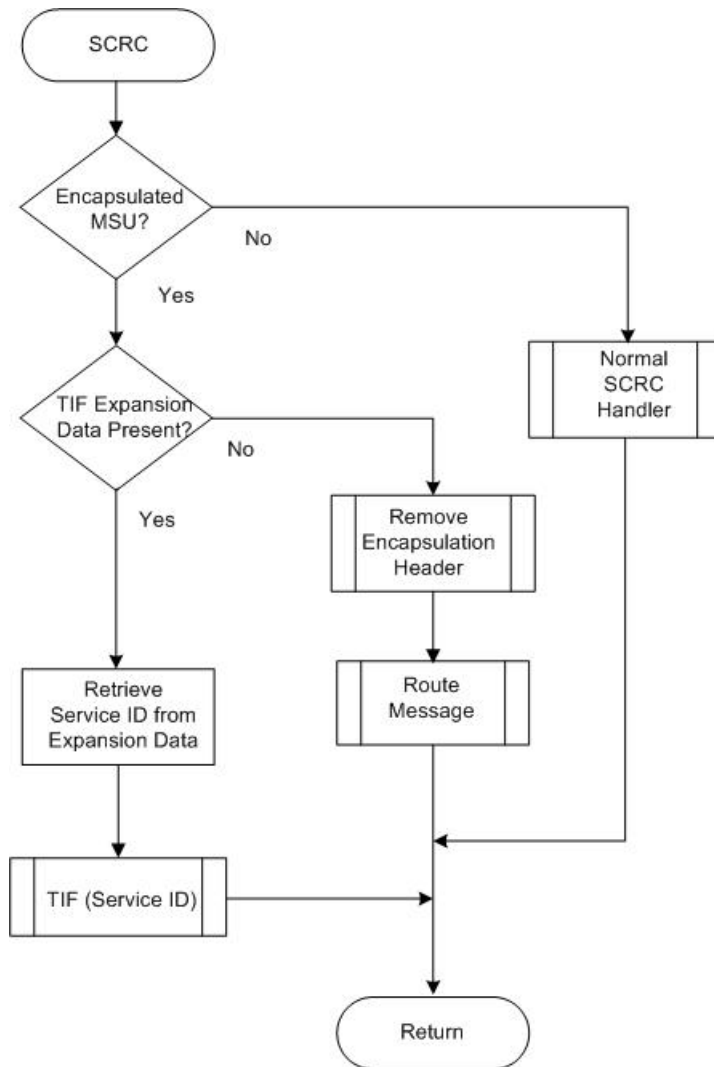

Figure 3: SCRC Processing of TIF Messages

Figure 4: TIF Service Module Processing Main Flow shows the overall TIF flow for Service Module processing. NPP provides the majority of the message processing, and is responsible for calling all Service Action Handlers, as shown in Figure 5: Basic NPP Processing.

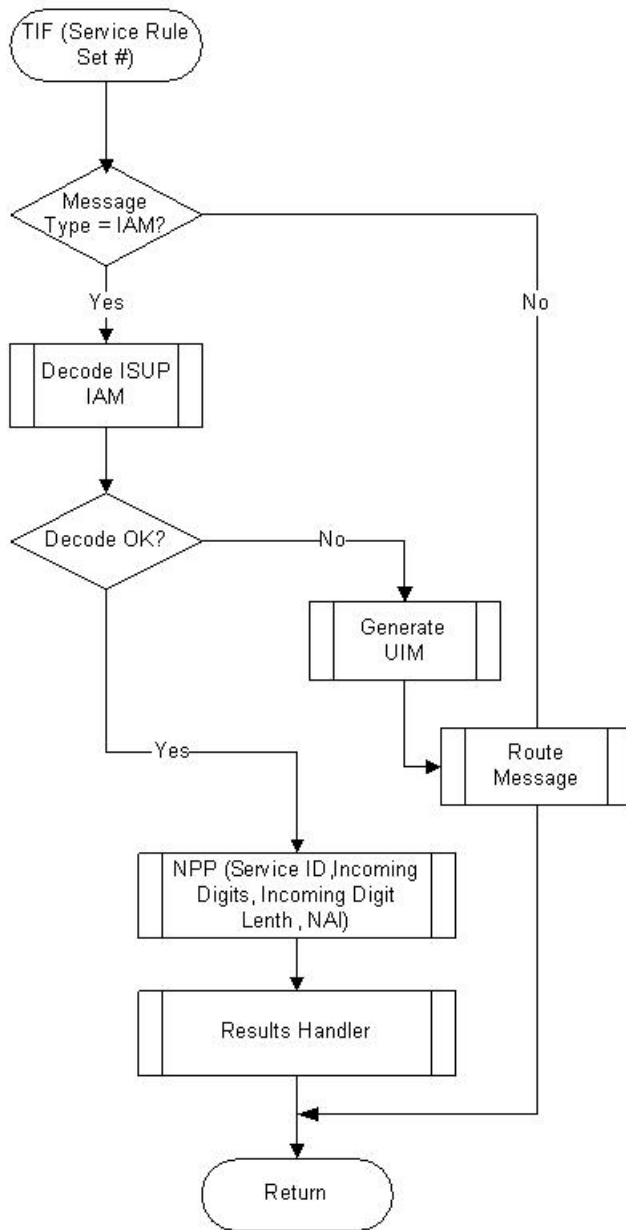

Figure 4: TIF Service Module Processing Main Flow

IAM Message Decoding

Fields in the incoming MSU identify the message as ISUP, IAM, and either ITU or ANSI. TIF decodes the following information in the incoming ITU ISUP IAM message:

- Called Party digits and NAI values that are passed to NPP for processing
- Calling Party digits and NAI value
- Called Party and Calling Party information that is used for RTDB lookup
- NM Bits (from the Forward Call Indicator field) that indicate whether RTDB lookup has been performed. (See [Use of NM Bits](#))
- Point codes and other information that are used in encoding the outgoing message.

NPP Processing for TIF

In the basic flow of NPP, TIF invokes NPP, and passes the TIF service name, Called Party digits and length, and the incoming NAI values to NPP. NPP conditions the Called Party digits for RTDB lookup, calls Service Action Handlers for service-specific processing, and formats the outgoing digit string.

There are two methods of invoking a TIF service for Calling Party digit processing:

- The CdPN Service Rule defined in NPP provides all instructions for handling the CgPN. Basic conditioning and formatting is supported with global TIFOPTS settings.

The 3 TIF CdPN services TIF, TIF2 and TIF3 all do a lookup in the NPP Service Rule Set based upon data from the CdPN portion of the messages. The three CdPN services also do some minimal conditioning (controlled by the TIFOPTS CondCgPN option) and formatting on the CgPN (controlled by the TIFOPTS IAMCGPN option). See [TIF Configuration Options](#). This minimal conditioning and formatting is always done the same regardless of the CgPN digits and NAI values. Service Actions concerning the CgPN are provisioned in the CdPN service, and use the minimally conditioned CgPN for their international form of the Calling Party. All CdPN Service Actions that reference the CgPN can use this method of processing Calling Party digits.

This method is used if the INVKSERV parameter value is NONE in the Service Rule TIF CdPN service. The Action Set in the Service Rule can contain most Service Actions that process CgPN digits. See [NPP Service Actions](#).

- The CgPN is processed via NPP rules, with access to all NPP Conditioning and Formatting controls.

The 3 TIF CgPN services TIFCGPN, TIFCGPN2, and TIFCGPN3 are invoked from the corresponding TIF CdPN service based on the INVKSERV value (not NONE) in the Service Rule for the TIF CdPN service . Because TIF CgPN services have full NPP processing, different conditioning and formatting for different CgPN and NAI values can be used. In some circumstances, information such as ASD can be shared between the TIF CdPN service and the TIF CgPN service.

Refer to *Numbering Plan Processor (NPP) User's Guide* for additional information on NPP processing. [Figure 5: Basic NPP Processing](#) shows the basic NPP processing flow.

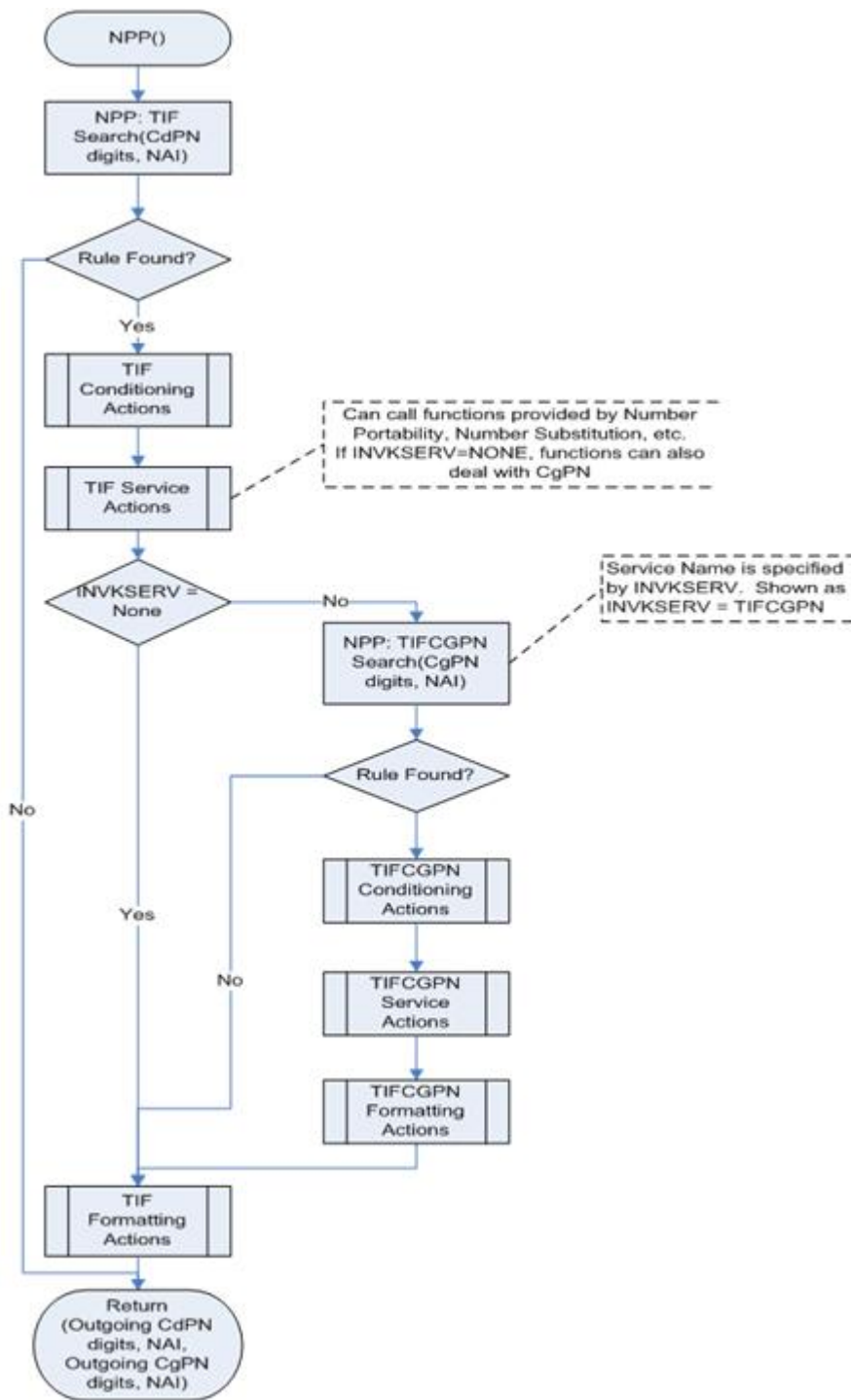

Figure 5: Basic NPP Processing

TIF Post-NPP Processing

After NPP processing is complete, the TIF post-NPP Results Handler performs the following functions:

- Evaluates results from NPP Service Actions and Formatting Actions
- Determines whether to generate a Release (REL) message or to relay the IAM message.

If Relay is indicated, the Results Handler performs the following functions:

- Updates the Called Party digits, the Calling Party digits, or both, if needed. If ISUP IAM Called Party digits terminate with a Stop Digit (F), the Stop Digit is present to terminate those digits in the relayed IAM message. If the CONDCGPN option value is ADDCC, the provisioned STPOPTS Default Country Code (DEFCC) value is pre-pended to the Calling Party digits.
- Handles IAM/SAM splitting (see [IAM/SAM Splitting](#)).
- Routes one IAM message, or an IAM message and a SAM message.
- Invokes any indicated TIF feature-specific Results Handlers.

If Release is indicated by a Service Action Handler, the Results Handler generates an ISUP Release message. After the Release message is generated, the original IAM message is discarded and processing terminates.

- For a Release message on a successful lookup, the message includes the Cause Value specified in the TIF RCAUSENP configuration option or the destination-based RCAUSE configuration options, depending on option settings (see [TIF Configuration Options](#)). The Redirection Number is included in the Release message if the TIF RNRQD configuration option value is YES.
- For a Release message on an unsuccessful lookup, the message includes the Cause Value specified in the TIF RCAUSENPFX configuration option value or the destination-based RCAUSE configuration options, depending on option settings (see [TIF Configuration Options](#)). The Redirection Number is not included in the Release message.

The flow of the TIF Results Handler is shown in [Figure 6: TIF Post-NPP Results Handler](#).

The following examples illustrate post-NPP results handling:

Corrective Dialing

1. IAM Relay is indicated.
2. Calling Number has not changed; replacement of the CgPN is not required.
3. CdPN number has changed; the CdPN is replaced.
4. No IAM/SAM splitting is required.
5. The FWDSCS Formatting Action is not indicated; DTA is not invoked.
6. The IAM message is routed.

NP Relay

1. IAM Relay is indicated.
2. Calling Number has changed; replacement of the CgPN is performed.
3. CdPN number has changed; the CdPN is replaced.
4. The FWDSCS Formatting Action is not indicated; DTA is not invoked.
5. The NP-specific result handler is invoked for IAM Relay to update the NM bits in the ISUP IAM message.
6. The IAM is routed.

NP Circular Routing

1. Release is indicated.
2. No Redirection Number is encoded in the release message.
3. The release cause is set to a provisioned value.
4. The message is routed.

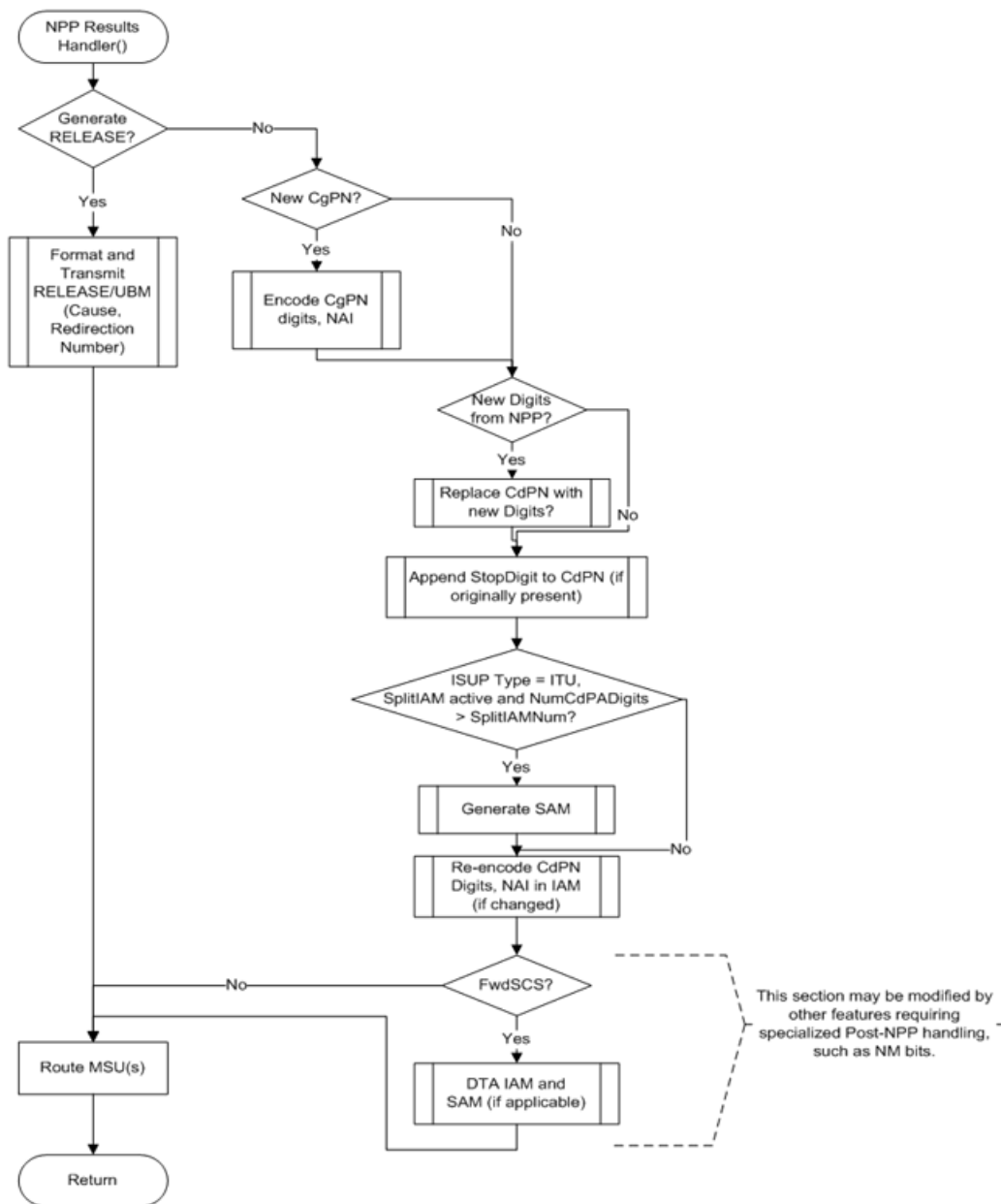

Figure 6: TIF Post-NPP Results Handler

RTDB Lookup

A single invocation of NPP can result in multiple invocations of various Service Action Handlers associated with TIF features. Because nearly all TIF Service Action Handlers perform RTDB lookups, TIF provides a common mechanism to ensure that only a single CdPN or CgPN lookup is done and that the resulting data are shared by all Service Action Handlers.

The CdPN lookup is performed on the conditioned CdPN digit string. The conditioned string is typically in International format.

The CgPN lookup is performed on the conditioned CgPN. The conditioned CgPN is typically in International format.

Interpreting Results of an RTDB Lookup

[Table 15: Portability Types Relevant to NP Lookups](#) lists portability types that are relevant to Number Portability lookups.

Table 15: Portability Types Relevant to NP Lookups

Value	Description
0	Not known to be ported (available for backward compatibility; 36 should be used instead of 0)
1	Out-of-network; my subscriber ported out
2	Out-of-network; foreign subscriber ported in, then ported out
5	In-network; number migrated from IS41 to GSM
36	Not known to be ported
0Xff	No status; Indicates "none" in the database

[Table 16: Possible Lookup Results](#) summarizes the meanings of the normal lookup return codes:

Table 16: Possible Lookup Results

Return Code	Meaning
ENTITY FOUND	The DN was found and at least one of the specified entities is present.
ENTITY NOT FOUND	The DN was found, but none of the specified entities are present
DN NOT FOUND	The DN was not found.

The general rule for determining portability status is that a subscriber is considered own-network (or in-network) if the entity type is SP, and the subscriber is considered ported out if the entity type is RN. There is a special case that is associated with both the IS41 to GSM migration feature and the Service Portability feature. With both of these features, the case where the network entity type is RN and the portability type is 0 (own network IS41 subscriber), the RN is treated as the SP.

The RN, SP, VMSID, and GRN (Generic Routing Number) entity types are supported.

In certain networks, a network an entity type other than RN and SP can affect portability status. For example, an entity type of GRN could imply ported number. This can be indicated by setting the NPTYPEPLY, NPTYPEPLS, or NPTYPECGPN configuration option to ANY or ALL.

The CDPN or CGPN lookup result can be different based on the MATCHSEQ configuration option value. The MATCHSEQ option can have values NPTYPE and DN.

Note: The TIFOPTS MATCHSEQ option value must be DN when any TIF feature that accesses the RTDB, except TIF NP or TIF Subscr CgPN Blacklist, is turned on. The TIFOPTS MATCHSEQ option

value can be NPTYPE when the TIF NP or TIF Subscr CgPN Blacklist feature is enabled. To configure the TIFOPTS SPORTRELAY and SPORTRLS options for Service Portability, the MATCHSEQ option value must be DN.

When the RTDB is searched for data using MATCHSEQ=NPTYPE (see [Table 17: RTDB Success Criteria for NP Type with MATCHSEQ=NPTYPE](#)),

- An individual subscriber lookup is done. If the DN is found, it is matched using the value of the TIFOPTS NPTYPEPLY, NPTYPEPLS, or NPTYPECGPN option. If the match is successful, the data associated with the entry is used for the Service Action processing of the applicable feature.
- If the DN is not found or the DN did not match with a TIFOPTS option value, a range lookup is done. If an entry is found, the data associated with the entry is used for the Service Action processing of the applicable feature.
- If no entry is found, there is no data available for the applicable features. The Service Actions for each feature define the specific behavior for handling this case.

Note: The combination of the IGM feature on or the Service Portability feature on, NE=RN, and PT=0 is considered entity type SP (own-network subscriber) for individual or range status.

Table 17: RTDB Success Criteria for NP Type with MATCHSEQ=NPTYPE

NP Type	Individual Status	Range Status	Result
SP	Found, NE=SP	N/A	Individual.SP
SP	Found, NE≠SP	Found, NE=SP	Range.SP
SP	Found, NE≠SP	Found, NE≠SP	None
SP	Found, NE≠SP	Not found	None
SP	Not found	Found, NE=SP	Range.SP
SP	Not found	Found, NE≠SP	None
SP	Not found	Not found	None
RN	Found, NE=RN	N/A	Individual.RN
RN	Found, NE≠RN	Found, NE=RN	Range.RN
RN	Found, NE≠RN	Found, NE≠RN	None
RN	Found, NE≠RN	Not found	None
RN	Not found	Found, NE=RN	Range.RN
RN	Not found	Found, NE≠RN	None
RN	Not found	Not found	None
RNSP / RNSPDN	Found, NE=SP	N/A	Individual.SP
RNSP / RNSPDN	Found, NE=RN	N/A	Individual.RN
RNSP / RNSPDN	Found, NE≠RN or SP	Found, NE=SP	Range.SP
RNSP / RNSPDN	Found, NE≠RN or SP	Found, NE=RN	Range.RN
RNSP / RNSPDN	Found, NE≠RN or SP	Found, NE≠RN or SP	None

NP Type	Individual Status	Range Status	Result
RNSP / RNSPDN	Found, NE≠RN or SP	Not found	None
RNSP / RNSPDN	Not found	Found, NE=SP	Range.SP
RNSP / RNSPDN	Not found	Found, NE=RN	Range.RN
RNSP / RNSPDN	Not found	Found, NE≠RN or SP	None
RNSP / RNSPDN	Not found	Not found	None
Any/All	Found, NE=SP	N/A	Individual.SP
Any/All	Found, NE=RN	N/A	Individual.RN
Any/All	Found, NE≠ RN/SP	Found, NE=SP	Range.SP
Any/All	Found, NE≠ RN/SP	Found, NE=RN	Range.RN
Any/All	Found, NE≠ RN/SP	Found, NE≠ RN/SP	None
Any/All	Found, NE≠ RN/SP	Not found	None
Any/All	Not found	Found, NE=SP	Range.SP
Any/All	Not found	Found, NE=RN	Range.RN
Any/All	Not found	Found, NE≠ RN/SP	None
Any	Not found	Not found	None
All	Not found	Not found	None

When the RTDB is searched for data using MATCHSEQ=DN (see [Table 18: RTDB Success Criteria for NP Type with MATCHSEQ=DN](#)),

- An individual subscriber lookup is done. If the DN is found, it is matched using the value of the TIFOPTS NPTYPEPLY, NPTYPEPLS, or NPTYPECGPN option. If the match is successful, the data associated with the entry is used for the Service Action processing of the applicable feature. No range lookup is done.
- If the DN is not found during the subscriber lookup, then a range lookup is done. If an entry is found, then the data associated with the entry shall be used for the Service Action processing of the applicable feature.
- If no entry is found, there is no data available for the applicable features. The Service Actions for each feature define the specific behavior for handling this case.

Table 18: RTDB Success Criteria for NP Type with MATCHSEQ=DN

NP Type	Individual Status	Range Status	Result
SP	Found, NE=SP	N/A	Individual.SP
SP	Found, NE≠ SP	N/A	None
SP	Not Found	Found, NE=SP	Range.SP
SP	Not Found	Found, NE≠ SP	None
SP	Not Found	Not Found	None

NP Type	Individual Status	Range Status	Result
RN	Found, NE≠ RN	N/A	Individual.RN
RN	Found, NE≠ RN	N/A	None
RN	Not Found	Found, NE=RN	Range.RN
RN	Not Found	Found, NE≠ RN	None
RN	Not Found	Not Found	None
RNSP / RNSPDN	Found, NE=SP	N/A	Individual.SP
RNSP / RNSPDN	Found, NE=RN	N/A	Individual.RN
RNSP / RNSPDN	Found, NE ≠ RN or SP	N/A	None
RNSP / RNSPDN	Not Found	Found, NE=SP	Range.SP
RNSP / RNSPDN	Not Found	Found, NE=RN	Range.RN
RNSP / RNSPDN	Not Found	Found, NE ≠ RN or SP	None
RNSP / RNSPDN	Not Found	Not Found	None
Any / All	Found, NE=SP	N/A	Individual.SP
Any / All	Found, NE=RN	N/A	Individual.RN
Any / All	N/A	N/A	None
Any / All	Not Found	Found, NE=SP	Range.SP
Any / All	Not Found	Found, NE=RN	Range.RN
Any / All	Not Found	Found, NE≠ RN/SP	None
Any	Not Found	Not Found	None
All	Not Found	Not Found	None

IAM/SAM Splitting

When the CdPN parameter in the ISUP message grows too long after TIF services have added Routing Numbers (RNs) or other prefixes or delimiters, the ISUP message needs to be split. A destination-based SPLITIAM configuration option and a TIFOPTS SPLITIAM configuration option can be used for determining when to split an internationally formatted ITU ISUP IAM message into one IAM message and one SAM message.

- If the SPLITIAM option value is 15-31 in the Destination table entry associated with the DPC in the incoming message, that destination-based option value is used as the maximum CdPN length.
- If the SPLITIAM option value is none in the Destination table entry associated with the DPC in the incoming message, and the TIFOPTS SPLITIAM option value is 15-31, the TIFOPTS SPLITIAM value is used as the maximum CdPN length.

- If both SPLITIAM option values are none, IAM/SAM splitting is not enabled for the message. Up to 32 Called Party digits are encoded in the IAM message and any remaining digits are discarded.
- When splitting is enabled for a message and the maximum CdPN length is 15-31, then that number of digits is encoded in the IAM message. Any remaining digits (up to that value) are encoded in a trailing SAM message. Any remaining digits after filling the SAM message are discarded.
- The SAM message is encoded with the same OPC, DPC, SLS, and CIC that are in the IAM message.

Note: If the DPC in the incoming message is not found in the Destination table, a UIM is generated and the message is discarded.

The SPLITIAM option is not applicable to ANSI ISUP messages; ANSI does not support SAM messages. Up to 32 Called Party digits are always encoded for ANSI ISUP messages.

MSU Sequencing

During TIF Stop Action processing, all messages are marked for sequencing on the incoming LIM card.

Sequencing of MSUs delivered to a TIF Stop Action is provided by the existing Class 1 Sequencing capabilities.

If the message is sent to the Service Module card, then the message must be returned to the incoming LIM card before actual transmission.

On the Service Module card, there are several potential actions:

- An error occurs, and the Service Module card does not generate an MSU for transmission. In this unexpected case, but the LIM card times out and transmits all pending messages.
- The Service Module card relays the IAM message. Because the original sequence information is still present, sequencing will occur as expected.
- The Service Module card generates a response message, such as REL. The sequence information from the original MSU is transferred to the response message, and sequencing is still maintained.
- The Service Module card generates multiple messages, which can occur if the Called Party digits are increased and the IAM/SAM splitting action is invoked (see *IAM/SAM Splitting*). An IAM message and a SAM message will be generated. The SAM message must follow the IAM message. Both MSUs will be given the same sequence number and sent back to the original LIM card on the same path.

If the message does not require Service Module card processing, the message is sent directly to the sequencer on the card. The message will wait in the sequencer for any preceding messages to complete processing before it is transmitted.

ISUP Decode and Encode Errors

The UIMs listed in *Table 36: TIF UIMs* indicate TIF encode and decode errors.

The UIMs listed in *Table 37: Existing ISUP Decode Errors* are used to handle ISUP decode and encode error cases.

Refer to *Unsolicited Alarm and Information Messages Reference* for information about EAGLE UIMs.

Hardware Requirements

EPAP-related features that perform an RTDB lookup require Service Module cards (E5-SM4G, E5-SM8G-B, or SLIC cards) running the SCCPHC application. The EAGLE can be equipped with up to 32 (31+1) Service Module cards.

Features that do not perform an RTDB lookup require Service Module cards only for GTT processing that might be performed for the feature. These features can coexist in systems with EPAP, but do not require an EPAP connection.

MPS/EPAP Platform

Oracle provides the Multi-Purpose Server (MPS) platform as a subsystem of the Oracle Communications EAGLE. The MPS provides support for EPAP-related features that perform Real Time Database (RTDB) lookups.

The MPS is composed of hardware and software components that interact to create a secure and reliable platform. For details about the MPS hardware, refer to *Application B Card Hardware and Installation Guide*. The MPS provides the means of connecting the customer provisioning application with the EAGLE and accepts the customer number portability data, while accommodating numbers of varying lengths.

The Oracle Communications EAGLE Application Processor (EPAP) is software that runs on the MPS hardware platform. EPAP collects and organizes customer provisioning data, and forwards the data to the EAGLE Service Module cards. For detailed information about EPAP, refer to *Administration Guide* for EPAP.

In this manual, Service Module card refers to an E5-SM4G, E5-SM8G-B, or SLIC card unless a specific card is required. For more information about the supported cards, refer to *Hardware Reference*.

Chapter 3

TIF Features

Topics:

- *TIF Number Portability Feature.....46*
- *TIF Number Substitution Feature.....63*
- *TIF Simple Number Substitution Feature70*
- *TIF SCS Forwarding Feature.....74*
- *TIF Additional Subscriber Data Feature75*
- *TIF Generic Routing Number Feature80*
- *TIF Blacklist Features.....85*

This chapter describes the EAGLE 5 features that use the Triggerless ISUP Framework (TIF) and the Numbering Plan Processor (NPP) to process ISUP messages:

- TIF Number Portability (TIF NP)
- TIF SCS Forwarding (TIF SCS)
- TIF Number Substitution (TIF NS)
- TIF Simple Number Substitution (TIF SNS)
- TIF Additional Subscriber Data (TIF ASD)
- TIF Generic Routing Number (TIF GRN)
- TIF Blacklist Features
 - TIF Subscriber CgPN Blacklist (TIF Subscr CgPN Blacklist)
 - TIF Range CgPN Blacklist
 - TIF Selective Screening

TIF Number Portability Feature

The TIF Number Portability (TIF NP) feature, along with the Numbering Plan Processor (NPP) the Service Portability feature, and the Triggerless ISUP Framework (TIF), provide the following capabilities:

- Complex prefix usage, where prefixes can be used to customize actions
- Non-NAI-compliant digit handling
- Complex outgoing digit formats
- Calling number portability
- Concurrent Release and Relay support
- Circular route prevention (CRP)
- IAM/SAM splitting
- Service Portability (S-Port)

The TIF NP feature is built upon the services provided by TIF and NPP to support ISUP messages.

TIF NP provides the following functions:

- Definition of feature-specific pre-NPP processing to be performed by TIF
- Service Action specification (including Service Action names and precedence)
- Service Action Handlers
- Feature-specific post-NPP processing, if needed

TIF NP Message Flows

Figure 7: ISUP Message Flows for TIF NP CdPN Relay shows basic TIF NP CdPN Relay use cases.

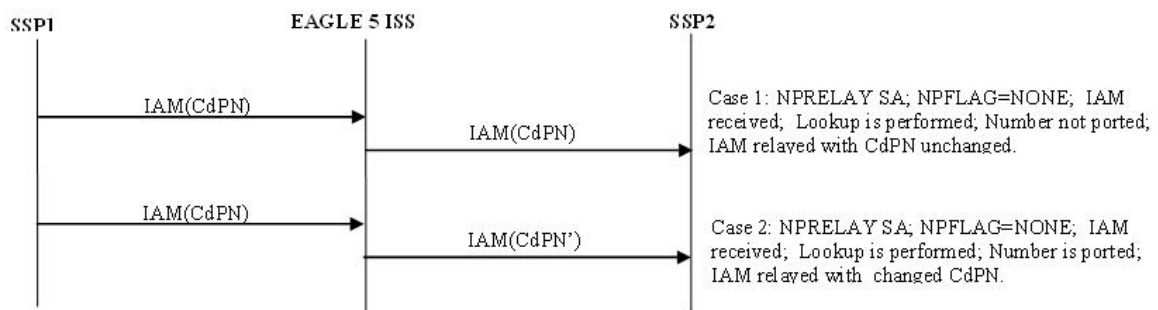

Figure 7: ISUP Message Flows for TIF NP CdPN Relay

Figure 8: ISUP Message Flows for TIF NP CdPN Relay, with Optional NM Bits shows TIF NP Relay cases where NM bits are used in the ISUP IAM message. In the sequence diagrams, the NM bits are shown as binary values. Refer to [Use of NM Bits](#) for details on the use of NM bits.

Note: Use of NM bits in the IAM message is an optional part of TIF NP.

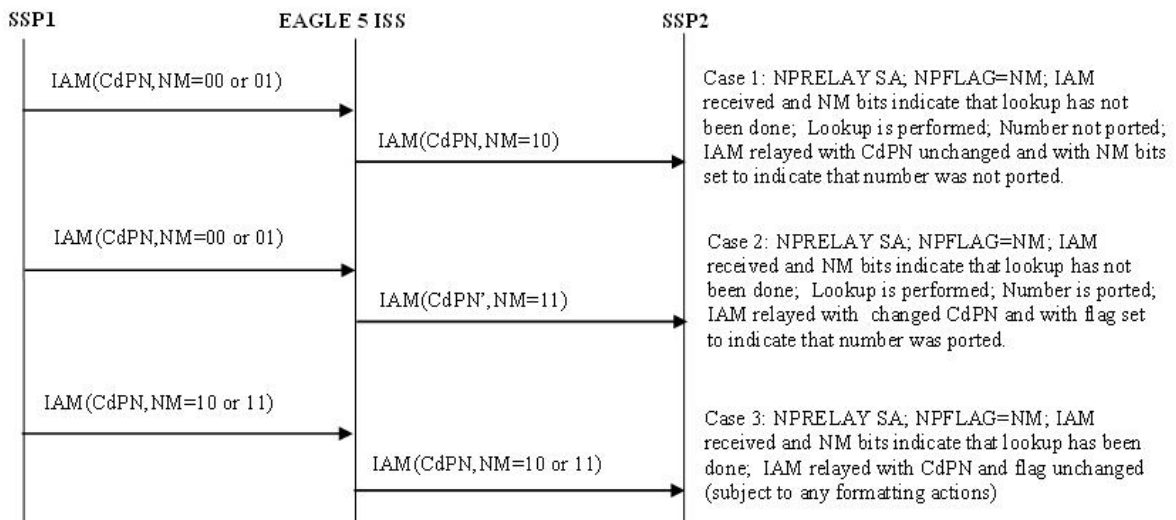

Figure 8: ISUP Message Flows for TIF NP CdPN Relay, with Optional NM Bits

Figure 9: ISUP Message Flows for TIF NP CgPN Portability shows basic TIF NP CgPN portability use cases.

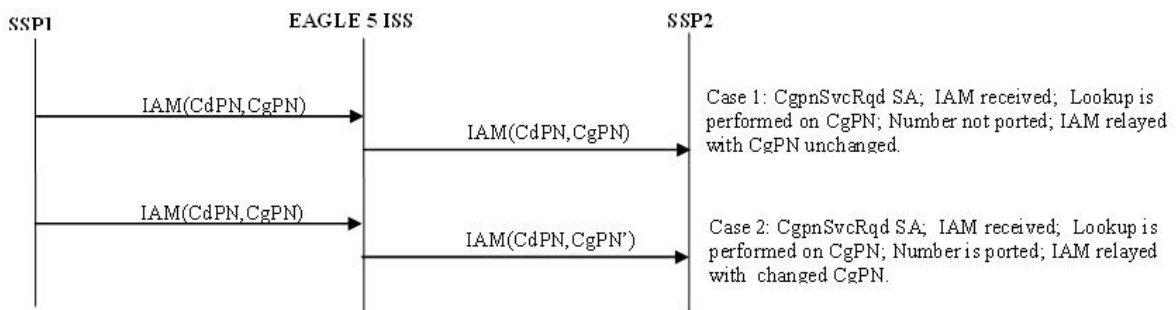

Figure 9: ISUP Message Flows for TIF NP CgPN Portability

A TIF NP CgPN use case is shown in *Figure 10: ISUP Message Flows for TIF NP CgPN with NPDELAY and CGPNNP* for a TIFCGPN, TIFCGPN2, or TIFCGPN3 NPP service when NPDELAY (in TIF, TIF2, or TIF3) and CGPNNP (in TIFCGPN, TIFCGPN2, or TIFCGPN3) Service Actions are provisioned and RTDB lookup is performed on both CdPN and CgPN. A TIFCGPN, TIFCGPN2, and TIFCGPN3 NPP service is invoked by the corresponding TIF, TIF2, or TIF3 NPP Service.

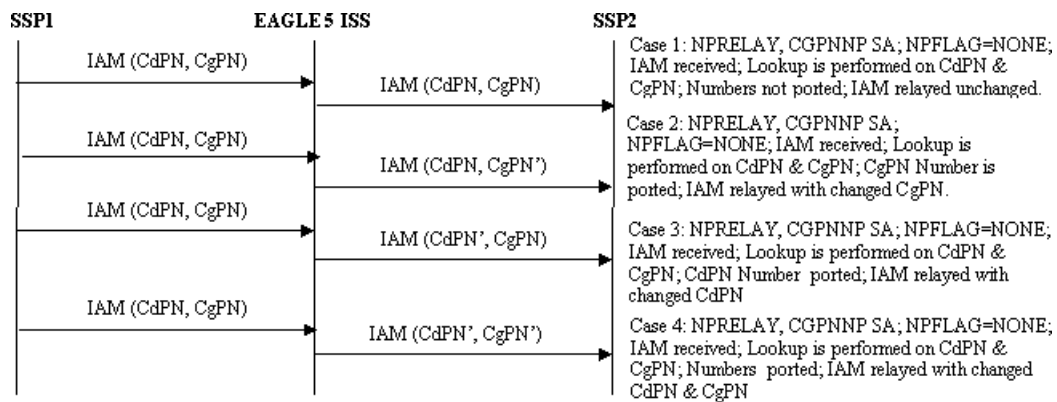

Figure 10: ISUP Message Flows for TIF NP CgPN with NPRELAY and CGPNNP

Figure 11: ISUP Message Flows for TIF NP Release shows basic TIF NP Release use cases.

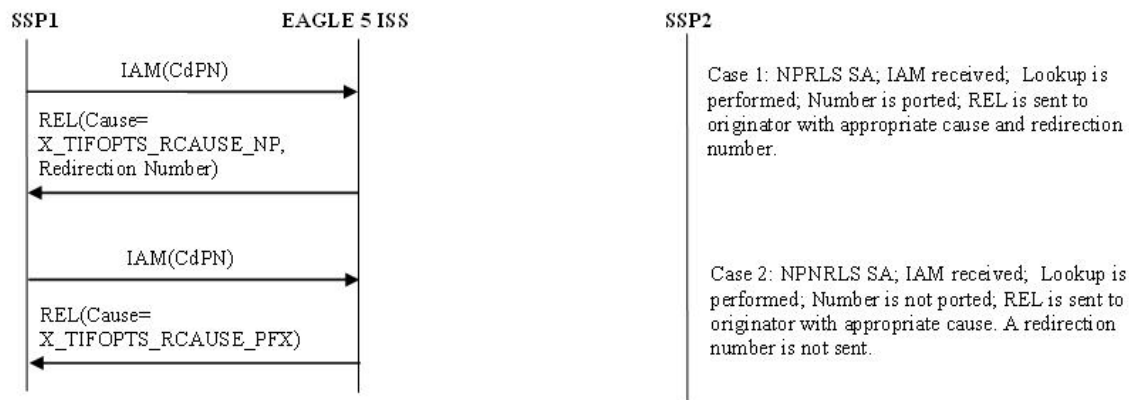

Figure 11: ISUP Message Flows for TIF NP Release

Figure 12: ISUP Message Flows for TIF NP Release, with Optional NM bits shows TIF NP Release use cases, with use of NM bits. See *Use of NM Bits* for details on the use of NM bits.

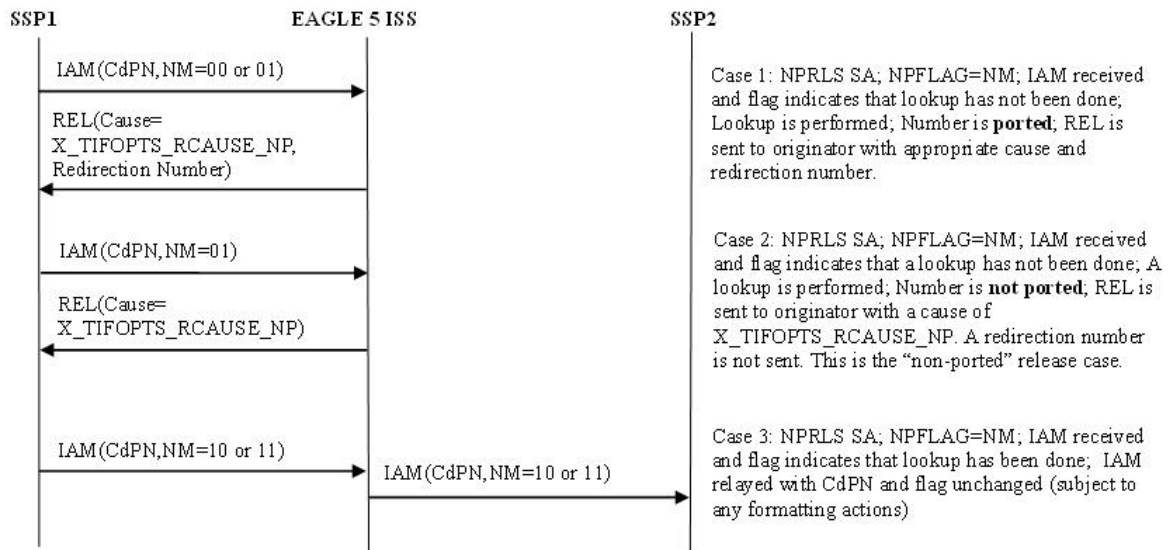

Figure 12: ISUP Message Flows for TIF NP Release, with Optional NM bits

Figure 13: ISUP Message Flows for TIF CRP shows Circular Route Prevention use cases. In these cases, subscriber X is ported from network A to network B. Network A's NP database has the correct entry indicating that subscriber X is ported, but network B has incorrect routing information, indicating that subscriber B still belongs to network A. Subscriber Y belongs to network A. In the use case, subscriber Y calls subscriber X.

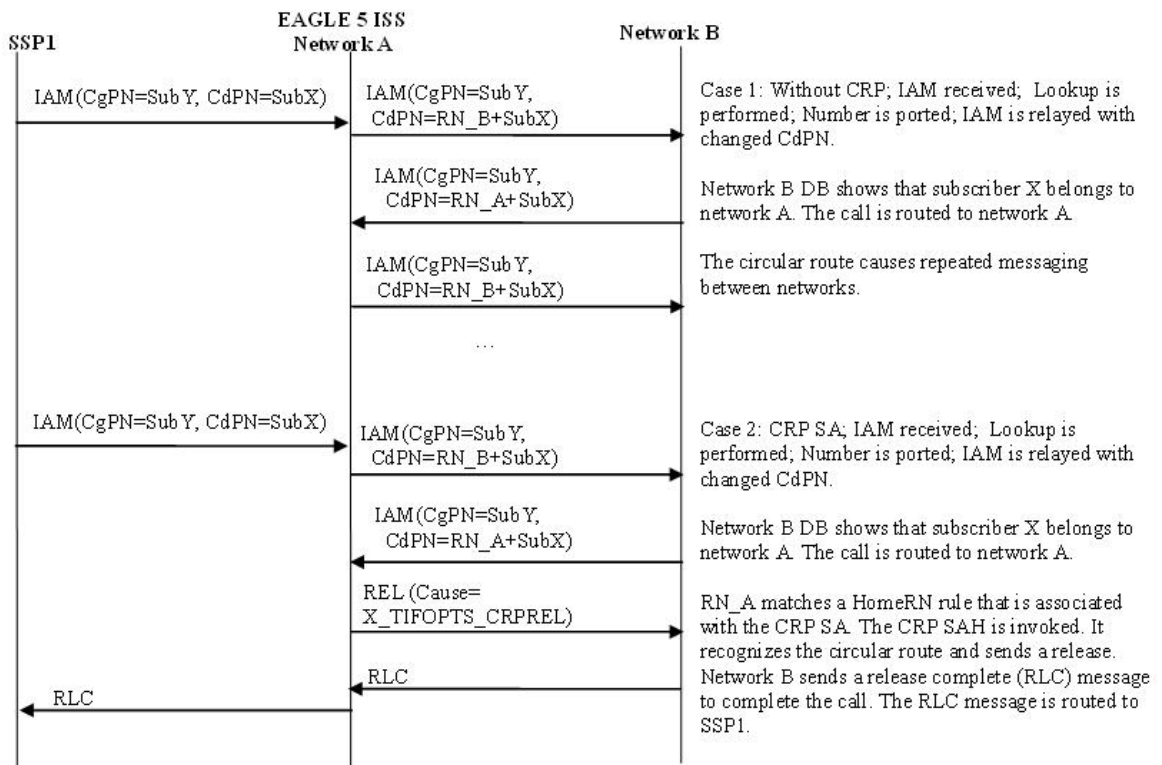

Figure 13: ISUP Message Flows for TIF CRP

A basic Service Portability use case is shown in [Figure 14: ISUP Message Flows for Service Portability](#). In this example, the Service Portability feature is turned on and the TIFOPTS SPORTRELAY option has been configured for Service Portability. If the subscriber is an own-network GSM or IS41 subscriber, then the RTDB GRN is used for the RN.

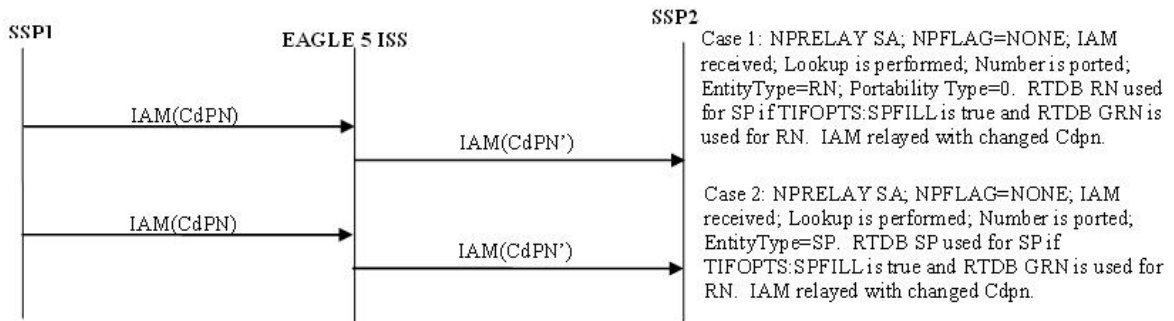

Figure 14: ISUP Message Flows for Service Portability

A use case using both the NPRLS and NPRELAY Service Actions is shown in [Figure 15: ISUP Message Flows for NPRLS + NPRELAY](#). In this example, only OLO subscribers are released; own-network subscribers are relayed. The Service Actions would be set to NPRLS and NPRELAY. The NPTYPEPLS configuration option is set to RN and the NPTYPEPLY configuration option is set to SP.

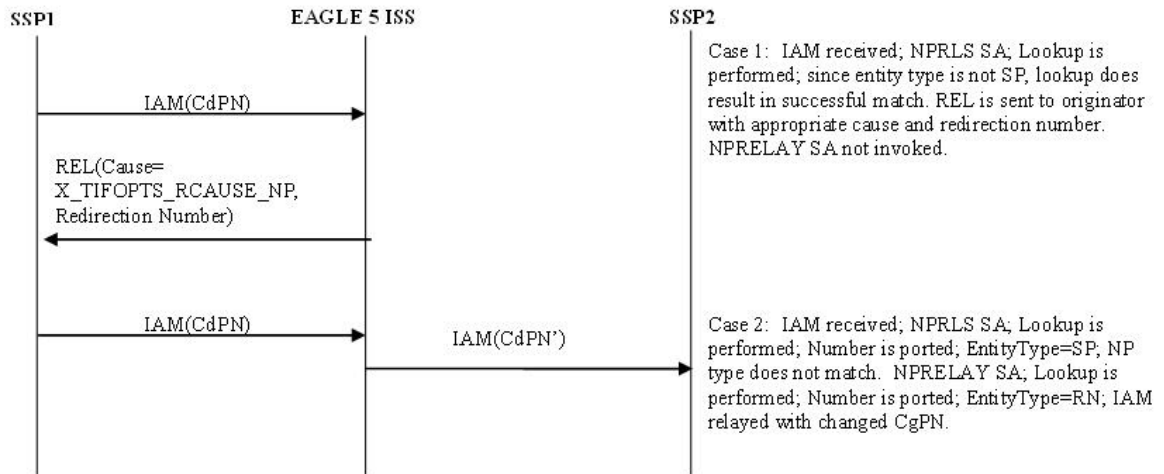

Figure 15: ISUP Message Flows for NPRLS + NPRELAY

TIF NP Configuration Options

TIF Configuration Options indicates the TIF configuration options that can be used specifically by TIF NP. TIF NP can also use other options that are available to any TIF feature.

TIF NP Protocol Handling

TIF NP protocol handling provides the following functions:

- TIF NP-specific pre-NPP processing
- TIF NP Service Action Handlers
- Post NPP-processing

TIF Pre-NPP Processing for TIF NP

TIF decodes the incoming MSU and passes the following information to NPP:

- Conditioned CgPN
- Number of Country Code digits in CgPN
- Incoming NM bits

TIF NP Service Action Handlers

TIF NP provides Service Action Handlers for the NPP Service Actions that are specific to TIF NP. TIF and NPP perform the following functions for the TIF NP feature:

- RTDB lookup
- Interpretation of results from RTDB lookups
- NPP processing of Service Actions that are used for TIF NP

Table 19: Summary of TIF NP Service Actions provides a summary of the Service Actions used for TIF NP.

Table 19: Summary of TIF NP Service Actions

Service Action	Description	Function	Precedence
CRP	Circular Route Prevention	Performs an RTDB lookup on the CdPN and attempts to detect a circular route.	92
NPNRLS	Number Portability Release on No Match	Performs an RTDB lookup on the CdPN and indicates release behavior on an unsuccessful lookup.	91
NPRELAY	Number Portability Relay	Performs an RTDB lookup on the CdPN and indicates relay behavior.	80
NPRLS	Number Portability Release on Match	Performs an RTDB lookup on the CdPN and indicates release behavior on a successful lookup.	80
CgPNSvcRqd	Calling Number Lookup	Performs an RTDB lookup on the CgPN.	80

Relationships Between TIF NP Service Actions

Figure 16: NP Service Action Precedence shows the relationships between NP Service Actions. The figure shows the precedence values (p) and shows which Service Actions are mutually exclusive in terms of Action Set configuration. In the diagram, Service Actions that are connected by lines are mutually exclusive. Service Actions that can be terminating actions are marked with asterisks.

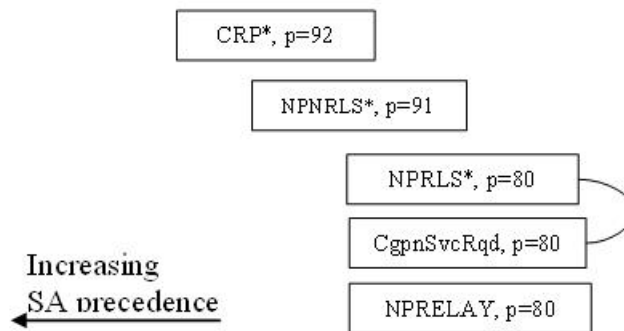

Figure 16: NP Service Action Precedence

The mutual exclusion relationships can be explained as follows:

- CgPNSvcRqd and NPRLS – CgPNSvcRqd implies Relay behavior.

The precedence relationships can be explained as follows:

- CRP – CRP should be first since it is a special case and a terminating action.
- NPNRLS – NPNRLS is a special condition and a terminating action.
- NPRLS – NPRELAY can be the same precedence. The NP lookup status determines whether or not the second Service Action needs to be executed.
- CgPNSvcRqd, NPRELAY – normal relay case

The following principles apply to precedence relationships:

- Special NP Release cases are given higher precedence.
- Handlers that need to override conditions set by other handlers must be given lower precedence

The mutual exclusion relationships are enforced during EAGLE 5 ISS configuration for TIF NP.

RN, SP, and DFLTRN Handling

The RN and SP values are set depending on the entity type retrieved from the RTDB and the values of the configuration options for NP type (NPTYPEPLY, NPTYPEPLS and NPTYPECGPN) and the SPFILL and DFLTRN configuration options. The options for NP type are used as part of the matching criteria to determine when the RTDB search is considered a success.

If a match is found and the Entity Type is RN, then RN digits are inserted into the outbound field.

If a match is found and the Entity Type is SP, then SP digits are inserted into the outbound field or the DFLTRN option digit string can be used instead of actual SP digits.

The DFLTRN and SPFILL configuration options allow a single digit string to be inserted instead of the actual SP digits to identify 'in-network subscribers'. There may be different SPs in the RTDB for use by G-Port or other EAGLE 5 ISS features, but a single digit string is needed for TIF. The DFLTRN string is considered 'routing digits'. When a DFLTRN string is provisioned, the RN Formatting Action is used to encode 'routing digits' (RN or DFLTRN) in the outbound digits. The SPFILL option is used to indicate how the SP is populated when DFLTRN is used for the RN. If the SPFILL option value is ON, RTDB network entity digits are used for the SP. If the SPFILL option value is OFF, the SP is not populated.

The RN Formatting Action inserts the 'routing digits' into the outbound digits (either be the actual RN or the DFLTRN string).

The SP Formatting Action inserts the SP digits into the outbound digits.

Note: If the IGM Feature is turned on, or the Service Portability feature is enabled, Entity Type is RN, and portability type (PT) is zero, then the Entity Type is treated as SP (in-network subscriber).

[Table 20: Rules for Determining Outbound RN and SP](#) summarizes the rules for determining the outbound RN and SP.

Table 20: Rules for Determining Outbound RN and SP

Case	NPTYPE	RTDB Entity Type	DFLTRN	SPFILL	RN	SP
1	RN, RNSP, RNSPDN, ANY, ALL	RN	N/A	N/A	Entity data digits from the RTDB	No data
2	SP	RN	N/A	N/A	No data	No data
3	RN	SP	N/A	N/A	No data	No data
4	SP, RNSP, RNSPDN, ANY, ALL	SP	Null	N/A	No data	Entity data digits from the RTDB
5	SP, RNSP, RNSPDN, ANY, ALL	SP	Not Null	ON	DFLTRN	Entity data digits from the RTDB
6	SP, RNSP, RNSPDN, ANY, ALL	SP	Not Null	OFF	DFLTRN	No data
7	SP, RN, RNSP, RNSPDN, ANY, ALL	Not RN, Not SP	N/A	N/A	No data	No data

Use of NM Bits

The Number Portability Forward Call Indicator NM bit values shown in [Table 21: NM Bits Values](#) are used in ISUP IAM messages to indicate CDPN portability status.

Table 21: NM Bits Values

NM Bits Value	Meaning
00	"Without indication" - DPC is out-of-network, or no RTDB lookup performed
01	"Query not performed" - DPC is in-network, RTDB lookup was not performed
10	"Query performed, not ported" - DPC is in-network, unsuccessful RTDB lookup
11	"Query performed, ported" - DPC is in-network, successful RTDB lookup

Use of NM Bits is optional, and is controlled by the TIFOPTS NPFLAG configuration option and by the destination-based NPRST configuration option for the DPC of the incoming message.

TIF determines the value of the NM Bits in the incoming message. The following CDPN-based Service Action Handlers inspect the incoming NM Bits value: NPRELAY, NPRLS, NPNRLS, and CRP.

- If TIFOPTS NPFLAG=NM and the incoming NM Bits value is 10 or 11, the Service Action Handler ends processing immediately.
- If TIFOPTS NPFLAG=NM and the NPRELAY Service Action Handler performs an RTDB lookup on the CdPN, TIF uses the NM Bits value indicated by the NPRELAY processing to determine if the NM Bits value needs to be updated in the outgoing IAM message.
- If TIFOPTS NPFLAG=NM, the incoming NM Bits value is 01, the NPRLS Service Action Handler performs an RTDB lookup on the CdPN, and no match is found, the NPRLS Service Action Handler sends a RELEASE message with no Redirection Number and the Release Cause set to the value of the TIFOPTS RCAUSENP option.

Note: The configuration options and the NM Bits apply only to the CdPN, not to the CgPN. Therefore, the CgPNSVCRQD and CGPNNP Service Action Handlers do not look at the NM bits. The NM Bits apply only for ITU ISUP messages when TIFOPTS NPFLAG=NM.

If the TIFOPTS NPFLAG configuration option is set to NM and the outgoing message NM bits are not 00, the Destination table is searched for the DPC from the IAM message.

- If the NPRST option valued in the Destination table entry is ON, the NM bits in the outgoing message are set to 00 ("without indication").
- If the NPRST option valued in the Destination table entry is OFF, the NM bits in the outgoing message are not set to 00.

Service Portability for TIF NP

With the Service Portability feature, the subscriber has ported to a different network technology with the same service provider. The Service Portability use case is very similar to number portability with the exception of what is used as the prefix for the Called Party digits. Service Portability is applicable to TIF Number Portability Relay and TIF Number Portability Release, and is handled by the NPRELAY and the NPRLS Service Actions.

Service Portability is controlled by the Service Portability feature P/N 893-0343-01. The SPORTRELAY and SPORTRLS options in the TIFOPTS table control the mode of the Service Portability for NP Relay and NP Release. These options have the following values:

- NONE - Apply standard NP processing for own-network GSM and IS41 subscribers.
- GSM - Use the GSM Service Portability prefix for GSM own-network subscribers, and apply standard NP processing for own-network IS41 and OLO subscribers.
- IS41 - Use the IS41 Service Portability prefix for Is41 own-network subscribers, and apply standard NP processing for own-network GSM and OLO subscribers.
- ALL - Use the GSM Service Portability prefix for GSM own-network subscribers, use the IS41 Service Portability prefix for IS41 own-network subscribers, and apply standard NP processing for OLO subscribers.

The determination of whether or not to invoke Service Portability depends on the subscriber's Entity type and the Portability Type. The subscriber is considered as an own-network IS41 subscriber if the Entity type is RN and the Portability Type is 0 (RN/PT=0). The subscriber is considered as an own-network GSM subscriber if the Entity type is SP with any Portability Type. In the case of RN/PT=0, the RN for this subscriber is actually considered to be the SP (the IS-41 HLR address).

After the Service Portability feature is considered to be applicable, the Service Action attempts to use the subscriber GRN data in the RTDB as the Service Portability prefix. This GRN is populated in the RN Formatting Action value as the Service Portability prefix. The TIFOPTS SPFILL option value determines the content of the SP. If the SPFILL option value is ON, then the RTDB Network Entity

digits are used for the .SP. If the SPFILL option value is OFF, then the SP value is null. [Table 22: TIF NP Service Portability Digit Formatting Scenarios](#) shows how the RN and SP are set according to the various scenarios. In all the cases, it is assumed that the Service Portability feature (893-0343-01) is ON.

Table 22: TIF NP Service Portability Digit Formatting Scenarios

		Subscriber Type Returned form RTDB		
		Own IS41	OLO	Own GSM
TIFOPTS Service Portability Option Value	NONE	No changes from default TIF-NP behavior	No changes from default TIF-NP behavior	No changes from default TIF-NP behavior
	GSM	No changes from current behavior	No changes from default TIF-NP behavior	RN=GRN
	IS41	RN=GRN	No changes from default TIF-NP behavior	No changes from default TIF-NP behavior
	ALL	RN=GRN	No changes from v behavior	RN=GRN

If the GRN is not present in the RTDB, then UIM 1426, "S-Port: Missing GRN for srvc prtd subs" is generated indicating that Service Portability could not be applied due to missing Service Portability data. The behavior of the Service Action is as follows for the case that S-Port applies and the GRN does not exist in the RTDB:

- For the NPRELAY Service Action, the IAM message is routed with the CdPN unmodified, unless CDIAL is indicated to cause Formatting Action execution.
- For the NPRLS Service Action with NP type of RN, SP, RNSP, or RNSPDN, the IAM message is routed with the CdPN unmodified, unless CDIAL is indicated to cause Formatting Action execution.
- For the NPRLS Service Action with NP type of ALL or ANY, a REL message is sent with no redirection number.

Using NPRELAY and NPRLS in One Service Action Set

In a Service Action set containing both the NPRELAY and NPRLS Service Actions, TIF will perform Service Action processing in the order in which the Service Actions are provisioned (the lower-numbered sax configuration parameter specifies the first Service Action to be executed). If the first Service Action (NPRELAY or NPRLS) has a successful database match, then the second Service Action (NPRLS or NPRELAY) will not be executed. If the first Service Action (NPRELAY or NPRLS) does not have a successful database match, then the second Service Action (NPRLS or NPRELAY) is executed.

The TIFOPTS NPTYPEPLY option will determine the Network Entity type behavior for the NPRELAY Service Action, and the The TIFOPTS NPTYPEPLS option will determine the Network Entity type behavior for the NPRLS Service Action. This s allows the NPRELAY and NPRLS Service Actions to be configured for non-ported subscribers and ported subscribers independently. See the use case in [Figure 15: ISUP Message Flows for NPRLS + NPRELAY](#). The following table has a list of possible combined Service Actions scenarios for NPRELAY and NPRLS. Scenarios 1 and 4 have the same behavior, and

scenarios 2 and 3 have the same behavior. If the NP type is the same for both Service Actions, the second Service Action will never get executed.

Table 23: Scenarios for Combining the NPRELAY and NPRLS Service Actions

Scenario	First Service Action	Second Service Action	Result
1	NPRELAY, NPTYPE=SP	NPRLS, NPTYPE=RN	NP Relay an own-network subscriber; NP Release a foreign subscriber
2	NPRELAY, NPTYPE=RN	NPRLS, NPTYPE=SP	NP Relay foreign subscriber; NP Release an own-network subscriber
3	NPRLS, NPTYPE=SP	NPRELAY, NPTYPE=RN	NP Release an own-network subscriber; NP Relay a ported subscriber
4	NPRLS, NPTYPE=RN	NPRELAY, NPTYPE=SP	NP Release a foreign subscriber; NP Relay an own-network subscriber

NPRELAY Service Action Handler

The NPRELAY Service Action Handler performs an RTDB lookup on the conditioned CdpN digit string and indicates Relay behavior.

Configuration Options Used

The TIFOPTS NPTYPE configuration option indicates the conditions that are used for a successful RTDB match.

The destination-based NPRST configuration option and the TIFOPTS NPFLAG configuration option indicate when and how the NM bits should be processed.

The value of the TIFOPTS DFLTRN option, if provisioned, is used to populate the RN on a successful match on SP.

The TIFOPTS SPFILL option indicates whether SP should be populated when the DFLTRN value or the GRN data is used for the RN value.

The TIFOPTS SPORTRELAY option indicates the Service Portability processing for the NPRELAY Service Action (none, GSM, IS41, all).

Action Performed

If the NPRLS Service Action has already been executed with a successful match, no NPRELAY processing is performed.

This Service Action Handler uses the incoming NM bits to determine if a lookup has already been performed. See [Use of NM Bits](#).

If the TIFOPTS NPFLAG option is set to NM and the NM bits indicate that a lookup has already been performed, then the Service Action Handler returns immediately.

If a lookup has not already been performed, the NPRELAY Service Action Handler performs an RTDB lookup on the CdPN digit string. RN and SP can be found as a successful match. RN and SP entities are processed as described in [RN, SP, and DFLTRN Handling](#).

Interpretation of lookup results is described in [Interpreting Results of an RTDB Lookup](#).

Depending on the Formatting Action configuration for the selected rule, the updated RN or SP can be used during CdPN formatting by NPP.

Service portability processing is applied as described in [Service Portability for TIF NP](#) when the Service Portability feature is ON, and:

- Network Entity type is RN/PT=0 and the SPORTRELAY option value is IS41 or ALL
- Network Entity type is SP and the SPORTRELAY option value is GSM or ALL

If the NPTYPEPLY configuration option is RNSPDN, ANY, or ALL and a match is found on a non-RN/SP condition, then the RN or SP entities are not used. The end result is that NPP performs formatting of the outgoing CdPN.

The NPP Formatting Action processing will be skipped on an unsuccessful lookup. One way to force formatting of the outgoing CdPN, even after an unsuccessful lookup, is to configure the CDIAL Service Action.

On a successful lookup, where DN and entity data was found, the CdPN message parameter is changed to the ported number and the message is relayed to the recipient network.

On a successful lookup, where DN was found but entity data was not found (NPTYPEPLY=ALL), the CdPN is unchanged and the message is relayed to the original destination.

The decoded NM result is used to determine if the NM bits need to be set in the outgoing IAM message.

Terminating Action?

This is not a terminating action.

NPRLS Service Action Handler

The NPRLS Service Action Handler performs a lookup on the conditioned CdPN digit string and indicates Release behavior on a successful lookup.

This Service Action should be used after the CRP Service Action.

Configuration Options Used

The TIFOPTS NPTYPEPLS configuration option indicates the conditions used for a successful match.

The TIFOPTS RNRQD configuration option indicates if a Redirection Number should be included in the Release message.

The TIFOPTS RLCOPC option indicates whether the destination-based RCAUSE configuration option value or the TIFOPTS RCAUSENP configuration option value is used as the Release Cause to be included in the Release message.

The value of the TIFOPTS DFLTRN option, if provisioned, is used to populate the RN on a successful match on SP.

The destination-based NPRST configuration option and the TIFOPTS NPFLAG configuration option indicates if the NM bits should be processed, and if a Release message should be generated if a DN is-not-found.

The TIFOPTS SPORTRLS option indicates the Service Portability processing for the NPRLS Service Action (none, GSM, IS41, all).

The TIFOPTS SPFILL option indicates whether SP should be populated when the DFLTRN value or the GRN data is used for the RN value.

Action Performed

If the NPRELAY Service Action has already been executed with a successful match, no NPRLS processing is performed.

This Service Action Handler uses the incoming NM bits to determine whether a lookup has already been performed. See [Use of NM Bits](#).

If the NPFLAG configuration option is set to NM and the NM bits indicate that a lookup has already been performed, then the Service Action Handler returns immediately.

If the NM bits indicate that a lookup has not already been performed, the Service Action Handler performs an RTDB lookup on the conditioned CdPN digit string. RN or SP can be found as successful match. The RN and SP values are processed as described in [RN, SP, and DFLTRN Handling](#).

Interpretation of lookup results is described in [Interpreting Results of an RTDB Lookup](#).

On a match, the RNRQD option indicates whether or not a Redirection Number is included in the Release message, and the RCAUSE option or the RCAUSENP option indicates the Release Cause to be included in the Release message.

- On a successful lookup, where DN and entity data was found, a Release message is sent. If the Redirection Number configuration option (RNRQD) is set to YES, then the ported number is included in the ISUP Release message.
- On a successful lookup, where DN was found but entity data was not found (NPTYPE=ALL), a Release message is sent. If the Redirection Number configuration option (RNRQD) is set to YES, then the original CdPN is included in the ISUP Release message.

Depending on the Formatting Action configuration for the selected rule, the updated RN or SP can be used during CdPN formatting by NPP.

Service portability processing is applied as described in [Service Portability for TIF NP](#) when the Service Portability feature is ON, and:

- Network Entity type is RN/PT=0 and the SPORTRLS option value is IS41 or ALL
- Network Entity type is SP and the SPORTRLS option value is GSM or ALL

The Formatting Action processing will be skipped on an unsuccessful lookup. The original message is relayed using the original CdPN, unless NPFLAG=NM and a Release message is to be generated. If TIFOPTS NPFLAG=NM, the incoming NM Bits value is 01, and no match is found in the RTDB lookup on the CdPN, then the NPRLS Service Action Handler sends a Release message with no Redirection Number and the Release Cause set to the value of the TIFOPTS RCAUSENP option.

Terminating Action?

This is a terminating action in either of the following two conditions:

- The NPFLAG is set to NM, lookup is not successful, and the NM bits indicate “query not performed” (binary value 01).
- The lookup is successful.

NPNRLS Service Action Handler

The NPNRLS Service Action Handler performs a lookup on the conditioned CdPN digit string and indicates Release behavior on an unsuccessful lookup.

Configuration Options Used

The TIFOPTS NPTYPERLS configuration option indicates the conditions used for a successful match.

The destination-based NPRST configuration option and the TIFOPTS NPFLAG configuration option indicates when and how the NM bits should be processed.

The TIFOPTS RLCOPC option indicates whether the destination-based RCAUSE configuration option value or the TIFOPTS RCAUSENP configuration option value is used as the Release Cause to be included in the Release message.

Action Performed

This Service Action Handler uses the incoming NM bit decode result to determine if a lookup has already been performed.

If the TIFOPTS NPFLAG configuration option is set to NM and the NM bits indicate that a lookup has already been performed, then the Service Action Handler returns immediately.

If the NM bits indicate that a lookup has not already been performed, the RTDB lookup is performed and does not return a match.

In this no-match case, a Release message will be sent with a Release Cause specified in the RCAUSE option or the RCAUSEPFX option. The Redirection Number is not included in the Release message.

This Service Action Handler provides no inputs to Formatting Actions.

The post-NPP processing sends a Release message with a Release Cause that is configured in the RCAUSE option or the RCAUSEPFX option. The Redirection Number is not included in the Release message.

Terminating Action?

In the no-match case, this is a terminating action.

CGPNNP Service Action Handler

The CGPNNP Service Action Handler performs an RTDB lookup on the CgPN digits from the ISUP IAM message.

The CGPNNP Service Action Handler is supported for the TIFCGPN, TIFCGPN2, and TIFCGPN3 services, which are invoked only if the INVKSERV parameter value is not NONE for the corresponding TIF, TIF2, or TIF3 service.

The CGPNNP Service Action can be provisioned with any of the other Service Actions supported by the TIFCGPN, TIFCGPN2, and TIFCGPN3 services except for PFXRLS.

Configuration Options Used

The TIFOPTS NPTYPECGPN option indicates the conditions used for a successful match.

The value of the TIFOPTS DFLTRN option, if set, is used to populate the RN on a successful DN match and the effective entity type is SP.

The TIFOPTS SPFILL option indicates whether SP should be populated when the DFLTRN value is used for the RN value.

Action Performed

RTDB lookup is performed on the conditioned digit string in international format. The result is determined based on the TIFOPTS NPTYPECGPN option value.

On a lookup where an RN or SP entity was found

- The SRFIMSI digits assigned to the entity are used to populate the SRFIMSI Formatting Action value.
- If the IGM feature is turned on, Entity Type is RN, and PT=0, then the Entity Type is treated as SP (in-network subscriber).

If a match is found and the Entity Type is RN, then RN digits are inserted into the outgoing field.

If a match is found and the effective Entity Type is SP, then SP digits are inserted into the outgoing field or the DFLTRN option digit string can be used to populate the RN Formatting Action value instead of actual SP digits.

If a match is found and the Entity Type is SP, then SPFILL=ON causes the SP digits to populate the SP Formatting Action value when the DFLTRN value is used to populate the RN Formatting Action value.

On a lookup where an entry was found, but entity data was not found (NPTYPECGPN=ALL), the CgPN is unchanged, if the Formatting Actions do not modify the digits in some other manner.

Formatting Action processing is skipped on an unsuccessful lookup. Depending on the Formatting Action configuration for the selected rule, the updated RN, SP or SRFIMSI can be used during CgPN formatting by NPP.

Terminating Action?

This is not a terminating action.

CgPNSvcRqd Service Action Handler

The CgPNSvcRqd Service Action Handler performs an RTDB lookup on the conditioned CgPN digit string.

The CgPNSvcRqd and NPRLS Service Actions are mutually exclusive in an Action Set.

Configuration Options Used

The NPTYPECGPN option indicates the conditions used for a successful match.

The IAMCGPN option value (DN, RN, RNDN) indicates the format of outgoing CgPN string. For the IAMCGPN configuration option, RN implies either RN or SP.

The value of the DFLTRN option, if set, is used to populate the RN on a successful match on SP.

Action Performed

On a lookup where entity data was found, the CgPN is changed according to the IAMCGPN configuration option. TIF will use the updated CgPN string to set the CgPN in the outgoing message.

On a lookup where an entry was found, but entity data was not found (NPTYPE=ALL), the CgPN is unchanged. The outgoing CgPN string is empty.

The length of the provisioned STPOPTS Default Country Code (DEFCC) parameter value provides the number of Country Code (CC) digits that are at the front of the conditioned CgPN.

On a successful lookup, where the outgoing format includes the DN (IAMCGPN=DN or RNDN) and the Country Code (CC) was added to the conditioned CgPN, the CC will be removed from the conditioned CgPN before copying the DN to the outgoing CgPN digit sting.

For example,

- On entry to the Service Action Handler:
 - The conditioned CgPN is CCC1234567.
 - The number of CC digits is 3.
 - The IAMCGPN option values is RNDN.
- The lookup is successful.
 - The value of RN is AAA.
 - The resulting outgoing CgPN digit string is AAA1234567.

If a match is found and the Entity Type is RN, then RN digits are inserted into the outgoing field.

If a match is found and the Entity Type is SP, then SP digits are inserted into the outgoing field or the DFLTRN option digit string can be used instead of actual SP digits.

Note: If the IGM feature is turned on, Entity Type is RN, and PT=0, then the Entity Type is treated as SP (in-network subscriber).

Terminating Action?

This is not a terminating action.

CRP Service Action Handler

The Circular Route Prevention (CRP) Service Action Handler attempts to detect a circular route.

The CRP Service Action must have a higher precedence than the NPRLS Service Action, which is a terminating action.

Configuration Options Used

The TIFOPTS NPFLAG configuration option indicates when and how the NM bits should be processed.

The TIFOPTS CRPREL configuration option indicates the Release Cause code to be included in the Release message.

Actions Performed

If the TIFOPTS NPFLAG configuration option is set to NM and the NM bits indicate that a lookup has already been performed, then the Service Action Handler returns immediately. (NM bits are used in-network only. If the NM bits have been set, then portability has already been checked in the network. Another CRP check is not needed.)

If the NM bits indicate that a lookup has not already been performed, the RTDB lookup is performed. If an RN is returned, then it is assumed that the number was ported and that a circular route is detected.

A Release Cause code will be included, and a Redirection Number will not be included, in the outgoing Release message.

The NPP Formatting Action processing will be skipped when a circular route is detected. One way to force formatting of the outgoing CdPN is to configure the CDIAL Service Action.

Terminating Action?

If a circular route is detected, then this is a terminating action.

TIF Post-NPP Processing for TIF NP

TIF post-NPP processing performs all actions required for NP Release and most actions required for NP Relay. The only extra NP-specific logic in TIF post-NPP processing is a Result Handler that performs the following functions:

- If the NPFLAG option value is NM, and the NPRST parameter value is ON for the Destination Point Code in the Destination table, then the NM bits will be set to 00 (meaning “without indication”).
- If the NPFLAG option value is NM, and the NPRST parameter value is OFF for the Destination Point Code in the Destination table, and if the incoming NM bits are not equal to the outgoing NM bits, then the outgoing NM bits are written to the outgoing ISUP IAM message (see [NPRELAY Service Action Handler](#) for details).
- If the Destination Point Code is not found in the Destination table, then the message is discarded and a UIM is generated.

TIF Number Substitution Feature

Number substitution of both the Calling and Called Party provides customers the ability of supporting numbers outside their normal number range without having to upgrade all the nodes in the network. The TIF Number Substitution (TIF NS) feature, along with the Numbering Plan Processor (NPP) and the Triggerless ISUP Framework (TIF), provide the following capabilities:

- Called number substitution to change a Public DN into a Private DN
- Calling number substitution to change a Private DN into a Public DN

The TIF NS feature is built upon the services provided by TIF and NPP to support RTDB lookup of both Calling Party and Called Party numbers for substitution.

TIF NS provides the following functions:

- Definition of feature-specific pre-NPP processing to be performed by TIF
- Service Action specification (including Service Action names and precedence)
- Service Action Handlers
- Feature-specific post-NPP processing, if needed

TIF NS Message Flows

Figure 17: ISUP RELAY with TIF NS shows CgPN and CdPN substitution in an ISUP IAM Relay call flow.

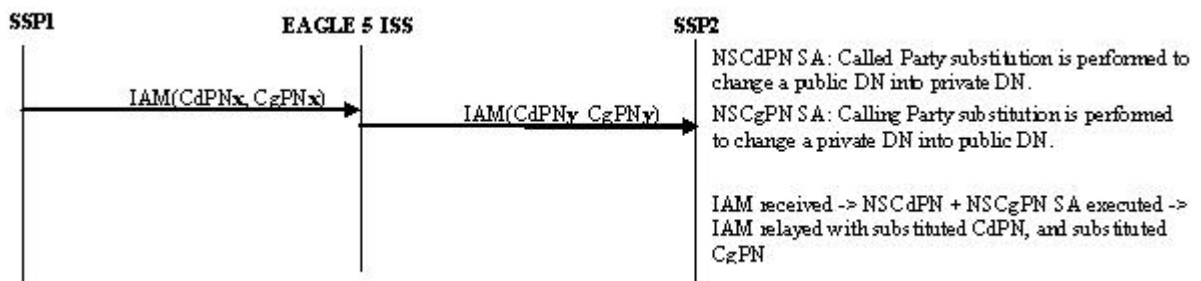

Figure 17: ISUP RELAY with TIF NS

Figure 18: ISUP RELAY with TIF NS - No CgPN Substitution shows the ISUP IAM Relay call flow where CdPN is substituted and CgPN is not substituted.

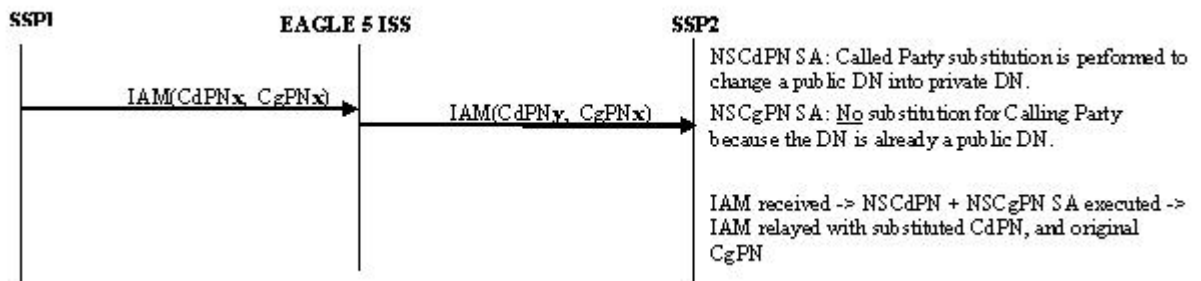

Figure 18: ISUP RELAY with TIF NS - No CgPN Substitution

Figure 19: ISUP RELAY with TIF NS - No CdPN Substitution shows the ISUP IAM Relay call flow where CgPN is substituted and CdPN is not substituted.

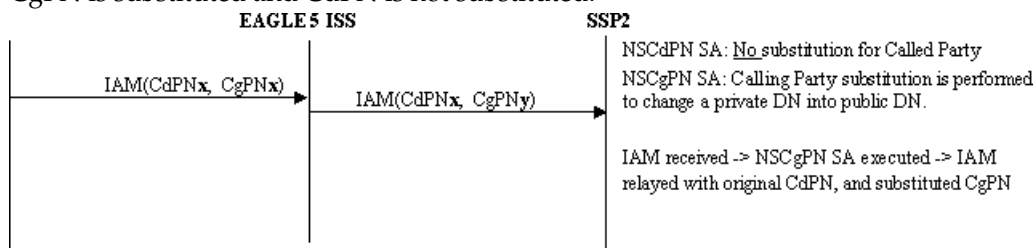

Figure 19: ISUP RELAY with TIF NS - No CdPN Substitution

TIF NS Basic Use Cases

This section describes two basic use cases for TIF NS:

- TIF NS use case for TIF CdPN Service
- TIF NS use case for TIF CgPN Service

TIF NS Use Case for TIF CdPN Service

Figure 20: TIF NS Basic Operation for TIF CdPN Service shows the steps involved in a basic TIF NS use case for CdPN service. This case uses the following Service Rule and configuration options:

- Filter PPFX=123
- Filter FDL=13
- Conditioning Actions=CC3+AC3+SN7
- Service Actions=NSCgPN, NSCdPN
- Formatting Actions=CC+AC+SN
- TIFOPTS options NSADDLDATA=yes, NSPUBLIC=5

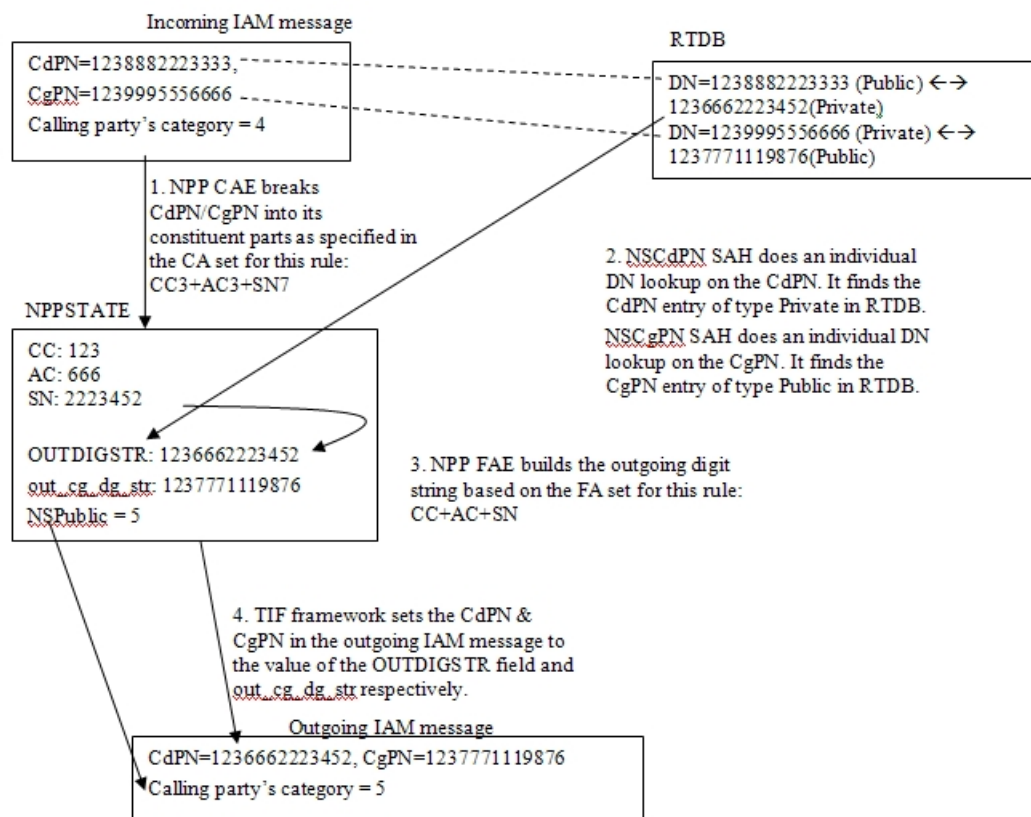

Figure 20: TIF NS Basic Operation for TIF CdPN Service

TIF NS Use Case for TIF CgPN Service

Figure 21: TIF NS Basic Operation for TIF CgPN Service shows the steps involved in a basic TIF NS use case for CgPN service. This case uses the following Service Rule and configuration options:

- Filter PPFX-123
- Filter FDL=13
- Conditioning Actions=CC3+AC3+SN7
- Service Action=NSCgPN
- Formatting Actions=CC+AC+SN
- TIFOPTS options NSADDLDATA=yes, NSPUBLIC=5

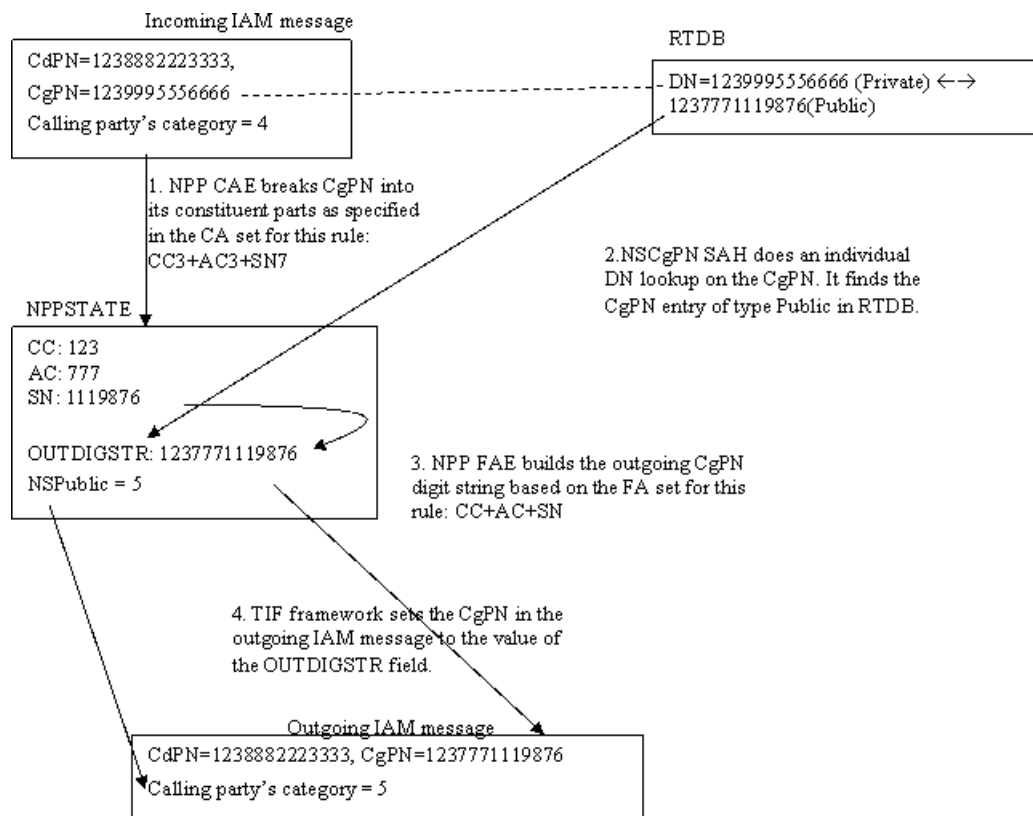

Figure 21: TIF NS Basic Operation for TIF CgPN Service

TIF NS Configuration Options

TIF Configuration Options indicates the TIF configuration options that can be used specifically by TIF NS. TIF NS can also use other options that are available to any TIF feature.

TIF NS Handling of IAM Message

When an IAM message is received and successfully decoded, an RTDB lookup is performed on the CdPN, the CgPN, or both.

For the CdPN, upon successful retrieval of the Called Party DN (Private), the CdPN is substituted in the outgoing IAM message.

For the CgPN, upon successful retrieval of the Calling Party DN (Public), the CgPN is substituted in the outgoing IAM message. If the Calling Party's Category is not the same as the value for the TIFOPTS nspublic configuration option and the lookup was successful, the Calling Party's Category is changed to the nspublic option value in the outgoing IAM message. The outgoing IAM message is then relayed.

TIF NS Protocol Handling

TIF NS protocol handling provides the following functions:

- TIF NS-specific pre-NPP processing
- TIF NS Service Action Handlers
- Post NPP-processing

TIF Pre-NPP Processing for TIF NS

TIF decodes the incoming MSU and passes either the conditioned CdPN or the conditioned CgPN to NPP.

For the conditioned CgPN, the country code provisioned in the STPOPTS DefCC parameter value will be prepended to the conditioned CgPN if the TIFOPTS condcgpn parameter value is set to addcc.

TIF NS Service Action Handlers

TIF NS provides Service Action Handlers for the NPP Service Actions that are specific to TIF NS. TIF and NPP perform the following functions for the TIF NS feature:

- RTDB lookup
- Interpretation of results from RTDB lookups
- NPP processing of Service Actions that are used for TIF NS

[Table 24: Summary of TIF NS Service Actions](#) provides a summary of the Service Actions used specifically for TIF NS.

Table 24: Summary of TIF NS Service Actions

Service Action	Description	Function	Precedence
NSCdPN	Called Number Substitution	Performs an RTDB lookup on the CdPN; if the lookup is successful, replaces the outgoing CdPN.	80
NSCgPN	Calling Number Substitution	Performs an RTDB lookup on the CgPN. if the lookup is successful, replaces the outgoing CgPN.	75

NSCdPN Service Action Handler

The TIF NSCdPN Service Action Handler executes the NSCdPN Service Action when NSCdPN is associated in a Service Rule Set with a CdPN service (TIF, TIF2, TIF3).

There are no mutually exclusive relationships with other NS Service Actions.

Configuration Options Used

None.

Action Performed

The NSCdPN Service Action Handler performs an RTDB lookup on the conditioned CdPN digit string. On a successful lookup it replaces the outgoing CdPN. A successful lookup is one in which the subscriber type is Public and there is a pointer to an associated Private DN. The subscriber can come from either the individual or range data.

This Service Action Handler copies digits from the Private DN found in the successful RTDB lookup, and populates one of the following sets of Formatting Action values:

- ZN
- CC+DN
- CC+AC+SN

This Service Action assumes that Formatting Action execution will occur. If another Service Action determines that Formatting Action execution will not occur, the CDIAL Service Action must be used to force Formatting Action execution to occur.

The post-NPP processing replaces the CdPN in the outgoing message.

Terminating Action?

This is not a terminating action.

TIF CdPN NSCgPN Service Action Handler

The TIF CdPN NSCgPN Service Action Handler executes the NSCgPN Service Action when NSCgPN is associated in a Service Rule Set with a CdPN service (TIF, TIF2, TIF3).

The SNSCgPN Service Action and the NSCgPN Service Action are mutually exclusive in the same Action Set.

NSCgPN for a TIF CdPN service cannot be specified if a TIF CgPN is configured to be invoked (INVKSERV parameter not NONE in CdPN Service Rule).

Configuration Options Used

The nsaddldata configuration option indicates whether to compare the incoming Calling Party's Category to the nspublic configuration option value before the RTDB lookup.

The nspublic configuration option indicates the value for the Calling Party's Category in a Public DN for the network.

Formatting of the outgoing CgPN string is based on the value of the iamcgpn configuration option.

Action Performed

The NSCgPN Service Action Handler performs an RTDB lookup on the conditioned CgPN digit string. On a successful lookup it replaces the outgoing CgPN. A successful lookup is one in which the subscriber type is Private and there is an associated Public DN.

The Calling Party Category can be:

- Used to determine if the incoming CgPN is Public or Private
- Replaced in the outgoing message with a "Public" value

This Service Action Handler uses the nsaddldata configuration option to determine whether to check the Calling Party Category for "Public" or "Private", and the nspublic configuration option value to replace the Calling Party Category in the outgoing message.

If a country code was prepended to the original CgPN by the TIF pre-NPP processing, the Public DN from the RTDB is assumed to begin with a country code. The STPOPTS default country code (DefCC) value is compared with the country code digits in the DN retrieved from the RTDB.

- If the two sets of digits match, the country code digits are removed from the retrieved DN.
- If the two sets of digits do not match, a UIM is generated and the Service Action returns normally.

The following actions are taken depending on the value of the iamcgpn configuration option:

- If iamcgpn=dn, all digits in the outgoing CgPN are substituted.
- If iamcgpn=rndn, the RN will contain the maximum number of digits allowed in the CgPN, and the digits following the RN are replaced with the substituted DN.

This Service Action Handler provides no inputs to Formatting Actions. Formatting of the outgoing CgPN digit string is completed in the Service Action Handler.

The post-NPP processing replaces the Calling Party Category and the CgPN (only the digit string and the odd/even indicator bits, not the NAI) as NPP processing indicates.

Terminating Action?

This is not a terminating action.

TIF CgPN NSCgPN Service Action Handler

The TIF CgPN NSCgPN Service Action Handler executes the NSCgPN Service Action when NSCgPN is associated in a Service Rule Set with a CgPN service (TIFCGPN, TIFCGPN2, TIFCGPN3).

The SNSCgPN Service Action and the NSCgPN Service Action are mutually exclusive in the same Action Set.

Configuration Options Used

The nsaddldata configuration option indicates whether to compare the incoming Calling Party's Category to the nspublic configuration option value before the RTDB lookup.

The nspublic configuration option indicates the value for the Calling Party's Category in a Public DN for the network.

Action Performed

The NSCgPN Service Action Handler performs an RTDB lookup on the conditioned CgPN digit string. On a successful lookup it replaces the outgoing CgPN. A successful lookup is one in which the subscriber type is Private and there is an associated Public DN.

The Calling Party Category can be:

- Used to determine if the incoming CgPN is Public or Private
- Replaced in the outgoing message with a "Public" value

This Service Action Handler uses the nsaddldata configuration option to determine whether to check the Calling Party Category for "Public" or "Private", and the nspublic configuration option value to replace the Calling Party Category in the outgoing message.

This Service Action Handler populates the ZN, CC+DN, or CC+AC+SN Formatting Action values that correspond to the provisioned Conditioning Actions.

The TIF post-NPP processing replaces the Calling Party Category and the CgPN (only the digit string and the odd/even indicator bits, not the NAI) as NPP processing indicates. Formatting Action execution uses the populated values to generate the outgoing CgPN digit string.

Terminating Action?

This is not a terminating action.

TIF Post-NPP Processing for TIF NS

TIF post-NPP processing performs all actions required for NS functions. TIF performs the following processing for TIF NS:

- Calling Party's Category replacement
- CgPN replacement
- CdPN replacement

TIF Simple Number Substitution Feature

The TIF Simple Number Substitution (TIF SNS) feature allows the Calling Party number in the ISUP IAM message to be substituted with a single Calling Party number that is provisioned in a TIF configuration option. The RTDB is not used in this case.

The TIF SNS feature uses services provided by the Triggerless ISUP Framework (TIF), and provides the following functions:

- Feature-specific pre-NPP processing
- Service Action specification (including Service Action names and precedence)
- Service Action Handlers
- Feature-specific post-NPP processing

TIF SNS Message Flows

Figure 22: ISUP Message Flows for TIF SNS shows TIF SNS use cases.

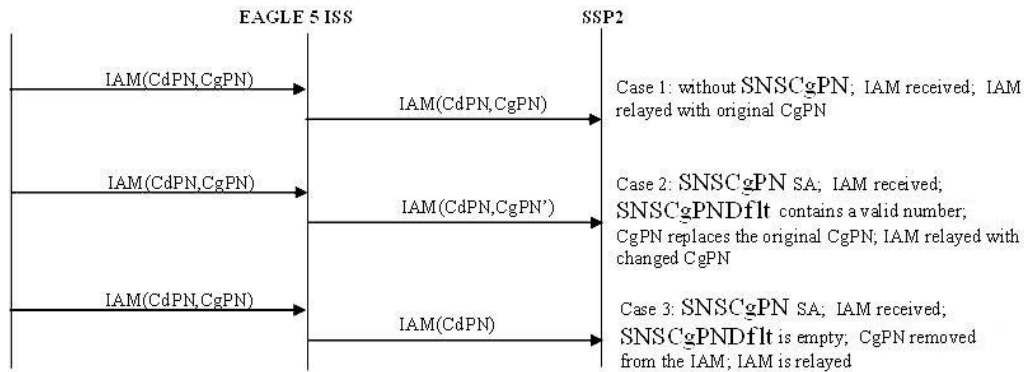

Figure 22: ISUP Message Flows for TIF SNS

TIF SNS Basic Use Cases

This section describes two basic use cases for TIF SNS:

- TIF SNS use case for TIF CdPN Service
- TIF SNS use case for TIF CgPN Service

TIF SNS Use Case for TIF CdPN Service

Figure 23: TIF SNS Basic Operation for TIF CdPN Service shows the steps involved in a basic TIF SNS use case for CdPN service. This case uses the following Service Rule and configuration options:

- Filter FPFx=123
- Filter FDL=13
- Conditioning Actions=CC3+AC3+SN7
- Service Action=SNSCgPN
- Formatting Actions=CC+AC+SN
- TIFOPTS option SNSCGPNDFLT=none

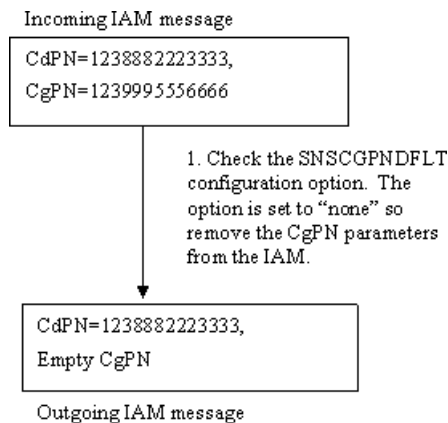

Figure 23: TIF SNS Basic Operation for TIF CdPN Service

TIF SNS Use Case for TIF CgPN Service

Figure 24: TIF SNS Basic Operation for TIF CgPN Service shows the steps involved in a basic TIF SNS use case for CgPN service. This case uses the following Service Rule and configuration options:

- Filter PPFX-123
- Filter FDL=13
- Conditioning Actions=CC3+AC3+SN7
- Service Action=SNSCgPN
- Formatting Actions=CC+AC+SN
- TIFOPTS option SNSCgPNDFLT=123777888999

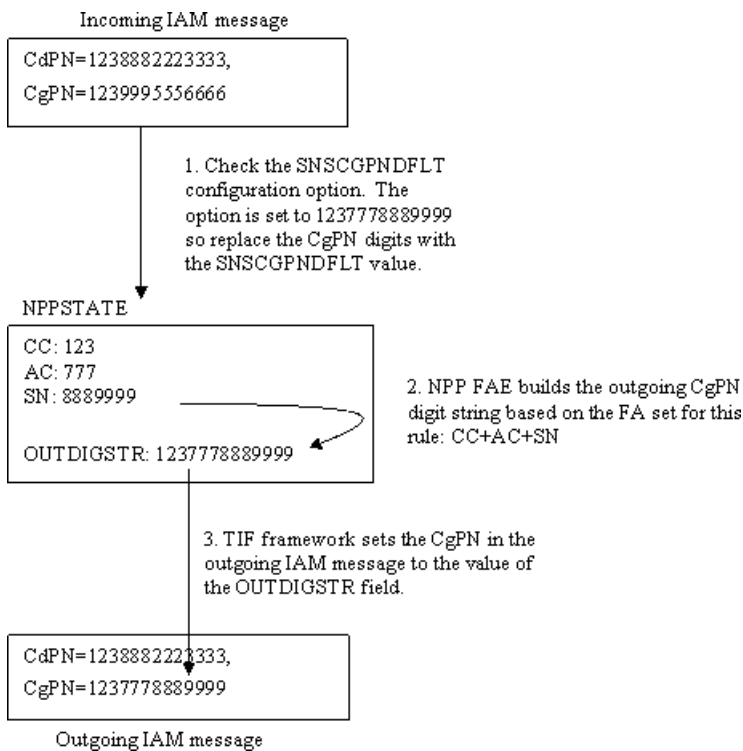

Figure 24: TIF SNS Basic Operation for TIF CgPN Service

TIF SNS Configuration Option

The SNSCgPNDFLT configuration option is used by TIF SNS. The provisioned option value indicates the number to be used to replace the CgPN during simple number substitution. A value of none indicates that the CgPN will be removed from the outgoing message.

The TIF SNS feature can use other TIF configuration options that are available to any TIF feature. See [TIF Configuration Options](#).

TIF SNS Protocol Handling

TIF SNS protocol handling consists of the following functions:

- TIF SNS-specific pre-NPP Processing

TIF sends the conditioned CgPN to NPP.

- SNSCgPN Service Action Handler
- TIF SNS-specific post NPP-Processing

TIF SNS Service Action Handlers

The SNSCgPN Service Action can be associated with a TIF CdPN service (TIF, TIF2, TIF3) or a TIF CgPN service (TIFCGPN, TIFCGPN2, TIFCGPN3) in a Service Rule Set. Two SNSCgPN Service Action Handlers indicate how to update the outgoing CgPN based on the value of the SNSCgPNDflt configuration option:

- [TIF CdPN SNSCgPN Service Action Handler](#)
- [TIF CgPN SNSCgPN Service Action Handler](#)

TIF CdPN SNSCgPN Service Action Handler

The TIF CdPN SNSCgPN Service Action Handler indicates how to update the outgoing CgPN based on the value of the SNSCgPNDflt configuration option.

SNSCgPN for a TIF CdPN service cannot be specified if a TIF CgPN service is invoked using the INVKSERV parameter in the CdPN Service Rule.

See [Table 10: Mutually Exclusive TIF Service Actions](#) for Service Actions that are mutually exclusive with SNSCgPN.

Configuration Options Used

The SNSCgPNDflt option indicates the number used to replace the CgPN, or a value of NONE if the CgPN should be removed.

Actions Performed

If the CgPN parameter is not included in the IAM message or the CgPN digits are empty in the CgPN parameter, then the TIF CgPN SNSCgPN Service Action will not be invoked.

If the SNSCgPNDflt option value is not NONE, the SNSCgPN Service Action Handler indicates that the CgPN is to be replaced with the specified SNSCgPNDflt option value.

If the SNSCgPNDflt option value is NONE, then the SNSCgPN Service Action Handler indicates that the CgPN will be removed from the message.

This Service Action Handler provides no input to NPP Formatting Actions.

Note: Formatting of the outgoing CgPN string is not based on the value of the IAMCGPN configuration option.

NPP Post-Processing

TIF post-NPP processing performs all actions required for SNS-related updates to the outgoing message:

- If the value of the SNSCgPNDflt option is NONE, then TIF removes the CgPN.
- If the value of the SNSCgPNDflt option is not NONE, then TIF replaces the CgPN in the outgoing message with the SNSCgPNDflt value. The CgPN NAI is not changed.

Terminating Action?

This is not a terminating action.

TIF CgPN SNSCgPN Service Action Handler

The SNSCgPN Service Action Handler indicates how to update the outgoing CgPN based on the value of the SNSCgPNDefault configuration option.

Configuration Options Used

The SNSCgPNDefault option indicates the number used to replace the CgPN, or a value of NONE if the CgPN should be removed.

Actions Performed

If the SNSCgPNDefault option value is the number used to replace the CgPN, the SNSCgPN Service Action Handler indicates that the CgPN is to be replaced.

If the SNSCgPNDefault option value is NONE, then the SNSCgPN Service Action Handler indicates that the CgPN should be removed from the message.

This Service Action Handler provides no input to NPP Formatting Actions.

Note: Formatting of the outgoing CgPN string is not based on the value of the IAMCGPN configuration option.

NPP Post-Processing

TIF post-NPP processing performs all actions required for SNS-related updates to the outgoing message:

- If the value of the SNSCgPNDefault option is NONE, then TIF removes the CgPN.
- If the value of the SNSCgPNDefault option is not NONE, then TIF replaces the CgPN with the SNSCgPNDefault value in the outgoing message. The CgPN NAI is not changed.

TIF SCS Forwarding Feature

The TIF SCS Forwarding feature provides the ability to forward messages to the SCS for additional processing after TIF processing is complete.

The only modifications made to the message by TIF are:

- Re-encode a modified CdPN
- Forward message to SCS, using DTA

The TIF SCS Forwarding feature provides the Service Action Handler for the FWDSCS Service Action that is provided by TIF to NPP. Before an NPP Rule can be provisioned with the FWDSCS Service Action in the Action Set, the TIF SCS Forwarding feature must be enabled in the system.

The feature does not require EPAP and RTDB lookup, but can operate with EPAP or ELAP subsystems.

FWDSCS Service Action Handler

The FWDSCS Service Action indicates that any relayed IAM and SAM messages require processing by the Database Transport Access (DTA; also called Redirect), a feature that encapsulates an MSU in an SCCP header and forwards it to a destination (the DTA DPC, usually an SCS). Refer to *Database Administration - Features User's Guide* for more information about DTA, including message size limits for encapsulation.

DTA might not be able to forward a message for the following reasons:

- The message is too large for DTA to process.
- The DTA DPC is prohibited or congested (through TFC, local link congestion is not considered).
- The DTA node is disabled.

If DTA encapsulation is requested but cannot be performed, the message is relayed without additional modification.

TIF Additional Subscriber Data Feature

The TIF Additional Subscriber Data (TIF ASD) feature allows for the insertion of Additional Subscriber Data (ASD) into the CdPN or CgPN of an outgoing IAM or Redirection Number of a REL ISUP message.

The ASD is obtained from the RTDB lookup of the CdPN and CgPN digits.

TIF ASD provides Service Action Handlers for the ASDLKUP and CgPNASDRqd Service Actions associated with TIF CdPN services TIF, TIF2, and TIF3 in NPP. The ASDLKUP Service Action allows retrieval of ASD from the matched incoming CdPN to be inserted into the outgoing CdPN digits. The CgPNASDRqd Service Action allows retrieval of ASD from the matched incoming CgPN to be inserted into the outgoing CdPN digits.

TIF ASD provides a Service Action Handler for the ASDLKUP Service Action associated with TIF CgPN services TIFCGPN, TIFCGPN2, and TIFCGPN3 in NPP. The ASDLKUP Service Action allows retrieval of ASD from the matched incoming CgPN to be inserted into the outgoing CgPN digits.

A TIF CgPN service is invoked by the corresponding TIF CdPN service by setting the INVKSERV parameter value to the TIF CgPN service name in the Service Rule for the TIF CdPN service.

The NPP ASD and ASDOTHER Formatting Actions are used for TIF ASD:

- The ASD Formatting Action is used to process the ASD that is retrieved by TIF ASD Service Actions.
- The ASDOTHER Formatting Action allows the ASD returned from a RTDB search by the ASDLKUP Service Action for a TIF CgPN service to be used in CdPN formatting.

Basic TIF ASD Use Case for TIF CdPN Service

In the use case described in this section, the incoming IAM message contains CdPN=1238882223333 and CgPN=1239995556666.

The following Filter and Action Set components are used for the example:

- Filter Prefix (FPFX) = 123
- Filter Digit Length (FDL) = 13
- Conditioning Actions = CC3 + AC3 + SN7
- Service Action = CgPNASDRqd

- Formatting Actions = CC + ASD + AC + SN

The CgPNASDRqd Service Action Handler performs an RTDB DN lookup on the CgPN, finds the CgPN entry with ASD value a5d, and populates the ASD Formatting Action value with the ASD value.

NPP Formatting Action execution uses the extracted CdPN information and the ASD to construct the outgoing CdPN digit string as CC + ASD + AC + SN = 123a5d8882223333.

TIF inserts the outgoing CdPN digit into the outgoing IAM message. The CgPN is not changed. The IAM message is relayed.

Basic TIF ASD Use Case for TIF CgPN Service

In the use case described in this section, the incoming IAM message contains CdPN=1238882223333 and CgPN=1239995556666.

The following Filter and Action Set components are used for the example:

- Filter Prefix (FPFX) = 123
- Filter Digit Length (FDL) = 13
- Conditioning Actions = CC3 + AC3 + SN7
- Service Action = ASDLKUP
- Formatting Actions = CC + ASD + AC + SN

The ASDLKUP Service Action Handler performs an RTDB lookup for the DN in the CgPN, finds the CgPN entry with ASD value a5d, and populates the ASD Formatting Action value with the ASD value.

NPP Formatting Action execution uses the extracted information and the ASD to construct the outgoing CgPN digit string as CC + ASD + AC + SN = 123a5d9995556666.

TIF inserts the outgoing CgPN digit string into the outgoing IAM message. The CdPN is not changed. The IAM message is relayed.

TIF ASD Use Case for TIF CgPN Service using ASDOTHER

In the use case described in this section, the incoming IAM message contains CdPN=4568882223333 and CgPN=1239995556666.

The following TIF Filter and Action Set components are used for the example:

- Filter Prefix (FPFX) = 456
- Filter Digit Length (FDL) = 13
- INVKSERV=TIFCGPN
- Conditioning Actions = CC3 + AC3 + SN7
- Service Action = CDIAL
- Formatting Actions = CC + ASDOTHER + AC + SN

The following TIFCGPN Filter and Action Set components are used for the example:

- Filter Prefix (FPFX) = 123
- Filter Digit Length (FDL) = 13
- Conditioning Actions = CC3 + AC3 + SN7
- Service Action = ASDLKUP
- Formatting Actions = CC + AC + SN

The ASDLKUP Service Action Handler performs an RTDB lookup for the DN in the CgPN, finds the CgPN entry with ASD value a5d, and populates the CgPN ASD Formatting Action value with the ASD value.

NPP Formatting Action execution uses the extracted information to construct the outgoing CgPN digit string as CC + AC + SN = 1239995556666.

TIF populates the CdPN ASDOTHER Formatting Action value from the CgPN ASD Formatting Action value.

NPP Formatting Action execution uses the extracted information and the CdPN ASDOTHER value to construct the outgoing CdPN digit string as CC + ASDOTHER + AC + SN = 456a5d8882223333.

TIF inserts the outgoing CdPN and CgPN into the outgoing IAM message. The IAM message is relayed.

TIF ASD Message Flows

Figure 25: ISUP IAM Message Flows for TIF ASD for TIF CdPN Service shows TIF ASD use cases for ISUP IAM messages, with TIF CdPN service.

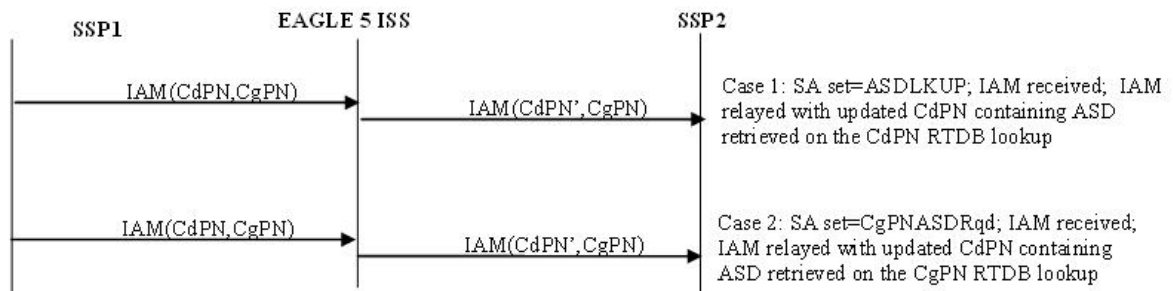

Figure 25: ISUP IAM Message Flows for TIF ASD for TIF CdPN Service

Figure 26: ISUP REL Message Flow for TIF ASD for TIF CdPN Service with NPRLS and NPNRLS SAs shows TIF ASD use cases with the NPRLS and NPNRLS Service Actions.

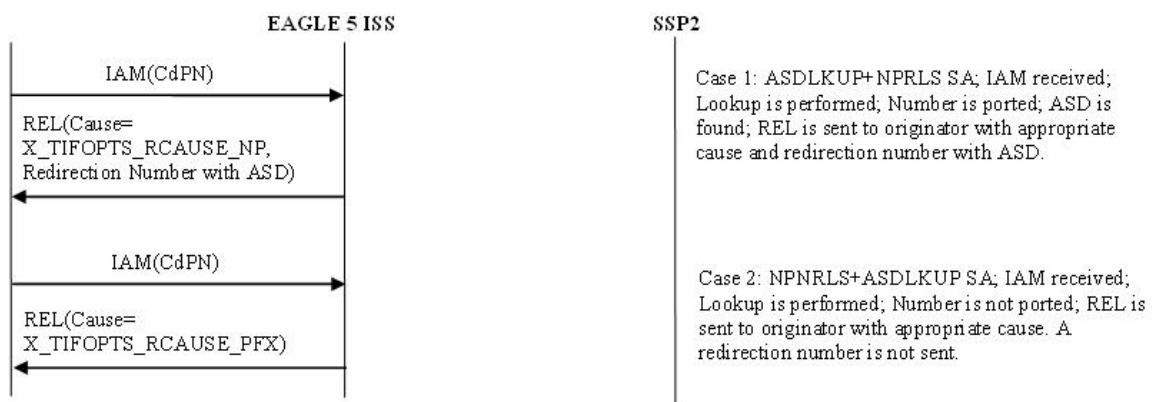

Figure 26: ISUP REL Message Flow for TIF ASD for TIF CdPN Service with NPRLS and NPNRLS SAs

Figure 27: ISUP IAM Message Flow for TIF ASD for CgPN Service shows TIF ASD use cases for TIF CgPN service.

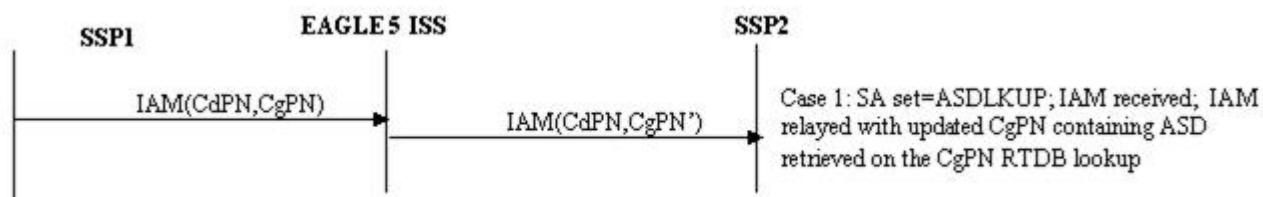

Figure 27: ISUP IAM Message Flow for TIF ASD for CgPN Service

TIF ASD Service Action Handlers

TIF ASD provides Service Action Handlers for the NPP Service Actions shown in [Table 25: NPP Service Actions used by TIF ASD](#):

Table 25: NPP Service Actions used by TIF ASD

TIF Services	Service Action	Description
TIF, TIF2, TIF3	ASDLKUP	Performs an individual or range RTDB lookup on the CdPN to find an entry containing an ASD digit string.
TIF, TIF2, TIF3	CgPNASDRqd	Performs an individual or range RTDB lookup on the CgPN to find an entry containing an ASD digit string.
TIFCGPN, TIFCGPN2, TIFCGPN3	ASDLKUP	Performs an individual or range RTDB lookup on the CgPN to find an entry containing an ASD digit string.

TIF CdPN ASDLKUP Service Action Handler

The ASDLKUP Service Action Handler executes the ASDLKUP Service Action associated with a TIF CdPN service (TIF, TIF2, TIF3) to find a CdPN entry containing an ASD digit string.

The TIF CdPN ASDLKUP Service Action and the CgPNASDRqd Service Action are mutually exclusive in the same Action Set. The CgPNASDRqd Service Action cannot be specified if a TIF CgPN service is invoked.

Configuration Options Used

None.

Action Performed

The TIF CdPN ASDLKUP Service Action Handler performs an individual or range RTDB lookup on the conditioned CdPN, to find an entry containing an ASD digit string.

ASDLKUP populates the ASD Formatting Action value with the ASD digit string.

Depending on the Formatting Action configuration for the selected NPP Service Rule, the ASD digit string can be used during CdPN formatting by NPP.

TIF uses the formatted CdPN in the outgoing IAM or the Redirection Number in the outgoing REL message.

If the TIF ASD feature is turned off in the system, the ASDLKUP Service Action Handler returns immediately.

Terminating Action?

This is not a terminating action.

TIF ASD CgPNASDRqd Service Action Handler

The CgPNASDRqd Service Action Handler executes the CgPNASDRqd Service Action associated with a TIF CdPN service (TIF, TIF2, TIF3) to find a CgPN entry containing an ASD digit string.

The TIF CdPN ASDLKUP Service Action and the CgPNASDRqd Service Action are mutually exclusive in the same Action Set. The CgPNASDRqd Service Action cannot be specified if a TIF CgPN service is invoked using the INVKSERV parameter in the TIF CdPN Service Rule.

Configuration Options Used

None.

Action Performed

The CgPNASDRqd Service Action Handler performs an individual or range RTDB lookup on the conditioned CgPN, to find an entry containing an ASD digit string.

CgPNASDRqd populates the ASD Formatting Action value with the ASD digit string.

Depending on the Formatting Action configuration for the selected NPP Service Rule, the ASD digit string can be used during CdPN formatting by NPP.

TIF uses the formatted CdPN in the outgoing IAM or the Redirection Number in the outgoing REL message.

If the TIF ASD feature is turned off in the system, the CgPNASDRqd Service Action Handler returns immediately.

Terminating Action?

This is not a terminating action.

TIF CgPN ASDLKUP Service Action Handler

The ASDLKUP Service Action Handler executes the ASDLKUP Service Action associated with a TIF CgPN service (TIFCGPN, TIFCGPN2, TIFCGPN3) to find a CgPN entry containing an ASD digit string.

Configuration Options Used

None.

Action Performed

The TIF CgPN ASDLKUP Service Action Handler performs an individual or range RTDB lookup on the conditioned CgPN, to find an entry containing an ASD digit string.

ASDLKUP populates the TIF CgPN ASD Formatting Action value with the ASD digit string.

Depending on the Formatting Action configuration for the selected NPP Service Rule, the ASD digit string can be used during CgPN formatting by NPP.

If the TIF ASDOTHER Formatting Action is provisioned for the TIF CdPN service that invoked the TIF CgPN service, TIF copies the TIF CgPN ASD Formatting Action value to the TIF CdPN ASDOTHER Formatting Action value for use in CdPN formatting. TIF uses the formatted CgPN in the outgoing IAM or the Redirection Number in the outgoing REL message.

If the TIF ASD feature is turned off in the system, the TIF CgPN ASDLKUP Service Action Handler returns immediately.

Terminating Action?

This is not a terminating action.

TIF Generic Routing Number Feature

The TIF Generic Routing Number (TIF GRN) feature allows for the insertion of a Generic Routing Number (GRN) digit string into the CdPN or CgPN of an outgoing IAM or Redirection Number of a REL ISUP message.

The GRN is obtained from the RTDB lookup of the CdPN and CgPN digits.

TIF GRN provides Service Action Handlers for the GRNLKUP and CgPNGRNRqd Service Actions associated with TIF CdPN services TIF, TIF2, and TIF3 in NPP. The GRNLKUP Service Action allows retrieval of the GRN from the matched incoming CdPN to be inserted into the outgoing CdPN digits. The CgPNGRNRqd Service Action allows retrieval of GRN from the matched incoming CgPN to be inserted into the outgoing CdPN digits.

TIF GRN provides a Service Action Handler for the GRNLKUP Service Actions associated with TIF CgPN services TIFCGPN, TIFCGPN2, and TIFCGPN3 in NPP. The GRNLKUP Service Action allows retrieval of the GRN from the matched incoming CgPN to be inserted into the outgoing CgPN digits.

A TIF CgPN service is invoked by the corresponding TIF CdPN service by setting the INVKSERV parameter value to the TIF CgPN service name in the Service Rule for the TIF CdPN service.

The NPP GRN Formatting Action is used to process the GRN that is retrieved by TIF GRN Service Actions.

The NPP GRN and GRNOTHER Formatting Actions are used for TIF GRN:

- The GRN Formatting Action is used to process the GRN that is retrieved by TIF GRN Service Actions.

- The GRNOTHER Formatting Action allows the GRN returned from a RTDB search by the GRNLKUP Service Action for a TIF CgPN service to be used in CdPN formatting.

Basic TIF GRN Use Case for TIF CdPN Service

In the use case described in this section, the incoming IAM message contains CdPN=1238882223333 and CgPN=1239995556666.

The following Filter and Action Set components are used for the example:

- Filter Prefix (FPFX) = 123
- Filter Digit Length (FDL) = 13
- Conditioning Actions = CC3 + AC3 + SN7
- Service Action = CgPNGRNRqd
- Formatting Actions = CC + GRN + AC + SN

The CgPNGRNRqd Service Action Handler performs an RTDB DN lookup on the CgPN, finds the CgPN entry with GRN value a5d, and populates the GRN Formatting Action value with the GRN value.

NPP Formatting Action execution uses the extracted CdPN information and the GRN to construct the outgoing CdPN digit string as CC + GRN + AC + SN = 123a5d8882223333.

TIF inserts the outgoing CdPN digit into the outgoing IAM message. The CgPN is not changed. The IAM message is relayed.

Basic TIF GRN Use Case for TIF CgPN Service

In the use case described in this section, the incoming IAM message contains CdPN=1238882223333 and CgPN=1239995556666.

The following Filter and Action Set components are used for the example:

- Filter Prefix (FPFX) = 123
- Filter Digit Length (FDL) = 13
- Conditioning Actions = CC3 + AC3 + SN7
- Service Action = GRNLKUP
- Formatting Actions = CC + GRN + AC + SN

The GRNLKUP Service Action Handler performs an RTDB lookup for the DN in the CgPN, finds the CgPN entry with GRN value a5d, and populates the GRN Formatting Action value with the GRN value.

NPP Formatting Action execution uses the extracted information and the GRN to construct the outgoing CgPN digit string as CC + GRN + AC + DN = 123a5d9995556666.

TIF inserts the outgoing CgPN digit into the outgoing IAM message. The CdPN is not changed. The IAM message is relayed.

TIF GRN Use Case for TIF CgPN Service using GRNOTHER

In the use case described in this section, the incoming IAM message contains CdPN=4568882223333 and CgPN=1239995556666.

The following TIF Filter and Action Set components are used for the example:

- Filter Prefix (FPFX) = 456

- Filter Digit Length (FDL) = 13
- INVKSERV=TIFCGPN
- Conditioning Actions = CC3 + AC3 + SN7
- Service Action = CDIAL
- Formatting Actions = CC + GRNOTHER + AC + SN

The following TIFCGPN Filter and Action Set components are used for the example:

- Filter Prefix (FPFX) = 123
- Filter Digit Length (FDL) = 13
- Conditioning Actions = CC3 + AC3 + SN7
- Service Action = GRNLKUP
- Formatting Actions = CC + AC + SN

The GRNLKUP Service Action Handler performs an RTDB lookup for the DN in the CgPN, finds the CgPN entry with GRN value a5d, and populates the CgPN GRN Formatting Action value with the GRN value.

NPP Formatting Action execution uses the extracted information to construct the outgoing CgPN digit string as CC + AC + SN = 1239995556666.

TIF populates the CdPN GRNOTHER Formatting Action value from the CgPN GRN Formatting Action value.

NPP Formatting Action execution uses the extracted information and the CdPN GRNOTHER value to construct the outgoing CdPN digit string as CC + GRNOTHER + AC + SN = 456a5d8882223333.

TIF inserts the CdPN and CgPN in the outgoing IAM message. The outgoing message is relayed.

TIF GRN Message Flows

Figure 28: ISUP IAM Message Flows for TIF GRN for TIF CdPN Service shows TIF GRN use cases for TIF CdPN service.

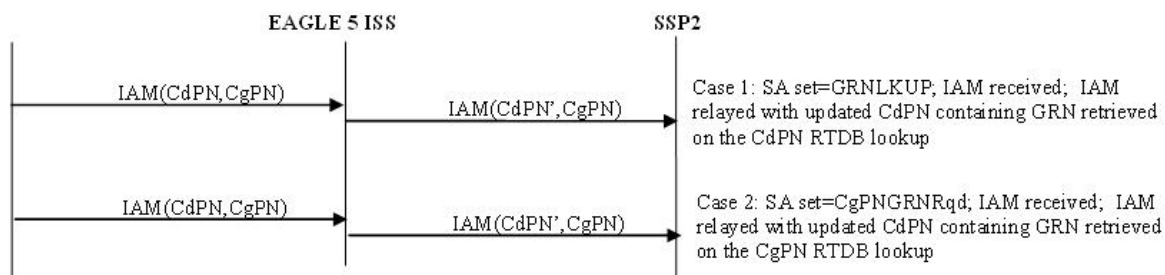

Figure 28: ISUP IAM Message Flows for TIF GRN for TIF CdPN Service

Figure 29: ISUP REL Message Flow for TIF GRN for TIF CdPN Service with NPRSL and NPNRLS shows TIF GRN use cases with NPRLS and NPNRLS for TIF CdPN service.

TIF Services	Service Action	Description
		find an entry containing a GRN digit string.

TIF CdPN GRNLKUP Service Action Handler

The GRNLKUP Service Action Handler executes the GRNLKUP Service Action associated with a TIF CdPN service (TIF, TIF2, TIF3) to find a CdPN entry containing a GRN digit string.

The TIF CdPN GRNLKUP Service Action and the CgPNGRNRqd Service Action are mutually exclusive in the same Action Set. The CgPNGRNRqd Service Action cannot be specified if a TIF CgPN service is invoked.

Configuration Options Used

None.

Action Performed

The TIF CdPN GRNLKUP Service Action Handler performs an individual or range RTDB lookup on the conditioned CdPN, to find an entry containing an GRN digit string.

GRNLKUP populates the GRN Formatting Action value with the GRN digit string.

Depending on the Formatting Action configuration for the selected NPP Service Rule, the GRN digit string can be used during CdPN formatting by NPP.

TIF uses the formatted CdPN in the outgoing IAM or the Redirection Number in the outgoing REL message.

If the TIF GRN feature is turned off in the system, the GRNLKUP Service Action Handler returns immediately.

Terminating Action?

This is not a terminating action.

TIF GRN CgPNGRNRqd Service Action Handler

The CgPNGRNRqd Service Action Handler executes the CgPNGRNRqd Service Action associated with a TIF CdPN service (TIF, TIF2, TIF3) to find a CgPN entry containing a GRN digit string.

The TIF CdPN GRNLKUP Service Action and the CgPNGRNRqd Service Action are mutually exclusive in the same Action Set. The CgPNGRNRqd Service Action cannot be specified if a TIF CgPN service is invoked using the INVKSERV parameter in the TIF CdPN Service Rule.

Configuration Options Used

None.

Action Performed

The CgPNGRNRqd Service Action Handler performs an individual or range RTDB lookup on the conditioned CgPN, to find an entry containing a GRN digit string.

CgPNGRNRqd populates the GRN Formatting Action value with the GRN digit string.

Depending on the Formatting Action configuration for the selected NPP Service Rule, the GRN digit string can be used during CdPN formatting by NPP.

TIF uses the formatted CdPN in the outgoing IAM or the Redirection Number in the outgoing REL message.

If the TIF GRN feature is turned off in the system, the CgPNGRNRqd Service Action Handler returns immediately.

Terminating Action?

This is not a terminating action.

TIF CgPN GRNLKUP Service Action Handler

The GRNLKUP Service Action Handler executes the GRNLKUP Service Action associated with a TIF CgPN service (TIFCGPN, TIFCGPN2, TIFCGPN3) to find a CgPN entry containing a GRN digit string.

Configuration Options Used

None.

Action Performed

The TIF CgPN GRNLKUP Service Action Handler performs an individual or range RTDB lookup on the conditioned CgPN, to find an entry containing an GRN digit string.

GRNLKUP populates the TIF CgPN GRN Formatting Action value with the GRN digit string.

Depending on the Formatting Action configuration for the selected NPP Service Rule, the GRN digit string can be used during CgPN formatting by NPP.

If the TIF GRNOTHER Formatting Action is provisioned for the TIF CdPN service that invoked the TIF CgPN service, TIF copies the TIF CgPN GRN Formatting Action value to the TIF CdPN GRNOTHER Formatting Action value for use in CdPN formatting. TIF uses the formatted CgPN in the outgoing IAM or the Redirection Number in the outgoing REL message.

If the TIF GRN feature is turned off in the system, the TIF CgPN GRNLKUP Service Action Handler returns immediately.

Terminating Action?

This is not a terminating action.

TIF Blacklist Features

The TIF Subscriber CgPN Blacklist, TIF Range CgPN Blacklist, and TIF Selective Screening features provide TIF blacklist capabilities, which help Network Operators reduce significantly or completely prevent spoofing their networks with illegal messages.

The TIF CgPN Blacklist functionality is controlled by the TIF Subscriber CgPN Blacklist feature. The TIF Subscriber CgPN Blacklist (TIF Subscr CgPN Blacklist) feature generates an ISUP Release (REL) message back to the originator of a processed ISUP IAM, based on the Calling Party Number (CgPN), if either of the following scenarios occur:

- The CgPN that is found in the RTDB is blacklisted; the CgPN has CgBL flag=YES.
- The CgPN is not found in the RTDB.

The TIF Range CgPN Blacklist feature generates an ISUP Release (REL) message back to the originator of a processed ISUP IAM, based on the CgPN, if either of the following scenarios occur:

- The CgPN begins with a specific prefix.
- The Calling Party parameter is not present in the IAM or it is present with no digits in it.

The TIF CdPN Blacklist functionality is controlled by the TIF Selective Screening feature. The TIF Selective Screening feature generates an ISUP Release (REL) message back to the originator of a processed ISUP IAM, based on the Called Party Number (CdPN), if any of the following scenarios occur:

- The CdPN that is found in the RTDB is blacklisted; the CdPN has CdBL flag = YES.
- The CdPN is not found in RTDB.
- The CdPN begins with a specific prefix.
- The Called Party is screened by TIF Selective Screening and the Release cause is not *NONE*.

NPP Service Action Data

An NPP Action Set can have optional Service Action Data (SA Data) for one or more Service Actions (SAs) in the Action Set. Not all NPP Service/Service Action combinations support SA Data. The SA Data contains two numerical values: SAxVAL configuration parameter values, where x is the same number as the associated Service Action parameter.

[Table 27: NPP Service Actions that Support SA Data](#) lists the TIF CdPN and TIF CgPN NPP services and Service Actions that support SA Data.

Table 27: NPP Service Actions that Support SA Data

NPP Service	Service Action	SA Values (SAxVAL)
TIFCGPN, TIFCGPN2, TIFCGPN3 TIF, TIF2, TIF3	FPFXRLS	Require 2 numerical values for an SAxVAL parameter, one value for ANSI and one value for ITU release causes, respectively. Both values have range 0-127.
TIFCGPN, TIFCGPN2, TIFCGPN3 TIF, TIF2, TIF3	BLRLS	Require 2 numerical values for an SAxVAL parameter, one value for ANSI and one value for ITU release causes, respectively. Both values have range 0-127.
TIFCGPN, TIFCGPN2, TIFCGPN3 TIF, TIF2, TIF3	BLNFNDRLS	Require 2 numerical values for an SAxVAL parameter, one value for ANSI and one value for

NPP Service	Service Action	SA Values (SAxVAL)
		ITU release causes, respectively. Both values have range 0-127.
TIF, TIF2, TIF3	NOCGPNRLS	Require 2 numerical values for an SAxVAL parameter, one value for ANSI and one value for ITU release causes, respectively. Both values have range 0-127.
TIF, TIF2, TIF3	SELSCR	Require 2 numerical values for an SAxVAL parameter, one value for ANSI and one value for ITU release causes, respectively. Both values have range 0-127. Additionally supports SAxDGTS (range 0-FF) to provision Call Types for CdPN.

TIF Blacklist Message Flow

Figure 31: TIF Blacklist Basic Message Flow shows the basic TIF Blacklist message flow.

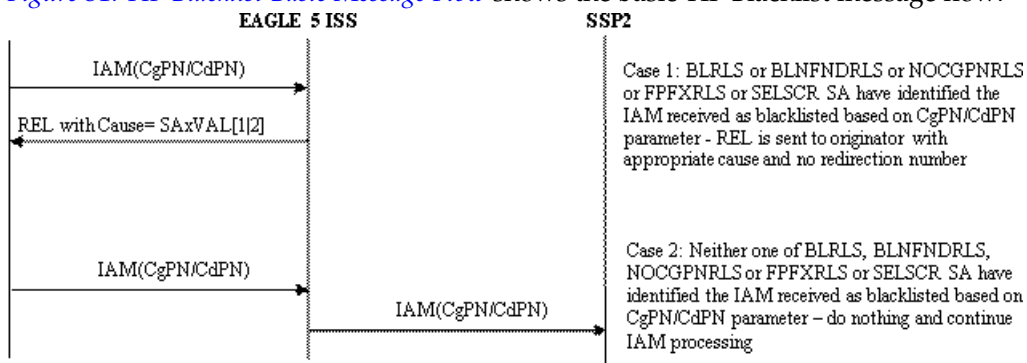

Figure 31: TIF Blacklist Basic Message Flow

TIF Subscr CgPN Blacklist Feature

The TIF Subscr CgPN Blacklist feature generates an ISUP Release (REL) message back to the originator of a processed ISUP IAM, based on the Calling Party Number (CgPN), if the following EPAP-based scenarios occur:

- The Calling Party is found in the RTDB and the CgPN is marked as blacklisted; the CgPN has CgBL flag=YES.
- The CgPN is not found in the RTDB.

Two Service Action Data (SA Data) values can be associated with provisioned TIF CgPN Blacklist Service Actions to provide configurable Release Cause values for the blacklist scenarios. One value is used for ANSI ISUP and the other value is used for ITU ISUP.

TIF Subscr CgPN Blacklist provides the following functions:

- Definition of feature-specific pre-NPP processing to be performed by TIF
- Service Action specification (including Service Action names and precedence)
- Service Action Handlers
- Feature-specific post-NPP processing, if needed

TIF Subscr CgPN Blacklist Service Action Handlers

The TIF Subscr CgPN Blacklist feature provides feature-specific Service Action Handlers for NPP Service Actions. TIF and NPP perform the following functions for the TIF Subscr CgPN Blacklist feature:

- RTDB lookup
- Interpretation of results from RTDB lookups
- NPP processing of Service Actions that are used for TIF Subscr CgPN Blacklist
- Post-NPP processing of the outgoing message

Table 28: Summary of TIF Subscr CgPN Blacklist Service Actions provides a summary of the Service Actions used specifically for TIF Subscr CgPN Blacklist.

Table 28: Summary of TIF Subscr CgPN Blacklist Service Actions

Service Action	Description	Function	Precedence
BLRLS	TIF CgPN Blacklist in EPAP Release	Indicates that a Release (REL) will be generated if the Calling Party is found in the RTDB and the CgPN contains the CgBL flag=YES.	91
BLNFNDRLS	TIF CgPN not-in-EPAP Release	Indicates that a Release (REL) will be generated if the CgPN digits are not found in the RTDB and finds the CgPN digits.	91

BLRLS Service Action Handler for TIF CgPN EPAP-based RELEASE

The BLRLS Service Action Handler indicates that an REL will be sent if Calling Party digits are found in the RTDB with CgBL=YES.

Configuration Options Used

The provisioned SAxVAL[1] value contains the Release Cause value used in the REL for an IAM ISUP ANSI message; the provisioned SAxVAL[2] value contains the Release Cause value used in the REL for an IAM ISUP ITU message.

Action Performed

The BLRLS Service Action Handler performs an RTDB lookup and finds the CgPN digits in the RTDB. If the Calling Party digits in the RTDB have CgBL=YES, the Service Action Handler indicates that an REL will be sent to the originator of the IAM during post-NPP processing. The REL will contain the

provisioned SAxVAL[1] value for the Release Cause if ANSI ISUP, or the provisioned SAxVAL[2] value for the Release Cause if ITU ISUP. The REL will not include a Redirection Number. The original MSU is discarded.

If the TIF Subscr CgPN Blacklist feature is not turned ON or the CgPN is not found in the RTDB, or if the CgPN is found but is not marked as blacklisted, the Service Action Handler completes without any changes.

No Formatting Actions are populated.

Terminating Action?

Yes when the subscriber is blacklisted.

BLNFNDRLS Service Action Handler for TIF CgPN not-in-EPAP RELEASE

The BLNFNDRLS Service Action Handler performs an RTDB lookup and does not find the CgPN digits in the RTDB.

Configuration Options Used

The provisioned SAxVAL[1] value contains the Release Cause value used in the REL for an IAM ISUP ANSI message; the provisioned SAxVAL[2] value contains the Release Cause value used in the REL for an IAM ISUP ITU message.

Action Performed

If CgPN digits are not found in the RTDB, the Service Action Handler indicates that an REL will be sent to the originator of the IAM during post-NPP processing. The REL will contain the provisioned SAxVAL[1] value for the Release Cause if ANSI ISUP, or with the provisioned SAxVAL[2] value for the Release Cause if ITU ISUP. The REL will not include a Redirection Number. The original MSU Is discarded.

If the TIF Subscr CgPN Blacklist feature is not turned ON or if the CgPN is found in the RTDB, the Service Action Handler completes without any changes.

No Formatting Actions are populated.

Terminating Action?

Yes

TIF Range CgPN Blacklist Feature

The TIF Range CgPN Blacklist feature generates an ISUP Release (REL) message back to the originator of a processed ISUP IAM, based on the Calling Party Number (CgPN), if the following non-EPAP-based scenarios occur:

- The CgPN begins with a specific prefix.
- The Calling Party parameter is not present in the IAM or it is present with no digits in it.

Two Service Action Data (SA Data) values can be associated with provisioned TIF CgPN Blacklist Service Actions to provide configurable Release Cause values for the blacklist scenarios. The SAxVAL[1] value is used for ANSI ISUP and the SAxVAL[2] value is used for ITU ISUP.

TIF Range CgPN Blacklist provides the following functions:

- Definition of feature-specific pre-NPP processing to be performed by TIF

- Service Action specification (including Service Action names and precedence)
- Service Action Handlers
- Feature-specific post-NPP processing, if needed

TIF Range CgPN Blacklist Service Action Handlers

The TIF Range CgPN Blacklist feature provides feature-specific Service Action Handlers for NPP Service Actions. TIF and NPP perform NPP processing of Service Actions that are used for TIF Range CgPN Blacklist and post-NPP processing of the outgoing message.

Table 29: Summary of TIF Range CgPN Blacklist Service Actions provides a summary of the Service Actions used specifically for TIF Range CgPN Blacklist.

Table 29: Summary of TIF Range CgPN Blacklist Service Actions

Service Action	Description	Function	Precedence
FPFXRLS	TIF CgPN Blacklist non-EPAP Release	Indicates that a Release (REL) will be generated if a matching Calling Party Rule is found in NPP.	92
NOCGPNRLS	TIF CgPN Empty Release	Indicates that a Release (REL) will be generated if the Calling Party parameter is not present in the ISUP IAM or it is present with no digits in it.	80

FPFXRLS Service Action Handler for TIF Prefix CgPN non-EPAP-based RELEASE

The FPFXRLS Service Action Handler indicates that an REL will be sent to the originator of the IAM if a matching Calling Party Rule is found by NPP.

The FPFXRLS Service Action is mutually exclusive with all other Service Actions in the same Action Set.

Configuration Options Used

The provisioned SAxVAL[1] value contains the Release Cause value used in the REL for an IAM ISUP ANSI message; the provisioned SAxVAL[2] value contains the Release Cause value used in the REL for an IAM ISUP ITU message.

Action Performed

If the Calling Party prefix is found by NPP, the Service Action Handler indicates that an REL will be sent to the originator of the IAM during post-NPP processing. If the subscriber is marked as blacklisted, the REL will contain the provisioned SAxVAL[1] value for the Release Cause if ANSI ISUP, or with the provisioned SAxVAL[2] value for the Release Cause if ITU ISUP. The REL will not include a Redirection Number. The original MSU is discarded.

If the TIF Range CgPN Blacklist feature is not turned ON , the Service Action Handler completes without any changes.

No Formatting Actions are populated.

Terminating Action?

Yes

NOCGPNRLS Service Action Handler for TIF Empty CgPN non-EPAP-based RELEASE

The NOCGPNRLS Service Action Handler indicates that an REL will be sent to the originator of the IAM if the CgPN is not present in the IAM or the CgPN is present but has no digits in it.

Configuration Options Used

The provisioned SAxVAL[1] value contains the Release Cause value used in the REL for an IAM ISUP ANSI message; the provisioned SAxVAL[2] value contains the Release Cause value used in the REL for an IAM ISUP ITU message.

Action Performed

If CgPN digits are not present in the MSU, the Service Action Handler indicates that an REL will be sent to the originator of the IAM during post-NPP processing. If the subscriber is marked as blacklisted, the REL will contain the provisioned SAxVAL[1] value for the Release Cause if ANSI ISUP, or with the provisioned SAxVAL[2] value for the Release Cause if ITU ISUP. The REL will not include a Redirection Number. The original MSU is discarded.

If the TIF Range CgPN Blacklist feature is not turned ON or if the CgPN in the processed MSU contains digits, the Service Action Handler completes without any changes.

No Formatting Actions are populated.

Terminating Action?

Yes when the subscriber is blacklisted.

TIF Selective Screening Feature

The TIF CdPN blacklist functionality is controlled by the TIF Selective Screening feature. The TIF Selective Screening feature generates an ISUP Release (REL) message back to the originator of a processed ISUP IAM, based on the Called Party Number (CdPN), if the following scenarios occur:

- The CdPN that is found in the RTDB is blacklisted; the CdPN has CdBL flag = YES.
- The CdPN is not found in RTDB.
- The CdPN begins with a specific prefix.
- The Called Party is screened by TIF Selective Screening and the Release cause is not *NONE*.

Three Service Action Data (SA Data) values can be associated with provisioned TIF Selective Screening Service Actions to provide configurable Release Cause values for the blacklist scenarios. The SAxVAL[1] value is used to indicate the Release Cause for ANSI ISUP; the SAxVAL[2] value is used to indicate the Release Cause for ITU ISUP. The SAxDGTS parameter indicates the Call Type for CdPNs that match the associated NPP Rule.

TIF Selective Screening provides the following functions:

- Definition of feature-specific pre-NPP processing to be performed by TIF
- Service Action specification (including Service Action names and precedence)
- Service Action Handlers
- Feature-specific post-NPP processing, if needed

TIF Selective Screening Service Action Handlers

The TIF Selective Screening feature provides feature-specific Service Action Handlers for NPP Service Actions. TIF and NPP perform the following functions for the TIF Selective Screening feature:

- RTDB lookup
- Interpretation of results from RTDB lookups
- NPP processing of Service Actions that are used for TIF Selective Screening
- Post-NPP processing of the outgoing message

[Table 30: Summary of TIF Selective Screening Service Actions](#) provides a summary of the Service Actions used for TIF Selective Screening.

Table 30: Summary of TIF Selective Screening Service Actions

Service Action	Description	Function	Precedence
BLRLS	TIF CdPN Blacklist in EPAP-based Release	Indicates that a Release (REL) message will be generated if the Called Party is found in the RTDB and the CdPN contains the CdBL flag=YES	91
BLNFNDRLS	TIF CdPN not-in-EPAP Release	Indicates that a Release (REL) message will be generated if a matching Called Party number is not found in the RTDB	91
FPEXRLS	TIF Pfx CdPN Release (non-EPAP based)	Indicates that a Release (REL) message will be generated if a matching Called Party rule is found by NPP	92
SELSCR	TIF CdPN EPAP-based Selective Screening	Indicates that the message is selectively screened based on CdPN and CgPN Call Types	91

BLRLS Service Action Handler for TIF Selective Screening (CdPN) EPAP-based RELEASE

The BLRLS Service Action Handler indicates that a Release (REL) message will be sent if Called Party digits are found in the RTDB with CdBL=YES.

Configuration Options Used

TIFOPTS options SAxVAL[1] and SAxVAL[2] contain the Release Cause value used in the Release (REL) message for an IAM ISUP ANSI message and an IAM ISUP ITU message.

Action Performed

The BLRLS Service Action Handler performs an RTDB lookup and finds the CdPN digits in the RTDB. If the Called Party digits in the RTDB have CdBL=YES, the Service Action Handler indicates that a Release (REL) message will be sent to the originator of the IAM during post-NPP processing. The Release (REL) message will contain the provisioned SAxVAL[1] value for the Release Cause if ANSI ISUP, or the provisioned SAxVAL[2] value for the Release Cause if ITU ISUP. The REL will not include a Redirection Number. The original MSU is discarded.

If the TIF Selective Screening feature is not turned on, the CdPN is not found in the RTDB, or the CdPN is found but is not marked as blacklisted, the Service Action Handler completes without any changes.

No Formatting Actions are populated.

Terminating Action?

Yes, when the subscriber is marked as blacklisted.

BLNFNDRLS Service Action Handler for TIF Selective Screening (CdPN) not-in-EPAP RELEASE

The BLNFNDRLS Service Action Handler performs an RTDB lookup and does not find the CdPN digits in the RTDB.

Configuration Options Used

TIFOPTS options SAxVAL[1] and SAxVAL[2] contain the Release Cause value used in the Release (REL) message for an IAM ISUP ANSI message and an IAM ISUP ITU message.

Action Performed

If CdPN digits are not found in the RTDB, the Service Action Handler indicates that a Release (REL) message will be sent to the originator of the IAM during post-NPP processing. The Release (REL) message will contain the provisioned SAxVAL[1] value for the Release Cause if ANSI ISUP, or the provisioned SAxVAL[2] value for the Release Cause if ITU ISUP. The REL will not include a Redirection Number. The original MSU is discarded.

If the TIF Selective Screening feature is not turned on, the CdPN is not found in the RTDB, or the CdPN is found but is not marked as blacklisted, the Service Action Handler completes without any changes.

No Formatting Actions are populated.

Terminating Action?

Yes.

FPFXRLS Service Action Handler for TIF Prefix CdPN non-EPAP-based RELEASE

The FPFXRLS Service Action Handler indicates that a Release (REL) message will be sent to the originator of the IAM if a matching Called Party Rule is found by NPP.

The FPFXRLS Service Action is mutually exclusive with all other Service Actions in the same Action Set.

Configuration Options Used

TIFOPTS options SAxVAL[1] and SAxVAL[2] contain the Release Cause value used in the Release (REL) message for an IAM ISUP ANSI message and an IAM ISUP ITU message.

Action Performed

If the Called Party prefix is found by NPP, the Service Action Handler indicates that a Release (REL) message will be sent to the originator of the IAM during post-NPP processing. If the subscriber is marked as blacklisted, the Release (REL) message will contain the provisioned SAxVAL[1] value for the Release Cause if ANSI ISUP, or with the provisioned SAxVAL[2] value for the Release Cause if ITU ISUP. The Release (REL) message will not include a Redirection Number. The original MSU is discarded.

If the TIF Range CdPN Blacklist feature is not turned ON , the Service Action Handler completes without any changes.

No Formatting Actions are populated.

Terminating Action?

Yes.

SELSCR Service Action Handler for TIF CdPN EPAP-based Selective Screening

The SELSCR Service Action Handler Indicates that the message is selectively screened based on CdPN and CgPN Call Types.

Configuration Options Used

TIFOPTS options SAxVAL[1] and SAxVAL[2] contain the Release Cause value used in the Release (REL) message for an IAM ISUP ANSI message and an IAM ISUP ITU message. TIFOPTS options SAxDGTS indicate the Call Type for CdPNs that match the associated NPP Rule.

Action Performed

If the CdPN is screened by the TIF selective screening process, the TIF selective screening post-processing checks whether the SAxVAL values are provisioned with SELSCR Service Action in the TIF NPP Service. If the SAxVAL is provisioned for the incoming ISUP message type, then the ISUP RElease (REL) message is generated with the RElease cause provisioned in SAxVAL.

If the SAxVAL is not provisioned (*None*) for the incoming ISUP message type, then the ISUP message is relayed to the destination point code in the incoming message (original DPC). The CdPN and CgPN parameters in the ISUP message are formatted based on the respective FASCRCd and FASCRCG formatting list values provisioned in the NPP Action Set associated with TIF NPP Service.

Terminating Action?

No

TIF Selective Screening Call Types

The TIF Selective Screening process is based on Call Types configured for a DN in the RTDB. The Call Types of a DN are a list of numerical values in the range of 1-254, 255, and 0. The zero (0) value indicates that the specific Call Type is *not provisioned*. The 255 value (hexadecimal 0xFF) of the first Call Type, which is the first byte of the digit string, indicates a wild card (any/*). Only the first number in the set of eight numbers can be provisioned with this wild card value of 255 (any/*) because the following seven numbers will be ignored. Any other Call Type except the first Call Type provisioned as 255 (0xFF/any/*) will be treated as *not provisioned*.

The Call Types for a DN are stored in the Number Substitution DN field. The Number Substitution DN field for the DN is stored in the RTDB. The Number Substitution DN field is a 15-digit digit string, with two digits stored per byte for a total of eight bytes). This allows provisioning seven 1-byte Call Types and one 4-bit Call Type for a total of eight possible Call Types per DN. The first seven Call Types a range from 1 till 254, and the eighth Call Type can have a value between 1 and 15. The Call Types are provisioned as hexadecimal digits: the first 7 Call Types are one-byte-long Call Types - as a pair of hexadecimal digits, and the last - eighth Call Type - as a single hexadecimal digit.

The Call Type for CdPN can also be configured with NPP rules for TIF NPP Service. The SELSCR Service Action is associatd with the configurable SAxDGTS parameter. A single Call Type (0x0 - 0xFF) can be configured in the SAxDGTS field corresponding to the SELSCR Service Action in the NPP Action Set.

The Call Types configured in the SAxDGTS parameter take precedence over the Call Types configured in the Number Substitution DN field. If the Call Type for the CdPN is configured in the SAxDGTS

field, then the Call Types configured in the RTDB are not considered for the CdPN. The Call Types for CgPN are always fetched from RTDB.

Only the first Call Type configured for the CdPN in RTDB is considered for Selective Screening. If more than one Call Type is configured for the CdPN in RTDB, then the rest of the Call Types after the first Call Type are ignored.

TIF Blacklist Post-NPP Processing

After NPP processing is complete, the TIF post-NPP Results Handler performs the following functions for the TIF Blacklist features:

- If the IAM MSU is marked as blacklisted, TIF generates a RELease MSU with the Release Cause value obtained by a Service Action that identified this MSU as blacklisted, and sends the RELease MSU to the originator of the incoming IAM.
- If the IAM MSU is not marked as blacklisted, the IAM message is relayed intact.

Chapter 4

EAGLE TIF Commands

Topics:

- [EAGLE Commands for TIF Features.....97](#)

This chapter contains brief descriptions of the EAGLE commands that are used for the configuration and test of the Triggerless ISUP Framework (TIF) and the features that use TIF.

EAGLE Commands for TIF Features

This chapter describes the EAGLE commands that are used for the configuration and test for the following features:

- TIF Number Portability
- TIF SCS Forwarding
- TIF Number Substitution
- TIF Simple Number Substitution
- TIF Additional Subscriber Data
- TIF Generic Routing Number
- TIF Subscriber CgPN Blacklist
- TIF Range CgPN Blacklist
- TIF Selective Screening

Refer to *Commands User's Guide* for complete descriptions of the commands listed in [Table 31: Commands used for TIF Features](#), including parameter names, valid parameter values, examples, and dependencies.

Table 31: Commands used for TIF Features

Type	Commands
System Serial Number	ent/rtrv-serial-num
Card	ent/dlt/rtrv/alw/inh/init/rept-stat-card
Numbering Plan Processor (NPP)	ent/chg/dlt/rtrv-npp-as, ent/chg/dlt/rtrv-npp-srs, chg/rtrv-npp-serv
Feature Control	chg/rtrv-feat, enable/chg/rtrv-ctrl-feat
Gateway Screening and Linksets	chg/rtrv-gws-actset, ent/chg/dlt/rtrv-scr-<xxx>, ent/chg/dlt/rtrv-scrset, ent/chg/dlt/rtrv-ls
STP Options	chg/rtrv-stpopts
TIF Options	chg/rtrv-tifopts
SCCP Options	chg/rtrv-sccpopts
Destination-based Options	chg/rtrv-dstn
TIF Test Tool	chg/rtrv-isup-msg, tst-msg

ent / chg / dlt / rtrv-npp-as, ent / chg / dlt / rtrv-npp-srs, chg / rtrv-npp-serv

The NPP commands are used to provision and display the values for components that are used in NPP processing.

The ent/chg/dlt/rtrv-npp-as commands are used to enter, change, delete, and display NPP Action Sets that contain various Service Actions, Conditioning Actions, and Formatting Actions.

The `ent/chg/dlt/rtrv-npp-srs` commands are used to create, change, delete, and display NPP Service Rule Sets for calling services.

The `chg/rtrv-npp-serv` commands are used to change and display the On/Off status for NPP Services, Delimiter values to use in formatting the outgoing digit string, and the FNAI Class mapping values for the outgoing NAI, and display the Service Action precedence values. An NPP Service is any EAGLE feature or function that uses NPP to process digit strings.

Refer to *Numbering Plan Processor (NPP) User's Guide* for descriptions of the NPP components: Service Actions, Conditioning Actions, Formatting Actions, Action Sets, Rules, and Service Rule Sets. See the TIF and TIF feature descriptions in this manual for the NPP components used by TIF and each feature.

enable-ctrl-feat / chg-ctrl-feat / rtrv-ctrl-feat

These commands are used to enable, turn on, and display the on/off status of TIF features and the Service Portability feature. Some TIF features can be turned off after they have been turned on.

chg / rtrv-gws-actset, ent / chg / dlt / rtrv-scr-<xxx>, ent / chg / dlt / rtrv-scrset

The `chg/rtrv-gws-actset`, `ent/chg/dlt/rtrv-scr-<xxx>`, and `ent/chg/dlt/rtrv-scrset` commands are used to define, change, and display the gateway screening stop action sets in the system database. Stop action sets are used to define the actions performed on the Message Sending Units (MSUs) that pass the gateway screening process.

TIF adds the TIF, TIF2, and TIF3 stop actions for gateway screening; each of these stop actions must be the last stop action in its Action Set. Each TIF stop action encapsulates incoming messages as SCCP data and forwards them to Service Module cards for processing. Each TIF stop action is association with a corresponding NPP service.

ent / chg / dlt / rtrv-ls

The `ent/chg/dlt/rtrv-ls` commands are used to turn on the gateway screening options (gwsa, gwsm, and gwsd) for linksets. The options determine whether gateway screening is on or off for the linkset, and how MSUs are handled when gateway screening is on for the linkset. The options need to be on for the TIF features.

chg-stpopts / rtrv-stpopts

The STP Options commands are used to provision system options for the EAGLE. The options are used to control system-level processing. Features can check the DEFCC option value to determine what processing to apply.

chg-tifopts / rtrv-tifopts

The TIF Options commands are used to provision the configuration options for the TIF features. The TIF option values influence number conditioning, response message formatting and generation, and Service Portability processing.

chg / rtrv-sccpopts

The SCCP Options commands are used to provision the ACLEN SCCP option that is used in NPP Conditioning Action execution for TIF features.

chg-dstn / rtrv-dstn

The `chg/rtrv-dstn` commands are used to define and display TIF-related configuration options for destination point codes. The options can be used with or instead of the TIFOPTS configuration options for the following functions:

- Setting of NM bits value—DPC-based lookup on relay of ITU IAM message with non-zero NM bits when TIFOPTS NPFLAG=NM
- Specifying the Release Cause for ported and not-ported release cases—OPC-based lookup on each incoming message to extract Release Cause values
- Splitting of ITU IAM messages—DPC-based lookup on relay of ITU IAM message to determine when and how to split the IAM message into 1 IAM message and 1 SAM message

chg / rtrv-isup-msg, tst-msg

The `chg/rtrv-isup-msg` commands are used to enter, change, and display ISUP test messages in the TESTMSG table. The `tst-msg` command invokes the test for the specified ISUP test message from the TESTMSG table, and displays the results.

Chapter 5

TIF Feature Configuration

Topics:

- *Introduction.....101*
- *TIF Configuration Procedure.....103*
- *Enabling TIF Features.....103*
- *Enabling the Service Portability Feature.....105*
- *Provisioning the TIF and SCCP Options.....106*
- *Provisioning the Destination-based Options for TIF.....106*
- *Provisioning NPP for TIF.....107*
- *Turning On TIF Features.....108*
- *Turning On the Service Portability Feature.....109*
- *Turning Off TIF Features.....110*
- *Turning Off the Service Portability Feature.....110*
- *TIF Test Tool.....111*

This chapter provides procedures for configuring the TIF features for use in the EAGLE 5.

Introduction

This chapter describes prerequisites and procedures for the EAGLE configuration of the TIF features. This chapter also provides procedures for configuration of the Service Portability feature for use with the TIF NP feature. Refer to *Commands User's Guide* for complete descriptions of the commands used in these procedures

TIF Configuration Procedure lists the steps for enabling and turning on each TIF feature and the Service Portability feature, and for the provisioning required for the features. Each step contains a link or reference to information and procedures to use to complete the step. Feature provisioning can be performed after the features are enabled and before the features are turned on.

Note: Controlled features are optional and must be purchased from Oracle before they can be used in your system. If you are not sure whether you have purchased a specific feature, contact your Oracle Sales or Account Representative.

EPAP Entity Provisioning

Oracle recommends that EPAP entity (SP or RN) administration not be performed until after the Point Code and/or Subsystem Number has been entered into the EAGLE MAP table.

- EPAP-administered entity data can become out-of-sync with the EAGLE MAP table when the creation of Point Codes and/or Subsystem Numbers in the MAP table is performed after EPAP database administration.
- If this mismatch is discovered in real-time operations, a UIM is sent to the EAGLE maintenance terminal. (Example UIMs: SCCP did not route - DPC not in MAP tbl, SCCP did not route - SS not in MAP tbl.)

System Prerequisites

Before any feature that is described in this manual can be enabled, the prerequisites listed in [Table 32: System Prerequisites](#) are required in the system.

Table 32: System Prerequisites

Prerequisite	Verification and Provisioning
<p>The system serial number must be correct and locked.</p> <p>For new installations, the system is shipped with an unlocked serial number. The serial number can be changed if necessary and must be locked after the system is on-site.</p> <p>For systems that are being upgraded, the serial number is usually already verified and locked.</p>	<p>Note: The serial number cannot be changed after it is entered and locked in the system.</p> <p>Locate the serial number for the system on a label affixed to the control shelf (1100).</p> <p>Enter the <code>rtrv-serial-num</code> command to display the serial number and its locked status.</p> <p>Verify that the displayed serial number is correct for the system.</p> <p>If no serial number is displayed, enter the <code>ent-serial-num</code> command (without the lock</p>

Prerequisite	Verification and Provisioning
	<p>parameter) to provision the serial number that appears on the control shelf label. Enter the <code>rtrv-serial-num</code> command and verify that the serial number was entered correctly.</p> <p>Enter the <code>ent-serial-num</code> command with the <code>lock=yes</code> parameter to lock the serial number in the system.</p>
A sufficient number of Service Module cards must be equipped.	<p>Enter the <code>rept-stat-card:appl=vsccp</code> command to list the Service Module cards in the system.</p> <p>If more cards or cards of a different type are needed, refer to the procedures in <i>Database Administration - GTT User's Guide</i> to add or remove Service Module cards.</p>
<p>The GTT feature must be on in the system.</p> <p>Some features require an additional GTT-related feature such as EGTT. See the specific feature prerequisites in this section.</p>	<p>Enter the <code>rtrv-feat</code> command to display the GTT feature status.</p> <p>If the GTT feature is on, the <code>gtt=on</code> entry appears in the output.</p> <p>If the <code>gtt=off</code> entry appears in the output, use the procedures in <i>Database Administration - GTT User's Guide</i> to turn on and provision the GTT feature and any other GTT-related features and functions that will be used in the system.</p>

TIF Feature Prerequisites and Considerations

Before any TIF feature can be enabled, the following prerequisites are required in the system:

Table 33: TIF Feature Prerequisite

Prerequisite	Verification and Provisioning
<p>GLS cards must be equipped, or the Integrated GLS feature must be enabled and turned on (with E5-MASP cards installed).</p> <p>The Gateway Screening feature must be turned on.</p>	<p>Refer to the procedures in <i>Database Administration - GWS User's Guide</i> for procedures to provision up to 8 GLS cards, to enable and turn on the Integrated GLS feature, and to turn on the Gateway Screening feature.</p>
The LNP feature cannot be on in the system	<p>Enter the <code>rtrv-ctrl-feat</code> command.</p> <p>If the LNP feature is on, shown with a quantity greater than zero for the LNP ported TNs entry in the command output, features described in this manual cannot be enabled.</p>

The following functions and components of the Gateway Screening (GWS) feature are used by TIF:

- Stop Action TIF, TIF2, or TIF3.

The provisioned Stop Action for TIF must have the same name as the TIF service that calls NPP for processing, and must be the last Stop Action in the Stop Action Set. See [TIF Services That Call NPP](#) and [Protocol Handling](#).

At least one TIF feature must be enabled before a GWS Stop Action can be provisioned.

- Gateway Screening linkset options

The options determine whether Gateway Screening is on or off for the linkset, and how MSUs are handled when Gateway Screening is on for the linkset.

The options need to be turned on for the TIF features after all other TIF configuration is complete, to make the TIF feature fully operational. Refer to *Database Administration - GWS User's Guide* for procedures to turn on the options.

TIF Configuration Procedure

The EAGLE configuration of each TIF feature consists of the following steps. The steps contain links and references to detailed procedures and information needed to complete each step.

1. Verify, and provision if needed, the system prerequisites. See [System Prerequisites](#).
2. Verify, and provision if needed, the feature prerequisites. See [TIF Feature Prerequisites and Considerations](#).
3. Enable each TIF feature. See [Enabling TIF Features](#).
4. If a Default Country Code (DEFCC) value other than NONE is required for a TIF feature, enter the `chg-stpopts` command with a `defcc` parameter value other than NONE specified.
5. Enable the Service Portability feature, if it will be used with the TIF NP feature. See [Enabling the Service Portability Feature](#).
6. Provision Gateway Screening stop actions for TIF. See [TIF Feature Prerequisites and Considerations](#) and refer to the procedures in *Database Administration - GWS User's Guide*.
7. Provision TIF and SCCP options. See [Provisioning the TIF and SCCP Options](#).
8. Provision NPP Action Sets, Service Rule Sets, and Services. See [Provisioning NPP for TIF](#).
9. Turn on each TIF feature. See [Turning On TIF Features](#).
10. Turn on the Service Portability feature if it will be used with the TIF NP feature. See [Turning On the Service Portability Feature](#).
11. Turn on Gateway Screening in linksets. See [TIF Feature Prerequisites and Considerations](#) and refer to the procedures in *Database Administration - GWS User's Guide*.

Enabling TIF Features

This procedure is used to enable TIF features in the EAGLE.

Each TIF feature must be enabled using its feature part number and a feature access key.

- TIF Number Portability - Part Number 893018901

- TIF SCS Forwarding - Part Number 893022201
- TIF Number Substitution - Part Number 893022501
- TIF Simple Number Substitution - Part Number 893024001
- TIF Additional Subscriber Data - Part Number 893024501
- TIF Generic Routing Number - Part Number 893025501
- TIF Subscr CgPN Blacklist - Part Number 893037601
- TIF Range CgPN Blacklist - Part Number 893037701
- TIF Selective Screening - Part Number 893040201

Note: Controlled features are optional and you must be entitled to use them in your system. If you are not sure whether you are entitled to use a specific feature, contact your Oracle Sales or Account Representative.

When a TIF feature is enabled, it is permanently enabled. The TIF features cannot be temporarily enabled.

Provisioning of TIF options and other information can be done after the feature is enabled and before the feature is turned on.

After a TIF feature has been enabled and database provisioning is complete, the TIF feature status must be set to on (the feature must be “turned on”). See [Turning On TIF Features](#).

Some of the TIF features can be turned off after they have been turned on. See [Turning Off TIF Features](#).

1. Display the status of the features that are controlled with feature access keys. Enter the `rtrv-ctrl-feat` command. The output lists the enabled features in the system and shows the on/off status for each feature.

If the entry for the TIF feature that you want to enable appears in the `rtrv-ctrl-feat` output with status on, performing this procedure is not necessary.

2. Enable the TIF feature, by entering the `enable-ctrl-feat` command and specify the part number and feature access key for the feature.

```
enable-ctrl-feat:partnum=<893xxxxx>:fak=<feature access key>
```

Note: The Feature Access Key is provided when the feature is purchased. If you do not have the controlled feature part number or the Feature Access Key for a feature, contact your Sales Representative or Account Representative.

After the feature is enabled, the entry for the enabled feature appears in the output of the `rtrv-ctrl-feat` command. The feature Status is off.

3. Back up the database changes, by entering the following command.

```
chg-db:action=backup:dest=fixed
```

The following messages appear; the active Maintenance and Administration Subsystem Processor (MASP) appears first.

```
BACKUP (FIXED) : MASP A - Backup starts on active MASP.
BACKUP (FIXED) : MASP A - Backup on active MASP to fixed disk complete.
BACKUP (FIXED) : MASP A - Backup starts on standby MASP.
BACKUP (FIXED) : MASP A - Backup on standby MASP to fixed disk complete.
```

Enabling the Service Portability Feature

If Service Portability can be applied to the messages processed by a feature described in this guide, use this procedure to enable the Service Portability feature in the EAGLE.

The Service Portability feature must be enabled using the feature part number 893034301 and a feature access key.

Note: Controlled features are optional and you must be entitled to use them in your system. If you are not sure whether you are entitled to use a specific feature, contact your Oracle Sales or Account Representative.

When the S-Port feature is enabled, it is permanently enabled. The S-Port feature cannot be temporarily enabled. After the S-Port feature is enabled and turned on, the S-Port feature can be turned off again.

Provisioning of S-Port options can be done after the feature is enabled and before the feature is turned on.

After the S-Port feature has been enabled and database provisioning is complete, the S-Port feature status must be set to on (the feature must be “turned on”) before S-Port processing will occur.

1. Display the status of the controlled features that are controlled with Feature Access Keys (FAKs). Enter the `rtrv-ctrl-feat` command. The output lists the enabled features in the system and shows the on/off status for each feature.

```
rlghncxa03w 09-06-29 16:40:40 EST EAGLE5 41.1.0
The following features have been permanently enabled:
Feature Name           Partnum   Status   Quantity
HC-MIM SLK Capacity    893012707 on        64
;
```

If the Service Portability entry appears in the `rtrv-ctrl-feat` output, performing this procedure is not necessary.

2. Enable the S-Port feature, by entering the `enable-ctrl-feat` command.
`enable-ctrl-feat:partnum=893034301:fak=<feature access key>`

When the feature is enabled, the Service Portability entry appears in the output of the `rtrv-ctrl-feat` command.

```
rlghncxa03w 09-06-29 16:40:40 EST EAGLE5 41.1.0
The following features have been permanently enabled:
Feature Name           Partnum   Status   Quantity
HC-MIM SLK Capacity    893012707 on        64
Service Portability    893034301 off        ----
;
```

3. Back up the database changes, by entering the following command.
`chg-db:action=backup:dest=fixed`

The following messages appear; the active Maintenance and Administration Subsystem Processor (MASP) appears first.

```
BACKUP (FIXED) : MASP A - Backup starts on active MASP.
BACKUP (FIXED) : MASP A - Backup on active MASP to fixed disk complete.
```

```
BACKUP (FIXED) : MASP A - Backup starts on standby MASP.
BACKUP (FIXED) : MASP A - Backup on standby MASP to fixed disk complete.
```

Provisioning the TIF and SCCP Options

This procedure is used to provision the configuration options for TIF and TIF features, and the SCCP option for Area Code length. At least one TIF feature must be enabled before TIF options can be provisioned.

1. Verify that each TIF feature is enabled for which options are being provisioned, by entering the `rtrv-ctrl-feat` command.

If a TIF feature is enabled but has not been turned on, the feature status in the entry is `off`.

- If a TIF feature is not enabled (the entry does not appear in the output), go to [Enabling TIF Features](#) to enable a TIF feature. Then continue with [Step 2](#).
- If a TIF feature is enabled, continue with [Step 2](#).

2. Display the current settings of the TIF options, using the `rtrv-tifopts` command.
3. Change the TIF options to the desired settings, by entering the `chg-tifopts` command with at least one of the option parameters specified.
4. Verify the changes, by entering the `rtrv-tifopts` command.
5. Display the current settings of the SCCP options, using the `rtrv-sccpopts` command.
6. Change the SCCP ACLEN option to the desired setting, by entering the `chg-sccpopts` command with the ACLEN parameter specified.
7. Verify the change, by entering the `rtrv-sccpopts` command.
8. Back up the changes, using the `chg-db:action=backup:dest=fixed` command.

These messages appear; the active Maintenance and Administration Subsystem Processor (MASP) appears first.

```
BACKUP (FIXED) : MASP A - Backup starts on active MASP.
BACKUP (FIXED) : MASP A - Backup on active MASP to fixed disk complete.
BACKUP (FIXED) : MASP A - Backup starts on standby MASP.
BACKUP (FIXED) : MASP A - Backup on standby MASP to fixed disk complete.
```

Provisioning the Destination-based Options for TIF

This procedure is used to provision the point codes and destination-based configuration options for TIF and TIF features. At least one TIF feature must be enabled before destination-based options can be provisioned.

1. Verify that each TIF feature is enabled for which options are being provisioned, by entering the `rtrv-ctrl-feat` command.

If a TIF feature is enabled but has not been turned on, the feature status in the entry is `off`.

- If a TIF feature is enabled, continue with [Step 2](#).
 - If a TIF feature is not enabled (the entry does not appear in the output), go to [Enabling TIF Features](#) to enable a TIF feature. Then continue with [Step 2](#).
2. Display the currently provisioned point codes and destination-based options, using the `rtrv-dstn` command.
 3. Enter new point codes and options using the `ent-dstn` command, or change the destination-based options to the desired settings using the `chg-dstn` command.

Refer to the procedures in *Database Administration - SS7 User's Guide* for configuring point codes destination-based options in the Destination table.

Refer to the `ent-dstn` and `chg-dstn` command descriptions in *Commands User's Guide* for valid parameter values, input examples, and rules for entering the commands correctly.

4. Verify the changes, by entering the `rtrv-dstn` command.
5. Back up the changes, using the `chg-db:action=backup:dest=fixed` command.
These messages appear; the active Maintenance and Administration Subsystem Processor (MASP) appears first.

```
BACKUP (FIXED) : MASP A - Backup starts on active MASP.
BACKUP (FIXED) : MASP A - Backup on active MASP to fixed disk complete.
BACKUP (FIXED) : MASP A - Backup starts on standby MASP.
BACKUP (FIXED) : MASP A - Backup on standby MASP to fixed disk complete.
```

Provisioning NPP for TIF

Refer to *Numbering Plan Processor (NPP) User's Guide* and the TIF feature descriptions in this manual for the required information and procedures to provision NPP components for TIF services.

NPP provisioning is performed in the following sequence for the components that are used for the specified TIF service.

1. Provision the FNAI mnemonic values required for filter matches on the NAI values for the service, using the `chg-npp-serv` command.
2. Provision the NPP Action Sets with the Conditioning Actions, Service Actions, Formatting Actions, and outgoing NAI value that are to be used by TIF and the enabled TIF features, using the `ent-npp-as` command.
3. Provision the Service Rule Sets (Rules that specify the filter values and Action Sets) that are to be used by TIF and the enabled TIF features. Enter the `ent-npp-srs` command.
4. Provision any delimiter values that are used in the outgoing digit string formatting. Enter the `chg-npp-serv` command.
5. Change the service Status to On to allow NPP processing for the specified service. Enter the `chg-npp-serv:svrn=<service name>:status=on` command.

Turning On TIF Features

Before a TIF feature can be turned on, the feature must be enabled in the EAGLE.

Provisioning of TIF options and other information can be done after the feature is enabled and before the feature is turned on.

After a TIF feature has been enabled and database provisioning is complete, the TIF feature must be turned on. MSUs are not be processed by the TIF feature until the feature is turned on.

This procedure is used to turn on TIF features in the EAGLE. Each TIF feature must be turned on using its feature part number.

- TIF Number Portability - Part Number 893018901
- TIF SCS Forwarding - Part Number 893022201
- TIF Number Substitution - Part Number 893022501
- TIF Simple Number Substitution - Part Number 893024001
- TIF Additional Subscriber Data - Part Number 893024501
- TIF Generic Routing Number - Part Number 893025501
- TIF Subscr CgPN Blacklist - Part Number 893037601
- TIF Range CgPN Blacklist - Part Number 893037701
- TIF elective Screening - Part Number 893040201

After some TIF features are enabled and turned on, they cannot be turned off again. Other TIF features can be turned on and off after they are enabled.

1. Display the status of the features that are controlled with feature access keys. Enter the `rtrv-ctrl-feat` command. The output lists the enabled features in the system and shows the on/off status for each feature.

If the entry for the TIF feature that you want to turn on appears in the `rtrv-ctrl-feat` output with status on, performing this procedure is not necessary.

If the status of the TIF feature in the output is off, continue with [Step 2](#).

2. Turn on the TIF feature, by entering the `chg-ctrl-feat` command.

```
chg-ctrl-feat:partnum=<893xxxxxx>:status=on
```

When the feature is turned on, the feature status changes to on in the `rtrv-ctrl-feat` command output.

3. Back up the database changes, by entering the following command.

```
chg-db:action=backup:dest=fixed
```

The following messages appear; the active Maintenance and Administration Subsystem Processor (MASP) appears first.

```
BACKUP (FIXED) : MASP A - Backup starts on active MASP.
BACKUP (FIXED) : MASP A - Backup on active MASP to fixed disk complete.
BACKUP (FIXED) : MASP A - Backup starts on standby MASP.
BACKUP (FIXED) : MASP A - Backup on standby MASP to fixed disk complete.
```

Turning On the Service Portability Feature

This procedure is used to turn on the Service Portability feature in the EAGLE, using the feature part number 893034301.

Before the Service Portability (S-Port) feature can be turned on, the feature must be enabled in the EAGLE.

Provisioning of S-Port options can be done after the feature is enabled and before the feature is turned on.

After the S-Port feature has been enabled and database provisioning is complete, the Service Portability feature status must be set to on (the feature must be "turned on"). MSUs will not be processed by the Service Portability feature until the feature is turned on.

After the Service Portability feature is enabled and turned on, it can be turned off again. Service Portability processing can occur only when the Service Portability feature is on and a feature that uses S-Port is on.

1. Display the status of the controlled features that are controlled with Feature Access Keys (FAKs). Enter the `rtrv-ctrl-feat` command. The output lists the enabled features in the system and shows the on/off status for each feature.

- If the entry for the Service Portability feature appears in the `rtrv-ctrl-feat` output with status on, performing this procedure is not necessary.
- If the status of the Service Portability feature in the output is off, continue with [Step 2](#).

2. Turn on the S-Port feature, by entering the `chg-ctrl-feat` command.

```
chg-ctrl-feat:partnum=893034301:status=on
```

When the feature is turned on, the feature status changes to on in the `rtrv-ctrl-feat` command output.

```
rlghncxa03w 09-08-29 16:40:40 EST EAGLE5 41.1.0
The following features have been permanently enabled:
Feature Name          Partnum    Status    Quantity
HC-MIM SLK Capacity   893012707  on        64
ATINP                 893022101  on        ----
Service Portability   893034301  on        ----
;
```

3. Back up the database changes, by entering the following command.

```
chg-db:action=backup:dest=fixed
```

The following messages appear; the active Maintenance and Administration Subsystem Processor (MASP) appears first.

```
BACKUP (FIXED) : MASP A - Backup starts on active MASP.
BACKUP (FIXED) : MASP A - Backup on active MASP to fixed disk complete.
BACKUP (FIXED) : MASP A - Backup starts on standby MASP.
BACKUP (FIXED) : MASP A - Backup on standby MASP to fixed disk complete.
```

Turning Off TIF Features

Before a TIF feature can be turned on and off, the feature must be enabled in the EAGLE 5.

After some TIF features are enabled, they can be turned on and off in the EAGLE 5.

This procedure is used to turn off the TIF features that can be turned off in the EAGLE 5. Each TIF feature must be turned off using its feature part number.

- TIF Additional Subscriber Data - Part Number 893024501
- TIF Generic Routing Number - Part Number 893025501
- TIF Number Substitution - Part Number 893022501
- TIF Subscr CgPN Blacklist - Part Number 893037601
- TIF Range CgPN Blacklist - Part Number 893037701
- TIF Selective Screening - Part Number 893040201

Note: MSUs will not be processed by a feature when the feature is turned off in the system.

1. Display the status of the features that are controlled with feature access keys. Enter the `rtrv-ctrl-feat` command. The output lists the enabled features in the system and shows the on/off status for each feature.

If the entry for the TIF feature that you want to turn on appears in the `rtrv-ctrl-feat` output with status off, performing this procedure is not necessary.

If the status of the TIF feature in the output is on, continue with [Step 2](#).

2. Turn off the TIF feature, by entering the `chg-ctrl-feat` command.

```
chg-ctrl-feat:partnum=<893xxxxxx>:status=off
```

When the feature is turned off, the feature status changes to off in the `rtrv-ctrl-feat` command output.

3. Back up the database changes, by entering the following command.

```
chg-db:action=backup:dest=fixed
```

The following messages appear; the active Maintenance and Administration Subsystem Processor (MASP) appears first.

```
BACKUP (FIXED) : MASP A - Backup starts on active MASP.
BACKUP (FIXED) : MASP A - Backup on active MASP to fixed disk complete.
BACKUP (FIXED) : MASP A - Backup starts on standby MASP.
BACKUP (FIXED) : MASP A - Backup on standby MASP to fixed disk complete.
```

Turning Off the Service Portability Feature

Before the Service Portability (S-Port) feature can be turned on and off, the feature must be enabled in the EAGLE.

This procedure is used to turn off the Service Portability feature, using its feature part number 8930343001.

Note: MSUs will not be processed by a feature when the feature is turned off in the system.

1. Display the status of the controlled features that are controlled with Feature Access Keys (FAKs). Enter the `rtrv-ctrl-feat` command. The output lists the enabled features in the system and shows the on/off status for each feature.

```
rlghncxa03w 09-06-29 16:40:40 EST EAGLE5 41.1.0
The following features have been permanently enabled:
Feature Name          Partnum  Status  Quantity
HC-MIM SLK Capacity   893012707 on       64
TIF Number Portability 893018901 on       ----
Service Portability   893034301 on       ----
;
```

If the entry for the Service Portability feature appears in the `rtrv-ctrl-feat` output with status off, performing this procedure is not necessary.

If the status of the Service Portability feature in the output is on, continue with [Step 2](#).

2. Turn off the S-Port feature, by entering the `chg-ctrl-feat` command.
`chg-ctrl-feat:partnum=<893034301>:status=off`

When the feature is turned off, the feature status changes to off in the `rtrv-ctrl-feat` command output.

```
rlghncxa03w 09-05-29 16:40:40 EST EAGLE5 41.1.0
The following features have been permanently enabled:
Feature Name          Partnum  Status  Quantity
HC-MIM SLK Capacity   893012707 on       64
TIF Number Portability 893018901 on       ----
Service Portability   893034301 off      ----
;
```

3. Back up the database changes, by entering the following command.
`chg-db:action=backup:dest=fixed`

The following messages appear; the active Maintenance and Administration Subsystem Processor (MASP) appears first.

```
BACKUP (FIXED) : MASP A - Backup starts on active MASP.
BACKUP (FIXED) : MASP A - Backup on active MASP to fixed disk complete.
BACKUP (FIXED) : MASP A - Backup starts on standby MASP.
BACKUP (FIXED) : MASP A - Backup on standby MASP to fixed disk complete.
```

TIF Test Tool

The TIF Test Tool can be used to send provisioned ISUP messages to a TIF service to test the call flow for a TIF feature. The test message is used to modify the internal data structure of the service and to study the call flow behaviour when the message is injected into the call path. The test message is never sent out to the network.

The Test Tool provides the following capabilities:

- Define up to 10 ISUP test messages in the TSTMSG table.

- Invoke TIF and NPP to process the a test message.
- Generate a report of the actions taken and the results of the test.

The Test Tool can be invoked as follows:

- After initial provisioning of TIF and NPP, before Gateway Screening is turned on for the linksets, to verify the provisioning
- During TIF feature operation, to quickly debug an issue
- After turning off Gateway Screening for a linkset, to debug an issue or test provisioning changes

The following information can be configured for each test message:

Table 34: TIF Test Tool Parameters

Parameter		Range	Default
Called Party Digits	CDPNDGTS	0-32 hexadecimal digits	01234567890abcdef
Called Party NAI	CDPNNAI	0-127	4
Calling Party Digits	CGPNDGTS	0-32 hexadecimal digits, or no digits (empty)	01234567890abcdef
Calling Party NAI	CGPNNAI	0-127	4
Calling Party Category	CGPNCAT	0-255	0
Active	ACTIVE	No, Yes	No
NM Bits	NMBITS	0-3	0

The `chg-isup-msg` command is used to configure the parameter values for each ISUP test message. The command must specify the message number (one of up to 10 messages) for the message that is being configured.

The `rtv-isup-msg` command displays the configured messages in the ISUP Message table. Configured information for all messages or for one specified message number can be displayed.

The `tst-msg` command invokes the test. The command must specify the `prot=isup` parameter, the message number for the test, the TIF CdPN service (TIF, TIF2, or TIF3), and the mode for displaying the results (full, brief, debug). The most complete and accurate test result information is provided when debug mode is used. The TIFCGPN, TIFCGPN2, or TIFCGPN3 service can be invoked with the Calling Party Digits if the INVKSERV parameter value in the TIF CdPN Service Rule is not NONE.

Note: The specified test message must be set to `active=yes` before the test is invoked for the message.

Chapter 6

Measurements

Topics:

- [TIF Measurements.....114](#)

This chapter describes the measurements that can be collected and generated for TIF, and the methods that can be used for generating reports for TIF measurements.

TIF Measurements

The EAGLE Measurements system supports the collection and retrieval of number portability measurements for the Triggerless ISUP Framework (TIF) and TIF features. At least one of the following features must be enabled before TIF measurements are collected:

- TIF Number Portability (TIF NP)
- TIF Simple Number Substitution (TIF SNS)
- TIF SCS Forwarding
- TIF Subscr CgPN Blacklist
- TIF Range CgPN Blacklist
- TIF Selective Screening

The TIF measurements can be collected and reported with the following collection methods:

- OAM-based (UI) measurements collection - Number Portability measurements are available using the File Transfer Area (FTA) and not directly to EAGLE UI terminals, when the E5-OAM Integrated Measurements feature is not on.
- The Measurements Platform feature enabled and the Measurements Platform collection option on
- The E5-OAM Integrated Measurements feature enabled and on and the E5-OAM Integrated Measurements collection option on

Refer to *Measurements Reference* for descriptions of collection methods, measurements, and measurements reports.

Refer to *Commands User's Guide* for descriptions of the commands used to enable and turn on features, turn on measurements collection options, and schedule and generate measurements reports.

Refer to the procedures in *Database Administration - System Management User's Guide* to configure the Measurements Platform feature or E5-OAM Integrated Measurements feature for use with TIF.

The TIF measurements shown in [Table 35: TIF IAM Measurements](#) are included in the Number Portability (NP) measurements entity (enttype=np), for system totals (SYSTOT) and per SSP daily (MTCD) and hourly (MTCH) reports.

Table 35: TIF IAM Measurements

Event Name	SYSTOT Description	SSP Description
TINPMRCV	Total number of IAM messages received that required TIF processing.	Total number of IAM messages received from a specific SSP that required TIF processing.
TINPMGEN	Total number of IAM messages received that required TIF processing and resulted in the modification of the IAM message or the generation of an REL message.	Total number of IAM messages received from a specific SSP that required TIF processing and resulted in the modification of the IAM message or the generation of an REL message.
TINPERR	Total number of IAM messages received that required TIF processing but resulted in the execution of an error case.	Total number of IAM messages received from a specific SSP that required TIF

Event Name	SYSTOT Description	SSP Description
		processing but resulted in the execution of an error case.
TIFRLS	Total number of MSUs processed by TIF and found be blacklisted by the BLRLS Service Action for the TIF Subscr CgPN Blacklist feature and the TIF Selective Screening feature.	
TIFSBSCRBL		Total number of MSUs processed by TIF and found be blacklisted by the BLRLS and BLNFNDRLS Service Actions for the TIF Subscr CgPN Blacklist feature and the TIF Selective Screening feature.
TIFNFNDRLS	Total number of MSUs processed by TIF and found be blacklisted by the BLNFNDRLS Service Action for the TIF Subscr CgPN Blacklist feature and the TIF Selective Screening feature.	
TIFFPFXRLS	Total number of MSUs processed by TIF and found be blacklisted by the FPFXRLS Service Action for the TIF Range CgPN Blacklist feature and the TIF Selective Screening feature.	
TIFRANGEBL		Total number of MSUs processed by TIF and found be blacklisted by the FPFXRLS and NOCGPNRLS Service Actions for the TIF Range CgPN Blacklist feature and by the FPFXRLS Service Action for the TIF Selective Screening feature.
TIFNOCGRLS	Total number of MSUs processed by TIF and found be blacklisted by the NOCGPNRLS Service Action for the TIF Range CgPN Blacklist feature.	
TIFSSCRREL	Total number of MSUs processed by TIF and ISUP RELEase message generated by the SELSCR Service Action for the TIF Selective Screening feature.	
TIFSSCRRLY	Total number of MSUs processed by TIF and Relayed by the SELSCR Service Action for the TIF Selective Screening feature.	
TIFSELSCR		Total number of MSUs processed by TIF and either the ISUP RELEase message generated by or the MSU Relayed by the

Event Name	SYSTOT Description	SSP Description
		SELSCR Service Action for the TIF Selective Screening feature.

Chapter

7

Maintenance

Topics:

- [Alarms.....118](#)
- [TIF UIMs.....118](#)
- [Maintenance Commands.....119](#)
- [Debug Commands.....120](#)
- [Status Reporting and Problem Identification...121](#)

This chapter describes the maintenance information that is available from the EAGLE 5 ISS for the TIF features. The information includes status, alarms (UAMs), and information messages (UIMs).

Alarms

Refer to *Unsolicited Alarms and Information Messages Reference* for descriptions and corrective procedures associated with EAGLE-related alarms (UAMs). Refer to *Alarms and Maintenance Guide* for EPAP for the descriptions and corrective procedures associated with MPS-related alarms.

TIF UIMs

Refer to *Unsolicited Alarms and Information Messages Reference* for descriptions of EAGLE UIMs.

UIM 1407 is issued when a message that is not ISUP is received by a TIF, TIF2, or TIF3 Stop Action.

UIM 1408 is issued when a TIF modified message is too large to route.

UIM 1426 is issued when Service Portability could not be applied due to missing GRN data.

Table 36: TIF UIMs

UIM #	Message Text	UIM Format	Output Group
1407	Unexpected SI in TIF Stop Action	I6 (MTP Data Dump)	GWS
1408	TIF: Modified MSU too large to route	I15 (RPT_SCCP_INV_MSG)	APSS
1426	S-Port: Missing GRN for srvc prtd subs	I15 (SCCP MESSAGE)	APSS

The UIMs listed in [Table 37: Existing ISUP Decode Errors](#) are used to handle ISUP decode and encode errors.

Table 37: Existing ISUP Decode Errors

Protocol Type	Error Description	UIM #	UIM Text
ISUP	IAM Decode Error (such as length or, missing parameter; the message is routed without modification)	1369	ISUP IAM decode failed
ISUP	IAM Called Party Decode Error, such as missing Called Party digits. The message is routed without modification.	1370	ISUP IAM Cld Pty decode failed
ISUP	Problem encoding IAM or SAM, Unknown DPC in REL	1371	ISUP encode failed

Maintenance Commands

The following commands can be used for maintenance when an EPAP-related feature is on.

Refer to *Commands User's Guide* for complete descriptions of the commands, including parameters, valid parameter values, rules for using the commands, and output examples.

Table 38: Maintenance Commands

Command	Description
rept-stat-sys	Reports the status of system entities, including cards. The output includes the number of Service Module cards that are in service (IS-NR) and how many are in another state (IS-ANR, OOS-MT, OOS-MT-DSBLD).
rept-stat-sccp	Reports operating status of services and subsystems, CPU usage, and Service Module card status. When the loc parameter is specified, the command displays detailed card traffic statistics, including cards that are denied SCCP service. See the section in this manual that describes the use of the <code>rept-stat-sccp</code> command.
rept-stat-mps	Displays the overall status of the EPAP application running on the MPS (multi-purpose server). Command output for the various reports of this command include overall MPS alarm status and card status, and status for a specific Service Module card when a feature is on.
rept-stat-trbl	Includes a summary of any trouble notifications (UAMs) for local subsystems, cards, and linksets. The severity of each alarm is indicated in the output report.
rept-stat-alm	Displays the alarm counts and totals for local subsystems and Service Module card/EPAP IP links.
rept-stat-db	Displays the status information for the EAGLE databases. This includes the level information for each Service Module card, and for the active and standby EPAP RTDB. The command reports database exception status such as corrupted, incoherent, or inconsistent, as well as providing the birth dates and levels. It shows the status of each PDB and RTDB when an EPAP-related feature is enabled.
rtrv-tbl capacity	Retrieves table use capacity summary information. For each table listed, the number of table entry elements in use and the total allowed number of table elements is presented, along with a percent (%) full value. Information is shown for some tables only if the feature that uses the table is enabled.
inh-card/alw-card	<p>The <code>inh-card</code> command is used to change the operating state of the card from In-Service Normal (IS-NR) to Out-of-Service Maintenance-Disabled (OOS-MT-DSBLD). A craftsperson then can test the card or physically remove it from the shelf.</p> <p>The <code>alw-card</code> command is used to change the card from OOS-MT-DSBLD (Out-of-Service Maintenance-Disabled) to IS-NR (In-Service Normal) if card loading is successful.</p>

Command	Description
inh-alm/unhb-alm	Used to allow and inhibit reporting of alarms for a given device, including the Service Module card ports. The commands allow both Port A and Port B to be specified. Inhibited alarms will not generate UAMs or cause alarm indicators to be turned on. All <code>rept-stat-xxx</code> commands continue to display the alarms with an indication that the device has its alarms inhibited.
rtrv-data-rtdb	Retrieves Entity data, DN data, IMEI data, IMSI data, TN data, NPANXX data, and LRN data from the RTDB on an active Service Module card. If the <code>loc</code> parameter is specified and the target card is an active Service Module card, the RTDB data is retrieved from that card. If the <code>loc</code> parameter is not specified, the RTDB data is retrieved on the active Service Module card that has the lowest IMT address. The RTDB status on the active Service Module card can be coherent or incoherent.

rept-stat-sccp

The `rept-stat-sccp` command provides statistics for Service Module cards and for the services that execute on the cards. The statistics can be displayed for all Service Module cards or for a specified card.

Refer to *Commands User's Guide* for a description of the `rept-stat-sccp` command, including parameter names, valid parameter values, and examples.

The `rept-stat-sccp` command reports TIF queries in the MNP statistics. Turning on a TIF feature does not trigger the display of the MNP server alarm status.

The following statistics for TIF are reported when a TIF feature is turned on: SUCCESS, ERRORS, TOTAL. For TIF,

- An IAM is counted as a SUCCESS if the message is processed completely.
- An IAM is counted as an ERROR if processing could not be completed for any reason.

When the `loc` parameter is specified and a TIF feature is turned on, MNP Alarm status, CPU usage and MNP statistics are displayed for the specified card.

Debug Commands

The *Commands User's Guide* contains descriptions of debug commands that can be used in assessing and modifying system status and operation. Most of the debug commands are used only under the direction of Oracle support personnel.

The `ent-trace` command can be used to trace MSUs sent to Service Module cards that are running the VSCCP application. The EAGLE traps MSUs that meet the specified tracing criteria, which include DN, some point codes, Entity ID, and message verification and message processing errors.

Refer to *Commands User's Guide* for a complete description of the `ent-trace` command.

For TIF, the `ent-trace` command can trace any MSU that is screened with the TIF, TIF2, or TIF3 Gateway Screening Stop Action. The trace output can be in standard format and in a brief format similar to the TIF Test Tool information (see *TIF Test Tool*). For full-format test output, the TIF Test Tool should be used. The following `ent-trace` options are supported for TIF:

- DN
- OPC/DPC/SSN
- ERROR
- SI
- CIC/ECIC (range)
- OPC
- DPC
- Incoming linkset
- ISUP message type

Status Reporting and Problem Identification

EAGLE commands can be used to obtain status and statistics for the EAGLE system, the EPAP systems, system devices including Service Module cards, EPAP-related features, local subsystems, and SCCP services.

Refer to *Commands User's Guide* for complete descriptions of the commands, including parameters and valid values, rules for using the commands correctly, and output examples.

Refer to *Unsolicited Alarm and Information Messages Reference* for descriptions and recovery procedures for UAMs and UIMs.

Refer to *Administration Guide* for EPAP for descriptions of EPAP functions and operation.

Refer to *Alarms and Maintenance Guide* for descriptions and recovery procedures for EPAP alarms.

Refer to the appropriate feature User's Guide for information about the functions and operation of EPAP-related features.

Table 39: Status Reporting for EPAP-Related Features

Reports, Status, and Statistics	Command
EAGLE	
Maintenance Status Report - indicates whether Maintenance, Routing, and SCCP Baselines have been established.	<code>rept-stat-sys</code>
Alarms and operating state for system devices, including Service Module ("SCCP") cards.	<code>rept-stat-sys</code>
Unsolicited Alarm Messages (UAMs) and Unsolicited Information Messages (UIMs)	<code>rept-stat-alm</code> <code>rept-stat-trbl</code>
EPAP/MPS (from the EAGLE)	

Reports, Status, and Statistics	Command
EPAP code version and operating state for each EPAP.	rept-stat-mps
MPS hexadecimal alarm strings for the active and standby EPAPs.	rept-stat-mps
Operating state and alarm status of equipped Service Module cards and their DSM ports and IP connections.	rept-stat-mps rept-stat-mps:loc=<Service Module card location>
Amount of memory used by the RTDB on the specified card, as a percent of available Service Module card memory.	rept-stat-mps:loc=<Service Module card location>
EPAP Provisioning Database (PDB), EPAP Real Time Database (RTDB), and Service Module card RTDB status information - Coherent, birthdate (date and time of creation), and exception (condition when a problem was detected).	rept-stat-db rept-stat-db:db=mps
Service Module Cards, EPAP-Related Features, Services, Local Subsystems	
Status of the Service Module cards, and the services executing on the cards for EPAP-related features that are turned on. Includes Service Report, Subsystem Report, and Alarm Status; Total Service Statistics.	rept-stat-sccp
Operating state and alarm status of equipped Service Module cards and their DSM ports and IP connections; EPAP-related feature status per card.	rept-stat-mps:loc=<Service Module card location>
Alarms and operating state for Service Module ("SCCP") cards.	rept-stat-sys rept-stat-mps
Any cards that are denied SCCP service.	rept-stat-sccp
Detailed view of the status of SCCP services provided by the specified Service Module card. Includes Card Alarm Status, Card Service Statistics	rept-stat-sccp:loc=<Service Module card location>
General SCCP traffic performance for Service Module cards. Message rates for TVG performance.	rept-stat-sccp:mode=perf
Statistics for EPAP-related feature local subsystems - Subsystem Report	rept-stat-sccp
Statistics for EPAP-related features	rept-stat-sccp

EPAP Status and Alarm Reporting

Because EPAP has no direct means of accepting user input or displaying output messages on EAGLE terminals, EPAP maintenance, measurements, and status information are routed through a Service Module card. EPAP sends two types of messages to the Service Module card: *EPAP Maintenance Blocks* and *DSM Status Requests and DSM Status Messages*. Each message type is discussed in the following sections.

EPAP Maintenance Blocks

The EPAP forwards all status and error messages to the Service Module cards in maintenance blocks. Maintenance blocks are asynchronously sent whenever the EPAP has something to report. The status information that is displayed when a `rept-stat-mps` command is issued includes information that came from the maintenance blocks.

The active EPAP generates and sends maintenance blocks to the primary Service Module card. One maintenance block is sent as soon as the IP link is established between the active EPAP and the primary Service Module card. Additional maintenance blocks are sent whenever the EPAP needs to report any change in status or error conditions. The information returned in maintenance blocks is included in the output of the `rept-stat-mps` and `rept-stat-sccp` commands.

The EPAP sends maintenance blocks that contain at least the following information:

- Status of EPAP A - actual states are active, standby, and down (inoperative). Maintenance blocks include a field for this information so that it can be available for the output of the `rept-stat-mps` command.
- Status of EPAP B - actual states are active, standby, and down (inoperative). Maintenance blocks include a field for this information so that it can be available for the output of the `rept-stat-mps` command.
- Identification of Active EPAP - a field to identify the active EPAP.
- Congestion Indicator - an indicator showing provisioning link congestion. The link between the EPAPs and the external source of provisioning data can become congested in high-provisioning traffic situations. When this occurs and subsequently as the congestion clears, the EPAP sends maintenance blocks to the Service Module card.
- Alarm Conditions - an error code field. If the EPAP needs to report an alarm condition, it puts an appropriate UAM identifier in this field.
- Current MPS Database Size - a field indicating the current RTDB size. The Service Module card uses this information to calculate the percentage of memory used by the RTDB.

DSM Status Requests and DSM Status Messages

When the EPAP needs to know the status of a Service Module card, the EPAP sends a DSM Status Request to all Service Module cards, and each Service Module card returns its status to the EPAP.

Service Module cards send a DSM Status Message to the EPAP when any the following events occur in the Service Module card:

- The Service Module card is booted.
- The Service Module card receives a DSM Status Request message from the EPAP.

- The Service Module card determines that it needs to download the entire RTDB; for example, the Service Module card determines that the RTDB needs to be downloaded because it is totally corrupted, or a user requests that the RTDB be reloaded. The Service Module card sends a Full Download Request message to the EPAP
- The Service Module card starts receiving RTDB downloads or updates. When a Service Module card starts downloading the RTDB or accepting updates, the Service Module card sends a DSM Status Message informing the EPAP of the first record received. This helps the EPAP keep track of downloads in progress.

The DSM Status Message provides the following information to the EPAP:

- **DSM Memory Size.** When the Service Module card is initialized, it determines the amount of memory present. The EPAP uses the value to determine if the Service Module card has enough memory to hold the RTDB.
- **Load Mode Status.** This indicator indicates whether or not a sufficient number of the IS-NR (In-Service Normal) LIMs have access to SCCP services.

A

AC
Alternating Current
Application Context
Area Code
Authentication Center

ANSI
American National Standards Institute
An organization that administers and coordinates the U.S. voluntary standardization and conformity assessment system. ANSI develops and publishes standards. ANSI is a non-commercial, non-government organization which is funded by more than 1000 corporations, professional bodies, and enterprises.

ASD
Additional Subscriber Data
Additional data that is associated with a subscriber (DN) or a range of subscribers.

C

CC
Connection Confirmed
Country Code
Composite Clock

CgPN
Calling party number
The field in the TCAP portion of the MSU that contains the additional addressing information of the origination of the MSU.

C

CIC

Carrier Identification Code

A 4-digit code that controls the routing applied to a message.

Circuit Identification Code

CRP

Circular Route Prevention

An MNP, INP, or A-Port feature that detects instances of circular routing caused by incorrect information in one or more of the network number portability databases. If a circular route has been detected, a message will be generated by the EAGLE and returned to the originator.

D

DEFCC

Default Country Code

DN

Directory number

A DN can refer to any mobile or wireline subscriber number, and can include MSISDN, MDN, MIN, or the wireline Dialed Number.

DPC

Destination Point Code - DPC refers to the scheme in SS7 signaling to identify the receiving signaling point. In the SS7 network, the point codes are numeric addresses which uniquely identify each signaling point. This point code can be adjacent to the EAGLE, but does not have to be.

DTA

Database Transport Access - A feature in the EAGLE that encapsulates specific MSUs into the data portion of SCCP within a new SS7 MSU and sends the new MSU

D

to the destination using global title translation. The EAGLE uses gateway screening to determine which MSUs are used by the DTA feature.

E

ELAP

EAGLE Local Number Portability Application Processor

The EAGLE LNP Application Processor (ELAP) platform provides capacity and performance required to support the ported number database.

EPAP

EAGLE Application Processor

EPAP-related features

Features that require EPAP connection and use the Real Time Database (RTDB) for lookup of subscriber information.

- ANSI Number Portability Query (AINPQ)
- ANSI-41 AnalyzedInformation Query – no EPAP/ELAP (ANSI41 AIQ)
- Anytime Interrogation Number Portability (ATI Number Portability, ATINP)
- AINPQ, INP, G-Port SRI Query for Prepaid, GSM MAP SRI Redirect, IGM, and ATINP Support for ROP
- A-Port Circular Route Prevention (A-Port CRP)
- Equipment Identity Register (EIR)
- G-Flex C7 Relay (G-Flex)
- G-Flex MAP Layer Routing (G-Flex MLR)
- G-Port SRI Query for Prepaid

E

- GSM MAP SRI Redirect to Serving HLR (GSM MAP SRI Redirect)
- GSM Number Portability (G-Port)
- IDP A-Party Blacklist
- IDP A-Party Routing
- IDP Relay Additional Subscriber Data (IDPR ASD)
- IDP Relay Generic Routing Number (IDPR GRN)
- IDP Service Key Routing (IDP SK Routing)
- IDP Screening for Prepaid
- INAP-based Number Portability (INP)
- Info Analyzed Relay Additional Subscriber Data (IAR ASD)
- Info Analyzed Relay Base (IAR Base)
- Info Analyzed Relay Generic Routing Number (IAR GRN)
- Info Analyzed Relay Number Portability (IAR NP)
- INP Circular Route Prevention (INP CRP)
- IS41 Mobile Number Portability (A-Port)
- IS41 GSM Migration (IGM)
- MNP Circular Route Prevention (MNPCR)
- MO-based GSM SMS NP
- MO-based IS41 SMS NP
- MO SMS Generic Routing Number (MO SMS GRN)
- MO- SMS B-Party Routing
- MO SMS IS41-to-GSM Migration
- MT-based GSM SMS NP
- MT-based GSM MMS NP
- MT-based IS41 SMS NP
- MTP Routed Messages for SCCP Applications (MTP Msgs for SCCP Apps)

E

- MTP Routed Gateway
Screening Stop Action
(MTPRTD GWS Stop Action)
- Portability Check for MO SMS
- Prepaid IDP Query Relay (IDP
Relay, IDPR)
- Prepaid SMS Intercept Phase 1
(PPSMS)
- Service Portability (S-Port)
- S-Port Subscriber
Differentiation
- Triggerless ISUP Framework
Additional Subscriber Data (TIF
ASD)
- Triggerless ISUP Framework
Generic Routing Number (TIF
GRN)
- Triggerless ISUP Number
Portability (TIF NP)
- Triggerless ISUP Framework
Number Substitution (TIF NS)
- Triggerless ISUP Framework
SCS Forwarding (TIF SCS
Forwarding)
- Triggerless ISUP Framework
Simple Number Substitution
(TIF SNS)
- Voice Mail Router (V-Flex)

F

FTA

File Transfer Area

A special area that exists on each OAM hard disk, used as a staging area to copy files to and from the EAGLE using the Kermit file-transfer protocol.

G

GRN

Generic Routing Number

GTT

Global Title Translation

G

A feature of the signaling connection control part (SCCP) of the SS7 protocol that the EAGLE uses to determine which service database to send the query message when an MSU enters the EAGLE and more information is needed to route the MSU. These service databases also verify calling card numbers and credit card numbers. The service databases are identified in the SS7 network by a point code and a subsystem number.

GWS

Gateway Screening

Used at gateway STPs to limit access into the network to authorized users. A gateway STP performs inter-network routing and gateway screening functions. GWS controls access to nonhome SS7 networks. Only an MSU that matches predefined criteria in the EAGLE database is allowed to enter the EAGLE.

I

IAM

Initial Address Message

Ensures the services offered are compatible with the reception devices, and can be used. For example, IAM prevents a phone being connected to a facsimile.

ISUP

ISDN User Part

The ISDN-specific part of the transmission with additional information via a signaling channel between exchanges.

ITU

International Telecommunications Union

I

An organization that operates worldwide to allow governments and the private telecommunications sector to coordinate the deployment and operating of telecommunications networks and services. The ITU is responsible for regulating, coordinating and developing international telecommunications, and for harmonizing national political interests.

L

LIM

Link Interface Module

Provides access to remote SS7, IP, and other network elements such as a Signaling Control Point (SCP) through a variety of signaling interfaces (DS0, MPL, E1/T1 MIM, LIM-ATM, E1-ATM, IPLIMx, IPGWx). The LIMs consist of a main assembly and possibly, an interface appliqué board. These appliqué boards provide level one and some level two functionality on SS7 signaling links.

M

MPS

Multi-Purpose Server

The Multi-Purpose Server provides database/reload functionality and a variety of high capacity/high speed offboard database functions for applications. The MPS resides in the General Purpose Frame.

Messages Per Second

A measure of a message processor's performance capacity. A message is any Diameter message (Request or Answer) which is received and processed by a message processor.

M

MSU

Message Signal Unit

The SS7 message that is sent between signaling points in the SS7 network with the necessary information to get the message to its destination and allow the signaling points in the network to set up either a voice or data connection between themselves. The message contains the following information:

- The forward and backward sequence numbers assigned to the message which indicate the position of the message in the traffic stream in relation to the other messages.
- The length indicator which indicates the number of bytes the message contains.
- The type of message and the priority of the message in the signaling information octet of the message.
- The routing information for the message, shown in the routing label of the message, with the identification of the node that sent message (originating point code), the identification of the node receiving the message (destination point code), and the signaling link selector which the EAGLE uses to pick which link set and signaling link to use to route the message.

N

NAI

Nature of Address Indicator

Standard method of identifying users who request access to a network.

Network Access Identifier

N

The user identity submitted by the client during network authentication.

NPP

Numbering Plan Processor
Provides the flexible service application behavior that satisfies the needs of customers resident in complex signaling networks. It is used for number conditioning, RTDB lookup, and outgoing number formatting.

O

OPC

Within an SS7 network, the point codes are numeric addresses which uniquely identify each signaling point. The OPC identifies the sending signaling point.

R

REL

Release

RN

Routing Number

The number provided by the Freephone Service Provider (FSP) to the Access Service Provider (ASP) to enable a pre-determined routing of traffic to a specific network/carrier/customer.

RTDB

Real Time Database

S

SAM

Subsequent Address Message

SCCP

Signaling Connection Control Part
The signaling connection control part with additional functions for

S

the Message Transfer Part (MTP) in SS7 signaling. Messages can be transmitted between arbitrary nodes in the signaling network using a connection-oriented or connectionless approach.

SCRC	SCCP Routing Control
SCS	Service Control and Screening
Service Module card	DSM, E5-SM4G, or E5-SM8G-B card that contains the Real Time Database (RTDB) downloaded from an EPAP or ELAP system.
Service Portability	See S-Port.
SI	Service Indicator
SLS	Signaling Link Selector
SP	Service Provider Signaling Point A set of signaling equipment represented by a unique point code within an SS7 domain.
SSP	Subsystem Prohibited network management message Subsystem Prohibited SCCP (SCMG) management message. (CER) Service Switching Point (SS7 Network) Signal Switching Point

S

Signal Switching Points are switches that originate, terminate, or tandem calls. An SSP sends signaling messages to other SSPs to setup, manage, and release voice circuits required to complete a call.

T

TIF	Triggerless ISUP Framework
TIF ASD	Triggerless ISUP Framework Additional Subscriber Data
TIF GRN	Triggerless ISUP Framework Generic Routing Data
TIF NP	Triggerless ISUP Framework Number Portability feature
TIF NS	Triggerless ISUP Framework Number Substitution feature
TIF SNS	Triggerless ISUP Framework Simple Number Substitution feature

U

UAM	Unsolicited Alarm Message A message sent to a user interface whenever there is a fault that is service-affecting or when a previous problem is corrected. Each message has a trouble code and text associated with the trouble condition.
UIM	Unsolicited Information Message

U

A message sent to a user interface whenever there is a fault that is not service-affecting or when a previous problem is corrected. Each message has a trouble code and text associated with the trouble condition.

Unified Inventory Management