

Server Administration Guide

Oracle Utilities Customer Care and Billing
Version 2.6.0.0.0 (OUAF 4.3.0.4.0)

E86579-01

April 2017

ORACLE®

Server Administration Guide, Oracle Utilities Customer Care and Billing, Version 2.6.0.0.0 (OUAF 4.3.0.4.0)

E86579-01

Copyright © 2007-2016 Oracle. All rights reserved.

Primary Author: Oracle Utilities Global Business Unit

The Programs (which include both the software and documentation) contain proprietary information; they are provided under a license agreement containing restrictions on use and disclosure and are also protected by copyright, patent, and other intellectual and industrial property laws. Reverse engineering, disassembly, or decompilation of the Programs, except to the extent required to obtain interoperability with other independently created software or as specified by law, is prohibited.

The information contained in this document is subject to change without notice. If you find any problems in the documentation, please report them to us in writing. This document is not warranted to be error-free. Except as may be expressly permitted in your license agreement for these Programs, no part of these Programs may be reproduced or transmitted in any form or by any means, electronic or mechanical, for any purpose.

If the Programs are delivered to the United States Government or anyone licensing or using the Programs on behalf of the United States Government, the following notice is applicable:

U.S. GOVERNMENT RIGHTS Programs, software, databases, and related documentation and technical data delivered to U.S. Government customers are "commercial computer software" or "commercial technical data" pursuant to the applicable Federal Acquisition Regulation and agency-specific supplemental regulations. As such, use, duplication, disclosure, modification, and adaptation of the Programs, including documentation and technical data, shall be subject to the licensing restrictions set forth in the applicable Oracle license agreement, and, to the extent applicable, the additional rights set forth in FAR 52.227-19, Commercial Computer Software--Restricted Rights (June 1987). Oracle USA, Inc., 500 Oracle Parkway, Redwood City, CA 94065.

The Programs are not intended for use in any nuclear, aviation, mass transit, medical, or other inherently dangerous applications. It shall be the licensee's responsibility to take all appropriate fail-safe, backup, redundancy and other measures to ensure the safe use of such applications if the Programs are used for such purposes, and we disclaim liability for any damages caused by such use of the Programs.

Oracle, JD Edwards, PeopleSoft and Siebel are registered trademarks of Oracle Corporation and/or its affiliates. Other names may be trademarks of their respective owners.

The Programs may provide links to Web sites and access to content, products, and services from third parties. Oracle is not responsible for the availability of, or any content provided on, third-party Web sites. You bear all risks associated with the use of such content. If you choose to purchase any products or services from a third party, the relationship is directly between you and the third party. Oracle is not responsible for:

(a) the quality of third-party products or services; or (b) fulfilling any of the terms of the agreement with the third party, including delivery of products or services and warranty obligations related to purchased products or services. Oracle is not responsible for any loss or damage of any sort that you may incur from dealing with any third party.

Table of Contents

Preface	2
Introduction	2
Updates to This Documentation	2
Other Documentation	2
Whitepapers	3
Architecture	5
Roles and Features	7
Client.....	7
Web Application Server	7
Business Application Server	8
Database Server	8
Batch Server BATCH	9
Concepts	12
Environment	12
Environment Identifier	12
Server Roles	12
Administration User Id and Group	13
Native Support vs Embedded Support	14
Directory Structure	16
Software Directory Structure	17
Software (splapp) Directory.....	19
Tools directory	21
Directory Permissions	22
Output Structure	22
Environment Variables	23
Common Application Logs	25
Automated Backup of Log files	26
Batch Concepts BATCH	27
Batch Clustering Concepts.....	27
Batch Controls	28
Standard parameters.....	28
Additional Key Parameters	30
Batch Run Tree	31
Timed Jobs	31
Level Of Service.....	32
Explanation of Commit Interval.....	32
Explanation of Thread Limit and Thread Number	33
Explanation of Restart and Rerun	34
Submission Methods	34
Operations	37
Command Line Utilities	37
bedit - Batch Edit BATCH	37
buildJavadocsIndex[.sh] - Builds Appviewer java docs.....	38
configureEnv – Setup Environment settings.....	39
createDBStandalone[.sh] - Creates Database Patches.....	40
extractCMSsourceUNIX[.sh] - Migrate Code Across Upgrades	40
genappvieweritems – generate AppViewer	41
initialSetup – Maintain Configuration Settings.....	42

installSFGroup[.sh] - Install Software Patches	45
invokeDBUpdatePatch[.sh] - Regenerates passwords in Installation Options	45
iwsdeploy - Inbound Web Services Deployment	46
jmxbatchclient[.sh] – JMX batch command line BATCH	46
ouafDatabasePatch[.sh] - Install Database Patches	48
PatchDeployUtility[.sh] - Create and Deploy Patch Rollups	48
showjavaproc[.sh] - Show java processes	49
splenvirom – Set Environment variables	50
spl – Start/Stop Environment	52
starttpw[.sh] - Start Threadpoolworker	53
submitjob[.sh] - Submit Batch Threads BATCH	53
threadpoolworker[.sh] - Manage Threadpools BATCH	57
Attaching to an Environment	59
Starting an Environment	60
Starting All Tiers on a Single Server	60
Starting/Stopping at Boot Time (UNIX/Linux)	61
Stopping an Environment	64
Stopping All Tiers on a Single Server	65
Starting and Stopping Using consoles	66
Monitoring	67
Monitoring Regimes	67
Monitoring Client Machines	68
Monitoring The Desktop	68
Client Debug facility	69
Monitoring Web/business Application Server	71
JMX Based Monitoring	71
Web Application Server JMX Reference	73
Business Application Server JMX Reference	82
Batch JMX Reference BATCH	85
JMX Security	91
Extending JMX Security	92
Execution Dump Format	92
Service Lists	93
Resetting Statistics	94
Database Connection Monitoring	94
Probe Transaction	95
Configuration	96
Configuration Files	96
application.xml – ADF Application configuration	96
cistab - Global Configuration Files	96
coherence-cache-config.xml - Oracle Coherence Configuration BATCH	97
e0Batch.properties - General Batch Properties BATCH	97
ejb-jar.xml - Enterprise Java Server Beans Configuration	98
ENVIRON.INI - Environment Configuration File	98
hibernate.properties - Database Connectivity Settings	99
log4j2.properties – Product Logging Configuration	100
Server Jar File (ouaf_jar_versions.txt)	100
spl.properties – Product Behaviour Settings	100
submitbatch.properties - Submitter Configuration BATCH	101
tangosol-coherence-override.xml - Coherence Overrides BATCH	101
threadpoolworker.properties - Threadpool Configuration BATCH	101
web.xml – JEE Deployment Descriptor	101

weblogic.xml – Oracle WebLogic Extensions.....	102
weblogic-ejb-jar.xml - WebLogic extensions for Enterprise Java Server Beans.....	104
webservices.xml.resource - Web Services configuration	105
Web Browser Configuration	105
Web Application Server Configuration.....	107
Caveat	107
Web Application Server Concepts.....	107
Web Applications	108
Web Application Server Configuration Files	108
Quick Reference Guide for Web Application Server Configuration.....	113
User Interface Backward Compatibility Settings	113
Web Application Server Deployment Process.....	114
Business Application Server Configuration.....	116
Business Application Server Concepts.....	117
Business Application Server Configuration Files	117
Business Application Server Configuration Process	118
Quick Reference Guide for Business Application Server Configuration.....	120
Business Application Server Deployment Process.....	121
Inbound Web Services Configuration	122
Enabling Inbound Web Services	122
Inbound Web Services Configuration Files.....	124
Inbound Web Services Concepts	124
Inbound Web Services Configuration Process.....	125
Inbound Web Services Deployment Process	127
Quick Reference Guide for Inbound Web Services Configuration	129
Inbound Web Services Deployment Utilities.....	129
Batch Server Configuration BATCH.....	130
Batch Configuration Files.....	130
General Configuration Process.....	131
Configuring Batch using bedit.....	132
Batch Configuration Guidelines	139
Oracle Cloud Support	141
Support for host whitelisting	141
Support for URI specification using Substitution Variables	143
Domain Template Support.....	145
Diagnostics Support (WLDF)	146
ECID Support	147
Global Cache Flush Support.....	148
Java Flight Recorder Support	149
Work Manager Support.....	149
Trust Store Support	150
Miscellaneous Operations And Configuration.....	151
Enabling Email Logging from Log4j2	151
Overriding the default Oracle database connection information	152
Centralized Properties Customization.....	153
Cache Management	154
Server Cache.....	155
Client Cache	156
Oracle WebLogic: Expanded or Archive Format	157
Implementing Custom Templates	158
Additional templates	159
Sending emails at the conclusion of batch processs BATCH	163
Oracle WebLogic Configuration Support.....	165
Using Configuration Files outside the WAR/EAR file.....	165
Oracle RAC Support	167
Adding a custom Privacy policy screen	168

IBM WebSphere/WebSphere ND Support	168
User Exit Include Files.....	170
Properties File User Exits	174
Custom JMS configuration.....	175
Online Transaction Timeouts.....	177
Setting the Date for testing purposes	178
Secure Transactions.....	179
Native Oracle WebLogic Support	180
Manual Re-Deployment Process.....	181
Oracle WebLogic Console Operations	182
Starting and Stopping from console.....	182
Monitoring Web Applications using the console.....	183
Specifying custom log file names BATCH	184
Turning off L2 Cache BATCH	185
JDBC Support	185
Cancelling Batch Processes Using JMX BATCH	187
Operations from Oracle Enterprise Manager	188
Discovering Oracle Utilities targets	188
Discovering Oracle WebLogic Targets.....	189
Oracle Utilities Targets	190
Monitoring using Oracle Enterprise Manager	190
Oracle Scheduler Integration	192
Introduction	192
Background Materials	192
Oracle Scheduler Interface Overview	192
Oracle Scheduler Configuration.....	194
Oracle Scheduler Execution.....	195
Oracle Scheduler Interface (OUAF_BATCH)	195
Submit_Job - Submit a Job or Thread.....	196
Restart_Thread - Restart a failed thread/job	198
Cancel_Job - Cancel a running Job.....	199
Set_Option - Set a global or Job option.....	199
Unset_Option - Reset a global or Job option.....	201
Raise_Thread_Error - Raise an error	201
Setting Preferences	201
Order Of Preference	202
Using soft_parm_map	202
Using soft_parm_list.....	203
Oracle Scheduler – OUAF REST APIs	203
Building a Schedule.....	211
Recommended tools.....	211
Defining Programs	212
Defining Job Classes.....	213
Defining Schedules.....	214
Defining Remote Destinations and Credentials.....	215
Defining Jobs.....	217
Defining Chains.....	219
Other Scheduler Objects	220
Executing Jobs	220
Monitoring Oracle Scheduler	220
Job States	220
Dictionary Views.....	221
Scheduler Notifications	221
Cancellation	221

Exporting Schedules across environments	221
Appendices - Parameters.....	223
Conventions in this section.....	223
ENVIRON.INI.....	223
ADDITIONAL_RUNTIME_CLASSPATH - Additional Classpath	223
ADDITIONAL_STOP_WEBLOGIC - Additional Stop Arguments.....	224
ADF_HOME - Location of ADF Software	224
ANT_ADDITIONAL_OPT - Additional options for ANT	225
ANT_HOME - Location of ANT.....	225
ANT_OPT_MAX - ANT Maximum Heap Size.....	225
ANT_OPT_MIN - ANT Minimum Heap Size	225
appViewer - Name of appViewer WAR file	226
BATCHDAEMON - Whether Online Batch Daemon is enabled	226
BATCHEDIT_ENABLED - Whether Batch Edit Facility is Enabled.....	226
BATCHENABLED - Whether Online Batch Server is Enabled	227
BATCHTHREADS - Number of Online Batch Server Threads	227
BATCH_DBPASS - Batch User Password	227
BATCH_DBUSER - Batch User.....	227
BATCH_MEMORY_ADDITIONAL_OPT - Threadpool Worker JVM additional options.....	228
BATCH_MEMORY_OPT_MAX - Threadpool Worker Java Maximum Heap Size.....	228
BATCH_MEMORY_OPT_MAXPERMSIZE - Threadpool Worker Java Maximum Perm Size	228
BATCH_MEMORY_OPT_MIN - Threadpool Worker Java Minimum Heap Size	229
BATCH_MODE - Default Mode of Batch.....	229
BATCH_ONLINE_LOG_DIR - Online Batch Submission Log Directory	229
BATCH_RMI_PORT - RMI Port for Batch.....	229
BSN_APP - Business Server Application Name	230
BSN_JMX_RMI_PORT_PERFORMANCE - JMX Port for Business Application Server.....	230
BSN_JMX_SYSPASS - Password for BAS JMX Monitoring	230
BSN_JMX_SYSUSER - Default User for BSN JMX Monitoring	231
BSN_NODENAME - IBM WebSphere Node Name.....	231
BSN_SVRNAME - IBM WebSphere Server Name.....	231
BSN_WASBOOTSTRAPPORT - Bootstrap Port	231
BSN_WLHOST - Business App Server Host.....	232
BSN_WLS_SVRNAME - Oracle WebLogic Server Name.....	232
CERT_IDENT_KS_ALIAS - SSL Certificate Keystore Alias.....	232
CERT_IDENT_KS_FILE - SSL Keystore File.....	233
CERT_IDENT_KS_PWD - SSL Keystore Password.....	233
CERT_IDENT_KS_TYPE - SSL Keystore Type	233
CERT_INSTALL_SCRIPT - Install SSL Keystore.....	233
CERT_KS - SSL Keystore Type.....	234
CERT_TRUST_KS_ALIAS - SSL Trust Alias.....	234
CERT_TRUST_KS_FILE - SSL Trust Keystore File	234
CERT_TRUST_KS_PWD - SSL Trust Keystore Password	235
CERT_TRUST_KS_TYPE - SSL Trust Keystore Type.....	235
CLOUD_CUSTOM_WHITE_LIST_PATH - Custom URL Whitelists for Cloud.....	235
CLOUD_RESTRICTIONS_URLS_ENABLE - Enable or Disable URL Restrictions.....	235
CLOUD_WHITE_LIST_PATH - URL Whitelists for Cloud.....	236
CMPDB - Database Type	236
CM_INSTALL_SAMPLE - Whether samples are installed	237
COHERENCE_CLUSTER_ADDRESS - Multicast address for Batch Cluster	237
COHERENCE_CLUSTER_MODE - Batch Cluster Mode	237
COHERENCE_CLUSTER_NAME - Batch Cluster Name	238
COHERENCE_CLUSTER_PORT - Batch Cluster Port Number.....	238
CONTEXTFACTORY - Context Factory for Mobile Application	238
DBCONNECTION - JDBC Connection string.....	239
DBDRIVER - Database Driver	239

DBNAME - Database Name.....	239
DBPASS - Online Database User Password.....	240
DBPASS_GEOCODE_WLS - GEOCODE Database Password.....	240
DBPASS_MDS - MDS Database Password.....	240
DBPASS_ORASDPM - DPM Database Password.....	241
DBPASS_OSB - OSB Database Password.....	241
DBPASS_SOAINFRA - SOA Database Password.....	241
DBPORT - Database Listener Port.....	242
DBSERVER - Database Server.....	242
DBURL_GEOCODE - GEOCODE JDBC URL.....	243
DBURL_OSB - OSB JDBC URL.....	243
DBURL_SOA - SOA Suite JDBC URL.....	243
DBUSER - Online Database User.....	243
DBUSER_GEOCODE - GEOCODE Database User.....	244
DBUSER_MDS - SOA MDS Database User.....	244
DBUSER_ORASDPM - DPM Database User.....	244
DBUSER_OSB - OSB Database User.....	245
DBUSER_SOAINFRA - SOA Database User.....	245
DB_OVERRIDE_CONNECTION - Custom JDBC URL.....	246
DESC - Environment Description.....	246
DIALECT - Hibernate Dialect.....	246
DIRSEP - Directory separator.....	247
DOC1BILLSCRIPT - Name Of External Print Script.....	247
DOC1SCRIPT - Name Of Generic Print Script.....	247
ENCODING - Whether Encryption Is Enabled.....	248
ENVIRONMENT_ID - Environment Identifier.....	248
FW_VERSION - Oracle Utilities Application Framework version.....	248
FW_VERSION_NUM - Oracle Utilities Application Framework Version Identifier.....	249
GIS - GIS Support.....	249
GIS_URL - GIS Service URL.....	250
GIS_WLSYSPASS - GIS WebLogic System Password.....	250
GIS_WLSYSUSER - GIS WebLogic System User Id.....	250
GLOBAL_JVMARGS - Additional JVM Arguments.....	251
help - Name of online help WAR file.....	251
HEADEND_CD_CB - Headend System URI for SOA Configuration Plan (CD_CB).....	251
HEADEND_MR_CB - Headend System URI for SOA Configuration Plan (MR_CB).....	252
HIBERNATE_JAR_DIR - Location of Hibernate JAR files.....	252
HIGHVALUE - Language specific highvalues.....	252
IWS_JDBC_NAME - JNDI Name for the IWS Connection pools.....	253
IPCSTARTPORT - Starting IPC Port for Scheduler.....	253
IWSWAR - Name of Inbound Web Services WAR.....	253
JAVAENCODING - Java Language Encoding.....	254
JAVA_HOME - Location of Java SDK.....	254
JAVA_VENDOR - Java Vendor.....	254
JAVA_VERSION - JVM Version string.....	254
JAVA_VERSION_MAIN - Abbreviated JVM Version.....	255
JDBC_NAME - JNDI Name for the Online JDBC Data Source.....	255
JNDI_GEOCODE - Geocode Data Source JNDI.....	255
JNDI_OSB - OSB Data Source JNDI.....	256
KS_ALIAS - Key Alias.....	256
KS_ALIAS_KEYALG - Key Algorithm.....	256
KS_ALIAS_KEYSIZE - Keysize.....	257
KS_HMAC_ALIAS - HMAC Key Alias.....	257
KS_HMAC_ALIAS_KEYALG - HMAC Key Algorithm.....	257
KS_HMAC_ALIAS_KEYSIZE - HMAC Keysize.....	257
KS_KEYSTORE_FILE - Keystore File Name.....	258
KS_MODE - Key Padding Mode.....	258

KS_PADDING - Key Padding Algorithm	258
KS_STOREPASS_FILE - Key Password Store Pass	259
KS_STORETYPE - Key Store Type	259
LD_LIBRARY_PATH - Library Path for Windows/Linux/Solaris	259
LIBPATH - Library Path for AIX	260
MAPDIR - Location of Map files used for Scheduler	260
MAPVIEWER_EAR - Location of Mapviewer EAR file.....	260
MAPVIEWER_ISLOCAL - Deploy Mapviewer Locally	261
MAXPROCESSINGTIME - Maximum Scheduler Processing Time	261
MINREQUESTS - Initial Scheduler Minimum Requests	261
MOBILITY_APP_ONLY - Deploy Only Mobility Web Application.....	262
MODULES - Names of Modules installed	262
NLS_LANG - NLS Language setting	262
NODEID - Scheduler Node Identifier	263
OIM_SPML_NAME_SPACE - OIM Default Namespace	263
OIM_SPML_SOAP_DEBUG_SETTING - OIM Interface Debug	263
OIM_SPML_SOAP_ELEMENT - OIM SOAP Element	264
OIM_SPML_UBER_SCHEMA_NAME - Name of OIM Interface Schema	264
ONLINE_DISPLAY_HOME - Location of Print Rendering Software.....	264
ONS_JAR_DIR - Location of Oracle Notification Service Libraries	265
ONSCONFIG - ONS Configuration	265
OPEN_SPML_ENABLED_ENV - Whether OIM Interface enabled.....	265
OPSYS - Operating System.....	265
ORACLE_CLIENT_HOME - Oracle Client Home	266
OSB_HOME - Oracle Service Bus Home	266
OSB_HOST - Oracle Service Bus Host Name.....	266
OSB_LOG_DIR - Default Location For Oracle Service Bus Logs.....	267
OSB_PASS_WLS - Password for Oracle Service Bus User.....	267
OSB_PORT_NUMBER - Oracle Service Bus Port Number.....	267
OSB_USER - User Name for Oracle Service Bus	268
PERLHOME - Location of PERL	268
SERVER_ROLES - Which server roles are enabled	269
SERVER_ROLE_BATCH - Whether the Batch Server is enabled in this installation	269
SERVER_ROLE_INTEGRATION - Whether the IWS Server is enabled in this installation	269
SERVER_ROLE_ONLINE - Whether the online server is enabled in this installation	269
SOA_HOME - Location Of Oracle SOA Suite	270
SOA_HOST - Hostname for Oracle SOA Suite.....	270
SOA_PORT_NUMBER - Port Number for Oracle SOA Suite.....	270
SPLADMIN - Administration Userid	271
SPLADMINGROUP - Administration Group	271
SPLApp - Name of Online WAR file.....	271
SPLDIR - Home Directory Of Product	272
SPLDIROUT - Location Of Product Output.....	272
SPLENVIRON - Environment Identifier	272
SPLSERVICEAPP - Name of Business Application Server Application	272
SPLWAS - JEE Web Application Server Type	273
SPLWEBAPP - Name of Web Application Server Application.....	273
STRIP_HTML_COMMENTS - Strip Out Comments In Code	273
TIMEOUT - Mobile Connection Timeout	274
TOP_VERSION - Product Version	274
TOP_VERSION_NUM - High level Product Version	274
TS_ALIAS - Trust Alias	275
TS_ALIAS_KEYALG - Key Algorithm	275
TS_ALIAS_KEYSIZE - Keysize	275
TS_HMAC_ALIAS - HMAC Key Alias.....	275
TS_HMAC_ALIAS_KEYALG - HMAC Key Algorithm	276
TS_HMAC_ALIAS_KEYSIZE - HMAC Keysize	276

TS_IMPORT_KEYSTORE_FOLDER - Import Folder for Trust Store.....	276
TS_KEYSTORE_FILE - Trust Store File Name	277
TS_MODE - Key Padding Mode.....	277
TS_PADDING - Key Padding Algorithm.....	277
TS_STOREPASS_FILE - Key Password Store Pass	278
TS_STORETYPE - Key Store Type.....	278
URL - Mobile JNDI URL.....	278
WAS_HOME - IBM WebSphere Home	279
WAS_PASSWORD - IBM WebSphere Administration Password	279
WAS_USERID - IBM WebSphere Administration User	279
WASND_DMGR_HOST - IBM WebSphere Deployment Manager Host Name.....	280
WASND_HOME - IBM WebSphere ND Home.....	280
WEBSERVICES_ENABLED - Whether Inbound Web Services Is Enabled.....	280
WEB_ADDITIONAL_OPT - Additional Java Options for Web	280
WEB_APP - Name of WebSphere Server Application.....	281
WEB_APPVIEWER_FORM_LOGIN_ERROR_PAGE - AppViewer Form Login Error Page.....	281
WEB_APPVIEWER_FORM_LOGIN_PAGE - AppViewer Form Login Page	281
WEB_APPVIEWER_PRINCIPAL_NAME - Application Viewer Principal Name	282
WEB_APPVIEWER_ROLE_NAME - Application Viewer Security Role	282
WEB_BATCH_CLUSTER_URL - Batch Cluster URL	282
WEB_CONTEXT_ROOT - Web Context Root.....	282
WEB_DEPLOY_APPVIEWER - Deploy AppViewer or not	283
WEB_DEPLOY_EAR - Deploy EAR file.....	283
WEB_ENABLE_HEALTHCHECK - Enable System Healthcheck.....	284
WEB_FORM_LOGIN_ERROR_PAGE - Default Form Login Error Page	284
WEB_FORM_LOGIN_PAGE - Default Form Login Page.....	284
WEB_HELP_FORM_LOGIN_ERROR_PAGE - Help Form Login Error Page.....	285
WEB_HELP_FORM_LOGIN_PAGE - Help Form Login Page	285
WEB_ISAPPVIEWER - Enable AppViewer	285
WEB_ISDEVELOPMENT - Development Environment.....	285
WEB_IWS_MDB_RUNAS_USER - Default User for MDB to run as within product	286
WEB_IWS_SUPER_USERS - Users to run as in IWS	286
WEB_JMX_RMI_PORT_PERFORMANCE - JMX Port for Web Application Server monitoring	287
WEB_L2_CACHE_MODE - Turn off L2 Cache for Online Submission	287
WEB_MAXAGE - Text Cache.....	287
WEB_MAXAGEI - Image Cache	288
WEB_MEMORY_OPT_MAX - Maximum Web Application Server JVM Memory.....	288
WEB_MEMORY_OPT_MAXPERMSIZE - Web Application Server JVM Max PermGen size	288
WEB_MEMORY_OPT_MIN - Initial Web Application Server JVM Memory	289
WEB_NODENAME - IBM WebSphere ND Node Name	289
WEB_PRELOADALL - Preload all pages On startup.....	289
WEB_PRINCIPAL_NAME - Default JEE Authorization Principal.....	289
WEB_ROLE_NAME - Default JEE Authorization Role	290
WEB_SERVER_HOME - Location Of Web Application Server.....	290
WEB_SERVER_VERSION - Web Server Version	290
WEB_SERVER_VERSION_MAIN -	291
WEB_SPLPASS - Application Administration Password.....	291
WEB_SPLUSER - Application Administration Userid	291
WEB_SVRNAME - IBM WebSphere Server Name	292
WEB_WASPASS - IBM WebSphere JNDI Password.....	292
WEB_WASUSER- IBM WebSphere JNDI Userid.....	292
WEB_WLAUTHMETHOD - Authentication Method.....	293
WEB_WLHOST - Web Server Host.....	293
WEB_WLPAGECHECKSECONDS - Interval for recompilation of JSP	293
WEB_WLPORT - Web Server HTTP Port	294
WEB_WLSSLPORT - Oracle WebLogic SSL HTTP Port.....	294
WEB_WLSYSPASS - Oracle WebLogic JNDI System Password	294

WEB_WLSYSUSER - Oracle WebLogic JNDI System Userid.....	294
WEB_WLS_SVRNAME - Oracle WebLogic Server Name.....	295
WLS_ADMIN_PORT - Admin Console Port Number.....	295
WLS_CLUSTER_NAME - Name of Cluster for Product.....	295
WLS_DIAGNOSTIC_BUILT_IN_MODULE - Diagnostic Module Name.....	296
WLS_DIAGNOSTIC_CONTEXT_ENABLED - ECID Support.....	296
WLS_DIAGNOSTIC_VOLUME- Diagnostic Volume.....	296
WLS_DOMAIN_HOME - Oracle WebLogic Domain Home.....	297
WLS_OVERRIDE_PROTECT - Override Protection.....	297
WLS_WEB_WLSYSPASS - Console Password for Oracle WebLogic.....	297
WLS_WEB_WLSYSUSER - Console User for Oracle WebLogic.....	298
WLTHININT3CLIENT_JAR_DIR - Location of Thin WebLogic T3 Client.....	298
WL_HOME - Oracle WebLogic Home.....	298
XAIApp - Name of XAI WAR file.....	298
XAI_DBPASS - Password for Database User for XAI.....	299
XAI_DBUSER - Database User used for XAI.....	299
XQUERIES_TO_CACHE - Size of XQuery Cache.....	299
XQUERY_CACHE_FLUSH_TIMEOUT - Cache Life for XQueries.....	300
Web.xml	300
Filter Mappings - JEE Filters.....	300
disableCompression - Disable Compression.....	301
maxAge - Max Age for Images.....	301
maxAge - Max Age for pages.....	302
auth-method - Authorization Method.....	302
fieldValuesAge - Server Cache Lifetime.....	303
disableUIPageCompression - Disable UI Compression.....	304
spl.properties	304
calendar.japanese.eras - Japanese Era Definition.....	304
com.oracle.ouaf.customer.whitelist.file – Customer’s URL whitelist file.....	305
com.oracle.ouaf.dbms.scheduler.schema – DBMS Scheduler object’s schema.....	305
com.oracle.ouaf.migrationAssistant.exportDirectory – Directory for exported CMA file.....	306
com.oracle.ouaf.migrationAssistant.importDirectory – Directory for CMA file for import.....	306
com.oracle.ouaf.migrationAssistant.fileExtension – Extension of CMA file.....	306
com.oracle.ouaf.system.database.disableTagging - Disables Database tagging.....	307
com.oracle.ouaf.system.keystore.alias - Keystore Alias.....	307
com.oracle.ouaf.system.keystore.hmac_key_alias - HMAC alias.....	307
com.oracle.ouaf.system.keystore.file - Location Of Keystore.....	308
com.oracle.ouaf.system.keystore.mode - Keystore Mode.....	308
com.oracle.ouaf.system.keystore.padding - Key Padding.....	308
com.oracle.ouaf.system.keystore.passwordFileName - Password File.....	308
com.oracle.ouaf.system.keystore.type - Keystore Type.....	309
com.oracle.ouaf.system.truststore.file - Location Of Truststore.....	309
com.oracle.ouaf.system.truststore.passwordFileName - Location Of Truststore Password file.....	309
com.oracle.ouaf.truststore.type - Type Of Truststore.....	310
com.oracle.ouaf.uriSubstitutionVariables.file – URI predefined variables list file.....	310
com.oracle.ouaf.uriValidation.enable – Enable Restriction of URLs.....	311
com.oracle.ouaf.whitelist.file – Oracle URL whitelist filename and location.....	311
com.oracle.ouaf.xsd.dir - Location of XSD files for XAI.....	311
com.oracle.ouaf.xml.dir - Location of XSL files for XAI.....	312
com.oracle.XPath.LRUSize - XPath Cache.....	312
com.oracle.XPath.flushTimeout - XPath Flush.....	312
com.splwg.batch.cluster.jvmName - Online Batch JVM Name.....	313
com.splwg.batch.scheduler.daemon - Online Submission Daemon.....	313
com.splwg.grid.executionMode - Online Execution Mode.....	313
com.splwg.grid.online.enabled - Online Batch Server.....	314
com.splwg.grid.distThreadPool.threads.DEFAULT - Online Submission Threadpool.....	314
com.splwg.schema.newValidations.F1 - Set behavior of validations.....	314

jmx.remote.x.access.file - JMX Access Control	315
jmx.remote.x.password.file - JMX Password Control	315
oracle.ouaf.jmx.remote.startPort - JMX Override Port	315
ouaf.accessibility.features - Enable Accessibility features	316
ouaf.attachment.disableSpecialCharCheckOnFileName - Disable Special Characters on file name ...	316
ouaf.batch.onlineLogDir - Online Line Batch Log Directory	316
ouaf.batch.onlineLogDir.retain – Retain Online Line Batch Log Files	317
ouaf.database.session.setInstallationTimeZone - Set Time Zone for sessions	317
ouaf.flush.jms.disabled - Global flush supported	317
ouaf.flush.jms.connection - Connection Factory for Global Flush	318
ouaf.flush.jms.requestTopic - Global Flush Request Topic	318
ouaf.flush.jms.responseTopic - Global Flush Response Topic	318
ouaf.runtime.compatibility.enablePrecisionScaleOnMoney - Money Processing	318
ouaf.jmx.com.oracle.ouaf.ws.mbeans.WSFlushBean - WS Cache Flush	319
ouaf.jmx.com.splwg.base.support.management.mbean.JVMInfo - JVM Information	319
ouaf.jmx.com.splwg.base.web.mbeans.FlushBean - Manage Cache	319
ouaf.list.buffer.limit - List Iteration limit	320
ouaf.messaging.transformerfactory - Tranformer	320
ouaf.shortcut.ignore.altKeys - Disable Hot Keys	320
ouaf.timeout.business_object.default - Set Default Business Object Timeout	321
ouaf.timeout.business_object.<bocode> - Set Specific Business Object Timeout	321
ouaf.timeout.business_service.default - Set Default Business Service Timeout	322
ouaf.timeout.business_service.<bocode> - Set Specific Business Service Timeout	322
ouaf.timeout.query.default - Set Default Query Timeout	322
ouaf.timeout.query.<zonecode> - Set Specific Query Timeout	323
ouaf.timeout.script.default - Set Default Script Timeout	323
ouaf.timeout.script.<scriptname> - Set Specific Script Timeout	324
ouaf.timeout.service.default - Set Default Service Timeout	324
ouaf.timeout.service.<service> - Set Specific Service Timeout	325
ouaf.web.appViewer.coreAppURL - AppViewer callback URL	325
ouaf.web.disablePreload - Disable Screen Preload	326
ouaf.web.help.coreAppURL - Help callback URL	326
ouaf.web.helpRootURL - Help URL	326
ouaf.web.JspHeader.maxAge - JSP Age	327
ouaf.web.preloadAllPages - Preload Scope	327
ouaf.web.useOHW - Use Oracle Help for Web engine	327
ouaf.weblogic.enableDiagnostics - Enable ECID tracking	328
ouaf.webservices.security.defaultPolicy – IWS customized security policy	328
ouaf.ws.defaultUser - Default User for Web Services	328
ouaf.ws.deploy.appxml.file - Application XML file for Inbound Web Services	329
ouaf.ws.deploy.ear - EAR file name for Inbound Web Services	329
ouaf.ws.deploy.contextpath - Context Path for Inbound Web Services	329
ouaf.ws.deploy.user - Web Services Deployment User	330
ouaf.ws.pageService.annotations - Security Annotation for XAI Legacy services	330
ouaf.ws.superusers - Effective Web Services Users	330
ouaf.ws.tools.artifact.generated.buildfile - Build File	331
ouaf.ws.tools.artifact.generated.sourcedir - Location of generated source	331
ouaf.ws.tools.artifact.resource.dir - Location of resources	331
ouaf.ws.tools.artifact.schema.dir - Location of Schemas	332
ouaf.ws.tools.artifact.xsl.dir - Web Service XSL Location	332
ouaf.ws.tracing - Inbound Web Services Tracing	333
ouaf.ws.xslDirOverride - Override XSL Location	333
ouaf.xai.HTTPBasicAuthPasswordEnc - Default XAI Password	333
ouaf.xai.HTTPBasicAuthUser - Default XAI User	334
ouaf.xai.XAIServerURL - Deafult XAI URL	334
spl.csv.delimiter.useFromDisplayProfile - List CSV delimiter	334
spl.ejbContainer.contextFactory - Context Factory for Business Application Server	334

spl.ejbContainer.password - Password for Business Application Server	335
spl.ejbContainer.url - Business Application Server URL.....	335
spl.ejbContainer.user - Business Application Server user.....	336
spl.geocodeDatasource.contextFactory - GIS Context Factory.....	336
spl.geocodeDatasource.password - GIS Connection Password	336
spl.geocodeDatasource.url - GIS Data Source	337
spl.geocodeDatasource.user - GIS Connection User	337
spl.mwm.abr.contextFactory - ABR Context Factory.....	337
spl.mwm.abr.password - ABR Connection Password	338
spl.mwm.abr.timeout - Timeout for ABR	338
spl.mwm.abr.url - ABR URL	338
spl.mwm.abr.userid - ABR Connection User	339
spl.mwm.scheduler.abr.maxProcessingTime - Processing Time for ABR	339
spl.mwm.scheduler.abr.minRequests - Initial Scheduler Pool Size	339
spl.mwm.scheduler.cleane.interval - Scheduler Cache Clense	340
spl.mwm.scheduler.connectionTimeout - Scheduler Connection Timeout	340
spl.mwm.scheduler.maintenanceCycleTime - Scheduler Integrity Check	340
spl.mwm.scheduler.mapDir - Map Directory.....	340
spl.mwm.scheduler.nodeId - Scheduler Node.....	341
spl.runtime.mwm.scheduler.ipcStartPort - IPC Start Port.....	341
spl.runtime.compatibility.uiMapDisableInputValue - Map Defaults.....	341
spl.runtime.compatibility.uiMapDropdownSelectFirstValue - Dropdown defaults	342
spl.runtime.compatibility.uiMapDisableTitle - Screen Title Defaults.....	342
spl.runtime.compatibility.uiMapDisableGenerateUniqueHtmlIDs - Map Ids.....	343
spl.runtime.customSQLSecurity – Enable SQL Whitelist	343
spl.runtime.disableCSRFProtection - Disable Security Tokens	343
spl.runtime.envIRON.init.dir - Location of Configuration Files.....	344
spl.runtime.envIRON.isWebExpanded - Expanded Mode	344
spl.runtime.envIRON.SPLeBASE - Location Of Software	345
spl.runtime.initiatize.waittime - Start Time Delay	345
spl.runtime.envIRON.SPLOUTPUT - Location Of Output.....	345
spl.runtime.management.batch.cluster.url - Batch Cluster URL.....	345
spl.runtime.management.connector.url.default - JMX URL.....	346
spl.runtime.management.rmi.port - JMX Port.....	346
spl.runtime.options.isFCFEnabled - RAC FCF enabled	347
spl.runtime.options.onsserver=nodes - ONS Configuration	347
spl.runtime.options.allowSystemDateOverride - Set Testing Date.....	347
spl.runtime.options.createSimpleWebAppContextEnable - Web Cache Loading.....	348
spl.runtime.options.isDevelopmentMode - Development Mode	348
spl.runtime.oracle.statementCacheSize - Java SQL Cache Size.....	349
spl.runtime.performSignedNumberValidation.<product> - Number Validation	349
spl.runtime.service.extraInstallationServices - Installation Service	349
spl.runtime.sql.highValue - SQL High Value.....	350
spl.runtime.utf8Database - UTF8 Support	350
spl.serviceBean.jndi.name - JNDI Name for Business Application Server	350
spl.tools.loaded.applications - Loaded product	351
hibernate.properties	351
hibernate.cache.use_second_level_cache - Use Cache.....	351
hibernate.connection.datasource - JNDI Data Source.....	351
hibernate.connection.driver_class - Connection Driver Class.....	352
hibernate.connection.password - Database User Password	352
hibernate.connection.provider_class - Connection Provider	352
hibernate.connection.release_mode - Connection Release.....	353
hibernate.connection.url - JDBC URL.....	353
hibernate.connection.username - Database User	353
hibernate.dialect - Dialect Used.....	354
hibernate.jdbc.batch_size - JDBC2 Update Support.....	354

hibernate.jdbc.fetch_size - Solution Set Size	354
hibernate.max_fetch_depth - Join Fetch Depth	355
hibernate.query.factory_class - HQL Parser.....	355
hibernate.query.substitutions - Literal Mappings	355
hibernate.show_sql - Debug Mode	356
hibernate.transaction.factory_class - Transaction Class	356
hibernate.ucp.connection_wait_timeout - UCP Connection Timeout.....	356
hibernate.ucp.inactive_connection_timeout - Connection Inactivity Timeout.....	357
hibernate.ucp.jmx_enabled - Enable UCP JMX.....	357
hibernate.ucp.max_size - Maximum Pool Size	357
hibernate.ucp.max_statements - SQL Buffer size	358
hibernate.ucp.min_size - Minimum Pool Size.....	358
submitbatch.properties	358
com.oracle.ouaf.system.keystore.alias - KeyStore Alias	359
com.oracle.ouaf.system.keystore.file - KeyStore File	359
com.oracle.ouaf.system.keystore.hmac_key_alias - KeyStore Mode	359
com.oracle.ouaf.system.keystore.mode - KeyStore Mode	359
com.oracle.ouaf.system.keystore.padding - KeyStore Padding Algorithm	360
com.oracle.ouaf.system.keystore.passwordFileName - KeyStore File.....	360
com.oracle.ouaf.system.keystore.type - KeyStore Type.....	360
com.ouaf.batch.jvmoptions - JVM Options	361
com.splwg.grid.executionMode - Mode of Execution	361
com.splwg.batch.submitter - THIN Submitter	361
com.splwg.batch.submitter.batchCd - Batch Code.....	362
com.splwg.batch.submitter.distThreadPool - Threadpool.....	362
com.splwg.batch.submitter.languageCd - Language Code.....	362
com.splwg.batch.submitter.maximumCommitRecords - Commit Interval.....	363
com.splwg.batch.submitter.promptForValues - Prompt for Values	363
com.splwg.batch.submitter.processDate - Business Date	364
com.splwg.batch.submitter.rerunNumber - Re Run Number	364
com.splwg.batch.submitter.softParameter - Job Parameters	364
com.splwg.batch.submitter.threadCount - Thread Limit	365
com.splwg.batch.submitter.threadNumber - Thread Number	365
com.splwg.batch.submitter.traceProgramEnd - Trace Program End.....	366
com.splwg.batch.submitter.traceProgramStart - Trace Program Start.....	366
com.splwg.batch.submitter.traceSQL - Trace SQL Statements	366
com.splwg.batch.submitter.traceStandardOut - Trace Output Statements.....	367
com.splwg.batch.submitter.userId - Security user	367
spl.runtime.batch.L2CacheMode - L2 Cache control	367
tangosol.coherence.distributed.localstorage - Cache Mode	368
tangosol.coherence.role - Submitter Role.....	368
threadpoolworker.properties	369
com.oracle.ouaf.batch.scriptDir - base scripts directory for infrastructure job.....	369
com.oracle.ouaf.system.keystore.alias - Threadpoolworker KeyStore Alias	369
com.oracle.ouaf.system.keystore.file - Threadpoolworker KeyStore File	370
com.oracle.ouaf.system.keystore.hmac_key_alias - Threadpoolworker KeyStore Mode	370
com.oracle.ouaf.system.keystore.mode - Threadpoolworker KeyStore Mode	370
com.oracle.ouaf.system.keystore.padding - Threadpoolworker KeyStore Padding Algorithm	371
com.oracle.ouaf.system.keystore.passwordFileName - Threadpoolworker KeyStore File	371
com.oracle.ouaf.system.keystore.type - Threadpoolworker KeyStore Type	371
com.ouaf.batch.disableAutoFlush – Auto flush batch L2 cache	371
com.ouaf.batch.flushIntervallnSeconds – Batch L2 cache auto flush interval.....	372
com.ouaf.batch.jvmoptions - Threadpool JVM Options	372
com.splwg.grid.executionMode - Threadpool Mode of Execution.....	373
com.splwg.grid.distThreadPool.threads - Threadpool Thread Limit.....	373
com.splwg.batch.scheduler.daemon - Scheduler Daemon	373
oracle.ouaf.jmx.remote.maxPortsToTry - Ports to Attempt to connect to.....	374

oracle.ouaf.jmx.remote.startPort - Override Batch JMX Port	374
ouaf.batch.onlineLogDir - Online Line Batch Log Directory	375
ouaf.batch.onlineLogDir.retain – Retain Online Line Batch Log Files	375
spl.runtime.batch.disableDeferredKeyInserts - Deferred Key Inserts	375
spl.runtime.batch.L2CacheMode - Threadpoolworker L2 Cache control	376
spl.runtime.management.connector.url.default - Batch JMX URL	376
spl.runtime.management.rmi.port - Batch JMX Port.....	377
tangosol.coherence.distributed.localstorage - DistributedCache Storage	377
tangosol.coherence.distributed.threads - Internal Cache Threads.....	377
tangosol.coherence.invocation.threads - Internal Invocation Threads	378
tangosol.coherence.localhost - Unicast Host Address.....	378
tangosol.coherence.localport - Unicast Port	378
tangosol.coherence.localport.adjust - Unicast Port Adjustment	379
tangosol.coherence.role - Threadpoolworker Role.....	379
coherence-cache.config.xml	380
tangosol-coherence-override.xml	380

Preface

Introduction

Welcome to the Oracle Utilities Customer Care and Billing Server Administration Guide for Version 2.2.0.1.0. This guide outlines the technical concepts for operating and configuring the product on its platforms as outlined in the product installation documentation.

Note: All examples and screen captures are used for publishing purposes only and may vary from the actual values seen at your site.

Note: This document covers Oracle Utilities Application Framework V4.3.0.4.0.

Note: For publishing purposes, the Oracle Utilities Customer Care and Billing product will be referred to as "product" in this document.

*Note: All utilities in this guide are multi-platform (unless otherwise indicated). For publishing purposes the commands will be in the format **command[.sh]** which indicates that the command can be used as **command** on the Windows platform or **command.sh** on the Linux/UNIX platforms.*

*Note: Sections of this manual cover the background processing, aka batch, aspects of the Oracle Utilities Application Framework for completeness only. Sections covering the background processing component are marked with a **BATCH** graphic.*

*Note: This document now covers aspects of the mobile framework used for mobile based products (Oracle Utilities Mobile Workforce Management and Oracle Realtime Scheduler). The relevant settings for this component are marked with a **MOB** graphic. Not all products use the mobile framework; please refer to the installation guide for clarification.*

*Note: This document now covers aspects of the bundling of Oracle Service Bus and SOA infrastructure. The relevant settings for this component are marked with **OSB** and **SOA** graphics. Not all products use the Oracle Service Bus and SOA infrastructure natively; please refer to the installation guide for clarification. Refer to the Oracle SOA Suite documentation for more information about these products.*

Updates to This Documentation

This documentation is provided with the version of the product indicated. Additional and updated information about the operations and configuration of the product is available from the Knowledge Base section of [My Oracle Support](#). Please refer to [My Oracle Support](#) for more information.

This document is regularly updated and should be re-downloaded on a regular basis. The Service Pack that applies to this document is indicated on the initial page of this document after the product version number.

Other Documentation

This document is part of the product technical documentation. There are groups of manuals that should also be read for additional specific advice and information:

- *Oracle Utilities Customer Care and Billing Installation Guide*

- *Oracle Utilities Customer Care and Billing Quick Installation Guide*
- *Oracle Utilities Customer Care and Billing DBA Guide*
- *Oracle Utilities Customer Care and Billing Security Guide*

These documents are available from [Oracle Software Delivery Cloud](#).

Whitepapers

A number of supplemental whitepaper are available for the Oracle Utilities Application Framework based products from [My Oracle Support](#). At the time of publication¹ the following whitepapers are available on specific topics:

Whitepaper	Doc Id
Technical Best Practices	560367.1
Performance Troubleshooting Guideline Series	560382.1
Software Configuration Management Series	560401.1
Security Overview	773473.1
LDAP Integration	774783.1
Interface Integration Overview	789060.1
Single Sign On Integration	799912.1
Architecture Guidelines	807068.1
Batch Best Practices	836362.1
XAI Best Practices	942074.1
Production Environment Configuration Guidelines	1068958.1
What's New In Oracle Utilities Application Framework	1177265.1
Database Vault Integration	1290700.1
BI Publisher Integration Guidelines	1299732.1
Oracle SOA Suite Integration	1308161.1
Oracle WebLogic JMS Integration	1308181.1
Implementing Oracle ExaLogic and/or Oracle WebLogic Clustering	1334558.1
IBM WebSphere Clustering	1359369.1
Oracle Identity Management Suite Integration	1375600.1
Advanced Security Overview	1375615.1
Configuration Migration Assistant Overview	1506830.1
Integration Reference Solutions	1506855.1

¹ Refer to My Oracle Support for any additional whitepapers

Whitepaper	Doc Id
Native Installation	1544969.1
Oracle Service Bus Integration	1558279.1
Using Oracle Text for Fuzzy Searching	1561930.1
Audit Vault Integration	1606764.1
Private Cloud Planning Guide	1643845.1
Migrating from XAI to IWS	1644914.1
ILM Planning Guide	1682436.1
ConfigTools Best Practices	1929040.1
Keystore Configuration	2014161.1

Architecture

The product is a multi-layered product with distinct tiers. The figure below illustrates the architecture of the product:

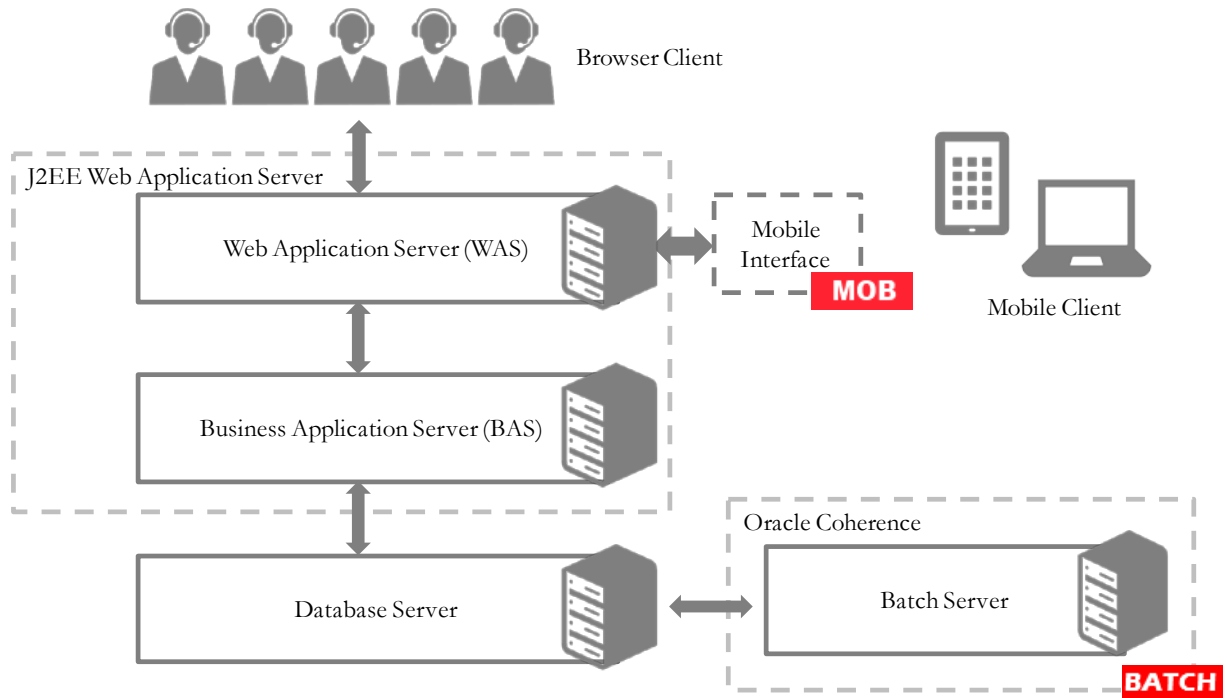

Figure 1 – Product Architecture.

The components of the architecture are as follows:

- **Browser Client** – The client component is a browser based interface which is *light* and only requires the Internet Explorer browser to operate.
- Communication between the client and server uses the HTTPS protocol across a TCP/IP network. Non communications (HTTP) is also supported. The user simply uses a URL containing the product hostname and allocated port number in the address bar of Internet Explorer to access the application.

Note: It is possible to use proxies to hide or translate the hostname and port numbers. Refer to the documentation provided with your JEE Web application server documentation for proxy support instructions.

Note: By default SSL is enabled with minimal facilities, by default for all new installations. Refer to the SSL documentation provided with your JEE Server to enable SSL to your individual needs.

Note: The default SSL certificate provided by Oracle is recommended for demonstration and development purposes only. It is highly recommended that customers purchase their own certificates for use for SSL.

- **Mobile Device Terminal (MDT)/Mobile Interface** – In some products the Mobile framework is deployed to allow mobile devices to interact with server processes. Refer to the product guides for applicability of the mobile framework to your product. **MOB**

Note: This manual has minimal information about the operation of the Mobile component of the Oracle Utilities Application Framework.

- **Web Application Server (WAS)** – The product web application is housed in a JEE compliant Web application server (Refer to the [Supported Platforms](#) section of the installation guide for JEE Web application servers and versions supported) This server can be run on a variety of supported Windows, Linux and Unix platforms (Refer to the Supported Platforms section of the guide for operating systems and versions supported). Within the Web application server the pages for the product are rendered using a combination of metadata and formatting rules to ensure a consistent look and feel. These pages are written using a combination of JEE Java script and Java. These pages are cached on the Web Server and served to the client upon request. If the page requires business rules to be invoked then business objects are called from this server.
- **Business Application Server (BAS)** – The business component of the architecture can be installed as part of the Web application server (default) or as a separate component. This means the Business Application Server is also housed in a JEE compliant Web application server (Refer to the Supported Platforms section of the installation guide for JEE Web application servers and versions supported). This server can be run on a variety of supported Windows, Linux and Unix platforms (Refer to the Supported Platforms section of the installation guide for operating systems and versions supported). Within the Business Application Server the following components are implemented:
 - **Business Objects** – The business logic for each object in the system is expressed as a Java object. It contains all the SQL, programmatic rules and structures to manage the data for the transactions. In some products.
 - **DB Connection Pool** – If any database access is required, we use an industry component called Universal Connection Pool to manage and pool the connections to the database for the batch component and use the Web Server's own native JDBC connection pooling for the online and Web Services component. This will reserve connections and ensure efficient use of connections to the database. To access the database product uses the networking client provided by the DBMS vendors to ensure correct connection. These clients are multi-protocol for maximum flexibility.
- **Database Server** – The RDBMS used for the implementation is implemented in the database server. The product supports a number of databases (Refer to the [Supported Platforms](#) section of the installation guide for databases and versions supported). The database server only stores and retrieves the data for the product as all the business logic is in the business objects.
- **Batch Server** - In some cases, processes need to be processed in bulk and in the background. The Batch Server is a set of JVM's clustered using Oracle Coherence². This feature supports multi-threaded background processes processing records in bulk across a cluster. **BATCH**

² The Oracle Coherence implementation is embedded with the product and is restricted to the background processing component only. Implementation of other Oracle Coherence features beyond that provided with the integration requires the purchase of a full Oracle Coherence license.

Roles and Features

Each tier in the architecture has a specific role in the operation of the product. The sections below outline the roles and features of each tier.

Client

The Browser User interface (BUI) is a combination of HTML and Java-script. AJAX, shorthand for Asynchronous JavaScript and XML, is a Web development technique for creating interactive Web applications. This makes web pages more responsive by exchanging small amounts of data with the server, so that the entire page does not have to be reloaded each time the user makes a change. This increases the Web page's interactivity, speed, and usability.

Note: Refer to the installation guide for the supported browsers and the supported versions of those browsers.

Note: In past releases, Adobe/Apache Flash Player was required for displaying and interacting with graphs. This is no longer required.

There are no ActiveX or Java components in the base product installation. This means that the deployment of the browser client is relatively simple as the only required component to use the product is a supported version of Internet Explorer on the client machine. If the implementation requires ActiveX controls for extensions then they can be added and used for the implementation.

The Browser tier of the product is provided for the end users to access the product on a desktop. The client provides the following roles in the architecture:

- **Screen Rendering and Caching** – All the screens are rendered using standard HTML and JavaScript (not Java). The rendering is performed as the screen is served from the Web Application server and stored in the local browser cache.
- **User Interaction** – The client provides the user with the screen interaction. After page is rendered the user can interact (manipulate data and screen elements) as per their business transaction. The browser client is responsible for ensuring that users can navigate and interact with the screen elements (e.g. resizing, display correctly).
- **User Context** – The product is stateless and therefore the client stores the transactional context locally and passes this to the transaction as required. The client records the context of the transaction in the browser memory.

No business logic is stored on the client component.

Web Application Server

The product is a JEE set of Web applications that are housed in a JEE compliant Web application server. The product and the Web application server provide the following roles in the architecture:

- **Authentication** – The Web application server software that houses the product provides adapters to common security repositories. This means that security products interfaced to the Web application server software can be used in conjunction (with configuration) with the product.

- **Managing Client connections** – The Web application server software manages any client connections (during and after they are authenticated) for processing and availability.
- **Page Server** – The major responsibility of the Web application server is to *serve* pages to the client on demand. At start-up time (or at the first request for a particular page) the product generates the screens dynamically using metadata and rendering style sheets. These are cached for reuse locally.
- **Cache Management** – For performance reasons, the static data (usually metadata and configuration data) is cached in memory on the Web application server.

No business logic is stored on the Web application server component. The Web application server Component of the product is written in Java and JavaScript.

Business Application Server

The product is a JEE set of business applications that are housed in a JEE compliant Web application server (this can be the same instance of the Web application server or a separate one). The product and the Business Application Server provide the following roles in the architecture:

- **Authorization** – After authentication has been performed by the Web application server, the Business Application server is responsible for determining which functions and which data can be accessed.
- **Data Integrity** – The Business Application Server contains the business logic to maintain referential integrity for the product data.
- **Validation** – The Business Application Server contains the business logic that contains all the validation rules for the product data.
- **Business Rules** – The Business Application Server contains the business logic that implements business rules and performs calculations.
- **SQL** – The Business Application Server contains all the SQL statements and formats and processes results from those SQL statements.

The Business Application Server Component of the product is written in Java.

Database Server

The product contains a database schema within a database management system. The database server has the following roles in the architecture:

- **Data Storage** – The database is responsible for efficiently storing all data.
- **Data Retrieval** – The database is responsible for efficiently retrieving data using SQL provided by the Business Application Server.
- **Data Management** – The database is responsible for efficiently managing all data.

No business logic is stored on the Database Server.

Note: Refer to the DBA Guide for your product for specific facilities supported by the Database Server.

Batch Server **BATCH**

The product is known for its online (or foreground) processing (a.k.a. *online* processing) but one of the major features of the product is its set of background processes. Background processing is a major part of the product with numerous background processes supplied as *standard*.

The easiest way to understand the concept behind background processing is to think that background processing is like a *super efficient user* that operates on a batch of objects. That is why background processing is commonly called *Batch*.

Note: For publishing purpose the term batch may also be used to denote background processing in this document.

Online typically operates on one object at a time, initiated by an online user or a Web Service call, where batch can operate on one or more objects (also known as a set of objects) at a time, initiated using a number of technologies.

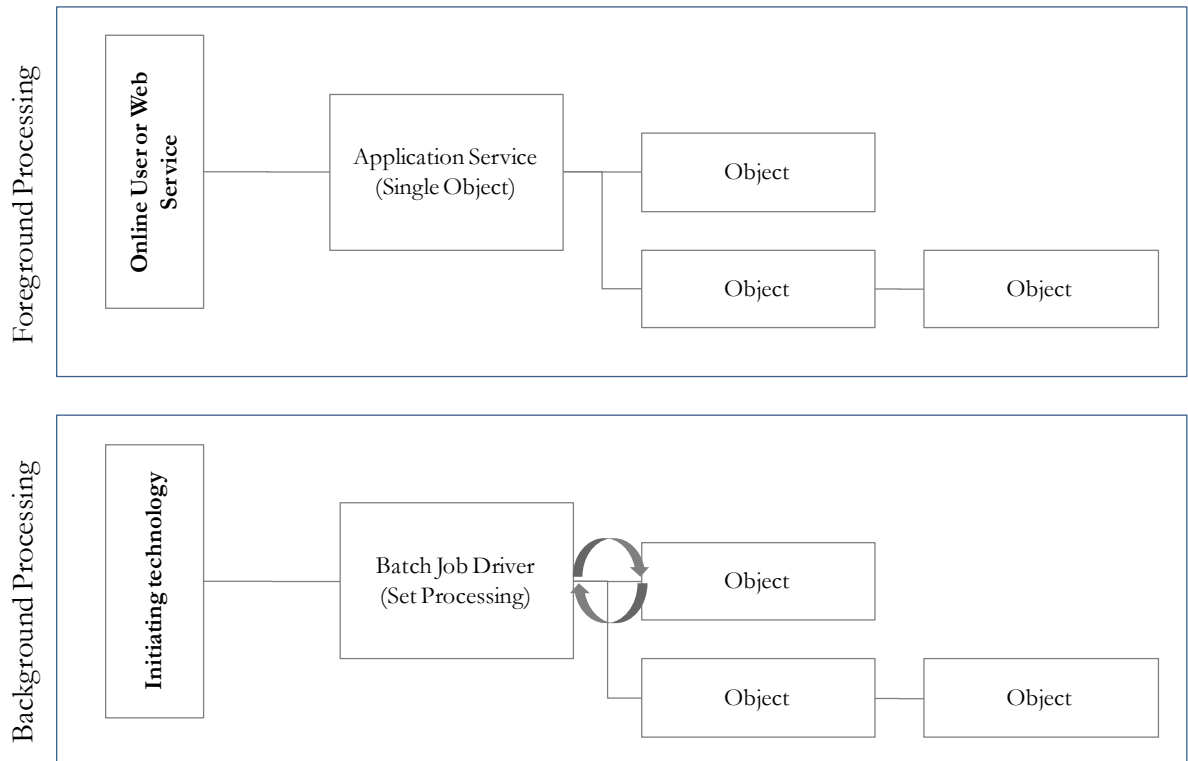

Figure 2 – Batch Processing Architecture

The main reasoning behind the *super efficient user* is that each background process consists of a driver object that identifies the set of valid objects to process and then processes each object through the same business objects that the online uses. For example, the **BILLING** driver determines which accounts are eligible to be billed according to business calendar and then passes each account to the rate object to produce a bill. Contrast this with online bill generation, where the user identifies the account manually, and then that single account is passed to the same rate object to be billed. The background process can call more than one object during the duration of the background process.

For the batch process, all of the database access and object access (including access to business objects, algorithms, user exits (server side only) etc) is done through the Oracle Utilities Application Framework.

Background processing and the Architecture BATCH

The Background Processing component is run within the Oracle Utilities Application Framework and is associated typically with the Business Application Server. It is not associated the Web Application Server and does not require the Web Application Server to be active to operate. The only component other than product that the background processing component requires is the database server (or tier).

Depending on the initiation method employed the background processing component uses a standalone copy of the product to perform access to the database and business objects and its own copy of the same business objects used by the Business Application Server.

Essentially the background processing has its own resources (Java Virtual machines (JVMs), connection pools) independent of the rest of the architecture and can therefore be run on the same hardware as the rest of the architecture or on dedicated hardware.

Batch Architecture Overview BATCH

The background processing component of the architecture is a scalable clustered batch approach that allows implementation, using configuration, to spread the batch load across a clustered based architecture.

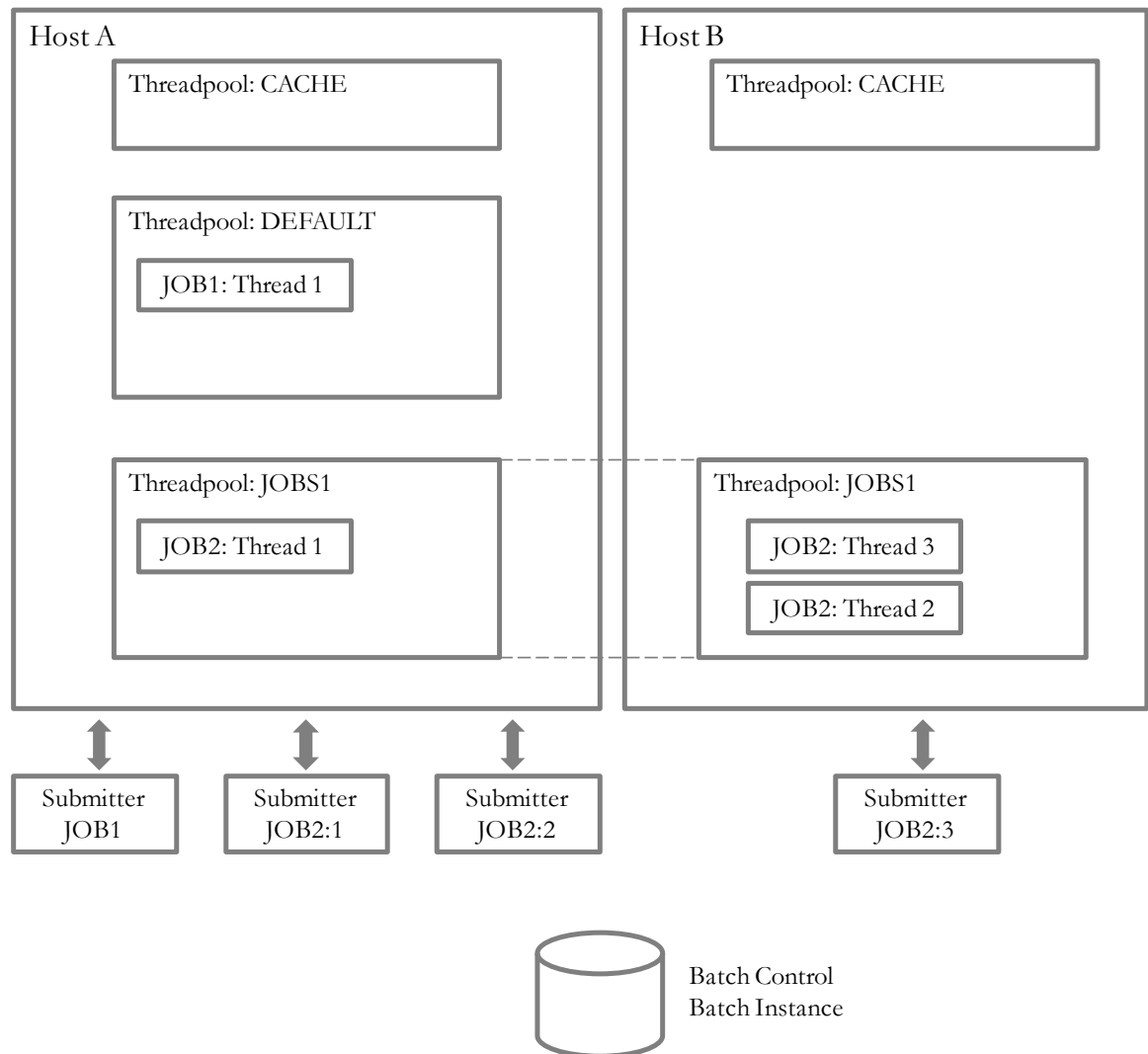

Figure 3 – Batch Architecture Overview

The architecture has the following features:

- A background process cluster is defined using the inbuilt Oracle Coherence³ configuration. This cluster defines the group of hosts, either communicating via unicast or multicast, which will execute background processing threads.
- Within the cluster, the configuration defines threadpoolworkers (also known as *workers*). These are running Java Virtual machines where the batch processes are executed. Threadpoolworkers are named to segregate batch threads and can be clustered across hosts defined in the Coherence cluster. Threadpoolworkers are defined with a maximum limit on the number of threads supported per instance of the threadpool.
- Background processes are submitted (known as *submitters*) to the named threadpools either at a particular threadpool/host instance or automatically distributed across a threadpool across the cluster.
- A background process is defined within the meta data as a [Batch Control](#) which defines the physical characteristics of the job as well as any configurable parameters of the background process.
- When a background process is executed, a number of threads (*1 to many*) are specified in the execution. Each thread will create *Batch Instance* records to track the progress of the job internally (exposed via the *Batch Run Tree* transaction within the product).
- Oracle Coherence is used, internally, to manage the communication between the cluster and all the members (such as workers and submitters) within that cluster. If a submitter or workers completes the thread or aborts then the cluster is informed and synchronized to take this into account. For instance, in the case of a status change (Completion or abort) the *Batch Instance* record is updated to reflect the state of the job.

³ The Oracle Coherence implementation within the product uses a subset of the Oracle Coherence feature set, specifically Named (or Job) Caches.

Concepts

Before you attempt to configure or operate the product, there are important concepts that you should understand. These concepts are addressed in this document as a basis for the other documents in the technical documentation.

Environment

In a product implementation and post-implementation there will be a number of copies of the product installed. Each copy of the product is known as an environment. Each environment will be created for a specific purpose, according to your site plans, and accessible to a group of users deemed necessary for that purpose. For example, there will be at least one testing environment where designated personnel will perform their testing tasks.

For planning purposes an environment is an instance of:

- The Web applications deployed in a JEE Web application server. This may be in a single server or across a cluster of servers.
- The business applications deployed in a JEE Web application server. This can be the same physical JEE Web application server or another instance (such as a separate server). This may be in a single server or across a cluster of servers.
- A database containing the product schema. Physically, a schema can exist in an individual database instance or shared within a database instance (i.e. you can install multiple schemas of the product in the same database). This may be in a single server or across a cluster of servers.

While there is no restriction on the number of environments it is recommended that the minimal number of copies of the product is installed using the guidelines outlined in the *Environment Management* document in the [Software Configuration Management Series](#) (Doc Id: [560401.1](#)) on [My Oracle Support](#).

Environment Identifier

As part of an installation an environment identifier is generated for the installation. This identifier is used by the technical utilities to manage the components and servers across the architecture. The environment identifier is used in the following ways:

- The Oracle Application Management Pack for Oracle Utilities uses the environment identifier to link child targets to an Utilities Environment target. This is used for monitoring and managing disparate targets (within a single host or across multiple hosts).
- It is used for tracking purposes only outside of the Oracle Application Management Pack for Oracle Utilities.

This feature is used in conjunction with the [Server Roles](#) facility.

Server Roles

One of the features of the installation and configuration is the ability to design architecture roles to a single installation (i.e. a product home). This allows the product to support specific

roles per installation or a combination of roles for a single installation for flexibility. There are three roles available to be used:

Role	Usage
batch	This installation will use the batch server functionality
integration	This installation will use the webservice functionality
online	This installation will use the online functionality

Selection of each of the roles will enable or disable certain parameters that are available in the [configureEnv\[.sh\]](#) utility.

Note: Even though the role can be set for individual sets of functionality, all the code and facilities are installed and patched to support post installation role change.

Note: If the role is changed post installation additional parameters may need to be provided.

Once the role is set a number of additional configuration parameters are set in the [ENVIRON.INI](#):

- [SERVER_ROLE_BATCH](#)
- [SERVER_ROLE_INTEGRATION](#)
- [SERVER_ROLE_ONLINE](#)

Administration User Id and Group

Prior to installing the product, you create a UNIX administration user ID and administration group. This account is used to install and operate the product. The product administration user ID and product group is provided as a parameter during the installation process. By default, the product administration user ID is **splsys** (**SPLADMIN** parameter and environment variable) and the group is **splusr** (**SPLADMINGRP** parameter and environment variable). However, alternative values can be used according to your site standards.

The administration userid is responsible for the following:

- It is the owner of the majority of the files installed for the product.
- It is the only userid that should be used to run any of the administration tools provided with the product.
- It is the userid that owns the UNIX resources used by the product. When the product is running, this userid owns the processes associated with running the base software.

The administration userid should be protected from unauthorized use. If components of the responsibility of administration need to be delegated to other users on the machine, we recommend not giving out the administration userid. Instead, an alternative solution may be sought (such as using *sudo* or similar security tools).

The administration userid should not be used for any of the following:

- As a product end user. By default, the administration userid does not have access to the functionality of the product.
- To run product background processes.
- To manipulate data files exported from or imported into the product from any interfaces.

This technical document will refer to the administration userid as **splsys**. If your site uses an alternative userid as the administration userid, substitute that userid value for **splsys**.

Implementation Tip: It is possible to implement a different owner per environment in the product. Why would you want to do this? If you want to allow developers or testers to restart environments themselves, you can give access only to appropriate environments to distribute the administration. This can be achieved by installing the product with different userids. You must log in and administrate each environment with its account only.

Native Support vs Embedded Support

Note: This facility applies to Oracle WebLogic customers only. IBM WebSphere uses Native Support only.

Note: This section only applies to the online and Web Services capabilities of the architecture.

Note: Native mode installation is recommended for Production environments and non-development environments.

Note: Embedded mode installation is recommended for development or demonstration environments.

By default, the utilities and configuration files use Oracle WebLogic in *embedded* mode. In this mode the Oracle WebLogic installation does not house the deployment of the product within the Oracle WebLogic installation structure. The utilities and configuration files allow the Oracle WebLogic installation to logically reference the structures and deployment files from the **spl app** directory within the product installation. The process uses templates to create product configuration files as well as Oracle WebLogic configuration files and utilities to logically reference the files in the product structure.

This has advantages where a single installation of Oracle WebLogic can be used for multiple product environments (including development environments and different products on the same framework) and is therefore ideal for non-production environments.

Whilst the embedded environment is recommended for non-production environment it has limitations that are not practical for a production environment. These limitations are:

- **Clustering Support** – By default the installation and creation of the configuration files predefines a simple installation with a single server. In production Oracle WebLogic clustering is typically used and this is difficult to configure and maintain when using *embedded* mode, without manual manipulation of configuration files.
- **Administration Server installation** – In each installation of the product the administration console is deployed in each server which is not recommended for production environments. Typically, a single installation of the administration server will exist, or Oracle Enterprise Manager will be used, for production management of the environment.
- **Set configuration** – The product installation contains a set configuration which is a common installation for non-production environments and is not optimized for production.

It is possible to use the *native* mode of Oracle WebLogic to house the product. In this case, the product is installed as outlined in the Installation Guide but deployed to the Oracle WebLogic domain location using the Oracle WebLogic deployment tools and managed from the console. This allows the native tools to be used instead of the provided utilities and

allows for the console to be used to manage the product. In this mode the product runtime for the product is either embedded in the EAR files or referenced indirectly by the EAR file.

The figures below illustrate the architecture differences in the two approaches:

Embedded Installation

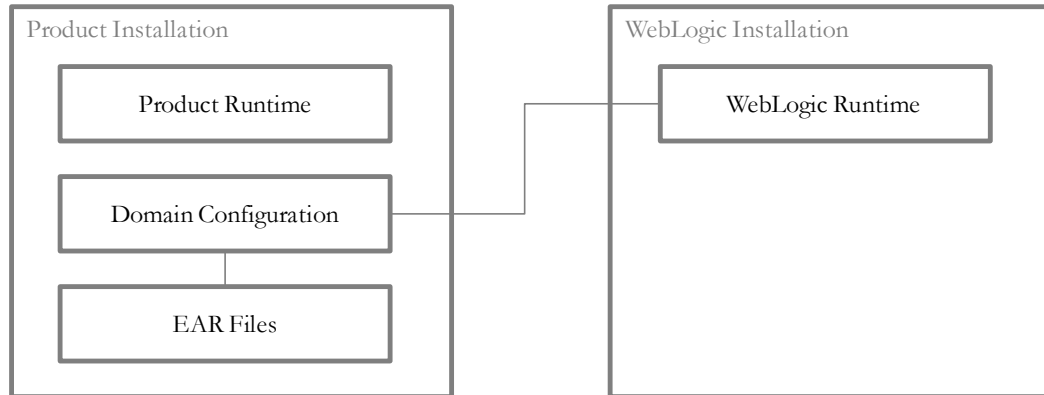

Native Installation

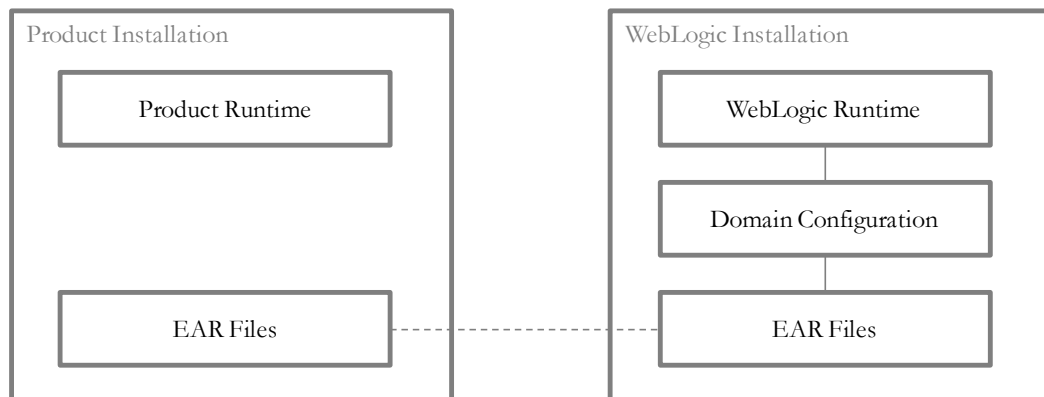

Figure 4 – Native and Embedded Architectures

In the *embedded* approach the domain files exist under the product installation and are built and maintained using the **configureEnv** and **initialSetup** utilities. No product installation files exist in the Oracle WebLogic installation but the Oracle WebLogic runtime is used by the generated utilities. Hence the term, *embedded* mode. This is recommended for non-production environments as it minimizes the number of Oracle WebLogic installations.

In the *native* approach, the domain files exist under the Oracle WebLogic installation location, as other Oracle applications use. The product files are deployed to the Oracle WebLogic location using the deployment utilities provided by Oracle WebLogic (console or *WLST* can be used). This means that all the administration for any Oracle WebLogic configuration can be performed from the console rather than from command lines and configuration files. This approach is recommended for customers using Oracle ExaLogic and/or Oracle WebLogic clustering.

In both modes all the product specific configuration files are maintained using the facilities outlined in this manual. Refer to the Installation Guide for steps to setup *embedded* or *native* mode.

Note: For native installation instructions refer to [Native Installation Oracle Utilities Application](#)

[Framework](#) (Doc Id: [1544969.1](#)) available from [My Oracle Support](#) and the installation guides for the product.

This guide will outline the operations and configuration for both approaches.

Directory Structure

In an effort to facilitate upgrades and ease maintenance, the product installation process creates a very specific directory hierarchy under the administration user ID of **splsys** (by default). The structure holds all the code, system products, scripts and temporary files that are created by the product during installation and operation.

Note. Every part of the product relies on the fact that this directory structure and the files within remain intact as delivered.

Note. At no time should you modify any of the supplied programs or scripts without the express direction of Oracle

There are two different directory structures that the product application uses:

- Base code directory structure (denoted in this documentation as **<SPLDIR>**)
- Application output directory structure / log directory (denoted in this documentation as **<SPLDIROUT>**)

Within each of the structures, there is a mount point and a subdirectory for each environment <environment> installed on the machine. The base mount point **<SPLDIR>** contains the environment directories that hold all of the application software for each particular environment. The application output mount point **<SPLDIROUT>** contains the environment directories that hold temporary files (such as the output batch) as well as batch log files. The default **<SPLDIR>** directory is **/spl** and the default **<SPLDIROUT>** directory is **/spl/spl output**.

When a user logs on to a particular environment of the product either using the browser-based interface or directly on UNIX/Windows, the environment is set up (i.e. environment variables, etc.) to point to the appropriate directory structure under the mount point. The environment variable that points to an environment directory under **<SPLDIR>** is **\$SPLEBASE** (or **%SPLEBASE%** in Windows). The environment variable that points to an environment directory under **<SPLDIROUT>** is **\$SPLOUTPUT** (or **%SPLOUTPUT%** on Windows). The **SPLEBASE** and **SPLOUTPUT** environment variables are two of the standard environment variables used by the utilities provided with the product and runtime.

*Implementation Tip. The actual location of the application directory **<SPLDIR>** and application output directory **<SPLDIROUT>** is up to site standards. The product does not care where it is installed as it internally uses the environment variables to access the correct locations.*

The actual location for the mount points can differ per environment if you want. This is handy if you need to vary the location because you do not have enough space for all your non-production environments. Typically the number of environments during an implementation varies according to the level of access and desired amount of testing and training. The only restriction is that there can only be one location for **SPLEBASE** and **SPLOUTPUT** per environment.

Software Directory Structure

The following components are stored in the base code directory structure:

- **Runtimes for Components** – All the runtime executables for the base software.
- **Business Object Binaries** – All the binaries that contain the business logic.
- **Configuration Files** – All the configuration files for the business objects and runtimes
- **Scripts** – Any administration or runtime scripts that are supplied to the customer.
- **Supported Plug-ins** – Source and executable for supplied plug-ins.

The following figure depicts the layout of where the product code is placed upon installation into the file system (where *<environment>* is the environment name chosen during the installation process):

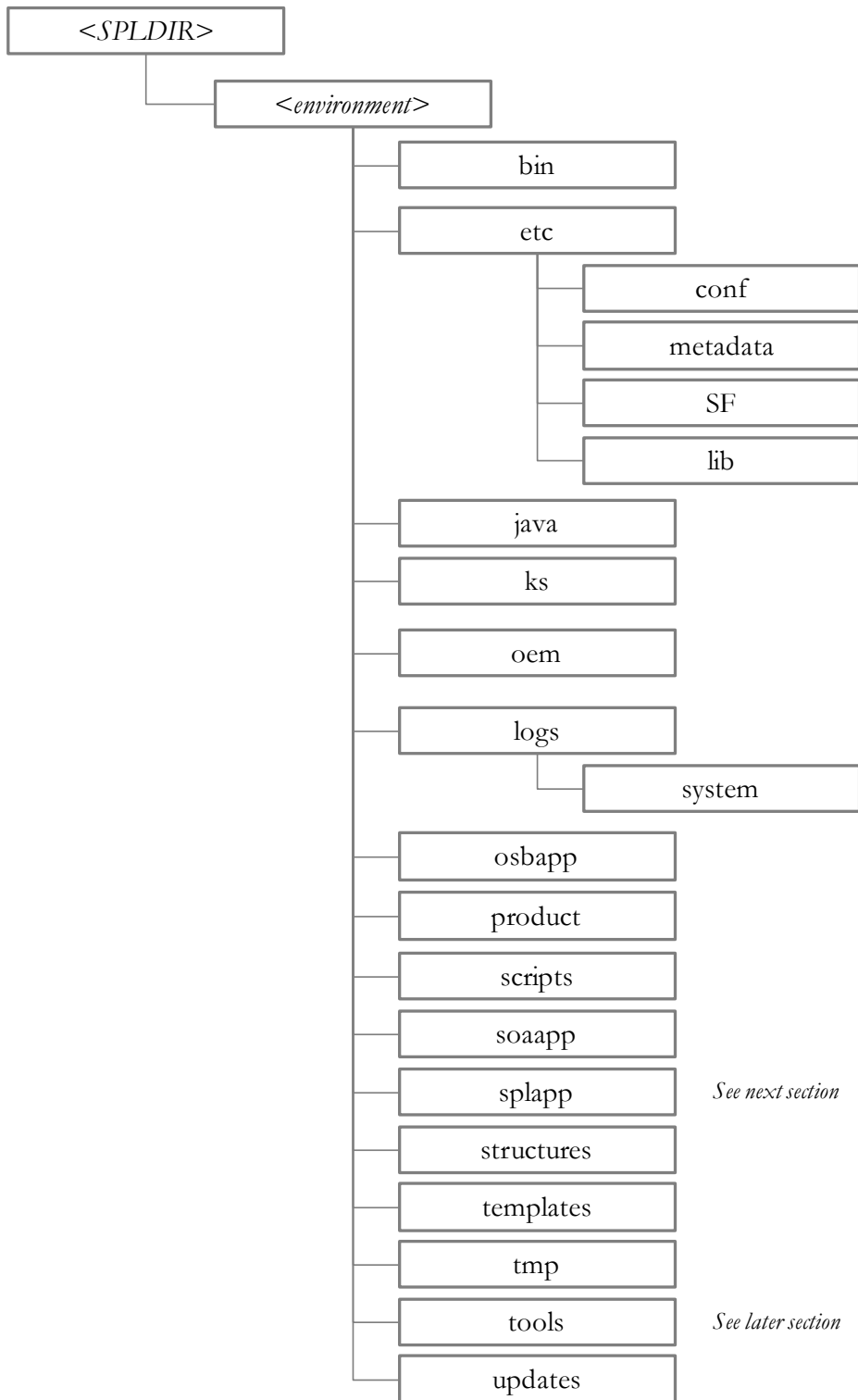

Figure 5 – Software Directory Structure

The following table outlines the typical contents of these directories:

Directory	Contents
bin	Utilities and commands for operations and configuration.
etc	A set of directories holding configuration files used in the product as well as template files and base libraries used to generate the configuration files.

Directory	Contents
java	Location of temporary files for java execution
ks	Location of Key Stores
oem	Application Management Suite for Oracle Utilities ⁴ generated files
logs	Location of product specific log files
osbapp	Oracle Service Bus integration (<i>optional</i>)
product	Directories containing any bundled software with the product.
scripts	Directory containing any implementation specific scripts.
soaapp	Oracle SOA integration (<i>optional</i>)
spl app	Directories containing the JEE Web Applications (see SPLApp)
structures	Internal structures used for configuration utilities
templates	Base templates used to build configuration files
tmp	Directory used to hold intermediary files used for the deployment process
tools	Location of service pack, single fix and group fix utilities. See Tools .
updates⁵	Location of installed_fixes.txt

Software (splapp) Directory

Under the **spl app** subdirectory for each environment there are a number of subdirectories:

⁴ Files in this directory are generated by the discovery process used with the Oracle Application Management Pack for Oracle Utilities.

⁵ The **updates** directory only exists after at least one patch has been installed. If the directory does not exist then no patches have been installed on this environment.

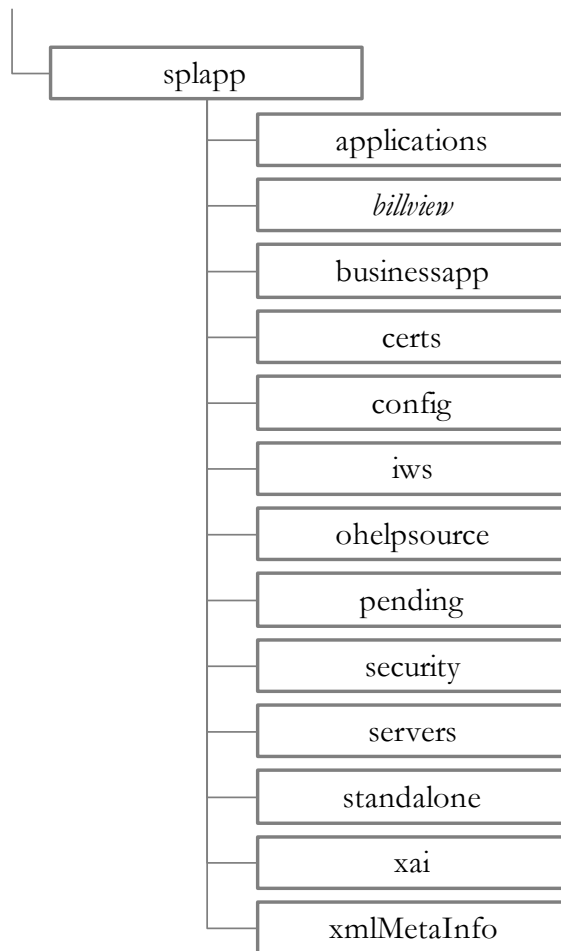

Figure 6 – Software directory structure

Directory	Contents
applications	Location of the Web application product files
billView	Location of the online bill viewing files (Products supporting bill view only)
businessapp	Location of the business application product files
certs	Location of security certificates
config	Location of temporary configuration files.
iws	Location of Native Web Services
ohelpsource	Oracle Help engine source location
pending	Internal use only
security	Default location of domain security initialization files (Embedded Oracle WebLogic installations only)
servers	Default location of copies of configuration and associated files (Embedded Oracle WebLogic installations only)
standalone	Location of common Java libraries and the batch component of the product.

Directory	Contents
xai	Location of the Web services adapter configuration and Incoming service schemas
xml MetaInfo	Location of the service definitions for the product.

Warning: Under no circumstances should files be manually altered in these directories unless instructed by Oracle Support. The Oracle Utilities SDK will deposit files in the relevant locations in this structure using the Packaging component of the SDK or using the Development tools directly.

Tools directory

Note: In past releases the utilities to install patches were included in each patch. This is not the case anymore as they are centralized as part of the installation.

Note: These utilities are not usually executed manually but are part of general installations and automation from Application Management Pack for Oracle Utilities

The tools directory is used for deployment and patching tools used by Application Management Pack for Oracle Utilities and the internal patching utilities. The directories are in the following structure:

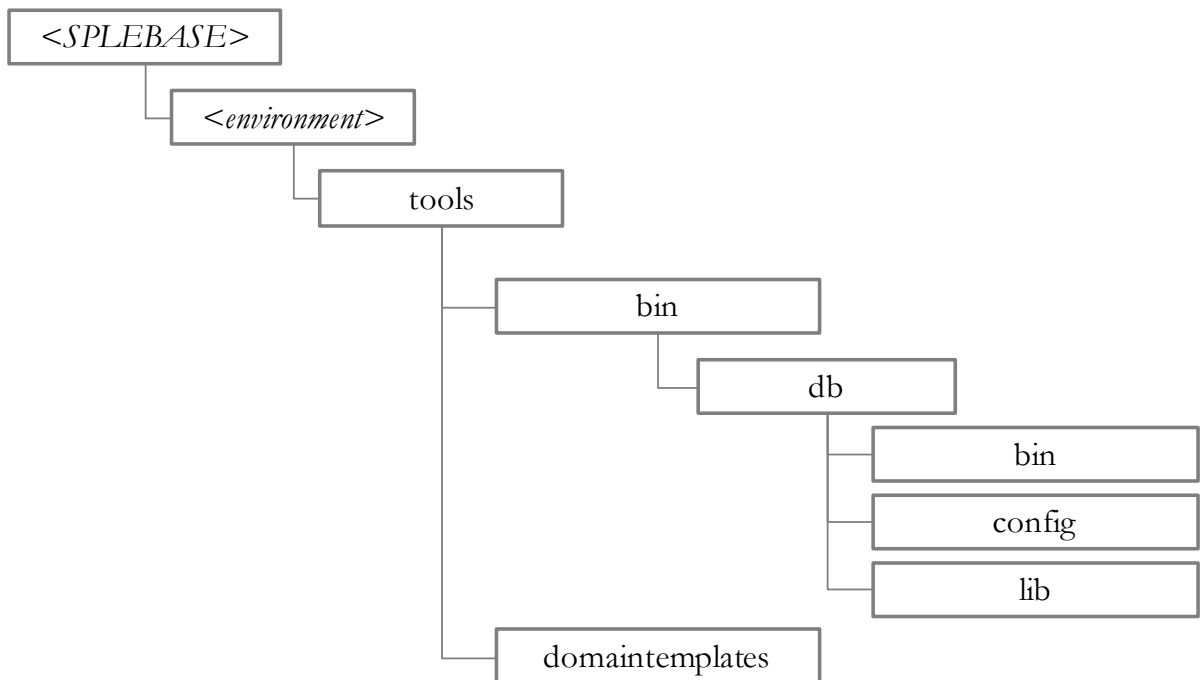

Figure 7 – Tools directory structure

Directory	Contents
bin	General Software patching utilities
bin/db	Database Patching utilities
bin/db/bin	Binaries for patching
bin/db/config	Logging configuration for patching utilities
bin/db/lib	Java Libraries for patching utilities

Directory	Contents
domaintemplates	Oracle WebLogic Domain Templates for product

Directory Permissions

Note: This facility only applies to Linux and Unix platforms only.

The directories within the product are controlled by the operating system security relating to the administration user assigned to the product. The table below outlines the permissions under the **\$SPLEBASE** location:

Directory/files	Owner	Group	Other
etc	rw	r	
Individual files	rw	r	
logs	rw	r	
logs/system	rw	rw	
Oracle WebLogic Configuration Files	rwX	rw	
Oracle WebLogic shell scripts (.sh)	rwX	rx	
product	rwX	rx	
product/apache-ant/bin/ant	rwX	rx	rx
runtime	rwX	r	
scripts, tools, updates	rwX	rx	
Shell scripts (.sh) in bin	rwX	rx	
osbapp, soaapp, splapp	rwX	rx	
structures	rwX	rx	
templates	rwX	rx	
tmp	rwX	rx	

Legend: r = Read Only, rw = Read Write, rwX = Read Write Execute, rx – Read/Execute, blank = no permissions.

These permissions are set by the **setpermissions.sh** utility which is executed as outlined in the Installation Guide.

Output Structure

The product processes (batch and online) that produce output and logs place information in this directory structure. The environment directories are referenced by the environment variable **\$SPOUTPUT**. By default, this directory is created as **/spl/splapp**, though this can be substituted for an alternative during the installation process. The figure below illustrates the typical directory structure for this location (where *<environment>* is the environment name chosen during the installation process):

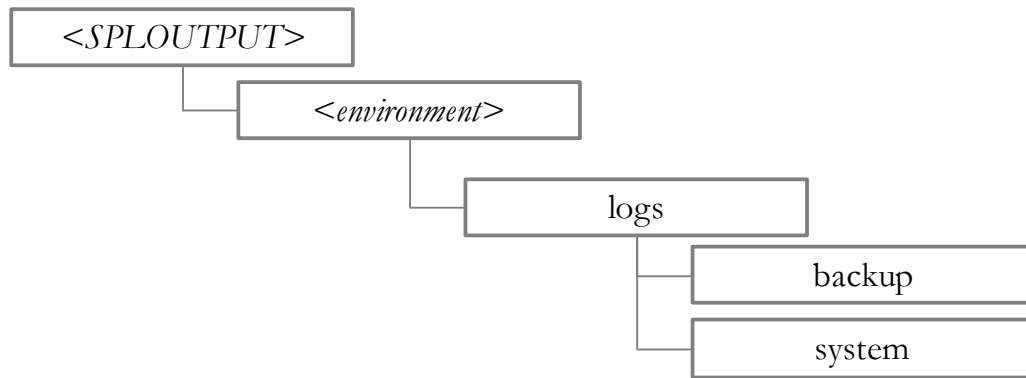

Figure 8 – Output directory structure

Directory	Contents
logs/system	Directory containing application logs files. This is independent of Web application server, Business Application Server and Database Server log files.
logs/backup	Default location of backup of logs if SPLBCKLOGDIR is set.

The implementation may add subdirectories as their site standards and implementation dictates.

Environment Variables

The product uses a number of environment variables to determine where information is stored and to be placed for its internal operations. Becoming familiar with these variables will assist you in finding information quickly and efficiently.

Note. If a custom script is written to access or write information to the product functionality, it is highly recommended that the following variables be referenced in your scripts. This is to maximize the chance that your script will remain functional across upgrades.

The following table outlines some of the key environment variables:

Variable	Usage
ADF_HOME	Location of the Oracle ADF files
ANT_ADDITIONAL_OPT	Options for <i>ant</i> as per the configuration settings at installation time
ANT_HOME	Location of <i>ant</i> build utilities
ANT_OPTS	Options for <i>ant</i> for Oracle SDK
ANT_OPT_MAX	Maximum memory settings for <i>ant</i> as per the configuration settings at installation time
ANT_OPT_MIN	Minimum memory settings for <i>ant</i> as per the configuration settings at installation time
CMPDB	Database Type (ORACLE)
DBNAME	Database Name

Variable	Usage
ENVFILE	Location and name of environment configuration file
HIBERNATE_JAR_DIR	Location of Hibernate Java library
HOSTNAME	Name of host (fully qualified)
JAVA_HOME	Location of JDK
LD_LIBRARY_PATH	Library Path
NLS_DATE_FORMAT	Oracle NLS Date Format
NLS_LANG	Oracle NLS Language string
NLS_SORT	Oracle NLS Sorting
ONLINEBLLINI	Location of document rendering software template building configuration files
ONLINEDOCINI	Location of document rendering software configuration files
OPSYS	Operating System Name
OPSYSINFO/OPSYSVER	Operating System Version
ORACLE_CLIENT_HOME	Location of the Oracle Client software (used for location of perl). If full Oracle Database software is installed on the host this value will match ORACLE_HOME .
ORACLE_HOME	Location of the DBMS software
OSTYPE	Operating System Type
PERL5LIB/PERLIB	Location of Perl Libraries
PERL_HOME	Location of Perl
SERVER_ROLES	Roles enable for this server
SERVER_ROLE_BATCH	Whether the batch server is included
SERVER_ROLE_INTEGRATION	Whether the integration server is included
SERVER_ROLE_ONLINE	Whether the online server is included
SPLADMIN	Administration user ID
SPLADMINGROUP	Administration group
SPLApp	Name of root Web application WAR file.
SPLAPP	See SPLOUTPUT
SPLBACKLOGDIR	Location of backups of online log files (must be set manually).

Variable	Usage
SPLEBASE	Location of software for environment
SPLENVI RON	Name of environment
SPLOUTPUT	Location of output for environment
SPLRUN	Location of runtime for environment
SPLSDKROOT	Location of SDK (Development environment only)
SPLSYSTEMLOGS	Location of product specific logs
SPLVERSI ON	Version identifier of product (prefixed with V)
SPLVERSI ON_NUM	Version number of product
SPLWAS	Web application Server type
WEB_DEPLOY_EAR	Determines whether the installation is native or embedded (true).
WEB_I SEXPANDED	Whether Web application is expanded or not (not = WAR/EAR files)
WEB_SERVER_HOME	Location of Web Application Server software
WL_HOME	Location of Oracle WebLogic installation (WebLogic supported platforms only)
XAI App	Name of the XAI Application WAR file

Note: If a custom script is written to access or write information to the product functionality, it is highly recommended that the following variables be referenced in your scripts. This is to maximize the chance that your script will remain functional across upgrades.

*Note: **HIBERNATE_JAR_DIR** is used for the installation process only. After installation is complete the jar files located at the locations specified by these environment variables are copied to the correct locations for execution.*

Note: Additional variable may be created by various operating system and product utilities. The list above consistutes the non-temporary variables.

Common Application Logs

When the product is operating the infrastructure logs messages within its own logs. For example, the database will log database errors or messages to the database logs, the JEE Web application server will log Web Application errors or messages to the JEE Web application server logs and so on. The name and location of these logs is set by relevant vendors of those logs. Refer to the documentation provided with that software on where logs are stored and their logging conventions.

The product additionally writes a number of application specific logs to **SSPLSYSTEMLOGS** (or **%SPLSYSTEMLOGS%** on Windows):

- **spl_web.log** - Web application server application messages .
- **spl_service.log** – Business Application Server messages. If the Business

Application Server exists on the same JEE Web Application Server instance (i.e. as per a *local install*) as the Web application server for an environment then this log does not exist and all messages are written to the **spl_web.log**.

- **spl_i ws. l og/spl _xai . l og** – Web Services Adapter messages.
- Background processing logs are located in **\$\$SPLOUTPUT** (or **%SPLOUTPUT%** on Windows) for the following:
 - **threadpool worker. <threadpool>. <datetime>. l og** - The threadpoolworker log for threadpool **<threadpool>** started at **<datetime>**.
 - **<batch_cd>. <datetime>. THD<thread>. stderr/<batch_cd>. <datetime>. THD<thread>. stdout** - The submitter log for thread **<thread>** of background process **<batch_cd>** started at **<datetime>**.

The format of all logs is as follows:

Field	Comments
<userid>	User ID of transaction (blank or "-" for system generated messages)
<pid>	Process identifier (optional)
<time>	Time of transaction in format HH:MM:SS,SSS
[<transaction>]	Transaction/Class identifier
<type>	Type of message
(<class>)	Java class generating message (see Javadocs in appViewer)
<message>	<message contents>

Sample log entries:

```
19: 03: 16, 390 [mai n] INFO (support. context. CacheManager) Registering cache
'MenuRepository'
- 19: 02: 37, 812 [mai n] INFO (support. context. ContextFactory) 461 services
registered, time 11. 742 ms
- 19: 03: 29, 140 [Remote JVM: 2 Thread 1] WARN (cobol. mem. CobolModeHelper)
Unspecified or unrecognized COBMODE (null) - inspecting JVM properties to
determine bit mode ...
19: 03: 40, 875 [Thread- 24] ERROR (web. dynami cui. MetaDataHolder) Unable to
find UI xml file '/an/generated/todoSummaryListGrid. xml' for program
'toDoSummaryListGrid'
DEMO - 259992- 101- 1 19: 17: 38, 750 [http- 6500- 5] INFO
(support. context. CacheManager) Registering cache 'Ui MapInfoCache'
```

Automated Backup of Log files

Note: This facility is only supported using the embedded mode of Oracle WebLogic. If native mode is used then Oracle WebLogic log management is used.

Note: Additional log management maybe specified in the [log4j](#) configuration files for individual components.

Note: Logs associated with background processes are not backed up using this technique.

When the product is started with the [spl](#) command and if the **SPLBCKLOGDIR** environment is set then the logs are backed up to the location specified in the **SPLBCKLOGDIR**

environment variable. If this variable is not set then the logs are removed prior to the start of the product.

The logs are backed up with the following pattern:

\$SPLBCKLOGDIR/<date>. <SPLENVIRON>. <logfile> (Linux/UNIX)

or

%SPLBCKLOGDIR%\<date>. <SPLENVIRON>. <logfile> (Windows)

where

<date> The date and time of the backup in the format YYYYMMDD.HHMM

<SPLENVIRON> The environment name

<logfile> The name of the original file that is backed up.

Batch Concepts **BATCH**

*Note: The **DISTRIBUTED** mode supported in previous versions of the product has been removed in this release. Customers using this mode should migrate to **CLUSTERED** mode using either a single server configuration (**ss**) or unicast configuration (**wka**) using [bedit](#).*

The batch component of the architecture has a number of key concepts to understand.

Batch Clustering Concepts

As mentioned in the previous section, Oracle Coherence is used internally to cluster the resources needed for the batch architecture. This is similar in concept to a cluster used by the JEE Web Application Server for online and web services.

- A cluster is one or more hosts that can execute batch processes. A cluster is named to delineate it from other clusters in your network. Oracle Coherence Named Caches are used to implement the cluster.
- Members of a cluster are hosts, threadpools and submitters. Each member is tracked by the cluster for high availability. At least one member must be active for a cluster to operate.
- Intracluster communication between members of the cluster can be achieved using uni-cast (also known as Well Known Addresses) or multi-cast.
 - In uni-cast implementations, each host and associated port is defined in the cluster. Each cluster member has definitions of other members. This mode is a less dynamic configuration⁶ but optimizes host to host communications for large clusters⁷.
 - In multi-cast (*default*) implementations, a multi-cast address and port are defined across the cluster which members attach to when executing. This mode is dynamic but traffic across nodes can be excessive for large clusters.

⁶ As each member must have its own configuration. To add or remove members requires manual synchronization of configuration files.

⁷ Large clusters are a large number of hosts, large number of threadpools and/or large number of threads executing at the same time.

- A threadpool is a Java Virtual Machine (JVM) that executes batch threads. It is a long running JVM that batch threads are submitted to. Threadpools are named to group resources across a cluster when using multiple instances of a threadpool.
- A threadpool has a configurable maximum capacity for running batch threads to prevent overloading of JVM's⁸. Running multiple instances of a threadpool (within or across hosts) can increase the limit and implement high availability.
- Clusters can support dedicated cache threadpools. In a cluster, each member can potentially communicate to each other member. In a large network this can cause network overheads that can adversely affect performance. To minimize the impact of network traffic, it is possible to configure a cache threadpool that will act as a central co-ordinator in the cluster to optimize and channel intramember communication.
- Clusters can support administration threadpools. In a cluster, it is possible to check on the status, in real time using JMX, across the cluster by connecting to any node in the cluster. It is possible to setup an administration node that can act as a single point of contact across the cluster to monitor performance, in a similar vein as the administration server in the JEE architecture. These administration threadpools can be used by command line utilities, jconsole, Oracle Enterprise Manager via Application Management Pack for Oracle Utilities and/or Coherence Management Pack.
- Submitters are instances of individual background processes or individual threads of background processes that are submitted to a named threadpool. The submitter waits for the thread or background process to complete or abort and reports the status of the thread or background process to the operating system. This latter facility is used by Batch Scheduling tools to determine the status of the background process.
- Submitter can be targeted to specific instances of a threadpool or submitted to the cluster of threadpools. Submitters can execute specific threads or all threads in a single execution.

Batch Controls

Note: The system is delivered with all necessary batch controls for the supplied base background processes.

Background processes within the product must be defined using meta data (as well as physical code) to execute the process in the architecture. Refer to the online help and user documentation for details of the attributes associated with a batch control.

Standard parameters

To standardize all the background processes, the product uses a number of common standard parameters to uniformly provide functionality across all processes. The table below lists all the standard parameters:

Parameter	Usage
Batch code	Code is the unique identifier of the background process

⁸ Threads in background processing are typically heavier in terms of resource usage than typical java threads hence lower thread limits.

Parameter	Usage
Batch thread number	Thread number is only used for background processes that can be run in multiple parallel threads. It contains the relative thread number of the process. For example, if the billing process has been set up to run in 20 parallel threads, each of the 20 instances receives its relative thread number (1 through 20).
Batch thread count	Thread count is only used for background processes that can be run in multiple parallel threads. It contains the total number of parallel threads that have been scheduled. For example, if the billing process has been set up to run in 20 parallel threads, each of the 20 instances receives a thread count of 20.
Batch rerun number	Rerun number is only used for background processes that download information that belongs to given run number. It should only be supplied if you need to download an historical run (rather than the latest run).
Batch business date	Business date is only used for background processes that use the current date in their processing. For example, billing using the business date to determine which bill cycles should be downloaded. If this parameter is left blank, the system date is used.
Commit Interval	Override maximum records between commits. This parameter represents the number of transactions that are committed in each unit of work. This parameter is optional and overrides the background process's Standard Commit between records (each background process's Standard Commit between records is documented in the product documentation). You would reduce these values, for example, if you were submitting a batch process during the day and you wanted more frequent commits to release held resources. You might want to increase these values when a background process is executed at night (or weekends) and you have a lot of memory on your servers.
Application Service	This is the application service that is associated to the batch. All the users who are allowed in the application service which is associated with particular batch control will be allowed to submit the batch job.
Language	This is the language code used to retrieve messages and format output from background processes.
Traces	Trace program at start (Y/N), trace program exit (Y/N), trace SQL (Y/N) and trace output. <ul style="list-style-type: none"> If trace program start is set to Y, a message is displayed whenever a program is started.

Parameter	Usage
	<ul style="list-style-type: none"> • If trace program at exit is set to Y, a message is displayed whenever a program is exited. • If trace SQL is set to Y, a message is displayed whenever an SQL statement is executed. • If trace out is set to Y, message are output from the program at execution points.
<p><i>Note: This facility should only be used in development.</i></p>	

Additional Key Parameters

In all batch controls there are two additional parameters that may not be specified in the batch control definition but are available for use within each job:

- **MAX-ERRORS** (**maxErrors**) - This is the error tolerance for the job. When the number of errored records in a thread for a job has been exceeded that thread is stopped with an appropriate error code. This setting is to prevent large amounts of errors to influence the state of the job.
- **DI ST- THD- POOL** (**threadPool**) - This allows a particular pool to be specified for the execution of the job. This is primarily used with online submission.
- **email Mode** - Defines the status for which an email notification⁹ is sent when a job ends. This does not apply to individual threads but when all threads are complete. Valid Values are:
 - **ERROR** - Send an email when at least one thread ends in error status.
 - **SUCCESS** - Send an email when all threads end successfully.
 - **ALL** (Default) - Always sends an email when all threads end regardless of status.
- **overri deLowI dVal ue** - Specifies a new low id to use in calculating the range for a thread. The product by default assumes that the Id is between 0's (e.g. 000000000) and 9's (e.g. 999999999), but this parameter will override the low value. The product calculates each thread's low and high id by slicing the job's range into chunks using the thread number and count. It is typically more appropriate for sequentially allocated Ids to evenly distribute work among threads. The parameter value can be an actual number or it can be set to *auto*. If the parameter is set to *auto*, then the value is set to the lowest current value on the associated database table. The table name is determined from the batch program's query iterator
- **overri deHi ghI dVal ue** - Specifies a new high id to use in calculating the range for a thread. The product, by default, assumes that the Id is between 0's (e.g. 000000000) and 9's (e.g. 999999999), but this parameter will override the high id. The product calculates each thread's low and high id by slicing the job's range into chunks using the thread number and count. It is typically more appropriate for sequentially allocated Ids to evenly distribute work among threads. The parameter value can be

⁹ This is used for online submission when an email address is provided on the job submission and the email server is configured.

an actual number or it can be set to *auto*. If the parameter is set to *auto*, then the value is set to the highest current value on the associated database table. The table name is determined from the batch program's query iterator.

- **idRangeOverrideClass** - Provides for a custom class to do thread range calculation. The class name specified must implement interface **com.splwg.base.api.batch.BatchIdRangeOverride**. During batch execution, this override class will be instantiated and the setter methods called to initialize the Ids as required. The low and high getter methods will be called to retrieve the high and low ids to be used for the run
- **numRecordsToFlush** - Defines how frequently to flush the Hibernate cache to prevent high heap consumption and **OutOfMemoryErrors**. In **SingleTransactionStrategy** there are no commits throughout the run, so this parameter can be used to flush the Hibernate cache periodically. This parameter is only applicable to jobs that use **SingleTransactionStrategy**.

*Note: The parameters **overrideLowIdValue** and **overrideHighIdValue** are only applicable to jobs that use **ThreadIteratorStrategy**.*

These parameters may be added to the Batch Control or properties files used for running the job.

Batch Run Tree

Within the product browser interface there is an ability to monitor the status and outcomes of individual processes. This can be useful for finding out what actually occurred if an error condition occurred. Refer to the online help for more information about this facility.

The Batch Run tree is available to any valid user and is a method to communicate the execution information to the relevant business representatives.

Timed Jobs

Note: Monitor processes are ideal for Timed Jobs.

By default, background processes start and finish when they have processed the records it has selected at the start of execution. In this case, to process more records it is necessary to run the batch process again.

In some business processes, it may be necessary to continually execute a job to process work that is ready at any time. For example, processing payments, meter reads, asset changes or tasks as they appear. This situation is handled as a *Timed Job*. This Batch Control type is configured with a *Timer Interval* (the desired runtime between executions in seconds) and a *Timer Active* flag (to enable and disable the job activity).

When the *Timer Active* flag is set to **true**, the product executes the job for the duration of the *Timer Interval* before executing another instance of the job. This allows the job to run continuously over time, whilst the *Timer Active* flag is set to **true**.

Each instance of the job will start and stop using the following rules:

- The job will only execute when the Timer Active Flag is set to **true**. To the next execution from starting this value should set to **false**.
- The job will execute using the parameters on the Batch Control including the

dedicated parameters for Timed Jobs such as *UserID*, *Batch Language* and *Email Address*.

- Once the Timer Interval has been reached, the job will commit after the latest transaction is complete and update the Batch Control is complete or errored (as appropriate).
- The next instance of the process is repeated as above.

Note: Due to varying transaction workloads the time taken may exceed the Timer Interval. This situation can be tracked using Level of Service if desired.

Level Of Service

Note: For backward compatibility purposes, Level of Service is in the disabled state and requires configuration of targets in the Level Of Service algorithm.

One of the features of the background processing architecture is that all executions of a Batch Control are tracked internally. This is typically expressed in the *Batch Run Tree* for information purposes but can also be used to calculate an indicator of the level of service if desired using the *Batch Control - Level Of Service* algorithm.

Algorithms of this type return one of three levels of service:

- **Disabled** - Batch level of service algorithm is not enabled for the batch control or no data is available for comparison¹⁰.
- **Error** - Indicates that errors were detected. In this case a message is also returned to indicate the issue.
- **Normal** - Indicated when there were no errors or issues detected by the algorithm.

Note: It is possible to write custom Level Of Service algorithms to compare any appropriate business metric.

Explanation of Commit Interval

The Commit interval parameter is a tuneable parameter to affect the impact of the background processes on the other processes running and prevent internal database errors. In most cases using the defaults will satisfy your site requirements. It is also important to understand their impact to ascertain whether any change is required.

During processing of any background process a main *object* is used to drive the process. Each process tables one or more objects to process. For example, billing processes accounts, meter reading processes meter reads or meter events, asset Processing uses assets, workforce processing uses tasks etc. For other processes it is other *objects* that are considered the main object. This status of the object or status of related transaction data is used to determine when a transaction is complete.

For the Commit interval this concept is important as:

- When a certain number of main objects have been processed then a database commit is issued to the database. This number is the expressed in the *Commit Interval*. The larger the commit interval the larger the amount of work that the database has to keep track of

¹⁰ This can occur for the initial execution only.

between commit points.

Note: The number of records in progress utilizes redo log space so the size of the redo logs in the database and commit interval must be compatible. The higher the commit interval the more redo log space is required.

- At any time in a process a commit for objects processed may be caused by the reaching the Commit Interval or the end of the job, whichever comes first.

Explanation of Thread Limit and Thread Number

Note: Optimization discussions for these parameters are covered in the [Batch Best Practices](#) (Doc Id: [836362.1](#)) available from [My Oracle Support](#).

One of the features of the Oracle Utilities Application Framework is the ability to run background processes using multiple threads.

The threading concept in the product is simple. Each thread takes a predetermined slice of the data to work on. The last thread checks if all other threads are finished and updates the status of the batch control records. For example, if you have 10 threads, then each thread takes 1/10th of the work. As each thread is executing it processes its workload and then completes, the last thread executing is responsible for updating the overall process status to indicate completion.

Implementing threading means you have to execute a number of background processes with an ascending thread number up to the thread limit. For example, if you have a background process with 10 threads, you must run 10 background processes each with a unique thread number between 1 and 10 to complete the background process. Threads can be located on the same machine or different machines. For example, you can run threads 1 to 5 on one machine and threads 6 – 10 on another.

Note: If there is limited data skew in the data then the threads should finish around the same time. If there is some data skew then some threads may finish later than others.

To implement multi-threading when you submit a process:

- Specify a thread limit greater than 1 as a parameter.
- Execute a background process for every thread with a sequential thread number up to an including the thread limit. There are a couple of implementation guidelines with threading:
 - Make sure the number of threads is not excessive. You do not want to flood the CPU's.
 - You must submit a process per thread. In some submission methods this is done automatically and in some it is done manually.
 - Threading will increase throughout BUT it will cause higher than usual resource usage (CPU, Disk etc) as well as higher contention. Excessive threading can in fact cause performance degradation in online as well as background processing. Therefore the number of threads should not be excessive.

Almost all background processes within the product support multiple threads (typically the only background processes that are single streamed are extracts and data loads as they involve reading and writing files).

Explanation of Restart and Rerun

The product allows all background processes to be restarted or rerun as required. During the execution of the background process, restart information per thread is stored within framework, like a *checkpoint*. This checkpoint is performed at the last commit point as dictated by the Commit Interval and/or Timeout value (Time out only applied to Oracle implementations only). When a *commit* is performed, the last commit point is recorded for the execution. If a thread of a background process fails, the database automatically rolls back to the last commit point. The thread can then be restarted from that point automatically or from the start of the data. To indicate the restart, the thread is executed with the same parameters as the original.

Additionally, processes are *re-runnable*. A background process is *re-run able* when you can specify a specific run number to be re-run as required or specify a specific business date to reprocess. Using a rerun number or a previously used business date are all that is required to rerun a process.

Note: Not all background processes use Run number as a run indicator. Refer to the online documentation for which batch processes are re-runnable.

Submission Methods

There are a number of methods for submission supported by the product.

- [Online Submission](#) - This allows testing users to submit batch jobs from the online component. This facility is typically used for non-production environments.

Note: Oracle strongly recommends that online submission is not used for Production environments.

- [Command Line Submission](#) - A number of commands are available to start/stop threadpools and jobs from the command line or from a third party scheduler.

Online Submission

One of the most important useful testing/demonstration facilities of the product is the ability to submit batch processes from the online component of the product. An authorized user can submit any batch process using an online batch submission page.

The on-line batch submission page enables you to request a specific background process to be run. Refer to the online help for a discussion on how to use the online submission function. When submitting a background process on-line, you may override standard system parameters and you may be required to supply additional parameters for your specific background process. After submitting your background process, you may use this page to review the status of the submission.

Basically the following process is used to submit background processes using the online submission method:

- The process to be executed is registered online as to be submitted (or queued). This marks the process execution as *Pending*. When you request a batch process to be submitted from on-line, the execution of the desired background process will result in the creation of a batch run. Just as with background processes executed through your

scheduler, you may use the Batch Run Tree page to view the status of the run, the status of each thread, the run-instances of each thread, and any messages that might have occurred during the run.

Note: Your online submission record is assigned a status value so that you may know whether your batch process has been submitted and whether or not it has ended; however, it will not contain any information about the results of the background process itself. You must navigate to the Batch Run Tree page to view this detail.

- A background process is scheduled using the submission daemon that will pickup any *Pending* background process executions and execute them. When you save a record on the batch process submission page, the batch process does not get submitted automatically. Rather, it saves a record in the batch process table. A special background process will periodically check this table for pending records and will execute the batch process. This background process will update the status of the batch process submission record so that a user can determine when their batch process is complete.

Note: At installation time, your system administrator will set up this special background process or configure the scheduler daemon to periodically check for pending records in the batch process submission table. Your administrator will define how often the system will look for pending records in this table.

It should be noted that this special background process only submits one pending batch process submission record at a time. It submits a batch process and waits for it to end before submitting the next pending batch process.

Note: If you request a batch process to be run multi-threaded, the special background process will submit the batch process as requested. It will wait for all threads to complete before marking the batch process submission record as ended.

During execution the status of the execution in the batch run tree is updated as well as the original submission screen. If you wish the system to inform you when the background process completes, you may supply your email address. The email you receive will contain details related to the batch process's output; similar to the batch process results you would see from the batch run tree.

Note: This assumes that during the installation process, your system administrator configured the system to enable email notification. Your administrator may also override the amount of detail included in the email notification.

To use this facility the following must be enabled:

- The online submission daemon and DEFAULT threadpoolworker is configured using the following parameters:
 - The **BATCHENABLED** setting must be set to true.
 - The **BATCHDAEMON** setting must be set to true.
 - The **BATCHTHREADS** setting must be greater than zero.

*Note: The default setting for **BATCHTHREADS** is 5 threads. This setting should only be altered if large numbers of testers need to use the DEFAULT threadpoolworker at the same time.*

- An external **DEFAULT** threadpool and daemon is started using the **-d Y** option on

the [threadpool worker](#) or [starttpw.sh](#) command. For example:
`threadpool worker.sh -p DEFAULT=5 -d Y`

Command Line Submission

At a site implementing the product, the batch processes to be executed to support the business as well as perform expected maintenance on the system needs to be scheduled, managed and executed from a central point. In most sites, this is done by using a third party batch process scheduler that controls the scheduling and execution of any batch processes across a site.

To support the use of such a scheduler with any Oracle Utilities Application Framework based product(s) a number of scripts and related configuration files have been provided to allow the scheduler to execute the process batch processes.

The scripts and configuration files allows for three fundamental facilities that can be used by external scheduling tools:

- The interface is command line based (*it can also be invoked using a java based API see the product javadocs within AppViewer for a description of the interface*) which most external scheduling tools support.
- The command based utilities return a standard return code to indicate the batch process has been successful or has been unsuccessful. Actions dependent on return code within the scheduler can then be configured.
- The logs within the utilities provided are in a common format that can be interrogated by the external scheduler to provide finer grained actions (*especially for unsuccessful executions*).

For additional advice about interfacing external schedulers with the product refer to the [Batch Best Practices](#) (Doc Id: [836362.1](#)) whitepaper on [My Oracle Support](#).

The following guidelines apply:

- Any command should execute [splenvi ron](#) prior to execution.
- Threadpoolworkers should be started prior to running any batch job threads using the [threadpool worker](#) or [starttpw.sh](#) command in the scheduler.
- Batch Job threads should be submitted using the [submi tjob](#) command.
- If threadpoolworkers need to be shutdown the [jmxbatchcli ent -k](#) command should be used.

Operations

There are a number of common operations that a site will perform on the product. This section outlines the steps involved in these common operations.

Note: This section only applies to the embedded mode installation of the product. Customers using native mode installations should start and stop servers via the Oracle WebLogic console, WLST or Oracle Enterprise Manager.

Command Line Utilities

The product includes several command scripts to aid with its configuration and operation. This section provides information about these utilities.

bedit - Batch Edit **BATCH**

Note: The [splenvi ron\[. sh\]](#) utility must be executed before this utility can be used. See [splenvi ron. sh](#) for details.

Note: This facility is only available if "Enable Batch Edit" is set to true in the installation.

To simplify the configuration of batch a new administration facility has been introduced. The **bedit[. sh]** is provided to guide the administrator through the cluster, threadpool and submitter configuration process using templates.

Command Usage:

Linux/Unix:

```
bedit.sh [-h] [[-g] [-t arg] [-b arg|-e arg|-l arg|-c|-s|-w] [file]] | [-A]
```

Windows:

```
bedit [-h] [[-g] [-t arg] [-b arg|-e arg|-l arg|-c|-s|-w] [file]] | [-A]
```

Where:

- h** Show command usage
- h** Show extended help
- g** Generate configuration from the template and exit immediately. The configuration file name may be specified explicitly or implicitly as described under Mutually Exclusive Arguments below.
- t arg** Template to use. Examples: **wka** for Well-Known-Addresses; **mc** for Multicast; **ss** for Single Server. This is optional. The default is determined from **be. prefs**, **be. properties** or **be. default. properties**, in that order

Mutually Exclusive Arguments:

- b arg** Configure batch code specific properties files. Maintains **job. <arg>. properties** files.
- e arg** Configure general submitter mode properties files. Supports **THIN** and **LOCAL** execution mode. Maintains **submitbatch. <arg>. properties**

files.

- l arg** Configure threadpool label specific properties files. Maintains **threadpool worker. <arg>. properti es** files.
 - c** Configure the cluster configuration. Shortcut name for **tangosol-coherence-overri de. xml**
 - s** Configure the base submitter configuration. Shortcut name for **submi tbatch. properti es**.
 - w** Configure the base threadpoolworker configuration. Shortcut name for **threadpool worker. properti es**.
- file** The properties file to edit. This must be a valid batch properties or Coherence XML configuration override file. May be used instead of the shortcut forms above and must be the last argument if specified.

Exclusive Argument:

- A** Generate ALL the base configuration files and exit. Combines **-c**, **-w** and **-s** option. Option **-A** must be the only option if specified.

Examples:

```
bedi t threadpool worker. properti es
bedi t -t wka -c
bedi t -c -l cache
```

*Note: For more information about **bedi t[. sh]** refer to the [Configuring Batch using bedit](#) section of this guide.*

buildJavadocsIndex[.sh] - Builds Appviewer java docs

*Note: The **spl envi ron[. sh]** utility must be executed before this utility can be used. See [spl envi ron. sh](#) for details.*

Note: This utility is only used for development environments where javadocs must be generated for other developers to use and appViewer is installed and deployed.

Note: This utility only works on custom java classes where source is provided with the customization installation and after the customizations have been installed.

The build AppViewer javadocs utility, **buil dJavadocsI ndex**, creates the javadocs for any custom java code for use for development. The utility does the following:

- After the custom java code has been installed using the SDK utilities, the utility generates the javadoc using the associated JDK.
- The utility optionally adds the generated to the javadoc to the product javadoc already installed in appViewer.
- Optionally regenerates the SPLWeb EAR file to update the appViewer.
- If running in embedded mode, the server needs to be restarted to reflect the change. If running in native mode the EAR file deployment needs to be updated.

Command Usage:

Linux/Unix:

buildJavadocsIndex.sh [-h] [-n]

Windows:

buildJavadocsIndex.cmd [-h] [-n]

Where:

- blank** Generate javadocs and update SPLWeb EAR file
- h** Show usage.
- n** Generate javadocs but skip EAR update.

configureEnv – Setup Environment settings

Note: The [splenviron\[.sh\]](#) utility must be executed before this utility can be used. See [splenviron.sh](#) for details.

Note: This utility can be used by both embedded and native mode customers. In native mode, some settings need to be specific values to support the native mode. Refer to the Installation Guide for further instructions on the use for the different modes.

The **configureEnv[.sh]** utility is an interactive method for configuring an environment on the system stored in the **etc/ENVIRON.INI**. This configuration script sets up important parameters used by other scripts within the system. Normally this script is executed without parameters and the current environment (i.e., the environment that you are currently attached to) is configured.

Command Usage:

Linux/Unix:

configureEnv.sh ([-a] | [-g]) [-i] [-h]

Windows:

configureEnv.cmd ([-a] | [-g]) ([-c] | [-i]) [-h]

Where:

- blank** Configure basic configuration options
- a** Configure advanced configuration options
- c** Calculate variables only via silent mode. This refreshes ENVIRON.INI from individual changes
- g** Configure all configuration options (basic and advanced).
- h** Show usage.
- i** Configure Installation options (used for initial installation)

Refer to [ENVIRON.INI](#) for more information on the output of this command.

*Note: If an unauthorized user attempts to execute this command the following error message – "**Can't open /configure.log for output**" is output.*

createDBStandalone[.sh] - Creates Database Patches

Note: The [splenviron\[.sh\]](#) utility must be executed before this utility can be used. See [splenviron.sh](#) for details.

Note: This utility is used for patching only. Refer to the patch documentation for more information.

The **createDBStandalone[.sh]** utility, assembles all the needed components to allow database patches to be applied from a remote server. This utility creates the jar file named **db_patch_standalone.jar** containing the following:

- Relevant files in the **bin** directory needed for the patch.
- Relevant libraries needed for the patch.
- Relevant configuration files needed for the patch.

Command Usage:

Linux/Unix:

```
createDBStandalone.sh [-h] [-l <location>]
```

Windows:

```
createDBStandalone.cmd [-h] [-l <location>]
```

Where:

- | | |
|----------------------------|--|
| blank | Performs complete extraction in default location SPLEBASE/tools/dbstandalone . |
| -h | Show usage. |
| -l <location> | Outputs jar file to the location <location> . If you do not specify a location then it will default to the <i>blank</i> action. |

extractCMSourceUNIX[.sh] - Migrate Code Across Upgrades

Note: The [splenviron\[.sh\]](#) utility must be executed before this utility can be used. See [splenviron.sh](#) for details.

Note: This utility is only used for extracting development source from one environment to another. This is used for initial migration from Oracle Utilities Application Framework V2.x to Oracle Utilities Application Framework V4.x

Note: This utility only works on custom java classes where source is provided with the customization installation and after the customizations have been installed.

Note: This utility is only provided on Linux/UNIX platforms.

When migrating from Oracle Utilities Application Framework Version 2.x to Oracle Utilities Application Framework Version 4.x, this utility extracts the source that was retained in the upgrade and reorganizes it to conform to the newer structures used in Oracle Utilities Application Framework Version 4.x. This is used as an initial load only and does not need to be executed again once the reorganization is complete.

The utility does the following:

- Existing code customizations are extracted to a central location.
- The code customization are reorganized into the Oracle Utilities Application Framework Version 4.x format.

The **applyCM** utility provided with the Oracle Utilities SDK can then be used to install the customizations on an initial environment as outlined in the [Software Configuration Management Series](#) (Doc Id: [560401.1](#)) available from [My Oracle Support](#).

Command Usage:

Linux/Unix:

```
extractCMSSourceUNIX.sh -v version -t target [-e ] [-l lang] [-h]
```

Where:

- h** Show usage.
- v *version*** Version identifier for custom build. This is the build number that is used for **CMVERSION.TXT**. This parameter is required.
- t *target*** Directory location for files to be housed. **applyCM** will be run against this location in future steps. This parameter is required.
- e** Include any custom AppViewer and/or Help content. This parameter is optional.
- l *lang*** Specific language code to extract for Help content. If blank, all languages are extracted. This parameter is optional.

genappvieweritems – generate AppViewer

*Note: The **splenvi ron[.sh]** utility must be executed before this utility can be used. See [splenvi ron.sh](#) for details.*

*Note: This utility should only be executed if AppViewer is used in your environment (if the value of **Deploy Application Viewer Module** is set to **true**).*

If the environment is used for reference or development then it may be necessary to regenerate the **appViewer** component from the metadata. A utility is provided that runs a number of provided background processes to regenerate the **appViewer** from the current environment.

Command Usage:

Linux/Unix:

```
genappvieweritems.sh [-j ] <j ob> [-Dshv]
```

Windows:

```
genappvieweritems.cmd [-j ] <j ob> [-Dshv]
```

Where:

- h** Show usage.
- blank** Execute all extract jobs
- v** Display Version
- j <j ob>** Execute specific <j ob> from the following list:
 - **F1-AVALG** - Generate XML file(s) for Algorithm data
 - **F1-AVMD** - Generate XML file(s) for Maintenance Object data

- **F1-AVTBL** - Generate XML file(s) for Table data
- **F1-AVTD** - Generate XML file(s) for To Do Types XML
- **F1-AVBT** - Generate XML file(s) for Batch Control Types XML

-S Silent Mode (logs only)

-D Debug Mode enabled (development use only).

Samples:

```
$ genappvieweritems.sh
```

...

Application Viewer is delivered with the system including xml services. This script will extend Application Viewer capabilities on site by generating additional items.

The Following Programs will be ran

```
F1-AVALG    Generate XML file(s) for Algorithm data
F1-AVMO     Generate XML file(s) for Maintenance Object data
F1-AVTBL    Generate XML file(s) for Table data
F1-AVTD     Generate XML file(s) for To Do Types XML
F1-AVBT     Generate XML file(s) for Batch Control Types XML
```

The Application EAR file will also be re-created if required.

Proceed (Y/N)?

...

Calling F1-AVALG

program F1-AVALG got a 0 response code

Calling F1AVMO

program F1-AVMO got a 0 response code

Calling F1-AVTBL

program F1-AVTBL got a 0 response code

Calling F1AVTD

program F1-AVTD got a 0 response code

Calling F1-AVABT

program F1-AVABT got a 0 response code

If you received a non response code 0 above, you should consult the logfiles

*Note: For platforms that use WAR/EAR files, the **genappvieweritems** utility will automatically rebuild the WAR/EAR files ready for deployment (deployment will need to be performed if **WEB_I_SAPPVIEWER** is set to true).*

This generates the HTML files to be included in the appViewer application. This will only generate the necessary files from the current environment. To deploy the appViewer, the relevant option of **initialSetup** command must be executed to deploy rebuild the WAR file and redeploy the application.

*Note: If an unauthorized user attempts to execute this command the following error message – "**ERROR: Could not create a backup of log file.**" is output.*

initialSetup – Maintain Configuration Settings

*Note: The **initialSetup[.sh]** script replaces the **gen*[.sh]** script provided with previous releases of the Oracle Utilities Application Framework.*

Note: The [*spl environ\[.sh\]*](#) utility must be executed before this utility can be used. See [*spl environ.sh*](#) for details.

Warning: This command will reset all configuration files to template settings. Any direct customization to configuration files will be lost. Backup configuration files prior to running this script. If changes are necessary for your site then use [user exits](#) or [custom templates](#) to retain settings across executions of [*initialSetup\[.sh\]*](#).

During the installation and configuration process a number of configuration files used by the components of the architecture are built to be used by the various components of the architecture. The utility takes the [ENVIRON.INI](#) settings and using a set of provided templates (located in the etc directory), builds the necessary configuration files for the product components.

This utility has three functions:

- Build/Rebuild the configuration files from templates.
- Build/Rebuild the WAR/EAR files used by the product.
- Deploy the WAR/EAR files to the JEE Web Application Server (*IBM WebSphere/ND only*). For customers using *native* mode, manual redeployment is necessary.
- Build/Rebuild the keystore files.

This concept is shown in the diagram below:

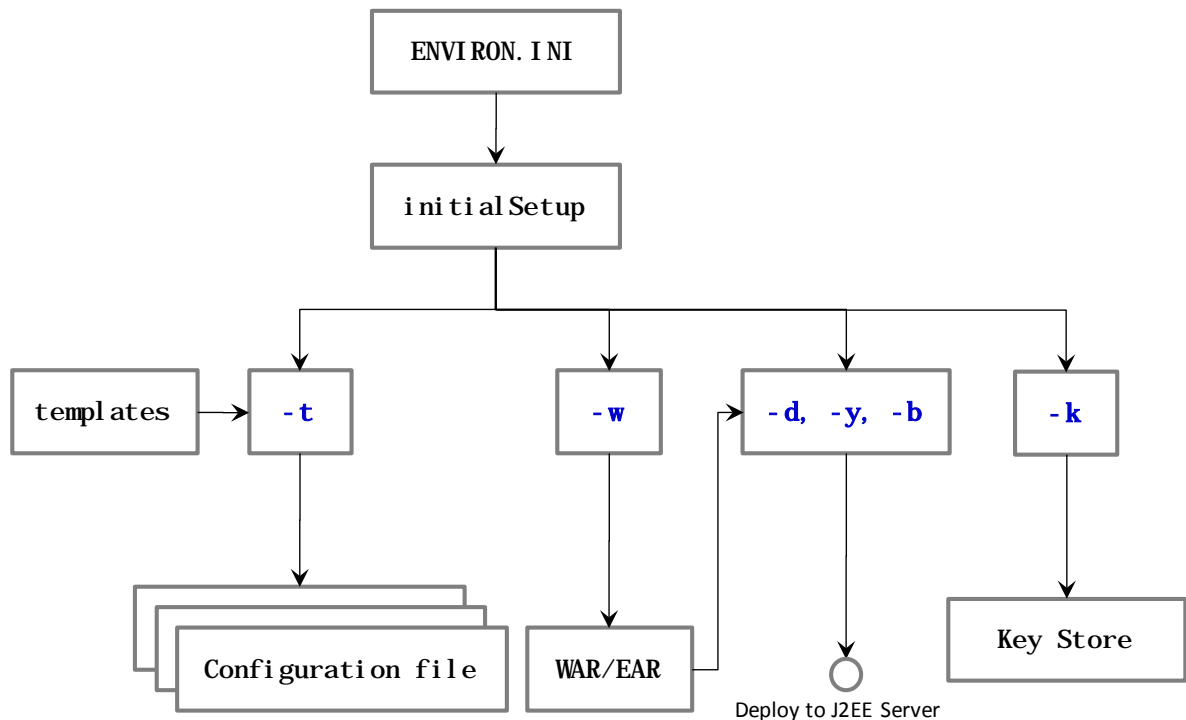

Figure 9 – initialSetup command structure

While this utility is used at installation time and configuration to reflect [configuration](#) settings in the product, it can also be used to reset the configuration files to the original settings as well as reflect changes to the [ejb-jar.xml - Enterprise Java Server Beans Configuration](#)

The Business Application Server and MDB functionality uses Enterprise Java Server beans to implement service calls. By default the behavior of these components is defined and controlled with the **ejb-jar.xml** configuration file.

This configuration file is generated by the **initialSetup** using the **templates/ejb-jar.xml.template** file.

Note: This configuration file is typically NOT altered unless custom JMS or MDB resources are to be included in the servers within the product. Typically JMS resources are not included in the server. Refer to the Oracle WebLogic JMS Integration (Doc Id: 1308181.1) whitepaper for details of JMS or MDB advanced configuration.

ENVIRON.INI - Environment Configuration File.

Command Usage:

Linux/Unix:

initialSetup.sh [-h] [-t] [-w] [-d] [-b] [-y] [-v] [-k] [-f] [-s]

Windows:

initialSetup.cmd [-h] [-t] [-w] [-d] [-b] [-y] [-v] [-k] [-f] [-s]

Where:

- blank** Process Templates, Build WAR/EAR files and Deploy to JEE Web Application Server in one process.
- h** Show usage.
- t** Process Templates only
- w** Build WAR/EAR files only
- d** Deploy WAR/EAR files only (IBM WebSphere/ND only)
- b** Deploy Business WAR/EAR files only (IBM WebSphere/ND only)
- y** Deploy Web Application WAR/EAR files only (IBM WebSphere/ND only)
- v** Display Version
- s** Import Key Store from external location (**KS_IMPORT_KEYSTORE_FOLDER**)
- k** Generate Key store
- f** Force Task, skipping any warnings (used for silent installs only)

Examples:

```
$ initialSetup.sh
100207.02:37:33 <info> Template generation step.
100207.02:37:43 <info> FW template generation step.
100207.02:37:43 <info> Create war file for SPLApp.war.
100207.02:38:14 <info> Create war file for XAIApp.war.
100207.02:38:26 <info> Create war file for appViewer.war.
100207.02:39:14 <info> Create war file for help.war.
100207.02:41:11 <info> FINISHED INITIAL INSTALL SETUP at Thu Aug 7
02:41:11 EST 2009
100207.02:41:11 <info> See file
/spl/TRAINING/logs/system/initialSetup.sh.log for details
```

*Note: If an unauthorized user attempts to execute this command the following error message – "**ERROR: Could not create a backup of log file.**" is output.*

installSFGroup[.sh] - Install Software Patches

Note: The [splenviron\[.sh\]](#) utility must be executed before this utility can be used. See [splenviron.sh](#) for details.

Note: This utility is located in the **tools/bin** directory of the software installation.

Note: This utility does not handle prerequisites unless used with the [PatchDeployUtility](#).

Note: This utility only does software installation. Database installation is handled by [ouafDatabasePatch](#).

The **installSFgroup** utility installs a single or group of software fixes that have been downloaded.

Command Usage:

Linux/Unix:

```
installSFgroup.sh -f InputFile -d InputDir -p product -v version -e splenviron -r splebase -l logfile
```

Windows:

```
installSFgroup -f InputFile -d InputDir -p product -v version -e splenviron -r splebase -l logfile
```

Where:

- f InputFile** Fill path of list of single fixes to install. This can be generated from [PatchDeployUtility](#), included in a service pack, included in a fix or manually created.
- d InputDir** Location of single fixes downloaded from My Oracle Support. These must be unzipped.
- p product** Product Name for patch file (this is the prefix of the file) (optional)
- v version** Version number of files (optional)
- e splenviron** Environment Name to apply fixes to. Defaults to current **SPLENVI RON** environment variable if not specified.
- r splebase** Root location of software for environment. Must match value in [/etc/cistab](#). Defaults to current **SPLEBASE** environment variable if not specified.
- l logfile** Name of log file to output. Defaults to **install.log** if not specified.

invokeDBUpdatePatch[.sh] - Regenerates passwords in Installation Options

Note: The [splenviron\[.sh\]](#) utility must be executed before this utility can be used. See [splenviron.sh](#) for details.

The **invokeDBUpdatePatch[.sh]** utility, updates the Installation options that use encryption for key updates.

It is recommended to refer to the [Keystore Configuration](#) (Doc ID [2014161.1](#)) whitepaper for details of how and when to use this utility.

iwsdeploy - Inbound Web Services Deployment

Note: The [spl environ\[.sh\]](#) utility must be executed before this utility can be used. See [spl environ.sh](#) for details.

The Inbound Web Services deployment utility, **iwsdeploy**, creates the Web Services EAR file and also deploys that EAR file to the servers. The process does the following:

- Extracts the Inbound Web Services that are new or changed as indicated on the deployment record (status of *Needs Repdeployment*).
- For each Web Service generates a number of artefacts required by the Web Application Server to define and execute the Web Service.
- Builds the components into a EAR file called *Webservices.ear* located in the **\$\$SPLEBASE/spl app/i ws/gen** directory (or **%SPLEBASE%\spl app\i ws\gen** directory on Windows).
- Deploys the EAR file to the container configured.

It also is possible to perform this activity using the Inbound Web Services Deployment online function. It is recommended that in non-production both methods are available but in production **iwsdeploy** is used.

The **iwsdeploy** does not have any options at the present time.

Command Usage:

Linux/Unix:

iwsdeploy.sh

Windows:

iwsdeploy.cmd

jmxbatchclient[.sh] – JMX batch command line **BATCH**

Note: The [spl environ\[.sh\]](#) utility must be executed before this utility can be used. See [spl environ.sh](#) for details.

Note: For more examples of usage of this command refer to the [Batch Best Practices](#) (Doc Id: [836362.1](#)) available from [My Oracle Support](#).

*Note: This facility will only operate if the **BATCH_RMI_PORT** is populated.*

The batch architecture While the JMX client interface provided allows real time information to be displayed in a JMX *browser*, if a JMX *browser* is not used then the JMX interface may be interfaced using a command line utility. This utility is useful to allow third party products (such as batch schedulers) or other systems to control and monitor the state of the system.

This JMX batch command line allows the following to be performed:

- Identify what thread pools are defined in a **threadpool worker**
- See what active batch processes or threads are currently running
- Be able to cancel a particular thread or a batch process
- Gracefully shutdown a **threadpool worker**
- The command line utility is in the following format:

To execute the command line, the administrator must:

- Logon to the machine running the product (any tier where the product software exists).

- Attach to the environment using the **spl environ[. sh]** command. This sets the appropriate environment settings for the script.
- Execute the JMX Batch command line utility:

jmxbatchclient[. sh] -j [URL] [options]

Where **[options]** are:

- c Specifies that active threads should be cancelled. Can be used with **-f** option to cancel only batch processes matching the regular expression provided. For example:

Note: Cancelled threads are marked with the date, time, userid and IP address of the user who initiated the cancel command.

- d Display the details of the currently active threads.
- f If a large number of threads are currently active, a filter can be supplied to only display or cancel threads that match the *regex* based pattern.
 For example the threadpool be filtered to show only the BAT1 with the option: **-f .*BAT1.*** as follows:

```
jmxbatchclient.sh -j
service:jmx:rmi:///jndi/rmi://myserver:9999/oracle/ouaf/batchConnector -f .*BAT1.*
```

 would yield:

```
Options: -j
service:jmx:rmi:///jndi/rmi://myserver:9999/oracle/ouaf/batchConnector -f .*BAT1.*
Connecting to
service:jmx:rmi:///jndi/rmi://myserver:9999/oracle/ouaf/batchConnector
ActiveGridNode
threadPools=[MYSERVER: 5,
LOCAL_THREAD_POOL: b9835d11f15fd71b: 681ba91d: 1200151a3c8: - 8000: 0,
SCHEDULER_DAEMON_THREAD_POOL: 1]
BatchThread_ZZQABAT1_1_of_1. 31
```
- h Display the available options and their descriptions.
- j JMX URL to perform the action against (Required).
 This should match the **spl.runtime.management.connector.url.default** property specified in the **threadpool worker.properties**.
- k Specifying this option will result in the cancellation of all currently running threads and the stoppage of the threadpoolworker process.

*Note: Active threads within a cancelled **threadpool worker** are marked with the date, time, userid and IP address of the user who initiated the kill command*

- l By default, all logging information is displayed and logged using log4j. Supplying this option will result in only select information being displayed to the system output.
- s Display the summary of the currently active threads is a listing format.
- t Amount of time, in ms, to wait as expressed in **<wait>** for active jobs to cancel.

<wait
>

-z Display the cache details. Must be used in conjunction with -j option.

ouafDatabasePatch[.sh] - Install Database Patches

Note: The [spl environ\[.sh\]](#) utility must be executed before this utility can be used. See [spl environ.sh](#) for details.

Note: For more information about patching refer to the [Software Configuration Management Series](#) (Doc Id: [560401.1](#)) available from [My Oracle Support](#).

The **ouafDatabasePatch** allows database patches to be installed from the command line or via the Application Management Pack for Oracle Utilities. This utility is a companion to with **installSFGGroup** which installs the software component of patches.

Command Usage:

Linux/Unix:

```
ouafDatabasePatch.sh [-h] [-u] [-v] [-x] [-t toolsdir] [-p ouafparms]
```

Windows:

```
ouafDatabasePatch [-h] [-u] [-v] [-x] [-t toolsdir] [-p ouafparms]
```

Where:

- h Show usage for patch.
- u Show usage of command
- v Display version of patch
- x Database Password for applying patch
- b Location of tools bin directory
- p Additional parameters passed to utility (as per patch documentation). This must be the last parameter on the command line. This is primarily used by the Application Management Pack for Oracle Utilities.

PatchDeployUtility[.sh] - Create and Deploy Patch Rollups

Note: The [spl environ\[.sh\]](#) utility must be executed before this utility can be used. See [spl environ.sh](#) for details.

Note: For more information about patching refer to the [Software Configuration Management Series](#) (Doc Id: [560401.1](#)) available from [My Oracle Support](#).

The **PatchDeployUtility** allows prerequisite product software and database patches to be analyzed, downloaded and applied in a single installation. This utility can be used from the command line or via the Application Management Pack for Oracle Utilities.

There are three phases for the utility to execute:

- **Report** Mode - Generate a patch dependency list for a particular patch.
- **Download** Mode - Download the patches not already downloaded from the Report mode list.
- **Rollup** Mode - Create a single installer to install all the patches in the patch

dependency list in one install.

*Note: This utility does not install the patches. They must be installed using the **installSFgroup** and **ouafDatabasePatch** utilities.*

Command Usage:

Linux/Unix:

```
PatchDeployUtility.sh -f patchfile -m mode -l missingfile -d dir -r dir -n missingfile
```

Windows:

```
PatchDeployUtility.sh -f patchfile -m mode -l missingfile -d dir -r dir -n missingfile
```

Where:

- f patchfile** The full path and file name to the **patchdependency.txt** file of the patch to use as a reference point. This parameter is used by the **REPORT** mode only and is required for that mode.
- m mode** Mode. Supported values: **REPORT**, **DOWNLOAD** or **ROLLUP**.
- l missingfile** Full path and file name for output for **REPORT** mode. This file will contain the list of fixes that have not been downloaded. This parameter is used by the **REPORT** mode only and is required for that mode.
- d dir** Full path to location where any missing patches will be downloaded to when using the **DOWNLOAD** mode. This is also used by the **ROLLUP** mode as a source directory.
- r dir** Full path to location where the rollup files will be generated. This is the location used by the **installSFGroup** and **ouafDatabasePatch** utilities will be executed from. This parameter is by the **ROLLUP** mode only and is required for that mode.
- n missingfile** Full patch and file name of the missing patches generated by the **REPORT** mode. This parameter is used by **DOWNLOAD** and **ROLLUP** modes.

For example:

```
PatchDeployUtility.sh -f /scratch/mypatches/fix10001/data/etc/patchdependency.txt -m REPORT -l /scratch/patches/missing.txt
```

```
PatchDeployUtility.sh -n /scratch/patches/missing.txt -m DOWNLOAD -d /scratch/mypatches
```

```
PatchDeployUtility.sh -n /scratch/patches/missing.txt -m ROLLUP -d /scratch/mypatches -r /scratch/myrollups
```

showjavaproc[.sh] - Show java processes

*Note: The **splenvron[.sh]** utility must be executed before this utility can be used. See [splenvron.sh](#) for details.*

Note: This utility is only provided on Linux/UNIX platforms.

Note: This utility is mainly useful for embedded installations. It can be used for native installations but the environment name will not be rendered.

The **showjavaproc** utility lists the process ids for the WebLogic servers installed on the

machine.

Command Usage:

Linux/Unix:

```
showj avaproc. sh [-e envname] [-q]
```

Where:

- blank*** Find all of the WebLogic servers running on the machine
- e *envname*** Filter the output by environment name. If it is found then output a 1 return code
- q** Do not put output on screen. Useful for custom scripting.

For example:

```
showj avaproc. sh -e MYENVIRON || echo "Weblogic Java Process is running"
showj avaproc. sh -e MYENVIRON && echo "Weblogic Java Process is NOT running"
```

splenviron – Set Environment variables

Note: On the Linux/UNIX environment this utility creates a subshell upon completion.

The **splenviron[.sh]** utility initializes a defined set of environment variables and paths for an environment. This script must be run before any other script or utility is run within the environment.

Command Usage:

Linux/Unix:

```
splenviron. sh -e <environment> [-c <command>] [-q] [-h]
```

Windows:

```
splenviron. cmd -e <environment> [-c <command>] [-q] [-h]
```

Where:

- e <environment>** *<environment>* is the environment id as installed in the **ci stab** file.
- c <command>** Execute *<command>* after running **splenviron[.sh]**. Command must be enclosed in double quotes (""). Default is shell (e.g. ksh).
- q** Quiet Mode. Do not show output from command. Any output from the -c command will be shown.
- h** Show usage.

Samples:

```
splenviron. sh -e DEMO
splenviron -e DEV
splenviron. sh -e DEMO -c "cat file.lst"
```

The **splenviron[.sh]** utility is executed whenever an environment needs to be initialized. One of the options to this script allows system administrators to optionally include the execution of an additional command as part of the environment initialization. This enables the system administrator to more finely tune the environment shell so they can change such

settings as TimeZone, PATH or environment variables.

Extending the splenvron Command

If your implementation needs to add environment variables (or modify existing variables) for a third party product you may wish to integrate with that product. For example, you might want to add some custom Java classes from a component that you want to use with the product.

When you run the **splenvron[.sh]** utility it sets the environment variables for the environment. These are standard variables as well as any required for operation of the product. For example, there are variables that can be used in utilities so they can be used across environments.

These environment variables can be extended (or added to) using one of the following options:

- **Change to ALL environments on machine** - If your integration is common across all environments then you can set or alter environment variables using the following technique:
 - Create a script in a central location on the machine that sets or alters the appropriate environment variables. Ensure that the product administrator user ID has read/execute access to the location and the script.
 - Set the **CMENV** environment variable with the location and name of the script to execute prior to running the **splenvron[.sh]** utility (for example, in your logon profile).
 - When the **splenvron[.sh]** utility is run it will detect the script specified in the **CMENV** environment variable and execute the script to set or alter the environment variables.
- **Change to a specific environment on machine** - If your integration is specific to an environment (or different for each environment, for example if you have a development as well as a test copy of the third party product) then you can set or alter environment variables using the following technique:
 - Create a script called **cmenv.sh** (or **cmenv.cmd** on Windows) in scripts subdirectory of the environment (usually **\$\$SPLEBASE/scripts** or **%SPLEBASE%\scri pts**). Ensure the permissions are set appropriately for the product administration account to execute the script.
 - When the **splenvron[.sh]** utility is run it will detect the **cmenv.sh** script (or **cmenv.cmd** on Windows) and execute the script to set or alter the environment variables at the end of the **splenvron[.sh]** utility.
- **Combination of both previously outlined options** – It is possible to combine the techniques in a combination which can mean you can have maximum flexibility. If you follow the instruction of both techniques then the following will happen in the following order:
 - When the **splenvron[.sh]** utility is run it will detect the script specified in the **CMENV** environment variable and execute the script to set or alter the environment variables.
 - If there is a **cmenv.sh** script (or **cmenv.cmd** on Windows) in the scripts

subdirectory of the environment, it will execute the script to set or alter the environment variables. This may override, add or alter environment variables already set.

In using this override technique, remember:

- If you alter any pre-existing environment variables then ensure your changes are not going to circumvent product requirements. For example, do not alter paths used by the product.
- If you add files or directories to library variables or **CLASSPATH** ensure your changes are suffixed at the end of the variable. This is especially important for java classes as classes you use may conflict with product supplied ones; adding them at the end of the **CLASSPATH** will minimize the effects of conflicts.
- Do not remove any environment variables used by the product.

spl – Start/Stop Environment

*Note: The **spl environ[. sh]** utility must be executed before this utility can be used. See [spl environ. sh](#) for details.*

Note: This utility should not be used for native mode customers. Use the [console](#) or scripts supplied with Oracle WebLogic to start or stop the product. Refer to the Oracle WebLogic documentation for information on this capability.

The **spl [. sh]** utility is used to start up and shut down an environment or individual components (web server or multi-purpose listener) of an environment. Usage of this utility is optional in sections of this document.

Use the command without a parameter to start up, reboot or shut down all components of an environment (note that the action must still be used). To start up or shut down an individual component, use the option that specifies that applies to that specific component.

Command Usage:

Linux/Unix:

```
spl.sh [-h] [-wsba] [-q] <action>
```

Windows:

```
spl.cmd [-h] [-wsba] [-q] <action>
```

Where:

-h	Show usage.
blank	Perform <action> on Web application server/Business Application only
-w	Perform <action> on Web application server only
-s	Perform <action> on Business application server only
-b	Perform <action> on batch component only. DEFAULT threadpool only. BATCH
-a	Perform <action> on all components
-q	Quiet Mode – Non-critical output goes to log file only
<action>	start – start the component/environment

stop – stop the component/environment

check – Check the status of the environment

When executed the script returns the following return codes:

Return Code (\$?)	Comments
0	Command executed successfully
1	Command executed unsuccessfully

Note: The command may issue other commands that need to be tracked separately depending on the platform. For Example

Action	Linux/Unix Command	Windows Command
Start Application Server	spl.sh start	spl start
Stop Application Server	spl.sh stop	spl stop
Start all components	spl.sh -a start	spl -a start
Stop DEFAULT threadpool	spl.sh -b stop	spl -b stop
Start Business Application Server	spl.sh -s start	spl -s start
Stop Web Application Server	spl.sh -w start	spl -w start

starttpw[.sh] - Start Threadpoolworker

Note: The [*spl environ\[.sh\]*](#) utility must be executed before this utility can be used. See [*spl environ.sh*](#) for details.

Note: This utility is only provided on Linux/UNIX platforms.

Note: This utility is useful for developers.

This utility is a wrapper utility that calls the threadpoolworker script for use in command line batch submitters or from the command line.

Command Usage:

Linux/Unix:

starttpw.sh [-h] [-Q] [threadpoolworker options]

Where:

- blank** Execute the *[threadpoolworker options]* in the background (nohup).
- h** Show usage.
- Q** Execute the *[threadpoolworker options]* in the foreground

submitjob[.sh] - Submit Batch Threads **BATCH**

Note: The [*spl environ\[.sh\]*](#) utility must be executed before this utility can be used. See [*spl environ.sh*](#) for details.

Note: For more examples of usage of this command refer to the [Batch Best Practices](#) (Doc Id: 836362.1) available from [My Oracle Support](#).

The following options can be specified when executing utility submitjob[.sh]:

submitjob[.sh] [-B][-b][-c][-d][-e][-f][-g][-h][-i][-J][-I][-L][-m] [-n] [-p][-P][-Q][-R][-r][-s][-t][-u][-x][-X]

where command line options are:

- b <batch code>** Batch code of the batch process to submit. When submitting a batch process, a batch code is always required. Either this option or **-P** may be specified, not both.

If this option is specified, **submitjob** will use the supplied batch code to look for a default properties file for that batch code (e.g. **VAL-SA.properties** or **VAL-SA.properties.xml** as discussed above) and use those properties if found.
- c <thread count>** Concurrent number of threads in which to run the process.
- d <date>** Process / business date.

Format is YYYY-MM-DD
- e < THIN|CLUSTERED>** Execution mode for this submission. If execution mode **THIN** is selected, the JVM will create a full application context and run the batch process inside the JVM – i.e. it will not be submitted to a thread pool for a worker JVM to pick up and run. This is analogous to running the batch process using the existing **SPLBATCH[.sh]** utility.

THIN mode is for development purposes only.

If **CLUSTERED** is selected, the batch process will be submitted to run in the specified distributed thread pool (option **-p**). It is also possible to have the submitter JVM be a worker JVM and run the batch process (similar to **THIN** mode, but in parallel threads). See option **-L**.
- f <record count>** Record commit frequency count.
- g <four Y|N switches>** Positional tracing switches:

 1. Program entry
 2. Program exit
 3. SQL statements
 4. General program debugging info

For example, **NNYN** will trace all SQL statements.

- Value of **NNNN** disables all tracing.
- h** Show help information. Display the available options and their descriptions. The information is not logged.
- i <RMI port number>** Port number of RMI Registry to start and/or reference. If specified with **-R**, this number will be used only to substitute applicable URL **{port}** references. This option will not add any new RMI/JMX properties - it can only be used to override existing ones. *See note below*
- J** Do not start JMX connector. This option disables JMX monitoring for this JVM. As far as **submit job** is concerned, options **-i**, **-R** and **-J** are only applicable to batch processes submitted in **THIN** mode, or **CLUSTERED** mode to the LOCAL thread pool.
- For each property prefixed by **spl.runtime.management.connector.url** that is defined with the default set of properties (e.g. in the **submitbatch.properties** file), the framework will start a JMX Connector for the specified URL.
- This activates JMX monitoring inside the worker node so that a client JMX console can be used to monitor and manage active threads. If this option is specified, the framework will not start any JMX connectors.
- l <ENG|FRA|etc. >** Language code. Relevant language pack must be installed.
- L** Submit this batch to the LOCAL thread pool (i.e. this JVM). Only applicable for **CLUSTERED** mode. If specified, any default thread pool property is ignored. This option and **-p** are mutually exclusive.
- By specifying option **-L**, the batch process is submitted to the LOCAL thread pool that every submitter JVM offers by default. This option is only applicable in a **CLUSTERED** mode execution (**-e**). This is similar to submitting the batch process in **THIN** mode (i.e. a worker JVM is not needed to run the batch process), except thread pool LOCAL can run multiple batch threads concurrently.
- For example, the following command will run

- batch process VAL-SA inside this submitter JVM (LOCAL thread pool) in 8 threads concurrently:
submitjob[.sh] -b VAL-SA -c 8 -L -e CLUSTERED
- n** <email address> Send a notification email when a batch process has ended to <email address>. See [Sending emails at the conclusion of batch processes](#) for more information.
- p** <threadpool name> Distributed thread pool in which to run the batch process. This option and **-L** are mutually exclusive.
- P** Issue console prompts for the standard batch process parameters. When submitting a batch process, a batch code is always required. Either this option or **-b** may be specified, not both. If **-P** is specified, the submitter JVM will prompt for the batch code and other run parameters. If a batch-specific properties file exists for the batch code entered at the prompt, it will NOT be used; the only defaults in effect would be the ones specified in **submitbatch.properties**.
- Q** Preview the properties that would be in use for the run without actually running the application. Specify other options along with this option to show how they would override or substitute the default properties. The information is not logged.
- R** Do not start a local RMI registry. As far as **submitjob** is concerned, options **-i**, **-R** and **-J** are only applicable to batch processes submitted in **THIN** mode, or **CLUSTERED** mode to the LOCAL thread pool. If property **spl.runtime.management.rmi.port** is defined as a default property (e.g. in the **submitbatch.properties** file), the batch framework will attempt to start an RMI registry on the given port number.
- This option can be used to suppress the automatic RMI registry startup. It may be required if an externally started RMI registry is already running. Note that if this option is used, the RMI port number supplied through the **-i** option is only used for substitution in the JMX Connector URLs.

-r <run number>	Run number of batch process to rerun.
-s <space name>	Space name for <i>hard partition</i> of workers. Default is MAIN . Used for development only.
-t <thread number>	Number of individual thread for this submission. Specify 0 to automatically submit all threads.
-u <user id>	Application user id used for batch process
-x <name=value, name=value, . . . >	Name=value pairs of INDIVIDUAL soft parameters expected by the batch program. Value portion may be enclosed in quotes. These parameters will be merged with any existing (defaulted) soft parameters. This option and -X are mutually exclusive.
-X <name=value, name=value, . . . >	Name=value pairs of ALL soft parameters expected by the batch program. Value portion may be enclosed in quotes. These parameters will replace all existing (defaulted) soft parameters. This option and -x are mutually exclusive.
-z <j vmoptions>	Java options to use for submitter.

This utility returns two return codes:

- Zero (0) - The job or thread was successful.
- Non-Zero - The job or thread was NOT successful.

threadpoolworker[.sh] - Manage Threadpools **BATCH**

Note: The [splenvi ron\[. sh\]](#) utility must be executed before this utility can be used. See [splenvi ron. sh](#) for details.

Note: For more examples of usage of this command refer to the [Batch Best Practices](#) (Doc Id: [836362.1](#)) available from [My Oracle Support](#).

The following options can be specified when executing script threadpoolworker.

threadpool worker[. sh] [-d] [-e] [-h] [-i] [-J] [-p] [-Q] [-R] [-s]

Where command line options are:

-d <Y N>	Whether the node is acting as a scheduler daemon. Specify N for No and Y for Yes. If you are already using a scheduler daemon in the online system or are not using online submission then set this to N . Default is N .
-e < THIN CLUSTERED >	Execution mode for this threadpool. If CLUSTERED is the threadpool will join the cluster specified in the threadpool worker. properti es file.
-h	Show command line help. List the available options

- and their descriptions. It is formatted for a 121-column width display. The information is not logged.
- i <RMI Port>** Override port number for JMX. If specified with **-R**, this number will be used only to substitute applicable URL {port} references. This option will not add any new RMI/JMX properties - it can only be used to override existing ones. This option specifies the port number to:
- Use when the framework starts an RMI Registry and
 - Substitute in all JMX Connector URL {port} references.
- J** Do not start JMX monitoring. For each property prefixed by **spl.runtime.management.connector.url** that is defined with the default set of properties (e.g. in the **threadpoolworker.properties** file), the framework will start a JMX Connector for the specified URL. This activates JMX monitoring inside the worker node so that a client JMX console can be used to monitor and manage active threads. If this option is specified, the framework will not start any JMX connectors.
- l2** Enable or disable batch caching. Default: **READ_WRITE.OFF** and **READ_ONLY** are reserved for specific processes
- <READ_ONLY | READ_WRITE | OFF>**
- p <name=value, name=value, ...>** Thread pool(s) offered by this worker node. Consists of one or more name=value pairs, where "name" is the name of the pool and "value" the number of threads offered in the pool. For example, **DEFAULT=5, ONLINE=3**
- Q** Preview the properties that would be active for this run. Used for testing. Preview the properties that would be in use for the run without actually running the application. Specify other options along with this option to show how they would merge with, override or substitute the default properties. The information is not logged.
- R** Do not start a local RMI registry. If property **spl.runtime.management.rmi.port** is defined as a default property (e.g. in the **threadpoolworker.properties** file), the batch framework will attempt to start an RMI registry on the given port number. This option can be used to

suppress the automatic RMI registry startup. It may be required if an externally started RMI registry is already running.

*Note: If this option is used, the RMI port number supplied through the **-i** option is only used for substitution in the JMX Connector URLs.*

-s <space name>	Space name for "hard partition" of workers. Default is MAIN. Reserved for internal use only.
-sf <file-path>	Generate or append command to a script. Reserved for system use.
-sl <line to add to script>	Add line to script reference. Reserved for system use.
-z <jvm options>	Add or override JVM options for threadpool.

When **threadpool worker** is invoked, the command-line options will alter its default configuration. The default configuration options come from either internal system defaults or the **threadpool worker. properties** file described above.

The properties are overridden in the following order:

1. The **threadpool worker. properties** supersedes the internal system defaults.
2. The command-line options supersede the defaults in **threadpool worker. properties** and the internal system defaults.

Example 1

Assuming we have the above set of properties in **threadpool worker. properties** and script **threadpool worker** is invoked as follows:

```
threadpool worker[. sh] -d Y
```

This will replace the default "daemon" property to "N" (i.e. false) so that the properties now look as follows:

```
com.spl.wg.grid.distThreadPool.threads.DEFAULT=5
com.spl.wg.grid.distThreadPool.threads.LOCAL=0
com.spl.wg.batch.scheduler.daemon=false
spl.runtime.management.rmi.port=9999
spl.runtime.management.connector.url.default=service:jmx:rmi:///jndi/rmi://{host}:{port}/oracle/ouaf/batchConnector
```

Attaching to an Environment

Note: This command is not necessary if using the Oracle WebLogic native support when managing the product from the Oracle WebLogic console.

Before performing any command against a product environment, you must attach to the environment. Attaching to an environment sets system and environment variables so that the correct runtime and code is used in the execution of subsequent commands.

To attach to an environment:

- Make sure that you are logged in using the administration account for the desired environment, for example **splsys**.

- Execute the following command:

```
<SPLDIR>/<environment>/bin/splenvi ron. sh -e <environment>
```

Or

```
<SPLDIR>\<environment>\bin\splenvi ron. cmd -e <environment>
```

Where **<SPLDIR>** is the mount point defined for the product and **<environment>** is the name of the environment to access.

Note: This command must be run before any UNIX-based command (including running the product background processes) to ensure that the correct environment is in place.

*Note: If you are running multiple versions of the product, ensure that you run the correct version of the **splenvi ron[. sh]** utility for the environment by manually changing to the directory where the **splenvi ron[. sh]** utility exists for the desired environment prior to running the command.*

The following is an example of splenvi ron.sh execution:

```
$ /spl /DEMO/bin/splenvi ron. sh -e DEMO
```

```
Versi on ..... (SPLVERSI ON) : Vx. x. x
Envi ronment Name ..... (SPLENI RON) : DEMO
Envi ronment Code Di rectory (SPLEBASE) : /spl /DEMO
App Output Dir - Logs ... (SPLOUTPUT) : /spl /spl out put /DEMO
```

The above example summary of the command illustrates that important environment variables and their values are set. Use this information to confirm that you have successfully attached to the correct environment.

Starting an Environment

To ensure a successful startup of the product the components should be started in the following order:

- The database server must be started according to local standards. This includes any communications software such as listeners to enable the product to communicate to the database. After starting the database server, the batch interface can be used.
- The Business Application Server must be started to enable the web application server to use the business objects and the business object conduit to accept web transactions.
- The web application server must be started to enable web clients to access the screens and business objects. After starting the Business Application Server and the web application server, the XAI incoming calls, the batch interface, and online users have access to the system.
- The end users can start the browser to access the product front-end screens.

Starting All Tiers on a Single Server

If the Business Application Server and web application server for an environment are on the same physical machine they can be started using the following set of tasks:

- Start the database using the utilities provided by the database vendor.
- Log on to the server containing the Web application server and/or Business application server using the administration account for the desired environment (for example, **splsys**).

- Execute the following command to attach to the desired environment:

Linux/Unix:

```
<SPLDIR>/<environment>/bin/spl environ. sh -e <environment>
```

Windows:

```
<SPLDIR>\<environment>\bin\spl environ. cmd -e <environment>
```

Where **<SPLDIR>** is the mount point defined for software the environment and **<environment>** is the name of the environment to start.

- Start the Web application server, Business Application Server and MPL using the following command:

Linux/Unix:

```
spl. sh start
```

Windows:

```
spl. cmd start
```

Refer to the [spl – Start/Stop Environment](#) for more options.

Note: As an alternative, it is possible to start the Web application server and business application tiers using the console or utilities provided with the JEE Web application server software.

The script will display the startup messages as dictated by the JEE Web application server vendor.

*Note: If an unauthorized user attempts to execute this command the following error message – “... **MUST be writable by admin user id**” is output.*

Starting/Stopping at Boot Time (UNIX/Linux)

One of the implementation questions that may arise is to start all the environments at UNIX/Linux boot time. This is possible by writing a script and placing it in **/etc/init.d** (or equivalent for your platform). A suggested standard is to provide a script that takes a parameter of start or stop. The script could then be used to start or stop product environments on the machine:

```
#!/usr/bin/ksh
#
# Purpose : Start/Stop all copies of the product on a machine
#

Usage() {
    echo "Usage :"
    echo "  $0 [start|stop]"
    exit 1
}

#-----
#
#####
#
# Main
```

```

# check command line arguments
if [ "$#" -eq "0" ]
then
  Usage
  exit 1
fi

# Loop through all environments in /etc/cistab

if [ ! -f /etc/cistab ]
then
  echo "/etc/cistab file does not exist. Product is not installed correctly"
  exit 1
fi

cat /etc/cistab | while IFS=: read _env _filler1 _splbase _splapp _filler2
_start
do
  # Only environments with the start parameter set to Y should be started
  if [ "${_start}" = "Y" ]
  then
    if [ -d "${_splbase}" ]
    then
      # Determine owner of the environment
      export OWNER=`perl ${_splbase}/bin/getconfvalue.plx -k SPLUSER`

      # Format start command

      _startcmd="${_splbase}/bin/spl environ -e {_env} -c "spl.sh
start""
      _stopcmd="${_splbase}/bin/spl environ -e {_env} -c "spl.sh stop""

      # Run command

      case $1 in
        "start") su - $OWNER -c "${_startcmd}" ;;
        "stop") su - $OWNER -c "${_stopcmd}" ;;
        *) Usage
          exit 1;;
      esac
    fi
  fi
done
# Finished

```

Note. The above script is provided as a sample only. Use the above script as an example for any custom scripts to start the product at boot time.

What to Look for in Startup

As outlined in Common Application Logs the application logs all information to application logs during the startup, operation and shutdown of the application. These logs can be used to check that the startup of the product is successful. The logs contain the following sections

for a startup (class indicates startup message):

- The Web Application is initialized (class = *web.startup.SPLWebStartup*) within the JEE Web application server.
- Configuration Settings are loaded from the relevant configuration files (class = *shared.environ.ApplicationProperties*).
- The product is set to Production mode (this denotes Development versus Production settings) (class = *shared.context.ApplicationMode*). Most installations are *Production* mode. Only environments where the Oracle Utilities SDK is used will not be in *Production* mode.
- The state of compression is verified (class = *web.dynamicui.TransformServletHelper*). Refer to Web application server Configuration for details of this setting.
- The framework used by the product is initialized and settings within the framework are prepared to be loaded (class = *support.context.ContextFactory*).
- The metadata is loaded into memory for configuration control (class = *shared.context.ContextLoader*).
- Any checks for any customizations (class = *shared.environ.ContextManagedObjectSet*). In most cases, environments that do not have any product customizations will report a warning about a resource not loading. This can be ignored.
- Any lookups are loaded into memory (class = *support.context.ComponentContainerLookupHelper*). Lookups are metadata used to enumerate valid values for flags, common values etc.
- Additional metadata is loaded into memory (class = *support.context.ContextFactory*). The metadata used to configured the product includes entities, Code Descriptions, algorithms, batch controls, components and Change Handlers.
- Hibernate ORM mappings used by the product are loaded (class = *support.context.ApplicationContext*). The number of mappings will vary between releases and parts of the product that are used.
- The connection pool to the database is initialized according to the configuration settings (class prefix *hibernate.**). If the connection information is incorrect or the database is down the connection pool connection will retry (according to the configuration settings). If this is the case you will see the connection information and error messages, such as "[Connections could not be acquired from the underlying database!](#)" in this log.

Note: The messages seen will vary depending your database type and version.

- A successful database connection is shown in the message "[Done building hibernate session](#)" (class = *support.context.ApplicationContext*). A number of additional messages may appear as dictated by the database vendor to indicate versions and connectivity information.
- The database statement cache is initialized within the product (class = *support.sql.PreparedStatementImpl* and class = *support.context.CacheManager*).
- The owner of the system is initialized. This identifies the application owner for implementation purposes. In all cases the implementation value is "CM" for Custom Modification. Other values are supported for Oracle internal use only.

- The Web application server/Business Application Server static cache is then loaded (*class = api.globalContext.GlobalContextHelper*) which includes:
 - Preloading language settings (*class = web.startup.PreloadLoginInfo*). If preloading is enabled then the progress of preloading is shown on the startup log. Preloading ends with message "XSLT main preload" (*class = web.startup.PreloadLoginInfo*).
 - Loading product based style sheets (XSL) for screen generation.
 - Navigation Keys (for static menus and context sensitive menus) (*class = web.dynamicui.NavigationInfoCache*)
 - Metadata is loaded as indicated (*class = support.context.CacheManager*)
 - Service Interceptors are loaded (*class = api.serviceinterception.InterceptorRepository*)
 - Menus are loaded (*class = domain.web.MenuLoginService*)
 - Navigation information is loaded (*class = domain.web.SystemLoginInfoHelperService*)
 - Service definitions are loaded (*class = service.metainfo.MetaInformationRepository*)
 - Installation record defaults are loaded (*class = web.common.WebInstallationDataHelper*)
- If the online batch daemon is enabled then the daemon is loaded into memory and started (*class = grid.node.DistributedGridNode* and prefix *grid.space*). Any work to be detected will result in additional messages (*class = grid.node.WorkProcessor*).

Once the application is loaded the JEE Web application server will indicate the product is available (the message for this varies – refer to the JEE Web application server documentation for details).

Stopping an Environment

To ensure a successful shut down of the product the components should be stopped in the following order:

- The end users should shut down the browser containing the product front-end screens.
- The MPL must be shutdown (if used) to prevent outgoing XAI transaction from being processed.
- The Web application server must be shutdown to disable web clients' access to the system. After the web application server is shutdown, end users do not have access to the system but batch processes may still run.
- The Business Application Server must be shutdown to disable the Web application server completely.
- The database server must be shut down according to local standards. This includes any communications software such as listeners to enable the product to communicate to the database. At this point all users (batch and online) do not have access to the environment.

Stopping All Tiers on a Single Server

If the Business Application Server and web application server for an environment are on the same physical machine they can be stopped/shutdown using the following set of tasks:

- Log on to the server containing the Web application server and/or Business application server using the administration account for the desired environment (for example, **splsys**).
- Execute the following command to attach to the desired environment:

Linux/Unix:

```
<SPLDIR>/<environment>/bin/spl environ. sh -e <environment>
```

Windows:

```
<SPLDIR>\<environment>\bin\spl environ. cmd -e <environment>
```

Where **<SPLDIR>** is the mount point defined for software the environment and **<environment>** is the name of the environment to stop.

- Stop the Web application server, Business Application Server and MPL using the following command:

Linux/Unix:

```
spl. sh stop
```

Windows:

```
spl. cmd stop
```

Refer to the [spl.sh](#) utility for more options.

Note: As an alternative, it is possible to stop the Web application server and business application tiers using the console or utilities provided with the JEE Web application server software.

The script will display the shutdown messages as dictated by the JEE Web application Server vendor.

- Stop the database using the utilities provided by the database vendor.

What to Look For in Shutdown Messages

As outlined in Common Application Logs the application logs all information to application logs during the startup, operation and shutdown of the application. These logs can be used to check that the shutdown of the product is successful. The logs contain the following sections for a shutdown (class indicates message class used):

- If the online batch daemon was enabled, it is shutdown (*classes = grid.node.OnlineGridNode, grid.node.DistributedGridNode, grid.space.SpaceManager, grid.space.TaskScheduler, grid.space.TaskScheduler and grid.space.ThreadPool*). The "[Thread pool shutting down](#)" message indicates a successful shutdown.
- The Web application server/Business Application Server applications are asked to shutdown (*class = web.startup.SPLWebStartup*).
 - JMX connectors to the product are shutdown
 - The Application Context within the JEE Web application server is shutdown.
- Database connections are closed (*class = hibernate.impl.SessionFactoryImpl*).

- Application shutdown is complete when the message "(web.startup.SPLWebStartup) Application Context shutdown successfully" is displayed.

Starting and Stopping Using consoles

The last section uses supplied utilities to stop and start embedded mode installations. If the native mode installation is used then there are a number of ways to start and stop the product:

- Logon to the Oracle WebLogic Administration console for the domain and navigate to the servers section where the product is installed. Using the Control function, start or stop the servers as necessary.

Note: This facility also allows enabling or disabling Administration Mode for a server. This allows administration tasks on that server while disabling end user access.

- For customers using Oracle Enterprise Manager, logon to the Oracle Enterprise Manager console the product can be started and stopped using the following target types:
 - WebLogic Domain
 - WebLogic Server for product servers
 - Domain Application Deployment¹¹
- For customers using the Oracle Application Management Pack for Oracle Utilities¹² the product can be started and stopped using the following target types:
 - Oracle Utilities Environment - Starts and Stops all child targets in a single operation.
 - Oracle Utilities Web Application
 - Oracle Utilities Web Services
 - Oracle Utilities Batch Server

¹¹ While it is possible to start and stop at the individual application deployment it is not recommended to maintain overall availability.

¹² Customers using the Application Management Pack for Oracle Utilities should use the WebLogic targets as additional features such as blackouts and brownouts are supported in those targets.

Monitoring

This section outlines some basic monitoring regimes and methods for the product. It is highly recommended that you read the [Performance Troubleshooting Guides](#) (Doc Id: [560382.1](#)) on [My Oracle Support](#).

During monitoring you are typically looking for unusual activity and seeing if the current configuration of the product can handle the peaks and troughs of usage.

Unusual activity is activity that is not representative of the normal activity. For example, maybe during a marketing campaign the call center traffic doubles. This would be regarded *unusual activity*. At this point the current configuration may not be configured to handle the traffic so the problem needs to be identified and the configuration changed to cater for the new load.

Also during normal operations underlying problems may surface in the form of long running transactions, increases in error rates (in logs and timeouts) or *runaway transactions*. *Runaway transactions* are transactions that seem to be looping. These can be caused by data inconsistencies or bugs. Most of them are due to an unusual combination of data entries.

Some customers collect usage information to identify and analyze unusual activity. This is known as Site Profiling, Capacity Planning or Availability Planning. This is typically *Proactive* activity.

The product stores usage information within the database that can be extracted for this purpose. This section outlines the methods and techniques you can use to extract this information reactively and proactively.

Monitoring Regimes

Typically the art of monitoring is the collection and analysis of various pieces of information and then making changes to the configuration to address any issues or problems that occur.

With the various monitoring facilities available in the product a combination that is valid for the site becomes a monitoring regime for that site. Typically, monitoring regimes pick up trends in the business or traffic volumes that require changes to the configuration. As part of the implementation of the product the monitoring regime for your site should be determined.

Typically the monitoring regimes that are chosen fall into a number of categories:

- **Reactive** - Monitoring for any exception after it happens and making changes to the configuration to prevent the exception from occurring again. This is the most common regime adopted by IT groups. The only problem with this approach is that you have to experience potentially threatening outages before stabilization happens.
- **Proactive** - Setting monitoring tolerances so that exception conditions are recognized before they happen and making configuration changes to prevent them from happening. This is also known as *Problem Anticipation* or *Problem Prevention*. This is the goal of most of the IT groups to ensure high availability.
- **Mixed** - This is a mixture of pro-active and re-active regime. This is not uncommon.

Monitoring Client Machines

The product's front end is the Microsoft Internet Explorer browser. Typically any Internet Explorer or operating system monitoring specified by Microsoft can be performed against the client to yield performance information.

While collecting this information can be performed using various tools, it is usually not applicable in all monitoring situations unless the client machine is below the specification outlined in the Installation Guide for the platform and version of the product you are using. The browser collection points specified here are typically the ones that are more applicable to the product than all of the available ones for the client.

Refer to the Microsoft documentation on how to fully monitor a client machine for performance information

Monitoring The Desktop

One of the areas that customers tend to monitor is the desktop client. Typically this involves using tools provided by Microsoft (and other vendors) to collect typical statistics, such as cpu, disk activity, memory usage and network usage. It is possible to monitor the client using the following tools:

- **Desktop vendor tools** (Performance Monitor) – The Performance Monitor (located in the "Administration Tools" menu from Windows) is a starting point for monitoring the client. Refer to Microsoft documentation on what aspects of a client machine to monitor.
- **Network Monitor** (*netMon* or other) – Windows Server includes a network capture facility that is handy to locate problems on a client machine. Alternatives are available such as Ethereal etc.
- **Network Latency** - Network tools like *ping* and *tracert* measure latency by determining the time it takes a given network packet to travel from source to destination and back, the so-called round-trip time. Round-trip time is not the only way to specify latency, but it is the most common. Inconsistent ping times or long ping times can indicate network issues.
- **Bandwidth Saturation levels** - A number of tools exist for computer networkers to measure the bandwidth of network connections. On LANs, these tools include *netperf* and *ttcp*.
- **Packet Loss** - Packet loss is when data packets appear to be transmitted correctly at one end of a connection, but never arrive at the other. This might be because:
 - Network conditions are poor and the packet became damaged in transit.
 - The packet was deliberately dropped at a router because of congestion.
- Packet loss can be detected from the client PC using *netstat* and calculating the percentage of the *Segments Sent* that become *Segments Retransmitted*.

Note: ping and tracert also include packet loss statistics.

- **Failed Connection Attempts** - When the client and/or server cannot accept a connection it generates a *Failed Connection Attempt* on either the client or the server (or both). A large number of *Failed Connection Attempts* can indicate networking or

capacity issues on the client or server. The most common cause is that the accept queue on the network parameters (usually on the network cards) is full, and there are some requests waiting on the sync queue (usually on the network card).

Client Debug facility

Before a problem is to be registered with Oracle support, the transaction that caused the problem should be traced to help support solve the issue quickly. A debug facility is provided within the product to help capture this additional information.

Logging of debug information can be set at a global level or at a *local* level. The global debug setting is not recommended for a production system as it reduces overall performance and therefore is not covered in this document.

The *local* level enables you to navigate to the problem area and then to switch debugging on for that individual user to recreate the problem. You can then collate the debug information to be sent to support.

To use this facility you must specify an additional parameter at the end of the URL. For example:

<http://<host>:<port>/<server>/cis.jsp?debug=true>

Where:

<host>	Web Application Server hostname
<port>	Port allocated to product installation
<server>	Context for the product at installation time

*Note: For the user to have debug access their userid must have "Change" access to service **F1DEBUG**.*

After the debug control menu is displayed, you navigate to the screen where the problem is encountered and then enable *Global Debug* by *toggling* the checkbox on. To turn off *Global Debug*, *toggle* the check box off. It is recommended to select *Trace All* for effective tracing. The other options are used by Developers only. The trace information is written to the **spl*.log** in the **\$SPLSYSTEMLOGS (%SPLSYSTEMLOGS%** in Windows).

*Note: The product uses **spl_web.log** and **spl_service.log** but **spl_service.log** or may not appear depending on the installation type, therefore the name **spl*.log** is used.*

Debug allows specific information to be logged:

- **Client Data** – Data presented to the browser. This pops up an additional window displaying the object as it is built.
- **Server Data** – Data presented to the server. This pops up an additional window displaying the object as it is received by the server.
- **Trace time** – Include time tracing in the log.
- **Trace All** – Enable all trace modes below except Trace SQL Parameters.
- **Trace Output** – Dump output from all calls
- **Trace SQL** – Dump SQL statements
- **Trace SQL Parameters** – Dump all result sets (Warning: This is not recommended for production systems as it will result in performance degradation.)
- **Program Start** – Write a record for every module start

- **Program End** – Write a record for every module end

Most tracing in non-development uses *Trace All* unless otherwise instructed by Oracle Support. All debug information is written to the **sp1*.log** files.

Steps to using the debug facility

To use the debug facility you follow the process:

- Add **?debug=true** to your URL for the product. This will display the debug toolbar on the browser screen as shown below:



Figure 10 – Debug toolbar

- **Start Debug** – Start the logging of the transaction.
- **Stop Debug** – Stop the logging process
- **Show Trace** – Show trace information (Configuration based objects only)
- **Clear Trace** – Clear Trace Information
- **Show User Log** – Show debug information for the user (line limit is configurable).
- **Validate on DB** – SDK Use only
- **Global Debug** – Set debug level.
- **JS Console** - enable JavaScript console
- Select *Global Debug* to specify the level of debug information. This will display the *Debug Control* window where you should ensure that *Trace All* is selected. Other options should only be used if instructed by Oracle Support. A sample of the Debug Control dialog is shown below:

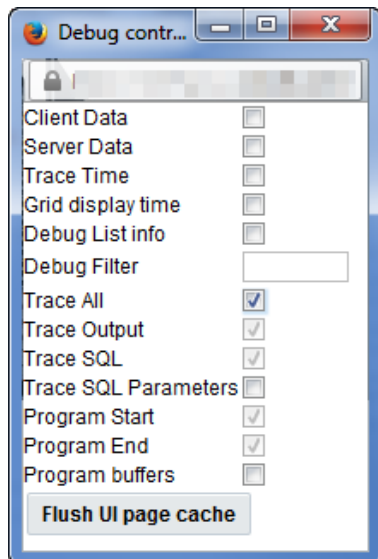

Figure 11 – Debug controls

- Navigate to the transaction that you wish to trace as a user would normally operate. Press *Start Debug* to initiate debug.
- Run the transaction that you want to trace and to recreate the issue. While you work the trace information is written to the log files.
- Deselect *Global Debug* or press *Stop Debug* so that debugging is disabled. This will stop debug code writing to the writing to the log. If you select *Show User Log* the log lines

output by the debug facility are displayed (*up to the line limit specified*). This will only show lines applicable to the Current User only.

Note: If the userid is shared across multiple physical users then the information may contain debug information from multiple sessions.

Monitoring Web/business Application Server

There are a number of methods that are available for monitoring a Web Application from a JEE Web application server:

- **Java Management Extensions (JMX)** – Most Web application servers expose JMX Management Beans (MBeans) to allow JMX browsers to view and use this information. Java 7 has a predefined set of MBeans that can be enabled automatically.
- **Web application server console** – All Web Application Servers offer a web based console that provides both administration and basic monitoring functions. These are usually sufficient for spot real time checking of tolerances and basic monitoring. Some console use calls to JMX API's provided by the Web application server vendor and built into Java 7 (and above).
- **Oracle Enterprise Manager** - Customers using Oracle WebLogic can use the Fusion Middleware targets available within Oracle Enterprise Manager to monitor online and web services applications. Customers using Application Management Pack for Oracle Utilities can use monitoring capabilities of those targets as well.
- **Command Based Utilities** – Apart from the console, most Web application server vendors offer a command line utility to extract performance information (or perform administration). Most console utilities call JMX MBeans and provide a command line interface into JMX that can be used natively.
- **Log-based monitoring** – Most Web application servers provide standardized logs that can be analyzed using consoles, log monitors or simple scripts.
- **Native OS utilities** – Most operating systems are becoming java aware and provide OS and Java monitoring from OS monitoring facilities.

Refer to the [Performance Troubleshooting Guides](#) (Doc Id: [560382.1](#)) on [My Oracle Support](#) for details of monitoring aspects of the product.

JMX Based Monitoring

With the advent of [Java Management Extensions](#) (JMX) technology into base java, it is possible to use the technology to monitor and manage java infrastructure from a [JSR160](#) compliant JMX compliant console (or JMX browser). Whilst the JEE components of the product can use basic JMX statistics such as Memory usage, Threads, Class information and VM summary information, there are application specific JMX classes added to the product to allow greater levels of information to be display and additional operations.

The Oracle Utilities Application Framework has implemented a set of product specific JMX classes on the Web Application Server and Business Application Server tiers of the architecture to allow the following:

- Management of the cache of the Web Application Server. See [Server Cache Management](#) for more details of this cache.

- Collection of JVM information and performance statistics for memory, thread usage and operating system level information. Most of these are extensions of java.lang.management classes.
- Collection of service based performance information for SLA tracking on the Business Application Server.

To use this facility the facility must be configured and enabled to allow the collection of the relevant information. This can be done at installation time by using the following configuration settings:

Configuration Setting	Deployment details
WEB_JMX_RMI_PORT_PERFORMANCE	Port Number used for JMX based management for Web Application Server.
ouaf.jmx.spl.wls.g.base.support.management.mbean.JVMInfo	Globally enable or disable JVMInfo Mbean (setting in spl.properties). Default is enabled .
ouaf.jmx.com.spl.wg.base.web.mbeans.Fl ushBean	Globally enable or disable Fl ushBean Mbean (setting in spl.properties). Default is enabled .
ouaf.jmx.com.oracle.ouaf.uws.mbeans.WSFl ushBean	Globally enable or disable WSFl ushBean Mbean (setting in spl.properties). Default is enabled .
BSN_JMX_RMI_PORT_PERFORMANCE	Port Number used for JMX based management for Business Application Server.
ouaf.jmx.com.spl.wg.ejb.service.management.PerformanceStatistics	Globally enable or disable PerformanceStatistics Mbean (setting in spl.properties). Default is enabled .
BSN_JMX_SYSUSER	Default JMX Userid for both Web Application Server and Business Application Server
BSN_JMX_SYSPASS	Default JMX Password for both Web Application Server and Business Application Server
BATCH_RMI_PORT BATCH	Port Number used for JMX based management for background processing.
WEB_BATCH_CLUSTER_URL BATCH	Cluster URL override to be used for JMX based management for background processing. This can manually be set to identify an administration node for processing.

These settings are registered in the [ENVIRON.INI](#) for setting in the relevant configuration

files. It is important that the values used for these port numbers are unique across all environments within a particular machine. The security used for these ports are defined as outlined in the [JMX Security](#) section of this document.

Web Application Server JMX Reference

Once configured a JMX client (e.g. **j console**) can be used to connect to the JMX information using the following Remote Connection string:

`service:jmx:rmi:///jndi/rmi://<host>:<jmx_port>/oracle/ouaf/webAppConnector`
and

`service:jmx:rmi:///jndi/rmi://<host>:<jmx_port>/oracle/ouaf/iwsConnector`

Where:

- `<host>` The Web Application Server host name
- `<jmx_port>` The JMX Port specified using **WEB_JMX_RMI_PORT_PERFORMANCE** for the online and **WEB_JMX_RMI_PORT_PERFORMANCE** for Inbound Web Services from the [ENVIRON.INI](#) configuration file.

The credentials provided to the JMX console are as configured in [JMX Security](#). Upon successful connection to the JMX port and host with the correct credentials provides access to the Mbean information. The figure below illustrates the successful connection to the JMX Mbeans using **j console** (*as an example*):

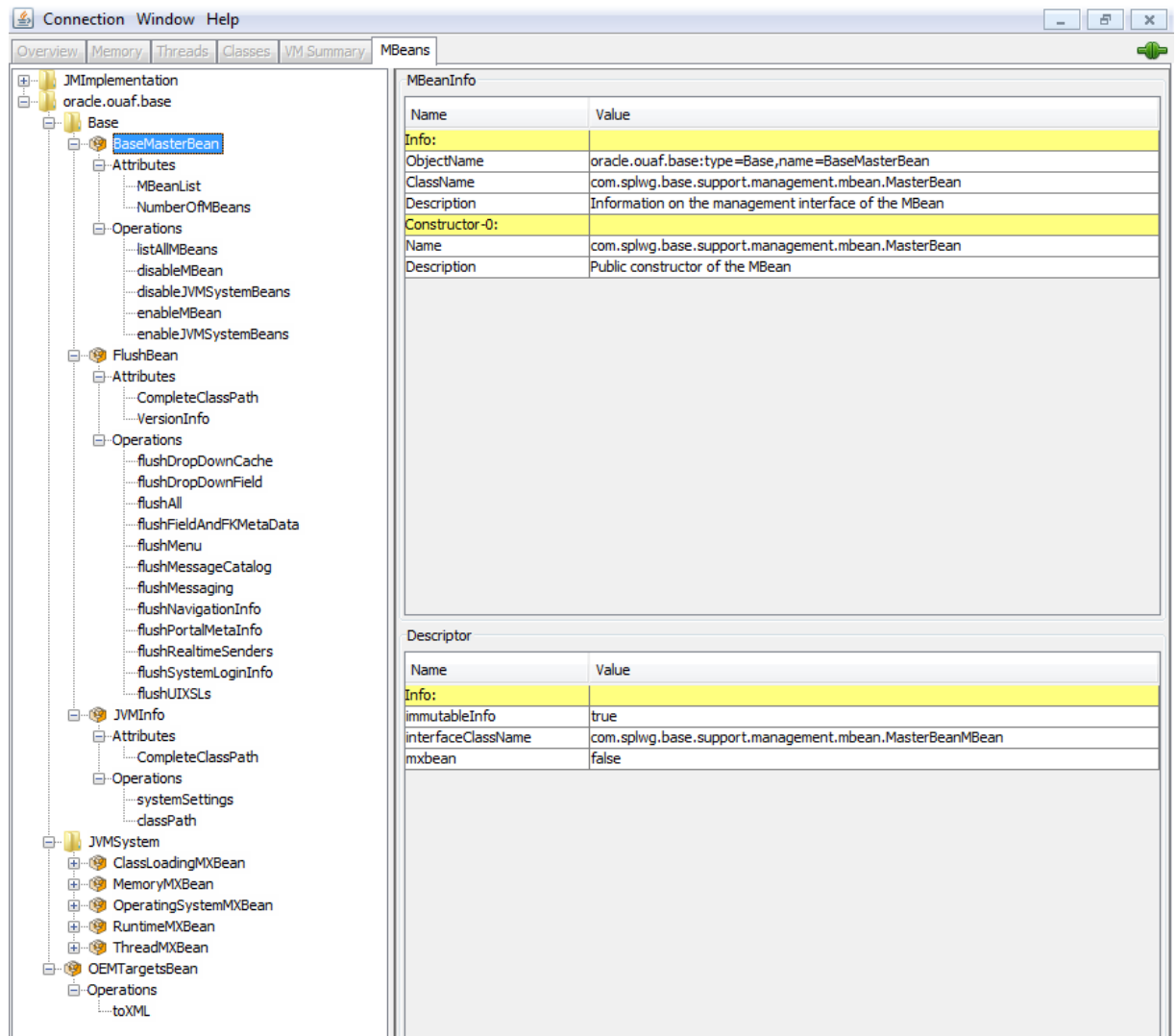

Figure 12 – Example Web Application Server Mbeans in jconsole

The structure of the Mbean is shown by the figure below:

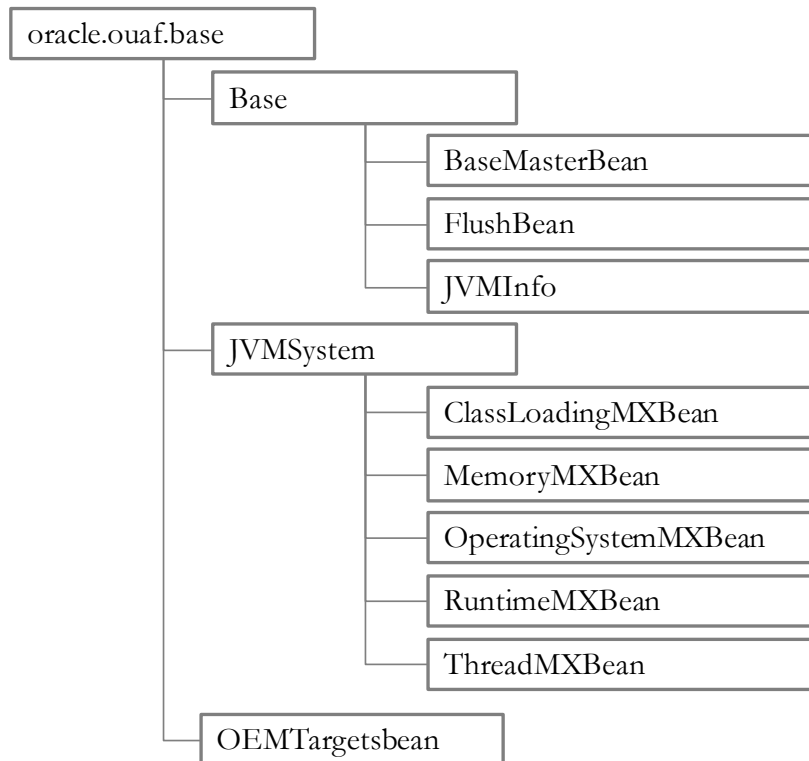

Figure 13 – Web Application Server Mbeans

The following table summarizes the Mbean attributes and operations for the Web Application Server:

Mbean	Usage
BaseMasterBean	Master MBean
Attributes	
NumberOfMbeans	Returns number of active Mbeans
MBeanList	Returns an array with the list of Mbeans defined to this Master Mbean
Operations	
disableMbean	Disables Mbean with designated name as a par
enableMbean	Enables Mbean with designated name
displayMbean	Returns a list with the list of Mbeans defined to this BaseMasterBean. Names can be programmatically used to supply parameters to disableMbean and enableMbean .
enableJVMSystemBeans	Enables base JVM system Mbeans
disableJVMSystemBeans	disables base JVM system Mbeans
FlushBean/WSFlushBean	Manages Online/IWS Cache
Attributes	
VersionInfo	Returns string of base version number of Mbean.

Mbean	Usage
CompleteClassPath	Returns classpath name of Mbean.
Operations	
flushAll	Reset all elements in online data cache
flushDropDownCache	Resets cached elements of the online drop down lists in online data cache
flushDropDownField	Resets drop down fields in online data cache (<i>Development use only</i>)
flushFieldAndFKMetaData	Resets Field and Foreign Key Meta Data in online data cache
flushMenu	Reset Menu items in online data cache
flushMessageCatalog	Reset field labels in online data cache
flushMessaging	Reset messages in online data cache
flushNavigationInfo	Reset navigation information in online data cache
flushPortalMetaInfo	Reset portal and zone information in online data cache
flushSystemLogInfo	Reset security information in online data cache
flushUIXSLs	Reset user interface style sheets in online data cache
JVMInfo	JVM Information Mbean
Attributes	
CompleteClassPath	Displays the class path of the JVMInfo mbean
Operations	
classpath	Returns the full classpath used by the online JVM
systemSettings	Returns the attributes of the JVM for debugging and support purposes.
JVMSystem	JVM Mbean (Java base metrics)
ClassLoadingMXBean	Class Loading JVM Mbean
Attributes	
LoadedClassCount	Returns the number of classes that are currently loaded in the JVM
ObjectName	The ObjectName for uniquely identifying the MXBean for the class loading system within an MBeanServer. In this case it is set to java.lang:type=ClassLoading
TotalLoadedClassCount	Returns the total number of classes that have been loaded since the JVM was last started.
UnloadedClassCount	Returns the total number of classes unloaded since the

Mbean	Usage
	Java virtual machine has started execution.
Verbose	Enables or disables the verbose output for the class loading system. Default is false (<i>disabled</i>)
MemoryMXBean	Memory JVM Mbean
Attributes	
HeapMemoryUsage	Returns the current memory usage of the heap that is used for object allocation. Initial, Committed, Maximum and Used memory statistics are provided for Heap memory
NonHeapMemoryUsage	Returns the current memory usage of non-heap memory that is used by the JVM. Initial, Committed, Maximum and Used memory statistics are provided for Non-Heap memory
ObjectPendingFinalization	Returns the approximate number of objects for which finalization is pending (used for diagnosing memory leaks).
ObjectName	The ObjectName for uniquely identifying the MXBean for the memory system within an MBeanServer. In this case it is set to java.lang:type=Memory
Verbose	Enables or disables the verbose output for the memory system. Default is false (<i>disabled</i>)
Operations	
gc	Initiate garbage collection
Notifications	
javax.management.Notification	Used for low memory notifications. Notification Types supported: (java.management.memory.threshold.exceeded, java.management.memory.collection.threshold.exceeded)
OperatingSystemMXBean	Operating System Mbean
Attributes	
MaxFileDescriptorCount	Returns the File Descriptor Maximum Limit in force on the JVM
OpenFileDescriptorCount	Returns the number of Open File Descriptors currently used by JVM
CommittedVirtualMemorySize	Returns the amount of committed virtual memory (that is, the amount of virtual memory guaranteed to be available to the running process).

Mbean	Usage
FreePhysicalMemorySize	Returns the total amount of free physical memory
FreeSwapSpaceSize	Returns the total amount of free swap space
ProcessCpuTime	Returns the amount of process CPU time consumed by the JVM
TotalPhysicalMemorySize	Returns the total amount of physical memory
TotalSwapSpaceSize	Returns the total amount of swap space
Name	Returns the operating system name
Version	Returns the version of the operating system
Arch	Returns the operating system architecture
AvailableProcessors	Returns the number of available processors to the JVM
SystemLoadAverage	Returns the system load average for the last minute.
Name	Returns the name representing the running JVM. The returned name string can be any arbitrary string and a JVM implementation can choose to embed platform-specific useful information in the returned name string. Each running virtual machine could have a different name.
ClassPath	Returns the Java class path that is used by the system class loader to search for class files.
ObjectName	The ObjectName for uniquely identifying the MXBean for the operating system within an MBeanServer. In this case it is set to java.lang:type=OperatingSystem
RuntimeMXBean	Java Runtime MBean
Attributes	
Starttime	Returns the start time of the Java virtual machine in milliseconds. This method returns the approximate time when the JVM started.
ManagementSpecVersion	Returns the version of the specification for the management interface implemented by the running JVM
VmName	Returns the Java virtual machine implementation name
VmVendor	Returns the Java virtual machine implementation vendor
VmVersion	Returns the Java virtual machine implementation version

Mbean	Usage
SpecName	Returns the Java virtual machine specification name
SpecVendor	Returns the Java virtual machine specification vendor
SpecVersion	Returns the Java virtual machine specification version
LibraryPath	Returns the Java library path
BootClassPath	Returns the boot class path that is used by the bootstrap class loader to search for class files
Uptime	Returns the uptime of the Java virtual machine in milliseconds
BootClassPathSupported	Tests if the JVM supports the boot class path mechanism used by the bootstrap class loader to search for class files. Returns <i>false</i> if not supported; <i>true</i> if supported
InputArguments	Returns the input arguments passed to the JVM which does not include the arguments to the main method. This method returns an empty list if there is no input argument to the JVM. Typically, not all command-line options to the ' java ' command are passed to the Java virtual machine. Thus, the returned input arguments may not include all command-line options
SystemProperties	Returns a map of names and values of all system properties
ThreadCount	Returns the current number of live threads including both daemon and non-daemon threads
PeakThreadCount	Returns the peak live thread count since the JVM started or peak was reset
TotalStartedThreadCount	Returns the total number of threads created and also started since the JVM started
DaemonThreadCount	Returns the current number of live daemon threads
ThreadContentionMonitoringSupported	Tests if the JVM supports thread contention monitoring. Returns <i>false</i> if not supported; <i>true</i> if supported
ThreadContentionMonitoringEnabled	Enables or disables thread contention monitoring. Set to <i>false</i> to disable; <i>true</i> to enable.
CurrentThreadCpuTime	Returns the total CPU time for the current thread in nanoseconds. The returned value is of nanoseconds precision but not necessarily nanoseconds accuracy. If the implementation distinguishes between user mode time and system mode time, the returned CPU time is the amount of time that the current thread has executed

Mbean	Usage
	in user mode or system mode
CurrentThreadUserTime	Returns the CPU time that the current thread has executed in user mode in nanoseconds. The returned value is of nanoseconds precision but not necessarily nanoseconds accuracy.
ThreadCpuTimeSupported	Tests if the JVM supports CPU time measurement for the current thread. Returns <i>false</i> if not supported; <i>true</i> if supported
ThreadCpuTimeEnabled	Enables or disables thread CPU time measurement. The default is platform dependent. Set to <i>false</i> to disable; <i>true</i> to enable.
CurrentThreadCpuTimeSupported	Tests if the Java virtual machine supports CPU time measurement for the current thread. Returns <i>false</i> if not supported; <i>true</i> if supported
ObjectMonitorUsageSupported	Tests if the Java virtual machine supports monitoring of object monitor usage. Returns <i>false</i> if not supported; <i>true</i> if supported
SynchronizerUsageSupported	Tests if the JVM supports monitoring of ownable synchronizer usage. Returns <i>false</i> if not supported; <i>true</i> if supported
AllThreadIDs	Returns all live thread IDs. Some threads included in the returned array may have been terminated when this method returns
ObjectName	The ObjectName for uniquely identifying the MXBean for the java runtime within an MBeanServer. In this case it is set to java.lang:type=Runtime
Operations	
dumpAllThreads	Returns the thread info for all live threads with stack trace and synchronization information. Some threads included in the returned array may have been terminated when this method returns <ul style="list-style-type: none"> • Locked Monitors - if <i>true</i>, dump all locked monitors • Locked Synchronizers - if <i>true</i>, dump all locked ownable synchronizers
findDeadlockedThreads	Finds cycles of threads that are in deadlock waiting to acquire object monitors or ownable synchronizers. Threads are deadlocked in a cycle waiting for a lock of these two types if each thread owns one lock while trying to acquire another lock already held by another

Mbean	Usage
	thread in the cycle
getThreadCpuTime	Returns the total CPU time for a thread of the specified ID in nanoseconds. The returned value is of nanoseconds precision but not necessarily nanoseconds accuracy. If the implementation distinguishes between user mode time and system mode time, the returned CPU time is the amount of time that the thread has executed in user mode or system mode
getThreadInfo	Returns the thread info for a thread of the specified id with no stack trace.
getThreadInfo	Returns the thread info for each thread whose ID is in the input array ids with no stack trace.
getThreadInfo	Returns thread information for a thread of the specified id, with stack trace of a specified number of stack trace elements. The <i>maxDepth</i> parameter indicates the maximum number of <i>StackTraceElements</i> to be retrieved from the stack trace. This method does not obtain the locked monitors and locked synchronizers of the thread
getThreadInfo	Returns the thread information for each thread whose ID is in the input array ids, with stack trace of a specified number of stack trace elements. The <i>maxDepth</i> parameter indicates the maximum number of <i>StackTraceElements</i> to be retrieved from the stack trace. This method does not obtain the locked monitors and locked synchronizers of the threads
getThreadInfo	Returns the thread info for each thread whose ID is in the input array ids, with stack trace and synchronization information. This operation obtains a snapshot of the thread information for each thread including: <ul style="list-style-type: none"> • the entire stack trace, • the object monitors currently locked by the thread if <i>lockedMonitors</i> is true, and • the ownable synchronizers currently locked by the thread if <i>lockedSynchronizers</i> is true
getThreadUserTime	Returns the CPU time that a thread of the specified ID has executed in user mode in nanoseconds
resetPeakThreadCount	Resets the peak thread count to the current number of live threads
OEMTargetsBean	Application Management Pack for Oracle Utilities

Mbean	Usage
	interface
Operations	
toXML	Generate Target information for Oracle Enterprise Manager. An XML document with information for the Application Management Pack for Oracle Utilities.

Business Application Server JMX Reference

Once configured a JMX client (e.g. **j console**) can be used to connect to the JMX information for the Business Application Server using the following Remote Connection string:

service:jmx:rmi:///jndi/rmi://<host>:<jmx_port>/oracle/ouaf/ejbAppConnector

Where:

- <host>** The Business Application Server host name
- <jmx_port>** The JMX Port specified using **BSN_JMX_RMI_PORT_PERFORMANCE** from the [ENVIRON.INI](#) configuration file.

The credentials provided to the JMX console are as configured in [JMX Security](#). Upon successful connection to the JMX port and host with the correct credentials provides access to the Mbean information. The figure below illustrates the successful connection to the JMX Mbeans using **j console** (as an example):

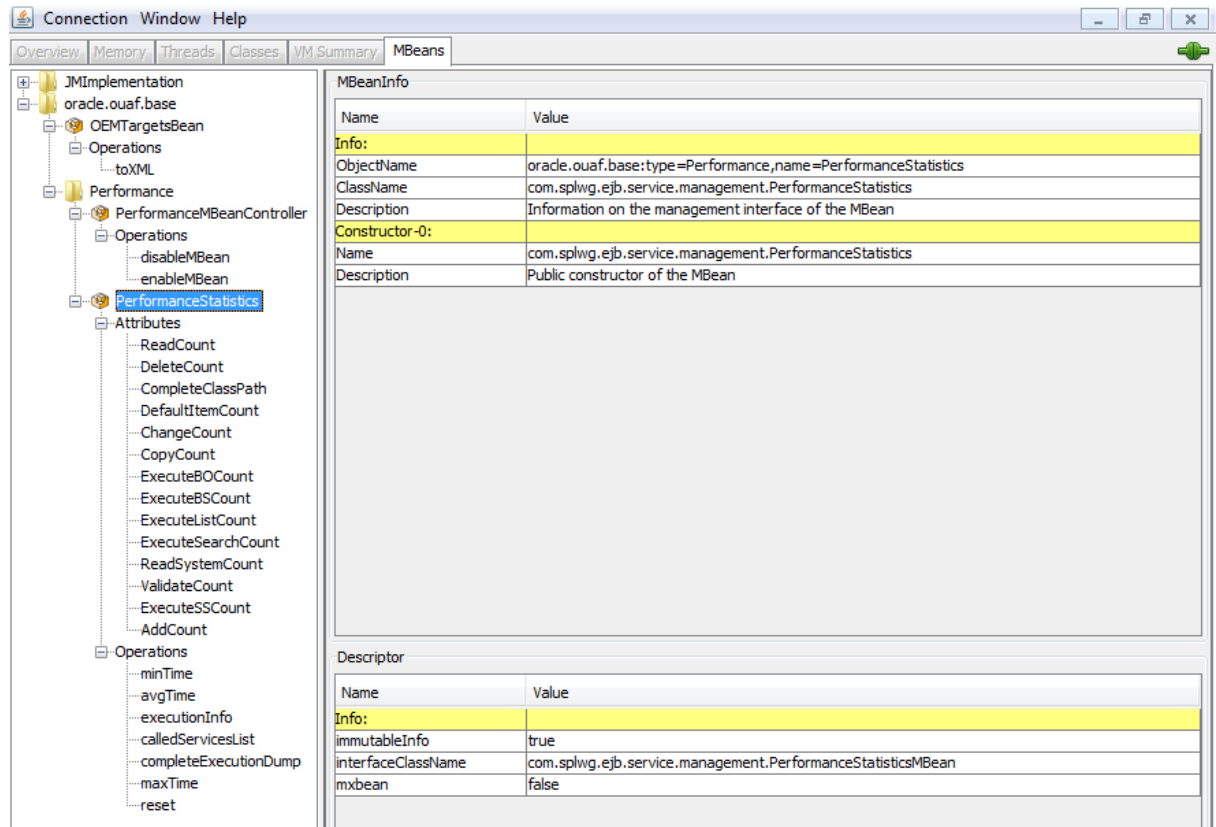

Figure 14 – Example Business Application Server Mbeans in jconsole

The structure of the Mbean is shown by the figure below:

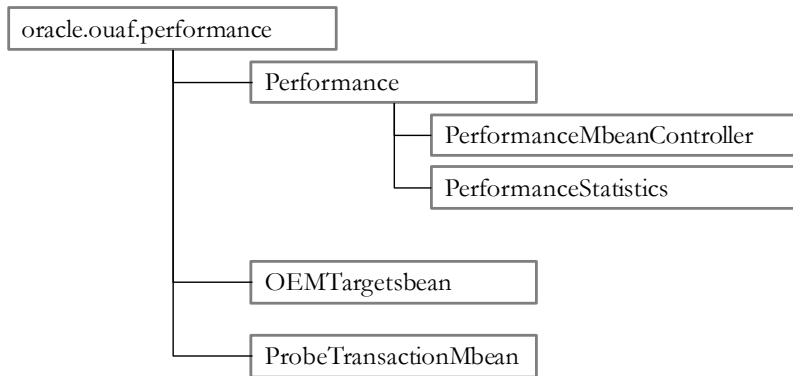

Figure 15 – Business Application Server Mbeans

The following table outlines the Mbean attributes and operations for the Business Application Server:

Mbean	Usage
PerformanceMbeanController	Performance Mbean Controller
Operations	
disableMbean	Disable PerformanceStatistics Mbean
enableMbean	Enable PerformanceStatistics Mbean
PerformanceStatistics	Performance Statistics
Attributes	
ReadCount	Returns number of executed <i>read object</i> calls since last reset or last time collection enabled
DeleteCount	Returns number of executed <i>delete object</i> calls since last reset or last time collection enabled
ChangeCount	Returns number of executed <i>change object</i> calls since last reset or last time collection enabled
AddCount	Returns number of executed <i>add object</i> calls since last reset or last time collection enabled
DefaultItemCount	Returns number of executed calls to <i>default the object values</i> since last reset or last time collection enabled
ExecuteB0Count	Returns number of calls to <i>Business Objects</i> since last reset or last time collection enabled
ExecuteBSCount	Returns number of calls to <i>Business Services</i> since last reset or last time collection enabled
ExecuteListCount	Returns number of calls to <i>List based services</i> since last reset or last time collection enabled
ExecuteSearchCount	Returns number of calls to <i>search based services</i> since last reset or last time collection enabled
ReadSystemCount	Returns number of calls to <i>Oracle Utilities Application</i>

Mbean	Usage
	<i>Framework system Objects</i> since last reset or last time collection enabled
ValidateCount	Returns number of calls to <i>Validate objects</i> since last reset or last time collection enabled
ExecuteSSCount	Returns number of calls to <i>Service Scripts</i> since last reset or last time collection enabled
Operations	
CompleteClassPath	Returns the class path used for the Mbeans
reset	Resets statistical values. See Resetting Statistics for more advice on this operation.
maxTime	Returns maximum (worst case) time, in ms, for the designated service since the last reset or last time collection enabled.
minTime	Returns minimum (best case) time, in ms, for the designated service since the last reset or last time collection enabled.
completeExecutionDump	Returns complete statistics for all services executed since the last reset or last time collection enabled. See Execution Dump section for details of format.
avgTime	Returns average time, in ms, for the designated service since the last reset or last time collection enabled.
executionInfo	Returns complete statistics for the designated service executed since the last reset or last time collection enabled. See Execution Dump Format section for details of format.
calledServices	Returns list of services and service types since the last reset or last time collection enabled. See Service Lists for details of format.
ProbeTransactionMbean	Component Probe
Operations	
checkApplicationServer	Constructs HTTP/HTTPS request and returns RFC 2616 HTTP response code and response time in ms
checkDatabaseConnectivity	Executes SQL SELECT to test database connectivity. Returns response time in ms.
checkBusinessApplicationServer	Executes base service (read only) to return application server performance in ms.
OEMTargetsBean	Application Management Pack for Oracle Utilities

Mbean	Usage
	interface
Operations	
toXML	Generate Target information for Oracle Enterprise Manager. An XML document with information for the Application Management Pack for Oracle Utilities.

Note: The times quoted in the statistics only record times experienced from the Business Application Server down to the data and back. They do not include network time to the Web Application Server, any time spent by the Web Application Server, network time to the browser client or browser rendering times. The Business Application Server time represents the typical majority of the time spent in a transaction.

Batch JMX Reference **BATCH**

Once configured a JMX client (e.g. **j console**) can be used to connect to the JMX information for the Business Application Server using the following Remote Connection string:

service:jmx:rmi:///jndi/rmi://<host>:<jmx_port>/oracle/ouaf/batchConnector

Where:

<host> A Batch Server host name

<jmx_port> The JMX Port specified using **BATCH_RMI_PORT** from the [ENVIRON.INI](#) configuration file.

*Note: In a multi-host environment, it is possible to reserve a specific host/port combination using the **WEB_BATCH_CLUSTER_URL** which specifies a specific host and **BATCH_RMI_PORT** combination as the administration machine.*

The credentials provided to the JMX console are as configured in [JMX Security](#). Upon successful connection to the JMX port and host with the correct credentials provides access to the Mbean information. The figure below illustrates the successful connection to the JMX Mbeans using **j console** (as an example):

The screenshot shows the JConsole interface with the 'MBeans' tab selected. The left pane displays a tree view of MBeans under 'oracle.ouaf.base'. The 'BatchCluster' MBean is expanded, showing its 'Attributes' (Address, Name, Port, ClusterAsString), 'Operations' (flushAllCaches, registerClusterMBeans, unregisterClusterMBeans), and 'ThreadPools'. The 'ThreadPools' section is further expanded to show a 'DEFAULT' pool with its own 'Attributes' (Name, AvailableThreads, NumberOfMembers) and 'Members'. One member is visible with its own 'Attributes' (HostName, JVMName, PID, MemberId, Info) and 'Operations' (flushAllCaches, stopNode, displayClusterCache). Other MBeans like 'L2OFF', 'cache', 'ClusteredNode', and 'OEMTargetsBean' are also visible in the tree.

The right pane displays the 'MBeanInfo' for the selected 'BatchCluster' MBean. It contains two tables: 'MBeanInfo' and 'Descriptor'.

Name	Value
Info:	
ObjectName	oracle.ouaf.base:duster=BatchCluster,name=
ClassName	com.splwg.base.support.batch.management.dcluster.Cluster
Description	Information on the management interface of the MBean
Constructor-0:	
Name	com.splwg.base.support.batch.management.dcluster.Cluster
Description	Public constructor of the MBean
Parameter-0-0:	
Name	p1
Description	
Type	java.lang.String

Name	Value
Info:	
immutableInfo	true
interfaceClassName	com.splwg.base.support.batch.management.dcluster.ClusterMBean
mxbean	false

Figure 16 – Example Batch Server Mbeans in jconsole

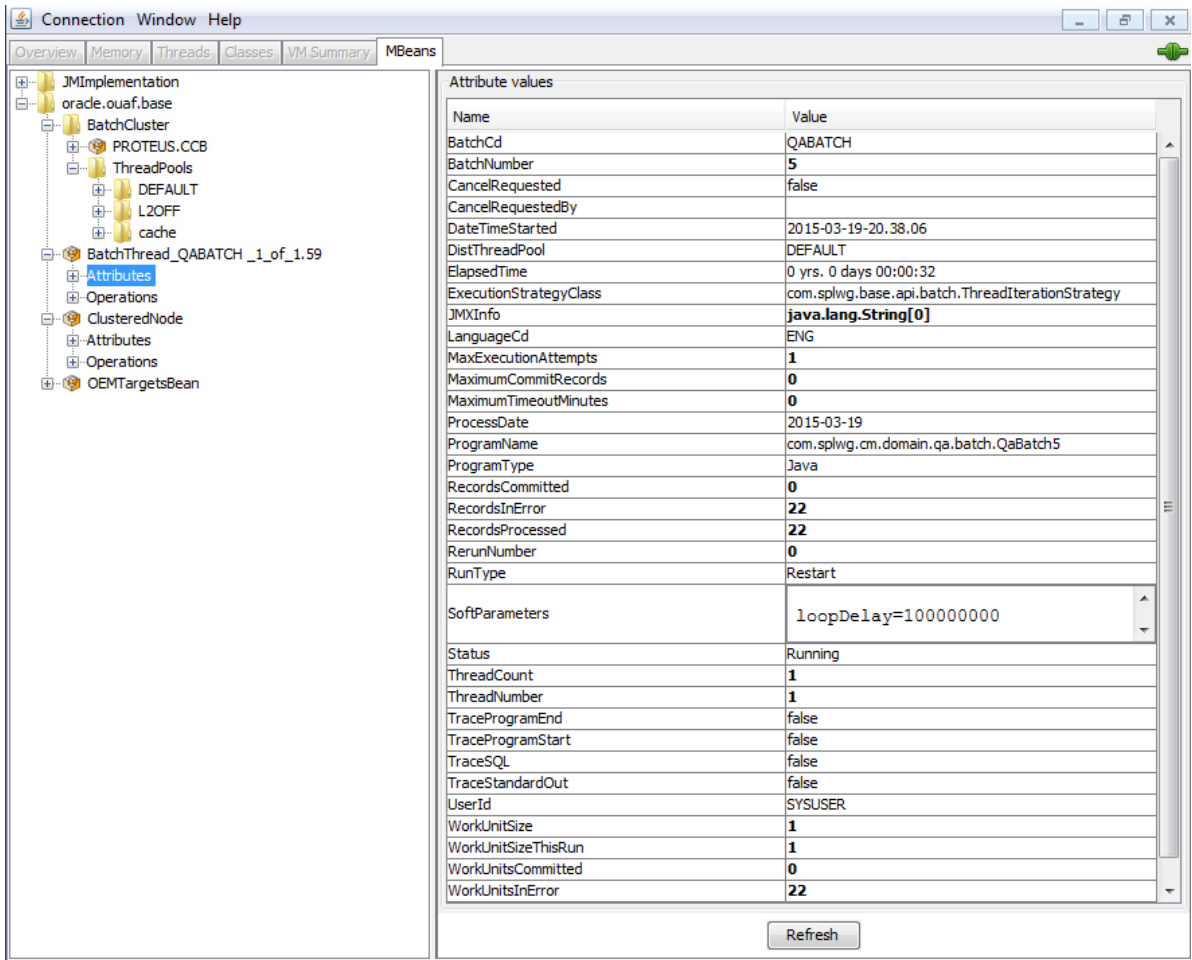

Figure 17 – Example Batch Thread Mbean in jconsole

The structure of the Mbean is shown by the figure below:

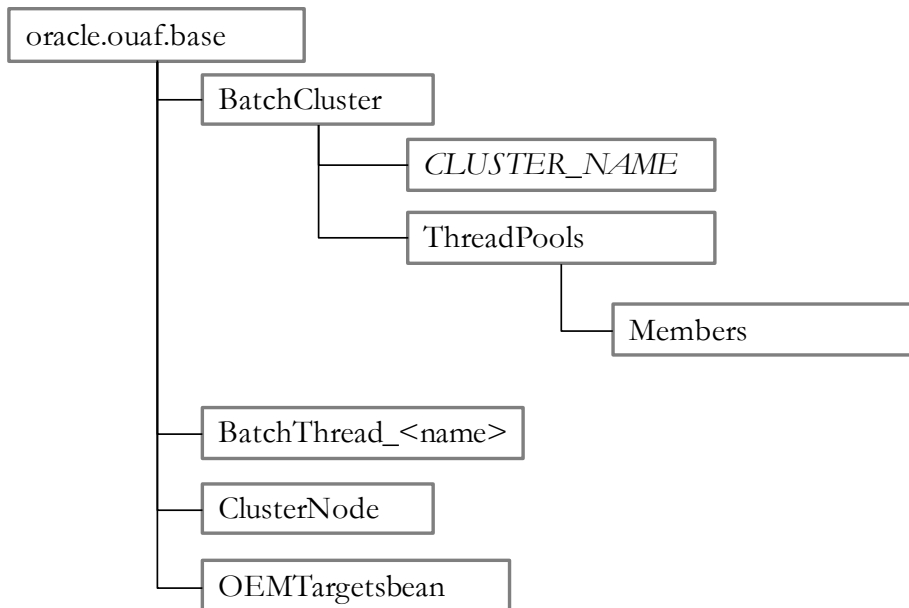

Figure 18 – Batch Server Mbeans

The following table outlines the Mbean attributes and operations for the Business Application Server:

Mbean	Usage
-------	-------

Mbean	Usage
BatchCluster	Cluster Mbean for cluster with name <ClusterName>
Attributes	
Address	Cluster address as specified in COHERENCE_CLUSTER_ADDRESS in ENVIRON.INI
Name	Name of Cluster as specified in COHERENCE_CLUSTER_NAME in ENVIRON.INI
Port	Port number assigned to Cluster as specified in COHERENCE_CLUSTER_PORT in ENVIRON.INI
ClusterAsString	XML representation of the cluster for use with Application Management Pack for Oracle Utilities. The structure represents the hierarchy of JMX calls in XML format.
Operations	
flushAllCaches	Flush the data reuse cache across the batch cluster. Invoke this operation to reload configuration data changes for batch jobs.
registerClusterMBeans	Register the Mbeans for lower level tracking. This needs to be invoked to allow threadpool and batch thread level tracking.
unregisterClusterMBeans	Disable lower level tracking. This stops low level tracking.
ThreadPool s¹³	Threadpool Statistics (an entry per threadpool)
Attributes	
Name	Name of Threadpool
AvailableThreads	Number of spare threads for batch processes. A value of zero (0) indicates the threadpool is at capacity. <i>Note: For cache or administration threadpools, this value is always zero (0).</i>
NumberOfMembers	Number of members/hosts defined to the threadpool. A value of zero (0) indicates a cache or administration threadpool.
Members	Member (submitters/nodes) statistics
Attributes	
HostName	Name of Host hosting this threadpool instance
JVMName	Name of JVM assigned at runtime
PID	Unique OS Process Id for JVM

¹³ This tree will only appear if registerClusterMbeans is executed to enable the additional metrics.

Mbean	Usage
MemberId	Member Number. This number of unique across the cluster and is used to track the member internally by the framework.
Info	Parameters used to start threadpool instance in free format. This is primarily used by Application Management Pack for Oracle Utilities.
Operations	
flushAllCaches	Flush the cache for this instance
stopNode	Stop this member. This allows members to be stopped manually.
displayClusterCache	Cluster Cache in free format. This is primarily used by Application Management Pack for Oracle Utilities.
ClusterNode	Member information about the member you are connected to
Attributes	
JVMName	Name of JVM assigned at runtime
PID	Unique OS Process Id for JVM
Info	Parameters used to start threadpool instance in free format. This is primarily used by Application Management Pack for Oracle Utilities.
Operations	
flushAllCaches	Flush the cache for this instance
stopNode	Stop this member. This allows members to be stopped manually.
displayClusterCache	Cluster Cache in free format. This is primarily used by Application Management Pack for Oracle Utilities.
BatchThread/BatchJob¹⁴	Batch Thread/Job Metrics
Attributes	
BatchCd	Batch Code
BatchNumber	Batch Number
Cancel Requested	True if the thread has been asked to stop running. See <i>CancelRequestedBy</i> .
Cancel RequestedBy	If <i>CancelRequested=true</i> , this will be a string indicating the workstation from where the cancellation was requested.

¹⁴ BatchThreads is spawned per thread. BatchJob is spawned for jobs with multiple threads as a control node. BatchJob will not be spawned for single thread jobs.

Mbean	Usage
	This value will also be logged to the Batch Run Tree.
DateTimeStarted	The date and time the batch process was started.
DistThreadPool	The thread pool to which this batch process belongs.
ElapsedTime	How long the batch process has been running in java format
ExecutionStrategyClass	This indicates the commit strategy followed by the program
JMInfo	Additional Tags for batch thread
LanguageCD	Language Code used for execution for messages
MaxExecutionAttempts	MAX- ERROR value
MaximumCommitRecords	Commit Interval for Timeouts (<i>Legacy Support only</i>)
MaximumTimeoutMinutes	Timeout Interval (<i>Legacy Support only</i>)
ProcessDate	Business Date
ProgramName	The program name executed. This is set on the Batch Control .
ProgramType	The program type. Value is typically: <i>Java</i>
RecordsCommitted	The number of record updates that have been committed to the database. See note below.
RecordsInError	The number of records so far in error. This is what will be logged to the Batch Run Tree. See note below.
RecordsProcessed	The number of records processed so far. This is what will be logged to the Batch Run Tree. See note below.
RerunNumber	Rerun Number if RunType is <i>Rerun</i> .
RunType	The type of run: <i>New Run, Restart</i> or <i>Rerun</i> .
SoftParameters	List of job parameters from Batch Control .
Status	Current status of the thread. Valid values are: <i>Initializing</i> " (at the start of execution to the call to getJobWork in the application class); <i>Getting Work</i> means it is currently in the process of selecting the work units for the batch process; <i>Got Work</i> means it is has successfully selected the work and is in the process of initiating the threads.
ThreadCount	Thread Limit
ThreadNumber	Thread Number
TraceProgramEnd	Whether tracing for Program End is enabled
TraceProgramStart	Whether tracing for Program Start is enabled
TraceSQL	Whether SQL statement tracing is enabled

Mbean	Usage
TraceStandardOut	Whether output tracing is enabled
UserId	User used for authorization
WorkUnitsSize	The total number of work units for this batch process. For new and restarted runs, this will always contain the total number of work units as selected in the getJobWork method when the batch process was originally started.
WorkUnitsSizeThisRun	This is the number of work units for this particular run. For a restarted run, this value will typically be less than the above value; otherwise they will be the same.
WorkUnitsCommitted	The number of work units that have had their work committed.
WorkUnitsInError	The work units that have been found to be in error so far.
WorkUnitsProcessed	The work units that have been processed so far.
Operations	
cancelThread	Cancel this thread. This updates CancelRequested and CancelRequestedBy . Information is persisted on the Batch Run Tree.
OEMTargetsBean	
Application Management Pack for Oracle Utilities interface	
Operations	
toXML	Generate Target information for Oracle Enterprise Manager. An XML document with information for the Application Management Pack for Oracle Utilities.

*Note: Each batch thread is uniquely identifiable in the BatchThread JMX call with the name **<mbean>**. **<batchcd>**. **<thread>_of_<threadlimit>**. **<javathread>**. Where **<mbean>** is BatchJob or BatchThread, **<batchcd>** is the batch control identifier for the job, **<thread>_of_<threadlimit>** is the thread within thread limit and **<javathread>** is the internal java thread number.*

Note: The "Records..." numbers are what will be used to log to the Batch Run Tree, and they are usually in step with the "WorkUnits..." values. The reason they are shown separately is because it is possible for custom background processes manually manipulate the record counts for the Batch Run Tree. The true progress status of a thread is reflected in the "WorkUnits..." counts.

JMX Security

By default, when JMX is enabled for either the Web Application Server, Web Service and Business Application Server then a default JMX configuration using simple security is implemented as outlined in <http://java.sun.com/javase/6/docs/technotes/guides/management/agent.html>.

The simple security system consists of two files that control the access permissions and

passwords specified by default for the installation:

Configuration Setting	Location of file	Template
Password File	<code>scripts/ouaf.jmx.password.file</code>	<code>ouaf.jmx.password.file.template</code>
Access Control File	<code>scripts/ouaf.jmx.access.file</code>	<code>ouaf.jmx.access.file.template</code>

These files are built by the [initialSetup](#) utility using the templates indicated. Refer to the templates or generated files for valid values. The format of these files is dictated by <http://java.sun.com/javase/6/docs/technotes/guides/management/agent.html#gdeup>.

Note: By default, the passwords stored in these files are in encrypted text. Alternative security schemes are allowed as documented in the [link above](#). This will require a [custom templates](#) and changes to specific files to implement.

Extending JMX Security

Whilst the base installation of the product uses the basic level of security there are ways of extending the current security:

- If the default security scheme is sufficient for your needs then additional users may be manually added using the [user exits](#) for the above files.
- For production it is recommended to implement an SSL based solution as outlined in <http://docs.oracle.com/javase/6/docs/technotes/guides/management/agent.html>.

Refer to the product Security Guide for more schemes available for this process.

Execution Dump Format

In previous versions (V1.x) of the Oracle Utilities Application Framework based products, it was possible to extract performance information from the Business Application Server using a logging based method using the Oracle Tuxedo **txrpt** utility. This facility was useful in tracking performance of individual services over time to detect non-compliance against Service Level Agreement targets. With the advent of later versions of the Oracle Utilities Application Framework, the need for Oracle Tuxedo was removed but there was a need for performance information to be collated.

In the latest version of the Oracle Utilities Application Framework, it is possible to track performance information using JMX to process externally to check performance and check compliance against Service Level Agreements.

To extract the information from the product the following needs to be done:

- Use a JMX browser (or JMX console) product to connect to the Business Application Server JMX port using the appropriate credentials.
- Invoke the **completeExecutionDump** operation from the **PerformanceStatistics** Mbean. This will return a Comma separated values, with field names in the header record, containing the performance data which can be transferred to the clipboard (or whatever format supported by the JMX client). The format of the CSV is shown in the table below:

Column	Comment
--------	---------

Column	Comment
ServiceName	Name of Service
ServiceType	Type Of Service or Action (see Service Lists for valid values)
MinTime	Minimum Service Time, in ms, since last reset
MaxTime	Minimum Service Time, in ms, since last reset
Avg Time	Average Service Time, in ms, since last reset
# of Calls	Number of Calls to Service since last reset
Latest Time	The service time of the latest call, in ms
Latest Date	The date of the latest service call (in format: YYYY-MM-DD::hh-mm-ss-sss)
Latest User	The userid of the user who issued the latest call

- (Optionally) Invoke the **reset** operation from the **PerformanceStatistics** Mbean to reset the statistics for the next collection period. Refer to [Resetting Statistics](#) for a discussion of this task.

This information can then be post processed in an appropriate analysis tool to determine appropriate actions.

Note: The statistics are active as long the Mbean is enabled or the system is active. Shutting down the Business Application Server with collection of the data may cause data loss for the statistics.

Service Lists

The JMX Performance Mbeans collect information about application services that have been executed during the collection period. This information can be obtained using the **calledServices** operation which returns a list of called services and their valid actions (summarized actions that have been called) in the format:

<servicename> [<valid action>]

Where

<servicename> Name of Service

<valid actions> List of valid actions recorded for the service. The table below lists the valid values

Valid Action	Comment
ADD	Service is attempting adding a new instance of an object to the system. For example, adding a to do record.
CHANGE	Service is attempting changes to an existing object in the system.
DEFAULT_ITEM	Service is resetting its values to defaults. For example, by pressing the <i>Clear</i> button on the product UI toolbar
DELETE	Service is attempting to delete an existing object
EXECUTE_BO	Service is a business object

EXECUTE_BS	Service is a business service
EXECUTE_LIST	Service is a list based service
EXECUTE_SEARCH	Service is a search
EXECUTE_SS	Service is a service script (including BPA scripts)
READ	Service is attempting to retrieve an object from the system
READ_SYSTEM	Service is a common Oracle Utilities Application Framework based service.
VALIDATE	Service is issuing a validation action

Resetting Statistics

The performance statistics collected represent values since the application was started or when it has been reset. Collection of statistics, without reset, can adversely influence the effectiveness of the statistics over time. It is therefore recommended to reset the statistics on a regular basis (after they are collected for example).

This can be achieved using the **reset** operation from the **PerformanceStatistics** Mbean to effectively zero or blank out the collection statistics.

For example, if the statistics are to be collected on an hourly basis then the reset should occur after the data collection happens per hour.

Note: Any statistics collected during the actual reset operation will not be reflected in the statistics. This situation should have minimal impact on overall statistics.

Database Connection Monitoring

By default, the product uses a common database userid for accessing the information from the connection pools used by the product (via Universal Connection Pool (UCP)). While this sufficient for execution of the product, it can complicate monitoring individual connections and troubleshooting database issues with individual users or transactions.

It is now possible to show additional details that are inherited from the from the online and Web Services components. The following information is available from the connection and accessible from **v\$session**.

Parameter	Online	Web Service	Batch
CLIENT_IDENTIFIER¹⁵	Userid	Userid	Userid
MODULE	Service Name	Web Service Name	Batch Control
ACTION	Transaction Type	Transaction Type	Thread Number
CLIENT_INFO	Contents Database	of Tag	"Web Service" Threadpool Name

¹⁵ Due to the length limitation on **CLIENT_IDENTIFIER** the value will be the authorization identifier not the authentication identifier.

Parameter	Online	Web Service	Batch
	characteristic User	on	

For example, the following database query will return the session ids and the users using then at any time:

```
SELECT sid, client_identifier, module, client_info, action FROM V$SESSION;
```

The new information can be used to track sessions using the **v\$session** view, use more advanced features of the database and use other database options.

Probe Transaction

One of the monitoring facilities in the product is a probe transaction for the online component of the product. This is a set of JMX calls to the various components of the architecture to determine two sets of metrics:

- Availability of the component - The availability will return a pass or fail on availability (including details is possible) of the component.
- Raw performance - The raw transaction performance of the component from the call. This represents the raw performance and should be used as a raw indication of performance at the network level.

The following components are tested using this capability:

Component	Test	Availability	Performance
Web Application Server	HTTP/HTTPS ping	RFC 2616 code	Time in ms
Business Application Server	Service Call	true or false	Time in ms
Database Server	SQL SELECT	True or SQL Error	Time in ms

The API is part of the [Business Application Server JMX](#) facility.

Note: Customers using Application Management Pack for Oracle Utilities can use additional API's for performance and availability tracking.

Configuration

Configuration Files

There are a number of configuration files that are implemented across the various components of the environment.

application.xml – ADF Application configuration

Note: This configuration file only applies to Oracle WebLogic and Oracle ADF implementations.

To use the Oracle Application Development Framework (ADF) integration the ADF components need to be deployed to a predefined ADF container. The definition of this container is controlled by the JEE standard **application.xml** file.

Parameter	Context	Source
context-root	ADF context root used for calls	Set to WEB_CONTEXT_ROOT/adf
display-name	Specifies the application display name	Set to SPLAdf
web-uri	Defines location of WAR file	Set to SPLAdf

Example:

```
<?xml version = ' 1.0' ?>
<application xmlns:xsi="http://www.w3.org/2001/XMLSchema-instance"
xsi:schemaLocation="http://java.sun.com/xml/ns/javaee
http://java.sun.com/xml/ns/javaee/application_5.xsd" version="5"
xmlns="http://java.sun.com/xml/ns/javaee">
  <display-name>SPLAdf</display-name>
  <module>
    <web>
      <web-uri>SPLAdf</web-uri>
      <context-root>demo/adf</context-root>
    </web>
  </module>
</application>
```

Note: This file should not be altered unless instructed by Oracle Support.

cistab - Global Configuration Files

The **cistab** file is a key configuration file for both the Web application server and the database application server. It is built during the installation process and is used by the product administration utilities to ensure that any output or log files generated by the product are stored in the correct location. It holds the mount points (e.g. directories) used during the installation of the product to hold the product and its log files.

Location of **cistab** file:

Linux/Unix:
/etc/cistab

Windows:

c: \spl \etc\ci stab

A sample cistab file is outlined below:

DEV: : /spl /DEV: /spl /spl output /DEV: : N

DEMO: : /spl /DEMO: /spl /spl output /DEMO: : N

TEST: : /spl /TEST: /spl /spl output /TEST: : N

TEST2: : d: \spl \TEST2: e: \spl output \TEST2: : N

The format of the file is described below:

Position	Usage
1	Environment Name – specified at installation time. It is in UPPER case.
2	Reserved for future use.
3	Directory for the product software and configuration files (the SPLEBASE environment variable definition).
4	Directory for the product output files (the SPLOUTPUT environment variable definition).
5	Reserved for future use.
6	This flag may be used in custom start up scripts to indicate whether to start the environment at system boot time. Valid values are Y or N. This is the only setting that should be altered after installation.

*Warning! Do not alter the **cistab** file unless instructed to do so by Oracle support personnel unless otherwise directed.*

*Note: For Windows environments it is possible to move the file to alternative drive by setting **%SYSTEMDRIVE%** to an alternative drive prior to running any utilities. For example **set SYSTEMDRIVE=D:** places the **cistab** in **d: \spl \etc**.*

coherence-cache-config.xml - Oracle Coherence Configuration **BATCH**

The [coherence-cache-config.xml](#) configuration file is used by the **CLUSTERED** mode of execution to manage the Oracle Coherence based cache across the batch cluster. This file is generally not altered at the implementation level as it is preconfigured to execute the batch component of the product.

For details of the contents of this file refer to the [Oracle Coherence Integration Guide](#).

e0Batch.properties - General Batch Properties **BATCH**

Note: This configuration file is generated and should not be altered unless instructed by Oracle Support.

This configuration file is used by the batch component to set the location of the installation and the location for any log files generated by the batch component.

This configuration file has two settings that are generated from the **e0Batch.properties.template** file located in **templates** directory:

Configuration Setting	Contents
standalone.dir	Location of batch installation
SPLOUTPUT	Location of output files

ejb-jar.xml - Enterprise Java Server Beans Configuration

The Business Application Server and MDB functionality uses Enterprise Java Server beans to implement service calls. By default the behavior of these components is defined and controlled with the [ejb-jar.xml](#) configuration file.

This configuration file is generated by the [initialSetup](#) using the **templates/ejb-jar.xml.template** file.

Note: This configuration file is typically NOT altered unless custom JMS or MDB resources are to be included in the servers within the product. Typically JMS resources are not included in the server. Refer to the [Oracle WebLogic JMS Integration](#) (Doc Id: [1308181.1](#)) whitepaper for details of JMS or MDB advanced configuration.

ENVIRON.INI - Environment Configuration File

The [ENVIRON.INI](#) file is used by the Web application server and the Business Application Server to define the environment and provide the basis for starting and stopping the environment. The file is created during the installation process and is used to generate other files. This file is maintained using the [configureEnv](#) utility provided in the installation.

Warning! Do not alter the [ENVIRON.INI](#) manually. Always use [configureEnv](#) utility because additional configuration files depend on the settings in this file. If the configurations mismatch, improper operation of the product may occur.

Location of ENVIRON.INI file:

Linux/Unix:

[\\$SPLEBASE/etc/ENVIRON.INI](#)

Windows:

[%SPLEBASE%\etc\ENVIRON.INI](#)

The file contents are in text format and are of the form:

[<parameter>=<value>](#)

Where:

[<parameter>](#) Name of configuration parameter

[<value>](#) Value of the configuration parameter

For example:

```
...
appViewer=appViewer
DBCONNECTI ON=jdbc:oracle:thin:@myserver:1521:train
DBDRIVER=oracle.jdbc.driver.OracleDriver
DBNAME=TRAIN
...
```

The settings contained in the [ENVIRON.INI](#) file are outlined in [Appendix - ENVIRON.INI](#).

Extracting Information from ENVIRON.INI for Scripts

It is possible to write your own calls to the [ENVIRON.INI](#) using the same utilities used by the product to get values of configuration parameters for your own utilities. Do not hardcode values that can be obtained from [ENVIRON.INI](#).

To obtain values of parameters use the command line:

Linux/Unix:

```
perl $SPLEBASE/bin/getconfvalue.plx -k <parameter>
```

Windows:

```
perl %SPLEBASE%\bin\getconfvalue.plx -k <parameter>
```

Where:

<parameter> Name of configuration parameter from [ENVIRON.INI](#) you desire to get the value of.

For example:

ENVIRON.INI content:

```
...
DBNAME=TRAIN
...
```

Example call:

```
$ export DB=`perl $SPLEBASE/bin/getconfvalue.plx -k DBNAME`
$ echo $DB
TRAIN
```

Note: If the value is NOT set or the key is invalid the value of the call is null or blank.

hibernate.properties - Database Connectivity Settings

Opening a connection to a database is generally much less expensive than executing an SQL statement. A connection pool is used to minimize the number of connections opened between application and database. It serves as a librarian, checking out connections to application code as needed. Much like a library, your application code needs to be strict about returning connections to the pool when complete, for if it does not do so, your application will run out of available connections. Hence, the need for having a connection pooling mechanism such as Hibernate using Oracle [Universal Connection Pool](#) (UCP) connection pooling or JNDI based connection pooling.

The online and Web Service components of the product use JNDI based connection pools and the batch component uses UCP based connection pools.

Hibernate is a powerful Object Relational Mapping (ORM) technology that makes it easy to work with relational databases. Hibernate makes it seem as if the database contains plain Java objects, without having to worry about how to get them out of (or back into) database tables. Coupled with the UCP or JNDI connection pooler, it provides a comprehensive connectivity tool for the java to operate effectively against the database.

The product uses the Hibernate and either JNDI or UCP libraries to create a connection pool and connect the java objects to the database to store, update, delete and retrieve data. It is

used for all the database access for online as well as batch.

Refer to <http://www.hibernate.org> and http://www.oracle.com/technology/software/tech/java/sqlj_jdbc/htdocs/ucp.html for more information on the technology aspects of Hibernate and UCP.

The product has a configuration file for the database connectivity and pooling called the **[hibernate.properties](#)** configuration file. This file contains the configuration settings for the database connections and the connection pool to be used by any of the SQL statements accessing the database.

The configuration settings contained in the **[hibernate.properties](#)** file are summarized in the **[hibernate.properties](#)** section.

For a more indepth description of these parameters and others not included with the product see <http://www.hibernate.org> and http://www.oracle.com/technology/software/tech/java/sqlj_jdbc/htdocs/ucp.html.

log4j2.properties – Product Logging Configuration

Note: This log file should not be altered unless specified. The generated configuration file has all the recommended settings for all sites.

The product uses the *log4j2* Java classes to centralize all log formats into a standard format. The details of the configuration settings and *log4j2* itself are available at <https://logging.apache.org/log4j/2.x/> or <https://logging.apache.org/log4j/2.x/>.

Server Jar File (ouaf_jar_versions.txt)

Note: This configuration file is used for internal purposes and should not be altered unless instructed to do so by Oracle Support.

Note: Additional external jar files used for customizations do not need to be added to this file. This is used for base product verification only.

The java component of the product uses a number of industry standard jar files that are provided or used by the product. The **[etc/ouaf_jar_versions.txt](#)** lists the jar file that is used and the required version used by the version of the product installed. This file is used at installation and runtime for integrity checks. If you wish to determine what version of an external jar is used then refer to this information file.

spl.properties – Product Behaviour Settings

The product Web Application has a specific number of settings outside of the JEE specification to control the internals of the product. This file exists as similar files exist for all modes of operation of the product (for example, Batch can be run outside the JEE Web application server). Because of this a common configuration standard was adopted:

For a description of all settings in the **[spl.properties](#)** file refer to the **[spl.properties](#)** parameter descriptions.

submitbatch.properties - Submitter Configuration **BATCH**

Note: This is the default configuration file. Refer to the [Configuring Batch using bedit](#) section for a discussion of the role of this configuration and its variations

Each background process requires a configuration file to control its behavior. There are two levels of files that control the individual batch job executions:

- [submitbatch.properties](#) - This file sets the global settings for all batch jobs that are submitted. This file is located in `$SPLEBASE/spl app/standalone/config` directory (or `%SPLEBASE%\spl app\standalone\config` on Windows)
- `<batchcode>.properties` - This file is the same format as [submitbatch.properties](#) but contains any job specific settings and/or overrides to settings in the [submitbatch.properties](#).

Note: Any command line options can override settings in any configuration file.

This file is generated using the [bedit](#) facility.

tangosol-coherence-override.xml - Coherence Overrides **BATCH**

The [tangosol-coherence-override.xml](#) configuration file is used by the **CLUSTERED** mode of execution to override the settings for the Oracle Coherence based cache across the batch cluster. This file is generally not altered at the implementation level as it is preconfigured to execute the batch component of the product.

This file is generated using the [bedit](#) facility.

For details of the contents of this file refer to the [Oracle Coherence Integration Guide](#).

threadpoolworker.properties - Threadpool Configuration **BATCH**

Note: This is the default configuration file. Refer to the [Configuring Batch using bedit](#) section for a discussion of the role of this configuration and its variations

Each threadpoolworker requires a configuration file to control its behavior. This file is generated using the [bedit](#) facility for each type of threadpoolworker.

Note: Any command line options on [threadpoolworker/.sh](#) utility can override settings in any configuration file.

This file is generated using the [bedit](#) facility.

web.xml – JEE Deployment Descriptor

Note: For Inbound Web Services, a resource version of this file is generated.

The Web deployment descriptor editor lets you specify deployment information for modules created in the Web development environment. The information appears in the [web.xml](#) file. The [web.xml](#) file for a Web project provides information necessary for deploying a Web application module. It is used in building a WAR/EAR file from a project.

The Web Application is controlled by a configuration file that holds behavioral information for the applications. Refer to <http://jcp.org/en/jsr/detail?id=109> for more details of the format. For example:

```

...
<env-entry>
  <description>Value of HTTP 1.1 max-age header parameter for
  JSPs</description>
  <env-entry-name>maxAge</env-entry-name>
  <env-entry-value>28800</env-entry-value>
  <env-entry-type>java.lang.Integer</env-entry-type>
</env-entry>
<env-entry>
  <description>How long to cache drop down values in
  seconds</description>
  <env-entry-name>fieldValuesAge</env-entry-name>
  <env-entry-value>3600</env-entry-value>
  <env-entry-type>java.lang.Integer</env-entry-type>
</env-entry>
<env-entry>
  <description>Is this a development environment</description>
  <env-entry-name>isDevelopment</env-entry-name>
  <env-entry-value>false</env-entry-value>
  <env-entry-type>java.lang.Boolean</env-entry-type>
</env-entry>
<env-entry>
  <description>Preload ALL Pages</description>
  <env-entry-name>preloadAllPages</env-entry-name>
  <env-entry-value>false</env-entry-value>
  <env-entry-type>java.lang.Boolean</env-entry-type>
</env-entry>
<env-entry>
  <description>Disable preloading of Pages</description>
  <env-entry-name>disablePreload</env-entry-name>
  <env-entry-value>false</env-entry-value>
  <env-entry-type>java.lang.Boolean</env-entry-type>
</env-entry>
...

```

For application specific entries refer to the [web.xml parameter descriptions](#).

Note: It is highly recommended that you do not change this configuration file by extracting the configuration file from the WAR/EAR file using Java utilities, making the change manually and rebuilding the WAR/EAR file. Use [initialSetup](#) to build the WAR/EAR file as documented in [Web application server Configuration Process](#)

weblogic.xml – Oracle WebLogic Extensions

Note: This configuration file only applies to Oracle WebLogic implementations.

Note: For Inbound Web Services, a resource version of this file is generated.

For backward compatibility with Oracle WebLogic environments, an additional Oracle WebLogic configuration file [weblogic.xml](#) is generated and used to influence the Oracle WebLogic Server to exhibit additional behavior.

Parameter	Context	Source
context-root	The context-root element defines the context root of this stand-	Defaults from template

Parameter	Context	Source
	alone Web application. If the Web application is part of an EAR, not stand-alone, specify the context root in the EAR's web.xml file. A context-root setting in web.xml takes precedence over context-root setting in weblogic.xml .	
java-charset-name	Specifies the Java character set to use.	Defaults from template (UTF-8)
page-check-seconds	Determines the interval at which a server checks to see if JSP files in a Web application have changed and need recompiling. Used for development	Derived from WEB_WLPAGECHECKSECONDS parameter from ENVIRON.INI
prefer-web-inf-classes	Loading of web classes from the WEB-INF are loaded in preference to system or Oracle WebLogic classes. Defaulted to false .	Defaults from template
resource-path	A path which, if included in the URL of a request, signals Oracle WebLogic Server to use the Java character set specified by java-charset-name.	Defaults from template
servlet-reload-check-secs	Defines whether an Oracle WebLogic Server will check to see if a servlet has been modified, and if it has been modified, reloads it. The -1 value tells the server never to check the servlets, 0 tells the server to always check the servlets, and the default is to check each 1 second. A value specified in the console will always take precedence over a manually specified value.	Defaults from template
url-rewriting-enabled	Provides methods for configuring a JEE web application that is deployed on an Oracle WebLogic Server	Defaults from template (false)

Parameter	Context	Source
	instance. Oracle WebLogic Server instantiates this interface only when you deploy a web application.	
	This interface can configure web applications that are deployed as a WAR file or an exploded directory.	

Note: This configuration file is not usually altered by an implementation as it applies to development (SDK) platforms only. It is documented for completeness here.

Example:

```
<weblogic-web-app xmlns="http://www.bea.com/ns/weblogic/90">
  <session-descriptor>
    <url-rewriting-enabled>false</url-rewriting-enabled>
  </session-descriptor>
  <jsp-descriptor>
    <page-check-seconds>43200</page-check-seconds>
  </jsp-descriptor>
  <container-descriptor>
    <servlet-reload-check-secs>-1</servlet-reload-check-secs>
    <prefer-web-inf-classes>true</prefer-web-inf-classes>
  </container-descriptor>
  <charset-params>
    <input-charset>
      <resource-path>/*</resource-path>
      <java-charset-name>UTF-8</java-charset-name>
    </input-charset>
  </charset-params>
  <context-root></context-root>
</weblogic-web-app>
```

weblogic-ejb-jar.xml - WebLogic extensions for Enterprise Java Server Beans

WebLogic Server-specific EJB deployment descriptor that contains elements related to WebLogic Server features such as clustering, caching, and transactions. This file is required if your beans take advantage of WebLogic Server-specific features.

This file is coupled with the [ejb-jar.xml](#) configuration file using the standard [weblogic-ejb-jar.xml](#) schema. This configuration file is generated by the [Initial Setup](#) using the `templates/weblogic-ejb-jar.xml.template` file.

Note: This configuration file is typically NOT altered unless custom JMS or MDB resources are to be included in the servers within the product. Typically JMS resources are not included in the server. Refer to the [Oracle WebLogic JMS Integration](#) (Doc Id: [1308181.1](#)) whitepaper for details of JMS or MDB advanced configuration.

webservices.xml.resource - Web Services configuration

Note: This file is automatically generated and should not be altered manually unless instructed by Oracle Support.

When using Inbound Web Services, a web services deployment descriptor, [webservices.xml](#), must be generated to inform the JEE Web Application Server of the Web Services.

This file is automatically generated from the template file [webservices.xml.resource.template](#) located in the [templates](#) directory.

Web Browser Configuration

The product is browser based (browsers, versions and platforms are documented in the Installation Guide for your platform. Additionally the following settings are applicable to the browser:

- **Microsoft Internet Explorer** - Cache settings need to be *Every visit to the page* or *Automatically*. For non-production it is recommended to be set to *Every visit to the page* or *Automatically*. For production it is recommended to be set to *Automatically* to fully exploit performance caching. For example:

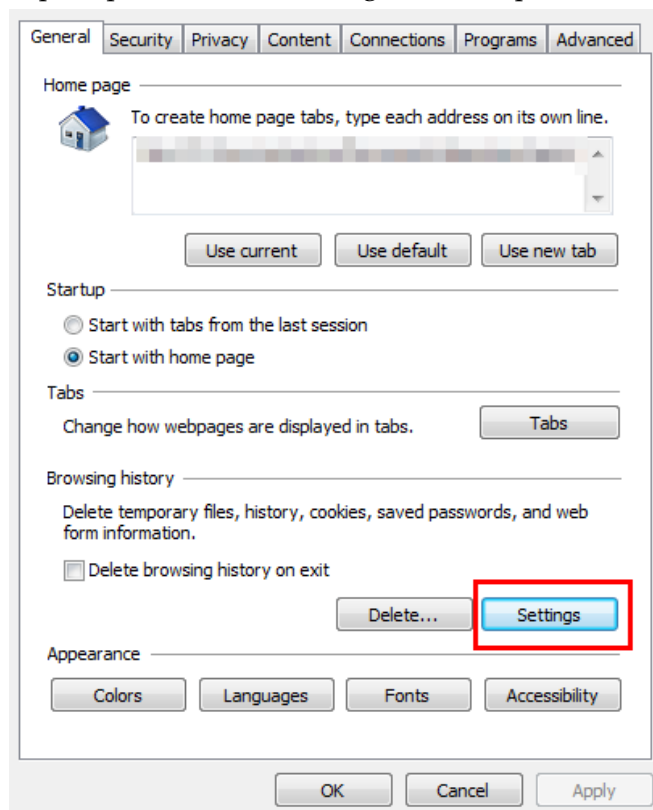

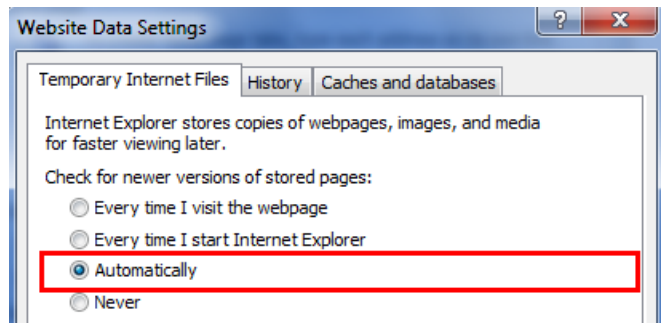

Figure 19 – Internet Explorer Cache Settings

- **Mozilla Firefox/Google Chrome** – Use the default settings with the browser for the browser.

Note: Clearing the cache upon exit will clear the cached screens of the product as well

- In Microsoft Internet Explorer¹⁶, the product requires support for the HTTP 1.1 protocol to support compression and client cache management.

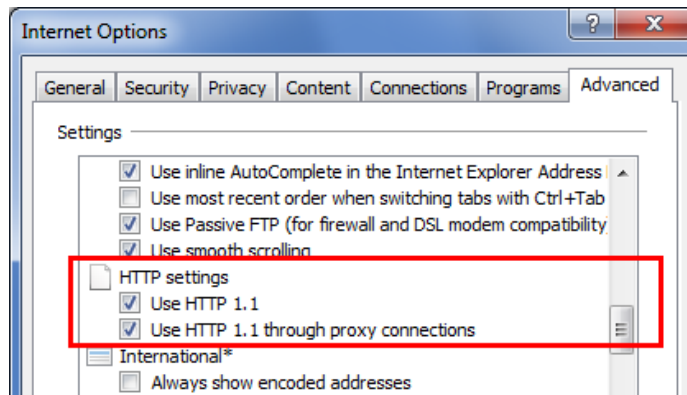

Figure 20 – HTTP 1.1 Settings

Note: If a network proxy is used then "Use HTTP 1.1 through proxy connections" may need to be selected as well.

- The product uses Java scripting for user interactivity therefore *Scripting of Java Applets* (IE) in security settings, *Allow sites to run Javascript* (Chrome) in *Content Settings* and *javascript.enabled* (Firefox)¹⁷ in *about:config* must be set to **true**.

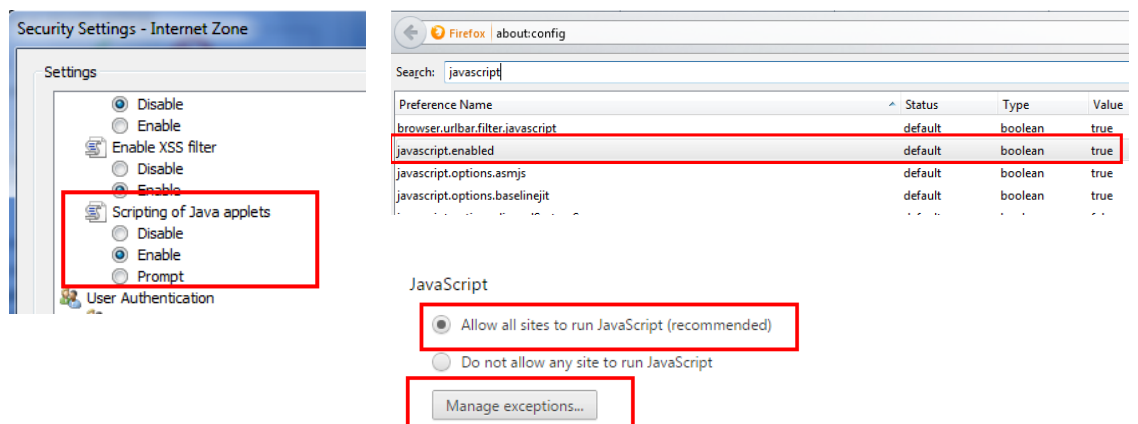

Figure 21 – Javascript Settings

¹⁶ This does not apply to Mozilla FireFox and Google Chrome.

¹⁷ By default, Firefox and Chrome enable Javascript automatically.

- The product uses popup windows for searches, therefore popup blockers should be configured to allow popups from the product Web application server hosts. Add the Application URL by adding an exception using the relevant function in the browser¹⁸. For example:

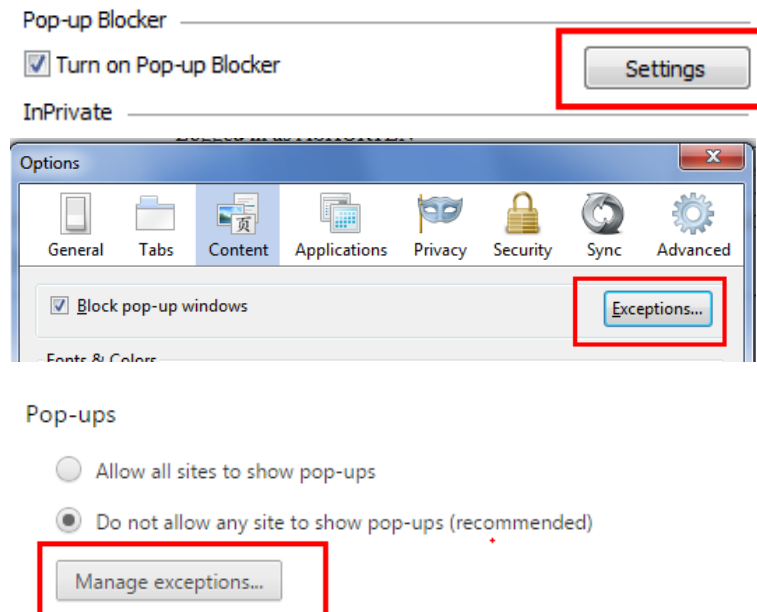

Figure 22 – Popup blocker configuration

- Set your browser cache size to a reasonable size to hold the cached pages as needed.

Web Application Server Configuration

Caveat

The product supports a number of JEE Web application servers. Each JEE Web application server is configured differently and has additional options (clustering, logging etc) that can be used. This document is written neutral to the differences of each JEE Web application server. Refer to the documentation provided with the JEE Web application servers for the location of specific configuration settings discussed in this section as well as advanced settings supported.

Web Application Server Concepts

Each Web application server has a number of levels and each uses different terminology. The following "neutral" terminology will be used:

- The software exists on a physical machine.
- An installation of the Web Application Software is called an instance. Typically one instance of the software exists on a machine but you can have more than one installed.
- Within an instance you can define a server. This is also called a Java "container"

¹⁸ Some browsers allow users to add an exception at runtime. Refer to the browser documentation for more information.

which will house one or more JEE applications. You will have at least one server per environment. A server uses one Java Virtual Machine (JVM).

- Within a server is the JEE application. It can be a single JEE application or multiples depending on the Web application server supported.

The Web application server you use may have different terminology for these same concepts. For the remainder of this section we will use the above terminology.

Web Applications

The product is deployed as a set of Web applications within the Web applications server:

- **root** – This is the product itself is installed.
- **XAIApp** – This is the Web services adapter component.
Note: XAI will be replaced by Inbound Web Services. Customers using XAI should migrate to Inbound Web Services. For a discussion of this process refer to [Migrating from XAI to IWS](#) (Doc Id: [1644914.1](#)) available from [My Oracle Support](#).
- **appViewer** – An Application Viewer which contains a data dictionary and source viewer.
- **help** – Online Help.
- **MCPApp** – Mobile Connection Platform (**MOB** only)

Each of these JEE Web Applications has its own configuration files and combined together when the product is "built" into a WAR/EAR file by the [initialSetup](#) utility.

Web Application Server Configuration Files

Within each JEE Web Application within the JEE Web application server has its own configuration files. These files are typically *embedded* within the WAR/EAR files deployed with the product following the JEE specification. In terms of configuration, the product structure within the WAR/EAR file looks like the following:

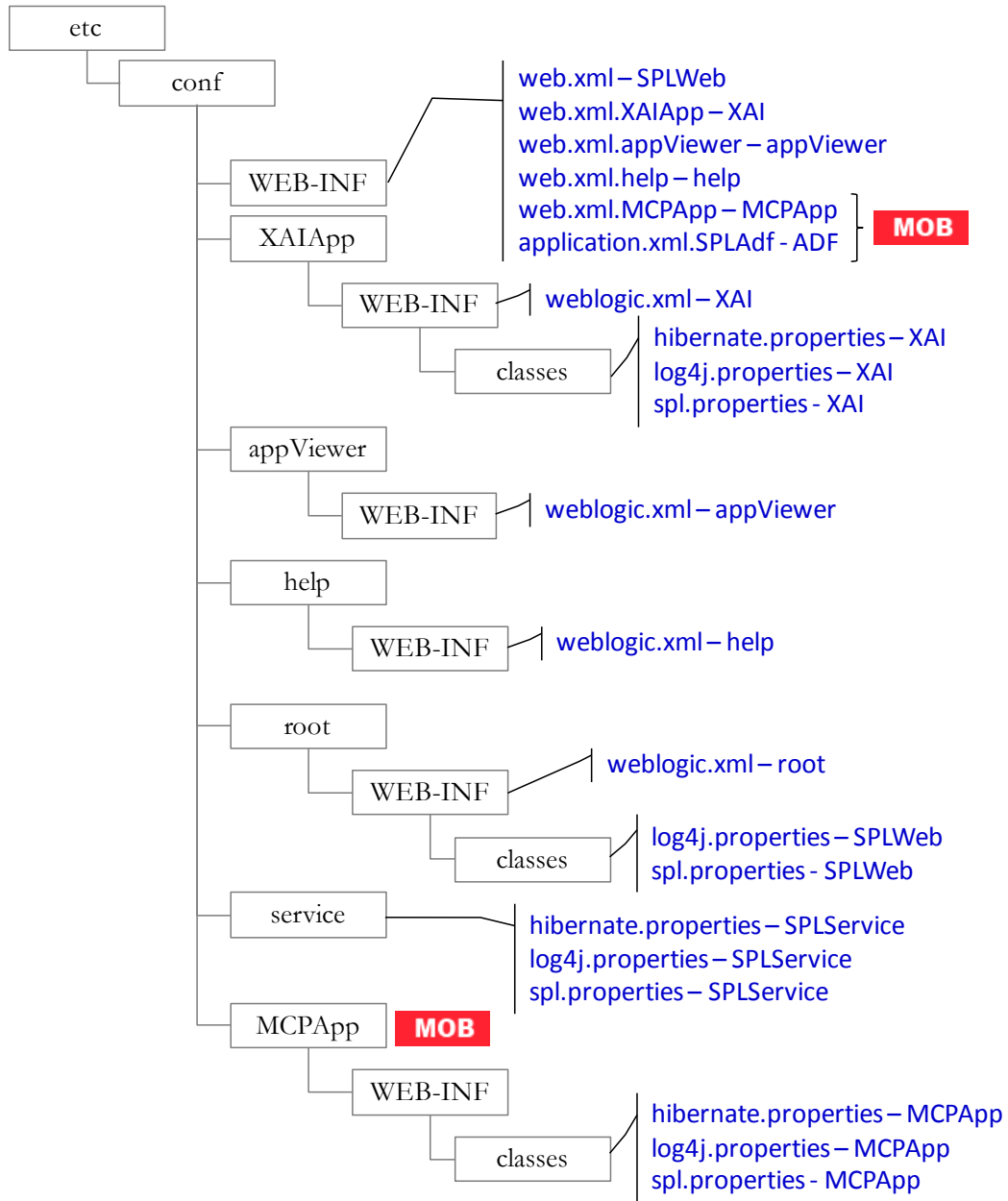

Figure 23 – Configuration File hierarchy

Configuration File	Contents
application.xml	Application Specifics MOB
hibernate.properties	Database connectivity
log4j2.properties	Logging configuration
spl.properties	Behavior configuration
web.xml	Deployment Descriptor
weblogic.xml	WebLogic extensions

Web Application Server Configuration Process

To configure the Web application server during the installation process and post-installation then the following process should be used:

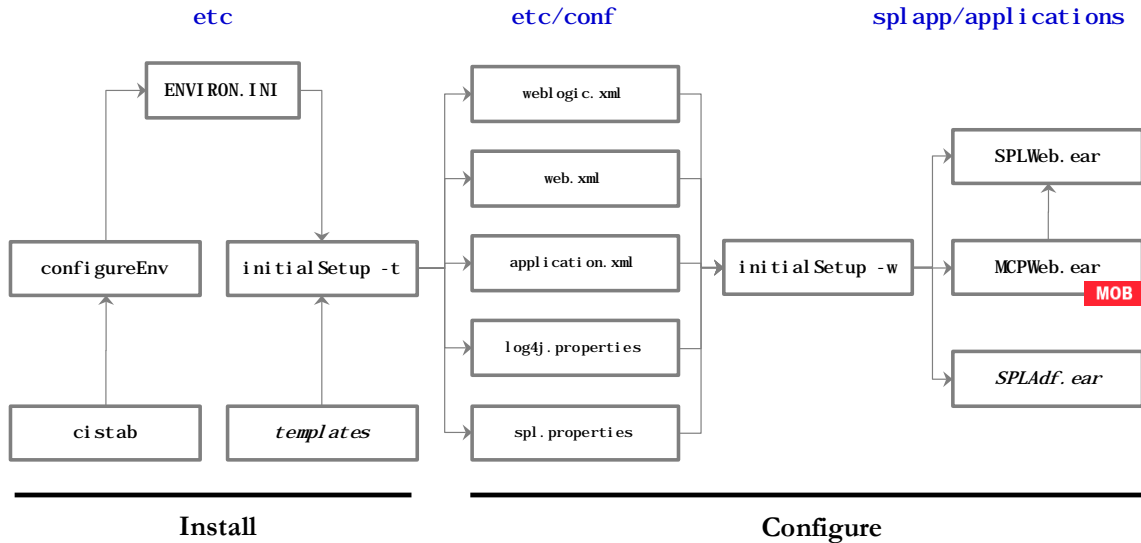

Figure 24 – Web Application Server Configuration Process

- The [configureEnv](#) utility is used during installation time and can be used post implementation to set parameters in the [ENVIRON.INI](#). If any parameters are derived or set from the [ENVIRON.INI](#) (see *Source* column in the relevant section) then the [configureEnv](#) utility should be used to maintain them.

Note: The [configureEnv](#) utility should be used to make any changes to the [ENVIRON.INI](#). Manual changes to this configuration file are not recommended.

- After the [ENVIRON.INI](#) has been set or altered, the settings must be reflected in the relevant configuration files used by the Web application server by running the [initialSetup](#) utility:
 - [web.xml](#)
 - [log4j2.properties](#)
 - [spl.properties](#)
 - [application.xml](#)
 - [weblogi.c.xml](#)
- The utility uses the templates from the **templates** directory to create substituted copies of these files in a standard location. The table below lists the configuration file, the templates used from the **templates** directory and the final configuration built during the initial configuration process:

Configuration File	Destination
Online Application (root)	
web.xml	<u>Linux/Unix:</u>
Template:	\$SPLEBASE/etc/conf/WEB-INF
web.xml.template	<u>Windows:</u>
	%SPLEBASE%\etc\conf\WEB-INF

Configuration File	Destination
<p>spl.properties</p> <p>Template:</p> <p>spl.properties.template</p>	<p>Linux/Unix:</p> <p>\$\$PLEBASE/etc/conf/root/WEB-INF/classes</p> <p>Windows:</p> <p>%SPLEBASE%\etc\conf\root\WEB-INF\classes</p>
<p>log4j2.properties</p> <p>Template:</p> <p>log4j2.properties.template</p>	<p>Linux/Unix:</p> <p>\$\$PLEBASE/etc/conf/root/WEB-INF/classes</p> <p>Windows:</p> <p>%SPLEBASE%\etc\conf\root\WEB-INF\classes</p>
<p>weblogic.xml</p> <p>Template:</p> <p>weblogic.xml.template</p>	<p>Linux/Unix:</p> <p>\$\$PLEBASE/etc/conf/root/WEB-INF</p> <p>Windows:</p> <p>%SPLEBASE%\etc\conf\root\WEB-INF</p>
Web Services Adapter (XAIApp)	
<p>web.xml (<i>web.xml.XAIApp</i>)</p> <p>Template:</p> <p>web.xml.XAIApp.template</p>	<p>Linux/Unix:</p> <p>\$\$PLEBASE/etc/conf/WEB-INF</p> <p>Windows:</p> <p>%SPLEBASE%\etc\conf\WEB-INF</p>
<p>spl.properties</p> <p>Template:</p> <p>spl.properties.XAIApp.template</p>	<p>Linux/Unix:</p> <p>\$\$PLEBASE/etc/conf/XAIApp/WEB-INF/classes</p> <p>Windows:</p> <p>%SPLEBASE%\etc\conf\XAIApp\WEB-INF\classes</p>
<p>log4j2.properties</p> <p>Template:</p> <p>log4j2.properties.XAIApp.template</p>	<p>Linux/Unix:</p> <p>\$\$PLEBASE/etc/conf/XAIApp/WEB-INF/classes</p> <p>Windows:</p> <p>%SPLEBASE%\etc\conf\XAIApp\WEB-INF\classes</p>
<p>weblogic.xml</p> <p>Template:</p> <p>weblogic.xml.XAIApp.template</p>	<p>Linux/Unix:</p> <p>\$\$PLEBASE/etc/conf/XAIApp/WEB-INF</p> <p>Windows:</p> <p>%SPLEBASE%\etc\conf\XAIApp\WEB-INF</p>
Application Viewer (appViewer)	
<p>web.xml (<i>web.xml.appViewer</i>)</p> <p>Template:</p> <p>web.xml.appViewer.template</p>	<p>Linux/Unix:</p> <p>\$\$PLEBASE/etc/conf/WEB-INF</p> <p>Windows:</p> <p>%SPLEBASE%\etc\conf\WEB-INF</p>
<p>weblogic.xml</p> <p>Template:</p> <p>weblogic.xml.appViewer.template</p>	<p>Linux/Unix:</p> <p>\$\$PLEBASE/etc/conf/appViewer/WEB-INF</p> <p>Windows:</p> <p>%SPLEBASE%\etc\conf\appViewer\WEB-INF</p>
Help Application (help)	
<p>web.xml (<i>web.xml.help</i>)</p> <p>Template:</p>	<p>Linux/Unix:</p> <p>\$\$PLEBASE/etc/conf/WEB-INF</p>

Configuration File	Destination
<code>web.xml.help.template</code>	<u>Windows:</u> %SPLEBASE%\etc\conf\WEB-INF
<u>webllogic.xml</u> <u>Template:</u>	<u>Linux/Unix:</u> \$SPLEBASE/etc/conf/help/WEB-INF
<code>webllogic.xml.help.template</code>	<u>Windows:</u> %SPLEBASE%\etc\conf\help\WEB-INF
<u>spl.properties</u> <u>Template:</u>	<u>Linux/Unix:</u> \$SPLEBASE/etc/conf/ohelp
<code>spl.properties.ohelp.template</code>	<u>Windows:</u> %SPLEBASE%\etc\conf\ohelp
MCP Application (MCPApp) MOB	
<u>web.xml</u> (<code>web.xml.MCPApp</code>) <u>Template:</u>	<u>Linux/Unix:</u> \$SPLEBASE/etc/conf/WEB-INF
<code>MMM_web.xml.MCPApp.template</code>	<u>Windows:</u> %SPLEBASE%\etc\conf\WEB-INF
<u>spl.properties</u> <u>Template:</u>	<u>Linux/Unix:</u> \$SPLEBASE/etc/conf/MCPApp/WEB-INF/classes
<code>MMM_spl.properties.MCPApp.template</code>	<u>Windows:</u> %SPLEBASE%\etc\conf\MCPApp\WEB-INF\classes
<u>log4j2.properties</u> <u>Template:</u>	<u>Linux/Unix:</u> \$SPLEBASE/etc/conf/MCPApp/WEB-INF/classes
<code>MMM_log4j2.properties.MCPApp.template</code>	<u>Windows:</u> %SPLEBASE%\etc\conf\MCPApp\WEB-INF\classes
SPLAdf Application (ADF Integration)	
<u>application.xml</u> (<code>application.xml.SPLAdf</code>) <u>Template:</u>	<u>Linux/Unix:</u> \$SPLEBASE/etc/conf/WEB-INF
<code>MMM_application.xml.SPLAdf.template</code>	<u>Windows:</u> %SPLEBASE%\etc\conf\WEB-INF
<u>webllogic.xml</u> (<code>webllogic.xml.SPLAdf</code>) <u>Template:</u>	<u>Linux/Unix:</u> \$SPLEBASE/etc/conf/WEB-INF
<code>MMM_webllogic.xml.SPLAdf.template</code>	<u>Windows:</u> %SPLEBASE%\etc\conf\WEB-INF

- At this point you may perform manual changes to the above files to parameters not implemented in the [**ENVIRON.INI**](#).

*Note: Any manual changes are overwritten after running the [**initialSetup**](#) utility unless the change is reflected in the appropriate template (see [Implementing Custom Templates for more information](#)). Backups should be made of any changes and then manually reapplied to reinstate all manual changes.*

- To reflect configuration changes into the product Web Applications the [**initialSetup**](#) utility with the `-w` option must be executed. This will build the

necessary WAR/EAR files to be deployed into the JEE Web application server. This step is optional if configuration overrides are in use.

Depending on the architecture, the [initialSetup](#) will generate one or more EAR files. Refer to [Business Application Server Configuration](#) for a description of the EAR files.

At this point the product Web Applications are ready for deployment into the JEE Web application server.

Quick Reference Guide for Web Application Server Configuration

To make configuration changes to the Web Application Server component of the product uses the following Quick Reference Guide to identify which process should be used:

- If the change is to any setting contained in the [ENVIRON.INI](#) for the Web Application Server then you must run the following utilities in the order indicated:
 1. Execute the [configureEnv](#) utility to reflect the parameter change in the [ENVIRON.INI](#).
 2. Execute the [initialSetup](#) utility (with the `-t` option) to rebuild the configuration files using the [ENVIRON.INI](#) and provided template files. This will reset the configuration to the contents of the base template files or custom template (if used).
 3. Any configuration changes that are overridden by templates (base or custom) must be manually reapplied (if necessary).
 4. Execute the [initialSetup](#) utility (with the `-w` option) to implement the configuration files in the product Web Application Server files. This step is not necessary if you are using configuration overrides.
- If the change is to any setting not contained in the [ENVIRON.INI](#) for the Web application server but is in the configuration files for the Web Application Server then you must run the following utilities in the order indicated:
 1. Make any manual changes to the relevant configuration files.
 2. Execute the [initialSetup](#) (with the `-w` option) utility to implement the configuration files in the product Web Application Server files. This step is not necessary if you are using configuration overrides.
- If native installation is used, it is recommended to redeploy or update the generated EAR files from the relevant command or console.

User Interface Backward Compatibility Settings

The following settings are used for backward compatibility of the User interface for customers upgrading in the [spl.properties](#) file from an Oracle Utilities Application Framework V2.1 based product (values of true emulate V2.1 user interface behavior for UI Maps):

- [spl.runtime.compatibility.uiMapDisableInputValue](#) – By default, if the XML schema has an input value with a default then setting this value to false will cause the product to set this value to blank and ignore the default value for add mode in all UI Maps. Setting of this value to true will cause the default to be displayed in the input field for add mode in all UI Maps. The default value for this parameter is

false.

- [**spl.runtime.compatibility.uiMapDropDownSelectFirstValue**](#) – By default, dropdown widgets on UI Maps are defaulted to no value to force the user to select a value. By setting this parameter to true, forces all dropdowns on all UI Maps to automatically default to the first value in the dropdown list. By setting this value to false, the default, the UI Maps will have blank values as the default value for the dropdowns.
- [**spl.runtime.compatibility.uiMapDisableTitle**](#) - By default UI Maps contain a rendered title section. By setting this parameter to true, the title sections for all UI Maps are not automatically rendered. By setting this parameter to false, the default, title sections are rendered automatically for all UI Maps.
- [**spl.runtime.compatibility.uiMapDisableGenerateUniqueHtmlIDs**](#) – By default screen elements have unique ids for reference, including individual records in lists or queries. By setting this value to false, the default, the framework will generate unique ids for ADA compliance. If customizations from past releases have issues with these unique ids then setting the value to true will revert to behavior available in past releases of the product.

Note: It is recommended to leave the default value, false, for these parameters unless otherwise required or instructed by Oracle Support.

Web Application Server Deployment Process

After the configuration of the Web Application is complete (as outlined in [Web application server Configuration Process](#)) the final step to implement the product technically is to deploy the product within the JEE Web application server.

There are three methods of deploying the product within the JEE Web application server:

1. Use the deployment utilities provided on the console of the JEE Web application server. The WAR/EAR files that are available under **\$SPLEBASE/spl app/applications** (or **%SPLEBASE%\spl app\applications** for Windows) can be manually deployed using the console. Refer to the Installation Guide for specific platform instructions and the administration guide for the JEE Web application server.

Note: This is the only method that can be used if virtual Web application servers are used with the product.

2. Use the deployment utilities provided on the command line of the JEE Web application server. The WAR/EAR files that are available under **\$SPLEBASE/spl app/applications** (or **%SPLEBASE%\spl app\applications** for Windows) can be manually deployed using the command line utilities supplied with your JEE Web application server. Refer to the Installation Guide for specific platform instructions and the administration guide for the JEE Web application server.
3. A number of specific utilities for JEE Web applications are provided with the product to deploy the Web Application to the JEE Web application server. These call the same utilities provided in Option 2 but are provided with the product.

Note: This section will outline Option 3 only.

A number of utilities are provided in the *bin* directory of the product to deploy the product to the JEE Web application server. These utilities are outlined below:

spl app/appl i cat i ons

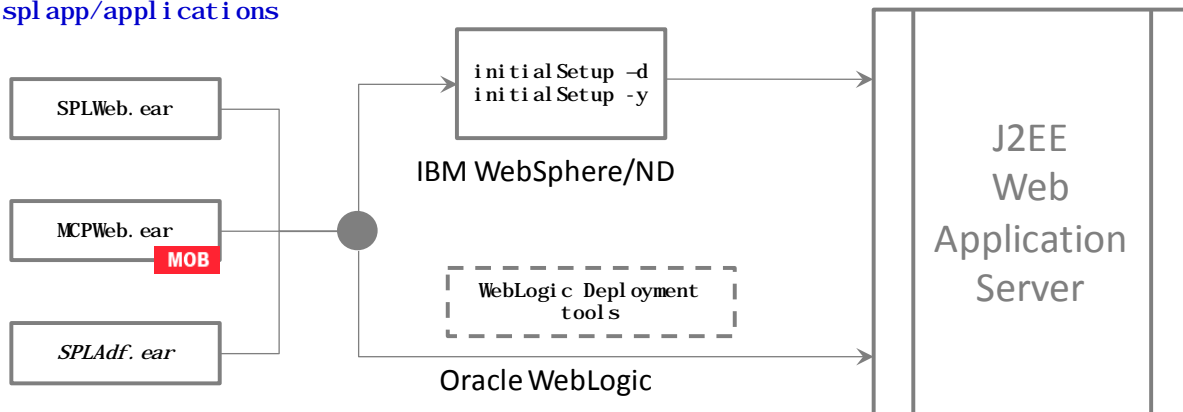

Deploy

Figure 25 – Web Application Server Deployment Process

- For the IBM WebSphere or IBM WebSphere ND platform, use the [initial Setup](#) utility (with the **-d** or **-y** options) utility. This will call the relevant IBM WebSphere utility to perform the deployment.

*Note: The **-y** option allows for a decoupled installation on IBM WebSphere. On Oracle WebLogic the console may be used to configure individual elements to achieve the same functionality.*

- For Oracle WebLogic, there are two options:
 - *Native Mode* – Use the WebLogic console or WLST to deploy/redeploy the EAR files.
 - *Embedded Mode* - No additional deployment is necessary as the product automatically detects Oracle WebLogic and allows Oracle WebLogic to read the WAR/EAR files directly.

These utilities will attempt to deploy the Web Applications within the JEE Web application server as follows:

JEE Web application server	Deployment details
Oracle WebLogic	Deployed to WEB_CONTEXT_ROOT application set by SPLWEBAPP to server WEB_WLS_SVRNAME by default using WEB_WLSYSUSER and WEB_WLSYSPASS from the ENVIRON. INI as administration credentials.
IBM WebSphere	Deployed to WEB_APP Application on WEB_SVRNAME server by default using WEB_WASUSER and WEB_WASPASS from ENVIRON. INI as administration credentials.
IBM WebSphere ND	Deployed to WEB_APP Application on WEB_SVRNAME server on WEB_NODENAME by default using WEB_WASUSER and WEB_WASPASS from ENVIRON. INI as administration credentials.

The Web Application should be available from the Web Application Server.

Business Application Server Configuration

It is possible for the Business Application Server logic to be separated from the Web Application Server component. Essentially the product has been split into TWO distinct EAR files:

- **SPLWeb.ear** ([SPLWEBAPP](#)) – This contains the Web application server component for the product.
- **SPLService.ear** ([SPLSERVICEAPP](#)) - This contains the Business Application Server component for the product.

There are two modes of installation:

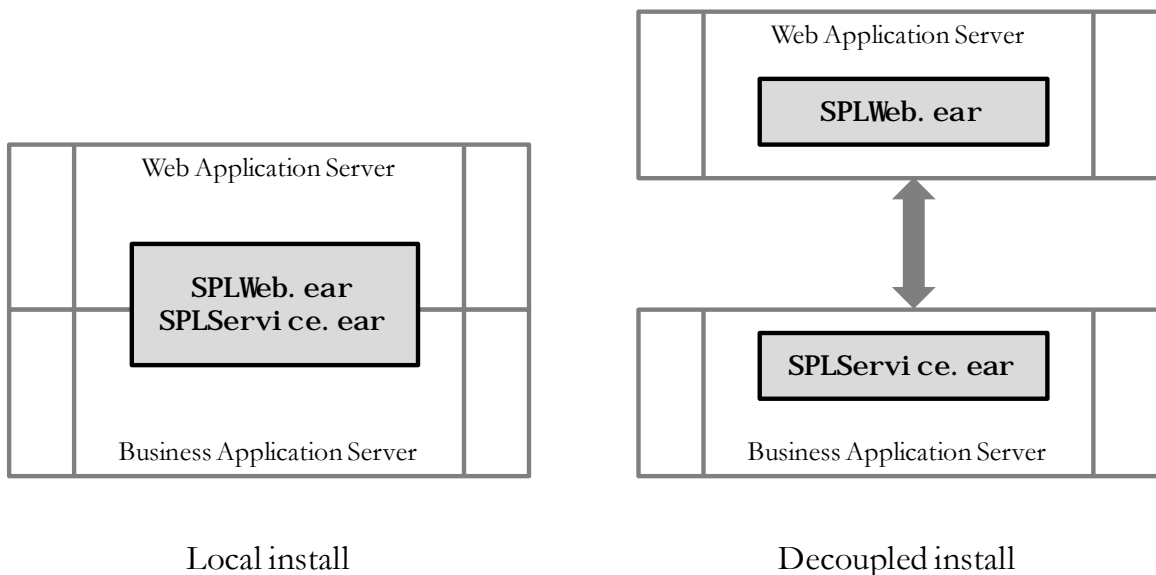

Figure 26 – Installation Modes

- **Local Installation** (also applicable to *expanded* installations for Development environments) - The Web application server and Business Application are on the same instance of the JEE Web application server. This is the *default* behavior of the product for backward compatibility. If this is the mode installed then for configuration the process is a combination of the [Web Application Server](#) and [Business Application Server](#) configuration and deployment process.

Note: Local installations are recommended for all environments.

- **Decoupled Installation** – The Business Application Server is on a separate instance of the JEE Web application server. This may be the same machine or different machines. In this case the [Web Application Server](#) and [Business Application Server](#) are managed and configured separately. To perform a decoupled installation the following must be performed:
 1. The product is installed on the machines housing the Web Application Server and [Business Application Server](#).
 2. A set of *servers* within one or more instances of the JEE Web Application Server must be created to house the [Web Application Server](#) and [Business Application Server](#) separately. This can be on the same machine or across machines.

3. The Web Application Server and [Business Application Server](#) are configured as outlined in [Web Application Server Configuration](#) and [Business Application Server Configuration](#).
4. The WAR/EAR files generated are deployed separately with the **SPLWeb.ear** (or set by **SPLWEBAPP**) EAR file deployed to the Web application server as outlined in [Web Application Server Deployment Process](#) and **SPLService.ear** EAR file (or set by **SPLSERVICEAPP**) deployed to the [Business Application Server](#) as outlined in [Business Application Server Deployment Process](#).

Note: For customers using Oracle ExaLogic, Oracle highly recommend that local installations be used for performance reasons.

Business Application Server Concepts

As mentioned previous the Business Application Server component can be deployed within a separate instance of the JEE Web Application server Software. This effectively allows the Business Application Server to be on separate hardware for architectures where this is a requirement. Typically this separation is implemented for a number of reasons:

- The site has an architectural principle for separating the Business Application Server and Web application server.
- The site prefers to optimize the individual servers for the individual tiers rather than having to compromise when two or more tiers are on the same platform.

The Business Application Server was designed to fit within the same concepts as the Web Application Server. The main differences are:

- Enterprise Java Beans (stateless) are used in the Business Application Server instead of Java Server Pages as used in the Web application server. The name of the EJB is **spl - servi cebean- <version>. jar** (where **<version>** is the version of the product e.g. 2.0.0).
- Database connectivity is configured in the Business Application Server.

The rest of this section will outline the differences specifically for the Business Application Server.

Business Application Server Configuration Files

Each JEE Web Application within the JEE Web application server has its own configuration files. These files are typically *embedded* within the WAR/EAR files deployed with the product following the JEE specification (refer the discussion of allowing the externalization of configuration settings for alternative methods). In terms of configuration, the product structure within the WAR/EAR file looks like the following:

Configuration File	Contents
ejb-jar.xml	Enterprise Service Bean configuration
hibernate.properties	Database connectivity
log4j2.properties	Logging configuration
spl.properties	Behavior configuration

Configuration File	Contents
web.xml	Deployment Descriptor
webl ogi c.xml	WebLogic extensions
webl ogi c- e j b- j ar.xml	WebLogic extensions for Enterprise Service Bean configuration

Business Application Server Configuration Process

To configure the Business Application Server during the installation process and post-installation then the following process should be used:

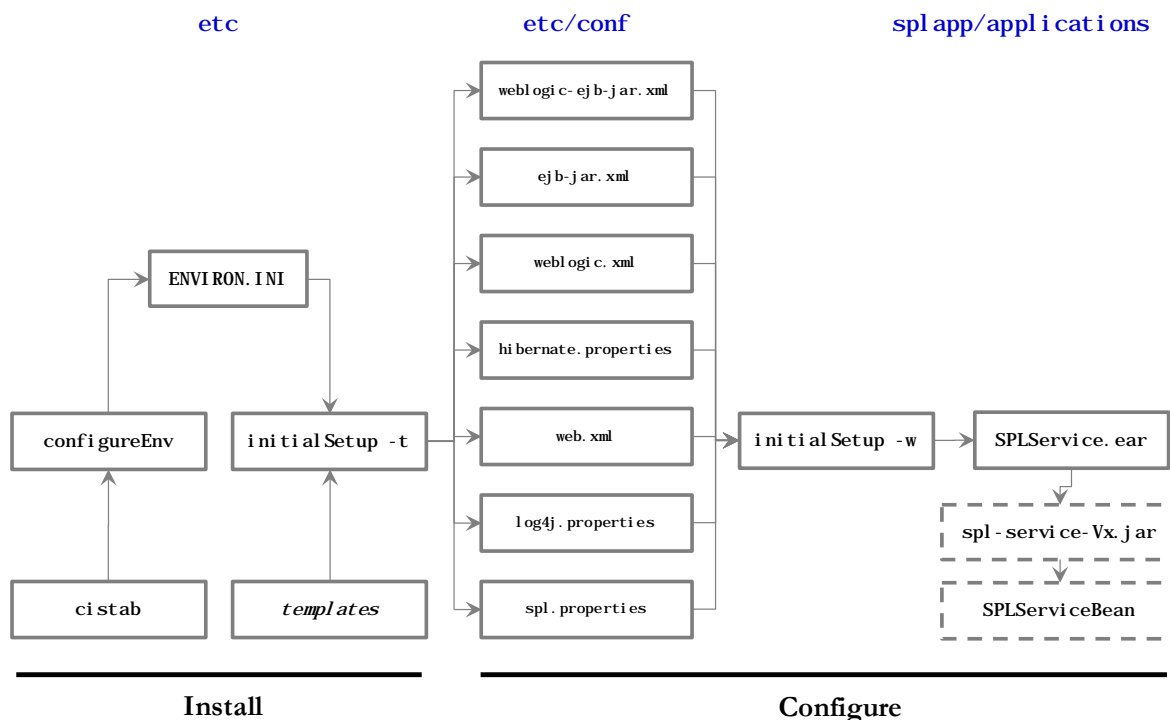

Figure 27 – Business Application Server Configuration Process

- The [configureEnv](#) utility is used during installation time and can be used post implementation to set parameters in the [ENVIRON.INI](#). If any parameters are derived or set from the [ENVIRON.INI](#) (see *Source* column in the relevant section) then the [configureEnv](#) utility should be used to maintain them.

Note: The [configureEnv](#) utility should be used to make ANY changes to the [ENVIRON.INI](#). Manual changes to this configuration file are not recommended.

- After the [ENVIRON.INI](#) has been set or altered, the settings must be reflected in the relevant configuration files used by the Business Application Server by running the [initialSetup](#):
 - [log4j2. properti es](#)
 - [spl. properti es](#)
 - [hi bernate. properti es](#)
 - [web.xml](#)
 - [webl ogi c.xml](#)
 - [e j b- j ar.xml](#)

- [weblogic-ejb-jar.xml](#)
- The utility uses the templates from the **templates** directory to create substituted copies of these files in a standard location:

Configuration File	Destination
Service Bean	
web.xml Template: web.xml.template	Linux/Unix: \$SPLEBASE/etc/conf/WEB-INF Windows: %SPLEBASE%\etc\conf\WEB-INF
spl.properties Template: spl.properties.service.template	Linux/Unix: \$SPLEBASE/etc/conf/service \$SPLEBASE/splapp/businessapp/properties Windows: %SPLEBASE%\etc\conf\service %SPLEBASE%\splapp\businessapp\properties
log4j2.properties Template: log4j2.properties.service.template	Linux/Unix: \$SPLEBASE/etc/conf/service \$SPLEBASE/splapp/businessapp/properties Windows: %SPLEBASE%\etc\conf\service %SPLEBASE%\splapp\businessapp\properties
hibernate.properties Template: hibernate.properties.web.template	Linux/Unix: \$SPLEBASE/etc/conf/service Windows: %SPLEBASE%\etc\conf\service
ejb-jar.xml Template: ejb-jar.xml.template	Linux/Unix: \$SPLEBASE/splapp/businessapp/config/META-INF Windows: %SPLEBASE%\splapp\businessapp\config\META-INF
weblogic-ejb-jar.xml Template: weblogic-ejb-jar.xml.template	Linux/Unix: \$SPLEBASE/splapp/businessapp/config/META-INF Windows: %SPLEBASE%\splapp\businessapp\config\META-INF

The locations of the configuration files can be summarized in the following figure:

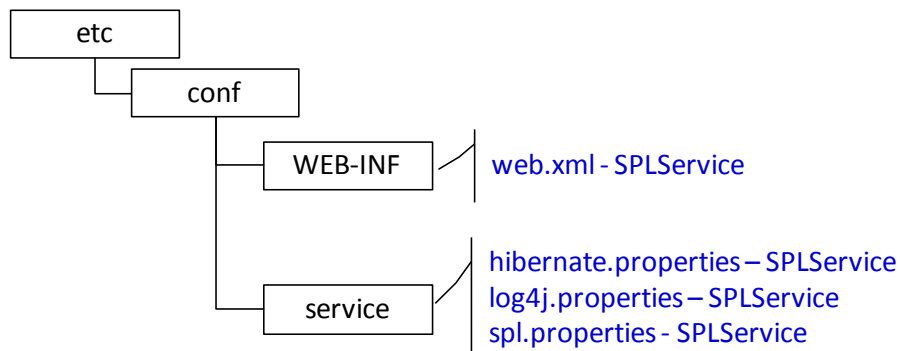

Figure 28 – Business Application Server Configuration files

- At this point you may perform manual changes to the above files to parameters not implemented in the [ENVIRON.INI](#).

Note: Any manual changes are overwritten after running the [initialSetup](#) utility unless the change is reflected in the appropriate template (see custom templates for more information). Backups should be made of any changes and then manually reapplied to reinstate all manual changes.

- To reflect configuration changes into the product Business EJB Applications the [initialSetup](#) utility, with the `-w` option, must be executed. This will build the necessary `spl - servicebean- <version>.jar` (where `<version>` is the version of the product used) and the `SPLService.ear` EAR file (or name set by [SPLSERVICEAPP](#)) to be deployed into the JEE Web application server. This step is optional if configuration overrides are in use (refer the discussion of allowing the externalization of configuration settings for alternative methods).

Depending on the architecture used, the [initialSetup](#) will generate one or more EAR files.

At this point the product Business Applications are ready for deployment into the JEE Web application server.

Quick Reference Guide for Business Application Server Configuration

To make configuration changes to the Business Application Server component of the product uses the following Quick Reference Guide to identify which process should be used:

- If the change is to any setting contained in the [ENVIRON.INI](#) for the Business Application Server then you must run the following utilities in the order indicated:
 1. Execute the [configureEnv](#) utility to reflect the parameter change in the [ENVIRON.INI](#).
 2. Execute the [initialSetup](#) utility (with the `-t` option) to rebuild the configuration files using the [ENVIRON.INI](#) and provided template files. This will reset the configuration to the contents of the base template files or custom template (if used).
 3. Any configuration changes that are overridden by templates (base or custom) must be manually reapplied (if necessary).
 4. Execute the [initialSetup](#) utility (with the `-w` option) to implement the configuration files in the product Business Application files. This step is not necessary if you are using [configuration overrides](#)
- If the change is to any setting not contained in the [ENVIRON.INI](#) for the Business Application Server but is in the configuration files for the Business Application Server then you must run the following utilities in the order indicated:
 1. Make any manual changes to the relevant configuration files.
 2. Execute the [initialSetup](#), with the `-w` option, utility to implement the configuration files in the product Business Application Server files. This step is not necessary if you are using configuration overrides.
- If a native installation

Business Application Server Deployment Process

After the configuration of the Business Application Server is complete (as outlined in Business Application Server Configuration Process) the final step to implement the product technically is to deploy the product within the JEE Web application server.

There are three methods of deploying the product within the JEE Web application server:

- Use the deployment utilities provided on the console of the JEE Web application server. The WAR/EAR files that are available under **\$SPLEBASE/spl app/appl i cat i ons** (or **%SPLEBASE%\spl app\appl i cat i ons** for Windows) can be manually deployed using the console. Refer to the *Installation Guide* for specific platform instructions and the administration guide for the JEE Web application server.
- Use the deployment utilities provided on the command line of the JEE Web application server. The WAR/EAR files that are available under **\$SPLEBASE/spl app/appl i cat i ons** (or **%SPLEBASE%\spl app\appl i cat i ons** for Windows) can be manually deployed using the JEE Web application server vendor supplied deployment command line utilities. Refer to the *Installation Guide* for specific platform instructions and the administration guide for the JEE Web application server.
- A number of specific utilities for JEE Web Application are provided with the product to deploy the EJB Application to the JEE Web application server. These call the same utilities provided in the previous option but are provided with the product.

This section will outline the latter option.

A number of utilities are provided in the *bin* directory to deploy the product to the JEE Web application server. These utilities are outlined below:

spl app/appl i cat i ons

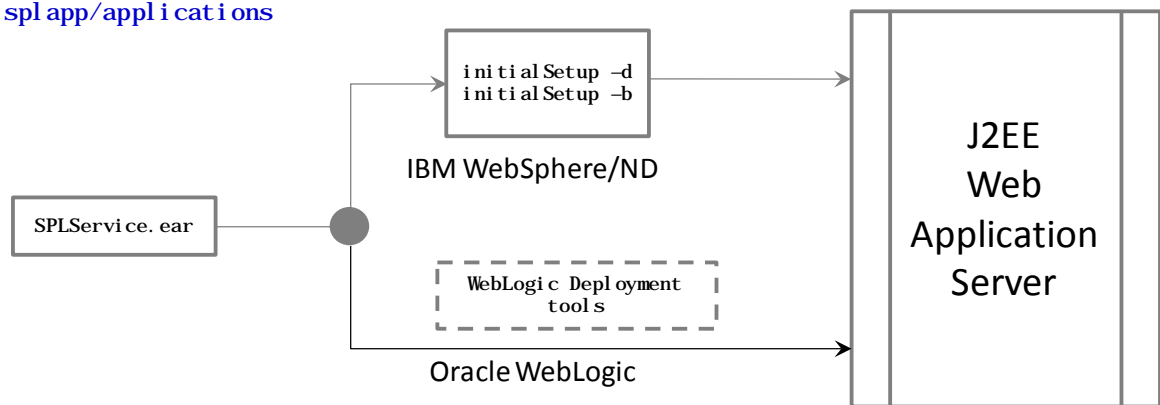

Deploy

Figure 29 – Business Application Server Deployment process

- For the IBM WebSphere/WebSphere ND platform, use the **initialSetup** utility (with the **-d** or **-b** options). This will call the relevant IBM provided utility to deploy the WAR/EAR files into the IBM WebSphere instance.

*Note: The **-b** option allows for a decoupled installation on IBM WebSphere. On Oracle WebLogic the console may be used to configure individual elements to achieve the same functionality.*

- For Oracle WebLogic, there are two options:
 - *Native Mode* – Use the WebLogic console or WLST to deploy/redeploy the EAR files.
 - *Embedded Mode* - No additional deployment is necessary as the product automatically detects Oracle WebLogic and allows Oracle WebLogic to read the WAR/EAR files directly.

These utilities will attempt to deploy the EJB Applications within the JEE Web application server as follows:

JEE Web application server	Deployment details
Oracle WebLogic	Deployed to WEB_CONTEXT_ROOT application set by SPLSERVICEAPP to server WEB_WLS_SVRNAME by default using WEB_WLSYSUSER and WEB_WLSYSPASS from the ENVIRON.INI as administration credentials.
IBM WebSphere	Deployed to BSN_APP Application on BSN_SVRNAME server by default using WEB_WASUSER and WEB_WASPASS from ENVIRON.INI as administration credentials.
IBM WebSphere ND	Deployed to BSN_APP Application on BSN_SVRNAME server on BSN_NODENAME by default using WEB_WASUSER and WEB_WASPASS from ENVIRON.INI as administration credentials.

Inbound Web Services Configuration

The Oracle Utilities Customer Care and Billing product supports the ability to implement product Web Services within the JEE Web Application Server instead of being accessible from the XML Application Integration (XAI) servlet. This has a number of advantages:

- Inbound Web Services can utilize the clustering and high availability features of the JEE Web Application Server directly.
- Individual Inbound Web Services can be monitored from the JEE Web Application Server directly. If Oracle Enterprise Manager is used, performance and diagnostic metrics on individual Inbound Web Services can be collected and analyzed for service level tracking and general monitoring.
- Individual Inbound Web Services can be secured using the WS-Policy support available in the JEE Web Application Server directly. Customer using Oracle WebLogic Server can also utilize the inbuilt [Oracle Web Services Manager](#) within Oracle WebLogic to add access rules to individual Web Services.

Note: It is highly recommended to use Inbound Web Services instead of XML Application Integration as the XAI Servlet will be deprecated in a future release.

Enabling Inbound Web Services

By default, for backward compatibility, the Inbound Web Services feature is disabled. To use the feature it must be enabled and a few features enabled to use the deployment facilities

provided by this capability. All these steps must be executed by the relevant administrator user as indicated in the individual steps.

Note: These steps, unless otherwise indicated, are performed once per environment.

Enable Inbound Web Services Feature

Note: For customers using the native installation of the product, should ensure that the [WEB_WLS_SVRNAME](#) is set to the name of the server or cluster used for the environment.

The first step is to enable the feature in the environment configuration file ([ENVIRON.INI](#)) to use additional facilities:

- Using the product administrator user on the machines where the product is installed, execute the `configureEnv[.sh] -a` command after executing the `splenvi ron[.sh] -e <environmentname>` where `<environmentname>` is the name of the installation environment to enable the feature upon.
- Change the option "Enable Web Services Functionality" on option 50 to **true**. Save the change using the "P" option.
- Execute the `initialSetup[.sh]` command to apply the changes to the infrastructure and generate the necessary build files for Inbound Web Services.

Set Credentials For Inbound Web Services

Note: Failure to perform this task may cause the deployment of Inbound Web Services to fail.

To deploy the Inbound Web Services seamlessly it is necessary to create an administration credential file so that the build and deployment utilities and online deployment facility for developers can access the domain.

To create this credential file the following commands must be executed:

- Using the product administrator user on the machines where the product is installed, execute the `splenvi ron[.sh] -e <environmentname>` where `<environmentname>` is the name of the installation environment to enable the feature upon.
- Execute the following command:

UNIX:

```
$JAVA_HOME/bin/java -classpath
$WL_HOME/server/lib/weblogic.jar weblogic.Admin -username
<username> -password <password> STOREUSERCONFIG -
userconfigfile $$PLEBASE/etc/.wlsuserconfig -userkeyfile
$$PLEBASE/etc/.wlsuserkey
```

Windows:

```
%JAVA_HOME%\bin\java -classpath
%WL_HOME%\server\lib\weblogic.jar weblogic.Admin -username
<username> -password <password> STOREUSERCONFIG -
userconfigfile %SPLEBASE%\etc\.wlsuserconfig -userkeyfile
%SPLEBASE%\etc\.wlsuserkey
```

Where `<username>` is an Administration password for the domain and `<password>` is the password for that user. For example, these values can correspond to `WEB_WLSYSUSER` and `WEB_WLSYSPASS` (in plain text).

Note: If the password for this user is changed at anytime, this step must be repeated for the facility to continue to operate.

Enable USER_LOCK Facility

To prevent multiple parallel deployments, the **USER_LOCK** feature of the database must be enabled on the product user. The following commands must be executed:

- Logon onto the database using SQL Developer or SQL Plus the **SYS** or **SYSTEM** user.
- Execute the following command:
@?/rdms/admin/userlock.sql

Note: ? corresponds to ORACLE_HOME.

- Grant access to the product user using the following command:
grant execute on USER_LOCK to <user>;
where <user> is the **DBUSER** and **BATCH_DBUSER**¹⁹ from the **ENVIRON.INI**.

Inbound Web Services Configuration Files

The location of the Inbound Web Service is as follows:

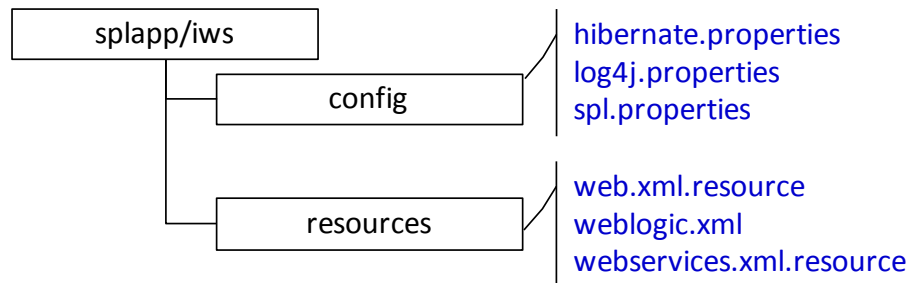

Figure 30 – Inbound Web Services configuration

The following configuration files apply to the Inbound Web Service:

File	Contents
hibernate.properties	Database connectivity for Inbound Web Services
log4j2.properties	Logging configuration
spl.properties	Inbound Web Service specific configurations
weblogic.xml	WebLogic extensions for Inbound Web Services
web.xml.resource	Web application descriptor
webservice.xml.resource	Web service application descriptor

Inbound Web Services Concepts

The Inbound Web Services deploys a web archive (**WebServices.ear** or name set by **IWSWAR**) containing the components of the inbound Web Services using the following structures:

¹⁹ **BATCH_DBUSER** is used for command line deployment.

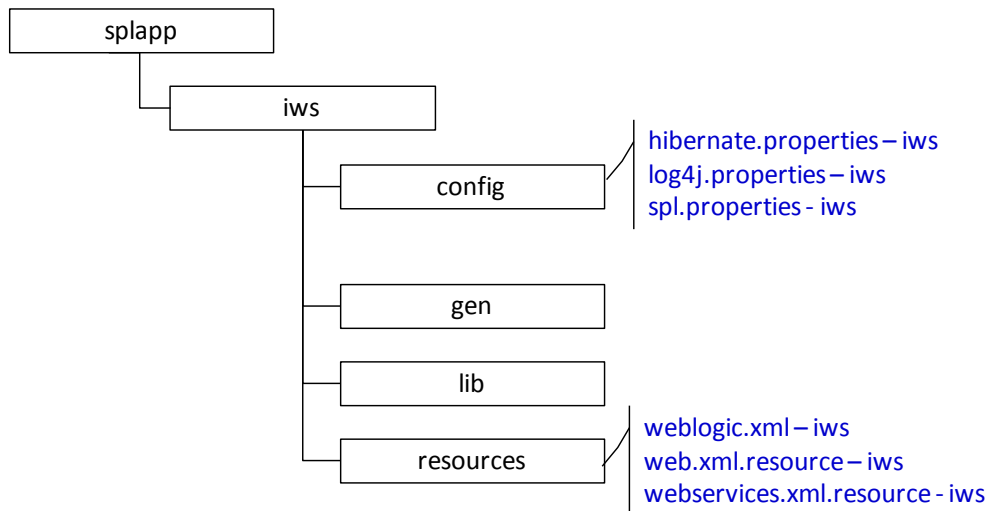

Figure 31 – Inbound Web Services Structures

Structure	Contents
config	Configuration files for Inbound Web Services
gen	Location of files generated by iwsdeploy
lib	Java Libraries
resources	Configuration files , custom policy, XSL and XSD files

The Inbound Web Services was designed to fit within the same concepts as the Web Application Server/Business Application Services. The main differences are:

- The **Web services. ear** file (or name set by [IWSWAR](#)) is located in the **\$SPLEBASE/spl app/i ws/gen** directory (or **%SPLEBASE%\spl app\i ws\gen** on Windows) and is deployed automatically using [iwsdeploy\[.sh\]](#) or the online deployment facility.

Note: Customers using native installation can optionally manually deploy the war file, if desired.

- Database connectivity is configured in the Inbound Web Services and included in the build file.

Inbound Web Services Configuration Process

Note: This section only covers the configuration and deployment of the physical Web Service resources. It does not cover the definition of Inbound Web Services within the product. Refer to the [Migrating XAI to IWS](#) (Doc Id: [1644914.1](#)) available from [My Oracle Support](#) for a discussion of Inbound Web Services.

Note: For this feature to operate, at least one Inbound Web Service should be defined for the build process to execute. If no Inbound Web Services are defined prior to the deployment then the build process will fail.

To configure the Inbound Web Services during the installation process and post-installation then the following process should be used:

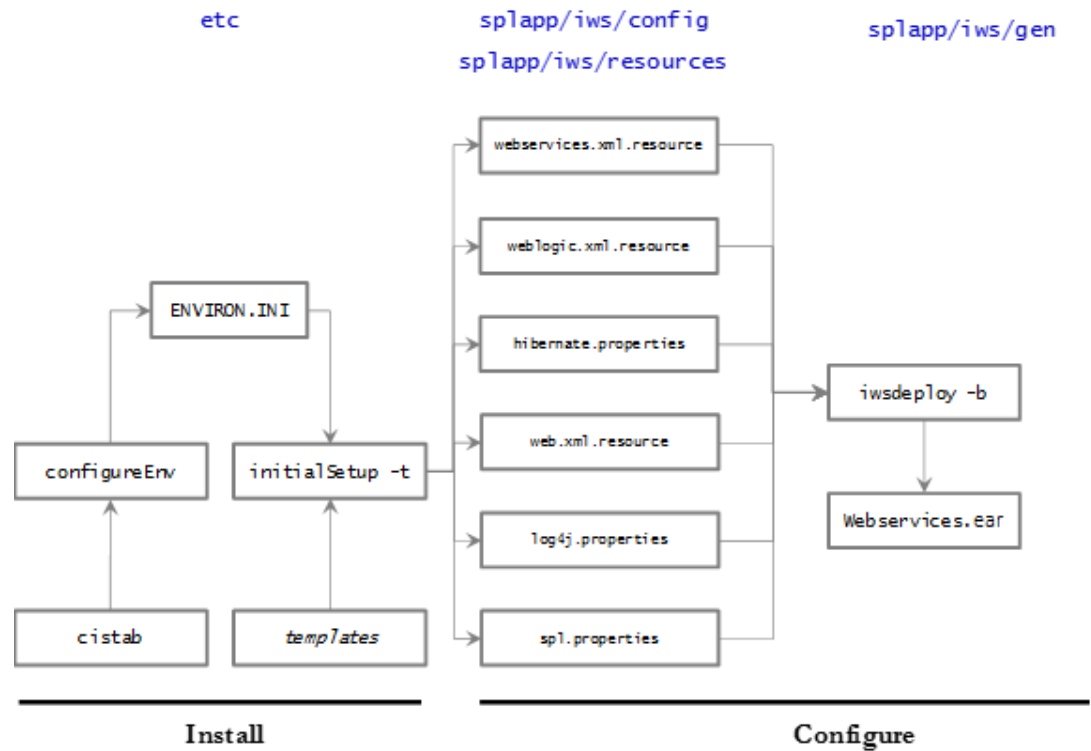

Figure 32 – Inbound Web Services Configuration Process

- The [configureEnv](#) utility is used during installation time and can be used post implementation to set parameters in the [ENVIRON.INI](#). If any parameters are derived or set from the [ENVIRON.INI](#) (see "Source" column in the relevant section) then the [configureEnv](#) utility should be used to maintain them.

Note: The [configureEnv](#) utility should be used to make ANY changes to the [ENVIRON.INI](#). Manual changes to this configuration file are not recommended.

- After the [ENVIRON.INI](#) has been set or altered, the settings must be reflected in the relevant configuration files used by the Inbound Web Services by running the [initialSetup -t](#)
- The utility uses the templates from the [templates](#) directory to create substituted copies of these files in a standard location:

Configuration File	Destination
Service Bean	
spl.properties	Linux/Unix:
Template:	\$SPLEBASE/spl app/i ws/confi g
spl.properties.iws.template	Windows:
	%SPLEBASE%\spl app\i ws\confi g
log4j2.properties	Linux/Unix:
Template:	\$SPLEBASE/spl app/i ws/confi g
log4j2.properties.iws.template	Windows:

Configuration File	Destination
	%SPLEBASE%\spl app\i ws\confi g
hibernate.properties	Linux/Unix:
Template:	SSPLEBASE/spl app/i ws/confi g
hibernate.properties.i ws.template	Windows:
	%SPLEBASE%\spl app\i ws\confi g
web.xml.resource	Linux/Unix:
Template:	SSPLEBASE/spl app/i ws/resources
web.xml.resource.i ws.template	Windows:
	%SPLEBASE%\spl app\i ws/resources
webservices.xml.resource	Linux/Unix:
Template:	SSPLEBASE/spl app/i ws/resources
webservices.xml.resource.i ws.template	Windows:
	%SPLEBASE%\spl app\i ws/resources
weblogic.xml.resource	Linux/Unix:
Template:	SSPLEBASE/spl app/i ws/resources
weblogic.xml.i ws.template	Windows:
	%SPLEBASE%\spl app\i ws/resources

- At this point you may perform manual changes to the above files to parameters not implemented in the [ENVIRON.INI](#).

Note: Any manual changes are overwritten after running the [initialSetup](#) utility unless the change is reflected in the appropriate template (see [custom templates](#) for more information). Backups should be made of any changes and then manually reapplied to reinstate all manual changes.

- To reflect configuration changes into the product the [iwsdeploy](#) utility, must be executed. This will build the necessary **Webseivces.ear** (or the value specified in **IWSWAR** setting) and to be deployed into the JEE Web application server. This step is optional if configuration overrides are in use.

Note: For IBM WebSphere customers and customers who want to use manual deployment methods, use the [iwsdeploy\[.sh\] -b](#) option to prevent autodeploy.

At this point the product Web Services are ready for deployment into the JEE Web application server.

Inbound Web Services Deployment Process

After the build of the Inbound Web Services EAR is complete (as outlined in [Inbound Web](#)

[Services Configuration Process](#)) the final step to implement the product technically is to deploy the product within the JEE Web application server.

There are three methods of deploying the product within the JEE Web application server:

- Use the deployment utilities provided on the console of the JEE Web application server. The EAR files is available under **\$SPLEBASE/spl app/i ws/gen** (or **%SPLEBASE%\spl app\i ws\gen** for Windows) can be manually deployed using the console. Refer to the *Installation Guide* for specific platform instructions and the administration guide for the JEE Web application server.
- Use the deployment utilities provided on the command line of the JEE Web application server. The EAR files is available under **\$SPLEBASE/spl app/i ws/gen** (or **%SPLEBASE%\spl app\i ws\gen** for Windows) can be manually deployed using the JEE Web application server vendor supplied deployment command line utilities. Refer to the *Installation Guide* for specific platform instructions and the administration guide for the JEE Web application server.
- Use the **iwsdeploy** utility for command line access for deployment.

Note: IBM WebSphere customers should not use the deployment options in this command. Use the -b options to build but not deploy. Manual deployment is recommended.

- Use the Inbound Web Services online transaction

A number of utilities are provided in the *bin* directory to deploy the product to the JEE Web application server. These utilities are outlined below:

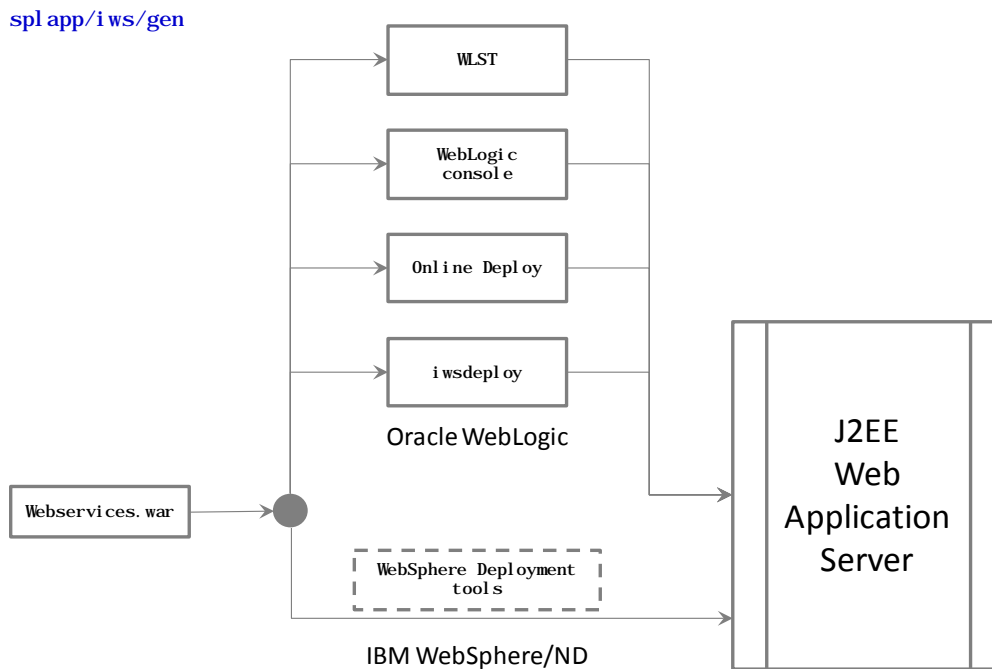

Figure 33 – Inbound Web Services Deployment process

These utilities will attempt to deploy the Web Services within the JEE Web application server as follows:

JEE Web application server	Deployment details
Oracle WebLogic	Deployed application set by IWSWAR to server WEB_WLS_SVRNAME by default using WEB_WLSYSUSER and WEB_WLSYSPASS from the ENVIRON.INI as

JEE Web application server	Deployment details
	administration credentials.
IBM WebSphere	Deployed to IWSWAR Application on WEB_SVRNAME server by default using WEB_WASUSER and WEB_WASPASS from ENVIRON.INI as administration credentials.
IBM WebSphere ND	Deployed to IWSWAR Application on WEB_SVRNAME server on WEB_NODENAME by default using WEB_WASUSER and WEB_WASPASS from ENVIRON.INI as administration credentials.

Quick Reference Guide for Inbound Web Services Configuration

To make configuration changes to the IWS component of the product uses the following Quick Reference Guide to identify which process should be used:

- If the change is to any setting contained in the [ENVIRON.INI](#) for the IWS then you must run the following utilities in the order indicated:
 1. Execute the [configureEnv](#) utility to reflect the parameter change in the [ENVIRON.INI](#).
 2. Execute the [initialSetup](#) utility (with the `-t` option) to rebuild the configuration files using the [ENVIRON.INI](#) and provided template files. This will reset the configuration to the contents of the base template files or [custom template](#) (if used).
 3. Any configuration changes that are overridden by templates (base or [custom template](#)) must be manually reapplied (if necessary).
 4. Execute the [initialSetup](#) utility (with the `-w` option) to implement the configuration files in the product IWS files. This step is not necessary if you are using [configuration overrides](#).
 5. Execute the [iwsdeploy](#) utility to build and deploy.
- If the change is to any setting not contained in the [ENVIRON.INI](#) for the IWS but is in the configuration files for the IWS then you must run the following utilities in the order indicated:
 1. Make any manual changes to the relevant configuration files.

Execute the [initialSetup](#), with the `-w` option, utility to implement the configuration files in the product IWS files.

Inbound Web Services Deployment Utilities

After the configuration of the Inbound Web Services is complete (as outlined in Inbound Web Services Configuration Process) the final step to implement the product technically is to deploy the product within the JEE Web application server.

There are three methods of deploying the Inbound Web Services component within the JEE Web application server:

- An Inbound Web Services Deployment facility available from the product online.

This is accessible from the *Admin* → *I* → *Inbound Web Services Deployment* menu item. This is suitable for development environments only. For example:

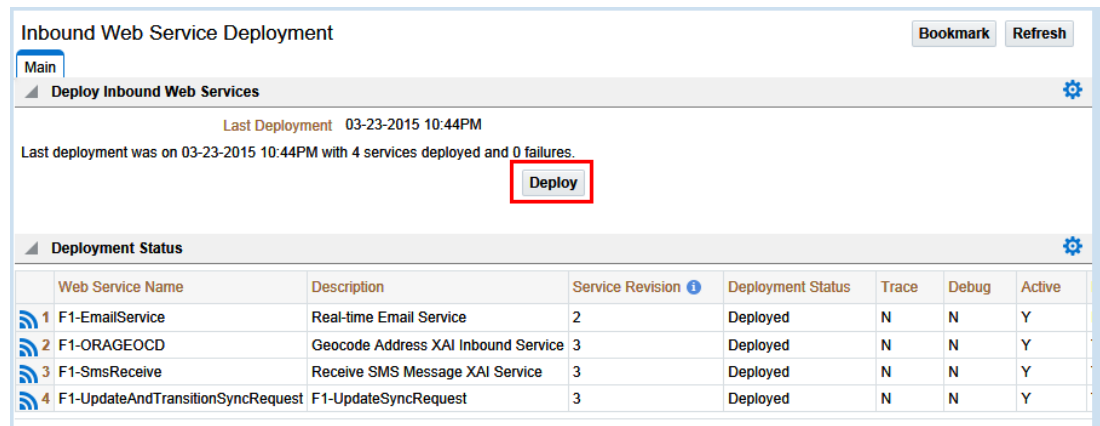

Figure 34 – Inbound Web Services online transaction

- Use the [i wsdepl oy](#) utility to trigger a deployment from the command line.
- Execute the [i wsdepl oy](#) utility but manually deploy the Web Services EAR file to the server(s) or cluster using the JEE console or deployment utilities.

Batch Server Configuration **BATCH**

The batch component contains a number of configuration files and utilities to manage the configuration of the cluster, threadpools and submitters. This section outlines the configuration files and configuration process for configuring batch.

Batch Configuration Files

As with the online component of the Oracle Utilities Application Framework there are a number of configuration files that control the performance and behaviour of the batch component.

The batch component houses the configuration files differently to the online and web services component. The online and web services are housed within a JEE Web Application Server and therefore the configuration files are located according to the JEE standards.

In the batch component the configuration are housed in directories as the batch component is housed as a standalone process that is clustered using Oracle Coherence. Therefore, during the configuration process, the configuration files used by the batch component are built using templates using the [initialSetup](#) utility. This utility deposits the configuration files in the `$SPLEBASE\spl app\standalone\config` directory (or `%SPLEBASE%/spl app/standalone/config` directory in Windows).

The figure below summarizes the directory structure and the relevant configuration files:

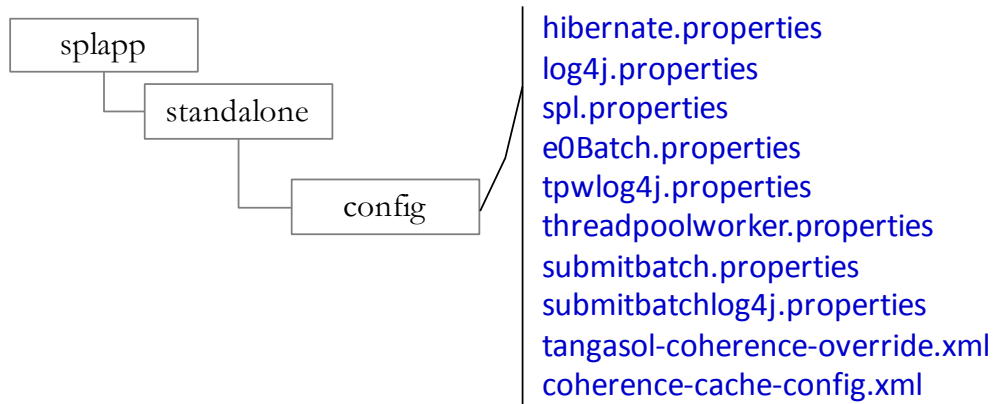

Figure 35 – Batch configuration files

The following configuration files (along with their templates) are listed below:

Configuration File	Contents
e0Batch.properties	General environment settings
hibernate.properties	Database connectivity
log4j2.properties	Logging settings
spl.properties	Application behaviour
submitbatch.properties	submitjob default settings
submitbatchlog4j2.properties	submitjob logging settings
threadpoolworker.properties	threadpoolworker configuration
tpwlog4j2.properties	threadpoolworker logging settings
coherence-cache-config.xml	Cache settings for cluster
tangasol-coherence-override.xml	Override setting for cluster

General Configuration Process

To configure the batch component during the installation process and post-installation then the following process should be used:

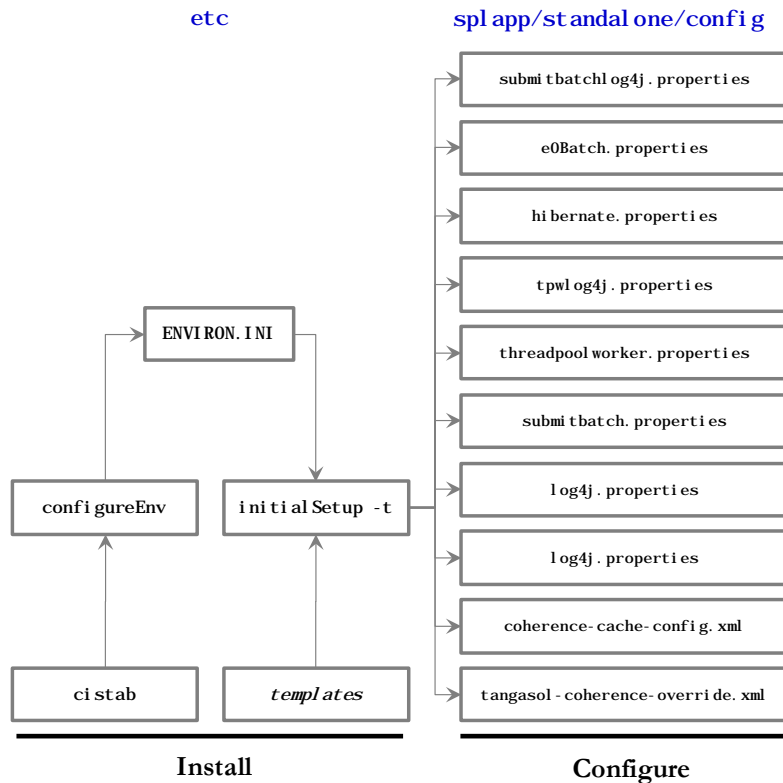

Figure 36 – Batch configuration process

- The [configureEnv](#) utility is used during installation time and can be used post installation to set parameters in the [ENVIRON.INI](#).

Note: The [configureEnv](#) utility should be used to make any changes to the [ENVIRON.INI](#). Manual changes to this configuration file are not recommended.

- After the [ENVIRON.INI](#) has been set or altered, the settings must be reflected in the relevant configuration files used by the batch component using the [initialSetup](#) utility. The [initialSetup](#) utility takes the relevant templates, builds the configuration files and deposits them in the `$$SPLEBASE\spl app\standalone\config` directory (or `$$SPLEBASE%\spl app\standalone\config` directory in Windows).

The configuration files are now ready to be used for the batch component. Additional configuration can be performed using [bedit](#).

Configuring Batch using bedit

The [bedit](#) utility is a set of wizards that allow a batch configuration to be built for an implementation using simple commands. The utility uses a set of templates to build a complete set of configuration files for the cluster, its threadpools and submitters at a global and individual level.

For guidelines and scenarios using this facility, refer to the [Batch Best Practices](#) (Doc Id: [836362.1](#)) whitepaper available from [My Oracle Support](#).

Batch Configuration Overview using edit

The [bedit](#) utility allows for a set of configuration files to be built on top of the global

configuration setting managed using the [Batch Configuration process](#). The following process should be used:

- **Global Settings** - Specify global batch settings using the [configureEnv](#) utility to set the defaults in the [ENVIRON.INI](#).
- **Apply Settings** - Apply any configuration settings to the global templates and default configuration files using the [initialSetup](#)²⁰ utility.
- **Perform Cluster Configuration** - Configure the desired [cluster configuration](#) using [bedit](#). Clusters are setup once per environment in either using multicast, unicast or single server optimized configurations.
- **Perform Threadpoolworker Configuration** - Configure the desired [threadpoolworker configuration](#) using [bedit](#). Threadpoolworkers can be created on an individual basis with unique configurations or *labelled* to share configurations.
- **Perform Submitter Configuration** - Configure the desired [submitter configuration](#) using [bedit](#). Submitters can be setup for specific development execution modes (**THIN** or **LOCAL**), generic configuration or project specific jobs.

The process is shown below:

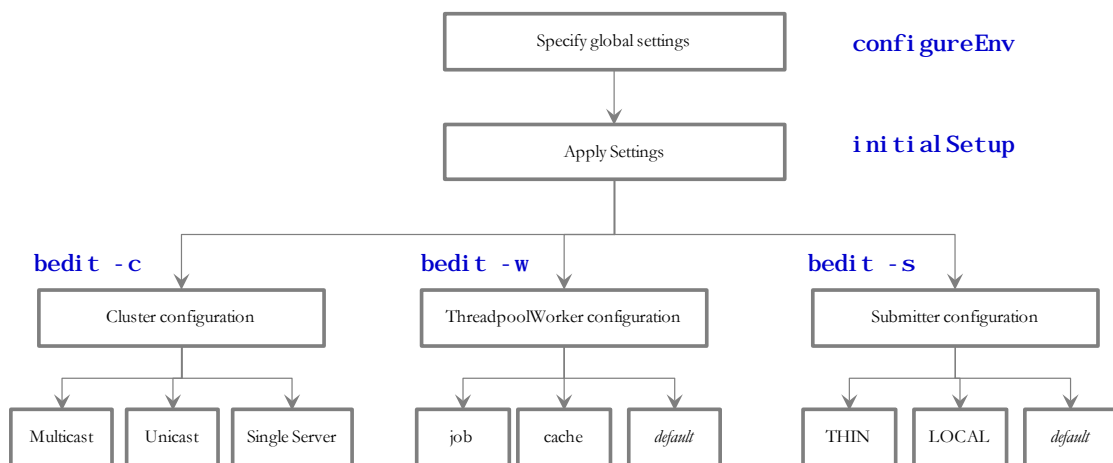

Figure 37 – bedit configuration process

*Note: At any time the file name and location of the generated file is determined at the start of the edit session or using the **what** command.*

Batch Edit Usage Guidelines

The [bedit](#) utility is available to simplify the creation and maintenance of these files to promote stability and flexibility whilst minimizing maintenance mistakes. The following guidelines apply when using the utility:

- The command line options specify the configuration file to be modified. The specific configuration file or the shortcut option can be used to set the scope of the command.
- Pre-optimized specialist templates (with **.be** extension) are used to decide the parameters applicable to the setting or command used in the configuration file being edited. The template name is displayed at the start of execution to confirm the

²⁰ Use the **-t** option to allow templates to be rebuilt only. Using other options may affect online.

configuration file edited.

- Configuration settings can be added, modified or deleted using interactive commands. The following commands are supported:

Command	Usage
add <i><group></i>	Add a group <i><group></i> with all its sub-elements. Values for the variables are defaulted from the template.
del <i><group></i>	Delete the group <i><group></i> and all its sub-elements.
exit	Exit the editor. If changes have been made, confirmation may be required.
help <i><topic></i>	Show online help for command or setting. Without a topic a list of topics for the configuration file and commands are listed
save	Save any changes to the configuration file
set <i><var></i> <i><value></i>	This command to update a variable's <i><var></i> to value <i><value></i> . If there are multiple sub-elements for a group, the variable name must be fully qualified by its parent group(s) - e.g. set pool.2 pool name DEFAULT . If there is only one group, the variable does not need to be qualified - e.g. set pool name DEFAULT .
what	This command shows which file is being edited and the template on which it is based.

- The templates will generate the necessary settings based upon the scope of the command. Use the online help to determine valid settings for your configuration.
- User preferences for labels and cluster types are stored in the **be.prefs** file.
- Using the **save** command will reflect your changes to the configuration file directly.
- If exit command is issued and changes have been detected then a confirmation message will be issued. Press **y** to save, **n** to quit without saving or **c** to cancel out of exit command.

Each subsection will outline specific settings within the scope of each configuration.

Cluster Configuration using bedit

Oracle Coherence is used to define and manage the batch cluster. The cluster must be configured to decide how the cluster will operate on the network and the scope of the cluster. The major decision for this step in the process is the type of cluster to implement. There are three styles of cluster supported:

- **Multicast cluster** (default) - A batch cluster based upon the multicast network protocol. The protocol requires a multicast address and common port. This protocol supports dynamic clustering.
- **Unicast cluster** - A batch cluster based upon unicast network protocol. Each host and port in the cluster must be explicitly configured and each server must be.
- **Single Server cluster** - A batch cluster confined to a single server using unicast. This is

designed for use in non-production environments to simplify the configuration.

The templates for these cluster types are as follows:

Template	Usage
<code>tangosol-coherence-override.mc.be</code>	Multicast cluster
<code>tangosol-coherence-override.ss.be</code>	Single Server cluster (useful for non-production environments)
<code>tangosol-coherence-override.wka.be</code>	Unicast (or wka) cluster

To configure the cluster use one of the example commands:

<code>bedit.sh -c -t <type></code>	Create or edit Cluster configuration. The <code>-t</code> option is used to set the cluster type as specified (<code>mc</code> - Multicast, <code>wka</code> - Unicast or <code>ss</code> - Single Server). Specifying the <code>-t</code> option on an already defined cluster may change the type
<code>bedit.sh -c</code>	Maintain the cluster configuration. Cluster type is defaulted from <code>be.prefs</code> .
<code>bedit.sh tangosol-coherence-override.xml</code>	Edit the <code>tangosol-coherence-override.xml</code> file.

Once the configuration is opened the following settings need to be configured:

Variable	ss	wka	mc	Recommendations
<code>cluster</code>	■	■	■	Unique cluster name for environment. This must be unique for the cluster. Typically use the environment name or database name.
<code>address</code>	■	■	■	IP address or host name for this node in the cluster. Use localhost if possible to minimize maintenance across hosts.
<code>port</code>	■	■	■	Unique port used for cluster. This must be unique per cluster per host. It use will vary from cluster type to cluster type. Refer to the online help for more information.
<code>loglevel</code>	■	■	■	The logging level associated with cluster operations. Refer to the online help to decide the amount of information you wish to log. The higher the value the more that is logged. High values are used by developers typically.
<code>mode</code>	■	■	■	The Coherence mode that the cluster is to be scoped to. Refer to the online help for more information.
<code>socket</code>		■		This is a section for each of the hosts in the Well Known Address format. Each host is a separate

Variable	ss	wka	mc	Recommendations
				socket entry. Refer to the online help for more information.
wkaaddress		■		The IP address or host name of the member of the cluster assigned to this socket.
wkport		■		The port number assigned of the member of the cluster assigned to this socket. This value ideally is the same across all hosts in the cluster but can be overridden to overcome port conflicts. The port number on each node must match the number assigned to the port value.

For unicast implementations a socket section must be created per host/port combination defined in the file using the following commands:

- Use the **add socket** command to add a new socket group. The group name generated will be in the form **socket. <number>** where **<number>** is the sequence number. For example:

```
> add socket
...
socket. 2
    wkaaddress (local host)
    wkport (42020)
```
- Set the **wkaaddress** and **wkport** using the **set socket. <number> <variable> <value>** where where **<number>** is the sequence number, **<variable>** is **wkaaddress** or **wkport** and **<value>** is the desired value. For example:

```
> set socket. 2 wkport 6402
...
socket. 2
    wkaaddress (local host)
    wkport (6402)
```
- Repeat for each node in the cluster.

Threadpoolworker Configuration using bedit

Once a cluster is defined the threadpools that will execute across that cluster must be defined with their name and attributes. The product supports different types of threadpools that can execute batch processes with the following:

- Cache Threadpools** - Threadpoolworkers that do not execute jobs but act as co-ordination node for network traffic. It is recommended that there be at least one cache threadpool per physical host per cluster. For a discussion of cache threadpools, refer to the [Batch Best Practices](#) (Doc Id: [836362.1](#)) whitepaper available from [My Oracle Support](#). This threadpool type has **tangosol.coherence.distributed.localstorage** set to **true**.
- Job Threadpools** - Threadpoolworkers that are optimized to run batch threads with support for additional java options and other cluster specific optimization settings.

- **Default Threadpools** - For backward compatibility, the default template used is pre-optimized with settings from past releases. It is recommended to migrate from this template to job template.

The templates for these threadpool types are as follows:

Template	Usage
threadpool worker. be. template	Default template
threadpool worker. cache. be. template	Cache Threadpool template
threadpool worker. job. be. template	Job Threadpool templates

To configure the cluster use one of the example commands:

bedi t. sh -w -l <type>	Create or edit threadpool configuration. The -l option is used to set the label type as specified (cache - cache or job - Job).
bedi t. sh -w	Maintain the default threadpool configuration.
bedi t. sh threadpool worker. properties	Edit the threadpool worker. properties file.

Once the configuration is opened the following settings need to be configured:

Parameter	Recommendations
minheap	Minimum JVM Heap size
maxheap	Maximum JVM Heap size
maxperm	Maximum JVM permgen size
daemon	Whether the threadpool should run the online submission daemon. This value should be set to false for production environments.
dkidisable	Key insert behavior
storage	Whether local storage is enabled. Used for cache threadpools.
disthds	Number of internal threads used for cache threadpools.
invcthds	Number of internal threads used for invocation services.
role	Information role for the threadpools used for monitoring
jmxstartport	JMX Start Port
pool	Group section for each threadpool
pool name	Name of threadpool
threads	Maximum number of threads for the threadpool per instance

For multiple threadpools per configuration use the following process:

- Use the **add pool** command to add a new pool group. The group name generated will be in the form **pool . <number>** where **<number>** is the sequence number. For example:
> **add pool**

```
...
pool . 2
  wkaaddress (localhost)
  wkaport (42020)
```

- Set the **pool name** and **threads** using the **set pool . <number> <variable> <value>** where where **<number>** is the sequence number, **<variable>** is **pool name** or **threads** and **<value>** is the desired value.

Submitter Configuration using bedit

The last step in configuration is to configure the submitters. A submitter is a JVM that submits jobs or threads of jobs to a threadpoolworker and waits for the thread to complete. It is responsible for interfacing to the threadpoolworker and also provides an interface to the process that submits the jobs in the first place (e.g. a third party batch scheduler or Oracle Scheduler).

A submitter needs one or more of the following pieces of information:

- It needs a configuration file that defines the parameters to be used for the individual batch process being executed. These can be global configuration files or individual configuration files optimized for a particular batch process.
- Command line options to set or override particular configuration parameters that define the execution parameters for the individual process or thread.

The single execution of a submitter can run a single threaded batch job, a single individual thread of a multi-threaded batch job or all threads of a multi-threaded job.

To create a specific configuration file for a batch job any of the following commands can be used:

- bedit t. sh -l <type>** Create or edit submitter configuration. The **-l** option is used to set the label type for development purposes as specified (**THIN** - THIN mode or **LOCAL**- local mode).
- bedit t. sh -b <batch_cd>** Create or edit submitter configuration for job **<batch_cd>**.
- bedit t. sh -s** Edit default submitter configuration

Once the configuration is opened the following settings need to be configured:

Parameter	Recommendations
pool name	Name of threadpool to execute this submitter within
threads	Thread limit of submitter. The number of threads must be equal to or less than the number of threads allocated to executing instances of the threadpool
commit	Default commit interval. This overrides the commit interval defined internally for the batch job.
user	The userid, defined to the User record, to be used to determine execution permissions and is used for records updated and created by this process. This MUST be a valid defined used.
lang	The language pack used for the batch process (default is ENG)

Parameter	Recommendations
storage	This sets whether this node is a storage node. Used for submitters that use THIN mode (for developers). This value is recommended to be set to false for all other submitter types.
role	The role used for this submitter. This is used for the JMX monitoring interface as a filter. By default the batch code used for this value.
soft	Group section for soft parameters. One section per parameter
parm	Parameter name as outlined on Batch Control.
value	Value assigned to the parameter

For multiple parameters per configuration use the following process:

- Use the **add soft** command to add a new parameter group. The group name generated will be in the form **soft. <number>** where **<number>** is the sequence number. For example:

```
> add soft
...
  soft. 2
      parm (maxErrors)
      value (500)
```
- Set the **parm** and **value** using the **set pool. <number> <variable> <value>** where where **<number>** is the sequence number, **<variable>** is **parm** or **value** and **<value>** is the desired value. For example:

```
> set soft. 2 parm fred
...
  soft. 2
      parm (fred)
      value (500)
```

Batch Configuration Guidelines

The following sections outline general guidelines for batch configuration.

Cache Threadpools

One of the new facilities in the batch architecture is the ability to define cache or storage nodes in your architecture. By default a batch cluster communicates across the cluster elements such as threadpools the state of other elements in the cluster. While this has benefits, as any element in the cluster can be queried, via JMX, to find out the global status of all active processes in that cluster, it can generate a large amounts of network traffic and cause instability as the cluster is performing a large amount of maintenance operations. To address this it is now possible in the product to create cache or storage threadpools. These act as conduits with the architecture and greatly reduce the network traffic and overheads in managing the cluster. This translates to more stable clusters.

The communications between elements are shown below:

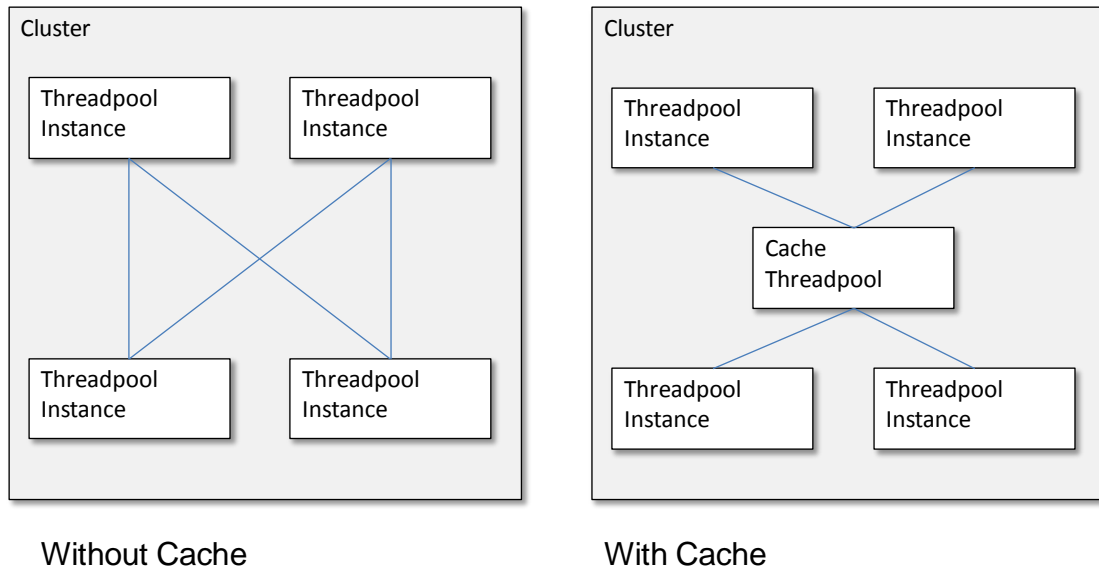

Figure 38 – Cache Architecture

The performance advantages of the cache increases with the number of elements the cluster has to manage and cache threadpools have the following implementation recommendations:

- Cache threadpools do not execute any threads of any jobs within them. They are exclusively used for administration, a storage node for the cluster state and a conduit for cluster management.
- Cache threadpools act as Coherence local storage nodes to maintain the integrity of the cluster and allow cluster management.
- Cache threadpools are ideally suited to allow JMX connections to monitor the performance of the cluster using the [Batch JMX interface](#).
- At least one cache threadpool per cluster per host is recommended. Multiple cache threadpools can be implemented where high availability is required or there are a large number of submitters, threads and/or threadpools to manage.
- If a cache threadpool, is shut down and no cache threadpools are active at any time, the cluster will not revert to individual elements communicating across other elements.
- To create cache clusters, use the `bedit [.sh] -l` cache command. A prebuilt template is created for the cache where **storage** is enabled, **di st thds**, **invoc thds** and the number of threads is set to 0 (to prevent jobs from actually running in the cache).

Adding custom JMX Information to jobs

The [Batch Server JMX interface](#) can be extended for additional tags using a new parameter **f1.jmxi info** for filtering purposes or additional documentation. For example:

ExecutionStrategyClass	com.splwg.base.api.batch.SingleTransactionStrategy
JMXInfo	foo2=bar2 foo1=bar1
LanguageCd	ENG
MaxExecutionAttempts	1

Figure 39 – Example JMXInfo in jconsole

The **submitbatch.properties** file for the particular job should have the following additional parameter:

```
com.splwg.batch.submitter.softParameter.f1.jmxInfo.<tag>=<value>
```

where:

<i><tag></i>	Additional JMX information identifier
<i><value></i>	Value for parameter

Multiple parameters of this type are supported within a single configuration file.

For example:

```
com.splwg.batch.submitter.softParameter.f1.jmxInfo.foo=bar
```

When using `bedit` the command sequence to use this facility is:

- Add a soft parameter section for each desired tag/value pair using the command (a section **soft. <sequence>** is created where **<sequence>** is a generated sequence number):
`add soft`
- Specify the parm property as **f1.jmxInfo. <tag>** where **<tag>** is the desired tag using the command:
`set soft. <sequence> parm f1.jmxInfo. <tag>`
- Specify the value property as the desired value for the tag using the command:
`set soft. <sequence> value <value>`

It is possible to specify this setting on the [submitjob\[.sh\]](#) command using the **-x** option. For example:

```
submit.sh ... -x f1.jmxInfo.foo=bar
```

Oracle Cloud Support

The Oracle Utilities products are progressively being implemented on Oracle Cloud in both Software as a Service (SaaS) and Platform as a Service (PaaS). This has resulted in new cloud based configurations and features. These features are also available for customers with customers with on-premise and hybrid implementations. This section will outline the additional configuration facilities that can be used for on-premise implementations.

Support for host whitelisting

The hosts and port numbers used by the feature sets in the product are typically restricted in scope for on-premise products but on the cloud, the ports and hosts can be restricted to ensure compliance. The product supports the configuration of the hosts and ports, that are accessible from the online system²¹, can be specified in a whitelist which is validated at configuration time and runtime. The product now supports whitelisting of URIs with schemes such as t3, t3s, ldap, ldaps, jdbc, etc. URI whitelisting can be enabled by setting the **com.oracle.ouaf.uriValidation.enable** parameter in the **spl.properties** file to **true**. Once enabled, it is possible to limit the values of URL's within the product for key objects with the configuration. This is implemented as a whitelist that can filter on scheme (aka protocol), hosts and ports. These are checked at runtime and can generate an error if

²¹ URL's within configuration files are subject to deployment restrictions within the deployment facility itself.

they do not adhere to the whitelist.

The feature allows for the following:

- Individual scheme, hosts and port combinations can be configured to limit runtime access for specific features.
- Specification of the '*' wildcard is supported for scheme, hosts and ports.

Note: Custom whitelists are not supported on Oracle Utilities SaaS Cloud Services.

There are a number of configuration settings (ENVIRON.INI) that control the *whitelist*:

- [**CLoud RESTRICTION URLs ENABLE**](#) - Whether the whitelisting feature is used or not (default is **false**).
- [**CLoud WHITE LIST PATH**](#) - The full path to the whitelist file for Oracle Cloud. This variable should not be populated for on-premise implementations. This is only used if [**CLoud RESTRICTION URLs ENABLE**](#) is set to **true**.
- [**CLoud CUSTOM WHITE LIST PATH**](#) - The full path to a custom whitelist for Oracle Cloud or on-premise implementations. This is only used if [**CLoud RESTRICTION URLs ENABLE**](#) [**CLoud RESTRICTIONS URLs ENABLE - En**](#) is set to **true**.

The format of the whitelist is an XML format document:

Attribute	Comments
<code><uri></code>	URI tag
<code><path></code>	Specific path on the host.
<code><host></code>	Host name or IP Address for host. Wildcards are supported. IPV4 and IPV6 formats are supported.
<code><port></code>	Port Number. Wildcards are supported.
<code><scheme></code>	Protocol supported (HTTP or HTTPS support). Wildcards are supported.

For example:

```
<?xml version="1.0" encoding="UTF-8"?>
<whitelist>
  <uri>
    <host>myhost.example.com</host>
    <port>10201</port>
    <scheme>HTTPS</scheme>
  </uri>
  <uri>
    <host>myhost2.example.com</host>
    <port>6501</port>
    <scheme>HTTP</scheme>
  </uri>
</whitelist>
```

There must be a separate entry for each **host**, **path**, **port** and **scheme** combination. The product now supports whitelisting of URIs with schemes such as t3, t3s, ldap, ldaps, jdbc, etc.

The following components are validated and when:

Component	Design time validation	Run time validation
Message Sender Context	■	
JNDI Server	■	
XAI JDBC Connection	■	
Web Service Adapter	■	■
Feature Configuration	■	
Reporting Options	■	
External Navigation Keys	■	■
XAI Executer	■	
XAI Command	■	
HTTP Sender		■
Real Time HTTP Sender		■
JSON Sender		■
Real Time Email Sender		■
JMS Sender		■
SMS BPEL Sender		■
Web Services (WSDL, OPA etc)		■

Support for URI specification using Substitution Variables

Applications need to define URI links to the integrate components for seamless navigation to different application pages, for map viewer, etc. URI specifications can now include substitution variables to allow parameterization of URI components.

This new enhancement featuring substitution variables ensures support for secure, stable and uniformly configured environments. For configuration stability such URL values will be defined using substitution variables, aka aliases. E.g. "@CCB@/demoprop/cis.jsp" . This would help in migrating values between different environments, e.g. from CCB Test to CCB Prod environment, and in performing CMA extracts that would allow to pull URL values that are not environment specific.

A substitution list is provided to implement the physical path per environment. This file is maintained in **`$SPLEBASE/etc/substitutionVariableList.xml`** (or **`%SPLEBASE%\etc\substitutionVariableList.xml`** in Windows).

The substitution list file can be specified using the **`CLOUD_SUBSTITUTION_VARIABLE_LIST_FILE_LOCATION`** config parameter in the ENVIRON.INI file.

Following is the format of the substitution variables file:

```

<?xml version="1.0" encoding="UTF-8"?>
<?xml version="1.0" encoding="UTF-8"?>
<substitutionVariables>
  <uriVariable>
    <name></name>
    <value></value>
  </uriVariable>
</substitutionVariables>

```

Attribute	Comments
<uri Variable>	URI Variable tag
<name>	The name of the substitution variable.
<value>	The URI(URL/Path) of the substitution variable.

uriVariable element has the attribute "allURICHildComponentsAreValid" with allowed values being true or false. If the attribute value is set to false, then the uriVariable value needs to be verified against the white list after the variable is replaced with the actual value. If the allURICHildComponentsAreValid is set to true, or is omitted, then this indicates that the variable value is already white listed and there is no further validation of the uri and all its child components (such as path, query and fragement) is needed. Note that the default behaviour is "true".

For example:

```

<?xml version="1.0" encoding="UTF-8"?>
<substitutionVariables>
  <uriVariable>
    <name>F1_INTERNAL_FILES</name>
    <value>/scratch/OUAF/sploutput/Files/Shared</value>
  </uriVariable>
  <uriVariable>
<name > F1_CUST_APP_BASE </name>
    <value>/usr/OUAF/CustomerFiles</value>
  </uriVariable>
<uriVariable >
    <name>CCB</name>
    <value>http://ccbenvurl.oracle.com:8001</value>
  </uriVariable>
</substitutionVariables>

```

The following substitution variables are provided by default in OUAF:

1. F1_CMA_FILES

Note: The below substitution variables are also provided by default, but no product functionality is using them. In a future release these variables will no longer be delivered (to remove any ambiguity). Implementation are suggested not to use any of the below names, but should rather use CM variable names.

1. F1_BI_EXTRACTS
2. F1_INTERNAL_FILES
3. F1_CUST_APP_BASE
4. F1_PROCESS_DIR
5. F1_SVC_CATALOG_WSDL_DIR
6. F1_PDB_EXTRACTS

*Note: The list **must not** contain variables and file paths that contain internal product infrastructure, e.g. config files, binaries, properties, security info and others.*

*The list **must not** contain existing environment variables such as SPLEBASE, SPLOUTPUT, COBOL_RUNTIME_LIB, APPVIEWER_DIR and their corresponding application directories.*

Domain Template Support

Note: This feature only applies to Oracle WebLogic 12 and above implementations only.

Note: Before using Domain Templates refer to the [Fusion Middleware Creating Domain Templates Using the Domain Template Builder](#) for more information about Domain Templates and Extension Templates.

Oracle WebLogic supports the concept of [Domain Templates](#). These are predefined domain configurations that can be used to establish the domain configuration reducing the need for manual effort in building domains.

The product now ships with a number of base templates that can be used when creating the domain:

- **Oracle-Utilities-Simple-Linux- <version>.jar** - This is a template useful for non-production installations with an Administration server and single product server with the base domain attributes, as per the native installation.
- **Oracle-Utilities-Complex-Linux- <version>.jar** - This is a template useful for clustered production installations with an Administration server and single product cluster (with a single server) with the base domain attributes, as per the native installation.

These templates are located in **\$SPLEBASE/tools/domaintemplates**. These can be used with the [Oracle WebLogic Configuration Wizard](#) or Oracle WebLogic installer.

If a native mode installation is desired, it is recommended to use the domain templates as

provided to reduce the amount of manual configuration.

Oracle WebLogic ships with a [Template Builder](#) to allow implementations to build their own custom templates. If the domain has been customized for any reason, then using a custom domain template can simplify the provisioning of new domains.

When using the domain template builder ensure the following is included in your custom domain template:

- Ensure the servers allocated to the product are included.
- Ensure all the deployments allocated to the product are included.
- Ensure the secure domain configuration is included. Optionally users can also be included. At a minimum the administration users should be transferred, if desired.
- Ensure the XML registry is included.
- Ensure JDBC and JMS resources used by the product are also included.

Diagnosics Support (WLDF)

Note: This feature only applies to Oracle WebLogic 12 and above implementations only.

Note: Refer to [Configuring and Capturing Diagnostic Images](#) for additional advice.

Oracle WebLogic includes a diagnostics capability in the form of [Oracle WebLogic Diagnosics Framework](#) (WLDF). Typically most diagnostics tools only detect an issue after it has happened, which means important diagnostic information may not be captured. The WLDF captures information at the time of the issue and after to provide additional diagnostics in a standard format for inclusion in diagnostic tools built into Oracle products and for Service Requests within My Oracle Support.

The diagnostic engines works in the following way:

- The diagnostics facility is enabled to capture information. As part of that enablement the location of the diagnostics is configured.
- A set of rules are added to configure the diagnostics engine to recognize issues that are above and beyond the typical issues. WLDF detects common java issues automatically.
- When a rule or the diagnostic engine detects an error is occurring or has occurred, it gathers as much diagnostics information it can at the time of the error and creates a diagnostic image which assembles the diagnostics information into a structured format. This is placed in the configured location.
- Diagnostic images are available from the console as well as Oracle Enterprise Manager where they can be viewed, analyzed and attached to Service Requests as necessary.

The product now supports the WLDF using the following:

- A set of configuration settings that enable the support as well as set some basic settings. These settings are primarily used for embedded installations. For native installations, the WLDF definitions are included in the provided [Domain Tempates](#).

Note: For customers with preexisting native installations wanting to use this facility, it is recommended to enable the facility in an embedded installation and manually make the changes to your domain to match the settings using the Oracle WebLogic console or Oracle

Fusion Middleware console.

- A set of base rules to instruct WLDF the conditions to track and detect issues. These are customizable rules for Oracle WebLogic to detect any issues outside of typical issues.

The following parameters control the implementation of the Diagnostics Framework:

- [**WLS DIAGNOSTIC CONTEXT ENABLED**](#) - This enables (**true**) or disables (**false**) the diagnostics generation support in the product.
- [**WLS DIAGNOSTIC BUILT IN MODULE**](#) - If [**WLS DIAGNOSTIC CONTEXT ENABLED**](#) is enabled, this sets the name of the diagnostics module to be used for diagnostics. The default value is **None**.
- [**WLS DIAGNOSTIC VOLUME**](#) - If [**WLS DIAGNOSTIC CONTEXT ENABLED**](#) is enabled, this determines the volume of diagnostics generated for the diagnostic tools such as [Flight Recorder](#). The default is **Off**.

For native installations, the following process should be used from the Oracle WebLogic console to enable support:

- Navigate to the *Environment* → *Servers* menu item and click on the product server name to enable.
- In the *Configuration* tab, change the value of *Diagnostic Volume* to the desired level of diagnostics. It is recommended to use **Low** as a minimum. *Save* the changes and repeat for each product server (if multiple are implemented in the domain).
- Navigate to the *Diagnostics* → *Built-in Diagnostics Modules* menu item and select the product servers. Click on the *Activate* button to enable basic diagnostics. This should change the *Status* to **Active**.
- If a custom Diagnostic Module is to be used, then navigate to the *Diagnostics* → *Diagnostic Modules* menu item and select the desired diagnostic module to maintain. From the *Targets* tab, select the product servers to apply the desired diagnostics module. *Save* the changes.

ECID Support

Note: This feature only applies to Oracle WebLogic 12 and above implementations only.

Note: Any settings outlined here are for embedded implementations only. Additional steps for native installations are also outlined.

Oracle WebLogic includes a set of facilities to add additional information to transactions known as the [Execution Context Identifier \(ECID\)](#). The single ECID is attached to each unique transaction within the product. This allows diagnostic tools to perform forensic analysis based on the identifier across the architecture.

There are a set of rules that apply to the ECID within the product:

- A unique ECID is generated at the start of a transaction within the product. This ECID is active for all calls within the product till a **COMMIT** or **ROLLBACK** is issued by the product. This constitutes a transaction boundary within the product.
- The ECID is only generated for online web based transactions in the present release.
- The ECID is used within the logs, diagnostic images and transaction tracking

facilities within Oracle WebLogic and the related database connections²².

- The use of ECID is optional and disabled, by default, for backward compatibility.
- The ECID is used by the various Oracle diagnostics tools such as [Oracle Enterprise Manager](#), [JVMD](#) and [Business Transaction Management](#).

The following parameters control the implementation of the Diagnostics Framework:

- [WLS DIAGNOSTIC CONTEXT ENABLED](#) - This enables (**true**) or disables (**false**) the diagnostics generation support in the product.

For native installations, the following process should be used from the Oracle WebLogic console to enable support:

- Navigate to the *Diagnostics* → *Context* menu item.
- Select the product servers and click on *Enable* to enable ECID support.
- The status of the selected servers should change to *Enabled*.

Global Cache Flush Support

Note: This facility is only available in Oracle WebLogic.

One of the architectural features of the products is the support for caching of commonly used data. This cache is used to prevent the transactions to perform unnecessary calls for commonly used data. This cache is loaded and maintained by the product automatically.

In some cases, it may be necessary to force a refresh of the cache to reload the static data. Whilst a number of utilities are provided to [flush the online/web services](#) cache as well as the [batch cache](#), if there were a number of servers or threadpools then the cache request may have to be performed on each threadpool or server.

In the current release any cache request can be configured to flush all caches, known as a global flush, across the architecture. Use of this facility is optional, but recommended in production environments to ensure consistent processing.

To use this facility the following must be configured:

- The [ouaf.flush.jms.disabled](#) property in the [spl.properties](#) file must be set to **false**.
- The [ouaf.flush.jms.connection](#), [ouaf.flush.jms.requestTopic](#) and [ouaf.flush.jms.responseTopic](#) properties must be populated in the [spl.properties](#) with the JMS resources used. These JMS resources must be created within the domain of the product.

Once enabled all flush requests now are global.

The global flush operates in the following way:

- When a flush is requested from the online using the JSP or JMX facility, Web Services via JMX and batch via running **F1-FLUSH**, an entry is placed in the JMS Topic dictated by [ouaf.flush.jms.requestTopic](#).
- Each of the components of the architecture has subscribed to the JMS resource specified by [ouaf.flush.jms.requestTopic](#) at their startup time.

²² This is only supported when using Oracle WebLogic JDBC Data Sources. It is not supported for UCP at the present time.

- When they receive a message in that topic, each component flushes their cache according to their local methods and sends an appropriate response in the JMS resource specified by [ouaf.flush.jms.responseTopic](#) indicating success or failure. This JMS resource may be monitored using the Oracle WebLogic console, Oracle Enterprise Manager, a JMS Browser or the JMS Viewing facility within the product.

Note: It is possible to configure additional features of the JMS resources outlined above to decide on retention periods and other settings. Refer to the [Understanding Oracle WebLogic JMS](#) documentation for additional features.

Java Flight Recorder Support

Note: This feature only applies to Oracle JDK 7u60 and above implementations only.

Note: If Java Flight Recorder is enabled then these will also be included in Diagnostic Images if [Diagnostics](#) is enabled.

The [Java Flight Recorder](#) is a component of Java that collected diagnostic and profile data for a running Java Virtual Machine (JVM). The product now supports the enabling of the Java Flight Recorder for tracking online java performance.

To enable the support for Java Flight Recorder in a native installation the following process must be performed on the Oracle WebLogic console:

- Navigate to the *Environment* → *Servers* menu item. Click on the product server to enable configuration.
 - Navigate to the *Server Start* tab on the *Configuration* tab and add the following java options to the *Arguments* field.
-XX: +UnlockCommercialFeatures -XX: +FlightRecorder
-

Note: If your site is using the [setUserOverrides.sh](#) facility, place these arguments in that script as an alternative.

- Navigate to the *General* tab on the *Configuration* tab and alter the *Diagnostics Volume* to the desired amount of diagnostics to capture. At a minimum this value should be set to **Low**.
- Optionally, enable [ECID tracking](#) for advanced diagnostics for tracing individual transactions.
- Edit any Diagnostic Modules you are using, or create one if you are not using a module and configure a DyeInjection Monitor as outlined in [Configuring the DyeInjection Monitor to Manage Diagnostic Contexts](#). Filters may be specific to focus the scope of the monitor if desired.

Work Manager Support

Note: This feature only applies to native installation implementations only.

Note: This feature is only available in Oracle WebLogic implementations only.

Oracle WebLogic supports [Work Managers](#) that allow implementations to set limits on the server to help optimize performance and prevent server overloading. The product now allows specification of Work Managers to provide additional throttling capabilities.

To use this feature the following must be performed within the Oracle WebLogic console:

- Create a Work Manager with an appropriate name using the *Environment* → *Work Managers* menu item. Target the Work Manager to the product servers using the *Targets* tab. By default, the Work Manager will be unlimited and have no restrictions.
- The product supports the following [constraints](#):
 - Minimum Threads Constraint
 - Maximum Threads Constraint
 - Capacity Constraint
- It is also possible to override the action used for Stuck Threads.
- Request Class is currently not supported.
- *Save* the changes.

Work Managers can be monitored using Oracle WebLogic console or Oracle Enterprise Manager. Refer to the [Work Managers](#) documentation for additional information.

Trust Store Support

Note: For more information about trust stores refer to the [JSSE documentation](#) and [Keystore Configuration](#) (Doc Id: [2014161.1](#)).

The product now supports trust stores as well as key stores for two phase authentication for the online web channel. The format of a trust store is the same as the keystore but the trust store is used to verify credentials whilst the keystore provides the credentials.

The following in the [ENVIRON. INI](#) entries need to be provided:

- [TS ALIAS](#)
- [TS ALIAS KEYALG](#)
- [TS ALIAS KEYSIZE](#)
- [TS HMAC ALIAS](#)
- [TS HMAC ALIAS KEYALG](#)
- [TS HMAC ALIAS KEYSIZE](#)
- [TS IMPORT KEYSTORE FOLDER](#)
- [TS KEYSTORE FILE](#)
- [TS MODE](#)
- [TS PADDING](#)
- [TS STOREPASS FILE](#)
- [TS STORETYPE](#)

Miscellaneous Operations And Configuration

Enabling Email Logging from Log4j2

The following sample configuration will enable email logging of ERROR level log messages in the product. When an error is encountered in startup and during operations of the product any ERROR message displayed on the console log file will be emailed to an Administrator's email account or email group.

Note: This change outlined below will make manual changes to a configuration file. Execution of [initialSetup](#) may overwrite these changes unless [template overrides](#) are used. Please ensure you make adequate backups to preserve this change. Refer to <https://logging.apache.org/log4j/2.x/manual/appenders.html#SMTPAppender> for details of the appender.

The following changes are required to enable this.

- 1) Open the log4j.properties in the relevant **\$SPLEBASE/etc/conf** (%SPLEBASE%\etc\conf in Windows) subdirectory:

- Web Application Server – [log4j2.properties](#)
- Business Application Server - [log4j2.properties](#)

- 2) Add the following lines to the file:

```
### E1 is an EmailAppender
log4j2.appender.E1 = org.apache.log4j.net.SMTPAppender
log4j2.appender.E1.Threshold = ERROR
log4j2.appender.E1.layout = org.apache.log4j.PatternLayout
log4j2.appender.E1.layout.ConversionPattern = %d{ISO8601} [%t] %-5p
%c %x - %m%n
log4j2.appender.E1.From = <from>
log4j2.appender.E1.SMTPHost = <SMTPHost>
log4j2.appender.E1.Subject = <subject>
log4j2.appender.E1.To = <to>
###
### The following settings are optional
###
log4j2.appender.E1.SMTPUsername = <SMTPUsername>
log4j2.appender.E1.SMTPPassword = <SMTPPassword>
log4j2.appender.E1.CC = <cc>
log4j2.appender.E1.BCC = <bcc>
```

Parameter	Field from example	Usage
From	<from>	Email address for emails
To	<to>	Email address/group to send emails to
CC	<cc>	Email address/group to send courtesy copy of

Parameter	Field from example	Usage
BCC	<i><bcc></i>	Email address/group to send "blind" courtesy copy of emails to
SMTPHost	<i><SMTPHost></i>	Host Name of SMTP Server
SMTPUsername	<i><SMTPUsername></i>	Logon User for SMTP Server (<i>if supported</i>)
SMTPPassword	<i><SMTPPassword></i>	Password for Logon User for SMTP Server (<i>if supported</i>)
Subject	<i><subject></i>	Subject for email message

- 3) Modify the following lines in the log4j.properties file:

```
## System-wide settings
# set log levels - for more verbose logging change 'info' to
' debug' ###
log4j2.rootCategory=info, A1, F1, E1
```
- 4) Execute the [initialSetup](#) utility, with the `-w` option, to reflect the changes in the WAR/EAR file.
- 5) To deploy the application refer to the [Web Application Server Deployment Process](#) or [Business Application Server Deployment Process](#)

Overriding the default Oracle database connection information

By default the database connection for Oracle databases is of the format:

`jdbc:oracle:thin:@<hostname>:<dbport>:<database_sid>`

where

<code><hostname></code>	Database hostname
<code><dbport></code>	Database Listener portname
<code><database_sid></code>	Database Name

The URL format is described at http://www.oracle.com/technology/tech/java/sqlj_jdbc/htdocs/jdbc_faq.html#05_03

This configuration setting is sufficient for the majority of the environments at a site. If your site requires a specialist URL for RAC support then you must override the default URL.

To override the default URL specify the following:

- Log on to the server containing the Business application server using the administration account for the desired environment (for example, **splsys**).
- Execute the [splenviron](#) utility, with the `-e` option, to attach to the desired environment to change.
- Execute the [configureEnv](#) utility and choose to change menu block 4 (Database).
- Change the *Database Override Connection String* to the desired custom JDBC url.
- Press **p** to save the change to the [ENVIRON.INI](#).

- Execute [initialSetup](#), with the `-t` option, to reflect the change in the [hibernate.properties](#) files. This may overwrite custom changes if [custom templates](#) are not used.
- Execute [initialSetup](#), with the `-w` option, to include the configuration changes in the WAR/EAR files. This option is not required if [externalization of configuration](#) is implemented.
- For selected platforms redeployment of the WAR/EAR files is required as per [Business Application Server deployment process](#).

The following example uses the Oracle JDBC thin client (for Oracle Real Application Clustering):

```
j dbc: oracl e: thi n: @(DESCR IPTION =(ADDRESS = (PROTOCOL = TCP) (HOST = machi ne-
name) (PORT = 1251)
  (ADDRESS = (PROTOCOL = TCP) (HOST = machi ne- name) (PORT = 1251)
  (LOAD_BALANCE = yes)
  (FAILOVER=YES)
  (CONNECT_DATA =
    (SERVER = DEDI CATED)
    (SERVI CE_NAME = SI D. WORLD)
  )
)
```

Refer to [Oracle RAC support](#) for other examples.

Example URL using the Oracle JDBC thick client:

```
j dbc: oracl e: oci : @SI D. WORLD
```

*Note: For thick client to work, the Oracle client library directory must be added to the library search path. Oracle client libraries are installed under **ORACLE_HOME/lib** and **ORACLE_HOME/lib32** directories. Add this directory to the library search path environment variable. The library search path environment for AIX is **LIBPATH**, for HP-UX is **SH_LIB_PATH** for Linux is **LD_LIBRARY_PATH** and for Windows is **PATH**.*

*Note: For Oracle Database 12.1 and above, use the format: **j dbc: oracl e: thi n: <hostname>: <dbport>: /<database_service>** to use Pluggable Databases where **<database_service>** is the PDB name.*

Centralized Properties Customization

Support is now added for a centralized properties customization file using which properties present in various configuration files can be customized. Instead of customizing individual properties files, a single file can be used to specify all the properties that are to be customized (add, modify or remove).

Once specified in this custom central properties file, the properties are automatically migrated to specified properties files. All the configuration properties should be specified in the custom centralized properties file "**etc/cm_properties.ini**" (this can be created as a customization). If the file exists the content will be processed for the relevant properties.

Each entry in the centralized properties customization file should be specified in the following format:

<PROPERTIES_FILE> : <PROPERTY_NAME> = <VALUE>

Parameter	Usage
PROPERTIES_FILE	The property file in which the property needs to be added/updated/removed.
PROPERTY_NAME	The name of the property.
VALUE	The value to be added/updated against the property in the specified property file.

- For each property entry(<PROPERTIES_FILE> : <PROPERTY_NAME> = <VALUE>) specified in the centralized properties customization file, the property(PROPERTY_NAME=VALUE) is added in the specified properties file(PROPERTIES_FILE), if doesn't exist in the specified property file.
- If the property(PROPERTY_NAME=VALUE) already exists in the specified properties file(PROPERTIES_FILE), then the entry is updated with the specified value(VALUE).
- If user doesn't specify the properties file name in the entry i.e., the entry in the centralized properties customization file is "<PROPERTY_NAME> = <VALUE>", then the <PROPERTY_NAME> in all property files is overridden with <VALUE>, if <PROPERTY_NAME> exists.
- In order to remove an existing property from a specific properties file, the centralized properties file will need to have the entry specified as "<PROPERTIES_FILE> : <PROPERTY_NAME> = [DELETE]"
- In order to remove an existing property from a all the properties file, the centralized properties file will need to have the entry specified as "<PROPERTY_NAME> = [DELETE]"

Sample entry in the centralized properties customization file:

```
hibernate.service.properties.template:hibernate.user=clouduser
```

This sets the hibernate.user property to clouduser in the hibernate.service.properties file.

Note: This feature is implemented if the [initialSetup.sh](#) script is executed with the minimum of -t option.

Cache Management

Note: If cache management requires global cache management across various nodes then refer to the [Global Cache Flush Support](#) section for more details.

A great deal of information in the system changes infrequently. In order to avoid accessing the database every time this type of information is required by an end-user, the system maintains a cache of static information on the Web Application Server. In addition to the Web Application Server cache, information is also cached on each client browser.

Server Cache

Note: Maintenance of the cache is performed automatically by the product. Whilst there are commands to force refreshes of the cache, these are designed for administrator and developer use only. Additional security setup is required to enable individual users to access to the facilities below.

The cache is populated the first time any user accesses a page that contains cached information. For example, consider a control table whose contents appear in a dropdown on various pages. When a user opens one of these pages, the system verifies that the list of records exists in the cache. If so, it uses the values in the cache. If not, it accesses the database to retrieve the records and saves them in the cache. In other words, the records for this control table are put into the cache the first time they are used by any user. The next user who opens one of these pages will have the records for this control table retrieved from the cache (thus obviating the database access).

Typically, this information

The following points describe the type of data that is cached on the web server:

- **Field labels.** This portion of the cache contains the labels that prefix fields on the various pages in the system.
- **System information.** This portion of the cache contains installation and license key information as well as basic information about the various application services (e.g., the URL's that are associated with the various pages).
- **Menu items.** This portion of the cache contains the menu items.
- **Dropdown contents.** This portion of the cache contains the contents of the various dropdowns that appear throughout the system.
- **XSL documents.** This portion of the cache contains each page's static HTML.
- **Portal information.** This portion of the cache contains information about which zones are shown on the various pages.

The contents of the cache are cleared whenever the Web Application Server is restarted or as automatically refreshed as controlled by the `fieldValuesAge` parameter on the Web Application Server `web.xml` configuration file. This means that fresh values are retrieved from the database upon first use by end users.

If you change the database after the cache is built and the information you changed is kept in the cache, users may continue to see the old values. If you don't want to restart your Web Application Server, you can either use the relevant operation on the JMX `FlushBean` Mbean available on the Web Application Server or issue a custom browser URL to issue the appropriate command (see below).

*Note: To use the browser URL for the resetting of the cache the user must be logged on to the product browser interface and have access to the **F1ADMIN** application service.*

Function	JSP	MBean Operation
Refresh all cache	<code>flushAll.jsp</code>	<code>flushAll</code>
Refresh all drop down data	<code>flushDropDownCache.jsp</code>	<code>flushDropDownCache</code>
Refresh field labels	<code>flushMessageCatalog.jsp</code>	<code>flushMessageCatalog</code>

Function	JSP	MBean Operation
Refresh Fields and FK information	<code>flushFieldsAndFKMetaData.jsp</code>	<code>flushFieldsAndFKMetaData</code>
Refresh menu items	<code>flushMenu.jsp</code>	<code>flushMenu</code>
Refresh messages	<code>flushMessaging.jsp</code>	<code>flushMessaging</code>
Refresh navigation keys	<code>flushNavigationInfo.jsp</code>	<code>flushNavigationInfo</code>
Refresh portals and zones	<code>flushPortalMetaInfo.jsp</code>	<code>flushPortalMetaInfo</code>
Refresh screen style sheets	<code>flushUI_XSLs.jsp</code>	<code>flushUI_XSLs</code>
Refresh security	<code>flushSystemLogInfo.jsp</code>	<code>flushSystemLogInfo</code>
Refresh specific drop down data	<code>flushDropDownFields.jsp</code>	<code>flushDropDownFields</code>

Note: It is recommended that the "Refresh all cache" is used for non-production and production systems. The other commands are designed for primarily for development use only. Refer to the [Oracle Utilities SDK](#) documentation for more information about the options available with the commands.

Note: When using these commands the cache will be reloaded over time with fresh data. As the data is loaded there is a negligible delay in each transaction that reloads data into the cache for the first time. Therefore it is recommended not to execute this command frequently.

Client Cache

In addition to the server cache, information is cached on each user browser. After clearing the cache that's maintained on the Web Application Server, it is recommended to also clear the cache that is maintained on the client browser (if possible). To do this, follow the following steps:

Browser	Steps
Microsoft Internet Explorer	<ul style="list-style-type: none"> Select <i>Tools</i> on your browser menu bar Select <i>Internet Options</i> on the menu that appears. Click the <i>Delete Files</i> button on the pop-up that appears. Click the <i>Delete all...</i> button on the subsequent pop-up that appears and then click OK. Enter the standard product URL to re-invoke the product.
Mozilla Firefox	<ul style="list-style-type: none"> Select <i>Tools</i> from your browser menu bar. Click <i>Options</i> on the Tools menu. Select the <i>Advanced</i> tab from the Options dialog. Select the <i>Network</i> tab from the <i>Advanced</i> tab. Click on the <i>Clear Now</i> button. Enter the standard product URL to re-invoke the

Browser	Steps
	product.

Note: Each user's cache is automatically refreshed as controlled by the `maxAge` and `maxAgeI` parameters in the Web Application Server `web.xml` configuration file. . We recommend that you set this parameter to 1 second on development / test environments and 28800 seconds (8 hours) on production environments.

Oracle WebLogic: Expanded or Archive Format

Note: Expanded format is not support on IBM WebSphere or IBM WebSphere ND.

By default, the product is built into a set of WAR/EAR files and deployed in this format on Oracle WebLogic and IBM WebSphere/ND to operate. For Oracle WebLogic it is possible to use *expanded* mode rather than the WAR/EAR format. This mode allows the Oracle WebLogic instance directories access to the directories and files used by the JEE components of the product without the need for WAR/EAR files. This has a number of key advantages:

- Changes to the individual files in the product (such as JSP's or graphics) do not require a rebuild of the WAR/EAR file.
- Outage time to deploy and execute the WAR/EAR file is reduced as Oracle WebLogic reads the files directly. In the deployment process, Oracle WebLogic loads the WAR/EAR file and uncompressed it to a staging or temporary location for actual execution. This is greatly reduced under *expanded* mode as the files are already uncompressed.
- Application of patches and service packs is faster as the patch installer does not need to rebuild the WAR/EAR files after applying patches.

This expanded mode is suggested for non-production and demonstration environments and is not recommended for production (the default is *Archive* [non-expanded] mode) as the during the WAR/EAR process additional integrity checks are performed and security control of individual application files adds higher security requirements to production.

The figure below illustrates the expanded mode main directories:

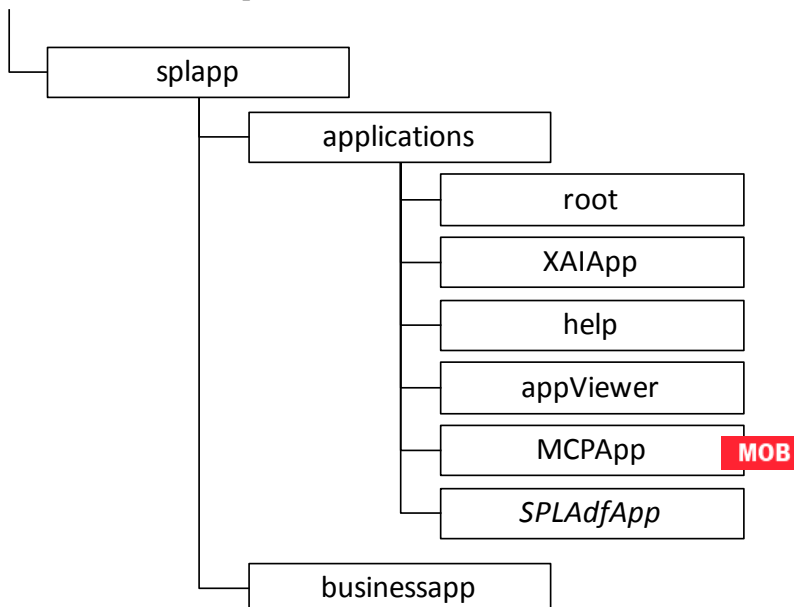

Figure 40 – Expanded Format

- Under the **root** directory are the product specific subdirectories for each subsystem or part of the online component of the product.
- Under the **XAI App** directory are the product specific subdirectories for each subsystem or part of the Web Services component of the product.
- Under the **busi enssapp** directory are the business object specific files for each subsystem or part of the online component of the product.
- The **hel p** and **AppVi ewer** directories contain an expanded mode version of the **hel p** HTML (and related files) and **appVi ewer** generated files (after running [genappvieweritems](#)).
- Under the **MCPApp** directory are the Mobile Communications Platform specific files (if the mobile framework is deployed with your product). **MOB**
- Under the **SPLAdfApp** directory are any ADF specific files if the Oracle ADF interface is installed and used with your product.

Implementing Custom Templates

As described in the [Web Application Server Configuration Process](#) and [Business Application Server Configuration Process](#) the configuration files used in the product are built from templates. These templates are typically located in the **\$\$SPLEBASE/templates** (or **%SPLEBASE%\templates** on Windows) subdirectory of each environment.

*Note: The file **FW_template_structure.xml** in the **structures** subdirectory lists all the templates and their destination paths. This file should not be altered unless instructed by Oracle Support.*

By default the product uses the base produce provided templates to build the configuration files. These configuration files are usually adequate for most needs in non-production but usually require some customization for production or site specific standards not covered by the base templates. In the past the site had two options:

- **Make custom changes to the configuration file directly** – This can performed against the **\$\$SPLEBASE/etc/conf** (**%SPLEBASE%\etc\conf** on Windows) copies of the configuration files. The issue here is that if the configuration files are reset back to the templates intentionally or unintentionally, using the [initialSetup](#) utility, custom manual changes may be lost if not reapplied manually.
- **Make custom changes to base configuration templates** – In extreme conditions it was possible to make manual changes to the base product templates to reflect your site standards and customizations. The issue is that new releases of the templates for new features would overwrite any customizations if not reapplied manually.

To address this it is now possible to override base product templates with a copy of the template (a custom template). This can be achieved by copying the desired base template in the templates directory to the same name prefixed with "**cm.**". The [initialSetup](#) utility will use the custom template instead of the base template.

The process to implement this is as follows:

- Identify the template in the that is used by the desired configuration file. Use the information in the [Web Application Server Configuration Process](#) and [Business](#)

[Application Server Configuration Process](#) sections of this document to help identify the templates used for each configuration file.

- Copy the desired template in the **\$SPLEBASE/templates** (or **%SPLEBASE%\templates** on Windows) subdirectory to the same name but prefixed with a "**cm.**". This will be the override custom template. To disable the custom template at any time either rename the template to another name or remove it from the subdirectory.
- Make the necessary adjustments to the custom template as per your site standards. Please follow any conventions used in the template including use of [environment variables](#) or configuration settings from [ENVIRON.INI](#).
- Use initialSetup as per [Web Application Server Configuration Process](#) and [Business Application Server Configuration Process](#) sections of this document to use the template to generate the new configuration files and incorporate the changes in the product.

Note: If custom templates are implemented, it is the sites responsibility to maintain the custom templates to reflect any changes in the base templates for new, changed or removed functionality.

Additional templates

The templates mentioned in previously in this document are the main configuration file based templates. There are additional configuration files that are built and used for various purposes. Most of these configuration files are used internally for management of the infrastructure and generation of utilities.

*Note: The file **FW_template_structure.xml** in the **structures** subdirectory lists all the templates and their destination paths. This file should not be altered unless instructed by Oracle Support.*

There are a number of areas the templates cover:

- **Configuration Files for Oracle WebLogic** – Oracle WebLogic has specific requirements for configuration settings and files. Refer to [Oracle WebLogic Configuration Support](#) for more specific details.
- **Configuration Files for other software** – Third party software has specific requirements for configuration files.
- **Utilities for deployment** – Additional configuration files are built to use in the deployment process to define the product applications to the relevant runtime software.
- **Internal ANT build configuration files** – Configuration and build files are built to support the configuration build process.

Note: The latter two categories of templates and configurations (utilities and ANT build files) should not be altered unless instructed by Oracle Support.

The table below lists the templates in the template directory not covered by other sections of this document applicable to the online, service and XAI components:

Templates	Configuration File	Usage
appl i cati on. xml . template	appl i caton_web. xml	JEE global

Templates	Configuration File	Usage
		application configuration file, which contains common settings for the Web Application Server
<code>application_service.xml.template</code>	<code>application_service.xml</code>	JEE global application configuration file, which contains common settings for the Business Application Server
<code>billdirfile.ini.template</code>	<code>billdirfile.ini</code>	Bill Print extract configuration file
<code>boot.properties.template</code>	<code>boot.properties</code>	Oracle WebLogic boot credentials file used for starting server
<code>coherence-cache-config.xml.template</code>	<code>coherence-cache-config.xml</code>	Batch Coherence settings. BATCH
<code>config.xml.template</code> <code>config.xml.win.template</code>	<code>config.xml</code>	Oracle WebLogic main configuration file. The win.template is used for the Windows environments.
<code>doc1dirfile.ini.template</code>	<code>doc1dirfile.ini</code>	Bill Print extract configuration file
<code>e0Batch.properties.template</code>	<code>e0Batch.properties</code>	Global batch properties BATCH
<code>earServiceBuild.xml.template</code>	<code>earServiceBuild.xml</code>	ANT Build file for EAR file for Business Application Server
<code>earWebBuild.xml.template</code>	<code>earWebBuild.xml</code>	ANT Build file for EAR file for Web Application Server
<code>ejb-jar.xml.template</code>	<code>ejb-jar.xml</code>	Generic Business Application Server

Templates	Configuration File	Usage
		descriptor for EJB's
Fault.xsd.iws.template	Fault.xsd	Web Services Fault Schema
ibm-application-bnd.xmi.template	ibm-application-bnd.xmi	Deployment descriptor for IBM WebSphere/ND.
iws-build-common.xml.iws.template	iws-build.xml	Common settings for IWS Build
iws-build-WAS.xml.iws.template	iws-build.xml	IWS build Settings for IBM WebSphere
iws-build-WLS.xml.iws.template	iws-build.xml	IWS build Settings for Oracle WebLogic
iwsdeploy-log4j2.properties.iws.template	log4j2.properties	Log properties for IWS build process
jar-service.xml.template	jar-service.xml	ANT Build file for jar files.
java.login.config.template	java.login.config	JAAS Login file
jps-config.xml.template	jps-config.xml	ADF security configuration.
log4j2.properties.iws.template	log4j2.properties	Log configuration for IWS
log4j2.properties.service.template	log4j2.properties	Log configuration for BAS
log4j2.properties.standalone.template	log4j2.properties	Log configuration for batch
log4j2.properties.template	log4j2.properties	Log configuration for online
log4j2.properties.XAIApp.template	log4j2.properties	Log configuration for XAI
ouaf.jmx.access.file.template	ouaf.jmx.access.file	Default access file for JMX .
ouaf.jmx.password.file.template	ouaf.jmx.password.file	Default security file for JMX .
OAAF-Target.xml.template	OAAF-Target.xml	Oracle Identity Manager interface configuration File. Refer Doc Id: 970785.1 to My

Templates	Configuration File	Usage
		Oracle Support for details of this integration.
<code>setDomainEnv.cmd.template</code>	<code>setDomainEnv.cmd</code>	Utility to set Domain configuration for Oracle WebLogic on Windows.
<code>setEnv.sh.template</code>	<code>setEnv.sh</code>	Utility to set Oracle WebLogic environment variables.
<code>startWebLogic.cmd.template</code>	<code>startWebLogic.cmd</code>	Utility to start Oracle WebLogic on Windows.
<code>startWebLogic.sh.template</code>	<code>startWebLogic.sh</code>	Utility to start Oracle WebLogic on Linux/UNIX.
<code>startWLS.sh.template</code>	<code>startWLS.sh</code>	Utility invoking JVM for Oracle WebLogic .
<code>stopWebLogic.cmd.template</code>	<code>stopWebLogic.cmd</code>	Utility to stop Oracle WebLogic on Windows.
<code>system-jazn-data.xml.template</code>	<code>system-jazn-data.xml</code>	ADF security store definitions.
<code>tangasol-coherence-overrides.xml.template</code>	<code>tangasol-coherence-overrides.xml</code>	Batch Coherence overrides BATCH
<code>warbuild.xml.template</code>	<code>warbuild.xml</code>	ANT WAR Build file
<code>warupdate.xml.template</code>	<code>warupdate.xml</code>	ANT WAR file for updates
<code>weblogic.policy.template</code>	<code>weblogic.policy</code>	Java Security file used by Oracle WebLogic to protect the product files.
<code>weblogic-ejb-jar.xml.template</code>	<code>weblogic-ejb-jar.xml</code>	Deployment descriptor for Business Application Server for Oracle WebLogic .

Templates	Configuration File	Usage
<code>XAIParameterInfo.xml.template</code>	<code>XAIParameterInfo.xml</code>	XAI Configuration file.

Note: Templates not mentioned in this document that exist in the templates directory are included in one or more templates above depending on the configuration requirements.

Sending emails at the conclusion of batch process **BATCH**

It is possible to send a notification email when a batch process has ended. This notification happens after the batch process has ended and all application-related commits/rollbacks have taken place. It does not impact the batch process itself in the event of errors happening during the notification process. The default email is a simple text email that contains the batch control, date and time of the submission, run number, submission parameters, batch process summary indicating records processed and in-error, as well as the thread details, including logged messages (up to 100).

The email address can be an individual person or a valid mail group (the latter requires additional configuration in your email system).

To use email notification the email server must be configured using one of the following options:

1. The mail server can be defined through the default Message Sender (Class **RTEMAILSND**) with the appropriate SMTP settings on the Context tab.
2. Alternatively the properties can be supplied in the form of JVM properties as follows:

```
# Host whose mail services will be used
# (Default value : localhost)
mail.host=<your mail server>
# Return address to appear on emails
# (Default value : username@host)
mail.from=<name@host>
```

```
# Other possible items include:
# mail.user=
# mail.store.protocol=
# mail.transport.protocol=
# mail.smtp.host=
# mail.smtp.user=
# mail.debug=
```

Name	Type	Description
<code>mail.debug</code>	boolean	The initial debug mode. Default is false.
<code>mail.from</code>	String	The return email address of the current user, used by the InternetAddress method getLocalAddress . To ensure that the value of mail.from property is handled properly when set through a user exit include file, add a '\'

Name	Type	Description
		(backslash) in front of the '@' symbol. e.g. If the value desired for <code>mail.from</code> is <code>demo@orgname.org</code> then it should be set as <code>demo\@orgname.org</code>
<code>mail.host</code>	String	The default host name of the mail server for both Stores and Transports. Used if the <code>mail.protocol.host</code> property isn't set.
<code>mail.mime.address.strict</code>	boolean	The <code>MimeMessage</code> class uses the <code>InternetAddress</code> method <code>parseHeader</code> to parse headers in messages. This property controls the strict flag passed to the <code>parseHeader</code> method. The default is true.
<code>mail.smtp.class</code>	String	Specifies the fully qualified class name of the provider for the specified protocol. Used in cases where more than one provider for a given protocol exists; this property can be used to specify which provider to use by default. The provider must still be listed in a configuration file.
<code>mail.smtp.host</code>	String	The host name of the mail server for the specified protocol. Overrides the <code>mail.host</code> property.
<code>mail.smtp.port</code>	int	The port number of the mail server for the specified protocol. If not specified the protocol's default port number is used.
<code>mail.smtp.user</code>	String	The user name to use when connecting to mail servers using the specified protocol. Overrides the <code>mail.user</code> property.
<code>mail.store.protocol</code>	String	Specifies the default message access protocol. The <code>Session</code> method <code>getStore()</code> returns a <code>Store</code> object that implements this protocol. By default the first <code>Store</code> provider in the configuration files is returned.
<code>mail.transport.protocol</code>	String	Specifies the default message access protocol. The <code>Session</code> method <code>getTransport()</code> returns a <code>Transport</code> object that implements this protocol. By default the first <code>Transport</code> provider in the configuration files is returned.
<code>mail.user</code>	String	The default user name to use when connecting to the mail server. Used if the

Name	Type	Description
		mail.protocol.user property isn't set.

These properties can be added to the **threadpool.worker.properties** file for the standalone batch **threadpool.worker**, or the **spl.properties** file for an online application server that hosts a batch worker.

Oracle WebLogic Configuration Support

Whilst the product supports multiple JEE Web Application Server vendors, the product has *native* support for Oracle WebLogic. Normally the JEE Web Application is installed and the JEE Web Application Server components are embedded in the directories controlled by the Web Application Server software during the deployment process. The deployment process usually transfers the WAR/EAR files to the JEE Web Application Server directories (varies according to JEE Web Application Server software).

For Oracle WebLogic, the Oracle WebLogic software is effectively *pointed* to directories as in the product installation. This avoids Oracle WebLogic having additional copies of its configuration and WAR/EAR files under its own directory structure.

In this case the following configuration aspects of Oracle WebLogic apply:

- The **\$SPLEBASE/spl app** (or **%SPLEBASE%\spl app** in Windows) subdirectory is referenced directly in the configuration files.
- In non-expanded mode (see [Oracle WebLogic: Expanded or Archive Format](#) for details), the WAR/EAR files are directly referenced from the [config.xml](#) file.
- In expanded mode (see [Oracle WebLogic: Expanded or Archive Format](#) for details), the application files are directly reference in the **spl app** subdirectories from the [config.xml](#) file.
- The [config.xml](#) file is located under **spl app/config** rather than using the Oracle WebLogic location. Any changes made from the Oracle WebLogic console are stored in this file.
- The utilities to start and stop the Oracle WebLogic instance are located under the **spl app** subdirectory.
- The security configuration files for the Oracle WebLogic instance are located under the **spl app** subdirectory. The security repository configured is configured in the location supplied with the Oracle WebLogic instance.

Thus facility allows one installation of Oracle WebLogic to be used across many environments with each environment being independent.

Using Configuration Files outside the WAR/EAR file

Typically, the configuration files specified [Web Application Server Configuration Process](#) and [Business Application Server Configuration Process](#) are embedded into the WAR/EAR files, as per the JEE specification, ready for deployment for use at runtime. While this is generally acceptable for most sites, it also means that any configuration change requires rebuilding of the WAR/EAR files and redeployment to fully implement the configuration

changes. This may add outage time to implement configuration changes.

It is possible to allow the product to use versions of the certain configuration files outside the WAR/EAR files to minimize outage time to implement changes. In most cases, a restart of the product components is necessary to implement the configuration change.

The table below outlines the configuration files that can be *externalized* from the WAR/EAR file by product component:

Component	Configuration File	Externalized
Web Application Server (root and XAIApp)	web.xml	✗
	spl.properties	✓
	weblogic.xml	✗
	log4j2.properties	✓
Business Application Server	web.xml	✗
	spl.properties	✓
	hibernate.properties	✓
	log4j2.properties	✓

By default, the externalization works on the following principles:

- The **SPLEBASE** environment variable must be set to the home location of the software prior to execution of the Web Application Server or Business Application Server. This must match the value configured for the environment in the [cistab](#) configuration file on the machine.
- The external versions of the configuration files should be in their default locations (as supplied) in the **\$SPLEBASE/etc/conf** (or **%SPLEBASE%\etc\conf** for Windows) subdirectories.
- The product use the external configuration file versions instead of the versions embedded in the WAR/EAR files. If you wish to revert to the embedded versions then the site can either rename the **conf** subdirectories to prevent the external configuration files being detected or ensuring the **SPLEBASE** environment is not set.

*Warning: If the **conf** subdirectories are renamed they should be reverted to their original names before ANY single fix, service pack or upgrade is performed to prevent configuration reset to base templates or installation failure.*

This facility is useful for a number of situations:

- If any passwords are changed that are used by the product on a regular basis, reflecting changes in the configuration files directly or using templates is easier using externalized configuration files. The WAR/EAR files do not need to be rebuilt and redeployed and this can save time.
- During the initial phases of production or when traffic volumes fluctuate, it may be necessary to tune specific settings. This allows experimentation of the changes before committing to specific values. It allows greater level of *flexibility* in configuration change.

Note: It is recommended to ensure that in the long term that both the external versions and embedded

versions are kept in synch on a regular basis to prevent configuration issues. This can be done using standard maintenance windows as necessary.

Oracle RAC Support

Note: Refer to the Oracle Real Application Clustering (RAC) documentation for setup instructions and parameter settings for RAC. It is assumed that RAC is installed, including Oracle Notification Service (ONS) for Fast Connection Failover support and configured prior to configuration of the product to take advantage of the RAC installation.

The product supports the use of Oracle's Real Application Clustering (RAC) for high availability and performance through database clustering. The product has additional setting to tell the database pooling aspects of the product to take advantage of the RAC facilities.

Once RAC has been installed and configured on the database there are a number of options that can be used to configure the product to use RAC in all modes of configuration:

- It is possible to setup a custom DB Connection string to take advantage of the RAC as outlined in the [Overriding the default Oracle database connection information](#) section of this document. This is the easiest implementation of RAC but does not take advantage of the full RAC features.
- Configure RAC specific settings in the installation configuration files (via the [configureEnv\[.sh\]](#) utility). The following settings should be set:

Environment Setting	Usage	Comments
ONS_JAR_DIR	Location of ONS Jar file (ons.jar)	This is the location of the Oracle Notification Service Jar files for use in the product.
ONSCONFIG	ONS configuration string with RAC server nodes delimited by ", " in the form <host>: <port> where <host> is the RAC host node and <port> is the ONS listener port.	Used for connections

Note: Native RAC Support does not support XA transactions using Universal Connection Pool (UCP) at the present time. If XA compliance is required, it is suggested that JNDI based pools provided by the Web Application server be used as documented in [Using JNDI Based Data Sources](#).

Note: At the present time Oracle Single Client Access Name (SCAN) is not supported in the configuration of RAC native support.

*Note: Once configured the **spl.runtime.options.isFCFEnabled** is set to true and **spl.runtime.options.onserver** is set to the value specified in **ONSCONFIG**.*

Note: Support for Implicit Connection Caching has been removed as this feature has been superseded by Universal Connection Pool (UCP).

Adding a custom Privacy policy screen

In certain sites the product must display a privacy policy to remind users of privacy rules at a site. The product allows for a custom HTML based page to be added by the site. The privacy page should be named **privacy.html** and placed in the **cm** directory so that the URL is:

<https://<host>:<port>/<server>/cm/privacy.html>

where

- <host>** Host Name of the Web Application Server used by the product
- <port>** Port Number allocated to the Web Application Server used by the product
- <server>** Server context allocated to Web Application Server used by the product

Refer to the Oracle Utilities SDK on how to add custom HTML to the product.

Once implemented the privacy statement can be obtained from the above URL or the following URL:

<http://<host>:<port>/<server>/privacy>

where

- <host>** Host Name of the Web Application Server used by the product
- <port>** Port Number allocated to the Web Application Server used by the product
- <server>** Server context allocated to Web Application Server used by the product

IBM WebSphere/WebSphere ND Support

Whilst the product supports both Oracle WebLogic and IBM WebSphere there are specific additional options available for IBM WebSphere and IBM WebSphere ND. The list below summarizes the specific additional support for these Web Application Servers:

- The application within IBM WebSphere is set to the following values:

Tier	Usage
Web Application Server	SPLWeb- <WEB_SVRNAME> where <WEB_SVRNAME> is the value of the WEB_SVRNAME environment setting.
Business Application Server	SPLService- <BSN_SVRNAME> where <BSN_SVRNAME> is the value of the BSN_SVRNAME environment setting.

- The following IBM WebSphere specific environment settings (**ENVIRON.INI**) should be specified for correct basic operation:

Environment Setting	IBM WebSphere edition
BSN_APP (SPLService)	WAS WASND
BSN_NODENAME	WASND
BSN_SRVNAME	WAS WASND

Environment Setting	IBM WebSphere edition
BSN_WLHOST	WAS WASND
WAS_HOME	WAS
WASND_DMGR_HOST	WASND
WASND_HOME	WASND
WEB_APP (SPLWeb)	WAS WASND
WEB_NODENAME	WASND
WEB_SVRNAME	WAS WASND
WEB_WLHOST	WAS WASND

These variables are used by the [initial Setup](#) utility to build and deploy the EAR/WAR files correctly.

- A number of Python scripts are used by the utilities to interface to IBM WebSphere administration API:

Command Script	Usage
websphereDeployService.py	Deploy Business Application Service WAS
websphereDeployWeb.py	Deploy Web Application Service WAS
websphereNDDeployService.py	Deploy Business Application Service WASND
websphereNDDeployWeb.py	Deploy Web Application Service WASND
websphereNDStartService.py	Start Business Application Service WASND
websphereNDStartWeb.py	Start Web Application Service WASND
websphereNDStopService.py	Stop Business Application Service WASND
websphereNDStopWeb.py	Stop Web Application Service WASND
websphereNDUnDeployService.py	Undeploy Business Application Service WASND
websphereNDUnDeployWeb.py	Undeploy Web Application Service WASND
websphereStartService.py	Start Business Application Service WAS
websphereStartWeb.py	Start Web Application Service WAS
websphereStopService.py	Stop Business Application Service WAS
websphereStopWeb.py	Stop Web Application Service WAS
websphereUnDeployService.py	Undeploy Business Application Service WAS

Command Script	Usage
<code>websphereUnDeployWeb.py</code>	Undeploy Web Application Service WAS

- The utilities to deploy/undeploy ([initialSetup](#)) the Web and Business Application WAR/EAR files and start/stop the server ([spl](#)) utilize the IBM WebSphere `wsadmin` command. Refer to the IBM WebSphere/ND documentation for more details of this command.
- The [initialSetup](#) utility, provided with the product, operate at the `node` level and not the `cluster` level for IBM WebSphere/ND. Customers wanting to deploy/undeploy at the cluster level should use the `wasadmin` command natively or use the IBM WebSphere administration console to achieve this.

User Exit Include Files

Whilst the product supports custom templates it is now possible to only supply fragments of a customization rather than whole configuration templates, known as *user exit include files*. This allows you to specify additional settings to be included in the templates provided *in stream* when the product templates are used to generate the configuration files when using the [initialSetup](#) command.

When [initialSetup](#) is executed the templates are applied with the following order of preference:

- Base framework templates (no prefix). These templates should not be altered.
- If a product specific template exists (prefixed by the product code) then the product template is used instead of the base Framework template for the configuration file. These templates should not be altered.
- If a template is prefixed with "`cm_`" then this is a custom template to be used instead of the product specific and base framework template.

These templates should live in `$$PLEBASE/templates` (or `%SPLEBASE%\templates` on Windows).

Note: When creating custom templates please use the base framework and any related product templates as the basis for the content of the custom template.

Whilst this facility is flexible it means that any updates to the base or product templates MUST be reflected in any custom templates. A new option is to use user exits that are placed strategically in the most common configuration files that need change. When [initialSetup](#) is executed the existence of user exit files are checked (when an `#ouaf_user_exit` directive exists in the template) and the contents included in the generated configuration file. The figure illustrates the process for a typical configuration change:

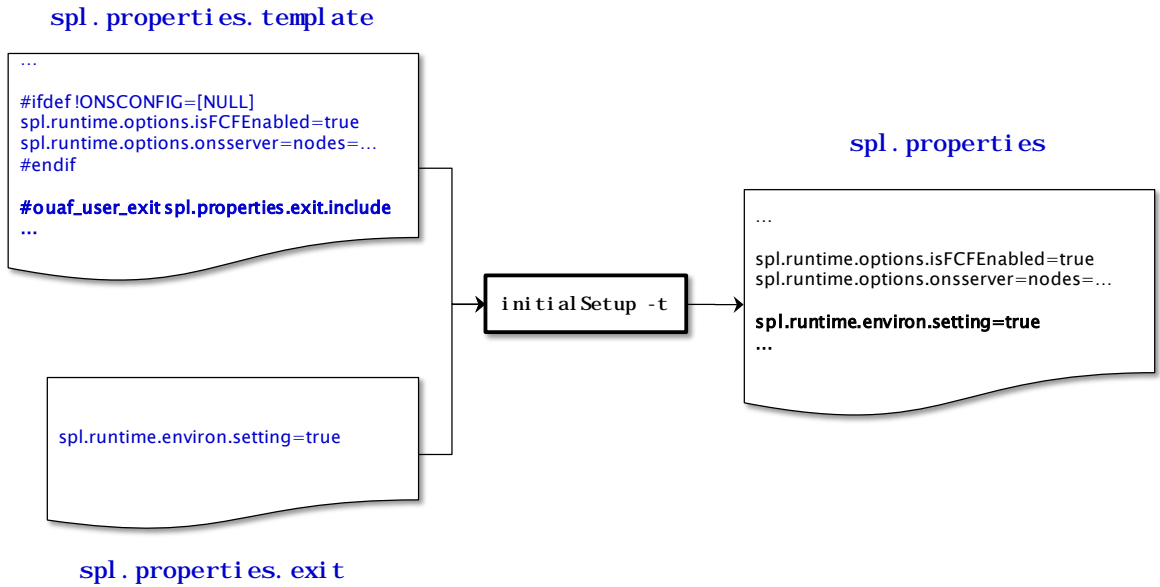

Figure 41 – Include files

As with the custom templates user exits have preferences depending on the ownership of the user exit include file. Custom includes will override any product specific includes. There are no base includes as they are already included in the template files. The figure below illustrates the preferences for both templates and includes:

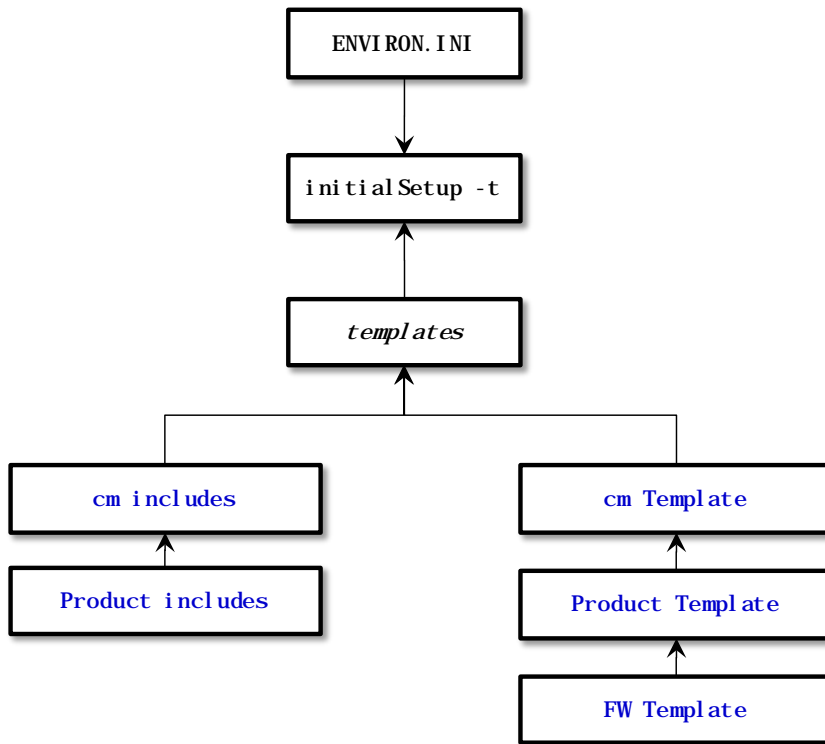

Figure 42 – Template Hierarchy

The table below outlines the currently available user exits in the available templates:

Template File	User Exit Include file	Position and Usage
<code>boot.properties.template</code>	<code>boot.properties.exit.include</code>	Used to change boot properties file from Oracle WebLogic

Template File	User Exit Include file	Position and Usage
config.xml.template²³	config.xml.exit_1.include	Before ADF deployment information (used for ADF)
	config.xml.exit_2.include	After Web Application container definition
	config.xml.exit_3.include	End of Configuration File
	config.xml.exit_4.include	Before Web Application container definition
	config.xml.jms.include	WebLogic JMS Configuration
config.xml.win.template²⁴	config.xml.win.exit_1.include	Before ADF deployment information (used for ADF)
	config.xml.win.exit_2.include	After Web Application container definition
	config.xml.win.exit_3.include	End of Configuration File
	config.xml.win.exit_4.include	Before Web Application container definition
	config.xml.win.jms.include	WebLogic JMS Configuration
ejb-jar.xml.template	ejb-jar.xml.wls.jms_1.include	JMS Mappings for Oracle WebLogic
	ejb-jar.xml.was.jms_1.include	JMS Mappings for IBM WebSphere/ND
hibernate.properties.web.template	hibernate.properties.exit.include	At end of file (common hibernate.properties entries)
	hibernate.properties.web.exit.include	At end of file (online specific hibernate.properties entries)
log4j2.properties.template	log4j2.properties.exit.include	At end of file (common log4j2.properties entries)
	log4j2.properties.root.exit.include	At end of file (specific online log4j2.properties entries)

²³ This is the template for the Oracle WebLogic instance, refer to the Oracle WebLogic for an example of contents.

²⁴ This is the template for the Windows version of Oracle WebLogic.

Template File	User Exit Include file	Position and Usage
log4j2.properties.XAIApp.template	log4j2.properties.exitt.include	At end of file (common log4j2.properties entries)
	log4j2.properties.XAIApp.exitt.include	At end of file (specific XAI log4j2.properties entries)
log4j2.properties.service.template	log4j2.properties.exitt.include	At end of file (common log4j2.properties entries)
	log4j2.properties.service.exitt.include	At end of file (specific XAI log4j2.properties entries)
ouaf.jmx.access.file.template	ouaf.jmx.access.file.exitt.include	Allows for additional users to be specified for JMX connections
ouaf.jmx.password.file.template	ouaf.jmx.password.file.exitt.include	Allows for additional passwords to be specified for JMX users
spl.properties.service.template	spl.properties.exitt.include	At end of file (common spl.properties entries)
	spl.properties.service.exitt.include	At end of file for EJB spl.properties entries.
	spl.properties.service.timeouts.exitt.include	User exit for service timeouts.
spl.properties.template	spl.properties.exitt.include	At end of file (common spl.properties entries)
	spl.properties.root.exitt.include	At end of file for Web Application based spl.properties entries.
	spl.properties.timeouts.root.exitt.include	User exit for global timeouts
spl.properties.XAIApp.template	spl.properties.exitt.include	At end of file (common spl.properties entries)
	spl.properties.XAIApp.exitt.include	At end of file for XAI Application based spl.properties entries.
	spl.properties.XAIApp.timeouts.exitt.include	Future use
submitbatch.properties.template	submitbatch.properties.exitt.include	Submitter extensions
threadpoolworker.properties.template	threadpoolworker.properties.exitt.include	Threadpool extensions

Template File	User Exit Include file	Position and Usage
te	ude	
web.xml.template	spl.properties.images.include	Image processing overrides for web.xml
	web.xml.servlet.mapping.include	Allow custom servlet mappings
	web.xml.servlet.include	Allow custom servlet definitions
	spl.properties.filter.mapping.include	Allow custom filter mappings

To use these user exits create the user exit include file with the prefix "**cm_**" in the **\$SPLEBASE/templates** (or **%SPLEBASE%\templates**) directory. To reflect the user exits in the configuration files you must execute the [initialSetup](#) utility. Refer to the [Custom JMS Configuration](#) section for an example of this process.

Properties File User Exits

The product behavior is controlled at a technical level by the values in the properties files. Whilst most of the settings are defaulted to their correct settings in the file, additional parameters may be added to the properties files to add new behavior. User exits are used to set these additional parameters in the properties files.

From the table above there are more than one user exit available in each properties file template to use. This is designed to maximize the reusability of configuration settings. There are a number of specialized user exits that may need to be used:

- **Common Settings** – The configuration files used by each channel of execution (online, Web Services and batch) has a common user exit. This user exit is used to house all the setting you want to implement regardless of the channel used. For example the common setting user exits are:

Configuration File	User Exits for common settings
hibernate.properties	hibernate.properties.exit.include
log4j2.properties	log4j2.properties.exit.include
spl.properties	spl.properties.exit.include

- **Channel specific Settings** – To implement custom settings per channel there is a separate user exit to hold those parameters for those channels. The specific user exits are:

Channel	Configuration File	User Exits for common settings
Web App Server	hibernate.properties	hibernate.properties.web.exit.include
	log4j2.properties	log4j2.properties.root.exit.include
	spl.properties	spl.properties.root.exit.include
Business App Server	log4j2.properties	log4j2.properties.service.exit.include

Channel	Configuration File	User Exits for common settings
	spl . properties	spl . properties . servi ce . exit . include spl . properties . servi ce . timeouts . exit . include
XAI Web Services	log4j 2 . properties	log4j 2 . properties . XAIApp . exit . include
	spl . properties	spl . properties . XAIApp . exit . include
Inbound Web Services	log4j 2 . properties	No User Exit available
	spl . properties	No User Exit available
Batch Server BATCH	hibernate . properties	hibernate . properties . batch . exit . include
	log4j 2x . properties	log4j 2x . properties . standalone . exit . include
	spl . properties	spl . properties . standalone . exit . include spl . properties . timeouts . standalone . exit . include

Custom JMS configuration

The product includes a realtime Java Message Services (JMS) connector to provide application to application integration. To use this facility the physical JMS definitions need to be defined as part of the configuration to be included in the configuration of the JEE Web Application Server²⁵. These will match the JMS configuration within the product itself. Refer to the installation documentation provided with the product to understand the required JMS integration.

To reflect the JMS settings a number of [custom user exist include files](#) have been provided to implement the JMS changes in the **config.xml** and **ejb-jar.xml** configuration files required by the JEE Web Application Servers.

There are two sets of files that are provided for the JMS integration as examples:

- A set of user exit include files in the **scripts/cm_examples/FW/templates** directory for the various files necessary to define the physical JMS configuration settings.
- A set of sample XML files that define the attributes of sample JMS settings that are referred to by the custom templates user exit include files. These are the files that need to be maintained by the site according to product or local standards.

The figure below illustrates the location of the sample JMS files:

²⁵ It is possible to define the physical JMS configuration using the console provided with the JEE Web Application Server but this may be overwritten during upgrades.

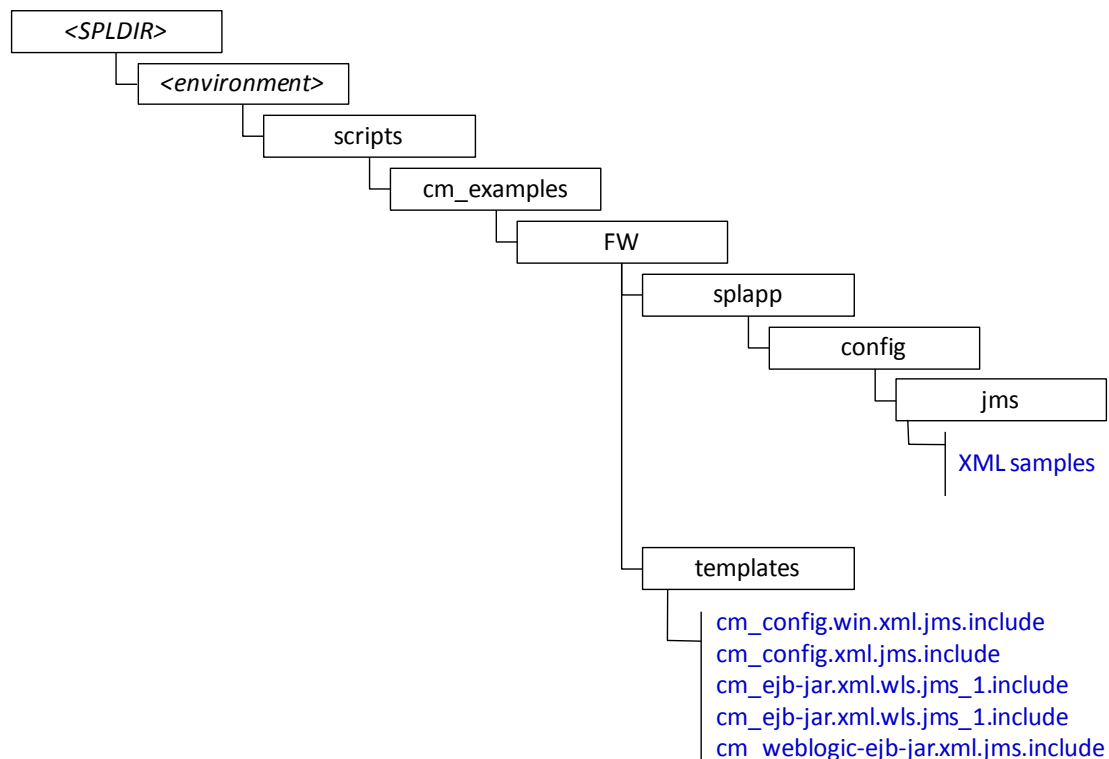

Figure 43 – Custom JMS configuration

To implement the JMS configuration files at your site:

- Logon to the Web Application Server and/or Business Application Server machine using the product administration account.
- Execute the **spl environ** command to orientate to the desired environment you wish to apply the JMS configuration to.
- Create a JMS configuration repository directory under **/spl app/confi g/j ms**. The following:

Linux/Unix:

```
mkdi r -p $SPLEBASE/spl app/confi g/j ms
```

Windows:

```
mkdi r %SPLEBASE%\spl app\confi g\j ms
```

- Copy the sample XML configuration files to the directory created using the following commands:

Linux/Unix:

```
cp $SPLEBASE/scripts/cm_exampl es/FW/spl app/confi g/j ms/*
$SPLEBASE/spl app/confi g/j ms/
```

Windows:

```
xcopy %SPLEBASE%\scri pts\cm_exampl es\FW\spl app\confi g\j ms\*
%SPLEBASE%\spl app\confi g\j ms\
```

- Copy the user exit include files to the template directory so that the user exits are implemented whenever **ini tial Setup** is executed.

Linux/Unix:

```
cp $SPLEBASE/scripts/cm_exampl es/FW/templ ates/*
$SPLEBASE/templ ates/
```

Windows:

```
xcopy %SPLEBASE%\scri pts\cm_exampl es\FW\templ ates\*
```

%SPLEBASE%\templates

*Note: To reverse out the change at any time the template files that are copied (prefixed by cm) can be removed from the templates subdirectory under **%SPLEBASE%** or **SSPLEBASE**.*

- Modify the sample XML files in the **config/jms** directory to suit your product requirements or your site requirements.

At configuration time the settings provided these files are included in the target configuration files as indicated by the user exit include files.

Online Transaction Timeouts

By default the product does not impose any transaction time limits on online and web services transactions. If this is not appropriate for your site then transaction time limits can be implemented globally as well as on individual objects using configuration settings defining the desired transaction time limits.

Specific [user exits](#) should be used to maintain these settings. To implement these create or modify the user exit files indicated in the table below in **SSPLEBASE/templates** (or **%SPLEBASE%\templates** on Windows).

To impose global limits the following settings must be added to your user exit files:

Tier/configuration file	Configuration Setting
Web Application Server (cm_spl.properties.timeouts.root.exit.include user exit file)	<ul style="list-style-type: none"> • Set the ouaf.timeout.query.default parameter to the desired timeout (in seconds) to set a global default on query zones.
Business Application Server (cm_spl.properties.service.timeouts.exit.include user exit file)	<ul style="list-style-type: none"> • Set the ouaf.timeout.business_service.default parameter to the desired timeout (in seconds) to set a global default on business service invocations. • Set the ouaf.timeout.business_object.default parameter to the desired timeout (in seconds) to set a global default on business object invocations. • Set the ouaf.timeout.script.default parameter to the desired timeout (in seconds) to set a global default on service script invocations. • Set the ouaf.timeout.service.default parameter to the desired timeout (in seconds) to set a global default on application service invocations.

To impose timeout values on individual object/service/scripts then an entry in the Business Application Server **cm_spl.properties.service.timeouts.exit.include** user exit file must exist for each individual object/service/script to specify the timeout:

Object	Comments
Business Objects	Default: ouaf.timeout.business_object.default Specific: ouaf.timeout.business_object.<bocode>
Business Services	Default: ouaf.timeout.business_service.default Specific: ouaf.timeout.business_service.<bocode>
Query Zones	Default: ouaf.timeout.query.default Specific: ouaf.timeout.query.<zonename>
Scripts	Default: ouaf.timeout.script.default Specific: ouaf.timeout.script.<scriptname>
Application Services	Default: ouaf.timeout.service.default Specific: ouaf.timeout.service.<service>

For example:

[ouaf.timeout.service.CILTUSEP=600](#)

Note: Timeout values are not precise as they do not include additional time needed to process any rollback or networking activity necessary after a timeout has occurred.

Note: Timeout user exits exist for batch and XAI as well but they are not used in the current release of the product. These are reserved for potential use in future releases.

Setting the Date for testing purposes

One of the common techniques used in testing is to set the date to a fixed point in time to simulate data aging in the product. By default, the date (and time) used in the system is obtained from the database server with the time zone used on the user record to offset (if used by the product). It is possible to override the system date used at a global level or at an individual user level for testing purposes.

Note: This facility is not recommended for use in Production environments.

To use this facility the following must be configured:

- Set the **spl.runtime.options.allowSystemDateOverride** to **true** in the

spl.properties file for the online (Web or Business Application Server), XAI (Business Application Server) and/or Batch (standalone).

- To set the feature at the global level for an environment, navigate to the *Administration* menu → *F* → *Feature Configuration* menu option and add a *General System Configuration* Feature Type with the *System Override Date* option in **YYYY-MM-DD** format. For example:

The screenshot shows the 'Feature Configuration' page. At the top, there are navigation links for Home, Menu, Admin, and History. Below that, there are buttons for Bookmark, Clear, Save, and Refresh. The 'Feature Name' field is empty. The 'Feature Type' dropdown is set to 'General System Configuration'. The 'Description' field is empty. The 'Options' table has the following structure:

	Option Type	Sequence	Value	Detailed Description
+	System Override Date	1		This option provides a way to override the system date for on-line operations. Specify a system override date in the format YYYY-MM-DD. If populated, the system will use this date as the system date instead of retrieving the system date from the database.

Figure 44 – Feature Configuration

- If individual test users wish to use different dates they can set the feature at the user level. This feature does not require the global override setting to be used but if the global override is also used, then this user specific setting is used. To set the date override at the user level, add the *Overridden system date* Characteristic Type to the individual user record (via *Administration* menu → *U* → *User* menu option) with the Characteristic Value set to the desired date in **YYYY-MM-DD** format. For example:

The screenshot shows the 'User' page for user 'SYSUSER'. There are tabs for Main, To Do Roles, Access Security, Portal Preferences, Bookmarks, Favorite Links, Favorite Scripts, Characteristics, and Miscellaneous. The 'Characteristics' tab is active. Below the tabs, there are buttons for Bookmark, Clear, Save, and Refresh. The 'User ID' is 'SYSUSER'. The 'Characteristic Type' dropdown is set to 'System Override Date'. The 'Sequence' field is empty and the 'Characteristic Value' field is empty.

Figure 45 – System override for individual users

When the facility is active the following applies:

- The facility will only be active if the **spl.runtime.options.allowSystemDateOverride** parameter is set to **true** in the relevant **spl.properties** file.
- If the system override via Feature configuration is set then all users using that channel will use that date for any transactions. If the Feature configuration is not set then the default current date as per the database server is used.
- If users have system date overrides as characteristics then that user for that channel will use that date regardless if the system override is set or not.

Secure Transactions

Note: Refer to the Security Guide for the product for an indepth discussion on implementing SSL.

The product supports HTTP and HTTPS protocols for transmission of data from the browser client and within the architecture. Customers must choose either HTTP (unsecure) or HTTPS (secured) for protocol. Use of both protocols simultaneously is not supported. The default

protocol is HTTP.

If you wish to implement HTTPS protocol then the following process must be used:

- The value for [WEB_WLSSLPORT](#) must be specified for the SSL port to use. When this is specified then HTTP is disabled automatically.
- The product ships with the demonstration certificate shipped with the Web Application Server software. It is not recommended to use this certificate for your site. It is highly recommended that you obtain a certificate for your site from a trusted source and install the certificate as per the Web Application Server documentation.
- For all traffic directly to the product please use the **https** protocol on the URL's used for direct interaction (via the browser or Web Services interfaces).

Note: For Oracle WebLogic customers, refer to the [Configuring Identity And Trust](#) section of the Oracle WebLogic Installation Guide.

Note: For both protocols, the PUT, DELETE, TRACE and OPTIONS methods not permitted in the security constraints for the product by default.

Native Oracle WebLogic Support

Note: The product also now supports the Oracle Fusion Middleware console as an alternative to the Oracle WebLogic console. This manual covers the Oracle WebLogic console only. Customers using the Fusion Middleware console should use the corresponding feature in that console.

One of the features of the product is the ability to use the Oracle WebLogic features in either embedded or native mode. In non-production it is recommended to use embedded mode unless otherwise required. Customers using Oracle ExaLogic for non-production should use native mode to fully support Oracle ExaLogic's architecture.

Whilst all the details of installing the product in native mode is covered in the Installation Guide a summary of what is required is shown below:

- A copy of the Oracle WebLogic must be installed on the machine. This copy of Oracle WebLogic must not be shared across multiple environments. Using native mode restricts a single copy of the product to an individual installation of Oracle WebLogic. Customers requiring multiple environments on a single installation should use embedded mode or install multiple Oracle WebLogic installation and use Oracle Enterprise Manager to manage the multiple instances.

Note: The product now includes a set of base [domain templates](#) that can be used with the installation of the product to avoid manual installation issues. [Domain Template Builder](#) can also be used to build custom domain templates.

- When using native mode, the product installation should not be placed under a users home directory or under the Oracle WebLogic home location. It should be installed in a separate location and using the deployment utilities deployed into the Oracle WebLogic domain location.
- Oracle WebLogic must be setup and configured with the following before deployment is to be performed:

Configuration Setting	Comments
Domain should be created	The Oracle WebLogic domain to install the product

Configuration Setting	Comments
	upon should be created with the Administration Server active on that environment.
Servers should be created	Using the Oracle WebLogic console the Servers to house the product should be created.
Create XML Registry	Using the Oracle WebLogic console an XML Registry to define the default parser should be created. On AIX this is done at the Oracle WebLogic command line level. Refer to the Installation Guide for more details.
Set Java parameters in console	Set the Domain level java settings for memory etc as per the Installation Guide.
Define Security	Define the Security Role, Security Realm and other Security definitions for the product as per the Installation Guide.
Create SYSUSER	Create the initial User for the product (SYSUSER) and attach the security role created earlier.
Set SPLEBASE variable	Prior to deployment and execution ensure the SPLEBASE variable is set to point to the location of the product as per the Installation Guide

- To start and stop the online component of the product, in *native* mode, it is recommended to use the facilities provided by Oracle WebLogic. This can be either using the Oracle WebLogic console, Oracle WebLogic utilities or via Oracle Enterprise Manager.
- To monitor the online component of the product use the facilities provided in Oracle WebLogic console, Oracle WebLogic utilities or via Oracle Enterprise Manager. Additional monitoring capabilities are available using the *Oracle Application Management Pack for Oracle Utilities*.
- When making changes to the product anytime the EAR files are changed they must be redeployed using the Oracle WebLogic console.

Manual Re-Deployment Process

Whenever the installation EAR/WAR files are updated they must be redeployed to the JEE Web Application Server to implement the change using one of the following techniques:

- Using the Oracle WebLogic console, use the *Update* transaction on the selected *Deployments*. The wizard will remember the last settings, which need to be confirmed, prior to deployment. For example:

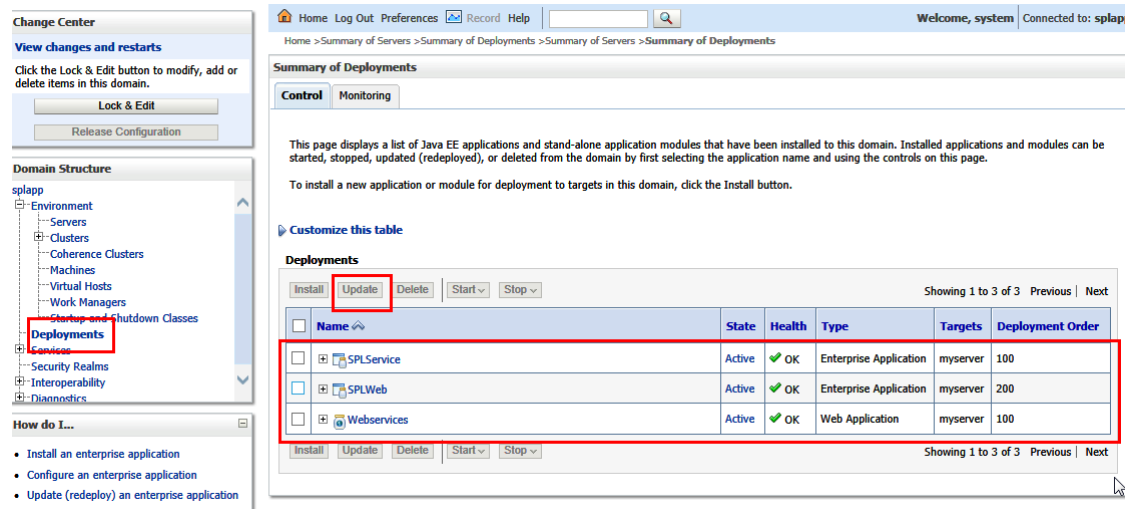

Figure 46 – Update Oracle WebLogic Deployment

- Use the WLST command line using the [redeploy](#) command in the Deployment API. Refer to the [WLST Reference](#) for more information.

The following situations require a redeployment event:

- Any execution of [initialSetup](#) or [initialSetup -w](#) which requires [SPLService](#) (or the value of [SPLSERVCEAPP](#)) and [SPLWeb](#) (or the value of [SPLWEBAPP](#)) to be redeployed.
- Any execution of [iwsdeploy.sh](#) or online deployment of Inbound Webservices. This requires Webservices (or the value of [IWSWAR](#)) deployment

Oracle WebLogic Console Operations

Note: Parts of this section do not apply to implementations using the embedded mode. Refer to individual sections for guidance.

When using the native mode of Oracle WebLogic to manage the product, the Oracle WebLogic administration console can be used to perform common operations. This section outlines the common operations that can be used from the console. Refer to the Administration documentation supplied with Oracle WebLogic for further advice.

Starting and Stopping from console

Note: This facility should only be used for customers using native mode. Customers using embedded mode should use the [spl](#) utility.

As the product is using the native mode and native utilities provided by Oracle WebLogic it is possible to manage the product start and stop from the console. To perform this function, the user must do the following:

- Login to the console designated to administrate the environment using an appropriate administration account²⁶.
- Select the *Deployments* section of the *Domain Structure*. This will list the deployments to the domain.

²⁶ The default installation account is **system** if used.

- Select the appropriate deployments to start or stop.
- Use the *Start* or *Stop* function to perform the start or stop operation, respectively.

For example:

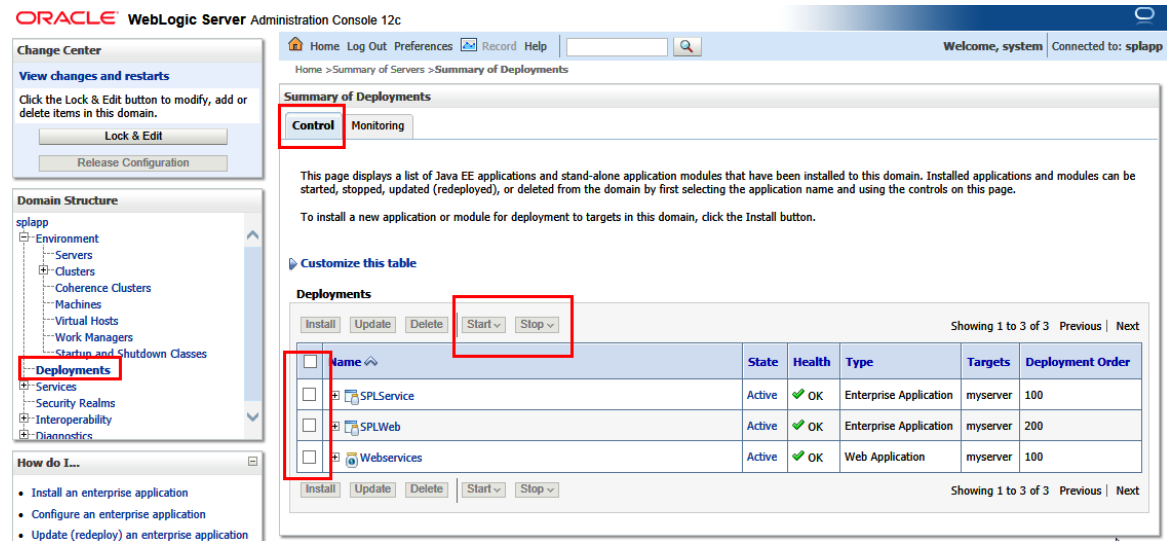

Figure 47 – Default Oracle WebLogic Deployments

While it is possible to start or stop individually components it is recommended that all components be started at once to avoid availability issues. If individual components are started or stopped use the following guidelines to minimize issues:

- Be aware of the [architecture](#) when stopping components. When starting the product, components lower in the architecture must be started first. When stopping the product, components higher in the architecture should be stopped first. Use the table below as a guide:

Deployment	Role
Root	Web Application Server
SPLService	Business Application Server
XAI App/Webservices	XML Application Integration
Help	Online Help
AppViewer	Data Dictionary

- Stopping non-essential runtime components such as Online Help and AppViewer may result in HTTP 404 error when users select these functions unless they are sourced from other servers.

Monitoring Web Applications using the console

Note: This facility is available regardless of mode (i.e. embedded or native) used on the environment.

The Oracle WebLogic administration console can be used to monitor the state and performance of the individual components of the product. This can be achieved using the *Monitoring* tab of the *Deployments* option of the *Domain Structure* section of the Oracle WebLogic administration console.

This allows the following to be monitored:

- **Web Applications** – Statistics relating to the Web Applications deployed to the server. The Context Root and Source Information outlines the individual component monitored.
- **JMS** – If you are using the Message Driven Bean functionality within the product to integrate to the JMS resources in the Oracle WebLogic server then statistics related to this function can be monitored.
- **EJBs** – The Business Application Server and Message Driven Bean functionality are expressed as Enterprise Java Beans (EJB) and can be monitored from the console. The EJB **SPLServiceBean** is the Business Application server.
- **Web Services/Web Service Clients** – When using the native Web Service capability the statistics applicable to individual Web Services can be monitored.
- **JDBC** – If JDBC data sources are manually configured then statistics relating to these connections can be monitored.
- **Workload** – By default, Oracle WebLogic allocates simple workload managers for each deployment. These workload managers and any custom constraints can be monitored.

Refer to the Oracle WebLogic documentation for a detailed description of each of the statistics and their relevance.

Specifying custom log file names **BATCH**

By default the [submitjob](#) and [threadpoolworker](#) utilities will create logs in a specific location. For example:

User Exit	Platform	Default Location and Name
submitjob.sh	Unix	<code>\$SPLOUTPUT/submitjob. {batchCode}. {sysDateTi me}. log</code>
submitjob.cmd	Windows	<code>%SPLOUTPUT%\submitjob. {batchCode}. {sysDateTi me}. log</code>
threadpoolworker.cmd	Windows	<code>%SPLOUTPUT%\threadpoolworker. {sysDateTi me}. log</code>
threadpoolworker.sh	Unix	<code>\$SPLOUTPUT/threadpoolworker. {sysDateTi me}. {pi d}. log</code>

Where:

{batchCode}	Batch Control used for job
{sysDateTi me}	System Date and Time in YYYYMMDDHHmmSSSSS format
{pi d}	Process Id

If your implementation wishes to implement custom log file names then this may be achieved using user exits which allow custom setting of the file name pattern. In the utilities an environment variable is set to the name and location of the log file. The user exit may be used to set this environment variable to an alternative. The user exit contains the script code fragment used to set the log file environment file name.

The table below lists the user exit, environment variable name and the platform:

User Exit	Platform	User Exit Name	Env Variable
submitjob.sh	Unix	submitjob.sh.setvars.include	SBJLOGID

User Exit	Platform	User Exit Name	Env Variable
<code>submitjob.cmd</code>	Windows	<code>submitjob.cmd.setvars.include</code>	SBJLOGID
<code>threadpoolworker.cmd</code>	Windows	<code>threadpoolworker.cmd.setvars.include</code>	TPWLOGID
<code>threadpoolworker.sh</code>	Unix	<code>threadpoolworker.sh.setvars.include</code>	TPWLOGID

Additionally internal session variables are available for use in the user exits:

Variable	submitjob ²⁷	threadpoolworker	Comments
RUNOPTS		■	Runtime Options
batchCode	■		Batch Code
sysDateTi me	■		Run Date and Time

Note: Other environment variables in the session can be used and determined in the user exit script code.

Turning off L2 Cache **BATCH**

Note: This facility should only be used where background processes specifically require it. Turning off the cache in other circumstances will adversely affect performance.

By default, the threadpools use a batch cache to load common configuration data to avoid excessive calls to the database. In some cases it is desirable to disable the caching for a particular threadpool. To disable the cache on startup of the threadpool use the following command:

```
threadpool worker[. sh] -l2 OFF -p <threadpool name>
```

where *<threadpool name>* is the name of the threadpool to start with the caching disabled.

Once the threadpool is started then all jobs that require caching off can be executed in this threadpool using the **DIST-THD-POOL** parameter (for online submission), **com.splwg.batch.submitter.distThreadPool** parameter in the job [specific properties file](#) or **-p** option on the **submitjob** command.

JDBC Support

Note: This facility is only available for online and web services channels only.

By default, the product uses the Universal Connection Pooling (UCP) to manage database connections. It is also possible to use Oracle WebLogic connection pooling via Data Sources for the online transactions (UCP will continued to be used for batch transactions). To use Data Sources the data sources must be created within Oracle WebLogic and then configuration files altered to utilize the Data Source using the following process:

- Create the Data Source in the Oracle WebLogic console using the *Services* → *Data Sources* menu item. Repeat for the connsnction pool for online and connection pool for web services. Specify the following:

²⁷ These are set for the Java runtime.

Attribute	Comment
Name	Allocate a name for monitoring and management purposes
JNDI Name	Allocate a name to be used by the connection. This is used as <i><datasourcename></i> later. It is recommended that the name be prefixed with j dbc/ to conform to naming standards.
Row Prefetch Enabled	This should be enabled .
Row Prefix Size	Specify a value between 2 - 100. Default: 48
Stream Chunk Size	This is not used by the product
Database Type	Specify Oracle
Database Driver	Specify the database driver to use. <i>Do not use the XA versions of the driver for the product. By default use the Thin driver for Service Connections.</i>
Supports Global Transactions	Deselect this option as it does not apply.
One Phase Commit	Ensure this option is selected.
Database Name	Specify the Oracle SID of the database to connect to. This should correspond to DBNAME in the ENVIRON. INI .
Host Name	Specify the host allocated to Oracle. This should correspond to DBSERVER in the ENVIRON. INI .
Port	Specify the Oracle Listener Port number of the database to connect to. This should correspond to DBPORT in the ENVIRON. INI .
Database User Name	Specify the product database user. This should correspond to DBUSER in the ENVIRON. INI . If creating a separate connection pool for Web Services then it is recommended to use XAI_DBUSER in the ENVIRON. INI to separate traffic in the database.
Password	Specify the password for the user. This should correspond to DBPASS in the ENVIRON. INI . If creating a separate connection pool for Web Services then it is recommended to use XAI_DBPASS in the ENVIRON. INI to separate traffic in the database.
Initial Capacity	This is the initial size of the connection pool
Maximum Capacity	This is the maximum size of the connection pool
Capacity Increment	This is the number of connections that are added to the connection pool when necessary.
Statement Cache Type	This denotes the type of cache to use. Use the LRU setting.

Attribute	Comment
Statement Cache Size	This is the cache size.

- Specify the following values in the [ENVIRON.INI](#) using the [configureEnv](#) utility:

Setting	Recommendation
IWS JDBC DataSource Name	Fully qualified JNDI Name for Web Services Data Source
Web JDBC DataSource Name	Fully qualified JNDI Name for Web Data Source

- Execute the **initialSetup** utility to reflect the change.
- If using native mode, [redeploy](#) the product EAR files.

Cancelling Batch Processes Using JMX **BATCH**

While JMX can be used to obtain monitoring information it is possible to cancel threads of batch processes using the operations component of JMX. To cancel a thread the following process must be performed:

- Start the JMX console of your choice and connect to the relevant JMX port configured for the batch.
- Select the thread and batch process to be cancelled from the JMX console.
- Select the *Cancel* operation from the operations component of the console. The console may recognize the operations of the JMX classes and allow the actions to be processed. For example, **jconsole** will generate *cancelThread* button. Issue the action.

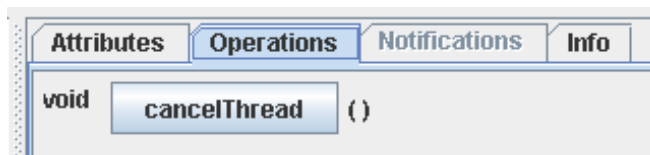

Figure 48 – Example cancelThread

Note: Depending on the JMX console used, a confirmation dialog may NOT be displayed and cannot be undone once issued. Ensure that the correct thread for the batch process is selected. To cancel a batch process, ALL threads must be cancelled.

The batch process will be marked as cancelled and stopped. The IP address of the requestor is logged in the Batch Run Tree for auditing purposes.

Operations from Oracle Enterprise Manager

Note: This section of the Server Administration Guide provides an overview of using Oracle Enterprise Manager along with the Application Management Pack for Oracle Utilities to administer the product.

Note: This section assumes that Oracle Enterprise Manager and the Application Management Pack for Oracle Utilities are installed prior to using this section. If this is not the case, refer to the installation documentation for these products to complete that prerequisite installation.

Discovering Oracle Utilities targets

Prior to using Oracle Enterprise Manager the Oracle Utilities targets must be discovered and registered with the Oracle Management Repository (OMR) within an Oracle Management Server (OMS) using Oracle Management Agents (OMA).

To discover the Oracle Utilities targets the following process must be followed:

- Install the Oracle Management Server and Oracle Management Repository to the relevant centralized server as per the Oracle Enterprise Manager documentation.

Note: It is not recommended to install the Oracle Management Server or Oracle Management Repository on the same servers housing the products.

- Deploy the Oracle Management Agents to the hosts housing the products.
- Discover and register the hosts and agents to the Oracle Management Repository using any of the methods described in the Oracle Enterprise Manager documentation.
- Start the products using the console or scripts.

Note: Oracle Enterprise Manager will only discover and register targets that are active at the time of discovery.

- Deploy the base Fusion Middleware functionality to the agents on the hosts for the products.
- Discover the Fusion Middleware targets associated with the product. This includes the domain, servers and application deployments.
- Download the Application Management Pack for Oracle Utilities via Oracle Software Delivery Cloud or Oracle Enterprise Manager Self Update.
- Deploy the Application Management Pack for Oracle Utilities to the Oracle Management Server to enable the server content.

Note: This may require a short outage on the Oracle Management Server.

- Deploy the the Application Management Pack for Oracle Utilities to the Oracle Management Agents on the product hosts to enable agent content.
- Discover the Oracle Utilities Environment target using the Discovery process as documented in the Oracle Enterprise Manager documentation. All related targets will be automatically discovered.

Note: At discovery time, target names are autogenerated. They can only be renamed with more meaningful names at discovery time.

After discovery of the Oracle Utilities Environment target the following Oracle Utilities targets are discovered, registered and associated with the Oracle Utilities Environment target:

- **Oracle Utilities Web Application** target - One or more Web Application Server targets (SPLWeb) associated with the Oracle Utilities Environment target. This target is associated with the Fusion Middleware Web Application Server base target.
- **Oracle Utilities Web Services** target - One or more Business Application Server targets (SPLService) associated with the Oracle Utilities Environment target. This target is associated with the Fusion Middleware Web Application Server base target.
- **Oracle Utilities Home** target - One or more software installations associated with the product associated with the Oracle Utilities Environment target.
- **Oracle Utilities Batch Server** target - One or more Coherence hosts associated with the Oracle Utilities Environment target.

Discovering Oracle WebLogic Targets

Oracle Enterprise Manager can discover and manage the products using the Oracle Application Management Pack for Oracle Utilities.

It is possible to manage and monitor the database and Oracle WebLogic from Oracle Enterprise Manager. When using native mode, Oracle Enterprise Manager will autodiscover the Oracle WebLogic instance using its native facilities. To use Oracle Enterprise Manager with environments using the default embedded support of Oracle WebLogic the following can be used to discover and monitor the instance:

- Within Oracle Enterprise Manager console, navigate to the *Add Targets Manually* menu option under the Setup menu.
- Select *Add Non-host Targets using Guided Process* from the options list.
- Select *Oracle Fusion Middleware* to denote that Oracle WebLogic will be discovered.
- In the dialog specify the following values:
 - **Administration Server Host** - The host name used for **WL_HOST** in your environment. This host must be registered to Oracle Enterprise Manager as a target so that the agent is redeployed.
 - **Port** - The port number assigned to the environment (**WL_PORT**).
 - **Username** - An account authorized to the Oracle WebLogic console. The Oracle Utilities Application Framework installer creates an initial user system that can be used if you have not got a site specific value for this user. This userid is used, by default, for all operations to the target. It must be an Administration account not a product account.
 - **Password** - The password configured for the Username.
 - **Unique Domain Identifier** - An unique identifier for the domain to denote within Oracle Enterprise Manager. This is important and should be some value that means something for your administrator to understand. This also allows multiple targets per host to be defined easily. Make sure you do not use any embedded blanks and special characters for the name.
 - **Agent** - This is the default host and port for the OEM agent on that machine.

Just for references and can be altered if the default port is different for OEM at your site.

- Choose to *Continue* and the above target will be registered for use within Oracle Enterprise Manager.
- Each server in your domain will be registered as an *Oracle WebLogic Server* and every component of the product will be registered as an *Application Deployment*. For example:

Target Name	Target Type	Target Status	Line of Business
/BTMFarm_btm_domain/btm_domain	Oracle WebLogic Domain	n/a	Business
/BTMFarm_btm_domain/btm_domain/AdminServer	Oracle WebLogic Server	↑	Business
/BTMFarm_btm_domain/btm_domain/AdminServer/FMW Welcome Page Application(11.1.0.0.0)	Application Deployment	↑	Business
/BTMFarm_btm_domain/btm_domain/btmMainServer	Oracle WebLogic Server	↑	Business
/Farm_..._domain/..._domain	Oracle WebLogic Domain	n/a	Oracle U
/Farm_..._domain/..._domain/jvmpool	Java Virtual Machine Pool	n/a	Oracle U
/Farm_..._domain/..._domain/Acsra	Domain Application Deployment	n/a	Oracle U
/Farm_..._domain/..._domain/AdminServer	Oracle WebLogic Server	↑	Oracle U
/Farm_..._domain/..._domain/AdminServer/HttpDeployer	Application Deployment	↑	Oracle U
/Farm_..._domain/..._domain/HttpDeployer	Domain Application Deployment	n/a	Oracle U
/Farm_..._domain/..._domain/javadiagnosticagent	Domain Application Deployment	n/a	Oracle U
/Farm_..._domain/..._domain/jmsserver1	Oracle WebLogic Server	↑	Oracle U
/Farm_..._domain/..._domain/jmsserver1_jvm	Java Virtual Machine	↑	Oracle U
/Farm_..._domain/..._domain/jmsserver1/Acsra	Application Deployment	↑	Oracle U
/Farm_..._domain/..._domain/jmsserver1/javadiagnosticagent	Application Deployment	↑	Oracle U
/Farm_..._domain/..._domain/myserver	Oracle WebLogic Server	↑	Oracle U
/Farm_..._domain/..._domain/myserver_jvm	Java Virtual Machine	↑	Oracle U
/Farm_..._domain/..._domain/myserver/Acsra	Application Deployment	↑	Oracle U
/Farm_..._domain/..._domain/myserver/javadiagnosticagent	Application Deployment	↑	Oracle U
/Farm_..._domain/..._domain/myserver/SPLService	Application Deployment	↑	Oracle U
/Farm_..._domain/..._domain/myserver/SPLWeb	Application Deployment	↑	Oracle U
/Farm_..._domain/..._domain/myserver/WebServices	Application Deployment	↑	Oracle U
/Farm_..._domain/..._domain/SPLService	Domain Application Deployment	n/a	Oracle U
/Farm_..._domain/..._domain/SPLWeb	Domain Application Deployment	n/a	Oracle U
/Farm_..._domain/..._domain/WebServices	Domain Application Deployment	n/a	Oracle U
/EMGC_GCDomain/GCDomain	Oracle WebLogic Domain	n/a	Enterpris

Figure 49 – Oracle WebLogic Targets

Oracle Utilities Targets

The following targets are available for the product:

Target	Usage
Oracle Utilities System Environment	Environment Target as a collection of other targets
Oracle Utilities Home	Software installation(s) for environment. Used to cloning and patching
Oracle Utilities Web Application	Online Web Application(s)
Oracle Utilities Web Services Application	Business Application Server Application(s)
Oracle Utilities Batch Server	Threadpool/Submitter Batch Server(s)

Refer to the [Oracle Application Management Pack for Oracle Utilities Overview](#) (Doc Id: 1474435.1) for more information.

Monitoring using Oracle Enterprise Manager

The following target types within Oracle Enterprise Manager can be used with the product directly:

Target	Monitoring capabilities
--------	-------------------------

Target	Monitoring capabilities
Oracle Utilities Web Application	Availability for online transaction including Oracle WebLogic basic metrics.
Oracle Utilities Web Services Application	Online performance monitoring
Oracle Utilities Batch Server	Batch performance monitoring
Oracle WebLogic Server	Availability, JMS, MDB and URL performance information
Application Deployment	Individual deployment metrics for Online, Business Application Server and Inbound Web Services including availability, performance and other metrics.
Java Virtual Machine	JVM Diagnostics (if Oracle WebLogic Management Pack EE installed)
Database Instance	Database metrics including performance and availability

Note: It is not recommended to use the Oracle Coherence targets within Oracle Enterprise Manager for monitoring or managing the batch cluster.

Oracle Scheduler Integration

Note: The Oracle Scheduler interface is an optional installation for using the Oracle Scheduler in the Oracle Database to schedule and execute product jobs. Customers using alternative methods or tools can ignore this section.

Introduction

The product now includes optional interfaces to the Oracle Scheduler which is part of the Oracle Database. These interfaces allow the management of Oracle Scheduler objects and the execution of product batch processes using the scheduling capabilities of the Oracle Scheduler.

Background Materials

Before reading this section it is recommended to familiarize yourself with the Oracle Scheduler by reading the following documentation:

- [Oracle Scheduler Concepts](#) - Overview of the scheduler including the architecture.
- [Scheduling Jobs with Oracle Scheduler](#) - Creating, running and monitoring jobs, chains and prioritization.
- [Administrating Oracle Scheduler](#) - Configuration, monitoring, import/export schedules, troubleshooting etc
- [Using Oracle Scheduler with a CDB](#) - Using Oracle Scheduler in and/or with a multi-tenant container database.
- [DBMS_SCHEDULER Reference](#) - Reference API for the Oracle Scheduler including all the valid procedures available.

Note: The Oracle Scheduler in Oracle Database 12c and above is recommended to be used for this interface.

Oracle Scheduler Interface Overview

The product now includes REST services that lets users manage Oracle Scheduler objects using product services. This interface makes it easier to integrate batch schedules with enterprise schedulers.

- These are a set of services (invoked through REST APIs) to create, update, read, delete and execute Oracle Scheduler objects. These services are managed within the product itself. These services internally invoke necessary Oracle Scheduler functions to manage & monitor schedules and batch executions.
- Following set of OUAF business services can be invoked using REST to manage Oracle scheduler objects: (detailed interface definition is mentioned in [Oracle Scheduler – OUAF REST APIs sections](#))
 - F1-DBMSProgram - Add, read, change, or deletes a DBMS Scheduler Program object

based on the action provided.

- F1-DBMSChain - Add, read, change, or deletes a DBMS Scheduler Chain object based on the action provided.
- F1-DBMSSchedule - Add, read, change, or deletes a DBMS Scheduler Schedule object based on the action provided
- F1-DBMSJob - Add, read, change, or delete a DBMS Scheduler Job object based on the action provided
- F1-DBMSList - Retrieves a list of names and descriptions of scheduler object based on the type provided and an optional name to filter with
- F1-DBMSSubmitJob - Submits a scheduler job for execution.
- F1-DBMSGetJobDetails - Retrieves the details of DBMS Scheduler Job based on job name
- F1-GetDBMSJobs - Retrieves a list of scheduler jobs based on status. The output is either a list of running jobs or a list of completed jobs based on the status provided.
- F1-DBMSCancelJob - Uses the service defined above to cancel a DBMS Scheduler Job.
- F1-DBMSRestartThread - Uses the service defined above to restart a batch job thread.
- F1-DBMSRestartChain - Uses the service defined above to restart DBMS Scheduler Chain.

In addition to the above, the product includes interfaces to allow Oracle Scheduler to schedule and execute product batch processes.

The components of interface are as follows:

- A set of tables to configure and control the interface. These tables are not managed by any object within the product itself as they are exclusively reserved for internal use by the Scheduler interface. These are installed in the product schema.
- A PL/SQL procedure ([OUAF BATCH](#)) that implements an interface to Oracle Scheduler to populate the scheduler interface tables, execute jobs and manage jobs from the PL/SQL interface supported by the Oracle Scheduler. This is installed on the product schema.
- The scheduler object may exist on the same database as the product or remotely on a

scheduler database. If the remote option is used then the [Oracle Scheduler Agent](#)²⁸ must be installed and enabled on the product database servers. A [destination](#) and [credentials](#) must also be configured.

- If [File Watchers](#) are used on product software hosts, then the [Oracle Scheduler Agent](#) must be enabled to access the files on the hosts holding the file.
- No user interface components are supplied with the interface from the product itself. The Oracle Scheduler uses Oracle SQL Developer or Oracle Enterprise Manager to maintain, execute and monitor Oracle Scheduler objects. It is recommended customers and partners use those interfaces to manage your schedule and related objects for Oracle Scheduler.
- For the Oracle Scheduler Interface to operate at least one threadpool.
- The Oracle Scheduler interface must be installed on the product schema but the schedule can be maintained locally or remotely. To support remote invocations, it is highly recommended to setup a dedicated database user for the schedule which is independent of the product database users. The product installation guide uses the default **SCHADM** for this role. All schedule information is stored in this schema not the product schema.

*Note: This manual will use the default value for this schedule administrator **SCHADM** but the actual implementation may vary.*

Oracle Scheduler Configuration

The Oracle Scheduler interface is installed on the product database and optionally on the scheduler database (for enterprise wide deployments).

After the Oracle Scheduler interface is installed the scheduler interface operates on the following principles:

- The Oracle database holding the schedule must have the **JOB_QUEUE_PROCESSES**²⁹ set to the maximum number of total concurrent threads³⁰ expected to execute at peak times to ensure maximum thread usage.
- The Oracle Scheduler and interface are configured to define the preferences to set the behavior:
 - The Oracle Scheduler preferences are configured with global scheduling defaults including email servers, time zones etc. For more information on the Oracle Scheduler preferences refer to [Setting Scheduler Preferences](#) and [Oracle Scheduler Preferences](#).
 - The Oracle Scheduler Interface options are set appropriately. For more information refer to [Scheduler Interface Options](#).
- The Oracle Scheduler is configured with the following minimal schedule objects. Additional objects can be configured as outlined in [Scheduling Jobs with Oracle Scheduler](#) and [Using Additional objects in Oracle Scheduler](#).

²⁸ The Oracle Scheduler Agent is an option on the database installation or the Oracle Client installation.

²⁹ The default is set to 1000 jobs, unless altered.

³⁰ This includes any DBA tasks and non-product processes that use the Oracle Scheduler at ANY time.

- **Job** - Define one or more jobs per Batch Control using the [Submit Job](#) interface. Refer to [Defining Jobs](#) for additional interface advice.
- **Chain** - Define the dependency chain with all the jobs that need to be executed with that chain. Refer to [Defining Chains](#) for additional advice.
- Optionally, populate the parameters of the each job as outlined in [Specifying Job Parameters](#))

Oracle Scheduler Execution

Note: The threadpools used by any process must be started before any job can execute.

Note: Refer to the [Scheduler Architecture](#) of how the Oracle Scheduler internally operates.

Once the scheduler objects are defined the Oracle Scheduler will initiate the batch jobs using the following technique:

- When a job in the Scheduler is deemed ready to execute, the Oracle Scheduler Interface determines the parameters from the various objects (including from the PL/SQL command line) and creates entries in the batch instance tables.
- The product batch daemon detects a pending process and distributes the job to the threadpool(s) indicated on the job parameters for execution. The Oracle Scheduler does not distribute the jobs to the threadpools, that is done via the daemon.
- During execution the monitoring capabilities in Oracle Scheduler, Oracle Enterprise Manager, JMX or the Batch Run Tree can be used to monitor the process. Refer to [Monitoring Oracle Scheduler](#) for more information.
- If the batch process fails the interface set the job to the **FAILED** state for the Oracle Scheduler to react accordingly. If the batch process completes successfully the interface will set the job to the **SUCCEEDED** state for the Oracle Scheduler to react accordingly.

The following figure summarizes the flow and processing for the Oracle Scheduler, the Oracle Scheduler Interface and batch architecture:

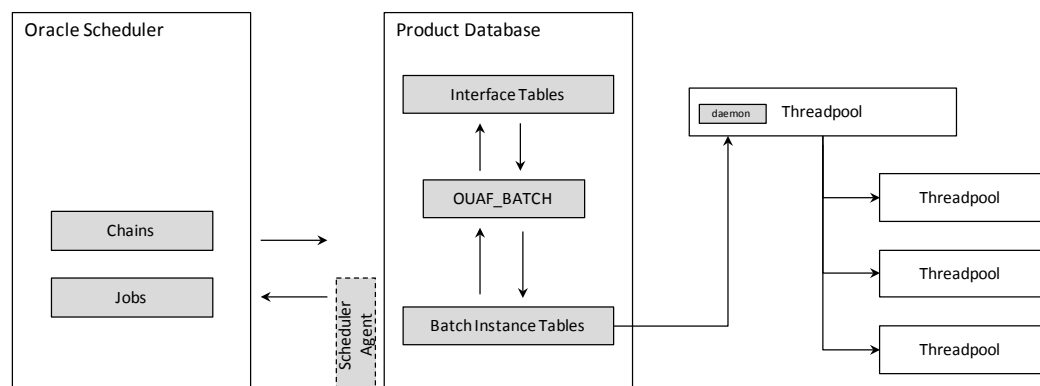

Figure 50 – Oracle Scheduler Interface

Oracle Scheduler Interface (OUAF_BATCH)

The Oracle Scheduler Interface is a PL/SQL based package **OUAF_BATCH** which contains a number of procedures to initiate batch processes, cancel running batch processes and

manage the parameters for the interface.

Submit_Job - Submit a Job or Thread

The **Submit_Job** procedure submits a batch job and waits for it to complete or fail. It returns COMPLETED or FAILED state to the Oracle Scheduler when used in a Job or Program object.

Column Name	Data Type	Req	Description
batch_code	Text	■	Valid batch control
user_id	Text	■	Valid product user defined in user object. The email address specified on the user object is used to send any configured notifications. Value can be inherited from configured parameters.
thread_count	Number		Override for thread count on batch control.
business_date	Date		Process date to be used for batch job. Value can be inherited from configured parameters. Value can be set using the to_date function. If no value is provided, the current date will be used. The format of the date must be in a recognizable format. For example, DD-MMM-YYYY is supported. It is recommended to use the to_date function to avoid confusion.
max_timeout_mins	Number		Maximum timeout, in minutes, for transactions to avoid ORA-01555 Snapshot too old errors . Default is 15 .
rerun_number	Number		Used for rerunning specific extracts. Default is: 0 (zero) for current extract.
thread_pool	Text		Valid Threadpool name to execute this batch job. This corresponds to the DIST-THD-POOL parameter. If not provided at all, the value of DEFAULT is assumed.
min_run_status	Number		Minimum Run Status that will cause this procedure to exit. The default is RUN_STAT_COMPLETED (40). Other values supported:

		<ul style="list-style-type: none"> • 10 - RUN_STAT_PENDING • 20 - RUN_STAT_IN_PROGRESS • 30 - RUN_STAT_ERROR • 40 - RUN_STAT_COMPLETED
raise_error	Boolean	If the min_run_status is set a value less than 40 , this parameter is set to true and the job status matches the value of the min_run_status then raise an application error. This allows the chain to support conditional branches or stop chains on conditions. Default is false .
thread_notifications	Boolean	Whether if an error in any thread should trigger a notification event. Default is true . See Notification Options for more information.
soft_parm_map	Array	Associate array of soft parameters. Refer to Specifying Job Parameters for more details.
soft_parm_list	Array	Table array of soft parameters. Refer to Specifying Job Parameters for more details.

Example command lines:

```
begin
  OUAF_BATCH.Submit_Job(
    batch_code => 'F1-SYNRQ',
    user_id => 'FRED01',
    thread_count => 4,
    business_date => '01-JUN-15',
    max_timeout_mins => 15,
    rerun_number => 0,
    thread_pool => 'DEFAULT',
    min_run_status => OUAF_BATCH.RUN_STAT_COMPLETED,
    raise_error => true,
    thread_notifications => true,
    soft_parm_list => OUAF_BATCH.parm_list_t('someParm', 'someValue'));
end;
```

```
begin
  OUAF_BATCH.Submit_Job(batch_code => 'F1-SYNRQ', user_id => 'FRED01');
end;
```

```
begin
  OUAF_BATCH.Submit_Job(batch_code => 'F1-SYNRQ',
    user_id => 'FRED01',
    business_date => to_date('2016-01-01', 'YYYY-MM-DD'),
```

```

thread_count => 1);
end;
begin
  OUAF_BATCH.Submi t_Job(batch_code => ' F1-SYNRQ' ,
                        user_id => ' FRED01' ,
                        thread_pool => ' POOL01' );
end;
begin
  OUAF_BATCH.Submi t_Job(
    batch_code => ' F1-SYNRQ' ,
    user_id => ' FRED01' ,
    soft_parm_list =>
      OUAF_BATCH.parm_list_t(' maintenanceObject' , ' F1- SYNC REQ' ,
                             ' isRestrictedByBatchCode' , ' true' ));
end;
begin
  OUAF_BATCH.Submi t_Job(batch_code => ' F1-SYNRQ' ,
                        user_id => ' FRED01' ,
                        busi ness_date => to_date(' 2015- 06- 01' , ' YYYY- MM- DD' ));
end;

```

Restart_Thread - Restart a failed thread/job

If a batch job or a thread of a job has failed and needs to be restarted the **OUAF_BATCH** includes an operation to restart the thread.

The **Restart_Thread** procedure uses the same parameters of the **Submi t_Job** procedure with an additional parameter:

Column Name	Data Type	Req	Description
thread_number	Number	■	Thread Number to restart. For single threaded jobs, this should be set to 1 .

The parameters can match the original execution or be altered to change the behavior of the individual thread.

*Note: The **thread_count** should match the original to ensure all data is processed correctly.*

The major difference between **Submi t_Job** procedure and **Restart_Thread** procedure is that **Restart_Thread** procedure does not wait for the thread to complete. It simply ends after submitting the thread. Therefore it is not recommended to be used in a schedule in Oracle Scheduler.

Examples of the command are as follows:

```

begin
  OUAF_BATCH.Restart_Thread(batch_code => ' F1-SYNRQ' ,
                            thread_number => 2,
                            user_id => ' FRED01' ,
                            thread_count => 4,
                            busi ness_date => ' 01- JUN- 15' ,
                            max_timeout_mins => 15,
                            rerun_number => 0,
                            thread_pool => ' POOL01' );
end;

```

Cancel_Job - Cancel a running Job

Note: This technique is an alternative to the technique outlined in [Batch JMX Reference](#).

Note: The **dbms_scheduler.stop_job** procedure is recommended to stop a scheduler job.

A job that is executing can be stopped using the **Cancel_Job** procedure. The procedure can use one of the following identifiers to cancel the running job:

Column Name	Data Type	Description
batch_code	Text	Valid batch control
job_id	Number	Allocated job identifier from batch daemon (on ci_batch_job table).

For example:

```
begin
  OUAF_BATCH.Cancel_Job(job_id => '0000000000123',
                        batch_code => 'F1-SYNRQ');
end;
```

```
begin
  OUAF_BATCH.Cancel_Job(job_id => '0000000000123');
end;
```

```
begin
  OUAF_BATCH.Cancel_Job(batch_code => 'F1-SYNRQ');
end;
```

The **Cancel_Job** procedure asynchronously changes the running **Submit_Job** status to **CANCELLED** state and terminates. The **Submit_Job** instance continually monitors the status and will take appropriate action to cancel all the running threads and end with a cancellation error once all the threads have ended.

Refer to [Cancellation](#) for more details.

Set_Option - Set a global or Job option

The **Set_Option** procedure is used to set global or job specific options for the scheduler interface. Any option specified using this procedure is subject to the [Order Of Preference](#) for parameters.

The **Set_Option** procedure uses the following command format:

```
begin
  OUAF_BATCH.Set_Option(scope => '<scope>', name => '<parmname>', value
=> '<parmvalue>');
end;
```

<scope> Scope of the parameter. The valid values are **GLOBAL** for global settings or a valid Batch Control for a specific Batch Control. Settings at the Batch Control level override the **GLOBAL** scope.

<parmname> The parameter name from the list below. This setting can be overridden on the command line.

<parmvalue> The value of the parameter designated by **<parmname>** to be used for the scope designated by **<scope>**.

The parameters supported by this option are listed below:

Parameter Name	Description
business_date	The default business date is the database's current system date, but this can provide an alternative default. It is typically useful in the case of jobs that run past midnight to make it maintain the same date for all the submissions. The date format is ISO format: YYYY-MM-DD .
user_id	The user id is required for every submission but to avoid having to specify it on every Submit_Job call, this will define a default either globally or for specific batch codes. The user must be defined as an user object within the product.
poll_seconds	By default the batch tables are checked every 1 second for updates. This provides for very responsive job handling, but if it is too taxing on the database, the frequency can be modified with this setting. The value must be between 1 and 60.
notify_job_name	Oracle Scheduler job OUIF_NOTIFY is the default thread notification job. That is defined out of the box to send emails for every failed thread. If that behavior is undesired, a custom thread notification, Oracle Scheduler job can be created and it defined as the default handler with this option. The new notify Oracle Scheduler job must exist.
thread_notifications	Set to false to suppress thread notifications for failed threads. The default is true .
thread_pool	The default threadpool to use. The installation default threadpool is 'DEFAULT' .
discard_queue	Set to true to delete all unused online job queue entries (CI_BATCH_JOB rows) created by OUIF_BATCH . The default is false . OUIF_BATCH uses individual CI_BATCH_JOB rows for the threads so it may become quite voluminous, and the job queue entries are typically not useful once a thread has started executing as the <i>Batch Run Tree</i> entries are used to track the job. This option can be used to clean up the unused entries.
debug	Set to true to see internally generated DBMS_OUTPUT debug messages. The default is false . Used for development purposes.

For example:

Begin

```
OUPAF_BATCH.Set_Option(scope => 'GLOBAL', name => 'user_id', value =>
'FRED01');
end
```

To remove the option, use the [Unset_Option](#) procedure.

Unset_Option - Reset a global or Job option

By using the [Set_Option](#) feature sets the global or job specific parameters for the scheduler it is possible to also remove the settings using the [Unset_Option](#) feature on the parameters covered by the [Set_Option](#) feature. The format of the command is:

```
begin
OUPAF_BATCH.Unset_Option(scope => '<scope>', name => '<parmname>');
end;
```

<scope> Scope of the parameter to reset. The valid values are **GLOBAL** for global settings or a valid Batch Control for a specific Batch Control.

<parmname> The parameter name to reset. Refer to the [Set_Option](#) procedure for the valid list.

For example:

```
begin
OUPAF_BATCH.Unset_Option(scope => 'GLOBAL', name => 'business_date');
end;
```

Raise_Thread_Error - Raise an error

Whenever a thread or job fails the Oracle Scheduler Interface informs the product of the failure as well as the scheduler itself. This is handled by the [Raise_Thread_Error](#). This procedure is not directly called by the scheduler itself and is used internally by the interface itself.

Setting Preferences

One of the first steps in configuration is setting the preferences

- The Oracle Scheduler includes a number of key preferences that need to be configured to ensure a consistent operation of the scheduler. These preferences are documented in the [Setting Scheduler Preferences](#) section of the [Oracle Scheduler Administration](#) documentation. It is recommended to set the preferences before using any of the functionality in the Oracle Scheduler.
- Once the Oracle Scheduler Interface is installed the **GLOBAL** options for the interface, should be set if they differ from the recommended defaults. This can be achieved using the [Set_Option](#) procedure. At a minimum, it is recommended to set a global **user_id** to act as a default to avoid individual job issues.
- Optionally, it is possible to set Batch Job specific options using the Batch Control as the key for the [Set_Option](#) procedure.

The above facilities set the overall scheduler and interface preferences.

Order Of Preference

There are a number of different techniques available for setting the parameters for any job. The available techniques from lowest precedence to highest are as follows:

- **Batch Control** - Job parameters can be set on the Batch Control record within the user interface under control of authorized users. This is commonly maintained by the business.
- **Global Preferences** - Some of the parameters from the Batch Control can be specified as a **GLOBAL** preference using the [Set Option](#) procedure. These preferences, if set, will override any Batch Control settings for the same setting.
- **Batch Job Preferences** - The [Set Option](#) procedure also supports the setting of parameters using the Batch Control as the key. Any overlapping settings set at this level will override settings on the Batch Control and any **GLOBAL** preference for the same setting.
- **Command Line Options** - It is possible to override all settings using command line options on the [Submit Job](#) and [Restart Thread](#) procedures. This is handy for special processing. See [soft_parm_map](#) and [soft_parm_list](#) for advice and examples.

It is recommended to set the values in the relevant level and use command line options for special situations or when using dynamic parameters.

Using soft_parm_map

Batch parameters can be specified on the command line through the [soft_parm_map](#), which is an [associative array](#). This format can be used in isolation or in association with [soft_parm_list](#) when specifying command line parameters. When both are used, the [soft_parm_list](#) values are taken in precedence.

To use [associative arrays](#), the array must be declared before use in the PL/SQL command.

Any array must be declared as type **OUIF_BATCH.parm_map_t**.

The format of soft parameter in an [associative array](#) is:

Segment	Format
Declaration of array	<code>declare <arrayname> OUIF_BATCH.parm_map_t;</code>
Definition of value	<code><arrayname>(' <paramname>') := ' <paramvalue>' ;</code>
Use of map	<code>soft_parm_map => <arrayname></code>

where:

<arrayname> Name of associative array to be used as the soft_parm_map

<paramname> Name of the parameter to be set

<paramvalue> Value of parameter

For example:

```

declare
  my_soft_parms OUAF_BATCH.parm_map_t;
begin
  my_soft_parms('maintenanceObject') := 'F1-SYNC REQ';
  my_soft_parms('isRestrictedByBatchCode') := 'true';
  OUAF_BATCH.Submit_Job(batch_code => 'F1-SYNRQ',
                       user_id => 'FRED01',
                       soft_parm_map => my_soft_parms);
end;
```

The **my_soft_parms** is the **soft_parm_map** in the above example. The use of associative arrays is a way of supporting dynamic parameters for complex parameters. This technique can be used exclusively or in conjunction with [soft_parm_list](#).

Note: The associative array should not contain common parameters such as business_date, user_id etc

Using soft_parm_list

An alternative to the [soft_parm_map](#) is to explicitly specify the parameters as a list of parameter and value pairs. This method is recommended for explicit values for the parameters. The parameter list must be of type **OUAF_BATCH.parm_list_t**.

The parameters are specified in the following format:

```
OUAF_BATCH.parm_list_t(' <parmname>', ' <parmval ue>' ...)
```

where:

<parmname> Name of the parameter to be set

<parmval ue> Value of parameter

For example:

```

begin
  OUAF_BATCH.Submit_Job(
    batch_code => 'F1-SYNRQ',
    user_id => 'SYSUSER',
    soft_parm_list =>
      OUAF_BATCH.parm_list_t('maintenanceObject', 'F1-SYNC REQ',
                             'isRestrictedByBatchCode', 'true'));
end;
```

This technique can be used exclusively or in conjunction with [soft_parm_map](#).

Note: The array should not contain common parameters such as business_date, user_id etc

Oracle Scheduler – OUAF REST APIs

The below are the list of OUAF services that can be used for managing Oracle DBMS scheduler objects:

1. F1-DBMSPROGRAM service:

This service can be used to Add, read, change, and delete a DBMS Scheduler Program object. There are currently two types of program that can be created:

- 1) Program associated with a batch code
- 2) Program to set/unset options

If a list of options is provided, it will create a program to set/unset options. Otherwise, it will create a program associated with a batch code

Parameter Name	Description
Action	Specifies the action to be performed on the scheduler object. Valid values are: ADD – Add READ – Read CHNG – Change DEL – Delete
Name	The name of the scheduler program on which the operation needs to be performed.
description	Description of the scheduler program.
batchCode	Batch code of the OUAF batch process for which the program is being created.
userId	ID under which the batch process will run.
threadCount	Use Thread Count to control whether a background process is run single threaded or in multiple parallel threads. This value defines the total number of threads that have been scheduled
businessDate	Process date to be used for batch job. If no value is provided, the current date will be used. The format of the date must be in a recognizable format.
maxTimeoutMins	Maximum timeout, in minutes, for transactions to avoid ORA-01555 Snapshot too old errors. Default is 15.
rerunNumber	Is only used for OUAF background processes that download information that belongs to given run number. It should only be supplied if you need to download an historical run (rather than the latest run).
threadPool	The default threadpool to use. The installation default threadpool is DEFAULT .
minRunStatus	Minimum Run Status that will cause this procedure to exit. The default is RUN_STAT_COMPLETED (40). Other values supported: <ul style="list-style-type: none"> • 10 - RUN_STAT_PENDING • 20 - RUN_STAT_IN_PROGRESS

Parameter Name	Description
	<ul style="list-style-type: none"> 30 - RUN_STAT_ERROR 40 - RUN_STAT_COMPLETED
raiseError	If the min_run_status is set a value less than 40, this parameter is set to true and the job status matches the value of the min_run_status then raise an application error. This allows the chain to support conditional branches or stop chains on conditions. Default is false.
threadNotifications	Whether if an error in any thread should trigger a notification event. Default is true. See Notification Options for more information.
parmName (list parameter)	The name of the parameter to the OUAF batch process, if applicable.
parmValue (list parameter)	The corresponding value of the parameter to the OUAF batch process, if applicable. parmValue and parmName pairs should be defined in repeated lists.
optionName (list parameter)	Option name to set/unset before program is executed
optionScope (list parameter)	Corresponding scope for the options to set/unset before program is executed. The scope can be global or per batch code.
optionValue (list parameter)	Corresponding value for the option name.

2. F1-DBMSChain service:

Add, read, change, or deletes a DBMS Scheduler Chain object based on the action provided.

Parameter Name	Description
action	Specifies the action to be performed on the scheduler object. Valid values are: ADD – Add READ – Read CHNG – Change DEL – Delete
name	The name of the scheduler chain on which the operation needs to be performed.

Parameter Name	Description
description	Description of the scheduler chain.
stepName (list parameter)	The name of the step within the scheduler chain
programName (list parameter)	The program name that is part of the corresponding step.
condition (list parameter)	A condition that must be met to complete the step and to transition to the next step or to end the chain execution.

Note: A step called 'END' step must be included in the chain definition that includes the condition to meet for the chain to end.

3. F1- DBMSSCHEDULE service:

Add, read, change, or deletes a DBMS Scheduler's schedule object based on the action provided.

Parameter Name	Description
action	Specifies the action to be performed on the scheduler object. Valid values are: ADD – Add READ – Read CHNG – Change DEL – Delete
name	The name of the scheduler's schedule object being created/edited/read/deleted.
description	Description of the schedule.
repeatInterval	The schedule's repeat interval to be specified in the format supported by Oracle DBMS Scheduler. (Refer to Oracle DBMS scheduler's documentation)

4. F1-DBMSJOB service:

Add, read, change, or deletes a DBMS Scheduler's job object based on the action provided.

- The job can be associated with either a program or a chain by populating the appropriate field. A validation error will result if both or neither of the fields are

populated.

- If schedule name is not populated, it will be for immediate execution.
- When called for change action, the job is added if it does not exist, else it is replaced with new definition.

Parameter Name	Description
action	Specifies the action to be performed on the scheduler object. Valid values are: ADD – Add READ – Read CHNG – Change DEL – Delete
name	The name of the scheduler's job object being created/edited/read/deleted.
description	Description of the scheduler's job object.
programName	The name of the scheduler's program to which this job should be associated with.
chainName	The name of the scheduler's chain to which this job should be associated with.
scheduleName	The name to the schedule's schedule object based on which this job needs to be executed.
Enabled	Specified if this job should be enabled or disabled.

5. F1-DBMSJOB service:

This service returns a list of name and descriptions of DBMS Scheduler objects based on the type and name (if specified) provided.

Parameter Name	Description
type	Specifies the type of scheduler object whose list is to be retrieved. Valid values are: PROG – DBMS Scheduler Program CHAN – DBMS Scheduler Chain SCHD – DBMS Scheduler Schedule JOB – DBMS Scheduler Job
name	Name to search with. Appending '%' to the end of name will

Parameter Name	Description
	perform a 'like' query resulting in a list of objects starting with the name provided.

6. F1-DBMSSUBMITJOB service:

This service submits a scheduler job for execution.

Parameter Name	Description
name	Name of the scheduler's job object to be submitted for execution.

7. F1-DBMSGETJOBDETAILS service:

Retrieves the details of DBMS Scheduler job based on job name. More specifically, this retrieves the steps and the step state of the DBMS scheduler job.

Parameter Name	Description
name	Name of the scheduler's job object whose details are to retrieved/read.
Status	Status of the DBMS scheduler job.
startDate	The start date of the DBMS scheduler job.
runDuration	The run duration of the DBMS scheduler job.
stepName (list parameter of "steps" list)	The name of the DBMS Scheduler job's step.
status (list parameter of "steps" list)	The status of the corresponding step.
runDuration	The run duration of the corresponding step.

8. F1-DBMSGETJOBS service:

This service retrieves a list of scheduler jobs based on status of running or completed. A date range can be specified to limit the list.

Note: The maximum numbers of records returned for completed jobs is 100.

This retrieves list of jobs for COMPLETED jobs, list of jobs with steps for RUNNING chains

Parameter Name	Description
jobStatus	The status based on which the list of DBMS scheduler jobs list has to be retrieved. Valid values are: RUN – Running Jobs COMP – Completed Jobs
startDate	The start date of the date range for which the details have to be retrieved.
endDate	The end date of the date range for which the details have to be retrieved.
jobStatus (list parameter of “jobs” list)	The status of the job.
runDate (list parameter of “jobs” list)	The execution date of the corresponding job.
runDuration (list parameter of “jobs” list)	The run duration of the corresponding job.
chainName (list parameter of “jobs” list)	The name of the associated chain (if applicable)
stepName (list parameter of “steps” list)	The name of the chain step within the job.
stepState (list parameter of “steps” list)	The state of the corresponding step.

9. F1-DBMSCANCELJOB service:

This service cancels a DBMS schedule job if it is running.

Parameter Name	Description
----------------	-------------

Parameter Name	Description
name	The name of the DBMS scheduler job to cancel.

10. F1-DBMSRESTARTTHREAD service:

This service can be used for restarting a failed OUAF batch thread.

Parameter Name	Description
batchCode	Batch code of the OUAF batch process for which the failed thread needs to be restarted.
userId	User Id of the user using which the batch thread needs to be restarted.
threadNumber	The thread number of the batch program that needs to be restarted.
threadCount	Use Thread Count to control whether a background process is run single threaded or in multiple parallel threads. This value defines the total number of threads that have been scheduled
businessDate	Process date to be used for batch job. If no value is provided, the current date will be used. The format of the date must be in a recognizable format.
maxTimeoutMins	Maximum timeout, in minutes, for transactions to avoid ORA-01555 Snapshot too old errors. Default is 15.
rerunNumber	Is only used for OUAF background processes that download information that belongs to given run number. It should only be supplied if you need to download an historical run (rather than the latest run).
threadPool	The default threadpool to use. The installation default threadpool is 'DEFAULT'.
parmName (list parameter)	The name of the parameter to the OUAF batch process, if applicable.
parmValue (list parameter)	The corresponding value of the parameter to the OUAF batch process, if applicable. parmValue and parmName pairs should be defined in repeated lists.

11. F1-DBMSRESTARTCHAIN service:

This service can be used to restart DBMS scheduler Chain. The service determines the failed step and changes status so the chain can resume

Parameter Name	Description
j obName	The name of the DBMS scheduler job to cancel.

Building a Schedule

Note: This section summarizes the features of the scheduling jobs in Oracle Scheduler using the Oracle Scheduler integration. Refer to [Scheduling Jobs with Oracle Scheduler](#) for additional information.

To use the Oracle Scheduler the scheduler objects must be loaded and the command lines use the provided Oracle Scheduler Interface PL/SQL package.

Recommended tools

There are a number of tools that are recommended to be used to define, maintain and manage the Oracle Scheduler:

- **PL/SQL interface** - There is a PL/SQL based command line interface that can be used to define the scheduler objects and control the scheduler via the **DBMS_SCHEDULER** package from any SQL interface tool. For more information about the PL/SQL interface, refer to the [DBMS_SCHEDULER Reference](#). This is useful for direct access environments. It is also used by the other tools, via generated statements, to manage the Oracle Scheduler.
- **Oracle SQL Developer** - Oracle SQL Developer includes an interface to manage scheduler objects including wizards to define key objects. For example:

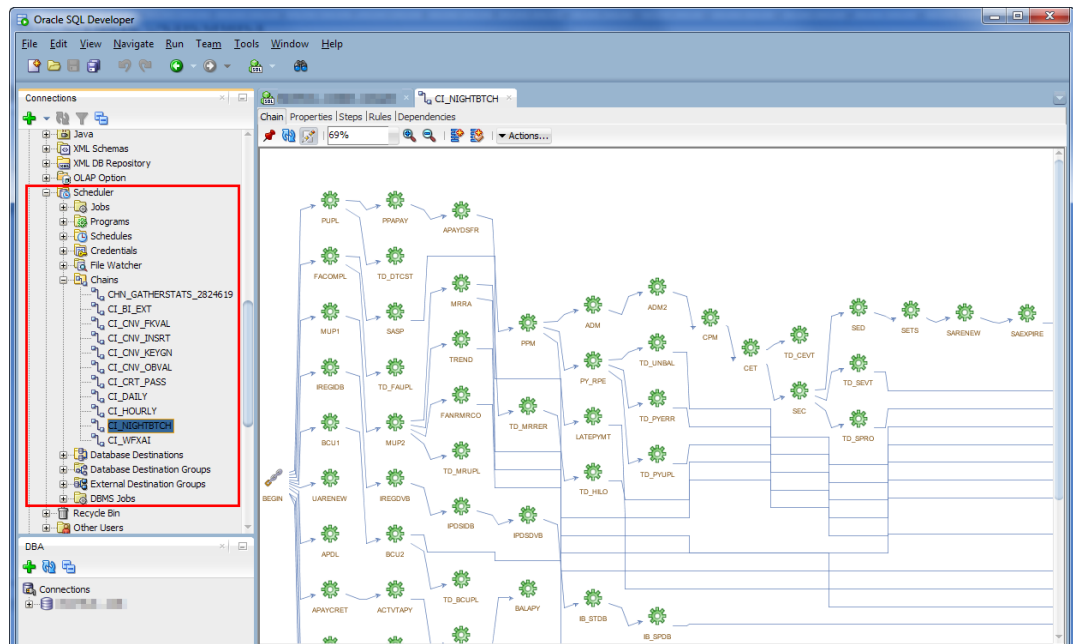

Figure 51 – Example Oracle SQL Developer Oracle Scheduler interface

- **Oracle Enterprise Manager** - The database targets associated with the Oracle Scheduler allow for the definition, management and monitoring scheduler objects. For example:

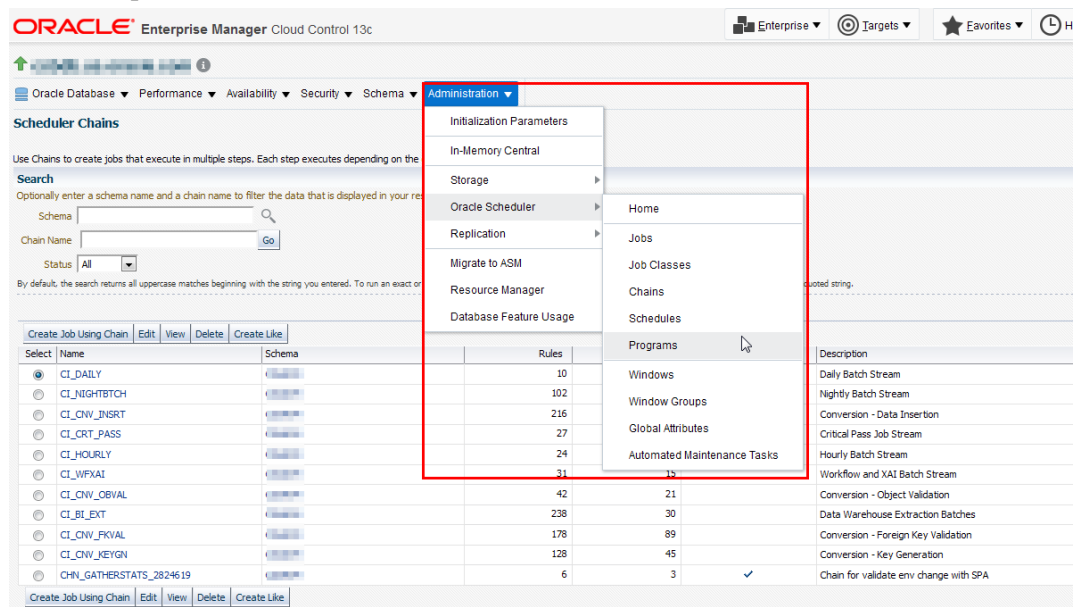

Figure 52 – Example Oracle Enterprise Manager Oracle Scheduler interface

It is possible to use any of the interfaces above to manage your schedule objects. Refer to the help pages associated with each tool for additional advice on individual objects.

Defining Programs

Note: Definition of Program Objects is optional and can be replaced directly with Job definitions. It is recommended that Program Objects be used for maximum reuse.

The first step in the process is to define each batch control as a Program object in the scheduler using the following attributes:

Attribute	Recommended content
program_name	Name of the Program. This name should not include any embedded characters or '-' character according to Oracle object naming conventions.
comments	A short description of the program. This is useful for searching the program.
enabled	Set to true to enable this program to be used by the scheduler.
program_type	Specify the PL/SQL Block as the type of program for the Oracle Scheduler Interface.
program_action	Specify the interface commands line for the execution. You may include any overrides, if desired, at this time. For optimization purpose, only specify the parameters that are not inherited from the global options or are not defaulted on the batch control. It is recommended to specify the Batch Control to avoid issues in submission. An example of a simple command line is: begin OUAF_BATCH. Submit_Job(batch_code => ' BATCH01'); end;

There are number of ways that can be used to specify the program using the various tools available:

Interface	Method of Definition
PL/SQL	Use the DBMS_SCHEDULER.CREATE_PROGRAM procedure using the above parameters to define the program object.
SQL Developer	Use the <i>New Program</i> menu item of the <i>Scheduler</i> tree to define the new program using a right click action on the <i>Program</i> node.
Enterprise Manager	Using the <i>Administration</i> → <i>Oracle Scheduler</i> → <i>Programs</i> menu item, specify the program information as above. Use the Source field to hold the PL/SQL command line for the interface.

You may create more than one program for the same batch control if there are different parameters is needed for different executions.

Defining Job Classes

*Note: The use of [Job Classes](#) is optional. It is only used to group jobs for attribute inheritance, service affinity, monitoring purposes and/or resource profiling. **DEFAULT_JOB_CLASS** is used if no job class is specified.*

Note: Job Class is only one technique for prioritizing jobs. Refer to [Prioritizing Jobs](#) for more information.

If [Job Classes](#) are to be used, they need to be setup to be used by the jobs allocated to them. This attributes of a Job Class are as follows:

Attribute	Recommended content
job_class_name	Name of the Job Class. This name should not include any embedded characters or '-' character according to Oracle object naming conventions.
comments	A short description of the job class. This is useful for searching for the job class.
resource_consumer_name	Name of the resource consumer group associated with jobs in this job class. Optional.
service	Name of database service associated with this job class name. Optional.
logging_level	Sets the level of logging is performed by the Oracle Scheduler. Optional.
log_history	Sets the retention period, in days, log history are retained by the Oracle Scheduler. Optional.

There are number of ways that can be used to specify the job class using the various tools available:

Interface	Method of Definition
PL/SQL	Use the DBMS_SCHEDULER.CREATE_JOB_CLASS procedure using the above parameters to define the job class object.
SQL Developer	Use the <i>New Job Class</i> menu item of the <i>Scheduler</i> tree to define the new job class using a right click action on the <i>Scheduler</i> node.
Enterprise Manager	Using the <i>Administration</i> → <i>Oracle Scheduler</i> → <i>Job Class</i> menu item, specify the class information as above.

Defining Schedules

Note: This section is only a subset of the capabilities of the schedule object. For more advanced discussions and different scenarios refer to the [Creating and Managing Schedules to Define Jobs](#) in the Oracle Database documentation.

Before defining jobs and chains you may need to define a schedule to run them against. Schedules can be time based and/or event based. It is also possible to create multiple schedules to support complex scheduling requirements. For example, you can create a holiday schedule with the dates that are blacklisted for execution in another schedule.

The following attributes are typically populated for the schedule object:

Attribute	Recommended content
schedule_name	Name of the schedule. This name should not include any embedded characters or '-' character according to Oracle object naming conventions.
comments	A short description of the schedule. This is useful for searching the schedule.

Attribute	Recommended content
start_date	Optional start date and time when the schedule becomes valid. If not populated then the date jobs or windows are activated is used.
repeat_interval	This specifies how often the schedule repeats. It uses the Calendaring Syntax supported by the Oracle Scheduler. Even schedules decide the repeat interval for checking the event.
end_date	Optional date and time after jobs and windows allocated to this schedule will not execute.

There are number of ways that can be used to specify the schedule using the various tools available:

Interface	Method of Definition
PL/SQL	Use the DBMS_SCHEDULER.CREATE_SCHEDULE procedure using the above parameters to define the schedule object. This interface is recommended for complex Calendaring Syntax support.
SQL Developer	Use the <i>New Credential</i> menu item of the <i>Scheduler</i> tree to define the new schedule using a right click action on the <i>Schedule</i> node.
Enterprise Manager	Using the <i>Administration</i> → <i>Oracle Scheduler</i> → <i>Schedules</i> menu item, specify the schedule information as above.

Defining Remote Destinations and Credentials

*Note: This section outlines the process of specifying destinations and credentials for remote processing. If the database scheduler is housed within the product database (the default installation) then this section only applies to **File Watcher** type jobs.*

Note: In Oracle Database 12c, the [CREATE_CREDENTIAL](#) procedure for [DBMS_SCHEDULER](#) has been deprecated and replaced with the [CREATE_CREDENTIAL](#) procedure within the [DBMS_CREDENTIAL](#) package.

When executing Jobs and File Watchers that are remote from the scheduler database and location, it is required that a destination be defined for the job and relevant credentials for the job to execute on that destination. The following needs to be setup:

- To execute product jobs remotely, the product database server needs to be defined as a destination and the product database credentials should be specified. It is recommended that the values expressed in [BATCH_DBUSER](#) and [BATCH_DBPASS](#) be specified as credentials.
- For **File Watcher** jobs, the product server where the file is housed must be defined as a destination. The operating system credentials for the batch process must be specified to access the file must be specified as credentials.
- There is no explicit process for creating non-database related destinations in the API (there is no [CREATE_AGENT_DESTINATION](#) procedure). When an agent registers with the database scheduler as part of the startup procedure, it is automatically added as a destination. If you wish to register remote databases then use the

CREATE DATABASE DESTINATION package.

- For [Database Destinations](#), the database TNS information must exist on the scheduler database to connect remotely.
- At least one product related database destination must be registered for remote invocation of product jobs.
- The [Oracle Scheduler agents](#) must be executing for the scheduler to initiate and track remote jobs.

To specify the credentials the following [attributes](#) must be provided:

Attribute	Recommended content
credential_name	Name of the credential. This name should not include any embedded characters or '-' character according to Oracle object naming conventions.
comments	This attribute is not used by the DBMS_SCHEDULER package but can be provided for documentation purposes.
username	The userid to be used for connection. This attribute is required and is case sensitive.
password	The password associated with the username. This value is stored in obfuscated format and is not available in Oracle Scheduler views.
database_role	This is the database role associated with this user. This is not used for product jobs but is required for any DBA tasks requiring privileged access.
windows_domain	For Windows Server implementations only. This is the windows domain for the user to connect to.

There are number of ways that can be used to specify the credentials using the various tools available:

Interface	Method of Definition
PL/SQL	Use the DBMS_CREDENTIAL.CREATE_CREDENTIAL procedure using the above parameters to define the credential object.
SQL Developer	Use the <i>New Credential</i> menu item of the <i>Scheduler</i> tree to define the new credential using a right click action on the <i>Credentials</i> node. Oracle SQL Developer uses DBMS_CREDENTIAL for credential management.
Enterprise Manager	Oracle Enterprise Manager uses its own security system for credentials. Refer to the Enterprise Manager Cloud Control Security Guide for more details.

When specifying [Database Destinations](#), the following attributes need to be specified:

Attribute	Recommended content
destination_name	Name of the destination. This name should not include any

Attribute	Recommended content
	embedded characters or '-' character according to Oracle object naming conventions.
comments	This attribute is not used by the DBMS_SCHEDULER package but can be provided for documentation purposes.
agent	The agent name as specified in the agent configuration file.
tns_name	Oracle service name as documented in the TNS file attached to the configuration file. This is used to connect from the scheduler database to the remote database.

There are number of ways that can be used to specify the database destination using the various tools available:

Interface	Method of Definition
PL/SQL	Use the DBMS_CREDENTIAL.CREATE_DATABASE_DESTINATION procedure using the above parameters to define the credential object.
SQL Developer	Use the <i>New Database Destination</i> menu item of the <i>Scheduler</i> tree to define the new destination using a right click action on the <i>Database Destinations</i> node.
Enterprise Manager	Oracle Enterprise Manager uses its own security system for destinations. Refer to the Enterprise Manager Cloud Control Security Guide for more details.

Defining Jobs

Note: This section is only a subset of the capabilities of the job object. For more advanced discussions refer to the [Jobs](#) section in the Oracle Database documentation.

Note: Product jobs should never be defined as Lightweight jobs. Those are reserved for specific Oracle products.

The key object in the Oracle Scheduler is the **Job** object. This object is a collection of data that tells the scheduler what, when, where and how to execute a particular process. In the case of the product, a job defines how to execute an instance of a Batch Control whether it is independent or part of a Chain.

Each Job definition has a set of attributes that define the Job:

Attribute	Recommended content
j ob_name	Name of the job. This name should not include any embedded characters or '-' character according to Oracle object naming conventions. It is recommended to replace '-' in Batch Controls with '_' to avoid naming issues.
comments	Description of Job. Useful for finding jobs.
j ob_type	If programs have been used then the type STORED_PROCEDURE

Attribute	Recommended content
	should be used. If programs are not used, then specify PLSQL_BLOCK with the action containing the source PL/SQL command.
job_action	Value depends on the specification of the job_type : <ul style="list-style-type: none"> If job_type is STORED_PROCEDURE, then this will contain the fully qualified name of the program to execute. If job_type is PLSQL_BLOCK, then this will contain the PL/SQL command to execute the OUIF_BATCH interface.
start_date	Optional start date and time when the schedule becomes valid. If not populated then the date jobs or windows are activated is used. If schedule_name is specified, then this date and time may be null to inherit the value from the schedule or chain.
repeat_interval	Optional. Definition of how often the job will repeat. It uses the Calendaring Syntax supported by the Oracle Scheduler. Even schedules decide the repeat interval for checking the event. If schedule_name is specified, then this value may be null to inherit the value from the schedule or chain.
schedule_name	Optional. Name of schedule object dictating the schedule for this job.
job_class	Optional. Name of job class allocated to this job.
end_date	Optional date and time after jobs and windows allocated to this job will not execute. If schedule_name is specified, then this date and time may be null to inherit the value from the schedule or chain.
credential_name	Optional. Name of credential to use for remote invocation for this job.
destination_name	Optional. Name of destination to use for remote invocation for this job. For remote product jobs this must be the location of the product database.
enabled	Whether this job is enabled or not. Only enabled jobs (true) are executed.
auto_drop	Whether after execution of this job, the job definition will be dropped. This is typically set to true for temporary jobs only. It is recommended to set to false for all regular product jobs.

There are additional attributes to manage the advanced features of the job. Refer to the [Job Object](#) for a discussion of the additional parameters.

There are number of ways that can be used to specify jobs using the various tools available:

Interface	Method of Definition
-----------	----------------------

Interface	Method of Definition
PL/SQL	Use the DBMS_SCHEDULER.CREATE_JOB procedure using the above parameters to define the job object.
SQL Developer	Use the <i>New Job</i> menu item of the <i>Scheduler</i> tree to define the new job using a right click action on the <i>Jobs</i> node.
Enterprise Manager	Using the <i>Administration</i> → <i>Oracle Scheduler</i> → <i>Jobs</i> menu item, specify the job information as above.

Defining Chains

Note: It is recommended to review the [Creating and Managing Job Chains](#) documentation for additional advice.

Once the jobs and schedule have been defined the next step is to define the set of job chains which configure the order and rules for a sequence of related jobs. Typically a job chain represents a set of business related processes that must be scheduled and processed in a specific order. For example, a nightly set of jobs that constitute a set of business processes is considered a chain.

There are a various rules for a chain:

- There is a begin event and an end event that are automatically generated for a chain. The chain is considered ended when all jobs directly related to the end event are complete.
- Relationships in the chain are based upon [job state events](#) to dictate next actions. Typically, this is **SUCCEEDED** but can support other events. For example, it is possible to start the next job in a chain based upon a **FAILED** event to perform cleanup activities if required.

There are a number of key steps outlined in [Creating and Managing Job Chains](#) that should be performed with the following additions building chains that include product jobs:

- The naming conventions for the objects defined in the chain are subject to rules for all Oracle dictionary objects. It is recommended to prefix customizations with **CM** to avoid conflicts with base provided objects.
- It is recommended to implement a chain step per batch control that is applicable to the chain. The step name can match the Batch control or a valid alternative for your implementation.
- For each sequence in the chain, set the appropriate state in a Chain Rule for the setup. For example, if StepB must start only if StepA is complete then set the condition for the rule for Step A as "StepA SUCCEEDED" and action as "START StepB". Complex rules are supported. Refer to [Adding Rules to a Chain](#) for more details.

There are number of ways that can be used to specify chains using the various tools available:

Interface	Method of Definition
PL/SQL	Refer to Creating and Managing Job Chains for the sequence of statements to execute.

Interface	Method of Definition
SQL Developer	Use the <i>New Chain</i> menu item of the <i>Scheduler</i> tree to define the new chain using a right click action on the <i>Chains</i> node.
Enterprise Manager	Using the <i>Administration</i> → <i>Oracle Scheduler</i> → <i>Chains</i> menu item, specify the chain information.

Other Scheduler Objects

There are a number of scheduler objects not covered in the above documentation that can be used by implementations using the following guidelines:

- [File Watchers](#) - These objects create events based upon an arrival of a file in a configured location. To use File Watchers, a destination and credentials need to be defined along with the File Watcher itself. The file needs to be accessible by the process that is using it.
- [Windows](#) - These are definitions of times and dates where certain conditions, restrictions or resource profiles can be used. Oracle Scheduler supports discrete or overlapping Windows³¹.
- [Groups](#) - It is possible to group certain scheduler objects for efficient administration and clustering purposes.

Executing Jobs

There are a number of techniques that can be used to execute a schedule and/or a job. The following techniques can be used:

- Chains can be executed using a predefined schedule or manually started by starting the job created for the chain. Refer to [Running Jobs](#) for additional information.
- Events can trigger jobs when the event occurs. Refer to [Using Events to Start Jobs](#) for more information.

Chains and Jobs that are enabled are only executed.

Monitoring Oracle Scheduler

There are various techniques available from the interface and related tools to monitor Oracle Scheduler. Refer to [Monitoring Jobs](#) for additional advice.

Note: Any product job can also be monitored using the Batch Run Tree, JMX interface or via the Oracle Utilities Batch Server target page within Oracle Enterprise Manager via the Application Management Pack for Oracle Utilities.

Job States

When any job is waiting to be executed, executing, completed or errored the scheduler updates the state of the job in its job tables. These states are available from the tools

³¹ Whilst supported, Oracle does not recommend overlapping windows.

mentioned earlier in various forms. The states that are raised are documented in [Monitoring Job State with Events Raised by the Scheduler](#).

Dictionary Views

The most common technique for monitoring the scheduler itself is the provided [Scheduler Data Dictionary Views](#). These views not only provide details of the Oracle Scheduler Objects but can provide execution information. There are two views that are of particular interest for executions:

- ***_SCHEDULER_RUNNING_CHAINS** - Show all chains that have active jobs.
- ***_SCHEDULER_RUNNING_JOBS** - Show state information for all jobs running at the moment.

These views are accessible from any SQL product or via Oracle Enterprise Manager via the *Administration* → *Oracle Scheduler* → *Home* menu item on the database target used by the Oracle Scheduler.

Scheduler Notifications

One of the features of the Oracle Scheduler is that it is possible to send an email based upon the state of a particular job within the scheduler. This is based upon the state of the job and the email format can be customized based upon the state. For more information and examples of the capability refer to [Monitoring Job State with E-mail Notifications](#).

The Oracle Scheduler Interface includes the **OUIFY_NOTIFY** job that can be used as a template.

Cancellation

Once a job has been executed there are two techniques for cancelling a running job or thread:

- Use the [OUIFY_BATCH.Cancel_Job](#) API to stop the thread or job. The job state will be set to **STOPPED**.
- Use the [Batch JMX API](#) to cancel a thread.

The cancellation will be registered on the batch run tree including any relevant security information for auditing purposes.

Exporting Schedules across environments

As the schedule is a set of dictionary objects it can be exported and imported using any of the Oracle database copy, cloning or exporting functions. Utilities such as **exp** or **expdp** can be used to export the schema of the owner of the schedule.

It is also possible to isolate the scheduler objects using the data pump **INCLUDE** function. The **INCLUDE** statement should use the following filter:

```
INCLUDE=procobj:"IN (SELECT NAME FROM sys.OBJ$ WHERE TYPE# IN (47, 48, 66, 67, 68, 69, 71, 72, 74))"
```

For example:

```
expdp <user>/<password> DIRECTORY=<directory> DUMPFILE=<expfile>  
LOGFILE=<logfile> SCHEMAS=<schema> INCLUDE=procobj:"IN (SELECT NAME
```

FROM sys. OBJ\$ WHERE TYPE# IN (47, 48, 66, 67, 68, 69, 71, 72, 74) "

Appendices - Parameters

Conventions in this section

This section contains a number of conventions to illustrate attributes and scope of configuration parameters:

- Valid values are indicated for each parameter and where applicable the default which is indicated in **bold**.
- The scope of the parameter is indicated with relevant icons:

WEB	Web Application Server
BAS	Business Application Server
IWS	Inbound Web Services
XAI	XML Application Integration
DB	Database
BATCH	Background Processing
MOB	Mobile based products only

- Some parameters depend on the JEE Web Application Server used. The following icons will be used to denote the applicable JEE Web Application Server. No icon indicates the parameter applies across all supported JEE Web Application Server:

WLS	Oracle WebLogic
WAS	IBM WebSphere
WASND	IBM WebSphere Network Deployment

- Some parameters apply to embedded mode installation settings for Oracle WebLogic. These do not need to be set for native mode installations. The following icons will indicate these settings:

EMBED	Embedded Mode
NATIVE	Native Mode

- The ordinality of the parameter is indicated. Parameters that are mandatory must exist and are set in the relevant configuration file for the product to operate.
- Where applicable an example is indicated with the format.

ENVIRON.INI

The [ENVIRON.INI](#) is the environment file that is output from [configureEnv](#) and is used by [initialSetup](#) to build the configuration files from templates.

ADDITIONAL_RUNTIME_CLASSPATH - Additional Classpath

Parameter

ADDITIONAL_RUNTIME_CLASSPATH

Description	Additional Runtime Classpath for Web Application Server to allow custom jar libraries to be added to path, for Oracle WebLogic. For native mode customers, additional jar libraries can be added on the classpath on the Server definition.
Ordinality	Optional
Valid Values	Valid Classpath
JEE Web Application Server	WLS
Tier	WEB
Installation Mode	EMBED

ADDITIONAL_STOP_WEBLOGIC - Additional Stop Arguments

Parameter	ADDITIONAL_STOP_WEBLOGIC
Description	Additional Stop arguments when running the Administration Server on a different port. Refer to Starting and Stopping Servers for more information.
Ordinality	Optional
Valid Values	Valid Stop options for Oracle WebLogic
JEE Web Application Server	WLS
Tier	WEB
Installation Mode	EMBED

ADF_HOME - Location of ADF Software

Parameter	ADF_HOME
Description	Location of Oracle ADF libraries. Only set if ADF Zone Type is used in implementation or within product.
Ordinality	Optional
Valid Values	Full path to ADF libraries on server
JEE Web Application Server	WLS
Tier	WEB BAS
Installation Mode	EMBED NATIVE

ANT_ADDITIONAL_OPT - Additional options for ANT

Parameter	ANT_ADDITIONAL_OPT
Description	Implementation specific options for WAR and EAR builds used by initialSetup .
Ordinality	Optional
Valid Values	Valid ANT options
JEE Web Application Server	WLS WAS WASND
Tier	WEB BAS IWS XAI BATCH MOB
Installation Mode	EMBED NATIVE

ANT_HOME - Location of ANT

Parameter	ANT_HOME
Description	Generated location of ANT used by initialSetup . This value is autogenerated and should not be altered.
Ordinality	Mandatory
Valid Values	Valid location of ANT
JEE Web Application Server	WLS WAS WASND
Tier	WEB BAS IWS XAI BATCH MOB
Installation Mode	EMBED NATIVE

ANT_OPT_MAX - ANT Maximum Heap Size

Parameter	ANT_OPT_MAX
Description	Maximum memory in MB allocated to ANT builds. Unless otherwise instructed by Oracle Support this value should not be altered.
Ordinality	Optional
Valid Values	Default: 800
JEE Web Application Server	WLS WAS WASND
Tier	WEB BAS IWS XAI BATCH MOB
Installation Mode	EMBED NATIVE

ANT_OPT_MIN - ANT Minimum Heap Size

Parameter	ANT_OPT_MIN
Description	Minimum memory in MB allocated to ANT builds. Unless

otherwise instructed by Oracle Support this value should not be altered.

Ordinality	Optional
Valid Values	Default: 200
JEE Web Application Server	WLS WAS WASND
Tier	WEB BAS IWS XAI BATCH MOB
Installation Mode	EMBED NATIVE

appViewer - Name of appViewer WAR file

Parameter	appViewer
Description	Name of AppViewer WAR file
Ordinality	Mandatory
Valid Values	This value is automatically generated
JEE Web Application Server	WLS WAS WASND
Tier	WEB
Installation Mode	EMBED NATIVE

BATCHDAEMON - Whether Online Batch Daemon is enabled

Parameter	BATCHDAEMON
Description	Whether the Online Batch Deamon is enabled or not.
Ordinality	Mandatory
Valid Values	[true false]
JEE Web Application Server	WLS WAS WASND
Tier	BAS BATCH
Installation Mode	EMBED NATIVE

BATCHEDIT_ENABLED - Whether Batch Edit Facility is Enabled

Parameter	BATCHEDIT_ENABLED
Description	Whether the Batch Edit facility is enabled or not.
Ordinality	Mandatory
Valid Values	[true false]
JEE Web Application Server	Not Applicable
Tier	BATCH
Installation Mode	Not Applicable

BATCHENABLED - Whether Online Batch Server is Enabled

Parameter	BATCHENABLED
Description	Whether the Online Batch Server is enabled or not.
Ordinality	Mandatory
Valid Values	[true false]
JEE Web Application Server	WLS WAS WASND
Tier	BAS BATCH
Installation Mode	EMBED NATIVE

BATCHTHREADS - Number of Online Batch Server Threads

Parameter	BATCHTHREADS
Description	Number of Threads in DEFAULT online threadpool.
Ordinality	Mandatory
Valid Values	Default: 5
JEE Web Application Server	WLS WAS WASND
Tier	BAS
Installation Mode	EMBED NATIVE

BATCH_DBPASS - Batch User Password

Parameter	BATCH_DBPASS
Description	Encrypted password for database user used for batch.
Ordinality	Mandatory
Valid Values	Encrypted password
JEE Web Application Server	Not Applicable
Tier	BATCH DB
Installation Mode	Not Applicable

BATCH_DBUSER - Batch User

Parameter	BATCH_DBUSER
Description	Database user used for batch.
Ordinality	Mandatory
Valid Values	Valid database user
JEE Web Application Server	Not Applicable

Tier	BATCH DB
Installation Mode	Not Applicable

BATCH_MEMORY_ADDITIONAL_OPT - Threadpool Worker JVM additional options

Parameter	BATCH_MEMORY_ADDITIONAL_OPT
Description	Additional JVM Options for Threadpools
Ordinality	Mandatory
Valid Values	Valid Threadpool parameters. For example: <code>BATCH_MEMORY_ADDITIONAL_OPT=-Xdebug -Xnoagent -Xrunj dwp: transport=dt_socket, address=7757, server=y, suspend=n -Djava.compiler=NONE</code>
JEE Web Application Server	Not Applicable
Tier	BATCH
Installation Mode	Not Applicable

BATCH_MEMORY_OPT_MAX - Threadpool Worker Java Maximum Heap Size

Parameter	BATCH_MEMORY_OPT_MAX
Description	Maximum JVM Memory for each Threadpool instance
Ordinality	Mandatory
Valid Values	Memory specification (in MB). Default: 1024
JEE Web Application Server	Not Applicable
Tier	BATCH
Installation Mode	Not Applicable

BATCH_MEMORY_OPT_MAXPERMSIZE - Threadpool Worker Java Maximum Perm Size

Parameter	BATCH_MEMORY_OPT_MAXPERMSIZE
Description	Maximum JVM PermGen for each Threadpool instance
Ordinality	Mandatory
Valid Values	Memory specification (in MB). Default: 192
JEE Web Application Server	Not Applicable
Tier	BATCH
Installation Mode	Not Applicable

BATCH_MEMORY_OPT_MIN - Threadpool Worker Java Minimum Heap Size

Parameter	BATCH_MEMORY_OPT_MIN
Description	Minimum JVM Memory for each Threadpool instance
Ordinality	Mandatory
Valid Values	Memory specification (in MB). Default: 512
JEE Web Application Server	Not Applicable
Tier	BATCH
Installation Mode	Not Applicable

BATCH_MODE - Default Mode of Batch

Parameter	BATCH_MODE
Description	Batch Execution Mode for Threadpools
Ordinality	Mandatory
Valid Values	[THIN CLUSTERED]
JEE Web Application Server	Not Applicable
Tier	BATCH
Installation Mode	Not Applicable

BATCH_ONLINE_LOG_DIR - Online Batch Submission Log Directory

Parameter	BATCH_ONLINE_LOG_DIR
Description	Location of Online Batch Submission logs
Ordinality	Optional
Valid Values	Valid directory
JEE Web Application Server	WLS WAS WASND
Tier	BAS
Installation Mode	EMBED NATIVE

BATCH_RMI_PORT - RMI Port for Batch

Parameter	BATCH_RMI_PORT
Description	Port number used for communication to Threadpools. This is used for JMX monitoring.
Ordinality	Mandatory
Valid Values	Valid Port Number

JEE Web Application Server	Not Applicable
Tier	BATCH
Installation Mode	Not Applicable

BSN_APP - Business Server Application Name

Parameter	BSN_APP
Description	Deployed Business Application Server Name
Ordinality	Mandatory
Valid Values	Default: SPLService
JEE Web Application Server	WLS WAS WASND
Tier	BAS
Installation Mode	EMBED NATIVE

BSN_JMX_RMI_PORT_PERFORMANCE - JMX Port for Business Application Server

Parameter	BSN_JMX_RMI_PORT_PERFORMANCE
Description	JMX Port for Business Application Server monitoring
Ordinality	Optional
Valid Values	Valid open port for JMX
JEE Web Application Server	WLS WAS WASND
Tier	BAS
Installation Mode	EMBED NATIVE

BSN_JMX_SYSPASS - Password for BAS JMX Monitoring

Parameter	BSN_JMX_SYSPASS
Description	Default encrypted password for JMX monitoring of Business Application Server Name for BSN_JMX_SYUSER . This is required if BSN_JMX_RMI_PORT_PERFORMANCE is set.
Ordinality	Optional
Valid Values	Encrypted Password
JEE Web Application Server	WLS WAS WASND
Tier	BAS
Installation Mode	EMBED NATIVE

BSN_JMX_SYSUSER - Default User for BSN JMX Monitoring

Parameter	BSN_JMX_SYSUSER
Description	Default user for JMX monitoring of Business Application Server Name. This is required if BSN_JMX_RMI_PORT_PERFORMANCE is set.
Ordinality	Optional
Valid Values	Administration User
JEE Web Application Server	WLS WAS WASND
Tier	BAS
Installation Mode	EMBED NATIVE

BSN_NODENAME - IBM WebSphere Node Name

Parameter	BSN_NODENAME
Description	IBM WebSphere Node to deploy Business Application Server to.
Ordinality	Mandatory
Valid Values	Valid IBM WebSphere Node Names
JEE Web Application Server	WAS WASND
Tier	BAS
Installation Mode	EMBED

BSN_SVRNAME - IBM WebSphere Server Name

Parameter	BSN_SVRNAME
Description	IBM WebSphere Server Name used to deploy Business Application Server to.
Ordinality	Mandatory
Valid Values	Valid IBM WebSphere Server Names
JEE Web Application Server	WAS WASND
Tier	BAS
Installation Mode	EMBED

BSN_WASBOOTSTRAPPORT - Bootstrap Port

Parameter	BSN_WASBOOTSTRAPPORT
Description	IBM WebSphere Server Bootstrap Port used for Business

	Application Server.
Ordinality	Mandatory
Valid Values	Valid IBM WebSphere Bootstrap Ports
JEE Web Application Server	WAS WASND
Tier	BAS
Installation Mode	EMBED

BSN_WLHOST - Business App Server Host

Parameter	BSN_WLHOST
Description	Oracle WebLogic host name for Business Application Server. For native and/or clustered installations this setting should be set to local host .
Ordinality	Mandatory
Valid Values	Default: Current Host Name
JEE Web Application Server	WLS
Tier	BAS
Installation Mode	EMBED NATIVE

BSN_WLS_SVRNAME - Oracle WebLogic Server Name

Parameter	BSN_WLS_SVRNAME
Description	Oracle WebLogic server name for Business Application Server. For native and/or clustered installations this setting should be set to the server or cluster created for the deployment.
Ordinality	Mandatory
Valid Values	Default: myserver
JEE Web Application Server	WLS
Tier	BAS
Installation Mode	EMBED NATIVE

CERT_IDENT_KS_ALIAS - SSL Certificate Keystore Alias

Parameter	CERT_IDENT_KS_ALIAS
Description	Alias used for SSL Keystore.
Ordinality	Mandatory for SSL implementations

JEE Web Application Server	WLS
Tier	WEB BAS IWS MOB
Installation Mode	EMBED

CERT_IDENT_KS_FILE - SSL Keystore File

Parameter	CERT_IDENT_KS_FILE
Description	Full path to SSL Keystore file
Ordinality	Mandatory for SSL implementations
JEE Web Application Server	WLS
Tier	WEB BAS IWS MOB
Installation Mode	EMBED

CERT_IDENT_KS_PWD - SSL Keystore Password

Parameter	CERT_IDENT_KS_FILE
Description	Full path to SSL Keystore file
Ordinality	Mandatory for SSL implementations
JEE Web Application Server	WLS
Tier	WEB BAS IWS MOB
Installation Mode	EMBED

CERT_IDENT_KS_TYPE - SSL Keystore Type

Parameter	CERT_IDENT_KS_TYPE
Description	SSL Keystore file type supported by the JEE Web Application Server.
Ordinality	Mandatory for SSL implementations
JEE Web Application Server	WLS
Tier	WEB BAS IWS MOB
Installation Mode	EMBED

CERT_INSTALL_SCRIPT - Install SSL Keystore

Parameter	CERT_INSTALL_SCRIPT
Description	Whether the SSL should be installed by the installer or manually installed. If set to true then the product installer will install the demonstration certificate. Set to false when

	providing a production certificate.
Ordinality	Mandatory for SSL implementations
Valid Values:	[true false]
JEE Web Application Server	WLS
Tier	WEB BAS IWS MOB
Installation Mode	EMBED

CERT_KS - SSL Keystore Type

Parameter	CERT_KS
Description	Keystore Type used for generating keystore
Ordinality	Mandatory for SSL implementations
Valid Values:	[DEMO PROD ³²]
JEE Web Application Server	WLS
Tier	WEB BAS IWS MOB
Installation Mode	EMBED

CERT_TRUST_KS_ALIAS - SSL Trust Alias

Parameter	CERT_TRUST_KS_ALIAS
Description	Full path to SSL Trust Keystore alias
Ordinality	Mandatory for SSL implementations
JEE Web Application Server	WLS
Tier	WEB BAS IWS MOB
Installation Mode	EMBED

CERT_TRUST_KS_FILE - SSL Trust Keystore File

Parameter	CERT_TRUST_KS_FILE
Description	Full path to SSL Trust Keystore file
Ordinality	Mandatory for SSL implementations
JEE Web Application Server	WLS
Tier	WEB BAS IWS MOB
Installation Mode	EMBED

³² This is a suggested value. Values other than DEMO are recognized.

CERT_TRUST_KS_PWD - SSL Trust Keystore Password

Parameter	CERT_TRUST_KS_PWD
Description	Password to SSL Trust Keystore file
Ordinality	Mandatory for SSL implementations
Valid Values:	Encrypted Password
JEE Web Application Server	WLS
Tier	WEB BAS IWS MOB
Installation Mode	EMBED

CERT_TRUST_KS_TYPE - SSL Trust Keystore Type

Parameter	CERT_TRUST_KS_TYPE
Description	SSL Trust Keystore file type
Ordinality	Mandatory for SSL implementations
Valid Values:	Keystore types supported by JEE Web Application Server
JEE Web Application Server	WLS
Tier	WEB BAS IWS MOB
Installation Mode	EMBED

CLOUD_CUSTOM_WHITE_LIST_PATH - Custom URL Whitelists for Cloud

Parameter	CLOUD_CUSTOM_WHITE_LIST_PATH
Description	The full path to a custom whitelist for aliases for URLs within the product. This whitelist is added to the base product whitelist which is provided in CLOUD_WHITE_LIST_PATH variable. This is primarily for cloud implementations to define URL aliases .
Ordinality	Optional
Valid Values	Full path (including filename to whitelist)
JEE Web Application Server	WLS
Tier	WEB BAS BATCH MOB
Installation Mode	EMBED NATIVE

CLOUD_RESTRICTIONS_URLS_ENABLE - Enable or Disable URL Restrictions

Parameter	CLOUD_RESTRICTIONS_URLS_ENABLE
-----------	---------------------------------------

Description	Whether the whitelists for URL's are enabled.
Ordinality	Optional
Valid Values	true false
JEE Web Application Server	WLS
Tier	WEB BAS BATCH MOB
Installation Mode	EMBED NATIVE

CLOUD_WHITE_LIST_PATH - URL Whitelists for Cloud

Parameter	CLOUD_WHITE_LIST_PATH
Description	The full path to a base whitelist for aliases for URLs within the product. This whitelist is added with the custom product whitelist which is provided in CLOUD_CUSTOM_WHITE_LIST_PATH variable. This is primarily for cloud implementations to define URL aliases .
Ordinality	Optional
Valid Values	Full path (including filename to whitelist)
JEE Web Application Server	WLS
Tier	WEB BAS BATCH MOB
Installation Mode	EMBED NATIVE

CMPDB - Database Type

Parameter	CMPDB
Description	Database Type. This parameter is provided for backward compatibility and is set to ORACLE . This should not be altered.
Ordinality	Mandatory
Valid Values	ORACLE
JEE Web Application Server	WLS WAS WASND
Tier	BAS BATCH MOB
Installation Mode	EMBED NATIVE

CM_INSTALL_SAMPLE - Whether samples are installed

Parameter	CM_INSTALL_SAMPLE
Description	Whether sample code is installed or not This is done at installation time
Ordinality	Mandatory
Valid Values	true false
JEE Web Application Server	WLS WAS WASND
Tier	WEB BAS BATCH MOB
Installation Mode	EMBED NATIVE

COHERENCE_CLUSTER_ADDRESS - Multicast address for Batch Cluster

Parameter	COHERENCE_CLUSTER_ADDRESS
Description	Multicast IP Address for CLUSTERED mode. Specify the multicast IP address that a Socket will listen or publish on.
Ordinality	Mandatory
Valid Values	Valid values are from 224.0.0.0 to 239.255.255.255.
JEE Web Application Server	Not Applicable
Tier	BATCH
Installation Mode	Not Applicable

COHERENCE_CLUSTER_MODE - Batch Cluster Mode

Parameter	COHERENCE_CLUSTER_MODE
Description	<p>Oracle Coherence mode. Coherence may be configured to operate in either development or production mode. These modes do not limit access to features, but instead alter some default configuration settings. For instance, development mode allows for faster cluster startup to ease the development process.</p> <p>The development mode is used for all pre-production activities, such as development and testing. This is an important safety feature because development nodes are restricted from joining with production nodes. Development mode is the default mode. Production mode (prod) must be explicitly specified when using Coherence in a production environment</p>
Ordinality	Mandatory
Valid Values	[dev prod]

JEE Web Application Server	Not Applicable
Tier	BATCH
Installation Mode	Not Applicable

COHERENCE_CLUSTER_NAME - Batch Cluster Name

Parameter	COHERENCE_CLUSTER_NAME
Description	Unique Cache name for Coherence Clusters.
Ordinality	Mandatory
Valid Values	Any string value. It is recommended to use the SPLENVIRON value, optionally, with the database schema owner as a unique identifier. For example: DEV.SPLADM
JEE Web Application Server	Not Applicable
Tier	BATCH
Installation Mode	Not Applicable

COHERENCE_CLUSTER_PORT - Batch Cluster Port Number

Parameter	COHERENCE_CLUSTER_PORT
Description	Unique Cache port for the Coherence Cluster.
Ordinality	Mandatory
Valid Values	Any open relevant port unique to the COHERENCE_CLUSTER_NAME .
JEE Web Application Server	Not Applicable
Tier	BATCH
Installation Mode	Not Applicable

CONTEXTFACTORY - Context Factory for Mobile Application

Parameter	CONTEXTFACTORY
Description	ContextFactory used for Mobile Integration
Ordinality	Mandatory
Valid Values	Refer to spl.mwm.abr.contextFactory - ABR Context Factory for more details.
JEE Web Application Server	WLS WAS WASND
Tier	MOB
Installation Mode	EMBED NATIVE

DBCONNECTION - JDBC Connection string

Parameter	DBCONNECTI ON
Description	Generated Database JDBC string. This is generated from the DBSERVER / DBPORT / DBNAME or DB_OVERRI DE_CONNECTI ON . As this is generated, it should not be altered. Customers using Native mode installation can replace this connection with JDBC Data Sources, if desired.
Ordinality	Mandatory
Valid Values	Generated URL
JEE Web Application Server	WLS WAS WASND
Tier	BAS BATCH DB
Installation Mode	EMBED NATIVE

DBDRIVER - Database Driver

Parameter	DBDRI VER
Description	Database Driver to use. Automatically generated by installation. This should not be altered.
Ordinality	Mandatory
Valid Values	Generated URL
JEE Web Application Server	WLS WAS WASND
Tier	BAS BATCH DB
Installation Mode	EMBED NATIVE

DBNAME - Database Name

Parameter	DBNAME
Description	Oracle Database Instance Name. Customers using Native mode installation can ignore this value if using JDBC Data Sources.
Ordinality	Mandatory
Valid Values	Valid Database instance name
JEE Web Application Server	WLS WAS WASND
Tier	BAS BATCH DB
Installation Mode	EMBED NATIVE

DBPASS - Online Database User Password

Parameter	DBPASS
Description	Encrypted database user password for the online component of the product. Password for DBUSER .
Ordinality	Mandatory
Valid Values	Encrypted Password
JEE Web Application Server	WLS WAS WASND
Tier	BAS BATCH DB
Installation Mode	EMBED NATIVE

DBPASS_GEOCODE_WLS - GEOCODE Database Password

Parameter	DBPASS_GEOCODE_WLS
Description	Encrypted database user password for the GEOCODE integration. Password for DBUSER_GEOCODE .
Ordinality	Mandatory
Valid Values	Encrypted Password
JEE Web Application Server	WLS WAS WASND
Tier	MOB DB
Installation Mode	EMBED NATIVE

DBPASS_MDS - MDS Database Password

Parameter	DBPASS_MDS
Description	Encrypted database user password for the SOA Suite Meta Data Service (MDS) integration. Password for DBUSER_MDS . This password was specified as part of the SOA Suite database installation process for the <i>prefix_MDS</i> user. This is only valid for products that include Oracle SOA Suite. This is used for deployment of content to Oracle SOA Suite for integration.
Ordinality	Mandatory
Valid Values	Encrypted Password
JEE Web Application Server	WLS WAS WASND
Tier	BAS BATCH DB
Installation Mode	EMBED NATIVE

DBPASS_ORASDPM - DPM Database Password

Parameter	DBPASS_ORASDPM
Description	<p>Encrypted database user password for the SOA Suite User Message Services (DPM) integration. Password for DBUSER_ORASDPM.</p> <p>This password was specified as part of the SOA Suite database installation process for the <i>prefix_ORASDPM</i> user.</p> <p>This is only valid for products that include Oracle SOA Suite. This is used for deployment of content to Oracle SOA Suite for integration.</p>
Ordinality	Mandatory
Valid Values	Encrypted Password
JEE Web Application Server	WLS WAS WASND
Tier	BAS BATCH DB
Installation Mode	EMBED NATIVE

DBPASS_OSB - OSB Database Password

Parameter	DBPASS_OSB
Description	<p>Encrypted database user password for the Oracle Service Bus (OSB) integration. Password for DBUSER_OSB.</p> <p>This password was specified as part of the Oracle Service Bus installation for the OSB database user.</p> <p>This is only valid for products that include Oracle Service Bus. This is used for deployment of content to Oracle Service Bus for integration.</p> <p>This is not used for the Oracle Service Bus Adapters for Oracle Utilities.</p>
Ordinality	Mandatory
Valid Values	Encrypted Password
JEE Web Application Server	WLS WAS WASND
Tier	BAS BATCH DB
Installation Mode	EMBED NATIVE

DBPASS_SOAINFRA - SOA Database Password

Parameter	DBPASS_SOAINFRA
Description	Encrypted database user password for the SOA Suite

integration. Password for [DBUSER_SOAINFRA](#).

This password was specified as part of the [SOA Suite database installation process](#) for the *prefix_SOAINFRA* user.

This is only valid for products that include Oracle SOA Suite. This is used for deployment of content to Oracle SOA Suite for integration.

Ordinality	Mandatory
Valid Values	Encrypted Password
JEE Web Application Server	WLS WAS WASND
Tier	BAS BATCH DB
Installation Mode	EMBED NATIVE

DBPORT - Database Listener Port

Parameter	DBPORT
Description	Oracle Listener port for connection to the database. Customers using Native mode installation can ignore this value if using JDBC Data Sources.
Ordinality	Mandatory
Valid Values	Valid Port Number
JEE Web Application Server	WLS WAS WASND
Tier	BAS BATCH DB
Installation Mode	EMBED NATIVE

DBSERVER - Database Server

Parameter	DBSERVER
Description	Oracle Database Host Name. Customers using Native mode installation can ignore this value if using JDBC Data Sources.
Ordinality	Mandatory
Valid Values	Valid Host Name
JEE Web Application Server	WLS WAS WASND
Tier	BAS BATCH DB
Installation Mode	EMBED NATIVE

DBURL_GEOCODE - GEOCODE JDBC URL

Parameter	DBURL_GEOCODE
Description	Oracle Database JDBC URL used for Geocoding. This is set for products using Oracle Spatial.
Ordinality	Mandatory
Valid Values	Valid JDBC URL
JEE Web Application Server	WLS WAS WASND
Tier	BAS BATCH DB
Installation Mode	EMBED NATIVE

DBURL_OSB - OSB JDBC URL

Parameter	DBURL_OSB
Description	Oracle Database JDBC URL for Oracle Service Bus. This is used for deploying content to Oracle Service Bus.
Ordinality	Mandatory
Valid Values	Valid JDBC URL
JEE Web Application Server	WLS WAS WASND
Tier	BAS BATCH DB
Installation Mode	EMBED NATIVE

DBURL_SOA - SOA Suite JDBC URL

Parameter	DBURL_SOA
Description	Oracle Database JDBC URL for Oracle SOA Suite. This is used for deploying content to Oracle SOA Suite.
Ordinality	Mandatory
Valid Values	Valid JDBC URL
JEE Web Application Server	WLS WAS WASND
Tier	BAS BATCH DB
Installation Mode	EMBED NATIVE

DBUSER - Online Database User

Parameter	DBUSER
Description	Database User, with Read/Write permissions used for pooled connections for online transactions.

Ordinality	Mandatory
Valid Values	Valid Database User used in installation
JEE Web Application Server	WLS WAS WASND
Tier	BAS BATCH DB
Installation Mode	EMBED NATIVE

DBUSER_GEOCODE - GEOCODE Database User

Parameter	DBUSER_GEOCODE
Description	Database User, with connection to Geocode Database.
Ordinality	Mandatory
Valid Values	Valid Database User on target database
JEE Web Application Server	WLS WAS WASND
Tier	BAS BATCH DB
Installation Mode	EMBED NATIVE

DBUSER_MDS - SOA MDS Database User

Parameter	DBPASS_MDS
Description	Database user password for the SOA Suite Meta Data Services (MDS) integration. This userid was specified as part of the SOA Suite database installation process for the <i>prefix_MDS</i> user. This is only valid for products that include Oracle SOA Suite. This is used for deployment of content to Oracle SOA Suite for integration.
Ordinality	Mandatory
Valid Values	Valid Database User (<i>prefix_MDS</i>) on target database
JEE Web Application Server	WLS WAS WASND
Tier	BAS BATCH DB
Installation Mode	EMBED NATIVE

DBUSER_ORASDPM - DPM Database User

Parameter	DBPASS_ORASDPM
Description	Database user password for the SOA Suite User Messaging Services (DPM) integration. This userid was specified as part of the SOA Suite database

[installation process](#) for the ***prefix_ORASDPM*** user.

This is only valid for products that include Oracle SOA Suite. This is used for deployment of content to Oracle SOA Suite for integration.

Ordinality	Mandatory
Valid Values	Valid Database User (<i>prefix_ORASDPM</i>) on target database
JEE Web Application Server	WLS WAS WASND
Tier	BAS BATCH DB
Installation Mode	EMBED NATIVE

DBUSER_OSB - OSB Database User

Parameter	DBPASS_OSB
Description	Database user password for the Oracle Service Bus integration. This userid was specified as part of the Oracle Service Bus database installation process. This is only valid for products that include Oracle Service Bus. This is used for deployment of content to Oracle Service Bus for integration.
Ordinality	Mandatory
Valid Values	Valid Database User on target database
JEE Web Application Server	WLS WAS WASND
Tier	BAS BATCH DB
Installation Mode	EMBED NATIVE

DBUSER_SOAINFRA - SOA Database User

Parameter	DBPASS_SOAINFRA
Description	Database user password for the SOA Suite integration. This userid was specified as part of the SOA Suite database installation process for the <i>prefix_SOAINFRA</i> user. This is only valid for products that include Oracle SOA Suite. This is used for deployment of content to Oracle SOA Suite for integration.
Ordinality	Mandatory
Valid Values	Valid Database User (<i>prefix_SOAINFRA</i>) on target database

JEE Web Application Server	WLS	WAS	WASND
Tier	BAS	BATCH	DB
Installation Mode	EMBED	NATIVE	

DB_OVERRIDE_CONNECTION - Custom JDBC URL

Parameter	DB_OVERRIDE_CONNECTION		
Description	Database JDBC Override string. For customers using Oracle 12c, use a string in the following format to support Pluggable Databases: <i>j dbc: oracl e: thi n: @//<host>: <port>/<pdname></i> Customers using Native mode installation can replace this connection with JDBC Data Sources, if desired.		
Ordinality	Mandatory		
Valid Values	Valid JDBC URL.		
JEE Web Application Server	WLS	WAS	WASND
Tier	BAS	BATCH	DB
Installation Mode	EMBED	NATIVE	

DESC - Environment Description

Parameter	DESC
Description	Environment Description. Used for documentation purposes only.
Ordinality	Optional
Valid Values	String Value
JEE Web Application Server	Not Applicable
Tier	Not Applicable
Installation Mode	Not Applicable

DIALECT - Hibernate Dialect

Parameter	DIALECT
Description	Hibernate Dialect This is the database dialect used by Hibernate to process database requests. This is automatically generated by the installer and should not be altered.
Ordinality	Mandatory

Valid Values	Valid Hibernate Dialects
JEE Web Application Server	WLS WAS WASND
Tier	BAS BATCH DB
Installation Mode	EMBED NATIVE

DIRSEP - Directory separator

Parameter	DIRSEP
Description	<p>Directory Separator</p> <p>This is an internal setting that sets the directory separator applicable for the platform. This setting is used by various scripts to set the paths correctly for the operating system.</p> <p>This setting is automatically generated at installation time and should not be altered.</p>
Ordinality	Mandatory
Valid Values	Directory Separator character
JEE Web Application Server	WLS WAS WASND
Tier	WEB BAS IWS XAI BATCH MOB
Installation Mode	EMBED NATIVE

DOC1BILLSCRIPT - Name Of External Print Script

Parameter	DOC1BILLSCRIPT
Description	<p>This setting sets the name of the external printing script used for printing extracts using Oracle Documaker.</p> <p>This is generated by individual products that support this feature.</p>
Ordinality	Mandatory
Valid Values	Name of supplied script
JEE Web Application Server	WLS WAS WASND
Tier	WEB BAS IWS XAI BATCH MOB
Installation Mode	EMBED NATIVE

DOC1SCRIPT - Name Of Generic Print Script

Parameter	DOC1SCRIPT
Description	<p>This setting sets the name of the generic printing script used for extracts using Oracle Documaker.</p> <p>This is generated by individual products that support this</p>

	feature.
Ordinality	Mandatory
Valid Values	Name of supplied script
JEE Web Application Server	WLS WAS WASND
Tier	WEB BAS IWS XAI BATCH MOB
Installation Mode	EMBED NATIVE

ENCODING - Whether Encryption Is Enabled

Parameter	ENCODING
Description	Enables or Disables encryption across the product. By default encryption is enabled (true) and is recommended to be enabled for all environments.
Ordinality	Mandatory
Valid Values	[true false]
JEE Web Application Server	WLS WAS WASND
Tier	WEB BAS IWS XAI BATCH MOB
Installation Mode	EMBED NATIVE

ENVIRONMENT_ID - Environment Identifier

Parameter	ENVIRONMENT_ID
Description	Unique identifier for each environment or copy of the product. This is specified at installation time to link disparate installations into a single environment for management purposes. This setting is used by the Oracle Application Management Pack for Oracle Utilities within Oracle Enterprise Manager to link disparate targets across a number of hosts into a single Oracle Utilities Environment target.
Ordinality	Mandatory
Valid Values	Autogenerated
JEE Web Application Server	WLS WAS WASND
Tier	WEB BAS IWS XAI BATCH
Installation Mode	EMBED NATIVE

FW_VERSION - Oracle Utilities Application Framework version

Parameter	FWVERSION
-----------	------------------

Description	Oracle Utilities Application Version This is an internal setting that is generated upon installation of the product, service pack installation or upgrade installation. This setting is automatically generated at installation time and should not be altered.
Ordinality	Mandatory
Valid Values	Valid Oracle Utilities Application Framework version
JEE Web Application Server	Not Applicable
Tier	Not Applicable
Installation Mode	Not Applicable

FW_VERSION_NUM - Oracle Utilities Application Framework Version Identifier

Parameter	FW_VERSION_NUM
Description	Oracle Utilities Application Version This is an internal setting that is generated upon installation of the product, service pack installation or upgrade installation. This setting is automatically generated at installation time and should not be altered.
Ordinality	Mandatory
Valid Values	Valid Oracle Utilities Application Framework version
JEE Web Application Server	Not Applicable
Tier	Not Applicable
Installation Mode	Not Applicable

GIS - GIS Support

Parameter	GIS
Description	Enables or Disables GIS support within the product. This setting is only used by products that use GIS integration. Setting this value to true enabled all other GIS settings.
Ordinality	Mandatory
Valid Values	[true false]
JEE Web Application Server	WLS
Tier	WEB BAS BATCH

Installation Mode **EMBED** **NATIVE**

GIS_URL - GIS Service URL

Parameter	GIS_URL
Description	Specifies the GIS JNDI URL used for connections. This setting is only used by products that use GIS integration. This setting is only used if GIS is set to true.
Ordinality	Mandatory
Valid Values	Valid JNDI URL
JEE Web Application Server	WLS
Tier	WEB BAS BATCH
Installation Mode	EMBED NATIVE

GIS_WLSYSPASS - GIS WebLogic System Password

Parameter	GIS_WLSYSPASS
Description	Encrypted JNDI Password for GIS integration. This setting is only used by products that use GIS integration. This setting is only used if GIS is set to true.
Ordinality	Mandatory
Valid Values	Valid Encrypted Password
JEE Web Application Server	WLS
Tier	WEB BAS BATCH
Installation Mode	EMBED NATIVE

GIS_WLSYSUSER - GIS WebLogic System User Id

Parameter	GIS_WLSYSUSER
Description	Encrypted JNDI User for GIS integration. This setting is only used by products that use GIS integration. This setting is only used if GIS is set to true.
Ordinality	Mandatory
Valid Values	Valid Encrypted User
JEE Web Application Server	WLS

Tier	WEB BAS BATCH
Installation Mode	EMBED NATIVE

GLOBAL_JVMARGS - Additional JVM Arguments

Parameter	GLOBAL_JVMARGS
Description	Specific additional JVM options for the online component of the product for Oracle JVM (to enable advanced features)
Ordinality	Mandatory
Valid Values	This is generated
JEE Web Application Server	WLS
Tier	WEB BAS
Installation Mode	EMBED NATIVE

help - Name of online help WAR file

Parameter	hel p
Description	Name of Help WAR file. Used in build of help application. This is use for IBM WebSphere implementations using the SPLHelp engine.
Ordinality	Mandatory
Valid Values	This value is automatically generated
JEE Web Application Server	WAS WASND
Tier	WEB
Installation Mode	EMBED NATIVE

HEADEND_CD_CB - Headend System URI for SOA Configuration Plan (CD_CB)

Parameter	HEADEND_CD_CB
Description	URI as configure in SOA Suite Configuration Plan for Headend System for the CD_DB interface (Echelon). This setting is only available to products interfacing to head end systems using SOA Suite.
Ordinality	Mandatory
Valid Values	Valid SOA Suite URI for CD_DB interface.
JEE Web Application Server	WLS WAS WASND
Tier	BAS
Installation Mode	EMBED NATIVE

HEADEND_MR_CB - Headend System URI for SOA Configuration Plan (MR_CB)

Parameter	HEADEND_MR_CB
Description	URI as configure in SOA Suite Configuration Plan for Headend System for the MR_DB interface (Echelon). This setting is only available to products interfacing to head end systems using SOA Suite.
Ordinality	Mandatory
Valid Values	Valid SOA Suite URI for MR_DB interface.
JEE Web Application Server	WLS WAS WASND
Tier	BAS
Installation Mode	EMBED NATIVE

HIBERNATE_JAR_DIR - Location of Hibernate JAR files

Parameter	HIBERNATE_JAR_DIR
Description	Location of the Hibernate JAR files. This setting is used by the installer to copy the relevant files to the desired locations for deployment. This setting is only used at installation time but is registered for potential post release use.
Ordinality	Mandatory
Valid Values	Valid location of Hibernate JAR Files as outlined in the product Installation Guide.
JEE Web Application Server	WLS WAS WASND
Tier	BAS BATCH IWS
Installation Mode	EMBED NATIVE

HIGHVALUE - Language specific highvalues

Parameter	HIGHVALUE
Description	High value used for SQL queries. This is autogenerated at installation time.
Ordinality	Mandatory
Valid Values	This value is automatically generated and should not be altered.
JEE Web Application Server	WLS WAS WASND
Tier	WEB BAS IWS BATCH MOB

Installation Mode **EMBED** **NATIVE**

IWS_JDBC_NAME - JNDI Name for the IWS Connection pools

Parameter	IWS_JDBC_NAME
Description	This is the JDBC Data Source connection name used for Inbound Web Services. The JDBC Data Source should be created prior to setting this value using the Configuring JDBC Data Sources instructions.
Ordinality	Optional
Valid Values	Valid fully qualified JNDI name for JDBC Data Source.
JEE Web Application Server	WLS
Tier	IWS
Installation Mode	EMBED NATIVE

IPCSTARTPORT - Starting IPC Port for Scheduler

Parameter	IPCSTARTPORT
Description	Starting port number for Interprocess Communications (IPC) for Scheduler
Ordinality	Mandatory
Valid Values	Valid open port numbers
JEE Web Application Server	WLS WAS WASND
Tier	MOB
Installation Mode	EMBED NATIVE

IWSWAR - Name of Inbound Web Services WAR

Parameter	IWSWAR
Description	Default Name for Inbound Web Services Application Name.
Ordinality	Mandatory
Valid Values	Valid Server Application Names
JEE Web Application Server	WLS WAS WASND
Tier	IWS
Installation Mode	EMBED NATIVE

JAVAENCODING - Java Language Encoding

Parameter	JAVAENCODING
Description	Encoding string for Java to support appropriate character sets.
Ordinality	Mandatory
Valid Values	Valid Java Encoding (java.lang). Default: UTF8
JEE Web Application Server	WLS WAS WASND
Tier	WEB BAS IWS BATCH MOB
Installation Mode	EMBED NATIVE

JAVA_HOME - Location of Java SDK

Parameter	JAVA_HOME
Description	Location of JDK for use with product
Ordinality	Mandatory
Valid Values	Valid JAVA_HOME location
JEE Web Application Server	WLS WAS WASND
Tier	WEB BAS IWS BATCH MOB
Installation Mode	EMBED NATIVE

JAVA_VENDOR - Java Vendor

Parameter	JAVA_VENDOR
Description	JVM Vendor
Ordinality	Mandatory
Valid Values	Generated and used in other utilities
JEE Web Application Server	WLS WAS WASND
Tier	WEB BAS IWS BATCH MOB
Installation Mode	EMBED NATIVE

JAVA_VERSION - JVM Version string

Parameter	JAVA_VERSION
Description	Fully qualified JVM version string
Ordinality	Mandatory
Valid Values	Generated and used in other utilities

JEE Web Application Server	WLS WAS WASND
Tier	WEB BAS IWS BATCH MOB
Installation Mode	EMBED NATIVE

JAVA_VERSION_MAIN - Abbreviated JVM Version

Parameter	JAVA_VERSION_MAIN
Description	Abbreviated JVM version string
Ordinality	Mandatory
Valid Values	Generated and used in other utilities
JEE Web Application Server	WLS WAS WASND
Tier	WEB BAS IWS BATCH MOB
Installation Mode	EMBED NATIVE

JDBC_NAME - JNDI Name for the Online JDBC Data Source

Parameter	JDBC_NAME
Description	This is the JDBC Data Source connection name used for Online channel. The JDBC Data Source should be created prior to setting this value using the Configuring JDBC Data Sources instructions.
Ordinality	Optional
Valid Values	Valid fully qualified JNDI name for JDBC Data Source.
JEE Web Application Server	WLS
Tier	WEB
Installation Mode	EMBED NATIVE

JNDI_GEOCODE - Geocode Data Source JNDI

Parameter	JNDI_GEOCODE
Description	JNDI name for the Geocode Data Source. This parameter is used with for the Geocode interface. This parameter is only valid for products that use the Geocode interface.
Ordinality	Mandatory
Valid Values	Valid JNDI for Geocode Data Source
JEE Web Application Server	WLS WAS WASND

Tier	BAS BATCH MOB
Installation Mode	EMBED NATIVE

JNDI_OSB - OSB Data Source JNDI

Parameter	JNDI_OSB
Description	JNDI name for the Oracle Service Bus Data Source. This parameter is used with for the Oracle Service Bus interface. This parameter is only valid for products that ship integration that requires Oracle Service Bus.
Ordinality	Mandatory
Valid Values	Valid JNDI for Oracle Service Bus Data Source
JEE Web Application Server	WLS WAS WASND
Tier	BAS BATCH
Installation Mode	EMBED NATIVE

KS_ALIAS - Key Alias

Parameter	KS_ALIAS
Description	Key Alias contained in keystore used by keytool . It is recommended to retain the default setting, unless an alternative is desired.
Ordinality	Mandatory
Valid Values	Valid alias. Default: ouaf.system
JEE Web Application Server	WLS WAS WASND
Tier	WEB BAS IWS BATCH MOB
Installation Mode	EMBED NATIVE

KS_ALIAS_KEYALG - Key Algorithm

Parameter	KS_ALIAS_KEYALG
Description	Key Alias Algorithm used by keystore used by keytool .
Ordinality	Mandatory
Valid Values	Valid algorithm . Default: AES
JEE Web Application Server	WLS WAS WASND
Tier	WEB BAS IWS BATCH MOB
Installation Mode	EMBED NATIVE

KS_ALIAS_KEYSIZE - Keysize

Parameter	KS_ALIAS_KEYSIZE
Description	Keysize strength used by keystore used by keytool .
Ordinality	Mandatory
Valid Values	Valid keysize . Default: 128
JEE Web Application Server	WLS WAS WASND
Tier	WEB BAS IWS BATCH MOB
Installation Mode	EMBED NATIVE

KS_HMAC_ALIAS - HMAC Key Alias

Parameter	KS_HMAC_ALIAS
Description	Key HMAC Alias contained in keystore used by keytool . It is recommended to retain the default setting, unless an alternative is desired.
Ordinality	Mandatory
Valid Values	Valid alias. Default: ouaf.system.hmac
JEE Web Application Server	WLS WAS WASND
Tier	WEB BAS IWS BATCH MOB
Installation Mode	EMBED NATIVE

KS_HMAC_ALIAS_KEYALG - HMAC Key Algorithm

Parameter	KS_HMAC_ALIAS_KEYALG
Description	Key HMAC Alias Algorithm used by keystore used by keytool .
Ordinality	Mandatory
Valid Values	Valid algorithm . Default: HmacSHA256
JEE Web Application Server	WLS WAS WASND
Tier	WEB BAS IWS BATCH MOB
Installation Mode	EMBED NATIVE

KS_HMAC_ALIAS_KEYSIZE - HMAC Keysize

Parameter	KS_HMAC_ALIAS_KEYSIZE
Description	HMAC Keysize strength used by keystore used by keytool .

Ordinality	Mandatory
Valid Values	Valid keysize . Default: 256
JEE Web Application Server	WLS WAS WASND
Tier	WEB BAS IWS BATCH MOB
Installation Mode	EMBED NATIVE

KS_KEYSTORE_FILE - Keystore File Name

Parameter	KS_KEYSTORE_FILE
Description	Keystore File used by keytool .
Ordinality	Mandatory
Valid Values	Valid location and file name for keystore . <u>Linux:</u> \$\$SPLEBASE/ks/. ouaf_keystore <u>Windows:</u> %SPLEBASE%\ks\. ouaf_keystore
JEE Web Application Server	WLS WAS WASND
Tier	WEB BAS IWS BATCH MOB
Installation Mode	EMBED NATIVE

KS_MODE - Key Padding Mode

Parameter	KS_MODE
Description	Key Padding Mode
Ordinality	Mandatory
Valid Values	Valid Padding for Keystore. Default: CBC
JEE Web Application Server	WLS WAS WASND
Tier	WEB BAS IWS BATCH MOB
Installation Mode	EMBED NATIVE

KS_PADDING - Key Padding Algorithm

Parameter	KS_PADDING
Description	Key Padding Algorithm used for key generation
Ordinality	Mandatory
Valid Values	Valid Padding Algorithm for Keystore. Default: PKCS5Padding

JEE Web Application Server	WLS WAS WASND
Tier	WEB BAS IWS BATCH MOB
Installation Mode	EMBED NATIVE

KS_STOREPASS_FILE - Key Password Store Pass

Parameter	KS_STOREPASS_FILE
Description	Password Keystore File used by keytool .
Ordinality	Mandatory
Valid Values	Valid location and file name for keystore . Linux: \$SPLEBASE/ks/.ouaf_storepass Windows: %SPLEBASE%\ks\.ouaf_storepass
JEE Web Application Server	WLS WAS WASND
Tier	WEB BAS IWS BATCH MOB
Installation Mode	EMBED NATIVE

KS_STORETYPE - Key Store Type

Parameter	KS_STORETYPE
Description	Keystore Store Type used by keytool .
Ordinality	Mandatory
Valid Values	Valid Key Store Type . Default:
JEE Web Application Server	WLS WAS WASND
Tier	WEB BAS IWS BATCH MOB
Installation Mode	EMBED NATIVE

LD_LIBRARY_PATH - Library Path for Windows/Linux/Solaris

Parameter	LD_LIBRARY_PATH
Description	Generated Library Path for Windows, Linux and Solaris
Ordinality	Mandatory
Valid Values	This value is generated by the product installer.
JEE Web Application Server	WLS WAS WASND
Tier	WEB BAS IWS BATCH MOB

Installation Mode **EMBED** **NATIVE**

LIBPATH - Library Path for AIX

Parameter **LIBPATH**

Description Generated Library Path for AIX

Ordinality Mandatory

Valid Values This value is generated by the product installer.

JEE Web Application Server **WLS** **WAS** **WASND**

Tier **WEB** **BAS** **IWS** **BATCH** **MOB**

Installation Mode **EMBED** **NATIVE**

MAPDIR - Location of Map files used for Scheduler

Parameter **MAPDIR**

Description Location of local Map file used by Scheduler.
This parameter only applies to products that use the Scheduler.

Ordinality Mandatory

Valid Values Fully qualified directory holding map files

JEE Web Application Server **WLS** **WAS** **WASND**

Tier **MOB**

Installation Mode **EMBED** **NATIVE**

MAPVIEWER_EAR - Location of Mapviewer EAR file

Parameter **MAPVIEWER_EAR**

Description Location of MapViewer EAR file.
This parameter only applies to products that use the Scheduler.

Ordinality Mandatory

Valid Values Fully qualified directory EAR file

JEE Web Application Server **WLS** **WAS** **WASND**

Tier **MOB**

Installation Mode **EMBED** **NATIVE**

MAPVIEWER_ISLOCAL - Deploy Mapviewer Locally

Parameter	MAPVIEWER_ISLOCAL
Description	Whether the MapViewer application is to be deployed within the same server as the product. This parameter only applies to products that use the Scheduler.
Ordinality	Mandatory
Valid Values	[true false]
JEE Web Application Server	WLS WAS WASND
Tier	MOB
Installation Mode	EMBED NATIVE

MAXPROCESSINGTIME - Maximum Scheduler Processing Time

Parameter	MAXPROCESSINGTIME
Description	Transaction timeout, in seconds, for each appointment booking processed by Scheduler. This parameter only applies to products that use the Scheduler.
Ordinality	Mandatory
Valid Values	1 - 2147483647 (Default: 5)
JEE Web Application Server	WLS WAS WASND
Tier	MOB
Installation Mode	EMBED NATIVE

MINREQUESTS - Initial Scheduler Minimum Requests

Parameter	MINREQUESTS
Description	Initial request pool size for Scheduler. This parameter only applies to products that use the Scheduler.
Ordinality	Mandatory
Valid Values	1 - 2147483647 (Default: 1)
JEE Web Application Server	WLS WAS WASND
Tier	MOB
Installation Mode	EMBED NATIVE

MOBILITY_APP_ONLY - Deploy Only Mobility Web Application

Parameter	MOBILITY_APP_ONLY
Description	Whether the mobile web application is the only deployment on the server. This allows for a distributed installation. This parameter only applies to products that use the Scheduler.
Ordinality	Mandatory
Valid Values	[true false]
JEE Web Application Server	WLS WAS WASND
Tier	MOB
Installation Mode	EMBED NATIVE

MODULES - Names of Modules installed

Parameter	MODULES
Description	Generated list of modules. This is generated by the product installer. This parameter is provided for backward compatibility as modules installed are now autogenerated from installation records.
Ordinality	Optional
Valid Values	List of product codes.
JEE Web Application Server	WLS WAS WASND
Tier	WEB BAS IWS BATCH MOB
Installation Mode	EMBED NATIVE

NLS_LANG - NLS Language setting

Parameter	NLS_LANG
Description	Globalization Language setting for the database.
Ordinality	Mandatory
Valid Values	Valid NLS_LANG . Default: AMERICA_AMERICAN.AL32UTF8
JEE Web Application Server	WLS WAS WASND
Tier	BAS IWS BATCH DB
Installation Mode	EMBED NATIVE

NODEID - Scheduler Node Identifier

Parameter	NODEID
Description	Scheduler Node Identifier. This parameter is provided for backward compatibility. This parameter only applies to products using the Scheduler.
Ordinality	Optional
Valid Values	Valid Node Identifier
JEE Web Application Server	WLS WAS WASND
Tier	MOB
Installation Mode	EMBED NATIVE

OIM_SPML_NAME_SPACE - OIM Default Namespace

Parameter	OIM_SPML_NAME_SPACE
Description	Default Namespace used for Oracle Identity Manager integration. This setting is only available if OPEN_SPML_ENABLED_ENV is true .
Ordinality	Optional
Valid Values	Valid SPML Namespace. Default: http://xmlns.oracle.com/OIM/provisioning
JEE Web Application Server	WLS WAS WASND
Tier	BAS
Installation Mode	EMBED NATIVE

OIM_SPML_SOAP_DEBUG_SETTING - OIM Interface Debug

Parameter	OIM_SPML_SOAP_DEBUG_SETTING
Description	Enables or Disables debug mode to diagnose issues with the Oracle Identity Manager integration. This setting is only available if OPEN_SPML_ENABLED_ENV is true .
Ordinality	Optional
Valid Values	[true false]
JEE Web Application Server	WLS WAS WASND
Tier	BAS
Installation Mode	EMBED NATIVE

OIM_SPML_SOAP_ELEMENT - OIM SOAP Element

Parameter	OIM_SPML_SOAP_ELEMENT
Description	Name of top level SOAP element used for Oracle Identity Manager interface. This is autogenerated. This setting is only available if OPEN_SPML_ENABLED_ENV is true .
Ordinality	Optional
Valid Values	Valid SOAP Element. Default: sOAPElement
JEE Web Application Server	WLS WAS WASND
Tier	BAS
Installation Mode	EMBED NATIVE

OIM_SPML_UBER_SCHEMA_NAME - Name of OIM Interface Schema

Parameter	OIM_SPML_UBER_SCHEMA_NAME
Description	Name of schema used for Oracle Identity Manager interface. This is autogenerated. This setting is only available if OPEN_SPML_ENABLED_ENV is true .
Ordinality	Optional
Valid Values	Valid product Schema. Default: F1-IDMUser
JEE Web Application Server	WLS WAS WASND
Tier	BAS
Installation Mode	EMBED NATIVE

ONLINE_DISPLAY_HOME - Location of Print Rendering Software

Parameter	ONLINE_DISPLAY_HOME
Description	Location of Print Rendering Software such as Oracle Documaker or Group 1 Doc 1.
Ordinality	Optional
Valid Values	Valid product location of the print rendering software
JEE Web Application Server	WLS WAS WASND
Tier	BAS BATCH
Installation Mode	EMBED NATIVE

ONS_JAR_DIR - Location of Oracle Notification Service Libraries

Parameter	ONS_JAR_DIR
Description	Location of Oracle Notification Services Libraries used for RAC Fast Connection Failover support.
Ordinality	Optional
Valid Values	Valid location of ons.jar file. Usually \$ORACLE_HOME/opmm/lib
JEE Web Application Server	WLS WAS WASND
Tier	BAS BATCH DB
Installation Mode	EMBED NATIVE

ONSCONFIG - ONS Configuration

Parameter	ONSCONFIG
Description	ONS configuration string used for RAC Fast Connection Failover support. For example: racnode1.my.com: 4200, racnode2.my.com: 4200
Ordinality	Optional
Valid Values	ONS configuration string without nodes= prefix.
JEE Web Application Server	WLS WAS WASND
Tier	BAS BATCH DB
Installation Mode	EMBED NATIVE

OPEN_SPML_ENABLED_ENV - Whether OIM Interface enabled

Parameter	OPEN_SPML_ENABLED_ENV
Description	Enable or Disable Oracle Identity Manager integration
Ordinality	Optional
Valid Values	[true false]
JEE Web Application Server	WLS WAS WASND
Tier	BAS
Installation Mode	EMBED NATIVE

OPSYS - Operating System

Parameter	OPSYS
Description	Internal variable used for platform specific configurations

	to be implemented.
Ordinality	Mandatory
Valid Values	Generated Operating System String
JEE Web Application Server	WLS WAS WASND
Tier	WEB BAS IWS XAI BATCH MOB
Installation Mode	EMBED NATIVE

ORACLE_CLIENT_HOME - Oracle Client Home

Parameter	ORACLE_CLIENT_HOME
Description	Location of Oracle Client Software or Oracle Home. This is used for ONS and/or the Perl runtime.
Ordinality	Mandatory
Valid Values	Location of Oracle Client Installation. If the Oracle Database software is installed on the same machine, then this can be ORACLE_HOME .
JEE Web Application Server	WLS WAS WASND
Tier	WEB BAS IWS XAI BATCH MOB
Installation Mode	EMBED NATIVE

OSB_HOME - Oracle Service Bus Home

Parameter	OSB_HOME
Description	Location of Oracle Service Bus. This is used to deploy Oracle Service Bus content. This setting only applies to products with prebuilt Oracle Service Bus content. This is not used for Oracle Service Bus Adapters.
Ordinality	Optional
Valid Values	Location of Oracle Service Bus installation.
JEE Web Application Server	WLS
Tier	BAS
Installation Mode	EMBED NATIVE

OSB_HOST - Oracle Service Bus Host Name

Parameter	OSB_HOST
Description	Host Name for Oracle Service Bus. This is used to deploy Oracle Service Bus content. This setting only applies to products with prebuilt Oracle Service Bus content.

	This is not used for Oracle Service Bus Adapters.
Ordinality	Optional
Valid Values	Host Name for Oracle Service Bus.
JEE Web Application Server	WLS
Tier	BAS
Installation Mode	EMBED NATIVE

OSB_LOG_DIR - Default Location For Oracle Service Bus Logs

Parameter	OSB_LOG_DIR
Description	Logging Directory Oracle Service Bus. This is used to deploy Oracle Service Bus content. This setting only applies to products with prebuilt Oracle Service Bus content. This is not used for Oracle Service Bus Adapters.
Ordinality	Optional
Valid Values	Logging directory for Oracle Service Bus content deployment.
JEE Web Application Server	WLS
Tier	BAS
Installation Mode	EMBED NATIVE

OSB_PASS_WLS - Password for Oracle Service Bus User

Parameter	OSB_PASS_WLS
Description	Encrypted password for OSB deployment user (OSB_USER). This is used to deploy Oracle Service Bus content. This setting only applies to products with prebuilt Oracle Service Bus content. This is not used for Oracle Service Bus Adapters.
Ordinality	Optional
Valid Values	Generated Password.
JEE Web Application Server	WLS
Tier	BAS
Installation Mode	EMBED NATIVE

OSB_PORT_NUMBER - Oracle Service Bus Port Number

Parameter	OSB_PORT_NUMBER
-----------	------------------------

Description	Port number allocated to Oracle Service Bus for . This is used to deploy Oracle Service Bus content. This setting only applies to products with prebuilt Oracle Service Bus content. This is not used for Oracle Service Bus Adapters.
Ordinality	Optional
Valid Values	Valid Administration port to use for deployment of content.
JEE Web Application Server	WLS
Tier	BAS
Installation Mode	EMBED NATIVE

OSB_USER - User Name for Oracle Service Bus

Parameter	OSB_USER
Description	Administration user used for OSB deployment user. This is used to deploy Oracle Service Bus content. This setting only applies to products with prebuilt Oracle Service Bus content. This is not used for Oracle Service Bus Adapters.
Ordinality	Optional
Valid Values	Valid Administration user to use for deployment of content.
JEE Web Application Server	WLS
Tier	BAS
Installation Mode	EMBED NATIVE

PERLHOME - Location of PERL

Parameter	PERLHOME
Description	Generated location for Perl runtime. Generated from ORACLE_CLIENT_HOME .
Ordinality	Mandatory
Valid Values	Generated location for Perl.
JEE Web Application Server	WLS WAS WASND
Tier	WEB BAS IWS XAI BATCH MOB
Installation Mode	EMBED NATIVE

SERVER_ROLES - Which server roles are enabled

Parameter	SERVER_ROLES
Description	Which server roles are enabled for this installation.
Ordinality	Mandatory
Valid Values	Install generated
JEE Web Application Server	WLS WAS WASND
Tier	WEB IWS BATCH
Installation Mode	EMBED NATIVE

SERVER_ROLE_BATCH - Whether the Batch Server is enabled in this installation

Parameter	SERVER_ROLE_BATCH
Description	Whether this installation is to be used for batch processing
Ordinality	Mandatory
Valid Values	Install generated with true or false
JEE Web Application Server	WLS WAS WASND
Tier	BATCH
Installation Mode	EMBED NATIVE

SERVER_ROLE_INTEGRATION - Whether the IWS Server is enabled in this installation

Parameter	SERVER_ROLE_INTEGRATION
Description	Whether this installation is to be used for integration (IWS)
Ordinality	Mandatory
Valid Values	Install generated with true or false
JEE Web Application Server	WLS WAS WASND
Tier	IWS
Installation Mode	EMBED NATIVE

SERVER_ROLE_ONLINE - Whether the online server is enabled in this installation

Parameter	SERVER_ROLE_ONLINE
Description	Whether this installation is to be used for online
Ordinality	Mandatory
Valid Values	Install generated with true or false

JEE Web Application Server	WLS WAS WASND
Tier	WEB
Installation Mode	EMBED NATIVE

SOA_HOME - Location Of Oracle SOA Suite

Parameter	SOA_HOME
Description	Location of Oracle SOA Suite software. This is used to deploy Oracle SOA Suite content. This setting only applies to products with prebuilt Oracle SOA Suite content.
Ordinality	Optional
Valid Values	Valid location of Oracle SOA Suite.
JEE Web Application Server	WLS
Tier	BAS
Installation Mode	EMBED NATIVE

SOA_HOST - Hostname for Oracle SOA Suite

Parameter	SOA_HOST
Description	Hostname for Oracle SOA Suite software. This is used to deploy Oracle SOA Suite content. This setting only applies to products with prebuilt Oracle SOA Suite content.
Ordinality	Optional
Valid Values	Valid host name for Oracle SOA Suite.
JEE Web Application Server	WLS
Tier	BAS
Installation Mode	EMBED NATIVE

SOA_PORT_NUMBER - Port Number for Oracle SOA Suite

Parameter	SOA_PORT_NUMBER
Description	Port Number for Oracle SOA Suite software. This is used to deploy Oracle SOA Suite content. This setting only applies to products with prebuilt Oracle SOA Suite content.
Ordinality	Optional
Valid Values	Valid port number for Oracle SOA Suite.
JEE Web Application Server	WLS
Tier	BAS

Installation Mode **EMBED** **NATIVE**

SPLADMIN - Administration Userid

Parameter **SPLADMIN**

Description Administration OS user used to install the software. Used by utilities to assign ownership and for deployment purposes.

Ordinality Mandatory

Valid Values Valid Administration Account.

JEE Web Application Server **WLS** **WAS** **WASND**

Tier **WEB** **BAS** **IWS** **XAI** **BATCH** **MOB**

Installation Mode **EMBED** **NATIVE**

SPLADMINGROUP - Administration Group

Parameter **SPLADMINGROUP**

Description Administration OS group used to install the software. Used by utilities to assign ownership and for deployment purposes.

Ordinality Mandatory

Valid Values Valid Administration Group.

JEE Web Application Server **WLS** **WAS** **WASND**

Tier **WEB** **BAS** **IWS** **XAI** **BATCH** **MOB**

Installation Mode **EMBED** **NATIVE**

SPLApp - Name of Online WAR file

Parameter **SPLApp**

Description Name of online WAR file used for building purposes

Ordinality Mandatory

Valid Values Valid WAR file name.

JEE Web Application Server **WLS** **WAS** **WASND**

Tier **WEB** **BAS** **XAI**

Installation Mode **EMBED** **NATIVE**

SPLDIR - Home Directory Of Product

Parameter	SPLDIR
Description	Home Location of product software. This value must match the corresponding entry in cistab .
Ordinality	Mandatory
Valid Values	Valid Location of software. Generated by installer.
JEE Web Application Server	WLS WAS WASND
Tier	WEB BAS IWS XAI BATCH MOB
Installation Mode	EMBED NATIVE

SPLDIROUT - Location Of Product Output

Parameter	SPLDIROUT
Description	Home Location of product output. This value must match the corresponding entry in cistab .
Ordinality	Mandatory
Valid Values	Valid Location of output. Generated by installer.
JEE Web Application Server	WLS WAS WASND
Tier	WEB BAS IWS XAI BATCH MOB
Installation Mode	EMBED NATIVE

SPLENVIRON - Environment Identifier

Parameter	SPLDIROUT
Description	Home Location of product output. This value must match the corresponding entry in cistab .
Ordinality	Mandatory
Valid Values	Valid Location of output. Generated by installer.
JEE Web Application Server	WLS WAS WASND
Tier	WEB BAS IWS XAI BATCH MOB
Installation Mode	EMBED NATIVE

SPLSERVICEAPP - Name of Business Application Server Application

Parameter	SPLSERVICEAPP
Description	Default Name for Business Application Application Name.
Ordinality	Mandatory

Valid Values	Valid Server Application Names
JEE Web Application Server	WLS WAS WASND
Tier	BAS
Installation Mode	EMBED NATIVE

SPLWAS - JEE Web Application Server Type

Parameter	SPLWAS
Description	JEE Web Application Server to be used for product.
Ordinality	Mandatory
Valid Values	Following Valid Values: WLS - Oracle WebLogic WAS - IBM WebSphere WASND - IBM WebSphere ND
JEE Web Application Server	WLS WAS WASND
Tier	WEB BAS IWS XAI MOB
Installation Mode	EMBED NATIVE

SPLWEBAPP - Name of Web Application Server Application

Parameter	SPLWEBAPP
Description	Default Name for Web Application Application Name.
Ordinality	Mandatory for Oracle WebLogic implementations
Valid Values	Valid Server Application Names
JEE Web Application Server	WLS
Tier	WEB XAI MOB
Installation Mode	EMBED NATIVE

STRIP_HTML_COMMENTS - Strip Out Comments In Code

Parameter	STRIP_HTML_COMMENTS
Description	Enable or Disable Stripping comments in generated code. By default, code is commented for ease of extension. If these comments represent a security issue for your site, then they can be stripped out at runtime (true).
Ordinality	Mandatory
Valid Values	[true false]

JEE Web Application Server	WLS WAS WASND
Tier	BAS
Installation Mode	EMBED NATIVE

TIMEOUT - Mobile Connection Timeout

Parameter	TIMEOUT
Description	Connection timeout, in seconds, for Mobile component between handhels and server.
Ordinality	Mandatory
Valid Values	Valid Timeout value. Refer to spl.mwm.abr.timeout for more details.
JEE Web Application Server	WLS WAS WASND
Tier	MOB
Installation Mode	EMBED NATIVE

TOP_VERSION - Product Version

Parameter	TOP_VERSION
Description	Product Version identifier string used by utilities and upgrade scripts.
Ordinality	Mandatory
Valid Values	Generated by installer and should not be altered manually.
JEE Web Application Server	WLS WAS WASND
Tier	WEB BAS IWS XAI BATCH MOB
Installation Mode	EMBED NATIVE

TOP_VERSION_NUM - High level Product Version

Parameter	TOP_VERSION_NUM
Description	Product Version identifier number used by utilities and upgrade scripts.
Ordinality	Mandatory
Valid Values	Generated by installer and should not be altered manually.
JEE Web Application Server	WLS WAS WASND
Tier	WEB BAS IWS XAI BATCH MOB
Installation Mode	EMBED NATIVE

TS_ALIAS - Trust Alias

Parameter	TS_ALIAS
Description	Trust Alias contained in trust store used by keytool . It is recommended to retain the default setting, unless an alternative is desired.
Ordinality	Mandatory
Valid Values	Valid alias. Default: ouaf.system
JEE Web Application Server	WLS WAS WASND
Tier	WEB BAS IWS BATCH MOB
Installation Mode	EMBED NATIVE

TS_ALIAS_KEYALG - Key Algorithm

Parameter	TS_ALIAS_KEYALG
Description	Trust Alias Algorithm used by trust store used by keytool .
Ordinality	Mandatory
Valid Values	Valid algorithm . Default: AES
JEE Web Application Server	WLS WAS WASND
Tier	WEB BAS IWS BATCH MOB
Installation Mode	EMBED NATIVE

TS_ALIAS_KEYSIZE - Keysize

Parameter	TS_ALIAS_KEYSIZE
Description	Trust key size strength used by trust store used by keytool .
Ordinality	Mandatory
Valid Values	Valid keysize . Default: 128
JEE Web Application Server	WLS WAS WASND
Tier	WEB BAS IWS BATCH MOB
Installation Mode	EMBED NATIVE

TS_HMAC_ALIAS - HMAC Key Alias

Parameter	TS_HMAC_ALIAS
Description	Trust HMAC Alias contained in trust store used by

[keytool](#).

It is recommended to retain the default setting, unless an alternative is desired.

Ordinality	Mandatory
Valid Values	Valid alias. Default: ouaf.system.hmac
JEE Web Application Server	WLS WAS WASND
Tier	WEB BAS IWS BATCH MOB
Installation Mode	EMBED NATIVE

TS_HMAC_ALIAS_KEYALG - HMAC Key Algorithm

Parameter	TS_HMAC_ALIAS_KEYALG
Description	Key HMAC Alias Algorithm used by trust store used by keytool .
Ordinality	Mandatory
Valid Values	Valid algorithm . Default: HmacSHA256
JEE Web Application Server	WLS WAS WASND
Tier	WEB BAS IWS BATCH MOB
Installation Mode	EMBED NATIVE

TS_HMAC_ALIAS_KEYSIZE - HMAC Keysize

Parameter	TS_HMAC_ALIAS_KEYSIZE
Description	HMAC Keysize strength used by trust store used by keytool .
Ordinality	Mandatory
Valid Values	Valid keysize . Default: 256
JEE Web Application Server	WLS WAS WASND
Tier	WEB BAS IWS BATCH MOB
Installation Mode	EMBED NATIVE

TS_IMPORT_KEYSTORE_FOLDER - Import Folder for Trust Store

Parameter	TS_IMPORT_KEYSTORE_FOLDER
Description	Location to import a third party Trust Store File from.
Ordinality	Mandatory
Valid Values	Valid location for external trust store .

JEE Web Application Server	WLS WAS WASND
Tier	WEB BAS IWS BATCH MOB
Installation Mode	EMBED NATIVE

TS_KEYSTORE_FILE - Trust Store File Name

Parameter	TS_KEYSTORE_FILE
Description	Trust Store File used by keytool .
Ordinality	Mandatory
Valid Values	Valid location and file name for trust store . <u>Linux:</u> \$\$SPLEBASE/ks/. ouaf_truststore <u>Windows:</u> %SPLEBASE%\ks\. ouaf_truststore
JEE Web Application Server	WLS WAS WASND
Tier	WEB BAS IWS BATCH MOB
Installation Mode	EMBED NATIVE

TS_MODE - Key Padding Mode

Parameter	TS_MODE
Description	Key Padding Mode
Ordinality	Mandatory
Valid Values	Valid Padding for Trust store. Default: CBC
JEE Web Application Server	WLS WAS WASND
Tier	WEB BAS IWS BATCH MOB
Installation Mode	EMBED NATIVE

TS_PADDING - Key Padding Algorithm

Parameter	TS_PADDING
Description	Key Padding Algorithm used for key generation
Ordinality	Mandatory
Valid Values	Valid Padding Algorithm for Trust store. Default: PKCS5Padding
JEE Web Application Server	WLS WAS WASND

Tier	WEB BAS IWS BATCH MOB
Installation Mode	EMBED NATIVE

TS_STOREPASS_FILE - Key Password Store Pass

Parameter	TS_STOREPASS_FILE
Description	Password Trust store File used by keytool .
Ordinality	Mandatory
Valid Values	Valid location and file name for trust store . <u>Linux:</u> \$SPLEBASE/ks/. ouaf_truststorepass <u>Windows:</u> %SPLEBASE%\ks\. ouaf_truststorepass
JEE Web Application Server	WLS WAS WASND
Tier	WEB BAS IWS BATCH MOB
Installation Mode	EMBED NATIVE

TS_STORETYPE - Key Store Type

Parameter	TS_STORETYPE
Description	Trust Store Type used by keytool .
Ordinality	Mandatory
Valid Values	Valid Key Store Type . Default: JCEKS
JEE Web Application Server	WLS WAS WASND
Tier	WEB BAS IWS BATCH MOB
Installation Mode	EMBED NATIVE

URL - Mobile JNDI URL

Parameter	URL
Description	Connection URL, for Mobile component.
Ordinality	Mandatory
Valid Values	Valid URL. Refer to spl . mwm . abr . url for more details.
JEE Web Application Server	WLS WAS WASND
Tier	MOB
Installation Mode	EMBED NATIVE

WAS_HOME - IBM WebSphere Home

Parameter	WAS_HOME
Description	Location of IBM WebSphere software for deployment purposes. This setting is only applicable to IBM WebSphere customers.
Ordinality	Mandatory
Valid Values	Location of IBM WebSphere installation
JEE Web Application Server	WAS
Tier	WEB BAS IWS XAI MOB
Installation Mode	NATIVE

WAS_PASSWORD - IBM WebSphere Administration Password

Parameter	WAS_PASSWORD
Description	Encrypted password for administration user for IBM WebSphere/IBM WebSphere ND. This setting is only applicable to IBM WebSphere and IBM WebSphere ND customers.
Ordinality	Mandatory
Valid Values	Encrypted password for administration user.
JEE Web Application Server	WAS WASND
Tier	WEB BAS IWS XAI MOB
Installation Mode	NATIVE

WAS_USERID - IBM WebSphere Administration User

Parameter	WAS_USERID
Description	Administration user for IBM WebSphere/IBM WebSphere ND. This setting is only applicable to IBM WebSphere and IBM WebSphere ND customers.
Ordinality	Mandatory
Valid Values	Administration user.
JEE Web Application Server	WAS WASND
Tier	WEB BAS IWS XAI MOB
Installation Mode	NATIVE

WASND_DMGR_HOST - IBM WebSphere Deployment Manager Host Name

Parameter	WASND_DMGR_HOST
Description	Location of IBM WebSphere ND host for deployment purposes. This setting is only applicable to IBM WebSphere ND customers.
Ordinality	Mandatory
Valid Values	Host of IBM WebSphere ND Deployment Manager
JEE Web Application Server	WASND
Tier	WEB BAS IWS XAI MOB
Installation Mode	NATIVE

WASND_HOME - IBM WebSphere ND Home

Parameter	WASND_HOME
Description	Location of IBM WebSphere ND software for deployment purposes. This setting is only applicable to IBM WebSphere ND customers.
Ordinality	Mandatory
Valid Values	Location of IBM WebSphere ND installation
JEE Web Application Server	WASND
Tier	WEB BAS IWS XAI MOB
Installation Mode	NATIVE

WEBSERVICES_ENABLED - Whether Inbound Web Services Is Enabled

Parameter	WEBSERVICES_ENABLED
Description	Enable or Disable Inbound Web Services support.
Ordinality	Mandatory
Valid Values	[true false]
JEE Web Application Server	WLS WAS WASND
Tier	IWS
Installation Mode	EMBED NATIVE

WEB_ADDITIONAL_OPT - Additional Java Options for Web

Parameter	WEB_ADDITIONAL_OPT
Description	Additional Java Options for Web Application Server. For

native installations, these options can be set on the Server definition.

Ordinality	Optional
Valid Values	Valid java options for JVM used.
JEE Web Application Server	WLS WAS WASND
Tier	WEB BAS IWS XAI MOB
Installation Mode	EMBED

WEB_APP - Name of WebSphere Server Application

Parameter	WEB_APP
Description	Default Name for Web Application Application Name.
Ordinality	Mandatory for WebSphere implementations
Valid Values	Valid Server Application Names
JEE Web Application Server	WAS WASND
Tier	WEB XAI MOB
Installation Mode	EMBED NATIVE

WEB_APPVIEWER_FORM_LOGIN_ERROR_PAGE - AppViewer Form Login Error Page

Parameter	WEB_APPVIEWER_FORM_LOGIN_ERROR_PAGE
Description	Error Page used for invalid AppViewer Login.
Ordinality	Mandatory
Valid Values	Valid JSP for error pages
JEE Web Application Server	WLS WAS WASND
Tier	WEB
Installation Mode	EMBED NATIVE

WEB_APPVIEWER_FORM_LOGIN_PAGE - AppViewer Form Login Page

Parameter	WEB_APPVIEWER_FORM_LOGIN_PAGE
Description	Login Page used for AppViewer Login.
Ordinality	Mandatory
Valid Values	Valid JSP for login
JEE Web Application Server	WLS WAS WASND
Tier	WEB
Installation Mode	EMBED NATIVE

WEB_APPVIEWER_PRINCIPAL_NAME - Application Viewer Principal Name

Parameter	WEB_APPVIEWER_PRINCIPAL_NAME
Description	Principal Name for AppViewer
Ordinality	Mandatory
Valid Values	Valid Principal Name
JEE Web Application Server	WLS WAS WASND
Tier	WEB
Installation Mode	EMBED NATIVE

WEB_APPVIEWER_ROLE_NAME - Application Viewer Security Role

Parameter	WEB_APPVIEWER_ROLE_NAME
Description	Role Name for AppViewer
Ordinality	Mandatory
Valid Values	Valid Role Name
JEE Web Application Server	WLS WAS WASND
Tier	WEB
Installation Mode	EMBED NATIVE

WEB_BATCH_CLUSTER_URL - Batch Cluster URL

Parameter	WEB_BATCH_CLUSTER_URL
Description	Batch Cluster URL for online submission tracking of Mobile application
Ordinality	Mandatory
Valid Values	Valid Role Name
JEE Web Application Server	WLS WAS WASND
Tier	MOB
Installation Mode	EMBED NATIVE

WEB_CONTEXT_ROOT - Web Context Root

Parameter	WEB_CONTEXT_ROOT
Description	Web Context for product
Ordinality	Mandatory

Valid Values	Valid context. Default: spl
JEE Web Application Server	WLS WAS WASND
Tier	WEB BAS IWS XAI MOB
Installation Mode	EMBED NATIVE

WEB_DEPLOY_APPVIEWER - Deploy AppViewer or not

Parameter	WEB_DEPLOY_APPVIEWER
Description	<p>Whether the AppViewer application is included in the online EAR file. A value of true adds the appViewer to the online EAR file. A value of false does not add the appViewer content to the online EAR file.</p> <hr/> <p><i>Note: If the appViewer is not deployed the online administration functions that use the appViewer will not display this content.</i></p> <hr/> <p>It is recommended to set this value to false for non-development environments.</p>
Ordinality	Mandatory
Valid Values	[true false]
JEE Web Application Server	WLS WAS WASND
Tier	WEB
Installation Mode	EMBED NATIVE

WEB_DEPLOY_EAR - Deploy EAR file

Parameter	WEB_DEPLOY_EAR
Description	<p>Whether the EAR file is built and deployed or not for development environments.</p> <p>It is recommended to set this value to true for non-development environments.</p> <p>This setting replace components of the WEB_ISDEVELOPMENT variable to allow development platforms to use expanded or EAR mode independently.</p>
Ordinality	Mandatory
Valid Values	[true false]
JEE Web Application Server	WLS
Tier	WEB
Installation Mode	EMBED

WEB_ENABLE_HEALTHCHECK - Enable System Healthcheck

Parameter	WEB_ENABLE_HEALTHCHECK
Description	Enable the system healthcheck function used by the Oracle Application Management Pack for Oracle Utilities available from Oracle Enterprise Manager.
Ordinality	Mandatory
Valid Values	[true false]
JEE Web Application Server	WLS
Tier	WEB
Installation Mode	EMBED NATIVE

WEB_FORM_LOGIN_ERROR_PAGE - Default Form Login Error Page

Parameter	WEB_FORM_LOGIN_ERROR_PAGE
Description	Error Page used for invalid online Login.
Ordinality	Mandatory
Valid Values	Valid JSP for error pages
JEE Web Application Server	WLS WAS WASND
Tier	WEB
Installation Mode	EMBED NATIVE

WEB_FORM_LOGIN_PAGE - Default Form Login Page

Parameter	WEB_FORM_LOGIN_PAGE
Description	Login Page used for online Login.
Ordinality	Mandatory
Valid Values	Valid JSP for login
JEE Web Application Server	WLS WAS WASND
Tier	WEB
Installation Mode	EMBED NATIVE

Note: If *WEB_HELP_FORM_LOGIN_ERROR_PAGE* and/or *WEB_APPVIEWER_FORM_LOGIN_ERROR_PAGE* are not specified then they default to the value specified in *WEB_FORM_LOGIN_ERROR_PAGE*.

Note: If *WEB_HELP_FORM_LOGIN_PAGE* and/or *WEB_APPVIEWER_FORM_LOGIN_PAGE* are not specified then they default to the value specified in *WEB_FORM_LOGIN_PAGE*.

Note: If *WEB_APPVIEWER_ROLE_NAME* and/or *WEB_APPVIEWER_PRINCIPAL_NAME* are not specified they are default to *WEB_ROLE_NAME* and *WEB_PRINCIPAL_NAME* respectively.

WEB_HELP_FORM_LOGIN_ERROR_PAGE - Help Form Login Error Page

Parameter	WEB_HELP_FORM_LOGIN_ERROR_PAGE
Description	Error Page used for invalid Help Login.
Ordinality	Mandatory
Valid Values	Valid JSP for error pages
JEE Web Application Server	WLS WAS WASND
Tier	WEB
Installation Mode	EMBED NATIVE

WEB_HELP_FORM_LOGIN_PAGE - Help Form Login Page

Parameter	WEB_HELP_FORM_LOGIN_PAGE
Description	Login Page used for Help Login.
Ordinality	Mandatory
Valid Values	Valid JSP for login
JEE Web Application Server	WLS WAS WASND
Tier	WEB
Installation Mode	EMBED NATIVE

WEB_ISAPPVIEWER - Enable AppViewer

Parameter	WEB_ISAPPVIEWER
Description	Enable or Disable AppViewer from deployment. The use of AppViewer is recommended for appropriate non-production environments only.
Ordinality	Mandatory
Valid Values	[true false]
JEE Web Application Server	WLS WAS WASND
Tier	WEB
Installation Mode	EMBED NATIVE

WEB_ISDEVELOPMENT - Development Environment

Parameter	WEB_ISDEVELOPMENT
Description	Enable or Disable Development on this product environment. This setting assumes that the Oracle Utilities

	SDK.
Ordinality	Mandatory
Valid Values	[true false]
JEE Web Application Server	WLS WAS WASND
Tier	WEB BAS IWS XAI BATCH MOB
Installation Mode	EMBED NATIVE

WEB_IWS_MDB_RUNAS_USER - Default User for MDB to run as within product

Parameter	WEB_IWS_MDB_RUNAS_USER
Description	The default product user the MDB uses to run its interface. This value is used if no JMS credentials are provided on the message header. A blank value, the default, for this parameter disables the function and assumes all JMS messages will include their credentials in the head of the message.
Ordinality	Optional
Valid Values	Blank (not enabled) or a valid product authorization userid (not login id)
JEE Web Application Server	WLS WAS WASND
Tier	IWS
Installation Mode	EMBED NATIVE

WEB_IWS_SUPER_USERS - Users to run as in IWS

Parameter	WEB_IWS_SUPER_USERS
Description	Default product user used for authorization for Inbound Web Services. This value is used for internal calls used for Inbound Web Services.
Ordinality	Optional
Valid Values	Blank (not enabled) or a valid product authorization userid (not login id)
JEE Web Application Server	WLS WAS WASND
Tier	IWS
Installation Mode	EMBED NATIVE

WEB_JMX_RMI_PORT_PERFORMANCE - JMX Port for Web Application Server monitoring

Parameter	WEB_JMX_RMI_PORT_PERFORMANCE
Description	Port number for JMX monitoring for Online monitoring.
Ordinality	Mandatory
Valid Values	Valid open port number for monitoring.
JEE Web Application Server	WLS WAS WASND
Tier	WEB
Installation Mode	EMBED NATIVE

WEB_L2_CACHE_MODE - Turn off L2 Cache for Online Submission

Parameter	WEB_L2_CACHE_MODE
Description	Enables (on) or disables (off) Level 2 cache for online submission. Used for development purposes where online submission cache is off. <hr/> <i>Note: Some batch processes require L2 Cache to be disabled. Refer to individual job documentation for details.</i> <hr/>
Ordinality	Mandatory
Valid Values	[on off]
JEE Web Application Server	WLS WAS WASND
Tier	WEB BATCH
Installation Mode	EMBED NATIVE

WEB_MAXAGE - Text Cache

Parameter	WEB_MAXAGE
Description	Set the duration (in seconds) to store page structures from the product, in the client cache , on the client browser.
Ordinality	Mandatory
Valid Values	See maxAge for valid values.
JEE Web Application Server	WLS WAS WASND
Tier	WEB
Installation Mode	EMBED NATIVE

WEB_MAXAGEI - Image Cache

Parameter	WEB_MAXAGEI
Description	Set the duration (in seconds) to store images, in the client cache , from the product on the client browser.
Ordinality	Mandatory
Valid Values	See maxAgeI for valid values.
JEE Web Application Server	WLS WAS WASND
Tier	WEB
Installation Mode	EMBED NATIVE

WEB_MEMORY_OPT_MAX - Maximum Web Application Server JVM Memory

Parameter	WEB_MEMORY_OPT_MAX
Description	Maximum Web Application Server JVM Memory in MB. Corresponds to Xmx java option. In native mode implementations, this setting is set on the Server definition.
Ordinality	Optional
Valid Values	Valid Memory setting (in MB). Default: 1024
JEE Web Application Server	WLS WAS WASND
Tier	WEB
Installation Mode	EMBED

WEB_MEMORY_OPT_MAXPERMSIZE - Web Application Server JVM Max PermGen size

Parameter	WEB_MEMORY_OPT_MAXPERMSIZE
Description	Maximum Web Application Server JVM PermGen Memory in MB. Corresponds to XX:Permsize java option. This options does not apply to Oracle JRockit implementations. In native mode implementations, this setting is set on the Server definition.
Ordinality	Optional
Valid Values	Valid Memory setting (in MB). Default: 500
JEE Web Application Server	WLS WAS WASND
Tier	WEB
Installation Mode	EMBED

WEB_MEMORY_OPT_MIN - Initial Web Application Server JVM Memory

Parameter	WEB_MEMORY_OPT_MIN
Description	Initial Web Application Server JVM Memory in MB. Corresponds to Xms java option. In native mode implementations, this setting is set on the Server definition.
Ordinality	Optional
Valid Values	Valid Memory setting (in MB). Default: 1024
JEE Web Application Server	WLS WAS WASND
Tier	WEB
Installation Mode	EMBED

WEB_NODENAME - IBM WebSphere ND Node Name

Parameter	WEB_NODENAME
Description	Node Name for IBM WebSphere ND.
Ordinality	Mandatory
Valid Values	Valid IBM WebSphere ND node name
JEE Web Application Server	WASND
Tier	WEB BAS IWS XAI MOB
Installation Mode	EMBED NATIVE

WEB_PRELOADALL - Preload all pages On startup

Parameter	WEB_PRELOADALL
Description	Enable or Disable preload of pages at startup. This determines the scope of any reload. A value of false (default) only preloads the Main menu only. A value of true preloads all functions on all menus. A value of true will lengthen the startup process.
Ordinality	Mandatory
Valid Values	[true false]
JEE Web Application Server	WLS WAS WASND
Tier	WEB
Installation Mode	EMBED NATIVE

WEB_PRINCIPAL_NAME - Default JEE Authorization Principal

Parameter	WEB_PRINCIPAL_NAME
-----------	---------------------------

Description	Principal Name for online application.
Ordinality	Mandatory
Valid Values	Valid Principal Name. Default: cisusers
JEE Web Application Server	WLS WAS WASND
Tier	WEB BAS IWS XAI
Installation Mode	EMBED NATIVE

WEB_ROLE_NAME - Default JEE Authorization Role

Parameter	WEB_ROLE_NAME
Description	Role Name for online application
Ordinality	Mandatory
Valid Values	Valid Role Name. Default: cisusers
JEE Web Application Server	WLS WAS WASND
Tier	WEB BAS IWS XAI
Installation Mode	EMBED NATIVE

WEB_SERVER_HOME - Location Of Web Application Server

Parameter	WEB_SERVER_HOME
Description	Generic location of Web Application Server. This value is then used to set the following values: WAS_HOME - IBM WebSphere WASND_HOME - IBM WebSphere ND WL_HOME - Oracle WebLogic
Ordinality	Mandatory
Valid Values	Home location of Web Application Server software
JEE Web Application Server	WLS WAS WASND
Tier	WEB BAS IWS XAI
Installation Mode	EMBED NATIVE

WEB_SERVER_VERSION - Web Server Version

Parameter	WEB_SERVER_VERSION
Description	Full Version of JEE Web Application Server. Used for utilities to ensure correct templates are used.
Ordinality	Mandatory

Valid Values	Generated by installer.
JEE Web Application Server	WLS WAS WASND
Tier	WEB BAS IWS XAI
Installation Mode	EMBED NATIVE

WEB_SERVER_VERSION_MAIN -

Parameter	WEB_SERVER_VERSION_MAIN
Description	Substring Version of JEE Web Application Server. Used for utilities to ensure correct templates are used.
Ordinality	Mandatory
Valid Values	Generated by installer.
JEE Web Application Server	WLS WAS WASND
Tier	WEB BAS IWS XAI
Installation Mode	EMBED NATIVE

WEB_SPLPASS - Application Administration Password

Parameter	WEB_SPLPASS
Description	Encrypted password for administration user for Oracle WebLogic. This setting is only applicable to Oracle WebLogic customers and is only used for embedded mode installations.
Ordinality	Mandatory
Valid Values	Encrypted password for administration user.
JEE Web Application Server	WLS
Tier	WEB BAS IWS XAI MOB
Installation Mode	EMBED

WEB_SPLUSER - Application Administration Userid

Parameter	WEB_SPLUSER
Description	Administration user for Oracle WebLogic. This setting is only applicable to Oracle WebLogic customers and is only used for embedded mode installations.
Ordinality	Mandatory
Valid Values	Administration user. Default: system
JEE Web Application Server	WLS

Tier	WEB BAS IWS XAI MOB
Installation Mode	EMBED

WEB_SVRNAME - IBM WebSphere Server Name

Parameter	WEB_SVRNAME
Description	Server Name for IBM WebSphere/IBM WebSphere ND.
Ordinality	Mandatory
Valid Values	Valid IBM WebSphere/IBM WebSphere ND server name
JEE Web Application Server	WAS WASND
Tier	WEB BAS IWS XAI MOB
Installation Mode	EMBED NATIVE

WEB_WASPASS - IBM WebSphere JNDI Password

Parameter	WEB_WASPASS
Description	Encrypted password for JNDI user for IBM WebSphere/IBM WebSphere ND. This setting is only applicable to IBM WebSphere/IBM WebSphere ND customers.
Ordinality	Mandatory
Valid Values	Encrypted password for JNDI user.
JEE Web Application Server	WAS WASND
Tier	WEB BAS IWS XAI MOB
Installation Mode	EMBED

WEB_WASUSER- IBM WebSphere JNDI Userid

Parameter	WEB_WASUSER
Description	Administration JNDI user for IBM WebSphere/IBM WebSphere ND. This parameter is used for any JNDI calls to the servers. This setting is only applicable to IBM WebSphere/IBM WebSphere ND customers.
Ordinality	Mandatory
Valid Values	JNDI Administration User.
JEE Web Application Server	WAS WASND
Tier	WEB BAS IWS XAI MOB
Installation Mode	EMBED

WEB_WLAUTHMETHOD - Authentication Method

Parameter	WEB_WLAUTHMETHOD
Description	JEE Authorization Method implemented.
Ordinality	Mandatory
Valid Values	Valid Values: <ul style="list-style-type: none"> • FORM(Default) - Use login forms • BASIC - Use Operating System Login • CLIENT-CERT - Client Certificate
JEE Web Application Server	WLS WAS WASND
Tier	WEB BAS IWS XAI MOB
Installation Mode	EMBED NATIVE

WEB_WLHOST - Web Server Host

Parameter	WEB_WLHOST
Description	Host Name for Oracle WebLogic Install. This is used for Oracle WebLogic customers only and embedded installations only.
Ordinality	Mandatory
Valid Values	Valid Host Name. Default: localhost
JEE Web Application Server	WLS
Tier	WEB BAS IWS XAI MOB
Installation Mode	EMBED

WEB_WLPAGECHECKSECONDS - Interval for recompilation of JSP

Parameter	WEB_WLPAGECHECKSECONDS
Description	Interval, in seconds, to force recompilation for server JSP's. This is used for Oracle WebLogic customers only. This setting is designed to be altered for development environments. The default is recommended for all other environments.
Ordinality	Mandatory
Valid Values	Valid Recompile time. Default: 43200
JEE Web Application Server	WLS
Tier	WEB

Installation Mode **EMBED** **NATIVE**

WEB_WLPORT - Web Server HTTP Port

Parameter	WEB_WLPORT
Description	Port number for environment for online system.
Ordinality	Mandatory
Valid Values	Valid open port number. Default: 6500
JEE Web Application Server	WLS
Tier	WEB
Installation Mode	EMBED NATIVE

WEB_WLSSLPORT - Oracle WebLogic SSL HTTP Port.

Parameter	WEB_WLSSLPORT
Description	SSL Port number for environment for online system.
Ordinality	Mandatory
Valid Values	Valid open port number. Default: 6501
JEE Web Application Server	WLS
Tier	WEB
Installation Mode	EMBED NATIVE

WEB_WLSYSPASS - Oracle WebLogic JNDI System Password

Parameter	WEB_WLSSYSPASS
Description	Encrypted Oracle WebLogic JNDI Password used for JNDI lookups. This is used for Oracle WebLogic customers only.
Ordinality	Mandatory
Valid Values	Valid JNDI Password.
JEE Web Application Server	WLS
Tier	WEB
Installation Mode	EMBED NATIVE

WEB_WLSYSUSER - Oracle WebLogic JNDI System Userid

Parameter	WEB_WLSSYSUSER
Description	Oracle WebLogic JNDI User used for JNDI lookups. This is used for Oracle WebLogic customers only.

Ordinality	Mandatory
Valid Values	Valid JNDI User.
JEE Web Application Server	WLS
Tier	WEB
Installation Mode	EMBED NATIVE

WEB_WLS_SVRNAME - Oracle WebLogic Server Name

Parameter	WEB_WLS_SVRNAME
Description	Oracle WebLogic Server Name. This is used for Oracle WebLogic customers only and embedded installations only.
Ordinality	Mandatory
Valid Values	Valid Server Name. Default: myserver
JEE Web Application Server	WLS
Tier	WEB
Installation Mode	EMBED

WLS_ADMIN_PORT - Admin Console Port Number

Parameter	WLS_ADMIN_PORT
Description	Oracle WebLogic Administration Port. Only supplied if Administration port differs from application port. Oracle WebLogic Server Name. This is used for Oracle WebLogic customers only and embedded installations only.
Ordinality	Mandatory
Valid Values	Valid Port Number. Default: Value of WEB_WLPORT .
JEE Web Application Server	WLS
Tier	WEB
Installation Mode	EMBED

WLS_CLUSTER_NAME - Name of Cluster for Product

Parameter	WLS_CLUSTER_NAME
Description	Oracle WebLogic Cluster Name for clustered environments. This value must be set for customers using the Application Management Pack for Oracle Utilities to link the cluster target with the product.
Ordinality	Optional

Valid Values	Valid Cluster Name.
JEE Web Application Server	WLS
Tier	WEB
Installation Mode	EMBED NATIVE

WLS_DIAGNOSTIC_BUILT_IN_MODULE - Diagnostic Module Name

Parameter	WLS_DIAGNOSTIC_BUILT_IN_MODULE
Description	Name of Diagnostics Module used for diagnostics rules if WLS_DIAGNOSTIC_CONTEXT_ENABLED is set to true .
Ordinality	Optional
Valid Values	Valid Diagnostics Module name. Default: None
JEE Web Application Server	WLS
Tier	WEB
Installation Mode	EMBED

WLS_DIAGNOSTIC_CONTEXT_ENABLED - ECID Support

Parameter	WLS_DIAGNOSTIC_CONTEXT_ENABLED
Description	This enables (true) or disables (false) ECID Support.
Ordinality	Optional
Valid Values	{true false }.
JEE Web Application Server	WLS
Tier	WEB
Installation Mode	EMBED

WLS_DIAGNOSTIC_VOLUME- Diagnostic Volume

Parameter	WLS_DIAGNOSTIC_VOLUME
Description	This sets the diagnostic volume used by Oracle diagnostic tools if WLS_DIAGNOSTIC_CONTEXT_ENABLED is set to true.
Ordinality	Optional
Valid Values	{ Off Low Medium High}. Refer to the Oracle WebLogic online help for a description of the values.
JEE Web Application Server	WLS
Tier	WEB

Installation Mode	EMBED
-------------------	--------------

WLS_DOMAIN_HOME - Oracle WebLogic Domain Home

Parameter	WLS_DOMAIN_HOME
Description	Domain Home directory for installation. Used if installation has multiple domains installed.
Ordinality	Mandatory
Valid Values	Valid Domain Home
JEE Web Application Server	WLS
Tier	WEB
Installation Mode	EMBED

WLS_OVERRIDE_PROTECT - Override Protection

Parameter	WLS_OVERRIDE_PROTECT
Description	Sets Overload Protection setting in Oracle WebLogic.
Ordinality	Mandatory
Valid Values	Valid Panic Action settings for Overload (system-exit or no-action). Default: system-exit ³³ .
JEE Web Application Server	WLS
Tier	WEB
Installation Mode	EMBED

WLS_WEB_WLSYSPASS - Console Password for Oracle WebLogic

Parameter	WLS_WEB_WLSYSPASS
Description	Encrypted Oracle WebLogic Password used for console. This is used for Oracle WebLogic customers only and embedded installations only.
Ordinality	Mandatory
Valid Values	Valid console Password.
JEE Web Application Server	WLS
Tier	WEB
Installation Mode	EMBED

³³ **system-exit** will force out overload users. They will receive an appropriate error.

WLS_WEB_WLSYSUSER - Console User for Oracle WebLogic

Parameter	WLS_WEB_WLSYSUSER
Description	Encrypted Oracle WebLogic user used for console. This is used for Oracle WebLogic customers only and embedded installations only.
Ordinality	Mandatory
Valid Values	Valid console user. Default: system
JEE Web Application Server	WLS
Tier	WEB
Installation Mode	EMBED

WLTHININT3CLIENT_JAR_DIR - Location of Thin WebLogic T3 Client

Parameter	WLTHININT3CLIENT_JAR_DIR
Description	Location of Oracle WebLogic thin Client for JMX and other interfaces. Used for integration to Oracle products for monitoring.
Ordinality	Optional
Valid Values	Valid location of wlthinint3client.jar
JEE Web Application Server	WLS
Tier	IWS WEB
Installation Mode	EMBED

WL_HOME - Oracle WebLogic Home

Parameter	WL_HOME
Description	Home directory of Oracle WebLogic. This is used for Oracle WebLogic customers only and embedded installations only.
Ordinality	Mandatory
Valid Values	Valid console user. Default: system
JEE Web Application Server	WLS
Tier	WEB
Installation Mode	EMBED

XAIApp - Name of XAI WAR file

Parameter	XAIApp
-----------	---------------

Description	Name of XAI WAR file as generated for builds. This is generated and should not be changed.
Ordinality	Mandatory
Valid Values	Valid WAR file name. Default: XAIApp.war
JEE Web Application Server	WLS WAS WASND
Tier	XAI
Installation Mode	EMBED NATIVE

XAI_DBPASS - Password for Database User for XAI

Parameter	XAI_DBPASS
Description	Encrypted database user password for the XAI component of the product.
Ordinality	Mandatory
Valid Values	Encrypted Password
JEE Web Application Server	WLS WAS WASND
Tier	XAI DB
Installation Mode	EMBED NATIVE

XAI_DBUSER - Database User used for XAI

Parameter	XAI_DBUSER
Description	Database User, with Read/Write permissions used for pooled connections for XAI transactions.
Ordinality	Mandatory
Valid Values	Valid Database User used in installation
JEE Web Application Server	WLS WAS WASND
Tier	XAI DB
Installation Mode	EMBED NATIVE

XQUERIES_TO_CACHE - Size of XQuery Cache

Parameter	XQUERIES_TO_CACHE
Description	Size of XQuery/XPath Cache in number of queries. Increasing the cache size may increase memory requirements for the product. This sets the value of com.oracle.XPath.LRUSize in the spl.properties file

Ordinality	Optional
Valid Values	Defaults from templates (- 1 - Unlimited in size)
JEE Web Application Server	WLS WAS WASND
Tier	BAS BATCH IWS MOB
Installation Mode	EMBED NATIVE

XQUERY_CACHE_FLUSH_TIMEOUT - Cache Life for XQueries

Parameter	XQUERY_CACHE_FLUSH_TIMEOUT
Description	Length of time in seconds that XQuery and XPath queries are cached and set the value of com.oracle.XPath.flushTimeout in the spl.properties file.
Ordinality	Optional
Valid Values	Defaults from templates (0 - Never flush is the default)
JEE Web Application Server	WLS WAS WASND
Tier	BAS BATCH IWS MOB
Installation Mode	EMBED NATIVE

Web.xml

The Web deployment descriptor editor lets you specify deployment information for modules created in the Web development environment. The information appears in the *web.xml* file. The *web.xml* file for a Web project provides information necessary for deploying a Web application module. It is used in building a WAR/EAR file from a project.

The online and web Services JEE applications for the product are controlled by this configuration file which holds the behavioral configuration for the applications. Refer to <http://jcp.org/en/jsr/detail?id=109> for more details of the XML format.

The following sections outline the specific settings for the product.

Filter Mappings - JEE Filters

Note: Filters should not be altered unless instructed by Oracle Support. Refer to the web.xml file for the relevant settings.

The following filters apply to the product:

Filter	Usage
Browser Cache Filter	Browser Client side caching settings - Used with MaxAge .
CSS Stylesheet Direction Filter	CSS Filter
Doctype Replace Filter	JDOC Filter

Filter	Usage
FlushAll Redirect Filter	Cache management utility Filter
GZip Compression Filter	HTTP 1.1 compression filter
Header Security Filter	OWASP processing of HTTP headers using SAMEORIGIN
HTML Comment stripping Filter	Removal of comments from HTTP transmission
Image Browser Cache Filter	Browser Client side caching settings for image files - Used with MaxAgeI .
Image RTL Filter	Right to Left support Filter
Javascript Comment stripping Filter	Removal of comments from javascript transmission
Minification Filter	Optimization code
Privacy Page Redirect Filter	Privacy page redirect to /cm/privacy.html
Request Context Filter	Generic context Filter
Rest Security Filter	REST security support
Security Filter	Generic security filter to delegate security to JEE container
Timezone Database ContentType Filter	Time zone support

disableCompression - Disable Compression

Parameter	disableCompression
Description	Enables or disables compression between the Web Application Server and Business Application Server (true or false).
Ordinality	Mandatory
Valid Values	[true false]
Source	Derived from WEB_I\$DEVELOPMENT parameter from ENVIRON.INI . It is highly recommended to set to false for all environment exception is development environments using Oracle Utilities SDK.
Applicability	WEB
Example:	<pre><context-param> <param-name>disableCompression</param-name> <param-value>false</param-value> </context-param></pre>

maxAgeI - Max Age for Images

Parameter	maxAgeI
-----------	----------------

Description	Set the duration (in seconds) to store images, in the client cache , from the product on the client browser.
Ordinality	Mandatory
Valid Values	As per JEE Standards . Default: 28850
Source	Derived from WEB_MAXAGE parameter from ENVIRON. INI . It is highly recommended to set to the default unless otherwise recommended.
Applicability	WEB
Example:	<pre><filter> <filter-name>Image Browser Cache Filter</filter-name> <filter- class>com.splwg.base.web.services.BrowserCacheFilter</filter- class> <init-param> <param-name>maxAge</param-name> <param-value>28850</param-value> </init-param> </filter></pre>

maxAge - Max Age for pages

Parameter	maxAge
Description	Set the duration (in seconds) to store page structures from the product, in the client cache , on the client browser.
Ordinality	Mandatory
Valid Values	As per JEE Standards . Default: 28850
Source	Derived from WEB_MAXAGE parameter from ENVIRON. INI . It is highly recommended to set to the default unless otherwise recommended.
Applicability	WEB
Example:	<pre><filter> <filter-name>Browser Cache Filter</filter-name> <filter- class>com.splwg.base.web.services.BrowserCacheFilter</filter- class> <init-param> <param-name>maxAge</param-name> <param-value>28850</param-value> </init-param> </filter></pre>

auth-method - Authorization Method

Parameter	auth-method
Description	Sets the JEE authentication method for the product.
Ordinality	Mandatory

Valid Values	[BASIC CLIENT-CERT FORM]
Source	<p>Derived from WEB_WLAUTHMETHOD parameter from ENVIRON. INI. Depending on the value this may lead to further settings being implemented.</p> <ul style="list-style-type: none"> • BASIC - Enables the operating system to provide the logon dialog. • CLIENT-CERT - Enables an external solution such as a SSO solution, Kerberos or any security implementing client certificates to provide credentials. • DIGEST - Use digest authentication³⁴. • FORM - This instructs the product to implement the following additional settings: <ul style="list-style-type: none"> ▪ WEB_FORM_LOGIN_PAGE and WEB_HELP_FORM_LOGIN_ERROR_PAGE need to be set to indicate the form to use for online authentication. ▪ WEB_HELP_FORM_LOGIN_PAGE and WEB_HELP_FORM_LOGIN_ERROR_PAGE need to be set to indicate the form to use for online help authentication. ▪ WEB_APPVIEWER_FORM_LOGIN_PAGE and WEB_APPVIEWER_FORM_LOGIN_ERROR_PAGE need to be set to indicate the form to use for AppViewer authentication. <hr/> <p><i>Note: Appviewer must be enabled for this setting to apply.</i></p>
Applicability	WEB
Example:	<pre><login-config> <auth-method>FORM</auth-method> <form-login-config> <form-login-page>/loginPage.jsp</form-login-page> <form-error-page>/formLoginError.jsp</form-error-page> </form-login-config> </login-config></pre>

fieldValuesAge - Server Cache Lifetime

Parameter	fieldValuesAge
Description	Set the duration (in seconds) to hold data in the server data cache .
Ordinality	Mandatory
Valid Values	1 - 2147483647 Default: 3600

³⁴ Not supported for an external LDAP provider or custom provider within Oracle WebLogic. Digest Authentication is only supported if SIP is installed with Oracle WebLogic.

Source	Defaulted from template. Changes to the value require a custom template .
Applicability	WEB BAS
Example:	<pre><env-entry> <description>How long to cache drop down values in seconds</description> <env-entry-name>fieldValuesAge</env-entry-name> <env-entry-type>java.lang.Integer</env-entry-type> <env-entry-value>3600</env-entry-value> </env-entry></pre>

disableUIPageCompression - Disable UI Compression

Parameter	disableUIPageCompression
Description	Enables or disables compression between the browser and Web Application Server (true or false).
Ordinality	Mandatory
Valid Values	[true false]
Source	Derived from WEB_I\$DEVELOPMENT parameter from ENVIRON.INI . It is highly recommended to set to false for all environment exception is development environments using Oracle Utilities SDK.
Applicability	WEB
Example:	<pre><env-entry> <description>Disable UIPage compression</description> <env-entry-name>disableUIPageCompression</env-entry-name> <env-entry-type>java.lang.Boolean</env-entry-type> <env-entry-value>false</env-entry-value> </env-entry></pre>

spl.properties

The `threadpool` **spl.properties** file is used by each layer of the product to configure the technical aspects of the product behavior. All settings in this file are of the format:

<parameter>=<parameter value>

calendar.japanese.eras - Japanese Era Definition

Parameter	calendar.japanese.eras
Description	<p>This is a set of strings defining the era used in the Japanese calendar. The string is a collection of the following tags (one set per era separated with a ";" delimiter):</p> <ul style="list-style-type: none"> name - Name of era abbr - Era Abbreviation since - Date era starts in ISO format (YYYY-MM-DD)

- **endDate** - Date era ends in ISO format (YYYY-MM-DD)
- **jaAbbr** - The Japanese character for the era in Unicode format

Note: This feature is only appropriate if the Japanese language pack is also installed.

Ordinality	Mandatory
Valid Values	String set by implementations
Source	Value inherited from templates. Use custom template to set this value, if desired.
Applicability	BAS BATCH
Example:	<code>calendar.japanese.eras=name: Tai sho, abbr: T, since: 1912- 07- 30, endDate: 1926- 12- 24, jaAbbr: \u5927\u6B63; name: Showa, abbr: S, since: 1926- 12- 25, endDate: 1989- 01- 07, jaAbbr: \u662D\u548C; name: Hei sei , abbr: H, since: 1989- 01- 08, endDate: , jaAbbr: \u5E73\u6210</code>

com.oracle.ouaf.customer.whitelist.file – Customer’s URL whitelist file

Parameter	com.oracle.ouaf.customer.whitelist.file
Description	Full directory path to the URL customer’s whitelist file to be checked for restricting URLs.
Ordinality	Optional
Valid Values	Location of whitelist URL file, along with filename.
Source	Defaulted from the CLOUD_CUSTOM_WHITE_LIST_PATH value in ENVIRON.INI .
Applicability	BAS
Example:	<code>com.oracle.ouaf.customer.whitelist.file=@SPLEBASE@/etc/cm_w whitelist.xml</code> The installed product base directory is defaulted from SPLEBASE value in ENVIRON.INI

com.oracle.ouaf.dbms.scheduler.schema – DBMS Scheduler object’s schema

Parameter	com.oracle.ouaf.dbms.scheduler.schema
Description	The DBMS scheduler objects will be created in the user/schema specified by the property. This property should match the schema where the DBMS integration package was installed in.
Ordinality	Optional
Valid Values	DB Schema name where DBMS integration package is installed.
Source	Defaulted from the value in ENVIRON.INI .
Applicability	BAS

Example: `com.oracle.ouaf.dbms.scheduler.schema=DBSchemaName`

`com.oracle.ouaf.migrationAssistant.exportDirectory` – Directory for exported CMA file

Parameter	<code>com.oracle.ouaf.migrationAssistant.exportDirectory</code>
Description	Contains a directory specification, using the defined substitution variable <code>@F1_MIGR_ASSISTANT_FILES@</code> , in the white list.
Ordinality	Optional
Valid Values	Location of the CMA export file on the server.
Source	Value inherited from templates. Use custom template to set this value.
Applicability	BAS BATCH
Example:	<code>com.oracle.ouaf.migrationAssistant.exportDirectory=@F1_MIGR_ASSISTANT_FILES@/export</code>

`com.oracle.ouaf.migrationAssistant.importDirectory` – Directory for CMA file for import

Parameter	<code>com.oracle.ouaf.migrationAssistant.importDirectory</code>
Description	Contains a directory specification, using the defined substitution variable <code>@F1_MIGR_ASSISTANT_FILES@</code> , in the white list.
Ordinality	Optional
Valid Values	Location of the CMA import file on the server.
Source	Value inherited from templates. Use custom template to set this value.
Applicability	BAS BATCH
Example:	<code>com.oracle.ouaf.migrationAssistant.importDirectory=@F1_MIGR_ASSISTANT_FILES@/import</code>

`com.oracle.ouaf.migrationAssistant.fileExtension` – Extension of CMA file

Parameter	<code>com.oracle.ouaf.migrationAssistant.fileExtension</code>
Description	Specifies the file extension of the CMA file.
Ordinality	Optional
Valid Values	File Extensions.
Source	Value inherited from templates. Use custom template to set this value.
Applicability	BAS BATCH

Example: `com.oracle.ouaf.migrationAssistant.fileExtension=cma`

com.oracle.ouaf.system.database.disableTagging - Disables Database tagging

Parameter	com.oracle.ouaf.system.database.disableTagging
Description	This enables (false) or disables (true) the database connection tagging feature. <i>Note: Disabling this feature can reduce monitoring capabilities, disable support for Oracle Audit Vault, disable session resource management in Oracle Real Application Clusters and disable advanced support for Database resource plans.</i>
Ordinality	Mandatory
Valid Values	[true false]
Source	Value inherited from templates. Use custom template to set this value to true , if desired.
Applicability	WEB BAS IWS XAI BATCH MOB
Example:	<code>com.oracle.ouaf.system.database.disableTagging=false</code>

com.oracle.ouaf.system.keystore.alias - Keystore Alias

Parameter	com.oracle.ouaf.system.keystore.alias
Description	Sets name alias in keystore. Corresponds to the alias option on keytool .
Ordinality	Mandatory
Valid Values	Set to ouaf.system
Source	This value is set by the KS_ALIAS value in ENVIRON.INI .
Applicability	WEB BAS IWS XAI BATCH MOB
Example:	<code>com.oracle.ouaf.system.keystore.alias=ouaf.system</code>

com.oracle.ouaf.system.keystore.hmac_key_alias - HMAC alias

Parameter	com.oracle.ouaf.system.keystore.hmac_key_alias
Description	Sets HMAC name alias in keystore. Corresponds to the alias option on keytool .
Ordinality	Mandatory
Valid Values	Set to ouaf.system.hmac by default.
Source	This value is set by the KS_HMAC_ALIAS value in ENVIRON.INI .
Applicability	WEB BAS IWS XAI BATCH MOB
Example:	<code>com.oracle.ouaf.system.keystore.hmac_key_alias=ouaf.system.hmac</code>

com.oracle.ouaf.system.keystore.file - Location Of Keystore

Parameter	com.oracle.ouaf.system.keystore.file
Description	Location of keystore file. Corresponds to the keystore option on keytool . This entry should <u>not</u> be altered.
Ordinality	Mandatory
Valid Values	Set to full path location of keystore and name of keystore file.
Source	Defaulted to \$SPLEBASE/ks/.ouaf_keystore (or for Windows %SPLEBASE%\ks\.ouaf_keystore) from the KS_KESTORE_FILE value in ENVIRON.INI .
Applicability	WEB BAS IWS XAI BATCH MOB
Example:	com.oracle.ouaf.system.keystore.file=/opt/.ouaf_keystore

com.oracle.ouaf.system.keystore.mode - Keystore Mode

Parameter	com.oracle.ouaf.system.keystore.mode
Description	Mode of the keystore. This is not used to create the keystore, just how the product processes the keys inside.
Ordinality	Mandatory
Valid Values	Set to valid keystore mode. Defaulted to CBC .
Source	This value is set from the KS_MODE value in ENVIRON.INI .
Applicability	WEB BAS IWS XAI BATCH MOB
Example:	com.oracle.ouaf.system.keystore.mode=CBC

com.oracle.ouaf.system.keystore.padding - Key Padding

Parameter	com.oracle.ouaf.system.keystore.padding
Description	Padding used for keys. This is not used to create the keystore, just how the product processes the keys inside.
Ordinality	Mandatory
Valid Values	Set to valid keystore mode. Defaulted to PKCS5Padding .
Source	This value is set from the KS_PADDING value in ENVIRON.INI .
Applicability	WEB BAS IWS XAI BATCH MOB
Example:	com.oracle.ouaf.system.keystore.padding=PKCS5Padding

com.oracle.ouaf.system.keystore.passwordFileName - Password File

Parameter	com.oracle.ouaf.system.keystore.passwordFileName
-----------	---

Description	Location of keystore password file. Corresponds to the storepass option on keytool . This entry should <u>not</u> be altered.
Ordinality	Mandatory
Valid Values	Set to full path location of keystore and name of keystore file.
Source	Defaulted to \$SPLEBASE/ks/.ouaf_storepass (or for Windows %SPLEBASE%\ks\.ouaf_storepass) from the KS_STOREPASS_FILE value in ENVIRON.INI .
Applicability	WEB BAS IWS XAI BATCH MOB
Example:	<code>com.oracle.ouaf.system.keystore.passwordFileName=/spl/OUAFDEMO/ks/.ouaf_storepass</code>

com.oracle.ouaf.system.keystore.type - Keystore Type

Parameter	com.oracle.ouaf.system.keystore.type
Description	Keystore Type. Corresponds to the storetype option on keytool .
Ordinality	Mandatory
Valid Values	Set to valid keystore mode. Defaulted to JCEKS .
Source	This value is set from the KS_STORETYPE value in ENVIRON.INI .
Applicability	WEB BAS IWS XAI BATCH MOB
Example:	<code>com.oracle.ouaf.system.keystore.type=JCEKS</code>

com.oracle.ouaf.system.truststore.file - Location Of Truststore

Parameter	com.oracle.ouaf.system.truststore.file
Description	Location of truststore file. Corresponds to the truststore option on keytool .
Ordinality	Mandatory
Valid Values	Set to full path location of truststore and name of truststore file.
Source	Defaulted from the TS_KEYSTORE_FILE value in ENVIRON.INI .
Applicability	BAS
Example:	<code>com.oracle.ouaf.system.truststore.file=/opt/.ouaf_trstore</code>

com.oracle.ouaf.system.truststore.passwordFileName - Location Of Truststore Password file

Parameter	com.oracle.ouaf.system.truststore.passwordFileName
Description	Location of truststore password file.
Ordinality	Mandatory

Valid Values	Set to full path location of truststore password file.
Source	Defaulted from the TS_STOREPASS_FILE value in ENVIRON.INI .
Applicability	BAS
Example:	<code>com.oracle.ouaf.system.truststore.passwordFileName=/opt/.ouaf_trstorepass</code>

com.oracle.ouaf.truststore.type - Type Of Truststore

Parameter	com.oracle.ouaf.truststore.type
Description	Type of truststore file.
Ordinality	Mandatory
Valid Values	Sets Type of Truststore.
Source	Defaulted from the TS_STORETYPE value in ENVIRON.INI .
Applicability	BAS
Example:	<code>com.oracle.ouaf.system.truststore.file=/opt/.ouaf_trstore</code>

com.oracle.ouaf.uriSubstitutionVariables.file – URI predefined variables list file

Parameter	com.oracle.ouaf.uriSubstitutionVariables.file
Description	Points to the file containing the predefined URI substitution variable list.
Ordinality	Mandatory for cloud installations. Optional for on premise installations.
Valid Values	Path of the URI substitution variable list file.
Source	Value inherited from <code>CLOUD_SUBSTITUTION_VARIABLE_LIST_FILE_LOCATION</code> in the <code>ENVIRON.INI</code> file.
	The following substitution variables are provided by default in OUAF:
	<ol style="list-style-type: none"> 1. F1_CMA_FILES <i>(The below variables are provided for this release, but will be removed from future releases as these are not used in any product functionality.)</i> 2. F1_BI_EXTRACTS 3. F1_INTERNAL_FILES 4. F1_CUST_APP_BASE 5. F1_PROCESS_DIR 6. F1_SVC_CATALOG_WSDL_DIR 7. F1_PDB_EXTRACTS
Applicability	BAS
Example:	<code>com.oracle.ouaf.uriSubstitutionVariables.file=@SPLEBASE@/etc/substitutionVariableList.xml</code>

com.oracle.ouaf.uriValidation.enable – Enable Restriction of URLs

Parameter	com.oracle.ouaf.uriValidation.enable
Description	Enable URL validation. Restricts external URLs based on white list filename.
Ordinality	Mandatory for cloud installations. Optional for on premise installations.
Valid Values	[true false]. Default value is false
Source	Defaulted from the CLOUD_RESTRICTION_URLS_ENABLE value in ENVIRON.INI .
Applicability	BAS
Example:	com.oracle.ouaf.uriValidation.enable=false

com.oracle.ouaf.whitelist.file – Oracle URL whitelist filename and location

Parameter	com.oracle.ouaf.whitelist.file
Description	Full directory path to the URL oracle whitelist file to be checked for restricting URIs.
Ordinality	Mandatory if restriction is activated.
Valid Values	Location of whitelist URI file, along with filename.
Source	Defaulted from the CLOUD_WHITE_LIST_PATH value in ENVIRON.INI .
Applicability	BAS
Example:	com.oracle.ouaf.whitelist.file=@SPLEBASE@/etc/whitelist.xml . The installed product base directory is defaulted from SPLEBASE value in ENVIRON.INI

com.oracle.ouaf.xsd.dir - Location of XSD files for XAI

Parameter	com.oracle.ouaf.xsd.dir
Description	Full directory path to XSD schemas used for XML Application Integration. This replaces the XAI Options versions of this setting.
Ordinality	Mandatory

Valid Values	Location of schemas. Typically set to spl app/xai /schemas directory under software install location.
Source	Generated
Applicability	XAI
Example:	<code>com.oracle.ouaf.xsl.dir=/spl /OUAFDEMO/spl app/xai /schemas</code>

com.oracle.ouaf.xsl.dir - Location of XSL files for XAI

Parameter	com.oracle.ouaf.xsl.dir
Description	Full directory path to XSLT style sheets used for XML Application Integration. This replaces the XAI Options versions of this setting.
Ordinality	Mandatory
Valid Values	Location of XSL files. Typically set to spl app/xai /schemas directory under software install location.
Source	Generated
Applicability	XAI
Example:	<code>com.oracle.ouaf.xsl.dir=/spl /OUAFDEMO/spl app/xai /schemas</code>

com.oracle.XPath.LRUSize - XPath Cache

Parameter	com.oracle.XPath.LRUSize
Description	Sets Maximum XPath queries cached used in Schema based objects.
Ordinality	Optional
Valid Values	0 - No queries cached, -1 - Unlimited (7k per query), Value - Number of queries.
Source	Uses XQUERIES TO CACHE value in ENVIRON.INI..
Applicability	BAS MOB BATCH
Example:	<code>com.oracle.XPath.LRUSize=2000</code>

com.oracle.XPath.flushTimeout - XPath Flush

Parameter	com.oracle.XPath.flushTimeout
Description	Sets time (in seconds) to reset XPath cache.
Ordinality	Optional
Valid Values	0 - Never auto flush, Value - Time in seconds between flushes.
Source	Uses XQUERY CACHE FLUSH TIMEOUT value in ENVIRON.INI..
Applicability	BAS BATCH MOB

Example: `com.oracle.XPath.flushTimeout=86400`

com.splwg.batch.cluster.jvmName - Online Batch JVM Name

Parameter	com.splwg.batch.cluster.jvmName
Description	Sets name for monitoring purposes for online batch JVM for online submission. This value is not used by the runtime, just exposed to the JMX interface for categorization purposes.
Ordinality	Optional
Valid Values	Any string without embedded blanks.
Source	Use the spl.properties.root.exit.include user_exit to set this value.
Applicability	WEB
Example:	<code>com.splwg.batch.cluster.jvmName=onlineBatch</code>

com.splwg.batch.scheduler.daemon - Online Submission Daemon

Parameter	com.splwg.batch.scheduler.daemon
Description	Enable or Disable the Batch Daemon for online submission. The Batch Daemon is used to detect <i>Pending</i> Batch Submission objects and send them to Batch Online servers. It is highly recommended to specify a value of false for Production environments. The Batch Daemon is only recommended to be used, set to true , in Testing, Development or Demonstration environments.
Ordinality	Mandatory
Valid Values	[true false]
Source	Derived from BATCHDAEMON parameter from ENVIRON.INI .
Applicability	BAS
Example:	<code>com.splwg.batch.scheduler.daemon=false</code>

com.splwg.grid.executionMode - Online Execution Mode

Parameter	com.splwg.grid.executionMode
Description	Sets the execution mode of the online Batch submission.
Ordinality	Mandatory
Valid Values	[THIN CLUSTERED]
Source	Derived from BATCH_MODE parameter from ENVIRON.INI .
Applicability	BAS

Example: `com.splwg.grid.executionMode=CLUSTERED`

com.splwg.grid.online.enabled - Online Batch Server

Parameter	com.splwg.grid.online.enabled
Description	Enable or Disable the Batch Server for online submission. The Batch Server is responsible for managing and executing jobs allocated by the Batch Daemon. It is highly recommended to specify a value of false for Production environments.
	<i>Note: The Batch Server is only recommended to be used in Testing, Development or Demonstration environments.</i>
Ordinality	Mandatory
Valid Values	[true false]
Source	Derived from BATCHENABLED parameter from ENVIRON.INI .
Applicability	BAS
Example:	<code>com.splwg.grid.online.enabled=false</code>

com.splwg.grid.distThreadPool.threads.DEFAULT - Online Submission Threadpool

Parameter	com.splwg.grid.distThreadPool.threads.DEFAULT
Description	Maximum number of concurrent threads used to execute online submission. This setting is used in conjunction with the Online Batch Server setting.
Ordinality	Mandatory
Valid Values	1 - 1000. Default: 5
Source	Derived from BATCHTHREADS parameter from ENVIRON.INI .
Applicability	BAS
Example:	<code>com.splwg.grid.distThreadPool.threads.DEFAULT=5</code>

com.splwg.schema.newValidations.F1 - Set behavior of validations

Parameter	com.splwg.schema.newValidations.F1
Description	Sets behavior of schema validations. Internal use only. This is set by individual products and should not be altered unless otherwise instructed by Oracle Support.
Ordinality	Mandatory
Valid Values	[true false]
Source	Value inherited from templates. Use custom template to set this value to false , if desired.

Applicability	WEB BAS
Example:	<code>com.splwg.schema.newValidations.F1=true</code>

jmx.remote.x.access.file - JMX Access Control

Parameter	jmx.remote.x.access.file
Description	Sets relative location of JMX access control file holding the valid user. Refer to JMX Security for more details.
Ordinality	Mandatory
Valid Values	Relative location of file from \$\$SPLEBASE/\$\$SPLEBASE% . Defaults to scripts/ouaf.jmx.access.file
Source	Value inherited from templates. Use custom template to set this value to the desired location and file, if desired.
Applicability	WEB BAS
Example:	<code>jmx.remote.x.access.file=scripts/ouaf.jmx.access.file</code>

jmx.remote.x.password.file - JMX Password Control

Parameter	jmx.remote.x.password.file
Description	Sets relative location of JMX password file holding the valid passwords for jmx.remote.x.access.file . Refer to JMX Security for more details.
Ordinality	Mandatory
Valid Values	Relative location of file from \$\$SPLEBASE/\$\$SPLEBASE% . Defaults to scripts/ouaf.jmx.password.file
Source	Value inherited from templates. Use custom template to set this value to the desired location and file, if desired.
Applicability	WEB BAS
Example:	<code>jmx.remote.x.password.file=scripts/ouaf.jmx.password.file</code>

oracle.ouaf.jmx.remote.startPort - JMX Override Port

Parameter	oracle.ouaf.jmx.remote.startPort
Description	Alternative port number for JMX monitoring. Allows for overrides from standard port. Overrides spl.runtime.management.rmi.port .
Ordinality	Optional
Valid Values	Valid port numbers. Defaults to spl.runtime.management.rmi.port
Source	Specif.
Applicability	WEB BAS
Example:	<code>jmx.remote.x.password.file=scripts/ouaf.jmx.password.file</code>

ouaf.accessibility.features - Enable Accessibility features

Parameter	ouaf.accessibility.features
Description	Enables or disabled accessibility support from the product, specifically around implementing tabIndex for column headers. Other accessibility features are not altered by this setting.
Ordinality	Mandatory
Valid Values	[true false]
Source	Value inherited from templates. Use custom template to set this value to false , if desired.
Applicability	WEB
Example:	ouaf.accessibility.features=true

ouaf.attachment.disableSpecialCharCheckOnFileName - Disable Special Characters on file name

Parameter	ouaf.attachment.disableSpecialCharCheckOnFileName
Description	Disables (true) or enables (false) check for special characters used in file name for attachment objects.
Ordinality	Mandatory
Valid Values	[true false]
Source	Value inherited from templates. Use custom template to set this value to true , if desired.
Applicability	BAS
Example:	ouaf.attachment.disableSpecialCharCheckOnFileName=false

ouaf.batch.onlineLogDir - Online Line Batch Log Directory

Parameter	ouaf.batch.onlineLogDir
Description	Sets the location of output from online batch submission and batch scheduler integration. If this property is set, batch logs will be accessible via the Batch Run Tree (application UI). Otherwise, the batch logs download link in the application will be disabled.
Ordinality	Optional
Valid Values	Valid location. Defaults to: \$SPLOUTPUT (%SPLOUTPUT% on Windows)
Source	Value inherited from BATCH_ONLINE_LOG_DIR from ENVIRON.INI .
Applicability	BATCH
Example:	ouaf.batch.onlineLogDir=/tmp

ouaf.batch.onlineLogDir.retain – Retain Online Line Batch Log Files

Parameter	ouaf.batch.onlineLogDir.retain
Description	Sets the total number of log files that are to be stored for each batch code and thread number. The log files for the particular batch code and thread number will be deleted except for the latest number of logs specified.
Ordinality	Optional
Valid Values	Number.
Source	Generated by template. Use bedit to implement a different value.
Applicability	BATCH
Example:	ouaf.batch.onlineLogDir.retain=3 The above example will keep the last three logs and delete the rest

ouaf.database.session.setInstallationTimeZone - Set Time Zone for sessions

Parameter	ouaf.database.session.setInstallationTimeZone
Description	Set this property to true if the Time Zone on the installation record via the online <i>Installation Options - Framework</i> menu item (under <i>Main</i> tab) is different to the default timezone on the database. This will ensure session timezone is corrected.
Ordinality	Mandatory
Valid Values	[true false]
Source	Value inherited from templates. Use custom template to set this value to true , if desired.
Applicability	BAS MOB BATCH
Example:	ouaf.database.session.setInstallationTimeZone=false

ouaf.flush.jms.disabled - Global flush supported

Parameter	ouaf.flush.jms.disabled
Description	Enables (false) or disables (true) global flush feature.
Ordinality	Optional
Valid Values	[true false]
Source	Value inherited from templates. Use custom template to set this value to false , if desired.
Applicability	WEB BAS IWS BATCH MOB
Example:	ouaf.flush.jms.disabled=true

ouaf.flush.jms.connection - Connection Factory for Global Flush

Parameter	ouaf.flush.jms.connection
Description	JNDI Name for Global JMS connection
Ordinality	Optional
Valid Values	Valid JNDI for JMS Connection Factory. Default: jms/OUFlushConnectionFactory
Source	Value inherited from templates. Use custom template to set this value to an alternative value, if desired.
Applicability	WEB BAS IWS BATCH MOB
Example:	ouaf.flush.jms.connection=jms/OUFlushConnectionFactory

ouaf.flush.jms.requestTopic - Global Flush Request Topic

Parameter	ouaf.flush.jms.requestTopic
Description	JNDI Name for Global JMS Request Topic
Ordinality	Optional
Valid Values	Valid JNDI for JMS Request Topic. Default: jms/OUFlushRequestTopic
Source	Value inherited from templates. Use custom template to set this value to an alternative value, if desired.
Applicability	WEB BAS IWS BATCH MOB
Example:	ouaf.flush.jms.requestTopic=jms/OUFlushRequestTopic

ouaf.flush.jms.responseTopic - Global Flush Response Topic

Parameter	ouaf.flush.jms.responseTopic
Description	JNDI Name for Global JMS Response Topic
Ordinality	Optional
Valid Values	Valid JNDI for JMS Response Topic. Default: jms/OUFlushResponseTopic
Source	Value inherited from templates. Use custom template to set this value to an alternative value, if desired.
Applicability	WEB BAS IWS BATCH MOB
Example:	ouaf.flush.jms.responseTopic=jms/OUFlushResponseTopic

ouaf.runtime.compatibility.enablePrecisionScaleOnMoney - Money Processing

Parameter	ouaf.runtime.compatibility.enablePrecisionScaleOnMoney
-----------	---

Description	Enables or disabled precision checking on money fields.
Ordinality	Mandatory
Valid Values	[true false]
Source	Value inherited from templates. Use custom template to set this value to false , if desired.
Applicability	WEB
Example:	<code>ouaf.runtime.compatibility.enablePrecisionScaleOnMoney=false</code>

ouaf.jmx.com.oracle.ouaf.ws.mbeans.WSFlushBean - WS Cache Flush

Parameter	ouaf.jmx.com.oracle.ouaf.ws.mbeans.WSFlushBean
Description	Enables or disables the Flush mbean used for the online JMX monitoring. Refer to the Web Services JMX interface for more information. This parameter is only enabled if the JMX interface is enabled.
Ordinality	Mandatory
Valid Values	[enabled disabled]
Source	Value inherited from templates. Use custom template to set this value to disabled , if desired.
Applicability	IWS
Example:	<code>ouaf.jmx.com.oracle.ouaf.ws.mbeans.WSFlushBean=enabled</code>

ouaf.jmx.com.splwg.base.support.management.mbean.JVMInfo - JVM Information

Parameter	ouaf.jmx.com.splwg.base.support.management.mbean.JVMInfo
Description	Enables or disables the JVMInfo mbean used for the online JMX monitoring. Refer to the Web Application Server JMX interface for more information. This parameter is only enabled if the JMX interface is enabled.
Ordinality	Mandatory
Valid Values	[enabled disabled]
Source	Value inherited from templates. Use custom template to set this value to disabled , if desired.
Applicability	WEB
Example:	<code>ouaf.jmx.com.splwg.base.support.management.mbean.JVMInfo=enabled</code>

ouaf.jmx.com.splwg.base.web.mbeans.FlushBean - Manage Cache

Parameter	ouaf.jmx.com.splwg.base.web.mbeans.FlushBean
Description	Enables or disables the mbean to reset the online data cache manually.

Refer to the [Web Application Server JMX interface](#) for more information.
This parameter is only enabled if the JMX interface is enabled.

Ordinality	Mandatory
Valid Values	[enabled disabled]
Source	Value inherited from templates. Use custom template to set this value to disabled , if desired.
Applicability	WEB
Example:	<code>ouaf.jmx.com.splwg.base.web.mbeans.FlushBean=enabled</code>

ouaf.list.buffer.limit - List Iteration limit

Parameter	ouaf.list.buffer.limit
Description	The number of iterations a list is allowed to be read before being truncated. A default of 30 is used, if none or an invalid value is specified for this property.
Ordinality	Optional
Valid Values	Value between 0 - 256
Source	Value inherited from JEE container. Use custom template to set this value, if alternative desired
Applicability	BAS
Example:	<code>ouaf.list.buffer.limit=30</code>

ouaf.messaging.transformerfactory - Transformer

Parameter	ouaf.messaging.transformerfactory
Description	Sets the transformation factory for the real time adapters. This parameter is only set if requested by Oracle Support.
Ordinality	Optional
Valid Values	Set to one of the following values: com.sun.org.apache.xml.internal.xsltc.trax.TransformerFactoryImpl org.apache.xml.xsltc.trax.TransformerFactoryImpl
Source	Value inherited from JEE container. Use custom template to set this value, if alternative desired
Applicability	BAS BATCH
Example:	<code>ouaf.messaging.transformerfactory = org.apache.xml.xsltc.trax.TransformerFactoryImpl</code>

ouaf.shortcut.ignore.altKeys - Disable Hot Keys

Parameter	ouaf.shortcut.ignore.altKeys
-----------	-------------------------------------

Description	Allows specific hot keys to be disabled to support specific keyboard layouts (e.g. Polish keyboards).
Ordinality	Optional
Valid Values	Comma separated list of keys to disable
Source	Set within template. Use the spl.properties.root.exit.include user exit to set this value.
Applicability	WEB
Example:	ouaf.shortcut.ignore.altKeys=C, L

ouaf.timeout.business_object.default - Set Default Business Object Timeout

Parameter	ouaf.timeout.business_object.default
Description	Sets the default timeout (in seconds) for Business Objects. Refer to Online Transaction Timeouts for more information.
Ordinality	Optional
Valid Values	1 - 2147483647
Source	Use the spl.properties.service.timeouts.exit.include user exit to set this value as outlined in Online Transaction Timeouts .
Applicability	BAS
Example:	ouaf.timeout.business_object.default=10

ouaf.timeout.business_object.<bocode> - Set Specific Business Object Timeout

Parameter	ouaf.timeout.business_object.<bocode>
Description	<p>Sets the timeout (in seconds) for Business Object designated by <i><bocode></i> which corresponds to the Business Object Name. This overrides the ouaf.timeout.business_object.default setting for the indicated business object. Refer to Online Transaction Timeouts for more information.</p> <p>To find valid values for Business Objects, use the Business Object Maintenance function or use the following SQL:</p> <pre>SELECT bus_obj_cd, descr FROM f1_bus_obj_l where language_cd = 'ENG' ;</pre> <p>The LANGUAGE_CD in the above query can be altered to other languages for language packs installed.</p>
Ordinality	Optional
Valid Values	1 - 2147483647
Source	Use the spl.properties.service.timeouts.exit.include user exit to set this value as outlined in Online Transaction Timeouts .

Applicability	BAS
Example:	<code>ouaf.timeout.business_object.CMUser=10</code>

ouaf.timeout.business_service.default - Set Default Business Service Timeout

Parameter	<code>ouaf.timeout.business_service.default</code>
Description	Sets the default timeout (in seconds) for Business Services. Refer to Online Transaction Timeouts for more information.
Ordinality	Optional
Valid Values	1 - 2147483647
Source	Use the <code>spl.properties.service.timeouts.exclude_user_exit</code> to set this value as outlined in Online Transaction Timeouts .
Applicability	BAS
Example:	<code>ouaf.timeout.business_service.default=10</code>

ouaf.timeout.business_service.<bscode> - Set Specific Business Service Timeout

Parameter	<code>ouaf.timeout.business_service.<bscode></code>
Description	<p>Sets the timeout (in seconds) for Business Service designated by <code><bscode></code> which corresponds to the Business Service Name. This overrides the <code>ouaf.timeout.business_service.default</code> setting for the indicated business service. Refer to Online Transaction Timeouts for more information.</p> <p>To find valid values for Business Services, use the Business Service Maintenance function or use the following SQL:</p> <pre>SELECT bus_svc_cd, descr FROM f1_bus_svc_l where language_cd = 'ENG' ;</pre> <p>The LANGUAGE_CD in the above query can be altered to other languages for language packs installed</p>
Ordinality	Optional
Valid Values	1 - 2147483647
Source	Use the <code>spl.properties.service.timeouts.exclude_user_exit</code> to set this value as outlined in Online Transaction Timeouts .
Applicability	BAS
Example:	<code>ouaf.timeout.business_service.F1-EmailService=10</code>

ouaf.timeout.query.default - Set Default Query Timeout

Parameter	<code>ouaf.timeout.query.default</code>
-----------	---

Description	Sets the default timeout (in seconds) for query zones (searches and lists). Refer to Online Transaction Timeouts for more information. Use the Zone maintenance function to determine valid values. This setting only applies to the following zone types: F1-DE, F1-DE-MULQRY, F1-DE-QUERY and F1-DE-SINGLE
Ordinality	Optional
Valid Values	1 - 2147483647
Source	Use the spl . properti es. servi ce. ti meouts. exi t. i ncl ude user exit to set this value as outlined in Online Transaction Timeouts .
Applicability	BAS
Example:	ouaf. ti meout. query. defaul t=10

ouaf.timeout.query.<zonecode> - Set Specific Query Timeout

Parameter	ouaf. ti meout. query. <zonecode>
Description	Sets the timeout (in seconds) for the online query zone designated by <zonecode> which corresponds to the Query Zone. This overrides the ouaf. ti meout. query. defaul t setting for the indicated query zone. Refer to Online Transaction Timeouts for more information. This setting only applies to the following zone types: F1-DE, F1-DE-MULQRY, F1-DE-QUERY and F1-DE-SINGLE Use the Zone maintenance function to determine valid values. Alternatively it is possible to use SQL to find the ZONE_CD's <zonecode> : <pre>SELECT z. zone_cd, d. descr, z. zone_hdl_cd FROM ci_zone z, ci_zone_l d WHERE z. zone_hdl_cd LIKE ' F1-DE%' AND z. zone_cd = d. zone_cd AND d. language_cd = ' ENG' ;</pre> The LANGUAGE_CD in the above query can be altered to other languages for language packs installed.
Ordinality	Optional
Valid Values	1 - 2147483647
Source	Use the spl . properti es. servi ce. ti meouts. exi t. i ncl ude user exit to set this value as outlined in Online Transaction Timeouts .
Applicability	BAS
Example:	ouaf. ti meout. busi ness_servi ce. F1-MSTCFGLS=10

ouaf.timeout.script.default - Set Default Script Timeout

Parameter	ouaf. ti meout. scri pt. defaul t
-----------	--

Description	Sets the default timeout (in seconds) for Scripts. Refer to Online Transaction Timeouts for more information.
Ordinality	Optional
Valid Values	1 - 32767
Source	Use the spl . properties . service . timeouts . exit . include user exit to set this value as outlined in Online Transaction Timeouts .
Applicability	BAS
Example:	ouaf . timeout . script . default t=10

ouaf.timeout.script.<scriptname> - Set Specific Script Timeout

Parameter	ouaf . timeout . script . <scriptname>
Description	Sets the timeout (in seconds) for Scripts designated by <scriptname> which corresponds to the Script Name. This overrides the ouaf . timeout . script . default t setting for the indicated script. Refer to Online Transaction Timeouts for more information.
	<i>Note: This timeout does not apply to plug-in scripts.</i>
	To find valid values for Script, use the Script Maintenance function or use the following SQL: <pre>SELECT s. scr_cd, d. descr254 FROM ci_scr s, ci_scr_l d where s. scr_cd = d. scr_cd and s. scr_type_flg in ('BPSC', 'SVSC') and d. language_cd = 'ENG';</pre> The LANGUAGE_CD in the above query can be altered to other languages for language packs installed
Ordinality	Optional
Valid Values	1 - 2147483647
Source	Use the spl . properties . service . timeouts . exit . include user exit to set this value as outlined in Online Transaction Timeouts .
Applicability	BAS
Example:	ouaf . timeout . script . F1-ViewWSDL=10

ouaf.timeout.service.default - Set Default Service Timeout

Parameter	ouaf . timeout . service . default t
Description	Sets the default timeout (in seconds) for Application Services. Refer to Online Transaction Timeouts for more information.
Ordinality	Optional
Valid Values	1 - 2147483647

Source	Use the spl.properties.service.timeouts.exit.include user exit to set this value as outlined in Online Transaction Timeouts .
Applicability	BAS
Example:	<code>ouaf.timeout.service.default=10</code>

ouaf.timeout.service.<service> - Set Specific Service Timeout

Parameter	ouaf.timeout.service.<service>
Description	<p>Sets the timeout (in seconds) for Application Services designated by <service> which corresponds to the Application Service Name. This overrides the ouaf.timeout.service.default setting for the indicated Application Service. Refer to Online Transaction Timeouts for more information.</p> <p>To find valid values for Application Service, use the Application Service Maintenance function or use the following SQL:</p> <pre>SELECT SVC_NAME, DESCR from CI_MD_SVC_L where language_cd = 'ENG' ;</pre> <p>The LANGUAGE_CD in the above query can be altered to other languages for language packs installed</p>
Ordinality	Optional
Valid Values	1 - 2147483647
Source	Use the spl.properties.service.timeouts.exit.include user exit to set this value as outlined in Online Transaction Timeouts .
Applicability	BAS
Example:	<code>ouaf.timeout.service.CILTUSEP=10</code>

ouaf.web.appViewer.coreAppURL - AppViewer callback URL

Parameter	ouaf.web.appViewer.coreAppURL
Description	URL for AppViewer to navigate back to the product.
Ordinality	Mandatory
Valid Values	Generated URL from WEB_WLHOST , WEB_WLPORT , WEB_WLSSLPORT and WEB_CONTEXT_ROOT .
Source	Value inherited from templates. Use custom templates to set this value to desired value.
Applicability	WEB
Example:	<code>ouaf.web.appViewer.coreAppURL=http://localhost:6500/ouaf/loginPage.jsp#fromAppViewer</code>

ouaf.web.disablePreload - Disable Screen Preload

Parameter	ouaf.web.disablePreload
Description	Enables or disables screen preloading at startup. Screens that are preloaded are autoloaded at startup rather than at first use, saving time at runtime for first use transactions. This parameter works in conjunction with ouaf.web.preloadAllPages . It is highly recommended to set this value to false (default) for Production Environments. It is only suggested to set this to true in development environments that are used in conjunction with the Oracle Utilities SDK.
Ordinality	Mandatory
Valid Values	[true false]
Source	Derived from WEB_ISDEVELOPMENT parameter from ENVIRON.INI . It is highly recommended to set to the default unless otherwise recommended
Applicability	WEB
Example:	<code>ouaf.web.help.coreAppURL=http://localhost:6500/ouaf/loginPage.jsp</code>

ouaf.web.help.coreAppURL - Help callback URL

Parameter	ouaf.web.help.coreAppURL
Description	URL for Help to navigate back to the product.
Ordinality	Mandatory
Valid Values	Generated URL from WEB_WLHOST , WEB_WLPORT , WEB_WLSSLPORT and WEB_CONTEXT_ROOT .
Source	Value inherited from templates. Use custom templates to set this value to desired value.
Applicability	WEB
Example:	<code>ouaf.web.help.coreAppURL=../.. /ouaf/loginPage.jsp</code>

ouaf.web.helpRootURL - Help URL

Parameter	ouaf.web.helpRootURL
Description	URL for Help for help requests from online.
Ordinality	Mandatory
Valid Values	Generated URL from WEB_WLHOST , WEB_WLPORT , WEB_WLSSLPORT and WEB_CONTEXT_ROOT .
Source	Value inherited from templates. Use custom templates to set this value to desired value.

Applicability	WEB
Example:	<code>ouaf.web.hel pRoot URL=/ouaf/hel p/</code>

ouaf.web.JspHeader.maxAge - JSP Age

Parameter	ouaf.web.JspHeader.maxAge
Description	Set the duration (in seconds) to screen HTML, in the client cache , from the product on the client browser.
Ordinality	Mandatory
Valid Values	As per JEE Standards . Default: 28850
Source	Derived from WEB_MAXAGE parameter from ENVIRON.INI . It is highly recommended to set to the default unless otherwise recommended.
Applicability	WEB
Example:	<code>ouaf.web.JspHeader.maxAge=28850</code>

ouaf.web.preloadAllPages - Preload Scope

Parameter	ouaf.web.preloadAllPages
Description	Set the scope of the preloading of pages. This parameter is only used if the ouaf.web.disablePreload is set to false . It is highly recommended to set this value to false (default) for all environments.
Ordinality	Mandatory
Valid Values	[true false] - Main menu only (false), Main menu and Administration menu (true)
Source	Derived from WEB_PRELOADALL parameter from ENVIRON.INI . It is highly recommended to set to the default unless otherwise recommended.
Applicability	WEB
Example:	<code>ouaf.web.preloadAllPages=false</code>

ouaf.web.useOHW - Use Oracle Help for Web engine

Parameter	ouaf.web.useOHW
Description	Use the Oracle Help for Web engine rather than the legacy SPLHelp engine. This setting is only applicable to Oracle WebLogic customers. Customers on IBM WebSphere must use the SPLHelp engine.
Ordinality	Mandatory
Valid Values	[true false]
Source	Value inherited from templates. Use custom template to set this value to

	false , if desired.
Applicability	WEB
Example:	<code>ouaf.web.use0HW=true</code>

ouaf.weblogic.enableDiagnostics - Enable ECID tracking

Parameter	ouaf.weblogic.enableDiagnostics
Description	Enables (true) or disable (false) ECID feature .
Ordinality	Mandatory
Valid Values	[true false]
Source	Value inherited from templates. Use custom template to set this value to true , if desired.
Applicability	WEB q
Example:	<code>ouaf.weblogic.enableDiagnostics = false</code>

ouaf.webservices.security.defaultPolicy – IWS customized security policy

Parameter	ouaf.webservices.security.defaultPolicy
Description	Sets the customized policy for the deployed IWS.
Ordinality	Mandatory
Valid Values	[true false]
Source	Value inherited from templates. Use custom template to set this value to true , if desired.
Applicability	WEB
Example:	<code>ouaf.weblogic.enableDiagnostics = false</code>

ouaf.ws.defaultUser - Default User for Web Services

Parameter	ouaf.ws.defaultUser
Description	Default user used for authorization for Inbound Web Services if no credentials are provided on the Web Service call. This is provided for backward compatibility for XML Application Integration customers. It is recommended not to be set at all, as to enforce stronger security for Web Services.
Ordinality	Optional

Valid Values	Valid authorization user for product. A null or blank value enforces security on each Web Service call.
Source	Defaulted from templates. Use custom templates to set this value to an alternative desired value.
Applicability	IWS
Example:	<code>ouaf.ws.defaultUser=AUSER</code>

ouaf.ws.deploy.appxml.file - Application XML file for Inbound Web Services

Parameter	ouaf.ws.deploy.appxml.file
Description	Location of application.xml file for Web Services.
Ordinality	Man
Valid Values	Valid Path and location.
Source	Derived from template. This should not be changed.
Applicability	IWS
Example:	<code>ouaf.ws.deploy.appxml.file=/spl/ouaf/iws/resources/application.xml</code>

ouaf.ws.deploy.ear - EAR file name for Inbound Web Services

Parameter	ouaf.ws.deploy.ear
Description	Name of EAR file used for Inbound Web Services
Ordinality	Optional
Valid Values	Valid authorization user for product. A null or blank value enforces security on each Web Service call.
Source	Derived from template Use custom templates to set this value to an alternative desired value
Applicability	IWS
Example:	<code>ouaf.ws.deploy.ear=WebServices.ear</code>

ouaf.ws.deploy.contextpath - Context Path for Inbound Web Services

Parameter	ouaf.ws.deploy.contextpath
Description	Default context path used for Inbound Web Services calls
Ordinality	Optional
Valid Values	Valid authorization user for product. A null or blank value enforces security on each Web Service call.
Source	Derived from template Use custom templates to set this value to an

	alternative desired value
Applicability	IWS
Example:	<code>ouaf.ws.deploy.contextpath=/ouaf/webservices/</code>

ouaf.ws.deploy.user - Web Services Deployment User

Parameter	ouaf.ws.deploy.user
Description	JEE Administration account used to deploy Inbound Web Services container. Password for this user is contained in keystore as outlined in Enabling Inbound Web Services .
Ordinality	Mandatory
Valid Values	Valid Administration account for JEE container.
Source	Derived from WLS_WEB_WLSYSUSER parameter from ENVIRON.INI . Use custom templates to set this value to an alternative desired value.
Applicability	IWS
Example:	<code>ouaf.ws.deploy.user=system</code>

ouaf.ws.pageService.annotations - Security Annotation for XAI Legacy services

Parameter	ouaf.ws.pageService.annotations
Description	The default security WS-Policy annotations attached for legacy page services (XAI) within IWS. To ensure backward compatibility, for customers using XAI legacy services, it is recommended to set this value to the default F1-USERNAM annotation.
Ordinality	Optional
Valid Values	Valid Web Service Annotation
Source	Defaulted from templates. Use custom templates to set this value to an alternative desired value.
Applicability	IWS
Example:	<code>ouaf.ws.pageService.annotations=F1-USERNAM</code>

ouaf.ws.superusers - Effective Web Services Users

Parameter	ouaf.ws.superusers
Description	Sets the effective users for Inbound Web Services. This allows credentials from foreign systems to use credentials from the product. This is only set to alternatives if effective users are used.
Ordinality	Mandatory

Valid Values	Valid comma separated list of credentials
Source	Derived from WEB_SPLUSER parameter from ENVIRON.INI . Use custom templates to set this value to an alternative desired value.
Applicability	IWS
Example:	<code>ouaf.ws.superusers=SYSUSER</code>

ouaf.ws.tools.artifact.generated.buildfile - Build File

Parameter	ouaf.ws.tools.artifact.generated.buildfile
Description	Location and name of ant build file used to generate the WAR file used for Inbound Web Services. This setting is used by the iwsdeploy.sh command as well as the online Inbound Web Services deployment tool.
Ordinality	Mandatory
Valid Values	Location and name of build file. Defaults to \$\$SPLEBASE/spl app/iws/iws-build.xml (or \$\$SPLEBASE%\spl app\iws\iws-build.xml on Windows)
Source	Derived from SPLDIR parameter from ENVIRON.INI . Use custom templates to set this value to an alternative desired value.
Applicability	IWS
Example:	<code>ouaf.ws.tools.artifact.generated.buildfile=/spl/OUAFDEMO/spl app/iws/iws-build.xml</code>

ouaf.ws.tools.artifact.generated.sourcedir - Location of generated source

Parameter	ouaf.ws.tools.artifact.generated.sourcedir
Description	Location of the source generated for Inbound Web Services during the Web Services deployment process.
Ordinality	Mandatory
Valid Values	Location of generated source directory. Defaults to \$\$SPLEBASE/spl app/iws/gen (or \$\$SPLEBASE%\spl app\iws\gen on Windows)
Source	Derived from SPLDIR parameter from ENVIRON.INI . Use custom templates to set this value to an alternative desired value.
Applicability	IWS
Example:	<code>ouaf.ws.tools.artifact.generated.sourcedir=/spl/OUAFDEMO/spl app/iws/gen</code>

ouaf.ws.tools.artifact.resource.dir - Location of 331resources

Parameter	ouaf.ws.tools.artifact.resource.dir
Description	Location of the resource files used in the generation of Inbound Web

	Services during the Web Services deployment process.
Ordinality	Mandatory
Valid Values	Location of resources used for Inbound Web Services. Defaults to \$\$SPLEBASE/spl app/i ws/resources (or \$\$SPLEBASE%\spl app\i ws\resources on Windows)
Source	Derived from SPLDIR parameter from ENVIRON.INI . Use custom templates to set this value to an alternative desired value.
Applicability	IWS
Example:	<code>ouaf.ws.tools.artifact.resource.dir=/spl/OUAFDEMO/spl app/i ws/resources</code>

ouaf.ws.tools.artifact.schema.dir - Location of Schemas

Parameter	ouaf.ws.tools.artifact.schema.dir
Description	Location of the schema files used in the generation of Inbound Web Services during the Web Services deployment process.
Ordinality	Mandatory
Valid Values	Location of schema files used for Inbound Web Services. Defaults to \$\$SPLEBASE/spl app/xai /schemas (or \$\$SPLEBASE%\spl app\xai \schemas on Windows)
Source	Derived from SPLDIR parameter from ENVIRON.INI . Use custom templates to set this value to an alternative desired value.
Applicability	IWS
Example:	<code>ouaf.ws.tools.artifact.schema.dir=/spl/OUAFDEMO/spl app/xai /schemas</code>

ouaf.ws.tools.artifact.xsl.dir - Web Service XSL Location

Parameter	ouaf.ws.tools.artifact.xsl.dir
Description	Location of the XSLT files used by Inbound Web Services during the Web Services deployment process. This parameter can be overridden using the ouaf.ws.xslDirOverride setting.
Ordinality	Mandatory
Valid Values	Location of XSLT files used for Inbound Web Services. Defaults to \$\$SPLEBASE/spl app/xai /schemas (or \$\$SPLEBASE%\spl app\xai \schemas on Windows). By default this value is shared with ouaf.ws.tools.artifact.schema.dir .
Source	Derived from SPLDIR parameter from ENVIRON.INI . Use custom templates to set this value to an alternative desired value.

Applicability	IWS
Example:	<code>ouaf.ws.tools.artifact.xml.dir=/spl/OUAFDEMO/splapp/xai/schemas</code>

ouaf.ws.tracing - Inbound Web Services Tracing

Parameter	ouaf.ws.tracing
Description	Enable or Disable tracing for Inbound Web Services.
Ordinality	Mandatory
Valid Values	[true false]
Source	Defaulted from templates. Use custom templates to set this value to an alternative desired value.
Applicability	IWS
Example:	<code>ouaf.ws.tracing=true</code>

ouaf.ws.xslDirOverride - Override XSL Location

Parameter	ouaf.ws.xslDirOverride
Description	Location of the XSLT files used by Inbound Web Services during the Web Services deployment process. This parameter overrides the ouaf.ws.tools.artifact.xml.dir setting.
Ordinality	Mandatory
Valid Values	Valid directories on server containing xsl For Windows environments, use the file protocol.
Source	Not set. Use custom templates to set this value to an alternative desired value.
Applicability	IWS
Examples:	<code>ouaf.ws.xslDirOverride=/temp</code> <code>ouaf.ws.xslDirOverride=file:///c:/temp</code>

ouaf.xai.HTTPBasicAuthPasswordEnc - Default XAI Password

Parameter	ouaf.xai.HTTPBasicAuthPasswordEnc
Description	Encrypted password for default application user for XML Application Integration .
Ordinality	Mandatory
Valid Values	Encrypted password for users.
Source	Derived from WEB_SPLPASS parameter from ENVIRON.INI .
Applicability	WEB

Example: `ouaf.xai.HTTPBasicAuthPasswordEnc=ENC(unj0oM7+zufXI5r6Q...)`

ouaf.xai.HTTPBasicAuthUser - Default XAI User

Parameter	ouaf.xai.HTTPBasicAuthUser
Description	Default application user for XML Application Integration.
Ordinality	Mandatory
Valid Values	Valid Application User
Source	Derived from WEB_SPLUSER parameter from ENVIRON.INI .
Applicability	WEB
Example:	<code>ouaf.xai.HTTPBasicAuthUser=SYSUSER</code>

ouaf.xai.XAIServerURL - Default XAI URL

Parameter	ouaf.xai.XAIServerURL
Description	Default URL for XML Application Integration.
Ordinality	Mandatory
Valid Values	Generated URL for XAI Server from WEB_WLHOST , WEB_WLPORT and WEB_CONTEXT_ROOT from ENVIRON.INI .
Source	Use custom templates to set this value to an alternative, if desired.
Applicability	WEB
Example:	<code>ouaf.xai.XAIServerURL=http://localhost:6500/ouaf/XAIApp/xaiserver</code>

spl.csv.delimiter.useFromDisplayProfile - List CSV delimiter

Parameter	spl.csv.delimiter.useFromDisplayProfile
Description	Enables or disables the display of the delimiter for CSV upload/downloads from zones.
Ordinality	Mandatory
Valid Values	[true false]
Source	Derived from template. Use custom templates to set this value to true , if desired.
Applicability	WEB
Example:	<code>spl.csv.delimiter.useFromDisplayProfile=false</code>

spl.ejbContainer.contextFactory - Context Factory for Business Application Server

Parameter	spl.ejbContainer.contextFactory
-----------	--

Description	Default JEE Context Factory to connect tiers.
Ordinality	Mandatory
Valid Values	Valid connection factory: <u>Oracle WebLogic:</u> <code>weblogic.jndi.WLInitialContextFactory</code> <u>IBM WebSphere/IBM WebSphere ND:</u> <code>com.ibm.websphere.naming.WsInitialContextFactory</code>
Source	Derived from template. Use custom templates to set this value to an alternative, if desired.
Applicability	WEB IWS
Example:	<code>spl.ejbContainer.contextFactory=weblogic.jndi.WLInitialContextFactory</code>

spl.ejbContainer.password - Password for Business Application Server

Parameter	spl.ejbContainer.password
Description	Default encrypted password for tier defined for Business Application Server connections.
Ordinality	Mandatory
Valid Values	Valid password encrypted Administration user
Source	<u>Oracle WebLogic:</u> <code>WEB_WLSYPASS</code> from ENVIRON.INI <u>IBM WebSphere/IBM WebSphere ND:</u> <code>WEB_WASPASS</code> from ENVIRON.INI Use custom templates to set this value to an alternative, if desired.
Applicability	WEB IWS
Example:	<code>spl.ejbContainer.password=ENC(Hi7/Rfy...)</code>

spl.ejbContainer.url - Business Application Server URL

Parameter	spl.ejbContainer.url
Description	URL to connect to the Business Application Server from the Web Application Server or Inbound Web Services.
Ordinality	Mandatory
Valid Values	Valid URL for: <u>Oracle WebLogic:</u> <code>t3://<server>:<port></code> or <code>t3s://<server>:<port></code> <u>IBM WebSphere/IBM WebSphere ND:</u> <code>iiop://<server>:<port></code>

Source	Derived from template. Use custom templates to set this value to an alternative, if desired.
Applicability	WEB IWS
Example:	<code>spl.ejbContainer.url = t3://localhost: 6500</code>

spl.ejbContainer.user - Business Application Server user

Parameter	spl.ejbContainer.user
Description	Administration user for Business Application server to connect to from the Web Application Server and Inbound Web Services.
Ordinality	Mandatory
Valid Values	Valid Administration User on JEE Server
Source	Oracle WebLogic: WEB_WLSYSUSER from ENVIRON.INI IBM WebSphere/IBM WebSphere ND: WEB_WASUSER from ENVIRON.INI Use custom templates to set this value to an alternative, if desired.
Applicability	WEB IWS
Example:	<code>spl.ejbContainer.user=system</code>

spl.geocodeDatasource.contextFactory - GIS Context Factory

Parameter	spl.geocodeDatasource.contextFactory
Description	Default JEE Context Factory to connect to GIS. This option will only be enabled if GIS is set to true in the ENVIRON.INI .
Ordinality	Mandatory
Valid Values	Valid connection factory: Oracle WebLogic: webl ogi c. j ndi . WLI ni ti al Context Factory IBM WebSphere/IBM WebSphere ND: com. i bm. websphere. nami ng. WsnI ni ti al Context Factory
Source	Derived from template. Use custom templates to set this value to an alternative, if desired.
Applicability	WEB BAS BATCH
Example:	<code>spl.geocodeDatasource.contextFactory=webl ogi c. j ndi . WLI ni ti al Context Factory</code>

spl.geocodeDatasource.password - GIS Connection Password

Parameter	spl.geocodeDatasource.password
-----------	---------------------------------------

Description	Encrypted password for GIS connection for spl.geocodeDataSource.user . This option will only be enabled if GIS is set to true in the ENVIRON.INI .
Ordinality	Mandatory
Valid Values	Encrypted password for GIS.
Source	Derived from GIS_WLSYSPASS from ENVIRON.INI
Applicability	WEB BAS BATCH
Example:	spl.geocodeDataSource.password=ENC(Hi 7/RFy...)

spl.geocodeDataSource.url - GIS Data Source

Parameter	spl.geocodeDataSource.url
Description	JNDI name for GIS Data Source. This option will only be enabled if GIS is set to true in the ENVIRON.INI .
Ordinality	Mandatory
Valid Values	Valid JNDI path for GIS Data Source
Source	Derived from GIS_WLSYSUSER from ENVIRON.INI
Applicability	WEB BAS BATCH
Example:	spl.geocodeDataSource.url=t3://localhost:7666/jdbc/gisdb

spl.geocodeDataSource.user - GIS Connection User

Parameter	spl.geocodeDataSource.user
Description	Valid JNDI user for GIS connection. This option will only be enabled if GIS is set to true in the ENVIRON.INI .
Ordinality	Mandatory
Valid Values	Encrypted password for GIS.
Source	Derived from GIS_WLSYSUSER from ENVIRON.INI
Applicability	WEB BAS BATCH
Example:	spl.geocodeDataSource.user=gisadmin

spl.mwm.abr.contextFactory - ABR Context Factory

Parameter	spl.mwm.abr.contextFactory
Description	Default JEE Context Factory to connect to Appointment Booking Reservation (ABR) component.
Ordinality	Mandatory
Valid Values	Valid connection factory:

Oracle WebLogic:

webl ogi c. j ndi . WLI ni ti al ContextFactory

IBM WebSphere/IBM WebSphere ND:

com. i bm. websphere. nami ng. WsnI ni ti al ContextFactory

Source Derived from **CONTEXTFACTORY** from [ENVIRON. INI](#)

Applicability **MOB**

Example: **spl . mwm . abr . contextFactory=webl ogi c. j ndi . WLI ni ti al ContextFactory**

spl.mwm.abr.password - ABR Connection Password

Parameter **spl . mwm . abr . password**

Description Encrypted password for Appointment Booking Reservation (ABR) component connection for [spl . mwm . abr . user](#).

Ordinality Mandatory

Valid Values Encrypted password for ABR.

Source Derived from **WLS_PASSWORD** from [ENVIRON. INI](#)

Applicability **MOB**

Example: **spl . mwm . abr . password=ENC(Hi 7/RFy...)**

spl.mwm.abr.timeout - Timeout for ABR

Parameter **spl . mwm . abr . ti meout**

Description Connection timeout, in seconds, for Appointment Booking Reservation (ABR) component.

Ordinality Mandatory

Valid Values 1 - 2147483647 (Default: 120000)

Source Derived from **TIMEOUT** from [ENVIRON. INI](#)

Applicability **MOB**

Example: **spl . mwm . abr . ti meout=120000**

spl.mwm.abr.url - ABR URL

Parameter **spl . mwm . abr . url**

Description URL to connect to the Appointment Booking Reservation (ABR) component.

Ordinality Mandatory

Valid Values Valid URL for:
Oracle WebLogic:

	t3: //<server>: <port> or t3s: //<server>: <port>
	<u>IBM WebSphere/IBM WebSphere ND:</u>
	iiop: //<server>: <port>
Source	Derived from URL from ENVIRON. INI
Applicability	MOB
Example:	spl.abr.url = t3://localhost:7751

spl.mwm.abr.userid - ABR Connection User

Parameter	spl.mwm.abr.user
Description	Valid JNDI user for Appointment Booking Reservation (ABR) component connection.
Ordinality	Mandatory
Valid Values	Encrypted connection user for GIS.
Source	Derived from WLS_USERID from ENVIRON. INI
Applicability	MOB
Example:	spl.mwm.abr.userid=ENC(ho4tqPhP...)

spl.mwm.scheduler.abr.maxProcessingTime - Processing Time for ABR

Parameter	spl.mwm.scheduler.abr.maxProcessingTime
Description	Transaction timeout, in seconds, for each appointment booking processed by Appointment Booking Reservation (ABR) component.
Ordinality	Mandatory
Valid Values	1 - 2147483647 (Default: 5)
Source	Derived from MAXPROCESSINGTIME from ENVIRON. INI
Applicability	MOB
Example:	spl.mwm.scheduler.abr.maxProcessingTime=5

spl.mwm.scheduler.abr.minRequests - Initial Scheduler Pool Size

Parameter	spl.mwm.scheduler.abr.minRequests
Description	Initial request pool size for Appointment Booking Reservation (ABR) component.
Ordinality	Mandatory
Valid Values	1 - 2147483647 (Default: 1)
Source	Derived from MINREQUESTS from ENVIRON. INI
Applicability	MOB

Example: `spl.mwm.scheduler.abr.minRequests=1`

spl.mwm.scheduler.cleanser.interval - Scheduler Cache Clense

Parameter **spl.mwm.scheduler.cleanser.interval**

Description Prefresh time, in seconds, for scheduler cache with product.

Ordinality Mandatory

Valid Values 1 - 2147483647 (Default: 900)

Source Derived from **CLEANSE_INTERVAL** from [ENVIRON.INI](#)

Applicability **MOB**

Example: `spl.mwm.scheduler.cleanser.interval=900`

spl.mwm.scheduler.connectionTimeout - Scheduler Connection Timeout

Parameter **spl.mwm.scheduler.connectionTimeout**

Description Connection timeout, in seconds, between product and scheduler.

Ordinality Mandatory

Valid Values 1 - 2147483647 (Default: 300000)

Source Derived from **SCHED_CONN_TIMEOUT** from [ENVIRON.INI](#)

Applicability **MOB**

Example: `spl.mwm.scheduler.connectionTimeout=300000`

spl.mwm.scheduler.maintenanceCycleTime - Scheduler Integrity Check

Parameter **spl.mwm.scheduler.maintenanceCycleTime**

Description Time, in seconds, between scheduler integrity checks.

Ordinality Mandatory

Valid Values 1 - 2147483647 (Default: 300)

Source Derived from **SCHED_CYCLE_TIMEOUT** from [ENVIRON.INI](#)

Applicability **MOB**

Example: `spl.mwm.scheduler.maintenanceCycleTime=300`

spl.mwm.scheduler.mapDir - Map Directory

Parameter **spl.mwm.scheduler.mapDir**

Description Location of Map files if external maps are used.

Ordinality Mandatory

Valid Values	Valid Directory
Source	Derived from MAPDIR from ENVIRON.INI
Applicability	MOB
Example:	<code>spl.mwm.scheduler.mapDir=/spl/splapp/OUAFDEMO/sploutput</code>

spl.mwm.scheduler.nodeId - Scheduler Node

Parameter	spl.mwm.scheduler.nodeId
Description	Node Identifier for Scheduler. This setting is used for backward compatibility only as Scheduler now dynamically determines nodes.
Ordinality	Mandatory
Valid Values	Valid Node Id (If used must match Scheduler object)
Source	Derived from NODEID from ENVIRON.INI
Applicability	MOB
Example:	<code>spl.mwm.scheduler.nodeId=MyNode</code>

spl.runtime.mwm.scheduler.ipcStartPort - IPC Start Port

Parameter	spl.runtime.mwm.scheduler.ipcStartPort
Description	Starting port number for Inter Process Communication (IPC) between the scheduler and products.
Ordinality	Mandatory
Valid Values	Valid port numbers. Schedulers allocate port numbers starting from this number.
Source	Derived from IPCSTARTPORT from ENVIRON.INI
Applicability	MOB
Example:	<code>spl.runtime.mwm.scheduler.ipcStartPort=7568</code>

spl.runtime.compatibility.uiMapDisableInputValue - Map Defaults

Parameter	spl.runtime.compatibility.uiMapDisableInputValue
Description	<p>Enables or disables compatibility behavior with Oracle Utilities Application Framework V2.1 in relation to blanking out default values in screens.</p> <p>Setting this value to true will emulate Oracle Utilities Application Framework V2.1 behavior.</p> <p>This setting is only applicable to customers who are upgrading from Oracle Utilities Application Framework V2.1 and wish to retain that behavior.</p>
Ordinality	Optional

Valid Values	[true false]
Source	Manually set. Use user exit spl . properti es. exi t. i ncl ude to set this value to true , if desired
Applicability	WEB
Example:	spl . runti me. compati bi li ty. ui MapDi sabl eInputVal ue=fal se

spl.runtime.compatibility.uiMapDropdownSelectFirstValue - Dropdown defaults

Parameter	spl . runti me. compati bi li ty. ui MapDropdownSel ectFi rstVal ue
Description	Enables or disables compatibility behavior with Oracle Utilities Application Framework V2.1 in relation to defaulting to the first value in dropdownlist. Setting this value to true will emulate Oracle Utilities Application Framework V2.1 behavior. This setting is only applicable to customers who are upgrading from Oracle Utilities Application Framework V2.1 and wish to retain that behavior.
Ordinality	Optional
Valid Values	[true false]
Source	Manually set. Use user exit spl . properti es. exi t. i ncl ude to set this value to true , if desired
Applicability	WEB
Example:	spl . runti me. compati bi li ty. ui MapDropdownSel ectFi rstVal ue=fal se

spl.runtime.compatibility.uiMapDisableTitle - Screen Title Defaults

Parameter	spl . runti me. compati bi li ty. ui MapDi sabl eTi tle
Description	Enables or disables compatibility behavior with Oracle Utilities Application Framework V2.1 in relation to rendering screen titles. Setting this value to true will emulate Oracle Utilities Application Framework V2.1 behavior. This setting is only applicable to customers who are upgrading from Oracle Utilities Application Framework V2.1 and wish to retain that behavior.
Ordinality	Optional
Valid Values	[true false]
Source	Manually set. Use user exit spl . properti es. exi t. i ncl ude to set this value to true , if desired
Applicability	WEB
Example:	spl . runti me. compati bi li ty. ui MapDi sabl eTi tle=fal se

spl.runtime.compatibility.uiMapDisableGenerateUniqueHtmlIDs - Map Ids

Parameter	spl . runtime . compati bility . ui MapDi sabl eGenerateUni queHtml IDs
Description	<p>Enables or disables compatibility behavior with Oracle Utilities Application Framework V2.x in relation to generating an unique idenitifer's for HTML for duplicate elements in the screen. In Oracle Utilities Application Framework V2.x (true), duplicate HTML ids were permitted on screen elements. In Oracle Utilities Application Framework V4.x (false), unique ids are generated for screen elements by default.</p> <p>Setting this value to true will emulate Oracle Utilities Application Framework V2.x behavior.</p> <p>This setting is only applicable to customers who are upgrading from Oracle Utilities Application Framework V2.x and wish to retain that behavior.</p>
Ordinality	Optional
Valid Values	[true false]
Source	Manually set. Use user exit spl . properti es . exit . i nclude to set this value to true , if desired
Applicability	WEB
Example:	spl . runtime . compati bility . ui MapDi sabl eGenerateUni queHtml IDs=false

spl.runtime.customSQLSecurity – Enable SQL Whitelist

Parameter	spl . runtime . customSQLSecuri ty
Description	<p>Enables or disables SQL whitelist validations for CM data explorer zones.</p> <p>Setting this to true will restrict the SQL in CM data explorer zone to the whitelist.</p> <p>Setting this to false will not restrict the SQL in CM data explorer zones.</p>
Ordinality	Mandatory
Valid Values	[true false]
Source	Manually set.
Applicability	WEB
Example:	spl . runtime . customSQLSecuri ty=false

spl.runtime.disableCSRFProtection - Disable Security Tokens

Parameter	spl . runtime . di sabl eCSRFProtecti on
Description	Enables or disables security token support for testing purposes with testing tools that do not support security tokens.

It is highly recommended that this configuration setting be set to **false** in all environments, especially Production.

It should only be set to **true** in testing environments where test tools are used and the test tool used does not support security tokens.

Ordinality	Optional
Valid Values	[true false]
Source	Manually set. Use user exit spl . properti es. exi t. i ncl ude to set this value to true , if desired
Applicability	WEB
Example:	spl . runt i me. di sabl eCSRFPprotect i on=false

spl.runtime.envIRON.INIT.DIR - Location of Configuration Files

Parameter	spl . runt i me. envi ron. i ni t. di r
Description	Location of the configuration files used for the product. This is used to allow the product to read configuration files at runtime to determine behavior.
Ordinality	Mandatory
Valid Values	URL is derived from spl . runt i me. envi ron. SPLEBASE with the etc directory appended.
Source	Derived from ci stab file.
Applicability	WEB BAS IWS
Example:	spl . runt i me. envi ron. i ni t. di r=/spl /OUAFDEMO/etc

spl.runtime.envIRON.ISWEBEXPANDED - Expanded Mode

Parameter	spl . runt i me. envi ron. i sWebExpanded
Description	Determines whether WAR/EAR files are built [false] or as expanded directories [true]. The expanded mode is used for development purposes only and is only supported on Oracle WebLogic. It is recommended to set this to false to use WAR/EAR files for deployment.
Ordinality	Mandatory
Valid Values	[true false]
Source	Derived from WEB_I SXPANDED parameter from ENVI RON. I NI.
Applicability	WEB BAS
Example:	spl . runt i me. envi ron. i sWebExpanded=false

spl.runtime.envIRON.SPLEBASE - Location Of Software

Parameter	spl . runtime . envi ron . SPLEBASE
Description	Home directory of the product installation
Ordinality	Mandatory
Valid Values	Full expanded directory on machine
Source	Derived from ci stab file.
Applicability	WEB BAS IWS XAI BATCH
Example:	spl . runtime . envi ron . SPLEBASE=/spl /OUAFDEMO

spl.runtime.initialize.waittime - Start Time Delay

Parameter	spl . runtime . ini tial ize . wai tti me
Description	Delay Time (in seconds) for start of application from initiation time. This is used to delay startup to ensure downstream connections are established prior to startup.
Ordinality	Optional
Valid Values	0 - 3000 (Default: 45)
Source	Derived from templates. Use custom templates to set this value to an alternative, if desired
Applicability	IWS
Example:	spl . runtime . ini tial ize . wai tti me = 45

spl.runtime.envIRON.SPLOUTPUT - Location Of Output

Parameter	spl . runtime . envi ron . SPLOUTPUT
Description	Home directory of the product output
Ordinality	Mandatory
Valid Values	Full expanded directory on machine
Source	Derived from ci stab file.
Applicability	WEB BAS IWS XAI BATCH
Example:	spl . runtime . envi ron . SPLEBASE=/spl /spl app/OUAFDEMO

spl.runtime.management.batch.cluster.url - Batch Cluster URL

Parameter	spl . runtime . management . batch . cl uster . url
Description	URL for the Batch Cluster

Ordinality	Mandatory
Valid Values	Valid URL for Batch Cluster
Source	Derived from WEB_BATCH_CLUSTER_URL parameter from ENVIRON.INI .
Applicability	WEB
Example:	<code>spl.runtime.management.batch.cluster.url =</code>

spl.runtime.management.connector.url.default - JMX URL

Parameter	spl.runtime.management.connector.url.default
Description	JMX formatted URL to be used for JMX based monitoring .
Ordinality	Optional
Valid Values	URL is generated from the following settings: <u>Web Application Server</u> WEB_WLHOST and WEB_JMX_RMI_PORT_PERFORMANCE <u>Business Application Server</u> BSN_WLHOST and BSN_JMX_RMI_PORT_PERFORMANCE <u>Inbound Web Services</u> BSN_WLHOST and BSN_JMX_RMI_PORT_PERFORMANCE
Source	Derived from ENVIRON.INI file.
Applicability	WEB BAS IWS
Example:	<code>spl.runtime.envi ron.SPLEBASE= service:j mx:rmi : ///j ndi /rmi : //l ocal host : 1100/oracl e/ouaf /ej bAppConnect or</code>

spl.runtime.management.rmi.port - JMX Port

Parameter	spl.runtime.management.rmi.port
Description	Port number to be used for JMX based monitoring .
Ordinality	Optional
Valid Values	Port Number is generated from the following settings: <u>Web Application Server</u> WEB_JMX_RMI_PORT_PERFORMANCE <u>Business Application Server</u> BSN_JMX_RMI_PORT_PERFORMANCE <u>Inbound Web Services</u> BSN_JMX_RMI_PORT_PERFORMANCE <u>Batch</u> BATCH_RMI_PORT
Source	Derived from ENVIRON.INI file.

Applicability	WEB BAS IWS
Example:	<code>spl.runtime.management.rmi.port=1100</code>

spl.runtime.options.isFCFEnabled - RAC FCF enabled

Parameter	spl.runtime.options.isFCFEnabled
Description	Enable or Disable RAC Fast Connection Failover support for database connections. Oracle Notification Services configuration is set by the spl.runtime.options.onserver=nodes parameter.
Ordinality	Mandatory
Valid Values	[true false]
Source	Derived from ONSCONFIG parameter from ENVIRON.INI .
Applicability	BAS BATCH
Example:	<code>spl.runtime.options.isFCFEnabled=false</code>

spl.runtime.options.onserver=nodes - ONS Configuration

Parameter	spl.runtime.options.onserver=nodes
Description	Specify the Oracle Notification Services (ONS) configuration for Fast Connection Failover support for database connections. Refer to the Oracle Notification Services documentation for details of ONS setup and values for this setting.
Ordinality	Mandatory
Valid Values	Valid ONS configuration string (without the nodes= prefix)
Source	Derived from ONSCONFIG parameter from ENVIRON.INI .
Applicability	BAS BATCH
Example:	<code>spl.runtime.options.onserver=nodes=racnode1: 4200, racnode2: 4200\nwalletfile= /oracle11/onwalletfile</code>

spl.runtime.options.allowSystemDateOverride - Set Testing Date

Parameter	spl.runtime.options.allowSystemDateOverride
Description	Allows the user of system test date override feature for testing. Refer to the Setting the Date for testing purposes for more information. It is highly recommended that this setting should be set to false in Production environments.
Ordinality	Mandatory
Valid Values	[true false]
Source	Manually set. Use custom templates to set this value to true, if desired.

Applicability	WEB BAS
Example:	<code>spl.runtime.options.allowSystemDateOverride=false</code>

`spl.runtime.options.createSimpleWebApplicationContextEnable` - Web Cache Loading

Parameter	<code>spl.runtime.options.createSimpleWebApplicationContextEnable</code>
Description	<p>Enables or disables cache loading from Web Application Server. Setting this value to true will load the server cache through the Business Application Server. If the cache loading, is desired to be loaded within each tier then set this value to false.</p> <p>It is highly recommended that this setting should be set to true in Production environments.</p>
Ordinality	Optional
Valid Values	[true false]
Source	Manually set. Use user exit <code>spl.properties.exit.include</code> to set this value to false , if desired.
Applicability	WEB
Example:	<code>spl.runtime.options.createSimpleWebApplicationContextEnable=false</code>

`spl.runtime.options.isDevelopmentMode` - Development Mode

Parameter	<code>spl.runtime.options.isDevelopmentMode</code>
Description	<p>Enables or disables Development Mode for the product. Development mode disables and enables key features within the architecture to allow the Oracle Utilities SDK to be used optimally. The following settings are affected by this parameter:</p> <ul style="list-style-type: none"> • Caching is disabled at all layers of the architecture. This can be reenabled manually. • Screen Preloading is disabled. This can be reenabled manually. • Compression is disabled at all layers of the architecture. This can be reenabled manually. • The product is set to expanded mode to allow developers access to individual JEE objects rather than using WAR/EAR files. <p>It is highly recommended that this setting should be set to false in Production environments.</p> <p>This setting is only set to true where the Oracle Utilities SDK is used directly.</p>
Ordinality	Mandatory
Valid Values	[true false]
Source	Derived from WEB_I SDEVELOPMENT parameter from ENVIRON.INI .

Applicability **WEB** **BAS** **IWS** **XAI**
 Example: `spl.runtime.options.isDevelopmentMode=false`

spl.runtime.oracle.statementCacheSize - Java SQL Cache Size

Parameter **spl.runtime.oracle.statementCacheSize**
 Description Number of SQL statement cached for Java based code.
 It is highly recommended not to alter this value unless otherwise advised by Oracle Support.
 Ordinality Mandatory
 Valid Values 1 - 2147483647 (Default: 300)
 Source Derived from templates. Use [custom templates](#) to set this value to an alternative, if desired
 Applicability **WEB** **BAS** **BATCH**
 Example: `spl.runtime.oracle.statementCacheSize=300`

spl.runtime.performSignedNumberValidation.<product> - Number Validation

Parameter **spl.runtime.performSignedNumberValidation.<product>**
 Description Unsigned Number Validation routine used by product. By default a F1 based routine is provided and this setting allows products to provide their own processing.
 This setting is provided for products only. Implementations should not set this value.
 Ordinality Optional
 Valid Values [true|false]
 Source Derived from templates. Use [user](#) [exit](#) **spl.properties.service.exit.include** and **spl.properties.standalone.exit.include** to set this value to an alternative, if desired.
 Applicability **BAS** **BATCH**
 Example: `spl.runtime.performSignedNumberValidation.F1=true`

spl.runtime.service.extraInstallationServices - Installation Service

Parameter **spl.runtime.service.extraInstallationServices**
 Description Specifies the internal service used for checking the installation records at startup time.
 This setting is used by the products, it is not recommended to be altered, unless otherwise directed by Oracle Support.

Ordinality	Optional
Valid Values	Service Name
Source	By default the service CILTINCP is used internally
Applicability	WEB
Example:	<code>spl.runtime.service.extraInstallationServices=CILTINCP</code>

spl.runtime.sql.highValue - SQL High Value

Parameter	spl.runtime.sql.highValue
Description	The high value used for parameters by SQL queries. It is highly recommended not to alter this value unless otherwise advised by Oracle Support.
Ordinality	Mandatory
Valid Values	Valid high value generated by installer.
Source	Derived from the HIGHVALUE setting in the ENVIRON.INI
Applicability	WEB BAS BATCH
Example:	<code>spl.runtime.sql.highValue=\uF8FF</code>

spl.runtime.utf8Database - UTF8 Support

Parameter	spl.runtime.utf8Database
Description	Enables or disables UTF8 support within the product.
Ordinality	Mandatory
Valid Values	[true false]
Source	Derived from the ENCODING (CHAR_BASED_DB) setting in the ENVIRON.INI
Applicability	WEB BAS IWS XAI BATCH
Example:	<code>spl.runtime.utf8Database=true</code>

spl.serviceBean.jndi.name - JNDI Name for Business Application Server

Parameter	spl.serviceBean.jndi.name
Description	JNDI name for Business Application Server generated by installer. It is highly recommended not to alter this value unless otherwise advised by Oracle Support.
Ordinality	Mandatory
Valid Values	Generated by installer.
Source	Derived from the WEB_CONTEXT_ROOT setting in the ENVIRON.INI

Applicability	WEB IWS XAI
Example:	<code>spl . servi ceBean. j ndi . name=ouaf /servi cebean</code>

spl.tools.loaded.applications - Loaded product

Parameter	spl . tool s. l oaded. appl i cati ons
Description	List the internal product codes installed under the Oracle Utilities Application Framework. This setting is maintained by the individual products and should not be altered unless otherwise instructed by Oracle Support.
Ordinality	Mandatory
Valid Values	Comma separated list of products
Source	Maintained by product templates
Applicability	WEB BAS IWS XAI BATCH
Example:	<code>spl . tool s. l oaded. appl i cati ons=base, cm</code>

hibernate.properties

The hibernate.properties file defines the connection to the database and the Object to Relational database mapping.

hibernate.cache.use_second_level_cache - Use Cache

Parameter	hi bernate. cache. use_ second_ l evel_ cache
Description	Enable or Disable the second level cache, which is enabled by default for classes which specifies a cache mapping. This is disabled by default as Oracle Utilities Application Framework includes its own cache.
Ordinality	Mandatory
Valid Values	[true false]
Source	Maintained by product templates. Use custom templates to implement a different value.
Applicability	BAS IWS XAI BATCH
Example:	<code>hi bernate. cache. use_ second_ l evel_ cache = fal se</code>

hibernate.connection.datasource - JNDI Data Source

Parameter	hi bernate. connecti on. datasour ce
Description	Enables Data Source support and indicates JNDI data source. This is an alternative to UCP. See JNDI Data Sources for more information. JNDI data sources cannot be used for batch processing.

Ordinality	Mandatory
Valid Values	JNDI path to data source
Source	Maintained by product templates. Use custom templates to implement a different value.
Applicability	BAS IWS XAI
Example:	<code>hibernate.connection.datasource=jdbc/ouafdb</code>

hibernate.connection.driver_class - Connection Driver Class

Parameter	hibernate.connection.driver_class
Description	Driver class used by Hibernate.
Ordinality	Mandatory
Valid Values	Valid Driver Class. Default: <code>oracle.jdbc.driver.OracleDriver</code>
Source	Maintained by product templates. Use custom templates to implement a different value.
Applicability	BAS IWS XAI BATCH
Example:	<code>hibernate.connection.driver_class = oracle.jdbc.driver.OracleDriver</code>

hibernate.connection.password - Database User Password

Parameter	hibernate.connection.password
Description	Encrypted password for Database User.
Ordinality	Mandatory
Valid Values	Generated Database Password. Value depends on channel: Online uses DBPASS XAI/IWS uses XAI_DBPASS Batch uses BATCH_DBPASS
Source	Maintained by product templates. Set appropriate value for user required in required parameter.
Applicability	BAS IWS XAI BATCH
Example:	<code>hibernate.connection.password = ENCKS(...)</code>

hibernate.connection.provider_class - Connection Provider

Parameter	hibernate.connection.provider_class
Description	Connection Provider Class for Hibernate. Use the default UCP provider as supplied unless using JDBC Data Sources where com.hibernatedatasourceconnectionprovider is

	used instead.
Ordinality	Mandatory
Valid Values	Generated Provider Class. Default: com.splwg.shared.common.UCPConnectionProvider
Source	Maintained by product templates. Use custom templates to implement a different value.
Applicability	BAS IWS XAI BATCH
Example:	<code>hibernate.connection.provider_class=com.splwg.shared.common.UCPConnectionProvider</code>

hibernate.connection.release_mode - Connection Release

Parameter	hibernate.connection.release_mode
Description	This parameter controls when a connection is released to the pool. By default the value is set to after_transaction . Whilst other values can be used, for consistency of the connection it is recommended to use the default.
Ordinality	Mandatory
Valid Values	Generated Release Mode. Default: after_transaction
Source	Maintained by product templates. Use custom templates to implement a different value.
Applicability	BAS IWS XAI BATCH
Example:	<code>hibernate.connection.release_mode=after_transaction</code>

hibernate.connection.url - JDBC URL

Parameter	hibernate.connection.url
Description	JDBC URL for connection to database.
Ordinality	Mandatory
Valid Values	Generated URL or using override database connection.
Source	Maintained by product templates. Use DB_OVERRIDE_CONNECTION for specific values.
Applicability	BAS IWS XAI BATCH
Example:	<code>hibernate.connection.url = jdbc:oracle:thin:@uafdemo.us.oracle.com:1522:/MYPDB</code>

hibernate.connection.username - Database User

Parameter	hibernate.connection.username
Description	JDBC User for connection.

Ordinality	Mandatory
Valid Values	The value depends on the channel accessed: Online uses DBUSER XAI/IWS uses XAI_DBUSER Batch uses BATCH_DBUSER
Source	Maintained by product templates. Set appropriate value for user required in required parameter.
Applicability	BAS IWS XAI BATCH
Example:	<code>hibernate.connection.username = CUSUSER</code>

hibernate.dialect - Dialect Used

Parameter	hibernate.dialect
Description	This is the SQL dialect (database type) for the database being used. Any valid Hibernate dialect may be used. Refer to http://www.hibernate.org/hib_docs/v3/api/org/hibernate/dialect/package-summary.html for a full list.
Ordinality	Mandatory
Valid Values	Generated Dialect. Default: org.hibernate.dialect.Oracle10gDialect .
Source	Maintained by product templates. Use custom templates to implement a different value.
Applicability	BAS IWS XAI BATCH
Example:	<code>hibernate.dialect = org.hibernate.dialect.Oracle10gDialect</code>

hibernate.jdbc.batch_size - JDBC2 Update Support

Parameter	hibernate.jdbc.batch_size
Description	A non-zero value enables use of JDBC2 batch updates by Hibernate.
Ordinality	Mandatory
Valid Values	Generated Value. Default: 30 .
Source	Maintained by product templates. Use custom templates to implement a different value.
Applicability	BAS IWS XAI BATCH
Example:	<code>hibernate.jdbc.batch_size = 30</code>

hibernate.jdbc.fetch_size - Solution Set Size

Parameter	hibernate.jdbc.fetch_size
-----------	----------------------------------

Description	Determines a hint to the JDBC driver on the the number of rows to return in any SQL statement. This is overridden at runtime on zone parameters and commit interval.
Ordinality	Mandatory
Valid Values	Generated Value. Default: 100.
Source	Maintained by product templates. Use custom templates to implement a different value.
Applicability	BAS IWS XAI BATCH
Example:	<code>hibernate.jdbc.fetch_size = 100</code>

hibernate.max_fetch_depth - Join Fetch Depth

Parameter	hibernate.max_fetch_depth
Description	Sets a maximum <i>depth</i> for the outer join fetch tree for single-ended associations (one-to-one, many-to-one). A 0 disables default outer join fetching
Ordinality	Mandatory
Valid Values	Generated Value. Default: 2.
Source	Maintained by product templates. Use custom templates to implement a different value.
Applicability	BAS IWS XAI BATCH
Example:	<code>hibernate.max_fetch_depth = 2</code>

hibernate.query.factory_class - HQL Parser

Parameter	hibernate.query.factory_class
Description	The classname of a Query Factory to use for HQL parsing.
Ordinality	Mandatory
Valid Values	Generated Value. Default: org.hibernate.hql.internal.classic.ClassicQueryTranslatorFactory
Source	Maintained by product templates. Use custom templates to implement a different value.
Applicability	BAS IWS XAI BATCH
Example:	<code>hibernate.query.factory_class=org.hibernate.hql.internal.classic.ClassicQueryTranslatorFactory</code>

hibernate.query.substitutions - Literal Mappings

Parameter	hibernate.query.substitutions
-----------	--------------------------------------

Description	Mapping from tokens in Hibernate queries to SQL tokens (tokens might be function or literal names, for example).
Ordinality	Mandatory
Valid Values	Generated Value. Default: true 'Y', false 'N'
Source	Maintained by product templates. Use custom templates to implement a different value.
Applicability	BAS IWS XAI BATCH
Example:	<code>hibernate.query.substitutions = true 'Y', false 'N'</code>

hibernate.show_sql - Debug Mode

Parameter	hibernate.show_sql
Description	Use of Debug Mode for all SQL Statements. It is highly recommended not to enable debug at this level.
Ordinality	Mandatory
Valid Values	[true false]
Source	Maintained by product templates. Use custom templates to implement a different value.
Applicability	BAS IWS XAI BATCH
Example:	<code>hibernate.show_sql = false</code>

hibernate.transaction.factory_class - Transaction Class

Parameter	hibernate.transaction.factory_class
Description	The classname of a Transaction Factory to use with Hibernate Transaction API.
Ordinality	Mandatory
Valid Values	Generated Value. Default: org.hibernate.transaction.JDBCTransactionFactory.
Source	Maintained by product templates. Use custom templates to implement a different value.
Applicability	BAS IWS XAI BATCH
Example:	<code>hibernate.transaction.factory_class = org.hibernate.transaction.JDBCTransactionFactory</code>

hibernate.ucp.connection_wait_timeout - UCP Connection Timeout

Parameter	hibernate.ucp.connection_wait_timeout
Description	Specifies how long, in seconds, an application request waits to obtain a

	connection if there are no longer any connections in the pool
Ordinality	Mandatory
Valid Values	Generated Value. Default: 5.
Source	Maintained by product templates. Use custom templates to implement a different value.
Applicability	BAS IWS XAI BATCH
Example:	<code>hibernate.ucp.connection_wait_timeout=5</code>

hibernate.ucp.inactive_connection_timeout - Connection Inactivity Timeout

Parameter	hibernate.ucp.inactive_connection_timeout
Description	Specifies how long, in seconds, an available connection can remain idle before it is closed and removed from the pool.
Ordinality	Mandatory
Valid Values	Generated Value. Default: 300.
Source	Maintained by product templates. Use custom templates to implement a different value.
Applicability	BAS IWS XAI BATCH
Example:	<code>hibernate.ucp.inactive_connection_timeout=300</code>

hibernate.ucp.jmx_enabled - Enable UCP JMX

Parameter	hibernate.ucp.jmx_enabled
Description	Enable or Disable JMX Mbeans for UCP. The Mbeans will appear as additional classes on the existing JMX capabilities for that tier.
Ordinality	Mandatory
Valid Values	[true false]
Source	Maintained by product templates. Use custom templates to implement a different value.
Applicability	BAS IWS XAI BATCH
Example:	<code>hibernate.ucp.jmx_enabled=false</code>

hibernate.ucp.max_size - Maximum Pool Size

Parameter	hibernate.ucp.max_size
Description	Maximum Pool size for this tier. Maximum number of active connections to the database.
Ordinality	Mandatory

Valid Values	Generated. Default: 30
Source	Maintained by product templates. Use custom templates to implement a different value.
Applicability	BAS IWS XAI BATCH
Example:	<code>hibernate.ucp.max_size=30</code>

hibernate.ucp.max_statements - SQL Buffer size

Parameter	hibernate.ucp.max_statements
Description	Number of statements cached for performance on this teir.
Ordinality	Mandatory
Valid Values	Generated. Default: 50
Source	Maintained by product templates. Use custom templates to implement a different value.
Applicability	BAS IWS XAI BATCH
Example:	<code>hibernate.ucp.max_statements=50</code>

hibernate.ucp.min_size - Minimum Pool Size

Parameter	hibernate.ucp.min_size
Description	Initial Connection Pool size for this teir.
Ordinality	Mandatory
Valid Values	Generated. Default: 1
Source	Maintained by product templates. Use custom templates to implement a different value.
Applicability	BAS IWS XAI BATCH
Example:	<code>hibernate.ucp.min_size=1</code>

submitbatch.properties

The submitbatch.properties controls the behavior of individual batch job threads within the batch architecture. This configuration file exists in two forms:

- A global **submitbatch.properties** that defines global defaults for the implementation.
- A set of **submitbatch.properties** files for individual jobs that defines any configuration overrides or specific configuration settings for an individual job.

This section outlines each setting for the configuration file.

Note: It is recommended to use the [bedit](#) configuration utility to maintain this configuration file.

com.oracle.ouaf.system.keystore.alias - KeyStore Alias

Parameter	com.oracle.ouaf.system.keystore.alias
Description	Alias used within keystore.
Ordinality	Mandatory
Valid Values	Generated using the KS ALIAS parameter.
Source	Maintained by product templates. Use custom templates to implement a different value.
Applicability	BATCH
Example:	<code>com.oracle.ouaf.system.keystore.alias=thealias</code>

com.oracle.ouaf.system.keystore.file - KeyStore File

Parameter	com.oracle.ouaf.system.keystore.file
Description	Location and name of keystore file for encryption keys.
Ordinality	Mandatory
Valid Values	Generated using the KS KEYSTORE FILE parameter.
Source	Maintained by product templates. Use custom templates to implement a different value.
Applicability	BATCH
Example:	<code>com.oracle.ouaf.system.keystore.file=/scratch/OUAF/ks/.ouaf_keystore</code>

com.oracle.ouaf.system.keystore.hmac_key_alias - KeyStore Mode

Parameter	com.oracle.ouaf.system.keystore.hmac_key_alias
Description	HMAC Alias used within keystore
Ordinality	Mandatory
Valid Values	Generated using the KS HMAC ALIAS parameter.
Source	Maintained by product templates. Use custom templates to implement a different value.
Applicability	BATCH
Example:	<code>com.oracle.ouaf.system.keystore.hmac_key_alias=thealiasHMAC</code>

com.oracle.ouaf.system.keystore.mode - KeyStore Mode

Parameter	com.oracle.ouaf.system.keystore.mode
Description	Padding mode used within keystore

Ordinality	Mandatory
Valid Values	Generated using the KS_MODE parameter.
Source	Maintained by product templates. Use custom templates to implement a different value.
Applicability	BATCH
Example:	<code>com.oracle.ouaf.system.keystore.mode=CBC</code>

com.oracle.ouaf.system.keystore.padding - KeyStore Padding Algorithm

Parameter	com.oracle.ouaf.system.keystore.padding
Description	Padding algorithm used within keystore
Ordinality	Mandatory
Valid Values	Generated using the KS_PADDING parameter.
Source	Maintained by product templates. Use custom templates to implement a different value.
Applicability	BATCH
Example:	<code>com.oracle.ouaf.system.keystore.padding=PKCS5Padding</code>

com.oracle.ouaf.system.keystore.passwordFileName - KeyStore File

Parameter	com.oracle.ouaf.system.keystore.passwordFileName
Description	Location and name of keystore password file.
Ordinality	Mandatory
Valid Values	Generated using the KS_STOREPASS_FILE parameter.
Source	Maintained by product templates. Use custom templates to implement a different value.
Applicability	BATCH
Example:	<code>com.oracle.ouaf.system.keystore.passwordFileName=/scratch/OUAF/ks/.ouaf_storepass</code>

com.oracle.ouaf.system.keystore.type - KeyStore Type

Parameter	com.oracle.ouaf.system.keystore.type
Description	Type of keystore.
Ordinality	Mandatory
Valid Values	Generated using the KS_STORETYPE parameter.
Source	Maintained by product templates. Use custom templates to implement a different value.

Applicability **BATCH**
 Example: `com.oracle.ouaf.system.keystore.type=JCEKS`

com.ouaf.batch.jvmoptions - JVM Options

Parameter **com.ouaf.batch.jvmoptions**
 Description Custom JVM Options for submitter.
*Note: This setting can be overridden using the **-z** option on the [submitjob/.sh](#) command line.*
 Ordinality Mandatory
 Valid Values Valid JVM Options for the Java version used
 Source Maintained by product templates. Use [bedit](#) to implement a different value.
 Applicability **BATCH**
 Example: `com.ouaf.batch.jvmoptions=-Xms1024k -Xmx2048k -XX:MaxPermSize=512m`

com.splwg.grid.executionMode - Mode of Execution

Parameter **com.splwg.grid.executionMode**
 Description Execution Mode used by process.
*Note: This setting can be overridden using the **-e** option on the [submitjob/.sh](#) command line.*
 Ordinality Mandatory
 Valid Values [**CLUSTERED** | THIN]
*Note: The **THIN** mode is used by the Oracle Utilities SDK and should not be used outside that tool.*
 Source Maintained by product templates. Use [custom templates](#) to implement a different value.
 Applicability **BATCH**
 Example: `com.splwg.grid.executionMode=CLUSTERED`

com.splwg.batch.submitter - THIN Submitter

Parameter **com.splwg.batch.submitter**
 Description Whether this execution can run without a threadpoolworker. Reserved for development of batch using the Oracle Utilities SDK. If set to **true** then, [com.splwg.grid.executionMode](#) must be set to **THIN**.
 Ordinality Mandatory
 Valid Values [**false** | true]

Source	Maintained by product templates for LOCAL submission.
Applicability	BATCH
Example:	<code>com.splwg.batch.submitter=true</code>

com.splwg.batch.submitter.batchCd - Batch Code

Parameter	com.splwg.batch.submitter.batchCd
Description	Batch Code for bbatch specific configuration. This setting should not be set in the global submitbatch.properties file. <hr/> <i>Note: This setting should only be set in configuration files for testing purposes. In other situations the -b option on the submitjob.sh command line should be used.</i> <hr/>
Ordinality	Mandatory
Valid Values	Batch Code
Source	Maintained by product templates for submission.
Applicability	BATCH
Example:	<code>com.splwg.batch.submitter.batchCd=QABATCH</code>

com.splwg.batch.submitter.distThreadPool - Threadpool

Parameter	com.splwg.batch.submitter.distThreadPool
Description	Name of pool to be used for batch process. If threadpoolworker not used then LOCAL must be specified. This can be set globally and at the individual batch job level. <hr/> <i>Note: This setting can be overridden using the -p option on the submitjob.sh command line.</i> <hr/>
Ordinality	Mandatory
Valid Values	Default: DEFAULT
Source	Maintained by product templates. Use custom templates to implement a different value.
Applicability	BATCH
Example:	<code>com.splwg.batch.submitter.distThreadPool=DEFAULT</code>

com.splwg.batch.submitter.languageCd - Language Code

Parameter	com.splwg.batch.submitter.languageCd
Description	Language code used for messages for execution of background process. Relevant language pack must be installed. <hr/> <i>Note: This setting can be overridden using the -l option on the submitjob.sh</i> <hr/>

command line.

Ordinality	Mandatory
Valid Values	Default: ENG
Source	Maintained by product templates. Use custom templates to implement a different value.
Applicability	BATCH
Example:	<code>com.splwg.batch.submitter.l languageCd=ENG</code>

com.splwg.batch.submitter.maximumCommitRecords - Commit Interval

Parameter	com.splwg.batch.submitter.maximumCommitRecords
Description	Commit Interval used for execution. This is the number of objects processed per work unit. <i>Note: This setting can be overridden using the -f option on the submitjob/.sh command line.</i>
Ordinality	Mandatory
Valid Values	Job specific
Source	Maintained by product templates. Use custom templates to implement a different value.
Applicability	BATCH
Example:	<code>com.splwg.batch.submitter.maximumCommitRecords=200</code>

com.splwg.batch.submitter.promptForValues - Prompt for Values

Parameter	com.splwg.batch.submitter.promptForValues
Description	Prompt for value when running in interactive mode. This is primarily used for developers who are testing their job manually. <i>Note: Implementers should only use the true value if executing jobs from the Oracle Utilities SDK.</i>
Ordinality	Mandatory
Valid Values	[true false]
Source	Maintained by product templates. Use custom templates to implement a different value.
Applicability	BATCH
Example:	<code>com.splwg.batch.submitter.promptForValues=false</code>

com.splwg.batch.submitter.processDate - Business Date

Parameter	com.splwg.batch.submitter.processDate
Description	Business Date for batch process. This setting should not be set in the global submitbatch.properties file. <hr/> <i>Note: This setting should only be set in configuration files for testing purposes. In other situations the -d option on the submitjob.sh command line should be used.</i> <hr/>
Ordinality	Mandatory
Valid Values	Business Date in ISO YYYY-MM-DD format
Source	Maintained by product templates for submission.
Applicability	BATCH
Example:	<code>com.splwg.batch.submitter.processDate=2015-03-08</code>

com.splwg.batch.submitter.rerunNumber - Re Run Number

Parameter	com.splwg.batch.submitter.rerunNumber
Description	Rerun Number to be used for execution. <hr/> <i>Note: Only batch controls that support rerun numbers are supported with this configuration setting.</i> <i>Note: This setting can be overridden using the -r option on the submitjob.sh command line.</i> <hr/>
Ordinality	Optional
Valid Values	Valid run number. A value of zero (0) denotes disables this setting.
Source	Maintained by product templates. Use custom templates to implement a different value.
Applicability	BATCH
Example:	<code>com.splwg.batch.submitter.rerunNumber=56</code>

com.splwg.batch.submitter.softParameter - Job Parameters

Parameter	com.splwg.batch.submitter.softParameter
Description	For any program-specific parameters, use this form of property specification in the format: <code>com.splwg.batch.submitter.softParameter.<parmname>=<value></code> The <parmname> denotes the name of the parameter. For example, to specify a <i>number of rows to skip</i> when submitting a validation program: <code>com.splwg.batch.submitter.softParameter.SKIP-ROWS=1000</code> Multiple soft parameters may be specified.

*Note: This setting can be overridden using the **-x** or **-X** options on the [submitjob.sh](#) command line.*

Ordinality	Mandatory
Valid Values	Valid value for parameter
Source	Maintained by product templates for submission.
Applicability	BATCH
Example:	<code>com.splwg.batch.submitter.softParameter.SKIP-ROWS=1000</code>

com.splwg.batch.submitter.threadCount - Thread Limit

Parameter	com.splwg.batch.submitter.threadCount
Description	Thread limit used for execution. <i>Note: Only batch controls that support multithreaded are supported with this configuration setting.</i> <i>Note: This setting can be overridden using the -c option on the submitjob.sh command line.</i>
Ordinality	Mandatory
Valid Values	Valid thread limit. A value of one (1) is used for single threaded jobs. Default: 1
Source	Maintained by product templates. Use custom templates to implement a different value.
Applicability	BATCH
Example:	<code>com.splwg.batch.submitter.threadCount=1</code>

com.splwg.batch.submitter.threadNumber - Thread Number

Parameter	com.splwg.batch.submitter.threadNumber
Description	Individual thread number used for execution. <i>Note: This setting can be overridden using the -t option on the submitjob.sh command line.</i>
Ordinality	Mandatory
Valid Values	Valid thread number. The value must be less than or equal to the com.splwg.batch.submitter.threadCount . A value of zero (0) spawns multiple threads up to the limit expressed in com.splwg.batch.submitter.threadCount . Default: 0
Source	Maintained by product templates. Use custom templates to implement a different value.
Applicability	BATCH

Example: `com.splwg.batch.submitter.threadNumber=0`

com.splwg.batch.submitter.traceProgramEnd - Trace Program End

Parameter	com.splwg.batch.submitter.traceProgramEnd
Description	Enables or disables tracing for the end of the program. <i>Note: This setting is designed for developers and for support purposes.</i> <i>Note: This setting can be overridden using the -g option on the submitjob/.sh command line.</i>
Ordinality	Mandatory
Valid Values	[true false]
Source	Maintained by product templates for submission.
Applicability	BATCH
Example:	<code>com.splwg.batch.submitter.traceProgramEnd=false</code>

com.splwg.batch.submitter.traceProgramStart - Trace Program Start

Parameter	com.splwg.batch.submitter.traceProgramStart
Description	Enables or disables tracing for the start of the program. <i>Note: This setting is designed for developers and for support purposes.</i> <i>Note: This setting can be overridden using the -g option on the submitjob/.sh command line.</i>
Ordinality	Mandatory
Valid Values	[true false]
Source	Maintained by product templates for submission.
Applicability	BATCH
Example:	<code>com.splwg.batch.submitter.traceProgramStart=false</code>

com.splwg.batch.submitter.traceSQL - Trace SQL Statements

Parameter	com.splwg.batch.submitter.traceSQL
Description	Enables or disables tracing of ALL SQL statements executed by the program. <i>Note: This setting is designed for developers and for support purposes.</i> <i>Note: This setting can be overridden using the -g option on the submitjob/.sh command line.</i>
Ordinality	Mandatory
Valid Values	[true false]

Source	Maintained by product templates for submission.
Applicability	BATCH
Example:	<code>com.splwg.batch.submitter.traceSQL=false</code>

com.splwg.batch.submitter.traceStandardOut - Trace Output Statements

Parameter	com.splwg.batch.submitter.traceStandardOut
Description	Enables or disables tracing of ALL in-program debug statements executed by the program. <hr/> <i>Note: This setting is designed for developers and for support purposes.</i> <i>Note: This setting can be overridden using the -g option on the submitjob/.sh command line.</i> <hr/>
Ordinality	Mandatory
Valid Values	[true false]
Source	Maintained by product templates for submission.
Applicability	BATCH
Example:	<code>com.splwg.batch.submitter.traceStandardOut=false</code>

com.splwg.batch.submitter.userId - Security user

Parameter	com.splwg.batch.submitter.userId
Description	Userid used by job to check authorization to underlying application services. <hr/> <i>Note: This setting can be overridden using the -u option on the submitjob/.sh command line.</i> <hr/>
Ordinality	Mandatory
Valid Values	Valid userid. <hr/> <i>Note: The SYSUSER account should not be used for non-demonstration environments.</i> <hr/>
Source	Maintained by product templates. Use custom templates to implement a different value.
Applicability	BATCH
Example:	<code>com.splwg.batch.submitter.userId=USER01</code>

spl.runtime.batch.L2CacheMode - L2 Cache control

Parameter	spl.runtime.batch.L2CacheMode
Description	Defines the 2nd-level cache mode. Valid values are READ_ONLY (default), READ_WRITE or OFF . <ul style="list-style-type: none"> READ_ONLY is for performance as it loads the configuration entities

into the 2nd-level (JVM-level) cache and accesses them from there only. In **READ_ONLY** mode, the cached entities may not be updated.

- **READ_WRITE** also loads them into the L2 cache, but they can be updated. The drawback is that an update of a cached entity hits both the database and cache as it gets updated in both places.
- In **OFF** mode the 2nd-level cache is completely disabled. Some jobs, for example LDAP import (**F1-LDAP**), need to update some of these entities (e.g. User), so it requires the L2 cache to be either **OFF** or **READ_WRITE**. The choice between **OFF** and **READ_WRITE** depends on requirement; the effect is the same.

*Note: This setting can be overridden using the **-I2** option on the [submitjob/.sh](#) command line.*

Ordinality	Mandatory
Valid Values	[READ_ONLY READ_WRITE OFF]
Source	Maintained by product templates for submission.
Applicability	BATCH
Example:	<code>spl . runtime . batch . L2CacheMode=READ_ONLY</code>

tangosol.coherence.distributed.localstorage - Cache Mode

Parameter	tangosol . coherence . distributed . local storage
Description	Sets whether data is cached local or not. This is used to optimize large networks of submitters and threadpools with cache nodes.
Ordinality	Mandatory
Valid Values	[false true]
Source	Maintained by product templates. Use custom templates to implement a different value.
Applicability	BATCH
Example:	<code>tangosol . coherence . distributed . local storage=false</code>

tangosol.coherence.role - Submitter Role

Parameter	tangosol . coherence . role
Description	Sets role of Submitter. Informational information on JVM used for monitoring purposes only.
Ordinality	Optional
Valid Values	Generated with the name OUIF_<batchcode>_Submitter where <batchcode> is the Batch Control identifier for the batch job.
Source	Maintained by product templates. Use custom templates to implement a

different value.

Applicability **BATCH**

Example: `tangosol.coherence.role=OUAF_QABATCH_Submitter`

threadpoolworker.properties

This configuration sets the threadpoolworker configuration for global and individual threadpoolworkers. As with submitters there are global defaults as well as individual threadpoolworker configurations.

Note: Some settings in this file are shared with the [submitbatch.properties](#) file but these settings apply to the threadpoolworker JVM's rather than submitter JVM's.

Note: This section is the default set of configuration parameters. Additional [Oracle Coherence parameters](#) can be added using [custom templates](#).

com.oracle.ouaf.batch.scriptDir - base scripts directory for infrastructure job

Parameter **com.oracle.ouaf.batch.scriptDir**

Description The base directory in which the scripts have to be placed for the generic infrastructure job to execute them.

Ordinality Optional

Valid Values Directory path.

Source Defaulted by configureEnv.

Applicability **BATCH**

Example: `com.oracle.ouaf.batch.scriptDir=$SPLEBASE/scripts/generic/batch/exposed/$OWNER`

\$OWNER would be the owner flag of the batch control thereby allowing restrictions on which scripts might be executed. Additional owners can be provided access by creating symbolic links in those owners' directories.

com.oracle.ouaf.system.keystore.alias - Threadpoolworker KeyStore Alias

Parameter **com.oracle.ouaf.system.keystore.alias**

Description Alias used within keystore for threadpoolworker.

Ordinality Mandatory

Valid Values Generated using the [KS_ALIAS](#) parameter.

Source Maintained by product templates. Use [custom templates](#) to implement a different value.

Applicability **BATCH**

Example: `com.oracle.ouaf.system.keystore.alias=thealias`

com.oracle.ouaf.system.keystore.file - Threadpoolworker KeyStore File

Parameter	com.Oracle.OUAF.system.keystore.file
Description	Location and name of keystore file for encryption keys for threadpoolworker.
Ordinality	Mandatory
Valid Values	Generated using the KS_KESTORE_FILE parameter.
Source	Maintained by product templates. Use custom templates to implement a different value.
Applicability	BATCH
Example:	<code>com.Oracle.OUAF.system.keystore.file=/scratch/OUAF/ks/.ouaf_keystore</code>

com.oracle.ouaf.system.keystore.hmac_key_alias - Threadpoolworker KeyStore Mode

Parameter	com.Oracle.OUAF.system.keystore.hmac_key_alias
Description	HMAC Alias used within keystore for threadpoolworker.
Ordinality	Mandatory
Valid Values	Generated using the KS_HMAC_ALIAS parameter.
Source	Maintained by product templates. Use custom templates to implement a different value.
Applicability	BATCH
Example:	<code>com.Oracle.OUAF.system.keystore.hmac_key_alias=thealiasHMAC</code>

com.oracle.ouaf.system.keystore.mode - Threadpoolworker KeyStore Mode

Parameter	com.Oracle.OUAF.system.keystore.mode
Description	Padding mode used within keystore for threadpoolworker.
Ordinality	Mandatory
Valid Values	Generated using the KS_MODE parameter.
Source	Maintained by product templates. Use custom templates to implement a different value.
Applicability	BATCH
Example:	<code>com.Oracle.OUAF.system.keystore.mode=CBC</code>

com.oracle.ouaf.system.keystore.padding - Threadpoolworker KeyStore Padding Algorithm

Parameter	com.Oracle.Ouaf.System.Keystore.Padding
Description	Padding algorithm used within keystore for threadpoolworker.
Ordinality	Mandatory
Valid Values	Generated using the KS_PADDING parameter.
Source	Maintained by product templates. Use custom templates to implement a different value.
Applicability	BATCH
Example:	<code>com.Oracle.Ouaf.System.Keystore.Padding=PKCS5Padding</code>

com.oracle.ouaf.system.keystore.passwordFileName - Threadpoolworker KeyStore File

Parameter	com.Oracle.Ouaf.System.Keystore.PasswordFileName
Description	Location and name of keystore password file for threadpoolworker.
Ordinality	Mandatory
Valid Values	Generated using the KS_STOREPASS_FILE parameter.
Source	Maintained by product templates. Use custom templates to implement a different value.
Applicability	BATCH
Example:	<code>com.Oracle.Ouaf.System.Keystore.PasswordFileName=/scratch/OUAF/ks/.ouaf_storepass</code>

com.oracle.ouaf.system.keystore.type - Threadpoolworker KeyStore Type

Parameter	com.Oracle.Ouaf.System.Keystore.Type
Description	Type of keystore for threadpoolworker.
Ordinality	Mandatory
Valid Values	Generated using the KS_STORETYPE parameter.
Source	Maintained by product templates. Use custom templates to implement a different value.
Applicability	BATCH
Example:	<code>com.Oracle.Ouaf.System.Keystore.Type=JCEKS</code>

com.ouaf.batch.disableAutoFlush – Auto flush batch L2 cache

Parameter	com.Ouaf.Batch.DisableAutoFlush
-----------	--

Description	Disables the auto flushing of batch L2 cache. If this value is set to true, the L2 cache auto flush will be disabled.
Ordinality	Mandatory
Valid Values	[true false]. Default value is false.
Source	Generated by template. Use bedit to implement a different value.
Applicability	BAS
Example:	com.ouaf.batch.disableAutoFlush=true

com.ouaf.batch.flushIntervalInSeconds – Batch L2 cache auto flush interval

Parameter	com.ouaf.batch.flushIntervalInSeconds
Description	Sets the time interval between batch L2 cache auto flushes. The time interval should be specified in seconds. Default value is 60.
Ordinality	Optional
Valid Values	Value in seconds. Default is 60.
Source	Generated by template. Use bedit to implement a different value.
Applicability	BAS
Example:	com.ouaf.batch.flushIntervalInSeconds=90

com.ouaf.batch.jvmoptions - Threadpool JVM Options

Parameter	com.ouaf.batch.jvmoptions
Description	Custom JVM Options for threadpool. <hr/> <i>Note: This setting can be overridden using the -z option on the threadpoolworker/.sh command line.</i> <hr/>
Ordinality	Mandatory
Valid Values	Valid JVM Options for the Java version used
Source	Maintained by product templates. Use bedit to implement a different value.
Applicability	BATCH
Example:	com.ouaf.batch.jvmoptions=-Xms1024k -Xmx2048k -XX:MaxPermSize=512m

com.splwg.grid.executionMode - Threadpool Mode of Execution

Parameter	com. spl wg. gri d. execut i onMode
Description	Execution Mode used by this threadpool. <hr/> <i>Note: This setting can be overridden using the -e option on the threadpool worker[.sh] command line.</i> <hr/>
Ordinality	Mandatory
Valid Values	[CLUSTERED]
Source	Maintained by product templates.
Applicability	BATCH
Example:	com. spl wg. gri d. execut i onMode=CLUSTERED

com.splwg.grid.distThreadPool.threads - Threadpool Thread Limit

Parameter	com. spl wg. gri d. di stThreadPool . threads
Description	Maximum number of threads for a particular threadpool. The format of the setting is: com. spl wg. gri d. di stThreadPool . threads. <pool name>=<limit> where: <pool name> is the Name of the threadpool <limit> is the thread limit supported by each instance of the threadpool <hr/> <i>Note: This setting can be overridden using the -p option on the threadpool worker[.sh] command line.</i> <hr/>
Ordinality	Mandatory
Valid Values	Threadpool names and limit must be valid.
Source	Maintained by product templates. Use bedit to implement a different value.
Applicability	BATCH
Example:	com. spl wg. gri d. di stThreadPool . threads. DEFAULT=5

com.splwg.batch.scheduler.daemon - Scheduler Daemon

Parameter	com. spl wg. batch. schedul er. daemon
Description	Configures whether the threadpool should execute the online scheduler daemon. The online scheduler daemon checks that the Batch Submission transaction and initiates execution of <i>pending</i> batch jobs. <hr/> <i>Note: This setting can be overridden using the -d option on the</i> <hr/>

[***threadpoolworker/.sh***](#) command line.

Note: This setting should only be set to **true** in non-Production environment where online submission is enabled.

Note: In any non-Production environment that uses online submission; one threadpool should have this setting enabled. Typically this is the **DEFAULT** threadpool but can be any other threadpool.

Ordinality	Mandatory
Valid Values	[true false]
Source	Maintained by product templates. Use bedit to implement a different value.
Applicability	BATCH
Example:	<code>com.spl.wg.batch.scheduler.daemon=false</code>

oracle.ouaf.jmx.remote.maxPortsToTry - Ports to Attempt to connect to

Parameter	oracle.ouaf.jmx.remote.maxPortsToTry
Description	Number of ports to try starting from either oracle.ouaf.jmx.remote.startPort or spl.runtime.management.rmi.port . If oracle.ouaf.jmx.remote.startPort is not specified, the property spl.runtime.management.rmi.port is used that as the starting port. If neither property is defined or the maximum number of ports to try has been reached, an exception will be thrown that will prevent the system from starting.
Ordinality	Optional
Valid Values	Number. Default: 200
Source	Set by BATCH_RMI_PORT . Use bedit to implement a different value.
Applicability	BATCH
Example:	<code>oracle.ouaf.jmx.remote.maxPortsToTry=100</code>

oracle.ouaf.jmx.remote.startPort - Override Batch JMX Port

Parameter	oracle.ouaf.jmx.remote.startPort
Description	Alternative Port number allocated for Batch JMX facility . This value is typically the same as spl.runtime.management.rmi.port . But may be set to the Cohernece JMX port if Coherence based JMX is used on a different port.
Ordinality	Optional
Valid Values	Valid JMX Port
Source	Set by BATCH_RMI_PORT . Use bedit to implement a different value.

Applicability **BATCH**
 Example: `oracle.ouaf.jmx.remote.startPort=6510`

ouaf.batch.onlineLogDir - Online Line Batch Log Directory

Parameter **ouaf.batch.onlineLogDir**
 Description Sets the location of output from online batch submission and batch scheduler integration. If this property is set, batch logs will be accessible via the Batch Run Tree (application UI). Otherwise, the batch logs download link in the application will be disabled.
 Ordinality Optional
 Valid Values Valid location. Defaults to: `$$SPLOUTPUT` (`%SPLOUTPUT%` on Windows)
 Source Value inherited from [BATCH_ONLINE_LOG_DIR](#) from [ENVIRON.INI](#).
 Applicability **BATCH**
 Example: `ouaf.batch.onlineLogDir=/tmp`

ouaf.batch.onlineLogDir.retain – Retain Online Line Batch Log Files

Parameter **ouaf.batch.onlineLogDir.retain**
 Description Sets the total number of log files that are to be stored for each batch code and thread number. The log files for the particular batch code and thread number will be deleted except for the latest number of logs specified.
 Ordinality Optional
 Valid Values Number.
 Source Generated by template. Use [bedit](#) to implement a different value.
 Applicability **BATCH**
 Example: `ouaf.batch.onlineLogDir.retain=3`
 The above example will keep the last three logs and delete the rest

spl.runtime.batch.disableDeferredKeyInserts - Deferred Key Inserts

Parameter **spl.runtime.batch.disableDeferredKeyInserts**
 Description Whether the deferring of key insert in batches should be disabled or not. Enables (**false**) or disables (**true**) deferred Key Inserts.

The default is to use deferred inserts. However if an aggressive key insert is desired in batches, a value of **true** should be used.

Note: This setting is used by particular base batch jobs. Refer to the online documentation for individual batch jobs for more information.

Ordinality	Mandatory
Valid Values	[true false]
Source	Generated by template. Use bedit to implement a different value.
Applicability	BATCH
Example:	<code>spl.runtime.batch.disableDeferredKeyInserts=false</code>

spl.runtime.batch.L2CacheMode - Threadpoolworker L2 Cache control

Parameter	spl.runtime.batch.L2CacheMode
Description	<p>Defines the 2nd-level cache mode for threads in threadpool. Valid values are READ_ONLY (default), READ_WRITE or OFF.</p> <ul style="list-style-type: none"> • READ_ONLY is for performance as it loads the configuration entities into the 2nd-level (JVM-level) cache and accesses them from there only. In READ_ONLY mode, the cached entities may not be updated. • READ_WRITE also loads them into the L2 cache, but they can be updated. The drawback is that an update of a cached entity hits both the database and cache as it gets updated in both places. • In OFF mode the 2nd-level cache is completely disabled. Some jobs, for example LDAP import (F1-LDAP), need to update some of these entities (e.g. User), so it requires the L2 cache to be either OFF or READ_WRITE. The choice between OFF and READ_WRITE depends on requirement; the effect is the same. <p><i>Note: This setting can be overridden using the -I2 option on the threadpoolworker/.sh command line.</i></p>
Ordinality	Mandatory
Valid Values	[READ_ONLY READ_WRITE OFF]
Source	Maintained by product templates for threadpoolworker. Use bedit to implement a different value.
Applicability	BATCH
Example:	<code>spl.runtime.batch.L2CacheMode=READ_ONLY</code>

spl.runtime.management.connector.url.default - Batch JMX URL

Parameter	spl.runtime.management.connector.url.default
Description	JMX URL for Batch JMX interface.

Note: This URL is generated and should not be altered.

Ordinality	Optional
Valid Values	Valid JMX URL
Source	Generated by template
Applicability	BATCH
Example:	<code>spl.runtime.management.connector.url.default=service:jmx:rmi:///jndi/rmi://{host}:{port}/oracle/ouaf/batchConnector</code>

spl.runtime.management.rmi.port - Batch JMX Port

Parameter	spl.runtime.management.rmi.port
Description	Port number allocated for Batch JMX facility . <i>Note: This setting can be overridden using the -i option on the threadpoolworker/.sh command line.</i>
Ordinality	Optional
Valid Values	Valid JMX Port
Source	Set by BATCH_RMI_PORT . Use bedit to implement a different value.
Applicability	BATCH
Example:	<code>spl.runtime.management.rmi.port=1001</code>

tangosol.coherence.distributed.localstorage - DistributedCache Storage

Parameter	tangosol.coherence.distributed.localstorage
Description	Specifies whether this member of the DistributedCache service enables local storage. <i>Note: This setting is used by the Oracle Coherence DistributedCache Service.</i>
Ordinality	Optional
Valid Values	[true false]
Source	Generated by template. Use bedit to implement a different value.
Applicability	BATCH
Example:	<code>tangosol.coherence.localport.adjust=true</code>

tangosol.coherence.distributed.threads - Internal Cache Threads

Parameter	tangosol.coherence.distributed.threads
Description	Specifies the number of daemon threads used by the distributed cache service.

Note: This setting is used by the Oracle Coherence [DistributedCache Service](#).

Ordinality	Optional
Valid Values	Valid thread numbers. Default: 0
Source	Generated by template. Use bedit to implement a different value.
Applicability	BATCH
Example:	<code>tangosol . coherence. di stri buted. threads=4</code>

tangosol.coherence.invocation.threads - Internal Invocation Threads

Parameter	tangosol . coherence. i nvocati on. threads
Description	Specifies the number of daemon threads to be used by the invocation service. If zero, all relevant tasks are performed on the service thread.
	<i>Note: This setting is used by the Oracle Coherence InvocationService.</i>
Ordinality	Optional
Valid Values	Valid thread numbers. Default: 0
Source	Generated by template. Use bedit to implement a different value.
Applicability	BATCH
Example:	<code>tangosol . coherence. i nvocati on. threads=4</code>

tangosol.coherence.localhost - Unicast Host Address

Parameter	tangosol . coherence. l ocal host
Description	Host name for local host for Unicast address.
	<i>Note: This setting applies to unicast or well known address implementations.</i>
	<i>Note: This setting is used by the Oracle Coherence unicast-listener.</i>
Ordinality	Optional
Valid Values	Valid host name defined in hosts file and/or DNS.
Source	Generated by template (wka only). Use bedit to implement a different value.
Applicability	BATCH
Example:	<code>tangosol . coherence. l ocal host=myserver. exampl e. com</code>

tangosol.coherence.localport - Unicast Port

Parameter	tangosol . coherence. l ocal port
Description	Port number for local host for Unicast address.

Note: This setting applies to unicast or [well known address](#) implementations.

Note: This setting is used by the Oracle Coherence [unicast-listener](#).

Ordinality	Optional
Valid Values	Valid port number.
Source	Generated by template (wka only). Use bedi t to implement a different value.
Applicability	BATCH
Example:	<code>tangosol . coherence. l ocal port =6570</code>

tangosol.coherence.localport.adjust - Unicast Port Adjustment

Parameter	tangosol . coherence. l ocal port. adj ust
Description	Specifies whether the unicast port is automatically incremented if the specified port cannot be bound to because it is in use.
	<i>Note: This setting applies to unicast or well known address implementations.</i>
	<i>Note: This setting is used by the Oracle Coherence unicast-listener.</i>
Ordinality	Optional
Valid Values	[true false]
Source	Generated by template (wka only). Use bedi t to implement a different value.
Applicability	BATCH
Example:	<code>tangosol . coherence. l ocal port. adj ust =true</code>

tangosol.coherence.role - Threadpoolworker Role

Parameter	tangosol . coherence. rol e
Description	This contains the name of the member role. This name allows an application to organize members into specialized roles, such as cache servers and cache clients. The name is also useful for displaying management information (for example, JMX) and interpreting log entries.
	<i>Note: This setting is used by the Oracle Coherence member-identity.</i>
Ordinality	Optional
Valid Values	Role Name
Source	Generated by template. Use bedi t to implement a different value.
Applicability	BATCH
Example:	<code>tangosol . coherence. rol e=OUAF_Base_TPW</code>

coherence-cache.config.xml

The **coherence-cache.config.xml** file is generated using the **coherence-cache.config.xml.template** located in the **templates** directory.

The [format and structure](#) are setup for the implementation of Oracle Coherence for the batch infrastructure within the product.

Note: This file is fixed in format and should not be altered unless instructed by Oracle Support.

tangosol-coherence-override.xml

The **tangosol-coherence-override.xml** file is generated using the templates located in the **templates** directory.

There are four templates for this file:

Template	Contents
tangosol-coherence-override.mc.be.template	Multicast Overrides (for bedit)
tangosol-coherence-override.ss.be.template	Single Server Overrides (for bedit)
tangosol-coherence-override.wka.be.template	WKA Overrides (for bedit)
tangosol-coherence-override.xml.template	General Overrides

The [format and structure](#) are setup for the implementation of Oracle Coherence for the batch infrastructure within the product.

Note: This file is fixed in format and should not be altered unless instructed by Oracle Support.
