

# **Oracle® Real User Experience Insight**

Installation Guide

13.2.2.1 for Linux x86-64

**E86275-01**

March 2017

Oracle Real User Experience Insight Installation Guide, 13.2.2.1 for Linux x86-64

E86275-01

Copyright © 2012, 2017 Oracle and/or its affiliates. All rights reserved.

Primary Author: Pavithra Mendon

Contributing Author: Pushpa Raghavachar

This software and related documentation are provided under a license agreement containing restrictions on use and disclosure and are protected by intellectual property laws. Except as expressly permitted in your license agreement or allowed by law, you may not use, copy, reproduce, translate, broadcast, modify, license, transmit, distribute, exhibit, perform, publish, or display any part, in any form, or by any means. Reverse engineering, disassembly, or decompilation of this software, unless required by law for interoperability, is prohibited.

The information contained herein is subject to change without notice and is not warranted to be error-free. If you find any errors, please report them to us in writing.

If this is software or related documentation that is delivered to the U.S. Government or anyone licensing it on behalf of the U.S. Government, then the following notice is applicable:

U.S. GOVERNMENT END USERS: Oracle programs, including any operating system, integrated software, any programs installed on the hardware, and/or documentation, delivered to U.S. Government end users are "commercial computer software" pursuant to the applicable Federal Acquisition Regulation and agency-specific supplemental regulations. As such, use, duplication, disclosure, modification, and adaptation of the programs, including any operating system, integrated software, any programs installed on the hardware, and/or documentation, shall be subject to license terms and license restrictions applicable to the programs. No other rights are granted to the U.S. Government.

This software or hardware is developed for general use in a variety of information management applications. It is not developed or intended for use in any inherently dangerous applications, including applications that may create a risk of personal injury. If you use this software or hardware in dangerous applications, then you shall be responsible to take all appropriate fail-safe, backup, redundancy, and other measures to ensure its safe use. Oracle Corporation and its affiliates disclaim any liability for any damages caused by use of this software or hardware in dangerous applications.

Oracle and Java are registered trademarks of Oracle and/or its affiliates. Other names may be trademarks of their respective owners.

Intel and Intel Xeon are trademarks or registered trademarks of Intel Corporation. All SPARC trademarks are used under license and are trademarks or registered trademarks of SPARC International, Inc. AMD, Opteron, the AMD logo, and the AMD Opteron logo are trademarks or registered trademarks of Advanced Micro Devices. UNIX is a registered trademark of The Open Group.

This software or hardware and documentation may provide access to or information about content, products, and services from third parties. Oracle Corporation and its affiliates are not responsible for and expressly disclaim all warranties of any kind with respect to third-party content, products, and services unless otherwise set forth in an applicable agreement between you and Oracle. Oracle Corporation and its affiliates will not be responsible for any loss, costs, or damages incurred due to your access to or use of third-party content, products, or services, except as set forth in an applicable agreement between you and Oracle.

---

---

# Contents

<b>Preface</b> .....	xi
Audience .....	xi
Documentation Accessibility .....	xi
Related Documents .....	xi
Conventions .....	xii
<b>1 Getting Started</b>	
1.1 What is RUEI? .....	1-1
1.1.1 Data Collection .....	1-1
1.1.2 Product Architecture .....	1-4
1.2 Security for Network Data Collection .....	1-5
1.3 Connection Options for Network Data Collection .....	1-5
1.3.1 Copy Ports .....	1-6
1.3.2 TAPs .....	1-7
1.4 Installation Options .....	1-8
1.5 Local and Remote Database Installations .....	1-8
1.6 Scaling Scenarios .....	1-9
1.7 Server Requirements .....	1-13
1.7.1 Single-Server Requirements .....	1-13
1.7.2 Reporter Requirements .....	1-14
1.7.3 Collector Requirements .....	1-14
1.7.4 Processing Engine Requirements .....	1-15
1.7.5 Deployment Best Practices .....	1-15
1.7.6 Data Retention Policies .....	1-16
1.7.7 Full Session Replay Storage Requirements .....	1-17
1.7.8 Memory Requirements .....	1-18
1.8 Software Requirements .....	1-19
1.9 Network Requirements .....	1-19
1.10 Client Requirements .....	1-21
<b>2 Installing the RUEI Software</b>	
2.1 Prerequisites .....	2-1
2.1.1 Planning the Software Installation .....	2-1
2.1.2 Planning the Software Installation Location .....	2-2
2.1.3 Configuring the Network Interface for Network Data Collection .....	2-3

2.1.4	Configuring Operating System Security .....	2-3
2.1.5	Verify NTP Daemon Operation for Network Data Collection.....	2-3
2.1.6	Installing the RUEI Prerequisites .....	2-4
2.1.6.1	Installing RedHat Enterprise/Oracle Linux 5.x Prerequisites .....	2-4
2.1.6.2	Installing RedHat Enterprise/Oracle Linux 6.x Prerequisites .....	2-4
2.1.7	Installing All Requirements Using a Yum Repository (Alternative) .....	2-5
2.1.7.1	Installing RedHat Enterprise/Oracle Linux 5.x Prerequisites .....	2-5
2.1.7.2	Installing RedHat Enterprise/Oracle Linux 6.x Prerequisites .....	2-6
2.1.8	Installing Oracle Database.....	2-7
2.2	Obtaining the RUEI Software.....	2-7
2.3	Unpacking the RUEI Software .....	2-7
2.4	Generic Installation Tasks.....	2-8
2.4.1	Check The RUEI Configuration File .....	2-8
2.4.2	Installing Java .....	2-10
2.5	Reporter Installation .....	2-11
2.5.1	Installing the Apache Web Server and PHP .....	2-11
2.5.1.1	PHP Configuration .....	2-11
2.5.1.2	Avoiding RSVG Warnings .....	2-11
2.5.1.3	Securing Apache Web Server.....	2-11
2.5.1.4	PHP Multibyte Character Support.....	2-11
2.5.2	Installing the Oracle Database Instant Client .....	2-12
2.5.3	Installing the php-oci8 Module.....	2-12
2.5.4	Installing the Zend Decoder.....	2-12
2.5.4.1	Installing the Zend Optimizer (version 5.x) .....	2-12
2.5.4.2	Installing the Zend Guard Loader (version 6.x).....	2-13
2.5.5	Creating the Reporter Database Instance .....	2-13
2.5.6	Installing the Reporter Software.....	2-16
2.6	Remote Tag Data Collector Installation.....	2-17
2.7	Remote Network Data Collector Installation.....	2-18
2.8	Configuring the Network Interface.....	2-19
2.9	Enabling International Fonts (Optional, but Recommended) .....	2-19
2.10	Mail (MTA) Configuration (Optional, Reporter Only).....	2-19
2.11	Configuring SNMP (Reporter Only) .....	2-20
2.11.1	Configuring SNMP for RUEI .....	2-20
2.12	Configuring Automatic Browser Redirection (Optional) .....	2-21
2.13	Configuring Reporter Communication (Split-Server Setup Only) .....	2-21
2.14	Verifying Successful Installation of RUEI .....	2-22
2.15	Using RUEI with Oracle Enterprise Manager .....	2-22

### 3 Upgrading to RUEI 13.2.2.1

3.1	Migrating Users with Enterprise Manager Access .....	3-1
3.2	Patching the Operating System.....	3-1
3.3	Upgrading From RUEI 13.x.x.x to 13.2.2.1 .....	3-1
3.3.1	Upgrading the Reporter System from RUEI 13.x.x.x.....	3-2
3.3.2	Upgrading the Remote Collector System(s) from RUEI 13.x.x.x .....	3-3
3.3.3	Upgrading the Processing Engine System(s) from RUEI 13.x.x.x .....	3-4
3.4	Steps After Upgrading From RUEI 13.x.x.x .....	3-4

## 4 Configuring RUEI for ADF Monitoring

4.1	Introduction to ADF Monitoring .....	4-1
4.2	Deploying the ADF Monitoring Service .....	4-2
4.2.1	Create a RUEI System User .....	4-2
4.2.2	Deploy the ADF Monitoring Service Software.....	4-2
4.2.3	Configure the ADF Application .....	4-3
4.2.3.1	Generate a Default Deployment Descriptor .....	4-3
4.2.3.2	Modify the Deployment Descriptor.....	4-4
4.2.3.3	Create a Wallet.....	4-5
4.2.3.4	Redeploy the ADF Application with the Modified Deployment Descriptor .....	4-7
4.2.4	Specifying Domain and Port for ADF Applications.....	4-7
4.2.5	Troubleshooting the ADF Monitoring Service .....	4-7

## 5 Installing and Configuring SSO Authentication Integration

5.1	Turning off the Default Web Server .....	5-1
5.2	Reporter System Without Local Database.....	5-1
5.2.1	Creating the Oracle User .....	5-1
5.2.2	Setting up the Oracle HTTP Server Environment.....	5-2
5.2.3	Creating the Installation Directory.....	5-2
5.3	Reporter System With Local Database.....	5-2
5.4	Installing Oracle HTTP Server .....	5-2
5.5	Registering RUEI with the Oracle SSO Server.....	5-5
5.5.1	Registering with Oracle SSO Version 10.1.4 .....	5-5
5.5.2	Registering with Oracle SSO Version 11.1 .....	5-5
5.6	Verifying the Oracle HTTP Server Configuration .....	5-7

## 6 Configuring RUEI

6.1	Introduction to Configuring RUEI .....	6-1
6.2	Performing Initial RUEI Configuration .....	6-1
6.3	Configuring Collector Systems .....	6-4
6.3.1	Resetting Collector Systems .....	6-5
6.4	Performing Post-Installation Configuration .....	6-5
6.4.1	Specifying the Cookie Technology.....	6-5
6.4.2	Adding/Uploading HTTPS SSL Keys.....	6-5
6.4.3	Specifying How Users are Identified .....	6-5
6.4.4	Defining Applications and Page Identification.....	6-6
6.4.5	Specifying the Scope of Monitoring .....	6-6
6.4.6	Authorizing Initial Users.....	6-6
6.5	Verifying and Evaluating Your Configuration.....	6-6
6.5.1	Viewing Traffic Summary .....	6-6
6.5.2	Confirming Data Collection .....	6-7
6.6	Configuring Support for the T3 Protocol .....	6-8

## 7 Configuring the Oracle Access Manager

7.1	Configuring OAM 10g .....	7-1
-----	---------------------------	-----

7.1.1	Downloading and Installing the Access Gate Software.....	7-1
7.1.2	Configuring the Access Gate Software on the RUEI Server.....	7-1
7.1.3	Configuring the Required Session Traffic Definitions.....	7-2
7.1.4	Creating an OAM Access Gate for RUEI.....	7-3
7.1.4.1	Configuring the OAM_REMOTE_USER Header Variable.....	7-6
7.2	Configuring OAM 11g.....	7-7
7.2.1	Exporting and Importing the OAM 11g AES key.....	7-7
7.2.1.1	Exporting an OAM 11g AES key.....	7-8
7.2.1.2	Importing an OAM 11g AES key.....	7-8
7.2.1.3	Removing an OAM 11g AES Key.....	7-8
7.2.2	Configuring an Application to Use OAM.....	7-9

## 8 Installing Processing Engines

8.1	Prerequisites for Processing Engines.....	8-1
8.1.1	Planning the Software Installation Location.....	8-1
8.1.2	Configuring Operating System Security.....	8-2
8.1.3	Verifying NTP Daemon Operation.....	8-2
8.1.4	Installing the RUEI Prerequisites.....	8-3
8.1.5	Installing Oracle Database Software.....	8-3
8.2	The RUEI Configuration File.....	8-3
8.3	Installing the Processing Engine.....	8-4
8.3.1	Creating Groups and Users.....	8-4
8.3.2	Installing the Oracle Database Instant Client.....	8-4
8.3.3	Creating the Processing Engine Database Instance.....	8-4
8.3.4	Installing the Processing Engine Software.....	8-6
8.4	Configuring Processing Engine Communication.....	8-7
8.4.1	Configuring the SSH Connections.....	8-7
8.4.2	Configuring the Database Link Connections.....	8-9
8.5	Registering Processing Engines.....	8-10
8.6	Configuring Multiple Processing Engines.....	8-10

## 9 Configuring a Failover Reporter System

9.1	Introduction to Failover Reporter Systems.....	9-1
9.2	Preparing the Primary Reporter.....	9-2
9.3	Installing the Secondary Reporter.....	9-2
9.4	Configuring Reporter Failover.....	9-3
9.5	Initiating Reporter Failback.....	9-5

## 10 Configuring a Failover Collector System

10.1	Introduction to Failover Collector Systems.....	10-1
10.2	Installing the Secondary Collector.....	10-3
10.3	Configuring the Secondary Collector.....	10-3
10.4	Initiating Collector Failback.....	10-5

## 11 Configuring a Failover Processing Engine System

11.1	Introduction to Failover Processing Engine Systems.....	11-1
------	---	------

11.2	Preparing the Primary Processing Engine .....	11-2
11.3	Installing the Secondary Processing Engine .....	11-2
11.4	Configuring Processing Engine Failover .....	11-3
11.5	Instigating Processing Engine Failback .....	11-5

## **A Installing the Oracle Database Software**

A.1	Download the Oracle Database Software.....	A-1
A.2	Operating System Prerequisites.....	A-1
A.3	Creating the Database User Accounts and Groups .....	A-1
A.4	Configuring the Kernel Parameter Settings .....	A-2
A.5	Setting Shell Limits for the Oracle User.....	A-2
A.6	Creating the Database Directory.....	A-3
A.7	Configuring the Oracle User's Environment and Installing the Database.....	A-3
A.8	Creating an Oracle init Script File .....	A-6

## **B Generic Database Instance Setup**

B.1	Overview of Database Setup .....	B-1
B.2	Creating the Database Instance.....	B-2
B.3	Creating Tablespaces .....	B-2
B.4	Rescheduling Oracle Database Maintenance.....	B-3
B.5	Installing SQL Packages.....	B-3
B.6	Creating the RUEI Database User .....	B-3
B.7	Creating Database Triggers .....	B-4
B.8	Setting up the Connection Data .....	B-4
B.9	Setting up the Oracle Wallet.....	B-5

## **C Setting up an Alternative Enriched Data Export Database Instance**

C.1	Introduction to Enriched Data Export Setup .....	C-1
C.2	Setting up the Alternative Database Instance.....	C-2
C.2.1	Creating the Database Instance .....	C-2
C.2.2	Using Compressed Tablespaces .....	C-2
C.2.3	Rescheduling Oracle Database Maintenance.....	C-3
C.2.4	Creating the RUEI Database User .....	C-3
C.3	Connecting the RUEI Systems to the Alternative Database Server.....	C-3
C.3.1	Setting up the Connection Data.....	C-3
C.3.2	Setting up the Oracle Wallet .....	C-4
C.3.3	Editing the RUEI Configuration File.....	C-4

## **D Setting up a Connection to the Enterprise Manager Repository**

D.1	Introduction to Enterprise Manager .....	D-1
D.2	Creating a RUEI User for Communication with Enterprise Manager .....	D-1
D.3	Creating a non-sysman Enterprise Manager Repository User.....	D-2
D.4	Setting Up a Connection to Oracle Enterprise Manager .....	D-2
D.5	Clearing a Connection to Oracle Enterprise Manager.....	D-3

## **E The ruei-check.sh Script**

## **F Verifying Monitored Network Traffic**

F.1	Introduction to Network Traffic .....	F-1
F.2	Creating Traffic Snapshots .....	F-2
F.3	Analyzing Traffic Information .....	F-4

## **G Troubleshooting**

G.1	Running the ruei-check.sh Script.....	G-1
G.2	ORA-12805: Parallel Query Server Died Unexpectedly .....	G-2
G.3	The ruei-prepare-db.sh Script Fails .....	G-2
G.4	Starting Problems.....	G-2
G.5	Data Collection Problems .....	G-3
G.6	Data Processing Problems .....	G-4
G.7	E-Mail Problems.....	G-4
G.8	SSL Decryption Problems .....	G-5
G.9	Missing Packages and Fonts Error Messages .....	G-5
G.10	ORA-xxxxx Errors.....	G-6
G.11	Oracle DataBase Not Running .....	G-7
G.12	General (Non-Specific) Problems .....	G-7
G.13	Network Interface Not Up.....	G-7
G.14	OAM-Related Problems .....	G-7
G.15	ruei-check.sh Script Reports PHP Timezone Error.....	G-8
G.16	ORA-00020: maximum number of processes (%s) exceeded.....	G-9
G.17	rsync Fails When user@ Argument not Specified .....	G-9
G.18	ORA-00600 Error Reported .....	G-9
G.19	Dropped Segments and Bad Checksums .....	G-10
G.20	Errors During Installation on RedHat Enterprise/Oracle Linux 6.x.....	G-11
G.21	SSL Error on RedHat Enterprise/Oracle Linux 6.x.....	G-12

## **H Installation Checklist**

## **I Removing RUEI From Systems**

## **J Third-Party Licenses**

J.1	Apache Software License, Version 2.0 .....	J-1
J.2	OpenSSL.....	J-4
J.3	PHP .....	J-4
J.4	Java Runtime Environment .....	J-4
J.5	The MIT License (MIT).....	J-8

## **K Setting up RUEI against a remote database Service**

K.1	Prerequisites .....	K-1
K.2	Setting Up.....	K-1



K.3	Running rui-prepare-db.sh.....	K-2
-----	--------------------------------	-----

## **Index**



---

---

# Preface

Oracle Real User Experience Insight (RUEI) provides you with powerful analysis of your network and business infrastructure. You can monitor the real-user experience, define Key Performance Indicators (KPIs) and Service Level Agreements (SLAs), and trigger alert notifications for incidents that violate them.

## Audience

This document is intended for the following people:

- System administrators responsible for the installation of RUEI. This assumes a sound understanding of the Linux operating system.
- The person within your organization designated as RUEI Super Administrator (that is, the `admin` user). They are responsible for post-installation configuration, and system maintenance.

Some familiarity with network and web technology is assumed. In particular, you should have a sound understanding of network topology, and a good operational knowledge of your organization's network and application environment.

## Documentation Accessibility

For information about Oracle's commitment to accessibility, visit the Oracle Accessibility Program website at <http://www.oracle.com/pls/topic/lookup?ctx=acc&id=docacc>.

### Access to Oracle Support

Oracle customers that have purchased support have access to electronic support through My Oracle Support. For information, visit

<http://www.oracle.com/pls/topic/lookup?ctx=acc&id=info> or visit <http://www.oracle.com/pls/topic/lookup?ctx=acc&id=trs> if you are hearing impaired.

## Related Documents

For more information, see the following documents in the Oracle Real User Experience Insight (RUEI) documentation set:

- *Oracle Real User Experience Insight Release Notes.*
- *Oracle Real User Experience Insight User's Guide.*
- *Oracle Real User Experience Insight Administrator's Guide.*

The latest version of this and other RUEI books can be found at the following location:

<http://www.oracle.com/technetwork/documentation/realuserei-091455.html>

## Conventions

The following text conventions are used in this document:

<b>Convention</b>	<b>Meaning</b>
<b>boldface</b>	Boldface type indicates graphical user interface elements associated with an action, or terms defined in text or the glossary.
<i>italic</i>	Italic type indicates book titles, emphasis, or placeholder variables for which you supply particular values.
monospace	Monospace type indicates commands within a paragraph, URLs, code in examples, text that appears on the screen, or text that you enter.

---

---

# Getting Started

This chapter introduces the role of Oracle Real User Experience Insight (RUEI). In particular, it describes how RUEI monitors data traffic, its operational requirements, and the available deployment options. Information is also provided about how you can increase the amount of information available within the RUEI Reporter database.

## 1.1 What is RUEI?

The usage of web applications and services continues to grow. This includes not only the use of the Internet as a marketing channel, but also Extranet-based supply chain and back-office integration, and Intranet deployment of internal applications. Increasingly, it also includes the utilization of web services which implement clearly defined business functions. Applications can be accessed from mobile devices and there are many cloud based deployment options including on-premises, SaaS and hybrid. RUEI is designed for measuring, analyzing, and improving the availability and performance of all of these deployment scenarios. To achieve this, RUEI is capable of performing data collection from network traffic, ADF servers and/or data collection using Javascript browser instrumentation.

To view a visual demonstration on how you can use RUEI, access the following URL and click Begin Video:

[https://apex.oracle.com/pls/apex/f?p=44785:24:0::NO:24:P24\\_CONTENT\\_ID,P24\\_PREV\\_PAGE:5783,1](https://apex.oracle.com/pls/apex/f?p=44785:24:0::NO:24:P24_CONTENT_ID,P24_PREV_PAGE:5783,1)

### 1.1.1 Data Collection

[Figure 1–1](#) shows the Network Data Collector (available in previous RUEI releases) and [Figure 1–2](#) shows the Tag Data Collector which is an option that allows you to collect data using Javascript and does not require network monitoring.

**Figure 1–1 Network Data Collector**

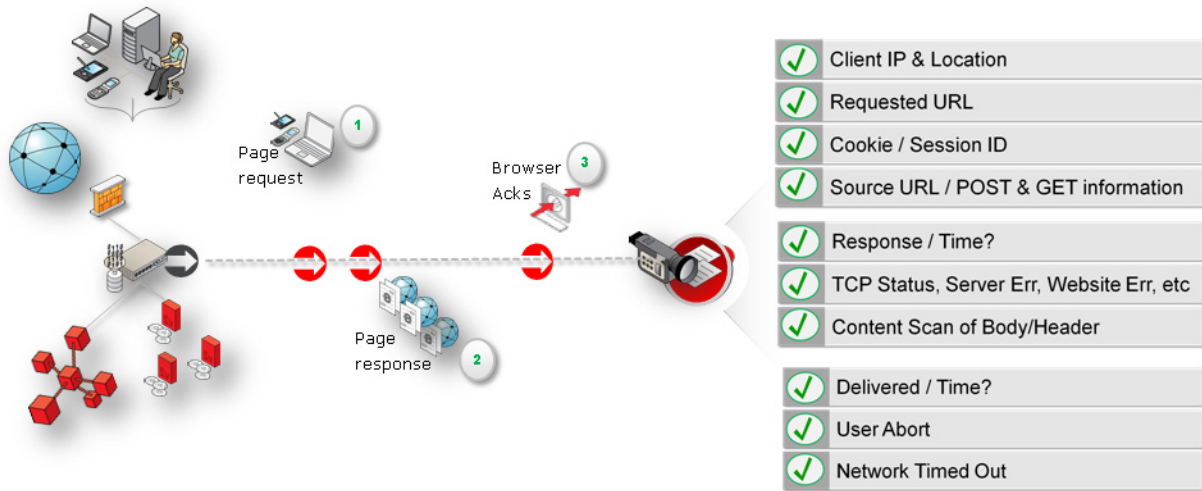

**Figure 1–2 Tag Data Collector**

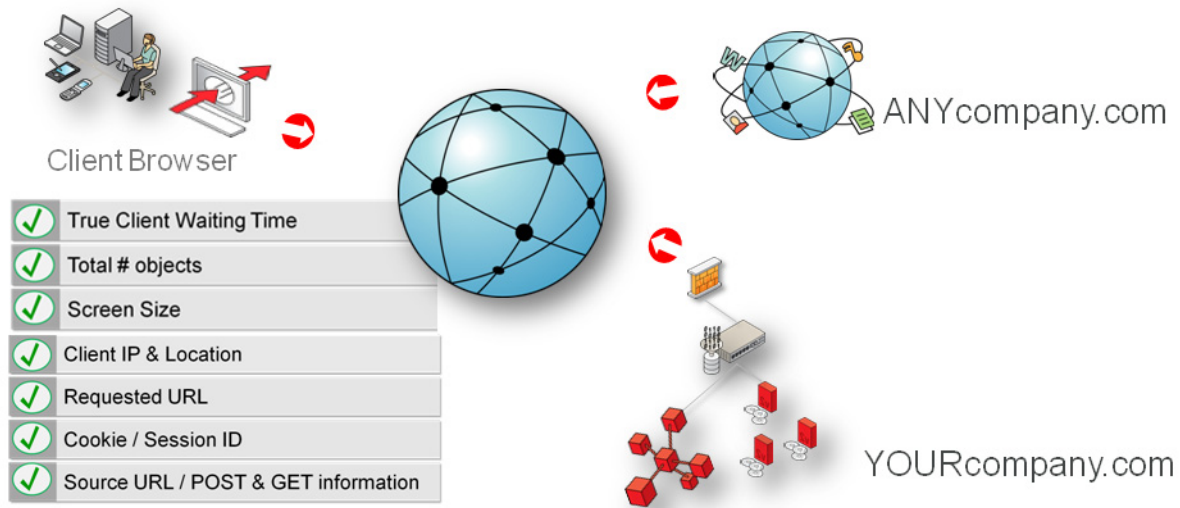

Table 1–1 outlines the different data collections that are available with RUEI.

**Table 1-1 Data Collection Methods**

	<b>Network</b>	<b>Tag</b>
Overview	This option collects data that passes through the network and was the default option in previous releases and requires either a local or remote collector. It monitors all network traffic in promiscuous mode.	This option, also called tag based monitoring, collects data by monitoring the request and processing of a specific web URL (the tag) which is inserted into all pages and requires either a local or remote collector. It monitors only the traffic related to a local IP address.
Applications	You must define an application. See <i>Identifying and Reporting Web Pages</i> chapter of <i>User's Guide</i> .	You must define an onload object and use the generated javascript in your application. See <i>Identifying and Reporting Web Pages</i> chapter of <i>User's Guide</i> .
Suites	You must define a Suite. See <i>Working With Suites and Web Services</i> chapter of <i>User's Guide</i> .	<b>Only</b> WebCenter Sites can be monitored using tag-based data collection. See <i>Working With Suites and Web Services</i> chapter of <i>User's Guide</i> .
Further Information	<a href="#">Section 2.1.1, "Planning the Software Installation"</a> <a href="#">Section 1.2, "Security for Network Data Collection"</a> <a href="#">Section 1.3, "Connection Options for Network Data Collection"</a>	<a href="#">Section 2.1.1, "Planning the Software Installation"</a>
<b>ADF Monitoring</b>	Various data collection options are available for monitoring ADF based applications, including the ADF monitoring Service. This service collects data (for example, user names) from the application server for ADF based applications, enhancing the data from network data collection. See <a href="#">Chapter 4, "Configuring RUEI for ADF Monitoring"</a> for more information on these options.	

The options are further described in [Section 2.1.1, "Planning the Software Installation"](#).

The network data collection method is based on Network Protocol Analysis (NPA) technology. This method is 100% non-intrusive. Hence, it does not place any load on a web server, or require installing software agents that will impact performance. In addition, it does not require any change to the current application or infrastructure. When a new application release is deployed, or when an additional web server is added, there is no or very little change required to RUEI's monitoring environment. Typically, RUEI is installed before the web servers, behind a firewall in the DMZ (as shown in [Figure 1-3](#)).

**Figure 1-3 How RUEI Collects Data with a Network Data Collector**

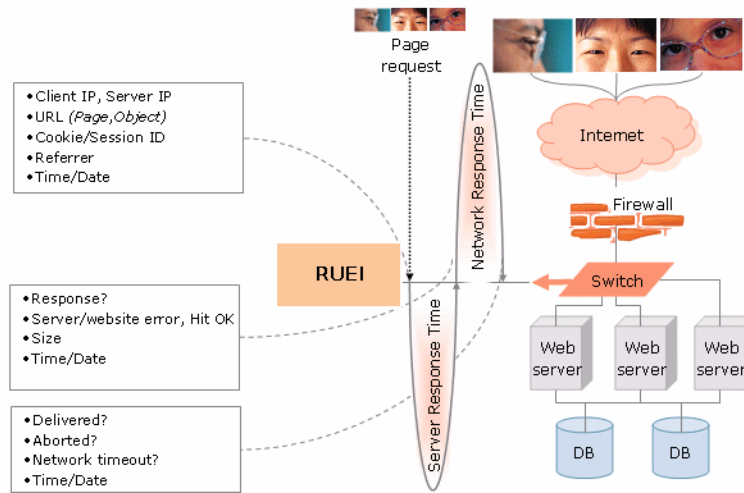

When an object is requested by a visitor, RUEI sees the request and measures the time the web server requires to present the visitor with the requested object. At this point, RUEI knows who requested the page (the client IP), which object was requested, and from which server the object was requested (server IP).

When the web server responds and sends the requested object to the visitor, RUEI sees that response. At this point, RUEI can see whether there is a response from the server, whether this response is correct, how much time the web server required to generate the requested object, and the size of the object. In addition, RUEI can also see whether the object was completely received by the visitor, or if the visitor aborted the download (that is, proof of delivery). Hence, RUEI can determine the time taken for the object to traverse the Internet to the visitor, and calculate the Internet throughput between the visitor and the server (that is, the connection speed of the visitor).

### 1.1.2 Product Architecture

RUEI is based on a three-layer product architecture, as shown in [Figure 1-4](#).

**Figure 1-4 RUEI Product Architecture**

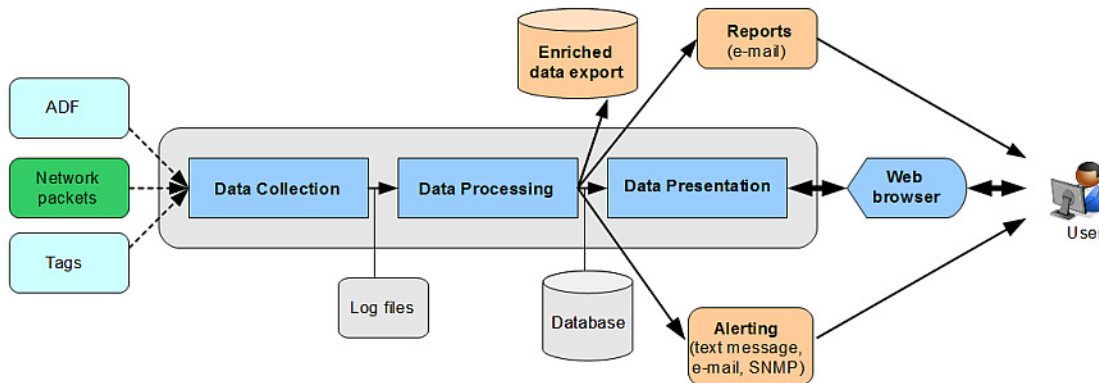

The monitored data packets are processed by the layers shown in [Table 1-2](#).



**Table 1–2 Product Architecture Layers**

Layer	Description
Data Collection	This layer is responsible for acquiring raw data and delivering it to the Data Processor layer. This data can be collected from multiple sources. The available attachment options are described later in this section.
Data Processing	This layer converts the raw data into the OLAP data sets. These comprise the multi-dimensional data structure that is viewable with the Data Browser.
Data Presentation (Reporter)	This layer is RUEI's analysis and reporting environment. This is a web-based information portal that can be accessed from any supported browser.

As will be explained in a later section, each of these layers can be deployed on the same system, or for scalability issues, on separate systems.

## 1.2 Security for Network Data Collection

To read HTTP(S) data streams, a proprietary software module reassembles TCP/IP packet streams. Because the network data collectors do not have an assigned IP number, and the software using these data collectors does not have a functional IP stack, RUEI is not able to respond to incoming traffic received on the data collectors. This makes RUEI "invisible" to the monitored networks, and completely secure.

---

**Note:** Because of the non-intrusive way in which RUEI collects data, it is not possible for it to request retransmission in the event of an error on the measurement port.

---

Data collection can be configured to log encrypted data. To facilitate this, a copy of the web server's private SSL keys needs to be set up in the data collector. In addition, RUEI can be configured to omit logging of sensitive data in the arguments of POST requests of forms or content; so called *data masking* (or blinding).

## 1.3 Connection Options for Network Data Collection

RUEI supports the use of both copy ports<sup>1</sup> and TAPs<sup>2</sup> for monitoring network traffic (10/100 Mbps and 1/10 Gbps Ethernet connections are supported). Copy ports and TAPs are available for copper or fibre-based network infrastructures. While both devices allow non-intrusive monitoring of network traffic, there are differences between these two connection options. These are highlighted in the rest of this section.

### Monitoring SSL and Forms Traffic

Be aware that SSL and Oracle Forms traffic are particularly sensitive to disruptions in the TCP packet stream. This is because they require state information to be maintained for the duration of the connection, and any lost packets can cause that information to be lost, preventing RUEI from accurately monitoring and reporting the connection.

Therefore, you should ensure that each Collector is connected to a reliable network device, such as a TAP. In addition, it is *strongly* recommended that you regular review

<sup>1</sup> Copy ports are also known as Switched Port Analyzer (SPAN) ports which is a feature of Cisco switches.

<sup>2</sup> Test Access Port (TAP) devices are provided by specialist vendors, such as NetOptics Inc.

the information available through the Collector Statistics window (select **System**, then **Status**, and then **Collector status**) to verify the integrity of the TCP packet stream. Particular attention should be paid to the reported TCP and SSL connection errors. Also, note that the Collector software needs direct access to the physical network interface and that a configuration where multiple servers share a single physical network interface, for example certain blade server types, may not work reliably. Contact your hardware vendor if you have any doubt about your configuration.

### 1.3.1 Copy Ports

A copy port is a switch that starts to build up a Layer 2 forwarding table on the basis of the source MAC address of the different packets that the switch receives. After this forwarding table is built, the switch forward traffic that is destined for a MAC address directly to the corresponding port.

For example, after the web server MAC in [Figure 1-5](#) is learned, unicast traffic from the browser to the web server is only forwarded to the web server port. Therefore, the Collector does not see this traffic.

**Figure 1-5 Network Connection Using a Copy Port**

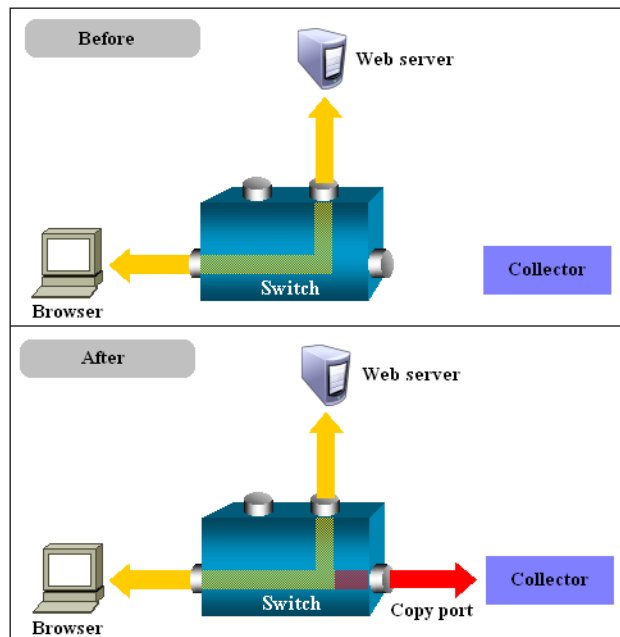

In the configuration shown in the lower part of [Figure 1-5](#), the Collector is attached to a port that is configured to receive a copy of every packet that the browser sends and receives. This port is called a copy port. Copy ports can copy traffic from any or all data ports to a single unused port and prevents bi-directional traffic on the port to protect against backflow or traffic into the network.

Be aware that activating a copy port on a switch can have a performance impact. Typically, copy ports support a wide range of configuration options, and for further information about these options you should consult your switch documentation or contact the vendor.

## 1.3.2 TAPs

TAPs can be placed between any two network devices (such as routers and firewalls). Any monitoring device connected to a TAP receives the same traffic as if it were in-line, including all errors. This is achieved through the TAP duplicating all traffic on the link, and forwarding it to the monitoring port(s). The example shown in [Figure 1-6](#) illustrates a typical TAP deployment for one Collector.

**Figure 1-6 Network Monitoring Using a TAP**

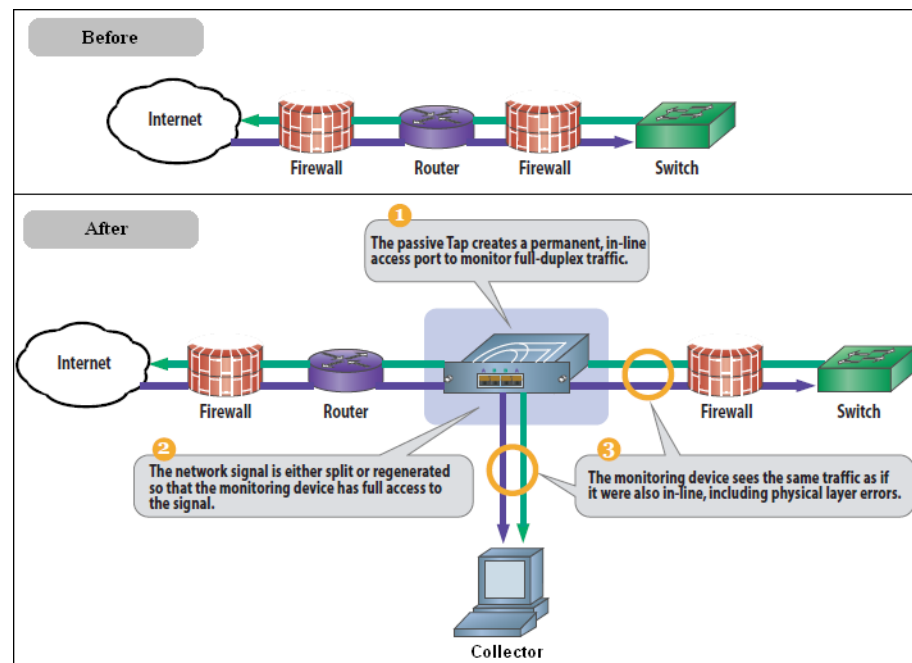

### Important

Unlike copy ports, in the event of power failure, TAPs continue to allow data to flow between network devices. In addition, copy ports are prone to packet loss when under load. TAP devices are available for copper or fibre-based infrastructures. Moreover, they can be easily deployed when and where required, but without reconfiguration of switches or engineers needing to re-cable a network link. For these reasons, the use of TAPs is *strongly* recommended over that of copy ports.

Broadly speaking, there are three types of TAPs: network, regeneration, and aggregation TAPs. RUEI supports the use of network and regeneration TAPs. Aggregation taps are only supported if they maintain the ordering of packets in the packet stream. Note that reporting accuracy can be impacted when using aggregation taps if the monitor port gets saturated, resulting in packet loss and inaccurate timing information. In addition, be aware that when capturing data with a network TAP, the use of cascaded TAP configurations is not supported.

It is possible in RUEI to monitor and process data from multiple networks, by either deploying a tap on each network segment and connecting those to a central collector, or by deploying multiple collectors, one on each monitored segment (see [Section 1.6, "Scaling Scenarios"](#)).

## 1.4 Installation Options

A RUEI system can be installed to be one of three things: a Reporter, a Collector, or a Processing Engine. Each of these installation options is reviewed in the following sections.

### Reporter

A Reporter system processes the data gathered by the Collectors attached to it. After processing, this data is stored in an Oracle database, referred to as the Reporter database. System users can review the collected data through a browser-based interface.

In order for RUEI to be able to accurately monitor network traffic, and report its results, it needs certain information about your network and application infrastructure. This includes how pages, service function calls, and end users will be identified, the scope of monitoring in your network environment, the monitoring of specific KPIs and SLAs, and the roles and permissions assigned to system users. This information is held in a separate Configuration database.

### Collector

A Collector gathers data and submits the data to a Reporter. Multiple Collectors can be attached to the same Reporter. Note that a direct connection is required between the Collector systems and the Reporter system. A collector can be either network based or tag based as described in [Section 2.1.1, "Planning the Software Installation"](#).

Note that each Reporter installation also contains a local Collector instance. The Reporter can be configured to just process information gathered by this local Collector (this is a single-server configuration), or to receive information from additional Collectors. Note that the local Collector instance on the Reporter system can also be disabled if not required.

### Processing Engine

A Processing Engine is an optional component in a RUEI deployment that undertakes the data processing role normally performed by the Reporter. Essentially, it involves offloading the overhead of processing the data gathered by the Collectors to one or more separate systems.

---

---

**Note:** Installing a separate Processing Engine might degrade performance of a RUEI system. Contact Oracle Support for advice before installing a Processing Engine.

---

---

Each Processing Engine has its own (local) database, in which intermediate network traffic monitoring results are stored. Once processed, this data is used to update the Reporter's database. All configuration information is also maintained within this database. Note that each Processing Engine system requires a direct connection between its associated Collector systems and the Reporter system.

## 1.5 Local and Remote Database Installations

As explained earlier, the data available via the Reporter system is stored in an Oracle database, called the Reporter database. The information required by RUEI in order to correctly monitor and report on your web infrastructure, such as information about monitored applications and system users, is held in a separate Configuration part of

the database. The database can reside locally on the Reporter system, or on a remote database server (such as a database cluster).

The use of a remote database server provides a number of potential advantages over a locally installed database. In particular, it offers easier integration with existing security and back-up policies, as well as improved performance through the use of dedicated servers.

Currently, RUEI supports Oracle 11g and 12c Release 1 database installations. Note that the Oracle 10g (or older) database is not supported.

## 1.6 Scaling Scenarios

This section highlights the different deployment scenarios available to you. The selection of the most appropriate deployment scenario is primarily determined by the level of monitored network traffic, your reporting requirements, and the hardware specifications of your deployment systems.

### Single-Server Deployment

This is the simplest deployment, and is suitable for monitoring web environments with low to medium levels of traffic. An example is shown in [Figure 1-7](#).

**Figure 1-7 Single-Server Deployment**

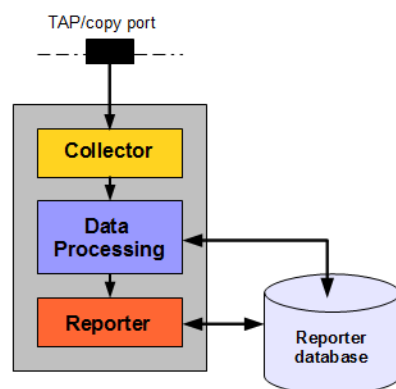

In this deployment, a single system servers as both Collector and Reporter. As explained in the previous section, the Reporter database can reside locally on the Reporter system or on a remote database server.

### Multiple-Server Deployment

The use of multiple servers may be considered when there is a need to monitor very high levels of traffic. In addition, this deployment also provides the possibility of enhanced security. For example, by placing the Collector(s) outside the office network, while placing the Reporter system within the network. [Figure 1-8](#) shows an example of a multiple-Collector deployment.

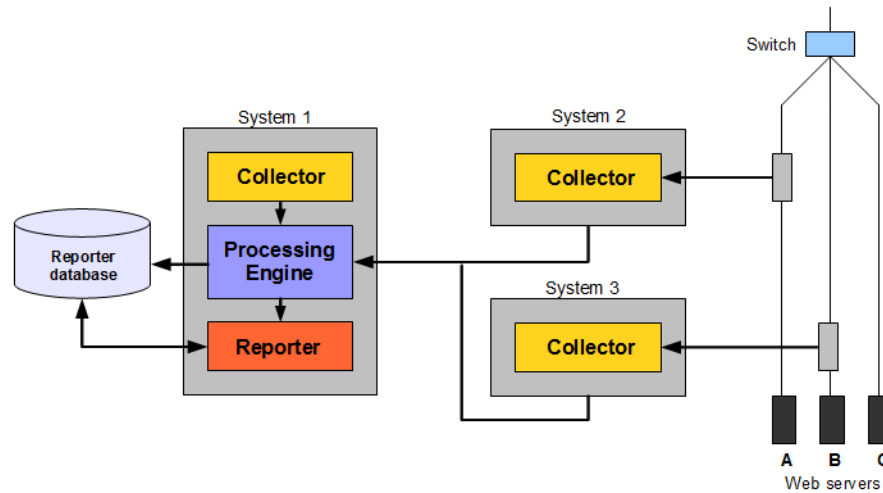
**Figure 1–8 Multiple-Collector Deployment**

This features a deployment in which both data lines are monitored in the same reporting environment. Note that this deployment assumes that the traffic on each line is mutually exclusive. It also illustrates a deployment used for security reasons. While the traffic from web servers A and B are monitored and reported, the traffic from web server C is not. This is also the reason why the Collectors are not placed above the switch. Note that the Collector instance on the Reporter system (system 1) is disabled.

For security reasons, it is recommended that access to the Reporter system is restricted to trusted IP ranges. Similarly, you may want to locate the Reporter system inside the internal network to maximize its security. The Collector's data gathering ports should be within the DMZ.

The application and infrastructure configuration information held in the database is maintained by the Reporter based on information provided by system users through its browser-based interface. Each Collector uses this information to determine how the data it gathers should be reported.

### Three-Tier Deployment

As explained earlier, a Processing Engine serves to offload a significant amount of the processing normally performed by the Reporter to a separate system. It is strongly recommended that you consider the use of a Processing Engine within your deployment when CPU utilization on the Reporter system is reaching its upper limit. [Figure 1–9](#) shows an example of a Processing Engine within a multiple-Collector deployment.

---

**Note:** The use of Processing Engines is only supported for remote Collectors. A combined installation of a Processing Engine and a Collector on the same system is not supported.

---

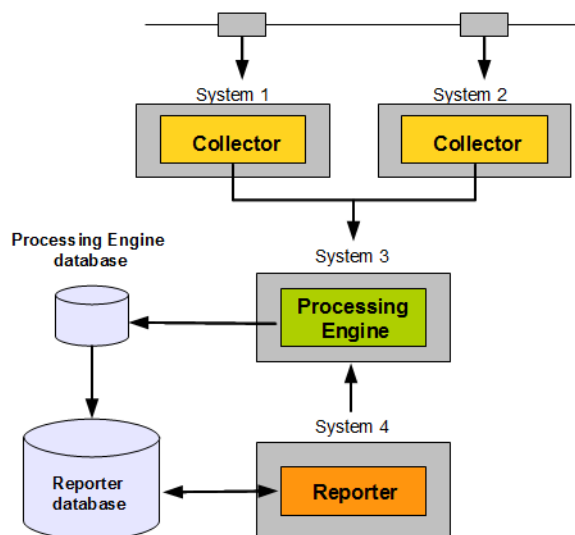
**Figure 1–9 Three-Tier Deployment**

It is important to understand that the processing performed on the Reporter system includes not only the processing of the data gather by the attached Collectors, but also the use of the Enriched data export facility. This enables you to combine the data gathered by RUEI with other data sources. Be aware that, when enabled, this facility places a considerable additional load on the Reporter system. The Enriched data export facility is described in the *Oracle Real User Experience Insight User's Guide*.

Table 1–3 shows the location of data in a distributed environment where **P** is the processor node and **R** is the reporter node.

**Table 1–3 Location of Data**

Name	Display	Real time	5 min	Hour	Day	Month
ADF	ADF Framework		P	P	P	P
DYNADF	ADF Framework Diagnostics	P	P			
SERVICE	All functions		R		R	R
PAGE	All pages		P	R	R	R
VISIT	All sessions				P	P
SESSION_ACTIVITY	All sessions		P	P		
SESSION_APP	All sessions	P				
BROWSER_EXCEPTION	Browser exceptions		P			
EBS	E-Business (Forms)		P	P	P	P
DYNEBS	E-Business (Forms) Diagnostics	P	P			
RTERROR	Error instance data	P				
FCDB	FC Direct Banking		P	P	P	P
DYNFCDB	FC Direct Banking Diagnostics	P	P			

**Table 1–3 (Cont.) Location of Data**

<b>Name</b>	<b>Display</b>	<b>Real time</b>	<b>5 min</b>	<b>Hour</b>	<b>Day</b>	<b>Month</b>
FCUB	FC Universal Banking		P	P	P	P
DYNFCUB	FC Universal Banking Diagnostics	P	P			
FAILED_URL	Failed URLs	R				
FAILED_SERVICE	Failed functions	R				
FAILED_PAGE	Failed pages	R				
DIAG_SERVICES	Function diagnostics	P				
RTWSCALL	Function instance data	P				
FUS	Fusion Applications		P	P	P	P
DYNFUS	Fusion Applications Diagnostics	P	P			
FUS_PROD_FAMILY	Fusion product family	P				
FUS_PROD_USERS	Fusion product users	P				
RTECID	Hit ECID instance data	R				
JDE	JD Edwards EnterpriseOne		P	P	P	P
DYNJDE	JD Edwards EnterpriseOne Diagnostics	P	P			
KEY_PAGE	Key pages		P	R	R	R
KPI	Monitored KPIs			R	R	
RTPAGE	Page instance data	P				
PSFT	PeopleSoft		P	P	P	P
DYNPSFT	PeopleSoft Diagnostics	P	P			
SLA	Service levels			R		
SLM	Service tests		R		R	
SESSION	Session Diagnostics	P				
SBL	Siebel		P	P	P	P
DYNSBL	Siebel Diagnostics	P	P			
SLOW_URL	Slow URLs	P			P	
SLOW_SERVICE	Slow functions	R				
TCP_STATISTICS	TCP statistics					
EURL	URL diagnostics	P	P			
RTURL	URL instance data	P				
USER_FLOW_ACTIVITY	User flow activity		P	P	P	



**Table 1–3 (Cont.) Location of Data**

Name	Display	Real time	5 min	Hour	Day	Month
USER_FLOW_COMPLETED	User flow completion		P		P	P
RTTRANS	User flow instance data	P				
WCS	Webcenter		P	P	P	P
DYNWCS	Webcenter Diagnostics	P	P			
WCSP	Webcenter Portal		P	P	P	P
DYNWCSP	Webcenter Portal Diagnostics	P	P			
WCSS	Webcenter Sites		P	P	P	P
DYNWCSS	Webcenter Sites Diagnostics	P	P			
WLP	Weblogic Portal		P	P	P	P
DYNWLP	Weblogic Portal Diagnostics	P	P			

## 1.7 Server Requirements

The required minimum system specifications for the selected configuration (as explained in [Section 1.4, "Installation Options"](#)) are described in the following sections.

### Network Cards

It is recommended that you carefully consider the selection of network cards for your infrastructure. Depending on the connection option you selected in [Section 1.3, "Connection Options for Network Data Collection"](#), both copper and fibre-based network cards may be required. If necessary, consult both your network and systems management teams.

### Network Cards Within Bonded Groups

Be aware that monitoring of network traffic using network cards that are part of a bonded group is not supported.

---



---

**Note:** For more information about required and recommended system specifications, please contact Customer Support.

---



---

### 1.7.1 Single-Server Requirements

**Table 1–4 Single-Server System Minimum Requirements**

Element	Requirements
CPU	64-bit Intel or AMD dual-CPU, dual-core processor (> 2 G Hz) or equivalent.
Memory	16 GB.
Disk space	Minimum 700 GB HDD free space. <sup>1,2,3</sup>

**Table 1–4 (Cont.) Single-Server System Minimum Requirements**

Element	Requirements
Network interfaces	When using a network-TAP device <sup>4</sup> , a minimum of three network interfaces are required: <ul style="list-style-type: none"> <li>■ Two interfaces for network traffic capturing.</li> <li>■ One interface for network services.</li> </ul>
GSM modem (optional)	Optional support for a GSM modem to send text messages. The modem needs to be either GSM07.05 or GSM07.07 compatible. It can be connected through a serial or USB port. If USB is used, RUEI uses the first available port (ttyUSB0). Alternative methods of sending text messages are available (http/e-mail).

<sup>1</sup> To ensure acceptable performance of the RUEI installation, it is recommended to use high performance disk systems, with a minimum supported I/O rate of 70 MB/s. When monitoring high volumes of traffic, more powerful disk systems may be required. (Hardware) RAID-10 or equivalent storage configurations are strongly recommended.

<sup>2</sup> This may need to be increased if Enriched data exchange is enabled.

<sup>3</sup> The use of an NFS share for local data (that is, `$RUEI_DATA` and `$RUEI_HOME`) is not supported. Note that this restriction does not apply to `$RUEI_DATA/processor/data` and `$RUEI_DATA/collector/wg/REPLAY`.

<sup>4</sup> When capturing data with a network-TAP device, the use of cascaded TAP configurations is not supported.

## 1.7.2 Reporter Requirements

**Table 1–5 Reporter System Minimum Requirements**

Element	Requirements
CPU	64-bit Intel or AMD dual-CPU, dual-core processor (> 2 GHz) or equivalent.
Memory	16 GB.
Disk space	Minimum 700 GB HDD free space <sup>1,2,3</sup> .
Network interfaces	A minimum of one network interface is required.
GSM modem (optional)	Optional support for a GSM modem to send text messages. The modem needs to be either GSM07.05 or GSM07.07 compatible. It can be connected through a serial or USB port. If USB is used, RUEI uses the first available port (ttyUSB0). Alternative methods of sending text messages are available (http/e-mail).

<sup>1</sup> To ensure acceptable performance of the RUEI installation, it is recommended to use high performance disk systems, with a minimum supported I/O rate of 70 MB/s. When monitoring high volumes of traffic, more powerful disk systems may be required. (Hardware) RAID-10 or equivalent storage configurations are strongly recommended.

<sup>2</sup> This may need to be increased if Enriched data exchange is enabled.

<sup>3</sup> The use of an NFS share for local data (that is, `$RUEI_DATA` and `$RUEI_HOME`) is not supported. Note that this restriction does not apply to `$RUEI_DATA/processor/data` and `$RUEI_DATA/collector/wg/REPLAY`.

## 1.7.3 Collector Requirements

The requirements for Collector systems are shown in [Table 1–6](#).

**Table 1–6 Collector System Minimum Requirements**

Element	Requirement
CPU	64-bit Intel or AMD dual-core processor or equivalent.
Memory	8 GB.
Disk space	Minimum 200 GB HDD free space <sup>1</sup> .

**Table 1–6 (Cont.) Collector System Minimum Requirements**

Element	Requirement
Network interfaces	<p>When using a network-TAP<sup>2</sup> device, a minimum of three network interfaces are required:</p> <ul style="list-style-type: none"> <li>■ Two interfaces for network traffic capturing<sup>3</sup>.</li> <li>■ One interface for communication with the Reporter system.</li> </ul> <p>When using a network-copy port, a minimum of two network interfaces are required:</p> <ul style="list-style-type: none"> <li>■ One interface for network traffic capturing.</li> <li>■ One interface for communication with the Reporter system.</li> </ul>

<sup>1</sup> The use of an NFS share for local data (that is, `$RUEI_DATA` and `$RUEI_HOME`) is not supported. Note that this restriction does not apply to `$RUEI_DATA/processor/data` and `$RUEI_DATA/collector/wg/REPLAY`.

<sup>2</sup> Capturing data with a network-TAP device prevents the use of a cascaded TAPs configuration.

<sup>3</sup> For up and down stream traffic. Note that the use of TAPs that integrate up and down stream traffic on one line (that is, link aggregation TAPs) is not recommended.

## 1.7.4 Processing Engine Requirements

The requirements for Processing Engine systems are shown in [Table 1–7](#).

---



---

**Note:** A separate Processing Engine server is only required in very large scale environments (for example, handling hundreds of millions of clicks per day). At least two servers must be dedicated to Processing Engine duties if you want to run the Processing Engine separately from the Reporter.

---



---

**Table 1–7 Processing Engine System Minimum Requirements**

Element	Requirements
CPU	64-bit Intel or AMD dual-CPU, dual-core processor (> 2 GHz) or equivalent.
Memory	16 GB.
Disk space	Minimum 700 GB HDD free space <sup>1,2,3</sup> .
Network interfaces	A minimum of one network interface is required.

<sup>1</sup> To ensure acceptable performance of the RUEI installation, it is recommended to use high performance disk systems, with a minimum supported I/O rate of 70 MB/s. When monitoring high volumes of traffic, more powerful disk systems may be required. (Hardware) RAID-10 or equivalent storage configurations are strongly recommended.

<sup>2</sup> This may need to be increased if Enriched data exchange is enabled.

<sup>3</sup> The use of an NFS share for local data (that is, `$RUEI_DATA` and `$RUEI_HOME`) is not supported. Note that this restriction does not apply to `$RUEI_DATA/processor/data` and `$RUEI_DATA/collector/wg/REPLAY`.

---



---

**Important:** Please note that an Intel (or compatible) 64-bit platform is a *strict* requirement for both the hardware and the operating system in all deployment scenarios.

---



---

## 1.7.5 Deployment Best Practices

This section presents a best practices framework within which to optimize your RUEI deployment. It is recommended that you carefully review the following information.

### **Planning Your Deployment**

It is important that the nature of the monitored network environment is clearly understood before deciding upon your RUEI deployment strategy. This includes not only the basic network connectivity, ports, addressing, and physical device requirements, but also a sound understanding of the monitored applications.

Moreover, before deploying RUEI, the basic traffic flows within the network must have been identified. This should include information about average and peak volumes of traffic. Any physical deployment requirements (such as space limitations, distances, power planning, rack space and layout, or cabling) should also have been identified.

You can use the checklist presented in [Appendix H, "Installation Checklist"](#) to capture much of this information.

### **Forms-Based Traffic**

If you are planning to monitor Forms-based traffic, be aware that the memory requirements may be higher than those outlined in [Section 1.7, "Server Requirements"](#). This is especially the case in deployments with heavy levels of Forms traffic. In this case, you should consider a split-server deployment.

### **Full Session Replay**

If you are planning to make use of the Full Session Replay (FSR) facility, you may need to configure additional storage capacity. This is explained in [Section 1.7.7, "Full Session Replay Storage Requirements"](#).

### **Encrypted Traffic**

If a significant level of the monitored traffic is encrypted, this can increase the CPU overhead. In this case, it is recommended that you consider configuring additional CPUs or, alternatively, a split-server deployment.

### **Very High Levels of Traffic**

When very high levels of traffic are being monitored (that is, more than 10 million page views per day), it is *strongly* recommended that you consider a split-server deployment. Alternatively, consider the use of a remote database server. The latter has the effect of significantly reducing (by up to 30%) the CPU overhead on the Reporter system. Monitored environments with more than 20 million page views per day should consider the use of both a split-server deployment and a remote database server.

## **1.7.6 Data Retention Policies**

The availability of specific data within the Data Browser, as well as reports based on that data, depends on the amount of available disk space on the Collector and Reporter systems, as well as the amount of database space available on the Reporter system.

Data gathered during monitoring is first written to log files, stored on the Collector system. These files are copied to, and processed by, the Reporter to populate the database that holds the multi-dimensional data structure viewable through the Data Browser and reports. These temporary log files are automatically removed from the Collector system after three days, and from the Reporter system (by default) after seven days.

The size of the database user quota for the Reporter system is configurable during installation. By default, it is set to 500 GB. It is important to understand that data is

consolidated when it is no longer required by the Reporter's defined retention policy. For example, by default, daily information about the last 32 days is retained. Daily information older than this is consolidated into the monthly information. Similarly, monthly information is consolidated into yearly information.

RUEI maintains data at several aggregation levels, whose retention is configured in days. The following describes the various aggregation levels and their default values:

- Instance: 8 days
- 5-minute: 15 days
- Hourly: 32 days
- Daily: 90 days
- Monthly: 60 months

These numbers can be fine-tuned per category of data (app, suite, service, SLA) and beyond that per individual type (for example, All Pages or Failed Pages). The default value for enriched data exchange is 8 days for each type.

DB space is about 5 GB per period each. This is heavily dependent on load and diversity of traffic. You should occasionally check the reporter data retention screen, especially in the first month, to verify enough disk space is available.

Statistics data is configurable from the CLI. However, statistics retention is not configurable, while User flow completion and fusion product retention are only configurable from the command line.

Minimum and maximum values for data retention settings are automatically determined. Less-detailed aggregation levels must always have at least as much retention as more-detailed aggregation levels.

Be aware that a new RUEI installation will grow quickest during the first 32 days. After that time, the growth rate will slow. Of course, the growth rate depends on monitored traffic levels.

### 1.7.7 Full Session Replay Storage Requirements

If you are planning to make use of the Full Session Replay (FSR) facility, you may need to configure additional storage capacity available to the Collector system. This should be a separate device (not a partition of the Collector server's existing hard drive), and made accessible to the RUEI file system. The procedure to do this, together with guidance on storage requirements, is described in the rest of this section. Note that this procedure must be repeated for each Collector for which full session replay information is required.

#### Configuring Additional Storage for Full Session Replay

The procedure described below assumes that you have a fully operational system, and that FSR has been enabled. To configure the additional required storage, do the following:

1. Mount the device. For example, under `/mnt/external_storage`.
2. Temporarily stop the Collector by issuing the following command:
 

```
appsensor stop wg
```
3. Move the `$APPSENSOR_HOME/wg/REPLAY` directory to the new device. In the above example, this is `/mnt/external_storage`, and the result is that the replay files are now located in the `/mnt/external_storage/REPLAY` directory.

4. Create a symbolic link from `/mnt/external_storage/REPLAY` to `$APPSENSOR_HOME/wg/REPLAY`.
5. Restart the Collector by issuing the following command:
 

```
appsensor start wg
```
6. Calculate the required storage capacity. To do so, multiply the average number of daily page views by the average page size. Then, multiply this number by the number of days you wish full session replay data to be retained. Use [Table 1–8](#) as guidance.

**Table 1–8 Full Session Replay Storage Estimates**

Page views per day (millions)	Low page weight (~10 Kb)		Medium page weight (~50 Kb)		High page weight (~100 Kb)	
	Size per day (GB)	Disk I/O (MB/sec)	Size per day (GB)	Disk I/O (MB/sec)	Size per day (GB)	Disk I/O (MB/sec)
0.5	5	0.1	25	0.3	50	0.6
2	20	0.2	100	1.2	200	2.3
5	50	0.6	250	2.9	500	5.8
10	100	1.2	500	5.8	1000	11.6
20	200	2.3	1000	11.6	2000	23.1
50	500	5.8	2500	28.9	5000	57.9

**Important:** [Table 1–8](#) is intended for guidance only. It is *strongly* recommended that you regularly review average page sizes and daily page views, and adjust the required storage size as necessary.

**Note:** Be aware that FSR functionality uses a significant number of non-sequential read operations. Please consult your hardware vendor for information on how to optimize your I/O performance.

7. Select **Configuration**, then **General**, then **Advanced settings**, and then **Collector data retention policy**. Click the **Full session replay storage size (GB)** setting. Specify (in gigabytes) the required storage size. Note that the maximum that can be specified is 100 TB. When ready, click **Save**.

## 1.7.8 Memory Requirements

When calculating the amount of RAM required by your RUEI installation, it is recommended that you consider the following:

- For a Reporter system without configured Processing Engines, or a Processing Engine system itself, each million visitor sessions per day requires 256 MB. Hence, 3 million visitor sessions per day would require 768 MB. In addition, each million page views requires 100 MB - 256 MB. Note that exact amount depends the length of monitored URLs, average session duration, and the number of events (such as custom dimensions).
- For each Collector system, each 100 concurrent hits require 2 MB, and each 1000 SSL connections require 1 MB. In addition, up to 600 MBps of network traffic can

be buffered before individual TCP sessions start to be dropped. Up to 600 MBps should also be assumed for content checks (such as XPath queries and error strings). Note that if you define a large number of content checks, or specify that they contain NLS character sets, the memory required may increase.

## 1.8 Software Requirements

The following GNU/Linux distributions are supported:

- Oracle Linux 5.x or 6.x 64-bit Intel or AMD compatible.
- RedHat Enterprise Linux 5.x or 6.x 64-bit Intel or AMD compatible.

The following database versions are supported:

- 11gR2
- 12c Release 1

The minimum required Oracle Database release for RUEI is 11gR2. Note that the best performance for RUEI 13.2.2.1 is achieved with Oracle Database 12c Release 1.

---



---

**Note:** If you experience an ORA-12805: Parallel Query Server Died Unexpectedly error, see [Section G.2](#) for a suitable workaround.

---



---

### Encrypting Sensitive Data

If sensitive data needs to be encrypted, you have the opportunity to encrypt your entire disk configuration during the disk partitioning phase of the Linux installation procedure.

## 1.9 Network Requirements

- All server system clocks should be synchronized via NTP using UDP port 123.
- Support DNS information requests over TCP and UDP port 53.
- Support reports and e-mail alerts using TCP port 25.
- Support SNMP traps on request from an SNMP Manager using UDP port 161/162.
- The RUEI user interface is accessible over HTTPS port 443.
- In the case of a remote database setup, access to TCP port 1521 is required between the Reporter and remote database server.
- Each remote Collector system should be accessible by the Reporter system over TCP port 22. It is recommended all other ports be blocked.
- If you are configuring a failover Reporter system (described in [Chapter 9](#), "[Configuring a Failover Reporter System](#)"), the primary and secondary Reporter systems need to be able to contact each other using ICMP.
- If you are configuring a failover Collector system (described in [Chapter 10](#), "[Configuring a Failover Collector System](#)"), the primary and secondary Collector systems need to be able to contact each other using ICMP.

### Collector-Reporter and Collector-Processing Engine Bandwidths

The amount of data transferred between a remote Collector and the Reporter system largely depends on the type and level of network application traffic monitored by RUEI. In addition, the configuration of RUEI (such as defined functional errors,

content checks, and page naming schemes) also influences the size of Collector files that need to be transferred to the Reporter system.

At peak times, the amount of data that needs to be transferred will be higher than during low traffic periods. Note that the exact amount of the data transmission from a remote Collector to the Reporter system can only be determined after the actual RUEI deployment.

For an initial deployment, the following simple rule can be used: each 5 million daily page views will result in a peak transfer of approximately 125 MB at peak time, and approximately 1 GB per day. Hence, typically only a few percent of the actual monitored traffic will be stored by a Collector and transferred to the Reporter. When you want or need to minimize this data transfer, it is recommended that you minimize the amount of monitored HTTP traffic which is not required by RUEI. For example, by using a subnet or VLAN-filtered network.

In the case of deployments that make use of Processing Engines, the above also applies to Collector-Processing Engine connections.

### Firewall Requirements

Table 1–9 shows the firewall requirements for your RUEI deployment.

**Table 1–9 RUEI Firewall Rules**

From	To	Port(s)	Socket type	Required	Description
Reporter	Collector	22 (SSH)	TCP	Y	Each remote Collector system must be accessible by the Reporter system over TCP port 22.
Reporter	Processing Engine	22 (SSH)	TCP	Y	Each Processing Engine system must be accessible by the Reporter system over TCP port 22.
Reporter	Processing Engine	1521 <sup>1</sup> (NET8)	TCP	Y	Each Processing Engine system must be accessible by a database connection (by default, over port 1521).
Reporter	NTP server	123 (NTP)	UDP	Y	All server system clocks must be synchronized via NTP.
Processing Engine	NTP server	123 (NTP)	UDP	Y	All server system clocks must be synchronized via NTP.
Processing Engine	Collector	22 (SSH)	TCP	Y	Each Collector system must be accessible by the Processing Engine system over TCP port 22.
Processing Engine	Reporter	1521 (NET8)	TCP	Y	Each Processing Engine system must be accessible by a database connection (by default, over port 1521).
Collector	NTP server	123 (NTP)	UDP	Y	All server system clocks must be synchronized via NTP.
Remote DB server	NTP server	123 (NTP)	UDP	Y	All server system clocks must be synchronized via NTP.
Reporter	DNS server	53 (DNS)	TCP/UDP	N <sup>2</sup>	Support DNS information requests.



**Table 1–9 (Cont.) RUEI Firewall Rules**

From	To	Port(s)	Socket type	Required	Description
Collector	DNS server	53 (DNS)	TCP/UDP	N <sup>2</sup>	Support DNS information requests.
Remote DB server	DNS server	53 (DNS)	TCP/UDP	N <sup>2</sup>	Support DNS information requests.
Reporter	Mail server	25 (SMTP)	TCP	N	Support reports and E-mail requests.
Reporter	SNMP Manager server	161, 162 (SNMP)	UDP	N	Support SNMP traps on request from an SNMP Manager.
Client browsers	Reporter	443 (HTTPS)	TCP	Y	The RUEI user interface is accessible over HTTPS.
Client browsers	Tag based collector	80/443	TCP	N	Support tag based data collection.
ADF Application	Reporter	443 (HTTPS)	TCP	N	Support ADF Monitoring Service.

<sup>1</sup> Note that this port is configurable.

<sup>2</sup> Optional, but *strongly* recommended.

## 1.10 Client Requirements

The workstations that will access the RUEI user interface must have one of the following browsers installed:

- Mozilla Firefox 3.6 (or above).
- Internet Explorer 7, 8, or 9.
- Safari 4 and 5.
- Google Chrome 17 (or above).

Note that JavaScript must be enabled. No other browser plug-ins are required.

In addition, the workstation should have a screen resolution of 1024 \* 768 (or higher).

---



---

**Important:** Ensure that any pop-up blocker within the browser has been disabled.

---



---

### AJAX Support

RUEI uses AJAX to enhance its user interaction. Internet Explorer relies on the MSXML control to facilitate AJAX. The AJAX dependencies can trigger a security warning when using strict security settings.



---

---

## Installing the RUEI Software

This chapter describes the prerequisites and procedure for installing each of the RUEI components. The procedure for upgrading an existing RUEI 13.x.x.x installation to release 13.2.2.1 is described in [Chapter 3, "Upgrading to RUEI 13.2.2.1"](#). The post-installation configuration procedure is described in [Chapter 6, "Configuring RUEI"](#).

---

---

**Note:** Before attempting to install RUEI components on any system, make sure that you have applied the latest OpenSSL patches for your operating system using the appropriate commands (for example, `yum update` or `up2date`). Applying the latest OpenSSL patches helps improve the security of the system.

---

---

### 2.1 Prerequisites

This section describes the steps that should be taken before starting to install the RUEI software. Ensure that *all* preconditions described in this section are met before proceeding with the installation process.

---

---

**Note:** RUEI installation is supported for both RedHat Enterprise/Oracle Linux 5.x and RedHat Enterprise/Oracle Linux 6.x, however for maximum reliability and security, upgrade the system to the latest patch version before installing RUEI.

---

---

#### 2.1.1 Planning the Software Installation

For an introduction to RUEI data collection see [Section 1.1.1, "Data Collection"](#). The following installation data collection options are available:

- Network data collector: This option collects data that passes through the network and was the default option in previous releases and requires either a local or remote collector.
- Tag data collector: This option, also called tag based monitoring, collects data by monitoring the request and processing of a specific web URL (the tag) which is inserted into all pages.
- ADF monitoring: Various data collection options are available for monitoring ADF based applications, including the ADF monitoring Service. This service collects data (for example, user names) from the application server for ADF based applications, enhancing the data from network data collection. See [Section 4, "Configuring RUEI for ADF Monitoring"](#) for more information on these options.

**Table 2–1 Installation Overview and Data Collection Methods**

	Network	Tag
Requirement	Access to network traffic to perform Network Protocol Analysis.	Access to application templates to insert Javascript code.
Single Server (as in Figure 1–7)	Use the <code>reporter</code> option when running the installer as described in Section 2.5.6, "Installing the Reporter Software" (installs network data collector automatically).	Use the <code>reporter-tag</code> option when running the installer as described in Section 2.5.6, "Installing the Reporter Software" (installs tag based data collector automatically).
Multiple Server (as in Figure 1–9)	Use the <code>collector</code> option when running the installer as described in Section 2.7, "Remote Network Data Collector Installation" for Systems 1 and 2 of Figure 1–9.  Use the <code>reporter</code> option when running the installer as described in Section 2.5.6, "Installing the Reporter Software" for Systems 3 and 4 of Figure 1–9.	Use the <code>tag-server</code> option when running the installer as described in Section 2.6, "Remote Tag Data Collector Installation" for Systems 1 and 2 of Figure 1–9.  Use the <code>reporter</code> option when running the installer as described in Section 2.5.6, "Installing the Reporter Software" for Systems 3 and 4 of Figure 1–9.
ADF Monitoring	Various data collection options are available for monitoring ADF based applications, including the ADF monitoring Service. This service collects data (for example, user names) from the application server for ADF based applications, enhancing the data from network data collection. See Chapter 4, "Configuring RUEI for ADF Monitoring" for more information on these options.	

## 2.1.2 Planning the Software Installation Location

Depending on the installation location of the Reporter database and the RUEI software, the necessary disk space needs to be carefully planned. During operating system installation, you will need this information at hand for the disk partitioning phase.

Table 2–2 shows the disk space requirements for the RUEI installation components.

**Table 2–2 Required Disk Space Specifications**

Partition	Min. Required Disk Space (GB)	Component
ORACLE_BASE (default /u01/app/oracle) <sup>1</sup>	500	Database server
RUEI_HOME (default /opt/ruei)	5	Reporter, Collector
RUEI_DATA (default /var/opt/ruei/)	100	Reporter, Collector

<sup>1</sup> This is the example database location used throughout this guide.

This means that for a stand-alone RUEI server installation, a minimum of 700 GB is required. In the case of a high-traffic implementation, involving a dedicated remote Collector, a minimum of 200 GB of disk space is recommended for /var/opt/ruei (*RUEI\_DATA*).

---

**Important:** The Reporter and database servers require high-performance data storage. RAID-10 or RAID-5 (or equivalent) storage configurations with high-performance disks are *strongly* recommended.

---

### 2.1.3 Configuring the Network Interface for Network Data Collection

If you want to use network data collection:

1. Ensure that a static IP address is assigned to the interface used to access the RUEI web interface. In addition, the assigned IP address and host name should be configured in the `/etc/hosts` file. If necessary, ensure that all Reporter, Collector, and Processing Engine systems are correctly defined in the DNS system.
2. Ensure that the network interface(s) used for network packet monitoring are administratively *up*, but *without* an IP address.

---

**Important:** Make the network interface *up* status permanent (after a reboot) by setting the `ONBOOT` parameter of the capturing interfaces to `yes`. The network interfaces configuration can be found in the `/etc/sysconfig/network-scripts/ifcfg-ethX` file (where `X` represents the necessary network interface). Alternatively, use the graphical utility **system-config-network** to perform the above actions.

---

### 2.1.4 Configuring Operating System Security

When the system boots for the first time, a post-installation wizard appears, and allows you to finalize the operating system configuration settings. Ensure that:

1. The RUEI firewall rules shown in [Table 1-9](#) are correctly configured.
2. Security Enhanced Linux (SELinux) is disabled. This is necessary for the correct operation of RUEI. Note that changing the SELinux setting requires rebooting the system so that the entire system can be relabeled.
3. For security reasons, it is *strongly* recommended that you check the **Encrypt System** check box during operating system installation so that all sensitive data is stored in a secure manner. A passphrase is required during booting the system.

### 2.1.5 Verify NTP Daemon Operation for Network Data Collection

Ensure that the date and time settings are correctly specified. The use of NTP is *strongly* recommended, and is required in a split-server deployment. In addition, all time zones specified for Reporter, Collector, and Processing Engine systems *must* be identical.

Because the NTP daemon is a critical component of RUEI, especially in a split server configuration, it is recommended that you verify that it is activated in at least run level 5 during boot. Use the following commands:

```
/sbin/chkconfig --list | grep ntpd
ntpd    0:off  1:off  2:off  3:off  4:off  5:off  6:off
/sbin/chkconfig ntpd on
/sbin/chkconfig --list | grep ntpd
ntpd    0:off  1:off  2:on   3:on   4:on   5:on   6:off
/etc/init.d/ntpd start
Starting ntpd:                                [ OK ]
```

Note that if the NTP daemon is not already running, you can start it by issuing the following command:

```
/etc/init.d/ntpd restart
```

The following sample output shows when the NTP daemon is synchronized (indicated by an `"*"`).

```

ntpq -pn
      remote          refid          st t when poll reach  delay  offset  jitter
=====
*194.171.167.130     .PPS.             1 u 994 1024 377    6.429  0.041  0.093
+80.85.129.25       130.235.20.3     3 u 725 1024 377    4.435  0.673  0.129
+82.94.235.106     135.81.191.59   2 u 678 1024 377    1.709  1.774  0.020
127.127.1.0        .LOCL.            10 1   8   64 377    0.000  0.000  0.001

```

---

**Important:** In distributed environments, all time zones specified for Reporter, Collector, and Processing Engine systems *must* be identical.

---

## 2.1.6 Installing the RUEI Prerequisites

Note that the procedure described in this section is only required for a Reporter system. The procedure depends on whether you are using RedHat Enterprise/Oracle Linux 5.x or 6.x, and is described in the following sections.

### 2.1.6.1 Installing RedHat Enterprise/Oracle Linux 5.x Prerequisites

After performing a minimum RedHat installation, complete the following steps:

1. The required packages are available from the RedHat Enterprise/Oracle Linux distribution sets. Issue the following command to install all prerequisites for the Reporter:

```

rpm -Uvh httpd-2.2.15-*.x86_64.rpm \
libpcap-0.9*.x86_64.rpm \
apr-1.2.7-11.*.x86_64.rpm \
apr-util-1.2.7-*.x86_64.rpm \
php-5.1.6-*.x86_64.rpm \
mod_ssl-2.2.3-*.el5.x86_64.rpm \
distcache-1.4.5-*.x86_64.rpm \
php-common-5.1.6-*.x86_64.rpm \
php-cli-5.1.6-*.x86_64.rpm \
php-mbstring-5.1.6-*.x86_64.rpm \
php-soap-5.1.6-*.x86_64.rpm \
php-ldap-5.1.6-*.x86_64.rpm \
gmp-4.1.4-*.el5.x86_64.rpm \
postgresql-libs-8.1.11-*.el5_1.1.x86_64.rpm \
lm_sensors-2.10.7-*.el5.x86_64.rpm \
net-snmp-5.3.2.2-*.el5.x86_64.rpm \
net-snmp-utils-5.3.2.2-*.el5.x86_64.rpm \
perl-XML-Twig-3.26-*.fc6.noarch.rpm \
perl-XML-Parser-2.34-*.x86_64.rpm \
bridge-utils-1.1-*.x86_64.rpm

```

2. Issue the following command to install all optional fonts. Alternatively, install the multi-byte character sets necessary to meet your NLS requirements.

```
rpm -Uvh fonts-*
```

### 2.1.6.2 Installing RedHat Enterprise/Oracle Linux 6.x Prerequisites

After performing a minimum RedHat installation, complete the following steps:

1. The required packages are available from the RedHat Enterprise/Oracle Linux 6.x distribution sets. Issue the following command to install all prerequisites for the Reporter:

```
rpm -Uvh httpd-2.2.15-*.x86_64.rpm \
```

```

apr-1.3.9-*.x86_64.rpm \
apr-util-1.3.9-*.x86_64.rpm \
php-5.3.3-*.x86_64.rpm \
mod_ssl-2.2.15-*.x86_64.rpm \
php-common-5.3.3-*.x86_64.rpm \
php-cli-5.3.3-*.x86_64.rpm \
php-soap-5.3.3-*.x86_64.rpm \
php-ldap-5.3.3-*.x86_64.rpm \
hdparm-9.16-*.x86_64.rpm \
libpcap-1.0.0-*.x86_64.rpm \
gmp-4.3.1-*.x86_64.rpm \
lm_sensors-3.1.1-*.x86_64.rpm \
net-snmp-5.5-*.x86_64.rpm \
net-snmp-libs-5.5-*.x86_64.rpm \
net-snmp-utils-5.5-*.x86_64.rpm \
perl-XML-Twig-3.34-*.noarch.rpm \
perl-XML-Parser-2.36-*.x86_64.rpm \
ksh-20100621-*.x86_64.rpm \
rsync-3.0.6-*.x86_64.rpm \
wget-1.12-*.x86_64.rpm \
bc-1.06.95-*.x86_64.rpm \
bind-utils-9.7.3-*.x86_64.rpm \
bridge-utils-1.2-*.x86_64.rpm \
zlib-1.2.3-*.el6.x86_64.rpm \
ncurses-libs-5.7-*.x86_64.rpm \
ncurses-5.7-*.x86_64.rpm \
ncurses-base-5.7-*.x86_64.rpm \
php-process-5.3.3-*.x86_64.rpm

```

2. Issue the following command to install all optional fonts. Alternatively, install the multi-byte character sets necessary to meet your NLS requirements.

```
rpm -Uhv *-fonts*
```

3. Issue the following command to ensure that connections between Collectors and Reporters do not fail.

```
ln -s /usr/lib64/libpcap.so.N.N.N /usr/lib64/libpcap.so.0.9.4
```

where *N.N.N* is the version of libpcap installed. For example:

```
ln -s /usr/lib64/libpcap.so.1.0.0 /usr/lib64/libpcap.so.0.9.4
```

## 2.1.7 Installing All Requirements Using a Yum Repository (Alternative)

As an alternative to manual installation (described in the previous section), you can use a Yum repository to install the required RPMs. This requires a working Yum repository. Information about Yum repositories is available at the following location:

<http://linux.duke.edu/projects/yum/>

The procedure depends on whether you are using RedHat Enterprise/Oracle Linux 5.x or 6.x, and is described in the following sections.

### 2.1.7.1 Installing RedHat Enterprise/Oracle Linux 5.x Prerequisites

After performing a minimum RedHat installation, complete the following steps. Note that a graphic environment is not required.

1. Install the necessary Reporter packages using the following commands:

```
yum -y install perl-URI
yum -y install perl-XML-Twig
yum -y install net-snmp-utils
yum -y install sendmail-cf
yum -y install httpd
yum -y install mod_ssl
yum -y install php
yum -y install php-mbstring
yum -y install php-ldap
yum -y install php-soap
yum -y install librsvg2
yum -y install xorg-x11-xinit
yum -y install bridge-utils
```

2. Issue the following command to install all optional fonts. Alternatively, install the multi-byte character sets necessary to meet your NLS requirements.

```
rpm -Uhv fonts-*
```

### 2.1.7.2 Installing RedHat Enterprise/Oracle Linux 6.x Prerequisites

After performing a minimum RedHat installation, complete the following steps. Note that a graphic environment is not required.

1. Install the necessary Reporter packages using the following commands:

```
yum -y install perl-URI
yum -y install perl-XML-Twig
yum -y install net-snmp-utils
yum -y install sendmail-cf
yum -y install httpd
yum -y install mod_ssl
yum -y install php
yum -y install php-ldap
yum -y install php-soap
yum -y install librsvg2
yum -y install xorg-x11-xinit
yum -y install rsync
yum -y install ksh
yum -y install *-fonts
yum -y install wget
yum -y install bc
yum -y install bind-utils
yum -y install hdparm
yum -y install libpcap
yum -y install bridge-utils
yum -y install ncurses
yum -y install zlib
yum -y install php-process
```

2. Issue the following command to install all optional fonts. Alternatively, install the multi-byte character sets necessary to meet your NLS requirements.

```
rpm -Uhv fonts-*
```

3. Issue the following command to ensure that connections between Collectors and Reporters do not fail.

```
ln -s /usr/lib64/libpcap.so.N.N.N /usr/lib64/libpcap.so.0.9.4
```

where *N.N.N* is the version of libpcap installed. For example:



```
ln -s /usr/lib64/libpcap.so.1.0.0 /usr/lib64/libpcap.so.0.9.4
```

## 2.1.8 Installing Oracle Database

Download and install Oracle Database 12c Enterprise Edition from the Oracle database home page at the following location:

<http://www.oracle.com/technetwork/database/enterprise-edition/downloads>

The procedure for installing the Oracle database is fully described in the product documentation. It is *strongly* recommended that you download and review the appropriate *Oracle Database 12c Quick Installation Guide*. It is available from the Oracle Database Documentation Library. A summary of this procedure is described in [Appendix A, "Installing the Oracle Database Software"](#). Note that the path, user, and group names used in this guide are based on the Oracle database product documentation.

---

---

**Note:** While RUEI is supported on Oracle Database release 11gR2 and later, the best performance for this release of RUEI is achieved with Oracle Database 12c Release1.

---

---

## 2.2 Obtaining the RUEI Software

The RUEI software is available from the Oracle E-Delivery web site (<http://edelivery.oracle.com>). Select the following media pack criteria:

- Oracle Enterprise Manager
- Linux x86-64

## 2.3 Unpacking the RUEI Software

Copy the downloaded RUEI zip file to `/root` directory on the server, and unzip it. Use the following commands:

```
cd /root
unzip package_name.zip
```

The following directories are created which contain the software required to complete the RUEI installation:

- `/root/RUEI/132`
- `/root/RUEI/ZendOptimizer`
- `/root/RUEI/ZendGuardLoader`
- `/root/RUEI/IC`
- `/root/RUEI/PHP`
- `/root/RUEI/Java`
- `/root/RUEI/extra`
- `/root/RUEI/mkstore`

## 2.4 Generic Installation Tasks

All steps described in this section must be performed regardless of your planned installation (that is, a Reporter with local database, a Reporter with remote database, a Processing Engine, or a Collector).

---



---

**Note:** Installing a separate Processing Engine might degrade performance of a RUEI system. Contact Oracle Support for advice before installing a Processing Engine.

---



---

### 2.4.1 Check The RUEI Configuration File

The `/etc/ruei.conf` file specifies the settings used within your installation. A template of this file is provided in the `/root/RUEI/extra` directory of the RUEI distribution zip. Note that all components in your RUEI environment (such as the remote database and Collectors) require the same global `/etc/ruei.conf` configuration file. Note that there is one exception to this requirement, and that is for Processing Engine systems. This requirement is fully described in [Chapter 8, "Installing Processing Engines"](#). The settings shown in [Table 2–3](#) are defined.

**Table 2–3 RUEI Configuration Settings**

Setting	Description	Value <sup>1</sup>
RUEI_HOME <sup>2</sup>	Home directory of the RUEI software. Do not set to any path beginning with <code>/var/opt/ruei</code> .	<code>/opt/ruei</code>
RUEI_DATA <sup>2</sup>	Directory for RUEI data files. Do not set to any path beginning with <code>/opt/ruei</code> .	<code>/var/opt/ruei</code>
RUEI_USER	The RUEI operating system user.	<code>moniforce</code>
RUEI_GROUP	The RUEI operating system group.	<code>moniforce</code>
RUEI_DB_INST <sup>3</sup>	The database instance name.	<code>ux</code>
RUEI_DB_TSCONF <sup>4</sup>	The configuration tablespace name	<code>UXCONF</code>
RUEI_DB_TSSTAT <sup>4</sup>	The statistics tablespace name	<code>UXSTAT</code>
RUEI_DB_USER <sup>5</sup>	The database user name.	<code>UXINSIGHT</code>
RUEI_DB_TNSNAME <sup>6</sup>	The Reporter or Processing Engine database connect string.	<code>uxinsight</code>
RUEI_DB_TNSNAME_CFG <sup>7</sup>	The Reporter database connect string.	<code>\$(RUEI_DB_TNSNAME or config)</code>
RUEI_DB_TNSNAME_BI <sup>5</sup>	The export database connect string.	<code>uxinsight</code>
MKSTORE_BIN <sup>8</sup>	The location of the <code>mkstore</code> utility.	
TZ <sup>9</sup>	The PHP timezone setting.	<code>Europe/Amsterdam</code>
DEFAULT_TABLESPACE (see, foot 10)	The name for the default RUEI tablespace.	
REMOTE_DB <sup>10</sup>	Default is 0. Set to 1 for remote database.	
DBCONNECT (see, foot 10)	Fully qualified database connection string to remote database	

<sup>1</sup> Be aware that all variables specified in this table are the values used throughout this guide, and can be modified as required.

- <sup>2</sup> The directory name cannot exceed 50 characters in length. Note that RUEI\_HOME and RUEI\_DATA must be independent paths. For example, if RUEI\_HOME is /opt/ruei, then RUEI\_DATA cannot be set to /opt/ruei/data. Also note that RUEI\_HOME cannot be set to a subdirectory of /var/opt/ruei and that RUEI\_DATA cannot be set to a subdirectory of /opt/ruei.
- <sup>3</sup> The database instance name cannot exceed 8 characters in length.
- <sup>4</sup> A database table space name cannot exceed 30 characters in length.
- <sup>5</sup> The database user name cannot exceed 30 characters in length.
- <sup>6</sup> The alias name cannot exceed 255 characters in length.
- <sup>7</sup> RUEI\_DB\_TNSNAME is the default for a Reporter system. For a Processing Engine, the example value config is used in this guide.
- <sup>8</sup> Necessary for creating the RUEI wallet using ruei-prepare-db.sh (see Section 2.5.5, "Creating the Reporter Database Instance") and when you want to integrate your RUEI deployment with Oracle Enterprise Manager's Incident Manager facility (see Appendix D, "Setting up a Connection to the Enterprise Manager Repository").
- <sup>9</sup> This should be the appropriate timezone setting, and must be valid for both Linux and PHP. For Linux, you can use the tzselect utility, and for PHP use the following location: <http://www.php.net/manual/en/timezones.php>.
- <sup>10</sup> Necessary when you do not have command-line access to the remote database host and running ruei-prepare-db.sh there is an option. (See Appendix K, "Setting up RUEI against a remote database Service")

### Important

Be aware that the TZ, RUEI\_HOME, RUEI\_DATA, RUEI\_USER and RUEI\_GROUP settings described in Table 2-3 *must* be specified in terms of literal values. Therefore, the following is not permitted:

```
RUEI_BASE=/my/ruei/dir
export RUEI_HOME=$RUEI_BASE/home
```

---

**Note:** If you change settings in /etc/ruei.conf after the installation of a RUEI system, you must restart system processing to make these changes effective (System > Maintenance > System reset > Restart system processing).

---

### Failover Reporter Configuration Settings

Table 2-4 shows the settings that are used to configure a failover Reporter, and are only relevant to Reporter systems. See Chapter 9, "Configuring a Failover Reporter System" for information on the configuration procedure.

**Table 2-4 RUEI Failover Reporter Configuration Settings**

Setting	Description
RUEI_REP_FAILOVER_PRIMARY_IP	The primary Reporter IP address.
RUEI_REP_FAILOVER_STANDBY_IP	The secondary Reporter IP address.
RUEI_REP_FAILOVER_VIRTUAL_IP	The virtual Reporter IP address.
RUEI_REP_FAILOVER_VIRTUAL_DEV	The network interface used to connect to the virtual Reporter IP address.
RUEI_REP_FAILOVER_VIRTUAL_MASK	The network mask of the virtual Reporter IP address.

### Failover Collector Configuration Settings

Table 2-5 shows the settings that are used to configure a failover Collector, and are only relevant to Collector systems. See Chapter 10, "Configuring a Failover Collector System" for information on the configuration procedure.

**Table 2-5 RUEI Failover Collector Configuration Settings**

Settings	Description
RUEI_COL_FAILOVER_PRIMARY_IP	The primary Collector IP address.

**Table 2–5 (Cont.) RUEI Failover Collector Configuration Settings**

Settings	Description
RUEI_COL_FAILOVER_STANDBY_IP	The secondary Collector IP address.
RUEI_COL_FAILOVER_VIRTUAL_IP	The virtual Collector IP address.
RUEI_COL_FAILOVER_VIRTUAL_DEV	The network interface used to connect to the virtual Collector IP address.
RUEI_COL_FAILOVER_VIRTUAL_MASK	The network mask of the virtual Reporter IP address.

There is no need to change the settings for `JAVA_HOME` and `INSTANTCLIENT_DIR` if you intend to use the software contained on the RUEI distribution pack.

1. Create the `moniforce` group and `RUEI_USER` user. The home directory of `moniforce` should be set to `/var/opt/ruei`, with read permissions for group members.

```
/usr/sbin/groupadd moniforce
/usr/sbin/useradd moniforce -g moniforce -d /var/opt/ruei
chmod -R 750 /var/opt/ruei
chown -R moniforce:moniforce /var/opt/ruei
```

---

**Note:** The login shell for the `moniforce` (`RUEI_USER`) user must be set to `/bin/bash`.

---

2. An example of the configuration file is included in the RUEI distribution pack. Ensure the file is readable by the `RUEI_USER` user by issuing the following commands:

```
cp /root/RUEI/extra/ruei.conf /etc/
chmod 644 /etc/ruei.conf
chown moniforce:moniforce /etc/ruei.conf
```

In case of a remote Reporter database installation, the `ruei.conf` file needs to be identical to that of the Reporter system.

## 2.4.2 Installing Java

For Reporter, Collector, and Processing Engines systems, you need to install the Java Runtime Environment (JRE). Java is bundled within the RUEI distribution pack.

1. Issue the following commands:

```
mkdir -p /usr/java/
chmod 755 /usr/java
cd /usr/java
tar xzf /root/RUEI/Java/jre-8u121-linux-x64.tar.gz
```

2. This installs the necessary Java software in the directory `/usr/java/jre1.8.0_121`. To make the install directory version independent, create a more generic symlink using the following command:

```
ln -s /usr/java/jre1.8.0_121 /usr/java/jre
```

## 2.5 Reporter Installation

This section describes the procedure for installing the required components for a Reporter system. These include the Apache web server, the Oracle database Instant Client, and the Zend Optimizer (or Zend Guard Loader).

### 2.5.1 Installing the Apache Web Server and PHP

This section describes the installation and configuration of the Apache web server, and the components that use it.

#### 2.5.1.1 PHP Configuration

1. Ensure that the web server starts automatically after re-boot by issuing the following command:

```
/sbin/chkconfig httpd on
```

2. Edit the `/etc/sysconfig/httpd` file to include the following line at the bottom of the file:

```
source /etc/ruei.conf
```

3. Create the following settings in the `/etc/php.d/ruei.ini` file:

```
session.gc_maxlifetime = 14400
memory_limit = 192M
upload_max_filesize = 128M
post_max_size = 128M
```

#### 2.5.1.2 Avoiding RSVG Warnings

RUEI uses RSVG for graph generation. In order to avoid warnings about a missing directory, create the empty `.gnome2` directory using the following command:

```
mkdir -p /var/www/.gnome2
```

#### 2.5.1.3 Securing Apache Web Server

In order to protect sensitive data on RUEI, it is *strongly* recommended that access to the Reporter interface is restricted to HTTPS. Use the following command as the root user:

```
sed -i -e 's/^Listen 80/#Listen 80/' /etc/httpd/conf/httpd.conf
```

In addition to the already disabled SSLv2, also disable support for SSLv3 in the web server using the following command as the root user:

```
sed -i -e 's/^SSLProtocol all -SSLv2/SSLProtocol all -SSLv2 -SSLv3/'
/etc/httpd/conf.d/ssl.conf
```

#### 2.5.1.4 PHP Multibyte Character Support

This section only applies to RedHat Enterprise/Oracle Linux 6.x. You need to install the `php-mbstring` RPM version on the distribution set relevant to your operating system. For example:

```
cd /root/RUEI/PHP/OL6
rpm -Uhv php-mbstring-5.3.3-version.x86_64.rpm
```

Updates and patches of `php-mbstring` can be found here:

<http://public-yum.oracle.com/repo/OracleLinux/OL6/>

## 2.5.2 Installing the Oracle Database Instant Client

Install the Oracle database Instant Client and SQLplus extension by issuing the following commands as the root user:

```
cd /root/RUEI/IC
rpm -Uvh oracle-instantclient11.2-basic-11.2.0.4.0-1.x86_64.rpm
rpm -Uvh oracle-instantclient11.2-sqlplus-11.2.0.4.0-1.x86_64.rpm
```

## 2.5.3 Installing the php-oci8 Module

Install the php-oci8 module (this is part of the RUEI distribution set). Note that the procedure differs depending on whether you are using RedHat Enterprise/Oracle Linux 5.x or 6.x.

### RedHat Enterprise/Oracle Version 5.x

Issue the following commands:

```
cd /root/RUEI/PHP/OL5
rpm -Uvh php-oci8-11gR2-5.1.6-27.el5_7.4.x86_64.rpm
```

Note that if you are using a version of RedHat Enterprise/Oracle Linux prior to 5.7, you should use php-oci8-11gR2-5.1.6-27.el5.x86\_64.rpm. This is also shipped with the RUEI distribution set.

### RedHat Enterprise/Oracle Version 6.x

Issue the following commands:

```
cd /root/RUEI/PHP/OL6
rpm -Uvh php-oci8-11gR2-5.3.3-4.el6.x86_64.rpm
```

## 2.5.4 Installing the Zend Decoder

If you are installing on RedHat Enterprise/Oracle Linux version 5.x, you will need to install the Zend Optimizer. If you are installing on version 6.x, you need to install the Zend Guard Loader. The procedure is described in the following sections.

### 2.5.4.1 Installing the Zend Optimizer (version 5.x)

Go to the directory containing the Zend Optimizer code, unpack the tar file, and run the Zend optimizer installer. Read the license agreement. You will not be able to proceed until you have accepted the license terms. Accept all default settings, and allow the installer to restart the Apache web server. Issue the following commands:

```
cd /root/RUEI/ZendOptimizer
tar zxvf ZendOptimizer-3.3.3-linux-glibc23-x86_64.tar.gz
cd ZendOptimizer-3.3.3-linux-glibc23-x86_64
./install
```

---

---

**Note:** If you upgrade your system packages (for example, using Yum), this can overwrite changes you previously made to the /etc/php.ini file. Therefore, you should be prepared to re-install the Zend Optimizer. When doing so, ensure the Zend Optimizer installer indicates the location of the php.ini file as /etc/php.ini and not /usr/local/Zend/etc/php.ini.

---

---

**Important:** it is recommended you move the Zend configuration lines created in the `/etc/php.ini` file to the RUEI-specific PHP configuration file `/etc/php.d/ruei.ini` to prevent PHP upgrade issues. If you performed a default installation of the Zend Optimizer, this involves moving the following lines:

```
[Zend]
zend_extension_manager.optimizer=/usr/local/Zend/lib/Optimizer-3.3.3
zend_extension_manager.optimizer_ts=/usr/local/Zend/lib/Optimizer_TS-3.3.3
zend_optimizer.version=3.3.3

zend_extension=/usr/local/Zend/lib/ZendExtensionManager.so
zend_extension_ts=/usr/local/Zend/lib/ZendExtensionManager_TS.so
```

### 2.5.4.2 Installing the Zend Guard Loader (version 6.x)

Go to the directory containing the Zend Guard Loader code, unpack the tar file, copy the required module to the Reporter system, and set its permissions. Issue the following commands:

```
cd /root/RUEI/ZendGuardLoader
tar xvf ZendGuardLoader-php-5.3-linux-glibc23-x86_64.tar.gz
cp ZendGuardLoader-php-5.3-linux-glibc23-x86_64/php-5.3.x/ZendGuardLoader.so \
/usr/lib64/php/modules/
chown root:root /usr/lib64/php/modules/ZendGuardLoader.so
chmod 755 /usr/lib64/php/modules/ZendGuardLoader.so
```

Add the following lines to the `/etc/php.d/ruei.ini` file:

```
zend_extension=/usr/lib64/php/modules/ZendGuardLoader.so
zend_loader.enable=1
```

**Important:** because the Zend Guard Loader does not handle garbage collection very well, it must be disabled by including the following line in the `/etc/php.d/ruei.ini` file:

```
zend.enable_gc = Off
```

Be aware that this disables garbage collection for *all* PHP-based applications running on the Reporter system.

## 2.5.5 Creating the Reporter Database Instance

---

**Note:** If you intend to use RUEI with Enterprise Manager, you require the RUEI wallet password described below. Without the correct wallet password you cannot associate RUEI with Enterprise Manager.

---

The procedure described in this section should be skipped if you are installing a secondary (failover) Reporter system (see [Chapter 9, "Configuring a Failover Reporter System"](#)), and you should continue at [Section 2.5.6, "Installing the Reporter Software"](#).

The Reporter database can reside either locally (that is, on the Reporter server) or on a remote database server. In this section you will create the database instance required for RUEI, and generate the "connection data" required for the Reporter to connect to this database instance. As an alternative for the database setup described in this chapter, you can follow the procedure described in [Appendix B, "Generic Database Instance Setup"](#).

If you are using a remote database and you do not have command-line access to the remote database server because, for example, you want to configure RUEI using a "Pluggable Database", see [Appendix K, "Setting up RUEI against a remote database Service"](#).

You will need the following scripts to be present on the system where the database instance (*RUEI\_DB\_INST*) will be created:

- `ruei-prepare-db.sh`: creates the database instance, Oracle wallet, and database connect files. Note that this script will only run on Linux. If you are installing the Oracle database on a different operating system, see [Appendix B, "Generic Database Instance Setup"](#) for more information.
- `sql_scripts`: this directory contains a number of SQL scripts that are called by the `ruei-prepare-db.sh` script.
- `db_templates`: this directory contains templates for the RUEI database instance that is created by the `ruei-prepare-db.sh` script.
- `ruei-check.sh`: this is a hardware and environment check utility, and is automatically invoked by `ruei-prepare-db.sh`. The script can also be used as a stand-alone troubleshooting utility. For a complete description of the script, refer to [Appendix E, "The ruei-check.sh Script"](#).

For creating the database autologin wallet in this section and, optionally, for the integration with Enterprise Manager later on, a specific version of the "mkstore" utility is needed. You can set up this utility as follows. This needs to be done on the system where the database instance (*RUEI\_DB\_INST*) will be created as well as the reporter if those are separate systems.

- Issue the following commands:

```
cd /usr/local
tar xzf /root/RUEI/mkstore/mkstore-11.2.0.4.0.tar.gz
```
- This installs the mkstore utility to `/usr/local/mkstore-11.2.0.4.0`. To make the install directory version independent, create a more generic symlink using the following command:

```
ln -s /usr/local/mkstore-11.2.0.4.0 /usr/local/mkstore
```
- Make the following change to `/etc/ruei.conf`:

```
* export MKSTORE_BIN=/usr/local/mkstore/mkstore
```
- If you are executing these steps on a database server separate from the reporter system, make the following change to `/etc/ruei.conf`:

```
* export JAVA_HOME=$ORACLE_HOME/jdk/jre
```

The four "connection data" files created during the procedure described in this section are as follows:

- `cwallet.sso`
- `ewallet.p12`
- `sqlnet.ora`
- `tnsnames.ora`

The RUEI configuration file (`/etc/ruei.conf`) also needs to be present on the database server and configured as described in [Section 2.4.1, "Check The RUEI Configuration File"](#) and the instructions for setting up mkstore, given earlier in this section.



Do the following:

1. Copy the `ruei-prepare-db.sh` and `ruei-check.sh` scripts, and the `sql_scripts` and `db_templates` directories to the server on which you intend to run the database instance, and make them executable for the `oracle` user. These scripts and directories can be found in the RUEI distribution zip (`/root/RUEI/131`).
2. Review the settings in the `/etc/ruei.conf` file to match your needs as described in [Section 2.4.1, "Check The RUEI Configuration File"](#). If you want to use different names for the configuration and statistics tablespaces make sure these names are set before continuing. Note that the same tablespace names must be used for all components in your RUEI environment, such as the remote database and Processors.
3. Logon to the database server as the `oracle` user on the database server, and set the `ORACLE_HOME` environment variable. You need to run the `ruei-prepare-db.sh` script as the `oracle` user. This script creates the `$RUEI_DB_INST` database, but only after a number of hardware and software environment checks have been performed. The actual checks performed depend on the system type you are currently installing.

The script prompts you for the Reporter database user password<sup>1</sup>. This enables the RUEI application to login to the database automatically. The script also creates the "connection data" files for you now.

The script also prompts you for a default tablespace name to be used for this installation, and then creates the "connection data" files.

Issue the following commands:

```
chmod +x ruei-prepare-db.sh ruei-check.sh
chmod -R +r /home/oracle/sql_scripts/
chmod -R +r /home/oracle/db_templates/
export ORACLE_HOME=/u01/app/oracle/product/11.2.0/dbhome_12
./ruei-prepare-db.sh create
```

Note that you are prompted whether you want the installation script to check your system. It is recommended that you do so. The checks performed are fully described in [Appendix E, "The ruei-check.sh Script"](#).

If you ran the above commands on a combined Reporter/Database server, you can skip step 4 and proceed to step 5.

4. This step only applies when using a remote database.

In the case of a Reporter system using a remote database, you will need to copy the generated `/tmp/ruei-database-configuration.tar` file in step 3 from the database server to the Reporter system. The `/tmp/ruei-database-configuration.tar` file must be extracted on the Reporter server in the directory `/var/opt/ruei` (`RUEI_DATA`). The permissions of the files need to be set so that the specified `RUEI_USER` (`moniforce`) can use them.

Copy the generated `.tar` file, which holds connection data files to the Reporter system. Logon to the Reporter server and extract the `.tar` file using the following commands:

```
cd /var/opt/ruei
```

<sup>1</sup> The database password is also used as the Oracle wallet password. Both passwords must be 8-30 characters in length, and contain both numbers and letters. For information on changing the Oracle wallet password, please consult the appropriate Oracle documentation.

<sup>2</sup> This line requires customization based on your database version and installation path.

```
tar xvf path-to-tar-file/ruei/database-configuration.tar
chown moniforce:moniforce cwallet.sso ewallet.p12 sqlnet.ora tnsnames.ora
```

5. Because logging of the database can consume a large amount of disk space, it is recommended that you install a clean-up script to avoid the usage of unnecessary disk space. Copy the (example) script to the `oracle` user directory and activate it via `cron` using the following commands:

```
mkdir -p /home/oracle/bin
cp /root/RUEI/extra/ruei-clean.sh /home/oracle/bin
chmod +x /home/oracle/bin/ruei-clean.sh
su - oracle -c 'echo "10 0 * * * /home/oracle/bin/ruei-clean.sh" | crontab'
```

## 2.5.6 Installing the Reporter Software

The procedure described in this section is relevant to all configurations described in [Section 1.6, "Scaling Scenarios"](#) and [Section 2.1.1, "Planning the Software Installation"](#). Installing the reporter software also installs the collector and processor software.

1. The RUEI directory locations are flexible, however it is necessary to use the *exact* directory name described as configured in the `/etc/ruei.conf` file. Create the RUEI application root directory using the following commands:

```
mkdir -p /opt/ruei
chmod 755 /opt/ruei
```

---



---

**Note:** The specified `$RUEI_HOME` and `$RUEI_DATA` directories must have 755 permissions defined for them. See [Table 2-3](#) for more information on these directories.

---



---

2. Make the `apache` and `moniforce` members of two additional groups using the following commands:

```
/usr/sbin/usermod -aG moniforce apache
/usr/sbin/usermod -aG uucp apache
/usr/sbin/usermod -aG uucp moniforce
```

3. Go to the directory that holds the RUEI software, and enter the following commands:

```
cd /root/RUEI/132
chmod +x ruei-install.sh
```

4. Use one of the following options to install the reporter software:
  - If you are installing a reporter in a split server configuration or you want to use only network based data collection as described in [Section 2.1.1, "Planning the Software Installation"](#):

```
./ruei-install.sh reporter
```

- If you are installing on a single server and you want to use tag based data collection as described in [Section 2.1.1, "Planning the Software Installation"](#) (Note that this option also supports network based data collection):

```
./ruei-install.sh reporter-tag
```

For information on monitoring an application based on tagging, see [Defining Applications](#) in the *Identifying and Reporting Web Pages* chapter of the *RUEI Users Guide*.

5. Re-start the Apache web server using the following command:

```
/sbin/service httpd restart
```

6. As the `root` user, add the following lines to the `.bash_profile` file of the `RUEI_USER` (`RUEI_DATA/.bash_profile`):

```
source /etc/ruei.conf
source $RUEI_HOME/bin/env.sh
```

7. Verify that the RUEI software was correctly installed by issuing the following command:

```
./ruei-check.sh postinstall
```

8. This step should not be performed if you are installing a secondary (failover) Reporter system (see [Chapter 9, "Configuring a Failover Reporter System"](#)). You should continue at [Section 2.8, "Configuring the Network Interface"](#).

As the `moniforce` user, set the RUEI admin user password to enable logging onto the RUEI interface with the following commands:

```
su - moniforce
set-admin-password
```

You are prompted to enter and confirm the password.

### Password Requirements

When defining the `admin` user password, bear the following in mind:

- The password must have at least eight characters, and contain at least one non-alphanumeric character (such as `$`, `@`, `&`, and `!`).
- The initial password must be changed within seven days.
- The user name and password are case sensitive.

## 2.6 Remote Tag Data Collector Installation

The procedure described in this section is only relevant to remote tag-based data Collector systems, see [Section 2.1.1, "Planning the Software Installation"](#) and [Section 1.6, "Scaling Scenarios"](#).

Logon to the Collector system as the `root` user, and do the following:

1. Make sure that the `rsync` and `libpcap` packages are installed. For example, enter the following commands to install the packages using Yum:

```
yum -y install rsync
yum -y install libpcap
```

2. If you are using RedHat Enterprise/Oracle Linux 6.x, enter the following command:

```
ln -s /usr/lib64/libpcap.so.N.N.N /usr/lib64/libpcap.so.0.9.4
```

where `N.N.N` is the version of `libpcap` installed. For example:

```
ln -s /usr/lib64/libpcap.so.1.0.0 /usr/lib64/libpcap.so.0.9.4
```

3. Install Apache using the following command:

```
rpm -Uhv httpd-2.2.15-*.x86_64.rpm
```

4. Ensure that the web server starts automatically after re-boot by issuing the following command:  

```
/sbin/chkconfig httpd on
```
5. Create the RUEI application root directory using the following commands:  

```
mkdir -p /opt/ruei  
chmod 755 /opt/ruei
```
6. Change to the RUEI root directory and run the `ruei-install.sh` script using the following commands:  

```
cd /root/RUEI/132  
chmod +x ruei-install.sh ruei-check.sh
```
7. Install the tag based data collector as described in [Section 2.1.1, "Planning the Software Installation"](#):  

```
./ruei-install.sh tag-server
```
8. Re-start the Apache web server using the following command:  

```
/sbin/service httpd restart
```
9. As the root user, add the following lines to the `.bash_profile` file of the RUEI\_USER (RUEI\_DATA/.bash\_profile):  

```
source /etc/ruei.conf  
source $RUEI_HOME/bin/env.sh
```
10. Verify that the RUEI software was correctly installed by issuing the following command:  

```
./ruei-check.sh postinstall
```
11. Set up a password-less remote login from the Reporter system to the newly created Collector system. The necessary configuration steps are described in [Section 2.13, "Configuring Reporter Communication \(Split-Server Setup Only\)"](#)

## 2.7 Remote Network Data Collector Installation

The procedure described in this section is only relevant to remote network data Collector systems, see [Section 2.1.1, "Planning the Software Installation"](#) and [Section 1.6, "Scaling Scenarios"](#).

Logon to the Collector system as the root user, and do the following:

1. Make sure that the `rsync` and `libpcap` packages are installed. For example, enter the following commands to install the packages using Yum:

```
yum -y install rsync  
yum -y install libpcap
```

2. If you are using RedHat Enterprise/Oracle Linux 6.x, enter the following command:

```
ln -s /usr/lib64/libpcap.so.N.N.N /usr/lib64/libpcap.so.0.9.4
```

where *N.N.N* is the version of `libpcap` installed. For example:

```
ln -s /usr/lib64/libpcap.so.1.0.0 /usr/lib64/libpcap.so.0.9.4
```

3. Create the RUEI application root directory using the following commands:

```
mkdir -p /opt/ruei
chmod 755 /opt/ruei
```

4. Change to the RUEI root directory and run the `ruei-install.sh` script using the following commands:

```
cd /root/RUEI/132
chmod +x ruei-install.sh ruei-check.sh
```

5. Install the network based collector as described in [Section 2.1.1, "Planning the Software Installation"](#):

```
./ruei-install.sh collector
```

6. As the root user, add the following lines to the `.bash_profile` file of the RUEI\_USER (RUEI\_DATA/`.bash_profile`):

```
source /etc/ruei.conf
source $RUEI_HOME/bin/env.sh
```

7. Configure the network interfaces as described in [Section 2.8, "Configuring the Network Interface"](#).

8. Verify that the RUEI software was correctly installed by issuing the following command:

```
./ruei-check.sh postinstall
```

9. Set up a password-less remote login from the Reporter system to the newly created Collector system. The necessary configuration steps are described in [Section 2.13, "Configuring Reporter Communication \(Split-Server Setup Only\)"](#)

## 2.8 Configuring the Network Interface

This section is only relevant to network data Collector systems.

Make the monitoring network interface up status permanent (after a reboot) by setting the `ONBOOT` parameter of the capturing interfaces to `yes` in the interface configuration files. The network interfaces configuration can be found in the `/etc/sysconfig/network-scripts/ifcfg-ethX` file (where `X` represents the necessary network interface). Alternatively, use the graphical utility **system-config-network** to set the appropriate interfaces to "activate device when computer starts".

## 2.9 Enabling International Fonts (Optional, but Recommended)

This section is only relevant to the Reporter system.

For PDF generation with international character content, additional fonts are required to be enabled. These fonts need to be made available to Java. Use the following command to copy (or move) the RUEI-installed fonts to the appropriate Java directory:

```
cp RUEI_HOME/bi-publisher/fonts/* \
/usr/java/jre/lib/fonts/
```

## 2.10 Mail (MTA) Configuration (Optional, Reporter Only)

This section is only relevant to the Reporter system.

RUEI assumes a working local MTA for sending PDF reports and E-mail alerts. By default, Linux uses the Sendmail MTA. By default, Sendmail delivers the E-mail directly to the destination MTA. If this behavior is not according to your needs or policies, sending mail via a SmartHost (relay) might be an alternative. To configure a SmartHost in Sendmail, do the following:

1. Install the Sendmail configuration utility by going to the directory containing the uploaded RPM and issuing the following command for RedHat Enterprise/Oracle Linux 5.x:

```
rpm -Uhv sendmail-cf-8.13.8-*.el5.x86_64.rpm
```

In RedHat Enterprise/Oracle Linux 6.x, issue the following command:

```
rpm -Uhv sendmail-cf-8.14.4-*.el6.x86_64.rpm
```

2. Find the line which contains the Smart Host setting in `/etc/mail/sendmail.mc`. Modify the `SMART_HOST` setting to your needs. For example:

```
define('SMART_HOST', 'my.example')dnl
```

3. Generate the new configuration into a new `sendmail.cf` by executing the following command:

```
make -C /etc/mail
```

4. Restart Sendmail. For example:

```
/etc/init.d/sendmail restart
```

---

---

**Note:** Extensive information about the configuration of the Sendmail MTA is available at <http://www.sendmail.org>.

---

---

## 2.11 Configuring SNMP (Reporter Only)

You can download the RUEI MIB definition file through the Reporter interface. This definition file can then be added to your SNMP manager. The procedure for downloading the MIB file is described in the *Oracle Real User Experience Insight User's Guide*.

### 2.11.1 Configuring SNMP for RUEI

To enable the RUEI\_USER to use the SNMP utilities, complete the following (applies to OL6, not OEL5):

1. As the root user, edit the `snmpd` config file in `/etc/sysconfig/snmpd` and make sure the 'OPTIONS' line is not commented out by removing the '#' at the start of the line.
2. Add the following option to the line:

```
-u RUEI_USER
```

3. As the root user, start and stop the `snmpd` daemon to have it set the correct permissions on all related files by issuing the following commands:

```
service snmpd start  
service snmpd stop
```

## 2.12 Configuring Automatic Browser Redirection (Optional)

This section is only relevant to Reporter systems.

To have the browser automatically redirected to the correct RUEI path, create the file `/var/www/html/index.html` with the following content:

```
<head>
<meta http-equiv="REFRESH" content="0;URL=/ruei/">
</head>
```

## 2.13 Configuring Reporter Communication (Split-Server Setup Only)

This section is only relevant to a Reporter system with remote Collector(s).

A password-less SSH connection must be setup between the `moniforce` user from the Reporter system to each Collector system. Do the following:

1. Logon to the Reporter server as `root`. Issue the following commands:

```
su - moniforce
ssh-keygen -P ""
```

Press **Enter** to accept the defaults.

2. Logon as `root` to each of the Collector systems and become the `moniforce` user by issuing the following command:

```
su - moniforce
```

3. Create the `.ssh` directory (if it does not already exist) for the `moniforce` user on each Collector system by issuing the following commands:

```
mkdir ~/.ssh
chmod 700 ~/.ssh
```

4. Copy the SSH key on the Reporter system to the required location on the Collector system by issuing the following commands:

```
cd ~/.ssh
ssh root@Reporter cat /var/opt/ruei/.ssh/id_rsa.pub >> authorized_keys
```

(you will need to specify the Reporter system `root` password)

```
chmod 600 authorized_keys
```

5. Check that it is now possible to execute a remote command (as `moniforce` user) on the Reporter system without using a password. For example:
  - Logon as `root` on the Reporter server.
  - Logon as `moniforce` user: `su - moniforce`.
  - Execute a remote `pwd` command: `ssh Collector pwd`.
  - Enter `yes` to the question "Are you sure you want to continue connecting (yes/no)?".
  - The command should return `/var/opt/ruei`.
6. The above steps must be performed for each Collector!

---

---

**Note:** If the connection between the Reporter and the Collector(s) has not been correctly configured, you will receive an authorization error when you try to register the remote Collector.

---

---

## 2.14 Verifying Successful Installation of RUEI

On completion of the Initial Setup Wizard (described in [Section 6.2, "Performing Initial RUEI Configuration"](#)), you can verify your installation by selecting **System**, then **Status**. All system indicators should report OK. Note Status notification will indicate "Unknown" because no system alerts have yet been configured. This is fully described in the *Oracle Real User Experience Insight User's Guide*.

## 2.15 Using RUEI with Oracle Enterprise Manager

You can set up a connection to the Oracle Enterprise Manager Repository so that KPIs defined for the applications, suites, and services that comprise your business applications can be reported as events in Incident Manager. The use of the business application facility is described in *Oracle Enterprise Manager Cloud Control Oracle Fusion Middleware Management Guide*.



---

---

## Upgrading to RUEI 13.2.2.1

This chapter describes the procedure for upgrading an existing RUEI 13.x.x.x installation to release 13.2.2.1. The post-installation configuration procedure is described in [Chapter 6, "Configuring RUEI"](#). Before upgrading RUEI, check that your system conforms to the prerequisites outlined in [Section 2.1, "Prerequisites."](#)

### 3.1 Migrating Users with Enterprise Manager Access

As of Release 13.1.2.1, RUEI does not allow user accounts (as distinct from system accounts) to have the Enterprise Manager access role. When upgrading from a release prior to 13.1.2.1, non-system accounts that have this privilege will have that privilege revoked and a message will be displayed. You need to create new system accounts with the Enterprise Manager access permission as described in the *Managing Users and Permissions* chapter of the *RUEI User's Guide*. The revocation of the privilege happens during "rpm\_post\_install" phase, for example:

```
2015-01-13 23:28:29 check_em_access_permissions ...
[User Permissions] EM access has been revoked, for the following user account(s):
[User Permissions] - em_user
[User Permissions] To restore, the user(s) must first be converted to a system
account. This can be accomplished via the edit user wizard in the UI.
2015-01-13 23:28:30 check_em_access_permissions done
...
```

### 3.2 Patching the Operating System

RUEI installation is supported for both RedHat Enterprise/Oracle Linux 5.x and RedHat Enterprise/Oracle Linux 6.x, however for maximum reliability and security, upgrade the system to the latest patch version before upgrading to RUEI 13.2.2.1.

### 3.3 Upgrading From RUEI 13.x.x.x to 13.2.2.1

This section describes the procedure for upgrading from an existing RUEI 13.x.x.x installation to release 13.2.2.1.

---

---

**Important:** Before proceeding with the upgrade, make a backup of your configuration, the main database, and the databases on each processor separately. To perform a configuration backup, select **System**, then select **Maintenance**, and then click **Backup and restore**. The configuration backup is required in case of a rollback.

For instructions on how to back up your database, refer to the *Oracle Enterprise Manager Cloud Control Administrator's Guide*.

---

---

### 3.3.1 Upgrading the Reporter System from RUEI 13.x.x.x

The Reporter upgrade procedure described in this section applies to both single server installations as well as dedicated Reporter systems.

Do the following:

1. Login to the Reporter as `root`. Within the `/root` directory, unzip the RUEI zip file, and go to the directory containing the application files. Use the following commands:

```
cd /root
unzip Vxxxx.zip
```

2. Issue the following commands:

```
cd /usr/java
tar xzf /root/RUEI/Java/jre-8u121-linux-x64.tar.gz
```

3. This installs the necessary Java software in the directory `ln -s /usr/java/jre1.8.0_121 /usr/java/jre`. To make the install directory version independent, change the `/usr/java/jre` symlink to point to the new Java software version:

```
rm /usr/java/jre
ln -s /usr/java/jre1.8.0_121 /usr/java/jre
```

4. To upgrade the reporter RUEI system on RedHat Enterprise/Oracle Linux 6.x, you should install the php-process module.

---

---

**Note:** This step should be executed when upgrading from a version prior to 13.2.2.1.

---

---

When using rpm manually (For example, installation media of the operating system), issue the following command:

```
rpm -Uhv php-process-5.3.3*.x86_64.rpm
```

When using a yum repository, issuing the following command:

```
yum install php-process
```

5. Stop all processing on the Reporter and Collector system(s) using the following commands:

```
cd /root/RUEI/extra
chmod +x ruei-upgrade-13.2.2.1.sh
./ruei-upgrade-13.2.2.1.sh stop_ruei
```

6. Perform the necessary pre-upgrade actions by executing the following commands:

```
cd /root/RUEI/extra
./ruei-upgrade-13.2.2.1.sh rpm_pre_install
```

7. For each required Collector system, perform the steps indicated in [Section 3.3.2, "Upgrading the Remote Collector System\(s\) from RUEI 13.x.x.x"](#).
8. For each required Processing Engine system, perform the steps described in [Section 3.3.3, "Upgrading the Processing Engine System\(s\) from RUEI 13.x.x.x"](#).
9. Install the new versions of the RPMs using the following commands:

```
cd /root/RUEI/132
chmod +x ruei-install.sh
./ruei-install.sh reporter
```

Existing installations (upgrades) need to copy the fonts after the RPMs have been installed using the following commands:

```
. /etc/ruei.conf
cp $RUEI_HOME/bi-publisher/fonts/* /usr/java/jre/lib/fonts/
```

10. Perform the necessary post-upgrade actions by executing the following commands:

```
cd /root/RUEI/extra
./ruei-upgrade-13.2.2.1.sh rpm_post_install
```

11. Restart processing using the following commands:

```
cd /root/RUEI/extra
./ruei-upgrade-13.2.2.1.sh reinitialize
./ruei-upgrade-13.2.2.1.sh start_ruei
```

### 3.3.2 Upgrading the Remote Collector System(s) from RUEI 13.x.x.x

For each required remote Collector system, login as root. Within the /root directory, unzip the RUEI zip file, go to the directory containing the application files, and install the new versions of the RPMs. Do the following:

1. Unzip the RUEI distribution package using the following commands:

```
cd /root
unzip Vxxxx.zip
```

2. Issue the following commands:

```
cd /usr/java
tar xzf /root/RUEI/Java/jre-8u121-linux-x64.tar.gz
```

3. This installs the necessary Java software in the directory /usr/java/jre1.8.0\_121. To make the install directory version independent, change the /usr/java/jre symlink to point to the new Java software version:

```
rm /usr/java/jre
ln -s /usr/java/jre1.8.0_121 /usr/java/jre
```

4. Upgrade the Collector RPMs using the following commands:

```
cd /root/RUEI/132
chmod +x ruei-install.sh
./ruei-install.sh collector
```

After completing the above procedure for each required Collector system, you should continue with the upgrade of the Reporter system (as described in [Section 3.3.1, "Upgrading the Reporter System from RUEI 13.x.x.x"](#)).

### 3.3.3 Upgrading the Processing Engine System(s) from RUEI 13.x.x.x

The upgrade procedure described in this section should be performed for each Processing Engine system. Note that Processing Engine systems should be upgraded sequentially. That is, do not start upgrading the next system until upgrade of the previous system is complete. Do the following:

1. Login to the Processing Engine as root. Within the /root directory, unzip the RUEI zip file, and go to the directory containing the application files. Use the following commands:

```
cd /root
unzip Vxxxx.zip
```

2. Issue the following commands:

```
cd /usr/java
tar xzf /root/RUEI/Java/jre-8u121-linux-x64.tar.gz
```

3. This installs the necessary Java software in the directory /usr/java/jre1.8.0\_121. To make the install directory version independent, change the /usr/java/jre symlink to point to the new Java software version:

```
rm /usr/java/jre
ln -s /usr/java/jre1.8.0_121 /usr/java/jre
```

4. Perform the necessary pre-upgrade actions by executing the following commands:

```
cd /root/RUEI/extra
./ruei-upgrade-13.2.2.1.sh rpm_pre_install
```

5. Install the new versions of the RPMs using the following commands:

```
cd /root/RUEI/132
chmod +x ruei-install.sh
./ruei-install.sh processor
```

After completing the above procedure for each required Processing Engine, you should continue with the upgrade of Reporter system (as described in [Section 3.3.1, "Upgrading the Reporter System from RUEI 13.x.x.x"](#)).

## 3.4 Steps After Upgrading From RUEI 13.x.x.x

For All Sessions data, to make pre-upgrade data available again in the data browser, issue the following command:

---

---

**Note:** These post-upgrade steps should only be executed when upgrading from versions prior to 13.2.1.1.

---

---

```
./ruei-upgrade-13.2.2.1.sh migrate_visit_data
```

After migrating the pre-upgrade data successfully, issue the following command to delete the old data:

```
./ruei-upgrade-13.2.2.1.sh drop_visit_cube
```

For Sessions Diagnostic data, to make pre-upgrade data available again in the data browser, issue the following command:

```
./ruei-upgrade-13.2.2.1.sh migrate_session_data
```

After migrating the pre-upgrade data successfully, issue the following command to delete the old data:

```
./ruei-upgrade-13.2.2.1.sh drop_session_cube
```



---

---

## Configuring RUEI for ADF Monitoring

This chapter describes the options for monitoring ADF applications and the procedure for deploying and configuring the ADF Monitoring Service.

### 4.1 Introduction to ADF Monitoring

Various data collection options are available for ADF monitoring. See [Section 1.1.1, "Data Collection"](#) for an introduction to the RUEI data collection. ADF can be monitored using one of the following methods:

**Table 4–1 ADF Monitoring Options**

Mode	Metrics Collected	Description
Network data collector only	Default ADF metrics as described in the <i>Oracle ADF Support</i> appendix of the <i>RUEI User's Guide</i> .	This option is described in <a href="#">Section 1.1.1, "Data Collection"</a> and does not require any specific configuration on the ADF servers.

**Table 4–1 (Cont.) ADF Monitoring Options**

Mode	Metrics Collected	Description
ADF Monitoring Service only	Pages, UserID, ADF based dimensions, client-side page load time	To use this option, you must deploy the ADF Monitoring Service as described in <a href="#">Section 4.2, "Deploying the ADF Monitoring Service"</a> and enable the Monitoring Service in an ADF application.
Hybrid - Network data collector	Default ADF metrics as described in the <i>Oracle ADF Support</i> appendix of the <i>RUEI User's Guide</i> and UserID, ADF based dimensions, client-side page load time from ADF Monitoring Service	<p>The network data collector is the primary source of data and the ADF Monitoring service provides enhanced reporting. RUEI 12.1.0.6 only supported this mode of operation. The network data collector is primarily used to monitor the ADF Application and the ADF Monitoring Service provides additional information (for example, UserID) that is correlated with the network traffic using the ECID cache.</p> <p>To use this option, you must deploy the ADF Monitoring Service as described in <a href="#">Section 4.2, "Deploying the ADF Monitoring Service"</a> and enable the Monitoring Service in an ADF application.</p>
True-Hybrid	Default ADF metrics as described in the <i>Oracle ADF Support</i> appendix of the <i>RUEI User's Guide</i> and UserID, ADF based dimensions, client-side page load time from ADF Monitoring Service	<p>This option provides the most flexible collection of data, allowing you to collect some data from the network data collector and some data from the ADF monitoring service. This is particularly useful if your application consists of some components that are not ADF based.</p> <p>To use this option, you must deploy the ADF Monitoring Service as described in <a href="#">Section 4.2, "Deploying the ADF Monitoring Service"</a>, enable the Monitoring Service in an ADF application and use framework exceptions to determine which parts of an application are monitored by the network data collector and which are monitored by the ADF monitoring service.</p> <p>The <i>Working With Suites and Web Services</i> chapter of the <i>RUEI User's Guide</i> describes how to create framework exceptions.</p>

## 4.2 Deploying the ADF Monitoring Service

This section describes the procedure for deploying and configuring the ADF Monitoring Service.

Using the ADF Monitoring Service is optional. The ADF Monitoring Service allows diagnostics information to be collected from tiers not reachable with Network Protocol Analysis (NPA). This information can be consolidated with other ADF information and used to identify causes of End User Experience problems. The resulting information is available in RUEI Reporting, Data Browser and Session Diagnostics.

### 4.2.1 Create a RUEI System User

To communicate with RUEI, the ADF Monitoring Service requires a RUEI user with the ADF Monitoring Service permissions. This permission is only available to a RUEI *system* account. See the *Managing Users and Permissions* chapter of the *User's Guide* for information on creating this account and setting the permission.

### 4.2.2 Deploy the ADF Monitoring Service Software

To deploy the ADF Monitoring Service into the WebLogic Server environment:



1. Copy the `RueiEUMService.war` file from the `/root/RUEI/131/extra` directory of the RUEI distribution zip file to a location accessible to the WebLogic server.
2. Log into the WebLogic Server Administration Console and navigate to the **Deployments** screen, then click **Install** to deploy the war file. Install as a library and not as an application.

An alternative to step 2 above is to deploy using the command line:

1. Set the environment variables:

```
setenv BEA_HOME Weblogic_home_dir
setenv PATH JDK_dir/bin:$PATH
setenv DOMAIN_HOME ${BEA_HOME}/user_projects/domains/domain_name
setenv WARFILE $DOMAIN_HOME/servers/AdminServer/upload/RueiEUMService.war
```

where

- *Weblogic\_home\_dir* is the location where WebLogic was installed
  - *JDK\_dir* is the location where JDK is installed
  - *domain\_name* is the name of the WebLogic domain
2. Change directory to the location you used in step one and enter the following commands (enter password when prompted):

```
. $BEA_HOME/wlserver_10.3/server/bin/setWLSEnv.sh
cp RueiEUMService.war $DOMAIN_HOME/servers/AdminServer/upload/
java weblogic.Deployer -adminurl adminurl -username username -deploy -source
$WARFILE -targets wlservername -stage -library
```

where:

- *adminurl* is the URL for the WebLogic Administration console
- *username* is the admin username
- *wlservername* is the name of the WebLogic Server

## 4.2.3 Configure the ADF Application

To configure the ADF application for use with the ADF Monitoring Service you must redeploy it with a custom deployment plan.

### 4.2.3.1 Generate a Default Deployment Descriptor

To generate a standard deployment descriptor of an ADF application's EAR, you can use either the web console or the commands below:

1. Set the environment variables:

```
setenv BEA_HOME Weblogic_home_dir
setenv PATH JDK_dir/bin:$PATH
```

where

- *Weblogic\_home\_dir* is the location where WebLogic was installed
  - *JDK\_dir* is the location where JDK is installed
2. Enter the following commands:

```
. $BEA_HOME/wlserver_10.3/server/bin/setWLSEnv.sh
setenv PLANFILE path_of_app/Appname/deploy/stdplan.xml
setenv EARFILE path_of_app/Appname/deploy/application_file
```

```
java weblogic.PlanGenerator -all -plan $PLANFILE $EARFILE
```

where:

- *path\_of\_app* is the full directory location to the ADF application
- *Appname* is the name of the ADF application
- *application\_file* is the name of either your application ear or war file

#### 4.2.3.2 Modify the Deployment Descriptor

Modify the deployment descriptor files created in [Section 4.2.3.1](#) as follows:

1. Add the <variable-definition> section to the stdplan.xml file using the following:

```
<!-- variables for RUEI eum -->
<variable>
  <name>oracle.adf.view.faces.context.ENABLE_ADF_EXECUTION_CONTEXT_
PROVIDER</name>
  <value>>true</value>
</variable>
<variable>

<name>oracle.sysman.apm.ruei.monitoring.RueiEndUserMonitoringService.rueiUrl</n
ame>
  <value>http(s)://app_host:port/ruei/receive.php</value>
</variable>
<variable>
  <name>LibraryRef_RueiEUMLibrary</name>
  <value>RueiEUMLibrary</value>
</variable>
<variable>

<name>oracle.sysman.apm.ruei.monitoring.RueiEndUserMonitoringService.bufferSize
</name>
  <value>Buffer_size</value>
</variable>
<variable>

<name>oracle.sysman.apm.ruei.monitoring.RueiEndUserMonitoringService.flushTime<
/name>
  <value>Buffer_fushtime</value>
</variable>
<!-- variables for RUEI eum -->
```

where:

- *app\_host* is the RUEI host name.
  - *port* is the RUEI port number.
  - *Buffer\_size*: is the integer value for buffering data sent to RUEI.
  - *Buffer\_flushtime*: is the time (in millisecond) before flushing buffered data to RUEI.
2. Add the <module-override> section to the WebLogic.xml file using the following:

```
<!-- RUEI library -->
<variable-assignment>
  <name>LibraryRef_RueiEUMLibrary</name>
```

```

<xpath>/weblogic-web-app/library-ref/[context-root="null",library-name="RueiEnd
UserMonitoringService"]/library-name</xpath>
</variable-assignment>
<!-- RUEI library -->

```

**3. Add the <module-override> section to the web.xml file using the following:**

```

<!-- set RUEI eum variables -->
<variable-assignment>
  <name>oracle.adf.view.faces.context.ENABLE_ADF_EXECUTION_CONTEXT_
PROVIDER</name>

<xpath>/web-app/context-param/[param-name="oracle.adf.view.faces.context.ENABLE
_ADF_EXECUTION_CONTEXT_PROVIDER"]/param-value</xpath>
</variable-assignment>
<variable-assignment>

<name>oracle.sysman.apm.ruei.monitoring.RueiEndUserMonitoringService.bufferSize
</name>

<xpath>/web-app/context-param/[param-name="oracle.sysman.apm.ruei.monitoring.Ru
eiEndUserMonitoringService.bufferSize"]/param-value</xpath>
</variable-assignment>
<variable-assignment>

<name>oracle.sysman.apm.ruei.monitoring.RueiEndUserMonitoringService.flushTime<
/name>

<xpath>/web-app/context-param/[param-name="oracle.sysman.apm.ruei.monitoring.Ru
eiEndUserMonitoringService.flushTime"]/param-value</xpath>
</variable-assignment>
<variable-assignment>

<name>oracle.sysman.apm.ruei.monitoring.RueiEndUserMonitoringService.rueiUrl</n
ame>

<xpath>/web-app/context-param/[param-name="oracle.sysman.apm.ruei.monitoring.Ru
eiEndUserMonitoringService.rueiUrl"]/param-value</xpath>
</variable-assignment>

<!-- set RUEI eum variables -->

```

---

**Note:** If any of the variables above already exist in the ADF application you can use <operation>replace</operation> to replace those variables with new values.

---

### 4.2.3.3 Create a Wallet

In [Section 4.2.1, "Create a RUEI System User"](#), you created the user credentials for the ADF Monitoring Service. To create a wallet to store these credentials:

**1. Set the environment variables:**

```

setenv BEA_HOME Weblogic_home_dir
setenv PATH JDK_dir/bin:$PATH

```

where

- *Weblogic\_home\_dir* is the location where WebLogic was installed
  - *JDK\_dir* is the location where JDK is installed
2. Start the WebLogic Server console:
 

```
. $BEA_HOME/wlserver_10.3/server/bin/setWLSEnv.sh
$BEA_HOME/oracle_common/common/bin/wlst.sh
```
  3. Enter the following WebLogic Server console command:
 

```
connect()
```

When prompted, enter the WebLogic administrator username and password.  
When prompted for the URL, enter `t3://admin_host:admin_port` where

    - *admin\_host* is the WebLogic hostname
    - *admin\_password* is the WebLogic port
  4. Enter the following WebLogic Server console commands ( enter password when prompted):
 

```
map = "ruei_adf_monitoring_agent"
key = "receiver"
desc = "RUEI Receiver"

createCred(map=map, key=key, user="user", password="password", desc=desc)
```

where:

    - *user* is the username you created in [Section 4.2.1, "Create a RUEI System User"](#)
    - *password* is the password of the RUEI system user
  5. To ensure the user was created, enter the following WebLogic Server console:
 

```
listCred(map=map, key=key)
```
  6. If the user is listed, enter the following WebLogic Server console to disconnect:
 

```
disconnect()
```
  7. Exit the WebLogic Console using Ctrl-D.
  8. Edit the `user_projects/domains/domain_name/config/fmwconfig/system-jazn-data.xml` file so that it includes:
 

```
<grant>
    <grantee>
      <codesource>
        <url>file:${domain.home}/servers/${weblogic.Name}/tmp/_
WL_user/RueiEndUserMonitoringService/-</url>
      </codesource>
    </grantee>
    <permissions>
      <permission>

<class>oracle.security.jps.service.credstore.CredentialAccessPermission</class>
      <name>context=SYSTEM,mapName=ruei_adf_monitoring_
agent,keyName=receiver</name>
      <actions>read</actions>
    </permission>
  </permissions>
</grant>
```

where

- *domain\_name* is the name of the WebLogic domain

#### 4.2.3.4 Redeploy the ADF Application with the Modified Deployment Descriptor

To redeploy the ADF application, either use the WebLogic Server administration console (**Deployments > Update**) or use the procedure below.

1. Set the environment variables:

```
setenv BEA_HOME Weblogic_home_dir
setenv PATH JDK_dir/bin:$PATH
. $BEA_HOME/wlserver_10.3/server/bin/setWLSEnv.sh
setenv PLANFILE deployment_path/stdplan.xml
setenv EARFILE path_to_YourApplicationFile
```

where:

- *Weblogic\_home\_dir* is the location where WebLogic was installed
  - *JDK\_dir* is the location where JDK is installed
  - *deployment\_path* is the location of the ADF deployment
  - *path\_to\_YourApplicationFile* is the location of the ADF ear or war file
2. Enter the following commands (enter password when prompted):

```
java weblogic.Deployer -adminurl adminurl -username username -deploy -name app_name -source $EARFILE -targets target_server -stage -plan $PLANFILE
```

where:

- *adminurl* is the URL for the WebLogic Administration console
- *username* is the admin username
- *app\_name* is the application deployment name
- *target\_server* is the name of the target WebLogic Server

## 4.2.4 Specifying Domain and Port for ADF Applications

If you want to monitor an ADF application and the weblogic domain/port differs from the end user application domain/port (for example, if you use a load balancer, or depending of the location of the RUEI installation in the network), you must enter both application domain/port details when defining the suite in RUEI.

Add the second application domain/port details after creating the suite as follows:

1. Select **Applications**, then select **Suites**.
2. Select the ADF Suite that you want to modify.
3. Select **Add new filter** in the **Identification** tab. Enter the details of the second domain/port.

## 4.2.5 Troubleshooting the ADF Monitoring Service

Use the following procedure to troubleshoot the ADF Monitoring Service:

1. Log into your ADF application and interact with it to provoke an HTTP request (The ADF Monitoring Service is only initialized after the first HTTP request).

2. Use a HTTP tool, such as the HTTPHeaders Firefox extension, to make sure that the POST headers include the string  
oracle.adf.view.rich.monitoring.UserActivityInfo. For example:

```
...&org.apache.myfaces.trinidad.faces.FORM=f1...&oracle.adf.view.rich.monitoring.UserActivityInfo=%3Cm+xmlns%3D%22http%3A%2F%2Foracle.com...
```

If the header does not include the text, check the web.xml file and the ADF version used.

3. Check the server logs for library registration log. For example, search the *Oracle\_Home/Middleware\_11.1.2.3.0/user\_projects/domains/domain\_name/servers/AdminServer/logs/AdminServer.log* file for an entry similar to the following:

```
Registered library Extension-Name: RueiEndUserMonitoringService
```

If the log files do not contain an entry similar to the above, make sure the library (RueiEUMService.war) is deployed correctly as described in [Section 4.2.2, "Deploy the ADF Monitoring Service Software"](#).

4. Check the *server-diagnostics.log* file for oracle.sysman.apm.ruei entries. For example, the following log entries in *AdminServer-diagnostics.log* indicate normal operation:

```
.[NOTIFICATION] ... Starting RUEI End User Monitoring Service
...[NOTIFICATION] ... Successfully retrieved information for user eud from the
wallet
...[NOTIFICATION] ... Using Basic Authentication
...[NOTIFICATION] ... Set RUEI receiver URL to http://<your ruei
host:port>/ruei/receive.php
...[NOTIFICATION] ... RUEI End User Monitoring Service running
...[TRACE]...[SRC_METHOD: logUserActivity] Received useractivity to ruei ecid=
649d46b0ef2a475a:d6e5334:14077999955:-8000-0000000000000259:_adfStreaming
...[TRACE]...[SRC_METHOD: logUserActivity] Received useractivity with
requestobject to ruei
ecid=weblogic.servlet.internal.RequestEventsFilter$EventsRequestWrapper
...[TRACE]...[SRC_METHOD: process] 9 items for http://<your ruei
host:port>/ruei/receive.php
.....
```

If you do not find appropriate log entries, repeat the procedures described in this chapter.

---

---

# Installing and Configuring SSO Authentication Integration

This chapter describes the procedure for installing and configuring the Oracle HTTP server. This is an optional part of the RUEI installation process, and is only required if you intend to use the Oracle Single Sign-On (SSO) service to authenticate RUEI users. Note that the Oracle SSO service must be fully installed and configured before it can be used for RUEI user authentication.

The procedure to configure the Reporter system for Oracle SSO user authentication is described in the *Oracle Real User Experience Insight User's Guide*. Note that RUEI must be fully installed before it can be configured for Oracle SSO user authentication.

## 5.1 Turning off the Default Web Server

The Oracle SSO server uses its own web server in order to prevent conflicts with the currently installed web server. Therefore, the currently installed web server needs to be turned off by issuing the following commands:

```
/sbin/service httpd stop
/sbin/chkconfig --del httpd
```

---

---

**Note:** It is recommended that you do *not* un-install the default Linux Apache web server because this would also un-install the PHP module.

---

---

## 5.2 Reporter System Without Local Database

The procedure described in this section should only be followed if you are installing and configuring the oracle HTTP server for a Reporter that does not a local database. Otherwise, the procedure described in [Section 5.3, "Reporter System With Local Database"](#) should be followed.

### 5.2.1 Creating the Oracle User

This section is only relevant for RUEI installations configured to use a remote database. In this case, the oracle user does not yet exist, and so must be created by issuing the following commands:

```
/usr/sbin/groupadd oinstall oinstall
/usr/sbin/useradd -g oinstall oracle
```

## 5.2.2 Setting up the Oracle HTTP Server Environment

This section is only relevant for RUEI installations configured to a remote database. In this case, the following lines need to be added to the `/etc/security/limits.conf` file:

```
oracle soft nofile 16384
oracle hard nofile 65536
```

## 5.2.3 Creating the Installation Directory

Issue the following commands to create the Oracle HTTP server installation directory:

```
mkdir -p /u01/app/oracle
chown -R oracle:oinstall /u01/app/oracle
```

## 5.3 Reporter System With Local Database

The procedure described in this section should only be followed if you are installing and configuring the oracle HTTP server for a Reporter that is configured with a local database. Otherwise, the procedure described in [Section 5.2, "Reporter System Without Local Database"](#) should be followed.

Increase the number of open files limit. Edit the following line in the `/etc/security/limits.conf` file:

```
oracle soft nofile 16384
```

## 5.4 Installing Oracle HTTP Server

Do the following:

1. Login to the Reporter server as the `oracle` user, and unzip the Oracle HTTP server zip file. Ensure that your X Window environment is properly set up. In addition, when logging on remotely with SSH, ensure X forwarding is enabled. The installation of Oracle HTTP server needs to be performed as the `oracle` user (only certain parts of this chapter require root privileges). Issue the following commands:

```
unzip ofm_webtier_11.1.1.6.0_64_disk1_10f1.zip
cd webtier/Disk1
export ORACLE_BASE=/u01/app/oracle
./runInstaller
```

2. As the installation script runs, you should accept all default values, except for step 5. Here, you must uncheck the two check boxes **Oracle Web Cache** and **Associate selected components with weblogic domain** shown in [Figure 5-1](#).

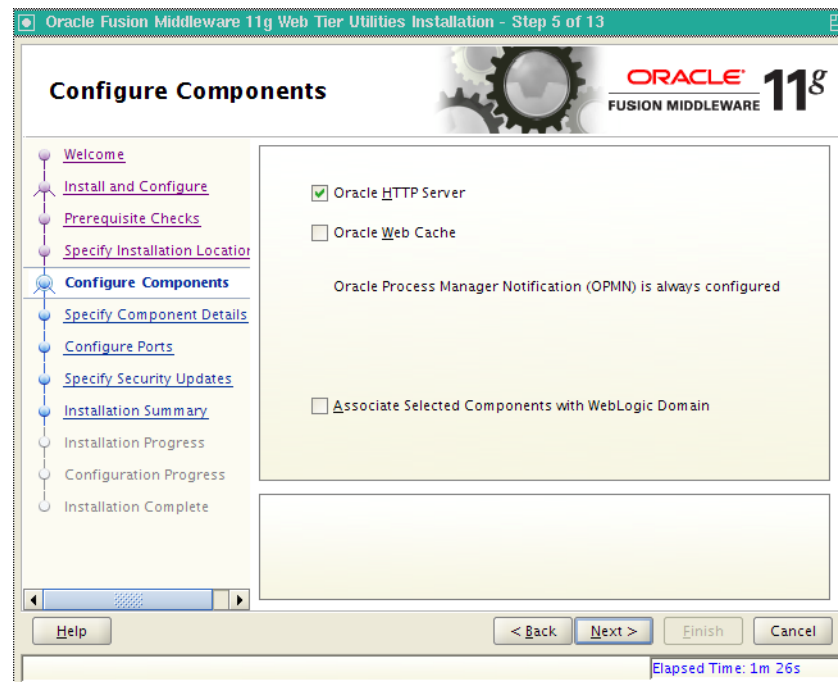

**Figure 5–1 Configure Components Dialog**

3. After exiting the installation script, set the following environment variables:

```
export ORACLE_HOME=$ORACLE_BASE/middleware/oracle_WT1
export ORACLE_INSTANCE=$ORACLE_HOME/instances/instance1
```

4. Stop the Oracle HTTP server and Oracle Process Manager Notification (OPMN) using the following command:

```
$ORACLE_INSTANCE/bin/opmnctl stopall
```

5. Edit the `$ORACLE_INSTANCE/config/OPMN/opmn/opmn.xml` file to use the `httpd.prefork` in order so that the PHP module can be loaded. Ensure that the following variables are set in the `/etc/ruei.conf` configuration file:

```
<environment>
  <variable id="TEMP" value="/tmp"/>
  <variable id="TMP" value="/tmp"/>
  <variable id="OHSMPM" value="prefork"/>
  <variable id="TNS_ADMIN" value="/var/opt/ruei"/>
  <variable id="RUEI_DB_TNSNAME" value="uxinsight"/>
  <variable id="RUEI_DB_USER" value="uxinsight"/>
  <variable id="RUEI_HOME" value="/opt/ruei"/>
  <variable id="RUEI_DATA" value="/var/opt/ruei"/>
  <variable id="JAVA_HOME" value="/usr/java/jre"/>
  <variable id="TZ" value="timezone"/>
</environment>
```

where *timezone* is the value of time zone you set in the `/etc/ruei.conf` file.

6. Logon as the root user, and change the permissions for the `.apachectl` file so that the Oracle HTTP server can run as the Apache user. Issue the following commands:

```
chown root $ORACLE_HOME/ohs/bin/.apachectl
chmod 6750 $ORACLE_HOME/ohs/bin/.apachectl
```

7. Add apache to the oinstall group using the following command:

```
usermod -aG oinstall apache
```

8. Logon as the oracle user and edit the `ORACLE_INSTANCE/config/OHS/ohs1/httpd.conf` file for the Oracle HTTP server to run as the Apache user. Edit the following lines:

```
User apache  
Group apache
```

9. Create the `ORACLE_INSTANCE/config/OHS/ohs1/moduleconf/php5.conf` file, and edit it to contain the following:

```
LoadModule php5_module "/usr/lib64/httpd/modules/libphp5.so"  
AddHandler php5-script php  
AddType text/html php
```

10. Copy the `/etc/httpd/conf.d/uxinsight.conf` file, and make it available to the Oracle HTTP server using the following command:

```
cp /etc/httpd/conf.d/uxinsight.conf $ORACLE_INSTANCE/config/OHS/ohs1/moduleconf
```

11. Start Oracle Process Manager Notification (OPMN) and the Oracle HTTP server using the following command:

```
$ORACLE_INSTANCE/bin/opmnctl startall
```

12. Stop the HTTP server using the following command:

```
$ORACLE_INSTANCE/bin/opmnctl stopproc ias-component=ohs1
```

13. In order to have RUEI running on the default HTTPS port, edit the `ORACLE_INSTANCE/config/OHS/ohs1/ssl.conf` file, and change the line with the `Listen` directive to the following:

```
Listen 443
```

In addition, edit the `VirtualHost` definition as follows:

```
<VirtualHost *:443>
```

14. Comment out the `LoadModule` settings in the `config/OHS/ohs1/moduleconf/plsql.conf` and `config/OHS/ohs1/mod_wl_ohs.conf` files.

15. Create the `ORACLE_INSTANCE/config/OHS/ohs1/moduleconf/mod_osso.conf` file:

```
LoadModule osso_module "${ORACLE_HOME}/ohs/modules/mod_osso.so"  
  
<IfModule osso_module>  
    OssoConfigFile /u01/app/oracle/product/11.1.1/as_  
1/instances/instance1/config/OHS/ohs1/osso.conf  
    OssoIpCheck off  
    OssoIdleTimeout off  
</IfModule>
```

16. Copy the `osso.conf` file that you received after registering RUEI with the Oracle SSO server to the `ORACLE_INSTANCE/config/OHS/ohs1` directory. This is described in [Section 5.5, "Registering RUEI with the Oracle SSO Server"](#).

17. Start the Oracle HTTP server using the following command:

```
$ORACLE_INSTANCE/bin/opmnctl startproc ias-component=ohs1
```

## 5.5 Registering RUEI with the Oracle SSO Server

In order to create the required `osso.conf` file, you need to register RUEI with the Oracle SSO server. The procedure to do this differs depending on whether you are using Oracle SSO version 10.1.4 or 11.1, and is described in the following sections.

### 5.5.1 Registering with Oracle SSO Version 10.1.4

Use the 10.1.4 Oracle Identity Manager registration tool `ssoreg.sh` to update the registration record in the `osso.conf` file. Do the following:

1. Go to the Oracle Identity Manager directory:

```
ORACLE_HOME/sso/bin/ssoreg
```

2. Run the `ssoreg.sh` tool with the following parameters and values:

```
./ssoreg.sh -site_name hostname:4443 \  
-config_mod_osso TRUE \  
-mod_osso_url hostname:4443 \  
-config_file location
```

where:

- *hostname* specifies the full URL of the RUEI Reporter system (for example, `https://ruei.us.myshop.com`).
  - *location* specifies the location to which the `osso.conf` file will be written (for example, `tmp/osso.conf`).
3. Copy the created `osso.conf` file to the `$ORACLE_INSTANCE/config/OHS/ohs1` directory on the RUEI Reporter system.

Further information is available at the following location:

[http://docs.oracle.com/cd/E14571\\_01/core.1111/e10043/osso.htm#autoId89](http://docs.oracle.com/cd/E14571_01/core.1111/e10043/osso.htm#autoId89)

### 5.5.2 Registering with Oracle SSO Version 11.1

To register RUEI as a partner application within Oracle SSO version 11.1, do the following:

1. Within Oracle Access Manager console, click the **Policy Configuration** tab. The screen shown in [Figure 5-2](#) appears.

**Figure 5–2 OAM Policy Configuration Screen.**

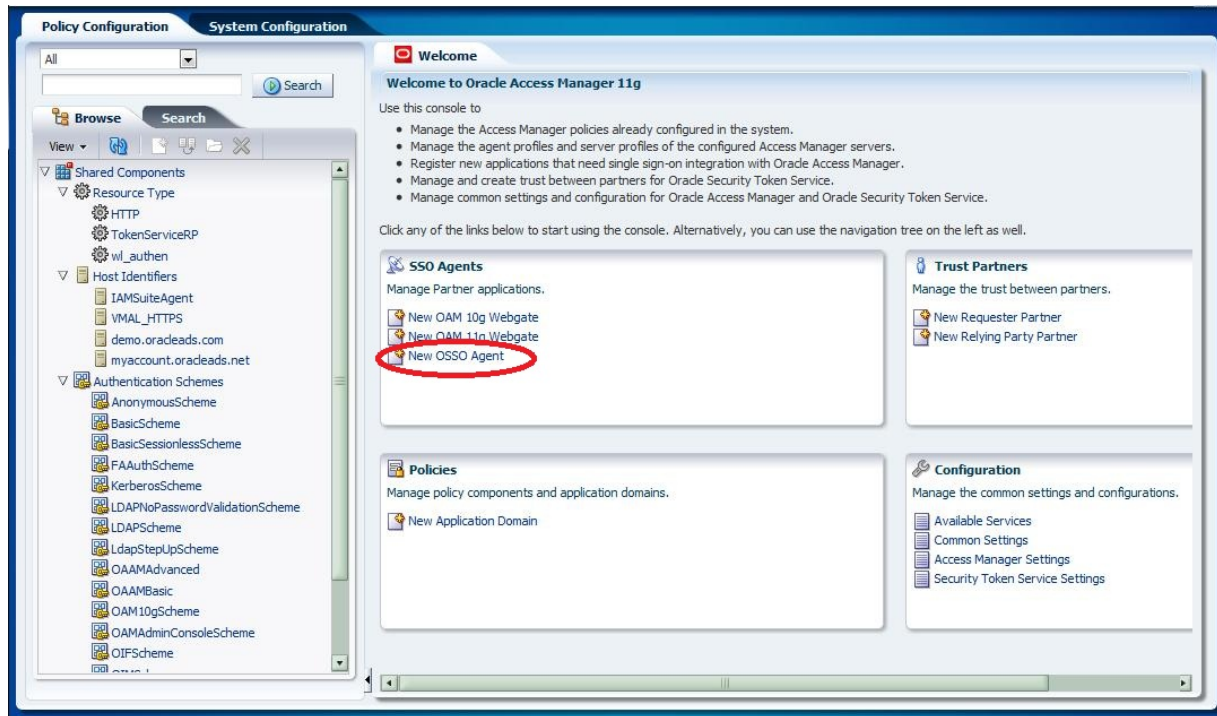

2. Click the New OSSO Agent item. The screen shown in Figure 5–3 appears.

**Figure 5–3 Create OSSO Agent Screen**

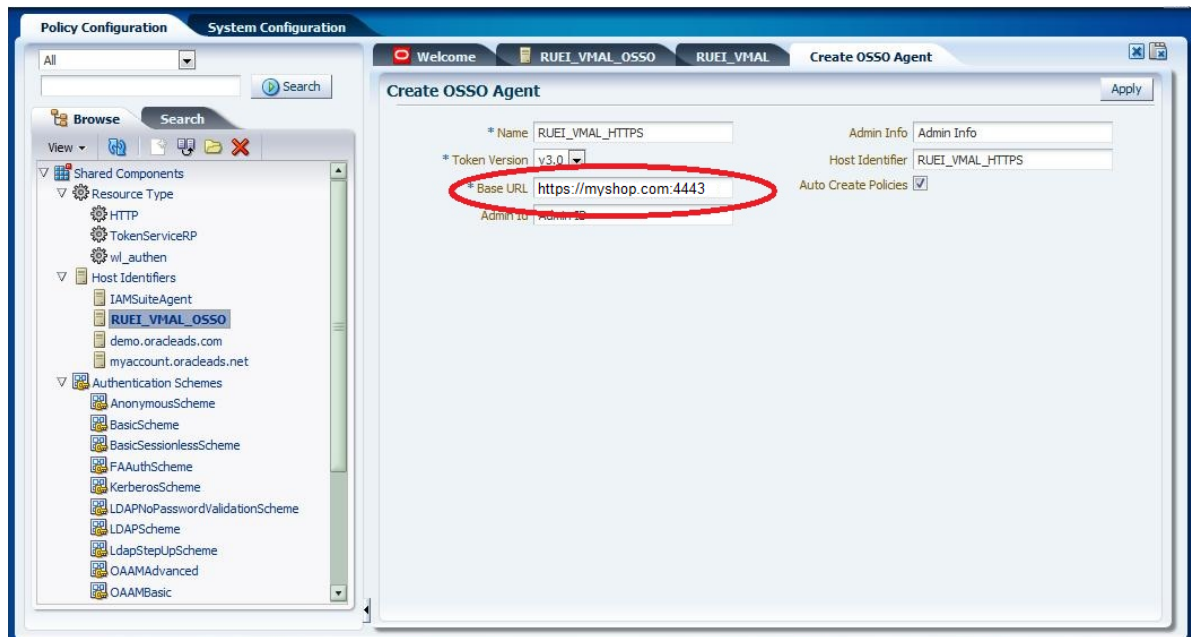

3. Specify the required parameters. When ready, click **Apply**. The screen shown in Figure 5–4 appears.

Figure 5–4 OSSO Agent Creation Confirmation.

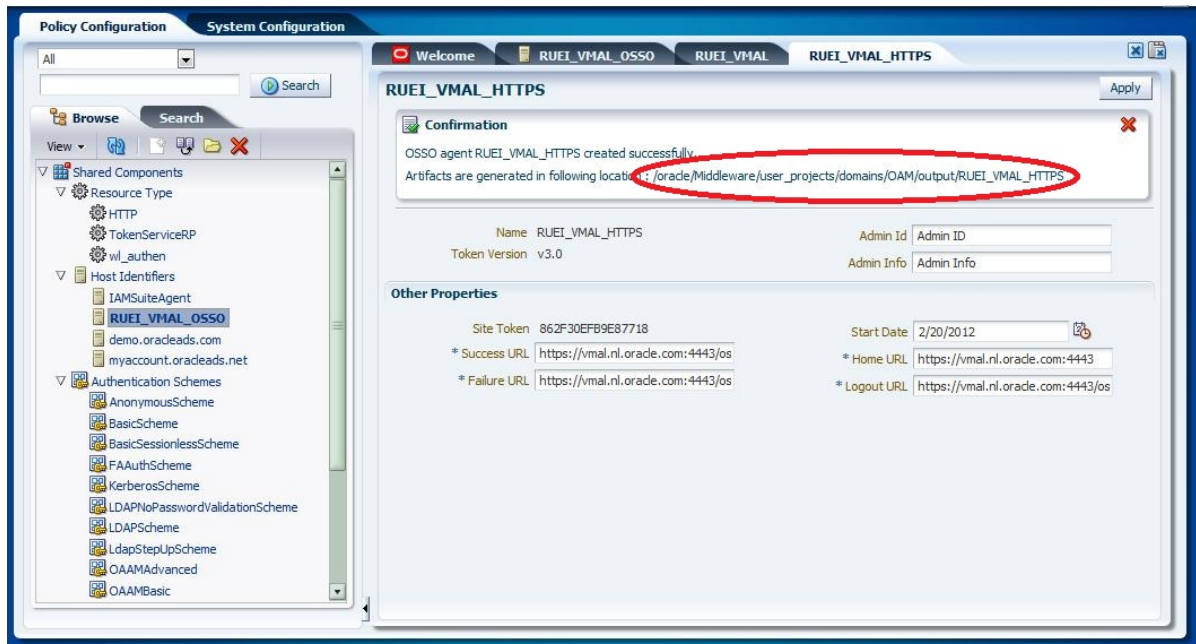

4. Copy the `osso.conf` file from the indicated location to the `$ORACLE_INSTANCE/config/OHS/ohs1` directory on the RUEI Reporter system.

Further information is available from the following location:

[http://docs.oracle.com/cd/E23943\\_01/doc.1111/e15478/agents.htm#BABGIDAB](http://docs.oracle.com/cd/E23943_01/doc.1111/e15478/agents.htm#BABGIDAB)

## 5.6 Verifying the Oracle HTTP Server Configuration

You can test the Oracle HTTP server for integration with RUEI by directing your browser to `https://Reporter/ruei`. When you select **System**, then **User management**, the **Configure SSO connection** option should be enabled.

For information about enabling Oracle SSO user authentication within RUEI, see the *Oracle Real User Experience Insight User's Guide*.



---

---

## Configuring RUEI

This chapter describes the procedure for initially configuring RUEI. This task is performed by the individual within your organization who has been assigned the role of RUEI Super Administrator (this is, the `admin` user). For more information about roles, see the *Oracle Real User Experience User's Guide*.

### Important

It is *strongly* recommended that a network engineer within your organization validates collected network traffic after configuring RUEI. The procedure to do this is described in [Appendix F, "Verifying Monitored Network Traffic"](#).

## 6.1 Introduction to Configuring RUEI

In order to get RUEI up and running, you will need to have prepared the server systems for RUEI, and installed the RUEI software. This is described in [Chapter 2, "Installing the RUEI Software"](#). After that, you are required to specify the installation type and mail setup (described in [Section 6.2, "Performing Initial RUEI Configuration"](#)), and then perform some post-installation configuration (described in [Section 6.4, "Performing Post-Installation Configuration"](#)). This is necessary in order to start reporting. It includes deciding how pages and users will be identified, and specifying the scope of monitoring in your network environment. Finally, you will need to define the system's initial users, as described in [Section 6.4.6, "Authorizing Initial Users"](#). Note that if you are installing a split-server configuration, you will need to configure each Collector system. This is described in [Section 6.3, "Configuring Collector Systems"](#).

### Important

The configuration of RUEI should be discussed with someone with a detailed knowledge of your organization's network topology.

## 6.2 Performing Initial RUEI Configuration

In order for RUEI to start data monitoring and reporting, it must be configured with some information about your network infrastructure. Once completed, user traffic reporting is available. Note that this initial configuration can be changed later, as necessary. It is only intended to provide RUEI with sufficient information to start real-user monitoring and reporting.

To perform the initial RUEI configuration, do the following:

1. Start the Initial setup wizard by pointing your browser at the following URL:  
`https://Reporter/ruei`.

where *Reporter* specifies the host name or IP address of your RUEI installation. The dialog shown in [Figure 6-1](#) appears.

**Figure 6-1 Logon Dialog**

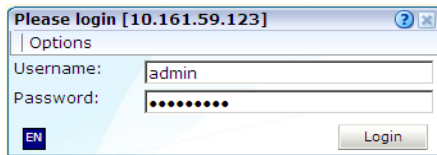

2. Specify the admin user, and the password defined with the `set-admin-password` script (defined in [Section 2.5.6, "Installing the Reporter Software"](#)). When ready, click **Login**. The dialog shown in [Figure 6-2](#) appears.

**Figure 6-2 Initial Setup Wizard**



Note that the first time a user logs on, they receive a warning that the web server was unable to verify the identify of the site's certificate. Depending on your security policies, you can either choose to accept this certificate permanently, temporarily for this session, or reject the certificate. Alternatively, you can purchase a certificate from a Certificate Authority (CA). You can also create an SSL certificate. More information is available at the following location:

[http://httpd.apache.org/docs/2.2/ssl/ssl\\_faq.html#realcert](http://httpd.apache.org/docs/2.2/ssl/ssl_faq.html#realcert)

3. Click **Next** to proceed with configuration. The dialog shown in [Figure 6-3](#) appears.



**Figure 6–3 Mail Setup Dialog**

4. Specify the requested information as explained in [Table 6–1](#).

**Table 6–1 E-mail Setup Fields**

Field	Description
Return address	Specifies the e-mail address to which failed or problem e-mails are reported. It is <i>strongly</i> recommended that this an address that is regularly checked.
From address	Specifies the address the recipient sees in their mail client.
Reply-to address	Specifies the address that users can click within an e-mail to reply to an e-mail. If this is not specified, the <b>From address</b> setting is used.
Mail size limit	Specifies the maximum message size (in kilobytes) allowed for e-mails. Note that if an e-mail contains reports that exceed this limit, the system will try to split up the reports into individuals e-mails to overcome this limitation. Reports that are too large to be sent individually are not sent, and the user is informed of the problem. The default mail size limit is 5000 Kb.
Reporter URL	Specifies the exact URL required for e-mail recipients to connect to the Reporter system. Typically, this is the same URL used by RUEI users to access the Reporter system.

The e-mail information is used to configure RUEI's interface to your internal network, and will be used for reporting problems. When you have entered the required information, click **Next**. The dialog shown in [Figure 6–4](#) appears.

**Figure 6–4 Settings Overview Dialog**

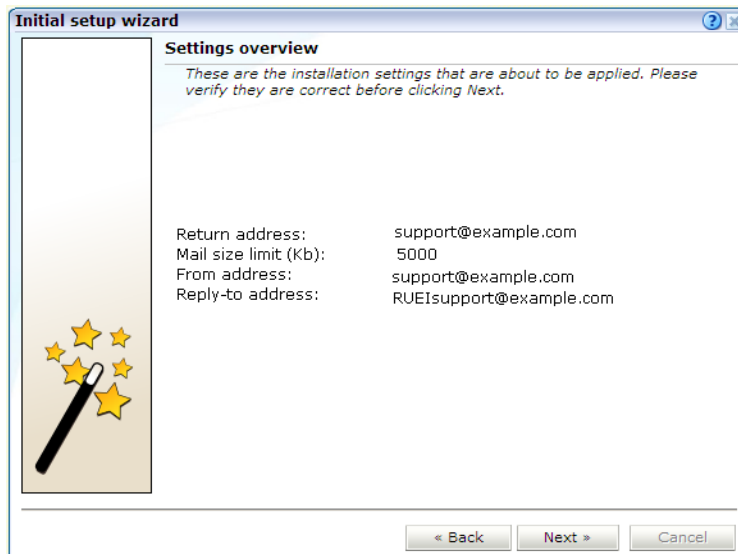

5. Check that the information specified in the settings overview is correct. You can use **Back** and **Next** to move between dialogs as necessary. When ready, click **Next**. The dialog shown in [Figure 6–5](#) appears.

**Figure 6–5 Applying Settings Dialog**

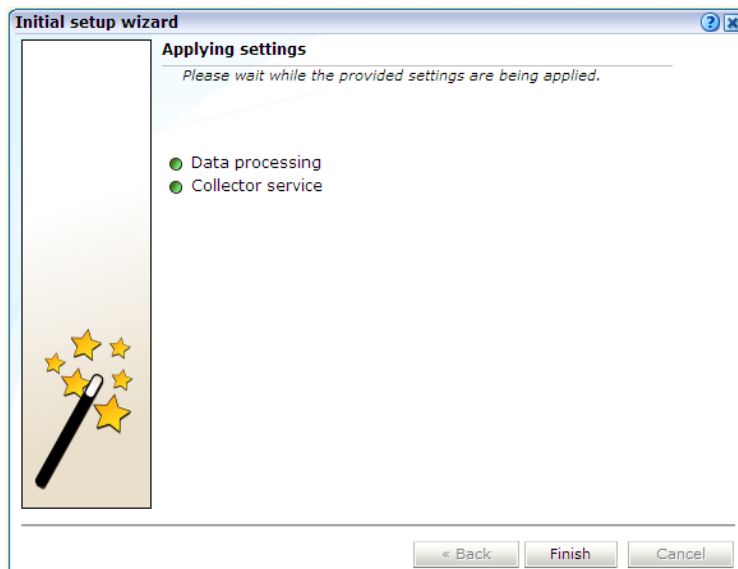

6. This dialog indicates how far the system has got in applying your specified settings. Typically, this process takes a maximum of 15 minutes. When finished, click **Finish** to close the dialog.

## 6.3 Configuring Collector Systems

To register Collectors to a Reporter system, do the following:

1. Install the Collector software on the required systems. This is described in [Chapter 2, "Installing the RUEI Software"](#).

2. Register the Collector systems with the Reporter. The procedure to do this is described in the *Oracle Real User Experience Insight User's Guide*.
3. If you expect high volumes of traffic and have installed the collector on a powerful system ( minimum of 12 cores, 32GB RAM or more), and RUEI is not monitoring servlet forms traffic, you can configure the collector to take advantage of the more powerful hardware using the procedure described in the *Configuring Collector Systems* chapter of the *Real User Experience Administration Guide*.

### 6.3.1 Resetting Collector Systems

If for any reason you need to register a Collector system with a different Reporter system than earlier configured, do the following:

1. Logon to the Collector system as the `moniforce` user, and remove the Collector's currently defined Reporter assignment by issuing the following commands:

```
su - moniforce
appsensor delete wg
```

2. Follow the procedure described in the *Oracle Real User Experience Insight User's Guide* to register the Collector with the required Reporter.

## 6.4 Performing Post-Installation Configuration

In order to start reporting, the RUEI needs certain information about the monitored network environment. It is important to understand that RUEI is designed to work within a wide range of network environments. Therefore, the configuration choices you make will affect the accuracy and usability of the reported data. It is strongly recommended that you carefully review the settings described in this section.

### 6.4.1 Specifying the Cookie Technology

Within RUEI, session information is based on cookies. Therefore, RUEI needs to know and understand the cookie technology (or technologies) your organization is using. The procedure to configure this, together with the structure of supported cookie technologies, is described in the *Oracle Real User Experience Insight User's Guide*.

If cookie information is not available, user tracking is based on visitor IP address. This can lead to unreliable session information. For example, in the case of users behind a proxy server, all users coming from that network would be identified as the same user.

### 6.4.2 Adding/Uploading HTTPS SSL Keys

Uploading SSL keys to the system is extremely important if most of your HTTP traffic is based on SSL sessions. Without the SSL keys being available to the system, the Collector will not be able to decrypt the SSL session traffic. In these circumstances, further configuration of cookies, user identification, and application pages would make little sense. Ensure that you upload and activate your HTTPS SSL keys as early on as possible in the configuration process. The management of SSL keys is fully described in the *Oracle Real User Experience Insight User's Guide*.

### 6.4.3 Specifying How Users are Identified

Within RUEI, user identification is first based on the HTTP Authorization field. After that, it is derived from the supplied GET/POST argument within URLs. Therefore, if you are using arguments within URLs, the item within these used for user

identification must be specified in order to provide reliable results. This is fully described in the *Oracle Real User Experience Insight User's Guide*.

#### 6.4.4 Defining Applications and Page Identification

Page identification within RUEI is based on defined applications. Essentially, an application is a collection of web pages. This is because pages on a web site are typically bound to a particular application. For each page that the system detects, it uses the available application definitions to assign a name to it. Note that information about any pages that could not be identified using these definitions is discarded, and, therefore, not available through reports and the data browser. This is fully described in the *Oracle Real User Experience User's Guide*.

##### Suites

In addition to generic applications, dedicated support is available for the monitoring of certain Oracle Enterprise architectures (such as Oracle E-Business suite, Siebel, and WebLogic Portal). If you are using any of the currently supported architectures within your monitored environment, it is *strongly* recommended that you make use of this facility. It not only saves you time in defining your applications, and makes applications within suites more compatible, but also ensures that these architectures are monitored correctly.

#### 6.4.5 Specifying the Scope of Monitoring

Within RUEI, you control the scope of traffic monitoring by specifying which TCP ports the SYSTEM should monitor. Obviously, no information is available for non-monitored ports. In addition, you can restrict monitoring to specific servers and subnets. This is fully described in the *Oracle Real User Experience Insight User's Guide*.

#### 6.4.6 Authorizing Initial Users

In order for users to start working with RUEI, you will need to authorize the required users. Only one user, `admin`, is available after installation. The procedure to set the initial `admin` user password is described in [Section 2.5.6, "Installing the Reporter Software"](#). All other required users must be created and assigned the necessary roles and access permissions through the Reporter GUI. In particular, it is recommended that you create a dedicated Security Officer account to finalize the security-related configuration. User roles, and the creation and management of user accounts are described in the *Oracle Real User Experience Insight User's Guide*.

Note that user names and passwords are case sensitive. For ease of entry, it is recommended that you do not include any diacritic characters, such as umlauts, within passwords.

### 6.5 Verifying and Evaluating Your Configuration

To ensure the quality and quantity of data being collected and analyzed by your RUEI system, it is strongly advised that you verify the system's configuration using some core metrics. These are described in the following sections.

#### 6.5.1 Viewing Traffic Summary

You can open an overview of the monitored network traffic by selecting **System**, then **Status**, and then **Data processing**. This provides you with immediate information about hits, pages, and session processing, as well as the system load. An example is

shown in Figure 6–6.

**Figure 6–6** Data Processing Dialog

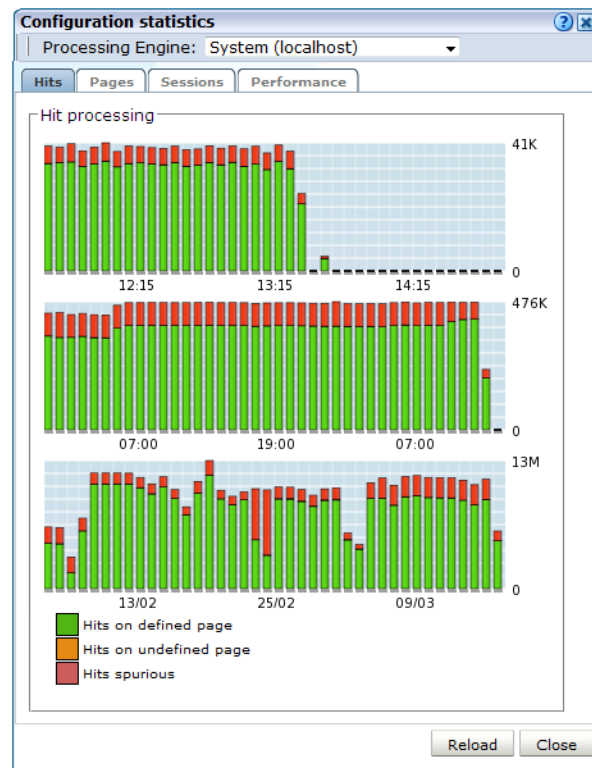

The precise number of percentage of identified sessions, page views, and hits relies heavily on your exact configuration. If you intend to measure all traffic, it is recommended that at least 80% of sessions, page views, and hits are reported as "identified". It is also recommended that you regularly review the reported numbers and percentages to ensure the quality and quantity of reported data.

---

**Important:** After initial configuration of cookies, user identification, and application page structure, the system will take at least 5 - 10 minutes before the **Sessions/Hits/Page views** tabs are updated with green bars. If, after 20 - 30 minutes after initial configuration, there are no green bars showing on any of the tabs, please review your initial RUEI configuration. If the bars do not indicate any activity at all, please review your system's network card configuration as outlined in [Section 1.7, "Server Requirements"](#)

---

## 6.5.2 Confirming Data Collection

At this point, RUEI should be collecting data from each of its associated Collectors. You can easily check the status of these Collectors by selecting **System**, then **Status**, and then **Collector status**. This opens the Network data collectors window. This is fully described in the *Oracle Real User Experience Insight User's Guide*.

It is important to understand that the data being collected by Collector system(s) is offered to the RUEI data processing module for further analysis. If no data is collected, there is no means by which it can be processed.

## 6.6 Configuring Support for the T3 Protocol

RUEI 13.2.2.1 includes limited support for the T3 protocol. T3 is an Oracle proprietary protocol for communication to and between Oracle WebLogic Server instances. With this release of RUEI you can monitor service calls between Oracle WebLogic Server instances, however future releases of RUEI might change how T3 is supported and any 13.2.2.1 configuration might not be backwards compatible.

To configure support for the T3 protocol:

1. Configure the T3 port in RUEI. Select **Configuration**, then Security, and select the **Protocols** option. The resulting screen is described in the *Managing Security-Related Information* chapter of the *RUEI User's Guide*. Select HTTP for the T3 protocol or HTTPS for the ST3 protocol and enter the port number, typically 7001.
2. Create a suite of the type **T3 Java RMI** as described in the *Working With Suites and Web Services* chapter of the *RUEI User's Guide*. Note that the **T3 Java RMI** type will only be available option after you have configured the T3 protocol port as described in step 1.
3. Modify the newly defined suite as required to monitor T3 traffic. Note that data masking and identification using content messages are not supported for the T3 protocol.

---

---

# Configuring the Oracle Access Manager

This chapter describes the procedure for configuring the Oracle Access Manager (OAM) for identifying user IDs within OAM-based traffic. The procedure described assumes that you already have a working OAM server. Note that the procedure may need to be modified to reflect the specific configuration of your OAM server.

## 7.1 Configuring OAM 10g

This section describes the procedure for configuring OAM 10g version 10.1.4.x (or higher). For information on configuring OAM 11g see [Section 7.2, "Configuring OAM 11g."](#)

### 7.1.1 Downloading and Installing the Access Gate Software

Do the following:

1. Download and install the GCC libraries. These can be obtained from either your operating system vendor or <http://gcc.gnu.org>. Note that a description of the contents of the Oracle Access Manager 10.1.4 third-party integration disks is available at the following location:

<http://www.oracle.com/technetwork/middleware/ias/downloads/10gr3-webgates-integrations-readme-154689.pdf>

2. Download the 64-bit OAM Access Server SDK from the following location:

[http://download.oracle.com/otn/linux/ias/101401/oam\\_int\\_linux\\_v7\\_cd3.zip](http://download.oracle.com/otn/linux/ias/101401/oam_int_linux_v7_cd3.zip)

3. Extract, unzip, and copy the GCC libraries using the following commands:

```
cat as_linux_x86_gcc_runtime_lib_access_manager_101401.cpio | cpio -idmv
unzip Oracle_Access_Manager10_1_4_0_1_linux_GCClib.zip
cp lib* /usr/local/lib/
```

### 7.1.2 Configuring the Access Gate Software on the RUEI Server

Do the following:

1. Unzip the OAM Access Server SDK distribution set, and run the installer, by issuing the following commands:

```
unzip oam_int_linux_v7_cd3.zip
./Oracle_Access_Manager10_1_4_2_5_linux64_AccessServerSDK
```

By default, the OAM Access Server SDK is installed in the `/opt/netpoint/AccessServerSDK/` directory.

---



---

**Note:** The user specified while running the Access Gate SDK installation wizard should be the same as that specified for RUEI\_USER in the `ruei.conf` configuration file (see [Table 2-3](#)).

---



---

2. Create a trust between RUEI and the Access Server by creating XML files using the `configureAccessGate` utility. Issue the following commands:

```
cd /opt/netpoint/AccessServerSDK/oblix/tools/configureAccessGate
./configureAccessGate -i /opt/netpoint/AccessServerSDK/ -t AccessGate
```

3. As the utility runs, specify the following information based on the configuration of the Access Gate you created earlier:

```
Please enter the Mode in which you want the AccessGate to run : 1(Open)
2(Simple) 3(Cert) : 1
```

```
Please enter the AccessGate ID : short_name
```

```
Please enter the Password for this AccessGate :
```

```
Please enter the Access Server ID : accessSrv1
```

```
Please enter the Access Server Host Machine Name : fully_qualified_hostname
```

```
Please enter the Access Server Port : 6021
```

```
Preparing to connect to Access Server. Please wait.
```

```
AccessGate installed Successfully.
```

```
Press enter key to continue ...
```

Where *short\_name* specifies the Access Gate ID, and *fully\_qualified\_hostname* is the OAM Access Server system host name.

4. At this point, the RUEI Reporter system is connected to the OAM Access Server. Update the `OBACCESS_INSTALL_DIR` variable in the `/etc/ruei.conf` configuration file to reflect the installation path of the Access Server SDK. In the case of the default installation path, the required line would be as follows:

```
export OBACCESS_INSTALL_DIR=/opt/netpoint/AccessServerSDK/
```

5. Re-start RUEI processing by selecting **System**, then **Maintenance**, then **System reset**, and select the **Restart system processing** option. When ready, click **Next**. When prompted, confirm the restart.

### 7.1.3 Configuring the Required Session Traffic Definitions

In order to enable correct tracking of OAM-based sessions, you need to specify the following configuration information within RUEI:

1. Configure all required applications for user identification based on OAM. To do so, click the **User ID** tab within each required application overview, and then click **Add new source**. Within the **Source type** menu, select the "Oracle Access Manager" option. When ready, click **Save**.
2. Select **Configuration**, then **Applications**, and then **Session tracking**. Ensure that the "Oracle Access Manager" item is included in the list of cookie technologies



configured for your RUEI installation. By default, this uses the cookie name ObSSOcookie.

---

**Note:** In order for OAM-based traffic to be correctly reported, the masking of the OAM cookie must be configured as "Plain" within the Cookie masking facility (Select **Configuration**, then **Security**, then **Masking**, and then **Cookie masking**).

---

Note that until an OAM request has been processed by the RUEI system Access Gate, the following message is shown when requesting the Access Servers listing for your Access Gate:

```
Not Responding
AM service status mismatch
```

## 7.1.4 Creating an OAM Access Gate for RUEI

Do the following:

1. Direct your web browser to The Oracle Access Manager server interface. If you are unsure of the required URL, you should contact the OAM system administrator. The page shown in [Figure 7-1](#) appears.

**Figure 7-1** OAM Server Interface



2. Click the **Access System Console** link. The page shown in [Figure 7-2](#) appears.

**Figure 7-2 OAM Access Administration**

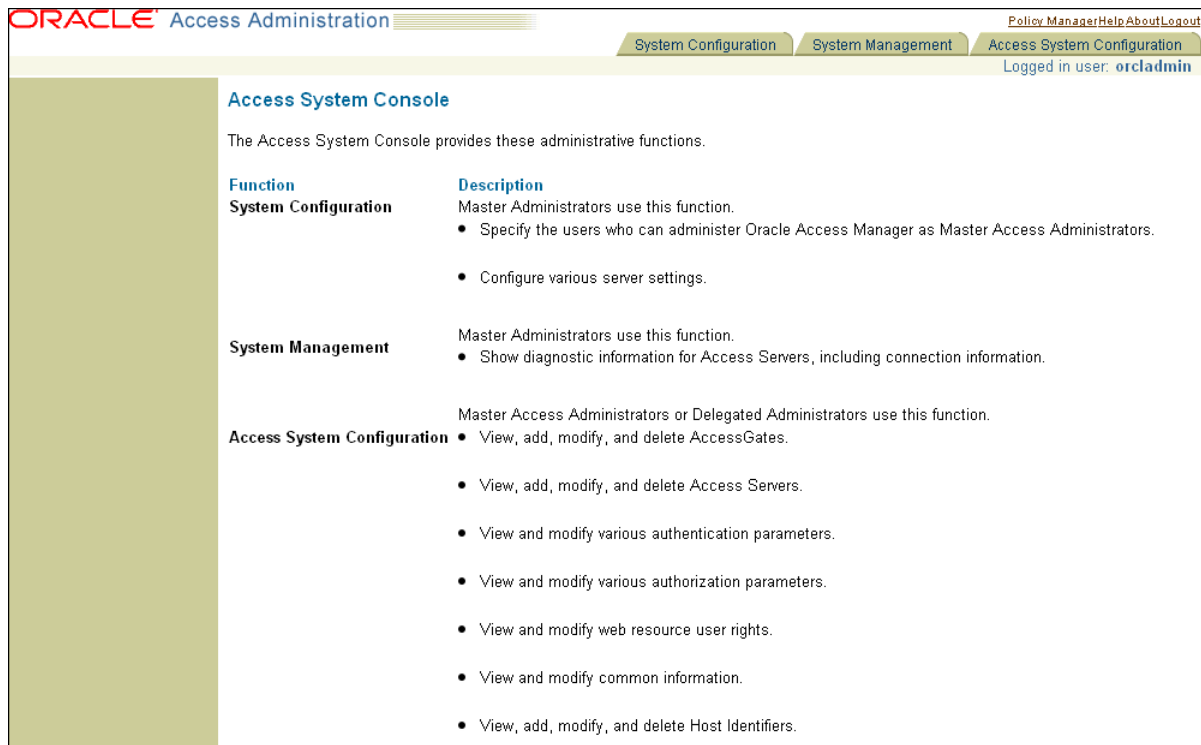

3. Click the **Access System Configuration** tab. The page shown in [Figure 7-3](#) appears.

**Figure 7-3 OAM Access System Configuration Page**

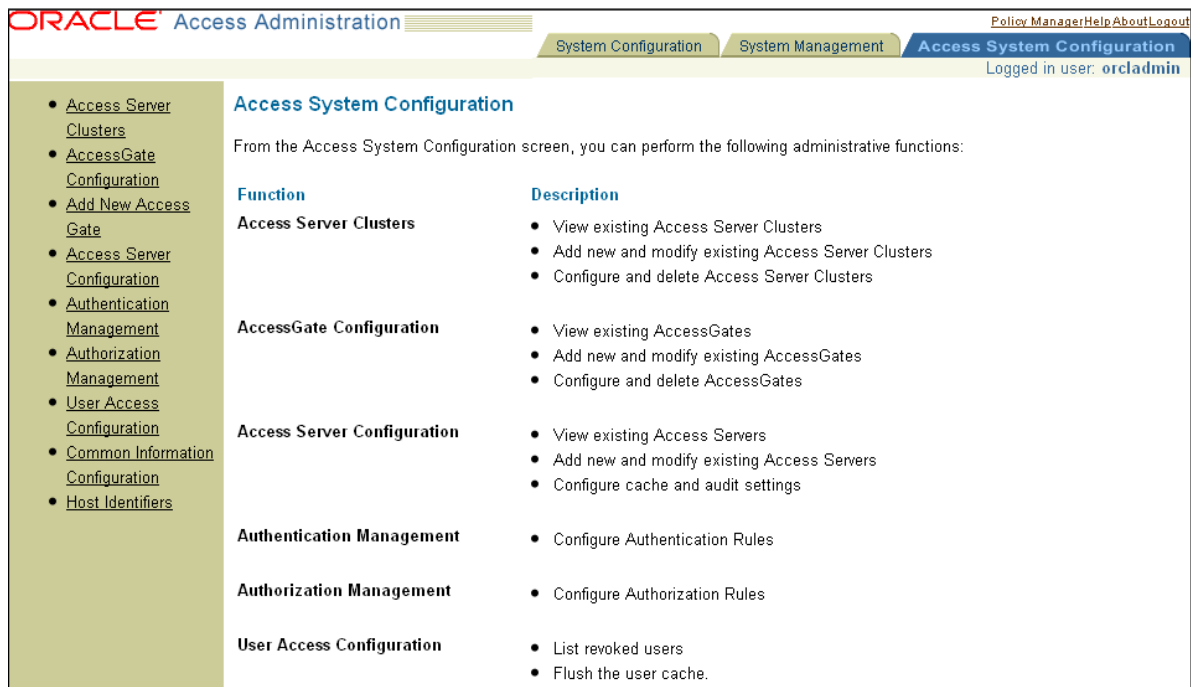

- Click the **Add New Access Gate** option on the left-hand side of the page. The page shown in [Figure 7-4](#) appears.

**Figure 7-4 Add New Access Gate Page**

### Add New Access Gate

AccessGate Name	<input type="text" value="ruei"/>	
Description	<input type="text"/>	
Hostname	<input type="text"/>	
Port	<input type="text"/>	
Access Gate Password	<input type="password"/>	
Re-type Access Gate Password	<input type="password"/>	
Debug	<input checked="" type="radio"/> Off <input type="radio"/> On	
Maximum user session time (seconds)	<input type="text" value="3600"/>	
Idle Session Time (seconds)	<input type="text" value="3600"/>	
Maximum Connections	<input type="text" value="1"/>	
Transport Security	<input checked="" type="radio"/> Open <input type="radio"/> Simple <input type="radio"/> Cert	
IPValidation	<input type="radio"/> Off <input checked="" type="radio"/> On	
IPValidationException	<input type="text"/>	- +
Maximum Client Session Time (hours)	<input type="text" value="24"/>	
Failover threshold	<input type="text"/>	
Access server timeout threshold	<input type="text"/>	
Sleep For (seconds)	<input type="text" value="60"/>	
Maximum elements in cache	<input type="text" value="100000"/>	
Cache timeout (seconds)	<input type="text" value="1800"/>	
Impersonation username	<input type="text"/>	
Impersonation password	<input type="password"/>	
Re-type impersonation password	<input type="password"/>	
<b>ASDK Client</b>		
Access Management Service	<input checked="" type="radio"/> Off <input type="radio"/> On	
<b>Web Server Client</b>		
Primary HTTP Cookie Domain	<input type="text"/>	
Preferred HTTP Host	<input type="text"/>	
Deny On Not Protected	<input checked="" type="radio"/> Off <input type="radio"/> On	
CachePragnaHeader	<input type="text" value="no-cache"/>	
CacheControlHeader	<input type="text" value="no-cache"/>	
LogOutURLs	<input type="text"/>	- +
<b>User Defined Parameters</b>		
Parameters	Values	
<input type="text"/>	<input type="text"/>	- +
		Add Delete
Save Cancel		

- Provide the following information:
  - **Access Gate Name:** specify a unique ID for the new Access Gate. For example, ruei.
  - **Hostname:** specify the hostname of the RUEI Reporter system.

- **Port:** specify the port RUEI should monitor for OAM-based traffic. This should be port 443.
- **Access Gate Password:** specify the password that should be used to authorize the RUEI Reporter system to access the OAM server.
- **Re-Type Access Gate Password:** confirm the authorization password.
- **Preferred HTTP Host:** specify `SERVER_NAME`.

Note that the remaining fields can be left blank or with default values specified.

When ready, click **Save**.

6. Click the **List Access Servers** command button to connect the newly created Access Gate with the required Access Server. Select the required Access Server from the displayed list and, when ready, click **Add**.

Note that if no Access Server is listed, Click **Add** and add the new access gate to the default Access Server.

#### 7.1.4.1 Configuring the OAM\_REMOTE\_USER Header Variable

To configure the OAM\_REMOTE\_USER header variable, complete the following:

1. Click the Policy Manager link, as shown at the top of the screen in [Figure 7-1, "OAM Server Interface"](#).
2. From the **Authorization Rules** tab, click **Time based access**, then click **Actions**.
3. Under "Authentication Success", configure the following header variable:  
Type=headervar, Name=OAM\_REMOTE\_USER, and Return Attribute=cn.
4. Click **Save**.

The following shows the Access Administration screen.

Figure 7-5 Access Administration

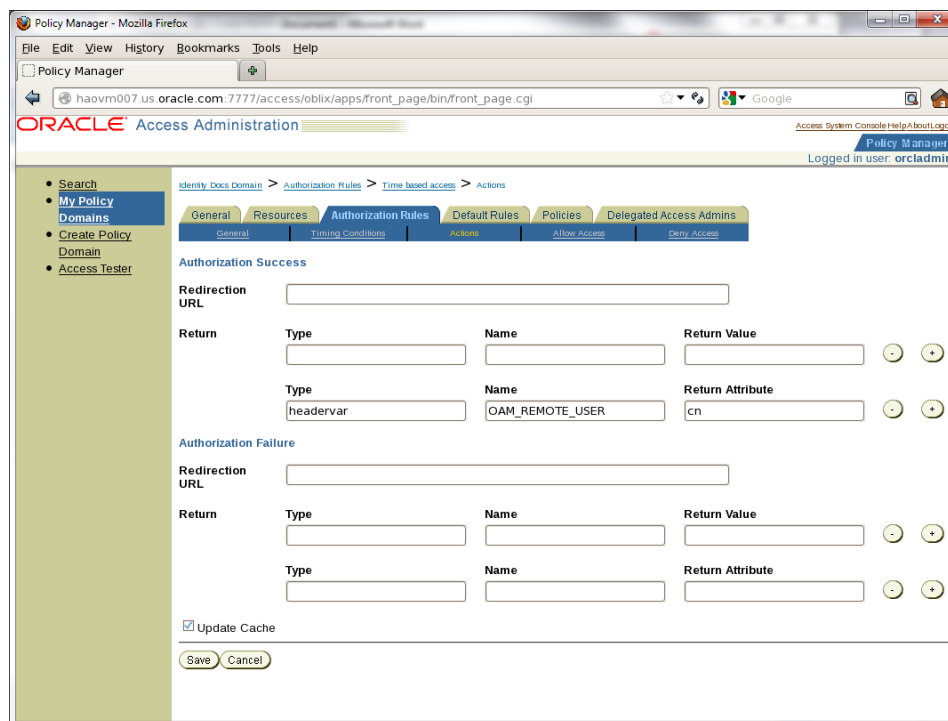

## 7.2 Configuring OAM 11g

This section describes the procedure for configuring OAM 11g. For information on configuring OAM 10g see [Section 7.1, "Configuring OAM 10g."](#)

RUEI is able to monitor OAM 11g (R2PS3 BP02) secured web applications in order to report on user identification information provided by OAM. OAM provides this information for each user session in an encrypted cookie which, once properly configured, is monitored and decrypted by RUEI. The user identification (user id) is extracted from the decrypted content and used within RUEI.

### 7.2.1 Exporting and Importing the OAM 11g AES key

A shared AES key is available for each OAM server which can be used by RUEI to decrypt the OAM 11g cookie (OAM\_DIAG\_CTS). This key needs to be extracted from the OAM server and uploaded to the RUEI Reporter. RUEI allows you to upload a

'global' OAM AES key and allows key uploads per application. An application OAM AES key overrides the global OAM AES key.

### 7.2.1.1 Exporting an OAM 11g AES key

Export the key using the following procedure:

1. Start the WebLogic Server console, for example enter:

```
$MW_HOME/Oracle_IDM1/common/bin/wlst.sh
```

2. Connect to the WebLogic Server, for example enter:

```
Connect('user','password','t3://hostname:port')
```

3. Run the following WLST command to retrieve the key:

```
retrieveDiagnosticCookieKey( keystoreLocation="keystoreLocation",
password="password")
```

where *keystoreLocation* is an existing directory where the output JKS file will be stored, and *password* is the password used to encrypt the JKS file.

### 7.2.1.2 Importing an OAM 11g AES key

On the RUEI side use the `oam-key.sh` tool to add or remove OAM AES keys. Either import a global key, or import one or more application specific keys.

1. You must specify a collector profile name during the import process, to list all profiles, enter:

```
execsql config_get_profiles
```

2. If you want to use an application specific key, you must specify an application name during the import process, to list all application names, enter:

```
execsql get_matches
```

3. Gather the required passwords. During import the following passwords are requested:

- original key password - this is the password provided during the JSK export from the OAM server. This password is used to decrypt the JKS keystore file.
- key storage passphrase - this is the password RUEI uses to safely store and encrypt the AES key.

4. To import a global key, enter:

```
oam-key.sh install PATH_TO_JKS_FILE 'Collector Profile Name'
```

where *PATH\_TO\_JKS\_FILE* is the location of the JKS file created during export.

5. To import an application specific key, enter:

```
oam-key.sh install PATH_TO_JKS_FILE 'Collector Profile Name' 'Application Name'
```

where *Application Name* is the name of the application.

### 7.2.1.3 Removing an OAM 11g AES Key

To remove a global key, enter:

```
oam-key.sh delete 'Collector Profile Name'
```

To remove an application specific key, enter:

```
oam-key.sh delete 'Collector Profile Name' 'Application Name'
```

## 7.2.2 Configuring an Application to Use OAM

After configuring OAM 11g, you can add a user id source to an application based on 'Oracle Access Manager 11g' as described in the "Monitoring OAM and SSO-Based Traffic" chapter of the *RUEI User's Guide*.





---



---

## Installing Processing Engines

This chapter describes the prerequisites and procedure for installing Processing Engines. Note that the use of Processing Engines is only supported for remote Collectors and in most scenarios is not required. A combined installation of a Processing Engine and Collector on the same system is not supported.

---



---

**Note:** Installing a separate Processing Engine might degrade performance of a RUEI system. Contact Oracle Support for advice before installing a Processing Engine.

---



---

### 8.1 Prerequisites for Processing Engines

This section describes the steps that should be taken before starting to install the Processing Engine software. Ensure that the Reporter and remote Collector systems are up and running before proceeding with the installation process.

---



---

**Important:** It may be necessary to increase the maximum number of processes available to the databases within your environment. The procedure to do this is described in [Section G.16, "ORA-00020: maximum number of processes \(%s\) exceeded"](#).

---



---

#### 8.1.1 Planning the Software Installation Location

Make sure that your processing engine, reporters including database, are on the same network segment.

Depending on the installation location of the database and the RUEI software, the necessary disk space needs to be carefully planned. During operating system installation, you will need this information at hand for the disk partitioning phase.

[Table 8–1](#) shows the disk space requirements for the RUEI installation components.

**Table 8–1 Required Disk Space Specifications**

Partition	Minimum Required Disk Space (GB)	Component
ORACLE_BASE (default /u01/app/oracle) <sup>1</sup>	300	Processing Engine Database
RUEI_HOME (default /opt/ruei)	1	Processing Engine
RUEI_DATA (default /var/opt/ruei/)	100	Processing Engine

<sup>1</sup> This is the example database location used throughout this guide.

---



---

**Important:** The Processing Engine and database servers require high-performance data storage. RAID-10 or RAID-5 (or equivalent) storage configurations with high-performance disks are *strongly* recommended.

---



---

## 8.1.2 Configuring Operating System Security

When the system boots for the first time, a post-installation wizard appears, and allows you to finalize the operating system configuration settings. Ensure that:

1. The RUEI firewall rules shown in [Table 1-9](#) are correctly configured.
2. Security Enhanced Linux (SELinux) is disabled. This is necessary for the correct operation of RUEI. Note that changing the SELinux setting requires rebooting the system so that the entire system can be relabeled.
3. For security reasons, it is *strongly* recommended that you check the **Encrypt System** check box during operating system installation so that all sensitive data is stored in a secure manner. A passphrase is required during booting the system.

## 8.1.3 Verifying NTP Daemon Operation

Ensure that the date and time settings are correctly specified. The use of NTP is *strongly* recommended, and is required in a split-server deployment. In addition, all time zones specified for Reporter, Collector, and Processing Engine systems *must* be identical.

Because the NTP daemon is a critical component of RUEI, especially in a split server configuration, it is recommended that you verify that it is activated in at least run level 5 during boot. Use the following commands:

```
/sbin/chkconfig --list | grep ntpd
ntpd    0:off  1:off  2:off  3:off  4:off  5:off  6:off
/sbin/chkconfig ntpd on
/sbin/chkconfig --list | grep ntpd
ntpd    0:off  1:off  2:on   3:on   4:on   5:on   6:off
/etc/init.d/ntpd start
Starting ntpd:                               [ OK ]
```

Note that if the NTP daemon is not already running, you can start it by issuing the following command:

```
/etc/init.d/ntpd restart
```

The following sample output shows when the NTP daemon is synchronized (indicated by an "\*").

```
ntpq -pn
      remote           refid      st t when poll reach  delay  offset  jitter
=====
*194.171.167.130      .PPS.          1 u 994 1024 377    6.429  0.041  0.093
+80.85.129.25        130.235.20.3   3 u 725 1024 377    4.435  0.673  0.129
+82.94.235.106       135.81.191.59  2 u 678 1024 377    1.709  1.774  0.020
 127.127.1.0         .LOCL.         10 l 8    64 377    0.000  0.000  0.001
```

---



---

**Important:** In distributed environments, all time zones specified for Reporter, Collector, and Processing Engine systems *must* be identical.

---



---

## 8.1.4 Installing the RUEI Prerequisites

Note that the procedure described in this section is only required for a Processing Engine system. The required packages are available from the Oracle Linux or RedHat Enterprise Linux distribution sets.

### RedHat Enterprise/Oracle Linux 5.x

Issue the following command to install all prerequisites for the Reporter:

```
rpm -Uhv lm_sensors-2.10.7-*.el5.x86_64.rpm \
net-snmp-5.3.2.2-*.el5.x86_64.rpm \
net-snmp-utils-5.3.2.2-*.el5.x86_64.rpm
```

### RedHat Enterprise/Oracle Linux 6.x

Issue the following command to install all prerequisites for the Reporter:

```
rpm -Uhv lm_sensors-3.1.1-*.el6.x86_64.rpm \
net-snmp-5.5-*.el6.x86_64.rpm \
net-snmp-utils-5.5-*.el6.x86_64.rpm
```

### Installing All Requirements Using a Yum Repository (Alternative)

As an alternative to manual installation, you can use a Yum repository to install the required RPMs. This requires a working Yum repository. Information about Yum repositories is available at the following location:

<http://linux.duke.edu/projects/yum/>

Install the necessary Reporter packages using the following command:

```
yum -y install net-snmp-utils
```

## 8.1.5 Installing Oracle Database Software

Download and install Oracle Database 12c Enterprise Edition from the Oracle database home page at the following location:

<http://www.oracle.com/technetwork/database/enterprise-edition/downloads>

The procedure for installing the Oracle database is fully described in the product documentation. It is *strongly* recommended that you download and review the appropriate *Oracle Database 12c Quick Installation Guide*. It is available from the Oracle Database Documentation Library. A summary of this procedure is described in [Appendix A, "Installing the Oracle Database Software"](#). Note that the path, user, and group names used in this guide are based on the Oracle database product documentation.

## 8.2 The RUEI Configuration File

The `/etc/ruei.conf` file specifies the settings used within your installation. A template of this file is provided in the `/root/RUEI/extra` directory of the RUEI distribution zip. Note that all components in your RUEI environment (such as the remote database and Collectors) require the same global `/etc/ruei.conf` configuration file *except* the value specified for `RUEI_DB_TNSNAME_CFG`. If you

intend to use different names for the configuration and statistics tablespaces make sure that the same tablespace names are used for all components in your RUEI environment.

Within the Processing Engine `ruei.conf` file, the following two settings must be carefully distinguished:

- `RUEI_DB_TNSNAME_CFG` must contain the alias to the Reporter database (in this guide referred to as `config`).
- `RUEI_DB_TNSNAME` must contain the alias to the Processing Engine database (in this guide referred to as `uxinsight`).

## 8.3 Installing the Processing Engine

This section describes the procedure for installing the required components for a Processing Engine system. These include the Oracle database Instant Client.

### 8.3.1 Creating Groups and Users

Create the `moniforce` group and user. The home directory of `moniforce` should be set to `/var/opt/ruei`, with read permissions for group members. Issue the following commands:

```
/usr/sbin/groupadd moniforce
/usr/sbin/useradd moniforce -g moniforce -d /var/opt/ruei
chmod -R 750 /var/opt/ruei
chown -R moniforce:moniforce /var/opt/ruei
```

### 8.3.2 Installing the Oracle Database Instant Client

Install the Oracle database Instant Client and SQLplus extension by issuing the following commands as the `root` user:

```
cd /root/RUEI/IC
rpm -Uhv oracle-instantclient11.2-basic-*.rpm
rpm -Uhv oracle-instantclient11.2-sqlplus-*.rpm
```

### 8.3.3 Creating the Processing Engine Database Instance

The Processing Engine database can reside either locally (that is, on the Processing Engine server) or on a remote database server. In this section you will create the database instance required for the Processing Engine, and generate the "connection data" required for the Processing Engine to connect to its database instance and the central RUEI database instance. As an alternative for the database setup described in this chapter, you can follow the procedure described in [Appendix B, "Generic Database Instance Setup"](#).

#### Requirements

You will need the following scripts to be present on the system where the database instance (`RUEI_DB_INST`) will be created:

- `ruei-prepare-db.sh`: creates the database instance, Oracle wallet, and database connect files. Note that this script will only run on Linux. If you are installing the Oracle database on a different operating system, see [Appendix B, "Generic Database Instance Setup"](#) for more information.

- `sql_scripts`: this directory contains a number of SQL scripts that are called by the `ruei-prepare-db.sh` script.
- `db_templates`: this directory contains templates for the RUEI database instance that is created by the `ruei-prepare-db.sh` script.
- `ruei-check.sh`: this is a hardware and environment check utility, and is automatically invoked by `ruei-prepare-db.sh`. The script can also be used as a stand-alone troubleshooting utility. For a complete description of the script, refer to [Appendix E, "The ruei-check.sh Script"](#).

The four "connection data" files created during the procedure described in this section are as follows:

- `cwallet.sso`
- `ewallet.p12`
- `sqlnet.ora`
- `tnsnames.ora`

The RUEI configuration file (`/etc/ruei.conf`) also needs to be present on the database server and configured as described in [Section 8.2, "The RUEI Configuration File"](#).

### Procedure

Do the following:

1. Copy the `ruei-prepare-db.sh` and `ruei-check.sh` scripts, and the `sql_scripts` and `db_templates` directories to the server on which you intend to run the database instance, and make them executable for the `oracle` user. These scripts and directories can be found in the RUEI distribution zip (`/root/RUEI/131`).
2. Review the settings in the `/etc/ruei.conf` file to match your needs as described in [Section 8.2, "The RUEI Configuration File"](#). If you intend to use different names for the configuration and statistics tablespaces make sure that the same tablespace names are used for all components in your RUEI environment.
3. Logon to the database server as the `oracle` user, and set the `ORACLE_HOME` environment variable. You need to run the `ruei-prepare-db.sh` script as the `oracle` user. This script creates the `RUEI_DB_INST` database, but only after a number of hardware and software environment checks have been performed. The actual checks performed depend on the system type you are currently installing.

The script prompts you for the RUEI database user and wallet passwords, and the hostname of the database server. This enables the RUEI application to login to the database automatically. The script also prompts you for a default tablespace name to be used for this installation. Ensure that the default tablespace name is the same for all components in your RUEI environment, such as the remote database and Processors. The script also creates the "connection data" files.

Issue the following commands:

```
chmod +x ruei-prepare-db.sh ruei-check.sh
chmod -R +r /home/oracle/sql_scripts/
chmod -R +r /home/oracle/db_templates/
export ORACLE_HOME=/u01/app/oracle/product/11.2.0/dbhome_11

./ruei-prepare-db.sh create
```

<sup>1</sup> This line requires customization based on your database version and installation path.

If you run the `ruei-prepare-db.sh` script for a combined Processing Engine/Database server, all files are placed automatically in the correct location<sup>2</sup>. In case of a remote database, a separate `.tar` file is generated, and you will need to perform the extra step 4.

If you ran the above commands on a combined Processing Engine/Database server, you can skip step 4 and proceed to step 5.

4. This step only applies when using a remote Processing Engine database.

In the case of a Processing Engine system using a remote database, you will need to copy the generated `/tmp/ruei-database-configuration.tar` file in step 3 from the database server to the Processing Engine system. The `/tmp/ruei-database-configuration.tar` file must be extracted on the Processing Engine server in the directory `/var/opt/ruei` (RUEI\_DATA). The permissions of the files need to be set so that the specified RUEI\_USER (`moniforce`) can use them.

Copy the generated `.tar` file, which holds connection data files to the Processing Engine system. Logon to the Processing Engine server and extract the `.tar` file using the following commands:

```
cd /var/opt/ruei
tar xvf path-to-tar-file/ruei/database-configuration.tar
chown moniforce:moniforce cwallet.sso ewallet.p12 sqlnet.ora tnsnames.ora
```

5. Because logging of the database can consume a large amount of disk space, it is recommended that you install a clean-up script to avoid the usage of unnecessary disk space. Copy the (example) script to the `oracle` user directory and activate it via `cron` using the following commands:

```
mkdir -p /home/oracle/bin
cp /root/RUEI/extra/ruei-clean.sh /home/oracle/bin
chmod +x /home/oracle/bin/ruei-clean.sh
su - oracle -c 'echo "10 0 * * * /home/oracle/bin/ruei-clean.sh" | crontab'
```

### 8.3.4 Installing the Processing Engine Software

1. The RUEI directory locations are flexible. Therefore, it is necessary to use the *exact* directory name described as configured in the `/etc/ruei.conf` file. Create the RUEI application root directory using the following commands:

```
mkdir -p /opt/ruei
chmod 755 /opt/ruei
```

---

**Note:** The specified RUEI\_HOME and RUEI\_DATA directories must have 755 permissions defined for them.

---

2. Go to the directory that holds the RUEI software, and install the RUEI packages. You can specify `reporter` or `collector` to the `ruei-install.sh` script depending on the required installation:

```
cd /root/RUEI/132
chmod +x ruei-install.sh
./ruei-install.sh reporter
```

<sup>2</sup> If you do not know the `root` password, you can select the "remote database" option, and manually extract the connection tar file. This is described in step 4.

- Verify that the RUEI software was correctly installed by issuing the following command:

```
./ruei-check.sh postinstall
```

## 8.4 Configuring Processing Engine Communication

Table 1–9 provides a complete description of all required connections. Figure 8–1 shows a summary of those relevant to Processing Engines.

Figure 8–1 Required Connections

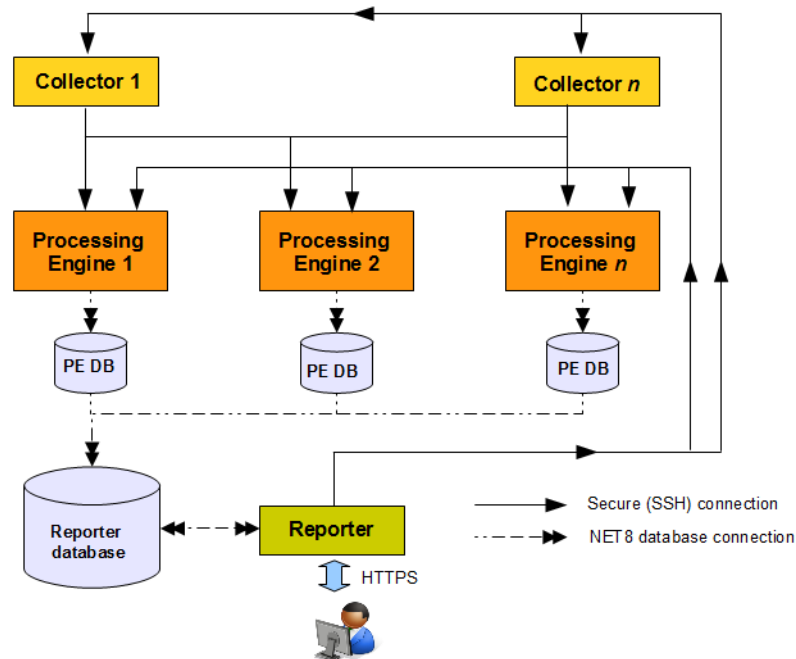

Each Processing Engine requires two database connections: one to the Reporter database, and the other to its own database. In addition, a passwordless SSH connection is required to each Collector system (and any failover Collector systems if applicable).

The Reporter system requires a connection to the Reporter database, and each Processing Engine database. In addition, a connection is required to each Collector system.

### 8.4.1 Configuring the SSH Connections

A password-less SSH connection must be setup between the `moniforce` user from the Reporter system to each Processing Engine, and from every Processing Engine to all Collector systems.

#### Configuring the Reporter-Processing Engine SSH Connection

- Logon to the Reporter server as `root`. Issue the following commands:

```
su - moniforce
ssh-keygen -P ""
```

Press **Enter** to accept the defaults.

2. Logon as `root` to each of the Processing Engine systems and become the `moniforce` user by issuing the following command:

```
su - moniforce
```

3. Create the `.ssh` directory (if it does not already exist) for the `moniforce` user on each Processing Engine system by issuing the following commands:

```
mkdir ~/.ssh
chmod 700 ~/.ssh
```

4. Copy the SSH key from the Reporter system to the required location on the Processing Engine system by issuing the following commands:

```
cd ~/.ssh
ssh root@Reporter cat /var/opt/ruei/.ssh/id_rsa.pub >> authorized_keys
```

(you will need to specify the Reporter system `root` password)

```
chmod 600 authorized_keys
```

5. Check that it is now possible to execute a remote command (as `moniforce` user) on the Reporter system without using a password. For example:

- Logon as `root` on the Reporter server.
- Logon as `moniforce` user: `su - moniforce`.
- Execute a remote `pwd` command: `ssh ProcessingEngine pwd`.
- Enter `yes` to the question "Are you sure you want to continue connecting (yes/no)?".
- The command should return `/var/opt/ruei`.

6. Steps 1, 2, and 3 above must be performed for each Processing Engine system. Steps 4 and 5 must be performed for each Collector system.

### Configuring the Processing Engine-Collector SSH Connection

Do the following:

1. Logon to the Processing Engine server as `root`. Issue the following commands:

```
su - moniforce
ssh-keygen -P ""
```

Press **Enter** to accept the defaults.

2. Logon as `root` to each of the Collector systems and become the `moniforce` user by issuing the following command:

```
su - moniforce
```

3. Create the `.ssh` directory (if it does not already exist) for the `moniforce` user on each Collector system by issuing the following commands:

```
mkdir ~/.ssh
chmod 700 ~/.ssh
```

4. Copy the SSH key from the Processing Engine system to the required location on the Collector system by issuing the following commands:

```
cd ~/.ssh
ssh root@ProcessingEngine cat /var/opt/ruei/.ssh/id_rsa.pub >> authorized_keys
```



(you will need to specify the Processing Engine system root password)

```
chmod 600 authorized_keys
```

5. Check that it is now possible to execute a remote command (as `moniforce` user) on the Processing Engine system without using a password. For example:
  - Logon as root on the Processing Engine server.
  - Logon as `moniforce` user: `su - moniforce`.
  - Execute a remote `pwd` command: `ssh Collector pwd`.
  - Enter yes to the question "Are you sure you want to continue connecting (yes/no)?".
  - The command should return `/var/opt/ruei`.
6. The above steps must be performed for each Collector system!

## 8.4.2 Configuring the Database Link Connections

1. Create the database links for each required Processing Engine by logging onto the Reporter system as the `moniforce` user, and executing the following command:

```
make-dblink proc1.example.com
```

The script will show a summary of the database link properties, and prompt you for the Reporter database password, as shown below:

```
database link : ux.proc1.example.com
hostname      : proc1.example.com
DB instance   : ux
DB server type : DEDICATED
```

### Manual Creation of Database Links

As an alternative to the above, you can manually create the database links for each required Processing Engine by logging onto the Reporter system as the `moniforce` user, and executing the following commands:

```
SQL> create database link
      ux.proc1.example.com
connect to
      UXINSIGHT
identified by
      "password"
using
      '(DESCRIPTION =
        (ADDRESS = (PROTOCOL = tcp)(HOST = proc1.example.com)(PORT = 1521))
        (CONNECT_DATA =
          (SID = UX)
        )
      )'
```

Note that you will need to modify the above example to meet your RUEI environment requirements.

## 8.5 Registering Processing Engines

Once installed and configured, each Processing Engine must be registered with the Reporter. This is fully described in the *Oracle Real User Experience Insight User's Guide*.

## 8.6 Configuring Multiple Processing Engines

When using more than two Processing Engines within your deployment, you need to modify the Collector `/etc/ssh/ssh_config` file. For *each* required Collector system, increase the `MaxStartups` setting from its default value of 10 to 100. When ready, restart each Collector system using the following command:

```
/etc/init.d/ssh restart
```

---

## Configuring a Failover Reporter System

This chapter describes the procedure for configuring a failover Reporter system that will immediately take over processing of network traffic in the event that the primary Reporter system becomes unavailable. Note that the described procedure assumes that the primary Reporter system has been installed, configured, and is fully operational. Note that the installation procedure for a primary Reporter is identical to that of a standalone Reporter. The procedure to configure a failover Collector system is described in [Chapter 10, "Configuring a Failover Collector System"](#).

### 9.1 Introduction to Failover Reporter Systems

The configuration of a secondary (or failover) Reporter system offers the advantage that it can seamlessly take over processing of monitored traffic in the event that the primary Reporter system becomes unavailable. In this way, a high level of operational reliability is achieved. The configuration of a failover Reporter system is shown in [Figure 9-1](#).

**Figure 9-1** Failover Reporter Configuration

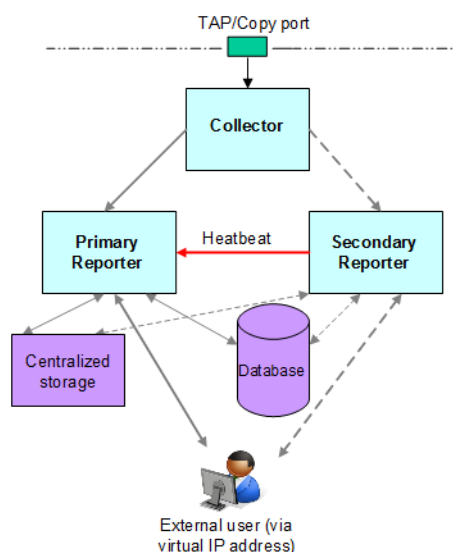

At server level, a crossover cable connects the primary and secondary Reporter systems. As long as a regular "heartbeat" continues between the primary and secondary servers, the secondary server will not initiate processing of traffic. However, the secondary server will immediately take over the processing task of the primary

server as soon as it detects an alteration in the "heartbeat" of the primary server. This process is referred to as failover.

Note that failback (that is, the process of restoring the RUEI installation to its original state), must be performed manually. The procedure is described in [Section 9.5, "Initiating Reporter Failback"](#).

### Prerequisites

In order to configure a failover Reporter installation, the following conditions must be met:

- The primary and secondary Reporter systems must be directly connected via a crossover cable. In addition, both systems must also be connected to a local or public network to in order to connect to the remote Collector, Processing Engine, and database systems.
- The database and Collector instances used by the RUEI installation must both be remote.
- The primary and secondary Reporter systems must share the same storage (such as SAN or NFS). In particular, the `RUEI_DATA/processor/data` and `RUEI_DATA/processor/data/sslkeys` directories.

## 9.2 Preparing the Primary Reporter

Make the `RUEI_DATA/processor/data` and `RUEI_DATA/processor/sslkeys` directories available on a shared storage location.

1. Stop all processing on the primary Reporter system by issuing the following command as the `RUEI_USER` user:

```
project -stop
```

2. Mount the shared Reporter location on the primary Reporter system. To do so, edit the `/etc/fstab` file so that it is mounted at boot. For example:

```
10.6.5.9:/home/nfs /reporter_share nfs rsize=1024,wsiz=1024 0 0
```

3. Move the existing data and sslkey directories to the shared Reporter location. For example:

```
mv RUEI_DATA/processor/data /reporter_share  
mv RUEI_DATA/processor/sslkeys /reporter_share
```

where `reporter_share` specifies the shared location for data and SSL keys on the primary and secondary Reporter systems.

## 9.3 Installing the Secondary Reporter

The installation procedure for a secondary Reporter system is almost identical to that of a standalone Reporter system. Note that Initial Setup Wizard should *not* be run. Do the following:

1. When starting the installation procedure for the secondary Reporter system, ensure that the `/etc/ruei.conf` file is identical to that of the primary Reporter system.
2. Install the Linux operating system and RUEI Reporter software on the secondary Reporter system. The procedure to do this is described in [Chapter 6, "Configuring RUEI"](#). Specifically:

- Follow the instructions described in [Chapter 2, "Installing the RUEI Software"](#) up to and including [Section 2.5.4, "Installing the Zend Decoder"](#).
- Copy the following files from the `RUEI_DATA` directory on the primary Reporter system to the secondary Reporter system: `cwallet.sso`, `ewallet.p12`, `sqlnet.ora`, and `tnsnames.ora`. You should ensure that the ownerships and permissions of these files are identical on both Reporter systems.
- Follow the instructions described in steps 1-5 in [Section 2.5.6, "Installing the Reporter Software"](#).
- Follow the instructions described in [Section 2.8, "Configuring the Network Interface"](#).
- If you performed the instructions described in [Section 2.9, "Enabling International Fonts \(Optional, but Recommended\)"](#) through [Section 2.12, "Configuring Automatic Browser Redirection \(Optional\)"](#) for the primary Reporter system, then you will need to repeat them for the secondary Reporter system.

## 9.4 Configuring Reporter Failover

Do the following:

1. If you have not already done so, login to the primary Reporter system as the `RUEI_USER` user, and issue the following command to stop all processing of monitored traffic:

```
project -stop
```

2. Copy the `.ssh` directory of the `RUEI_USER` user on the primary Reporter system, created while performing the procedure described in [Section 2.13, "Configuring Reporter Communication \(Split-Server Setup Only\)"](#), to the secondary Reporter system. Note that it *must* be copied to the same location.

3. Ensure that the `uid` and `gid` settings of the `RUEI_USER` user are the same on both the primary and secondary Reporter systems. For example:

```
id moniforce
uid=501(moniforce) gid=502(moniforce) groups=502(moniforce)
```

4. Configure the static IP addresses on both Reporter systems used for the crossover cable. This can be done using a utility such as `system-config-network`.

5. Edit the `/etc/fstab` file so the `RUEI_DATA/processor/data` and `RUEI_DATA/processor/sslkeys` directories are mounted at boot. For example:

```
10.6.5.9:/home/nfs /reporter_share nfs rsize=1024,wsize=1024 0 0
```

where `reporter_share` specifies the shared location for data and SSL keys on the primary and secondary Reporter systems.

6. Move the local `data` and `sslkeys` directories for the secondary Reporter system to the shared Reporter location by issuing the following commands:

```
rm -rf RUEI_DATA/processor/data
rm -rf RUEI_DATA/processor/sslkeys
ln -s /reporter_share/data RUEI_DATA/processor/data
ln -s /reporter_share/sslkeys RUEI_DATA/processor/sslkeys
```

7. Login to the secondary Reporter system as the `RUEI_USER` user, and issue the following command:

```
project -new -fromdb UX
```

This creates the secondary Reporter's on-disk configuration files using the primary Reporter's database configuration.

8. Edit the `/etc/ruei.conf` file on both the primary and secondary Reporters to specify the virtual, primary, and standby IP addresses. For example:

```
export RUEI_REP_FAILOVER_PRIMARY_IP=192.168.56.201
export RUEI_REP_FAILOVER_STANDBY_IP=192.168.56.202
export RUEI_REP_FAILOVER_VIRTUAL_IP=10.11.12.23
export RUEI_REP_FAILOVER_VIRTUAL_DEV=eth0
export RUEI_REP_FAILOVER_VIRTUAL_MASK=255.255.255.0
```

THE `RUEI_REP_FAILOVER_PRIMARY_IP` and `RUEI_REP_FAILOVER_STANDBY_IP` settings should specify the IP addresses of the crossover cable between the two Reporter systems. See [Section 2.4.1, "Check The RUEI Configuration File"](#) for an explanation of these settings. Note that the settings specified on both Reporter systems *must* be identical except for the `RUEI_REP_FAILOVER_VIRTUAL_DEV` setting.

9. Issue the following command to restart processing of monitored traffic on the primary Reporter system:

```
project -start
```

10. Install the `ruei-reporter-failover.sh` script on both Reporter systems. For example, in the `/usr/local/sbin` directory. It is located in the RUEI zip file (see [Section 2.3, "Unpacking the RUEI Software"](#)).

11. Add the following entry to the root user's crontab file of both the primary and secondary Reporter systems:

```
* * * * * /usr/local/sbin/ruei-reporter-failover.sh
```

This causes the secondary Reporter to send a heartbeat signal to the primary Reporter every 60 seconds, and take over processing of RUEI monitored traffic in the event that the Primary Reporter becomes unavailable.

Wait at least 60 seconds.

12. Ensure that *all* user access to the Reporter GUI is via the specified virtual IP address. This is necessary to ensure automatic failover to the secondary Reporter system in the event that the primary Reporter system becomes unavailable.
13. Check the `RUEI_DATA/processor/log/failover.log` file on both Reporter systems. These files contain the results of the "ping" commands. Ensure that there are no error messages. For example, about unspecified failover configuration settings.
14. Check the output of the `/sbin/ifconfig` command on the primary Reporter to ensure that the virtual IP address has been correctly configured. For example:

```
/sbin/ifconfig
eth0      Link encap:Ethernet  HWaddr 08:00:27:F7:B0:14
          inet addr:192.168.56.201  Bcast:192.168.56.255  Mask:255.255.255.0
          inet6 addr: fe80::a00:27ff:fe77:b014/64 Scope:Link
          UP BROADCAST RUNNING MULTICAST  MTU:1500  Metric:1
          RX packets:80 errors:0 dropped:0 overruns:0 frame:0
          TX packets:311 errors:0 dropped:0 overruns:0 carrier:0
```

```

collisions:0 txqueuelen:1000
RX bytes:12793 (12.4 KiB) TX bytes:26268 (25.6 KiB)

eth0:0 Link encap:Ethernet HWaddr 08:00:27:F7:B0:14
inet addr:10.11.12.23 Bcast:192.168.56.255 Mask:255.255.255.0
UP BROADCAST RUNNING MULTICAST MTU:1500 Metric:1

```

15. Unregister all remote Collectors with the primary Reporter, and re-register them using the virtual IP address.
16. Shutdown the primary Reporter system, and verify that the secondary Reporter begins processing monitored traffic. A warning that the primary system is unreachable and that the secondary system is being activated is reported in the Event log. Note that after doing so, you must perform a failback to return your RUEI installation to its original state.
17. Update the Reporter URL (select **System**, then **Maintenance**, and then **E-mail setup**) with the virtual Reporter host name or IP address.

## 9.5 Initiating Reporter Failback

Failback to the primary Reporter system must be performed manually in order to return your RUEI installation to its original state. Do the following:

1. Load your global RUEI configuration settings on the secondary server using the following command as the `root` user:
 

```
. /etc/ruei.conf
```
2. Ensure that the heartbeat mechanism between the primary and secondary Reporter systems is functioning correctly. To do so, verify that they can 'ping' each other on the `RUEI_REP_FAILOVER_PRIMARY_IP` and `RUEI_REP_FAILOVER_STANDBY_IP` IP addresses.
3. To instigate the fallback, remove the `active-failover-server` file, and shutdown the virtual interface on the secondary server by issuing the following commands:

```

rm $RUEI_DATA/processor/data/active-failover-server
ifconfig $RUEI_REP_FAILOVER_VIRTUAL_DEV:0 down

```





---

## Configuring a Failover Collector System

This chapter describes the procedure for configuring a failover remote Collector system that will take over monitoring of network traffic in the event that the primary Collector system becomes unavailable. Note that the described procedure assumes that the primary Collector system has been installed, configured, and is fully operational.

The procedure to configure a failover Reporter system is described in [Chapter 9](#), "Configuring a Failover Reporter System".

### SSL and Forms Traffic

Be aware that SSL and Oracle Forms traffic are particularly sensitive to disruptions in the TCP packet stream. This is because they require state information to be maintained for the duration of the connection. Therefore, during a failover or fallback, traffic may be lost.

## 10.1 Introduction to Failover Collector Systems

The configuration of a secondary (or failover) Collector system offers the advantage that it can seamlessly take over monitoring of network traffic in the event that the primary Collector system becomes unavailable. In this way, a high level of operational reliability is achieved. Note that this facility is only available for remote Collectors. The configuration of a failover Collector system is shown in [Figure 10-1](#).

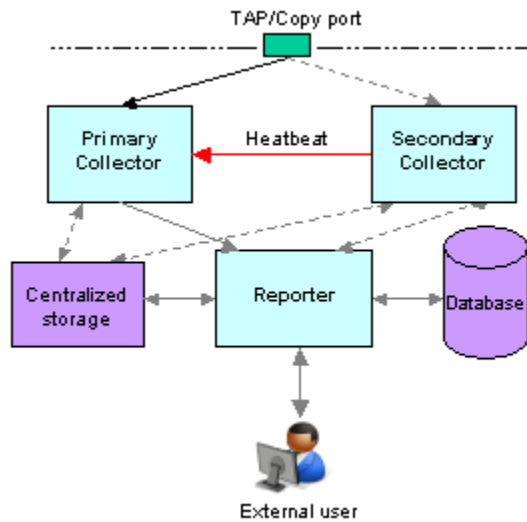
**Figure 10–1 Failover Collector Configuration**

At server level, a crossover network cable connects the primary and secondary Collector systems. As long as a regular "heartbeat" continues between the primary and secondary servers, the secondary server will not initiate monitoring of the network traffic. However, the secondary server will take over the monitoring task of the primary Collector as soon as it detects a failure in the "heartbeat" of the primary server. This process is referred to as failover. The secondary Collector will take over the primary Collector's virtual IP address, and it is through this that the Reporter system will communicate with it.

Note that failback (that is, the process of restoring the primary Collector to its original state), must be performed manually. The procedure is described in [Section 10.4, "Initiating Collector Failback"](#).

### Prerequisites

In order to configure a failover Collector installation, the following conditions must be met:

- A secondary TAP or copy port must be inserted at the same location as the primary one within the monitored network.
- The RUEI software version of the primary and secondary Collectors must be identical.
- The primary and secondary Collector systems must be directly connected via a crossover cable. In addition, both systems must also be connected to a local or public network in order to connect to the Reporter system.
- Both the primary and secondary Collector systems must have direct access to the same shared storage on which log files and replay data is written. In particular, the `$RUEI_DATA/collector` directory must be accessible by both systems.

### Important

When configuring a failover Collector system, be aware of the following:

- When failover to the secondary Collector is initiated, the data that is currently being recorded by the primary Collector is lost. Typically, this represents information about traffic for up to a 1-minute period.

- When failover is initiated, state information that needs to be maintained for the duration of the connection for TCP, HTTP, SSL and Oracle Forms-based sessions is lost. Therefore, details of these sessions during failover are not available.
- Because of the above points, some page views are lost. It is possible that these pages contain session logon details. In this case, the session is reported as anonymous. In addition, specific user flow steps can be lost.

## 10.2 Installing the Secondary Collector

The installation procedure for a secondary Collector system is identical to that of a remote Collector system.

1. Install the Linux operating system and the RUEI Collector software on both Collector systems. The procedure to do so is described in [Section 2.1, "Prerequisites"](#).
2. When starting the installation procedure for the secondary Collector system, ensure that the `/etc/ruei.conf` file is identical to that of the primary Collector system.

## 10.3 Configuring the Secondary Collector

Do the following:

1. Copy the `.ssh` directory (created when following the procedure described in [Section 2.13, "Configuring Reporter Communication \(Split-Server Setup Only\)"](#)) on the primary Collector to the secondary Collector. Note that it must be copied to the same location.
2. On the primary Collector system, issue the following commands to add the "host keys" for the Collector to the global `known_hosts` file on the Reporter system:

```
. /etc/ruei.conf
ifconfig ${RUEI_COL_FAILOVER_VIRTUAL_DEV}:0 $RUEI_COL_FAILOVER_VIRTUAL_IP \
netmask $RUEI_COL_FAILOVER_VIRTUAL_MASK up
sleep 2
arping -c 3 -A -I $RUEI_COL_FAILOVER_VIRTUAL_DEV $RUEI_COL_FAILOVER_VIRTUAL_IP
```

On the Reporter system, use an `arp -a` or `ping` command to check that you can reach the virtual IP address on the primary Collector system.

Then, issue the following command:

```
ssh-keyscan -t rsa,dsa Collector-virt-ip-address >> /etc/ssh/ssh_known_hosts
```

As the `RUEI_USER` user, ensure that the virtual Collector IP address is not specified in the `~/.ssh/known_hosts` file.

Attempt to establish an SSH connection as the `RUEI_USER` user from the Reporter system to the primary Collector system. Note that you should not receive any warning or prompt about the host key, and you should be logged in automatically.

On the primary Collector system, bring down the virtual IP address using the following command:

```
ifconfig ${RUEI_COL_FAILOVER_VIRTUAL_DEV}:0
$RUEI_COL_FAILOVER_VIRTUAL_IP netmask $RUEI_COL_FAILOVER_VIRTUAL_MASK down
```

Repeat the above procedure for the secondary Collector system. Upon completion, four keys should be specified in the `/etc/ssh/ssh_known_hosts` file for the virtual IP address.

3. Ensure that the `uid` and `gid` settings of the `RUEI_USER` user are the same on both the primary and secondary Collector systems. For example:

```
id moniforce
uid=501(moniforce) gid=502(moniforce) groups=502(moniforce)
```

### Important

If you need to change the UID of the `RUEI_USER` user on an operational Collector system, you should:

- Issue the following commands as the `RUEI_USER` user:

```
appsensor stop wg
sslloadkeys -f
```

Note that you should enter `yes` (written in full) when prompted.

- Change the user:group ownership of all files and directories under `/var/opt/ruei/collector` to the new UID.
- Issue the following command as the root user:

```
/etc/init.d/crond restart
```

4. Configure the static IP addresses on both Collector systems used for the crossover cable. This can be done using a utility such as `system-config-network`.
5. Mount the shared storage on the `RUEI_DATA/collector` directory, and edit the `/etc/fstab` file so that it is mounted at boot. For example:

```
10.6.5.9:/home/nfs /var/opt/ruei/collector/data nfs rsize=1024,wsiz=1024 0 0
```

---

**Important:** Note that if the Collector is already operational before this step, and the `$RUEI_DATA/collector` directory is not shared, the existing directory content must be copied to the mount point specified above. Security Officers should be aware that this copying process includes server SSL keys.

---

Note that if the Collector is already operational before this step, and the `$RUEI_DATA/collector` directory is not shared, the existing directory content must be copied to the mount point specified above. Security Officers should be aware that this copying process includes server SSL keys.

Alternatively, if your shared storage does not provide sufficient bandwidth to keep up with the storage of replay data, you can symlink the `REPLAY` directories to a local location instead. In this case, only the HTTP log files and logs will be written to the shared disk. However, be aware that if you specify this configuration, replay data recorded before failover is initiated will be lost, and only sessions after the failover are accessible. In addition, these links will be reset to factory defaults and, therefore, the directories do not currently exist in the initial Collector setup.

6. Edit the `/etc/ruei.conf` file on both the primary and secondary Collector systems to specify the virtual, primary, and standby IP addresses. For example:

```
RUEI_COL_FAILOVER_PRIMARY_IP=192.168.56.201 # crossover cable primary
RUEI_COL_FAILOVER_STANDBY_IP=192.168.56.202 # crossover cable secondary
```

```
RUEI_COL_FAILOVER_VIRTUAL_IP=10.11.12.23    # (virtual) IP to access Collector
RUEI_COL_FAILOVER_VIRTUAL_DEV=eth0
RUEI_COL_FAILOVER_VIRTUAL_MASK=255.255.255.0
```

The `RUEI_COL_FAILOVER_PRIMARY_IP` and `RUEI_COL_FAILOVER_STANDBY_IP` settings should specify the IP addresses of the crossover cable between the two Collector systems. See [Section 2.4.1, "Check The RUEI Configuration File"](#) for an explanation of these settings. Note that the settings specified on both Collector systems must be identical.

7. Ensure that *all* communication between the Reporter and the Collector is via the specified virtual IP address. This is necessary to ensure automatic failover to the secondary Collector system in the event that the primary Collector system becomes unavailable. Note that this may require you to reconfigure existing Collector systems.
8. Install the `ruei-collector-failover.sh` script on both Collector systems. For example, in the `/usr/local/bin` directory. It is located in the RUEI zip file (see [Section 2.3, "Unpacking the RUEI Software"](#)).
9. Add the following entry to the root user's crontab file of both the primary and secondary Collector systems:

```
* * * * * /usr/local/bin/ruei-collector-failover.sh
```

This causes the secondary Collector to send a heartbeat signal to the primary Collector every 60 seconds, and take over processing of RUEI monitored traffic in the event that the Primary Collector becomes unavailable.

Wait at least 60 seconds.

10. Check the output of the `/sbin/ifconfig` command on the primary Collector to ensure that the virtual IP address has been correctly configured. For example:

```
$ /sbin/ifconfig
eth0      Link encap:Ethernet  HWaddr 08:00:27:F7:B0:14
          inet addr:192.168.56.201  Bcast:192.168.56.255  Mask:255.255.255.0
          inet6 addr: fe80::a00:27ff:fef7:b014/64  Scope:Link
          UP BROADCAST RUNNING MULTICAST  MTU:1500  Metric:1
          RX packets:80 errors:0 dropped:0 overruns:0 frame:0
          TX packets:311 errors:0 dropped:0 overruns:0 carrier:0
          collisions:0 txqueuelen:1000
          RX bytes:12793 (12.4 KiB)  TX bytes:26268 (25.6 KiB)
eth0:0    Link encap:Ethernet  HWaddr 08:00:27:F7:B0:14
          inet addr:10.11.12.23  Bcast:192.168.56.255  Mask:255.255.255.0
          UP BROADCAST RUNNING MULTICAST  MTU:1500  Metric:1
```

11. Unregister the primary remote Collector with the Reporter, and re-register it using the virtual IP address.
12. Shutdown the primary Collector system, and verify that the secondary Collector begins processing monitored traffic. A warning that the primary system is unreachable and that the secondary system is being activated should be reported in the event log. Note that after doing so, you must perform a failback to return your RUEI installation to its original state.

## 10.4 Initiating Collector Failback

Failback to the primary Collector system must be performed manually in order to return your RUEI installation to its original state. Do the following:

1. On the primary Collector system, issue the following commands:

```
. /etc/ruei.conf
echo $RUEI_COL_FAILOVER_PRIMARY_IP > \
/var/opt/ruei/collector/active-failover-server
```

2. On the secondary Collector system, issue the following commands:

```
. /etc/ruei.conf
ifconfig ${RUEI_COL_FAILOVER_VIRTUAL_DEV}:0 $RUEI_COL_FAILOVER_VIRTUAL_IP \
netmask $RUEI_COL_FAILOVER_VIRTUAL_MASK down
```

3. On the primary Collector system (with the `/etc/ruei.conf` file still loaded), issue the following commands:

```
ifconfig ${RUEI_COL_FAILOVER_VIRTUAL_DEV}:0 $RUEI_COL_FAILOVER_VIRTUAL_IP \
netmask $RUEI_COL_FAILOVER_VIRTUAL_MASK up
sleep 2
arping -c 3 -A -I $RUEI_COL_FAILOVER_VIRTUAL_DEV $RUEI_COL_FAILOVER_VIRTUAL_IP
```

---

## Configuring a Failover Processing Engine System

This chapter describes the procedure for configuring a failover Processing Engine system that will immediately take over processing of network traffic in the event that the primary Processing Engine system becomes unavailable. Note that the described procedure assumes that the primary Processing Engine system has been installed, configured, and is fully operational.

The procedure to configure failover Reporter and Collector systems is described in [Section 9, "Configuring a Failover Reporter System"](#) and [Section 10, "Configuring a Failover Collector System"](#).

### 11.1 Introduction to Failover Processing Engine Systems

The configuration of a secondary (or failover) Processing Engine system offers the advantage that it can seamlessly take over processing of monitored traffic in the event that the primary Processing Engine system becomes unavailable. In this way, a high level of operational reliability is achieved. The configuration of a failover Processing Engine system is shown in [Figure 11-1](#).

**Figure 11-1 Failover Processing Engine Configuration**

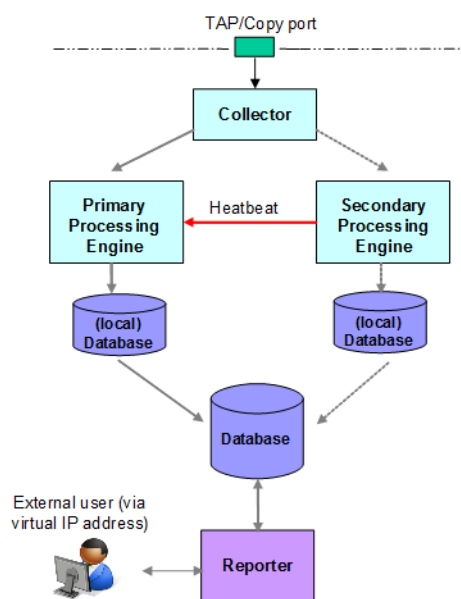

At server level, a crossover cable connects the primary and secondary Processing Engine systems. As long as a regular "heartbeat" continues between the primary and secondary servers, the secondary server will not initiate processing of traffic. However, the secondary server will immediately take over the processing task of the primary server as soon as it detects an alteration in the "heartbeat" of the primary server. This process is referred to as failover.

Note that failback (that is, the process of restoring the RUEI installation to its original state), must be performed manually. The procedure is described in [Section 11.5, "Instigating Processing Engine Failback"](#).

### Prerequisites

In order to configure a failover Processing Engine installation, the following conditions must be met:

- The primary and secondary Processing Engine systems must be directly connected via a crossover cable. In addition, both systems must also be connected to a local or public network to in order to connect to the Reporter, remote Collector, and database systems.
- The database and Collector instances used by the RUEI installation must both be remote.
- The primary and secondary Processing Engine systems must share the same storage (such as SAN or NFS). In particular, the `RUEI_DATA/processor/data` and `RUEI_DATA/processor/data/sslkeys` directories.

## 11.2 Preparing the Primary Processing Engine

Make the `RUEI_DATA/processor/data` and `RUEI_DATA/processor/sslkeys` directories available on a shared storage location.

1. Stop all processing on the primary Processing Engine system by issuing the following command as the `RUEI_USER` user:

```
project -stop
```

2. Mount the shared Processing Engine location on the primary Processing Engine system. To do so, edit the `/etc/fstab` file so that it is mounted at boot. For example:

```
10.6.5.9:/home/nfs /processing_share nfs rsize=1024,wsiz=1024 0 0
```

3. Move the existing data and sslkey directories to the shared Processing Engine location. For example:

```
mv RUEI_DATA/processor/data /processing_share
mv RUEI_DATA/processor/sslkeys /processing_share
```

where `processing_share` specifies the shared location for data and SSL keys on the primary and secondary Processing Engine systems.

## 11.3 Installing the Secondary Processing Engine

The installation procedure for a secondary Processing Engine system is almost identical to that of a standalone Processing Engine system. Note that Initial Setup Wizard should *not* be run. Do the following:



1. When starting the installation procedure for the secondary Processing Engine system, ensure that the `/etc/ruei.conf` file is identical to that of the primary Processing Engine system.
2. Install the Linux operating system and Processing Engine software on the secondary Processing Engine system. The procedure to do this is described in [Chapter 2, "Installing the RUEI Software"](#). Specifically:
  - Follow the instructions described in [Chapter 2, "Installing the RUEI Software"](#) up to and including [Section 2.5.4, "Installing the Zend Decoder"](#).
  - Copy the following files from the `RUEI_DATA` directory on the primary Processing Engine system to the secondary Processing Engine system: `cwallet.sso`, `ewallet.p12`, `sqlnet.ora`, and `tnsnames.ora`. You should ensure that the ownerships and permissions of these files are identical on both Processing Engine systems.
  - Follow the instructions described in steps 1-5 in [Section 2.5.6, "Installing the Reporter Software"](#).
  - Follow the instructions described in [Section 2.8, "Configuring the Network Interface"](#).
  - If you performed the instructions described in [Section 2.9, "Enabling International Fonts \(Optional, but Recommended\)"](#) through [Section 2.12, "Configuring Automatic Browser Redirection \(Optional\)"](#) for the primary Processing Engine system, then you will need to repeat them for the secondary Processing Engine system.

## 11.4 Configuring Processing Engine Failover

Do the following:

1. If you have not already done so, login to the primary Processing Engine system as the `RUEI_USER` user, and issue the following command to stop all processing of monitored traffic:

```
project -stop
```

2. Copy the `.ssh` directory of the `RUEI_USER` user on the primary Processing Engine system, created while performing the procedure described in [Section 2.13, "Configuring Reporter Communication \(Split-Server Setup Only\)"](#), to the secondary Processing Engine system. Note that it *must* be copied to the same location.

3. Ensure that the `uid` and `gid` settings of the `RUEI_USER` user are the same on both the primary and secondary Processing Engine systems. For example:

```
id moniforce
uid=501(moniforce) gid=502(moniforce) groups=502(moniforce)
```

4. Configure the static IP addresses on both Processing Engine systems used for the crossover cable. This can be done using a utility such as `system-config-network`.
5. Edit the `/etc/fstab` file so the `RUEI_DATA/processor/data` and `RUEI_DATA/processor/sslkeys` directories are mounted at boot. For example:

```
10.6.5.9:/home/nfs /reporter_share nfs rsize=1024,wsize=1024 0 0
```

where `reporter_share` specifies the shared location for data and SSL keys on the primary and secondary Processing Engine systems.

6. Move the local data and `sslkeys` directories for the secondary Processing Engine system to the shared Processing Engine location by issuing the following commands:

```
rm -rf RUEI_DATA/processor/data
rm -rf RUEI_DATA/processor/sslkeys
ln -s /reporter_share/data RUEI_DATA/processor/data
ln -s /reporter_share/sslkeys RUEI_DATA/processor/sslkeys
```

7. Login to the secondary Processing Engine system as the `RUEI_USER` user, and issue the following command:

```
project -new -fromdb UX
```

This creates the secondary Processing Engine's on-disk configuration files using the primary Processing Engine's database configuration.

8. Edit the `/etc/ruei.conf` file on both the primary and secondary Processing Engines to specify the virtual, primary, and standby IP addresses. For example:

```
export RUEI_REP_FAILOVER_PRIMARY_IP=192.168.56.201
export RUEI_REP_FAILOVER_STANDBY_IP=192.168.56.202
export RUEI_REP_FAILOVER_VIRTUAL_IP=10.11.12.23
export RUEI_REP_FAILOVER_VIRTUAL_DEV=eth0
export RUEI_REP_FAILOVER_VIRTUAL_MASK=255.255.255.0
```

THE `RUEI_REP_FAILOVER_PRIMARY_IP` and `RUEI_REP_FAILOVER_STANDBY_IP` settings should specify the IP addresses of the crossover cable between the two Processing Engine systems. See [Section 2.4.1, "Check The RUEI Configuration File"](#) for an explanation of these settings. Note that the settings specified on both Processing Engine systems *must* be identical except for the `RUEI_REP_FAILOVER_VIRTUAL_DEV` setting.

9. Issue the following command to restart processing of monitored traffic on the primary Processing Engine system:

```
project -start
```

10. Install the `ruei-reporter-failover.sh` script on both Processing Engine systems. For example, in the `/usr/local/sbin` directory. It is located in the RUEI zip file (see [Section 2.3, "Unpacking the RUEI Software"](#)).

11. Add the following entry to the root user's crontab file of both the primary and secondary Processing Engine systems:

```
* * * * * /usr/local/sbin/ruei-reporter-failover.sh
```

This causes the secondary Processing Engine to send a heartbeat signal to the primary Processing Engine every 60 seconds, and take over processing of RUEI monitored traffic in the event that the Primary Processing Engine becomes unavailable.

Wait at least 60 seconds.

12. Ensure that *all* user access to the Reporter GUI is via the specified virtual IP address. This is necessary to ensure automatic failover to the secondary Processing Engine system in the event that the primary Processing Engine system becomes unavailable.

13. Check the `RUEI_DATA/processor/log/failover.log` file on both Processing Engine systems. These files contain the results of the "ping" commands. Ensure

that there are no error messages. For example, about unspecified failover configuration settings.

14. Check the output of the `/sbin/ifconfig` command on the primary Processing Engine to ensure that the virtual IP address has been correctly configured. For example:

```
/sbin/ifconfig
eth0      Link encap:Ethernet  HWaddr 08:00:27:F7:B0:14
          inet addr:192.168.56.201  Bcast:192.168.56.255  Mask:255.255.255.0
          inet6 addr: fe80::a00:27ff:fef7:b014/64 Scope:Link
          UP BROADCAST RUNNING MULTICAST  MTU:1500  Metric:1
          RX packets:80 errors:0 dropped:0 overruns:0 frame:0
          TX packets:311 errors:0 dropped:0 overruns:0 carrier:0
          collisions:0 txqueuelen:1000
          RX bytes:12793 (12.4 KiB)  TX bytes:26268 (25.6 KiB)

eth0:0    Link encap:Ethernet  HWaddr 08:00:27:F7:B0:14
          inet addr:10.11.12.23  Bcast:192.168.56.255  Mask:255.255.255.0
          UP BROADCAST RUNNING MULTICAST  MTU:1500  Metric:1
```

15. Shutdown the primary Processing Engine system, and verify that the secondary Processing Engine begins processing monitored traffic. A warning that the primary system is unreachable and that the secondary system is being activated is reported in the Event log. Note that after doing so, you must perform a failback to return your RUEI installation to its original state.

## 11.5 Instigating Processing Engine Failback

Failback to the primary Processing Engine system must be performed manually in order to return your RUEI installation to its original state. Do the following:

1. Load your global RUEI configuration settings using the following command as the root user:

```
. /etc/ruei.conf
```

2. Ensure that the heartbeat mechanism between the primary and secondary Processing Engine systems is functioning correctly. To do so, verify that they can 'ping' each other on the RUEI\_REP\_FAILOVER\_PRIMARY\_IP and RUEI\_REP\_FAILOVER\_STANDBY\_IP IP addresses.
3. To instigate the fallback, remove the active-failover-server file, and shutdown the virtual interface on the secondary server by issuing the following commands:

```
rm $RUEI_DATA/processor/data/active-failover-server
ifconfig $RUEI_REP_FAILOVER_VIRTUAL_DEV:0 down
```



---

---

# Installing the Oracle Database Software

This appendix presents a summary of the procedure for installing the Oracle database software. Note that the complete installation procedure is described in the product documentation.

The information in this appendix is based on the *Oracle Database 12c for Linux x86-64 Quick Installation Guide* and *Oracle Database 11g for Linux x86-64 Quick Installation Guide*. It is recommended that you download and review it. It is available from the Oracle Database Documentation Library at the following location:

[http://www.oracle.com/pls/db121/portal.portal\\_db?selected=11](http://www.oracle.com/pls/db121/portal.portal_db?selected=11)

---

---

**Note:** While RUEI is supported on Oracle Database releases 11gR2 and later, the best performance for RUEI 13.2.2.1 is achieved with Oracle Database 12c Release 1.

If you experience an ORA-12805: Parallel Query Server Died Unexpectedly error, see [Section G.2](#) for a suitable workaround.

---

---

## A.1 Download the Oracle Database Software

Download Oracle Database (12c Release 1 or 11g Release 2) Standard Edition, Standard Edition One, or Enterprise Edition from the Oracle database home page at the following location:

<http://www.oracle.com/technetwork/database/enterprise-edition/downloads>

## A.2 Operating System Prerequisites

Assuming you have a working Yum repository, you can install the required operating system dependencies for the database software with the following command:

```
yum install gcc gcc-c++ compat-libstdc++-33 glibc-devel libstdc++-devel \
elfutils-libelf-devel glibc-devel libaio-devel sysstat perl-URI \
bitstream-vera-fonts xorg-x11-xinit unixODBC unixODBC-devel xorg-x11-xinit rsync \
ksh
```

## A.3 Creating the Database User Accounts and Groups

1. Create two groups (dba and oinstall) with the following commands:

```
/usr/sbin/groupadd dba
/usr/sbin/groupadd oinstall
```

2. Create the `oracle` user, and specify `oinstall` as the primary group and `dba` as the secondary group, with the following command:

```
/usr/sbin/useradd -g oinstall -G dba oracle
```

3. Set the `oracle` user password with the following command:

```
passwd oracle
```

## A.4 Configuring the Kernel Parameter Settings

1. Modify the `/etc/sysctl.conf` file to satisfy the Oracle installer's requirements by adding the following lines:

```
kernel.sem = 250 32000 100 128
net.ipv4.ip_local_port_range = 9000 65500
net.core.rmem_default = 4194304
net.core.rmem_max = 4194304
net.core.wmem_default = 262144
net.core.wmem_max = 1048576
fs.aio-max-nr = 1048576
fs.file-max = 6815744
```

2. Make these changes effective immediately with the following command:

```
/sbin/sysctl -p
```

## A.5 Setting Shell Limits for the Oracle User

1. To improve the performance of the software, you must increase the shell limits for the `oracle` user. Add the following lines to the `/etc/security/limits.conf` file:

```
oracle soft nproc 2047
oracle hard nproc 16384
oracle soft nofile 1024
oracle hard nofile 65536
```

2. If not already present, add the following lines to the `/etc/pam.d/login` file:

```
session required /lib64/security/pam_limits.so
session required pam_limits.so
```

3. Depending on the `oracle` user's default shell, you need to make changes to it. For the Bourne, Bash, or Korn shell, add the following lines to the bottom of the `/etc/profile` file:

```
if [ $USER = "oracle" ]; then
    if [ $SHELL = "/bin/ksh" ]; then
        ulimit -p 16384
        ulimit -n 65536
    else
        ulimit -u 16384 -n 65536
    fi
fi
```

For information about other shells, you should refer to the *Oracle Database 12c for Linux x86-64 Quick Installation Guide* or *Oracle Database 11g Release 2 for Linux x86-64 Quick Installation Guide* available at the following location:

[http://download.oracle.com/docs/cd/B28359\\_01/install.111/b32285/toc.htm](http://download.oracle.com/docs/cd/B28359_01/install.111/b32285/toc.htm)

## A.6 Creating the Database Directory

Throughout this guide it is assumed that the directory `/u01/app` is the root of the Oracle installation. This is specified in the `ORACLE_BASE` environment variable.

1. Enter the following command to display information about all mounted file systems:

```
df -k
```

This command displays information about all the file systems mounted on the system, including:

- The physical device name.
  - The total amount, used amount, and available amount of disk space.
  - The mount point directory for that file system.
2. Create the necessary subdirectories in the mount point directory that you identified and set the appropriate owner, group, and permissions for them using commands similar to the following:

```
mkdir -p /u01/app
chown -R oracle:oinstall /u01
chmod -R 775 /u01/app
```

## A.7 Configuring the Oracle User's Environment and Installing the Database

Perform the following steps to create the oracle user's environment and install the software:

---



---

**Note:** The screenshots show an 11g installation, but similar screens apply for 12c.

---



---

1. Logon to the system as the oracle user.
2. Add or edit the `umask` setting in the `~/.bash_profile` file to the following:
 

```
umask 022
```
3. Make the setting active for the current shell by issuing the following command:
 

```
.. ./bash_profile
```
4. Set the `ORACLE_BASE` environment variable to define the location of the root of the Oracle directory tree:
 

```
export ORACLE_BASE=/u01/app/oracle
```
5. Unzip the Oracle database installation zip file. This creates the directory database. Then, run the graphical installer (note this will not run under user `root`). Ensure that your X Window environment is properly set up. In addition, when logging on remotely with SSH, ensure X forwarding is enabled. Use the following commands:

```
cd <location of the zip file>
unzip linux_11gR2_database.zip
./database/runInstaller
```

- Use the installation wizard, and specify the values shown in [Figure A-1](#). When ready, click **Next**.

**Figure A-1 Specify Installation Location Dialog**

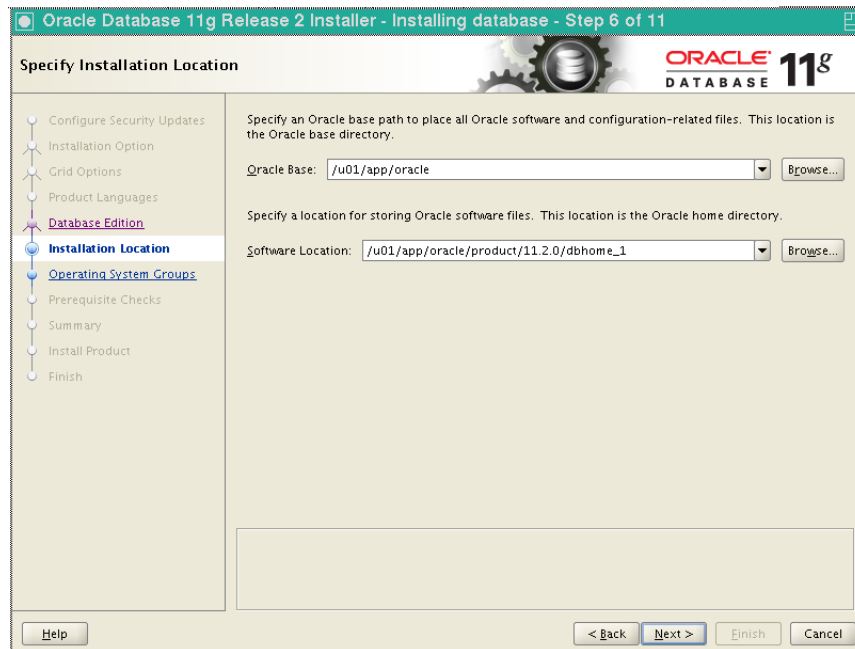

- Specify the values shown in [Figure A-2](#). When ready, click **Next**.

**Figure A-2 Specify Inventory Directory and Credentials Dialog**





---

**Important:** Any warnings or errors reported during database installation (especially any missing prerequisites) must be resolved before proceeding. See [Section 2.1.6, "Installing the RUEI Prerequisites"](#) and [Appendix G, "Troubleshooting"](#) for information about required components.

---

If all dependencies are met, you can click **Next**.

- When installation is almost complete, you are prompted to run two scripts, `oraInstRoot.sh` and `root.sh`, as `root`. This is shown in [Figure A-3](#).

**Figure A-3 Configuration Scripts Dialog**

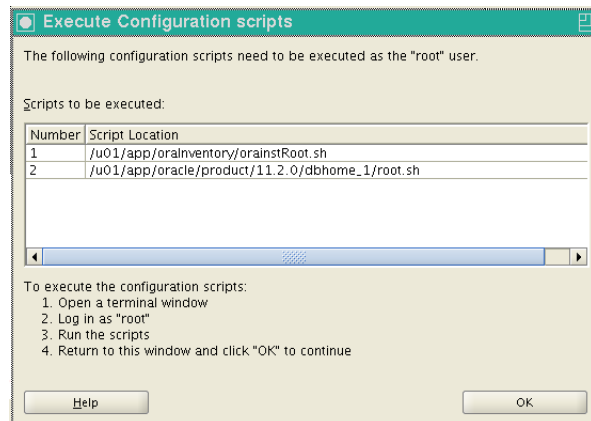

Run the two scripts indicated in [Figure A-3](#). They should be run in a terminal window as `root`. You will receive output similar to the following:

```
/u01/app/oraInventory/oraInstRoot.sh
Changing permissions of /u01/app/oraInventory.
Adding read,write permissions for group.
Removing read,write,execute permissions for world.
```

```
Changing groupname of /u01/app/oraInventory to oinstall.
The execution of the script is complete.
```

The second script generates the following output:

```
/u01/app/oracle/product/11.2.0/dbhome_1
/root.sh
Running Oracle 11g root.sh script...
```

```
The following environment variables are set as:
ORACLE_OWNER= oracle
ORACLE_HOME= /u01/app/oracle/product/11.2.0/dbhome_1
```

```
Enter the full pathname of the local bin directory: [/usr/local/bin]:
Copying dbhome to /usr/local/bin ...
Copying oraenv to /usr/local/bin ...
Copying coraenv to /usr/local/bin ...
```

```
Creating /etc/oratab file...
Entries will be added to the /etc/oratab file as needed by
Database Configuration Assistant when a database is created
```

```
Finished running generic part of root.sh script.  
Now product-specific root actions will be performed.  
Finished product-specific root actions.
```

On completion of each script, return the dialog shown in [Figure A-3](#), and click **OK**. In the main installer screen, verify that the message "The installation of Oracle database 11g was successful" appears. Click **Exit**, and confirm by clicking **Yes**.

## A.8 Creating an Oracle init Script File

1. Logon as the root user.
2. Create an `/etc/init.d/oracledb` script file to start and stop the Oracle database. An example of this initialization script is available in the RUEI installation zip file (`/root/RUEI/extra/oracledb`) explained in [Chapter 2, "Installing the RUEI Software"](#). Note that you will need to modify the settings for the `ORACLE_BASE` and `ORACLE_HOME` environment variables shown above if you selected a different installation directory for the Oracle database.
3. Make the script file executable and use it to start the Oracle database with the following commands:

```
chmod +x /etc/init.d/oracledb  
/sbin/chkconfig --add oracledb  
/sbin/service oracledb start
```

The Oracle database is now installed, and the database listener should be up and running.

---

---

## Generic Database Instance Setup

This appendix describes how you can manually set up an Oracle database instance for use by the RUEI Reporter. RUEI supports Oracle database version 11gR2 and 12c Release 1.

---

---

**Note:** While RUEI is supported on Oracle Database releases 11gR2 and later, the best performance for RUEI 13.2.2.1 is achieved with Oracle Database 12c Release 1.

---

---

Note that the approach taken in this appendix is to describe the requirements for a generic database instance, rather than a detailed procedural description. Therefore, a sound working knowledge of Oracle database administration is required.

### Platform Support

While a wide range of platforms are supported for deployment of a remote database, high performance platforms designed for large queries by comparatively few users offer the best deployment solutions.

## B.1 Overview of Database Setup

Upon completion, the following parameters and settings should be specified for the new Oracle database instance:

- RUEI\_DB\_INST: the name of the new database instance (as specified in the `/etc/ruei.conf` file). See [Section 2.4.1, "Check The RUEI Configuration File"](#) for more information.
- The instance should be based on the `Data_Warehouse.dbc` template.
- The character set of the instance should be set to `AL32UTF8`.
- The `recyclebin` and `audit_trail` features should be disabled for performance reasons.
- Monitor the `redolog` file size, and adjust the size if necessary.

Each of these requirements is discussed in more detail in the following sections. Note that you are required to have `sysdba` authorization.

### Location of SQL Scripts

The SQL scripts referred to as alternatives to the procedures described in the rest of this appendix can be found in the `/root/RUEI/extra/sql_scripts/` directory after extraction of the RUEI distribution zip.

## B.2 Creating the Database Instance

The following discussion assumes that the Oracle database instance is created on the command line. However, you are free to use any suitable utility to specify the required parameters.

Using the `ruei_database.dbt` template (32K blocksize) which can be found in the `/root/RUEI/131/db_templates/` directory, they should be consistent with the following:

```
dbca -silent -createDatabase -gdbName RUEI_DB_INST -sid RUEI_DB_INST \
-characterSet AL32UTF8 -templateName ruei_database.dbt -databaseType DATA_WAREHOUSING \
-redoLogFileSize 500 -initParams recyclebin=off -initParams audit_trail=none
```

Alternatively, on Linux platforms, the `ruei-prepare-db.sh` script can also be run (as the Oracle user) to create the Oracle database instance as follows:

```
./ruei-prepare-db.sh create_database
```

In addition to the `TSDEFAULT` tablespace, two additional tablespaces must be created for the RUEI Reporter system.

## B.3 Creating Tablespaces

Before continuing make sure you have chosen names for the default tablespace (named `TSDEFAULT` below for reference), the configuration tablespace (default is `UXCONF`) and the statistics tablespace (default is `UXSTAT`). The latter two names should also be set in the `/etc/ruei.conf` file using the `RUEI_DB_TSCONF` and `RUEI_DB_TSSTAT` variables respectively. Note that the same tablespace names must be used for all components in your RUEI environment, such as the remote database and Processors.

For performance reasons, it is *strongly* recommended that you use compressed tablespaces. The following command can be used to create the `TSDEFAULT` tablespace. Note that the default datafiles location is used, and you may want to specify a different location for the datafiles:

```
create tablespace TSDEFAULT datafile 'uxdefault01.dbf' size 5M reuse autoextend on
default compress;
```

The following command line instruction can be used to enable compression on the `TSDEFAULT` tablespace:

```
alter tablespace TSDEFAULT default compress;
```

The size of the required database instance is 500 GB (or larger). The required disk space depends on the specified Reporter data retention policy (select **Configuration**, then **General**, then **Advanced settings**, and then **Reporter data retention policy**).

For most RUEI deployments, you will require more than a single datafile in the `TSDEFAULT` tablespace. Note that the default datafiles location is used, and you may want to specify a different location for the datafiles. Use the following command to add additional datafiles:

```
alter tablespace TSDEFAULT add datafile 'user02.dbf' size 5M autoextend on;
```

In addition to the `TSDEFAULT` tablespace, two additional tablespaces must be created for the Reporter and Processing Engine systems:

- `RUEI_DB_TSCONF`: contains RUEI configuration information. Typically, less than 1 GB in size.

- `RUEI_DB_TSSTAT`: contains RUEI statistics information used for internal purposes. Typically, only a few GB in size.

Note that the names of these two tablespaces are fixed and not configurable. The required tablespaces can be created using the following commands:

```
create tablespace RUEI_DB_TSCONF datafile 'uxconf01.dbf' size 5M reuse autoextend
on default compress;
create tablespace RUEI_DB_TSSTAT datafile 'uxstat01.dbf' size 5M reuse autoextend
on default compress;
```

Alternatively, instead of using the commands described in this section, the table set up can be performed by running the `prepdb_tablespaces.sql` SQL script. Note that the script requires three input variables to be set, one for each configurable table space name.

## B.4 Rescheduling Oracle Database Maintenance

By default, Oracle database maintenance tasks are schedule to run at 22:00. These can have a significant impact on the overall database performance. Therefore, depending on traffic levels within the monitored environment, you may need to reschedule these maintenance tasks to a period with low traffic/load levels (for example, 03:00). For information on how to reschedule planned maintenance tasks, refer to the *Oracle Database Administrator's Guide* available at the following location:

[http://download.oracle.com/docs/cd/E11882\\_01/server.112/e17120/toc.htm](http://download.oracle.com/docs/cd/E11882_01/server.112/e17120/toc.htm)

The documented procedure can also be performed by running the `prepdb_maintenance_schedule.sql` SQL script.

## B.5 Installing SQL Packages

RUEI requires additional packages to be installed. These can be installed by issuing the following command:

```
./ruei-prepare-db.sh sql_packages
```

Alternatively, you can install the packages manually with the `ux_dbms_lock.sql` and `ux_dbms_session.sql` scripts in the `sql_scripts` directory.

## B.6 Creating the RUEI Database User

This section explains the creation of the RUEI database user, and the permissions it must be assigned.

The RUEI database user is specified in the `RUEI_DB_USER` setting (in the `/etc/ruei.conf` file). It receives the minimum required permissions. However, note that the `dbms_crypto` permission is required for encryption of the SSL private keys that a Collector is using. In addition, because RUEI typically operates in an unattended 7x24 environment, the `PASSWORD_LIFE_TIME` permission should be set to unlimited.

The following examples show how the RUEI database user can be created with the minimum required permissions.

```
create user RUEI_DB_USER
  identified by PASSWORD
  default tablespace TSDEFAULT
  temporary tablespace TEMP
  profile DEFAULT
```

```

        quota 500G on TSDEFAULT;

alter user RUEI_DB_USER
        quota unlimited on RUEI_DB_TSCONF
        quota unlimited on RUEI_DB_TSSTAT;

alter profile DEFAULT
        limit PASSWORD_LIFE_TIME unlimited;

grant      create session,
          create sequence,
          create table,
          create trigger,
          create view,
          create synonym,
          create database link,
          create procedure,
          create materialized view,
          create type
          to RUEI_DB_USER;

grant execute on dbms_crypto to RUEI_DB_USER;
grant execute on ux_dbms_lock to RUEI_DB_USER;
grant execute on ux_dbms_session to RUEI_DB_USER;

```

Alternatively, instead of using the commands described in this section, the RUEI database user configuration can be performed by running the `prepdb_user.sql` SQL script. Note that the script requires three input variables to be set, one for each configurable table space name.

## B.7 Creating Database Triggers

RUEI requires additional database triggers to be created. Create these triggers using the following command:

```
./ruei-prepare-db.sh create_triggers
```

Alternatively, you can create the triggers manually using the `prepdb_triggers.sql` scripts located in the `sql_scripts` directory.

## B.8 Setting up the Connection Data

After the Oracle database instance has been defined, the connection data needs to be set up. This requires two files, `sqlnet.ora` and `tnsnames.ora`, in the RUEI home directory (`RUEI_DATA`).

The following is an example of the contents of the `sqlnet.ora` file:

```

NAMES.DIRECTORY_PATH = (TNSNAMES)
SQLNET.WALLET_OVERRIDE = TRUE
WALLET_LOCATION = (SOURCE=(METHOD=FILE) (METHOD_DATA=(DIRECTORY=/var/opt/ruei)))
DIAG_SIGHANDLER_ENABLED = FALSE

```

Ensure that the `DIRECTORY` setting points to the directory for RUEI data files (`RUEI_DATA`) specified in the `/etc/ruei.conf` file.

The following is an example of the contents of the `tnsnames.ora` file:

```

uxinsight=(DESCRIPTION=
  (ADDRESS_LIST=(ADDRESS=(PROTOCOL=TCP) (HOST=localhost.localdomain) (PORT=1521)))

```

```
(CONNECT_DATA=(SERVICE_NAME=ruei))
```

In the example above, `uxinsight` is the database alias (`RUEI_DB_TNSNAME`) specified in the `/etc/ruei.conf` file. Ensure that the `HOST` setting specifies your database. If you specify a host name, ensure that it is also specified in the `/etc/hosts` setup. However, you can also specify an IP address.

If you have installed a processing engine as described in [Chapter 8, "Installing Processing Engines"](#) you require an additional entry for the processor engine to connect to a central reporter database. Add an alias similar to the following in your `tnsnames.ora` on the processing engine host:

```
config=(DESCRIPTION=
  (ADDRESS_LIST=(ADDRESS=(PROTOCOL=TCP) (HOST=reporter-hostname) (PORT=1521)))
  (CONNECT_DATA=(SID=ruei)))
```

where `config` is the alias which has been specified in `RUEI_DB_TNSNAME_CFG` in the `/etc/ruei.conf` configuration file on the processing engine host.

## B.9 Setting up the Oracle Wallet

The processing part of RUEI requires non-interactive access to the Oracle database. In order to achieve this, the Oracle `autologin` wallet is used to store passwords securely.

Use the following command to create the Oracle wallet on the database system:

```
mkstore -wrl /tmp -create
```

Note that you are prompted for the wallet password.

After the (empty) wallet has been created, you must add the credentials of `RUEI_DB_TNSNAME` and `RUEI_DB_USER` to the Oracle wallet using the following command:

```
mkstore -wrl /tmp -createCredential RUEI_DB_TNSNAME RUEI_DB_USER
```

Two wallet files, `ewallet.p12` and `cwallet.sso`, must be moved to the `RUEI_DATA` directory on the Reporter system. Both files should have the ownership of `RUEI_USER` and `RUEI_GROUP`. Note that `ewallet.p12` only needs to be readable by `RUEI_USER`, while `cwallet.sso` needs to be readable by both `RUEI_USER` and `RUEI_GROUP`. On Linux, this can be accomplished by issuing the following commands:

```
chown RUEI_USER:RUEI_GROUP *wallet*
chmod 600 ewallet.p12
chmod 640 cwallet.sso
```

If the Oracle database instance has been set up correctly, it should now be possible to enter the database without being prompted for the password. The `RUEI_USER` on the Reporter system can access the database instance as follows:

```
sqlplus /@RUEI_DB_TNSNAME
```

If this last step fails, you should carefully review the information in this appendix before proceeding with your RUEI deployment.

If you have installed a processing engine as described in [Chapter 8, "Installing Processing Engines"](#) the processor needs an additional entry in the wallet, so the processor can authenticate against the reporter database.

To add the credentials to the oracle wallet, use the following command:

```
mkstore -wrl /RUEI_DATA -createCredential RUEI_DB_TNSNAME_CFG RUEI_DB_USER
```





---

---

## Setting up an Alternative Enriched Data Export Database Instance

This appendix describes how you can set up an alternative Oracle database instance for use by the Enriched data export facility. The use of this facility is fully described in the *Oracle Real User Experience Insight User's Guide*.

---

---

**Note:** Before proceeding with the configuration of the alternative database, it is recommended that you make a backup of your configuration. Select **Configuration**, then **System**, then **Maintenance**, and then **Backup and restore**.

---

---

### C.1 Introduction to Enriched Data Export Setup

By default, when using the Enriched data export facility, the data is exported to the same database instance as used by the Reporter. However, it is *strongly* recommended that you configure an alternative database instance for enriched data export. This is due to the following reasons:

- The SQL queries used to access the exported data can place a significant performance overhead on the database. Be aware that if large amounts of data need to be handled, complex SQL queries need to be executed, or a number of queries need to be run against the exported data within a particular period, the use of a separate database will provide a significant performance improvement.
- The use of a separate export database instance will minimize the impact on your RUEI deployment, as well as provide for easier management of it. Particularly in the case of database sizing and backup.

If you intend to use an alternative export database, this must be an Oracle database version 11gR1, 11gR2 or 12c Release1, and installation of the Oracle database software should have been completed before starting the setup procedure described in the rest of this appendix. Be aware that advanced knowledge of Oracle database administration is assumed.

The setup procedure described in this appendix refers to a number of settings (such as RUEI\_DB\_TNSNAME\_BI). These are explained in [Table 2-3](#).

#### Migration to an Alternative Enriched Data Export Database

Be aware that when migrating enriched data export from one database to another, the export data currently stored in the previous database is *not* automatically migrated to the new database. Because the defined data retention policy is no longer enforced on

the previous database, any historical data will remain on the previous database. If required, the necessary tables can be manually purged from the previous database.

### Accessing the Export Data

Access to the data in the export database is available via SQL. Be aware that the SQL queries used to access exported data can place a significant performance overhead on the export database. Therefore, it is recommended that you carefully review the design of your SQL queries to minimize their overhead. In particular, you should ensure that table columns not required for external analysis are dropped from the returned data. In addition, you should try to minimize the number of SQL queries run during a particular period. In particular, try to avoid querying the same data more than once.

## C.2 Setting up the Alternative Database Instance

This section describes the procedure that must be followed in order to setup the database instance on the alternative database server.

### C.2.1 Creating the Database Instance

The following discussion assumes that the Oracle database instance is created on the command line. However, you are free to use any suitable utility to specify the required parameters. Do the following:

1. Logon to the alternative database system as the oracle user, and issue the following command:

```
dbca -silent -createDatabase -gdbName EXPORT_DATABASE_NAME \
-sid EXPORT_DATABASE_NAME -characterSet AL32UTF8 \
-templateName Data_Warehouse.dbc -databaseType DATA_WAREHOUSING \
-redoLogFileSize 500 -initParams recyclebin=off -initParams audit_trail=none
```

where:

- `EXPORT_DATABASE_NAME` specifies the literal export database instance name.
- For performance reasons, it is recommended that the `recyclebin` and `audit_trail` features are disabled.
- The character set instance should be specified as `ALT32UTF8`.

### C.2.2 Using Compressed Tablespaces

For performance reasons, it is *strongly* recommended that you use compressed tablespaces. Do the following:

1. Issue the following SQL command as the System Administrator on the alternative database server to enable compression on the `USERS` tablespace:

```
alter tablespace USERS default compress;
```

2. By default, a single 32 GB datafile is created for the `USERS` tablespace. For most deployments, you will need to add additional table space by using the following SQL command:

```
alter tablespace USERS add datafile 'user02.dbf' size 5M autoextend on;
```

Note that in the command shown above, the default datafile location is specified. You are free to specify an alternative location.

### C.2.3 Rescheduling Oracle Database Maintenance

By default, Oracle database maintenance tasks are scheduled to run at 22:00. These can have a significant impact on the overall database performance. Therefore, depending on traffic levels within the monitored environment, and the scheduled processes reading the export database tables, you may need to reschedule these maintenance tasks to a period with low traffic/load levels (for example, 03:00). Information on how to reschedule planned maintenance tasks is provided in the *Oracle Database Administrator's Guide* available at following location:

[http://docs.oracle.com/cd/E11882\\_01/server.112/e25494/tasks.htm#ADMIN0235](http://docs.oracle.com/cd/E11882_01/server.112/e25494/tasks.htm#ADMIN0235)

### C.2.4 Creating the RUEI Database User

Access to the alternative database requires the creation of an authorized user. Do the following:

1. Issue the following commands on the alternative database server to create the RUEI database user with the minimum required privileges:

```
create user RUEI_DB_USER_BI
  identified by "password"
  default tablespace USERS
  temporary tablespace TEMP
  profile DEFAULT
  quota 50G on USERS;

alter profile DEFAULT
  limit PASSWORD_LIFE_TIME unlimited;

grant  create session,
       create table
to RUEI_DB_USER_BI;
```

where:

- *RUEI\_DB\_USER\_BI* specifies the export database user name.
- *password* specifies the required password variable.

## C.3 Connecting the RUEI Systems to the Alternative Database Server

This section describes the procedure that must be followed in order for the Reporter and Processing Engine systems to connect to the alternative database server. Note that this procedure must be followed on the Reporter and *each* Processing Engine system.

### C.3.1 Setting up the Connection Data

After the alternative Oracle database instance has been defined, the connection data needs to be set up. This requires two files, *sqlnet.ora* and *tnsnames.ora*, in the RUEI data directory (*RUEI\_DATA*) on the Reporter and Processing Engine systems. Do the following:

1. Ensure that the *sqlnet.ora* file contains the following:

```
NAMES.DIRECTORY_PATH = (TNSNAMES)
SQLNET.WALLET_OVERRIDE = TRUE
WALLET_LOCATION = (SOURCE=(METHOD=FILE) (METHOD_DATA=(DIRECTORY=RUEI_DATA)))
DIAG_SIGHANDLER_ENABLED = FALSE
```

Ensure that the *DIRECTORY* setting points to the directory for RUEI data (*RUEI\_DATA*) specified in the */etc/ruei.conf* file.

2. Edit the `tnsnames.ora` files on the Reporter and Processing Engine systems. You should add the following:

```
RUEI_DB_TNSNAME_BI = (DESCRIPTION=
  (ADDRESS_LIST= (ADDRESS= (PROTOCOL=TCP) (HOST=BI_database_server)
    (PORT=1521)))
  (CONNECT_DATA= (SERVICE_NAME=RUEI_DB_INST_BI)))
```

where:

- `BI_database_server` specifies the network address (hostname or IP address) of the alternative Enriched data export database server.
- `RUEI_DB_TNSNAME_BI` specifies the export database connect string.
- `RUEI_DB_INST_BI` specifies the export database instance name.

Ensure that the `HOST` setting specifies your database. If you use a host name, ensure that it is also specified in the `/etc/hosts` setup. However, you can also specify an IP address.

### C.3.2 Setting up the Oracle Wallet

The Reporter and Processing Engines require non-interactive access to the alternative Enriched data export database. In order to achieve this, the Oracle autologin wallet is used to store passwords securely. A wallet should already exist to connect to the Reporter database. Do the following:

1. Use the following command to add the new credentials to the existing wallet files `ewallet.p12` and `cwallet.sso`:

```
mkstore -wrl RUEI_DATA -createCredential RUEI_DB_TNSNAME_BI RUEI_DB_USER_BI
```

where:

- `RUEI_DB_TNSNAME_BI` specifies the export database connect string.
- `RUEI_DB_USER_BI` specifies the user of the remote database.

Note that you are prompted for the wallet password and the database password for `RUEI_DB_USER_BI`.

2. Ensure that the permissions for these files are set correctly. Both files should have the ownership of `RUEI_USER` and `RUEI_GROUP`. The `ewallet.p12` file only needs to be readable by the `RUEI_USER`, but both files need to be readable by `RUEI_GROUP`.
3. If the database instance has been set up correctly, it should now be possible to access the export database without being prompted for the password. The `RUEI_USER` on the Reporter system can access the database instance as follows:

```
sqlplus /@RUEI_DB_TNSNAME_BI
```

If this step fails, you should carefully review the procedure described so far before proceeding.

### C.3.3 Editing the RUEI Configuration File

1. Edit the `/etc/ruei.conf` configuration file on the Reporter and *each* Processing Engine system from which you intend to export enriched data. Use the `RUEI_DB_TNSNAME_BI` setting to specify the export database connect string. For more information, see [Section 2.4.1, "Check The RUEI Configuration File"](#).

---

---

**Important:** Other than the modification described above, do *not* make any other changes to the `ruei.conf` file.

---

---

2. Logout and logon again as the `moniforce` user.
3. Restart processing on the Reporter system by issuing the following command:  
`project -restart`



# D

---

---

## Setting up a Connection to the Enterprise Manager Repository

This appendix describes how you can set up a connection to the Oracle Enterprise Manager Repository. This is necessary when you want KPIs defined for the applications, suites, and services that comprise your business applications to be reported as events in Incident Manager. The use of Incident Manager is described in *Oracle Enterprise Manager Cloud Control Administrator's Guide*. The use of the business application facility is described in *Oracle Enterprise Manager Cloud Control Oracle Fusion Middleware Management Guide*:

[http://docs.oracle.com/cd/E24628\\_01/install.121/e24215/toc.htm](http://docs.oracle.com/cd/E24628_01/install.121/e24215/toc.htm)

### D.1 Introduction to Enterprise Manager

Oracle Enterprise Manager supports the monitoring of business applications. These represent logical services or applications, and unify the dedicated performance monitoring, diagnostics, and reporting capabilities available through RUEI with that available through Oracle Enterprise Manager. The alerts generated by KPIs defined for the applications, suites, and services that comprise your business applications are reported as events in Incident Manager. For more information about the advantages of using Enterprise Manager to monitor KPIs see the *Oracle Enterprise Manager Cloud Control Oracle Fusion Middleware Management Guide*.

After completing the procedure described here, register the RUEI system in Enterprise Manager using the procedure described in the chapter "Monitoring Business Applications" of the *Oracle Enterprise Manager Cloud Control Oracle Fusion Middleware Management Guide*.

If you change any setting described in this Appendix, you must restart the system using the RUEI System Reset Wizard:

1. Select **System**, then **Maintenance**, and then **System** reset.
2. Select **Reapply latest configuration** option and click **Next** to apply the changes you have made.

### D.2 Creating a RUEI User for Communication with Enterprise Manager

In order for RUEI to communicate with Enterprise Manager, you must create a RUEI user with the **Enterprise Manager access** permission. Creating this *system* user using the RUEI user interface is described in *Chapter 14 Managing Users and Permissions* of the *Oracle Real User Experience Insight User's Guide*.

1. Log into RUEI as an administrator user.

2. Select **System**, then **User management**, and click the **Add new user** command button in the taskbar.
3. Complete the wizard, ensuring that you create a **system** user, with the **Enterprise Manager access** permission.

---

---

**Note:** You are not prompted to enter this user's credentials when registering RUEI with Enterprise Manager.

---

---

## D.3 Creating a non-sysman Enterprise Manager Repository User

During the process of registering RUEI with Enterprise Manager 12c, you must provide the credentials of an Enterprise Manager repository user. If you do not want to use the `sysman` user credentials, you can create a non-sysman user as follows:

---

---

**Note:** With Oracle Enterprise Manager 13c, a database user is automatically created (`EUS_ENGINE_USER`). When this user is first used, you are prompted to set a password for this user, and this password is stored in the RUEI wallet. By default this password will expire after 180 days. See the "Configuring Authentication" chapter of the *Database Security Guide* for information on configuring this user.

---

---

1. Log into the RUEI server as the `ruei` user.
2. [Section 2.3, "Unpacking the RUEI Software"](#) describes how to unpack the RUEI software. Copy the resulting `/root/RUEI/131/sql_scripts` directory from the RUEI server to the Enterprise Manager repository server.
3. Run SQL\*Plus as the `sysman` user in the `sql_scripts` directory on the Enterprise Manager repository server and create the user using the following script:

```
SQL> @create_em_user_for_event.sql
```

---

---

**Note:** After completing the procedure described here, set up RUEI as described in the chapter "Monitoring Business Applications" of the *Oracle Enterprise Manager Cloud Control Oracle Fusion Middleware Management Guide* using the username and password you entered in step 3.

---

---

## D.4 Setting Up a Connection to Oracle Enterprise Manager

The required procedure consists setting up RUEI to use the `mkstore` utility and restarting RUEI.

Configure RUEI to use the `mkstore` utility:

1. Determine the location of the `mkstore` utility. This utility is included with the Oracle Database and Oracle Client runtime. In both cases, it is located in `$ORACLE_HOME/bin`.

---

---

**Note:** If you are using a remote database, install the Oracle Client runtime software on the RUEI system to ensure the availability of the `mkstore` utility.

---

---



2. Edit the `/etc/ruei.conf` file and add the following line, where `mkstore_location` is the path determined in step one:

```
export MKSTORE_BIN=mkstore_location
```

## D.5 Clearing a Connection to Oracle Enterprise Manager

If you remove a RUEI registration from Oracle Enterprise Manager, you may see a message indicating there are some data in RUEI side that must be removed manually. If you see this message, complete the following procedure:

---

---

**Note:** The wallet password is required to complete this procedure.

---

---

1. Change directory to the location of the `mkstore` utility. This utility is included with the Oracle Database and Oracle Client runtime. In both cases, it is located in `$ORACLE_HOME/bin`.

2. Determine the credential you want to delete by listing the current credentials:

```
./mkstore -wrl ewallet.p12 -listCredential
```

3. Delete the wallet credential using a command similar to the following:

```
./mkstore -wrl ewallet.p12 -deleteCredential 'CREDENTIAL_NAME'
```

where `CREDENTIAL_NAME` is the name of the credential you want to delete.

4. Clear the database entries using the following SQL command:

```
delete from C_EM_SYSTEM where HOST_NAME='Host_Name';
```

where `Host_Name` is the hostname of the RUEI instance.



---



---

## The ruei-check.sh Script

This appendix provides a detailed explanation of the checks performed by the `ruei-check.sh` script. It is *strongly* recommended that you use this script to verify successful installation, and to troubleshoot any installation issues.

The script's location is explained in [Section 2.5.5, "Creating the Reporter Database Instance"](#), and should be run as the `root` user. When started, the script prompts you to specify which role or roles the system is required to perform. For example:

```
Please specify which role(s) this system will perform.
Use commas to separate multiple roles. For example, 1,2,4
```

```
1 - Reporter
2 - Processing Engine
3 - Collector
4 - Database
```

```
Enter role(s): 1,2,3,4
```

The permitted role combinations are shown in [Table E-1](#).

**Table E-1 Permitted System Role Combinations**

Roles	Description
1	Reporter only.
2	Processing Engine only.
3	(Remote) Collector only.
4	(Remote) database only.
1,2	Reporter with Processing Engine.
1,2,3	Reporter with Collector and Processing Engine.
1,2,4	Reporter with Processing Engine and database.
1,2,3,4	Reporter with Processing Engine, Collector, and database.

The checks are performed in the order shown in [Table E-2](#), and are divided into three types: pre-installation, system, and post-installation checks. Whether a specific check is performed depends on the selected role(s).

**Table E-2** *ruei-check.sh* Checks

Check	Role				Description
	1	2	3	4	
<b>System checks</b>					
Architecture	•	•	•	•	Must be x86_64.
Operating system	•	•	•	•	Must be Oracle/RedHat Linux 5.x or 6.x.
Memory	•	•	•	•	Must be at least 4 GB. Recommended 16 GB for Reporter installation. Recommended 8 GB for a Collector only or remote database installation.
Swap space	•	•	•	•	Must be at least 3/4 of the installed system memory <sup>1</sup> .
Disk space for <i>RUEI_HOME</i>	•	•	•		The disk space for the specified <i>RUEI_HOME</i> location must be at least 512 MB.
Disk space for <i>RUEI_DATA</i>	•	•	•		The disk space for the specified <i>RUEI_DATA</i> location must be at least 100 GB.
Disk speed on <i>RUEI_DATA</i>	•	•	•		The disk speed of the specified <i>RUEI_DATA</i> location must be at least 40 MB/s (120 MB/s or more is recommended).
SELinux	•	•	•	•	SELinux must be disabled.
Network interfaces				•	Must have at least one interface must be Up without an IP address.
Hostname	•	•	•	•	The system's configured IP address and hostname must be specified in the <i>/etc/hosts</i> file.
DNS	•	•	•	•	The configured DNS server must resolve the system's configured hostname to its IP address.
HTTPD autostart				•	Must be configured to start automatically.
HTTPD up				•	Must be up.
Database autostart				•	Must be configured to start automatically.
SSHD autostart	•	•	•	•	Must be configured to start automatically.
SSHD up	•	•	•	•	Must be up.
SSHD	•	•	•	•	Checks if the SSH is not firewalled.
NTPD autostart	•	•	•	•	Must be configured to start automatically.
NTPD up	•	•	•	•	Must be up.
NTPD	•	•	•	•	Must be synchronized with a time server.
PHP CLI				•	PHP must be available on the command line.
PHP settings				•	<i>session.gc_maxlifetime</i> should be at least 14400. <i>memory_limit</i> should be at least 96M. <i>post_max_size</i> should be at least 128M. <i>upload_max_filesize</i> should be at least 128M. Zend Optimizer must be available (Linux version 5.x). Zend Guard Loader must be available (Linux version 6.x). (These appear as individual checks, and are only performed if the above check is passed).

**Table E-2 (Cont.) ruei-check.sh Checks**

Check	Role				Description
	1	2	3	4	
PHP timezone	•				PHP must return the same timezone as the Reporter operating system. See <a href="#">Section G.15, "ruei-check.sh Script Reports PHP Timezone Error"</a> for additional information.
RSVG	•				The <code>~apache/.gnome2</code> directory must exist.
<b>Pre-install checks</b>					
Disk space for database data directory				•	Must be 500 GB. (If on the same partition as <code>RUEI_DATA</code> , must be 700 GB).
Disk containing database data directory				•	Should be local. (Remote file systems, such as NFS, are not supported).
Disk speed of database data directory				•	Must be at least 40 MB/s (120 MB/s is recommended).
<code>RUEI_USER</code> user exists	•	•	•		The specified <code>RUEI_USER</code> user must exist.
apache user exists	•				User apache must exist.
User apache in group <code>RUEI_GROUP</code>	•				User apache must be a member of the specified group <code>RUEI_GROUP</code> .
User apache in group <code>uucp</code>	•				User apache must be a member of the group <code>uucp</code> .
User <code>RUEI_USER</code> in group <code>uucp</code>	•	•	•		The specified <code>RUEI_USER</code> user must be in group <code>uucp</code> .
User root must have umask of 0022	•	•	•	•	User root must have the umask 0022.
User root can write to <code>/etc/http/conf.d</code>	•				User root must be able to write to the <code>/etc/http/conf.d</code> directory.
User root can write to <code>/etc/init.d</code>	•	•			User root must be able to write to the <code>/etc/init.d</code> directory.
User root can write to <code>/etc/ld.so.conf.d</code>				•	User root must be able to write to the <code>/etc/ld.so.conf.d</code> directory.
User root can write to <code>RUEI_HOME</code>	•	•	•		User root must be able to write to the specified <code>RUEI_HOME</code> directory.
User root can write to <code>RUEI_DATA</code>	•	•	•		User root must be able to write to the specified <code>RUEI_DATA</code> directory.
User root can write to <code>/tmp</code>	•	•	•	•	User root must be able to write to the <code>/tmp</code> directory.
<code>/etc/sysconfig/httpd</code> must call <code>/etc/ruei.conf</code>	•				The <code>/etc/sysconfig/httpd</code> script must call the <code>/etc/ruei.conf</code> configuration file.
<code>RUEI_USER</code> user able to contact database	•	•			The specified <code>RUEI_USER</code> user must be able to connect to the database.
oci8 PHP extension available	•				The <code>oci8</code> PHP extension must be available.
<code>RUEI_USER</code> user able to contact database via PHP	•				The specified <code>RUEI_USER</code> user must be able to connect to the database via PHP.
<code>RUEI_USER</code> user must have umask 0027	•	•	•		The specified <code>RUEI_USER</code> user must have a umask of 0027.
<code>RUEI_USER</code> user able to read <code>RUEI_HOME</code>	•	•	•		The specified <code>RUEI_USER</code> user must be able to read the specified <code>RUEI_HOME</code> directory.
<code>RUEI_USER</code> user able to write to <code>RUEI_DATA</code>	•	•	•		The specified <code>RUEI_USER</code> user must be able to read the specified <code>RUEI_DATA</code> directory.
Permissions and ownership of <code>RUEI_DATA</code>	•	•	•		The Apache user must be able to read from the specified <code>RUEI_DATA</code> directory.

**Table E-2 (Cont.) *ruei-check.sh* Checks**

Check	Role				Description
	1	2	3	4	
<code>/etc/ruei.conf</code> syntactically correct	•	•	•		The <code>/etc/ruei.conf</code> configuration file must be a syntactically correct shell script.
User <code>root</code> able to contact database after loading <code>ruei.conf</code>	•	•			The <code>root</code> user must be able to connect to the database after the environment specified in the <code>ruei.conf</code> configuration file has been loaded.
<code>wm_concat</code> available	•	•			The <code>wm_concat</code> database function (used by suites) must be available.
<code>\$JAVA_HOME</code> value valid	•	•			The value specified for <code>\$JAVA_HOME</code> in the <code>/etc/ruei.conf</code> configuration file must be valid.
<b>Post-install checks</b>					
Reporter RPM check	•				The <code>ux_collector</code> , <code>ux-bi-publisher</code> , <code>ux-core</code> , <code>ux-generic</code> , <code>ux-ipdb</code> , <code>ux-gui</code> , <code>ux-wlp</code> , <code>ux-suites-ebs</code> , <code>ux-suites-jde</code> , <code>ux-suites-sbl</code> , <code>ux-suites-fus</code> , <code>ux-suites-psft</code> , <code>ux-suites-flex</code> , and <code>ux-suites-wcs</code> RPMs must be installed and have the same version (for example, 11.1.0).
Processing Engine check					The <code>ux_collector</code> , <code>ux-core</code> , <code>ux-generic</code> , <code>ux-ipdb</code> , <code>ux-wlp</code> , <code>ux-suites-ebs</code> , <code>ux-suites-jde</code> , <code>ux-suites-sbl</code> , <code>ux-suites-fus</code> , <code>ux-suites-psft</code> , <code>ux-suites-flex</code> , and <code>ux-suites-wcs</code> RPMs must be installed and have the same version (for example, 11.1.0).
Collector RPM check				•	The <code>ux-collector</code> RPM must have been installed.
Java shared objects				•	The Java path must have been correctly added to the <code>LD_LIBRARY_PATH</code> (see <a href="#">Section 2.4, "Generic Installation Tasks"</a> ).
GUI reachable	•				The Reporter GUI must be reachable via the local hostname on the secure interface (note if a self-signed certificate is found, a warning is generated).
Reporter GUI can reach database	•				The Reporter GUI must be able to contact to the database.
Permissions and ownership of Oracle wallet	•	•			The Oracle wallet must be readable by the Apache user.
Permissions and ownership of Oracle wallet	•				The Oracle wallet must be readable by the <code>RUEI_USER</code> user.
Core binaries in path	•	•			The specified <code>RUEI_USER</code> user must be able to call the core binaries without specifying a full name.

<sup>1</sup> If memory is added to meet the memory requirement, this check may start failing.

### Re-running the `ruei-check.sh` Script

Be aware that the role selection you make when running the script is saved to file. Therefore, if you want to re-run the script and be able to specify a different role or roles for the system, you need to delete the file `/tmp/ruei-system-type` using the following command:

```
rm /tmp/ruei-system-type
```

## Verifying Monitored Network Traffic

This appendix describes how you can use the TCP diagnostic facility to verify that RUEI "sees" all required network traffic. It is *strongly* recommended that a network engineer within your organization validates collected network traffic after installation and configuration of RUEI.

### F.1 Introduction to Network Traffic

The TCP diagnostics utility allows you to create 1-minute snapshots of the network traffic seen by a selected Collector. This snapshot can then be used to help determine whether there are gaps in the expected traffic flow. For example, there could be unconfigured port numbers, or an incorrectly specified VLAN ID.

The TCP traffic can be analyzed across client and server IP and MAC address, as well as port number and VLAN ID. Each snapshot's scope in terms of network traffic information is shown in [Figure F-1](#).

**Figure F-1** Example Network Topology

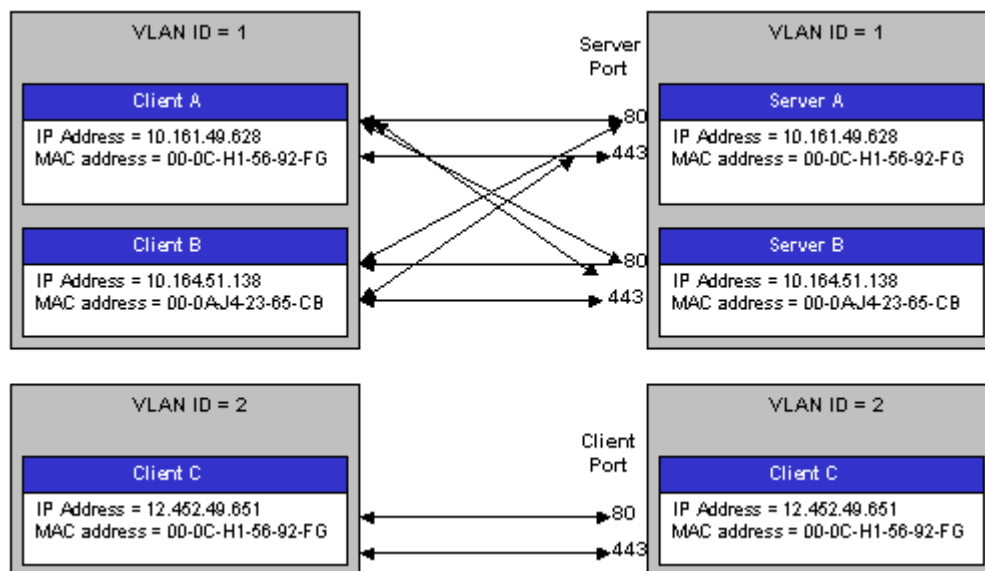

## F.2 Creating Traffic Snapshots

To create a TCP traffic snapshot, do the following:

1. Within the **Configuration** facility, click the **Show Collector status** icon. Alternatively, select **System**, then **Status**, and then **Collector status**. The Network data Collectors window shown in [Figure F-2](#) opens. This is fully explained in the *Oracle Real User Experience Insight User's Guide*.

**Figure F-2 Network Data Collectors**

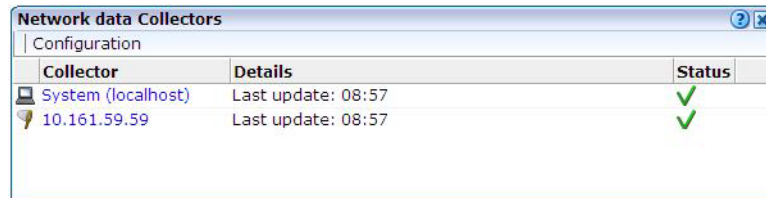

2. Click the required Collector. The **System (localhost)** item refers to the Collector instance running on the Reporter system. Other Collectors within the network are represented by their IP address.
3. Click the **TCP diagnostics** tab. A panel similar to the one shown in [Example F-3](#) appears.

**Figure F-3 TCP Diagnostics**

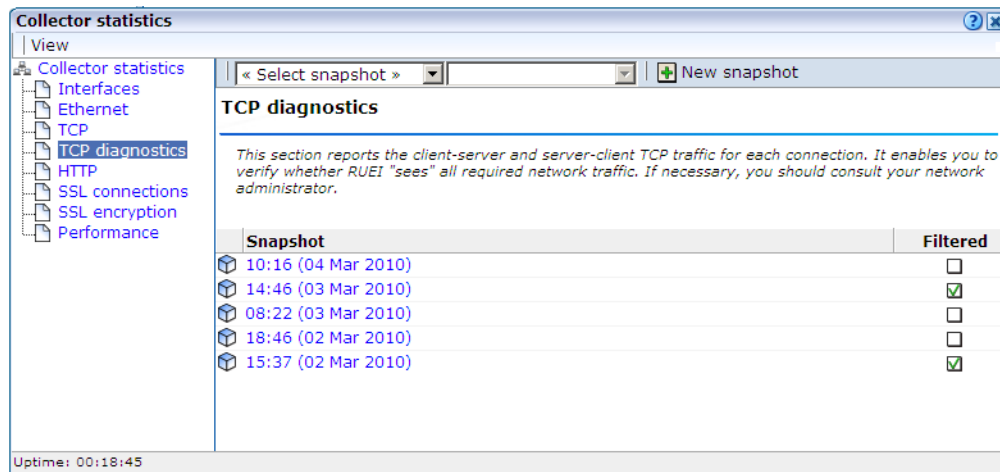

4. Click the **New snapshot** icon in the toolbar. The dialog shown in [Figure F-4](#) appears.



Figure F-4 New TCP Traffic Snapshot Dialog

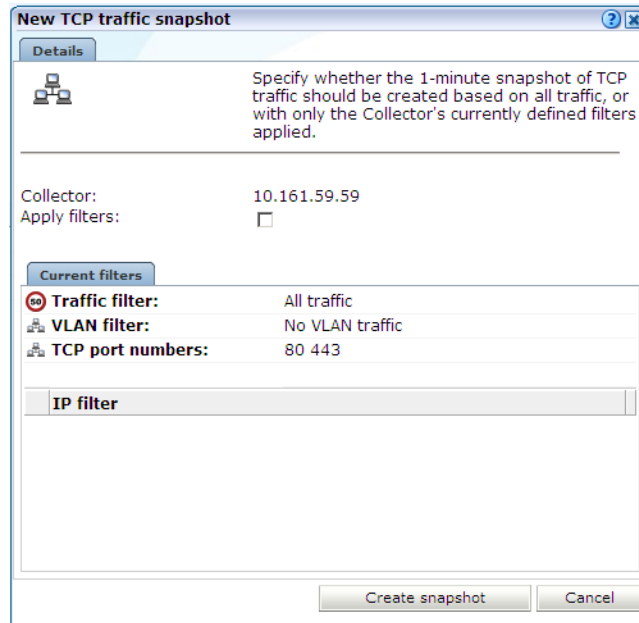

5. Use the **Apply filters** check box to specify whether the create traffic snapshot should be created to report all traffic seen by the selected Collector, or only that traffic that fits the Collector’s currently defined filters (see the *Oracle Real User Experience Insight User’s Guide* for more information). These are shown in the lower part of the dialog. Note that you can also view them by clicking the **View snapshot filters** icon on the toolbar. When ready, click **Create snapshot**.

---

**Note:** The maximum number of traffic snapshots across all Collector systems in your RUEI installation is 15. When this maximum is reached, the oldest snapshot is automatically replaced by the newly created snapshot.

---

6. There is a 1-minute delay while the snapshot is created. Upon completion, an overview of the newly created snapshot’s details is presented. An example is shown in [Figure F-5](#).

Figure F-5 TCP Traffic Snapshot Overview

Dimension level		Value				
Server VLAN/ID	Client VLAN/ID	Server IP/Address	Server TCP/Port	Server packets	Client packets	Status
0	0	10.161.59.165	80	12,942	15,149	✓
0	0	10.161.59.167	443	1,463	1,202	✓
0	0	10.161.59.165	443	1,064	824	✓

## F.3 Analyzing Traffic Information

To analysis a created snapshot, do the following:

1. Select the required snapshot from the snapshot menu, or click it via the TCP diagnostics main panel (shown in [Figure F-3](#)). Snapshots created with applied filters are indicated with a tick character in the **Filtered** column. You can view the applied filters by clicking the tick character.
2. An overview of the selected snapshot (similar to the one shown in [Figure F-5](#)) appears. Note that you can click a selectable item to filter on it. For example, the list of reported items should be restricted to those that include a particular server IP address. You can remove a filter by clicking the **Remove** icon beside it in the filters section of the panel.

Optionally, use the sort menu (shown in [Figure F-6](#)) to the right of the snapshot menu to select the primary column used for the displayed items.

**Figure F-6 Sort Menu**

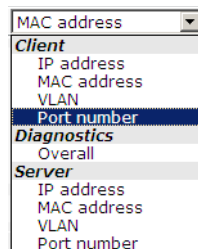

3. The **Status** column shown in [Figure F-5](#) indicates whether a possible problem may exist with the TCP traffic monitored during the snapshot. In the event of a fail status being reported, you can mouse over the status icon to see additional information. Possible identified problems are explained in [Table F-1](#).

**Table F-1 Identify Problems and Possible Causes**

Status	Description
Client/server packet ratio is too high.	The number of client packets compared to server packets seems to be unusually large. This could indicate that the Collector cannot see both directions of traffic due (or is seeing duplicate traffic in one direction), or there is a server-related issue (for example, it is switched off).
Server/client packet ratio is too high.	The number of server packets compared to client packets seems to be usually large. This could indicate that the Collector cannot see both directions of traffic due (or seeing duplicate traffic in one direction), or there is a client-related issue (for example, unacknowledged server packets).
Insufficient number of server and client packets for analysis.	There was insufficient traffic (TCP packets) to perform a reliable client/server ratio analysis. A minimum of 100 packets is required. This may be because normal traffic levels to the server are low. Otherwise, it may indicate routing issues with RUEI being unable to see some portions of network traffic.
Server VLAN ID does not match client VLAN ID.	This would normally indicate a routing issue. For example, traffic from the client to the server is being routed via one VLAN, but the traffic back from the server to the client is being routed via another VLAN. Be aware that RUEI can only monitor traffic on one VLAN segment at a time.

---

---

# Troubleshooting

This appendix highlights the most common problems encountered when installing RUEI, and offers solutions to locate and correct them. The information in this appendix should be reviewed before contacting Customer Support.

## More Information

Note the following:

- Information on Oracle Enterprise Manager is available at the following location:  
<http://www.oracle.com/us/products/enterprise-manager/index.html>
- Detailed technical information is available from My Oracle Support:  
<https://support.oracle.com>

## Contacting Customer Support

If you experience problems with the installation or configuration of the RUEI, you can contact Customer Support. However, before doing so, it is *strongly* recommended that you create a Helpdesk report file of your installation. To do so, select **System**, then **Configuration**, and then **Helpdesk report**. This file contains extended system information that is extremely useful to Customer Support when handling any issues that you report. Please note that this file contains information in a proprietary format. Do *not* try to modify its contents.

In addition, extended information about internal errors is available by enabling Session debugging. To do so, select the **Session debug** option from the **Help** menu. For further information, see the *Oracle Real User Experience Insight User's Guide*.

## G.1 Running the ruei-check.sh Script

It is recommended you use the `ruei_check.sh` script to troubleshoot installation issues. When first run, the script requires you to specify an installation type (`reporter`, `processor`, `collector`, or `database`). Be aware this selection is saved to file. Therefore, if you want to run the script and be able to specify a different installation type, you need to delete the file `/tmp/ruei-system-type` using the following command:

```
rm /tmp/ruei-system-type
```

You can specify the parameters shown in [Table G-1](#).

**Table G-1** *ruei-check.sh* Parameters

Parameter	Description
system	Performs basic system checks, as well as a number of prerequisites checks. These include interfaces that can be monitorable interfaces, that the Oracle database starts correctly, and that the Apache web server, PHP, and Zend optimizer are correctly configured.
preinstall	Checks whether the Oracle database is correctly configured.
postinstall	Checks if the RUEI RPMs have been installed correctly.
all	Performs all the above checks in the indicated sequences.

For example:

```
cd /root/RUEI/132
./ruei-check.sh all
```

The use of this script is fully described in [Appendix E, "The ruei-check.sh Script"](#).

## G.2 ORA-12805: Parallel Query Server Died Unexpectedly

When executing a parallel statement using a partial-partition wise join, where the set of partitions accessed is pruned at runtime to no partitions or partitions without any segments, you may run into an error similar to the following:

```
ORA-12805: PARALLEL QUERY SERVER DIED UNEXPECTEDLY
```

This is caused by a known bug in Oracle Database 11.2 and can be addressed by employing the following workaround to make GUI queries not parallel by setting `db_gui_dop` to 1:

```
$ execsql config_set_value wi_core db_gui_dop 1
```

However, Oracle recommends that you upgrade to database version 11.2.0.3 and download and install patch 13582702 available at the following location:

[https://support.oracle.com/epmos/faces/ui/patch/PatchDetail.jspx?\\_afLoop=33337295036267&patchId=13582702](https://support.oracle.com/epmos/faces/ui/patch/PatchDetail.jspx?_afLoop=33337295036267&patchId=13582702)

## G.3 The ruei-prepare-db.sh Script Fails

If the `ruei-prepare-db.sh` script fails, this can be because the database listener has not been started correctly due to a failing DNS look up. To resolve this problem, do the following:

- Ensure the `/etc/hosts` file includes your host.
- Ensure entries in the `/etc/nsswitch.conf` file are specified in the required (sequence hosts: files DNS).

---

**Note:** The `ruei-prepare-db.sh` script can be run with the `delete` option to remove the current database and install a new one.

---

## G.4 Starting Problems

If the system does not seem to start, or does not listen to the correct ports, do the following:

- Restart each Collector service. To do so, select **System**, then **Maintenance**, then **Network data collectors**, select each attached Collector, and select the **Restart** option from the menu. This is described in more detail in the *Oracle Real User Experience Insight User's Guide*.
- Review your network filter definitions. This is described in the *Oracle Real User Experience Insight User's Guide*. In particular, ensure that no usual network filters have been applied. This is particularly important in the case of VLANs.
- Ensure that RUEI is listening to the correct protocols and ports. This is described in the *Oracle Real User Experience Insight User's Guide*.
- Verify that the Collector interfaces are up.

### Resources and Log Files

If during, or directly after running the Initial setup wizard (described in [Section 6.2, "Performing Initial RUEI Configuration"](#)), the system returns an error, there are the following resources and log files available to help you in debugging:

- `RUEI_DATA/processor/log/gui_debug.log`: a proprietary debug and log file that shows low-level system information. Although its contents may be difficult to read, you can find standard system error messages listed here.
- `/var/log/httpd/access_log` and `/error_log`: the Apache daemon access and error log files. If any part of the HTTP or PHP execution of the RUEI user interface is in error, it will show up in these log files. (Note that these are *not* the log files used by RUEI for HTTP data analysis).

### Root-Cause Analysis

Before starting to address specific issues, it is important to understand the basic operation of data collection, data processing, and data reporting. Any root-cause analysis of RUEI problems should take the following:

- Verify data collection. Select **System**, then **Status**, and then **Collector status**. Select a Collector from the displayed list, and verify that the system interfaces are showing traffic activity on TCP, Ethernet, and HTTP level.
- In addition, verify that there are no problems with the SSL data decryption. It is normal that some errors occur (especially shortly after startup). But if SSL traffic is to be decrypted, the error rate can never be 100%.
- Verify data processing. Select **System**, then **Status**, then **Data processing**. A screen similar to the one shown in [Figure 6-6](#) appears. It should indicate some activity.

## G.5 Data Collection Problems

If the data collection service is not running, or will not start, do the following:

- Use the TCP diagnostics facility to verify that RUEI "sees" all required network traffic. The use of this tool is described in [Appendix F, "Verifying Monitored Network Traffic"](#).
- Ensure the network cards used for data collection are running in promiscuous mode. This can be verified by issuing the command `ifconfig ethN` (where *N* is the number of the network interface being used for data collection). It should return an output similar to the following:

```
ethn      Link encap:Ethernet  HWaddr 00:15:17:3E:26:AF
          UP BROADCAST RUNNING PROMISC MULTICAST  MTU:1500  Metric:1
          RX packets:0 errors:0 dropped:0 overruns:0 frame:0
```

```
TX packets:0 errors:0 dropped:0 overruns:0 carrier:0
collisions:0 txqueuelen:1000
RX bytes:0 (0.0 GiB) TX bytes:0 (0.0 GiB)
Memory:b9120000-b9140000
```

Note that you may want to repeat the above command to view changes in network traffic while diagnosing network issues.

- If the network interface is not available, make sure the `ONBOOT` parameter is set to `YES`.
- Verify there is *no* IP address assigned to the network interface being used for data collection. If there is a configured IP address, remove it.

---

---

**Note:** Do not set to 0.0.0.0 or 127.0.0.1. Remove the configured IP address completely.

---

---

## G.6 Data Processing Problems

If, for any reason, data processing does not start, try to restart it by selecting **System**, then **Maintenance**, and then **System reset**. The System reset wizard appears. Select the **Restart system processing** option. Note that restarting system processing can take between 5 and 30 minutes.

In general, if no data is being processed, verify your system's configuration as described in [Section 6.5, "Verifying and Evaluating Your Configuration"](#). If you do not apply any configuration to the system, no data processing will take place.

If you are using an environment with multiple Collectors, ensure all Collectors are up and running normally. To do so, select **System**, then **Status**, and then **Collector status**. A failing Collector can become a block to further data processing of the system's data.

## G.7 E-Mail Problems

Sending E-mails is RUEI functionality that is handled on a system level, together with your Mail Transfer Agent (MTA), such as Sendmail or Postfix. If problems occur when sending E-mails, do the following:

- If mail is sent correctly by RUEI to your MTA, the user interface will report "Message sent successfully" when you attempt to send a daily, weekly, or monthly report manually.
- If mail could not be sent correctly by RUEI to your MTA, verify that the MTA is up and running. Alternatively, analyze the mail settings by selecting **System**, then **Maintenance**, and **E-mail configuration**.
- If the mail was sent successfully, but not delivered to the recipient, analyze the operation of your MTA to further identify the root cause of the mails that are not delivered.
- Refer to the `/var/log/maillog` file for reported mailing issues.

Common issues with E-mail delivery often involve an incorrectly configured MTA, or an MTA that is not allowed to send E-mail within the Data Center or corporate network.

## G.8 SSL Decryption Problems

In order to decrypt SSL traffic, the Collector needs to have the SSL key and certificate available. To enable SSL decryption, you should do the following:

- Upload the SSL key through the appropriate Collector.
- Enable the SSL key by entering the required decryption passphrase (when applicable).

The certificate needs to be uploaded to the Collector(s) by selecting **Configuration**, then **Security**, and then **SSL keys**. To check the status of the SSL decryption, select **System**, then **Status**, and then **Collector status**, and select the Collector for which you want SSL decryption analysis. Within the **SSL encryption** page, note the following:

- Decryption errors will occur if there is no SSL key uploaded.
- The percentage of successful decryption will be a low number shortly after uploading and activating the appropriate SSL keys.
- This percentage should rise in the first minutes and hours after uploading the SSL keys.

RUEI accepts PKCS#12 and PEM/DER encoding of SSL keys and certificates. Basically, this means both the certificate and key should be concatenated into one file. If you have separate key and certificate files, you can create a PKCS#12-compliant file by issuing the following command:

```
openssl pkcs12 -export -in certificate.cer -inkey key.key -out pkcs12file.p12
-passout pass:yourpassphrase
```

Where:

- *certificate.cer* is your CA root certificate file.
- *key.key* is the server's SSL key file.
- *pkcs12file.p12* is the output file name for the PKCS#12-encoded file.
- *yourpassphrase* is the passphrase you want to use to protect the file from unwanted decryption.

For example, consider the situation where the CA root certificate filename is *ca\_mydomainroot.cer*, the server's SSL key is *appsrv12.key*, you want the output file to be called *uxssl.p12*, and want to protect this file with the passphrase *thisismysecretpassphrase*. The following command is required:

```
Openssl pkcs12 -export -in ca_mydomainroot.cer -inkey appsrv12.key -out uxssl.p12
-passout pass:thisismysecretpassphrase
```

Check the collector statistic page of RUEI for issues, specifically searching for sessions labelled:

- Ephemeral - These sessions provide forward secrecy and therefore cannot be monitored by RUEI.
- Anonymous - These sessions do not have a long-lived server key and therefore cannot be monitored by RUEI.

## G.9 Missing Packages and Fonts Error Messages

It is *strongly* recommended that you not perform a "minimal" installation of Oracle Linux. If you do so, it can lead to a wide range of reported problems, depending on the components not included in the installation, but required by RUEI.

The most common of these are reported `fontconfig` error messages in the `/var/log/http/error_log` file. These can be fixed by installing the following fonts:

- `urw-fonts-noarch v2.3`
- `ghostscript-fonts-noarch v5`
- `dejavu-lgc-fonts-noarch v2`
- `liberation-fonts v0.2`
- `bitmap-fonts v0.3`

Depending on your language settings, install all other required fonts.

However, other possible error messages include reported missing packages (such as `librsvg2`).

When a Yum repository is available, all dependencies available on the Linux 5.x DVD can be installed by issuing following command:

```
yum -y install gcc gcc-c++ compat-libstdc++-33 glibc-devel libstdc++-devel \
elfutils-libelf-devel glibc-devel libaio-devel sysstat perl-URI net-snmp libpcap \
sendmail-cf httpd php php-pear php-mbstring phpldap librsvg2 xorg-x11-xinit \
net-snmp-utils perl-XML-Twig
```

For RedHat Enterprise/Oracle Linux 6.x, issue the following command:

```
yum -y install gcc gcc-c++ compat-libstdc++-33 glibc-devel libstdc++-devel \
elfutils-libelf-devel glibc-devel libaio-devel sysstat perl-URI net-snmp \
libpcap sendmail-cf httpd php php-pear php-mbstring phpldap librsvg2 \
xorg-x11-xinit net-snmp-utils perl-XML-Twig rsync ksh openssl098e wget bc \
bind-utils
```

However, be aware that additional RPMs shipped with the RUEI installation zip file still need to be installed.

## G.10 ORA-xxxxx Errors

If you receive any Oracle database errors, do the following:

- Ensure that the `/etc/sysconfig/httpd` file contains the following lines:

```
source /etc/ruei.conf
```

If you have to add these lines, restart the Apache web server using the following command:

```
service httpd restart
```

- Ensure that the `ewallet.p12` file is readable by the `RUEI_USER` specified user. Additionally, the `cwallet.sso` file should also be readable by the `RUEI_GROUP` specified group. On Linux/UNIX, this can be accomplished by issuing the following commands:

```
chmod 600 ewallet.p12
chmod 640 cwallet.sso
```

- Ensure the same host name is specified in the `/var/opt/ruei/tnsnames.ora`, `/etc/sysconfig/network`, and `/etc/hosts` files.

Note if you make changes to any of these files, you may need to reboot the server.



## G.11 Oracle DataBase Not Running

Verify the Oracle database is up and running by changing to the `moniforce` user and obtaining an SQL\*Plus prompt with the following commands:

```
su - moniforce
sqlplus /@connect-string
```

where `connect-string` is either `RUEI_DB_TNSNAME` or `RUEI_DB_TNSNAME_CFG`.

You should receive the SQL\*Plus command line without being prompted for a password. This indicates that the Oracle wallet authentication was successful.

If necessary, re-start the Oracle database using the following command:

```
/etc/init.d/oracledb restart
```

## G.12 General (Non-Specific) Problems

If you are experiencing problems with the reporting module, or find its interface unstable, it is recommended that you do the following:

- Clear all content caching within your browser, and re-start your browser.
- Examine the error log. This is described in the *Oracle Real User Experience Insight User's Guide*.
- Select **System**, then **Status**, and verify correct operation of the core components by then selecting **Data Collection**, **Logfile processing**, and **Data processing**. If any of these components are in error, try to resolve them using the advice provided in this appendix.

## G.13 Network Interface Not Up

If the network interface you intend to use for data collection is not Up (that is, the `ONBOOT=YES` parameter was not set), you can bring it immediately using the following command:

```
ifconfig ethN up
```

where `N` represents the necessary network interface.

## G.14 OAM-Related Problems

In order to start isolating OAM-related problems, you should do the following:

1. Logon to the Reporter system as the `moniforce` user.
2. To obtain a sample value of the cookie, issue the following command:

```
EXAMPLE_VALUE=$(zgrep obSSOCookie \
$WEBSENSOR_HOME/data/wg_localhost/http/`date +"%Y%m%d" `/*/http-*/\
tail -1 |sed 's,^.*ObSSOCookie=\([^;[:space:]]*\)[;[:space:]].*$,\1,g')
```

3. To view the obtained sample value, issue the following command:

```
echo $EXAMPLE_VALUE
```

You should check that the returned output is not empty and does not contain errors. The following is an example of the possible output:

```
2bTxIrJxIGg%2FMrntHeRuhI1bADtml%2FNpXmho%2FuXK1S3PmiqdsQy4QAgcq0JiQbLfabiS1FBQc
```

```
%2Bq1Nadjw7naVCqAyT7ir883GoGkSTX8ODtW7S1HQLbATMahOSYsTn8wshgg%2Fg5vi0d18%2F3Zw6
t0dPevrhE0wTCk069p%2FkeIS8ftPBUSE6p9rEKiWBqyptQpUzW4SwfTz89iNxOoNULPkG4I5B%2BVa
2ac4pgA4rc%2Bre%2BdFk3Gcm7dyu5XC%2BiQKRznERRE1t7wQb7RF5zjFL8hD6Jl0yquJytYPV3x7u
fa%2BWatYE5uIHg3NdUKzLq0214
```

- To specify the obtained value as the OAM cookie, issue the following commands:

```
cp $WEBSSENSOR_INI/../../vt/OAM2* $WEBSSENSOR_INI
mklookup --match $EXAMPLE_VALUE|GET|/some/url.html '%' '%1[$OAM2UserName]' %0
```

---

**Note:** The URL should be a URL protected by OAM.

---

### Reported Errors

If the following error is received:

```
*ERROR* - obssockie: could not dlopen()
/opt/netpoint/AccessServerSDK//oblix/lib/libobaccess.so:
/opt/netpoint/AccessServerSDK//oblix/lib/libobaccess.so: cannot open shared
object file: Permission denied
```

This indicates that the moniforce user does not have the necessary permissions. You should logon to the Reporter system as the moniforce user, and issue the following commands:

```
find /opt/netpoint/AccessServerSDK -type d -exec chmod o+rx {} \;
find /opt/netpoint/AccessServerSDK -type f -exec chmod o+r {} \;
```

If the following error is received:

```
*ERROR* - obssockie: could not dlopen()
/opt/netpoint/AccessServerSDK//oblix/lib/libobaccess.so:
/opt/netpoint/AccessServerSDK//oblix/lib/libobaccess.so: wrong ELF class:
ELFCLASS32
```

This indicates that the 32-bit version of the Access Gate SDK was installed instead of the required 64-bit version. The procedure to download and install the required Access Gate SDK is described in [Section 7.1.1, "Downloading and Installing the Access Gate Software"](#).

Note that the Access Gate SDK installation package includes a utility to uninstall the 32-bit version (`_uninstAccessSDK/uninstaller.bin`).

If the following error is received:

```
Server is not authenticated to access the the OAM environment
```

This indicates that the creation of a trust between RUEI and the access server (described in [Section 7.1.2, "Configuring the Access Gate Software on the RUEI Server"](#)) was not successfully performed, and should be repeated.

If the following error is received:

```
*ERROR* - obssockie: environment variable OBACCESS_INSTALL_DIR not set
```

This indicates that the procedure described in [Chapter 7, "Configuring the Oracle Access Manager"](#) was not followed.

## G.15 ruei-check.sh Script Reports PHP Timezone Error

The following error is reported by the `ruei-check.sh` script:

```
Checking if the PHP timezone has been set correctly: [FAIL]
PHP and OS timezones do not match (os: winter +0000, summer +0100. php:
winter +0100, summer +0200)
```

This can easily be fixed by setting the TZ environment variable at the bottom of the `/etc/ruei.conf` file on the Reporter system as follows:

```
export TZ=Europe/Lisbon
```

## G.16 ORA-00020: maximum number of processes (%s) exceeded

If this error is reported, you will need to increase the maximum number of processes available to the databases within your environment. To increase the maximum number of processes from the default (150) to 300, do the following:

1. Logon as the `oracle` user to each database within your RUEI deployment.
2. Obtain an SQL\*Plus prompt by issuing the following command:

```
sqlplus / as sysdba
```

3. Issue the following commands:

```
SQL> alter system set processes=300 scope=spfile;
System altered.
```

```
SQL> shutdown immediate
Database closed.
Database dismounted.
ORACLE instance shut down.
SQL> startup
ORACLE instance started.
```

## G.17 rsync Fails When user@ Argument not Specified

Version 3.0.6-4 of the `rsync` utility distributed as part of RedHat Linux 5.7 is known to contain the bug BZ# 726060. This leads to a failure and error when specifying the source or destination argument of the `rsync` command without the optional `user@` argument.

If you encountered this issue, it is recommended that you upload and install the RedHat update 2011:1112-1. It is available from the following location:

<http://rhn.redhat.com/errata/RHBA-2011-1112.html>

## G.18 ORA-00600 Error Reported

The following error is reported when restoring a RUEI backup or deleting certain configuration items (for example, application, user id source, framework exception):

```
ORA-00600: internal error code, arguments: [kmmctbf:bad intcoln]
```

This is caused by a known bug in Oracle database version 11.2.0.3.0. It can be fixed by downloading and installing the patch 13582702 available at the following location:

[https://support.oracle.com/epmos/faces/ui/patch/PatchDetail.jspx?\\_afLoop=33337295036267&patchId=13582702](https://support.oracle.com/epmos/faces/ui/patch/PatchDetail.jspx?_afLoop=33337295036267&patchId=13582702)

## G.19 Dropped Segments and Bad Checksums

If the collector is reporting a large number of dropped segments or segments with bad checksums, this could indicate a problem with the network card settings. This is because large segments, also referred to as Jumbo frames, are typically created by the network interface card driver due to an optimization feature called "receive offload". Typically, such segments created by the driver do not have a checksum (blank checksum) or have a random (junk) value as the checksum.

The dropped segments and bad checksums counters can be inspected by selecting **System**, then **Status**, then **Collector Status**, select the collector host, then **TCP**.

To see if large frames are present on the network card, select **Interfaces** on the collector status screen. Look at the value of the **Largest Encountered Frame** field for each interface and compare it with the value of the **Configured Max Frame Size** field. If the configured size is less than the largest encountered frame, then the collector is dropping these frames as they are too large for its internal capture buffers. In addition, the collector will issue a warning event in the Event Log when it encounters a frame larger than the maximum configured size.

Note that in RUEI 12.1.0.6, the maximum configured frame size has been set to 64KB by default. In addition, checksum validation rules have been relaxed to accept both frames with blank checksums, and large frames with a junk checksum. Therefore, the rest of this section is only applicable if you have reduced the frame size for any reason and are running into drops due to bad checksums.

### Background to Receive Offload and Checksum Offload Settings

Some network drivers have provisions to combine multiple physical frames into a single, large frame (of anything up to 64Kb) that is then passed on to the kernel network stack in a single operation. Network card vendors may refer to this as **frame coalescing**, **large receive offload** or **generic receive offload**. The goal is to improve efficiency by reducing the number of interrupts and copy operations from driver to kernel.

In addition to frame coalescing, some network drivers also perform TCP checksum offloading, that is, they perform TCP checksum validations for incoming packets and compute and set the checksums for outgoing packets. The goal is to improve efficiency by offloading these tasks from the kernel software to the network card hardware.

To view the current offload settings of a network interface, use the following command (you may need to do this as the root user):

```
# ethtool -k eth1
Offload parameters for eth1:
Cannot get device udp large send offload settings: Operation not supported
rx-checksumming: on
tx-checksumming: on
scatter-gather: on
tcp segmentation offload: on
udp fragmentation offload: off
generic segmentation offload: on
generic-receive-offload: on
```

The actual interpretation of the fields might differ per driver, but typically, **generic-receive-offload** indicates that the network driver is coalescing frames. In addition, the driver may or may not be filling in checksums for the resulting large frames, this can depend on other offload settings, such as **rx-checksumming** or **tcp-segmentation-offload** or simply differ per driver implementation.

Frames for which the checksum was not filled in correctly are dropped because they fail the checksum validations performed by the collector.

Note that checksum validation is only be attempted on frames that are not coalesced, and that have a checksum field which is not blank.

### Disable Offloading Settings

To avoid large frame issues, disable the **offload settings** of the network card in order to stop it from coalescing frames altogether. Disable the **generic-receive**, **tcp-segmentation** and **generic-segmentation** offloads using the following command for each interface that the Collector is monitoring:

```
# ethtool -K eth1 tso off gso off gro off
```

### Enable Jumbo Frames

If you are still observing Jumbo frames after disabling offloading for all capture interfaces, then you need to increase the maximum frame size of the collector. Go to the **Configuration** tab, and click on the **Security** button on the left. Next, click on **Jumbo frames** in the Security panel in the lower left of the screen. Follow the instruction on screen to set the maximum frame size.

### Disable TCP Checksum Validation in Collector

To disable TCP checksum validation on the reporter system, enter the following commands as the RUEI user:

```
execsql config_set_profile_value System_name config TcpDoChecksum add no
```

where *System\_name* is the collector profile you want to configure. Replace this with the actual collector profile name.

### Disable TCP Checksums Offloading

If the driver is not filling in TCP checksums properly due to checksum offloading, and the collector statistics show checksum errors, disable it via the command:

```
# ethtool -K eth1 rx off tx off
```

The driver implementations might differ for different vendors, to the point that some might not even let you change any of these settings. Contact Oracle Support if you are unable to change the settings of your drivers successfully and are still observing packet loss in the collector.

## G.20 Errors During Installation on RedHat Enterprise/Oracle Linux 6.x

[Section 2.1.6.2, "Installing RedHat Enterprise/Oracle Linux 6.x Prerequisites"](#) of this guide instructs you to issue the following command to install all optional fonts.

```
rpm -Uhv fonts-*
```

This command may fail with a message similar to the following:

```
Transaction Check Error:
file /usr/share/fonts/opensymbol/opensymbol.woff conflicts between attempted
installs of openoffice.org-opensymbol-fonts-1:3.2.1-19.6.0.1.el6_2.7.noarch
and libreoffice-opensymbol-fonts-1:4.0.4.2-9.0.1.el6.noarch
```

To workaroud this issue, use the following command to install fonts:

```
yum install -y *-fonts --exclude=libreoffice*
```

## G.21 SSL Error on RedHat Enterprise/Oracle Linux 6.x

An error similar to the following may be displayed:

```
appSensor, version ux-collector-12.1.0.6.1-20140818-collector (Aug 18
2014(11:41:41), adc4150376) RUEI_12.1.0.6.0_LINUX.X64_140818 , 64-bit
Copyright (c) 2003, 2014, Oracle, All rights reserved.
Running as instance wg
Reading configuration in "wg/config".
Finished loading configuration.
Device "eth0" initialized for capture
OK
##### Cannot open /u01/ruei/opt/collector/lib64/libssl.so:
/u01/ruei/opt/collector/lib64/libssl.so: symbol EVP_aes_128_gcm, version
libcrypto.so.10 not defined in file libcrypto.so.10 with link time reference
##### Plugin "libssl" failed to load
Loading plugin "libssl"
FAILED
##### Error reading plugin configuration
Cannot open /u01/ruei/opt/collector/lib64/libssl.so:
/u01/ruei/opt/collector/lib64/libssl.so: symbol EVP_aes_128_gcm, version
libcrypto.so.10 not defined in file libcrypto.so.10 with link time reference
Plugin "libssl" failed to load
wg/config/plugins.cfg, 15: User give up
Error reading plugin configuration
Collector exited, initialization failed
```

This indicates that the incorrect version of OpenSSL is running. Make sure that you have applied the latest OpenSSL patches for your operating system using the appropriate commands (for example, `yum update` or `up2date`). Applying the latest OpenSSL patches helps improve the security of the system.

## Installation Checklist

This appendix provides a checklist of actions that should be complete, and information gathered, before starting to install the RUEI software. These include server and infrastructure readiness and configuration, as well as HTTPS encrypted traffic and alerting issues.

### Server Readiness

Base hardware and operating system requirements.

Intel/AMD 64-bit platform (minimum 2 dual-core CPUs).

Network connectivity:

- 10/100 MB NIC for office network connectivity.
- 10/100/1000 MB NIC for data collection connectivity.

Disk space: at least 400 GB (on high-performance RAID-5, RAID-10, or similar).

Memory: at least 16 GB RAM for single server.

OS: Oracle Linux 64-bit or RedHat Enterprise Linux 64-bit 5.x or 6.x.

Oracle Database 11g or 12c Enterprise Edition.

The `ruei-check.sh` script reports no errors.

The EBS, JD Edwards, FLEXCUBE, and PeopleSoft configuration zip files are available.

### Infrastructure Readiness

Ensure easy placement and accessibility of the system.

Prepare rackspace in the Data Center cabinet with power sockets.

The server is accessible through remote ports:

- Port 80/443 for HTTP(S) traffic to the RUEI web server.
- Port 22 for remote management over SSH/SCP.
- Port 25 (E-mail).
- Port 123 (NTP).
- Port 161/162 (SNMP).
- Port 1521 (for remote database setup).

Access to the Data Center on the appropriate day and time is arranged.

Network preparation for TAP/copy port is done and cables available in cabinet.

Server configuration completed (see below).

<b>Infrastructure Readiness</b>	
<p>Main topology with proxies, load balancers, routers, switches, and so on, is known.</p> <p>Main traffic flows throughout the infrastructure are known.</p> <p>VLAN topology, VLAD IDs, and IP addresses are known.</p> <p>The monitoring position for the RUEI server is located as close as possible to the firewall.</p> <p>The domains, applications, server farm(s), and/or VLANs to be monitored are identified.</p>	

<b>Server Configuration</b>	
<p>Complete the details below to for reference during server configuration.</p>	
<p>Host name and domain name (optional).</p> <p>Data Center name.</p> <p>Placement date and time.</p> <p>Server IP, netmask, and default gateway.</p> <p>Server type (Collector/Reporter).</p> <p>NTP server IP and backup.</p> <p>DNS server IP and backup.</p> <p>Mail server and sender mail.</p> <p>Socket 0: collection port to TAP/switch name.</p> <p>Socket 1: collection port to TAP/switch name.</p> <p>Socket 2: rescue/maintenance interface.</p> <p>Socket 3: Office network to switch name.</p> <p>Socket 4: collection port to TAP/switch name.</p> <p>Socket 5: collection port to TAP/switch name.</p>	<p>&lt;reserved&gt;</p>

<b>Data Collection Configuration</b>	
<p>Once in place, the server will start collecting data. Specify how much data is expected, and the technologies used.</p>	
<p>HTTP traffic (in MB, pageviews, or hits per hour).</p> <p>Base technology for web applications.</p> <p>Limits on amount of traffic to be captured:</p> <ul style="list-style-type: none"> <li>■ HTTP and HTTPS ports (if other than 80/443 HTTP/HTTPS).</li> <li>■ VLAN traffic and VLAN IDs (optional).</li> </ul> <p>Cookie technology.</p> <p>Page-labelling technology.</p> <p>Blind POST field names (such as passwd).</p> <p>User identification in URL (if other than login).</p> <p>Web service domains or networks.</p>	



---

**Data Collection Configuration**

XML/SOAP envelopes (max 10).

Chronos/EUM URL (for EBS and Forms).

---

**HTTPS Enablement**

Specify the contact(s) for the required SSL keys to monitor encrypted traffic.

Name:

Name:

Function:

Function:

E-mail:

E-mail:

Phone/Mobile:

Phone/Mobile:

Keys (if not all):

Keys (if not all):

---

**System Health Notifications**

The system can trigger and send alerts for various components. Specify the users, notification methods, and details for each component.

Name:

Name:

Function:

Function:

E-mail:

E-mail:

Mobile:

Mobile:

Text message:

Text message:

---

**Alerting via SNMP (Optional)<sup>1</sup>**

SNMP management server.

SNMP community name.

SNMP version.

---

<sup>1</sup> RUEI provides a standard MIB to be imported into the SNMP manager.



---

---

# Removing RUEI From Systems

This appendix describes the procedure for uninstalling RUEI from Reporter, Collector, and Processing Engine systems.

Do the following for each Reporter, Collector, and Processing Engine system unless indicated otherwise:

1. Logon to required system as the *RUEI\_USER* user, and clear all crontab entries by issuing the following command:

```
echo "" | crontab
```

2. Stop all processing on the Reporter and Processing Engine systems by issuing the following command as the *RUEI\_USER* user:

```
project -stop
```

In the case of Collector systems, stop data collection by issuing the following command:

```
appsensor stop wg
```

3. Remove the installed RUEI RPMs by issuing the following command as the root user:

```
rpm -qa | grep ^ux- | xargs rpm -e
```

If parts of the installed RPMs were removed manually or corrupted, errors might be encountered in the above step. In this case, you should issue the following command:

```
rpm -qa | grep ^ux- | xargs rpm -e --noscripts
```

Note that part of the installation may remain after issuing the above command.

4. On the Reporter system, unistall the *php-oci8* module, Oracle database Instant client, PHP configuration, and SQLplus extension by issuing the following commands as the root user:

```
rm /etc/php.d/ruei.ini
rpm -e php-oci8-11gR2
rpm -e oracle-instantclient11.2-sqlplus
rpm -e oracle-instantclient11.2-basic
```

5. Ensure that all RUEI daemons are deactivated by executing the following commands as the root user:

```
./etc/ruei.conf
killall -u $RUEI_USER
```

- 
6. Remove all RUEI data files by executing the following commands at the root user:

```
rm -rf $RUEI_HOME
rm -rf $RUEI_DATA
```

7. Remove each database instance by logging onto the required database server(s) as the oracle user, and executing the following commands:

```
. /etc/ruei.conf
. oraenv
dbca -silent -deleteDatabase -sourceDB ${RUEI_DB_INST}
```

Note that when prompted for the Oracle SID, you should specify the same value as that for the RUEI\_DB\_INST setting in the /etc/ruei.conf file.

8. For Reporter and Collector systems, remove the Java Runtime Environment (JRE) by executing the following commands as the root user:

```
rm /usr/java/jre1.7.0_09
rm /usr/java/jre
```

9. On the Reporter system, edit the /etc/sysconfig/httpd file, and remove the following line that loads the RUEI environment:

```
source /etc/ruei.conf
```

10. On the Reporter system, restore the original Zend Optimizer configuration file /etc/php.ini by executing the following commands as the root user:

```
cd /etc/
cp php.ini-zend_optimizer.bak php.ini
```

Remove the Zend Optimizer installation directory by executing the following command:

```
rm -rf /usr/local/Zend
```

Restart the Apache web server using the following command:

```
/etc/init.d/httpd restart
```

11. Revert the changes made to user and group settings by executing the following commands as the root user:

```
. /etc/ruei.conf
userdel $RUEI_USER
groupdel $RUEI_GROUP
usermod -G apache apache
```

12. Remove the RUEI configuration file /etc/ruei.conf using the following command as the root user:

```
rm /etc/ruei.conf
```

13. Note that during the installation procedure, you may have installed several additional RPMs. Which of these can safely be removed depends on the original Linux installation.

14. Be aware that a database installation will remain on each database server. The procedure for uninstalling the Oracle database is fully described in the product documentation.

---

---

## Third-Party Licenses

This appendix contains licensing information about certain third-party products included with this version of RUEI. Unless otherwise specifically noted, all licenses herein are provided for notice purposes only.

The sections in this appendix describe the following third-party licenses:

- [Apache Software License, Version 2.0](#)
- [OpenSSL](#)
- [PHP](#)
- [Java Runtime Environment](#)
- [The MIT License \(MIT\)](#)

### J.1 Apache Software License, Version 2.0

Apache License

Version 2.0, January 2004

<http://www.apache.org/licenses/>

#### TERMS AND CONDITIONS FOR USE, REPRODUCTION, AND DISTRIBUTION

1. **Definitions.** "License" shall mean the terms and conditions for use, reproduction, and distribution as defined by Sections 1 through 9 of this document.

"Licensor" shall mean the copyright owner or entity authorized by the copyright owner that is granting the License.

"Legal Entity" shall mean the union of the acting entity and all other entities that control, are controlled by, or are under common control with that entity. For the purposes of this definition, "control" means (i) the power, direct or indirect, to cause the direction or management of such entity, whether by contract or otherwise, or (ii) ownership of fifty percent (50%) or more of the outstanding shares, or (iii) beneficial ownership of such entity.

"You" (or "Your") shall mean an individual or Legal Entity exercising permissions granted by this License.

"Source" form shall mean the preferred form for making modifications, including but not limited to software source code, documentation source, and configuration files.

"Object" form shall mean any form resulting from mechanical transformation or translation of a Source form, including but not limited to compiled object code, generated documentation, and conversions to other media types.

"Work" shall mean the work of authorship, whether in Source or Object form, made available under the License, as indicated by a copyright notice that is included in or attached to the work (an example is provided in the Appendix below).

"Derivative Works" shall mean any work, whether in Source or Object form, that is based on (or derived from) the Work and for which the editorial revisions, annotations, elaborations, or other modifications represent, as a whole, an original work of authorship. For the purposes of this License, Derivative Works shall not include works that remain separable from, or merely link (or bind by name) to the interfaces of, the Work and Derivative Works thereof.

"Contribution" shall mean any work of authorship, including the original version of the Work and any modifications or additions to that Work or Derivative Works thereof, that is intentionally submitted to Licensor for inclusion in the Work by the copyright owner or by an individual or Legal Entity authorized to submit on behalf of the copyright owner. For the purposes of this definition, "submitted" means any form of electronic, verbal, or written communication sent to the Licensor or its representatives, including but not limited to communication on electronic mailing lists, source code control systems, and issue tracking systems that are managed by, or on behalf of, the Licensor for the purpose of discussing and improving the Work, but excluding communication that is conspicuously marked or otherwise designated in writing by the copyright owner as "Not a Contribution."

"Contributor" shall mean Licensor and any individual or Legal Entity on behalf of whom a Contribution has been received by Licensor and subsequently incorporated within the Work.

**2. Grant of Copyright License.** Subject to the terms and conditions of this License, each Contributor hereby grants to You a perpetual, worldwide, non-exclusive, no-charge, royalty-free, irrevocable copyright license to reproduce, prepare Derivative Works of, publicly display, publicly perform, sublicense, and distribute the Work and such Derivative Works in Source or Object form.

**3. Grant of Patent License.** Subject to the terms and conditions of this License, each Contributor hereby grants to You a perpetual, worldwide, non-exclusive, no-charge, royalty-free, irrevocable (except as stated in this section) patent license to make, have made, use, offer to sell, sell, import, and otherwise transfer the Work, where such license applies only to those patent claims licensable by such Contributor that are necessarily infringed by their Contribution(s) alone or by combination of their Contribution(s) with the Work to which such Contribution(s) was submitted. If You institute patent litigation against any entity (including a cross-claim or counterclaim in a lawsuit) alleging that the Work or a Contribution incorporated within the Work constitutes direct or contributory patent infringement, then any patent licenses granted to You under this License for that Work shall terminate as of the date such litigation is filed.

**4. Redistribution.** You may reproduce and distribute copies of the Work or Derivative Works thereof in any medium, with or without modifications, and in Source or Object form, provided that You meet the following conditions:

- You must give any other recipients of the Work or Derivative Works a copy of this License; and
- You must cause any modified files to carry prominent notices stating that You changed the files; and
- You must retain, in the Source form of any Derivative Works that You distribute, all copyright, patent, trademark, and attribution notices from the Source form of the Work, excluding those notices that do not pertain to any part of the Derivative Works; and

- If the Work includes a "NOTICE" text file as part of its distribution, then any Derivative Works that You distribute must include a readable copy of the attribution notices contained within such NOTICE file, excluding those notices that do not pertain to any part of the Derivative Works, in at least one of the following places: within a NOTICE text file distributed as part of the Derivative Works; within the Source form or documentation, if provided along with the Derivative Works; or, within a display generated by the Derivative Works, if and wherever such third-party notices normally appear. The contents of the NOTICE file are for informational purposes only and do not modify the License. You may add Your own attribution notices within Derivative Works that You distribute, alongside or as an addendum to the NOTICE text from the Work, provided that such additional attribution notices cannot be construed as modifying the License. You may add Your own copyright statement to Your modifications and may provide additional or different license terms and conditions for use, reproduction, or distribution of Your modifications, or for any such Derivative Works as a whole, provided Your use, reproduction, and distribution of the Work otherwise complies with the conditions stated in this License.

**5. Submission of Contributions.** Unless You explicitly state otherwise, any Contribution intentionally submitted for inclusion in the Work by You to the Licensor shall be under the terms and conditions of this License, without any additional terms or conditions. Notwithstanding the above, nothing herein shall supersede or modify the terms of any separate license agreement you may have executed with Licensor regarding such Contributions.

**6. Trademarks.** This License does not grant permission to use the trade names, trademarks, service marks, or product names of the Licensor, except as required for reasonable and customary use in describing the origin of the Work and reproducing the content of the NOTICE file.

**7. Disclaimer of Warranty.** Unless required by applicable law or agreed to in writing, Licensor provides the Work (and each Contributor provides its Contributions) on an "AS IS" BASIS, WITHOUT WARRANTIES OR CONDITIONS OF ANY KIND, either express or implied, including, without limitation, any warranties or conditions of TITLE, NON-INFRINGEMENT, MERCHANTABILITY, or FITNESS FOR A PARTICULAR PURPOSE. You are solely responsible for determining the appropriateness of using or redistributing the Work and assume any risks associated with Your exercise of permissions under this License.

**8. Limitation of Liability.** In no event and under no legal theory, whether in tort (including negligence), contract, or otherwise, unless required by applicable law (such as deliberate and grossly negligent acts) or agreed to in writing, shall any Contributor be liable to You for damages, including any direct, indirect, special, incidental, or consequential damages of any character arising as a result of this License or out of the use or inability to use the Work (including but not limited to damages for loss of goodwill, work stoppage, computer failure or malfunction, or any and all other commercial damages or losses), even if such Contributor has been advised of the possibility of such damages.

**9. Accepting Warranty or Additional Liability.** While redistributing the Work or Derivative Works thereof, You may choose to offer, and charge a fee for, acceptance of support, warranty, indemnity, or other liability obligations and/or rights consistent with this License. However, in accepting such obligations, You may act only on Your own behalf and on Your sole responsibility, not on behalf of any other Contributor, and only if You agree to indemnify, defend, and hold each Contributor harmless for any liability incurred by, or claims asserted against, such Contributor by reason of your accepting any such warranty or additional liability.

## END OF TERMS AND CONDITIONS

**APPENDIX:** How to apply the Apache License to your work.

To apply the Apache License to your work, attach the following boilerplate notice, with the fields enclosed by brackets "[ ]" replaced with your own identifying information. (Don't include the brackets!) The text should be enclosed in the appropriate comment syntax for the file format. We also recommend that a file or class name and description of purpose be included on the same "printed page" as the copyright notice for easier identification within third-party archives.

Copyright [yyyy] [name of copyright owner]

Licensed under the Apache License, Version 2.0 (the "License"); you may not use this file except in compliance with the License. You may obtain a copy of the License at

<http://www.apache.org/licenses/LICENSE-2.0>.

Unless required by applicable law or agreed to in writing, software distributed under the License is distributed on an "AS IS" BASIS, WITHOUT WARRANTIES OR CONDITIONS OF ANY KIND, either express or implied. See the License for the specific language governing permissions and limitations under the License.

## J.2 OpenSSL

This product includes software developed by the OpenSSL Project for use in the OpenSSL Toolkit (<http://www.openssl.org>).

Copyright © 1998-2011 The OpenSSL Project. All rights reserved. It is distributed under the license available at the following location:

<http://www.openssl.org/source/license.html>

## J.3 PHP

Copyright © 1999-2013 The PHP Group. All rights reserved.

This product includes PHP software, freely available from <http://php.net/software/>. It is distributed under the license available at the following location:

<http://creativecommons.org/licenses/by/3.0/legalcode>

## J.4 Java Runtime Environment

ORACLE AMERICA, INC. ("ORACLE"), FOR AND ON BEHALF OF ITSELF AND ITS SUBSIDIARIES AND AFFILIATES UNDER COMMON CONTROL, IS WILLING TO LICENSE THE SOFTWARE TO YOU ONLY UPON THE CONDITION THAT YOU ACCEPT ALL OF THE TERMS CONTAINED IN THIS BINARY CODE LICENSE AGREEMENT AND SUPPLEMENTAL LICENSE TERMS (COLLECTIVELY "AGREEMENT"). PLEASE READ THE AGREEMENT CAREFULLY. BY SELECTING THE "ACCEPT LICENSE AGREEMENT" (OR THE EQUIVALENT) BUTTON AND/OR BY USING THE SOFTWARE YOU ACKNOWLEDGE THAT YOU HAVE READ THE TERMS AND AGREE TO THEM. IF YOU ARE AGREEING TO THESE TERMS ON BEHALF OF A COMPANY OR OTHER LEGAL ENTITY, YOU REPRESENT THAT YOU HAVE THE LEGAL AUTHORITY TO BIND THE LEGAL ENTITY TO THESE TERMS. IF YOU DO NOT HAVE SUCH AUTHORITY, OR IF YOU DO NOT WISH TO BE BOUND BY THE TERMS, THEN SELECT THE "DECLINE LICENSE AGREEMENT" (OR THE EQUIVALENT) BUTTON AND YOU



MUST NOT USE THE SOFTWARE ON THIS SITE OR ANY OTHER MEDIA ON WHICH THE SOFTWARE IS CONTAINED.

1. DEFINITIONS. "Software" means the software identified above in binary form that you selected for download, install or use (in the version You selected for download, install or use) from Oracle or its authorized licensees, any other machine readable materials (including, but not limited to, libraries, source files, header files, and data files), any updates or error corrections provided by Oracle, and any user manuals, programming guides and other documentation provided to you by Oracle under this Agreement. "General Purpose Desktop Computers and Servers" means computers, including desktop and laptop computers, or servers, used for general computing functions under end user control (such as but not specifically limited to email, general purpose Internet browsing, and office suite productivity tools). The use of Software in systems and solutions that provide dedicated functionality (other than as mentioned above) or designed for use in embedded or function-specific software applications, for example but not limited to: Software embedded in or bundled with industrial control systems, wireless mobile telephones, wireless handheld devices, netbooks, kiosks, TV/STB, Blu-ray Disc devices, telematics and network control switching equipment, printers and storage management systems, and other related systems are excluded from this definition and not licensed under this Agreement. "Programs" means: (a) Java technology applets and applications intended to run on the Java Platform, Standard Edition platform on Java-enabled General Purpose Desktop Computers and Servers, and (b) JavaFX technology applications intended to run on the JavaFX Runtime on JavaFX-enabled General Purpose Desktop Computers and Servers. "README File" means the README file for the Software set forth in the Software or otherwise available from Oracle at or through the following URL:

<http://www.oracle.com/technetwork/java/javase/documentation/index.html>

2. LICENSE TO USE. Subject to the terms and conditions of this Agreement including, but not limited to, the Java Technology Restrictions of the Supplemental License Terms, Oracle grants you a non-exclusive, non-transferable, limited license without license fees to reproduce and use internally the Software complete and unmodified for the sole purpose of running Programs.

3. RESTRICTIONS. Software is copyrighted. Title to Software and all associated intellectual property rights is retained by Oracle and/or its licensors. Unless enforcement is prohibited by applicable law, you may not modify, decompile, or reverse engineer Software. You acknowledge that the Software is developed for general use in a variety of information management applications; it is not developed or intended for use in any inherently dangerous applications, including applications that may create a risk of personal injury. If you use the Software in dangerous applications, then you shall be responsible to take all appropriate fail-safe, backup, redundancy, and other measures to ensure its safe use. Oracle disclaims any express or implied warranty of fitness for such uses. No right, title or interest in or to any trademark, service mark, logo or trade name of Oracle or its licensors is granted under this Agreement. Additional restrictions for developers and/or publishers licenses are set forth in the Supplemental License Terms.

4. DISCLAIMER OF WARRANTY. THE SOFTWARE IS PROVIDED "AS IS" WITHOUT WARRANTY OF ANY KIND. ORACLE FURTHER DISCLAIMS ALL WARRANTIES, EXPRESS AND IMPLIED, INCLUDING WITHOUT LIMITATION, ANY IMPLIED WARRANTIES OF MERCHANTABILITY, FITNESS FOR A PARTICULAR PURPOSE OR NONINFRINGEMENT.

5. LIMITATION OF LIABILITY. IN NO EVENT SHALL ORACLE BE LIABLE FOR ANY INDIRECT, INCIDENTAL, SPECIAL, PUNITIVE OR CONSEQUENTIAL DAMAGES, OR DAMAGES FOR LOSS OF PROFITS, REVENUE, DATA OR DATA

USE, INCURRED BY YOU OR ANY THIRD PARTY, WHETHER IN AN ACTION IN CONTRACT OR TORT, EVEN IF ORACLE HAS BEEN ADVISED OF THE POSSIBILITY OF SUCH DAMAGES. ORACLE'S ENTIRE LIABILITY FOR DAMAGES HEREUNDER SHALL IN NO EVENT EXCEED ONE THOUSAND DOLLARS (U.S. \$1,000).

6. **TERMINATION.** This Agreement is effective until terminated. You may terminate this Agreement at any time by destroying all copies of Software. This Agreement will terminate immediately without notice from Oracle if you fail to comply with any provision of this Agreement. Either party may terminate this Agreement immediately should any Software become, or in either party's opinion be likely to become, the subject of a claim of infringement of any intellectual property right. Upon termination, you must destroy all copies of Software.

7. **EXPORT REGULATIONS.** You agree that U.S. export control laws and other applicable export and import laws govern your use of the Software, including technical data; additional information can be found on Oracle's Global Trade Compliance web site (<http://www.oracle.com/products/export>). You agree that neither the Software nor any direct product thereof will be exported, directly, or indirectly, in violation of these laws, or will be used for any purpose prohibited by these laws including, without limitation, nuclear, chemical, or biological weapons proliferation.

8. **TRADEMARKS AND LOGOS.** You acknowledge and agree as between you and Oracle that Oracle owns the ORACLE and JAVA trademarks and all ORACLE- and JAVA-related trademarks, service marks, logos and other brand designations ("Oracle Marks"), and you agree to comply with the Third Party Usage Guidelines for Oracle Trademarks currently located at <http://www.oracle.com/us/legal/third-party-trademarks/index.html>. Any use you make of the Oracle Marks inures to Oracle's benefit.

9. **U.S. GOVERNMENT LICENSE RIGHTS.** If Software is being acquired by or on behalf of the U.S. Government or by a U.S. Government prime contractor or subcontractor (at any tier), then the Government's rights in Software and accompanying documentation shall be only those set forth in this Agreement.

10. **GOVERNING LAW.** This agreement is governed by the substantive and procedural laws of California. You and Oracle agree to submit to the exclusive jurisdiction of, and venue in, the courts of San Francisco, or Santa Clara counties in California in any dispute arising out of or relating to this agreement.

11. **SEVERABILITY.** If any provision of this Agreement is held to be unenforceable, this Agreement will remain in effect with the provision omitted, unless omission would frustrate the intent of the parties, in which case this Agreement will immediately terminate.

12. **INTEGRATION.** This Agreement is the entire agreement between you and Oracle relating to its subject matter. It supersedes all prior or contemporaneous oral or written communications, proposals, representations and warranties and prevails over any conflicting or additional terms of any quote, order, acknowledgment, or other communication between the parties relating to its subject matter during the term of this Agreement. No modification of this Agreement will be binding, unless in writing and signed by an authorized representative of each party.

#### SUPPLEMENTAL LICENSE TERMS

These Supplemental License Terms add to or modify the terms of the Binary Code License Agreement. Capitalized terms not defined in these Supplemental Terms shall have the same meanings ascribed to them in the Binary Code License Agreement.

These Supplemental Terms shall supersede any inconsistent or conflicting terms in the Binary Code License Agreement, or in any license contained within the Software.

A. **SOFTWARE INTERNAL USE FOR DEVELOPMENT LICENSE GRANT.** Subject to the terms and conditions of this Agreement and restrictions and exceptions set forth in the README File incorporated herein by reference, including, but not limited to the Java Technology Restrictions of these Supplemental Terms, Oracle grants you a non-exclusive, non-transferable, limited license without fees to reproduce internally and use internally the Software complete and unmodified for the purpose of designing, developing, and testing your Programs.

B. **LICENSE TO DISTRIBUTE SOFTWARE.** Subject to the terms and conditions of this Agreement and restrictions and exceptions set forth in the README File, including, but not limited to the Java Technology Restrictions of these Supplemental Terms, Oracle grants you a non-exclusive, non-transferable, limited license without fees to reproduce and distribute the Software, provided that (i) you distribute the Software complete and unmodified and only bundled as part of, and for the sole purpose of running, your Programs, (ii) the Programs add significant and primary functionality to the Software, (iii) you do not distribute additional software intended to replace any component(s) of the Software, (iv) you do not remove or alter any proprietary legends or notices contained in the Software, (v) you only distribute the Software subject to a license agreement that protects Oracle's interests consistent with the terms contained in this Agreement, and (vi) you agree to defend and indemnify Oracle and its licensors from and against any damages, costs, liabilities, settlement amounts and/or expenses (including attorneys' fees) incurred in connection with any claim, lawsuit or action by any third party that arises or results from the use or distribution of any and all Programs and/or Software. The license set forth in this Section B does not extend to the Software identified in Section D.

C. **LICENSE TO DISTRIBUTE REDISTRIBUTABLES.** Subject to the terms and conditions of this Agreement and restrictions and exceptions set forth in the README File, including but not limited to the Java Technology Restrictions of these Supplemental Terms, Oracle grants you a non-exclusive, non-transferable, limited license without fees to reproduce and distribute those files specifically identified as redistributable in the README File ("Redistributables") provided that: (i) you distribute the Redistributables complete and unmodified, and only bundled as part of Programs, (ii) the Programs add significant and primary functionality to the Redistributables, (iii) you do not distribute additional software intended to supersede any component(s) of the Redistributables (unless otherwise specified in the applicable README File), (iv) you do not remove or alter any proprietary legends or notices contained in or on the Redistributables, (v) you only distribute the Redistributables pursuant to a license agreement that protects Oracle's interests consistent with the terms contained in the Agreement, (vi) you agree to defend and indemnify Oracle and its licensors from and against any damages, costs, liabilities, settlement amounts and/or expenses (including attorneys' fees) incurred in connection with any claim, lawsuit or action by any third party that arises or results from the use or distribution of any and all Programs and/or Software. The license set forth in this Section C does not extend to the Software identified in Section D.

D. **JAVA TECHNOLOGY RESTRICTIONS.** You may not create, modify, or change the behavior of, or authorize your licensees to create, modify, or change the behavior of, classes, interfaces, or subpackages that are in any way identified as "java", "javax", "javafx", "sun", "oracle" or similar convention as specified by Oracle in any naming convention designation. You shall not redistribute the Software listed on Schedule 1.

E. **SOURCE CODE.** Software may contain source code that, unless expressly licensed for other purposes, is provided solely for reference purposes pursuant to the terms of

this Agreement. Source code may not be redistributed unless expressly provided for in this Agreement.

F. **THIRD PARTY CODE.** Additional copyright notices and license terms applicable to portions of the Software are set forth in the THIRDPARTYLICENSEREADME file set forth in the Software or otherwise available from Oracle at or through the following URL:

<http://www.oracle.com/technetwork/java/javase/documentation/index.html>. In addition to any terms and conditions of any third party opensource/freeware license identified in the THIRDPARTYLICENSEREADME file, the disclaimer of warranty and limitation of liability provisions in paragraphs 4 and 5 of the Binary Code License Agreement shall apply to all Software in this distribution.

G. **TERMINATION FOR INFRINGEMENT.** Either party may terminate this Agreement immediately should any Software become, or in either party's opinion be likely to become, the subject of a claim of infringement of any intellectual property right.

H. **INSTALLATION AND AUTO-UPDATE.** The Software's installation and auto-update processes transmit a limited amount of data to Oracle (or its service provider) about those specific processes to help Oracle understand and optimize them. Oracle does not associate the data with personally identifiable information. You can find more information about the data Oracle collects as a result of your Software download at

<http://www.oracle.com/technetwork/java/javase/documentation/index.html>.

For inquiries please contact: Oracle America, Inc., 500 Oracle Parkway, Redwood Shores, California 94065, USA.

License for Archived Java SE Technologies; Last updated 13 March 2012.

## J.5 The MIT License (MIT)

Permission is hereby granted, free of charge, to any person obtaining a copy of this software and associated documentation files (the "Software"), to deal in the Software without restriction, including without limitation the rights to use, copy, modify, merge, publish, distribute, sublicense, and/or sell copies of the Software, and to permit persons to whom the Software is furnished to do so, subject to the following conditions:

The above copyright notice and this permission notice shall be included in all copies or substantial portions of the Software.

THE SOFTWARE IS PROVIDED "AS IS", WITHOUT WARRANTY OF ANY KIND, EXPRESS OR IMPLIED, INCLUDING BUT NOT LIMITED TO THE WARRANTIES OF MERCHANTABILITY, FITNESS FOR A PARTICULAR PURPOSE AND NONINFRINGEMENT. IN NO EVENT SHALL THE AUTHORS OR COPYRIGHT HOLDERS BE LIABLE FOR ANY CLAIM, DAMAGES OR OTHER LIABILITY, WHETHER IN AN ACTION OF CONTRACT, TORT OR OTHERWISE, ARISING FROM, OUT OF OR IN CONNECTION WITH THE SOFTWARE OR THE USE OR OTHER DEALINGS IN THE SOFTWARE.

---

---

## Setting up RUEI against a remote database Service

This appendix contains information on setting up RUEI against a remote database service including the pluggable database.

In a 'standard' setup, the Reporter Database Instance is created using `ruei-prepare-db.sh` which, along with other helper scripts, is to be executed on the host on which the Oracle Database software is installed. There are cases, however, in which you do not have access to the command-line of the database server, or where having to copy the scripts over is inconvenient. This includes Pluggable Database setups.

The sections in this appendix describe the following:

- [Prerequisites](#)
- [Setting Up](#)
- [Running `ruei-prepare-db.sh`](#)

### K.1 Prerequisites

- An existing database instance or Pluggable Database. The database instance or Container Database (if using a Pluggable Database) needs to be configured using paragraph B.1 and B.2 of [Appendix B, "Generic Database Instance Setup"](#) as a reference for the required options (e.g. Character Set).
- The fully-qualified connection string to the remote database service. In case of a pluggable database setup, this should be the name of the pluggable database, not the container database.
- The password for the SYS user who has "sysdba" rights. In case of a pluggable database setup this should be the `-global-` SYS user.

### K.2 Setting Up

- As the "root" user, issue the following commands:
  - `cd /usr/local`
  - `tar xzf /root/RUEI/mkstore/mkstore-11.2.0.4.0.tar.gz`
- This installs the `mkstore` utility to `/usr/local/mkstore-11.2.0.4.0`. To make the install directory version independent, create a more generic symlink using the following command:
  - `ln -s /usr/local/mkstore-11.2.0.4.0 /usr/local/mkstore`

- Add/change the following settings in /etc/ruei.conf:
  - export DEFAULT\_TABLESPACE=<name\_of\_default\_tablespace>
  - export REMOTE\_DB=1
  - export  
DBCONNECT="(DESCRIPTION=(ADDRESS=(PROTOCOL=TCP)(Host=<databasehostname>)(Port=<port>))(CONNECT\_DATA=(service\_name=<service name>)))"
  - export RUEI\_DB\_INST=<name of service or sid>
  - export MKSTORE\_BIN=/usr/local/mkstore/mkstore

All values between <> serve as an example. Replace them with values appropriate to your setup.

### K.3 Running ruei-prepare-db.sh

Running ruei-prepare-db.sh on the reporter system:

Make "ruei-prepare-db.sh" and the "sql\_scripts" subdirectory available to the \$RUEI\_USER user (e.g. /tmp) and set the proper permissions by issuing the following commands:

- cd /tmp
- chmod +x ruei-prepare-db.sh
- chmod -R +r sql\_scripts/

As the "\$RUEI\_USER" user, issue the following commands

- cd /tmp
- ./ruei-prepare-db.sh create

The ruei-prepare-db.sh script will execute all regular steps, except creating the instance and will prompt for the password of the database SYS user, a password for the RUEI user and a password for the wallet

---

---

# Index

## A

---

accounts  
    database, A-1  
    Security Officer, 6-6  
Administrator, 6-1  
Apache Web server, 2-11

## C

---

checklist, A-1, E-1, H-1  
client requirements, 1-21  
Collector  
    checking status, 6-7  
    configuring, 6-4  
    resetting, 6-5  
configuration  
    apache, 2-11  
    browser redirection, 2-21  
    Collector, 6-4  
    failover Reporter, 9-1, 11-1  
    file, 2-8, 8-3  
    initial RUEI, 6-1  
    MTA, 2-19  
    network interface, 2-19  
    OAM, 7-1  
    OS security, 2-3, 8-2  
    PHP, 2-11  
    post-installation, 6-1  
    Reporter communication, 2-21, 8-7  
    secondary Collector, 10-3  
    SNMP, 2-20  
cookie technology, 6-5  
cookies, B-1, C-1, F-1  
copy ports, 1-6

## D

---

data retention policies, 1-16  
database  
    generic setup, B-1  
    installation, 2-7  
    Processing Engine, 8-4  
deployment, 1-15

## E

---

Enriched data export, C-1

## F

---

failover  
    Collector, 10-1  
    Processing Engine, 11-1  
    Reporter, 9-1, 11-1  
Forms traffic, 1-5, 1-16  
full session replay, 1-17

## H

---

hardware requirements, 1-13

## I

---

installation  
    checklist, A-1, E-1, H-1  
    data collection, 1-3  
    database instant client, 2-12, 8-4  
    Java, 2-10  
    Oracle database, 2-7, 8-3  
    Oracle database directory, A-3  
    Oracle HTTP server, 5-2  
    prerequisites, 2-1, 8-1  
    Processing Engine, 8-1  
    remote Collector, 2-17, 2-18  
    Reporter, 2-16, 8-6  
    RUEI software, 2-7  
    secondary Collector, 10-3  
    secondary Processing Engine, 11-1  
    secondary Reporter, 9-2, 11-2  
    verifying, 2-22  
installation checklist, A-1, E-1, H-1  
Instant Client, 2-12, 8-4

## J

---

Java, 2-10

## L

---

Linux  
    NTP daemon, 2-3, 8-2

requirements, 1-19

## M

---

mail setup, 6-3

memory requirements, 1-18

MTA configuration, 2-19

multibyte fonts, 2-19

## N

---

network

cards, 1-13

configuration, 2-19

requirements, 1-19

traffic, 6-6

verifying traffic, F-1

NTP daemon, 2-3, 8-2

## O

---

OAM, 7-1

Oracle database

init script file, A-6

installation directory, A-3

Instant Client, 2-12, 8-4

kernel settings, A-2

required packages, 2-5, 8-3

shell limits, A-2

user accounts and groups, A-1

user's environment, A-3

Oracle wallet, B-5, C-4

## P

---

pages names, 6-6

php-oci8 module, 2-12

Processing Engines, 8-1

## R

---

Reporter

configuring communication, 2-21, 8-7

failover system, 9-1

installation, 2-11, 8-4

upgrading, 3-1

requirements

client, 1-21

disk space, 2-2, 8-1

FSR storage, 1-17

hardware, 1-13

memory, 1-18

network, 1-19

software, 1-19

rsvg warnings, 2-11

RUEI

client requirements, 1-21

configuration file, 2-8, 8-3

configuring, 6-1

confirming data collection, 6-7

connection options, 1-5

deployment, 1-15

hardware requirements, 1-13

installation checklist, A-1, E-1, H-1

introduction, 1-1

mail setup, 6-3

naming pages, 6-6

network requirements, 1-19

obtaining software, 2-7

post-installation configuration, 6-5

Processing Engines, 8-1

scope of monitoring, 6-6

security, 1-5

software requirements, 1-19

troubleshooting, G-1

verifying, 6-6

ruei-check.sh script, A-1, E-1

ruei.conf file, 2-8, 8-3

## S

---

security, 1-5

Sendmail MTA, 2-19

SNMP, 2-20

software requirements, 1-19

SSL keys, 1-5, 6-5

SSO authentication, 5-1

## T

---

TAPs, 1-7

TCP diagnostics, F-1

third-party licenses, J-1

troubleshooting, G-1

## U

---

upgrade

accelerator packages, 3-1

remote Collector, 3-3

Reporter system, 3-2

users

authorizing, 6-6

identification, 6-5

Oracle database, A-1

Oracle database environment, A-3

## W

---

wizard

initial setup, 6-2

## Z

---

Zend Guard Loader, 2-12

Zend Optimizer, 2-12