

Gateway Services User Guide
**Oracle FLEXCUBE Enterprise Limits
and Collateral Management**
Release 14.0.0.0.0

Part Number E88409-01

November 2017

Gateway Services User Guide
November 2017
Oracle Financial Services Software Limited

Oracle Park

Off Western Express Highway
Goregaon (East)
Mumbai, Maharashtra 400 063
India

Worldwide Inquiries:

Phone: +91 22 6718 3000

Fax: +91 22 6718 3001

www.oracle.com/financialservices/

Copyright © 2007, 2017, Oracle and/or its affiliates. All rights reserved.

Oracle and Java are registered trademarks of Oracle and/or its affiliates. Other names may be trademarks of their respective owners.

U.S. GOVERNMENT END USERS: Oracle programs, including any operating system, integrated software, any programs installed on the hardware, and/or documentation, delivered to U.S. Government end users are "commercial computer software" pursuant to the applicable Federal Acquisition Regulation and agency-specific supplemental regulations. As such, use, duplication, disclosure, modification, and adaptation of the programs, including any operating system, integrated software, any programs installed on the hardware, and/or documentation, shall be subject to license terms and license restrictions applicable to the programs. No other rights are granted to the U.S. Government.

This software or hardware is developed for general use in a variety of information management applications. It is not developed or intended for use in any inherently dangerous applications, including applications that may create a risk of personal injury. If you use this software or hardware in dangerous applications, then you shall be responsible to take all appropriate failsafe, backup, redundancy, and other measures to ensure its safe use. Oracle Corporation and its affiliates disclaim any liability for any damages caused by use of this software or hardware in dangerous applications.

This software and related documentation are provided under a license agreement containing restrictions on use and disclosure and are protected by intellectual property laws. Except as expressly permitted in your license agreement or allowed by law, you may not use, copy, reproduce, translate, broadcast, modify, license, transmit, distribute, exhibit, perform, publish or display any part, in any form, or by any means. Reverse engineering, disassembly, or decompilation of this software, unless required by law for interoperability, is prohibited.

The information contained herein is subject to change without notice and is not warranted to be error-free. If you find any errors, please report them to us in writing.

This software or hardware and documentation may provide access to or information on content, products and services from third parties. Oracle Corporation and its affiliates are not responsible for and expressly disclaim all warranties of any kind with respect to third-party content, products, and services. Oracle Corporation and its affiliates will not be responsible for any loss, costs, or damages incurred due to your access to or use of third-party content, products, or services.

Contents

1. Preface	1-1
1.1 Introduction.....	1-1
1.2 Audience.....	1-1
1.3 Documentation Accessibility.....	1-1
1.4 Acronyms and Abbreviations.....	1-1
1.5 Organization	1-1
1.6 Related Documents	1-2
1.7 Glossary of Icons.....	1-2
2. Gateway Functions - An Overview	2-1
2.1 Introduction.....	2-1
2.2 Inbound Application Integration	2-1
2.2.1 EJB Based Synchronous Deployment Pattern	2-1
2.2.2 Web Services Based Synchronous Deployment Pattern.....	2-2
2.2.3 HTTP Servlet Based Synchronous Deployment Pattern	2-2
2.2.4 MDB Based Asynchronous Deployment Pattern	2-2
2.3 Outbound Application Integration	2-3
2.4 Responsibilities of Integration Gateway	2-3
2.5 Deployment of Oracle FLEXCUBE Integration Gateway.....	2-3
2.6 Deployment Patterns for Application Integration	2-4
3. External System Maintenance	3-1
3.1 Introduction.....	3-1
3.2 External System	3-1
3.2.1 Defining an External System	3-1
3.2.2 Specifying External System Details	3-2
3.2.3 Indicating Correlation Pattern	3-2
3.2.4 Specifying Message Exchange Pattern	3-2
3.2.5 Specifying Queue Details	3-3
3.2.6 Specifying External System Queue Details	3-3
3.2.7 Viewing External System Details	3-3
3.2.8 Accessing Services and Operations	3-4
3.3 Access Rights to an External System.....	3-5
3.3.1 Defining Access Rights to an External System.....	3-5
3.3.2 Viewing External System Function Details	3-6
3.3.3 Defining Access Rights to a User ID.....	3-7
3.3.4 Maintaining Upload Source Details.....	3-7
3.3.5 Specifying Upload Source Preferences	3-8
3.3.6 Maintaining Function ID Preferences.....	3-9
3.4 Gateway Password Generation Logic For External System Authentication.....	3-10
3.4.1 Password and Message ID as input	3-11
3.5 Incoming Message Browser	3-11
3.5.1 Viewing Incoming Message Details	3-13
3.6 Duplicate Message Browser.....	3-13
3.6.1 Querying Duplicate Message Browser	3-15
3.7 Outgoing Message Browser	3-16
3.7.1 Querying Outgoing Message Browser.....	3-19
3.8 Defining Notification Messages	3-19
3.8.1 Viewing Installed Notification Details	3-21

3.9	Defining the Notifications Enroutes	3-22
3.9.1	<i>Viewing Summary screen</i>	3-23
3.10	Amendment Maintenance.....	3-23
3.10.1	<i>Maintaining Gateway Amendment Details</i>	3-23
4.	Message Formats	4-1
4.1	Introduction.....	4-1
4.2	Oracle FLEXCUBE Envelope	4-2
4.2.1	<i>FCUBS HEADER</i>	4-3
4.2.2	<i>FCUBS_BODY</i>	4-5
4.3	Oracle FLEXCUBE NOTIFICATION.....	4-6
4.3.1	<i>FCUBS NOTIFICATION HEADER</i>	4-6
5.	Annexure – List of Messages	5-1
5.1	Introduction.....	5-1
5.2	Inbound Application Integration – Services	5-1
6.	Planned Outage Support Server	6-1
6.1	Introduction.....	6-1
6.2	Handling Planned Outages.....	6-1
6.2.1	<i>Host Up</i>	6-1
6.2.2	<i>Outage Start</i>	6-2
6.2.3	<i>Host Down and POSS Up:</i>	6-2
6.2.4	<i>Host Up, Start Replay from POSS:</i>	6-2
6.2.5	<i>ELCM Impact</i>	6-3
6.3	Services Supported during Outage	6-3

1. Preface

1.1 Introduction

This manual is designed to help you quickly get acquainted with the Integration Gateway of Oracle FLEXCUBE ELCM.

It provides an overview to the module, and provides information on using the Integration Gateway module of Oracle FLEXCUBE ELCM. This user manual is a supplement to the Common Core - Core Entities and Services User Manual and contains only specific functionalities and information related to Oracle ELCM Gateway Services. Hence, this document should be read in conjunction with the Common Core - Core Entities and Services User Manual from the perspective of completeness in flow and understanding.

You can further obtain information specific to a particular field by placing the cursor on the relevant field and striking <F1> on the keyboard.

1.2 Audience

This manual is intended for the following User/User Roles:

Role	Function
IT department members responsible for integration	Input functions for maintenance related to the gateway
IT managers	Authorization functions

1.3 Documentation Accessibility

For information about Oracle's commitment to accessibility, visit the Oracle Accessibility Program website at <http://www.oracle.com/pls/topic/lookup?ctx=acc&id=docacc>.

1.4 Acronyms and Abbreviations

Abbreviation	Description
FLEXCUBE ELCM	FLEXCUBE Enterprise Limit Collateral Management

1.5 Organization

The manual is organized in the following manner:

Chapter	Description
Chapter 1	<i>About this Manual</i> gives information on the intended audience. It also lists the various chapters covered in this User Manual.
Chapter 2	<i>Gateway Functions - An Overview</i> explains the features of this module.





Chapter 3	<i>External System Maintenance</i> explains the maintenance of external systems and the various processes involved.
Chapter 4	<i>Message Formats</i> explains the different message formats.
Chapter 5	<i>Annexure – List of Messages</i> lists all the messages that you encounter while working with Oracle FLEXCUBE ELCM Gateway services.
Chapter 6	<i>Planned Outage Support Server</i> describes the process of having a support server to substitute the host server during downtime.
Chapter 7	<i>Function ID Glossary</i> has alphabetical listing of Function/Screen ID's used in the module with page references for quick navigation.

1.6 Related Documents

- Core Entities User Manual
- Procedures User Manual
- Settlements User Manual
- Profit and Charges User Manual
- Common Core - Core Entities and Services

1.7 Glossary of Icons

This User Manual may refer to all or some of the following icons:

Icons	Function
	Exit
	Add row
	Delete row
	Option List

2. Gateway Functions - An Overview

2.1 Introduction

Integration of different applications and solutions is a key area in today's systems. A variety of specialized applications deployed on disparate platforms and using different infrastructure need to be able to communicate and integrate seamlessly with Oracle FLEXCUBE in order to exchange data. The Oracle FLEXCUBE Integration Gateway (referred to as 'Gateway' in the rest of the document) will cater to these integration needs.

The integration needs supported by the Gateway can be broadly categorized from the perspective of the Gateway as follows:

- Inbound application integration – used when any external system needs to add, modify or query information within Oracle FLEXCUBE
- Outbound application integration – used when any external system needs to be notified of the various events that occur within Oracle FLEXCUBE.

This chapter contains the following sections:

- [Section 2.2, "Inbound Application Integration "](#)
- [Section 2.3, "Outbound Application Integration "](#)
- [Section 2.4, "Responsibilities of Integration Gateway"](#)
- [Section 2.5, "Deployment of Oracle FLEXCUBE Integration Gateway"](#)
- [Section 2.6, "Deployment Patterns for Application Integration "](#)

2.2 Inbound Application Integration

Oracle FLEXCUBE Inbound Application Gateway provides XML based interfaces thus enhancing the need to communicate and integrate with the external systems. The data exchanged between Oracle FLEXCUBE and the external systems will be in the form of XML messages. These XML messages are defined in FCUBS in the form of XML Schema Documents (XSD) and are referred to as 'FCUBS formats'

For more information on FCUBS formats refer the Message Formats chapter in this User Manual.

FCUBS Inbound Application Integration Gateway uses the Synchronous and Asynchronous Deployment Pattern for addressing the integration needs.

The Synchronous Deployment Pattern is classified into the following:

- Oracle FLEXCUBE EJB Based Synchronous Inbound Application Integration Deployment Pattern
- Oracle FLEXCUBE Web Services Based Synchronous Inbound Application Integration Deployment Pattern
- Oracle FLEXCUBE HTTP Servlet Based Synchronous Inbound Application Integration Deployment Pattern

Asynchronous Deployment Pattern is:

- Oracle FLEXCUBE MDB Based Asynchronous Inbound Application Integration Deployment Pattern

This section contains the following topics:

- [Section 2.2.1, "EJB Based Synchronous Deployment Pattern"](#)
- [Section 2.2.2, "Web Services Based Synchronous Deployment Pattern"](#)
- [Section 2.2.3, "HTTP Servlet Based Synchronous Deployment Pattern"](#)
- [Section 2.2.4, "MDB Based Asynchronous Deployment Pattern"](#)

2.2.1 EJB Based Synchronous Deployment Pattern

The Enterprise Java Beans (EJB) deployment pattern will be used in integration scenarios where the external system connecting to Oracle FLEXCUBE is 'EJB literate', i.e., the external system is capable of interacting with Oracle FLEXCUBE based upon the EJB interface. In this deployment pattern, the external system will use the RMI/IIOP protocol to communicate with the Oracle FLEXCUBE EJB.

In this deployment pattern the EJB displayed by Oracle FLEXCUBE will be a stateless session bean. The actual request is in the form of an XML message. After the necessary processing is done in Oracle FLEXCUBE based on the request, the response is returned to the external system as an XML message. The transaction control for the processing will stay with the Oracle FLEXCUBE EJB.

2.2.2 Web Services Based Synchronous Deployment Pattern

The web services deployment pattern is used in integration scenarios where the external system connecting to Oracle FLEXCUBE wants to connect using standards-based, interoperable web services.

This deployment pattern is especially applicable to systems which meet the following broad guidelines:

- Systems that are not 'EJB literate', that is, such systems are not capable of establishing connections with Oracle FLEXCUBE based upon the EJB interface; and/or
- Systems that prefer to use a standards-based approach

In this deployment pattern, the external system uses the SOAP (Simple Object Access Protocol) messages to communicate to the Oracle FLEXCUBE web services.

The services displayed by Oracle FLEXCUBE are of a 'message based' style, that is, the actual request is in the form of an XML message, but the request is a 'payload' within the SOAP message. After the necessary processing is done in Oracle FLEXCUBE based on the request, the response is returned to the external system as an XML message which is 'payload' within the response SOAP message. The transaction control for the processing stays with the Oracle FLEXCUBE.

2.2.3 HTTP Servlet Based Synchronous Deployment Pattern

The HTTP servlet deployment pattern will be used in integration scenarios where the external system connecting to Oracle FLEXCUBE wants to connect to Oracle FLEXCUBE using simple HTTP messages.

This is especially applicable to systems such as the following:

- Systems that are not 'EJB literate', that is, are not capable establishing a connections with Oracle FLEXCUBE based upon the EJB interface; and/or
- Systems that prefer to use a simple http message based approach without wanting to use SOAP as the standard

In this deployment pattern, the external system makes an HTTP request to the Oracle FLEXCUBE servlet.

For this deployment pattern, Oracle FLEXCUBE displays a single servlet. The actual request is in the form of an XML message. This XML message is embedded into the body of the HTTP request sent to the Oracle FLEXCUBE servlet. After the necessary processing is done in Oracle FLEXCUBE based on the request, the response is returned to the external system as an XML message which is once again embedded within the body of the response HTTP message. The transaction control for the processing stays with the Oracle FLEXCUBE.

2.2.4 MDB Based Asynchronous Deployment Pattern

The MDB deployment pattern is used in integration scenarios where the external system connecting to Oracle FLEXCUBE wants to connect to Oracle FLEXCUBE using JMS queues.

This is especially applicable to systems such as the following:

- Systems that prefer to use JMS queues based approach without wanting to wait for the reply

Here external system sends messages in XML format to request queue on which an MDB is listening. When a message arrives on the queue, it is picked up for processing. After the necessary processing is done in Oracle FLEXCUBE, based on the request, the response is sent to the response queue as an XML message

2.3 Outbound Application Integration

The Outbound Application Integration is also called the Oracle FLEXCUBE Notify Application Integration layer. This application layer sends out notification messages to the external system whenever events occur in Oracle FLEXCUBE.

The notification messages generated by FCUBS on the occurrence of these events will be XML messages. These XML messages are defined in FCUBS in the form of XML Schema Documents (XSD) and are referred to as 'FCUBS formats'

For more information on FCUBS formats refer the Message Formats chapter in this module.

2.4 Responsibilities of Integration Gateway

The primary responsibilities of Oracle FLEXCUBE Integration Gateway include the following:

- Authentication
- Duplicate recognition
- Validation
- Routing
- Logging of messages

2.5 Deployment of Oracle FLEXCUBE Integration Gateway

Message communication - incoming or outgoing from/to an external system in Oracle FLEXCUBE will happen only through an Oracle FLEXCUBE Integration Gateway. Hence, it becomes the first point of contact or last point of contact with the database in message flow. The Oracle FLEXCUBE Integration Gateway can be deployed to support both the distributed and single schema deployments of Oracle FLEXCUBE:

- Distributed deployment of FCUBS – In this situation the database components of the Gateway are deployed as two or more schemas
 - The messaging schema as part of SMS schema in the SMS and/or HO instance
 - The business schema(s) in the various branch schemas in the branch instance(s)
- Single schema deployment of FCUBS – In this situation the database components of the Gateway (messaging and business) are both deployed as part of the single Oracle FLEXCUBE schema.

2.6 Deployment Patterns for Application Integration

Business Integration Needs	Nature of Integration	Oracle FLEXCUBE Deployment Pattern	Remarks
Inbound Transactions into Oracle FLEXCUBE	Synchronous	FLEXCUBE UBS EJB	Recommended
		FLEXCUBE UBS HTTP Servlet	This can be used if the external system cannot communicate to Oracle FLEXCUBE using EJB.
		FLEXCUBE UBS Web Services	This can be used if the external system chooses to communicate only through Web Services.
	Asynchronous	FLEXCUBE UBS MDB	This can be used if the external system chooses to communicate only through JMS queues
Inbound Queries into Oracle FLEX-CUBE	Synchronous	FLEXCUBE UBS EJB	Recommended
		FLEXCUBE UBS In Servlet	This can be used if the external system cannot communicate to Oracle FLEXCUBE using EJB.
		FLEXCUBE UBS Web Services	This can be used if the external system chooses to communicate only through Web Services.
	Asynchronous	FLEXCUBE UBS MDB	This can be used if the external system chooses to communicate only through JMS queues
Handoffs from Oracle FLEX-CUBE	Asynchronous	FLEXCUBE UBS Notify	Recommended

3. External System Maintenance

3.1 Introduction

This chapter contains the following sections:

- [Section 3.2, "External System"](#)
- [Section 3.3, "Access Rights to an External System"](#)
- [Section 3.4, "Gateway Password Generation Logic For External System Authentication"](#)
- [Section 3.5, "Incoming Message Browser"](#)
- [Section 3.6, "Duplicate Message Browser"](#)
- [Section 3.7, "Outgoing Message Browser"](#)
- [Section 3.8, "Defining Notification Messages"](#)
- [Section 3.9, "Defining the Notifications Enroutes"](#)
- [Section 3.10, "Amendment Maintenance"](#)

3.2 External System

This section contains the following topics:

- [Section 3.2.1, "Defining an External System"](#)
- [Section 3.2.2, "Specifying External System Details"](#)
- [Section 3.2.3, "Indicating Correlation Pattern "](#)
- [Section 3.2.4, "Specifying Message Exchange Pattern"](#)
- [Section 3.2.5, "Specifying Queue Details"](#)
- [Section 3.2.6, "Specifying External System Queue Details"](#)
- [Section 3.2.7, "Viewing External System Details"](#)
- [Section 3.2.8, "Accessing Services and Operations "](#)

3.2.1 Defining an External System

You need to define an external system that will communicate with the Oracle FLEXCUBE Integration Gateway.

You can define an external system using the 'External System – Detailed' screen.

You can invoke this screen by typing 'GWDEXSYS' in the field at the top right corner of the Application tool bar and clicking the adjoining arrow button.

The various details required by the 'External System - Detailed' screen are described below.

3.2.2 Specifying External System Details

External System

Specify a name for the external system. This should be the same as the Source in an incoming message.

Description

Specify a brief description for the External System.

3.2.3 Indicating Correlation Pattern

Request

You can define a way in which the external system should correlate its request message with the response message. You can choose Message ID of a request message as the Correlation ID in the response message. Alternatively, you can choose Correlation ID of a request message and maintain it as the Correlation ID of the corresponding response message.

3.2.4 Specifying Message Exchange Pattern

Request Message

You can choose the Request message to be 'Full Screen' or 'Input Only'. If you select 'Full Screen' as the request message, the response message will also display 'Full Screen'.

Response Message

You can choose the Response message to be 'Full Screen' or 'Record Identification Msg'.

Note

You can select 'Record Identification Msg' as the response message only if you select 'Input Only' in the request message.

3.2.5 Specifying Queue Details

Default Response Queue

You can define a response queue for each of the In Queue's through which the External System will communicate with Oracle FLEXCUBE. Define a valid queue name as the Default Response Queue.

Dead Letter Queue

If the messages received are non-readable, such messages are directed to Dead Letter Queue defined for the external system.

Note

If the Dead Letter Queue is not defined, such messages will be redirected to a queue with the name of the request queue appended with '_E'.

XSD Validation Required

Check this box to indicate if the request message should be validated against its corresponding XSD.

Register Response Queue Message ID

Check this box to indicate if the message ID provided by the Response Queue should be logged when a response message is posted into the queue.

3.2.6 Specifying External System Queue Details

The 'External System Queues' list contains the 'In Queue' and 'Response Queue' lists. To add a record to the 'External System Queues' list click add icon. To delete a record from the list, select the record using its check box and then click delete icon.

In Queue

Specify the name of the queue from which the messages were received. The name of the queue will help identify the external system.

Note

This is required only if an incoming message does not display the source of the message. An In Queue is mapped to only one External System.

You can map multiple queues to a source. System will allow a source to post messages to multiple queues.

Response Queue

You can define Response Queue for every In Queue. This is required only when the External System fails to display the queue name on posting a request message into the In Queue.

3.2.7 Viewing External System Details

The details of previously defined external Systems can be viewed using the 'External System - Summary' screen as shown below. You can invoke this screen by typing 'GWSEXSYS' in

the field at the top right corner of the Application tool bar and clicking the adjoining arrow button.

The screenshot shows a web application window titled "Summary". At the top, there are "Advanced Search" and "Reset" buttons. Below this, there are five search criteria fields: "Authorization Status" (a dropdown menu), "Record Status" (a dropdown menu), "External System" (a text input with a search icon), "Dead Letter Queue" (a text input with a search icon), and "Default Response Queue" (a text input with a search icon). Below the search fields is a pagination bar with "Records per page" set to 15, and buttons for "First", "Previous", "1 Of 1", "Next", "Last", and "Go". Below the pagination bar is a table with five columns: "Authorization Status", "Record Status", "External System", "Default Response Queue", and "Dead Letter Queue". The table is currently empty. At the bottom of the window, there are buttons for "Authoriza", "Record St", and "Exit".

This summary screen can be used to search for external systems which match the data specified for any of the following criteria:

- Authorization Status
- External System
- Dead Letter Queue
- Record Status
- Default Response Queue

The 'Result' list shows the external systems which match your query. The search functions available are:

Advanced

Click **Advanced** to specify queries with logical operators such as AND, OR and NOT.

Reset

Click **Reset** to empty the values in the criteria fields, so that you may begin a new search.

Query

After specifying your search criteria click **Query** to view the list of results which match your search criteria.

Refresh

Click **Refresh** to refresh the list of results.

3.2.8 Accessing Services and Operations

In a message it is mandatory to maintain a list of Service Names and Operation Codes. This information is called Gateway Operations.

A combination of every such Service Name and Operation Code is mapped to a combination of Function ID and Action. Every screen in Oracle FLEXCUBE is linked with a function ID. This information is called Gateway Functions.

You can gain access to an external system using the Gateway Functions. The Function IDs mapped in Gateway Functions should be valid Function IDs maintained in Oracle FLEXCUBE. Hence, for every new Service or Operation being introduced, it is important that you provide data in Gateway Operations and Gateway Functions.

Refer the Message Formats chapter for more information on Services and Operations.

3.3 Access Rights to an External System

This section contains the following topics:

- [Section 3.3.1, "Defining Access Rights to an External System"](#)
- [Section 3.3.2, "Viewing External System Function Details"](#)
- [Section 3.3.3, "Defining Access Rights to a User ID"](#)
- [Section 3.3.4, "Maintaining Upload Source Details"](#)
- [Section 3.3.5, "Specifying Upload Source Preferences"](#)
- [Section 3.3.6, "Maintaining Function ID Preferences"](#)

3.3.1 Defining Access Rights to an External System

You can define access rights to an external system using the 'External System Functions – Detailed' screen.

You can invoke this screen by typing 'GWDEXFUN' in the field at the top right corner of the Application tool bar and clicking the adjoining arrow button.

The screenshot shows the 'External System Functions - Detailed' window. At the top, there are 'New' and 'Enter Query' buttons. The main area contains a form with the following fields: 'External System *', 'Function *', 'Action *', 'Service Name', and 'Operation Code'. Each of these fields has a small icon to its right. To the right of the form is a 'Description' field. At the bottom of the window, there is a 'Fields' section with the following items: 'Input By' and 'Authorized By' (both with 'Date Time' fields), 'Modification Number', and two checkboxes labeled 'Authorized' and 'Open'. An 'Exit' button is located in the bottom right corner of the window.

In the above screen, you need to specify the following details:

External System

Select an external system for which you wish to provide access rights. The adjoining option list displays all the external systems you have maintained in the 'External Systems – Detailed' screen.

Function ID

Select a Function ID from the list of values by clicking the adjoining option list. The function ids are invoked from Gateway Functions.

Action

Select an action for the external system from the option list provided.

Service Name

This displays the service name based on the Function ID and Action you select.

Operation Code

This displays the Operation Code based on the Function ID and Action you select.

3.3.2 Viewing External System Function Details

You can view the access rights details which have already been defined using the 'External System Functions - Summary' screen as shown below. You can invoke this screen by typing 'GWSEXFUN' in the field at the top right corner of the Application tool bar and clicking the adjoining arrow button.

Authorization Status	Record Status	External System	Function	Action
----------------------	---------------	-----------------	----------	--------

This summary screen can be used to search for external system functions which match any of the following criteria:

- Authorization Status
- External System
- Record Status
- Action
- Function

The 'Result' list shows the external system functions which match your query. The search functions available are:

Advanced

Click **Advanced** to specify queries with logical operators such as AND, OR and NOT.

Reset

Click **Reset** to empty the values in the criteria fields, so that you may begin a new search.

Query

After specifying your search criteria click **Query** to view the list of results which match your search criteria.

Refresh

Click **Refresh** to refresh the list of results.

3.3.3 Defining Access Rights to a User ID

For a User ID to access a request message, you can individually map each Function ID to a User ID.

Note

You can provide access to functions only if the Function IDs provided in Gateway Functions are valid.

3.3.4 Maintaining Upload Source Details

Oracle FLEXCUBE facilitates upload of data from an external source. The details of the source from which data has to be uploaded need to be maintained in Oracle FLEXCUBE using the 'Upload Source Maintenance' screen. You can invoke the 'Upload Source Maintenance' screen by typing 'CODSORCE' in the field at the top right corner of the Application tool bar and clicking the adjoining arrow button.

The screenshot shows the 'Upload Source Definition' window. The title bar includes a diamond icon and the text 'Upload Source Definition'. Below the title bar are two buttons: 'New' and 'Enter Query'. The main content area contains a 'Source Code *' field, a 'Description' field with a help icon, and two checkboxes: 'Base Data From FLEXCUBE' and 'System Authorization Required'. At the bottom, there is a 'Fields' section with three columns: 'Input By Date Time', 'Authorized By Date Time', and 'Modification Number'. Under 'Modification Number', there are two checkboxes: 'Authorized' and 'Open'.

The following details need to be captured here:

Source Code

Specify a code for the source from which data has to be uploaded to Oracle FLEXCUBE.

Description

Give a small description for the source code specified.

Base Data From FLEXCUBE

Check this box to indicate if base data has to be uploaded from Oracle FLEXCUBE.

3.3.5 Specifying Upload Source Preferences

You can set preferences for upload of data from an external source in the 'Upload Source Preferences Maintenance' screen. You can invoke the 'Upload Source Preferences Maintenance' screen by typing 'CODUPLDM' in the field at the top right corner of the Application tool bar and clicking the adjoining arrow button.

The screenshot shows the 'Upload Source Preferences Maintenance' window. It features a top toolbar with 'New' and 'Enter Query' buttons. The main area is divided into sections: 'Error Handling' with fields for 'Source Code *', 'Module Code *', and 'On Exception *' (set to 'Reject'), and 'On Override *' (set to 'Ignore'). The 'Post Upload' section includes a 'Status *' dropdown (set to 'Authorized'), a 'Purge Days(Calendar)' field, and three unchecked checkboxes: 'Allow Deferred Processing', 'Allow EOD with Deferred', and 'Allow Delete'. A bottom toolbar contains 'Input By', 'Authorized By', and 'Modification Number' labels, with 'Date Time' under the first two and 'Authorized'/'Open' checkboxes under the third. An 'Exit' button is in the bottom right.

The following details are captured here:

Source Code

Select Source Code from the option list. Depending on the source code you select here data is uploaded from that source into Oracle FLEXCUBE.

Module Code

You can choose to upload data from a source directly onto a module in FLEXCUBE. Indicate the module into which you would like to upload data from a given source.

On Override

Oracle FLEXCUBE generates override messages in case it encounters any discrepancies during data upload. You can choose to do any of the following:

- Ignore – Select this option to ignore such error messages and continue with the upload process
- Put on Hold – Select this option to put the record on hold for user intervention later
- Reject – Select this option to reject the record

On Exception

In case a serious error occurs during data upload, Oracle FLEXCUBE generates an error message. You can choose to put the record with the error on hold. In such a case, choose 'Put on Hold' from the list of options available. If you would like to reject the record altogether, choose 'Reject'.

Post Upload Status

If you would like to automatically authorize the data that is uploaded into Oracle FLEXCUBE choose the 'Authorize' option here.

If you would like the record to be put on hold choose this option in this field.

If you would like the record to be unauthorized, choose the 'Unauthorized' option in this field. The record will not be authorized automatically on upload. You will have to manually authorize the data.

Purge Days (Calendar)

Specify the days maintained for purging of the data uploaded.

Allow Deferred Processing

Check this option to defer processing of amendment and cancellation uploads.

Allow EOD with Deferred

Check this option to proceed even if the records exist in the deferred processing log.

If it is unchecked, then the EOD process halts until the deferred process log is cleared.

Allow Delete

Check this option to delete the process log.

3.3.6 Maintaining Function ID Preferences

Click 'Function ID Preferences' button in the 'Upload Source Preferences Maintenance' screen.

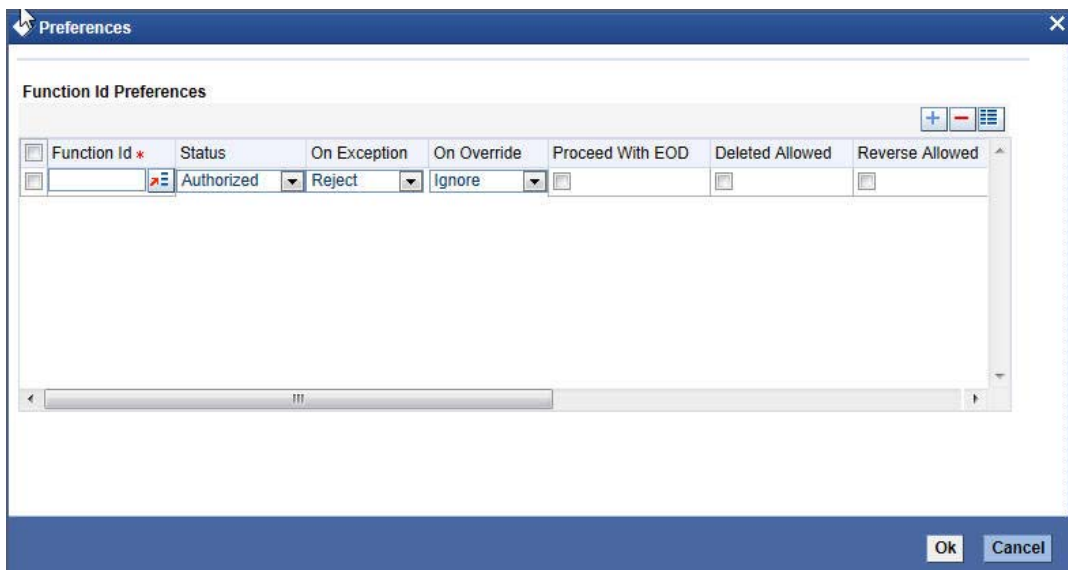

You can enter the following details:

Function Id

Specify the function ID. The adjoining option list displays all the function IDs maintained in the system. Select the appropriate one.

Status

Select the status of the record from the drop-down list and the available options are:

- Authorized
- Unauthorized
- Put On hold

On Exception

Select the record status in case of any exception while saving from the drop-down list and the available options are:

- Put On Hold
- Reject

On Override

Select the record status in case of any overriding a saved record from the drop-down list and the available options are:

- Put On Hold
- Reject
- Ignore

Proceed With EOD

Check this box, if you wish to proceed with EOD.

Deleted Allowed

Check this box, if deleting is allowed.

Reverse Allowed

Check this box, if reversal is allowed.

Amend Allowed

Check this box, if amendment is allowed.

Purge Days (Calendar)

Specify the calendar purge days

Allow Deferred Processing

Check this box, if deferred processing is allowed.

Allow EOD with Deferred

Check this box, if EOD with deferred is allowed.

3.4 Gateway Password Generation Logic For External System Authentication

This section describes the Encryption information for gateway authentication.

If Password authentication is required for an external system, then check the 'System Authentication Required' check box while maintaining the External System details in CODSORCE.

Once this check box is checked Oracle FLEXCUBE validates for Encrypted password as part of every request sent by the External System. The password encryption logic as below:

3.4.1 Password and Message ID as input

Message ID, present as part of the header in Request XML, is considered as hash. External System generates an unique Message ID, which is functional mandatory field in the header. Create a Message Digest with SHA-512 algorithm.

The hash created from the previous step and the password in clear text together is encrypted in DESede encryption method. Apply Base64 encoding to encrypted value and send to the Oracle FLEXCUBE gateway.

3.5 Incoming Message Browser

The messages received from the external system will be displayed in the Incoming Message Browser.

You can invoke the 'Incoming Message Browser' screen by typing 'GWDINBRW' in the field at the top right corner of the Application tool bar and clicking the adjoining arrow button.

Message Reference	Level Number	Tag Id *	Tag Name	Node	Parent Id	P:

In the 'Incoming Message Browser' screen you can view the details of the messages received from the external systems. You can also view the messages in the XML format or the Text format.

Click 'Text View' button to view the incoming messages in text format as shown below:

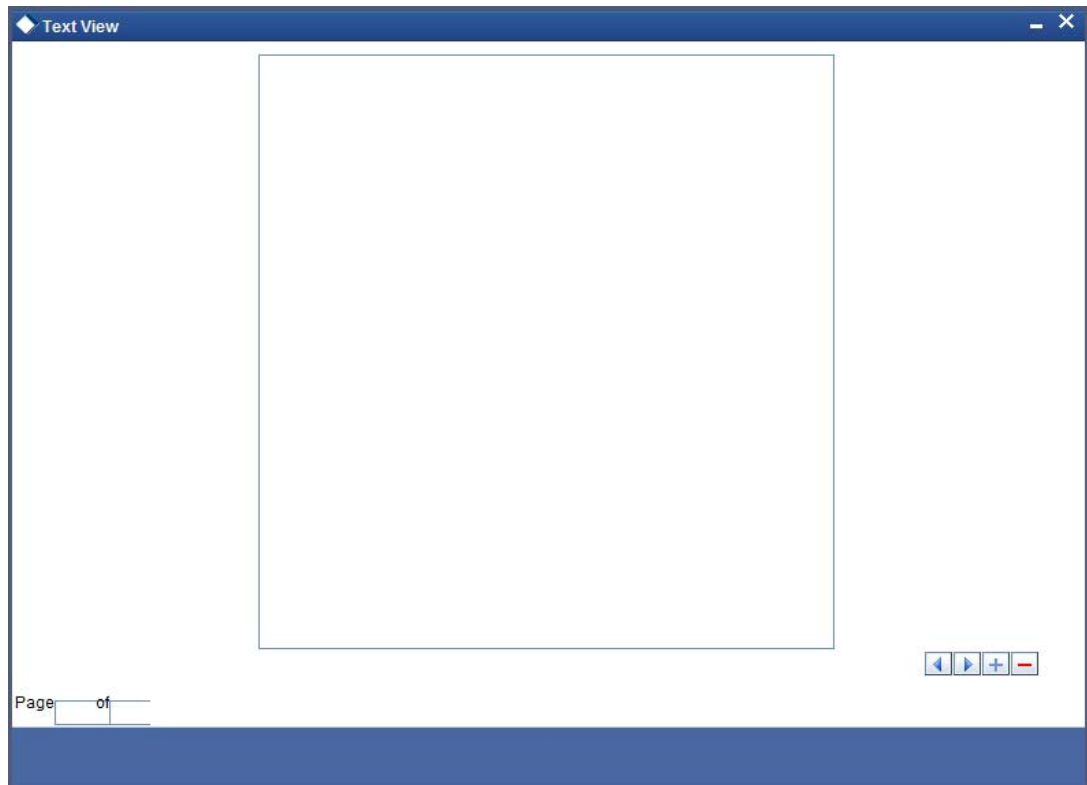

Click 'XML View' button to view the 'Gateway Browser Window' screen which displays the messages in XML format.

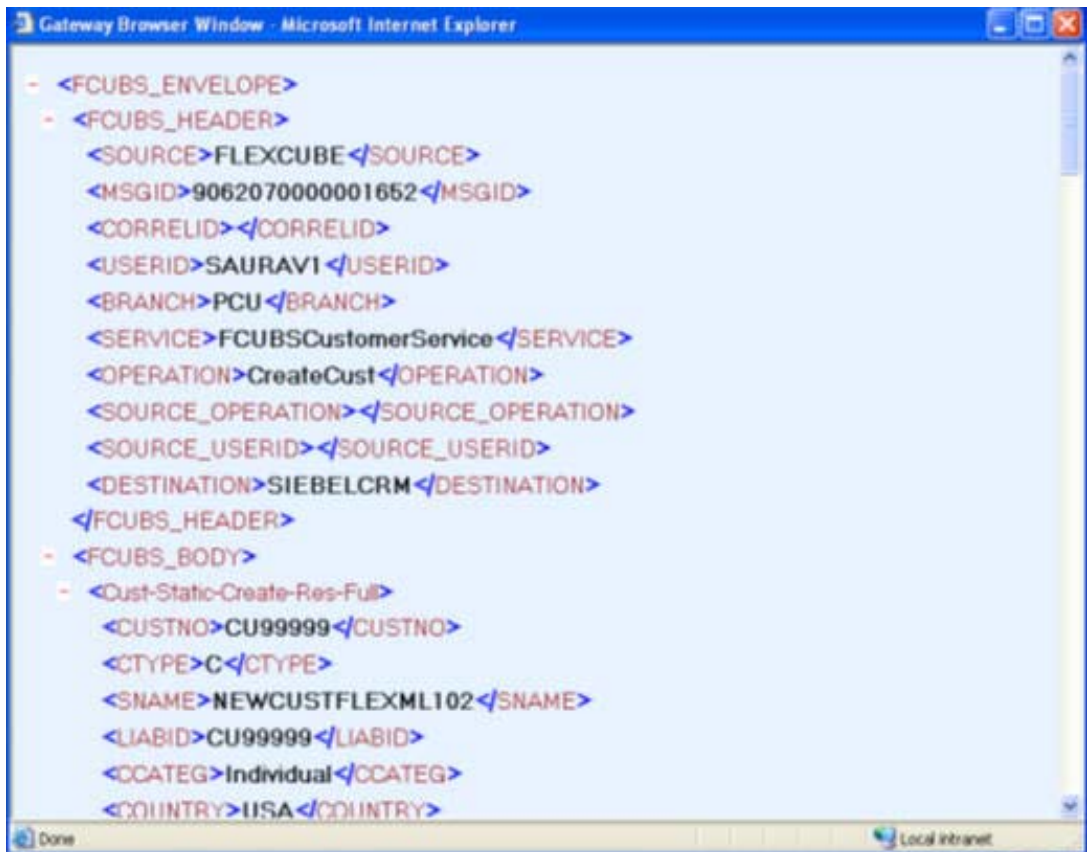

3.5.1 Viewing Incoming Message Details

The summary of all messages received from the external system can be viewed using the 'Incoming Message Browser - Summary' screen as shown below. You can invoke this screen by typing 'GWSINBRW' in the field at the top right corner of the Application tool bar and clicking the adjoining arrow button.

The screenshot shows a web application window titled "Summary". At the top, there are "Advanced Search" and "Reset" buttons. The main area contains a search form with two columns of fields. The left column includes: Message Reference, External System, Correlation Id, Service Name, User Id, Branch Date (with a calendar icon), and Message Status. The right column includes: Branch, Message Id, Request Queue Message Id, Operation Code, Their User Id, Server Date Stamp (with a calendar icon), and FLEXCUBE Reference. Below the form is a pagination bar with "Records per page" set to 15, and buttons for "First", "Previous", "1 Of 1", "Next", "Last", and "Go". A table header is visible below the pagination bar, listing the search criteria: Message Reference, Branch, External System, Message Id, Correlation Id, Request Queue Message Id, Service Name, Operation Code, and User Id. An "Exit" button is located in the bottom right corner of the window.

This summary screen can be used to search for incoming messages which match the criteria (Message Reference Number, External System, Service Name etc) you specify. The 'Result' list shows the messages which match your query. The search functions available are:

Advanced

Click **Advanced** to specify queries with logical operators such as AND, OR and NOT.

Reset

Click **Reset** to empty the values in the criteria fields, so that you may begin a new search.

Query

After specifying your search criteria click **Query** to view the list of results which match your search criteria.

Refresh

Click **Refresh** to refresh the list of results.

3.6 Duplicate Message Browser

If Oracle FLEXCUBE Integration Gateway identifies a duplicate message it will be sent to the Duplicate Messages Browser. You can invoke the 'Duplicate Message Browser - Summary'

screen by typing 'GWSPBROW' in the field at the top right corner of the Application tool bar and clicking the adjoining arrow button.

Summary

Advanced Search Reset

Message Reference

External System

Correlation Id

Service Name

User Id

Server Date Stamp

Branch

Message Id

Request Queue Message Id

Operation Code

Their User Id

Status

Records per page 15 First Previous 1 Of 1 Next Last Go

Message Reference	Branch	External System	Message Id	Correlation Id	Request Queue Message Id	Service Name	Operation Code	Us
-------------------	--------	-----------------	------------	----------------	--------------------------	--------------	----------------	----

Exit

Click 'Text View' button in the 'Duplicate Message Browser - Summary' screen to view the duplicate messages in the text format.

Duplicate Message Browser - Text View

Page of

Click 'XML View' button in the 'Duplicate Message Browser - Summary' screen to view the duplicate messages in the following format:

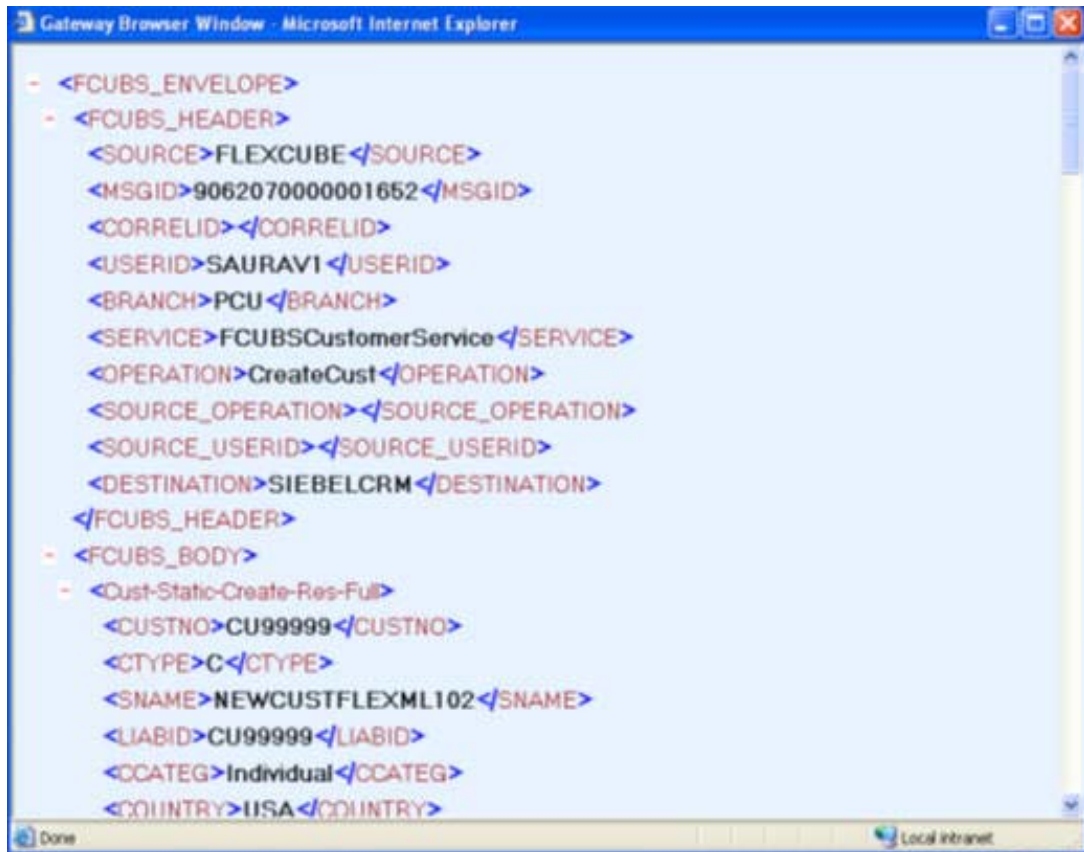

The screenshot shows an XML document displayed in a browser window titled 'Gateway Browser Window - Microsoft Internet Explorer'. The XML structure is as follows:

```
<FCUBS_ENVELOPE>
  <FCUBS_HEADER>
    <SOURCE>FLEXCUBE</SOURCE>
    <MSGID>9062070000001652</MSGID>
    <CORRELID></CORRELID>
    <USERID>SAURAVI</USERID>
    <BRANCH>PCU</BRANCH>
    <SERVICE>FCUBSCustomerService</SERVICE>
    <OPERATION>CreateCust</OPERATION>
    <SOURCE_OPERATION></SOURCE_OPERATION>
    <SOURCE_USERID></SOURCE_USERID>
    <DESTINATION>SIEBELCRM</DESTINATION>
  </FCUBS_HEADER>
  <FCUBS_BODY>
    <Cust-Static-Create-Res-Full>
      <CUSTNO>CU99999</CUSTNO>
      <CTYPE>C</CTYPE>
      <SNAME>NEWCUSTFLEXML102</SNAME>
      <LIABID>CU99999</LIABID>
      <CCATEG>Individual</CCATEG>
      <COUNTRY>IISA</COUNTRY>
    </Cust-Static-Create-Res-Full>
  </FCUBS_BODY>
</FCUBS_ENVELOPE>
```

3.6.1 Querying Duplicate Message Browser

You can query the list of duplicate messages using the 'Duplicate Message Browser - Summary' screen with functions for search. You can invoke this screen by typing

'GWSPBROW' in the field at the top right corner of the Application tool bar and clicking the adjoining arrow button.

Summary

Advanced Search Reset

Message Reference External System Correlation Id Service Name User Id Server Date Stamp

Branch Message Id Request Queue Message Id Operation Code Their User Id Status

Records per page 15 First Previous 1 Of 1 Next Last Go

Message Reference	Branch	External System	Message Id	Correlation Id	Request Queue Message Id	Service Name	Operation Code	Us
-------------------	--------	-----------------	------------	----------------	--------------------------	--------------	----------------	----

Exit

This query screen can be used to search for duplicate messages which match the criteria (Message Reference Number, External System, Service Name etc) you specify. The 'Result' list shows the messages which match your query. The search functions available are:

Advanced

Click **Advanced** to specify queries with logical operators such as AND, OR and NOT.

Reset

Click **Reset** to empty the values in the criteria fields, so that you may begin a new search.

Query

After specifying your search criteria click **Query** to view the list of results which match your search criteria.

Refresh

Click **Refresh** to refresh the list of results.

3.7 Outgoing Message Browser

Once the incoming messages have been processed, a response message will be sent to the external systems along with the status of the processed messages. The response messages will be displayed in the 'Outgoing Message Browser'. You can invoke the 'Outgoing Message

Browser' screen by typing 'GWDOTBRW' in the field at the top right corner of the Application tool bar and clicking on the adjoining arrow button.

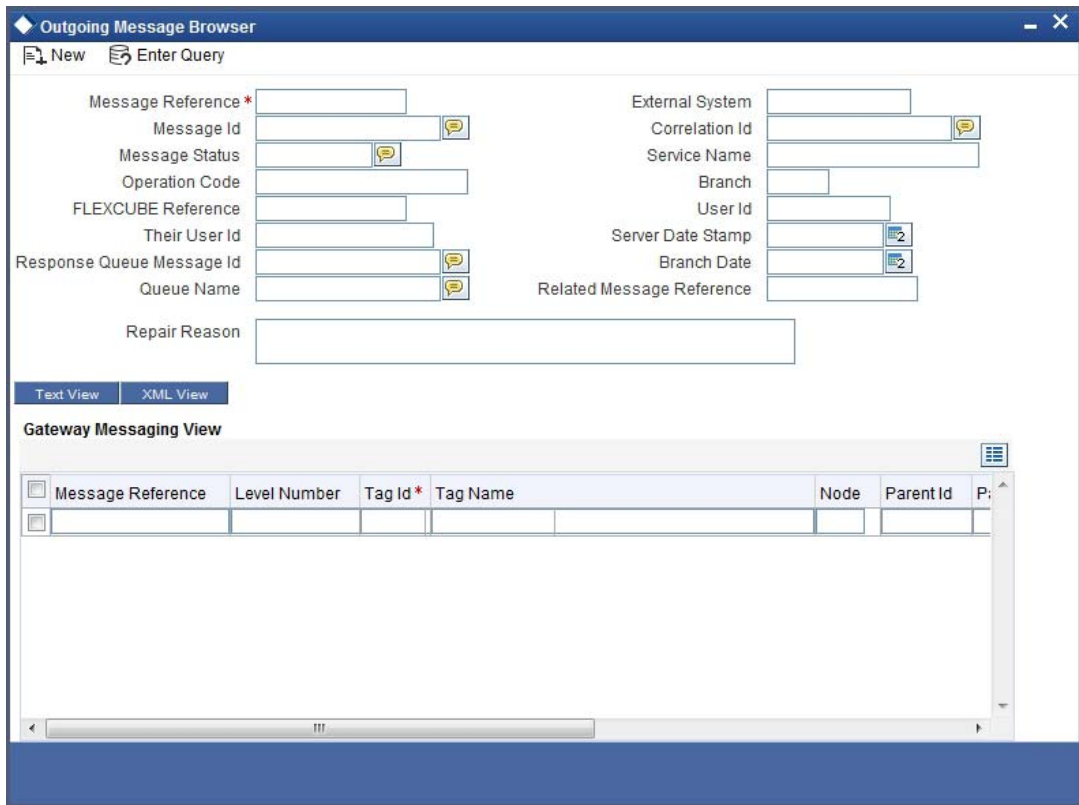

In the 'Outgoing Message Browser' screen you can view the details of the messages sent to the external systems. You can also view the messages in the XML format or the Text format.

Click 'Text View' button to view the response message in text format as shown below:

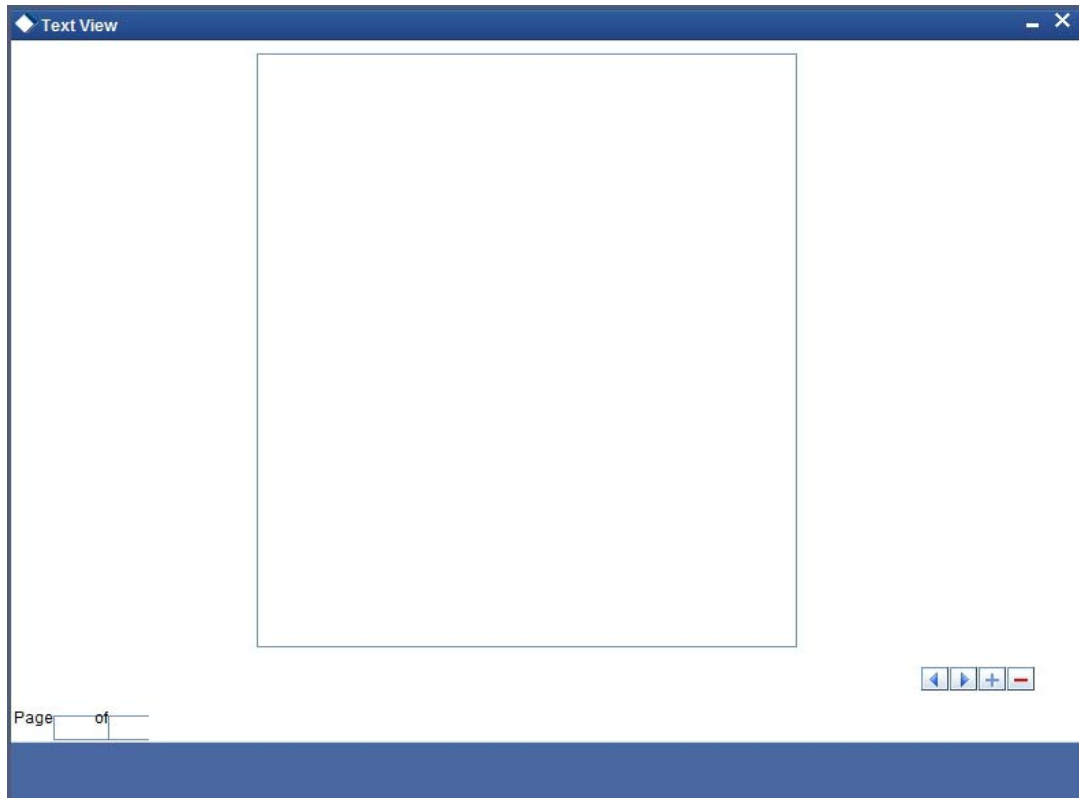

Click 'XML View' button to view the response messages in XML format as shown below:

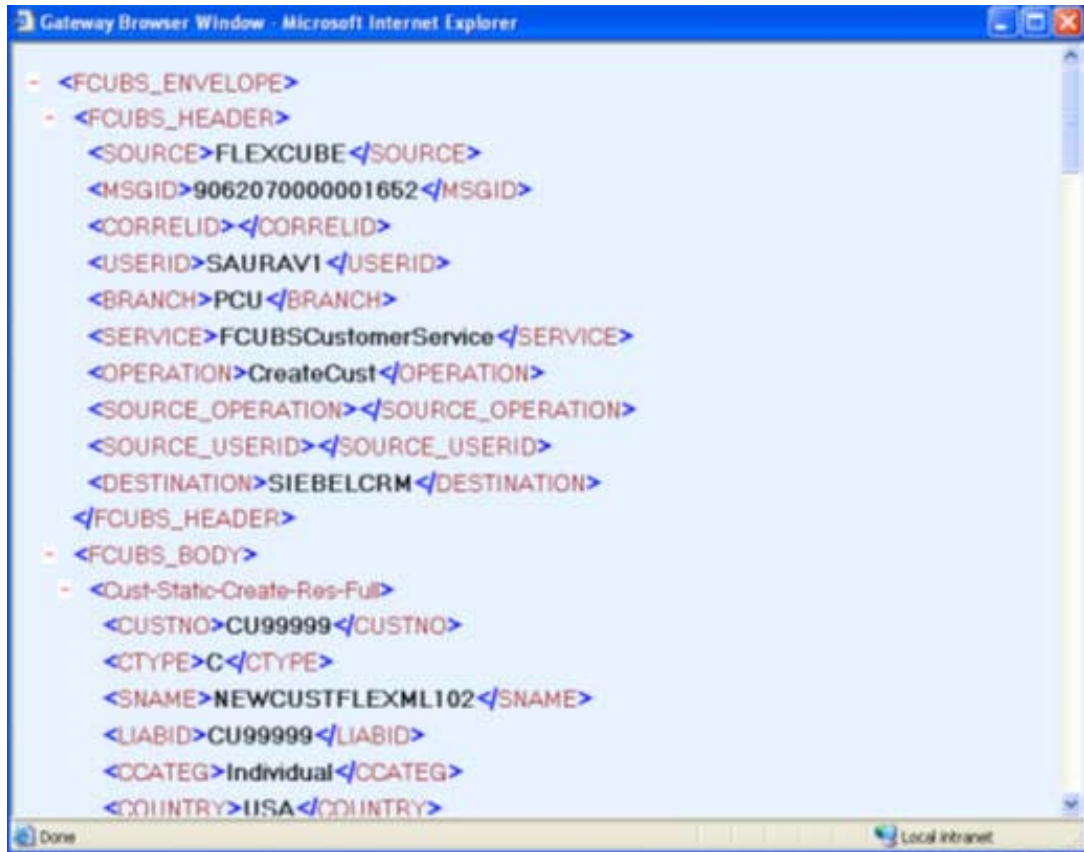

The screenshot shows a Microsoft Internet Explorer window titled "Gateway Browser Window - Microsoft Internet Explorer". The main content area displays XML data in a tree view. The root element is <FCUBS_ENVELOPE>, which contains <FCUBS_HEADER> and <FCUBS_BODY>. The <FCUBS_HEADER> element contains several sub-elements: <SOURCE>FLEXCUBE</SOURCE>, <MSGID>9062070000001652</MSGID>, <CORRELID></CORRELID>, <USERID>SAURAVI</USERID>, <BRANCH>PCU</BRANCH>, <SERVICE>FCUBSCustomerService</SERVICE>, <OPERATION>CreateCust</OPERATION>, <SOURCE_OPERATION></SOURCE_OPERATION>, <SOURCE_USERID></SOURCE_USERID>, and <DESTINATION>SIEBELCRM</DESTINATION>. The <FCUBS_BODY> element contains <Cust-Static-Create-Res-Full>, which in turn contains <CUSTNO>CU99999</CUSTNO>, <CTYPE>C</CTYPE>, <SNAME>NEWCUSTFLEXML102</SNAME>, <LIABID>CU99999</LIABID>, <CCATEG>Individual</CCATEG>, and <COUNTRY>IISA</COUNTRY>. The status bar at the bottom shows "Done" and "Local intranet".

```
- <FCUBS_ENVELOPE>
- <FCUBS_HEADER>
  <SOURCE>FLEXCUBE</SOURCE>
  <MSGID>9062070000001652</MSGID>
  <CORRELID></CORRELID>
  <USERID>SAURAVI</USERID>
  <BRANCH>PCU</BRANCH>
  <SERVICE>FCUBSCustomerService</SERVICE>
  <OPERATION>CreateCust</OPERATION>
  <SOURCE_OPERATION></SOURCE_OPERATION>
  <SOURCE_USERID></SOURCE_USERID>
  <DESTINATION>SIEBELCRM</DESTINATION>
</FCUBS_HEADER>
- <FCUBS_BODY>
- <Cust-Static-Create-Res-Full>
  <CUSTNO>CU99999</CUSTNO>
  <CTYPE>C</CTYPE>
  <SNAME>NEWCUSTFLEXML102</SNAME>
  <LIABID>CU99999</LIABID>
  <CCATEG>Individual</CCATEG>
  <COUNTRY>IISA</COUNTRY>
```

3.7.1 Querying Outgoing Message Browser

You can query the list of outgoing messages using the 'Outgoing Message Browser - Summary' screen. You can invoke this screen by typing 'GWSOTBRW' in the field at the top right corner of the Application tool bar and clicking the adjoining arrow button.

The screenshot shows a web application window titled "Summary". At the top, there are "Advanced Search" and "Reset" buttons. Below this is a search form with two columns of fields. The left column includes: Message Reference, Related Message Reference, Service Name, Message Id, Response Queue Message Id, Their User Id, and Server Date Stamp. The right column includes: Branch, External System, Operation Code, Correlation Id, User Id, Branch Date, and Message Status. Each field has a small icon to its right. Below the form is a navigation bar with "Records per page" set to 15, and buttons for "First", "Previous", "1 Of 1", "Next", "Last", and "Go". Below the navigation bar is a table header with columns: Message Reference, Branch, Related Message Reference, External System, Service Name, Operation Code, Message Id, Correlation Id, and Re. At the bottom right of the window is an "Exit" button.

This query screen can be used to search for outgoing messages which match the criteria (Message Reference Number, External System, Service Name etc) you specify. The 'Result' list shows the messages which match your query. The search functions available are:

Advanced

Click **Advanced** to specify queries with logical operators such as AND, OR and NOT.

Reset

Click **Reset** to empty the values in the criteria fields, so that you may begin a new search.

Query

After specifying your search criteria click **Query** to view the list of results which match your search criteria.

Refresh

Click **Refresh** to refresh the list of results.

3.8 Defining Notification Messages

The outgoing message browser also displays the notification messages. Every time the database layer receives a notification message, it updates the outgoing message browser to display the same.

At the branch level, you can maintain notification codes for each branch. You can do this using the 'Notifications Installed' screen.

You can invoke the 'Notifications Installed – Detailed' screen by typing 'GWDNTFIN' in the field at the top right corner of the Application tool bar and clicking the adjoining arrow button.

The screenshot shows a software window titled "Notifications Installed". At the top, there is a menu bar with "New" and "Enter Query" options. Below the menu bar, there are four input fields arranged in two columns. The left column contains "Branch Code *" and "Notification Code *", both with dropdown arrows. The right column contains "Branch Name" and "Description", also with dropdown arrows. Below these fields is a "Fields" section with a scrollable list of fields: "Input By Date Time", "Authorized By Date Time", and "Modification Number". To the right of this list are two checkboxes, "Authorized" and "Open", and an "Exit" button.

In this screen, you need to specify the following details:

Branch Code

Select a branch code for which you wish to assign a notification code. Once you select the branch code, the corresponding description is displayed.

Notification Code

From the list of values, select a notification code you wish to link with the branch. This will be used to generate notifications for the entire branch. Once you select the notification code, the corresponding description is displayed.

In addition to maintaining a notification code for a given branch, you can also specify a topic or a queue to which the notification messages should be sent.

You can define a topic/queue for a given branch and notification code in the 'Notifications Enroute' screen.

3.8.1 Viewing Installed Notification Details

You can view and query the list of notification messages using the 'Notifications Installed - Summary' screen. You can invoke this screen by typing 'GWSNTFIN' in the field at the top right corner of the Application tool bar and clicking the adjoining arrow button.

The screenshot shows a web application window titled 'Summary'. At the top, there are 'Advanced Search' and 'Reset' buttons. Below these are four search criteria: 'Authorization Status' (dropdown), 'Record Status' (dropdown), 'Branch Code' (text input with a search icon), and 'Notification Code' (text input with a search icon). A pagination bar indicates 'Records per page' is 15, with 'First', 'Previous', '1 Of 1', 'Next', 'Last', and 'Go' buttons. The main content area is a table with the following columns: 'Authorization Status', 'Record Status', 'Branch Code', and 'Notification Code'. The table is currently empty. At the bottom of the window, there are buttons for 'Authoriza', 'Record St', and 'Exit'.

This summary screen can be used to search for notification messages which match the criteria (Message Reference Number, External System, Service Name etc) you specify. The 'Result' list shows the messages which match your query. The search functions available are:

Advanced

Click **Advanced** to specify queries with logical operators such as AND, OR and NOT.

Reset

Click **Reset** to empty the values in the criteria fields, so that you may begin a new search.

Query

After specifying your search criteria click **Query** to view the list of results which match your search criteria.

Refresh

Click **Refresh** to refresh the list of results.

3.9 Defining the Notifications Enroutes

You can invoke the 'Notification Enroutes - Detailed' screen by typing 'GWDNTFEN' in the field at the top right corner of the Application tool bar and clicking the adjoining arrow button.

The screenshot shows a software window titled "Notification Enroute Maintenance". At the top left, there are buttons for "New" and "Enter Query". The main workspace contains two columns of input fields. The left column has "Branch Code *", "Description", and "Destination Name *". The right column has "Notification Code *" and "Description". Below the main workspace is a "Fields" section with "Input By", "Date Time", "Authorized By", "Date Time", "Modification Number", "Authorized" (checkbox), and "Open" (checkbox). An "Exit" button is in the bottom right corner.

In 'Notification Enroutes - Detailed' screen, you define the following details:

Branch Code

Specify a branch for which you wish to define a topic. If you want to use a single topic for all branches and for a given notification code, you can use a wildcard '****'. Once you select a Branch Code, the corresponding description is displayed.

Notification Code

Select a notification code from the list of notification codes provided. You can indicate a wildcard '****' if a single topic needs to be used for all notifications in a branch.

Destination Name

Specify the destination name.

Once you have captured the details, save the maintenance.

3.9.1 Viewing Summary screen

You can view and query the list of notifications enroute using the 'Notifications Enroutes - Summary' screen. You can invoke this screen by typing 'GWSNTFEN' in the field at the top right corner of the Application tool bar and clicking the adjoining arrow button.

The screenshot shows a web application window titled 'Summary'. At the top, there are 'Advanced Search' and 'Reset' buttons. Below these are search criteria fields: 'Authorization Status' (dropdown), 'Record Status' (dropdown), 'Branch Code' (text input with a search icon), and 'Destination Name' (text input with a search icon). There is also a 'Notification Code' field. Below the search fields is a pagination control showing 'Records per page' set to 15, and buttons for 'First', 'Previous', '1 Of 1', 'Next', 'Last', and 'Go'. Below the pagination is a table with the following columns: 'Authorization Status', 'Record Status', 'Branch Code', 'Notification Code', and 'Destination Name'. The table is currently empty. At the bottom of the window, there are buttons for 'Authorizal', 'Record St', and 'Exit'.

This summary screen can be used to search for notifications enroute which match the criteria (Message Reference Number, External System, Service Name etc) you specify. The 'Result' list shows the messages which match your query. The search functions available are:

Advanced

Click **Advanced** to specify queries with logical operators such as AND, OR and NOT.

Reset

Click **Reset** to empty the values in the criteria fields, so that you may begin a new search.

Query

After specifying your search criteria click **Query** to view the list of results which match your search criteria.

Refresh

Click **Refresh** button to refresh the list of results.

3.10 Amendment Maintenance

This section contains the following topics:

- [Section 3.10.1, "Maintaining Gateway Amendment Details"](#)

3.10.1 Maintaining Gateway Amendment Details

To recall, you need to identify the fields that can be amended by an external system, say, a Siebel CRM application.

Every amendment request coming from such a system has the following data:

- Service Name: – This is a broad level grouping of similar operations within a module in Oracle FLEXCUBE. The service names are published by Oracle FLEXCUBE. As an example, you can consider FCUBSCustomerAccountService. This service is exposed by the FCUBS Interface Gateway to do a permissible operation on a customer account.
- Operation Name:- This is the name of the operation that the external system wishes to perform within the service. These operations names are published by Oracle FLEXCUBE. As an example, you can consider ModifyCustomer, which is for modification of a customer.
- External Operation Name:- This is the specific area of operation that an external system is performing on its side within the broad context of the Oracle FLEXCUBE's amendment. In an external system, if the personal details of a customer are changed, this has a unique name by which it is identified within Oracle FLEXCUBE. Similarly, if the limits related details of a customer are modified, it also has a unique name.

It is through the 'Gateway Amendment Maintenance' screen that you maintain a set of amendable fields, which can amend in Oracle FLEXCUBE whenever a request for the same will be send from an external system. Based on this maintenance, the amendment request is addressed by Oracle FLEXCUBE. Invoke this screen by typing 'GWDAMDMT' in the field at the top right corner of the Application tool bar and clicking the adjoining arrow button.

The screen is as shown below:

The screenshot shows the 'Gateway Amendment Maintenance' application window. At the top, there's a 'New' section with several input fields: 'External System *', 'Origin System *', 'Source Operation *', 'Service Name', and 'Operation Code'. Below this, there are two data grids. The first is 'Amendable Nodes', which has a 'Go' button and a table with columns: 'Node Name *', 'New Allowed', 'LBL_DELETE_ALLOWED', and 'All Records'. The second is 'Amendable Fields', which also has a 'Go' button and a table with a 'Field Name *' column. At the bottom of the window, there are fields for 'Maker', 'Checker', 'Date Time', 'Mod No', 'Record Status', and 'Authorization Status', along with an 'Exit' button.

External System

Select the relevant external system. Based on the maintenance here, only the fields that are selected as amendable can be modified if a request comes from the chosen external system.

Note

The maintenance pertaining to external systems is factory shipped for your bank.

Origin System

Specify the origin system for which the amendment details are applicable.

For example, if we have a record that is created by a specific external system say 'CRM', and the requirement is that, for records created by this specific external system, only a set of fields are modifiable then, we should specify Origin System as CRM and FLEXCUBE as the External System. This Origin System field is used to identify such requirements wherein the amendable fields can be different if the Origination and Modification of the record are of different external sources.

You can specify the Origin System with the same value as the External System for Non FP services. For FP module services, you can provide the value as 'FLEXCUBE' and the respective External system can be specified in the External System field.

This feature is made available only for the FP modules with source operation as PMDTRONL_MODIFY.

Source Operation

The free format text (without spaces) which identifies the amendment you are doing. This is mandatory.

Note

Source Operation will be defaulted as (FUNCTIONID)_MODIFY, if the Source Operation is not sent from an external system and the function ID will be derived from Service and Operation combination.

Service Name

The relevant service name, this is a broad level grouping of similar operations within a module in Oracle FLEXCUBE. The service names are published by Oracle FLEXCUBE.

Note

The maintenance pertaining to service names is factory shipped for your bank

Operation Code

The relevant operation code. This is the operation that the external system wishes to perform within the selected service. The operation names are published by Oracle FLEXCUBE. As an example, you can take 'ModifyCustomer', which is for modification of a customer record. Each operation under different service names is identified by a unique code.

Note

The maintenance pertaining to operation codes is factory shipped for your bank.

Amendable Nodes

Node Name

Specify the node name. Alternatively, you can select the node name from the option list. The list displays all valid nodes maintained in the system.

New Allowed

Check this box if 'New Allowed' is applicable.

Delete Allowed

Check this box if 'Delete Allowed' is applicable.

All Records

Check this box if all records are applicable.

4. Message Formats

4.1 Introduction

Data exchanged between Oracle FLEXCUBE and the external systems are in the form of XML messages. These XML messages are defined in FCUBS in the form of XML Schema Documents (XSD) and are referred to as 'FCUBS formats'. An XML Schema is uniquely identified by its Namespace and its Root Element (root node). The root node for XSDs of gateway messages will be generated as per the following pattern:

- <OPERATION>_<MESSAGE EXCHANGE PATTERN>_REQ
- <OPERATION>_<MESSAGE EXCHANGE PATTERN>_RES
- Where
- <OPERATION> refers to an Oracle FLEXCUBE operation like CREATECUSTACC
- <MESSAGE_EXCHANGE_PATTERN> refers to the request & response message patterns exchanged. The Message Pattern is of the following types
 - FS (Full Screen) -This indicates that the payload contains all the elements on the corresponding Oracle FLEXCUBE screen.
 - IO (Input Only) - This indicates that the payload contains the only input elements on the corresponding Oracle FLEXCUBE screen.
 - PK (Primary Key): This indicates that the payload contains only the Primary Key elements of the corresponding Oracle FLEXCUBE screen.

<MESSAGE_EXCHANGE_PATTERN> is a combination of message patterns. The <MESSAGE_EXCHANGE_PATTERN> available in FLEXCUBE is shown below:

- FSFS - Full Screen Request and Full Screen Response
- IOPK - Input Only Request and Primary Key Response
- IOFS - Input Only Request and Full Screen Response

Non-Query Formats

For example, consider the Operation 'CREATECUSTACC'. The root node of messages under this operation will be as under:

- CREATECUSTACC_FSFS_REQ

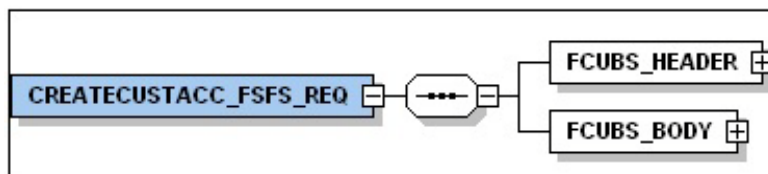

- CREATECUSTACC_FSFS_RES

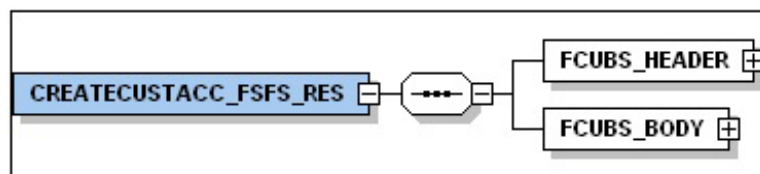

- CREATECUSTACC_IOPK_REQ

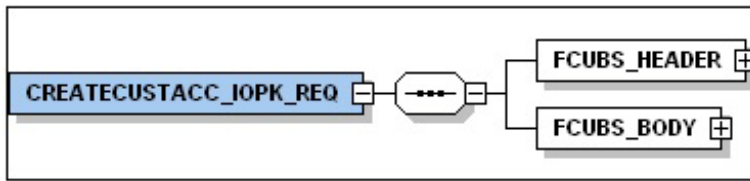

- CREATECUSTACC_IOPK_RES

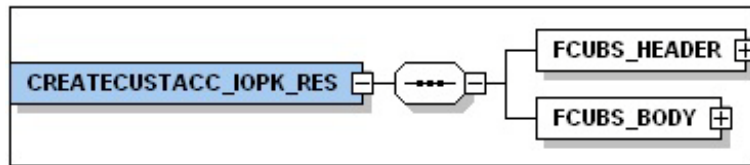

Query Formats

For example, consider the Operation 'QUERYCUSTACC'. The root node of messages under this operation will be as under:

- QUERYCUSTACC_IOFS_REQ

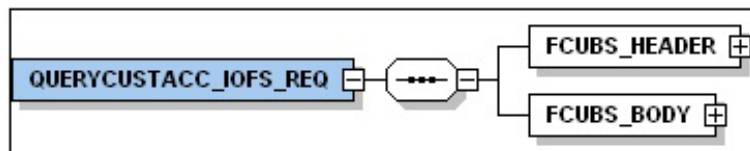

- QUERYCUSTACC_IOFS_RES

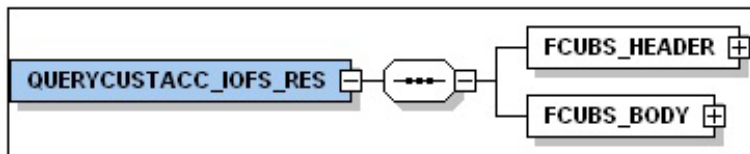

This chapter contains the following sections:

- [Section 4.2, "Oracle FLEXCUBE Envelope"](#)
- [Section 4.3, "Oracle FLEXCUBE NOTIFICATION"](#):

4.2 Oracle FLEXCUBE Envelope

This section contains the following topics:

- [Section 4.2.1, "FCUBS HEADER"](#)
- [Section 4.2.2, "FCUBS_BODY"](#)

A standard gateway message in the Oracle FLEXCUBE Envelope contains two main components namely:

- FCUBS_HEADER – This is a node that forms the header of the FCUBS Envelope. The tags under the header portion of a message will identify a partner system, a service, an operation, user, branch, and so on. These tags are constant across all messages.

- FCUBS_BODY – This node contains the actual payload of a message. The contents of this node will vary for each message.

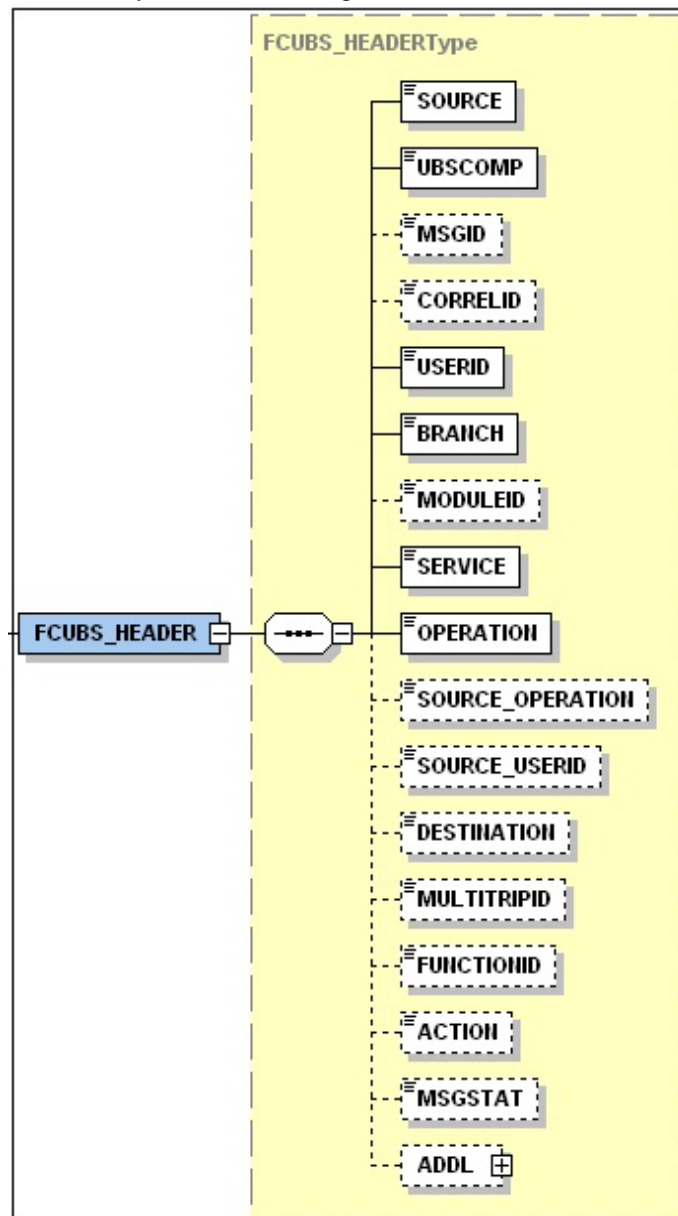

4.2.1 FCUBS HEADER

The tags under FCUBS HEADER have been described below:

SOURCE

This indicates the name of the External system that is the source of the message.

UBSCOMP

This indicates the Oracle FLEXCUBE component of the message - whether FCIS or FCUBS

MSGID

This unique ID identifies each message – incoming or outgoing in Oracle FLEXCUBE. Every message will have a distinct message ID.

CORRELID

This is the id using which any system which has sent a request to FC UBS can correlate to the response. In the External system maintenance, the Correlation Pattern can be configured for each external system. It can be maintained that either the 'MSGID' or the 'CORRELID' of the request message is returned back as the 'CORRELID' in the response message. Depending on this maintenance, Oracle FLEXCUBE sets either the 'MSGID' or the 'CORRELID' of the request message in the response message.

USERID

For request messages, this ID is used to submit message requests. Oracle FLEXCUBE processes this request using this id.

For response messages, the value of this is 'null'.

BRANCH

This indicates the Oracle FLEXCUBE Branch Code where the request message needs to be processed. If the BRANCH is missing in the header, request message is transmitted and processed in Head Office branch.

MODULE ID

This indicates the module ID.

SERVICE

This provides details on the various services of Oracle FLEXCUBE. For every incoming message in Oracle FLEXCUBE, the service name is mandatory.

OPERATION

This indicates the functional operation.

SOURCE OPERATION

This indicates the functional operation as registered in Oracle FLEXCUBE.

SOURCE USERID

This is the User ID with which the request message was invoked from the SOURCE.

DESTINATION

For incoming messages, the destination is Oracle FLEXCUBE. For response messages, system will populate the SOURCE of the request message as DESTINATION.

MULTIRIPID

This is a unique id which indicates overrides.

FUNCTIONID

This indicates the Oracle FLEXCUBE Function ID

MSGSTAT

This indicates whether the transaction is a SUCCESS or FAILURE.

ADDL

This is used to send additional parameters, that is, parameters not available in Oracle FLEXCUBE.

4.2.2 FCUBS_BODY

The FCUBS_BODY will contain the actual payload to perform the respective transaction. The contents of the payload will vary for each operation.

The following snapshot shows a sample FCUBS_BODY of QUERYCUSTACC operation.

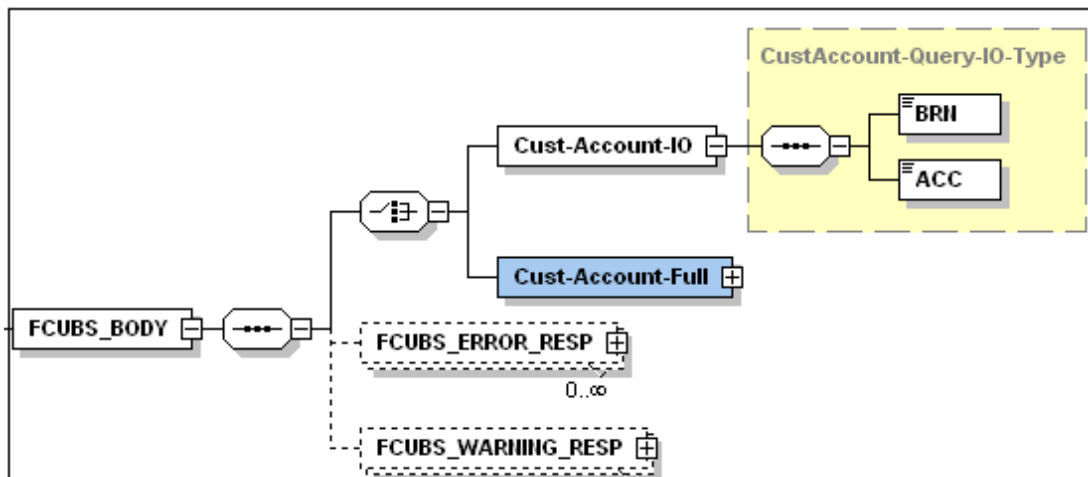

FCUBS_BODY will contain additional nodes for error response and warning response. A diagrammatic representation of the Error response is as shown below:

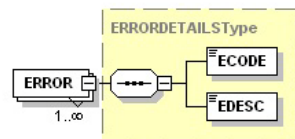
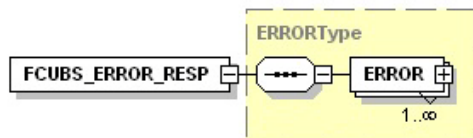

4.2.2.1 FCUBS_ERROR_RESP

The error response message is sent from Oracle FLEXCUBE when errors are raised in a transaction. The error response have another tag 'ERROR' within it.

ERROR

The 'ERROR' node have tags for error code and error description. The 'ERROR' node is generated for each error raised by FCUBS.

4.2.2.2 FCUBS_WARNING_RESP

The warning response message will be sent when overrides are raised in a transaction. The Warning response will have another tag 'WARNING' within it.

WARNING

This node have tags for warning code and warning description. The 'WARNING' node is generated for each override raised by FCUBS.

4.3 Oracle FLEXCUBE NOTIFICATION

The notification messages are generated in a standard format. The notification messages consist of two main components:

FCUBS_NOTIF_HEADER – This forms the header portion of a notification message. This contains a standard set of tags that can identify a notification. These tags are constant across all notification messages.

FCUBS_NOTIF_IDENTIFIER – This will identify the maintenance records based on the information provided under this node. The contents of this node will vary for each notification.

A diagrammatic representation of FCUBS NOTIFICATION is as shown below:

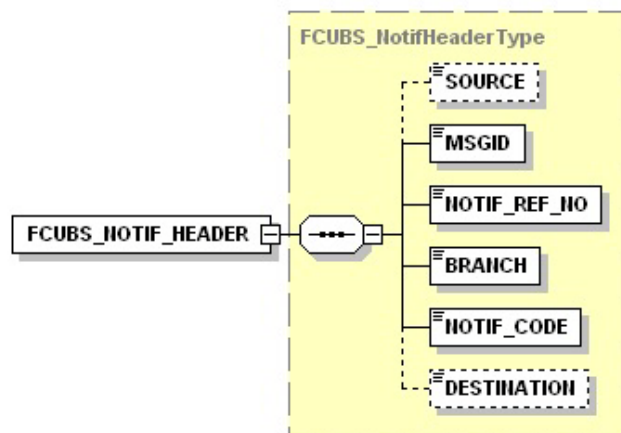
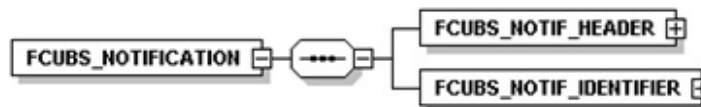

4.3.1 FCUBS NOTIFICATION HEADER

The tags under FCUBS NOTIFICATION HEADER have been described below:

SOURCE

This indicates the name of the External system or the source of the message.

MSGID

This is the unique reference number generated by Oracle FLEXCUBE.

NOTIF_REF_NO.

This unique reference number identifies each notification message generated in Oracle FLEXCUBE.

BRANCH

This indicates the branch in which notification has been triggered.

NOTIF_CODE

This indicates the code for the notification that has been triggered.

DESTINATION

For incoming messages, the DESTINATION should be Oracle FLEXCUBE. For response messages, system will populate the SOURCE of the request message as DESTINATION.

Refer 'Service-Documentation' available under 'Gateway' for details about each message.

5. Annexure – List of Messages

5.1 Introduction

This chapter lists out the various messages that fold under the purview of the following Gateway services:

- Inbound application integration – used when any external system needs to add, modify or query information within Oracle FLEXCUBE
- Outbound application integration – used when any external system needs to be notified of the various events that occur within Oracle FLEXCUBE.

5.2 Inbound Application Integration – Services

Oracle FLEXCUBE ELCM Inbound Application Gateway provides XML based 'Services'. These services consist of one or more 'Operations'. These operations can be invoked by any external system to perform the relevant operation in Oracle FLEXCUBE ELCM.

- COCategoryTypeService
- COExposureTypeService
- COHaircutTypeService
- COProductTypeService
- ELCMBatchService
- ELCollCategoryService
- ELCollateralService
- ELCollateralService
- ELCollateralTypeService
- ELCovenantService
- ELCreditAgencyService
- ELCreditScoreService
- ELCustLiabService
- ELCustomerLiabService
- ELExposureBlockService
- ELExposureService
- ELFacilityBlockService
- ELFacilityService
- ELFileProcessService
- ELInsuranceCompanyService
- ELInsuranceTypeService
- ELIssuerService
- ELLiabilityService
- ELPoolService
- ELSectorIndustryService
- ELSecuritiesService
- ELSecurityService

- ELUtilizationService
- ELValidLimitService
- ELBatchService

For more information about operations performed by each service, refer to *Gateway Web Services*.

6. Planned Outage Support Server

6.1 Introduction

Planned Outage Support Server (POSS) is the data replica of the host server and facilitates the channels to support the database server without any downtime during the planned outages.

When POSS is active:

- EOD will not run
- Non-Channel Interface has to be switched off.
- ELCM enterprise has to be switched off.
- Messaging and notification cannot be done.

A new server state XML is created for which the path is decided based on the entry in the properties file. The XML contains a parameter <SERVERSTATE> which can have any of the following values:

- A – Available
- S – Sleep
- U – Unavailable
- R - Replay

Gateway EJB takes the request information from the SSB when the full session bean retains the information.

This chapter contains the following sections:

- [Section 6.2, "Handling Planned Outages"](#)
- [Section 6.3, "Services Supported during Outage"](#)

6.2 Handling Planned Outages

This section contains the following topics:

- [Section 6.2.1, "Host Up"](#)
- [Section 6.2.2, "Outage Start"](#)
- [Section 6.2.3, "Host Down and POSS Up:"](#)
- [Section 6.2.4, "Host Up, Start Replay from POSS:"](#)
- [Section 6.2.5, "ELCM Impact"](#)

6.2.1 Host Up

When the request comes from the channel, it reaches the Gateway EJB or MDB and the bean check for the state of server. If the server state is 'A' (Available), the bean picks up the JNDI host server details from the properties file and add a parameter to the xml which implies that the request is being served at the host.

Then the request is processed at the back end and the response from the back end reaches the bean and then to the endpoint.

6.2.2 Outage Start

Using the restore point, the request data is synchronized from host server to POSS. Before the planned outage, the server state has to be changed into 'S' (Sleep) from 'A' to indicate that the server is down as soon as the synchronization starts.

During synchronization, if any new request comes to the bean, the gateway layer rejects the request and a XML error message is generated. Once the synchronization is completed, the server state is changed into 'U' (Unavailable) which indicates the bean that the host server is down and from then on any request that comes is processed at POSS.

6.2.3 Host Down and POSS Up:

When the host is down and POSS is up, the server state is 'U'. During this time, all the requests that reach the bean is served at POSS. The bean picks up the JNDI details of POSS from the properties file, establishes a connection, and sends the request which is logged into a table at the backend.

The log table have details which indicates if:

- the response has been built successfully
- the request has to be replayed at the host during replay
- any error has occurred and oracle SCN

The response is sent back to the bean which will send the response to the end point.

6.2.4 Host Up, Start Replay from POSS:

Once the host is up, a 'REPLAY ROUTINE' (which is a java routine) is carried out which consists of the following steps:

- The server state is changed from 'U' to 'R' (Replay mode).
- The replay routine get the requests from the log table at POSS for which response building has been completed and these are replayed to the host.
- The replay routine logs all message logs and places the message onto Oracle AQ on the Host database.
- Multiple processes, equal to the number of locks defined, start the request processing based on SCN.
- Each process replays the requests on to the host by calling a procedure in the service router.
- Once a record is replayed, the thread updates the log table indicating that the replay of this record is complete.

When the server state is 'R' and any new request comes to the bean, it executes a DAO to check for records in POSS that need to be replayed to the host. If any such record is found, the new request is sent to POSS else the server state is changed from 'R' to 'A'.

When the server state is 'R' the bean also slows down the processing of new requests to ensure there is a switch over back to host.

The following chart depicts a clear picture of request information that pass on to the various stages that are discussed.

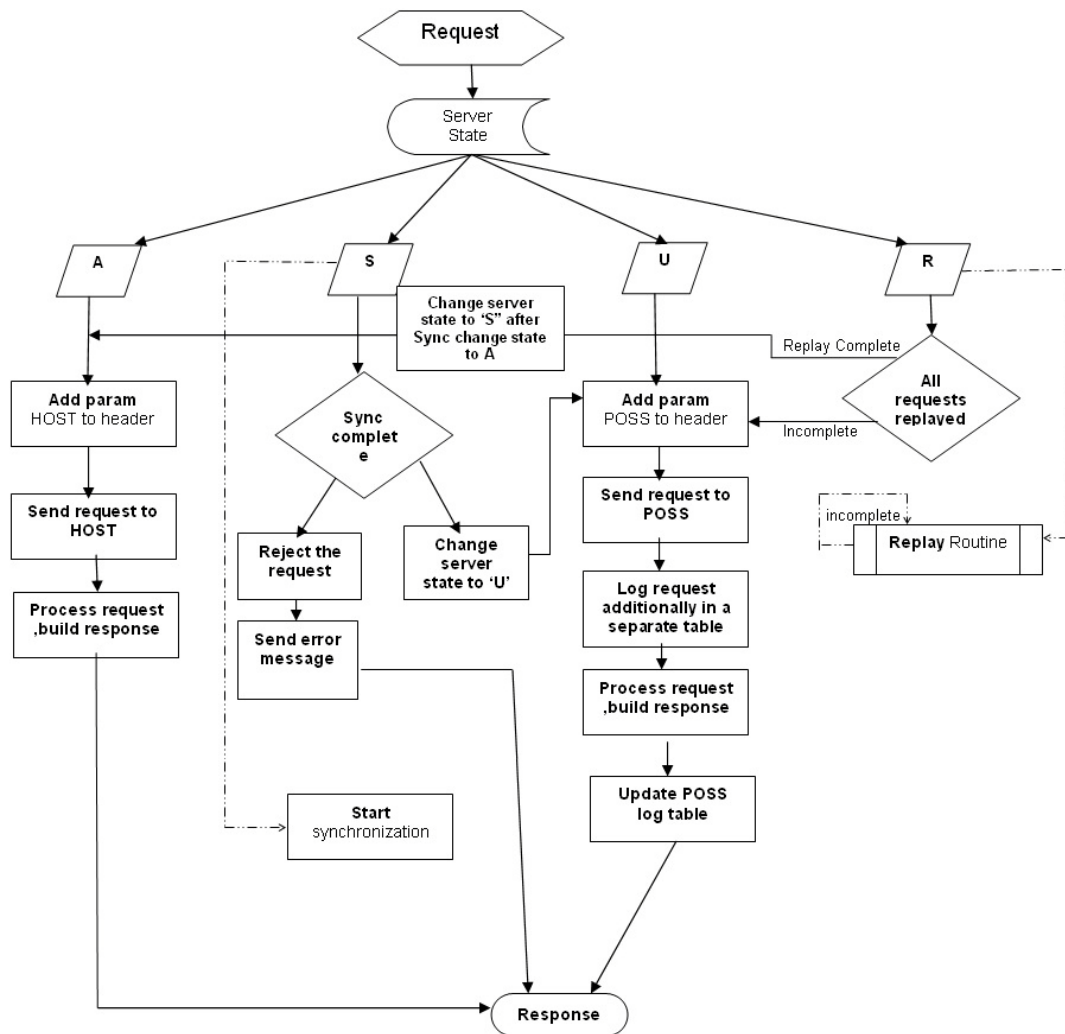

6.2.5 ELCM Impact

When the request comes, two ELCM gateways are deployed pointing towards the Host and the POSS. The external interface at ELCM is switched off and the transactions which are initiated through FLEXCUBE are serviced.

6.3 Services Supported during Outage

Oracle FLEXCUBE ELCM supports following services during outage.

- COCategoryTypeService
- COExposureTypeService
- COHaircutTypeService
- COProductTypeService
- ELCMBatchService
- ELCollCategoryService
- ELCollateralService
- ELCollateralService
- ELCollateralTypeService

- ELCovenantService
- ELCreditAgencyService
- ELCreditScoreService
- ELCustLiabService
- ELCustomerLiabService
- ELExposureBlockService
- ELExposureService
- ELFacilityBlockService
- ELFacilityService
- ELFileProcessService
- ELInsuranceCompanyService
- ELInsuranceTypeService
- ELIssuerService
- ELLiabilityService
- ELPoolService
- ELSectorIndustryService
- ELSecuritiesService
- ELSecurityService

For more information about operations performed by each service, refer to *Gateway Web Services*.

7. Function ID Glossary

C

CODSORCE3-7

CODUPLDM3-8

G

GWDAMDMT3-24

GWDEXFUN3-5

GWDEXSYS3-2

GWDINBRW3-11

GWDNTFEN3-22

GWDNTFIN 3-20

GWDOTBRW 3-17

GWSEXFUN 3-6

GWSEXSYS 3-3

GWSINBRW 3-13

GWSNTFEN 3-23

GWSNTFIN 3-21

GWSOTBRW 3-19

GWSPBROW 3-14, 3-16