

**Oracle® Financial Services Asset Liability  
Management (OFSALM)**

User Guide

Release 8.0.5.0.0

**E55583-01**

April 2020

Oracle Financial Services Asset Liability Management (OFS ALM) User Guide Release 8.0.5.0.0

Part No. E55583-01

Copyright © 2020 Oracle and/or its affiliates. All rights reserved.

Primary Author: Arpana Danayak

Contributing Author: Christopher Spofford, Brad Bruckschen, ALM PMG team

This software and related documentation are provided under a license agreement containing restrictions on use and disclosure and are protected by intellectual property laws. Except as expressly permitted in your license agreement or allowed by law, you may not use, copy, reproduce, translate, broadcast, modify, license, transmit, distribute, exhibit, perform, publish, or display any part, in any form, or by any means. Reverse engineering, disassembly, or decompilation of this software, unless required by law for interoperability, is prohibited.

The information contained herein is subject to change without notice and is not warranted to be error-free. If you find any errors, please report them to us in writing.

If this is software or related documentation that is delivered to the U.S. Government or anyone licensing it on behalf of the U.S. Government, the following notice is applicable:

U.S. GOVERNMENT END USERS: Oracle programs, including any operating system, integrated software, any programs installed on the hardware, and/or documentation, delivered to U.S. Government end users are "commercial computer software" pursuant to the applicable Federal Acquisition Regulation and agency-specific supplemental regulations. As such, use, duplication, disclosure, modification, and adaptation of the programs, including any operating system, integrated software, any programs installed on the hardware, and/or documentation, shall be subject to license terms and license restrictions applicable to the programs. No other rights are granted to the U.S. Government.

This software or hardware is developed for general use in a variety of information management applications. It is not developed or intended for use in any inherently dangerous applications, including applications that may create a risk of personal injury. If you use this software or hardware in dangerous applications, then you shall be responsible to take all appropriate fail-safe, backup, redundancy, and other measures to ensure its safe use. Oracle Corporation and its affiliates disclaim any liability for any damages caused by use of this software or hardware in dangerous applications.

Oracle and Java are registered trademarks of Oracle and/or its affiliates. Other names may be trademarks of their respective owners.

Intel and Intel Xeon are trademarks or registered trademarks of Intel Corporation. All SPARC trademarks are used under license and are trademarks or registered trademarks of SPARC International, Inc. AMD, Opteron, the AMD logo, and the AMD Opteron logo are trademarks or registered trademarks of Advanced Micro Devices. UNIX is a registered trademark of The Open Group.

This software or hardware and documentation may provide access to or information on content, products, and services from third parties. Oracle Corporation and its affiliates are not responsible for and expressly disclaim all warranties of any kind with respect to third-party content, products, and services. Oracle Corporation and its affiliates will not be responsible for any loss, costs, or damages incurred due to your access to or use of third-party content, products, or services.

<b>Preface</b> .....	13
Foreword .....	13
Intended Audience.....	15
Access to Oracle Support .....	16
Structure .....	16
Related Documents .....	17
Conventions .....	17
<b>1 Introduction to Oracle Asset Liability Management</b>	
<b>Overview of Oracle Financial Services Asset Liability Management</b> .....	1-1
Oracle Asset Liability Management Key Benefits .....	1-2
<b>Oracle Asset Liability Management and Other Oracle Financial Services Applications</b> .....	1-2
<b>Oracle Financial Services Enterprise Performance Management</b> .....	1-2
OFSAA Data Model .....	1-3
OFSAA Infrastructure .....	1-3
OFSAA Funds Transfer Pricing .....	1-3
OFSAA Profitability Management .....	1-3
OFSAA Pricing Management, Transfer Pricing Component .....	1-4
OFSAA Asset Liability Management .....	1-4
OFSAA Balance Sheet Planning.....	1-4
OFSAA Business Intelligence Applications .....	1-5
Oracle Asset Liability Management Integrations.....	1-5
Oracle Financial Services Analytical Overview .....	1-5
<b>2 Overview of OFSAA Infrastructure</b>	
<b>OFSAA Infrastructure</b> .....	2-1
<b>Overview of Dimensionality in OFSAA</b> .....	2-1
Internally .....	2-2
Externally .....	2-2
Combination .....	2-2
<b>Referential Integrity</b> .....	2-2
<b>Dimension Attributes</b> .....	2-2
<b>Hierarchies</b> .....	2-3
Internally .....	2-3
Externally .....	2-3
Combination .....	2-3
<b>Rollup Members for Dimensions Supporting Hierarchies</b> .....	2-3
<b>Dimension Types</b> .....	2-4
Key Processing Dimensions.....	2-4
Standard Dimensions .....	2-5
<b>Simple Dimensions</b> .....	2-5
Reserved Simple Dimensions.....	2-6
Simple Dimensions Used for Processing or Reporting Purposes .....	2-6
Simple Dimensions Used as Attribute Domains .....	2-6
<b>Overview of Attributes</b> .....	2-7
Attributes.....	2-7

Unbounded and Bounded Attribute Data Types .....	2-7
<b>Overview of OFSAA Rules</b> .....	2-8
Dependencies .....	2-8
OFSAA Filters .....	2-8
<b>OFSAA Expressions</b> .....	2-9
<b>Folders</b> .....	2-9
Visibility of Rules .....	2-10
<b>OFSAA Data Entry Forms and Queries</b> .....	2-10
<b>Access Type</b> .....	2-10
<b>Global Preferences</b> .....	2-11
<b>Application Preferences</b> .....	2-12

### 3 OFSAA Administrative Reporting

<b>Introduction</b> .....	3-1
Logging in to the Administrative Reports .....	3-1
Interactive Dashboards in Administrative Reports .....	3-2
OFSAA Infrastructure .....	3-2
Admin Home .....	3-2
<b>Access Permissions</b> .....	3-3
<b>Data Quality</b> .....	3-3
Data Quality Dashboard .....	3-4
<b>Object Registration</b> .....	3-10
<b>Security</b> .....	3-11
User Privileges .....	3-11
Group Privileges .....	3-12
Role Privileges .....	3-13
Function Privileges .....	3-14
<b>Adhoc Reporting – Special Instructions</b> .....	3-15
Data Quality .....	3-16
Object Registration .....	3-16
Security .....	3-16

### 4 OFSAA Rate Management

<b>Overview</b> .....	4-1
Interest Rates .....	4-1
Currency .....	4-2
Currency Rates .....	4-2
Economic Indicators .....	4-2
<b>Interest Rates Summary Screen</b> .....	4-3
Search Container .....	4-3
Interest Rates Container .....	4-3
Interest Rates Summary Grid .....	4-5
<b>Interest Rates Detail Screen</b> .....	4-6
Interest Rate Code Details Container .....	4-6
Interest Rate Code Tabs .....	4-8
Automate (Schedule) the Generate Rates Action in Hybrid IRCs .....	4-26
<b>Currency</b> .....	4-31

Search Container .....	4-31
Currencies Container .....	4-32
Currencies Summary Grid.....	4-32
Editing Currencies .....	4-33
Adding Currencies.....	4-34
Deleting Currencies .....	4-34
<b>Currency Rates</b> .....	4-34
Preparing to Work with Exchange Rate Data .....	4-34
Adding Exchange Rate Data.....	4-35
Adding Multiple Exchange Rates.....	4-37
Editing Exchange Rate Data .....	4-37
Viewing Exchange Rate Data .....	4-37
Deleting Exchange Rate Data .....	4-38
Excel Import/Export.....	4-39
<b>Currency Exchange Rate Validation</b> .....	4-40
Currency Rate Validation – Overview .....	4-40
Exchange Rate Validation – Feature Description .....	4-40
Currency Rate Validation – Procedure .....	4-40
Validating Exchange Rate Relationships.....	4-41
Running an Exchange Rate Validation .....	4-42
<b>Economic Indicators Summary Screen</b> .....	4-47
Search Container .....	4-47
Economic Indicators Container .....	4-47
Economic Indicators Summary Grid.....	4-48
<b>Economic Indicators Detail Screen</b> .....	4-49
Economic Indicator Details Container .....	4-49
Economic Indicators – Historical Data Container .....	4-50
Adding Multiple Data Points .....	4-51
Editing Economic Indicators – Historical Data.....	4-51
Viewing Economic Indicators – Historical Data.....	4-51
Deleting Economic Indicators – Historical Data.....	4-52
Data Loader.....	4-52
Excel Import/Export.....	4-52

## 5 Simplified Batches

<b>Overview of Simplified Batches</b> .....	5-1
Standard OFSAA Infrastructure Batching Functionality .....	5-1
Batch Maintenance .....	5-2
Batch Execution .....	5-2
Other Operations Batch Functionality .....	5-2
<b>Summary and Detail Screens</b> .....	5-3
<b>Navigation within the Summary Screen</b> .....	5-3
Search Container .....	5-3
Simplified Batch Container .....	5-3
Simplified Batch Summary Grid.....	5-5
<b>Navigation within the Detail Screen</b> .....	5-6
Simplified Batch Container .....	5-7

Batch Execution Type Container.....	5-7
Search Container .....	5-8
Task Details Container .....	5-8
<b>Task Selection .....</b>	<b>5-9</b>
Controls on the Task Details Container .....	5-9
Task Search Container.....	5-10
Task Selector Container.....	5-12
<b>Running a Simplified batch .....</b>	<b>5-14</b>
<b>Viewing the Task Logs.....</b>	<b>5-16</b>
<b>Additional Batch Options.....</b>	<b>5-17</b>

## 6 Holiday Calendar

Overview of Holiday Calendars.....	6-1
Searching for a Holiday Calendar.....	6-1
Creating a Holiday Calendar.....	6-2
Executing Holiday Calendar .....	6-4
Holiday Exceptions .....	6-5
Excel Import/ Export .....	6-5

## 7 Oracle Asset Liability Management Process

Overview of the Process.....	7-2
Reconciling the Data.....	7-6
Cleansing the Data by performing Cash Flow Edits.....	7-7
Setting Application Preferences .....	7-7
Activating Currencies and Loading Exchange Rates.....	7-7
<b>(Mandatory) Deciding on historical rate information and managing by creating Interest Rate Codes.....</b>	<b>7-9</b>
Defining Economic Indicators .....	7-9
<b>Capturing Instrument Behavior for non-standard instruments.....</b>	<b>7-10</b>
Defining Behavior Patterns.....	7-10
Defining Payment Patterns.....	7-13
Defining Repricing Patterns .....	7-16
Loading Payment Schedule details .....	7-20
<b>(Mandatory) Defining Time Buckets .....</b>	<b>7-20</b>
<b>(Mandatory) Defining Product Characteristics .....</b>	<b>7-22</b>
<b>(Mandatory - Deterministic) Defining Forecast Rate Scenarios .....</b>	<b>7-22</b>
<b>Defining Prepayments .....</b>	<b>7-22</b>
Prepayment Methodologies and Rules .....	7-22
Constant Prepayment Method .....	7-23
<b>Prepayment Model Method .....</b>	<b>7-23</b>
PSA Method .....	7-25
Arctangent Calculation Method.....	7-25
<b>Defining Discounting Methods .....</b>	<b>7-29</b>
<b>Defining Forecast Assumptions .....</b>	<b>7-29</b>
<b>Defining Transfer Pricing Rules .....</b>	<b>7-29</b>
<b>Transfer Pricing Methodologies and Rules .....</b>	<b>7-30</b>
Cash Flow: Average Life .....	7-31

Cash Flow: Duration.....	7-32
Cash Flow: Weighted Term .....	7-33
Cash Flow: Zero Discount Factors.....	7-34
Moving Averages .....	7-35
Straight Term .....	7-36
Spread from Interest Rate Code .....	7-37
Spread from Note Rate .....	7-37
Redemption Curve.....	7-37
<b>Defining Transfer Pricing Methodologies Using Node Level Assumptions .....</b>	<b>7-38</b>
<b>Defining Adjustment Rules .....</b>	<b>7-40</b>
Adjustment Methods and Rules .....	7-41
<b>Defining Transaction Strategies.....</b>	<b>7-46</b>
<b>Defining Formula Results .....</b>	<b>7-46</b>
<b>(Mandatory – Stochastic) Defining Stochastic Rate Indexing Rules .....</b>	<b>7-47</b>
<b>(Mandatory) Defining and Running the Asset Liability Management Process .....</b>	<b>7-47</b>
<b>Reviewing Processing Errors .....</b>	<b>7-47</b>
<b>Accessing Asset Liability Management, Detail Cash Flow Results for Audit Purposes .....</b>	<b>7-48</b>
<b>Accessing Asset Liability Management, Interest Rate Audit Results .....</b>	<b>7-48</b>
<b>Analyzing Results .....</b>	<b>7-48</b>
<b>Re - processing Erroneous Accounts.....</b>	<b>7-50</b>
<b>Consolidation of Results.....</b>	<b>7-50</b>

## **8 Common Rule Management Tasks**

Overview of Common Rule Management Tasks.....	8-1
The Rule Summary Page.....	8-2
Searching for Rules.....	8-3
Creating Rules.....	8-4
Viewing and Editing Rules .....	8-4
Copying Rules.....	8-4
Deleting Rules .....	8-5
Dependency Checking .....	8-5

## **9 Application Preferences**

Overview of Asset Liability Management Application Preferences .....	9-1
Updating Asset Liability Management Application Preferences .....	9-1

## **10 Cash Flow Edits**

Overview of Cash Flow Edit Processes .....	10-1
Creating Cash Flow Edit Processes .....	10-2
Executing Cash Flow Edit Processes.....	10-4
Prerequisites.....	10-4
Procedure .....	10-4

## **11 User Defined Behavior Patterns**

Overview of User Defined Behavior Patterns .....	11-1
--	------

<b>Searching for Behavior Patterns</b> .....	11-1
<b>Creating Behavior Patterns</b> .....	11-2
Defining Non Maturity Behavior Patterns .....	11-3
Defining Non Performing Behavior Patterns.....	11-5
Defining Devolvement and Recovery Behavior Patterns.....	11-7
<b>12 User Defined Payment Patterns</b>	
<b>Overview of User Defined Payment Patterns</b> .....	12-1
<b>Searching for Payment Patterns</b> .....	12-1
<b>Creating Payment Patterns</b> .....	12-2
Defining Absolute Payment Patterns.....	12-3
Defining Relative Payment Patterns .....	12-6
Defining Split Payment Patterns.....	12-9
<b>Payment Pattern Data Loader</b> .....	12-11
<b>13 User Defined Repricing Patterns</b>	
<b>Overview of Repricing Patterns</b> .....	13-1
<b>Searching for Repricing Patterns</b> .....	13-1
Prerequisites.....	13-2
Procedure .....	13-2
<b>Creating Repricing Patterns</b> .....	13-2
Procedure .....	13-2
Defining Absolute Repricing Patterns .....	13-3
Defining Relative Repricing Patterns .....	13-6
<b>14 Behavior Pattern Rule</b>	
<b>Overview of Behavior Pattern Rules</b> .....	14-1
<b>Creating Behavior Pattern Rules</b> .....	14-2
Procedure .....	14-2
<b>Defining Behavior Pattern Rule</b> .....	14-2
Prerequisites.....	14-2
Procedure .....	14-3
The Behavior Pattern Details screen.....	14-3
<b>Defining a Behavior Pattern Rule: An Example</b> .....	14-3
<b>15 Time Buckets</b>	
<b>Overview of Time Bucket Rules</b> .....	15-1
<b>Creating Time Bucket Rules</b> .....	15-3
<b>Defining Time Bucket Rules</b> .....	15-3
<b>16 Default Product Profiles</b>	
<b>Overview of Product Profiles</b> .....	16-1
<b>Viewing a seeded Product Profile</b> .....	16-2
<b>Creating Product Profiles</b> .....	16-2
<b>Summary of Seeded Product Profiles</b> .....	16-3



<b>17</b>	<b>Product Characteristics</b>	
	Overview of Product Characteristic Rules .....	17-1
	Creating Product Characteristic Rules .....	17-2
	Defining Product Characteristic Rules .....	17-2
	Copying Assumptions Across Currencies and Products .....	17-18
<b>18</b>	<b>Forecast Rate Scenarios</b>	
	Creating a Forecast Rates Assumption Rule .....	18-1
	Currency Forecast Methods .....	18-4
	Economic Indicator Forecast Methods .....	18-9
	Interest Rate Forecast Methods.....	18-12
	ALM Volatility Codes .....	18-19
	Editing a Forecast Rate .....	18-21
	Behavior Pattern Rule Mapping.....	18-21
	Data Loader Procedure .....	18-21
<b>19</b>	<b>Prepayment Rules</b>	
	Overview of Prepayment Rules.....	19-1
	Creating Prepayment Rules.....	19-2
	Procedure .....	19-2
	Defining Prepayment Methodologies.....	19-2
	Defining Prepayments Using Node Level Assumptions .....	19-3
	Defining the Constant Prepayment Method .....	19-5
	Defining the Prepayment Model Method .....	19-8
	Defining the PSA Prepayment Method .....	19-9
	Defining the Arctangent Calculation Method .....	19-10
	Defining Early Redemption Assumptions.....	19-11
	Prerequisites.....	19-12
	Procedure .....	19-12
	Associating Conditional Assumptions with Prepayment Rules .....	19-14
<b>20</b>	<b>Prepayment Models</b>	
	Overview of Prepayment Models .....	20-1
	Creating Prepayment Models .....	20-1
	Procedure to create a Prepayment Model .....	20-2
	Procedure to Define the Structure of the Prepayment Model .....	20-3
	Editing Prepayment Models.....	20-5
	Prerequisites.....	20-5
	Procedure .....	20-5
	Editing Prepayment Rates in a Prepayment Model.....	20-5
	Procedure .....	20-6
	Prepayment Rate Data Loader .....	20-6
<b>21</b>	<b>Discount Methods</b>	
	Overview of Discount Method Rules.....	21-1

<b>Creating Discount Method Rules</b> .....	21-2
<b>Defining Discount Method Rules</b> .....	21-2
Prerequisites.....	21-3
Procedure .....	21-3
The Discount Method Details screen.....	21-3
Discount Method.....	21-3
Cash Flow Definition Details.....	21-4
Cash Flow Interest Type.....	21-5
Interest Rate Parameters .....	21-5
Defining a Discount Methods Rule Using Spot IRC: An Example .....	21-5
Discount Rate Method Examples.....	21-6

## 22 Rate Dependency Patterns

<b>Overview of Rate Dependency Patterns</b> .....	22-1
<b>Searching for Rate Dependency Patterns</b> .....	22-2
<b>Creating Rate Dependency Patterns</b> .....	22-3
Defining Rate-Level Dependent Rate Dependency Patterns.....	22-3
Defining Rate-Spread Dependent Rate Dependency Patterns.....	22-5
Defining Economic Indicator Dependent Rate Dependency Patterns .....	22-6

## 23 Forecast Balance Rules

<b>Forecasting Methods</b> .....	23-1
No New Business .....	23-2
Target End Balance .....	23-2
Target Average Balance .....	23-3
Target Growth Percent .....	23-3
New Add Balance .....	23-4
Rollover.....	23-4
Rollover with New Add.....	23-5
Rollover with Growth Percent .....	23-5
Account Types and New Business .....	23-5
<b>Rate-Volume Modeling</b> .....	23-6
<b>Creating a Forecast Balance Rule</b> .....	23-7
<b>Examples of Forecast Balance Assumptions</b> .....	23-13

## 24 Forecast - Pricing Margins

<b>Overview of Pricing Margin Rules</b> .....	24-1
<b>Creating Pricing Margin Rules</b> .....	24-2
<b>Defining Pricing Margin Rules</b> .....	24-3
Defining Pricing Margins Using Node Level Assumptions.....	24-3
Prerequisites.....	24-3
Procedure .....	24-3
Rate Dependency Selection screen .....	24-4
The Pricing Margin Details screen.....	24-4
<b>Defining a Pricing Margin Rule: An Example</b> .....	24-6

<b>25 Forecast – Maturity Mix</b>	
Overview of Maturity Mix Rules .....	25-1
Creating Maturity Mix Rules .....	25-2
Defining Maturity Mix Rules .....	25-3
<b>26 Transfer Pricing Rules</b>	
Overview of Transfer Pricing Rules .....	26-1
Creating Transfer Pricing Rules .....	26-2
Defining Transfer Pricing Methodologies .....	26-3
Defining the Redemption Curve Methodology .....	26-6
<b>27 Adjustment Rules</b>	
Overview of Adjustment Rules .....	27-1
Creating Adjustment Rules .....	27-2
Defining Adjustment Methods .....	27-2
Availability of Adjustment Methods.....	27-4
Adjustment Method Parameters .....	27-4
Procedure to Define the Formula Based Rate Adjustment Method .....	27-7
<b>28 Transaction Strategies</b>	
Creating a Transaction Strategy Rule.....	28-1
Defining a Transaction Strategy.....	28-2
<b>29 Formula Results</b>	
Overview of Formula Results Rule.....	29-1
Creating Formula Results Rules .....	29-3
Defining Formula Results Rules .....	29-4
Defining a Formula Results Rule: An Example .....	29-11
Formula Results Functions .....	29-15
<b>30 Stochastic Rate Indexing</b>	
Overview of Stochastic Rate Indexing Rules.....	30-1
Defining Stochastic Rate Indexes .....	30-2
<b>31 ALM Processing</b>	
Overview of ALM Processes .....	31-1
Creating an ALM Process Rule .....	31-3
Creating a Static Deterministic ALM Process Rule .....	31-4
Creating a Static Stochastic / Historical Simulation Process Rule .....	31-9
Creating a Dynamic Deterministic Process Rule.....	31-14
Creating a Dynamic Stochastic / Historical Simulation Process Rule .....	31-19
Executing an ALM Process .....	31-24

<b>32</b>	<b>Andrew Davidson and Company (ADCo) Prepayment Method</b>	
	Overview of ADCo Prepayment Method .....	32-1
	Deployment of ADCo Libraries on OFSAAI .....	32-1
	Objectives .....	32-1
	Prerequisite .....	32-1
	Steps .....	32-1
	Procedure For Setting Up ADCo Process.....	32-2
	Mapping of the ADCo function .....	32-3
	ADCo Mapping .....	32-11
	Limitations.....	32-12
<b>33</b>	<b>Moody's WSA Integration with OFSAA ALM</b>	
	Overview of Moody's WSA Integration .....	33-1
	Deployment of Moody Libraries on OFSAAI .....	33-1
	Prerequisite .....	33-1
	Steps .....	33-1
	Moody's Integration – Considerations.....	33-2
	WSA Engine and Processing of the Records .....	33-2
	WSA Engine and OFSAA Rate Management .....	33-3
	WSA Engine and OFSAA Product Characteristic Definition .....	33-3
	Setting-up a Moody's Process .....	33-6
	Limitations.....	33-7
<b>34</b>	<b>Data Aggregation and Stratification</b>	
	Overview of Data Stratification .....	34-1
	Stratification Action Operations .....	34-2
	Aggregation Action Operations.....	34-2
	Stratification Tips .....	34-3
	Setting up Stratification Definitions.....	34-3
	Stratification Configuration Page .....	34-3
	Setting up Stratification Tier Structures.....	34-4
	Setting up Stratification Definitions .....	34-6
	Defining Stratification Rules.....	34-6
	Defining Stratification Tiers.....	34-9
	Executing a Stratification Rule .....	34-10
	Using SQL*Plus .....	34-10
	Using ICC Batch Framework.....	34-11
	Creating New Aggregate Table .....	34-12
<b>A</b>	<b>Viewing ALM Objects in Metadata Browser</b>	
	Metadata Browser (Object and Application View) .....	A-1
	Configuring Metadata Browser .....	A-1
	Viewing ALM Objects in Metadata Browser.....	A-2

## B Performance Tunning

<b>Process Tuning</b> .....	B-1
Multiprocessing Model .....	B-2
Multiprocessing Options.....	B-3
Specifying Multiprocessing Parameters .....	B-8
Tuning Multiprocessing .....	B-16
Invalid key Processing Data .....	B-17
Process Cash Flow Cleanup.....	B-18
Validate Node Map.....	B-18
Data Slicing .....	B-18
Configuring Payment Schedule .....	B-18
<b>Operating System Level Tuning</b> .....	B-19
Semaphores .....	B-19
Shared Memory .....	B-19
<b>Database Level Tuning</b> .....	B-20
Simple View vs Materialized View .....	B-20
Cursor Sharing .....	B-20
Process Cashflows Indexes Optimization .....	B-20
<b>Recommendations for Performance Improvement</b> .....	B-20

## C Manage ALM Run

<b>Overview of Manage ALM Run</b> .....	C-1
<b>Run Management</b> .....	C-1
<b>View Run Definition</b> .....	C-6
<b>Edit Run Definition</b> .....	C-6
<b>Run Definition Versioning</b> .....	C-6
<b>Copy Run Definition</b> .....	C-7
<b>Authorize Run Definition</b> .....	C-7
<b>Export Run to PDF</b> .....	C-8
<b>Fire Run</b> .....	C-8
<b>Delete Run Definition</b> .....	C-9
<b>Manage Run Execution</b> .....	C-9

## D Multi Language Support

<b>Overview</b> .....	D-1
-----------------------	-----

## E Archive-Restore

<b>Command Line Migration</b> .....	E-1
<b>Command Line Migration Utility</b> .....	E-1
Supported Objects .....	E-1
Input Values for OBJECTMIGRATION.xml .....	E-4
Logging .....	E-5

## F Interest Rate Risk in the Banking Book (IRRBB)

<b>Overview of Interest Rate Risk in the Banking Book (IRRBB)</b> .....	F-1
---	-----

Approach.....	F-2
Retail/Wholesale and Transactional Non Maturing Deposits.....	F-2
Option Valuation.....	F-3

**G Common Utilities and Scripts**

RMIPC.SH Script .....	G-1
-----------------------	-----

**H Standard Navigation Paths**

Standard Navigation Paths.....	H-1
--------------------------------	-----

**I Oracle ALM Error Messages**

Oracle ALM Error Messages .....	I-1
---------------------------------	-----

**J Glossary**

---

---

# Preface

This Preface provides supporting information for the Asset Liability Management (OFSALM) User Guide and includes the following topics:

- [Intended Audience](#)
- [Access to Oracle Support](#)
- [Structure](#)
- [Related Documents](#)
- [Conventions](#)

## Foreword

This user guide documents OFSAA Asset Liability Management for all versions of release 8. Some functional improvements have been introduced in various service packs and point releases within release 8.

This section documents the levels at which various functional enhancements to the Asset Liability Management application were first introduced.

### **Asset Liability Management release 8.0.1.0.0**

- Object Migration - This is to add Formula Result Link on Object Migration Screen Under ALM.
- Early Redemption - This is to support Holiday Calendar for Early Redemption User Defined Tenors.
- Early Redemption - Early Redemption for user defined tenors UI should support Conditional Assumptions.
- Financial Measure - Addition of New financial measure Dv01 and Pv01
- Error: Include formula results for ALM in object migration rules

### **Asset Liability Management release 8.0.2.0.0**

- Term structure parameter estimation UI has been added in the Interest Rates - Parameters Section. Users can use the tool to estimate parameters for the various

interest rate models supported in the CFE (Merton, Vasicek, Hull and White, Ho and Lee). This is a common tool used across ALM and FTP applications.

- New Income Simulation (standard) and Liquidity Gap financial elements have been added for the output of duration and dv01 metrics In Result detail output tables. FE 720: Duration, FE 721: DV01, FE 725: Mod Duration, FE 1720: Liquidity Gap Duration, FE 1721: Liquidity Gap DV01, FE 1725: Liquidity Gap Modified Duration.

#### **Asset Liability Management release 8.0.4.0.0**

- Inflation Indexed Instruments support to provide investors with a hedge against inflation.
- Support User defined Custom Prepayment similar to Custom defined Early Redemption.
- Enhanced Cash Flow Engine to support the cash settlement event of a futures contract for LRM.
- HTML 5 Support for ALM UI.
- Options Valuation Capabilities to Value Embedded, Bare, and Cap/FI options.
- Formulas are editable in Formula bar of Formula Results UI.
- Formula bar is sort terms by time period.
- New T2T TO MOVE DATA from STG\_BILL\_CONTRACTS to FSI\_D\_LOAN\_CONTRACTS.
- Archive-Restore support for ALM.
- SourcePro to OST Migration
- Session TimeOut enhancement for ALM
- TP adjustment rules to allow selection of TP methods
- Allow negative values in Payment Pattern

#### **Asset Liability Management release 8.0.5.0.0**

- Scenario Based Behavior Pattern Enhancement: Users can now define behavior pattern at product and currency combination to create Behavior Pattern Rule. Separate behavior pattern rules can be attached to each scenario in a Forecast Rates rule, enabling cashflow runoff to differ across multiple scenarios within an ALM process run. This feature is relevant for the IRRBB requirements
- Cash Flow Engine to read margin as a percent: The CFE has been enhanced to include a margin type code which can signal to the CFE to read margin as a rate (standard functionality) or a percent, wherein the percent change applies to the base rate (i.e. if the base rate is 5% and the margin is 10%, then the new rate will be 5.5% - or  $5\% * (1+.10)$ ).



- Options Valuation: CFE was enhanced to include the Black 76 model to value fixed rate instruments with embedded calls and puts (fixed rate bonds with embedded options)
- Support of Volatility Surface Shocks in Forecast Rate: In the Forecast Rates rule, users can now apply a volatility surface shock to value the change in option price relative to volatility. These can be applied at each scenario, and supports IRRBB requirements.
- Retail, Wholesale, Transactional accounts in non-maturing deposits: Per IRRBB standardized approach, non-maturing deposits need to be segmented into Retail and Wholesale categories, where retail deposits further need to be classified into transactional and non-transactional accounts. There are stipulations on the treatment based on certain factors noted in the approach. These attributes were added to the data model to support IRRBB.
- Amenability type for Product Dimension and Account: Per IRRBB regulation standardized approach, banks must classify the status of banking book instruments into 3 categories of an Amenable Status: Amenable to Standardization, Less Amenable to Standardization, and Not amenable to Standardization. The data model has been expanded to include these attributes for product and account.

## Intended Audience

Welcome to Release 8 of the Oracle Financial Services Asset Liability Management (OFSALM) User Guide.

The Oracle Financial Services Asset Liability Management (OFSALM) User Guide provides useful guidance and assistance to:

- Technical end users
- Functional end users
- Data Administrators
- Consultants
- Systems Analysts
- System Administrators
- Other MIS professionals

See [Related Documents](#) for more Oracle product information.

## Access to Oracle Support

Oracle customers have access to electronic support through My Oracle Support. For information, visit <http://www.oracle.com/pls/topic/lookup?ctx=acc&id=info> or

visit <http://www.oracle.com/pls/topic/lookup?ctx=acc&id=trs> if you are hearing impaired.

## Structure

1. Introduction to Oracle Asset Liability Management
2. Overview of OFSAA Infrastructure
3. OFSAA Administrative Reporting
4. OFSAA Rate Management
5. Simplified Batches
6. Holiday Calendar
7. Oracle Asset Liability Management Process
8. Common Rule Management Tasks
9. Application Preferences
10. Cash Flow Edits
11. User Defined Behavior Patterns
12. User Defined Payment Patterns
13. User Defined Repricing Patterns
14. Time Buckets
15. Default Product Profiles
16. Product Characteristics
17. Forecast Rate Scenarios
18. Prepayment Rules
19. Prepayment Models
20. Discount Methods
21. Rate Dependency Patterns
22. Forecast Balance Rules
23. Forecast – Maturity Mix
24. Forecast - Pricing Margins
25. Transfer Pricing Rules
26. Adjustment Rules
27. Transaction Strategies
28. Formula Results
29. Stochastic Rate Indexing

- 30. ALM Processing
- 31. Andrew Davidson and Company (ADCo) Prepayment Method
- 32. Moody's WSA Integration with OFSAA ALM
- 33. Viewing ALM Objects in Metadata Browse
- 34. Manage ALM Run
- 35. Process Tuning
- 36. Multi Language Support
- 37. Archive and Restore
- 38. IRRBB
- 39. Common Utilities
- 40. Standard Navigation Paths
- 41. Oracle ALM Error Messages

## Related Documents

For more information about using Oracle Financial Services Analytical Applications (OFSAA), see the following related documents:

- Oracle Financial Services Analytical Applications Data Model Utilities User Guide
- Oracle Financial Services Analytical Applications Data Model Data Dictionary.
- Oracle Financial Services Asset Liability Management (OFSALM) User Guide
- Oracle Financial Services Funds Transfer Pricing User Guide

## Conventions

The Oracle Financial Services Asset Liability Management User Guide uses the following text and font characteristics:

Convention	Meaning
<b>boldface</b>	Boldface type indicates graphical user interface elements associated with an action, or terms defined in text or the glossary.
<i>italic</i>	Italic type indicates book titles, emphasis, or placeholder variables for which you supply particular values.
monospace	Monospace type indicates commands within a paragraph, URLs, code in examples, text that appears on the screen, or text that you enter.
Upper case text connected by underscores	Used to denote table names. For example, FSI_O_RESULT_MASTER table or FSI_O_PROCESS_ERRORS table.
Lower case text connected by underscores	This convention is used to designate column name within a table. Examples of this convention include market_value and transfer_rate.

## **Symbols**

Bullets indicate a list of items or topics.

Numbered lists are used for sequential steps in completing a procedure.

---

---

# Introduction to Oracle Asset Liability Management

This module provides an introduction to Oracle Asset | Liability Management and discusses its place in the Oracle Financial Services Analytical (OFSAA) group of applications.

This chapter covers the following topics:

- [Overview of Oracle Financial Services Asset Liability Management](#)
- [Oracle Asset Liability Management and Other Oracle Financial Services Applications](#)

## Overview of Oracle Financial Services Asset Liability Management

Oracle Financial Services Asset Liability Management (ALM), helps financial services institutions measure and monitor Interest Rate Risk, Liquidity Risk, and Foreign Currency Risk. This solution measures and models every loan, deposit, investment, and portfolio individually, using both deterministic and stochastic methods. Oracle Financial Services ALM is a next-generation solution fully integrated with Oracle's Financial Services Analytical Applications and shares a common account level relational data model.

With this versatile forecasting tool, powerful analytical functions can be modeled for every instrument, including derivatives and embedded options. Modeling at the account level of detail (loan-by-loan and deposit-by-deposit) provides highly accurate modeling results. Flexible assumption rules and reporting structures support a wide range of analytical power.

Release 8 of Oracle ALM includes rate dependent business rules and improvements to derivative forecasting capabilities. You can define forecast assumption rules that leverage rate dependency patterns allowing you to dynamically model a range of portfolio characteristics that are dependent on the specific scenario being executed. Derivative instrument forecasting is directly supported through Transaction Strategy rules. Within Transaction Strategies, you can now select the derivative type and define the characteristics that apply to the specific derivative instrument being modeled.

## Oracle Asset Liability Management Key Benefits

Oracle Financial Services ALM is designed to model balance sheets under a variety of rate environments. Oracle Financial Services ALM functionality uses several key concepts and has evolved from the continual iterations of building simulated management processes. The basis of Oracle Financial Services ALM functionality includes:

- **Wealth of output information.** Oracle ALM calculates and stores a variety of financial risk indicators including: Var, Ear and related probability distributions; static and dynamic market value, duration and convexity; static and dynamic Gaps based on both repricing and liquidity bucket definitions; income simulation capabilities.
- **Rigorous Calculations.** Oracle ALM is designed to operate on transaction-level data, using Oracle's highly accessible and flexible financial services data model. Each account, as well as all forecasted new-business activity, is modeled independently on a daily cash flow basis.
- **A flexible time horizon and free-form timing bucket increments for reporting are critical to meeting the wide range of forecasting requirements of financial institutions.** Unconstrained chart of accounts definition is a basic requirement of effective modeling.
- **A structured process for defining and controlling assumptions is critical to any successful modeling process.**
- **Unconstrained batching of scenarios, with flexible assumptions sets, is required to achieve an effective and efficient analytical process.**

## Oracle Asset Liability Management and Other Oracle Financial Services Applications

Oracle Financial Services Asset Liability Management (ALM) operates on top of a common infrastructure, Oracle Financial Services Analytical Applications Infrastructure (OFSAAI). OFSAA applications form a comprehensive decision support solution that significantly enhances enterprise risk and performance management functions across a financial institution.

## Oracle Financial Services Enterprise Performance Management

More than ever, financial institutions, their regulators as well as their shareholders are focused on the need to measure and meet risk-adjusted performance objectives, price products to reflect their true risk, and better understand how their institution is impacted by threats to liquidity, capital adequacy, and exposure to market rate volatility.

## OFSAA Data Model

OFSAA Data Model (OFSAADM) is shipped with optimized data structures and pre-packaged data elements developed specifically for the financial services industry. OFSAADM is the foundation for the OFS applications. It provides the database structures necessary to support the individual business applications.

## OFSAA Infrastructure

OFSAA Infrastructure is the foundation for OFSAA. It provides support for User Administration, Metadata Management, a Processing Framework, a Forms Framework and additional capabilities necessary to support the individual business applications.

## OFSAA Funds Transfer Pricing

Oracle Financial Services Funds Transfer Pricing is the industry's first and leading matched maturity funds transfer pricing application, enabling financial institutions to determine the spread earned on assets, from funding sources, and the spread earned as a result of interest rate exposure for each and every customer relationship. This enables accurate assessment of profitability along product, channel, and business lines, as well as the centralization of interest rate risk so it can be effectively managed. Oracle Financial Services Funds Transfer Pricing is fully integrated with Oracle's Financial Services Analytical Applications and shares a common customer account level data model.

The transfer pricing process isolates the four major sources of a bank's margin:

The spread earned on assets

The spread earned on liabilities

The spread earned or lost as a result of interest rate exposure

The spread earned or lost as a result of embedded options such as prepayments

Measuring and managing interest margin offers tremendous profit opportunities. By separating the components of net interest income, Oracle Funds Transfer Pricing isolates rate risk into your funding center where it can be centrally managed. In turn, business units are held accountable for what they can control: pricing and profitability. Armed with this highly accurate information, companies make solid, supportable decisions that lead to increased success in the marketplace.

## OFSAA Profitability Management

Oracle Financial Services Profitability Management enables financial services institutions to calculate profitability by products, channels, segments, and even individual customers. These profitability calculations are adjusted for risk, and they drive Risk-Adjusted Performance Management (RAPM), an imperative for financial services institutions operating in this rapidly evolving and complex industry.

Isolating and analyzing business unit profitability is only the first step in building effective profitability management. To hold operational managers truly accountable for profitability, senior management must give them the power to identify the products that are profitable in each market segment, for each customer.

Together with OFSAA Transfer Pricing, OFSAA Profitability Management is the tool that delivers this power. Profitability Management links general ledger, account-level, and statistical data together to produce detailed financial statements for individual business units, products, and customers. Combining powerful modeling and disciplined accounting, OFSAA Profitability Management delivers complete, accurate, and inclusive profiles of profitability.

## **OFSAA Pricing Management, Transfer Pricing Component**

Oracle Financial Services Pricing Management, Transfer Pricing Component is an interactive application that provides real-time transfer rates to support pricing loan transactions that reflect immediate market conditions. Risk-based pricing queries are directly integrated with the Oracle Financial Services Funds Transfer Pricing solution and leverage the same business rule logic. Query results incorporate all details of the underlying transfer price and include all elements of a product's profit and loss, including the allocated expense, expected loss, and capital charge.

## **OFSAA Asset Liability Management**

Volatile market conditions and increasing regulatory pressures are placing greater demands on the risk management function. These stresses are driving financial institutions to review their current risk modeling and measurement capabilities. Yet, these circumstances also provide institutions with the opportunity to update technology solutions to systems fully integrated across the risk and performance spectrum. Departmental, one-off solutions are no longer viable alternatives in an environment where all systems need to work together.

Oracle Financial Services Asset Liability Management (ALM) helps financial services institutions measure and manage interest rate risk and liquidity risk, perform balance sheet valuations, and forecast both net interest income and net income. The Oracle Financial Services ALM solution has the ability to measure and model every loan, deposit, investment, and off-balance sheet instrument individually, using both deterministic and stochastic methods. This helps institutions gain a better understanding of the risks they have assumed and their sensitivity to changes in economic conditions.

## **OFSAA Balance Sheet Planning**

Oracle Financial Services Balance Sheet Planning is designed to help financial services institutions budget for a full balance sheet and the associated profit and loss statement. Banks have a number of very unique needs when looking ahead. They must be sensitive to economic conditions, and create plans that not only forecast future



performance, but also the forward risks they are assuming. Most importantly, they require tools that accurately forecast net interest margin. By accurately modeling the detailed and complex events on a bank's balance sheet, for both the current book of business and forecasted new volumes, Oracle Financial Services Balance Sheet Planning enables the delivery of accurate margin forecast and comprehensive, meaningful budgets.

## **OFSA Business Intelligence Applications**

OFSA Business Intelligence (BI) Applications are complete, prebuilt BI solutions that deliver intuitive, role-based intelligence for everyone in an organization—from front line employees to senior management—that enable better decisions, actions, and business processes.

## **Oracle Asset Liability Management Integrations**

Oracle Asset Liability Management integrates with the following modules:

- Oracle Financial Services Asset Liability Management Analytics
- Oracle Financial Services Balance Sheet Planning
- Oracle Financial Services Funds Transfer Pricing

A robust and flexible Asset Liability Management process is merely the beginning. Oracle ALM Analytics (ALM BI) is a fully integrated business intelligence application leveraging Oracle's industry leading BI technology. Oracle ALM BI contains ALM specific dashboards and reports providing an out of the box reporting solution that allows you to rapidly deploy your ALM solution and quickly realize significant return on your investment.

You can also integrate FTP business rules into Oracle Financial Services Asset Liability Management to project transfer pricing results into your forecasting process.

## **Oracle Financial Services Analytical Overview**

For over 15 years, Oracle has set the standard for analytical applications in financial services. With our applications financial services organizations can achieve management excellence with a lower total cost of ownership, due to our integrated architecture, combining performance and risk applications into a single, seamlessly integrated framework.

In today's turbulent markets, financial institutions require a better understanding of the relationship between risk and return, while strengthening competitive advantage and enhancing long-term customer value. Oracle Financial Services Analytical Applications enable financial institutions to measure profitability and meet risk adjusted performance objectives, cultivate a risk management culture through transparency, lower the costs of compliance and regulation, and improve insight into customer behavior.

## Management Excellence Begins at Intersections of Functional Silos

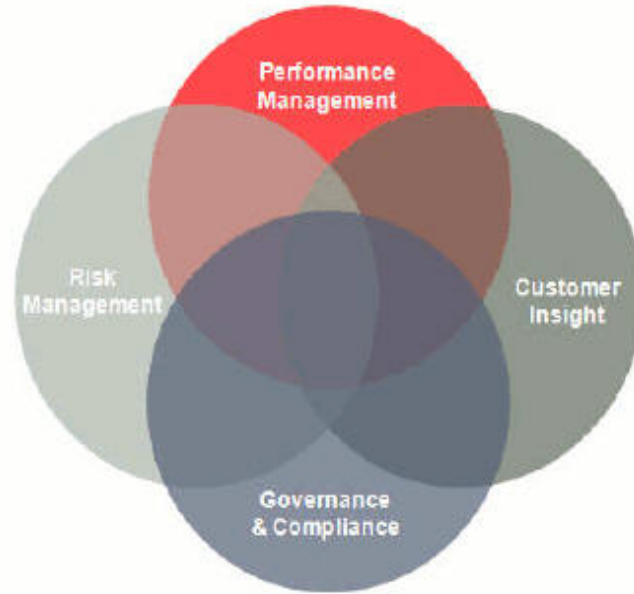

---

---

## Overview of OFSAA Infrastructure

### OFSAA Infrastructure

OFSAA Infrastructure includes facilities for creating and maintaining

- Dimensional reference data
- Interest rate & currency exchange rate data
- Process tuning data

OFSAA Infrastructure also includes functionality for building and maintaining rules that may be used by any Oracle Financial Services Analytical Application. These common rule objects include:

- Expressions
- Hierarchies
- Filters

The following chapters document how to navigate the OFSAA user interface to create and maintain dimensional reference data, interest rate & currency exchange rate data, and process tuning data; and to create and maintain OFSAA Infrastructure rules: Expressions, Hierarchies, and Filters.

For more information, refer to *Oracle Financial Services Analytical Applications Infrastructure User guide*.

The remainder of this chapter documents:

- Overview of Dimensionality in OFSAA
- Overview of OFSAA Rules
  - Hierarchies
  - Filters
  - Expressions

### Overview of Dimensionality in OFSAA

Dimensions are used to stratify your business data for processing or reporting purposes. For example, at a minimum General Ledger systems are typically stratified by a General Ledger dimension, an organization or cost center dimension, and a time dimension. Customer account level data will normally have these same dimensions but are often additionally segmented by dimensions such as Product or Customer. You may wish to construct models using a specialized product dimension or other customized dimensions such as geography, cost pool, transaction, activity or channel.

Dimensions are comprised of lists of members. For example, the Organizational Unit dimension might be comprised of Branch #1, Branch #2, Branch #3, etc. Some dimensions may contain tens or even hundreds of thousands of members (for example, a large organizational or customer dimension) while others may contain as few as two members (for example, a simple product-type dimension with values of Fixed and Variable).

The member values or "Chart of Accounts" for each dimension may be maintained either internally within the OFSAA Infrastructure or externally.

### Internally

OFSAA Infrastructure includes functionality for Adding, Viewing, Editing, or Deleting dimension member values. Which of these functions you can access depends on your logon privilege and on the dimension with which you wish to work. For details, on the creation and maintenance of Dimension Members, refer to *Oracle Financial Services Analytical Applications Infrastructure User guide*.

### Externally

You may choose to source and maintain some Charts of Accounts from external systems such as your General Ledger, a Data Warehouse, or from some other external master data management system. refer *Oracle Financial Services Analytical Applications Data Model Utilities User Guide* for details on loading dimensional data from external systems.

### Combination

You may also choose to maintain some Chart of Account values from an external source while maintaining other Chart of Account values internally.

## Referential Integrity

You may have dimension member values defined in your Chart of Accounts that do not exist in your business data, particularly if the dimension member values are used as attribute values (see discussion of attributes below). But you would never want to have an occurrence of a dimension member value in your business data that did not exist in the dimension's Chart of Accounts. When you load business data into OFSAA, you need assurance that there are no dimension member values present in the business data that are not defined in your Chart of Accounts. For details on ensuring referential integrity between your business data and your Chart of Accounts data, see *Oracle Financial Services Analytical Applications Infrastructure (OFSAAI) Installation and Configuration Guide*.

## Dimension Attributes

Some OFSAA dimensions support attributes. Dimension attribute values are used to qualify dimension members. For example, a cost center, say Branch #1, might have a Headcount attribute with a value of 32 and a Volume attribute with a value of High. A product dimension member, say 30-year fixed rate jumbo LIBOR mortgage, might have a Rate attribute with a value of LIBOR, a Size attribute with a value of Jumbo, and a Loan Type attribute of Fixed. A General Ledger account, say Benefit Expense, might have an Account Type attribute with a value of Non-Interest Expense.

Like dimensions, attributes are used to stratify your business data for processing or reporting purposes. Some dimension attributes are seeded within the OFSAA data

model and are used extensively in processing. You may define as many user-defined attributes as you need.

OFSAA Infrastructure includes functionality for Adding, Viewing, Editing, or Deleting dimension attributes. Which of these functions you can access depends on your logon privilege and on the dimension with which you wish to work.

Once an attribute has been defined for a dimension, attribute values may be assigned to individual dimension member values. These attribute values may be open-ended (dates, numbers, or strings) or may be restricted to a defined set of members.

## Hierarchies

Some OFSAA dimensions support hierarchies. Hierarchies may be used to provide sophisticated stratification for either processing or reporting purposes. For example, an organizational hierarchy might start with a Division level containing Western Region, Eastern Region, and Southern Region; the next level down within the hierarchy might be state or county. A product hierarchy might begin with branches for Asset vs. Liability vs. Service products; under the Asset branch, you might define additional branches for Mortgage Lending, Commercial Lending, Consumer Lending, and so on. Hierarchies are used extensively in OFSAA models to assign methods to products and to support allocation methodologies.

Like dimension members, dimension hierarchies may be maintained either internally within the OFSAA Infrastructure or externally.

### Internally

OFSAA Infrastructure includes functionality for Adding, Viewing, Editing, or Deleting hierarchies. Which of these functions you can access depends on your logon privilege and on the hierarchy with which you wish to work.

### Externally

You may choose to source and maintain some or all of your hierarchies from external systems such as your General Ledger, a Data Warehouse, or from some other external master data management system, such as Oracle Data Relationship Management (DRM). refer *Oracle Financial Services Analytical Applications Data Model Utilities User Guide* for details on loading hierarchy data from external systems.

### Combination

You may also choose to maintain some hierarchies from an external source while maintaining other hierarchies internally.

## Rollup Members for Dimensions Supporting Hierarchies

For dimensions that support hierarchies, every dimension member value has the property of being either a "leaf" value (child-only or last descendent child value) or a "rollup node" value. For example, if Branch #1, Branch #2, and Branch #3 all belonged to the West rollup point of an organizational hierarchy, then West would also be a dimension member value of the Organizational Unit dimension. Your business data is typically expressed at the "leaf" level.

## Dimension Types

OFSAA supports 3 fundamentally different kinds of dimensions

- Key Processing Dimensions
- Standard Dimensions
- Simple Dimensions

### Key Processing Dimensions

Key Processing Dimensions have the following features:

- Accessible as modeling dimensions for all of the OFSAA analytical engines.
- Expressed as columns in nearly all of your business fact tables.
- Support both attributes and hierarchies

Metadata for Key Processing Dimensions is stored in four tables:

- A base table (For example, DIM\_PRODUCTS\_B)
- A translation table (For example, DIM\_PRODUCTS\_TL)
- An attribute table (For example, DIM\_PRODUCTS\_ATTR)
- A hierarchy table (For example, DIM\_PRODUCTS\_HIER)

Base tables store basic information about each dimension member and translation tables store names and descriptions for each dimension member in multiple languages (refer *Oracle Financial Services Analytical Applications Infrastructure (OFSAAI) Installation and Configuration Guide* for details on multi-language support). Attribute tables store one or many attribute values for each dimension member. Hierarchy tables store one or more hierarchies for each dimension (you may define as many hierarchies as you wish for any dimension that supports hierarchies).

### Seeded Key Processing Dimensions

OFSAA is seeded with six Key Processing dimensions:

- Financial Element
- Organizational Unit
- General Ledger Account
- Common Chart of Accounts
- Product
- Legal Entity

Among the six seeded Key Processing dimensions, only the Financial Element dimension is pre-populated with a Chart of Accounts, but it is only populated in the range between 0 and 10,000 (For more details on the seeded Chart of Accounts for the Financial Element dimension refer Oracle Financial Services Profitability Management (OFSPM) User Guide). This is a reserved range in which you may not add new members, or edit or delete existing members. You may add user-defined Financial Elements anywhere outside the reserved range.

## User Defined Key Processing Dimensions

Refer *Oracle Financial Services Analytical Applications Infrastructure (OFSAAI) Installation and Configuration Guide* for details on adding your own user-defined Key Processing dimensions.

## Standard Dimensions

Standard dimensions may support attributes and/or hierarchies depending on how they are configured, but are not used as processing dimensions within any of the analytical application engines. Like Key Processing Dimensions, metadata for Standard Dimensions is stored in a base table and in a translation table. A Standard Dimension may or may not have an attribute table or a hierarchy table depending on how it is configured. Within the OFSAA modules, Standard dimensions that are defined as having a hierarchy table will support hierarchies and Standard dimensions that are defined as having an attribute table will support attributes. Refer the *Oracle Financial Services Analytical Applications Infrastructure (OFSAAI) Installation and Configuration Guide* and *Oracle Financial Services Analytical Applications Data Model Data Dictionary* for additional information.

## Seeded Standard Dimensions

OFSAA is seeded with two Standard Dimensions

- Country
- Customer

Both dimensions support attributes and hierarchies. Default member values are provided for the Country dimension, but no values are provided for the Customer dimension.

## User Defined Standard Dimensions

Refer the *Oracle Financial Services Analytical Applications Infrastructure (OFSAAI) Installation and Configuration Guide* for details on adding user-defined Standard dimensions.

## Simple Dimensions

Sometimes referred to as Code dimensions, Simple dimensions are "list of values" that support neither attributes nor hierarchies. Their three key uses are:

- Reserved for use within the analytical application engines
- Stratifying your data for process or report filtering purposes
- Serving as "list of values" when used as attributes

The OFSAA Data Model comes with more than 150 seeded Simple dimensions. Many of these seeded Simple dimensions are also seeded with dimension members. Unlike Key Processing dimensions and Standard dimensions, Simple dimensions are stored in two tables:

- A code table (For Example, AMRT\_TYPE\_CD)
- An Multi-Language Support or MLS table (For Example, AMRT\_TYPE\_MLS)

Again, refer *Oracle Financial Services Analytical Applications Infrastructure (OFSAAI) Installation and Configuration Guide* for details on multi-language support.

Simple Dimension "Process Identifier Code" helps to improve ALM process execution performance by skipping VALIDATE\_NODE\_MAP\_ALM package execution incase there is no change in underlying metadata while running ALM Process everytime. There is no direct method to identify whether any change in underlying data at node level and one need execute VALIDATE\_NODE\_MAP\_ALM and thats where "Process Identifier Code" Simple Dimension takes place. This dimension should contain list of process Ids for which there is no change in underlying node level metadata hence no need to run VALIDATE\_NODE\_MAP\_ALM everytime the process is run. In turn whenever ALM Engine is run; it check the currently considred process id and checks its existance in FSI\_PROCESS\_IDENTIFIER\_CD table; if present then ignores VALIDATE\_NODE\_MAP\_ALM procedure run.

## Reserved Simple Dimensions

Accrual Basis Code is an example of a seeded Simple dimension that is used extensively by the application modules. It is seeded with a small list of values (such as 30/360, Actual/360, Actual/Actual, and so on.) and its value set may not be modified.

Amortization Type Code is another example of a reserved Simple Dimension. Amortization Type Code is populated with reserved values that the Cash Flow engine interprets, and its value set may not be modified. Many other Simple Dimensions are reserved and may not be modified.

## Simple Dimensions Used for Processing or Reporting Purposes

This kind of Simple Dimension cannot be used directly by the application engines, but they are accessible to OFSAA Filter rules.

Credit Rating is an example of a seeded Simple Dimension that may be used for processing or reporting purposes. You may, for example, wish to allocate risk equity to individual instruments as a function of Credit Rating. The seeded values for Credit Rating are Moody's credit ratings, but you are free to completely redefine the membership of this dimension. Geographic Location is another example. Geographic Location is pre-populated with US States and Canadian provinces, but you are free to completely redefine the list of geographic locations.

## Simple Dimensions Used as Attribute Domains

Both seeded and user-defined attributes often utilize a Simple Dimension to provide a list of values. For example, you might create an Adjustable Type attribute on your Product dimension and you might want this attribute to be limited to the values of Fixed, Variable, or Administered. In this case, you might first build a Simple



Dimension called Type whose dimension members were limited to three values: Fixed, Variable, or Administered. Next you could assign the Type dimension to be the domain of your new Adjustable Type attribute.

Refer *Oracle Financial Services Analytical Applications Infrastructure (OFSAAI) Installation and Configuration Guide* and *Oracle Financial Services Analytical Applications Data Model Data Dictionary* for additional information on which Simple Dimensions you may extend or modify and on how to add your own Simple Dimensions to the data model.

## Overview of Attributes

OFSAAI Infrastructure includes functionality for Adding, Viewing, Editing, or Deleting dimension attributes. Which of these functions you can access depends on your logon privilege and on the dimension with which you wish to work.

### Attributes

The seeded OFSAAI Key Processing Dimensions have a number of seeded or seeded & required attributes. For example, the Common Chart of Accounts dimension includes an Account Type attribute and an Accrual Basis attribute; the Financial Element dimension includes an Aggregation Method attribute. Some of these attributes have important implications in processing within OFSAAI.

You may add Attributes to any Key Processing Dimension or to any Standard Dimension that supports Attributes (see sections above describing Key Processing Dimensions and Standard Dimensions).

One of the important properties of an Attribute is its Data Type. OFSAAI Infrastructure supports Dimension Attribute Data Types of:

- Date, String, or Number
- Dimension

### Unbounded and Bounded Attribute Data Types

Dimension attribute data types may be either bounded or unbounded. The Date, String, and Number type are unbounded, that is, there is no predetermined set of attribute values. A Date attribute value may be any valid date, a String attribute value may be any string up to 30 characters in length, and a Number attribute value may be any number. Examples of these kinds of attribute data types might include:

- Cost Center Open Date (a Date attribute on the Organizational Unit dimension)
- Product Memo (a String attribute on the Product dimension)
- Cost Center Headcount (a Number attribute on the Organizational Unit dimension)

Unlike attributes having the Date, String, or Number data type, attributes whose data type is Dimension have defined sets of values. For example, the Product dimension has a seeded attribute called Accrual Basis the data type of which is Dimension. The Accrual Basis dimension is seeded with 8 values. Accrual Basis is a restricted dimension (you may View Accrual Basis dimension members but you may not delete them or add new accrual bases), but whenever you assign an Accrual Basis attribute value to one of your Product dimension member values, you must select from the list of 8 available Accrual Bases.

## Overview of OFSAA Rules

OFS Analytical Application models are constructed using combinations of OFSAA rules. For example:

- An Allocation rule might utilize a Hierarchy Filter rule, an Expression rule, and a Static Table Driver rule
- A Transfer Pricing rule might utilize a Hierarchy rule, a Data Element Filter rule, and a Prepayment rule
- A Data Element Filter rule might utilize an Expression rule
- A Group Filter rule always incorporates one or more underlying Data Element Filter rules
- Hierarchy Filter rules always utilize an underlying Hierarchy rule

The advantage of constructing models from discrete rule components is that individual rules may be re-used dozens or even hundreds of times. For example, if you wish to build a large series of allocation rules which operate on non-interest expense data in the Western region, you may build filters for (1) non-interest expense and (2) the Western region and then utilize these filters in every allocation rule. As another example, if you wanted to assign the same transfer pricing method and assumptions to all mortgage products, you could build a Hierarchy on the product dimension containing a Mortgage Products rollup point and assign your method and assumptions at the rollup level. You could subsequently utilize the same Hierarchy rule for allocation processing or reporting purposes.

Many rule types are specific to individual analytical applications (For example, Transfer Pricing rules, Asset/Liability Management rules, Allocation rules, and so on.) while OFSAA Infrastructure rules are shared across all OFS applications. Rule types that are shared across all applications include:

- Hierarchies
- Hierarchy Filters
- Data Element Filters
- Group Filters
- Expressions

Dimensions, dimension members, attributes, and currency exchange rates are also shared across all applications.

## Dependencies

OFSAA rules often depend on other rules for some or all of their data or usefulness. For example, an Allocation rule may depend on a Data Element Filter rule to select and focus data in a meaningful way. If that Data Element Filter is deleted, then the Allocation rule becomes unusable. OFSAA applications track such dependencies and ensure that users may not delete rules that are consumed by other rules. Additionally, rule summary screens that present lists of rules that you have defined, offer functionality for you to generate reports on rule interdependency.

## OFSAA Filters

OFSAA Infrastructure supports three kinds of filtering:

- Data Element Filters

- Group Filters
- Hierarchy Filters

### Data Element Filters

Data Element Filters are used to select and focus data. For example, you may transfer price some financial instruments at their source and may therefore wish to ensure that you do not overwrite the transfer rates for any instruments that already have a non-zero transfer rate. In such a case, you could construct a Data Element Filter to isolate only those instruments having a non-zero transfer rate. As another example, you may wish to allocate a charge to demand deposit accounts having small balances. In this case, you could construct a Data Element Filter to focus on just those instrument records having balances less than your chosen threshold.

### Group Filters

Group Filters are used to join together one or more Data Element Filters. For example, if you built one Data Element Filter that focused on balances less than 10,000 and a second Data Element Filter that focused on accounts whose origination date was prior to 2009, a Group Filter built on the two Data Element Filters would focus on accounts with balances less than 10,000 AND whose origination dates were prior to 2009.

### Hierarchy Filters

Hierarchy Filters allow you to focus on data that rolls up to one or more points within a chosen hierarchy. You may also focus on "leaf" level data or a combination of "leaf" level and rollup levels. For example, if your organization had a Western, Northern, Southern, and Eastern division, you could construct a Hierarchy Filter that focused on data belonging to branch 1, 2, or 7 within the Eastern division plus any data belonging to the Northern division.

## OFSA Expressions

Expressions represent formulas for combining data from your data model (For example, Column A divided by Column B times Column C). The results of Expressions may be invoked within a number of OFSAA rule types (For example, Data Element Filters, Allocation rules, and so on).

## Folders

One of the fundamental properties of any OFSAA rule is the Folder in which it is stored. Your System Administrator will configure your user ID to have access to one or more folders in which you can store your rules. Your access rights will likely be similar to co-workers who have a similar business role. For details on security management and defining Segment Maintenance in OFSAA, refer *Oracle Financial Services Analytical Applications Infrastructure User Guide*.

Storing rules in folders gives you the means to segregate your rules for functional or security considerations. For example, you may wish to:

- Set up folders to store Transfer Pricing rules that are separate from folders you have built for Profitability Management rules and that are also separate from folders you have built for Asset/Liability Management rules
- Establish some folders for rules you are in the process of developing and testing and other folders for fully tested, production ready rules

- Segregate some rules that are fundamental to the definition of other rules (For example, some Data Element Filters may be used in dozens or hundreds of other rules) in order to ensure that access to those fundamental rules is highly controlled
- Segregate your hierarchies, which are also frequently fundamental to OFSAA models, into a restricted-access folder

## Visibility of Rules

Every navigation path to view a rule in OFSAA begins with a Summary screen. Within the Summary screen for each rule type, a user may browse through all of the rules that are stored within Folders to which the user has access. From each Summary screen, users may be granted the ability to Add, Edit, View, or Delete rules.

When building rules in an OFS Analytical Application, you frequently call upon other OFSAA rules (For example., a Data Element Filter nested within an Allocation rule or a Hierarchy utilized within a Transfer Pricing rule). When nesting a child rule within a parent rule you must specify the child rule by its Name and Folder (where both Name and Folder are presented in drop-down list boxes). In this context, the Folder drop-down list box for every user will include every Folder in the Information Domain regardless of his Folder access rights. This means that a user may invoke a child rule from any Folder even if he cannot access that child rule directly through its Summary screen.

Additionally, whenever a user nests a parent rule within a child rule, the OFSAA user interface provides the user the ability to view a read-only version of the underlying child rule.

## OFSAA Data Entry Forms and Queries

Data entry Forms and Queries (DEFQ) within the Infrastructure system facilitates you to design web based user-friendly Data Entry windows with a choice of layouts for easy data view and data manipulation. An authorized user can enter new data and update the existing data in the shared database. Data entry Forms are primarily focused to create data entry systems which access the database and load the generated input data.

For more information, refer to *Oracle Financial Services Analytical Applications Infrastructure User Guide Release 8.0.0.0.0*.

## Access Type

Another fundamental property of every OFSAA rule is its Access Type.

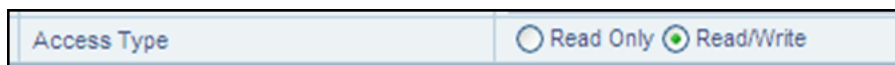

Access Type	<input type="radio"/> Read Only	<input checked="" type="radio"/> Read/Write
-------------	---------------------------------	---

Access Type may be set to either Read/Write or Read Only. Only the "creator" or "owner" of a rule may modify the rule if it is set to Read Only. The user ID under which a rule is initially built is the owner of a rule. You may modify a rule that you do not own provided that:

- The rule has been stored with the Read/Write access type
- You have been granted Edit privilege for the rule's type
- You have been granted access to the Folder in which the rule is stored

Again, for details on security management in OFSAA, refer *Oracle Financial Services Analytical Applications Infrastructure (OFSAAI) Installation and Configuration Guide*.

## Global Preferences

Clicking Global Preferences invokes the Global Preferences screen. Global Preferences items are used to configure your user interface. Here, you set your default application language and date format, and your desired Pagination Records. Pagination Records determine how many rows will be displayed on summary screens. If you select Pagination Records to be 25 records, then any screen displaying results in a tabular format will display a maximum of 25 records. To see the next set of 25 records, you can use the Next VCR button:



Functional Currency and Signage are installation-time parameters that may not be reset in Global Preferences.

Functional Currency is defined as "the currency of the primary economic environment in which an entity conducts its business". For details on signage, see the *Oracle Financial Services Analytical Applications Profitability Management (OFSPM) User Guide*.

Normally, you will set preferences for yourself, but if you are logged in as an Administrator, you may set Global Preferences for All Users. When setting preferences for All Users, you may restrict the ability of non-Administrators to change a Global Preference item by deselecting the "Is Editable" checkbox. If a preference item is defined as "not editable", a user who is not an Administrator will inherit the value of the preference item that his Administrator has set for him and he will not have the ability to change it for himself.

Global Preferences		
Select Preferences For		
Show Preferences For	GAUSER	
Display		
Property Name	Property Value	Is Editable
Default Application Language	US-English	<input checked="" type="checkbox"/>
Date Format	M/d/yyyy	<input checked="" type="checkbox"/>
Pagination Records	25	<input checked="" type="checkbox"/>
Ledger		
Property Name	Property Value	
Functional Currency	US Dollar	
Signage	Natural Signage	
<input type="button" value="Apply"/> <input type="button" value="Cancel"/> <input type="button" value="Reset to Default"/>		

## Application Preferences

In addition to Global Preferences, page 2-13, each of the OFS Analytical Applications has its own local application preferences. In the same way as in Global Preferences, Application Preferences (for each application) employs a "delegation" model that allows Administrators to set some preference items for all users while allowing non-administrative users to personalize other preference items.

Normally, you will set Application Preferences for yourself, but if you are logged in as an Administrator, you may set Application Preferences for all users of an application. When setting preferences for all users, you may restrict the ability of non-Administrators to change an Application Preference item by deselecting the "Is Editable" checkbox. If a preference item for a non-administrative user is defined as "not editable", a user who is not an Administrator will inherit the value of the preference item that his Administrator has set for him and he will not have the ability to change it for himself.

While most Application Preferences items are unique to the application to which they belong, two properties are common to Application Preferences for each of the OFS Analytical Applications: Folder Name and Access Type.

Having the Folder Name and Access Type properties set at the application level allows you to have a different default Folder and Access Type for each OFS Analytical Application. Within the Left Hand Side or LHS menu, all OFSAA Infrastructure rules (Hierarchies, Filters, & Expressions) are maintained under Master Maintenance.

Since Folder and Access Type are not Global Preference items, a user must select one application's set of Application Preferences to be "Active" to govern the default values of Folder and Access Type for Oracle Financial Services Analytical Applications Infrastructure rules. This is done by selecting one of your Application Preference sets to be the one that is "Active for Master Maintenance".

## System Configuration

### Application

Starting 8.0 release, once an application pack is installed, you can use only the Production or Sandbox information domain, created during the installation process. Though there is an option to create a new Information Domain, there is no menu to work with the frameworks on this new information domain. This new information domain then created acts only as a Sandbox Infodom. The Create New Application feature allows you (System Administrator) to create a new Application other than the standard OFSAA Applications and associate the standard/default platform framework menu with it, thereby enabling the new application for usage. The standard platform framework menu is seeded and rendered.

For more information, refer to System Configuration section in OFSAAI User Guide [[http://docs.oracle.com/cd/E60058\\_01/books/8.0.1.0.0/OFSAAI\\_User\\_Guide\\_8.0.1.0.0.pdf](http://docs.oracle.com/cd/E60058_01/books/8.0.1.0.0/OFSAAI_User_Guide_8.0.1.0.0.pdf)].

---

---

# OFSAA Administrative Reporting

## Introduction

Administrative Reports provide reporting functionality for the Administrators of Oracle Financial Services Analytical Applications (OFSAA) to monitor, analyze, and correct data.

The System Administrator or users with Administrative privileges can view the Administrative Reports.

## Logging in to the Administrative Reports

1. Click **Financial Services Applications >Administration >Administrative Reports**.

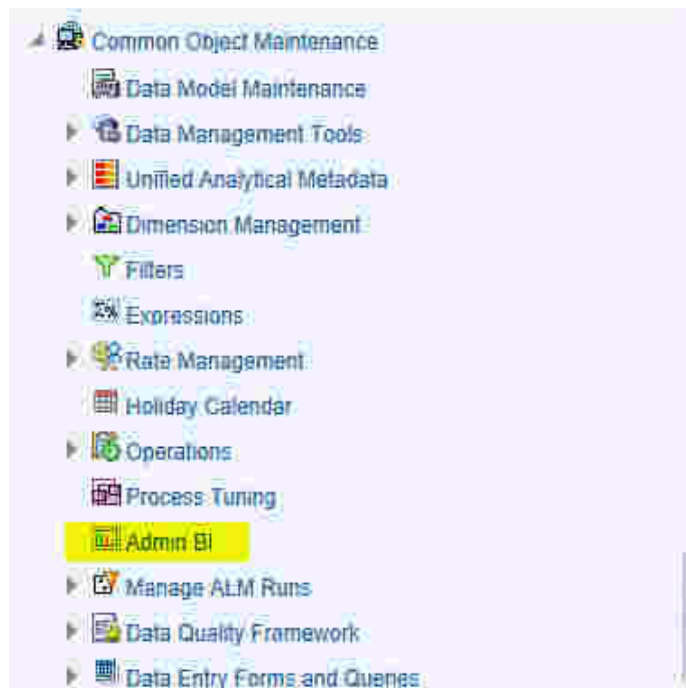

The Administrative Reports - Admin Home section is displayed.

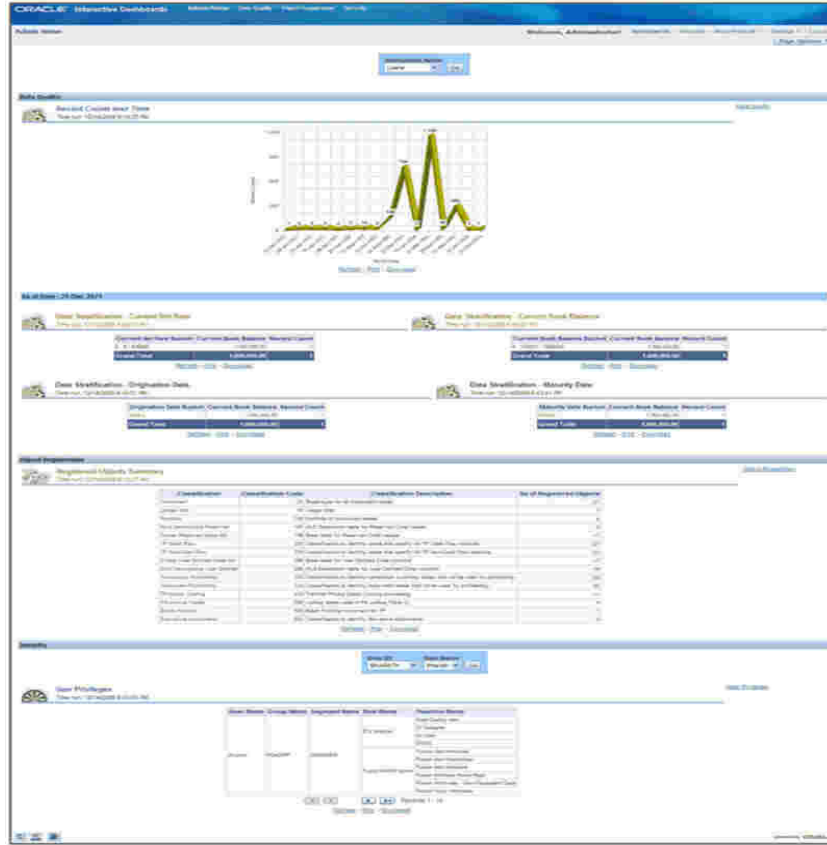

## Interactive Dashboards in Administrative Reports

In the Administrative Reports window, there are four dashboard links:

- Admin Home
- Data Quality
- Object Registration
- Security

## OFSAA Infrastructure

OFSAA Infrastructure is the foundation for OFSAA. It provides support for User Administration, Metadata Management, a Processing Framework, a Forms Framework and additional capabilities necessary to support the individual business applications.

## Admin Home

The Admin Home section is displayed by default when you login. If you are in any other section, click the Admin Home link in the top of the Administrative Reports header, to go to the Admin Home section. Admin Home displays the summary of reports from the other three links.



## Access Permissions

Following are the steps to access permissions to include Defi Forms for the Admin BI Buckets entries.

1. Login to the Oracle Financial Services Analytical Applications Infrastructure.
2. Go to **Common Object Maintenance > Data Entry Forms and Queries > Forms Designer**.
3. Click the **Assign Rights** radio button.
4. Select **Admin BI** in the Available Applications drop down box.
5. Select the four UI forms (one at a time) in the **Available Forms** drop down box (For example, Bucket definition of Book Balance).
6. Click **Next** button.
7. Select the users from the **Available User List**.
8. Select the relevant check boxes from **View, Add, Edit, Delete, and All** above.
9. Click **Save Access Rights**. You will get the message that user is mapped successfully.
10. Click **Back to Forms Designer**.
11. Repeat the steps 4 to 11 for other three forms (Bucket Definition Maturity Date, Bucket Definition net Rate, Bucket Definition Origination Date).

## Data Quality

To go to the Data Quality reports, click Data Quality link at the top of the Administrative Reports. The following window is displayed.

The screenshot displays the Oracle Data Quality report interface. At the top, there are navigation tabs for 'Data Quality', 'Dimension View', 'FTP Rates', 'Soveld Leases', 'Soveld Codes', 'Detailed Reports', 'Ledger Stat', and 'Product Instrument Map'. Below the navigation, there are filters for 'Instrument Name' (Loans), 'As of Date' (3/31/08), 'Currency Name' (All Chosen), 'Line Item Name' (All Chosen), and 'Balance Type' (All Chosen). The main content area is divided into four sections, each with a 'Data Stratification' title and a 'Time run' indicator.

Data Stratification - Current Net Rate			
Current Net Rate Bucket	Current Book Balance	Record Count	
1. 0 - 9.999	20,000,000.00	0	
2. 10 - 9.999	22,470,000.00	261	
3. 10 - 14.999	0.00	32	
4. 15 - 4.999	100,000,000.00	0	
<b>Grand Total</b>	<b>22,640,000.00</b>	<b>293</b>	

Data Stratification - Current Book Balance			
Current Book Balance Bucket	Current Book Balance	Record Count	
0	0.00	0	
1	22,640,000.00	293	
<b>Grand Total</b>	<b>22,640,000.00</b>	<b>293</b>	

Data Stratification - Origination Date			
Origination Date Bucket	Current Book Balance	Record Count	
0	22,640,000.00	293	
<b>Grand Total</b>	<b>22,640,000.00</b>	<b>293</b>	

Data Stratification - Maturity Date			
Maturity Date Bucket	Current Book Balance	Record Count	
1. 1-Jan-07 - 31-Dec-07	22,640,000.00	293	
2. 1-Jan-08 - 31-Dec-08	0.00	0	
<b>Grand Total</b>	<b>22,640,000.00</b>	<b>293</b>	

The Data Quality reports help you to validate the quality of the underlying fact data. By going through the reports, you can identify data discrepancies, missing data, incorrect data, and so on and then undertake the necessary steps to rectify any issues. These data reports can be customized to fit your needs by defining suitable bucket range values as described above.

The four data buckets available are:

- Book Balance Bucket Definition
- Maturity Date Bucket Definition

- Net Rate Bucket Definition
- Origination Date Bucket Definition

These values can be defined in the following section:

Common Object Maintenance > Data Entry Forms and Queries > Data Entry.

Refer the following screenshot for details:

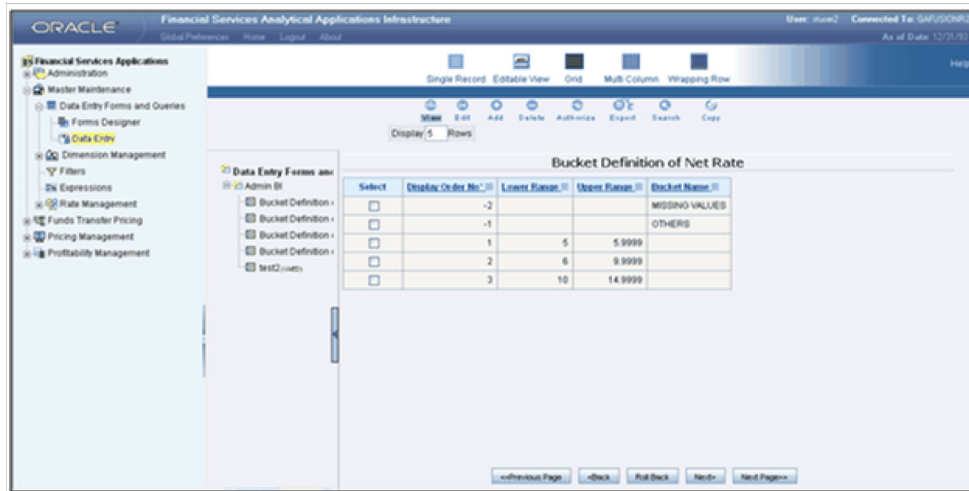

- The seeded values are Display Order No => -1 and - 2. You should not delete or edit these seeded values.
- Make sure there is no row with 'Display order No.' column with value 0 (zero). In case of AIX environment, display order No. might be generated with '0' (zero value). Delete this row using 'Delete option'.

## Data Quality Dashboard

Data Quality Dashboard page contains eight tabs.

### Data Quality Tab

This section contains a prompt to filter the data based on the value selected from the drop-down box.

You can select a value from the drop down list. Based on the selected values, the data is filtered.

There are four reports in this window.

1. **Data Stratification - Current Net Rate**

The current net rate details for each bucket range value of the Instruments are displayed here.

Current Net Rate/Book Balance		
 <b>Data Stratification - Current Net Rate</b> Time run: 12/11/2009 4:16:03 PM		
Current Net Rate Bucket	Current Book Balance	Record Count
1 . 5 - 5.9999	270,000,000.00	0
2 . 6 - 9.9999	22,470,000,000.00	251
3 . 10 - 14.9999	0.00	22
5 . 0 - 4.9999	100,000,000.00	1
<b>Grand Total</b>	<b>22,840,000,000.00</b>	<b>280</b>

[Refresh](#) - [Print](#) - [Download](#)

To view a detailed report, click the bucket range for which you need the detailed report. The detailed report for the selected bucket range is displayed.

Data Quality										
 <b>Detailed Report - Current Net Rate</b> Time run: 12/11/2009 4:20:36 PM										
ID Number	Identity Code	Account Number	Product ID	Org unit ID	GL Account ID	Common COA ID	Origination Date	Maturity Date	Cur Net Rate	Current Book Balance
10033	19960331	L-1000000032	135	1	300120	30012	31-Mar-1996	01-Apr-1996	4.5000	100,000,000.00
<b>Grand Total</b>										<b>100,000,000.00</b>

[Return](#) - [Refresh](#) - [Print](#) - [Download](#)

## 2. Data Stratification - Current Book Balance

The current book balance details for each bucket range value for the Instruments are displayed here.

Data Stratification - Current Book Balance		
 <b>Data Stratification - Current Book Balance</b> Time run: 12/15/2009 4:05:46 PM		
Current Book Balance Bucket	Current Book Balance	Record Count
1 . 101 - 1000	6,499.00	7
2 . 1001 - 10000	22,146.00	6
3 . 10001 - 100000	4,768,629.00	81
4 . 100001 - 1000000	332,594,117.00	660
Others	80,772,827,473.00	1619
<b>Grand Total</b>	<b>89,110,218,864.00</b>	<b>2372</b>

[Refresh](#) - [Print](#) - [Download](#)

To view a detailed report, click the bucket range for which you need the detailed report. The detailed report for the selected bucket range is displayed.

**Data Quality**  
**Detailed Report - Current Book Balance**  
 Time run: 12/11/2009 4:38:27 PM

ID Number	Identity Code	Account Number	Product ID	Org unit ID	GL Account ID	Common COA ID	Origination Date	Maturity Date	Cur Net Rate	Current Book Balance
10053	19900331	L-1000000032	135	1	300120	30012	31-Mar-1998	01-Apr-1998	4.5000	100,000,000.00
10059	19900331	L-22	135	0	14710	3002	31-Aug-1993	31-Aug-1998	5.0000	50,000,000.00
10302	19900331	L-7	135	0	14710	3001	31-Aug-1993	31-Aug-1998	5.0000	40,000,000.00
10056	19900331	L-21	135	0	14710	3002	31-Jul-1993	31-Jul-1998	5.5000	50,000,000.00
10060	19900331	L-23	135	0	14710	3002	30-Sep-1993	30-Sep-1998	5.5000	50,000,000.00
10301	19900331	L-6	135	0	14710	3001	31-Jul-1993	31-Jul-1998	5.5000	40,000,000.00
10303	19900331	L-8	135	0	14710	3001	30-Sep-1993	30-Sep-1998	5.5000	40,000,000.00
10019	19900331	L-9	135	0	14710	3001	31-Oct-1993	31-Oct-1998	5.0000	40,000,000.00
10057	19900331	L-20	135	0	14710	3002	30-Jun-1993	30-Jun-1998	5.0000	45,000,000.00
10051	19900331	L-24	135	0	14710	3002	31-Oct-1993	31-Oct-1998	5.0000	55,000,000.00
10283	19900331	L-5	135	0	14710	3001	30-Jun-1993	30-Jun-1998	5.0000	40,000,000.00
10017	19900331	L-10	135	0	14710	3001	30-Nov-1993	30-Nov-1998	5.5000	40,000,000.00
10055	19900331	L-19	135	0	14710	3002	30-May-1993	31-May-1998	5.5000	45,000,000.00
10062	19900331	L-25	135	0	14710	3002	30-Nov-1993	30-Nov-1998	5.5000	55,000,000.00
10068	19900331	L-4	135	0	14710	3001	30-May-1993	31-May-1998	5.5000	40,000,000.00

Records 1 - 15  
[Return](#) - [Refresh](#) - [Print](#) - [Download](#)

### 3. Data Stratification - Origination Date

The origination date details for each bucket range value for the Instruments are displayed here.

**Origination/Maturity Date**  
**Data Stratification - Origination Date**  
 Time run: 12/11/2009 4:16:03 PM

Origination Date Bucket	Current Book Balance	Record Count
Others	22,840,000,000.00	280
<b>Grand Total</b>	<b>22,840,000,000.00</b>	<b>280</b>

[Refresh](#) - [Print](#) - [Download](#)

To view a detailed report, click the bucket range for which you need the detailed report. The detailed report for the selected bucket range is displayed.

**Data Quality**  
**Detailed Report - Origination Date**  
 Time run: 12/11/2009 4:39:25 PM

ID Number	Identity Code	Account Number	Product ID	Org unit ID	GL Account ID	Common COA ID	Origination Date	Maturity Date	Current Book Balance
10016	19900331	L-1	135	0	14710	3001	31-Mar-1993	31-Mar-1998	40,000,000.00
10017	19900331	L-10	135	0	14710	3001	30-Nov-1993	30-Nov-1998	40,000,000.00
10018	19900331	L-11	135	0	14710	3001	31-Dec-1993	31-Dec-1998	40,000,000.00
10019	19900331	L-9	135	0	14710	3001	31-Oct-1993	31-Oct-1998	40,000,000.00
10028	19900331	L-3	135	0	14710	3001	30-Apr-1993	30-Apr-2003	40,000,000.00
10029	19900331	L-1000000002	135	1	14710	700000002	31-Jan-1996	31-Jan-1999	100,000,000.00
10030	19900331	L-1000000018	135	1	14710	100000009	31-Jan-1996	31-Jan-1997	100,000,000.00
10031	19900331	L-1000000019	135	1	14710	100000009	31-Mar-1996	31-Jan-1997	100,000,000.00
10032	19900331	L-1000000020	135	1	14710	100000009	01-Apr-1996	31-Jan-1997	100,000,000.00
10033	19900331	L-1000000032	135	1	300120	30012	31-Mar-1996	01-Apr-1996	100,000,000.00
10034	19900331	L-1000000066	135	1	14710	800017	31-Jan-1996	31-Jan-1997	100,000,000.00
10035	19900331	L-1000000067	135	1	14710	800037	31-Jan-1996	31-Jan-1997	100,000,000.00
10036	19900331	L-1000000068	135	1	14710	800038	31-Jan-1996	31-Jan-1997	100,000,000.00
10037	19900331	L-1000000069	135	1	14710	100020	31-Jan-1996	31-Jan-1997	100,000,000.00
10038	19900331	L-1000000070	135	1	14710	100021	31-Jan-1996	31-Jan-1997	100,000,000.00

Records 1 - 15  
[Return](#) - [Refresh](#) - [Print](#) - [Download](#)

### 4. Data Stratification - Maturity Date

The Maturity Date details for each bucket range value for the Instruments are displayed here.

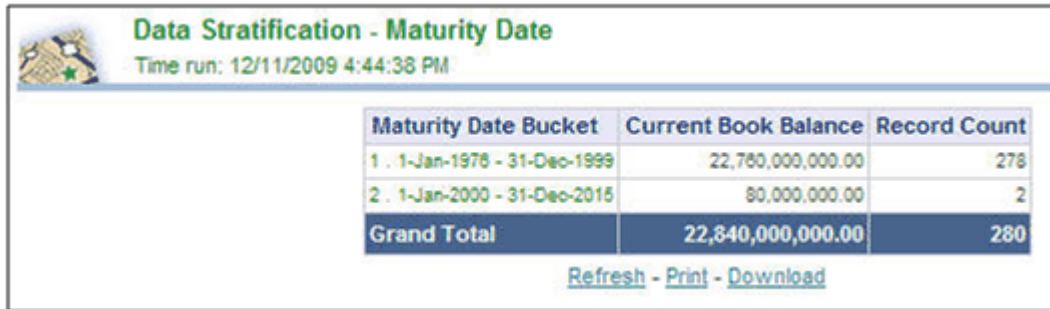

Maturity Date Bucket	Current Book Balance	Record Count
1 . 1-Jan-1976 - 31-Dec-1999	22,760,000,000.00	278
2 . 1-Jan-2000 - 31-Dec-2015	80,000,000.00	2
<b>Grand Total</b>	<b>22,840,000,000.00</b>	<b>280</b>

[Refresh](#) - [Print](#) - [Download](#)

To view a detailed report, click the bucket range for which you need the detailed report. The detailed report for the selected bucket range is displayed.

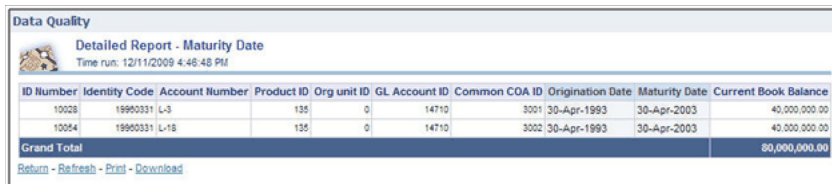

ID Number	Identity Code	Account Number	Product ID	Org unit ID	GL Account ID	Common COA ID	Origination Date	Maturity Date	Current Book Balance
10028	19900331	L-3		135	0	14710	3001 30-Apr-1993	30-Apr-2003	40,000,000.00
10054	19900331	L-16		135	0	14710	3002 30-Apr-1993	30-Apr-2003	40,000,000.00
<b>Grand Total</b>									<b>80,000,000.00</b>

[Return](#) - [Refresh](#) - [Print](#) - [Download](#)

### Dimension Wise

You can select the values to filter the data by selecting the values from the top drop down list. The following four reports are displayed here:

- Amortization Type / Adjust Type/ Reprice Freq
- Payment Frequency/ Remaining Payments
- Product
- General Ledger Account

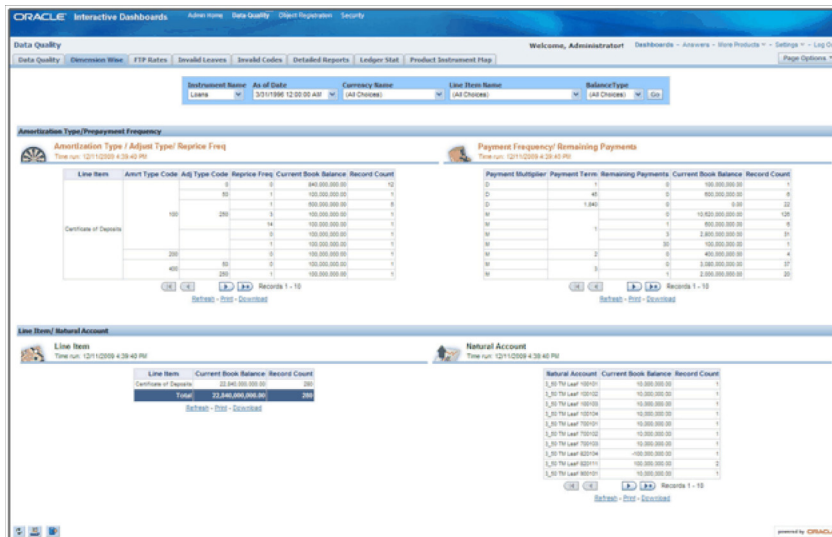

The screenshot displays the Oracle Data Quality interface with four reports:

- Amortization Type / Adjust Type / Reprice Freq:** A table with columns: Line Item, Adjust Type Code, Adj Type Code, Reprice Freq, Current Book Balance, Record Count. It shows data for various line items and their corresponding adjustments and reprice frequencies.
- Payment Frequency / Remaining Payments:** A table with columns: Payment Multiplier, Payment Term, Remaining Payments, Current Book Balance, Record Count. It details payment terms and remaining balances for different line items.
- Line Item / Natural Account:** A summary table with columns: Line Item, Current Book Balance, Record Count. It provides a high-level overview of the data.
- Natural Account:** A table with columns: Natural Account, Current Book Balance, Record Count. It breaks down the data by natural account.

## FTP Rates

You can filter the data by selecting the values from the drop down list. The Transfer Pricing Stratification Reports show a summary of the FTP results for all instrument tables.

**FTP Rate Detail**

**Transfer Pricing Stratification Report for All Products**  
Time run: 12/11/2009 4:15:47 PM

Product Name	Record Count	Avg Balance	WAvg Transfer Rate	WAvg Note Rate	WAvg Gross Spread
Certificate of Deposits	280	1,200,000,000.00	0.0000%	6.9000%	0.0000%

[Refresh](#) - [Print](#) - [Download](#)

You can click the product name to go to the account level - detail report as shown in the following screenshot.

**Data Quality** Welcome, Administrator | Dashboards - Answers - More

**Transfer Pricing Stratification Report for All Products Detailed**  
Time run: 12/11/2009 5:05:13 PM

Product Name	ID Number	Identity Code	Account Number	Product ID	Org unit ID	Common COA ID	GL Account ID	Origination Date	Maturity Date	Avg Balance	WAvg Transfer Rate	WAvg Note Rate	WAvg Gross Spread
Certificate of Deposits	10016	9990331	L-1	135	0	3001	14710	31-Jan-1993	31-Jan-1996	40,000,000.00	0.0000%	6.0000%	0.0000%
	10017	9990331	L-2	135	0	3001	14710	30-Nov-1993	30-Nov-1996	40,000,000.00	0.0000%	6.0000%	0.0000%
	10018	9990331	L-11	135	0	3001	14710	31-Dec-1993	31-Dec-1996	40,000,000.00	0.0000%	7.0000%	0.0000%
	10019	9990331	L-8	135	0	3001	14710	31-Oct-1993	31-Oct-1996	40,000,000.00	0.0000%	6.0000%	0.0000%
	10020	9990331	L-3	135	0	3001	14710	30-Apr-1993	30-Apr-2003	40,000,000.00	0.0000%	7.0000%	0.0000%
	10029	9990331	L-1000000002	135	1	70000002	14710	31-Jan-1996	31-Jan-1999	0.00	0.0000%	0.0000%	0.0000%
	10030	9990331	L-1000000016	135	1	10000009	14710	31-Jan-1996	31-Jan-1997	0.00	0.0000%	0.0000%	0.0000%
	10031	9990331	L-1000000019	135	1	10000008	14710	31-Jan-1996	31-Jan-1997	0.00	0.0000%	0.0000%	0.0000%
	10032	9990331	L-1000000020	135	1	10000009	14710	01-Apr-1996	31-Jan-1997	0.00	0.0000%	0.0000%	0.0000%
	10033	9990331	L-1000000032	135	1	30012	300120	31-Mar-1996	01-Apr-1996	0.00	0.0000%	0.0000%	0.0000%
	10034	9990331	L-1000000065	135	1	300017	14710	31-Jan-1996	31-Jan-1997	0.00	0.0000%	0.0000%	0.0000%
	10035	9990331	L-1000000067	135	1	300037	14710	31-Jan-1996	31-Jan-1997	0.00	0.0000%	0.0000%	0.0000%
	10036	9990331	L-1000000068	135	1	300038	14710	31-Jan-1996	31-Jan-1997	0.00	0.0000%	0.0000%	0.0000%
	10037	9990331	L-1000000069	135	1	100020	14710	31-Jan-1996	31-Jan-1997	0.00	0.0000%	0.0000%	0.0000%
	10038	9990331	L-1000000070	135	1	100021	14710	31-Jan-1996	31-Jan-1997	0.00	0.0000%	0.0000%	0.0000%
	10039	9990331	L-1000000071	135	1	300001	14710	31-Jan-1996	31-Jan-1997	0.00	0.0000%	0.0000%	0.0000%
	10040	9990331	L-1000000072	135	1	300032	14710	31-Jan-1996	31-Jan-1997	0.00	0.0000%	0.0000%	0.0000%
	10041	9990331	L-1000000073	135	1	300043	14710	31-Jan-1996	31-Jan-1997	0.00	0.0000%	0.0000%	0.0000%
	10042	9990331	L-1000000074	135	1	300044	14710	31-Jan-1996	31-Jan-1997	0.00	0.0000%	0.0000%	0.0000%
	10043	9990331	L-1000000076	135	1	300045	14710	31-Jan-1996	31-Jan-1997	0.00	0.0000%	0.0000%	0.0000%
	10044	9990331	L-1000000078	135	1	300046	14710	31-Jan-1996	31-Jan-1997	0.00	0.0000%	0.0000%	0.0000%
	10045	9990331	L-1000000077	135	1	100004	14710	31-Jan-1996	31-Jan-1997	0.00	0.0000%	0.0000%	0.0000%
	10046	9990331	L-1000000079	135	1	300046	14710	31-Jan-1996	31-Jan-1997	0.00	0.0000%	0.0000%	0.0000%
	10047	9990331	L-140000104	135	1	300001	14710	31-Jan-1996	31-Jan-1997	0.00	0.0000%	0.0000%	0.0000%
	10048	9990331	L-12	135	0	3001	14710	31-Jan-1994	31-Jan-1999	40,000,000.00	0.0000%	7.0000%	0.0000%

Records 1 - 25

## Invalid Leaves

Contains reports for invalid leaves based on the list of Dimension Members compared with the Instrument data. You can filter the data selecting the drop down list provided at the top. The following four reports are displayed here:

- Invalid Products
- Invalid Org Unit
- Invalid Common COA
- Invalid GL Account

## Invalid Codes

Contains the reports for invalid Codes based on the dimensions compared with Instruments. You can filter the data selecting the drop down list provided at the top. The following seven reports are displayed here:

- Accrual Basis Code

- Amortization Code
- Adjustable Type Code
- Compound Basis Code
- Behavior Type Code
- Behavior Sub Type Code
- Net Margin Code

## Detailed Reports

Contains the detailed report for a particular Instrument based on the selection in the drop down.

Identity Code	ID Number	Account Number	Product ID	Org Unit ID	Common COA ID	GL Account ID	Origination Date	Maturity Date	Current Book Balance	Current Par Balance
10016	L-1		135	0	3001	14710	31-Mar-1993	31-Mar-1998	40,000,000.00	40,000,000.00
10017	L-10		135	0	3001	14710	30-Nov-1993	30-Nov-1998	40,000,000.00	40,000,000.00
10018	L-11		135	0	3001	14710	31-Oct-1993	31-Oct-1998	40,000,000.00	40,000,000.00
10019	L-5		135	0	3001	14710	31-Oct-1993	31-Oct-1998	40,000,000.00	40,000,000.00
10020	L-9		135	0	3001	14710	30-Apr-1993	30-Apr-2003	40,000,000.00	40,000,000.00
19800031	L-1000000002		135	1	700000002	14710	31-Jan-1998	31-Jan-1999	100,000,000.00	100,000,000.00
	L-1000000019		135	1	100000019	14710	31-Jan-1998	31-Jan-1997	100,000,000.00	100,000,000.00
	L-1000000019		135	1	100000019	14710	31-Mar-1996	31-Jan-1997	100,000,000.00	100,000,000.00
	L-1000000020		135	1	100000020	14710	31-Apr-1996	31-Jan-1997	100,000,000.00	100,000,000.00
	L-1000000012		135	1	30012	300120	31-Mar-1996	31-Apr-1996	100,000,000.00	100,000,000.00
	L-1000000060		135	1	800017	14710	31-Jan-1998	31-Jan-1997	100,000,000.00	100,000,000.00
	L-1000000067		135	1	800037	14710	31-Jan-1998	31-Jan-1997	100,000,000.00	100,000,000.00
	L-1000000068		135	1	800038	14710	31-Jan-1998	31-Jan-1997	100,000,000.00	100,000,000.00
	L-1000000069		135	1	100020	14710	31-Jan-1998	31-Jan-1997	100,000,000.00	100,000,000.00
	L-1000000070		135	1	100021	14710	31-Jan-1998	31-Jan-1997	100,000,000.00	100,000,000.00

## Ledger Stat

Contains the reports for missing dimension members compared with Ledger Stat data values. You can filter the data by selecting from the drop down list provided at the top. The following five reports are displayed here:

- Missing Products
- Missing Org Units
- Missing Common COA
- Missing GL Account
- Missing Financial Elements

## Product Instrument Map

Contains the Product Instrument Map report. You can filter the data based on the drop down selection. The Product Instrument Map data is used within both ALM and FTP Process rules. These processes allow users to select data to be included in the process based on a Product Hierarchy. The engines must reference this data to determine which instrument tables to include in the process.

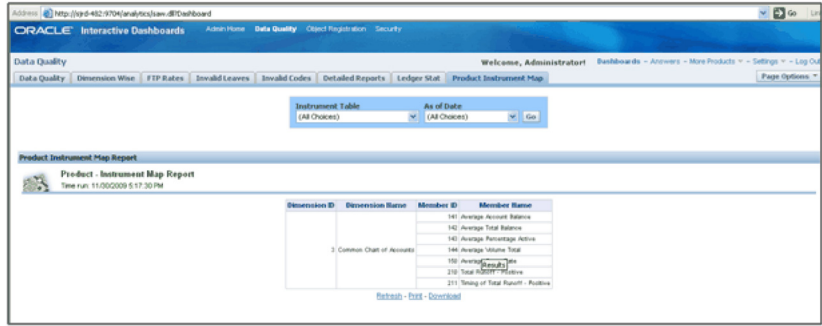

## Object Registration

To go to the Object Registration reports, click Object Registration at the top of the Administrative Reports page. The details of the registered objects are present in the reports. You can obtain the data type of each object from this report. There are two tabs

in this section.

### 1. Object Registration Tab

The details of the classification and number of registered objects are obtained here.

Classification	Classification Code	Classification Description	No of Registered Objects
Instrument	20	Super-type for all instrument tables	21
Ledger Bal	50	Ledger Bal	1
Portfolio	100	Portfolio of instrument tables	8
MLS Descriptions Reserved	187	MLS Description table for Reserved Code values	8
Codes Reserved (base 90)	190	Base table for Reserved Code values	11
TP Cash Flow	200	Classification to identify tables that qualify for TP Cash Flow methods	21
TP Non-Cash Flow	210	Classification to identify tables that qualify for TP Non-Cash Flow methods	21
Codes User Defined (base 90)	280	Base table for User Defined Code columns	17
MLS Descriptions User Defined	280	MLS Description table for User Defined Code columns	16
Transaction Profitability	300	Classification to identify transaction summary tables that will be used for profitability	20
Instrument Profitability	310	Classification to identify instrument tables that will be used for profitability	20
TP Option Costing	370	Transfer Pricing Option Costing processing	11
PA Lookup Tables	600	Lookup tables used in PA Lookup Table ID	4
Bank Funding	630	Bank Funding instrument for TP	1
Derivative Instruments	600	Classification to identify derivative instruments	5

### 2. Detailed Report

You can click any classification to navigate to the detailed registered objects report.



Registered Columns Report  
Time run: 12/14/2009 6:07:01 PM

Attribute	Column Name	Physical Data Type	Logical Data Type	Data Length	Data Precision	Data Scale	Nullable	Column Order	Processing Key	Balance	Standard Rate	Transfer Price Out	Related Field
Account Age	ACCOUNT_AGE_ID	NUMBER	DEFAULT	22	21	0	Y	1	No	No	No	No	ACCOUNT_AGE_MULT_C
Account Age Multiple	ACCOUNT_AGE_MULT_C	CHAR	MULT	1	1	0	Y	2	No	No	No	No	ACCOUNT_AGE_C
Account Officer	ACCOUNT_OFFICER	VARCHAR2	VARCHAR2	16			Y	3	No	No	No	No	
Account Base Code	ACRUA_BASE_CD	NUMBER	CODE	22	8	0	Y	4	No	No	No	No	
Accumulation Type Code	ACCOUNT_TYP_CD	CHAR	CODE	1	1	0	Y	5	No	No	No	No	
Adjustment Type Code	ADJUSTMENT_TYP_CD	NUMBER	CODE	22	8	0	Y	6	No	No	No	No	

Lookup tables are used within OFSAA Profitability Management application. Lookup tables have to be created and registered within OFSAAI, in order to display them in Lookup Table Driver definition of OFSAA Profitability Management application. For more information on Lookup Table creation, see Oracle Financial Services Analytical Applications Data Model Utilities User Guide.

## Security

The details about user privileges, group privileges, functions, and so on for the viewing of the objects are provided here.

Security  
Time run: 12/14/2009 6:38:27 PM

**User Privileges**  
User Name: PGASPP, Segment Name: DEV0005

User Name	Group Name	Segment Name	Role Name	Function Name
PGASPP	PGASPP	DEV0005		Own Query App
				DI Designer
				DI User
				OTD
				Fusion Add Attributes
				Fusion Add Hierarchies
				Fusion Add Members
				Fusion Add Role
				Fusion Attribute Home Page
				Fusion Attribute - View Dependent Data
				Fusion Copy Attributes

**Group Privileges**  
Group Name: PGASPP, Segment Name: DEV0005

Group Name	Role Name	Segment Name	Function Name	User Name
PGASPP		DEV0005		Own Query App
				DI Designer
				DI User
				OTD
				Fusion Add Attributes
				Fusion Add Hierarchies
				Fusion Add Members
				Fusion Add Role
				Fusion Attribute Home Page
				Fusion Attribute - View Dependent Data
				Fusion Copy Attributes

**Role Privileges**  
Role Name: DEV0005, Segment Name: DEV0005

Role Name	Function Name	Segment Name	User Name	Group Name
DEV0005		DEV0005	authAP	DEV0005
			DEV0005	DEV0005
			test1	DEV0005
			test2	DEV0005
			user1	DEV0005
			user2	DEV0005
			user3	DEV0005
			user4	DEV0005
			user5	DEV0005
			user6	DEV0005
			user7	DEV0005
			user8	DEV0005
			user9	DEV0005
			user10	DEV0005
			user11	DEV0005
			user12	DEV0005
			user13	DEV0005
			user14	DEV0005
			user15	DEV0005
			user16	DEV0005
			user17	DEV0005
			user18	DEV0005
			user19	DEV0005
			user20	DEV0005

**Function Privileges**  
Function Name: ALSA00, Function Name: ALSA00

Function Name	Role Name	Group Name	Segment Name	User Name
ALSA00		DEV0005		authAP
				DEV0005
				test1
				test2
				user1
				user2
				user3
				user4
				user5
				user6
				user7
				user8
				user9
				user10
				user11
				user12
				user13
				user14
				user15
				user16
				user17
				user18
				user19
				user20

## User Privileges

The details of a user and various associated privileges can be viewed in this report.

**User Privileges**

User ID: AA | User Name: (All Choices) | Segment Name: (All Choices) | Go

**User Privileges**  
Time run: 11/30/2009 5:29:01 PM

User Name	Group Name	Segment Name	Role Name	Function Name
Action Assessor	AAORP	RORSE02	Action Assessor	Access to user options link Action Identification AI Close AI Create AI Request for Appro AI Save Call Remote Web Services Close for document DOC_MNU Document Management Access

Records 1 - 10  
Refresh - Print - Download

You can click the user name to obtain the detailed user report.

**Security**

**Detailed User Report**  
Time run: 11/30/2009 5:33:59 PM

**User Name : Action Assessor**

User ID	AA
User Name	Action Assessor
Created Date	05/25/2009 21:28:08 PM
Created By	RORADMIN
User Start Date	05/25/2009
Last Login Date	09/01/2009 12:33:09 PM
Last Modified By	RORADMIN
Last Modified Date	05/25/2009 21:28:08 PM
Authorize Status	Authorized
EMail	snphari@identity.com

Return - Refresh - Print - Download

## Group Privileges

The details of a user group and various associated privileges can be viewed in this report.

**Group Privileges**

Group Code: AAGRP | Group Name: (All Choices) | Segment Name: (All Choices) | Go

**Group Privileges**  
Time run: 11/30/2009 5:29:06 PM

Group Name	Role Name	Segment Name	Function Name	User Name
AAGRP	Action Assessor	RORSEG02	Access to user options link	Action Assessor
			Action Identification	Action Assessor
			AI Close	Action Assessor
			AI Create	Action Assessor
			AI Request for Appro	Action Assessor
			AI Save	Action Assessor
			Call Remote Web Services	Action Assessor
			Close for document	Action Assessor
			DOC_MNU	Action Assessor
			Document Management Access	Action Assessor

Records 1 - 10  
Refresh - Print - Download

You can click the group name to get the detailed group report.

**Security**

**Detailed - Group**  
Time run: 11/30/2009 5:38:41 PM

**Group Name : AAGRP**

Group Code	AAGRP
Group Name	AAGRP
Group Desc	Action Assessor Group
Group Type	USER
Created Date	05/25/2009 21:29:38 PM
Created by	RORADMIN
Last Modified Date	05/25/2009 21:29:38 PM
Last Modified By	RORADMIN

Return - Refresh - Print - Download

## Role Privileges

The details related to role privileges can be viewed in this report.

**Role Privileges**

Role Code: CWSADMIN    Role Name: (All Choices)    Go

Time run: 12/11/2009 6:12:20 PM

Role Name	Function Name	Segment Name	User Name	Group Name
CWS Administrator	Call Remote Web Services	DEMOSEG	authdef	DEMOGRP
			DEMOUSER	DEMOGRP
			test11	DEMOGRP
			varun1	VRNGRP
			varun2	DEMOGRP
			varun3	DEMOGRP
			vicky	DEMOGRP
		GASEGR2	authdef	DEMOGRP
			DEMOUSER	DEMOGRP
			stuser2	STGROUP

Records 1 - 10  
[Refresh](#) - [Print](#) - [Download](#)

You can click the role name to get the detailed role report.

**Security**

**Detailed - Role**  
 Time run: 12/11/2009 6:27:09 PM

<b>Role Code</b>	CWSADMIN
<b>Role Name</b>	CWS Administrator
<b>Role Desc</b>	CWS Administrator Role
<b>Role Type</b>	SYSADMN
<b>Created Date</b>	10/10/1956 00:00:00
<b>Last Modified Date</b>	10/10/1956 00:00:00
<b>Created By</b>	SYSADMN
<b>Last Modified By</b>	SYSADMN

[Return](#) - [Refresh](#) - [Print](#) - [Download](#)

### Function Privileges

The details related to function privileges can be viewed in this report.

**Function Privileges**

Function Code: ALSADD    Function Name: (All Choices)    Go

Function Privileges  
Time run: 12/11/2009 6:12:20 PM

Function Name	Role Name	Group Name	Segment Name	User Name
Add Alias	Business Analyst	DEMOGRP	DEMOSEG	authdef
				DEMOUSER
				test11
				varun2
				varun3
			GASEGR2	vicky
				authdef
				DEMOUSER
				test11
				varun2

Records 1 - 10  
[Refresh](#) - [Print](#) - [Download](#)

You can click the function name to get the detailed function report.

**Security**

**Detailed - Function**  
Time run: 12/11/2009 6:32:37 PM

**Function Name : Add Alias**

Function Code	ALSADD
Function Name	Add Alias
Function Description	The user mapped to this function can add Alias
Function Type	SYS
Created Date	10/10/1956 00:00:00
Created By	SYSADMIN
Last Modified Date	10/10/1956 00:00:00
Last Modified By	SYSADMIN

[Return](#) - [Refresh](#) - [Print](#) - [Download](#)

## Adhoc Reporting – Special Instructions

The following instructions need to be followed whenever you want to carry out the Adhoc Reporting or Adhoc Querying using the OBI Answers tool or any other querying or reporting tools.

In the OBI Answers tool, when you click the Answers link, you will find single subject area, Fusion. Here you can select the tables (folders) and columns related to the Object Registration, Data Quality and Security dashboards. These tables (folders) and columns can also be used for Adhoc Reporting or Adhoc Querying.

Since these tables belong to different functional areas, namely Object Registration, Data Quality and Security, relationships or table joins across functional areas are not supported for Adhoc Reporting. Therefore, during Adhoc Report or request creation you have to make sure that tables and columns selected are within the functional groups mentioned in the following section to get correct results.

## Data Quality

You can use following folders (tables) and columns for Adhoc Querying on Data Quality related objects.

- Dim Stratification
- Dim Leaves
- Dim Invalid Codes
- Dim Ledger Stat
- Dim Product
- Dim Org Unit
- Dim Currency
- Dim General Ledger
- Dim Common COA
- Fact Stratification
- Fact Leaves
- Fact Invalid Codes

## Object Registration

You can use following folder for Adhoc Querying on Object Registration related queries.

- Dim Classification

## Security

You can use following folder for Adhoc Querying on Security related queries.

- Dim Security

---

---

# OFSA Rate Management

## Overview

OFSA Rate Management is a comprehensive utility enabling you to manage currencies, yield curves, and interest rate & currency exchange rate data with a high degree of security and control. OFSA Rate Management also allows you to maintain economic forecasts such as GDP growth, inflation rates, or unemployment projections that may be linked to your models for interest rates, exchange rates, or new business growth.

Historical rate data obtained from OFSA Rate Management is utilized within all of the Enterprise Performance Management (EPM) applications (OFSA Funds Transfer Pricing, OFSA Profitability Management, OFSA Asset Liability Management, and OFSA Balance Sheet Planning). Details regarding how each application draws upon Rate Management data are provided in the body of this chapter.

## Rate Management Subject Areas

There are four primary subject areas or modules within Common Object Maintenance > Rate Management:

- Interest Rates
- Currency
- Currency Rates
- Economic Indicators

## Interest Rates

The quality and availability of interest rate information varies throughout the world. In many markets, gathering comprehensive rate information is a challenge because of insufficient security types, inconsistent quoting conventions, and lack of liquidity. The Interest Rates module within OFSA Rate Management allows you to define and manage complex yield curve definitions using multiple rate formats and other rate attributes to give you data storage capabilities appropriate to your market. The Interest Rates module also supports the entry and maintenance of historical rate data for each yield curve you define.

Historical interest rate data from OFSAA Rate Management is utilized within OFSAA Transfer Pricing to generate transfer rates and option costs. Historical interest rate data is also utilized within OFSAA Asset Liability Management and within OFSAA Balance Sheet Planning in the generation of forecasted interest rate scenarios.

## Currency

Financial institutions commonly transact business in more than one currency. Transacting business in multiple currencies demands functional capabilities for multi-currency accounting and currency rate management.

OFSAA Rate Management's Currency module supports the definitions and maintenance of currencies. Currency definitions are fundamental to the definition of both interest rate yield curves and currency exchange rates. A key attribute of every yield curve is the currency with which it is associated; and currency exchange rates can only be established between defined currencies. OFSAA Rate Management provides a comprehensive list of ISO-defined currencies; you may also define and add your own user-defined currencies.

## Currency Rates

OFSAA Rate Management's Currency Rates module draws upon the currencies you have defined and activated in the Currency module to support the entry and maintenance of historical exchange rates. Currency exchange rates are utilized within:

- OFSAA Funds Transfer Pricing “Ledger Migration” processes (see Oracle Financial Services Analytical Applications Funds Transfer Pricing User Guide)
- OFSAA Asset Liability Management currency consolidation process (see Oracle Financial Services Analytical Applications Asset Liability Management (OFSALM) User Guide)
- OFSAA Profitability Management multi-currency allocations (see Oracle Financial Services Analytical Applications Profitability Management (OFSPM) User Guide)
- OFSAA Hedge Management and IFRS Valuations (see Oracle Hedge Management and IFRS User Guide)

## Economic Indicators

An economic indicator is any economic statistic such as the Consumer Price Index (CPI), the growth rate of the Gross Domestic Product (GDP), the unemployment rate, the Purchasing Managers Index, indices of consumer confidence, etc. Such macroeconomic statistics tell us how well the economy has behaved in the past. Some economic indicators are referred to as “lagging” indicators while others are classified as “leading” indicators. Leading indicators may provide insights into the future direction of the economy.

OFSAA Rate Management's Economic Indicators module allows you to define and store such historical indicators. Economic Indicators provide baselines from which



OFSAA Asset Liability Management can generate forecasts of future values of economic statistics that can affect new business or other modeling assumptions.

## Interest Rates Summary Screen

When you first navigate to Common Object Maintenance > Rate Management > Interest Rates, an empty screen will be displayed. After you have constructed one or more interest rate curves, navigating to Common Object Maintenance > Rate Management > Interest Rates will display a summary screen showing each of the interest rate curves that you have previously built.

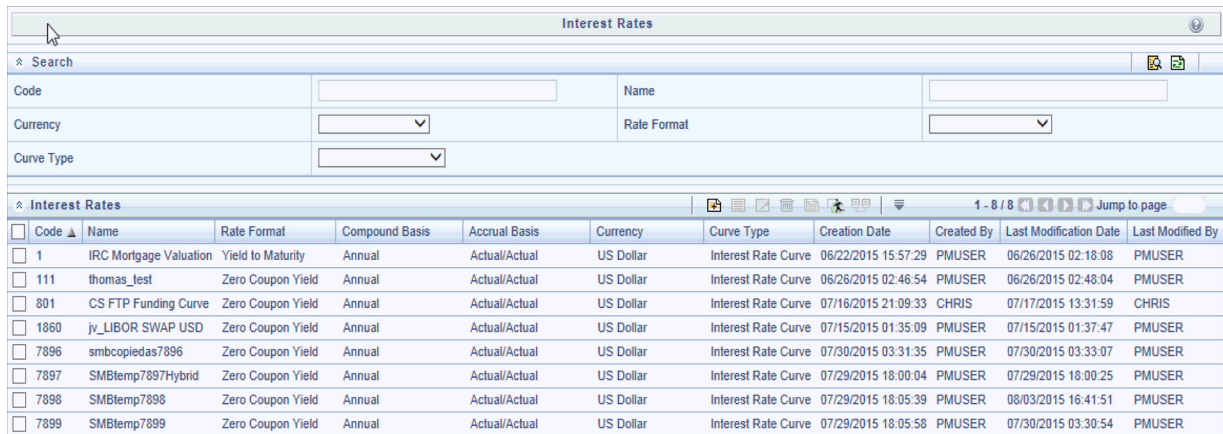

<input type="checkbox"/>	Code	Name	Rate Format	Compound Basis	Accrual Basis	Currency	Curve Type	Creation Date	Created By	Last Modification Date	Last Modified By
<input type="checkbox"/>	1	IRC Mortgage Valuation	Yield to Maturity	Annual	Actual/Actual	US Dollar	Interest Rate Curve	06/22/2015 15:57:29	PMUSER	06/26/2015 02:18:08	PMUSER
<input type="checkbox"/>	111	thomas_test	Zero Coupon Yield	Annual	Actual/Actual	US Dollar	Interest Rate Curve	06/26/2015 02:46:54	PMUSER	06/26/2015 02:48:04	PMUSER
<input type="checkbox"/>	801	CS FTP Funding Curve	Zero Coupon Yield	Annual	Actual/Actual	US Dollar	Interest Rate Curve	07/16/2015 21:09:33	CHRIS	07/17/2015 13:31:59	CHRIS
<input type="checkbox"/>	1860	jv_LIBOR SWAP USD	Zero Coupon Yield	Annual	Actual/Actual	US Dollar	Interest Rate Curve	07/15/2015 01:35:09	PMUSER	07/15/2015 01:37:47	PMUSER
<input type="checkbox"/>	7896	smbcopiedas7896	Zero Coupon Yield	Annual	Actual/Actual	US Dollar	Interest Rate Curve	07/30/2015 03:31:35	PMUSER	07/30/2015 03:33:07	PMUSER
<input type="checkbox"/>	7897	SMBtemp7897Hybrid	Zero Coupon Yield	Annual	Actual/Actual	US Dollar	Interest Rate Curve	07/29/2015 18:00:04	PMUSER	07/29/2015 18:00:25	PMUSER
<input type="checkbox"/>	7898	SMBtemp7898	Zero Coupon Yield	Annual	Actual/Actual	US Dollar	Interest Rate Curve	07/29/2015 18:05:39	PMUSER	08/03/2015 16:41:51	PMUSER
<input type="checkbox"/>	7899	SMBtemp7899	Zero Coupon Yield	Annual	Actual/Actual	US Dollar	Interest Rate Curve	07/29/2015 18:05:58	PMUSER	07/30/2015 03:30:54	PMUSER

### Search Container

A Search container is provided in which you may search for interest rate curves by Code, Name, Currency, Rate Format or Curve Type.

### Search Control

Enter your desired search criteria and click on the Search control.

### Reset Control

Clicking on the Reset control removes any Code, Name, Currency, Rate Format or Curve Type constraint you may have specified and refreshes the screen.

### Interest Rates Container

The Interest Rates container presents a grid containing all of the interest rate curves that meet your search criteria. The Interest Rates summary grid offers several controls that allow you to perform different functions when an interest rate curve is selected.

To select an interest rate curve, click on a check box in the first column of the grid. More than one interest rate curve can be selected at a time but this will cause some of the controls to become disabled. Clicking on a checkbox a second time de-selects the interest rate curve.

You may select or deselect all of the interest rate curves in the summary grid by clicking on the check box in the upper left hand corner of the summary grid directly to the left of the Name column header.

### Add

Clicking on the Add control begins the process of building a new interest rate curve. The Add control is disabled if any rows in the grid have been selected.

### View

Selecting a single row out of the grid enables the View control. Clicking on the View control allows you to view the contents of an interest rate curve on a read-only basis. The View control is only enabled when a single interest rate curve has been selected.

### Edit

Selecting a single row out of the grid enables the Edit control. Clicking on the Edit control allows you to modify a previously saved interest rate curve. The Edit control is only enabled when a single interest rate curve has been selected.

---

---

**Note:** You can control the number of rows to display on screen by selecting the "Pagination Options" icon from the action bar.

---

---

### Copy

Selecting a single row out of the grid enables the Copy control. Clicking the Copy control allows you to create a copy of an existing interest rate curve. The Copy control is only enabled when a single interest rate curve has been selected.

### Check Dependencies

Select an interest rate curve and then click the Check Dependencies control to generate a report on all rules that utilize your selected interest rate curve.

The Check Dependencies control is only enabled when a single interest rate curve has been selected.

### Delete

Selecting one or more rows out of the grid enables the Delete control. Clicking on the Delete control deletes the interest rate curves you have selected.

### Execute the Historical Interest Rates Data Loader

This Icon executes a function to import historical rates and parameters for all defined Interest rate Curves. For more information on setting up the automated process, see Oracle Financial Services Analytical Applications Data Model Utilities User Guide.

To execute a historical Interest Rate data load, click on the Execute the Historical Interest Rates Data Loader icon. A warning message will appear "Upload all available

Interest Rates and Parameters?" Click ok, and all historical rates and parameters will be loaded.

## Interest Rates Summary Grid

The following columns categorize each interest rate curve in the summary grid:

- Code
- Name
- Rate Format
- Compound Basis
- Accrual Basis
- Currency
- Curve Type
- Creation Date
- Created By
- Last Modification Date
- Last Modified By

### Code

Displays the interest rate curve's code. Code is a number in the range 1 to 9999999. It is unique. Performing a "mouse-over" on a row within the grid displays the interest rate curve's detailed description.

### Name

Displays the interest rate curve's short name.

### Rate Format

Displays the interest rate curve's rate format (zero coupon or yield-to-maturity).

### Compound Basis

Displays the interest rate curve's compounding basis (Annual, Semiannual, Monthly, or Simple).

### Accrual Basis

Displays the interest rate curve's Accrual Basis (e.g., 30/360, Actual/Actual, etc).

### Currency

Displays the currency (the Reference Currency) to which an interest rate curve is applicable.

### Curve Type

Displays the curve type - Interest Rate Curve or Volatility Curve.

### **Creation Date**

Displays the date and time at which an interest rate curve was created.

### **Created By**

Displays the name of the user who created an interest rate curve.

### **Last Modification Date**

Displays the date and time at which an interest rate curve was last modified.

### **Modified By**

Displays the name of the user who last modified an interest rate curve.

## **Interest Rates Detail Screen**

When you Add, Edit, or View an interest rate curve, the Interest Rate Code Detail Screen is displayed. The Interest Rate Code detail screen is comprised of an Interest Rate Code Details container, 5 Interest Rate Code tabs, and an Audit Trail container.

The Audit Trail container is a standard footer container for every OFSAA rule type. It displays Created By, Creation Date, Last Modified By, and Modification Date on the Audit Trail tab. The User Comments tab may be used to add comments to any rule, subject to a maximum of 4000 characters.

## **Interest Rate Code Details Container**

This is explained in detail in the following sections.

### **Interest Rate Code**

When constructing a new yield curve, you must specify an Interest Rate Code between 1 and 9999999. Interest Rate Codes are used internally to uniquely identify yield curves. When working with Rate Manager or other OFS Analytical Applications, you generally reference yield curves by Name, not by Interest Rate Codes. Interest Rate Codes, however, are embedded within your instrument data (for example, the INTEREST\_RATE\_CD and T\_RATE\_INT\_RATE\_CD columns within your instrument data are populated with Interest Rate Codes). Once you have saved a yield curve, you may not renumber its Interest Rate Code.

Interest Rate Code	
Master Maintenance > Rate Management > Interest Rates	
Interest Rate Code Details	
Interest Rate Code*	<input type="text"/>
(Hint: 1 - 9999999)	
Name*	<input type="text"/>
Description	<input type="text"/>
Volatility Curve	Rate Lock Option Volatility ▼
Risk Free	<input type="checkbox"/>
Display for All Currencies	<input type="checkbox"/>
Reference Currency*	Andorran Peseta ▼
Structure Type*	Standard ▼

## Name and Reference Currency

You must also provide a Name and Reference Currency for your yield curve. Unlike Interest Rate Codes, you may rename or change the Reference Currency for previously saved yield curves. While you may choose to rename a yield curve, however, it is very unlikely that you will choose to modify a yield curve's Reference Currency. A yield curve's Reference Currency is the currency for which your market rates are valid. For example, the Reference Currency for a Prime Rate yield curve would be US Dollars. LIBOR or other internationally quoted rates are always quoted with respect to an underlying Reference Currency (e.g., US Dollar LIBOR, Euro LIBOR, etc). The drop-down list box for Reference Currencies displays only "Active" currencies. See the section below entitled Currency for a discussion of Active and Inactive currencies.

## Description

You may optionally provide a description of your yield curve; you may modify a yield curve's description at any time.

## Structure Type

Another required attribute for each yield curve is its Structure Type. Structure Type supports both Standard and Hybrid yield curve definitions. Hybrid yield curves are re-expressions of one or more pre-existing Standard yield curves. For additional information, see Hybrid Term Structure Tab under Interest Rate Code Tabs below. Once you have saved the yield curve, you may not change the Structure Type selection.

## Volatility Curve

You can select the Volatility Curve option to indicate the curve selected will contain volatility rates. If you select this option, all other curve attributes become disabled and the curve is used exclusively for managing volatility details. For FTP Volatility, both the Terms tab and Historical Rates tab are available with this option. For ALM

Volatility, only the Historical Rates tab is available. Once you have saved the yield curve, you may not change the Volatility Curve selection.

---

---

**Note:** Volatility curves are used in Funds Transfer Pricing for calculating Rate Lock Option Costs. ALM Volatility is used to evaluate embedded options for Black 76 market valuation.

---

---

## Risk Free

This is for tagging IRC's as risk free. This field is an optional field. This flag is editable both in new and edit modes. It is available for non-hybrid curves and hybrid curves and not available for Volatility Curves.

## Display for all currencies

This option allows you to designate certain Interest Rate Curves that you would like to make available for assumption mapping to any currency. Typically, assumption rules will filter the list of Interest Rate Codes based on the currency, when defining assumptions for a specific product/currency combination. When this option is enabled the Interest Rate Code will appear in assumption rules for all currencies.

## Interest Rate Code Tabs

Interest Rate Code tabs are used to define your yield curve and to add, edit, or delete historical interest rate data. The Interest Rate Code tabs are:

- Attributes
- Terms
- Historical Rates
- Parameters
- Hybrid Term Structure



## Navigating Between Interest Rate Code Tabs

For new yield curves, you must begin with the Attributes tab. Once you have selected attributes for a yield curve, you will typically not change them. When you have finished assigning attributes, navigate to the Terms tab in order to establish a term structure for your yield curve or volatility curve, i.e., an overnight rate, a one month rate, a three month rate, etc. To navigate to the Terms tab, you may either select the Apply button on the Attribute tab or you may simply click the Terms tab.

---



---

**Note:** You must have specified an Interest Rate Code, a Name, and a Reference Currency in the Interest Rate Code Details container before you can navigate to the Terms tab.

---



---

As with your yield curve attributes, once you have established a term structure for your yield curve you will only rarely come back to change it. The first time you navigate to the Terms tab, an initial 1 month term point is provided, but even if this is the one and only term point you want for your curve, you must select the Apply button to tell the system that you have finished your term structure specification. In future revisions to your curve's definition, you may navigate directly to the Historical Rates tab simply by clicking on it, but if you modify your term structure in any way, you must always select the Apply button on the Term tab before you can navigate to the Historical Rates tab.

The Historical Rates tab is used to input interest rate or volatility data. This is the tab you will most often return to for maintaining your interest rates database over time. To navigate to the Historical Rates tab, you may either select the Apply button on the Terms tab or you may simply click the Historical Rates tab if you have already established your term structure.

---



---

**Note:** You must have specified (1) an Interest Rate Code, a Name, and a Reference Currency in the Interest Rate Code Details container and (2) a term structure in the Terms tab before you can navigate to the Historical Rates tab.

---



---

## Attributes Tab

Yield curve attributes include Rate Format, Compounding Basis, Accrual Basis, and Curve Identifier. Once you have initially saved a yield curve, you typically will not change these attributes, but Rate Management will allow you to do so.

---



---

**Note:** All Attribute fields will be disabled, if Volatility Curve is checked.

---



---

## Rate Format

As part of your yield curve definition, you must select either the Zero Coupon or Yield-to-Maturity rate format. Regardless of which format you select, rates entered into Rate Management (in the Historical Rates tab) are always entered in nominal

form, e.g., 5.125% or 6.875%, not as discount factors. For details on how the two rate formats affect internal cash flow engine calculations, see the Oracle Financial Services Analytical Applications Cash Flow Engine Reference Guide.

## Compounding Basis

You must also select a compounding basis for your yield curve: Annual, Semiannual, Monthly, or Simple. Annual is the most common method. The Monthly option is enabled based on Rate Format selection (if Rate Format is selected as "Yield to Maturity"). For details on Compounding Basis and how different compounding bases affect cash flow calculations in OFSAA, see the Oracle Financial Services Analytical Applications Cash Flow Engine Reference Guide.

## Accrual Basis

You must also select an accrual basis for your yield curve. The Accrual Basis list depends on Compounding Basis selection. If the Compounding Basis is selected as Annual, Semiannual, or Monthly, then the following Accrual Basis types are available:

Actual/Actual

30/365

Actual/365

If the Compounding Basis is selected as Simple, then the following Accrual Basis types are available:

30/360

Actual/360

Actual/Actual

30/365

30/Actual

Actual/365

For details on Accrual Basis and how different accrual bases affect cash flow calculations in OFSAA, see Oracle Financial Services Analytical Applications Cash Flow Engine Reference Guide.

## Curve Identifier

This is a drop-down list that contains the 6 curve identifier types, that is, Par Treasury, Zero-coupon Treasury, Par LIBOR/Swap, Zero-coupon LIBOR/Swap, Prime Lending Rate, and Cost of Funds Index. These curve identifiers can be mapped to the Adjustable Rate Mortgage (ARM) indices used for ADCO prepayment model processing. The Reference Currency for these indices is always US Dollar.



---

**Note:** This identifier is optional when the IRC is not being used for ADCO prepayment model processing. This is applicable only in ALM and HM applications.

---

## Terms Tab

Use the Terms tab to construct your yield curve's term structure. You may specify as many yield curve terms as you wish ranging from 1 day to 100 years.

Term	Multiplier
5	Months
10	Months
15	Months

---

**Note:** When constructing a volatility curve, there are two term types available, e.g. Contract Term and Expiration Term. You must add the relevant terms for each of these dimensions. Select the Apply button after defining terms for each dimension to save the assumptions before proceeding.

---

## Adding New Term Points

Click the Add control to add new term points. After clicking the Add control, select a Term value and a Multiplier (e.g., 7 days, 2 months, 5 years, etc). You can also add term points using the Data Input Helper.

Term	Multiplier
5	Months
10	Months
15	Months

## Deleting Existing Term Points

If you wish to delete an existing term, select the term point (or terms) you wish to delete and click the Delete control, and confirm that you want to delete the term (or terms) you have selected.

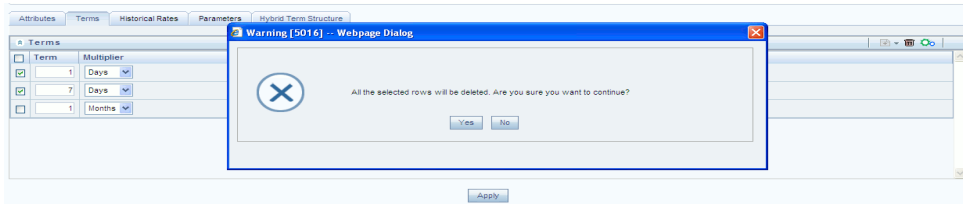

## Historical Rates Tab

Use the Historical Rates tab to enter, modify, or view interest rate data. Data should be entered as simple percentages (e.g., 5.125, 4.875, etc). If you are entering historical rates for a volatility curve, you will have to enter volatilities for the combination of contract term and expiration term. Select the desired expiration term from the drop list to complete the volatility matrix. Effective dates should be entered separately for each expiration term in the list.

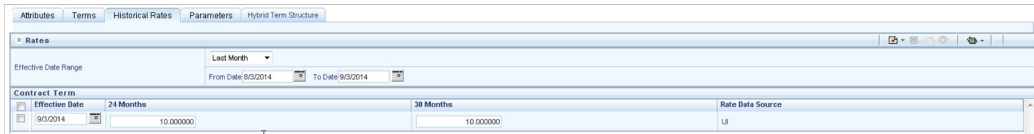

By default, the Historical Rates tab will display interest rate data for the past month (i.e., for the 30 days leading up to the current date). Click the Effective Date Range drop-down list box to expand your view to the last 3 months, 6 months, one year, 3 years, 6 years or all rate data.

---

**Note:** FTP Volatility curves are only applicable to FTP Rate lock option cost calculations and ALM Volatility only applies to embedded option market valuation.

---

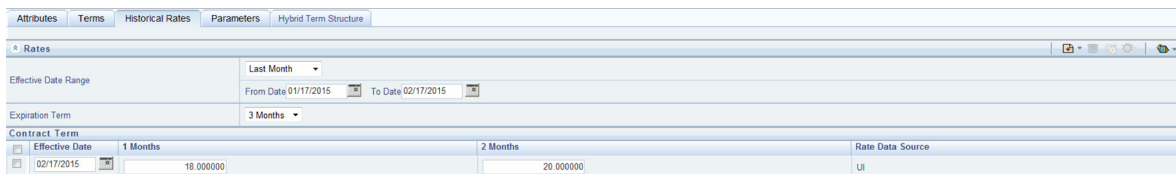

If you are entering historical rates for an FTP volatility curve, you will have to enter volatilities for the contract term. Select the desired expiration term from the drop-list to complete the volatility matrix. Effective dates should be entered for each expiration term.

The screenshot displays the 'Interest Rate Code' detail screen. The 'Interest Rate Code Details' section includes the following fields:

- Interest Rate Code: 2000
- Name: 6 Mo Calls - B76
- Description: Volatility surface for Black76 option market value testing, version 1
- Volatility Curve: ALM Surface Volatility
- Risk Free:
- Display for All Currencies:
- Reference Currency: US Dollar
- Structure Type: Standard

The 'Rates' section is active, showing the following parameters:

- Effective Date Range: All
- Effective Date: 12/31/2010
- Existing Effective Dates: 12/31/2010
- Strike Rate: 2
- Expiration Date: 2

A 'Generate' button is located below the 'Expiration Date' field. Below the 'Generate' button is a matrix of input fields for Strike Rate and Expiration Date. The matrix has two columns for Expiration Date (04/01/2011 and 12/31/2020) and two rows for Strike Rate (1.00000 and 10.00000). The intersection cells contain values: 5.00000, 10.00000, 15.00000, and 20.00000. An 'Apply' button is located below the matrix.

If you are entering rates for an ALM Volatility surface, you will have to enter volatilities based on two dimensions: Strike Rate (vertical axis) and Expiration Date (horizontal axis). For a new ALM Volatility surface, enter an as-of date and the number of breakpoints for Strike Rate and Expiration Date, then press the “Generate” button. The size of the matrix cannot exceed 20 x 20. For Strike Rate enter values in ascending order. For Expiration Date, enter values in ascending order with values greater than the currently specified as-of date. At every intersection of Strike Rate and Expiration Date enter a volatility amount in percent (i.e. 25 = 25%).

The Rate Data Source is a parameter that depicts from where the rates have been taken from, either they are entered through the UI or loaded through the data loader or generated using the Generate Rates of Hybrid IRC.

## Generate Graph

Generate Graph option allows you to generate the graph for selected Historical rates.

To generate a graph, follow the steps given below:

1. Select the Effective Date Range for which you want to generate the graph.  
The From Date and To Date fields will be automatically updated after selecting the Effective Date Range.
2. Select the Effective Date using corresponding calendar options.

The screenshot shows the 'Rates' screen with the 'Contract Term' table. The table has columns for 'Effective Date', '12 Months', '24 Months', '36 Months', and 'Rate Data Source'. The 'Effective Date' column contains three dates: 3/4/2015, 2/4/2015, and 4/15/2015. The other columns are empty, and the 'Rate Data Source' column contains 'UI' for all rows. An 'Apply' button is visible at the bottom.

3. Enter the term points in respective fields and click Apply button.
4. Select the Terms using the corresponding check-boxes.

The screenshot shows the 'Rates' screen with the 'Contract Term' table. The table has columns for 'Effective Date', '12 Months', '24 Months', '36 Months', and 'Rate Data Source'. The 'Effective Date' column contains three dates: 3/4/2015, 2/4/2015, and 4/15/2015. The '12 Months' column contains values 5.000000, 2.000000, and 7.000000. The '24 Months' column contains values 15.000000, 4.000000, and 9.000000. The '36 Months' column contains values 10.000000, 6.000000, and 11.000000. The 'Rate Data Source' column contains 'UI' for all rows. An 'Apply' button is visible at the bottom.

5. Click on Generate Graph icon.



6. The graph will be generated. Here, you can view the graph for Interest Rate vs Effective Date or Interest Rate vs Term Point.

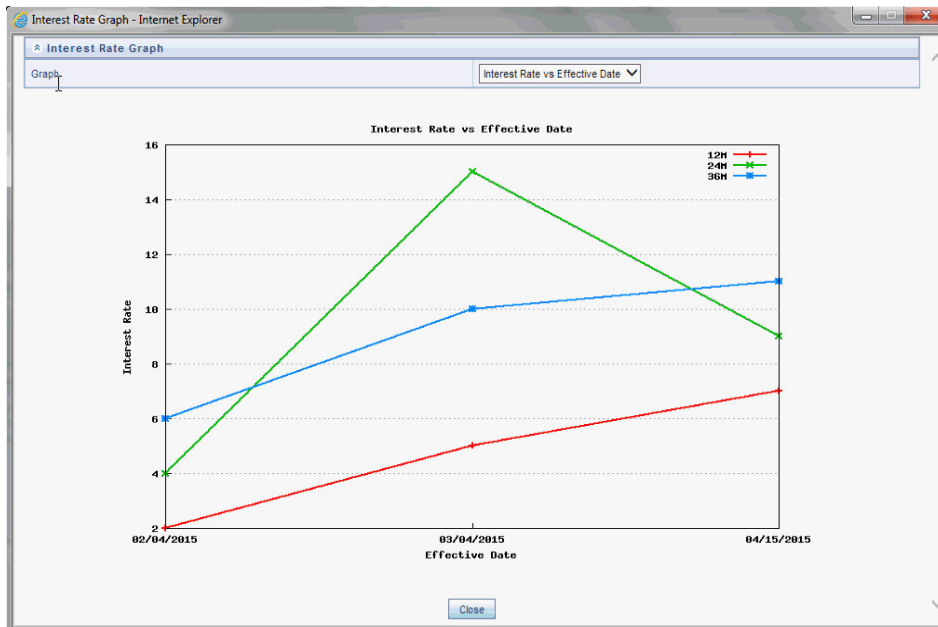

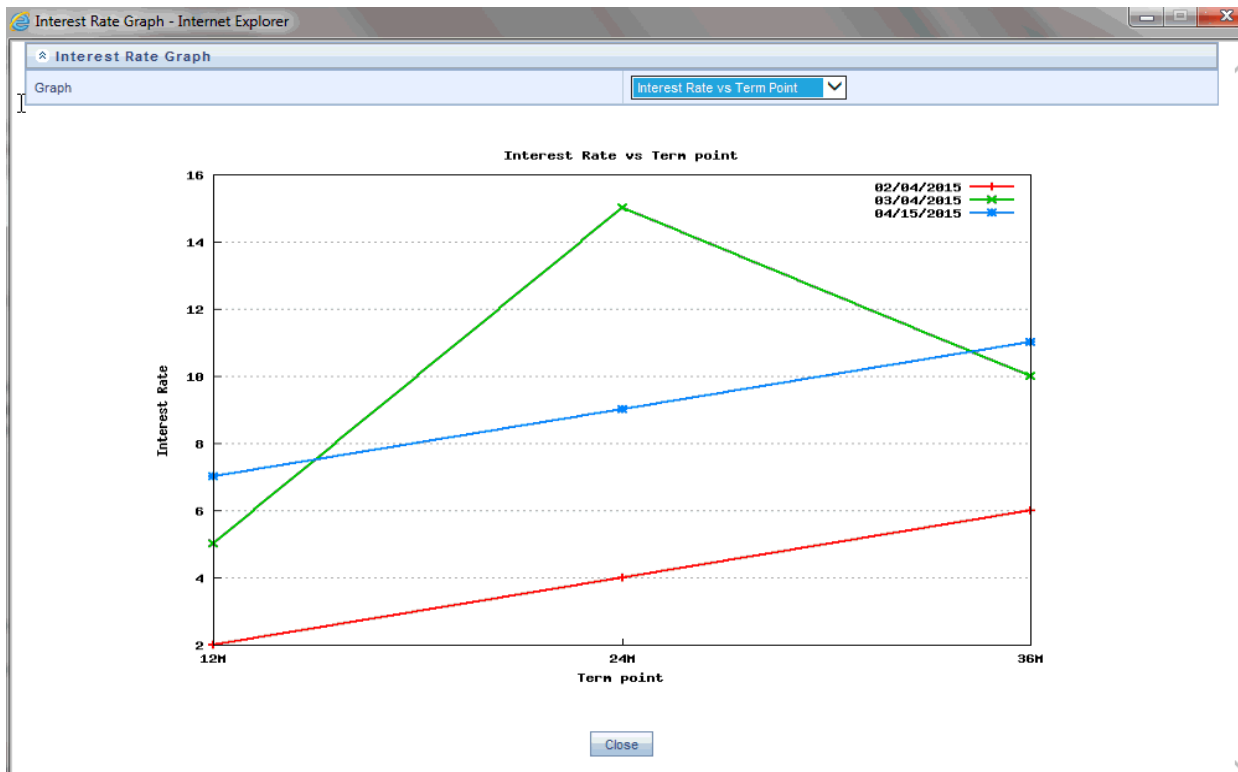

## Excel Import/Export

**Note:** Starting from 8.0.4 release, Excel Import feature will work only on Internet Explorer browser. Excel Export feature is supported by all browsers such as chrome/Firefox.

To aid in data entry, use the excel import/export functionality to add or edit rate data to historical rates. On the rates tool bar, click the excel icon. Click the 'export' toggle box to export data for the chosen selected effective date range. Within the same block, choose to export to excel. Doing so will launch the excel application and output the data grid, including headers.

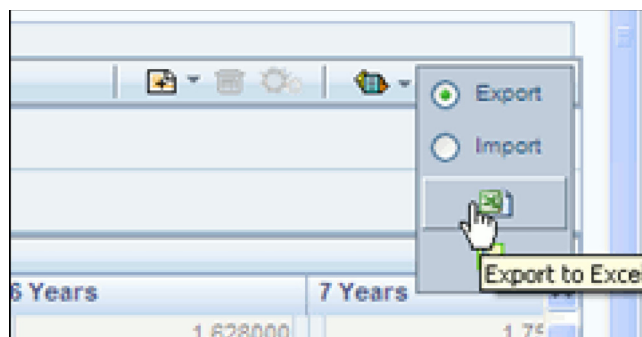

You can add rows to the grid in the same format. After all data is input (or existing data is edited), copy the range of the grid you want to append, and go back to the rates screen. In the same block, click the 'import' toggle box, and directly below click the import from clipboard icon. The data copied from excel will appear in the rate history grid.

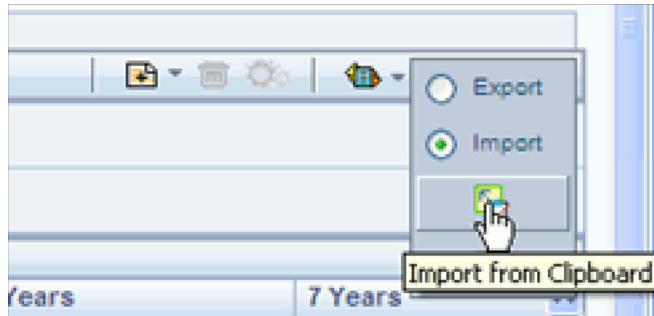

1. If appending data that preexisted for the same effective date, the import it will overwrite existing data.
2. In some cases, there are fields that will be output to the grid that are not editable, such as bucket start and end dates (when defining forecast assumptions). Be sure to only add or edit data in the columns that would be editable in the UI itself.

### Deletion of Historical Rates

You can delete historical rates entered by selecting one or more rows and then clicking the delete control.

### Data Input Helper

You may want to utilize the Data Input Helper to copy from a row where you have already defined the interest rate definition or apply a fixed value down the page. The following optional steps describe how to use this feature.

1. Select the checkbox next to the rows that you want to work with or use the "Select ALL" option by selecting the check-box on the header row.
2. Select the Data Input Helper icon.



3. From the Data Input Helper – popup screen, select Method – "Grow by Amount" or some other appropriate method.

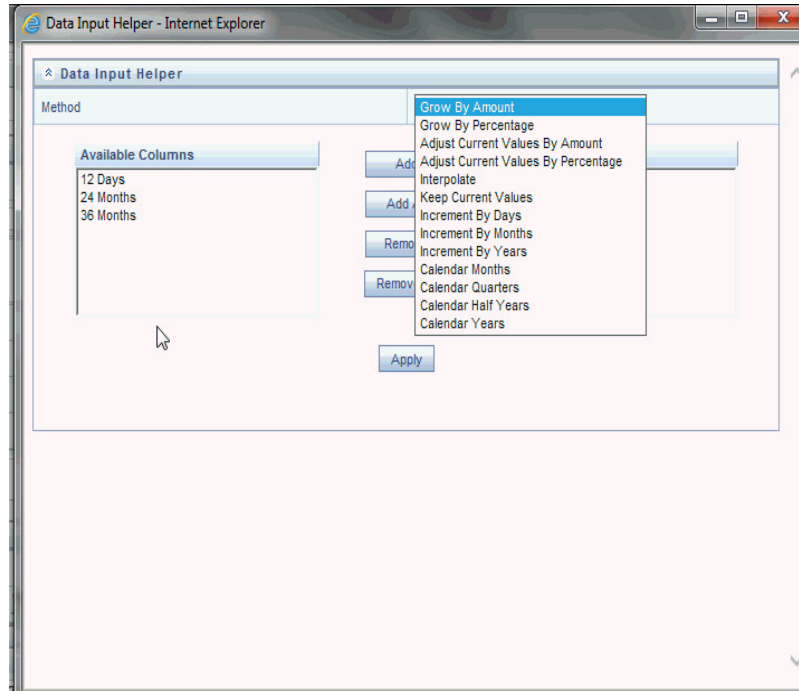

4. Select the term points from the left side (Available Columns) of the shuttle box.

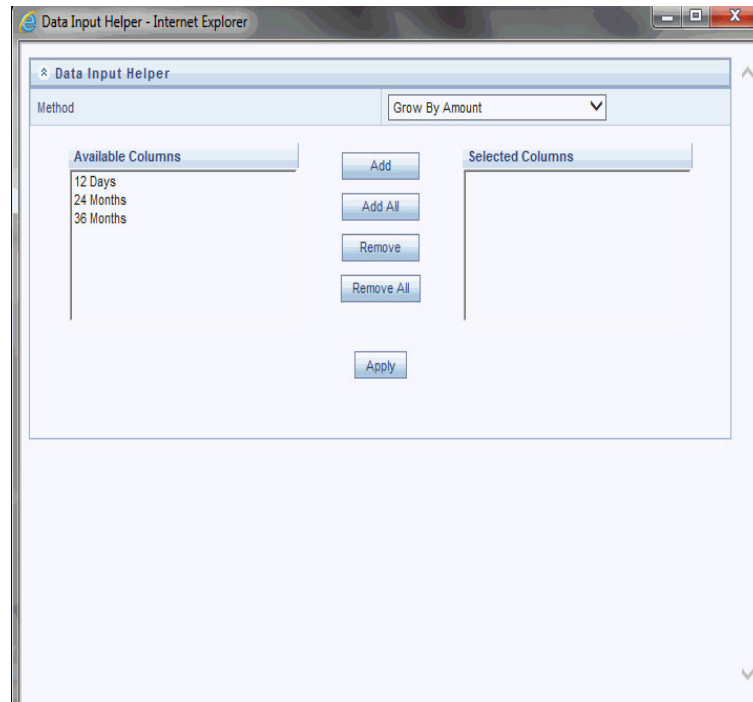

Based on selected Method, the list of Available Columns will vary. If Method is selected as "Increment By Months", "Increment By Days", or "Increment By Years", then only Effective Date option will be displayed in Available Columns list.

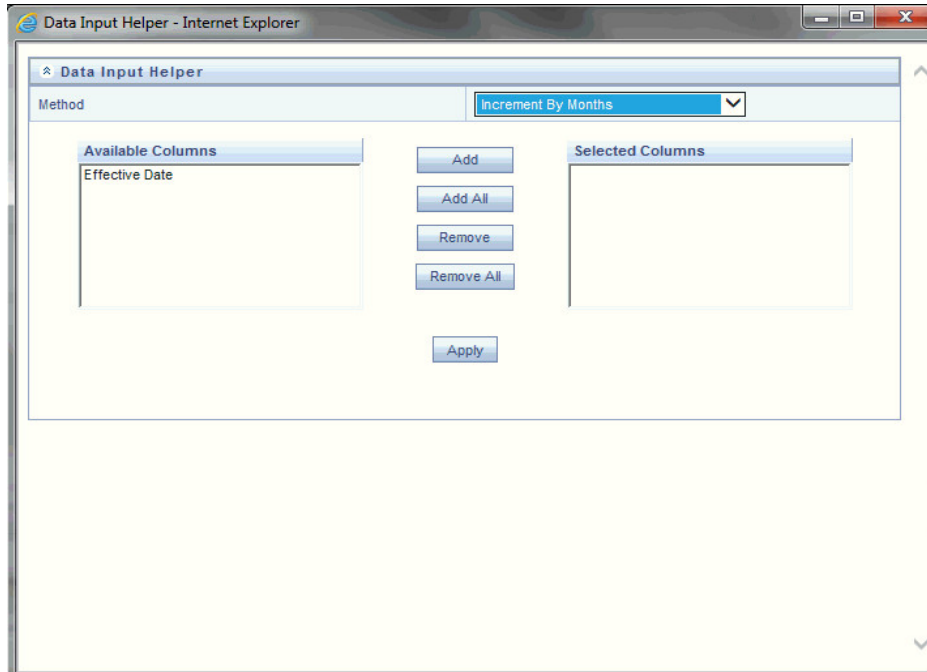

After clicking on Apply button, you can modify the Start date and enter the Incremental Value.

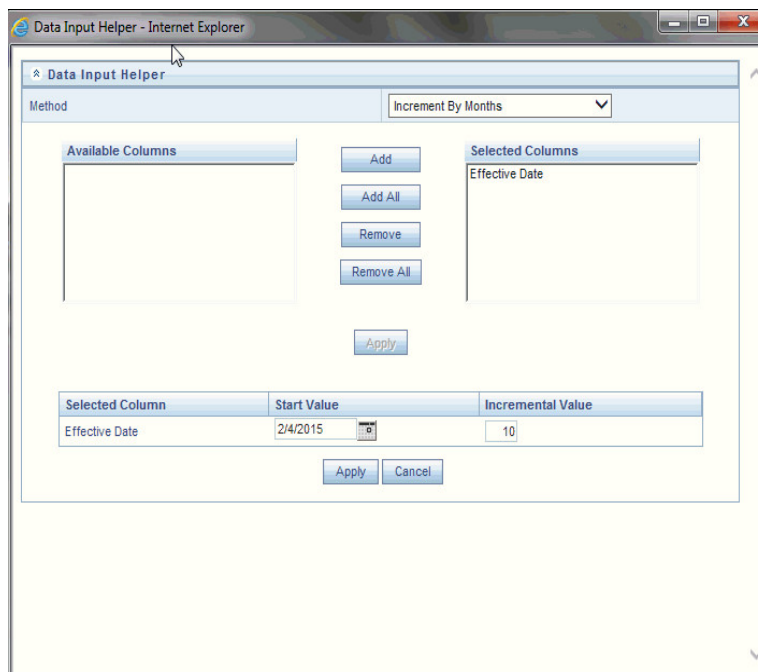

5. Select APPLY.

### Rate Lookup Behavior Between Term Points

The OFSAA cash flow engine is common to OFSAA Funds Transfer Pricing, OFSAA Pricing Management (Transfer Pricing Component), OFSAA Asset Liability



Management, and OFSAA Balance Sheet Planning. In looking up rates from OFSAA Rate Management, the cash flow engine will, where necessary, perform an interpolation between yield curve term points. For example, in determining a straight term transfer rate (common for products such as time deposits), the engine may need to determine a three month rate from a yield curve that contains only a one month rate and a six month rate. In such a case, the cash flow engine will perform an interpolation to determine the implied three month rate. While each of the above applications supports simple linear interpolation, OFSAA Transfer Pricing and OFSAA Asset Liability Management also support cubic and quartic spline interpolation methods. These more advanced methods will be supported for all OFS Analytical Applications in a future release.

### **Rate Lookup Behavior Beyond Term Points**

In cases where the cash flow engine needs to determine a rate from a yield curve for a term point smaller than the first term point of the yield curve, the engine will utilize the first term point of the yield curve. For example, if the engine needs to determine an overnight rate from a yield curve whose first term point is one month, the engine will utilize the one month rate. Similarly, in cases where the cash flow engine needs to determine a rate from a yield curve for a term point greater than the longest term point on the yield curve, the engine will utilize the last term point of the yield curve. For example, if the engine needs to determine a 30 year rate from a yield curve whose last term point is 10 years, the engine will utilize the 10 year rate.

### **Rate Lookup Behavior Between Effective Dates**

In looking up rates from OFSAA Rate Management for a business date, the cash flow engine may find that there is no rate data for that specific business date. For example, in generating an original term transfer rate for an instrument with an origination date of June 14, 2010, the cash flow engine may find rate data for May 31, 2010 and for June 30, 2010 but no rate data for any dates between May 31, 2010 and for June 30, 2010. In such cases, the cash flow engine always falls back to the latest available rate data prior to the business date of interest (May 31, 2010 in this case).

### **Parameters Tab**

Fixed income instruments are used for forecasting and simulating the Cash Flows. The Cash Flow Engine needs interest rate models to simulate the evolution of interest rates. The Cash Flow Engine uses these models as part of the stochastic engine. You can enter the parameters for these models in several ways:

- System-generated calculations via Parameter Estimation
- Direct input into the UI
- Excel Import
- UI entry via Data Input Helper methods
- Data Loader

Following interest rate models are available:

- Extended Vasicek
- Ho and Lee
- Merton
- Vasicek

## Parameter Estimation

This section explains the procedure to calculate estimated parameters.

### Prerequisites

**Installation of R and Oracle R Enterprise (ORE)** is required to use the Term Structure Parameter Estimation functionality under Rate Management – Interest Rates, for computing term structure parameters.

For more information, refer to *Oracle Financial Services Asset Liability Management Application Pack Installation and Configuration Guide 8* on OTN.

### Conditions for Parameter Estimation

If the following conditions are met, you can calculate parameters for any Term Structure Model for a given Effective Date, based on your relative look back term and a sufficient number of observations (available historical rates) for the IRC. If you rerun with a different lookback term, it will overwrite the existing parameters for the selected Term Structure Model on that IRC's Effective Date.

### Conditions:

- Term point: Underlying historical rates must be available for a 30-Day or 1-Month term point.
- Minimum number of historical rates: A total of at least 10 historical rates ("observations") are required, on appropriate lookback dates.
- Lookback dates: Historical rates must be available on dates looking back from the Parameter's Effective Date (the End Date), in roughly 30-day intervals moving backwards from End Date to Start Date, for a minimum of 10 intervals.

For example: If the first rate's Effective Date is 1 Jan. 2013, then the second rate's date should be 2 Dec. 2012 (1 Jan. 2013  $\pm$  30 days = 2 Dec. 2012), and so on. If a rate is not found for the required date, the engine looks for a rate within the neighborhood of 5 days up or down (therefore a total range of 10 days), searching iteratively starting with Date -1, then Date +1, through Date +5, then Date -5. The next rate lookup would be 60 days prior to the End Date, and so on.

The minimum relative term for all lookbacks must be at least 300 Days (i.e., to accommodate a minimum of ten 30-day intervals). Using the above logic, if a rate is not found for the lookup date (or date within the neighboring range), an error will be logged in FSI\_PROCESS\_ERRORS with ID\_Number there identifying the Interest Rate Code, then the parameter estimation engine will exit.

### Procedure

1. If you wish to edit or recalculate existing Parameters, you can enter the Effective Date Range filter.

Following Standard toolbar buttons are available here:

- Add
  - Delete
  - Data Input Helper
  - Refresh
  - Excel Export/Import
2. Initially, default parameters for the Extended Vasicek Model will be displayed for one Effective Date (the system date on which the Interest Rate Code was created). You can edit these parameters. You can also add new parameters using the Add button. Use the Refresh button to return to existing Parameters.

---

**Note:** Steps 3 and 4 are applicable only if you are Adding or Editing Parameters.

---

If you are adding or editing parameters, you can use the Data Input Helper or Excel Import/Export. For more details, refer Excel Import/Export and Data Input Helper.

3. Enter the Effective Date. Here, Effective Date cannot be greater than Current System Date.
4. Select the Model from Term Structure Model drop-down list. Effective Date + Term Structure Model combination must be unique within this IRC.

The following term structure models are utilized in stochastic modeling of interest rates in OFSAA Transfer Pricing and OFSAA Asset Liability Management:

- Extended Vasicek
- Ho and Lee
- Merton
- Vasicek

5. The parameters needed by the models are as follows:

Model	Parameter 1	Parameter 2	Parameter 3
Extended Vasicek	Volatility	Mean Reversion Speed	
Ho and Lee	Volatility		
Merton	Volatility		
Vasicek	Volatility	Mean Reversion Speed	Long Run Rate

Values for Long Run Rate and Volatility are assumed to be percentages.

For example, a long run rate of 5% is displayed as 5.000. To maintain the integrity of your data, Rate Management restricts the input values it accepts. Note the valid range and default setting for each parameter.

Parameter	Valid Range	Default Value
Volatility	0% to 500%	0.01
Mean reversion speed	0.00 to 500	0.0
Long run rate	0.00% to 500%	0.0

- Rate Data Source will indicate if you have directly entered Parameters through the UI. It will also allow you to Calculate the Parameters to display system-generated values.
- When you select **Calculate** option, the following Term Structures Parameter Estimation window is displayed:

If you are directly entering the Parameters, then enter values appropriate to the Model, as noted above, then click Apply else click Calculate.

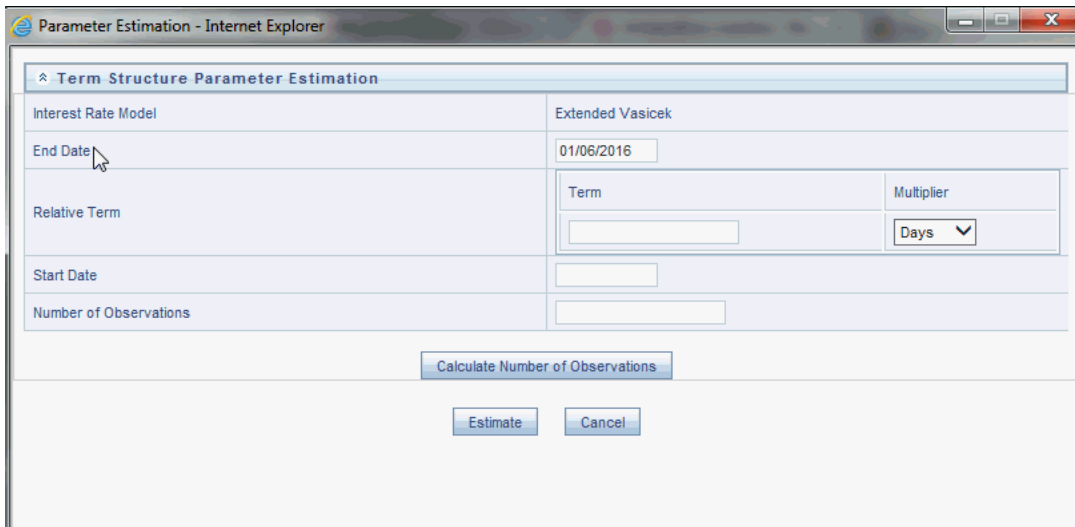

- End Date will be auto-populated with Effective Date. Enter the Relative Term with Multiplier to define the rate lookback period. The Term/Multiplier value should be at least 300 Days.

9. Start Date is automatically updated after entering Relative Term.

Interest Rate Model	Extended Vasicek	
End Date	01/06/2016	
Relative Term	Term	Multiplier
	300	Days
Start Date	03/12/2015	
Number of Observations	10	

Calculate Number of Observations

Estimate    Cancel

10. Click Calculate Number of Observations to confirm number of rates found for appropriate dates within the Relative Term. If there are at least 10 observations, the Estimate button will become active. For more information, refer to Conditions for Parameter Estimation section.
11. Click Estimate to Calculate the Parameters and store them in the historical parameters table (FSI\_IRC\_TS\_PARAM\_HIST). You will then see a confirmation box. Click Ok. The calculation will complete and you will be directed back to the Parameters screen.

Similar to the validation used for direct input from the UI, if any of the calculated parameters are outside of the valid range, the engine will write an error message.

You can delete parameters by selecting one or more rows and then clicking Delete. For details on term structure models and stochastic processing, refer to *Oracle Financial Services Funds Transfer Pricing User Guide*, *Oracle Financial Services Asset Liability Management (OFSALM) User Guide*, and *Oracle Financial Services Analytical Applications Cash Flow Engine Reference Guide*.

## Hybrid Term Structure Tab

Hybrid term structures will allow you to specify three types of hybrid yield curves:

- Spread
- Moving Average
- Merge

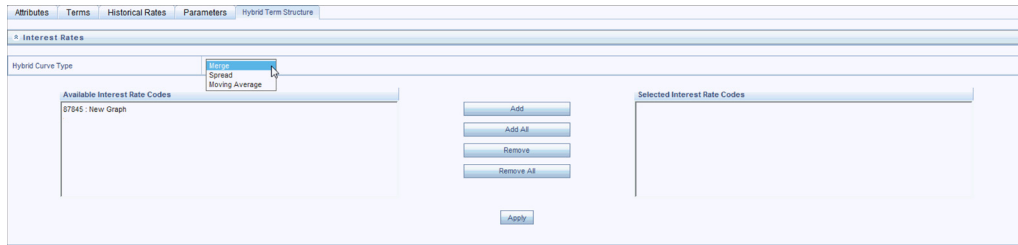

---

**Note:** The Parameters and Hybrid Term Structure tabs will be disabled, if Volatility Curve is checked.

---

Hybrid yield curves are built up from either one or more standard yield curves. When you add, modify, or delete any historical rate data from a standard yield curve, the data associated with any related hybrid yield curve should also be updated (see Generate Historical Rates below). Once defined, Hybrid Yield Curves are used like any other interest rate curve in the system. You can reference these curves within OFSAA application business rules that allow selection of an Interest Rate Code.

## Spread

A Spread hybrid yield curve is defined as the difference between two standard yield curves. The “spread” type of hybrid yield curve may be useful in establishing liquidity risk or basis risk yield curves.

## Moving Average

Moving average hybrid yield curves represent moving average data of a single underlying standard yield curve. These curves are typically used in Funds Transfer Pricing.

## Merge

Merge hybrid yield curves represent a blending of two or more underlying yield curves. In constructing a “merge” type of hybrid yield curve, you specify the percentage weighting applicable to each of the underlying standard hybrid yield curves.

## Defining a Hybrid Curve

To define a hybrid curve select the Source Type: Hybrid, in the Hybrid Term Structure tab, select the Hybrid Curve Type (Spread, Moving Average., or Merge), and select the Interest Rate Codes) for the hybrid type. Click “Apply.”

## Generate Historical Rates

Once a hybrid curve is defined, you can generate historical rates as far back as the rate source curves allow. The Generate Frequency determines the frequency of the historical rates populated with the Generate function. If you choose the generate frequency of monthly, it will generate month end values only. If you choose daily, it will generate the maximum number of historical values.

To generate the rates, select the interpolation method (Linear, Cubic or Quartic), select the Generate Frequency (Daily, Weekly, Bi-Weekly, or Monthly) and enter the specific date range (From Date / To Date), Click the “Generate” button. The rates will be populated and you will be directed to the Historical Rates tab to view the results.

If Hybrid Curve Type selected as Moving Average, then you can select the Moving Average Term in Days, Months, or Years.

The screenshot displays the 'Interest Rates' configuration window with the following sections:

- Interest Rates:** Includes a 'Hybrid Curve Type' dropdown set to 'Moving Average'.
- Available Interest Rate Codes:** An empty list box on the left.
- Selected Interest Rate Codes:** A list box on the right containing '07945: New Graph'.
- Buttons:** 'Add', 'Add All', 'Remove', 'Remove All', and 'Apply' buttons are positioned between the two list boxes.
- Hybrid Term Structure Weights:** A table with columns for 'Selected Term Structures', 'From Date', 'To Date', and three frequency options: '12 Months', '24 Months', and '36 Months'. The '12 Months' column has a checked checkbox. The 'From Date' is '2/4/2015' and the 'To Date' is '2/15/2015'. The frequency dropdowns are set to 'Months'.
- Bottom Section:** Contains 'Moving Average Term' (checked), 'Interpolation' (set to 'Linear Interpolation'), 'Generate Frequency' (set to 'Monthly'), and 'From Date' and 'To Date' fields. 'Apply' and 'Generate' buttons are at the bottom.

## Automate (Schedule) the Generate Rates Action in Hybrid IRCs

The generation of the Hybrid IRC rates which is currently available within the Rate Management user interface > Hybrid IRC, as a manual process, can additionally be scheduled to run through an ICC Batch process or through a Simplified Batch process.

When running Generate Rates through the user interface, there are 3 parameters provided by the user.

1. Interest Rate Code: For example, the user is in edit mode for a particular Hybrid IRC when they execute the Generate Rates option, so the IRC is implied.
2. FROM DATE: this is the start date of the generate rates process
3. TO DATE: this is the date to which hybrid rates will be computed

When generating Hybrid Rates through a batch (ICC or Simplified), specify 'ALL' in the Parameter list to generate rates for all Hybrid IRCs. On the other hand, a list of IRCs can be specified by means comma separated values within quotes.

'IRC\_Code1, IRC\_Code2, IRC\_Code3' and so on

---

**Note:** If you want to use all IRCs, then use 'ALL' in the Parameter list.

---

Additionally, the "TO DATE" is determined based on the Effective Date specified for the Batch and the "FROM DATE" for each IRC is determined by referring to the last (maximum) effective date in the current historical rates table +1 day.

There is one exception to the calculated "FROM DATE". In cases where a new Hybrid IRC is generating rates for the first time, then the minimum Effective Date from the Parent IRC is used as the "FROM DATE".



---



---

**Note:** Hybrid Rates generated by the Generate Rates procedure are written to the FSI\_IRC\_RATE\_HIST table. Outputs from the procedure can be verified within the Interest Rates UI or by querying this table directly.

---



---

The following topics are covered in this section:

- Dependent Tables
- Prerequisites to running - Hybrid IRC batches
- Batch Creation and Running Batches
- Viewing Log Messages

## Dependent Tables

FSI\_IRCS: Holds header information of all Interest Rate Codes.

FSI\_IRC\_HYBRID\_STRUCT\_WEIGHT: Holds the Hybrid IRCs' - interest rate term, interest rate term mult and rate weightage. It is the child Table of FSI\_IRCS.

FSI\_IRC\_RATE\_HIST: This Output table holds calculated rates for the Hybrid IRCs, as well as all historical rates for non-hybrid IRCs input through the Interest Rates UI or loaded directly using the interest rates data loader program.

FSI\_MESSAGE\_LOG: Holds error log information.

DATE\_TASK\_MASTER: Located in the Config Schema, this table should have a seeded date for IRC\_HYBRID\_SCHEDULER DT.

DATE\_TASK\_STEP\_PRECEDENCE : Similar to DATE\_TASK\_MASTER, this table should also have an entry for IRC\_HYBRID\_SCHEDULER DT

## Prerequisites to Running Hybrid IRC Batches

- The Function FN\_FSI\_IRC\_HYBRID\_SCHEDULER should be in “compiled” status in the ATOMIC schema. Sometimes, the functions created in Database can be in invalid state due to some issues (by the installer), so you can use compile option in DB to get them in valid state.
- Users can create the ICC batch using the "IRC\_HYBRID\_SCHEDULER" rule name, which is seeded with the installation.
- Hybrid IRC rates are calculated based on their underlying standard IRC rates, which are also stored in the FSI\_IRC\_RATE\_HIST table. Historical Rates should already exist for all parent and dependent IRCs for the relevant effective date range.

---



---

**Note:** Seeded data related to Batch information should be present in the DATE\_TASK\_MASTER and DATE\_TASK\_STEP\_PRECEDENCE tables in the Config schema.

---



---

## Batch Creation

As mentioned earlier, there are two methods for creating and running batch processes, ICC Batch and Simplified Batch. The following section describes how to setup and run Hybrid Rate Generation using both approaches.

### Running Hybrid Rate Generation using ICC Batch:

1. Navigate to: Common Object Maintenance> Operations > Batch Maintenance > Create Batch
  - Component = "Transform Data"
  - Rule Name = "IRC\_HYBRID\_SCHEDULER"
  - Parameter List = 'IRC\_Code'

---

**Note:** If you want to use all IRCs, then use 'ALL' in the Parameter list.

---

The screenshot shows the 'Batch Maintenance' application window. It includes a search section with fields for 'Batch ID Like' (ALMINFO\_), 'Batch Description Like' (NewBatch1), 'Module', and 'Last Modification Date'. Below the search is a table for 'Batch Name' with columns for 'Batch ID', 'Batch Description', and 'Batch Edit/Non Edit'. The table contains one entry: 'ALMINFO\_BATCH1' with description 'NewBatch1' and edit status 'E'. Below this is a 'Task Details' section with columns for 'Task ID', 'Task Description', 'Metadata Value', 'Component ID', and 'Precedence'. It shows a task named 'Task1' with description 'null', metadata 'IRC\_HYBRID\_SCHEDULER', and component 'TRANSFORM DATA'.

2. Save the batch
3. Navigate to: Applications> Common Object Maintenance> Operations> Batch Execution
4. Search for and Select the Batch created under Batch Maintenance.
5. Input the "Information Date" for the batch.
6. Select "Execute Batch"

**To schedule a future Hybrid Rate Generation Batch Process, or to schedule Hybrid Rate Generation Batch Process on a recurring basis, do the following:**

1. Navigate to Applications> Common Object Maintenance> Operations> Batch Scheduler.
2. Search for and select the Batch to schedule.
3. Select New Schedule or Existing Schedule:

---

**Note:** An Existing Schedule can be selected only if there are existing scheduled batches to view.

---

4. If New Schedule is selected, the New Schedule grid appears. Enter the Scheduled task name.
  - \_ To run the Hybrid Rate Generation process once, select once. Go to Step 6.
  - \_ To schedule the Hybrid Rate Generation on a recurring basis, select Daily, Weekly, Monthly or Adhoc.
5. In the Schedule Task grid, in the Date field, enter the start date and end date.
6. In the Run Time field, input the time for the next validation to be run.
7. Click Save to set the schedule as specified or Cancel to drop your changes.
 

Any error messages or warnings generated during the Hybrid Rate Generation process are displayed in the View Log.

### Running Hybrid Rate Generation using Simplified Batch

To run Hybrid Rate Generation using Simplified Batch, use the following steps:

1. Under Financial Service Applications, click Applications> Common Object Maintenance> Operations> Simplified Batch> Add.
2. From the Task Details block, click Select Task. In the Task Selection window, choose Task Type as Transform Data. Then, click Search. In the Task Selector, Scroll down the left shuttle box (Available tasks) and select IRC\_HYBRID\_SCHEDULER (move to right shuttle box), then click Ok.

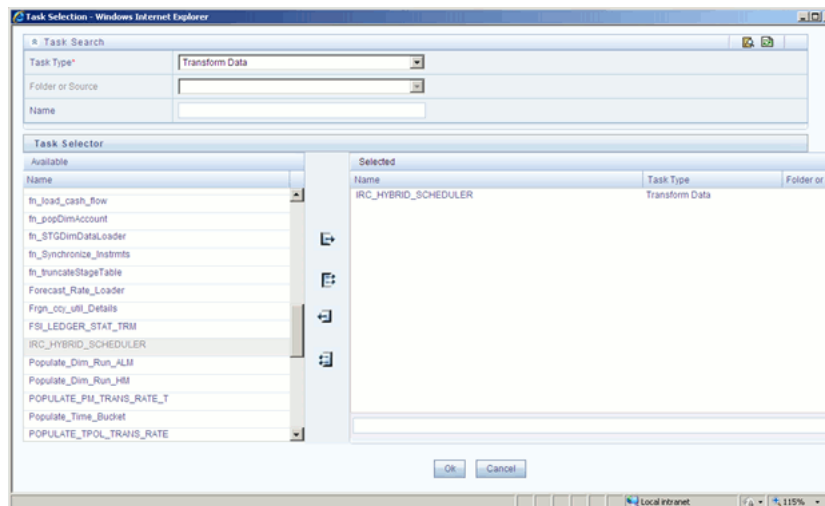

3. Enter the parameters and click Save.
4. In the Simplified Batch summary page, search for and select your Hybrid Rate Generation batch, then click the Run icon.
5. Click YES to confirm you want to continue, enter a date (this will be your "TO DATE") and click Ok to continue.
6. You will receive a message that the batch has been successfully launched.
7. Click Ok. When the batch is complete, optionally navigate to Operations > View Log to view the processing log.

Any error messages or warnings are accessible from the View Log screen.

---

---

**Note:** Simplified Batch does not yet provide access to logs for Transform Data tasks.

---

---

## Viewing Log Messages

Any error messages or warnings generated during the Rate Generation Batch are displayed in the Log Information window. To access this window:

1. Click Operations > View Log.
2. Enter search criteria: Data Transformation and related Batch ID
3. Select the Task ID hyperlink to view the log information

Users can additionally query the FSI\_MESSAGE\_LOG table directly to view the error log details.

## Data Loader

The Data Loader Icon executes a function to import historical interest rates and parameters for all defined IRCs. For more information on setting up the automated process, refer to *Oracle Financial Services Analytical Applications Data Model Utilities User Guide*.

---

---

**Note:** **FusionApps.properties** file should be present under *Web Server <deployed path>/WEB-INF/props* and *\$FIC\_WEB\_HOME/webroot/WEB-INF/props* directories.

Update the entry details of source name. It should be "infodom\_SOURCE\_NAME=Actual\_Source\_Name".

For example, if Infodom Name is "DEV6INFO" and source Name is "DEVETLSRC", then entry will be "DEV6INFO\_SOURCE\_NAME=DEVETLSRC".

Launch the Historical Interest Rates Data Loader from Interest rates screen after making this change.

For more information, refer to Doc ID 2233513.1.

---

---

To execute a data load, click the Data Loader icon. A warning message will appear Update all available interest rates and parameters?

---

---

**Note:** Upon clicking the data loader icon, the loader will execute all interest rates and parameters.

---

---

Interest Rates										
Search										
Code					Name					
Currency					Rate Format					
Curve Type										
Interest Rates										
1 - 20 / 97 Jump to page										
Code	Name	Rate Format	Compound Basis	Accrual Basis	Currency	Curve Type	Creation Date	Created By	Last Modification Date	Last Modified By
1	IRConc	Zero Coupon Yield	Annual	Actual/Actual	US Dollar	Interest Rate Curve	8/19/2014 10:31:34	JILNA	8/28/2014 11:38:14	JILNA
2	irc2	Zero Coupon Yield	Annual	Actual/Actual	Dollar	Interest Rate Curve	8/28/2014 06:51:37	JILNA	8/28/2014 06:51:50	JILNA
55	fgfgg	Zero Coupon Yield	Annual	Actual/Actual	Dollar	Interest Rate Curve	8/28/2014 08:16:44	ALMHM80USER		
78	sd	Zero Coupon Yield	Annual	Actual/Actual	Dollar	Interest Rate Curve	8/28/2014 07:48:46	ALMHM80USER	8/28/2014 07:48:55	ALMHM80USER
131	PAR_TSY_1YR	Zero Coupon Yield	Annual	Actual/Actual	US Dollar	Interest Rate Curve	11/7/2012 17:35:57	JOBUSER28	11/7/2012 17:36:02	JOBUSER28

## Currency

Upon initially navigating to Common Object Maintenance > Rate Management > Currency, a summary screen displays a comprehensive list of more than 170 seeded ISO currency codes.

Currencies					
Search					
Currency Code				Currency Name	
Status				Reporting Currency	[Blue]
Currencies					
1 - 8 / 8					
Code	Currency Name	Reference Interest Rate Code	Reporting Currency	Status	
			No	inactive	
ALL	Albanian Lek		Yes	Active	
AMD	Armenia Dram		No	Active	
AUD	Australian Dollar	IRC21 Test	No	Active	
AWE	hello		Yes	Active	
EUR	Euro (European EMU)	1. ING Yield Curve	Yes	Active	
GBP	Pound Sterling	GBP Libor	Yes	Active	
RUR	Russian Ruble		Yes	Active	
USD	US Dollar	1 YR Treasury Index	Yes	Active	

## Search Container

A Search container is provided in which you may search for currencies by Name, by Currency (by ISO currency code), by status or by reporting currency.

## Search Control

Enter your desired search criteria and click on the Search control.

## Reset Control

Clicking on the Reset control removes search constraint you may have specified and refreshes the screen.

## Currencies Container

The Currencies container presents a grid containing all of the currencies that meet your search criteria. The Currencies summary grid offers several controls that allow you to perform different functions when a currency is selected.

To select a currency, click on a check box in the first column of the grid. More than one currency can be selected at a time but this will cause some of the controls to become disabled. Clicking on a check-box a second time de-selects the currency.

You may select or deselect all of the currencies in the summary grid by clicking on the check box in the upper left hand corner of the summary grid directly to the left of the Code column header.

### Add

Clicking on the Add control begins the process of adding a new currency. The Add control is disabled if any rows in the grid have been selected.

### Edit

Selecting a single row out of the grid enables the Edit control. Clicking on the Edit control allows you to modify an existing currency. The Edit control is only enabled when a single currency has been selected.

---

---

**Note:** You can control the number of rows to display on screen by selecting the "Pagination Options" icon from the action bar.

---

---

### Delete

Selecting one or more rows out of the grid enables the Delete control. Clicking on the Delete control deletes the currency or currencies you have selected.

### Check Dependencies

Select a currency and then click the Check Dependencies control to generate a report on all rules that utilize your selected currency.

The Check Dependencies control is only enabled when a single currency has been selected.

## Currencies Summary Grid

The following columns categorize each currency shown in the summary grid:

- Code
- Currency Name
- Reference Interest Rate Code
- Reporting Currency

- Status

## Code

For seeded currencies, these are ISO Currency Codes. For user-defined currencies, these may be any pure character string (no numbers) up to a length of 3 characters.

## Currency Name

For seeded currencies, these are ISO Currency Codes. For user-defined currencies, these may be any string up to a length of 40 characters.

## Reference Interest Rate Code

Reference Interest Rate Code is the Interest Rate Code with which a currency is associated for forecasting purposes. You may define multiple yield curves each of which has the same Reference Currency, but a currency may only have one Reference Interest Rate Code.

## Reporting Currency

A reporting currency is an active currency to which balances in other currencies may be consolidated in order to facilitate reporting. Balances in reporting currencies may be, in turn, consolidated to the functional currency. For example, an American multinational bank might consolidate its holdings in Asian currencies to the Japanese yen (reporting currency) and its balances in European currencies to the Euro (reporting currency) after which it might consolidate these reporting currencies to the U.S. dollar (functional currency).

## Status

The status of any currency may be either Active or Inactive. You must “activate” a currency before you can:

- Define that currency as a Reference Currency for a yield curve (see Reference Currency above under the section entitled Interest Rates Detail Screen)
- Enter exchange rate data for a currency (see the section below entitled Currency Rates)
- Define Forecast Rates for that currency within OFSAA Asset Liability Management (see Forecast Rates in the Oracle Financial Services Asset Liability Management (OFSALM) User Guide)

## Editing Currencies

To edit a currency, select a currency and then click on the Edit control. You may not modify any currency Code value. You may, however, modify Currency Name, the Reference Interest Rate Code, the Reporting Currency value (limited to Yes or No), or the currency's Status (limited to Active or Inactive).

You may not inactivate any currency that is:

- Defined as the Reference Currency for any yield curve
- Associated with any exchange rate data
- Utilized within any Forecast Rates rule within OFSAA Asset/Liability Management

Once you have completed your edits, click Save.

## Adding Currencies

The first row in the Currencies container is an empty row that is ready for you to edit as a new currency. You may select this empty row, click on the Edit control, and generate a new currency. You may also generate a new currency by clicking on the Add control. This will generate another empty row at the top of the Currencies container that is ready for you to edit.

## Deleting Currencies

Click on one or more currencies and then select the Delete control. You may not delete any currencies that are utilized elsewhere in the system (see exclusions above under Editing Currencies).

## Currency Rates

Upon navigating to Common Object Maintenance > Rate Management > Currency Rates, the Currency Rates screen is displayed. Within this screen, you may manage historical exchange rates between currencies.

Currency Rates			
^ Currency Selection			
From Currency*	US Dollar	To Currency *	
Rate Type*	Floating Rate	Effective Date Range	Last Month
From Date	12.Feb.2013	To Date	12.Mar.2013

For ALM, TP and PFT, From Currency is to be defaulted to the Initial Currency selection from the Assumption Management Defaults in the active Application Preferences UI. You may select another From Currency. The From Currency drop-down list displays all Active currencies.

## Preparing to Work with Exchange Rate Data

In order to begin the process of viewing, entering, modifying, or deleting exchange rate data, you must supply a “To Currency” value. As with the From Currency, the To Currency drop-down list box displays only Active currencies.



Currency Rates				As of Date: 25/06/2014
* Currency Selection				
From Currency*	US Dollar	To Currency *	Albanian Lek	
Rate Type*	Floating Rate	Effective Date Range	Last Month	
From Date	16/06/2015	To Date	16/07/2015	
* Floating Currency Rates <span style="color: red;">Exchange Rate per 1 unit of Albanian Lek</span>				
<input type="checkbox"/>	Effective Date	Albanian Lek	Status	Data Source Code
<input type="checkbox"/>				
<input type="checkbox"/>	13/07/2015	4.000000000	Valid	UI

After having selected a To Currency value, select a value for Rate Type: Floating Rate or Fixed Rate (the default selection is Floating Rate). Once you have selected a To Currency value, a second container is displayed: Floating Currency Rates (if you have chosen a Rate Type of Floating Rate) or Fixed Currency Rates (if you have chosen a Rate Type of Fixed Rate).

## Floating Rates

Floating exchange rates, such as those between the US Dollar (USD), the Pound Sterling (GBP), the Japanese Yen (JPY), and the Euro (EUR), are market driven and may change from day-to-day, hour-to-hour, or minute-to-minute.

## Fixed Rates

Some countries, especially smaller countries or countries that have experienced significant inflation in the recent past, may wish to “peg” their currency to a larger, more stable currency such as the US Dollar, Japanese Yen, or Euro.

## Adding Exchange Rate Data

Once you have specified a value for To Currency, the Floating Currency Rates container appears. If you wish to define a Fixed Rate relationship, select the “Fixed Rate” Rate Type and the Floating Currency Rates container will be replaced by the Fixed Currency Rates container.

Both Currency Rates containers initially display a single blank row followed by the most recent month's exchange rate data (if any such exchange rate data already exists). To enter a single new exchange rate data point, enter your data into the blank row and click Save.

Currency Rates
As of Date: 25/06/2014

^ Currency Selection

From Currency*	US Dollar	To Currency*	Albanian Lek
Rate Type*	Floating Rate	Effective Date Range	Last Month
From Date	16/06/2015	To Date	16/07/2015

^ Floating Currency Rates Exchange Rate per 1 unit of Albanian Lek

<input type="checkbox"/> Effective Date	Albanian Lek	Status	Data Source Code
<input type="checkbox"/>			
<input type="checkbox"/> 13/07/2015	4.00000000	Valid	UI

## Effective Date

Directly enter a date or select the calendar control to choose an effective date for your new exchange rate data point.

Rate Management stores historical exchange rate data. You may not enter exchange rate data for dates greater than the current date. For more information regarding rate forecasts and the relationship between historical exchange rates for forecasted exchange rates, see Forecast Rate Scenarios chapter. If you have gaps in your historical exchange rate data, any OFS Analytical Application that needs to perform a rate translation function will fall back to the most recent date for which exchange rate data exists. For example, if an OFS Analytical Application needs to translate a rate from USD to EUR for February 22, 2010 and the latest available USD to EUR rate data in the Rate Management database is February 11, 2010, the application will utilize the exchange rate for February 11, 2010.

## Status

Status is a read-only display which is updated after the Currency Rates Validation has been run.

## Data Source Code

The Data Source Code is displayed read only and indicates whether the rates were input through the UI or via the data loader.

## Currency Exchange Rate

For both Floating Rates and Fixed Rates, units of the From Currency are converted to one unit of the To Currency. For example:

From Currency	To Currency	Approximate Rate
USD – US Dollar	GBP—Pound Sterling	1.50
USD – US Dollar	EUR – Euro	1.36
USD – US Dollar	JPY – Japanese Yen	0.01105

## Adding Multiple Exchange Rates

Click Add to add additional blank rows into which you may enter additional Effective Dates and Exchange Rates. When you have finished adding multiple new exchange rates, click Save.

## Editing Exchange Rate Data

Clicking on the check box on the left hand side of any row of data enables the Edit. After clicking Edit, the row becomes active and you may edit Effective Date and/or the Exchange Rate after which you may Save your changes.

## Viewing Exchange Rate Data

By default, both the Floating Currency Rates container and the Fixed Currency Rates container display the most recent month of historical exchange rate data. You can control the amount of data displayed by selecting a different value from the Effective Date Range drop-down list box in the Currency Selection container.

The screenshot shows the 'Currency Rates' application window. At the top right, it says 'As of Date: 25/06/2014'. Below this is the 'Currency Selection' container with the following fields:

- From Currency\*: US Dollar
- To Currency\*: Albanian Lek
- Rate Type\*: Floating Rate
- Effective Date Range: Last Month (selected in a dropdown menu)
- From Date: 16/06/2015
- To Date: (empty)

Below the selection container is the 'Floating Currency Rates' section, titled 'Exchange Rate per 1 unit of Albanian Lek'. It contains a table with the following data:

<input type="checkbox"/> Effective Date	Albanian Lek	Status	Data Source Code
<input type="checkbox"/>			
<input type="checkbox"/> 13/07/2015	4.000000000	Valid	UI

At the bottom of the window are 'Save' and 'Cancel' buttons.

You may also choose to view a specific range of effective dates by modifying the From Date, the To Date, or both dates within the Currency Rates container.

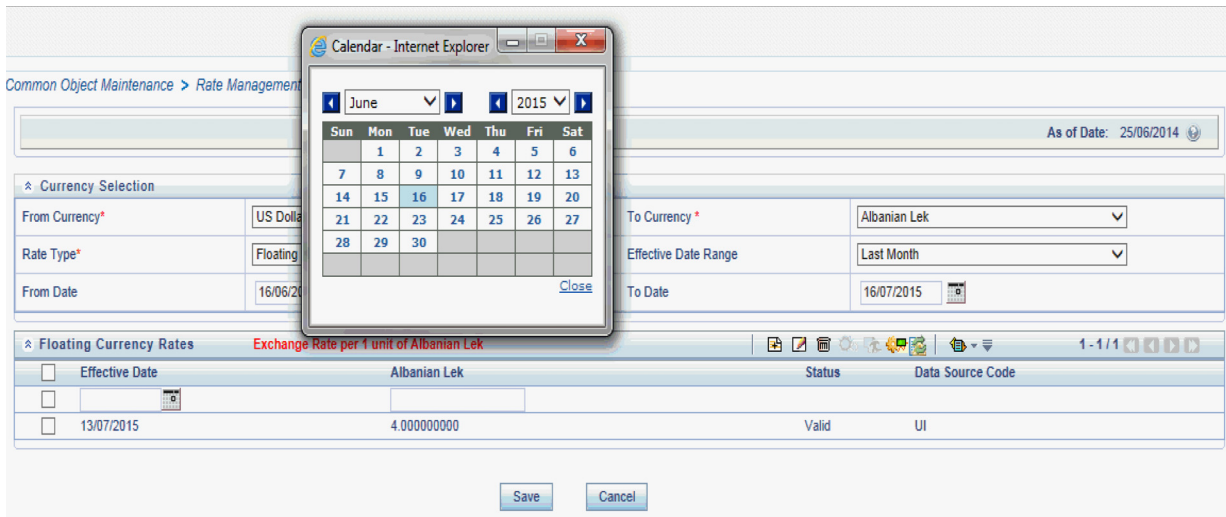

## Deleting Exchange Rate Data

Clicking on one or more check boxes on the left hand side of any row of data enables the Delete button. After clicking Delete, you will be asked to confirm that you wish to delete the rows you have selected.

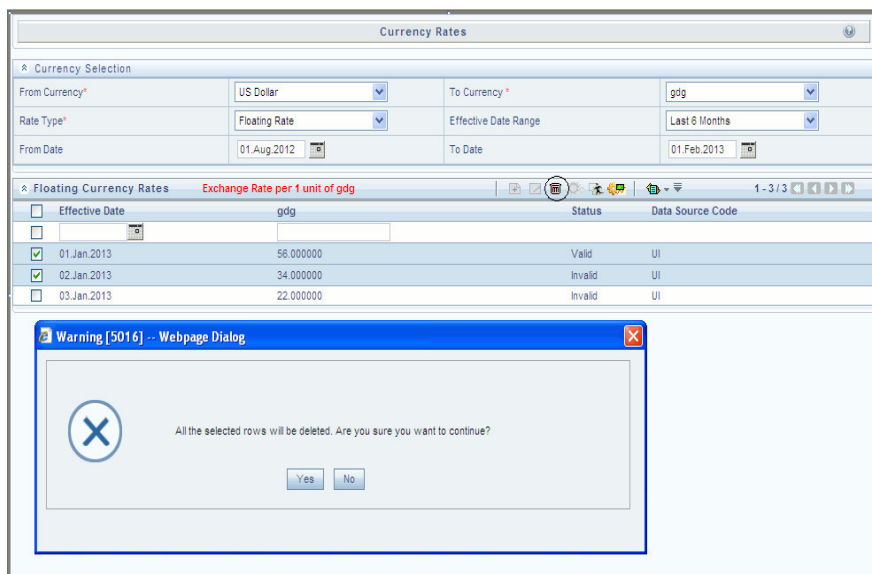

## Data Loader

The Data Loader Icon executes a function to import historical Currency rates for all defined Currencies. For more information on setting up the automated process, see Oracle Financial Services Analytical Applications Data Model Utilities User Guide.

To execute a data load, click on the Data Loader icon. A warning message will appear Upload all available Currency Rates?

**Note:** Upon clicking on the data loader icon, the loader will execute all currency rates.

Common Object Maintenance > Rate Management > Currency Rates

Currency Rates As of Date: 25/06/2014

---

Currency Selection  
 From Currency\* US Dollar To Currency\* Albanian Lek  
 Rate Type\* Floating Rate Effective Date Range Last 6 Months  
 From Date 16/01/2015 To Date 16/07/2015

---

Floating Currency Rates Exchange Rate per 1 unit of Albanian Lek
1 - 2 / 2

<input type="checkbox"/>	Effective Date	Albanian Lek	Status	Data Source Code
<input type="checkbox"/>	<span style="border: 1px solid black; padding: 2px;"></span>	<span style="border: 1px solid black; padding: 2px;"></span>		
<input type="checkbox"/>	13/07/2015	4.000000000	Valid	UI
<input type="checkbox"/>	16/07/2015	20.000000000	Valid	UI

## Excel Import/Export

Excel import/export functionality is used for adding/editing historical exchange rates.

**Note:** To export exchange rates, "Enable visual style buttons and controls in webpages" option in Internet Explorer should be enabled. Otherwise, it may show error message.

Common Object Maintenance > Rate Management > Currency Rates

Currency Rates As of Date: 25/06/2014

---

Currency Selection  
 From Currency\* US Dollar To Currency\* Albanian Lek  
 Rate Type\* Floating Rate Effective Date Range Last 6 Months  
 From Date 16/01/2015 To Date 16/07/2015

---

Floating Currency Rates Exchange Rate per 1 unit of Albanian Lek
1 - 2 / 2

<input type="checkbox"/>	Effective Date	Albanian Lek	Status	Data
<input type="checkbox"/>	<span style="border: 1px solid black; padding: 2px;"></span>	<span style="border: 1px solid black; padding: 2px;"></span>		
<input type="checkbox"/>	13/07/2015	4.000000000	Valid	UI
<input type="checkbox"/>	16/07/2015	20.000000000	Valid	UI

Export  
 Import

# Currency Exchange Rate Validation

## Currency Rate Validation – Overview

Features:

Exchange Rate Validation contains the following features:

- Movement of historical exchange rates to the Currency Direct Access table.
- Calculation of inverse exchange rates for reporting currencies.
- Calculation of triangulated exchange rates where possible.

---

---

**Note:** This feature is equivalent to the Rate Validation capability in OFSA 4.5 Rate Manager.

---

---

## Exchange Rate Validation – Feature Description

The goal of exchange rate validation is to ensure that exchange rates from all active currencies to all reporting currencies are available for processing in OFSAA applications. Some of these rates may come from the validated direct input, others are calculated based on relationships with other rates. To support triangulation, all fixed exchange rates are available for all currencies that make up a conversion that needs to be triangulated. In addition, a direct exchange rate between each Child currency and each reporting currency is calculated and supplied to support quick access to exchange rates. If a Child currency is a reporting currency, then exchange rates are calculated for all currencies having an exchange relationship with the Parent currency.

## Currency Rate Validation – Procedure

1. Load currency rates through the Rate Management UI or by using the Historical Rate Data Loader. Notice the initial status is "Not Yet Validated".
2. Execute the Currency Rate Validation engine.

Navigate to: Operations > Batch Maintenance > Create Batch

- Component = "Transform Data"

- Rule Name = "Rate\_Validation"

- Parameter List (Required) = FROM\_DATE and TO\_DATE, for example, '20110101', '20110131'

Note: After completion of the validation process, notice the status in the Currency Rates UI changes to Valid or in case there is an issue, Invalid.

3. View both input and calculated results in the FSI\_EXCHNG\_RATE\_DIRECT\_ACCESS table.
4. All of the OFSAA processing engines read from this table for sourcing historical exchange rates.

---



---

**Note:** Executing Rate Validation is a required step when multi-currency setup is enabled. All of the OFSAA processing engines require exchange rates to be validated through this process in order to convert results from base currency to a selected reporting currency. If exchange rate validation is not run or required exchange rates are not available, the engines will use default exchange rates = 1.

---



---

## Validating Exchange Rate Relationships

Users should run the exchange rate validation process after adding or modifying exchange rate data. You can run the process immediately or schedule one or more to be run in the future.

Each exchange rate is placed in one of the following statuses:

Status	Description
Not Yet Validated	The exchange rate has been input or loaded but not yet validated
Valid	The exchange rate has been validated.
Invalid	The exchange rate has violated one or more acceptance rules.

Only exchange rates in Valid status are available for processing and they are not subject to future validation unless you edit them.

The rate validation status is displayed in the Rate Management > Currency Rates UI.

## Exchange Rate Validation Criteria

In the rate validation process all exchange rate relationships in the database are examined for compliance with the following criteria. Error messages and warnings are displayed if one or more criteria are not met. (See Viewing the Messages section.)

1. If a currency is defined as a Child in a fixed exchange relationship then it must not be in any floating (standard) exchange rate relationship at the same time. Consequently all floating exchange rates to or from the Child currency must be defined through the Parent currency. If this criterion is not met then the following message is displayed: Invalid fixed relationship—Child currency exists in a standard exchange rate within the same time period.
2. A Child currency within a fixed relationship must not be a Child currency in any other fixed relationship during the same time period. If this criterion is not met then the following message is displayed: Invalid fixed relationship—Child currency already exists in a fixed relationship for same time period.
3. A circular relationship must not exist. In other words, a Child currency cannot link back to its Parent in any other fixed rate relationship within the same time period. If it does, then the following message is displayed: Invalid fixed relationship creates circular relationship with other fixed exchange rates.
4. Regarding new floating (standard) exchange rates, From and To currencies must not exist as Child currencies within any fixed exchange rate relationships. If this criterion is not met then the following message is displayed: From/To/Both

currency(ies) in new exchange rate already exist in a fixed relationship for the same time period.

5. If any exchange rate is equal to 0, then a warning message is displayed. Generally speaking, 0 is a valid value. You can use it, for example, to designate an exchange rate with a currency of a country that no longer exists.

If two exchange rate relationships fail to meet these criteria then both of them will be labeled Invalid. (Exception: if one of the relationships is already in Valid status, then the other one will be labeled Invalid.) For example, if a currency is defined as a Child in a fixed rate relationship and is also defined as being in a floating relationship at the same time, then both fixed and floating rates for that currency will be labeled Invalid.

If there are both direct and inverse floating exchange rates defined for any two currencies (in other words, one currency is both a To and a From currency in relation to the other), then both relationships will be marked Valid.

## Running an Exchange Rate Validation

You can run a validation immediately or schedule one or more for later. The validation status is displayed in the Rate Management > Currency Rates UI.

### Running a Validation Immediately

You can execute exchange rate validation using the "Currency Rates validation" option from the toolbar.

Common Object Maintenance > Rate Management > Currency Rates

Currency Rates

✚ Currency Selection

From Currency*	US Dollar	To Currency *	Australian Dollar
Rate Type*	Floating Rate	Effective Date Range	Last Month
From Date	01/26/2016	To Date	02/26/2016

✚ Floating Currency Rates Exchange Rate per 1 unit of Australian Dollar

Effective Date	Australian Dollar	Status	Data Source Code
<input type="checkbox"/>			
<input type="checkbox"/> 02/16/2016	25.000000000	Valid	UI
<input type="checkbox"/> 02/17/2016	7.676000000	Valid	UI

Save Cancel

To execute exchange rate validation from the Currency Rates user interface, the following two options are available:

- Specify Dates: When you select this option, a Select Dates section will be displayed that allows you to input/verify the FROM\_DATE and TO\_DATE parameters and these dates will be passed to the batch for execution.



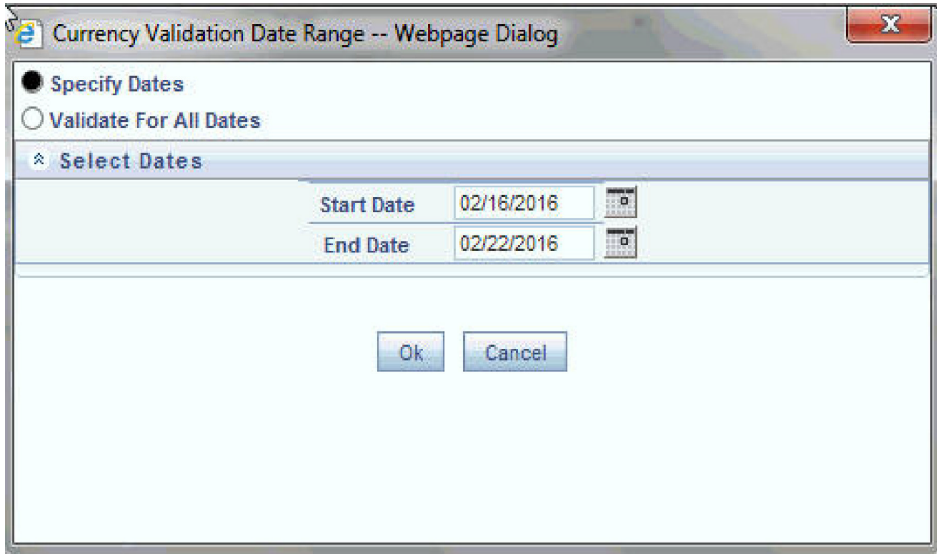

- FROM\_DATE: This is defaulted to the date of last rate validation.
- TO\_DATE: This is defaulted to the current date.
- Validate For All Dates: If you select this option, then it will validate all rates irrespective of dates.

---

---

**Note:** This option will replace all of the validated exchange rate history and can be a time consuming process depending on the amount history available to be processed.

---

---

You can execute rate validation using a Simplified Batch process or from the ICC Batch Screen, within the OFSAAI framework. You can also launch it from the Currency Rates UI (Currency Rates Validation toolbar button).

To run the validation using Simplified Batch, perform the following steps:

1. Click Common Object Maintenance-> Simplified Batch -> Add.

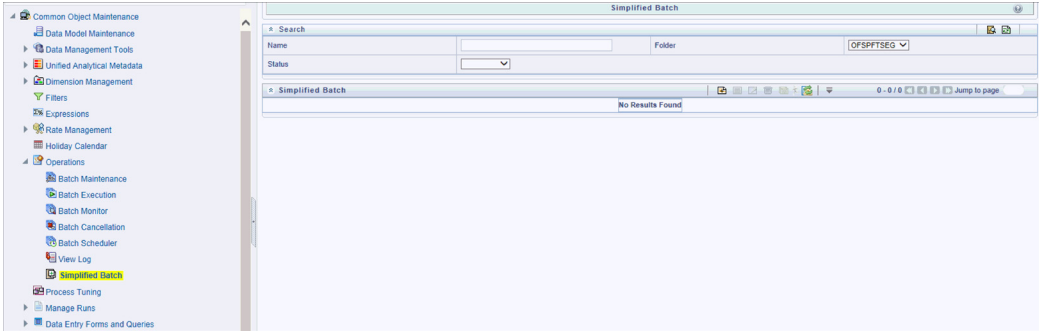

- From the Task Details block, click Select Task. In the Task Selection window, choose Task Type as Transform Data. Then, click Search. In the Task Selector, Scroll down the left shuttle box (Available tasks) and select Rate\_Validation (move to right shuttle box), then click Ok.

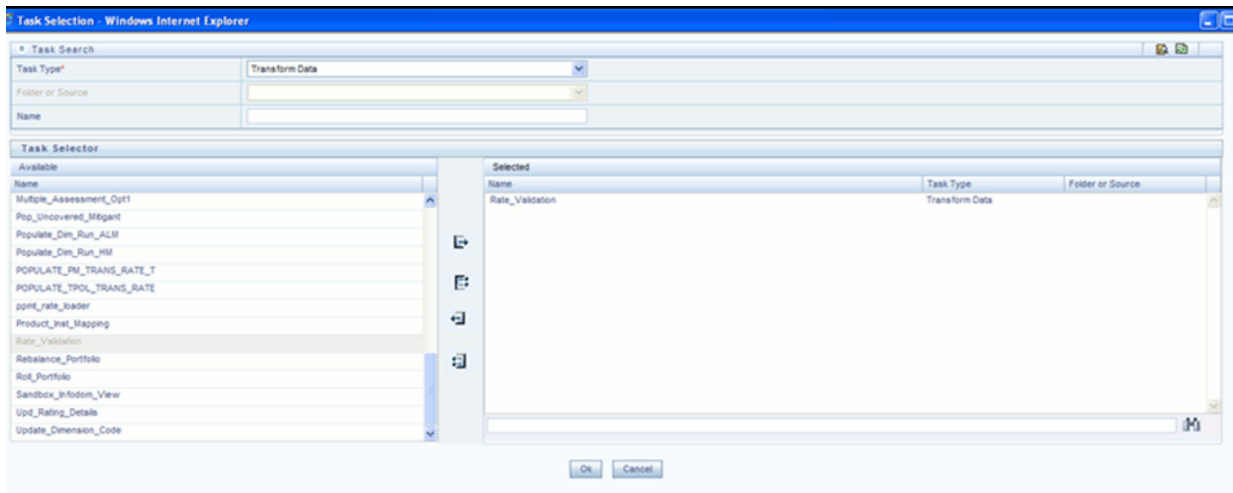

- Back in the Simplified Batch definition window, enter the optional parameters to specify the From and To dates, using the format 'YYYYMMDD','YYYYMMDD'.  
 Note: FROM\_DATE and TO\_DATE should not be the same value. Set FROM\_DATE equal to the last rate validation date and TO\_DATE to the current date. This will ensure that the Effective To Date for the prior record is set correctly.  
 Then click Save.

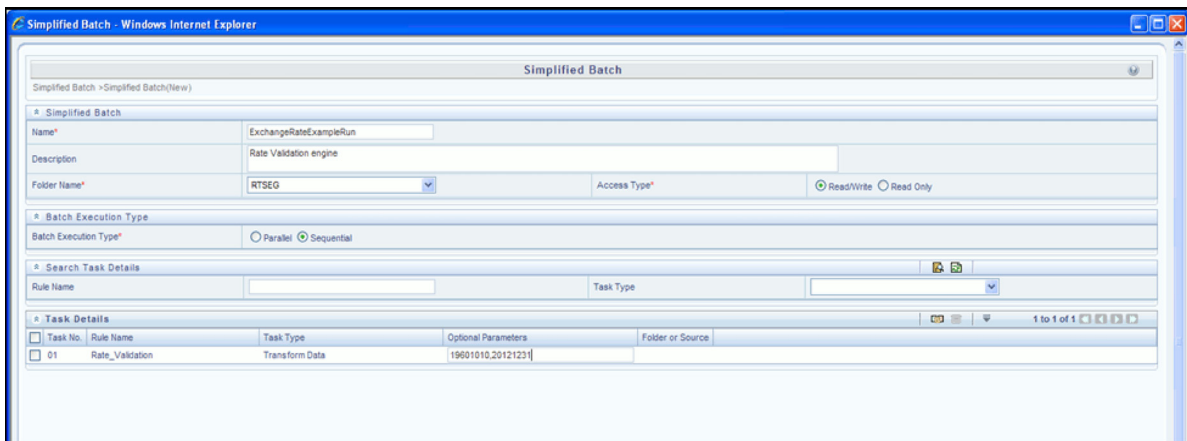

- In the Simplified Batch summary page, search for and select your batch, then click Run.
- Click Yes to confirm you want to continue, enter a date and click Ok to continue. You will receive a message that it has been successfully launched.
- Click Ok. When the batch is complete, optionally navigate to Operations -> View Log to view the processing log.

7. Any error messages or warnings are displayed in View Log. (See Viewing the Messages)

Note: Simplified Batch does not yet provide access to logs for Transform Data tasks.

To run the validation using the ICC Batch Framework, perform the following steps:

1. Navigate to Operations -> Batch Maintenance -> Add, and create a new batch.
2. Search for the above batch, and select it.
3. In the Task Details block (toolbar), click Add. In the Task Selection window, choose Task Type as Transform Data. Then, click Search. In the Task Selector, Scroll down the left shuttle box (Available tasks) and select Rate\_Validation (move to right shuttle box), then click Ok.
4. Back in the Task definition window, select the Rule Name Rate\_Validation and enter the optional parameters to specify the From and To dates, using the format 'YYYYMMDD','YYYYMMDD'.

Note: FROM\_DATE and TO\_DATE should not be the same value. Set FROM\_DATE equal to the last rate validation date and TO\_DATE to the current date. This will ensure that the Effective To Date for the prior record is set correctly.

Click Save.

5. Navigate to Operations -> Batch Execution. Search for and select your batch, enter Information Date, then click Execute Batch.
6. Click Ok to confirm you want to continue. A message is displayed stating Batch triggered successfully, also displaying the Batch Run ID.
7. Click Ok.
8. To view rates, query the database table FSI\_EXCHNG\_RATE\_DIRECT\_ACCESS after the run is complete.
9. FSI\_EXCHNG\_RATE\_DIRECT\_ACCESS: This output table holds the valid currency codes and their exchange rate with respect to the reporting currency for a period of time say "from date" value to optional "to date" value. When Exchange Rate Validation runs, if data already exists for the selected date range, the Rate Validation package will overwrite the existing values. If no dates are given, the Rate Validation package truncates this table and re-loads data for the entire historical date range. The following describes the structure of the FSI\_EXCHNG\_RATE\_DIRECT\_ACCESS table:

Column Name	Nullable	Data Type
FROM_CURRENCY_CD	Not Null	varchar2(15)
TO_CURRENCY_CD	Not Null	varchar2(15)
EFFECTIVE_FROM_DATE	Not Null	Date
EFFECTIVE_TO_DATE	Not Null	Date
EXCHANGE_RATE	Not Null	Number(15,9)
EXCHANGE_RATE_CONVERT_TYPE_CD	Not Null	Number(5)
EXCHANGE_RATE_CONV_FORMULA	Not Null	Number(15)

- When the batch is complete, optionally navigate to Operations -> View Log to view the processing log.

Any error messages or warnings are displayed in View Log. (See Viewing the Messages )

### Scheduling One or More Validations

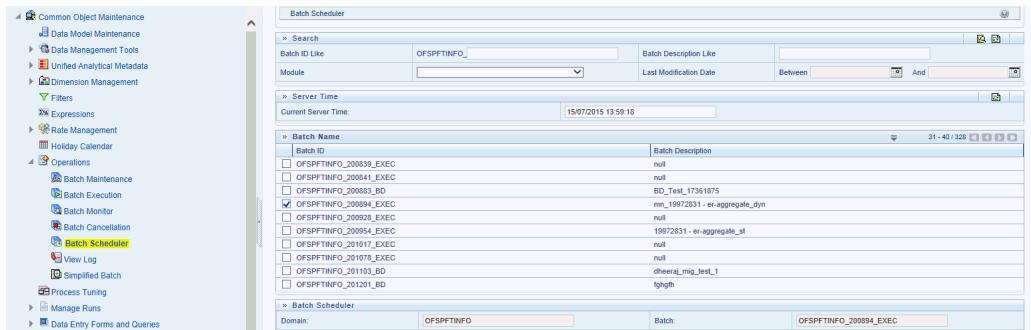

To schedule a future validation, or to schedule validations on a recurring basis, do the following:

- Navigate to Operations -> Batch Scheduler. The Batch Scheduler window appears.
- In the Batch Name block, select the Scheduled Batch ID. An unchecked box means that no validation is scheduled to run.
- Select New Schedule or Existing Schedule:

Existing Schedule can be selected only if there are existing schedule batches to view.

If New Schedule is selected, the New Schedule grid appears. Enter the Scheduled task name.

To run the validation once, select once. Go to Step 5.

To schedule the validation on a recurring basis, select Daily, Weekly, Monthly or Adhoc.

- In the Schedule Task grid, in the Date field, enter the start date and end date.
- In the Run Time field, input the time for the next validation to be run.
- Click Save to set the schedule as specified or Cancel to drop your changes.

Any error messages or warnings generated during the validation process are displayed in the View Log.

### Viewing the Messages

Any error messages or warnings generated during the exchange rate validation process are displayed in the Log Information window. To access this window: Click Operations -> View Log.

Click the Task ID. The Log Information window will display.

These exception messages could also be seen in FSI\_MESSAGE\_LOG table with the help of the batch\_id which was used during execution.

# Economic Indicators Summary Screen

When you first navigate to Common Object Maintenance > Rate Management > Economic Indicators, an empty screen will be displayed. After you have constructed one or more Economic Indicators, navigating to Common Object Maintenance > Rate Management > Economic Indicators will display a summary screen showing each of the Economic Indicators that you have previously built.



## Search Container

A Search container is provided in which you may search for Economic Indicators by Name or by Country. Each Economic Indicators rule is specific to one country.

## Search Control

Enter your desired search criteria and click on the Search control.

## Reset Control

Clicking on the Reset control removes any Name or Country constraint you may have specified and refreshes the screen.

## Economic Indicators Container

The Economic Indicators container presents a grid containing all of the Economic Indicators that meet your search criteria. The Economic Indicators summary grid offers several controls that allow you to perform different functions when an Economic Indicators is selected.

To select an Economic Indicators, click on a check box in the first column of the grid. More than one Economic Indicators can be selected at a time but this will cause some of the controls to become disabled. Clicking on a checkbox a second time de-selects the row.

You may select or deselect all of the Economic Indicators in the summary grid by clicking on the check box in the upper left hand corner of the summary grid directly to the left of the Name column header.

## Add

Clicking on the Add control begins the process of building a new Economic Indicator. The Add control is disabled if any rows in the grid have been selected.

## View

Selecting a single row out of the grid enables the View control. Clicking on the View control allows you to view the contents of an Economic Indicator on a read-only basis. The View control is only enabled when a row has been selected.

## Edit

Selecting a single row out of the grid enables the Edit control. Clicking on the Edit control allows you to modify a previously saved Economic Indicator. The Edit control is only enabled when a single row has been selected.

## Delete

Selecting one or more rows out of the grid enables the Delete control. Clicking on the Delete control deletes the Economic Indicators you have selected.

## Copy

Selecting a single row out of the grid enables the Copy control. Clicking the Copy control allows you to create a copy of an existing economic indicator. The Copy control is only enabled when a single economic indicator has been selected.

## Check Dependencies

Select an interest rate curve and then click the Check Dependencies control to generate a report on all rules that utilize your selected economic indicator.

The Check Dependencies control is only enabled when a single economic indicator has been selected.

## Data Loader

The Data Loader Icon executes a function to import historical economic indices for all defined Economic Indicators. For more information on setting up the automated process, see Oracle Financial Services Analytical Applications Data Model Utilities User Guide.

To execute a data load, click on the Data Loader icon.

A warning message will appear *"Upload all available Economic Indicators?"* Click Ok, and all historical indices will be loaded.

## Economic Indicators Summary Grid

The following columns categorize each Economic Indicator in the summary grid:

- Name
- Country

- Creation Date
- Created By
- Last Modification Date
- Last Modified By

**Name**

Displays the Economic Indicator's short name. Performing a "mouse-over" on a row within the grid displays the Economic Indicator's detailed description.

**Country**

Displays the Country to which an Economic Indicator applies.

**Creation Date**

Displays the date and time at which an Economic Indicator was created.

**Created By**

Displays the name of the user who created an Economic Indicator.

**Last Modification Date**

Displays the date and time at which an Economic Indicator was last modified.

**Modified By**

Displays the name of the user who last modified an Economic Indicator.

**Economic Indicators Detail Screen**

When you Add, Edit, or View an Economic Indicator, the Economic Indicator Detail Screen is displayed. The Economic Indicator detail screen is comprised of an Economic Indicator Details container, an Economic Indicators – Historical Data Container, and an Audit Trail container.

The Audit Trail container is a standard footer container for every OFSAA rule type. It displays Created By, Creation Date, Last Modified By, and Modification Date on the Audit Trail tab. The User Comments tab may be used to add comments to any rule, subject to a maximum of 4000 characters.

**Economic Indicator Details Container**

When creating a new Economic Indicator, you must supply a Name, a Frequency, a Value Type, and a Country. You may optionally provide a Description.

## Name

The name you give to your Economic Indicator is the means by which you will subsequently refer to your rule within other OFS Analytical Applications. You may not rename existing Economic Indicators.

## Frequency

The frequency of your Economic Indicator should match the frequency which with the indicator's data is made public. Unemployment statistics, for example, are generally released on a monthly frequency. Select a frequency from the Frequency drop-down list box. Available frequencies are Weekly, Monthly, Quarterly, Semi-Annually, and Annually.

## Value Type

Select a Value Type from the Value Type drop-down list box. Available Value Types are Numeric, Percentage, and Amount.

Value Type	Value Range
Numeric	0-999999
Percentage	-100 to +100
Amount	0-999999

## Country

Select a country to which your Economic Indicator applies from the Country drop-down list box. The value set of Countries is drawn from the seeded Country dimension. OFSAA is seeded with over 70 country values, and you may also add your own user-defined countries (see Chapter 6: OFSAA Dimension Members).

## Economic Indicators – Historical Data Container

Once you have made your selections in the Economic Indicator Details container, you may save your new rule. To build out your historical data, you must enter data within the Economic Indicators – Historical Data container.



The Economic Indicators – Historical Data container initially displays a single blank row followed by the most recent period's data (if data has previously been stored in the database).

## Start Date and End Date

Select the calendar control immediately adjacent to the End Date to choose an ending date for your Economic Indicator data point. The application will automatically populate the Start Date based on your Economic Indicator's frequency. For example, if your Economic Indicator is an unemployment statistic that has a monthly frequency, select an end date that is the last day of the month that the unemployment rate describes. In this example, the application will automatically populate the Start Date with the first day of the month you have chosen.

## Value

Enter the value for your Economic Indicator (e.g., the unemployment rate).

## Adding Multiple Data Points

Click on the Add control to add additional blank rows into which you may enter additional Economic Indicator data. When you have finished adding data, click Save.

## Editing Economic Indicators – Historical Data

Clicking on a single check box on the left hand side of any row of data enables the Edit control. After clicking on the Edit control, the row you have selected becomes active. You may edit this row and subsequently save your changes.

## Viewing Economic Indicators – Historical Data

By default, the Economic Indicators – Historical Data container displays the most recent month of historical data. You can control the amount of data displayed by selecting a different value from the Effective Date Range drop-down list box.

You may also choose to view a specific date range by modifying the From Date, the To Date, or both dates within the Economic Indicators – Historical Data container.

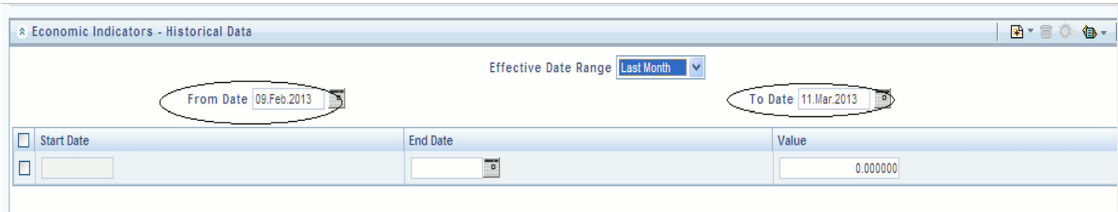

## Deleting Economic Indicators – Historical Data

Clicking on one or more check boxes on the left hand side of any row of data enables the Delete control. After clicking on the Delete control, you will be asked to confirm that you wish to delete the rows you have selected.

## Data Loader

The Data Loader Icon executes a function to import historical economic indicators for all defined economic indicators. For more information on setting up the automated process, see Oracle Financial Services Analytical Applications Data Model Utilities User Guide.

To execute a data load, click the Data Loader icon. A warning message will appear “Upload all available Economic Indicators?”

---

**Note:** Upon clicking the data loader icon, the loader will execute all economic indicators.

---



## Excel Import/Export

Excel import/export functionality is used for adding/editing historical economic indicators.

Economic Indicators - Historical Data

Effective Date Range: Last Month

From Date: 10.Feb.2013 To Date: 12.Mar.2013

Export/Import

Start Date	End Date	Value
06.Feb.2013	05.Mar.2013	1.000000



---

---

## Simplified Batches

### Overview of Simplified Batches

Simplified Batches provide a streamlined version of the functionality available in the broader standard Oracle Financial Services Analytical Applications (OFSAA) Infrastructure batch module (Common Object Maintenance > Operations). The Simplified Batch feature is designed to facilitate creation, maintenance, and execution of batches for the EPM application engines and various other OFSAA components. Users will find its drag-and-drop approach to task selection especially helpful in the management of large batches.

### Standard OFSAA Infrastructure Batching Functionality

You may view, execute, schedule, and monitor Simplified Batches within the broader OFSAA Infrastructure Operations batching framework. However, Simplified Batches may be built and maintained only through summary and detail screens with Common Object Maintenance > Operations > Simplified Batch user interfaces.

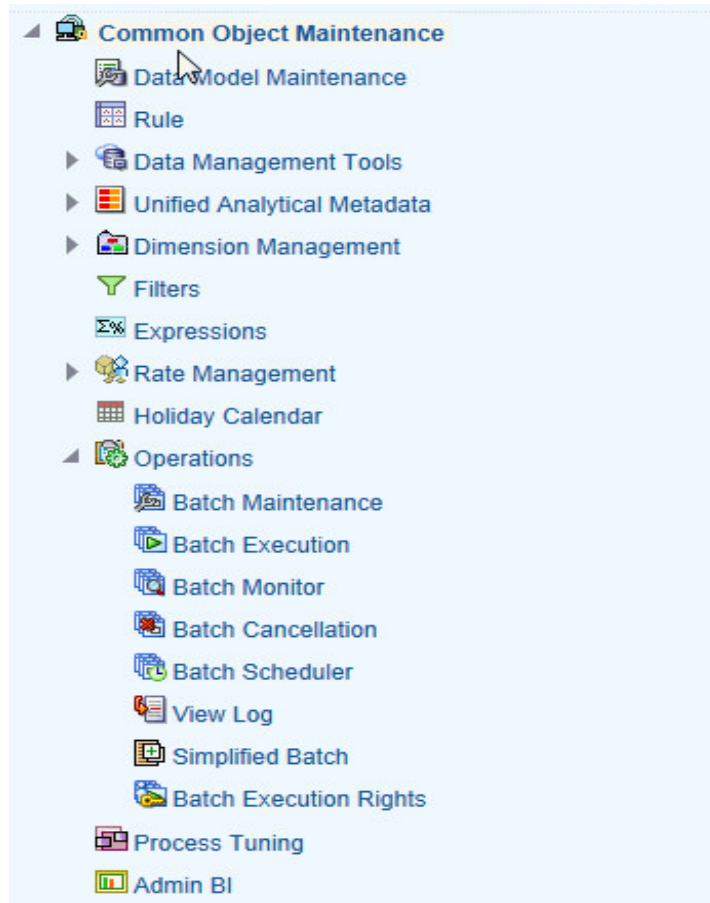

## Batch Maintenance

You may view Simplified Batches here, but they will be non-editable. You can create and modify them within the Simplified Batch screens, described later in this chapter.

## Batch Execution

Simplified Batches may be executed either from the Simplified Batch summary screen (see details as follows) or from OFSAA Infrastructure > Operations > Batch Execution.

## Other Operations Batch Functionality

Other Operations batch functionality including Batch Scheduler, Batch Monitor, Batch Processing Report, Batch Cancellation, and View Log apply equally to Simplified Batches and to batches that have been built under Common Object Maintenance > Operations > Batch Maintenance.

The remainder of this chapter describes the creation, maintenance and execution of Simplified Batches. Specifically, this chapter will cover:

- Simplified Batch Summary and Detail Screens
- Navigation within the Simplified Batch Summary Screen

- Navigation within the Simplified Batch Detail Screen
- Task Selection
- Running a Simplified Batch
- Viewing the Task Logs of a Simplified Batch
- Additional Batch Options

## Summary and Detail Screens

When you initially navigate to Common Object Maintenance > Operations> Simplified Batch, it displays a summary screen listing any existing Simplified Batch rules. Using search criteria, you can control the set of batches that are displayed.

When you Add, Edit, or View a rule, a detail screen is displayed.

## Navigation within the Summary Screen

The Simplified Batch summary screen presents two containers: a Search container and Simplified Batch container (the summary grid). When you first navigate to the Simplified Batch summary screen, the batches stored within your preferred Folder are presented in a summary grid. Your preferred Folder is determined by the set of Application Preferences that were last saved in which you selected the Active for Master Maintenance checkbox.

### Search Container

The Search container allows you to restrict the batches visible within the summary grid by any combination of Name, Folder, or Status. Searches by Name are wildcard searches, that is, searching for Name like pricing will find all batches that include pricing within their names.

### Search Control

Enter your desired search criteria and click the Search control.

### Reset Control

Click the Reset control to clear any search criteria you may be using and refresh the Simplified Batch summary grid.

### Simplified Batch Container

The Simplified Batch container presents a grid containing all of the batches that meet your search criteria. The Simplified Batch summary grid offers several controls that allow you to create a new batch or perform different functions when a batch is selected.

To select a batch rule, click a checkbox in the first column of the grid. More than one batch can be selected at a time but this will cause some of the controls to become

disabled. Clicking on a checkbox a second time deselects the batch. You may select or deselect all of the batches in the summary grid by clicking on the checkbox in the upper left hand corner of the summary grid directly to the left of the Name column header.

You can sort on any column in the summary grid by clicking on the column header (the column name).

Name	Creation Date	Created By	Last Modification Date	Last Modified By	Folder	Last Execution Date	Status
NP_1	9/2/2014 07:20:51	ALMHM80USER	9/2/2014 07:20:51	ALMHM80USER	ALMHMSEG		New
Sim	8/18/2014 04:58:29	ALMHM80USER	8/18/2014 04:58:29	ALMHM80USER	ALMHMSEG	8/18/2014 04:58:53	Failed
test	9/11/2014 11:32:16	JILNA	9/11/2014 11:32:16	JILNA	ALMHMSEG	9/12/2014 06:00:51	Failed
testnp	9/11/2014 11:19:05	JILNA	9/11/2014 11:19:05	JILNA	ALMHMSEG	9/11/2014 11:19:15	Complete
testwre	9/11/2014 10:50:12	JILNA	9/11/2014 11:13:51	JILNA	ALMHMSEG	9/11/2014 11:30:24	Complete

## Add

Clicking the Add control begins the process of building a new Simplified Batch. The Add control is disabled if any rows in the grid have been selected.

## View

Selecting a single row in the grid enables the View control. Clicking the View control allows you to view the detailed definition of a Simplified Batch on a read-only basis. The View control is only enabled when a single batch has been selected.

## Edit

Selecting a single row in the grid enables the Edit control. Clicking the Edit control allows you to modify an existing Simplified Batch. The Edit control is only enabled when a single batch has been selected.

## Delete

Selecting one or more rows in the grid enables the Delete control. Clicking the Delete control deletes the batch or batches you have selected.

## Copy

Selecting a single row in the grid enables the Copy control. Clicking the Copy control allows you to create a copy of an existing Simplified Batch. The Copy control is only enabled when a single Simplified Batch has been selected. You can also duplicate a batch using the Save As option from the detail page, as described later in this chapter.



## Run

Selecting a single row in the grid enables the Run control. Clicking on the Run control executes the selected Simplified Batch rule. The Run control is only enabled when a single Simplified Batch rule has been selected. The As-of-Date and other parameters applicable to each task within a Simplified Batch will vary by task type (for details, see *Specifying Task Parameters* chapter in *Oracle Financial Services Analytical Applications Infrastructure User Guide*).

## Refresh

Click the Refresh control to refresh the Simplified Batch summary grid, including updates to the Last Execution Date and Status.

## Simplified Batch Summary Grid

The following columns categorize each Simplified Batch in the summary grid:

- Name
- Creation Date
- Created By
- Last Modification Date
- Last Modified By
- Folder
- Last Execution Date
- Status

Name	Creation Date	Created By	Last Modification Date	Last Modified By	Folder	Last Execution Date	Status
NP_1	9/2/2014 07:20:51	ALMHM80USER	9/2/2014 07:20:51	ALMHM80USER	ALMHMSEG		New
Sim	8/18/2014 04:58:29	ALMHM80USER	8/18/2014 04:58:29	ALMHM80USER	ALMHMSEG	8/18/2014 04:58:53	Failed
test	9/11/2014 11:32:16	JILNA	9/11/2014 11:32:16	JILNA	ALMHMSEG	9/12/2014 06:00:51	Failed
testnp	9/11/2014 11:19:05	JILNA	9/11/2014 11:19:05	JILNA	ALMHMSEG	9/11/2014 11:19:15	Complete
testwre	9/11/2014 10:50:12	JILNA	9/11/2014 11:13:51	JILNA	ALMHMSEG	9/11/2014 11:30:24	Complete

## Name

Displays the Simplified Batch rule's short name. Performing a mouse-over on a batch name displays the rule's system identifier, long name, and description. Note that the rule's long name consists of a concatenation of the Information Domain (InfoDom) and the rule's short name. This long name is the name under which the batch is submitted

internally through Oracle Financial Services Analytical Applications (OFSAA) Infrastructure.

**Creation Date**

Displays the date and time at which a Simplified Batch rule was created.

**Created By**

Displays the name of the user who created a Simplified Batch rule.

**Last Modification Date**

Displays the date and time at which a Simplified Batch rule was last modified.

**Last Modified By**

Displays the name of the user who last modified a Simplified Batch rule.

**Folder**

Displays the name of the Folder in which a Simplified Batch rule is stored.

**Last Execution Date**

Displays the date and time at which a Simplified Batch was last executed.

**Status**

Displays the latest status for a batch rule and includes the following possible values:

- Complete
- Failed
- New
- Ongoing
- Cancelled

## Navigation within the Detail Screen

When you Add, Edit, or View a batch, the Simplified Batch Detail Screen is displayed. The detail screen presents five containers for defining and maintaining your batch:

- Simplified Batch - header level information such as Rule Name, and so on
- Batch Execution Type - Sequential vs. Parallel
- Search Task Details - Search container
- Task Details - Task Details grid
- Audit Trail

The Audit Trail container is a standard footer container for every OFSAA rule type. It displays Created By, Creation Date, Last Modified By, and Modification Date on the

Audit Trail tab. The User Comments tab may be used to add comments to any rule, subject to a maximum of 4000 characters.

The detail page also provides action buttons specific to the mode you are using (Add, Edit, or View). In View mode, you can duplicate the rule using the Save As button. This will allow you to specify the basic identifiers for the new rule, for example, Name, Description, Folder, and the Access Type selection.

## Simplified Batch Container

Specify the Simplified Batch Name and Description, select a Folder in which the batch is to be stored, and specify whether you want the batch rule to be Read/Write or Read Only (Access Type). Naming your batch is required before it can be saved.

- Unlike other OFSAA rules, you cannot edit the Name after you have created the rule.
- The maximum length for the Name is based on len (name+infodomain), subject to the total length not exceeding 42 characters. Underscore (\_) is the only special character allowed for simplified batch name.
- The maximum length for the Description is 300 characters. Allowed special characters for Simplified Batch description are underscore (\_), hyphen (-), Colon(:), Dot(.), Space( ).

The screenshot shows a web form titled "Simplified Batch" with a breadcrumb "Simplified Batch > Simplified Batch(New)". The form contains the following fields:

- Name\***: A text input field containing "Simple Batch Rule".
- Description**: A text area containing "This rule creates a batch from a Standard FTP process followed by 7 Allocation Rules".
- Folder Name\***: A dropdown menu showing "RTSEG".
- Access Type\***: Two radio buttons, "Read/Write" (which is selected) and "Read Only".

## Batch Execution Type Container

Select whether you want the tasks in your batch to run in Parallel or to run Sequentially. Should you wish to run some tasks sequentially and some in parallel, you must utilize the OFSAA Infrastructure Operations batching framework to construct your batch. The Simplified batching framework provides a simpler and faster pathway to specify many of the batches that you will require, but the Infrastructure Operations framework offers you more flexibility.

The screenshot shows a web form titled "Batch Execution Type" with a single field:

- Batch Execution Type\***: Two radio buttons, "Parallel" and "Sequential" (which is selected).

## Search Container

You may sometimes construct batches containing dozens or even hundreds of tasks. In such cases it may become difficult to isolate a specific task. The Search container allows you to focus the Task Details display to a specific task name or task type. The Rule Name search is a wildcard search. Click the Search control to execute a search. Click the Refresh control to remove your search criteria and refresh the Task Details Container to display all tasks within the batch.

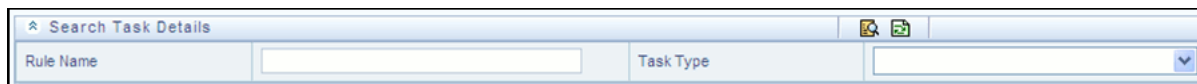

## Task Details Container

For a new batch rule, the Task Details container will initially be empty. Through the use of the Task Selector described below, you will populate the Task Details container with the processes that you wish to run in your batch. For a Sequential batch, the Task Details container presents the tasks in the order in which they will be run. For a Parallel batch, all tasks will be initiated in parallel.

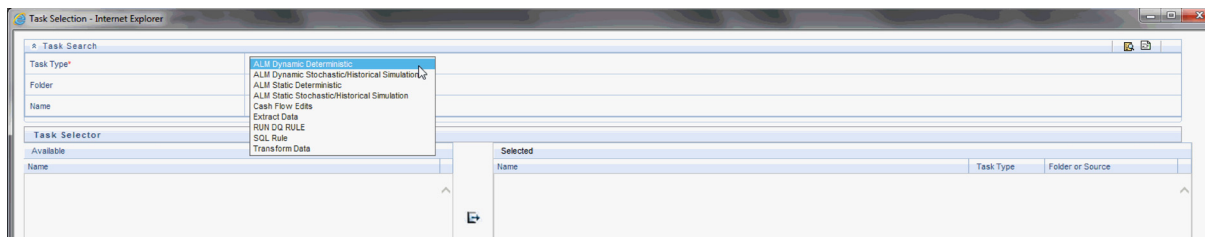

## Task Number

Each task is itemized serially by task number.

## Rule Name

Displays the task's short name, such as an Allocation rule name. The complete or long name under which the task is submitted for execution (becoming the task's Batch Run ID) is a concatenation of several identifiers, as noted below in the View Log section.

## Task Type

Using Simplified Batches you may submit different tasks for each of the application engines and various other components. For ALM, the task types you may submit within a Simplified Batch include:

- ALM Dynamic Deterministic
- ALM Dynamic Stochastic/Historical Simulation
- ALM Static Deterministic

- ALM Static Stochastic/Historical Simulation
- Cash Flow Edits
- Extract Data
- RUN DQ RULE
- SQL Rule
- Transform Data

This list will vary based on installed Application pack(s).

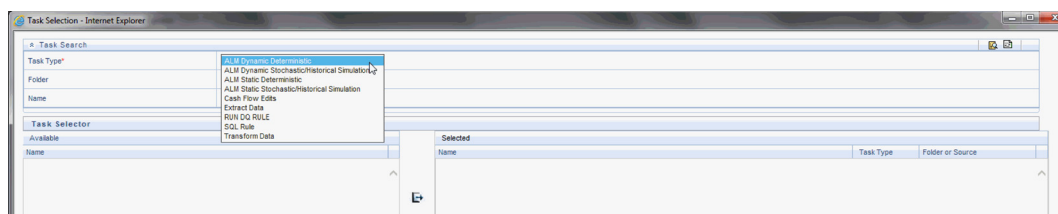

## As of Dates and Additional Parameters

The As-of-Date applicable to each task within a Simplified Batch will vary by task type. Some task types also accept runtime parameters. For additional information on task parameters, see Specifying Task Parameters chapter in Oracle Financial Services Analytical Applications Infrastructure User Guide.

## Folder or Source

For Extract Data tasks, values in this column represent Sources. For Transform Data tasks, this column is not applicable and is left blank. For all other task types, values in this column represent the Folder in which a rule is stored.

# Task Selection

## Controls on the Task Details Container

The Task Details container provides a Task Selector control that invokes a pop-up screen to support the maintenance of tasks in your batch. The Task Details container also provides a Delete control for removing tasks from your batch.

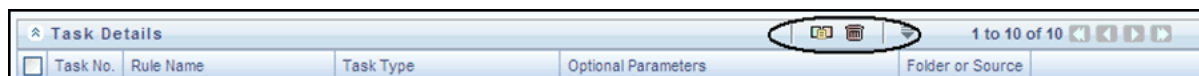

## Delete

Selecting one or more rows out of the Task Details grid enables the Delete control. Clicking on the Delete control deletes the task or tasks that you have selected. You can also remove tasks through the Task Selection pop-up screen.

## Task Selector

The Task Selector control is always enabled. Clicking on the Task Selector invokes the Task Selection pop-up screen.

## Navigation within the Task Selection screen

Use the Task Selection screen to:

- Choose tasks to include in your batch
- Remove tasks from your batch
- Re-order tasks within your batch

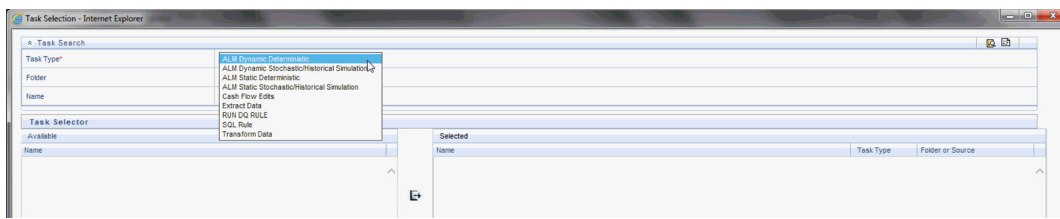

## Task Search Container

When you initially invoke the Task Selection screen, the list of Available tasks on the left-hand side of the Task Selector container is blank. To populate the list of available tasks, you must execute a search using the Search control. Prior to clicking on the Search control, you must select a specific type of task from the Task Type list box, and optionally specify search criteria for Folder (or Source) and Name, where applicable to the task type.

## Selecting Task Types

For ALM, the available task types include:

- ALM Dynamic Deterministic
- ALM Dynamic Stochastic/Historical Simulation
- ALM Static Deterministic
- ALM Static Stochastic/Historical Simulation
- Cash Flow Edits
- Extract Data
- RUN DQ RULE

- SQL Rule
- Transform Data

This list will vary based on installed Application pack(s).

### Source or Folder

- Extract Data Task

When you choose the Extract Data task, you must select a data source prior to executing your search.

The screenshot shows the 'Task Search' dialog box. The 'Task Type\*' dropdown is set to 'Extract Data'. The 'Source\*' dropdown is open, showing a list of data sources: PRICING\_PRC, MOCKIFRS\_STG, PRICING\_SRC, MOCK\_STAGE, mock\_PRC, and PRICING\_STG. The 'Source\*' field is circled in red. Below the dropdowns are sections for 'Task Selector' and 'Available'.

- Transform Data Task

When you choose the Transform Data task, it is not necessary for you to select a Folder prior to executing your search.

- All Other Task Types

When you select any other Task Type, you may constrain your search to a particular folder. Alternatively, you may search for your tasks in all Folders by selecting blank (all folders).

The screenshot shows the 'Task Search' dialog box. The 'Task Type\*' dropdown is set to 'Allocation Rule'. The 'Folder' dropdown is open, showing a list of folders: EPMMOCKSEG and RTSEG. The 'Folder' field is circled in red. Below the dropdowns are sections for 'Task Selector' and 'Available'.

Executing a search for tasks always refreshes the Available list of tasks, but never has any impact on tasks that you have already selected (tasks on the right-hand side of the screen entitled Selected).

## Name

You may further refine your search by entering a task Name. Searches by Name are wildcard searches, that is, searching for Name like rate will find all tasks that include rate within their Name.

## Task Selector Container

### Navigating the list of Available tasks

For task types with potentially large volumes of tasks, the Available list is divided into pages. Use the vertical scrollbar to navigate to the bottom of each page, then click more to display the names in the next page. To navigate back a page, scroll to the top of the page and click the hyperlink to return to the Previous page. You can control the number of tasks listed per page by changing the setting in SIMPLE\_BATCH\_PAGE\_SIZE parameter in FusionApps.properties file in WEB-INF/props under context root. The recommended default value is 50 records/page. As you increase the value over a certain amount, you will start to see a slower response in the Moving tasks between the Available and Selected UI.

### Moving tasks between the Available and Selected lists

You may use the Select or Select All shuttle controls to move rules from the displayed page of the Available list to the Selected list or vice versa. The Select control moves rules from the left to the right, adding rules from the Available list to the bottom of the Selected list. Moving rules from the right to the left removes rules from the Selected list. You can also use the drag-and-drop feature (described as follows) to place the rules in a specific position in the Selected list to specify execution order for a Sequential type batch.

On both the Available side and the Selected side, you may highlight multiple tasks. To select a range of tasks, click on the first task, hold down the Shift key, and then click on the last task. To select a non-sequential list of tasks, you may select them individually while holding down the Control key.



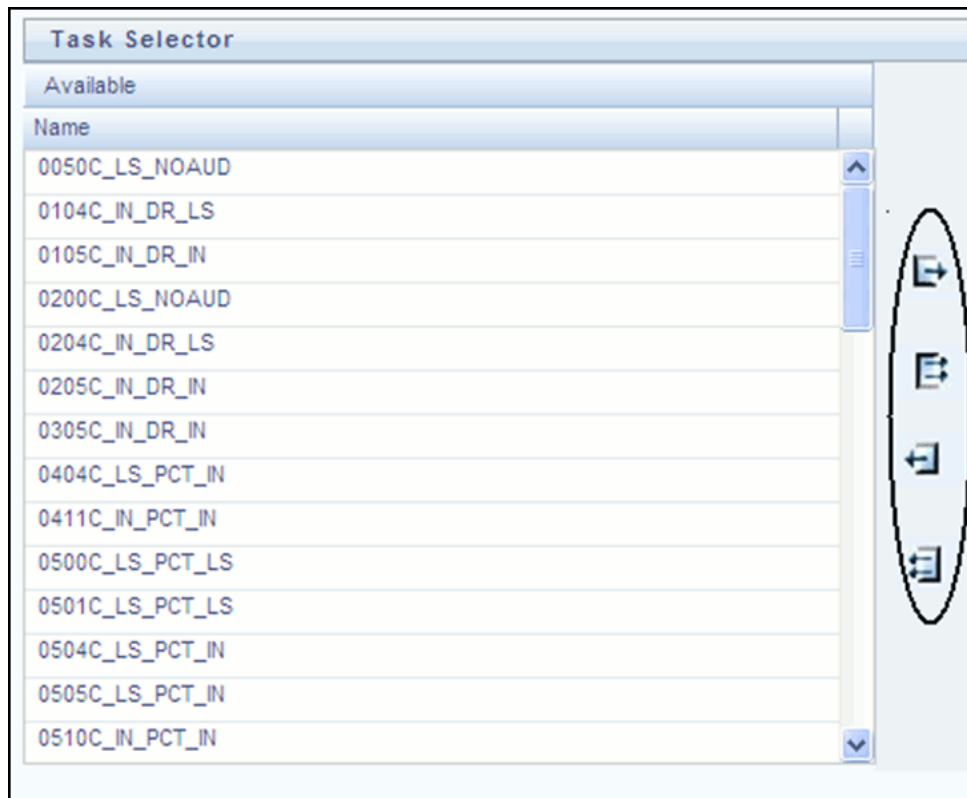

Tasks within the Available list of tasks are disabled (greyed-out) once they have been selected (that is, included within the Selected list of tasks).

### Drag and Drop Operations

The Task Selector also supports drag and drop operations for choosing Available tasks, removing Selected tasks, or rearranging the sequence of your Selected tasks.

- You may click on an Available task and then drag and drop it anywhere within the Selected list, where the targeted placement is displayed in red line.
- Dragging a task from the Selected list and dropping it into the Available list removes that task from the Selected list.
- To select or deselect a range of tasks, click first task in the range to be selected, hold the Shift key down, click last task in the range to be selected, and then drag and drop your set of tasks.
- To select or deselect a set of tasks which are not in sequence, click each task individually while holding down the Control key; after clicking on the last task you may drag and drop the set of tasks.

### Finding a Selected Task

To search for any of your selected tasks, enter the task name or partial name in the field under the Selected list, then click the adjacent button to find each successive match.

## Running a Simplified batch

To run a Simplified Batch from the Simplified Batch summary page, complete the following steps:

1. Select a Simplified Batch from the summary grid.

Name	Creation Date	Created By	Last Modification Date	Last Modified By	Folder	Last Execution Date	Status
NP_1	9/2/2014 07:20:51	ALMHM80USER	9/2/2014 07:20:51	ALMHM80USER	ALMHMSEG		New
Sim	8/18/2014 04:58:29	ALMHM80USER	8/18/2014 04:58:29	ALMHM80USER	ALMHMSEG	8/18/2014 04:58:53	Failed
test	9/11/2014 11:32:16	JILNA	9/11/2014 11:32:16	JILNA	ALMHMSEG	9/12/2014 06:00:51	Failed
testnp	9/11/2014 11:19:05	JILNA	9/11/2014 11:19:05	JILNA	ALMHMSEG	9/11/2014 11:19:15	Complete
testvwe	9/11/2014 10:50:12	JILNA	9/11/2014 11:13:51	JILNA	ALMHMSEG	9/11/2014 11:30:24	Complete

2. Click Run to execute the batch.
3. A popup window will appear asking for confirmation before proceeding. Click Yes to proceed, or No to return to the summary page.

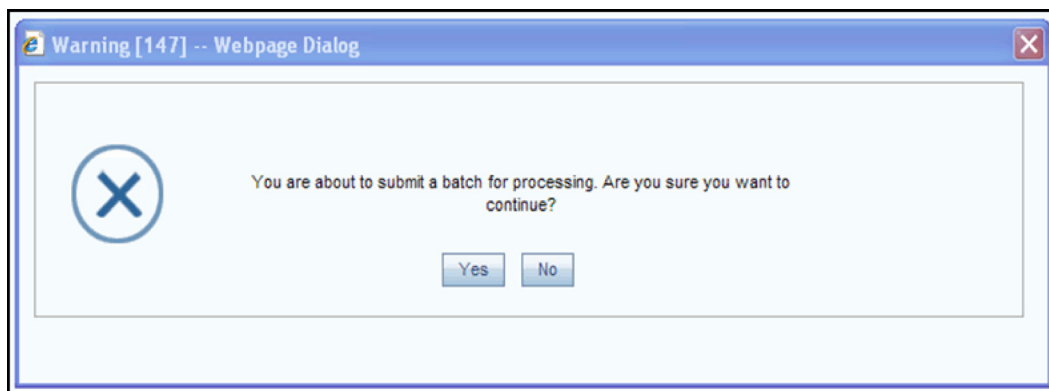

4. If you clicked Yes to proceed, you will see a Date Selection popup. If you have included any Extract Data or Transformation Data tasks in your batch, select the appropriate date for use in processing (it will ignore this date for all other task types). The date defaults to the system date. If you wish to change the date, you can either directly enter a date in the format displayed, or you can use the Calendar tool to select a date.

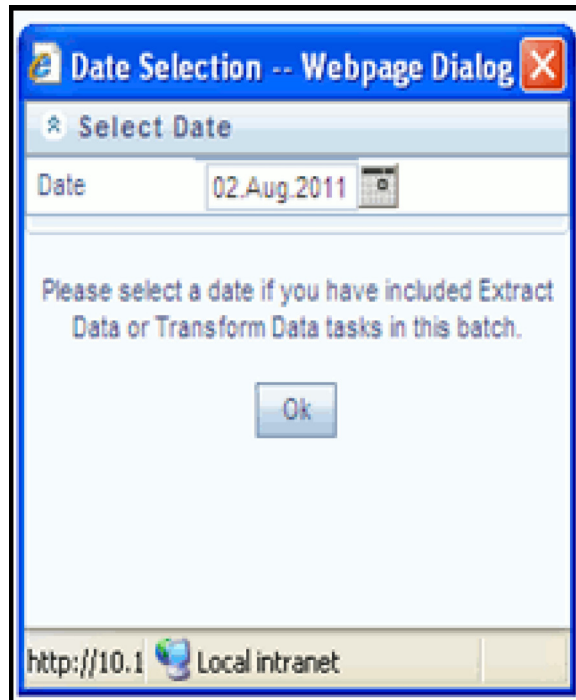

5. Click Ok to proceed.
6. You will now see a message indicating the batch has been launched. Click Ok to proceed.



7. You can monitor the status from the summary grid or detail page.
  1. To monitor from the summary grid, click Refresh. The summary grid will update the Last Execution Date with the current date and the Status at completion (for example, Complete, or Failed if there was a critical problem).
  2. To monitor from the detail page, please refer to the section on Viewing the Task Logs.

---

**Note:** This currently applies to all task types except Extract Data and Transform Data.

---

## Viewing the Task Logs

**Note:** This currently applies to all task types except Extract Data and Transform Data.

To view the processing log for each task in your batch, you can navigate to the log from the Simplified Batch detail page:

1. Select your batch from the summary grid.
2. Click View to navigate to the detail page.
3. For a specific task in the Task Details container, navigate to the processing log through View Log.

The screenshot displays the 'Simplified Batch' detail page. The main content area includes a 'Task Details' table with the following data:

Task No.	Rule Name	Task Type	Optional Parameters	Folder or Source	View Log
01	SMB FTP Charge Credit Cards 1	Allocation Rule		RTSEG	VIEW LOG

At the bottom of the page, the 'Audit Trail' section contains the following information:

System ID	Created By	Creation Date	Last Modified By	Last Modification Date
40018278	OTUSER	08/05/2011 05:36:34	OTUSER	08/05/2011 05:36:34

4. In the View Log page, you can drill down to the log details through the Task ID hyperlink.

As of Date	Component	Folder	Task Name	Task ID	Process Type	Status	Process Step	Records Processed	Number of Errors	Start Date	End Date	Elapsed Time	User	Batch Run ID
13 FEB 2013	Funds Transfer Pricing	EPM15EG	123	1000064539	FTP Standard Process	Completed	Process	6	0	13 FEB 2013 18:45:08	13 FEB 2013 18:45:49	00:00:34	OFSAAUSER EPM15INFO_test5_20130213_1	

The Task ID represents the System ID of the task (for example, in Profitability Management, an Allocation Rule's System ID).

The task's Batch Run ID is a concatenation of several identifiers. For example, Batch Run ID 'OELPMINFO\_Task1\_smb alloc2\_20110805\_2' represents the following:

- Information Domain name (for example, OELPMINFO)
- Task sequence within the Simplified Batch (for example, Task1)
- Simplified Batch rule name (for example, smb alloc2)
- The run date in YYYYMMDD format and the sequential run number for that date (for example, 20110805\_2, for the second execution on August 5, 2011).

## Additional Batch Options

As noted in the Overview for this chapter, you may also view, execute, schedule, monitor, cancel, and view task logs for Simplified Batches within the broader OFSAA Infrastructure Operations batching framework.



---

---

## Holiday Calendar

This chapter discusses the procedure for creating a Holiday Calendar and generating a list of weekend and holiday dates. Individual applications may consume the holiday calendar events in different ways, so please refer to application specific user guides and/or the Cash Flow Engine Reference Guide for more details.

This chapter covers the following topics:

- [Overview of Holiday Calendars](#)
- [Searching for a Holiday Calendar](#)
- [Creating a Holiday Calendar](#)
- [Executing Holiday Calendar](#)
- [Holiday Exceptions](#)
- [Excel Import/ Export](#)

### Overview of Holiday Calendars

A Holiday is a day designated as having special significance for which individuals, a government, or some religious groups have deemed that observance is warranted and thus no business is carried on this day. The Holiday Calendar code can range from 1 to 99999.

The procedure for working with and managing a Holiday Calendar is similar to that of other OFSAA business rules. It includes the following steps:

- Searching for a Holiday Calendar.
- Viewing and Updating a Holiday Calendar.
- Copying a Holiday Calendar.
- Deleting a Holiday Calendar.
- Check Dependencies in the Holiday Calendar definitions.
- Refresh the Holiday Calendar summary page.

### Searching for a Holiday Calendar

Search for a Holiday Calendar to perform any of the following tasks:

- View
- Edit

- Copy
- Delete
- Check Dependencies
- Refresh

Name	Created By	Creation Date	Last Modified By	Last Modification Date	Status
Bug 16751123	CHANNAMMA	9/4/2014 17:34:44	CHANNAMMA	9/4/2014 17:49:25	Processed
copyadSfsdghgjhghkjhkjjkjjk	ALMHM80USER	8/18/2014 10:42:24	ALMHM80USER	8/18/2014 10:42:57	Defined
HM_Holiday_Calender1	ALMHM80USER	8/18/2014 18:42:41	ALMHM80USER	8/18/2014 18:42:41	Defined
Holiday	ALMHM80USER	8/18/2014 10:39:18	JLNA	8/20/2014 10:31:36	Defined
Holi	ALMHM80USER	8/18/2014 10:38:58	ALMHM80USER	8/18/2014 10:40:32	Defined

## Prerequisites

Predefined Holiday Calendar

## Procedure

1. Navigate to the Holiday Calendar summary page. This page is the gateway to all Holiday Calendars and related functionality. You can navigate to other pages relating to Holiday Calendar from this page.
2. Enter the Search criteria.
  - Enter the name of the Holiday Calendar.
  - Click the Search icon.

Only holiday calendars that match the search criteria are displayed.

---

**Note:** You can control the number of rows to display on screen by selecting the "Pagination Options" icon from the action bar.

---

## Creating a Holiday Calendar

You create holiday calendars to capture holidays for a given date range for any organization. It is possible to create and use multiple holiday calendars.

## Procedure

1. Navigate to the Holiday Calendar summary page.
2. Click Add Holiday Calendar.
3. The Holiday Calendar details page is displayed.
4. Enter a code value for the new holiday calendar.



---



---

**Note:** The code, is a numeric identifier for the holiday calendar. The code value must be a number between 1 and 99999. The code value you assign to the new holiday calendar must be unique.

---



---

5. Enter the name and a brief description for the holiday calendar.

---



---

**Note:** The name you assign to the holiday calendar must be unique. Name can hold a maximum of 30 characters.

---



---

6. In the Holiday Properties grid, select not more than two weekend days. Then choose the Holiday Period. The Holiday Period can be defined for a range of up to 40 years less than the current date and 40 years greater than the current date, totally spanning a maximum of 80 years.

In the Holiday Details grid, define the Holiday details for the any period within the holiday range defined in step 6. There are two types of holidays that can be defined: Fixed and Moving.

A fixed holiday is one which is deemed as a holiday for every year in the holiday period, for that particular day.

#### **Example**

25th December – Christmas, is a fixed holiday.

Note: To define a fixed holiday, input the holiday date for the first occurrence in the date range. For example, if your Date Range runs from 01-JAN-2000 to 31-DEC-2050, you should input the fixed holiday, Christmas, as 25-DEC-2000. The holiday calendar procedure will populate all subsequent 25-DEC entries in the holiday list table (FSI\_HOLIDAY\_LIST). A HOLIDAY\_TYPE code = 0 is a Fixed type holiday, code = 1 is a Moving type holiday, and code = 2 is a weekend.

The holiday calendar procedure will also ensure that holiday and weekend entries are not duplicated. For example, if weekends are defined as Saturday/Sunday and Christmas falls on a weekend day, there will be only one entry in the FSI\_HOLIDAY\_LIST table. The PREVIOUS\_WORKINGDAY and NEXT\_WORKINGDAY fields designate the valid prior and following working days, respectively.

A moving holiday is one which is deemed as a holiday only for that particular date and year, and not for every year in the holiday period. All occurrences of a moving holiday must be input manually.

20th August 2012 is a moving holiday on account of the muslim festival, Ramzan.

7. Once the holiday calendar definition is saved, its status in the summary page is marked as defined.
8. A holiday calendar created can also be deleted. Select one or more rows of holiday calendar definitions and click the Delete control.

## **Excel Import / Export**

Excel import/export functionality is used for adding/editing holiday calendar definitions.

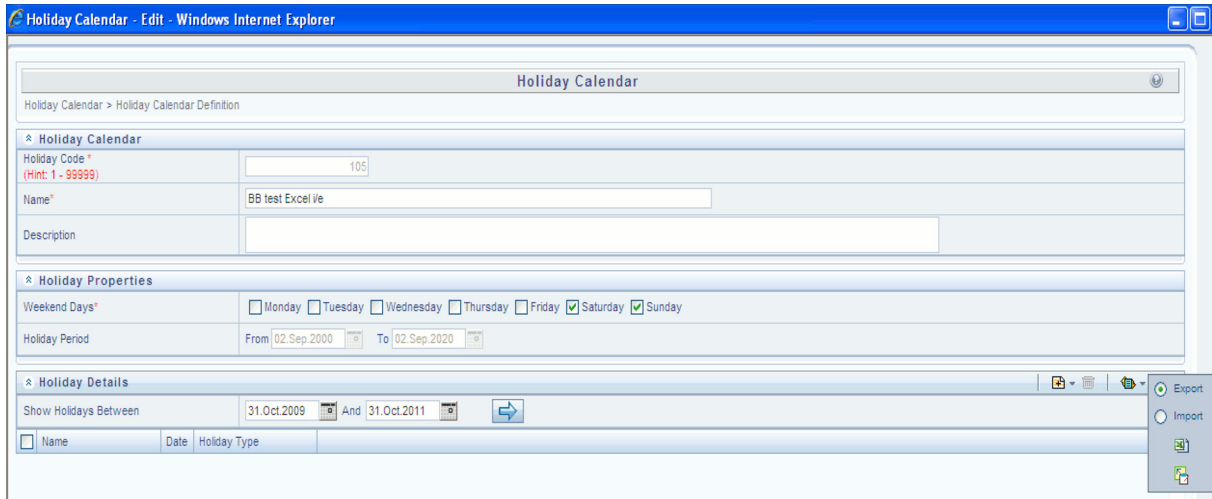

## Executing Holiday Calendar

You execute a holiday calendar definition to generate calendar dates listing the various types of holidays for a given holiday period.

### Prerequisites

Predefined Rules

### Procedure

1. Navigate to the Holiday Calendar summary page.
2. Search for a rule.
3. Select a Holiday Calendar and Click the Generate Calendar Dates icon to execute the selected holiday calendar. Holiday list for holiday ID #1 generated successfully message appears (where #1 is the holiday calendar code). The holiday list can be confirmed by querying the FSI\_HOLIDAY\_LIST table.
4. The status of a holiday calendar where holiday dates have been generated displays as “processed” in the status column in the summary page.

---

**Note:** In case you do not want to Generate Calendar dates immediately, you can select that particular holiday calendar anytime later from the summary page with its status defined, and then click the Generate Calendar Dates icon to execute the selected holiday calendar.

---

5. The generated holiday list is no longer valid if
  1. There is a change in the definition of the holiday calendar.
  2. There is any update or modification to the Holiday Exceptions defined for that holiday calendar.

In such a case, the user will get a message “This holiday calendar has been modified, Please generate the holiday list again” and the holiday calendar state will be changed to “Defined” until the holiday list is regenerated with new definition.

## Holiday Exceptions

---

**Note:** This section is applicable to Release Version 6.1 and higher.

---

1. You can specify exceptions to holidays. As a prerequisite, a holiday calendar should have been properly defined and the status of the holiday calendar in the summary page should be Processed. Generating the holiday list will populate the holidays (weekends, fixed and moving) along with the working days. Then the Show Exceptions button is enabled in the detail page. Any changes in the holiday definition will disable the “Show Exceptions” button. The user must generate the holiday list again to define or view the exceptions.
2. Click Show Exceptions in the Holiday Exceptions grid. The Holiday Exceptions window opens.
3. The search block in the Exceptions page has 6 fields: From(Year), To(year), Fixed Holidays, Moving Holidays, Holiday Date and All Exceptions.

From and To - Denotes the range of years which is a subset out of the holiday list generated, for which exceptions are required to be defined.

Fixed Holidays – You can filter the list of holidays by the type of Fixed Holidays.

Moving Holidays – You can filter the list of holidays by the type of Moving Holidays.

Holiday Date – For a particular known holiday date, exceptions can be defined.

All Exceptions - This checkbox when selected lists all the exceptions, if already defined, for the holidays within the From, To Date range.

The search result gives the list of all holidays based on the selection of the above search criteria fields.

4. In the Holiday Exceptions block, there are two types of exceptions that can be defined: Not a holiday and Shift to.

Any holiday can be marked as not a holiday, in which case that day is removed from the Holiday List. If the drop-down list in the exception type is selected as “Not a Holiday”, then the “shift to” date picker field is disabled.

Spring earlier considered as a holiday in the holiday calendar can be marked as Not a Holiday in the Exceptions Window. Further the user can write his comments or remarks in the Notes Text Box next to the Exception Type drop-down list.

Any holiday can be shifted to another day, in which case the earlier declared holiday is removed from the Holiday List, while the shifted to day is included as a holiday.

## Excel Import/ Export

Excel import/export functionality is used for adding/editing holiday exceptions.

Holiday Exceptions - Edit - Windows Internet Explorer

**Holiday Exceptions**

Holiday Calendar > Holiday Calendar Definition > Holiday Exceptions

Search

From Year: 2008 To Year: 2012

Fixed Holidays: [ ] Moving Holidays: [ ]

Holiday Date: [ ] All Exceptions: [ ]

<input type="checkbox"/> Holiday Name	Holiday Type	Holiday Date	Exception Type	Shift To	Notes
<input type="checkbox"/> Australia Day	Fixed	26.Jan.2008	[ ]	[ ]	
<input type="checkbox"/> Good Friday	Fixed	06.Apr.2008	[ ]	[ ]	
<input type="checkbox"/> ANZAC Day	Fixed	25.Apr.2009	[ ]	[ ]	
<input type="checkbox"/> ANZAC Day	Fixed	25.Apr.2010	[ ]	[ ]	
<input type="checkbox"/> New Years Day	Fixed	01.Jan.2011	[ ]	[ ]	
<input type="checkbox"/> Easter Monday	Fixed	09.Apr.2011	[ ]	[ ]	
<input type="checkbox"/> Queens Birthday	Fixed	11.Jun.2011	[ ]	[ ]	
<input type="checkbox"/> New Years Day	Fixed	01.Jan.2012	[ ]	[ ]	

Export  
 Import

---

---

# Oracle Asset Liability Management Process

This module describes the steps that you need to follow to define and execute the end to end Asset Liability Management Process.

Oracle Asset Liability Management is based on the Oracle Financial Services Analytical Applications Infrastructure (OFSAAI). OFSAAI is the central, integrated data source and Administration layer on which Oracle Financial Services Analytical Applications (OFSA) are built. This description of the Oracle Asset Liability Management Process assumes that your system administrator has setup the OFSAAI data repository and has populated it with your enterprise wide business data.

This chapter covers the following topics:

- [Overview of the Process](#)
- [Reconciling the Data](#)
- [Cleansing the Data by performing Cash Flow Edits](#)
- [Setting Application Preferences](#)
- [Activating Currencies and Loading Exchange Rates](#)
- [\(Mandatory\) Deciding on historical rate information and managing by creating Interest Rate Codes](#)
- [Defining Economic Indicators](#)
- [Capturing Instrument Behavior for non-standard instruments](#)
- [\(Mandatory\) Defining Time Buckets](#)
- [\(Mandatory\) Defining Product Characteristics](#)
- [\(Mandatory - Deterministic\) Defining Forecast Rate Scenarios](#)
- [Defining Prepayments](#)
- [Prepayment Model Method](#)
- [Defining Discounting Methods](#)
- [Defining Forecast Assumptions](#)
- [Defining Transfer Pricing Rules](#)

- [Transfer Pricing Methodologies and Rules](#)
- [Defining Transfer Pricing Methodologies Using Node Level Assumptions](#)
- [Defining Transaction Strategies](#)
- [Defining Formula Results](#)
- [\(Mandatory – Stochastic\) Defining Stochastic Rate Indexing Rules](#)
- [\(Mandatory\) Defining and Running the Asset Liability Management Process](#)
- [Reviewing Processing Errors](#)
- [Accessing Asset Liability Management, Detail Cash Flow Results for Audit Purposes](#)
- [Accessing Asset Liability Management, Interest Rate Audit Results](#)
- [Analyzing Results](#)
- [Re - processing Erroneous Accounts](#)
- [Consolidation of Results](#)

## Overview of the Process

Oracle Financial Services Asset Liability Management (OFS ALM) is designed to model balance sheets under a variety of rate environments. OFS ALM functionality uses several key concepts and has evolved from the continual iterations of building simulated management processes. The basis of OFS ALM functionality includes:

- The ability to model account-level detail in order to precisely capture the complex product characteristics within a financial institution's portfolios.
- A flexible time horizon and free-form timing bucket increments for reporting are critical to meeting the wide range of forecasting requirements of financial institutions.
- Unconstrained chart of accounts definition is a basic requirement of effective modeling.
- A structured process for defining and controlling assumptions is critical to any successful modeling process.
- Unconstrained batching of scenarios, with flexible assumptions sets, is required to achieve an effective and efficient analytical process.

## Key Operational Concepts

OFS ALM includes seven key modeling attributes:

- [Modeling Using Account-Level Data](#)
- [Separation of Data from Assumptions](#)
- [Separation of Assumptions Types](#)

- Flexible Reporting Buckets
- A Structured Approach to Defining Rate Scenarios
- Flexible Chart of Accounts
- Powerful Assumption IDs

## Modeling Using Account-Level Data

OFS ALM models data at an account level (loan-by-loan and deposit-by deposit). In this way cash flows are precisely modeled based on unique characteristics of each loan and deposit.

## Separation of Different Types of Assumptions

By separating data from modeling assumptions, you can modify assumptions and then run a reprocessing procedure without affecting data. In addition to the instrument data being separate from assumptions, each type of assumption is defined independently from other assumption types. Although they act dynamically during a processing run, assumptions about new business characteristics, new business volume, new business pricing, new business maturity mixes, prepayments and discounting methodology are defined independently. This facilitates the isolation of the impact of a change on one assumption. You simply modify the selected assumption, and reprocess in a separate processing run.

## Flexible Reporting Buckets

Because the assumptions are separate from the data, and because the model is operating on an account level of detail, you can specify assumptions and reporting time buckets in any increment desired. Since each transaction's cash flows are being solved independently, you can mix and match any combination of time buckets (up to 240). Changing the bucket structure will not impact the calculations. Thus you might model and report results on a daily and weekly basis for liquidity analysis, while employing a monthly five-year forecast for A/L Management. In either case, the results produced are consistent.

## Structured Approach to Defining Rate Scenarios

Structured testing of alternative rate environments is a key to a strong “what-if” analysis process. The model provides numerous utilities for defining and quality controlling rate scenarios. Because rate scenario modeling assumptions can be saved as patterns in Forecast Rate Scenario rules, the typical burden of quality controlling rate scenarios is dramatically reduced. Once a pattern of rate shocks, spread changes or yield curve rotations (or combination of the above) is defined, it can be saved as a Forecast Rate assumption rule to be used again and again. When data are updated in the model, all you need to do is update the base position of key market rates. The change pattern in an assumption rule can be applied and the forecast rate assumptions are automatically updated. It can also easily be cloned and modified to be saved as

another Forecast Rate assumption rule. This approach for defining rate scenarios is ideally suited for testing numerous rate environments in a controlled fashion.

## Flexible Chart of Accounts

You can define an unlimited chart of accounts (Dimension Member Values), incorporating all of the key elements which drive cash flow generation.

## The Power of Assumption Rules

You can mix and match any set of combinations of assumptions: forecast rate scenarios, forecast balances, pricing margins, maturity mix strategies, discounting methods, prepayments, transaction strategies, formula based results, and product characteristics. The separation of each element of the scenario assumptions means that you can incrementally modify one piece of the modeling equation and easily test its effect. By defining assumptions as distinct rule sets, unlimited batching of scenarios is possible.

## How the Model Works

While the specific operation of each section of the model is addressed separately in this guide, a general description of the modeling logic includes the following premises:

- The current position data defines the existing base of transactions
- New business volumes are generated by assumptions
- The maturity mix of new volumes is defined by assumptions
- Pricing of new volumes and repricing of existing volumes are defined by rate scenario assumptions and the contractual pricing characteristics of individual transactions
- Dynamic prepayment assumptions can be applied to any account
- Incremental transaction strategies can be used
- Cash flows are determined through the integration of data and assumptions
- Assumptions can be flexibly batched

## Current Position Data

OFS ALM forecasts on the basis of modeling the behavior of existing transactions, as well as those that originate in future periods. The complete cash flow characteristics of each existing transaction are defined in the data structure that is imported into the OFSAA data model on a loan-by-loan and deposit-by-deposit basis. Accounts are also defined to simulate non-interest income and expense.

## New Business Volumes

New Add volumes in each period are defined on the basis of a forecast of new incremental volume for each account, or calculated on the basis of achieving a “target



balance” in the account. The cash flow characteristics of newly originated volumes are determined by the Product Characteristics definitions. New volume assumptions apply to non-interest income and expense accounts as well.

## **The Maturity Mix of New Volumes**

The maturity mix of forecasted volumes originated for an account is determined by assumptions which are applied to each element of the account.

## **Pricing of New Volumes and Repricing**

Pricing of newly originated volumes, or repricing of adjustable and variable rate volumes, is determined by the integration of several factors. Each existing or newly originated transaction is linked to a single rate (a market rate) or a yield curve. The actual rate determined at origination or repricing takes into account the prevailing single rate or yield curve. The term of the transaction (if pricing is tied to a yield curve) is also taken into account, as well as other pricing characteristics (margin, life cap, period cap, etc.). Incremental pricing margins can be applied to new originations on a period-by-period basis for each account.

## **Dynamic Prepayment Assumptions**

You can apply dynamic prepayment assumptions to any account. Prepayments are applied on a loan-by-loan basis. Prepayment assumptions use individual instruments characteristics to drive prepayment behavior.

## **Incremental Transaction Strategies**

Incremental transaction strategies can be defined which create actual originations or sales of assets and liabilities, or off balance sheet transactions.

## **Cash Flows**

Cash flows for every instrument are calculated in every modeling period according to the contractual terms defined in the incoming data and/or product characteristics definitions, combined with interest rate scenario and prepayment assumptions. Principal and interest cash flows are recalculated as contractually defined.

## **Batching Assumptions**

Financial forecasts are built through the integration of current position data with each of the modeling scenario assumption elements:

- Current Position Data (account-level data)
- Forecast Rate Scenario Assumptions
- Forecast Balance Assumptions
- Maturity Mix Strategies
- Pricing Margin Assumptions

- Prepayment Assumptions
- Transaction Strategies
- Discount Method Assumptions (for market value calculations)
- Product Characteristics Assumptions
- Formula Result Assumptions

### Flow of the Modeling Process

The organization of the OFS ALM menu structure is better understood in the context of the general flow of the modeling process, as follows:

1. Set up Application Preferences, including:
  - Certain elements of Application Preferences (as of date for data, modeling leaves, etc.)
  - Default values and limit details
2. Load transaction-level data.
  - Load data into the system for modeling.
3. Perform cash flow edits.

Each of the individual instrument records must be quality controlled. For each instrument record, the cash flow edits check all of the columns used in cash flow calculations for internal consistency. For example, the maturity date must be greater than the origination date, and the payment frequency must be greater than zero. This process is available within ALM Processing, and is a critical step in ensuring that OFS ALM produces expected results.

4. Define modeling assumptions.

Define assumption sets. These include any number of the assumptions described in this module and will minimally include Time Buckets, Product Characteristics and Forecast Rate Scenarios.
5. Specify the model run. Select a combination of assumption sets which will be applied to the data you wish to model. You may define a single processing run, or a batch of several runs, including multiple sets of assumptions. The run or batch is launched and results are produced into results tables.

## Reconciling the Data

Reconciliation is the process of comparing the information carried in the Instrument tables to the general ledger balances (contained in Ledger Stat).

The goal of the Asset Liability Management Process is to measure and manage interest rate and liquidity risk for the entire balance sheet, as represented on the general ledger. Many ledger accounts have corresponding data in the Instrument tables. In such instances, the balances from the instrument data must be compared with the corresponding ledger balances.

The reconciliation process involves defining a level at which some piece of information in the Instrument tables is to be compared to the General Ledger data carried in the

Management Ledger (also known as LEDGER\_STAT). That level can be one dimension (to reconcile for each general ledger account number, for example, General Ledger Account ID) or multiple dimensions (to reconcile for each general ledger account number within each business unit, for example, General Ledger Account and Organization Unit).

The most common type of reconciliation is to compare the current balance of Instrument table data to the general ledger ending balance. The data carried in the database is a snapshot of the portfolio as of a given date. Consequently, comparing the current balances from the Instrument table to the general ledger ending balance measures the degree to which the extracted data is in balance with, or reconciles to, the general ledger.

Variances between the Instrument table and the Management Ledger table should be corrected. If the magnitude of the variances is within an accepted tolerance, plug entries should be created to force the reconciliation to zero. An Instrument table (FSI\_D\_LEDGER\_STAT\_INSTRUMENT) has been seeded in the database to hold these plug balances and any Ledger Specific balances that you wish to include as instrument balances for ALM processing.

## Cleansing the Data by performing Cash Flow Edits

It is extremely important that the data in the Instrument tables is clean, accurate, and complete before it is used to generate cash flows and for further processing. Oracle ALM provides seeded Cash Flow Edit rules to edit (clean and prepare) Instrument table data. You can create multiple Cash Flow Edit Processes depending on the data to be cleansed. In addition, you can view actual results of Cash Flow Edits by accessing the audit data written into the FSI\_PROCESS\_ERRORS table.

You can also select the preview mode option so that you can preview the changes that will be made to the Instrument table data as a result of cash flow edits before those changes are applied in the Instrument tables.

It is highly recommended that you create and run Cash Flow Edits before processing data to generate any type of cash flow-related results. See: Cash Flow Edits

## Setting Application Preferences

Application Preferences allow users to set the current as of date and configure default values used throughout the application.

## Activating Currencies and Loading Exchange Rates

Rate Management under “Common Object Maintenance” handles all currency definitions for OFSAA applications. Currencies are conveniently referred to by code and written description. A comprehensive list of ISO-defined currencies is included, and you can define and add your own. Upon installation, one currency is active and ready for processing: the one identified by your organization as the functional

currency. You can activate other currencies and define and activate newly-created currencies when needed. In addition, you can designate key currencies to be used for reporting. These alone will be available for cross-currency consolidation.

The Common Object Maintenance > Rate Management > Currencies screen enables you to select currencies for reporting and for establishing interest rates and exchange rates. It allows you to activate relevant currencies and classify as:

- Functional Currency
- Reporting Currencies
- Other Active Currencies

Before defining the classifications, let's begin by discussing two types of currencies: ISO-defined and user-defined.

### Currency Definitions and Classifications

OFSAA Rate Management provides a list of ISO-defined currencies for you to activate as needed. (The functional currency is activated upon installation). You can also define and add your own. Any currency except the functional currency can be deactivated or deleted.

Currencies are displayed in alphabetical order by currency code.

### The Functional Currency

At the time of installation, Rate Management requires the installer to designate a functional, or primary currency for the organization (stored in the FSI\_DB\_INFO table). A German multinational bank would therefore designate the Euro as its functional currency. Only one functional currency is allowed per organization, and once assigned it cannot be changed. The functional currency is both an active and a reporting currency.

### Reporting Currencies

A reporting currency is an active currency that balances in other currencies are consolidated to, to facilitate reporting. Balances in reporting currencies are, in turn, consolidated to the functional currency. For example, an American multinational bank might consolidate its holdings in Asian currencies to the Japanese Yen and its balances in European currencies to the Euro. Then it would consolidate the sums to the U.S. dollar.

### Other Active Currencies

An active currency is any currency the organization works with. When OFSAA is installed only the functional currency is active and available for processing. If your institution has holdings in more than one currency then you need to activate those currencies. A Mexican bank doing business in the United States and Canada, for instance, would activate the U.S. dollar and the Canadian dollar.

For more information on loading exchange rate data using the staging area and the related data loader utility, see *Oracle Financial Services Analytical Applications Data Model Utilities User Guide*, Stage History Rates Loader module.

For more information on loading exchange rate data using the Currency Rates user interface, see [Currency Rates](#)

## (Mandatory) Deciding on historical rate information and managing by creating Interest Rate Codes

The quality and availability of interest rate information varies throughout the world. In many markets, gathering comprehensive rate information is a challenge because of insufficient security types, inconsistent quoting conventions, and lack of liquidity.

OFSAA Rate Management facilitates the process of inputting and viewing interest rates and yields by supporting multiple rate formats and other rate attributes to give you data storage capabilities appropriate to your market. For example, you can store the following data attributes for each interest curve:

- Rate format (zero-coupon or yield-to-maturity)
- Accrual basis
- Compound basis

Term structure parameters provide insight into the stability and direction of future rates. Rate Management enables you to define and store—up to daily—term structure parameters for any and all currently supported term structure models.

When you add an Interest Rate Code, the Add/Edit page appears with four tabbed pages. The pages display interest rate code characteristics and enable you to define, input, modify, and view data. The tabs are Attributes, Terms, Rates, and Parameters. You can only define interest rates where you have an active currency. See: [Interest Rates Detail Screen](#)

For more information on loading interest rate data using the staging area and the related data loader utility, see *Oracle Financial Services Analytical Applications Data Model Utilities User Guide*, Stage History Rates Loader module.

## Defining Economic Indicators

You can define, input, and maintain economic indicator data within Rate Management. Economic Indicator data is used in ALM within Rate Dependency Patterns allowing users to associate their forecast assumptions with changes in specific Economic Indicators. Economic Indicator data is also available within the ALM Business Intelligence application for viewing related trends and spreads.

For more information on loading Economic Indicator data using the staging area and the related data loader utility, see *Oracle Financial Services Analytical Applications Data Model Utilities User Guide*, Stage History Rates Loader module.

For more information on loading interest rate data using the Economic Indicator user interface, see [Economic Indicators Summary Screen](#) Economic Indicators Summary Screen

## Capturing Instrument Behavior for non-standard instruments

Payment and repricing characteristics for most instruments can be accommodated through the data attribute values in the Instrument tables. However, certain instruments may not have contractual cash flows or may have cash flows that are based on unique payment and repricing patterns that are too complex to be accommodated in the standard fields of the Instrument tables. Oracle Asset Liability Management allows you to define custom behavior, payment and repricing patterns to accurately model the unique characteristics for such instruments.

### Defining Behavior Patterns

In user defined Behavior patterns, you can assign a unique amortization type code to a set of payment tenors, and define principal cash flow amounts (via percentages) for the following instrument types:

- Non-maturity Instruments
- Non Performing Instruments
- Devolvement and Recovery of Guarantees

Once you create a behavior pattern, you can use it by mapping the unique behavior pattern code as the amortization type code for your instruments. Behavior pattern codes are defined within a pre-set range (70000 – 99999). When the cash flow engine encounters an instrument with an amortization type code within this pre-determined range, it understands that a Behavior Pattern should be referenced for determining the principal cash flow amounts.

### CFE Requirements and Functionality

AMRT\_TYPE\_CD of the instrument table should contain the behavior pattern code.

Non Performing Assets

Behavior Sub Type = Substandard, Doubtful and Loss (from Behavior Pattern).

BEHAVIOR\_SUB\_TYPE\_CD can be NULL when BEHAVIOR\_TYPE\_CD = 1 (Non-Maturity). When BEHAVIOR\_TYPE\_CD = 2 (Non-Performing), then value is expected in BEHAVIOR\_SUB\_TYPE\_CD. All the Substandard, Doubtful and Loss events of Behavior Pattern will be processed by the CFE. Any outstanding balance after all the Non Performing events from the pattern definition are processed will be written off on the maturity date. No interest cash flows will be generated.

**Next Payment Date:** This will need to be after As of Date of the process run. Suggested to be the same as Maturity Date since no interest payment is expected to happen.

**Maturity Date:** This will need to be after As of Date of the process run. Write off event will happen on the maturity date.

**Compounding Basis, Accrual Basis, Remaining Number of Payments, Current Payments, Current Net Rate, Adjustable Type Code:** Since the interest cash flow will not be generated, these can be the default values. Interest cash flow is output for Earning Assets, Interest bearing Liabilities, Interest Income and Interest Expense account types.

## Non Maturity

Behavior Sub Type = Core and Volatile (from Behavior Pattern).

Instrument record need not contain behavior sub type. Engine will generate the core runoffs and volatile runoffs based on the pattern definition. Interest cash flow is paid out on the payment dates.

Original Term, Amortization Term, Maturity Date: Engine arrives at Maturity Date based on the highest tenor given in the pattern definition. It is suggested that the Original Term and Amortization term be assigned 99 years for non maturity accounts. If the engine calculated maturity date is less than the maturity date in the instrument record (as normally is the case), then the instrument matures on the calculated maturity date and the remaining interest is paid out on the calculated maturity date (interest in arrears case). The maturity date is calculated by the engine by adding the longest non maturity tenor to as of date.

## Devolvement and Recovery

Behavior Sub Type = Sight Devolvement, Sight Recovery, Usance Devolvement and Usance Recovery (from Behavior Pattern).

Instrument data should contain the behavior subtype as Sight (Code: 306) or Usance (Code: 305). The sub type code is used by the engine to generate the devolvement or recovery events.

- If sub type =Sight and Devolvement Status is “No” (both from the instrument record), then all the Sight Devolvement events from the Behavior Pattern will be processed. Finally, all the Sight Recovery Events will be processed.
- If sub type = Sight and Devolvement Status is “Yes” (both from the instrument record), then all the Sight Recovery events available in the Behavior Pattern will be processed.

Any unrecovered balances will be written off on the maturity date. Similarly, Usance events will be processed.

One Behavior pattern can contain a mix of Sight and Usance events but the Engine will process the events based on the Behavior Type Code of the instrument. No interest cash flows will be generated.

**Next Payment Date:** This will need to be after As of Date of the process run. Suggested to be the same as Maturity Date since no interest payment is expected to happen.

**Maturity Date:** This will need to be after As of Date of the process run. Any outstanding balance after all the Recovery events from the pattern definition are processed will be written off on the maturity date.

**Compounding Basis, Accrual Basis, Remaining Number of Payments, Current Payments, Current Net Rate, Adjustable Type Code:** Since the interest cash flow will not be generated, these can be the default values.

## Behavior Pattern Structure

Oracle Asset Liability Management allows you to build three types of behavior patterns:

- Non Maturity
- Non Performing
- Devolvement and Recovery

These behavior patterns differ in terms of how they allow you to categorize cash flows based on the specific behavior type being modeled. The following table summarizes the various payment types available for each type of behavior pattern

Pattern Type	Payment Type
Non Maturity	Volatile
	Core
Non Performing	Sub Standard
	Doubtful
	Loss
Devolvement and Recovery	Sight Devolvement
	Sight Recovery
	Usance Devolvement
	Usance Recovery

## Payment Events

You must define one or more payment events to complete a behavior pattern. A payment event is a set of payment characteristics, which define the time line and amount of a specific payment in the behavior pattern. While the payment types can change based on the pattern type selected, there are three inputs that are required for all behavior patterns:

- Term
- Amount
- Type

## Principal Runoff Term



The Term of the principal runoff is determined by the input of a Tenor and Multiplier. For example, if you are defining the “Volatile” component of a non-maturity instrument, you would likely define the runoff term for the first amount as “1 Day”. In this case, Tenor = “1” and Multiplier = “Day”

## Amount

The cash flow amount is defined as a percentage of the end of period balance. For example, in the case of Non Maturity behavior pattern type, if the assumption for the Volatile runoff amount is that 25% of the portfolio is to be categorized as "volatile", the input should be "25". The sum of the percentages for Non Maturity behavior pattern type must equal 100%. The "Total Percentage" is shown at the bottom of the Pattern detail area indicating the cumulative percentage.

## Payment Type

The payment type selection categorizes all payment runoff into meaningful groupings. The principal runoff type is carried forward by the cash flow engine and can be identified in the cash flow results by the following financial element codes.

- 186 Writeoff Positive
- 187 Timing of Writeoff Positive
- 188 Writeoff Negative
- 189 Timing of Writeoff Negative
- 200 Non Maturity - Core Runoff
- 201 Timing of Non Maturity - Core Runoff
- 202 Non Maturity - Volatile Runoff
- 203 Timing of Non Maturity - Volatile Runoff
- 204 Devolvement Runoff
- 205 Timing of Devolvement Runoff
- 206 Recovery Runoff
- 207 Timing of Recovery Runoff
- 208 Non Performing Asset Runoff
- 209 Timing of Non Performing Asset Runoff

## Defining Payment Patterns

In a user defined payment pattern, you can assign a unique amortization type code to a set of payment events, which may include some of the following customized features:

- Changes in payment frequency

- Seasonal payment dates
- Nonstandard or variable payment amounts

Once you create a payment pattern, you can use it by entering the payment pattern code as the amortization type code for the instrument.

## Payment Pattern Structure

Oracle Asset Liability Management allows you to build three types of payment patterns:

- Absolute
- Relative
- Split

These payment patterns differ in terms of how they address payment schedules, which determine whether the payment events constituting the pattern are determined by calendar dates or periods. Absolute patterns are defined with sets of payment characteristics scheduled on specific calendar dates. Relative patterns are defined with sets of payment characteristics scheduled for certain periods of time.

You can also define a payment pattern with both absolute and relative payment events. This type of pattern is called a split pattern.

In addition, for each payment pattern, you need to specify a payment type, either conventional, level principal, or non-amortizing. Your choice of the pattern type and the payment types will determine the fields that are used for calculation.

## Payment Events

You must define one or more payment event to complete a payment pattern. A payment event is a set of payment characteristics, which define the time line and amount of a specific payment in the payment pattern.

Though the characteristics of the payment phase change based on whether you are defining an absolute, relative, or split pattern, there are two characteristics that are required for all amortizing patterns:

- Payment method
- Value

## Payment Method

The payment methods determine the payment amount for the payment event. There are six different methods.

The following table describes the different payment methods.

Method	Description
% of Original Balance	This method calculates the payment as a percentage of the original balance; the percentage being defined by the input percent. This method is useful for apportioning the starting balance on a level principal instrument over several payments. This method is only available for payment patterns defined with a level principal payment type.
% of Current Balance	This method calculates the payment as a percentage of the current balance prior to payment; the percentage being defined by the input percent. This method is only available for payment patterns defined with a level principal payment type.
% of Original Payment	This method calculates the payment as a percentage of the original payment column from the detail instrument data. This percentage is defined by the input percent.
% of Current Payment	This method calculates the payment as a percentage of the previous payment; the percentage being defined by the input percent. This payment is calculated on the payment date based on the characteristics of the instrument at the time of the payment, including the current rate, current balance, and current payment frequency.
Absolute Payment	This is an input payment amount. This amount represents both principal and interest for a conventional payment type, and represents only principal for a level principal payment type. For both types of patterns, absolute value payment amounts are entered as gross of participations.
Interest Only	This is a calculated payment amount. An interest-only payment is calculated during processing as balance times rate times accrual factor.

## Value

The value reflects the percentage or payment amount based on the method chosen for the payment event. Value is disabled for phases using the Interest Only payment method.

Payment amounts for conventional pattern phases must reflect both principal and interest payments. Payment amounts for level principal pattern phases only reflect the principal portion of the payment. For level principal pattern phases, the total cash flow on a payment date is the principal amount stored as the payment plus the calculated interest.

---



---

**Note:** The payment method and value columns are not displayed for payment patterns defined with a non-amortizing payment type. All payments are assumed to be interest only for this type of payment pattern.

---



---

## Absolute Payment Patterns

Absolute payment patterns are commonly used for instruments that pay on a seasonal schedule, such as agricultural or construction loans that require special payment handling based on months or seasons.

Take the example of a loan that follows a seasonal payment pattern, in which the payment patterns for January, February and March are scheduled for interest-only payments. As revenues for the customer increase, the payment amount also increases. Therefore, the payments for April and May are 80% of the original payment, and June through September is 100% of the original payment. The payment decreases as the production season slows. The payment for October is decreased to 80% of the original payment, and the payments for November and December are decreased again to 50% of the original payment.

---

---

**Note:** You can define absolute payment patterns only up to a year. This is because all entries are automatically ordered by date and are scheduled in a single year rotation.

---

---

## Relative Payment Patterns

Relative payment patterns are commonly used for modeling instruments with irregular payment frequencies or for instruments where the payment type changes over time. Take the case of a four-year loan for example. The payment for the first 12 months could only be interest. The first 35 payments are scheduled for 50% of the currently scheduled payment, and the last payment is a balloon payment for the balance of the loan.

## Split Payment Patterns

A split pattern contains multiple sets of payment patterns under a single amortization code. You use a split pattern for financial instruments that make principal payments along two concurrent amortization schedules. Each separate amortization schedule is termed a time line and assigned a percentage of the balance. A Split Pattern can constitute both absolute and/or relative payment patterns within itself.

## Defining Repricing Patterns

User defined repricing patterns provide a mechanism to capture the repricing structure of instruments whose rates change according to complex schedules which cannot be captured in the standard fields of instrument tables.

The user defined repricing pattern allows you to define multiple changes to various elements affecting repricing including:

- Rates
- Margins
- Frequency

A repricing pattern has two major components:

- User Defined Repricing Pattern
- User Defined Repricing Event

---

---

**Note:** Oracle Asset Liability Management Repricing Pattern interface supports simultaneous multiple-user access.

---

---

## User Defined Repricing Pattern

The user defined repricing pattern provides you with the ability to define a series of repricing patterns and events that describe the interest rate adjustment characteristics over the life of a cash flow instrument. One repricing pattern can be assigned to many cash flow instruments. There are two types of repricing patterns that you can define:

- Absolute Repricing Pattern
- Relative Repricing Pattern

## User Defined Repricing Event

The events of a repricing pattern define changes to the interest rates of an instrument during its life. Every pattern begins with an initial event, which describes the behavior for the initial period.

---

---

**Note:** This initial event is required for the setup of all repricing patterns but is not used in Oracle Funds Transfer Pricing. This feature is used only by Oracle ALM, when assigning a rate at origination of new business and transaction strategy records.

---

---

The second event describes the change in behavior after the initial period is over. A third event describes the next change in behavior and so on. In relative repricing patterns, you can also define the number of times an event will be repeated before the next event is triggered.

At least one event must be defined for a repricing pattern. All events are listed in the Repricing Events table. The repricing pattern type, absolute or relative, determines the data required to be populated in the events table.

Caution: You have the option to change the repricing pattern type at any time during the create process. However, changing the repricing pattern type causes the system to automatically refresh the Repricing Events table, and the loss of all the data that you previously entered.

## Event Detail

You define each event with a repricing type of either flat rate or indexed rate. The repricing types determine the event detail characteristic that are available.

### Flat Rate

Selecting the flat rate repricing type allows you to set the rate of the instrument to a fixed value. For example, 6%. The following table describes the event detail characteristics that are available when the flat rate repricing type is selected.

Characteristic	Description
Net Rate	The new net rate value
Gross Rate	The new gross rate value
Transfer Rate	The new transfer rate value

---



---

**Note:** Flat rate always overrides the caps and floors defined on the instrument record.

---



---

## Indexed Rate

Selecting the indexed rate repricing type allows you to set the rate of the instrument to an adjustable value, defined as the index rate plus a margin. The following table describes the event detail characteristics that are available when the indexed rate repricing type is selected:

Characteristic	Description
Interest Rate Code	Reference interest rate used as the index rate to set gross and net rates. This list of values is pulled from the current Historical Rates database.
Transfer Rate Interest Rate Code	Interest rate used to calculate the transfer rate.
Yield Curve Term	Term used in interest rate code lookups; if left blank, defaults to the term until the next repricing; set with a value and multiplier.
Net Margin	Added to index rate to get net rate.
Gross Margin	Added to index rate to get gross rate.
Transfer Margin	Added to index rate to get transfer rate.
Rate Cap Life	The upper limit for gross rate.
Rate Floor Life	The lower limit for gross rate.
Rate Set Lag	Period by which the date of the interest rate used for calculation precedes the event date; set with a value and a multiplier.

## Absolute Repricing Pattern

The absolute repricing pattern is used for instruments that are date dependent. Each specific date is a separate event.

You may have up to one year of defined events that repeat for the life of the instrument. For example, you could define one event for each day of the year; the maximum number of events that you can define is 365. However, you can only define one event for any given date.

## Relative Repricing Pattern

The relative repricing pattern is a series of repricing events that are driven by user defined time lines. It is used for instruments where the repricing is determined by elapsed time since origination. You specify the duration of each repricing period (frequency) and the number of times the event should occur (repeat) before calculating the next event in the pattern.

For example, an event can be defined with a frequency of 1, a multiplier of Months, and a repeat value of 3. This translates into an event that reprices every month for a duration of 3 consecutive months.

You may have a graduated rate mortgage that requires three rate changes over the life of the instrument. You will have three events following the initial event. If you wish the instrument to retain the behavior defined for the last event, the repeat value should be set to 999. This prevents wrapping, or the recycling of all the defined events until the life of the instrument runs out.

## Pricing with Balance Tiers

Repricing Patterns include the option to set rates based on the balance of the instrument being priced. This selection is optional and users can select "None", meaning there are no balance tiers needed, or they can select "Current Balance". If Current Balance is selected, then users can define balance tier ranges and include different pricing details for each balance tier. This option is useful for applying pricing to products such as Savings Accounts or Money Market Accounts that pay different levels of interest based on the account balance.

Balance tiered pricing can be applied to detailed instrument records or to aggregate balances. When applying to aggregate balances, it is important to define the mix percentage of the portfolio for which the pricing will be applied. This is necessary because the original mix of accounts containing the related balance information is lost when the data is aggregated. The mix percentage input solves this problem. When balance tiered pricing is applied to detailed accounts, the mix percentage input is not required.

Example:

Suppose the repricing pattern is defined with the following balance tiers:

Balance > 0 and < 25,000 then current rate = 0.00%, mix % = 50%

Balance >=25,000 then current rate = 2.5%, mix % = 50%

Scenario 1, the instrument table contains detailed account records

Account #1 = \$10,000

Account #2 = \$10,000

Account #3 = \$10,000

Account #4 = \$10,000

Account #5 = \$10,000

Account #6 = \$50,000

The resulting rate will be  $[(\$50,000 \times 0.00\%) + (\$50,000 \times 2.50\%)] / \$100,000 = 1.25\%$

Scenario 2, the instrument table contains 1 aggregated instrument record

Account #1 = \$100,000

---

---

**Note:** In scenario 2, the mix percentage is needed.

---

---

The resulting rate will be  $(0.00 \times .50) + (2.50 \times .50) = 1.25\%$

## Loading Payment Schedule details

Supporting instrument records that have completely unique payment characteristics is the Payment Schedule option. User can directly load cash flows for individual instrument contracts into the FSI\_D\_PAYMENT\_SCHEDULE table.

Instrument records are associated with Payment Schedules through the Amortization Type Code (AMRT\_TYPE\_CD) column. If the cash flow engine encounters an AMRT\_TYPE\_CD = 800, 801 or 802 it understands that the instrument record is associated with a Payment Schedule and will perform a lookup in the Payment Schedule table based on the IDENTITY\_CODE, ID\_NUMBER and INSTRUMENT\_TYPE\_CD of the record being processed.

For more information, refer to *Initializing Schedule Records* and *Amortization Type Code* sections of *Cash Flow Engine Reference Guide*.

## (Mandatory) Defining Time Buckets

Time buckets allow you to specify the time periods used for storing and reporting results. Within the Time Bucket rule, income simulation buckets (also known as Modeling Buckets) set the modeling horizon for date-related business rules. When you change the number or frequency of the modeling buckets, existing rules are affected, so use caution before changing your active time bucket rule.

---

---

**Note:** Forecast Rules that have time bucket dependencies do not adjust dynamically if you change the modeling buckets in your Time Bucket Rule.

---

---

Within a Time Bucket rule, you can specify any combination of days, months, and years when setting up the buckets. Although all Oracle ALM cash flows are generated on a daily basis, they are aggregated into defined modeling buckets when results are stored. ALM BI Reports access information from the modeling buckets and let you aggregate buckets. For example, you can define monthly modeling buckets but



generate a quarterly income statement. On the other hand, you cannot generate a weekly balance sheet if all modeling buckets are monthly.

If you want to use different configurations of modeling buckets, such as all monthly or all quarterly, you should create a separate Time Bucket rule for each, and use a naming convention to identify the distinctions. All date-related assumption rules should be defined and used in the context of a single set of modeling buckets or a single Time Bucket rule.

---

---

**Note:** Defining Time Buckets is a mandatory step in setting up and configuring the Oracle ALM application.

---

---

### Defining Dynamic Start Dates

In addition to defining Income Simulation Buckets, Time Bucket rules also allow you to define separately bucket assumptions for Interest Rate GAP and Liquidity GAP results in a single rule. This capability allows you to minimize the number of Time Bucket rules needed to support all of your calculations. You also have the ability to define future start dates (also known as Dynamic Start Dates) within either of the Interest Rate or Liquidity GAP bucket screens.

The following example illustrates how to define additional Dynamic Interest Rate GAP and/or Liquidity GAP buckets within Time Bucket Rules.

The following screen shows the default setup:

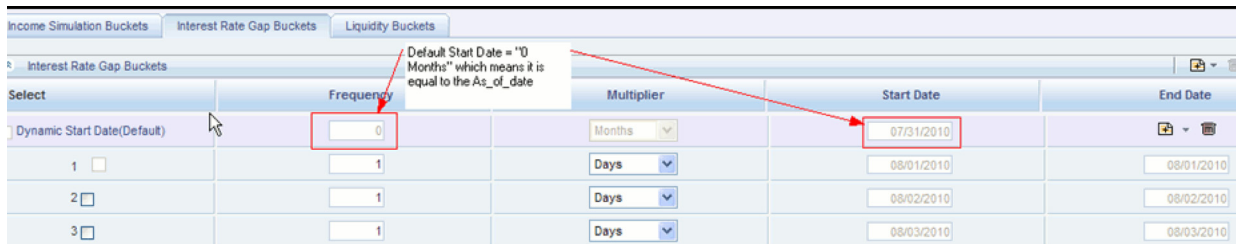

This screen shows the setup of an additional “Dynamic Start Date” set to begin at As\_of\_date + 3 days. If the forecast contains new business assumptions that occur between the As of Date and Dynamic Start Date 2, then they will be included in the output.

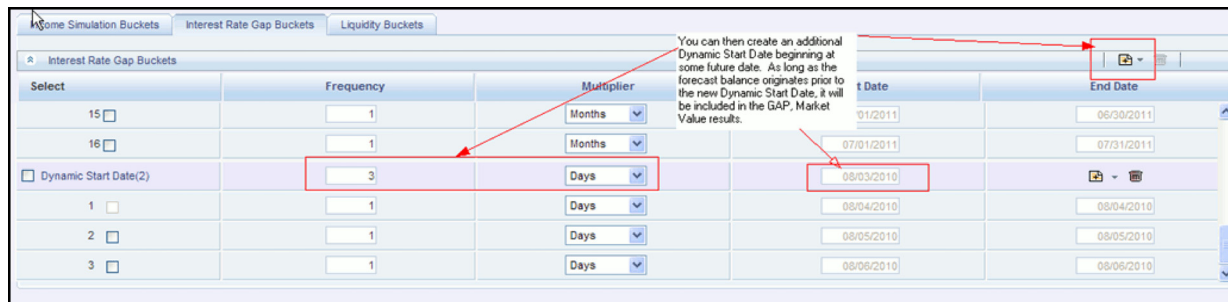

## (Mandatory) Defining Product Characteristics

Product Characteristic rules allow you to define payment, pricing and repricing characteristics for new business. They are also used to specify general calculation attributes for both existing accounts and new business.

Defining a Product Characteristics rule is a mandatory step in setting up and configuring the Oracle ALM Application.

## (Mandatory - Deterministic) Defining Forecast Rate Scenarios

Forecast Rate scenarios allow you to define your deterministic modeling scenarios including projections for future interest rates, future currency exchange rates and future economic indicators. The cash flow engine uses interest rate forecasts to project cash flows, including pricing new business, re-pricing existing business, calculating prepayments, determining discount methods and in determining rate dependent forecast assumptions. The ALM process uses currency exchange rate forecasts to account for the effects of currency fluctuations on income.

The Forecast Rates scenario rules use interest rate codes, currency codes and economic indicator codes defined / stored in Rate Management, including all the active and reporting currencies and the primary, or functional, currency at your institution.

Defining a Forecast Rate Scenario is a mandatory step in setting up and configuring the Oracle ALM Application.

## Defining Prepayments

One of the major business risks faced by financial institutions engaged in the business of lending is prepayment risk. Prepayment risk is the possibility that borrowers might choose to repay part or all of their loan obligations before the scheduled due dates. Prepayments can be made by either accelerating principal payments or refinancing.

Prepayments cause the actual cash flows from a loan to a financial institution to be different from the cash flow schedule drawn at the time of loan origination.

A Prepayment Rule contains methodologies to model the prepayment behavior of various amortizing instruments and quantify the associated prepayment risk.

Prepayment methodologies are associated with the product-currency combinations within the Prepayment rule. See: [Defining Prepayments](#)

## Prepayment Methodologies and Rules

You can use any of the following five methods in a Prepayment rule to model the prepayment behavior of instruments:

- Constant Prepayment method
- Prepayment Model method

- PSA method
- Arctangent method
- ADCo Prepayment method

---



---

**Note:** For more information on ADCo Prepayment method, refer to ADCo Prepayment Method Chapter.

---



---

## Constant Prepayment Method

The Constant Prepayment method of “Use Payment Dates”, calculates the prepayment amount as a flat percentage of the current balance.

You can create your own origination date ranges and assign a particular prepayment rate to all the instruments with origination dates within a particular origination date range.

Constant Prepayment method of “User Defined Prepayment Tenors” allows prepayment on any date, irrespective of contractual payment dates. You can create your own origination date ranges and define prepayment tenor(s) for each range. You can associate specific prepayment rate for each prepayment tenor.

## Prepayment Model Method

The Prepayment Model method allows you to define more complex prepayment assumptions compared to the other prepayment methods. Under this method, prepayment assumptions are assigned using a custom Prepayment model.

You can build a Prepayment model using a combination of up to three prepayment drivers and define prepayment rates for various values of these drivers. Each driver maps to an attribute of the underlying transaction (age/term or rate) so that the cash flow engine can apply a different prepayment rate based on the specific characteristics of the record.

---



---

**Note:** All prepayment rates should be input as annual amounts.

---



---

## Prepayment Model Structure

A typical Prepayment model structure includes the following:

- **Prepayment Drivers:** You can build a Prepayment model using one to three prepayment drivers. A driver influences the prepayment behavior of an instrument and is either an instrument characteristic or a measure of interest rates.
- **The Prepayment Driver Nodes:** You can specify one or more node values for each of the prepayment drivers that you select.

- **Interpolation or Range method:** Interpolation or Range methods are used to calculate prepayment rates for the prepayment driver values that do not fall on the defined prepayment driver nodes.

## Types of Prepayment Drivers

The prepayment drivers are designed to allow the calculation of prepayment rates at run time depending on the specific characteristics of the instruments for which cash flows are being generated. Although nine prepayment drivers are available, a particular prepayment model can contain only up to three prepayment drivers.

The prepayment drivers can be divided into the following two categories:

- **Age/Term Drivers:** The Age/Term drivers define term and repricing parameters in a Prepayment model. All such prepayment drivers are input in units of months. These Drivers include:

**Original Term:** You can vary your prepayment assumptions based on the contractual term of the instrument. For example, you could model faster prepayment speeds for longer term loans, such as a 10-year loan, than for short term loans, such as a 5-year loan. You would then select the Original Term prepayment driver and specify two node values: 60 months and 120 months.

**Repricing Frequency:** You can vary your prepayment assumptions based on the repricing nature of the instrument being analyzed. Again, you could specify different prepayment speeds for different repricing frequencies and the system would decide which one to apply at run time on a record by record basis.

**Remaining Term:** You can specify prepayment speeds based on the remaining term to maturity. For example, loans with few months to go until maturity tend to experience faster prepayments than loans with longer remaining terms.

**Expired Term:** This is similar to the previous driver but instead of looking at the term to maturity, you base your assumptions on the elapsed time. Prepayments show some aging effect such as the loans originated recently experiencing more prepayments than older ones.

**Term to Repricing:** You can also define prepayment speeds based on the number of months until the next repricing of the instrument.

- **Interest Rate Drivers:** The Interest Rate drivers allow the forecasted interest rates to drive prepayment behavior to establish the rate-sensitive prepayment runoff. Interest Rate Drivers include:

**Coupon Rate:** You can base your prepayment assumptions on the current gross rate on the instrument.

**Market Rate:** This driver allows you to specify prepayment speeds based on the market rate prevalent at the time the cash flows occur. This way, you can incorporate your future expectations on the levels of interest rates in the prepayment rate estimation. For example, you can increase prepayment speeds during periods of decreasing rates and decrease prepayments when the rates go up.

**Rate Difference:** You can base your prepayments on the spread between the current gross rate and the market rate.

**Rate Ratio:** You can also base your prepayments on the ratio of current gross rate to market rate.

The following diagram illustrates a three-driver prepayment model:

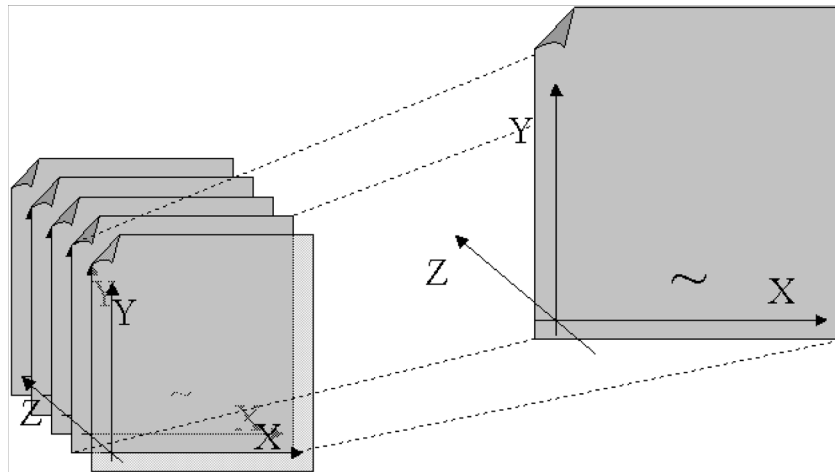

The ~ signifies a point on the X-Y-Z plane. In this example it is on the second node of the Z-plane. The Z-plane behaves like layers.

Oracle Asset Liability Management allows you to build prepayment models using the Prepayment Model rule. The Prepayment Model rule can then be referenced by a Prepayment Rule. See [Prepayment Models](#).

## PSA Method

The PSA Prepayment method (Public Securities Association Standard Prepayment Model) is a standardized prepayment model that is built on a single dimension, remaining term. The PSA curve is a schedule of prepayments which assumes that prepayments will occur at a rate of 0.2 percent CPR in the first month and will increase an additional 0.2 percent CPR each month until the 30th month and will prepay at a rate of 6 percent CPR thereafter ("100 percent PSA"). PSA prepayment speeds are expressed as a multiple of this base scenario. For example, 200 percent PSA assumes annual prepayment rates will be twice as fast in each of these periods -- 0.4 percent in the first month, 0.8 percent in the second month, reaching 12 percent in month 30 and remaining at 12 percent after that. A zero percent PSA assumes no prepayments.

You can create your own origination date ranges and assign a particular PSA speed to all the instruments with origination dates within a particular origination date range.

---



---

**Note:** PSA speed inputs can be between 0 and 1667

---



---

## Arctangent Calculation Method

The Arctangent Calculation method uses the Arctangent mathematical function to describe the relationship between prepayment rates and spreads (coupon rate less market rate).

**Note:** All prepayment rates should be input as annual amounts.

User defined coefficients adjust this function to generate differently shaped curves. Specifically:

$$CPR_t = k_1 - (k_2 * ATAN(k_3 * (-C_t/M_t + k_4)))$$

where  $CPR_t$  = annual prepayment rate in period t

$C_t$  = coupon in period t

$M_t$  = market rate in period t

$k_1 - k_4$  = user defined coefficients

A graphical example of the Arctangent prepayment function is shown below, using the following coefficients:

$$k_1 = 0.3$$

$$k_2 = 0.2$$

$$k_3 = 10.0$$

$$k_4 = 1.2$$

Each coefficient affects the prepayment curve in a different manner.

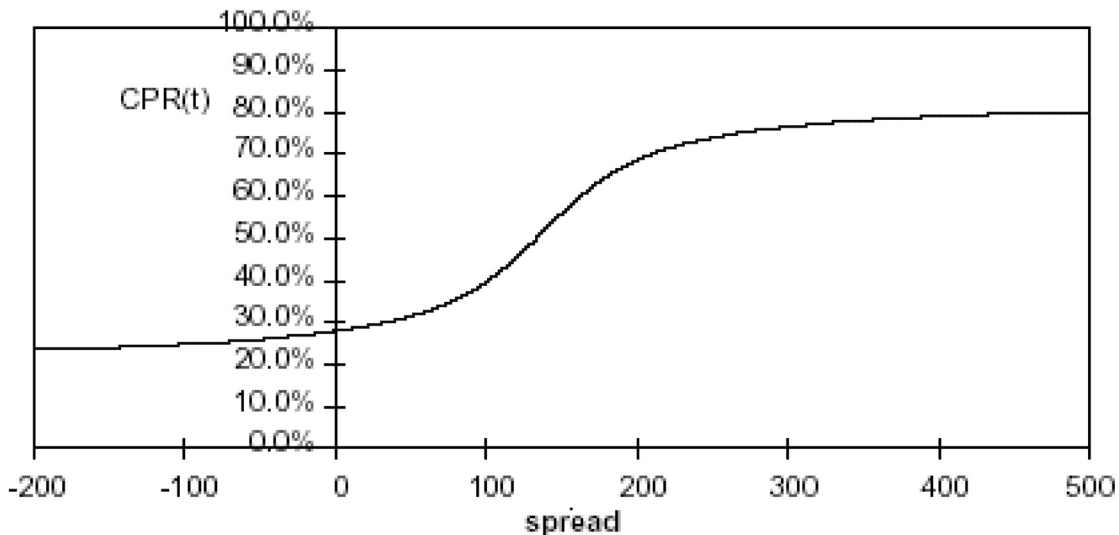

The following diagram shows the impact of K1 on the prepayment curve. K1 defines the midpoint of the prepayment curve, affecting the absolute level of prepayments. Adjusting the value creates a parallel shift of the curve up or down.

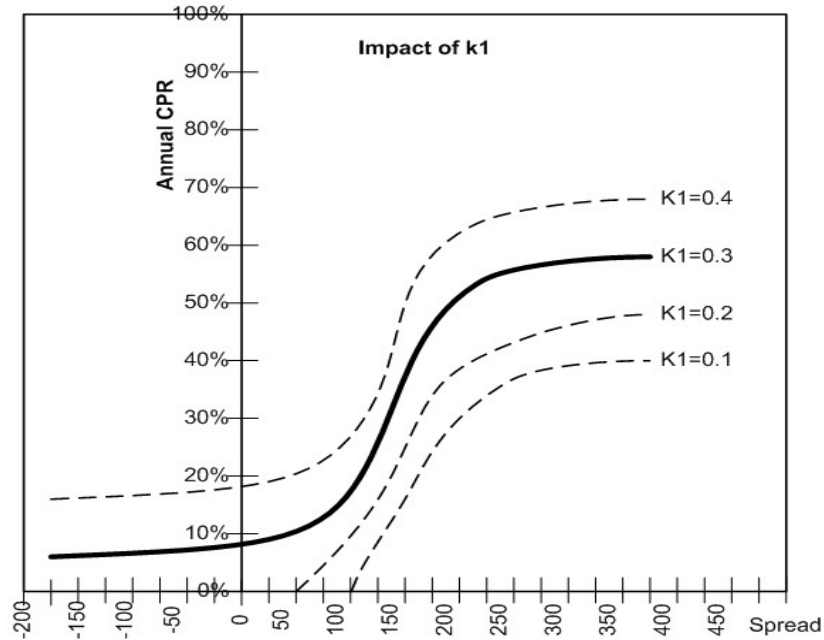

The following diagram shows the impact of K2 on the prepayment curve. K2 impacts the slope of the curve, defining the change in prepayments given a change in market rates. A larger value implies greater overall customer reaction to changes in market rates.

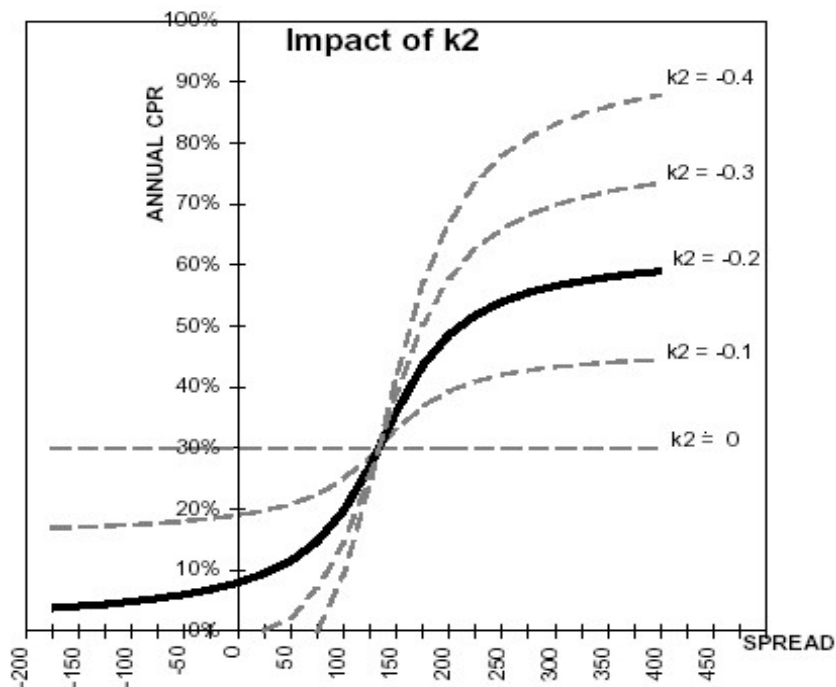

The following diagram shows the impact of K3 on the prepayment curve. K3 impacts the amount of torque in the prepayment curve. A larger K3 increases the amount of

acceleration, implying that customers react more sharply when spreads reach the hurdle rate.

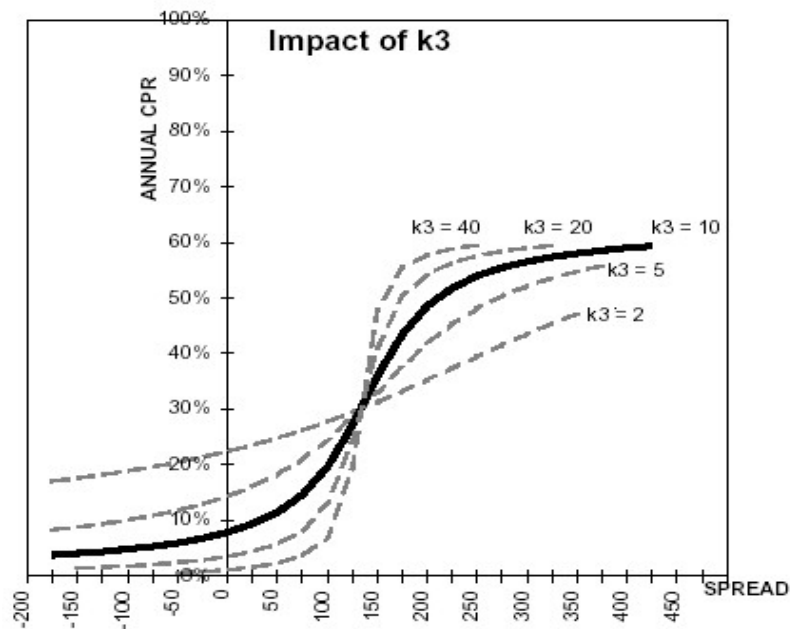

The following diagram shows the impact of K4 on the prepayment curve. K4 defines the hurdle spread: the spread at which prepayments start to accelerate. When the spread ratio = k4, prepayments = k1.

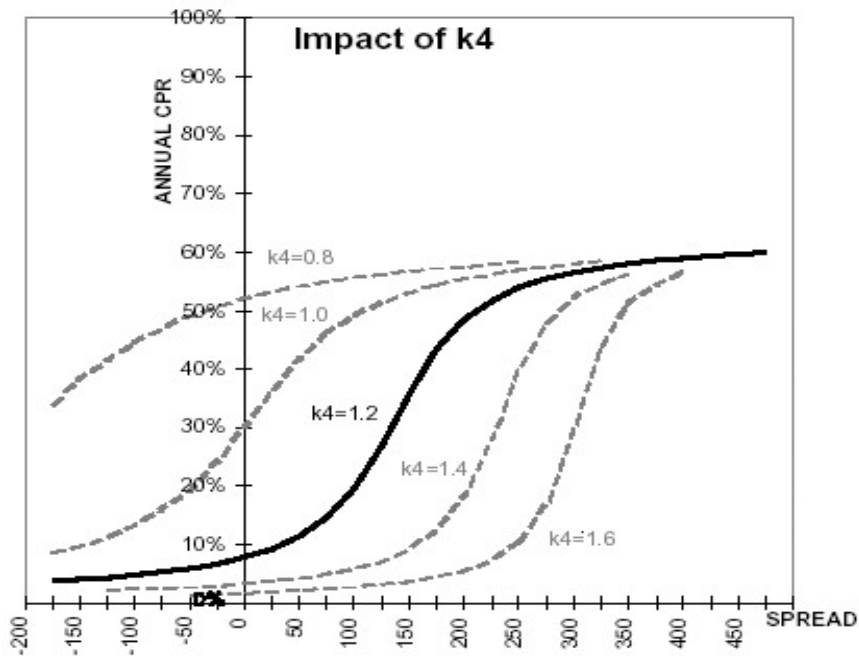



## Defining Discounting Methods

Discount Method rules allow you to define, based on your product hierarchy, the method for discounting projected cash flows for market value purposes. For each product and currency, you can choose one of the following discount methods and the corresponding reference rates (IRC) for discounting:

- Spot Input
- Spot Interest Rate Code
- Forecast (Original Term)
- Forecast (Remaining Term)

## Defining Forecast Assumptions

You can define new business assumptions in Oracle ALM through three different assumption rules, which work together to define the volume, term and pricing level:

- Forecast Balances
- Forecast Maturity Mix
- Forecast Pricing Margins

Forecast Balance rules allow you to input the new volumes that you expect to originate over the forecast horizon. The horizon over which you input Forecast Balance assumptions is determined by the Income Simulation buckets defined in your “Active” Time Bucket rule.

In addition to the volumes of new business defined in your Forecast Balance assumption rule, you must also define the corresponding Maturity Mix and Pricing Margins associated with the new volumes. These assumptions are managed through the Forecast Maturity Mix and Forecast Pricing Margin assumption rules.

## Defining Transfer Pricing Rules

Defining Transfer Pricing rules is one of the optional steps in the Oracle Asset Liability Management process. You must define Transfer Pricing rules, in order to transfer price your forecasted balances. A Transfer Pricing rule is used to manage the association of transfer pricing methodologies to various product-currency combinations. It can also be used to manage certain parameters used in option costing.

See: [Defining Transfer Pricing Methodologies Using Node Level Assumptions](#)

To reduce the amount of effort required to define the transfer pricing methodologies for various products and currencies, Oracle Funds Transfer Pricing allows you to define transfer pricing methodologies using node level and conditional assumptions.

Node Level Assumptions

Oracle Asset Liability Management uses the Product Dimension that has been selected within Application Preferences, to represent a financial institution's product portfolio. Using this dimension, you can organize your product portfolio into a hierarchical structure and define parent-child relationships for different nodes of your product hierarchy. This significantly reduces the amount of work required to define transfer pricing, prepayment, adjustment rule methodologies and other ALM assumption rules.

You can define transfer pricing, prepayment, adjustment rule methodologies and other ALM assumption rules at any level of your product hierarchy. Children of parent nodes on a hierarchy automatically inherit the methodologies defined for the parent nodes. However, methodologies directly defined for a child take precedence over those at the parent level. See [Defining Transfer Pricing Methodologies Using Node Level Assumptions](#).

### Conditional Assumptions

The conditional assumption feature allows you to segregate your product portfolio based on common characteristics, such as term to maturity, origination date, and repricing frequency, and assign specific transfer pricing methodologies to each of the groupings.

For example, you can slice a portfolio of commercial loans based on repricing characteristics and assign one global set of Transfer Pricing, Prepayment, Adjustment Rule Methodologies or other ALM assumption rules to the fixed-rate loans and another to the floating-rate loans.

## Transfer Pricing Methodologies and Rules

The transfer pricing methodologies supported by Oracle Asset Liability Management can be grouped into the following two categories:

- **Cash Flow Transfer Pricing Methods:** Cash flow transfer pricing methods are used to transfer price instruments that amortize over time. They generate transfer rates based on the cash flow characteristics of the instruments.

In order to generate cash flows, the system requires a detailed set of transaction-level data attributes, such as, origination date, outstanding balance, contracted rate, and maturity date, which resides only in the Instrument tables. Consequently, cash flow methods apply only if the data source is Account tables. Data stored in the Management Ledger Table reflects only accounting entry positions at a particular point in time and does not have the required financial details to generate cash flows, thus preventing you from applying cash flows methodologies to this data.

The cash flow methods are also unique in that Prepayment rules are used only with these methods. You can select the required Prepayment rule when defining an ALM Process.

Oracle Asset Liability Management supports the following cash flow transfer pricing methods:

Cash Flow: Average Life

Cash Flow: Duration

Cash Flow: Weighted Term

Cash Flow: Zero Discount Factors

- Non cash Flow Transfer Pricing Methods: These methods do not require the calculation of cash flows. Oracle Asset Liability Management supports the following non cash flow transfer pricing methods:

Moving Averages

Straight Term

Spread from Interest Rate Code

Spread from Note Rate

Redemption Curve

## Cash Flow: Average Life

The Average Life method determines the average life of the instrument by calculating the effective term required to repay back half of the principal or nominal amount of the instrument. The TP rate is equivalent to the rate on the associated interest rate curve corresponding to the calculated term.

$$\text{Average Life} = \sum_{i=1}^n \frac{P_i}{P} t_i$$

Where:

$P$  is the principal

$P_i$  is the principal repayment in coupon  $i$ , hence

$\frac{P_i}{P}$  is the fraction of the principal repaid in coupon  $i$ , and

$t_i$  is the time from the start of coupon  $i$

Oracle Asset Liability Management derives the Average Life based on the cash flows of an instrument as determined by the characteristics specified in the Instrument Table and using your specified prepayment rate, if applicable. The average life formula calculates a single term, that is, a point on the yield curve used to transfer price the instrument being analyzed.

---



---

**Note:** The Average Life TP Method provides the option to Output the result of the calculation to the instrument record (TP\_AVERAGE\_LIFE). This can be a useful option if you would like to refer to the average life as a reference term within an Adjustment Rule

---



---

## Cash Flow: Duration

The Duration method uses the Macaulay duration formula:

$$\text{Duration} = \frac{\sum_{n=1}^N \left[ \frac{CF_n}{(1+r)^m} \times t_n \right]}{\sum_{n=1}^N \left[ \frac{CF_n}{(1+r)^m} \right]}$$

In this formula:

N = Total number of payments from Start Date until the earlier of repricing or maturity

CF<sub>n</sub> = Cash flow (such as regular principal, prepayments, and interest) in period n

r = Periodic rate (current rate/payments per year)

m = Remaining term to cash flow/active payment frequency

t<sub>n</sub> = Remaining term to cash flow n, expressed in years

Oracle Asset Liability Management derives the Macaulay duration based on the cash flows of an instrument as determined by the characteristics specified in the Instrument Table and using your specified prepayment rate, if applicable. The duration formula calculates a single term, that is, a point on the yield curve used to transfer price the instrument.

- Within the Duration calculation, the discount rate or current rate, r, is defined in one of three ways, based on how the methodology is setup by the user:

Current rate is defined as current net rate if the processing option, "Model with Gross Rates" is not selected and current gross rate if the option is selected. The current rate is used as a constant discount rate for each cash flow.

The user may directly input, while defining the TP rule, a constant rate to use for discounting. If specified, this rate is used as a constant discount rate for each flow.

The user can select to discount the cash flows using spot rates from a selected interest rate curve. With this approach, a discount rate is read from the selected interest rate curve corresponding to the term of each cash flow.

- Remaining term to cash flow is the difference between the date of each cash flow and the modeling start date for that instrument.

---



---

**Note:** The Duration TP Method provides the option to Output the result of the calculation to the instrument record (TP\_DURATION). This can be a useful option if you would like to refer to the duration as a reference term within an Adjustment Rule

---



---

## Cash Flow: Weighted Term

The Weighted Term method builds on the theoretical concepts of duration. As shown earlier, duration calculates a weighted-average term by weighting each time period,  $n$ , with the present value of the cash flow (discounted by the rate on the instrument) in that period.

Since the goal of the Weighted Term method is to calculate a weighted average transfer rate, it weights the transfer rate in each period,  $y_n$ , by the present value for the cash flow of that period. Furthermore, the transfer rates are weighted by an additional component, time, to account for the length of time over which a transfer rate is applicable. The time component accounts for the relative significance of each strip cash flow to the total transfer pricing interest income/expense. The total transfer pricing interest income/expense on any cash flow is a product of that cash flow, the transfer rate, and the term. Hence, longer term cash flows will have relatively larger impact on the average transfer rate. The Weighted Term method, with "Discounted Cash Flow" option selected, can be summarized by the following formula:

$$\text{Weighted-Average} = \bar{y} = \frac{\sum_{n=1}^N \left[ y_n \times \frac{CF_n}{(1+r)^m} \times t_n \right]}{\sum_{n=1}^N \left[ \frac{CF_n}{(1+r)^m} \times t_n \right]}$$

In this formula:

$N$  = Total number of payments from Start Date until the earlier of repricing or maturity

$CF_n$  = Cash flow (such as regular principal, prepayments, and interest) in period  $n$

$r$  = Periodic coupon rate on instrument (current rate/payments per year)

$m$  = Remaining term to cash flow  $n$ /active payment frequency

$t_n$  = Remaining term to cash flow  $n$ , expressed in years

$y_n$  = Transfer rate in period  $n$

Within the Weighted Average Cash Flow method definition screen, users can choose whether or not to discount the cash flows as described earlier. If the "Cash Flow" option is selected, rather than the "Discounted Cash Flow", the following simplified formula is applied:

$$\text{Weighted Average} = \bar{y} = \left( \frac{\sum_{n=1}^N [y_n \times CF \times t_n]}{\sum_{n=1}^N [CF \times t_n]} \right)$$

## Cash Flow: Zero Discount Factors

The Zero Discount Factors (ZDF) method takes into account common market practices in valuing fixed rate amortizing instruments. For example, all Treasury strips are quoted as discount factors. A discount factor represents the amount paid today to receive \$1 at maturity date with no intervening cash flows (that is, zero coupon).

The Treasury discount factor for any maturity (as well as all other rates quoted in the market) is always a function of the discount factors with shorter maturities. This ensures that no risk-free arbitrage exists in the market. Based on this concept, one can conclude that the rate quoted for fixed rate amortizing instruments is also a combination of some set of market discount factors. Discounting the monthly cash flows for that instrument (calculated based on the constant instrument rate) by the market discount factors generates the par value of that instrument (otherwise there is arbitrage).

ZDF starts with the assertion that an institution tries to find a funding source that has the same principal repayment factor as the instrument being funded. In essence, the institution strip funds each principal flow using its funding curve (that is, the transfer pricing yield curve). The difference between the interest flows from the instrument and its funding source is the net income from that instrument.

Next, ZDF tries to ensure consistency between the original balance of the instrument and the amount of funding required at origination. Based on the transfer pricing yield used to fund the instrument, the ZDF solves for a single transfer rate that would amortize the funding in two ways:

- Its principal flows match those of the instrument.
- The Present Value (PV) of the funding cash flows (that is, the original balance) matches the original balance of the instrument.

ZDF uses zero coupon factors (derived from the original transfer rates, see the following example) because they are the appropriate vehicles in strip funding (that is, there are no intermediate cash flows between origination date and the date the particular cash flow is received). The zero coupon yield curve can be universally applied to all kinds of instruments.

This approach yields the following formula to solve for a weighted average transfer rate based on the payment dates derived from the instrument's payment data.

Zero Discount Factors =  $y =$

$$100 \times \left[ \frac{B_0 - \sum_{n=1}^N (B_{n-1} \times DTP_n) + \sum_{n=1}^N (B_n \times DTP_n)}{\sum_{n=1}^N (B_{n-1} \times DTP_n)} \right] \times p$$

In this formula:

$B_0$  = Beginning balance at time, 0

$B_{n-1}$  = Ending balance in previous period

$B_n$  = Ending balance in current period

$DTP_n$  = Discount factor in period n based on the TP yield curve

N = Total number of payments from Start Date until the earlier of repricing or maturity

p = Payments per year based on the payment frequency; (for example, monthly payments gives p=12)

Deriving Zero Coupon Discount Factors: An Example

This table illustrates how to derive zero coupon discount factors from monthly pay transfer pricing rates:

Term in Months	(a) Monthly Pay Transfer Rates	(b) Monthly Transfer Rate: (a)/12	(c) Numerator (Monthly Factor): 1+ (b)	(d) PV of Interest Payments: (b)*Sum((f)/100 to current row	(e) Denominator or (1 - PV of Int Pmt): 1 - (d)	(f) Zero Coupon Factor: [(e)/(c) * 100
1	3.400%	0.283%	1.002833	0.000000	1.000000	99.7175
2	3.500%	0.292%	1.002917	0.002908	0.997092	99.4192
3	3.600%	0.300%	1.003000	0.005974	0.994026	99.1053

### Moving Averages

Under this method, a user definable moving average of any point on the transfer pricing yield curve can be applied to a transaction record to generate transfer prices. For example, you can use a 12-month moving average of the 12-month rate to transfer price a particular product.

The following options become available on the user interface (UI) with this method:

- Interest Rate Code: Select the Interest Rate Code to be used as the yield curve to generate transfer rates.
- Yield Curve Term: The Yield Curve Term defines the point on the Interest Rate Code that is used.
- Historical Range: The Historical Range defines the period over which the average is calculated.

The following table illustrates the difference between the yield curve and historical terms.

<b>Moving Average</b>	<b>Yield Curve Term</b>	<b>Historical Range</b>
Six-month moving average of 1 year rate	1 year (or 12 months)	6 months
Three-month moving average of the 6 month rate	6 months	3 months

The range of dates is based on the As of date minus the historical Range plus one, because the historical Range includes the As of date. Oracle Asset Liability Management takes the values of the yield curve points that fall within that range and does a straight average on them.

For example, if As of Date is Nov 21, the Yield Curve Term selected is Daily, and the Historical Range selected is 3 Days, then, the system will calculate the three-day moving average based on the rates for Nov 19, 20, and 21. The same logic applies to monthly or annual yield terms.

## Straight Term

When you select the Straight Term method, the system derives the transfer rate using the last repricing date and the next repricing date for adjustable rate instruments, and the origination date and the maturity date for fixed rate instruments.

### 1. Standard Calculation Mode:

- For Fixed Rate Products (Repricing Frequency = 0), use Yield Curve Date = Origination Date, Yield Curve Term = Maturity Date - Origination Date.
- For Adjustable Rate Products (Repricing Frequency > 0)

For loans still in tease period (tease end date > As of Date, and tease end date > origination date), use Origination Date and Tease End Date - Origination Date.

For loans not in tease period, use Last Repricing Date and Repricing Frequency.

### 2. Remaining Term Calculation Mode:

- For Fixed Rate Products, use As of Date and Maturity - As of Date.
- For Adjustable Rate Products, use As of Date and Next Repricing Date - As of Date.

The following options become available on the application with this method:

- Interest Rate Code: Select the Interest Rate Code to be used for transfer pricing the account.



## Spread from Interest Rate Code

Under this method, the transfer rate is determined as a fixed spread from any point on an Interest Rate Code. The following options become available on the application with this method:

- **Interest Rate Code:** Select the Interest Rate Code for transfer pricing the account.
- **Yield Curve Term:** The Yield Curve Term defines the point on the Interest Rate Code that will be used to transfer price. If the Interest Rate Code is a single rate, the Yield Curve Term is irrelevant. Select Days, Months, or Years from the drop-down list, and enter the number.
- **Lag Term:** While using a yield curve from an earlier date than the Assignment Date, you need to assign the Lag Term to specify a length of time prior to the Assignment Date.
- **Rate Spread:** The transfer rate is a fixed spread from the rate on the transfer rate yield curve. The Rate Spread field allows you to specify this spread.
- **Assignment Date:** The Assignment Date allows you to choose the date for which the yield curve values are to be picked up. Choices available are the As of Date, Last Repricing Date, Origination Date, or TP Effective Date.

## Spread from Note Rate

To generate transfer prices using this method, you need to provide just one parameter: a rate spread. This spread is added or subtracted from the coupon rate of the underlying transaction to generate the final transfer rate for that record.

While entering the rate spread, make sure to input it with the appropriate positive or negative sign, as illustrated in the following table. The first row describes a situation where you are transfer pricing an asset and want to have a positive matched spread for it (the difference between the contractual rate of the transaction and the transfer rate is positive). Here, you need to enter a negative rate spread.

Account Type	Matched Spread	Sign of Rate Spread
Asset	Positive (Profitable)	Negative
Asset	Negative (Unprofitable)	Positive
Liability or Equity	Positive (Profitable)	Positive
Liability or Equity	Negative (Unprofitable)	Negative

## Redemption Curve

This method allows you to select multiple term points from your transfer pricing yield curve and calculate an average transfer rate based on the weights you assign to each term point. The following options become available in the application with this method:

- Interest Rate Code: Select the Interest Rate Code which you want to use as the transfer pricing yield curve.
- Assignment Date: The Assignment Date allows you to choose the date for which the yield curve values will be picked up. Choices available are the As of Date, Last Repricing Date, Origination Date, or TP Effective Date.
- Percentages/Term Points: Defining the Redemption Curve Methodology

## Defining Transfer Pricing Methodologies Using Node Level Assumptions

In Oracle Asset Liability Management, your product portfolio is represented using the Product Dimension specified in your ALM Application Preferences. Node Level Assumptions allow you to define transfer pricing, prepayment, adjustment and other ALM Rule assumptions at any level of the Product dimension Hierarchy. The Product dimension supports a hierarchical representation of your chart of accounts, so you can take advantage of the parent-child relationships defined for the various nodes of your product hierarchies while defining transfer pricing, prepayment, adjustment and other ALM Rule assumptions. Child nodes for which no assumptions have been specified automatically inherit the methodology of their closest parent node. Conversely, explicit definitions made at a child level will take precedence over any higher level parent node assumption.

Node level assumptions simplify the process of applying rules in the user interface and significantly reduce the effort required to maintain business rules over time as new products are added to the product mix. It is also not required for all rules to assign assumptions to the same nodes. Users may assign assumptions at different levels throughout the hierarchy.

### Behavior of Node Level Assumptions

The following graphic displays a sample product hierarchy:

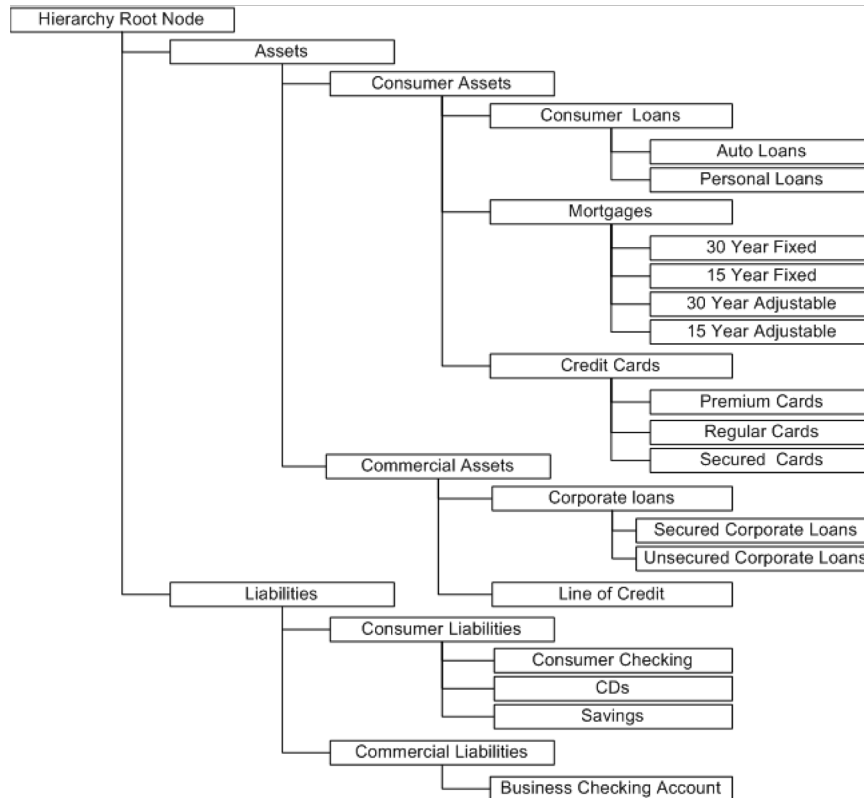

Suppose you want to transfer price this product hierarchy using the Spread from Interest Rate Code transfer pricing method except for the following products:

- Mortgages: You want to transfer price these using the Zero Discount Factors cash flow based method.
- Credit Cards: You want to transfer price all but secured credit cards using the Spread from Note Rate method.

To transfer price in this manner, you need to attach transfer pricing methods to the nodes of the product hierarchy as follows:

- Hierarchy Root Node: Spread from Interest Rate Code
- Mortgages: Zero Discount Factors Cash Flow
- Credit Cards: Spread from Note Rate
- Secured Credit Cards: Spread from Interest Rate Code

The transfer pricing method for a particular product is determined by searching up the nodes in the hierarchy. Consider the Secured Credit Cards in the above example. Since Spread from IRC is specified at the leaf level, the system does not need to search any further to calculate the transfer rates for the Secured Credit Cards. However, for a Premium Credit Card the system searches up the hierarchical nodes for the first node that specifies a method. The first node that specifies a method for the Premium Credit

Card is the Credit Card node and it is associated with the Spread from Note Rate method.

---

---

**Note:** Child nodes for which no assumptions have been specified automatically inherit the methodology of their closest parent node. So if neither a child node nor its immediate parent has a method assigned, the application searches up the nodes in the hierarchy until it finds a parent node with a method assigned, and uses that method for the child node. If there are no parent nodes with a method assigned then the application triggers a processing error stating that no assumptions are assigned for the particular product/currency combination.

---

---

All parameters that are attached to a particular methodology (such as Interest Rate Code) are specified at the same level as the method. If multiple Interest Rate Codes are to be used, depending on the type of the product, the method would need to be specified at a lower level. For instance, if you want to use IRC 211178 for Consumer Products and IRC 3114 for Commercial Products, then the transfer pricing methodologies for these two products need to be specified at the Commercial Products and Consumer Products nodes.

You need not specify prepayment assumptions at the same nodes as transfer pricing methods. For example, each mortgage category can have a different prepayment method while the entire Mortgage node uses the Zero Discount Factors cash flow method for transfer pricing.

## Defining Adjustment Rules

Adjustment Rules allow users to define Transfer Pricing Add-on rates that are assigned incrementally to the base FTP rate to account for a variety of miscellaneous risks such as Liquidity risk or Basis risk or to supplement strategic decision making through use of Pricing Incentives, Breakage Charges or other types of rate adjustments.

Within both the Standard and Stochastic Transfer Pricing Processes, users can select an appropriate Adjustment rule to calculate add-on rates or breakage charges.

Add-on rates can be a fixed rate, a fixed amount, or a formula based rate. Breakage Charges can be a fixed percentage, a fixed amount or can be calculated on an Economic Loss basis. The adjustments are calculated and output separately from the base funds transfer pricing rate, so they can be easily identified and reported. In addition, Adjustments allow you to apply event-based logic through the use of conditional assumptions that are applied or varied only if a specific condition is satisfied.

## Adjustment Methods and Rules

You can use any of the following methods in an Adjustment rule when the selected Adjustment Type is Liquidity Premium, Basis Risk Cost, Pricing Incentive or Other Adjustment:

- Fixed Rate
- Fixed Amount
- Formula Based Rate
- Use TP Method from selected TP Rule

Alternatively, you can use any of the following methods in an Adjustment rule when the selected Adjustment Type is Breakage Charge:

- Economic Loss
- Fixed Amount
- Fixed Percentage

For more information on Breakage Charge, refer to *Oracle Financial Services Funds Transfer Pricing User Guide*.

### Adjustment - Fixed Rate

The screenshot shows the 'Adjustment Rule' configuration interface. The 'Adjustment Type Selection' is set to 'Basis Risk Costs'. Under 'Define Adjustment Rule', 'Selected Product' is 'personal loan' and 'Adjustment Method' is 'Fixed Rate'. Under 'Fixed Rate', 'Reference Term' is 'Original Term' and 'Lookup Method' is 'Range'. The 'Parameters' table has one row with 'Term' '12 Months', 'Operator' '>=', and 'Rate' 'Months'. 'Apply' and 'Cancel' buttons are at the bottom.

Operator	Term	Multiplier	Operator	Term	Multiplier	Rate
>=	12 Months			Months		

The Fixed Amount Adjustment method allows the user to associate an amount with specific terms or term ranges. Reference term selections include

- Repricing Frequency: The fixed amount is matched to the specified reprice frequency of the instrument. If the instrument is fixed rate and, therefore, does not have a reprice frequency, the fixed amount lookup happens based on the original term of the instrument.
- Original Term: The calculation assigns the fixed amount based on the original term on the instrument.

- Remaining Term: The calculation assigns the fixed amount based the remaining term of the instrument.

The remaining term value represents the remaining term of the contract and is expressed in days.

Remaining Term = Maturity Date – As of Date

- Duration (read from the TP\_DURATION column): The calculation assigns the fixed amount based on the Duration of the instrument, specified in the TP\_DURATION column.
- Average Life (read from the TP\_AVERAGE\_LIFE column): The calculation assigns the fixed amount based on the Average Life of the instrument, specified in the TP\_AVG\_LIFE column.

You can create your own reference term ranges and assign a particular adjustment amount to all instruments with a reference term falling within the specified range.

---



---

**Note:** All adjustment rates should be input as annual rates.

---



---

## Adjustment - Fixed Amount

The Fixed Amount Adjustment method allows the user to associate an amount with specific terms or term ranges. Reference term selections include:

- Repricing Frequency: The calculation retrieves the rate for the term point equaling the reprice frequency of the instrument. If the instrument is fixed rate and, therefore, does not have a reprice frequency, the calculation retrieves the rate associated with the term point equaling the original term on the instrument.
- Original Term: The calculation retrieves the rate for the term point equaling the original term on the instrument.
- Remaining Term: The calculation retrieves the rate for the term point corresponding to the remaining term of the instrument. The remaining term value

represents the remaining term of the contract and is expressed in days. Remaining Term = Maturity Date – As of Date

- Duration (read from the TP\_DURATION column): The calculation retrieves the rate for the term point corresponding to the Duration of the instrument, specified in the TP\_DURATION column.
- Average Life (read from the TP\_AVERAGE\_LIFE column): The calculation retrieves the rate for the term point corresponding to the Average Life of the instrument, specified in the TP\_AVG\_LIFE column.

You can create your own reference term ranges and assign a particular adjustment amount to all instruments with a reference term falling within the specified range.

---

**Note:** All adjustment amounts should be input in base currency for the selected product / currency combination.

---

## Adjustment - Formula Based Rate

The Formula Based Rate Adjustment method allows the user to determine the add-on rate based on a lookup from the selected yield curve, plus a spread amount and then the resulting rate can be associated with specific terms or term ranges. Reference term selections include:

- Repricing Frequency: The calculation retrieves the rate for the term point equaling the reprice frequency of the instrument. If the instrument is fixed rate and, therefore, does not have a reprice frequency, the calculation retrieves the rate associated with the term point equaling the original term on the instrument.
- Original Term: The calculation retrieves the rate for the term point equaling the original term on the instrument.
- Remaining Term: The calculation retrieves the rate for the term point corresponding to the remaining term of the instrument. The remaining term value represents the remaining term of the contract and is expressed in days.

Remaining Term = Maturity Date – As of Date

- Duration (read from the TP\_DURATION column): The calculation retrieves the rate for the term point corresponding to the Duration of the instrument, specified in the TP\_DURATION column.
- Average Life (read from the TP\_AVERAGE\_LIFE column): The calculation retrieves the rate for the term point corresponding to the Average Life of the instrument, specified in the TP\_AVG\_LIFE column.

You can create your own reference term ranges and assign a particular formula based adjustment rate to all instruments with a reference term falling within the specified range.

With this method you also specify the Interest Rate Code and define an Assignment Date for the Rate Lookup. The Interest Rate Code can be any IRC defined within Rate Management, but will commonly be a Hybrid IRC defined as a Spread Curve (e.g. Curve A – Curve B).

Assignment Date selections include:

- As of Date
- Last Repricing Date
- Origination Date
- TP Effective Date
- Adjustment Effective Date
- Commitment Start Date

The formula definition is comprised of the following components

**Term Point:** Allows you to associate a specific term point from the IRC to each Term Range.

**Coefficient:** Allows you to define a multiplier which is applied to the selected rate.

**Rate Spread:** Allows you to define an incremental rate spread to be included on top of the IRC rate.

The resulting formula for the adjustment rate is: (Term Point Rate \* Coefficient) + Spread



Parameters						
	Operator	Term	Operator	Term	Multiplier	Formula
<input checked="" type="checkbox"/>	>=		0 <=		12 Months	(3M*10)+0.00

**Note:** For increased precision, you can reduce the Term Ranges to smaller term increments allowing you to associate specific IRC rate tenors with specific terms.

### Adjustment – Use TP Method from Selected TP Rule

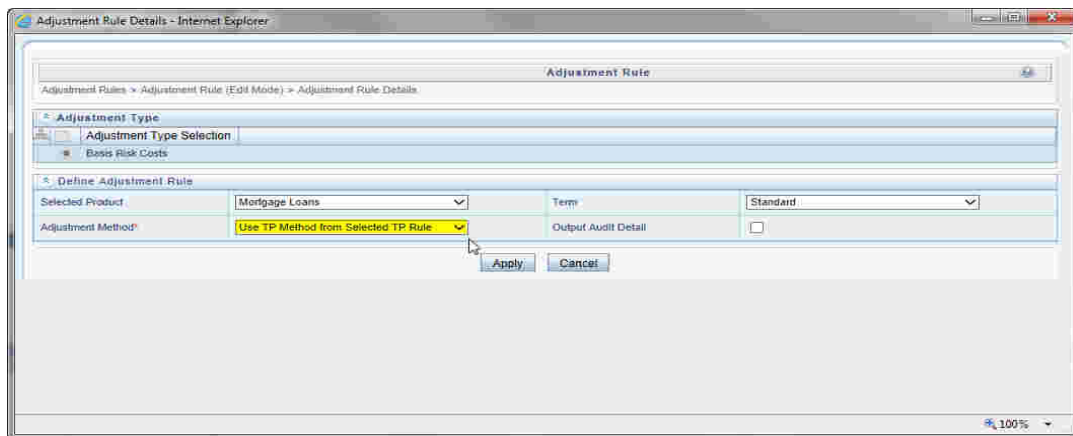

The “Use TP Method from Selected TP Rule” selection allows the user to calculate the add-on rate based on any TP method available in the selected Transfer Pricing Rule.

Users have the option to attach any Transfer Pricing Rule on the Adjustment Rule summary page, separately for each type of add-on rate. The TP Methods mapped to product hierarchy members in the TP Rule will be read during the adjustment rate calculation process and will be applied during calculation of the Adjustment Rate(s). Outputs will be written to the respective Adjustment Rate column, e.g. Basis Risk Cost Rate, Liquidity Premium Rate, Pricing Incentive Rate or Other Adjustment Rate.

Adjustment Type	Folder	Transfer Pricing Rule
<input type="checkbox"/> Basis Risk Costs	OFSPFTSEG	CS TP Rule 1 (for testing)
<input checked="" type="checkbox"/> Liquidity Adjustment	OFSPFTSEG	CS TP Rule 1 (for testing)

## Defining Transaction Strategies

With Transaction Strategies, you can test the impact of various hedging strategies that are integrated with basic scenario modeling assumptions. This supports you in testing alternative strategies and their incremental impact on results. The testing is facilitated by the separation of transaction strategies from basic scenario assumptions. You can also use this business rule to add specific instrument records to a processing run without changing the actual instrument data.

A transaction can be either positive or negative and can be defined for any product leaf member. A Transaction Strategy assumption rule can contain any number of individual transactions.

## Defining Formula Results

With Formula Results, you can model deterministic results for a specific product leaf using the results of the cash flow, gap, and market value processes to recalculate and change system-generated data. You can also use this capability to model results for a product leaf outside of the cash flow engine, using formulas to create outputs.

For example, you may want to model the ending balance of a particular account as 110% of the ending balance of a second account. You can also calculate non-interest income and expense amounts as percentages of new volumes. These relationships are defined in Formula Results.

There are four formula types:

- Cash flow
- Repricing Gap
- Liquidity Gap
- Market Value

## **(Mandatory – Stochastic) Defining Stochastic Rate Indexing Rules**

The Stochastic Rate Indexing rule is a required assumption rule, that you select within a Stochastic ALM Process to calculate Value at Risk and Earnings at Risk.

The purpose of the Stochastic Rate Indexing Rule is to establish relationships between a risk-free Interest Rate Code (IRCs) and other interest rate codes or Indexes used for re-pricing existing business and pricing new business. The Stochastic Rate Indexing rule allows you to select the valuation curve that the system uses during stochastic processing. The Rate Index rule provides full support for multi-currency processing by allowing you to select one valuation curve per currency supported in your system.

During stochastic ALM processing, the system generates future interest rates for the valuation curve you selected, which are then used to derive the future interest rates for any Index associated to that valuation curve based on the relationship you define. The rates thus forecasted for the IRCs or Indexes depend on the risk-free curve used for valuation of instruments associated with the derived IRCs or Indexes. As the risk-free rates change, the non risk-free interest rates change accordingly.

## **(Mandatory) Defining and Running the Asset Liability Management Process**

When all of the assumptions for a forecast are defined, users can define and execute ALM Processes where they combine the relevant assumptions into an ALM simulation run. ALM Processes initialize all selected assumption data and call the cash flow engine to execute the selected calculation processes and generate a results set. An ALM Process requires specific inputs based on the ALM Process type, including:

- Product Hierarchy / Data Source selection
- Calculation Elements
- Process Assumption Rules
- Output Preferences
- Audit Preferences
- Processing Parameters

Defining options within each of these pages and saving the process, creates a unique Process Identifier for individual forecasting objectives. Results from each process run are optionally stored in the ALM BI schema and become available for ALM reporting.

## **Reviewing Processing Errors**

There is always the possibility that errors may occur during the execution of an ALM Process. A log of such errors is generated during processing and can be accessed by selecting the "View Log" link from both the Standard and Stochastic ALM Process summary pages.

Within this log, the report lists the specific transaction for which an error was generated and provides the internally generated identifier of the ALM Process that generated it.

As part of the rectification process, it is advisable to determine what caused the error and what should be done to correct it for the next run.

## Accessing Asset Liability Management, Detail Cash Flow Results for Audit Purposes

Detailed cash flow results for individual account records can be written to an audit table for validation purposes. If you select the Detailed Cash Flows audit option on the ALM Process - Audit Block, the detailed cash flow results are written to the FSI\_O\_PROCESS\_CASH\_FLOWS table.

Application Preferences > Maximum Number of Instrument Records to Include in Detail Cash Flow Output

## Accessing Asset Liability Management, Interest Rate Audit Results

Forecast Rates, Implied Forward Rates and Stochastic - 1 Month Rates can be written to an audit table to facilitate validation of results and for reporting and analysis in ALM BI.

Within the ALM Process - Audit Block, selecting the Forecast Rates option allows you to output the interest rates, currency rates and economic indicator values for each scenario used in your ALM simulation run.

---

---

**Note:** When running a stochastic ALM process, because 360 one-month rates are written out for each rate path, selecting the rate output option will result in a large amount of rate data being written to the Interest Rates Audit table.

Both the Deterministic – Forecast Rates and the Stochastic One Month Rates audit results are written to the FSI\_INTEREST\_RATES\_AUDIT table.

---

---

## Analyzing Results

You should always analyze results obtained from the ALM Engine. For example, you should review the forecast rate – audit information to ensure that the new business rates and resulting interest accruals have been generated correctly for each scenario.

In addition, you should review both your beginning balances and resulting balances in each forecast period as well as your scenario specific behavioral assumptions to verify that assumptions have been defined and applied correctly.

This type of review is typically performed by analyzing the seeded reports delivered as part of the ALM Business Intelligence application. Many times however,

administrators and power users will need to analyze data and confirm processing results by running queries directly against the relational data prior to releasing reports for analysis through Oracle Business Intelligence.

The following relational database tables are populated with ALM Static Deterministic and Dynamic Deterministic process results and can be queried directly by a SQL query tool such as Oracle SQL Developer:

Table Name	Description	sample SQL query
Result Master	Static and point in time information such as current balance, current rate, current transfer rate, yield to maturity, market value, duration, DV01, and convexity are stored in this table for each Product COA member included in the process, for all scenarios associated with the process. Result Master data is stored in original / base currency.	select * from fsi_o_result_master where result_sys_id=xxxxxx order by start_date_index, scenario_num, product_id;
Result Detail	Cash flow results are stored in result detail and are spread across columns based on the "active" time bucket rule used when the process was run. Each row of data represents a distinct Financial Element such as Beginning Balance, Average Balance, Ending Balance, Interest Cash Flow, Principal Cash Flow, etc. Result Detail data is stored in original / base currency.	select * from res_dtl_xxxxxx order by start_date_index, scenario_num, product_id, financial_elem_id, result_type_cd;
Consolidated Master	The Consolidated Master table is populated only when processing data containing multiple currencies and the "Consolidate to Reporting Currency" option is selected. The data in this table will be expressed in a single designated currency (reporting currency), but will otherwise have the same structure as described above for Result Master.	select * from fsi_o_consolidated_master where result_sys_id=xxxxxx order by start_date_index, scenario_num, product_id;
Consolidated Detail	The Consolidated Detail table is populated only when processing data containing multiple currencies and the "Consolidate to Reporting Currency" option is selected. The data in this table will be expressed in a single designated currency (reporting currency), but will otherwise have the same structure as described above for Result Detail.	select * from cons_dtl_xxxxxx order by start_date_index, scenario_num, product_id, financial_elem_id, result_type_cd;

The following relational database tables are populated with ALM Static Stochastic and Dynamic Stochastic process results:

Table Name	Description	sample SQL query
Stochastic VaR	VaR results are output and stored in this table for each Product COA member included in the process.	select * from fsi_o_stoch_var where tm_process_sys_id = xxxxxx order by leaf_node, probability;
Stochastic Total VaR	VaR results are output and stored at the portfolio level in this table.	select * from fsi_o_stoch_tot_var where tm_process_sys_id = xxxxxx order by probability;
EAR Leaf Average	Earnings at Risk results are output and stored at the Product COA level as an average amount across all of the selected rate paths.	select * from ear_leaf_avg_xxxxxx order by end_date, leaf_node;
EAR Leaf Detail	Earnings at Risk results are output and stored at the Product COA level for each rate path selected in the process.	select * from ear_leaf_dtl_xxxxxx order by rate_path_num, end_date, leaf_node;
EAR Total Average	Earnings at Risk results in this table are aggregated to include only net interest income and net income and are shown as an average amount across all the selected rate paths.	select * from ear_total_avg_xxxxxx order by end_date;
EAR Total Detail	Earnings at Risk results in this table are aggregated to include only net interest income and net income and shown for each rate path.	select * from ear_total_dtl_xxxxxx order by rate_path_num, end_date;

---

**Note:** During Stochastic processing, if source data is expressed in multiple currencies, it is converted to reporting currency at the start of processing.

---

## Re - processing Erroneous Accounts

While reviewing your results, you might discover accounts with invalid results that need to be reprocessed. Oracle ALM Processes allow you to rerun a subset of information to make corrections to appropriate products when needed.

If you need to reprocess a portion of your instrument data, make sure that you reprocess all the Product dimensions members, across all instrument tables where relevant data exists.

## Consolidation of Results

Many times users have to create multiple ALM processes to meet various functional and non-functional requirements. Once executed the results generated in ALM are

identified by different system ids. For the purpose of reporting, users may want to combine the result sets from multiple processing runs.

The manner in which results from multiple ALM processes can be merged is described in chapter Consolidation of Results in *Oracle Financial Services Cash Flow Engine Reference Guide*.





---

---

## Common Rule Management Tasks

This section focuses on the rule management tasks that are common across all rules in this application.

This chapter covers the following topics:

- [Overview of Common Rule Management Tasks](#)
- [The Rule Summary Page](#)
- [Searching for Rules](#)
- [Creating Rules](#)
- [Viewing and Editing Rules](#)
- [Copying Rules](#)
- [Deleting Rules](#)
- [Dependency Checking](#)

### Overview of Common Rule Management Tasks

The rule management tasks that are common to business rules in this and other OFSAA applications are as follows.

- The Rule Summary Page
- Searching for Rules
- Creating Rules
- Viewing and Editing Rules
- Copying Rules
- Deleting Rules

---

**Note:** You can perform these tasks from the Summary page for the type of rule with which you are working. Depending on the rule type, some tasks might not be available.

---

The procedures for carrying out these tasks are the same for each rule type, except for rule-specific steps explicitly stated in the rule-specific documentation.

## The Rule Summary Page

The Rule summary page is the gateway to all rules and related functionality of the application. From there, you can navigate to other related pages. On the header of the Rule summary page, you can perform simple queries on Folder, Rule Name and in many cases, the dimension upon which the rule is based.

The following table shows the page components.

**Table 8-1**

<b>Name</b>	<b>Type</b>	<b>Default Value</b>	<b>Required/Optional</b>	<b>Updatable</b>	<b>LOV, additional information</b>
Folder	Drop Down	Set in Application Preferences	Required - for filtering the rules under the folder	No – Only able to select from presented list.	N/A
(Rule) Name	Text Box	None	Optional – for filtering the rules on Rule Name	Yes	You can specify all or part of a rule name. For example, if you want to see only those Rules which start with 'A' – Enter A in the text field.
Dimension	Drop Down	Set in Application Preferences		No - Only able to select from presented list	N/A
Search	Button	N/A	N/A	No	Initiates rule search based on specified criteria.
Reset	Button	N/A	N/A	No	Restores default search criteria.
Add	Button	N/A	N/A	No	Initiates the Data or Ledger Loader rule creation process
(Rule) Name	Display Value	N/A	N/A	No	Mouseover shows the rule description and in some cases also displays the unique system ID number.
Created By	Display Value	N/A	N/A	No	Who created the Rule version.
Creation Date	Display Value	N/A	N/A	No	When was the rule created.

**Table 8–1**

<b>Name</b>	<b>Type</b>	<b>Default Value</b>	<b>Required/Optional</b>	<b>Updatable</b>	<b>LOV, additional information</b>
Last Modified By	Display Value	N/A	N/A	No	Who last modified the rule.
Last Modified Date	Display Value	N/A	N/A	No	When the rule was last modified.
View	Icon	N/A	N/A	N/A	Opens the selected rule in read only mode.
Edit	Icon	N/A	N/A	N/A	Opens the selected rule in edit mode.
Delete	Icon	N/A	N/A	N/A	Deletes the selected Rule.
Copy	Icon	N/A	N/A	N/A	Initiates process for copying rules. Explained later in this document.
Run	Button	N/A	N/A	N/A	Initiates process for running Rules. Explained later in this document.
Pagination Options	Icon	Set in Global Preferences	N/A	N/A	Indicates the number of rows to display per page in the summary table.

## Searching for Rules

Search for a business rule to perform any of the following tasks:

- Update, Copy, delete or run existing rules
  - Define methodologies for products or define other processing assumptions
1. Navigate to the rule summary page for the appropriate rule type.
  2. Search for the rule, as follows:
    1. Select the folder in which the rule is stored.
    2. (Optional) Enter the name of the rule.
    3. Click Search.

Only rules that match the search criteria are displayed.

For more information, see [Overview of Common Rule Management Tasks](#) section.

## Creating Rules

You create a rule to specify the way you want a particular task or business process to be carried out by the application. Creating a rule is a process, in which you specify the properties for the rule itself.

To create a new Rule, perform the following procedure:

1. Navigate to the summary page of the Rule you want to create.
2. Click Add to display the rule definition page.
3. Enter a name for the rule.

The name of a rule must be unique within the selected folder for each rule type.

4. Select the folder in which you want to store the rule.
5. (Optional) Enter a description for the rule.
6. Select the required access for other users.
7. Click Apply or Save, depending on the rule type.
8. Specify any other properties or options that may apply for the rule that you are creating.

## Viewing and Editing Rules

You can view existing rules, and you can edit existing rules, provided you have read/write privileges.

To view and edit a Rule, perform the following procedure:

1. Navigate to the summary page of the Rule you want to update.
2. Search for a Rule. For further information, see [Searching for Rules](#) section.
3. Select the appropriate rule and click **Edit** to open the rule you want to update.
  1. Update the Name or Description.
  2. Click **Apply** or **Save**, depending on the Rule type.

## Copying Rules

You can copy rules to avoid having to enter data multiple times. This saves time and effort and also reduces mistakes.

To copy a Rule, perform the following procedure:

1. Navigate to the summary page of the Rule you want to copy.
2. Search for a Rule. For further information, see [Searching for Rules](#) section.
3. Select the appropriate Rule and click **Copy** corresponding to the Rule that you want to duplicate.
4. Select a folder.
5. Enter a unique name for the new Rule.
6. (Optional) Enter a brief description for the rule.
7. Select the access type.
8. Click **Save**.

## Deleting Rules

You can delete rules that are no longer needed.

---

**Note:** Once deleted, a rule cannot be retrieved.

---

Restrictions on deleting rules are:

- You cannot delete rules if you have only Read privileges. Only users with read/write privilege and rule owners can delete rules.
- You cannot delete a rule that has dependency.

To delete a Rule, perform the following procedure:

1. Navigate to the summary page of the Rule you want to delete.
2. Search for a Rule. For further information, see [Searching for Rules](#) section.
3. Select the appropriate Rule and click the **Delete** icon.

For more information, see [Overview of Common Rule Management Tasks](#) section.

## Dependency Checking

You can check dependencies for rules to know where a particular rule, dimension, member, attribute, IRC has been used. Also, this prevents accidental deletion of rules having dependencies.

To check dependency of a Rule, perform the following procedure:

1. Navigate to the summary page of the Rule you want to check dependencies.
2. Search for a Rule. For further information, see [Searching for Rules](#) section.
3. Select the appropriate rule(s) and click check dependencies corresponding to the rule that you want to check for.

---

**Note:** You can select more than one rule at a time to check dependencies.

---

The Dependency Information window opens containing the following information: Child object Name, Child Object Type, Folder, Parent Object Name, Parent Object Type, Folder.

### **Example 8-1**

If a Product Characteristics rule 'A' which has been used in a static deterministic process 'P' is checked for dependencies, then the following information is displayed in the Dependency Information window.

Child object Name –A

Child Object Type – Product Characteristics

Folder – The folder name in which A resides

Parent Object Name - P

Parent Object Type – Static Deterministic Process

Folder - The folder name in which P resides

---

**Note:** You cannot delete a child object which has dependencies. You will get a message: Dependencies found. Cannot delete.

In order to delete the child, you must first delete the outermost parent object which uses the child.

---

---

---

# Application Preferences

This module discusses the Procedure for defining and maintaining your ALM Application Preference settings.

This chapter covers the following topics:

- [Overview of Asset Liability Management Application Preferences](#)
- [Updating Asset Liability Management Application Preferences](#)

## Overview of Asset Liability Management Application Preferences

Application Preferences allow both Administrators and End Users to establish default values and to manage other core application parameters that affect the way business rules are created and the way Asset Liability Management Processes are run.

The procedure for working with and managing Application Preferences includes the following steps:

Updating Application Preferences.

Asset Liability Management > Application Preferences

## Updating Asset Liability Management Application Preferences

Navigate to Asset Liability Management Application Preference to update your preference items.

The following table describes each of the Asset Liability Management Preference items.

Term	Description
Show Preferences For	<p>There are two modes in which you can access Application Preferences: Administrator: If the user has Administrator privileges, he can define preferences for the “All User” group and for his own personal account, which may be the same or different from the “All User” settings. The Administrator can also designate the “All User” preferences as Editable or Non-editable on a row by row basis. If the individual preference is checked as “ is Editable”, then End Users can update or override the Administrator's default value for their own individual account. If the “is editable” box is not checked, then End Users are not able to change the default for their own account. End User: If the user does not have administrator privileges, then certain preference items may have been pre-set by the administrator and the user may not be allowed to change the value. All Application Preference settings are displayed, regardless of access privilege</p>
Active for Master Maintenance	<p>If a user has more than one application available on their Left Hand menu, then they will need to designate Application Preferences from one of their applications as “Active for Master Maintenance”. Certain preferences such as the default folder and read / write access setting will be referenced by items within Master Maintenance based on this selection.</p>
Security Map	<p>This option allows you to select an existing security map. Security Maps can be used to control the dimensions and dimension members each user can access when building and executing rules. For more information on Security Mapping refer to Oracle Financial Services Analytical Applications Infrastructure (OFSAAI) User Guide Release 8.0.</p>
As of Date	<p>All processes reference this date at run time to determine the data to include in the process. The As-of-Date value you set in Application Preferences applies to interactive job execution (i.e., when you choose to execute a rule directly from a Summary screen). For batch processing, the As-of-Date is a derived from the Information Date.</p>
Show Execution Parameters	<p>If this option is selected, a pop-up window appears whenever you execute a process interactively from a Summary screen. Within this pop-up window, you may confirm or modify your run execution parameters (As-of-Date and Legal Entity).</p>
Legal Entity	<p>Similar to As-of-Date, all processes reference Legal Entity at run time to determine the data to include in the process. The value of Legal Entity you set in Application Preferences applies to interactive job execution (i.e., when you choose to execute a process directly from a Summary screen) and batch processing (i.e., when you choose to execute a process from Simplified Batch).            Note: Legal Entity is designed to support implementations that require multi-entity or multi-tenant functionality. For details, see Appendix: Multi-Entity. If your implementation does not require this functionality, you may utilize the Default Legal Entity in all your processes.            No additional parameter is required for Legal Entity for command line execution. EPM Engines read the default Legal Entity from the Application preference value saved for the User who is executing from command line. The default legal entity is a per user preference setting. To set this, the following steps are required:</p>



Term	Description
	<p>Create a security-map in AAI containing the legal-entity hierarchy as an app-admin.</p> <p>Set the default security-map in a user preferences.</p> <p>Navigate to "execution parameters" block in user-preferences and choose the default legal-entity member.</p> <p>If you do not want to use the Multi-Entity feature with Security, you need to save the Application preference for the user executing the batch. The usual choice for Legal Entity would be Default Member in Application preferences.</p> <p>Default implies -1 code.</p> <p>Default value for Legal Entity dimension column in all instrument and ledger table is -1</p>
Disable Legal Entity	<p>If the "Disable Legal Entity" checkbox in application preferences screen is checked, then Legal Entity will no longer be a run time parameter. This is an optional parameter.</p>
Default Total Error Message Limit	<p>ALM Processes log error details into the FSI_PROCESS_ERRORS table. This parameter defines the limit on the total number of errors that will be logged for any ALM Process.</p>
Default Error Message Limit Per Item	<p>This parameter defines the total number of errors that will be logged for a given type of error.</p>
Debugging Output Level	<p>The debugging output level determines the amount of sql that will be written to the processing log. There are three levels available:</p> <p>Do not output SQL to log file: A log file will not be created.</p> <p>Show Significant Calculation SQL: Log file is created and will contain those SQLs that are tagged as significant.</p> <p>Show all SQL: Log file is created and will contain all the SQL that the engines execute.</p> <p>The log files can be accessed by the system administrator in the following location on the server:</p> <p>\$FIC_HOME/ficdb/log/FusionApps/ folder</p> <p>The file names will be prefixed with the application initials and will also contain the unique batch run id of the execution request.</p> <p>for example: ofsrn.&lt;batch-run-id&gt;.log</p>
Maximum Number of Instrument Records to Include in Detail Cash Flow Output	<p>This parameter allows administrators to define the maximum number of instrument records that any user can select within a process for outputting detailed cash flows. In Oracle ALM, there is no limit for this value. If you wish to remove the limit, you can leave the setting blank and upon selecting APPLY, you will notice "No Limit" text will appear. It is recommended however, that this value be set to 100 or less.</p>
Maximum Number of Rate Paths for Monte Carlo Processing	<p>This parameter allows administrators to limit the number of rate paths that can be selected by a user when running a monte carlo based process. The maximum value is 2,000.</p>
Random Number Generation Seed Method	<p>Determines the type of random number generation seed method for Monte Carlo processing. Selections include Fixed Seed (default) and Variable Seed.</p>
Initial Seed Value	<p>The Initial seed value input is available when the Seed Value Method is Fixed Seed. The default value is zero.</p>

Term	Description
Enable Holiday Calendar Adjustments	<p>Select this option to enable the Holiday Calendar Adjustment capability for the ALM Application. If this option is not selected, the ALM Cash Flow Engine will ignore all Holiday Calendar information, including instrument level inputs and assumption rule level inputs.</p> <p>Logic for applying Holiday Calendar assumptions is as follows:</p> <p>If Application Preferences – Enable Holiday Calendar Adjustments is checked, then the CFE will handle Holiday Calendar assumptions based on the Account Level values first.</p> <p>If Application Preferences – Enable Holiday Calendar Adjustments is checked but Holiday Calendar inputs are not defined at the Account Level, then the CFE will refer to the Product/Currency assumptions (TP rule and Adjustment rule).</p> <p>If Application Preferences – Enable Holiday Calendar Adjustments is checked and Holiday Calendar inputs are defined at both the Account Level and Product/Currency Assumption level, then the CFE will refer to the Account level inputs.</p> <p>If Application Preferences – Enable Holiday Calendar Adjustments checkbox is off, then no Holiday Calendar assumptions will be applied regardless of data or Product/Currency Holiday Calendar definitions. Data that specifies Bus/252 accrual basis will get processed as Actual/Actual, and a process error message will be populated: Invalid record: BUS/252 Accrual Basis is selected and no Holiday Calendar is defined. Defaulted to ACT/ACT leaf member.</p>
Folder Name	<p>This parameter allows you to define the default folder selection. The folder selection for all rule types will be defaulted to this selection within the summary page search screen and when creating a new rule. This selection acts as the starting value for convenience only and users can change to any other available value at their discretion.</p>
Access Type	<p>This parameter allows you to set the default access type setting. Selections include Read / Write and Read Only. This selection acts as the starting value for convenience only and users can change at their discretion.</p>
Initial Currency Selection ("Business Rule Currency")	<p>This parameter allows you to select the starting currency to be displayed within all business rules. This selection is made for convenience and can be changed within all business rules at the users' discretion.</p>
Product Dimension	<p>Oracle ALM requires users to declare one of the "Product" dimensions as the ALM Product dimension. The model is seeded with 3 possible selections:</p> <ul style="list-style-type: none"> <li>Product</li> <li>Common COA</li> <li>GL Account</li> </ul>

Term	Description
Default Product Hierarchy	<p>Users can also add user defined product dimensions, which would also appear in the above list. ALM business rules are based on the Product dimension selected here. The suggested default is the "Product" dimension.</p> <p><b>Note:</b> If Process is using Product Dimension as "Product", do not use Default Product Member (value of -1) within process.</p>
Organizational Unit Dimension	<p>The list of values for Default Product Hierarchy is based on the Default Product Dimension selection. The hierarchy selected here will be the default hierarchy selection in all business rules that support node level assumptions. This selection acts as the starting value for convenience only and users can change at their discretion within each business rule.</p> <p>Org Unit ID is the standard organizational dimension in the OFSAA relational data model and is intended to equate to the organizational dimension found in the General Ledger (e.g., Cost Center, Responsibility Center, Department, etc). Unless Users have defined additional Organizational dimensions, the Organizational Unit Dimension is set by default to Org Unit ID. For details on adding new key processing dimensions, see Adding Dimension Tables and Key Dimension (Leaf) Registration in the OFSAA Data Model Utilities Guide. If Users have defined additional Organizational dimensions, then they may select any Org type dimension to serve as their Organizational Unit Dimension.</p>
Hierarchy Members Navigation Size	<p>This parameter allows you to specify the maximum number of members that a parent node within a Hierarchy or Assumption Browser can show at a given time. When you expand a branch in a Hierarchy or Assumption Browser and the number of members in that branch exceed the specified Navigation Size, it will provide "More" and "Previous" options to enable you to navigate through the member list. Note: Recommended values for Navigation Size are 50 to 100. Higher value settings could impact screen refresh performance. The UI allows you to enter a value up to 10000.</p>
Autobalancing Leaves	<p>Autobalancing leaves allow you to assign dimension members to the various elements of the Autobalancing process. Autobalancing in ALM is commonly used when running simulation scenarios that require the balance sheet to remain in balance throughout the forecast horizon. The following Leaf types require dimension member assignments in order for the autobalancing process to run:</p> <ul style="list-style-type: none"> <li>Purchase of overnight funds to fill in cash shortfalls or sale of overnight funds to invest excess cash:</li> <li>Assets</li> <li>Liabilities</li> <li>Roll net income into retained earnings</li> <li>Retained Earnings</li> <li>Pay Dividends</li> <li>Dividends</li> <li>Pay Federal and Local Tax</li> <li>Federal Taxes</li> <li>State Taxes</li> <li>Accumulate unrealized currency gains/losses in equity</li> </ul>

Term	Description
	<p>Accumulated Translation Balance</p> <p>Note: All product COA dimension members mapped for use in autobalancing must have the correct account type attribute (via Common COA mapping) and all components must be mapped in order for the process to run. Also note that each autobalancing element should have a unique dimension member assignment.</p> <p>Mapping of Dimension members:</p> <p>Select the Product Hierarchy.</p> <p>Identify the Autobalancing Leaf type and select the product member using the Hierarchy Browser.</p> <p>Define the Product Characteristics for the above selected product member.</p> <p>During the processing, select the Product Characteristics definition for which autobalancing is defined.</p> <p>Note: Also, Autobalancing Leaves option (ALM Processing-&gt; Processing Parameters) should be selected.</p>
ADCO Parameters:	
National Housing Price Index (NHPI)	<p>This is an input parameter for ADCo definition purpose, that the user has to select from the drop-down list containing the list of all economic indicators defined from Rate Management. The user is required to set up a NHPI economic index as if they desire to override the base Adco NHPI forecast. This is an optional step, in the setting up of an ADCO process.</p>

1. Navigate to the Asset Liability Management Application Preferences page.

**Application Preferences**

⌵ Select Preferences For

Show Preferences For: ALMUSER ▼

Active for Master Maintenance:

⌵ Parameters - General

Property Name	Property Value	Is Editable
Security Map	None ▼	
As of Date	06/25/2014	<input checked="" type="checkbox"/>
Show Execution Parameters	<input checked="" type="checkbox"/>	<input checked="" type="checkbox"/>
Runtime Parameters	Leaf Description	
Legal Entity	<input type="text"/>	<input type="checkbox"/> Disable Legal Entity

⌵ Processing - General

Property Name	Property Value	Is Editable
Default Total Error Message Limit	250	<input checked="" type="checkbox"/>
Default Error Message Limit Per Item	25	<input checked="" type="checkbox"/>
Debugging Output Level	Do not output SQL to log file ▼	<input checked="" type="checkbox"/>

⌵ Processing - Application Specific

Property Name	Property Value	Is Editable
Maximum Number of Instrument records to include in detail cash flow output	10	<input checked="" type="checkbox"/>
Maximum Number of Rate Paths for Monte Carlo Processing	10	<input checked="" type="checkbox"/>
Random Number Generation Seed Method	Fixed Seed ▼	<input checked="" type="checkbox"/>
Initial Seed Value	0	
Enable Holiday Calendar Adjustments	<input type="checkbox"/>	<input checked="" type="checkbox"/>

⌵ Assumption Management Defaults

Property Name	Property Value	Is Editable
Folder Name	ALMSEC ▼	<input checked="" type="checkbox"/>
Access Type	<input type="radio"/> Read Only <input checked="" type="radio"/> Read/Write	<input checked="" type="checkbox"/>
Initial Currency Selection ["Business Rule Currency"]	US Dollar ▼	<input checked="" type="checkbox"/>

⌵ Dimensions and Hierarchies

Property Name	Property Value	Is Editable
Product Dimension	Common Chart of Accounts ▼	<input checked="" type="checkbox"/>
Default Product Hierarchy	AUTOD_CCA_01 ▼	<input checked="" type="checkbox"/>
Organizational Unit Dimension	Organizational Unit ▼	<input checked="" type="checkbox"/>
Hierarchy Members Navigation Size	100	<input checked="" type="checkbox"/>

⌵ Autobalancing Leaves

Property Name	Property Value	Is Editable
Product Hierarchy	▼	<input checked="" type="checkbox"/>
Type of Leaf	Leaf Description	
Assets	<input type="text"/>	
Liabilities	<input type="text"/>	
Retained Earnings	<input type="text"/>	
Dividends	<input type="text"/>	
Federal Taxes	<input type="text"/>	
State Taxes	<input type="text"/>	
Accumulated Translation Balance	<input type="text"/>	

⌵ ADCO Parameters

Property Name	Property Value	Is Editable
National Housing Pricing Index	▼	<input checked="" type="checkbox"/>

2. Input values for all line items.

---

---

**Note:** If you are the application administrator, define default values for the “All User” group by making the appropriate selection from the “Show Preference For”, drop list at the top of the page. Pay particular attention to the “Is Editable” status and determine which items require administrative control and which items non-administrative users will be able to set for themselves.

---

---

3. Select Apply to confirm changes
4. Select the Reset to Default option if you would like to clear all previously applied inputs and return to the original default state.

---

---

## Cash Flow Edits

This module discusses the procedure for validating and cleansing your Instrument table data before you process it to generate cash flow based results.

This chapter covers the following topics:

- [Overview of Cash Flow Edit Processes](#)
- [Creating Cash Flow Edit Processes](#)
- [Executing Cash Flow Edit Processes](#)

### Overview of Cash Flow Edit Processes

Cash Flow Edit processes allow you to verify the accuracy and check the completeness of your Instrument table data.

---

---

**Note:** Cash Flow Edits do not support the Derivatives tables.

---

---

The procedure for working with and managing a Cash Flow Edit process is similar to that of other Oracle Funds Transfer Pricing and Oracle Asset Liability Management Processes. It includes the following steps:

- Searching for Cash Flow Edit processes. For more information [Searching for Rules](#) section.
- Viewing and Updating Cash Flow Edit processes. For more information, see [Viewing and Editing Rules](#) section.
- Copying Cash Flow Edit processes. For more information, see [Copying Rules](#) section.
- Deleting Cash Flow Edit processes. For more information, see [Deleting Rules](#) section.
- Check Dependencies in the Cash Flow Edit processes
- Refresh the Cash Flow Edit summary page

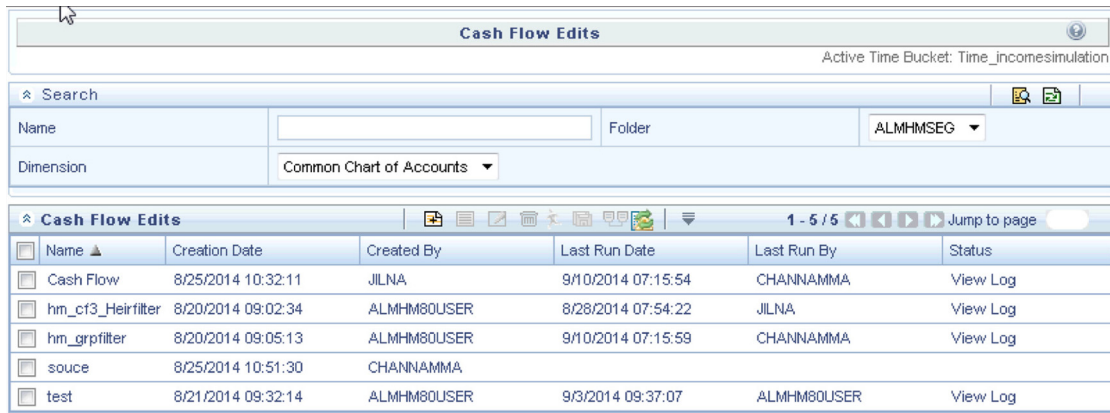

Ideally, you should create and run Cash flow Edit Processes on your Instrument table data before you submit cash flow engine based rules for processing.

For more information, see the following sections:

- [Creating Cash Flow Edit Processes](#)
- [Executing Cash Flow Edit Processes](#)

**Related Topics**

Cash Flow Edit Logic, Oracle Financial Services Cash Flow Engine Reference Guide

## Creating Cash Flow Edit Processes

Creating a Cash Flow Edit process is a one-step process. You define both the attributes that uniquely describe a particular Cash Flow Edit process and the data to be validated or cleansed by that process on the Create Cash Flow Edit process page.

The following table describes key terms used for this procedure.

**Table 10–1 Selected Terminology**

Term	Description
Filters	One of the two components that determine the data that will be cleansed by Cash Flow Edit processes. This field allows you to select a subset of data for processing by selecting a Filter that was previously created. Its default value is "No Filter".
Source Selection	One of the two components that determine the data that will be cleansed by Cash Flow Edit processes. This field allows you to select the Instrument tables that need to be included in a Cash Flow Edit process. Alternatively, you can select a hierarchy and then select the desired product members that will be included in the process. Note that the Source selection and Hierarchy selection options are mutually exclusive. You can define your dataset by selecting one or the other, but not a combination of both.
Preview Mode	Selecting this check box allows you to view the results of running a Cash Flow Edit process before the system updates the underlying records in the Instrument tables. The default value is checked.



**Table 10–1 Selected Terminology**

Term	Description
Source Selection: Available Tables	When the "Source Selection" option is made, you are presented with two Shuttle Control windows which contain the names of the Instrument Tables available for inclusion during a Cash Flow Edit process.
Source Selection: Selected Tables	One of the two Shuttle Control windows, it contains the names of the tables that have already been selected for processing by the Cash Flow Edit process.
Cash Flow Edit Rules	The Cash Flow Edit Rule section provides a summary of all seeded cash flow edit rules. Users can refer to this list to understand the validations that are applied to the cash flow fields on the instrument records and also view the default values that are applied when errors are found.

1. Navigate to the *Cash Flow Edits Summary* page.
2. Click **Add** button.

The *Create Cash Flow Edits Process* page is displayed.

Active Time Bucket: Default Time Bucket Rule      Cash Flow Edits Process      As Of Date: 30-Nov-200

^ Cash Flow Edit Details

Name\* Cash Flow Edit Process 1

Description This process should be run prior to executing any cash flow engine based processes.

Folder OFSAASEG      Preview Mode

^ Filter Selection

Filter Type No Filter

Folder OFSAASEG      Filters

^ Hierarchy Selection

Source Selection Source CommercialLoans >> ConsumerLoans

Folder OFSAASEG      Product Hierarchy Common COA Hierarch (for demo)

^ Cash Flow Edit Rules

Error Code	Error Condition	Assignment	Error Level	Warning	Description
9136	AMRT_TYPE_CD = 600 and PMT_INCR_CYCLE < 0	Set PMT_INCR_CYCLE equal to 0.	2	Pmt Incr Cycle < 0	Payment increase cycle cannot be less than zero (Neg Am instruments only)
9132	(CUR_PAYMENT < 0 and CUR_PAR_BAL > 0) or (CUR_PAYMENT > 0 and CUR_PAR_BAL < 0)	Set CUR_PAYMENT equal to 0.	2	Pmt, bal opposite signs	Current payment and current balance can not have opposite signs
9147	REMAIN_NO_PMTS_C < 1	REMAIN_NO_PMTS_C = 1	2	Rem No Pmts < 1	There has to be at least 1 payment left
9148	RATE_SET_FLAG < 0	RATE_SET_FLAG = 0	2	Set Flag < 0	Rate set flag can not be negative

Save      Cancel

3. Complete standard steps for this procedure. For more information, see [Creating Rules](#) section.

**Note:** At this point, you can input the components to ensure that the data processed by Cash Flow Edits will be clean. If you save the Rule without selecting Instrument tables or selecting product members from the hierarchy, the Process will be saved but no data would be selected for cleansing.

4. (Optional) Select a Filter.

5. Select the Instrument tables or use a hierarchy to make Product member selections.

**Note:** Use the Source Selection: Shuttle Control to select the Instrument tables that you want to include in the Cash Flow Edit process. You can move Instrument tables from Available Tables into Selected Tables and vice versa by using Move, Move All, Remove, and Remove All. These tables can also be reordered to change the order of processing.

Initially, the selected tables list is empty. However, during subsequent runs, the selected tables list retains the names of the tables that you selected previously. For example, if you select two tables and save the Cash Flow Edits Process, the system shows them the next time you open the rule.

A table name shown in the Selected Tables list does not appear in the Available Tables.

6. Click **Save**.

The Cash Flow Edits process is saved and the summary page is displayed.

## Executing Cash Flow Edit Processes

You execute a Cash Flow Edit process to check the accuracy and the completeness of your Instrument table data. When you run in Preview mode, you can view the results of running a Cash Flow Edits process by querying the FSI\_PROCESS\_ERRORS table for generated errors before the system updates the underlying records in the Instrument tables.

### Prerequisites

- Predefined Rules

Name	Creation Date	Created By	Last Run Date	Last Run By	Status
Cash Flow	8/25/2014 10:32:11	JILNA	9/10/2014 07:15:54	CHANNAMMA	View Log
hm_cf3_Heirfilter	8/20/2014 09:02:34	ALMHM80USER	8/28/2014 07:54:22	JILNA	View Log
hm_grpfilter	8/20/2014 09:05:13	ALMHM80USER	9/10/2014 07:15:59	CHANNAMMA	View Log
souce	8/25/2014 10:51:30	CHANNAMMA			
test	8/21/2014 09:32:14	ALMHM80USER	9/3/2014 09:37:07	ALMHM80USER	View Log

### Procedure

1. Navigate to the Cash Flow Edits summary page.
2. Search for a Rule.
3. Select a process and click the **Run** icon to execute the selected process. The *Cash Flow Edits run confirmation* page is displayed. The status of the process is

displayed in the **Status** column. Upon completion of the process, you can navigate to the Log Viewer page by selecting the "View Log" hyperlink. From the Log Viewer, you can access a report that provides details of any cash flow edit errors that were identified by the process.

**Note:** You can view the results of running a Cash Flow Edits rule before the system updates the underlying records in the Instrument tables, provided you selected Preview Mode while defining it. If run in Preview Mode, query the FSI\_PROCESS\_ERRORS table for any generated errors.

Name	Creation Date	Created By	Last Run Date	Last Run By	Status
<input checked="" type="checkbox"/> Cash Flow	8/25/2014 10:32:11	JILNA	9/10/2014 07:15:54	CHANNAMMA	View Log
<input type="checkbox"/> hm_cf3_Heirfilter	8/20/2014 09:02:34	ALMHM80USER	8/28/2014 07:54:22	JILNA	View Log
<input type="checkbox"/> hm_grpfilter	8/20/2014 09:05:13	ALMHM80USER	9/10/2014 07:15:59	CHANNAMMA	View Log
<input type="checkbox"/> souce	8/25/2014 10:51:30	CHANNAMMA			
<input type="checkbox"/> test	8/21/2014 09:32:14	ALMHM80USER	9/3/2014 09:37:07	ALMHM80USER	View Log

**Note:** In case you do not want to run the process immediately, make a note of the System ID displayed by doing a mouse-over on the Name. You can use the System ID to schedule the execution of the process on the *Operations > Batch Scheduling* screen. For more information, see Batch Execution/Scheduling sections in OFSAAI User Guide.

Cash Flow Edit process can also be executed from Common Object Maintenance > Operations. Create a new batch and specify the following parameters:

- Datastore Type: Select appropriate datastore from the list
- Datastore Name: Select appropriate name from the list
- P address: Select the IP address from the list
- Folder: Select appropriate name from the list
- Process Type: Select "CashFlowEdit" from the list
- Process Name: Select process name from the list
- Optional Parameters: OFS\_ALM

Task ID:

Description: Cash Flow Edit

Components: Cash Flow Edits

Property	Value
Datastore Type	EDW
Datastore Name	OFSALMINFO
Primary IP For Runtime Processes	whf00cld
Folder	ALMSEG
Process Type	CashFlowEdit
Process Name	CF Edits Process 01

Optional Parameters: OFS\_ALM

As of Date selection is made when the batch is executed.



---

---

## User Defined Behavior Patterns

This module describes the procedure for defining principal flows through Behavior Patterns, for instruments that do not have contractual amortization schedules.

This chapter covers the following topics:

- [Overview of User Defined Behavior Patterns](#)
- [Searching for Behavior Patterns](#)
- [Creating Behavior Patterns](#)

### Overview of User Defined Behavior Patterns

User defined behavior patterns allow you to define principal amortization patterns for non-maturity products in your portfolio. You can include a behavior pattern while generating cash flows by entering the behavior pattern code as the amortization type code for the instrument(s). In many cases, particularly for ALM processing, the "non-maturity" instruments will be aggregated or summarized balances. The Behavior Pattern code can range from 70000 to 99999.

The procedure for working with and managing Behavior Patterns is similar to that of other Oracle Asset Liability Management assumption rules. It includes the following steps:

- Searching for Behavior Patterns
- Creating Behavior Patterns
- Viewing and Editing Behavior Patterns.
- Copying Behavior Patterns.
- Deleting Behavior Patterns.

### Searching for Behavior Patterns

Search for a behavior pattern to perform any of the following tasks:

- View
- Edit
- Copy
- Delete
- Check Dependencies

### Prerequisites

Predefined behavior patterns

The screenshot shows the 'Behavior Patterns' application interface. At the top, there is a title bar 'Behavior Patterns' and a sub-header 'Active Time Bucket: Time\_incomesimulation'. Below this is a search section with a search icon and two input fields labeled 'Code' and 'Name'. The main area contains a table with the following data:

Code	Name	Pattern Type	Creation Date	Created By	Last Modification Date	Last Modified By
70000	almhm80user	Non Maturity	8/18/2014 07:50:42	ALMHM80USER	9/5/2014 04:21:18	JILNA
70008	BehavV	Non Maturity	8/18/2014 09:56:25	JILNA	8/18/2014 09:56:25	JILNA
70009	beNAME	Non Maturity	8/18/2014 10:15:04	JILNA	8/18/2014 10:15:04	JILNA
70056	Be	Non Maturity	8/18/2014 07:52:40	ALMHM80USER	8/18/2014 07:52:40	ALMHM80USER

**Procedure**

1. Navigate to the Behavior Pattern summary page. This page is the gateway to all behavior patterns and related functionality. You can navigate to other pages relating to behavior patterns from this page.
2. Enter the Search criteria
  - Enter the code or name of the Pattern.
  - Click the Search icon.

Only patterns that match the search criteria are displayed.

---

**Note:** You can control the number of rows to display on screen by selecting the "Pagination Options" icon from the action bar

---

**Creating Behavior Patterns**

You create behavior patterns to capture the principal run-off behavior of product types that do not have contractual maturities.

**Procedure**

1. Navigate to the Behavior Pattern summary page.
2. Click Add Behavior Pattern.
3. The Behavior Pattern details page is displayed.
4. Enter a code value for the new behavior pattern.

---

**Note:** The code, also known as an amortization type code, is a numeric identifier for the behavior pattern. The code value must be a number between 70000 and 99999. The code value you assign to the new pattern must be unique. In addition, the code must be mapped to the appropriate instrument records, (AMRT\_TYPE\_CD field) to connect the instrument to the appropriate pattern.

---

5. Enter the name and a brief description for the pattern.

6. Select the Behavior Pattern Type: Non Maturity, Non Performing, Devolvement and Recovery.

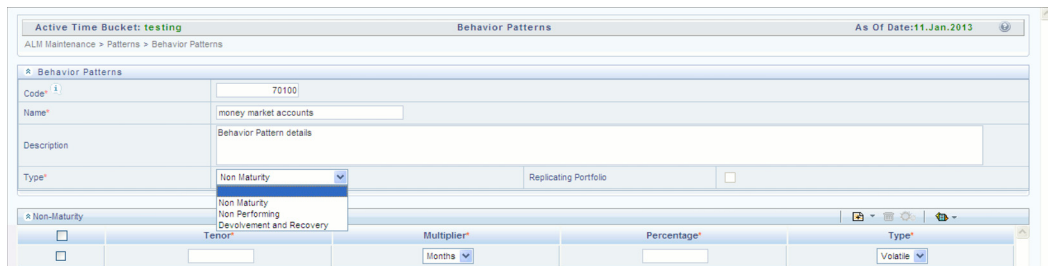

7. Define the Behavior Pattern Term Specifications for maturity tranches.
8. The selection of the Behavior Pattern type made in the previous step determines the information you must provide to successfully define that pattern type.

---

**Note:** The Behavior Pattern details page above, displays the specifications associated with the Non Maturity Pattern Type. Should you change this value for one of the other two alternatives, Non Performing or Devolvement and Recovery, the system will refresh the payment specifications section corresponding to the new Pattern Type. Although you can change your selection of the Pattern Type at any point in this procedure, sometimes this might result in loss of data related to any prior selection.

---

## Defining Non Maturity Behavior Patterns

Non Maturity behavior patterns are commonly used for deposit products like checking, savings and money market accounts as well as for credit card accounts. These account types are similar in that they do not have contractual cash flows because customers have the option to deposit or withdraw any amount at any time (up to any established limits).

When working with non maturity behavior patterns, your percentage weights, assigned to maturity terms must add up to 100%.

### Prerequisites

Select Non Maturity as the Behavior Pattern Type.

### Procedure

This table describes key terms used for this procedure.

Term	Description
Tenor	Used to specify the maturity term for the particular row. E.g. if "1 Day" is defined, then the applicable percentage of the balance will runoff (mature) on the As of Date + 1 Day.
Multiplier	The unit of time applied to the Tenor. The choices are:

Term	Description
	Days
	Months
	Years
Percentage s	The relative amount of the principal balance that will mature on the date specified by the Tenor + Multiplier. The percentage amounts must add to 100%.
Type	Allows you to classify the runoff based on the appropriate type.
Add	Used to add one or more rows
Delete	Used to delete one or more rows

1. Define the maturity tenor and multiplier for the first maturity strip. The first strip usually represents non-core or “volatile” funds and typically has a very short maturity, such as “1 Day”.
2. Select the Percentage to apply to the outstanding balance indicating how much of the outstanding balance will mature on the specified term.
3. Select the Runoff Type as Core or Volatile

---



---

**Note:** There is no difference in behavior from a cash flow perspective, but the runoff amount will be written to a principal runoff financial element corresponding to the selected Runoff Type.

---



---

4. Click the Add icon to add additional payment strips to the Pattern. After defining the initial strip as Volatile, subsequent strips are typically classified as Core with varying maturity terms assigned.
5. You can also use the Excel import/export feature to add the behavior pattern information.
6. You may want to utilize the Data Input Helper to copy from a row where you have already defined the Pattern definition or apply a fixed value down the page. The following optional steps describe how to use this feature.
  1. Select the checkbox next to the rows that you want to work with or use the "Select ALL" option by selecting the checkbox on the header row.
  2. Select the Data Input Helper icon.
  3. From the Data Input Helper – popup screen, select Method – "Grow by Amount" or some other appropriate method.
  4. Select the term points from the left side (Available Columns) of the shuttle box.



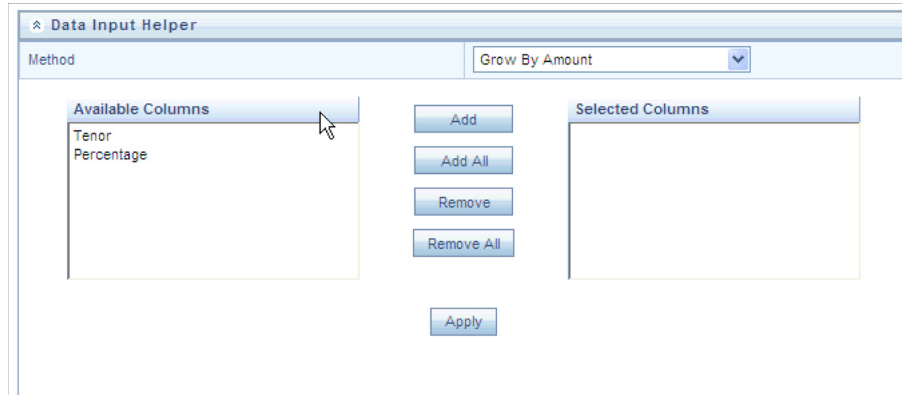

5. Select APPLY to copy assumptions to the selected rows.
7. To delete a row, select the check box corresponding to the row you want to remove and click the Delete icon
8. Click Save.

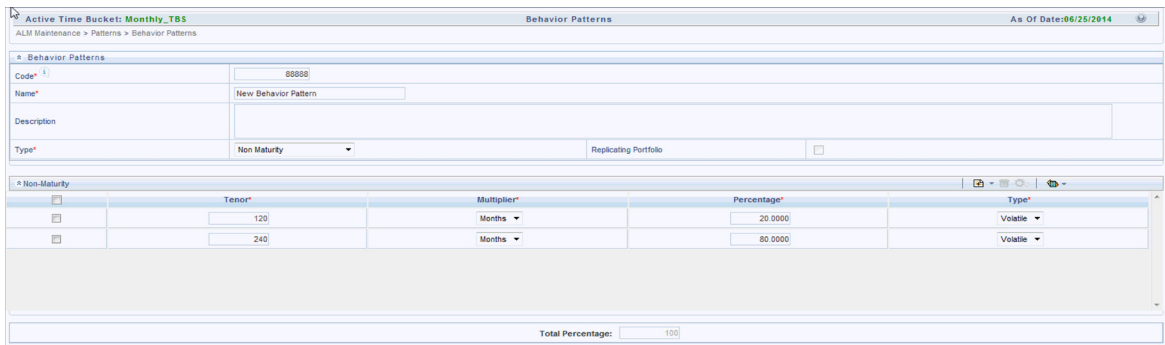

9. The Behavior Pattern is saved and the Behavior Pattern summary page is displayed.

## Defining Non Performing Behavior Patterns

Non Performing behavior patterns are commonly used for balances that are classified as non-earning assets. These balances are typically sourced from the management ledger as aggregate balances. Users are able to assign expected maturity profiles to these balances classifying them into appropriate categories of Sub Standard, Doubtful or Loss.

### Prerequisites

Select Non Performing as the Behavior Pattern Type.

### Procedure

This table describes key terms used for this procedure.

Term	Description
Tenor	Used to specify the maturity term for the particular row. E.g. if "1 Day" is defined, then the applicable percentage of the balance will runoff (mature) on the As of Date + 1 Day.
Multiplier	The unit of time applied to the Tenor. The choices are:  Days  Months  Years
Percentage	The relative amount of the principal balance that will mature on the date specified by the Tenor + Multiplier. The percentage amounts cannot exceed 100% for non performing patterns.
Runoff Type	Allows you to classify the runoff based on the appropriate type.
Add	Used to add one or more rows
Delete	Used to delete one or more rows

1. Define the maturity tenor and multiplier for the first maturity strip. The first strip can be any of the three categories including Substandard, Doubtful or Loss.
2. Select the Percentage to apply to the outstanding balance indicating how much of the outstanding balance will mature on the specified term.
3. Select the Runoff Type as Substandard, Doubtful or Loss.

---

**Note:** There is no difference in behavior from a cash flow perspective, but the runoff amount will be written to a principal runoff financial element corresponding to the selected Runoff Type.

---

4. Click the Add icon to add additional payment strips to the Pattern and define appropriate assumptions for each strip.
5. You can also use the Excel import/export feature to add the behavior pattern information.
6. You may want to utilize the Data Input Helper to copy from a row where you have already defined the Pattern definition or apply a fixed value down the page. The following optional steps describe how to use this feature.
  1. Select the checkbox next to the rows that you want to work with or use the "Select ALL" option by selecting the checkbox on the header row.
  2. Select the Data Input Helper icon.
  3. From the Data Input Helper – popup screen, select Method – "Grow by Amount" or some other appropriate method.

4. Select the term points from the left side (Available Columns) of the shuttle box.

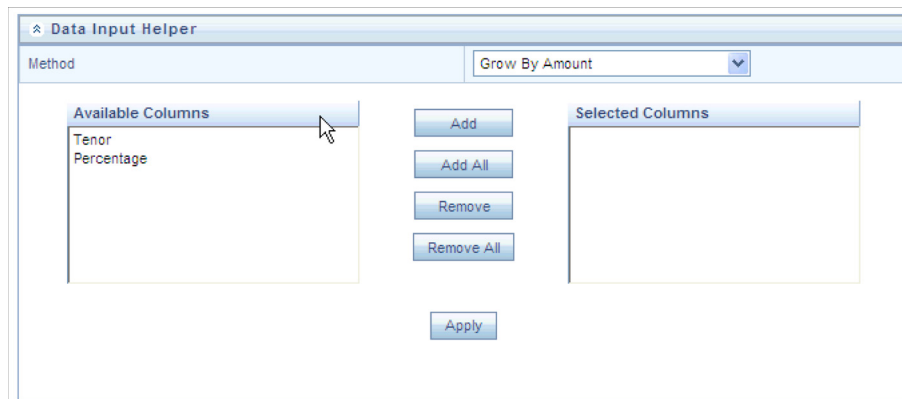

5. Select APPLY to copy assumptions to the selected rows.
7. To delete a row, select the check box corresponding to the row(s) you want to remove and click the Delete icon
8. Click Save.

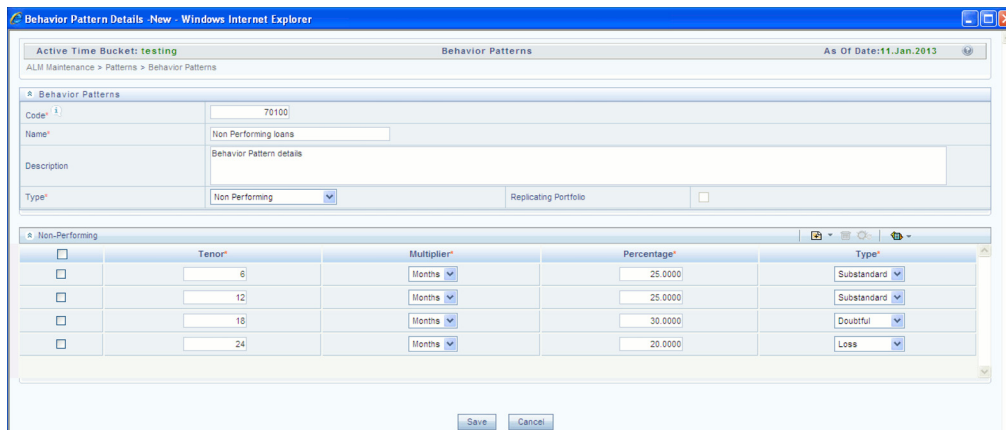

9. The Behavior Pattern is saved and the Behavior Pattern summary page is displayed.

## Defining Devolvement and Recovery Behavior Patterns

Devolvement and Recovery behavior patterns are commonly used for estimating cash flows associated with Letters of Credit and Guarantees. These product types are typically categorized as off balance sheet accounts. Users are able to assign expected maturity profiles to the related balances classifying them into appropriate categories of Sight Devolvement and Sight Recovery or Usance Devolvement and Usance Recovery. Sight Devolvement and Recovery are the most common types.

### Prerequisites

Select Devolvement and Recovery as the Behavior Pattern Type.

## Procedure

This table describes key terms used for this procedure.

Term	Description
Tenor	Used to specify the maturity term for the particular row. E.g. if "1 Day" is defined, then the applicable percentage of the balance will runoff (mature) on the As of Date + 1 Day.
Multiplier	The unit of time applied to the Tenor. The choices are:  Days  Months  Years
Percentage	The relative amount of the principal balance that will mature on the date specified by the Tenor + Multiplier. The percentage amounts cannot exceed 100% for devolvement and recovery patterns.
Runoff Type	Allows you to classify the runoff based on the appropriate type.  Sight: indicates the Beneficiary is paid as soon as the Paying Bank has determined that all necessary documents are in order. This is preferred approach.  Usance: is a period of time which can be between 30 and 180 days after the bill of lading date.
Add	Used to add one or more rows
Delete	Used to delete one or more rows

1. Define the maturity tenor and multiplier for the first maturity strip.
2. Select the Percentage to apply to the outstanding balance indicating how much of the outstanding balance will mature on the specified term.
3. Select the Runoff Type as Sight Devolvement, Sight Recovery, Usance Devolvement and Usance Recovery.

---

**Note:** There is no difference in behavior from a cash flow perspective, but the runoff amount will be written to a principal runoff financial element corresponding to the selected Runoff Type.

---

4. Click the Add icon to add additional payment strips to the Pattern and define appropriate assumptions for each strip.
5. You can also use the Excel import/export feature to add the behavior pattern information.

6. You may want to utilize the Data Input Helper to copy from a row where you have already defined the Pattern definition or apply a fixed value down the page. The following optional steps describe how to use this feature.].
  1. Select the checkbox next to the rows that you want to work with or use the "Select ALL" option by selecting the checkbox on the header row.
  2. Select the Data Input Helper icon.
  3. From the Data Input Helper – popup screen, select Method – "Grow by Amount" or some other appropriate method.
  4. Select the term points from the left side (Available Columns) of the shuttle box.

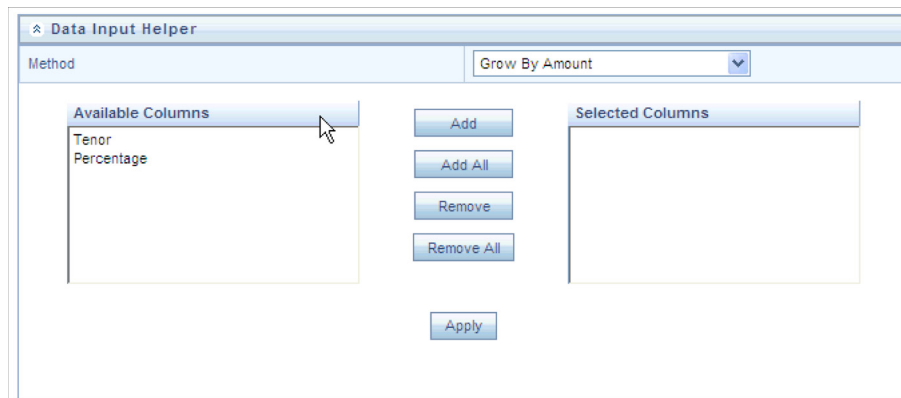

5. Select APPLY to copy assumptions to the selected rows.
7. To delete a row, select the check box corresponding to the row(s) you want to remove and click the Delete icon
8. Click Save.

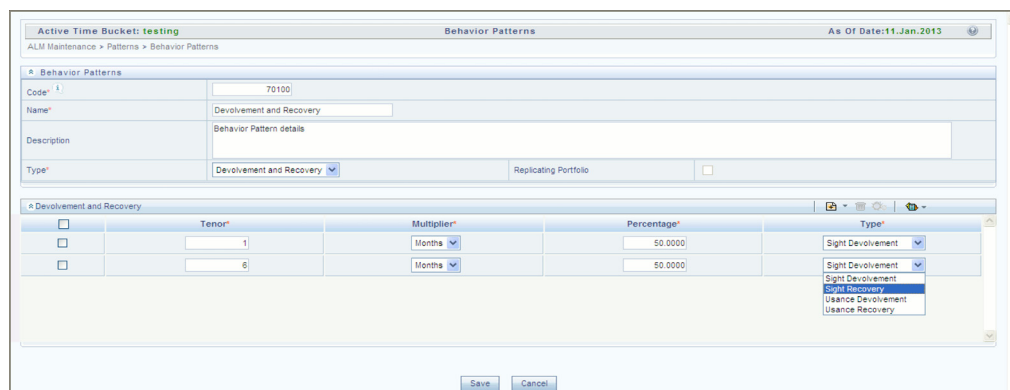

9. The Behavior Pattern is saved and the Behavior Pattern summary page is displayed.



---

---

## User Defined Payment Patterns

This module describes the procedure for capturing instrument payment patterns that are too complex to be accommodated in the standard fields of Instrument tables.

This chapter covers the following topics:

- [Overview of User Defined Payment Patterns](#)
- [Searching for Payment Patterns](#)
- [Creating Payment Patterns](#)
- [Payment Pattern Data Loader](#)

### Overview of User Defined Payment Patterns

User defined payment patterns allow you to define custom repayment patterns for products in your portfolio. You can include a payment pattern while generating cash flows by entering the payment pattern code as the amortization type code for the instrument.

### Searching for Payment Patterns

Search for a payment pattern to perform any of the following tasks:

- View
- Edit
- Copy
- Delete
- Check Dependencies

Code	Description	Pattern Type	Creation Date	Created By	Last Modification Date	Last Modified By
1007	PAyment	Absolute	8/18/2014 09:52:21	JILNA	8/18/2014 09:52:21	JILNA
1008	sfsdf	Absolute	8/25/2014 11:08:18	JILNA	8/25/2014 11:08:18	JILNA
1009	f	Absolute	8/25/2014 11:09:12	JILNA	8/25/2014 11:09:12	JILNA
1010	wdd	Absolute	8/25/2014 11:09:30	JILNA	8/25/2014 11:09:30	JILNA
1067	Paym	Absolute	8/18/2014 09:25:51	JILNA	8/18/2014 09:25:51	JILNA
1069	Absolute	Absolute	8/18/2014 09:51:41	JILNA	8/18/2014 09:51:41	JILNA
1076	test	Absolute	9/9/2014 11:08:07	JILNA	9/9/2014 11:11:42	JILNA
10056	Payment patter_Absolute	Absolute	8/18/2014 07:38:08	JILNA	8/18/2014 07:38:08	JILNA
10067	Payment_IRCbug	Absolute	8/20/2014 05:12:34	JILNA	8/20/2014 05:12:34	JILNA

## Creating Payment Patterns

You create payment patterns to capture the repayment behavior of instruments that are too complex to be accommodated through use of the standard instrument table fields.

1. Navigate to the *Payment Pattern summary* page.
2. Click **Add Payment Pattern**.  
The Add Payment Pattern page is displayed.
3. Enter a code value for the new payment pattern.

---

**Note:** The code, also known as an amortization type code, is a numeric internal identifier for the payment pattern. The code value must be a number between 1000 and 69999. The code value you assign to the new pattern must be unique. In addition, the code must be mapped to the appropriate instrument records (AMRT\_TYPE\_CD field) to connect the instrument to the appropriate pattern.

---

4. Enter a brief description for the pattern.
5. Select the Payment Pattern Type: Absolute, Relative, or Split.
6. Define the Payment Pattern Term Specifications for payment phases.

---

**Note:** You can enter negative values for amortization type of level principal that is applicable to pattern types absolute, relative and split, for absolute value Payment Method.

---

The selection of the payment pattern type made in the previous step determines the information you must provide to successfully define that pattern type. For more information, see the following:

- [Defining Absolute Payment Patterns](#)



- [Defining Relative Payment Patterns](#)
- [Defining Split Payment Patterns](#)

---

**Note:** The Payment Pattern Details page displays the specifications associated with the Absolute Payment Pattern Type, which is the default Payment Pattern Type value. You should decide to change this value for any of the other two alternatives, Relative or Split, the system will refresh the payment specifications corresponding to the new Pattern Type. Although you can change your selection of the Pattern Type at any point in this procedure, sometimes this might cause loss of data related to any prior selection.

---

## Defining Absolute Payment Patterns

Absolute payment patterns are commonly used for instruments that are on a seasonal schedule, such as agricultural or construction loans that require special payment handling based on months or seasons.

When working with absolute payment patterns, it is sufficient to define payments for one calendar year. Once the term exceeds a year, the payment schedule will loop until the instrument matures.

### Prerequisites

Select Absolute as the Pattern Type.

### Procedure

This table describes key terms used for this procedure.

**Table 12–1 Selected Terminology**

Term	Description
Month	This drop-down list allows you to select the month of the payment phase being defined.
Day	Used to specify the day of the month the payment is due.
Add	Used to add one or more rows.
Delete	Used to delete a row.

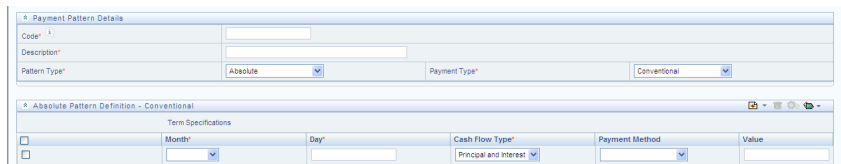

1. Select the Payment Type from the drop-down list: Conventional, Level Principal, or Non-Amortizing.

---

**Note:** The Payment Type determines the type of information required to successfully define the Payment Phase.

---

2. Define the Payment Phases.

---

---

**Note:** A Payment Phase is a set of payment characteristics that defines the time line of the instrument's amortization.

---

---

1. Select a Month for the pattern.
2. Enter a Date for the pattern.
3. Select the Payment Method.

---

---

**Note:** The available Payment Methods depend on the Payment Type. Payment Methods do not apply to the Non-Amortizing Payment Type.

---

---

4. Enter the Value for the Payment Method you selected in the previous step for applicable Payment Types.

---

---

**Note:** If you selected the Interest Only Payment Method in the previous step, the Value field does not apply.

---

---

5. Click **Add Another Row** to add additional Payment Phases to the Pattern and click **Delete** corresponding to the rows you want to delete.

---

---

**Note:** A Payment Pattern must have at least one valid Payment Phase to be successfully defined. The system raises a warning if you try to save a Payment Pattern with an incomplete Payment Phase. You can define up to 365 Payment Phases for each Payment Pattern.

---

---

3. Click **Save**.

The Payment Pattern is saved and the Payment Pattern summary page is displayed.

4. You may want to utilize the Data Input Helper to copy from a row where you have already defined the pattern definition or apply a fixed value down the page. The following optional steps describe how to use this feature
  1. Select the checkbox next to the rows that you want to work with or use the "Select ALL" option by selecting the checkbox on the header row.
  2. Select the Data Input Helper icon.
  3. From the Data Input Helper – popup screen, select Method – "Grow by Amount" or some other appropriate method.

- Select the term points from the left side (Available Columns) of the shuttle box.

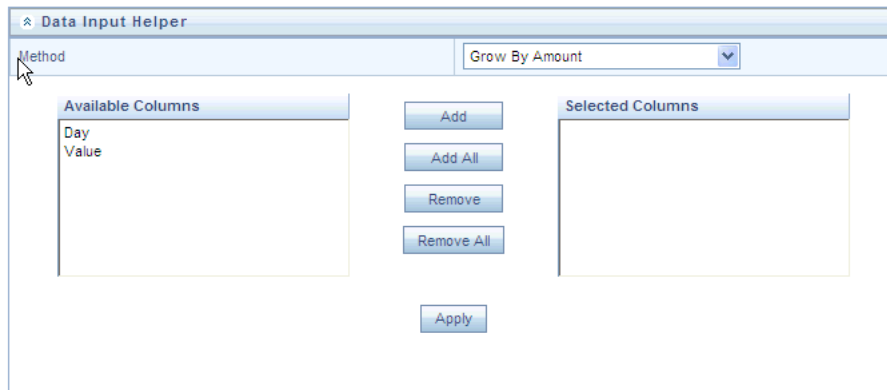

- Select APPLY to copy assumptions to the selected rows.
- Click Save.  
The Payment Pattern is saved and the Payment Pattern summary page is displayed.

### Excel Import/Export

Excel import/export functionality is used for adding/editing absolute payment pattern information. For more details, refer to [Excel Import/Export](#).

### Guidelines

When a detail instrument using an Absolute Payment Pattern is processed for Remaining Term cash flow processing, the Next Payment Date is internally calculated to determine which Payment Phase should be used. The calculated Next Payment Date is only used for this purpose. The Next Payment Date stored on the Instrument record in the Instrument table is always the date used for processing the initial payment.

The following table describes the relationship between Payment Phase properties and Payment Types.

**Table 12–2 Relationship between Payment Phase Attributes and Payment Types**

	Conventional	Level Principal	Non Amortizing
Month	Yes	Yes	Yes
Day	Yes	Yes	Yes
Payment Method	Yes	Yes	
Value	Yes	Yes	

The following table describes relationship between Payment Method and Payment Types.

**Table 12–3 Relationship between Payment Method and Payment Types**

Payment Method	Conventional	Level Principal	Non Amortizing
Percentage of Original Balance		Yes	

**Table 12–3 Relationship between Payment Method and Payment Types**

Payment Method	Conventional	Level Principal	Non Amortizing
Percentage of Current Balance		Yes	
Percentage of Original Payment	Yes	Yes	
Percentage of Current Payment	Yes	Yes	
Absolute Payment	Yes	Yes	
Interest Only	Yes	Yes	

## Defining Relative Payment Patterns

You create Relative Payment patterns for instruments that have irregular scheduled payments.

### Prerequisites

Select Relative as the Pattern Type.

### Procedure

This table describes key terms used for this procedure.

**Table 12–4 Selected Terminology**

Term	Description
Frequency	The frequency of the payment.
Multiplier	The unit of time applied to the frequency. The choices are: <ul style="list-style-type: none"> <li>? Days</li> <li>? Months</li> <li>? Years</li> </ul>
Repeat	The number of times the Payment Phase should be repeated.
Move Up	Allows you to move a particular Payment Phase row up by one position. <b>Note:</b> The Move Up icon for the first row of the table is always inactive.
Move Down	Allows you to move a particular row down by one position. <b>Note:</b> The Move Down icon for the last row of the table is always inactive.
Delete	Allows you to delete a row.

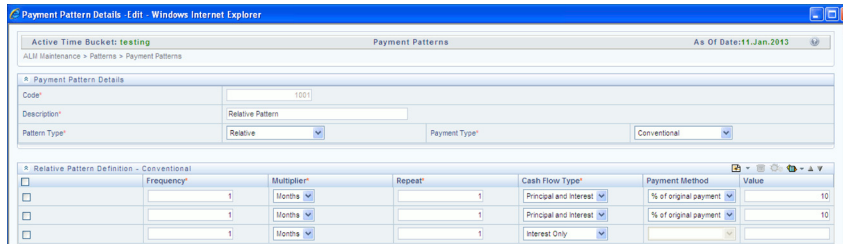

1. Select the Payment Type from the drop-down list: Conventional, Level Principal, or Non-Amortizing.

The payment type determines the available characteristics for defining the payment amount.

2. Define the Payment Phase.

---



---

**Note:** The payment type determines the type of information required to successfully define the payment phase.

---



---

1. Enter the Frequency for each payment phase.
2. Select the appropriate Multiplier for each payment phase.
3. Enter the number of times each Payment Phase should be repeated in the Repeat column.
4. Select the Payment Method.

---



---

**Note:** The available Payment Methods depend on the Payment Type. Payment Methods do not apply to the Non-Amortizing Payment Type.

---



---

5. Type the Value for the Payment Method you selected in the previous step for applicable Payment Types.
6. Click Add Another Row to add additional Payment Phases to the Pattern and click Delete corresponding to the rows you want to delete.

---



---

**Note:** A Payment Pattern must have at least one valid Payment Phase to be successfully defined. The system raises a warning if you try to save a Payment Pattern with an incomplete Payment Phase. You can define upto 365 Payment Phases for each Payment Pattern.

---



---

3. You may want to utilize the Data Input Helper to copy from a row where you have already defined the Pattern definition or apply a fixed value down the page. The following optional steps describe how to use this feature.

1. Select the checkbox next to the rows that you want to work with or use the "Select ALL" option by selecting the checkbox on the header row.
2. Select the Data Input Helper icon.

3. From the Data Input Helper – popup screen, select Method – "Grow by Amount" or some other appropriate method.
4. Select the Frequency and/or Repeat from the left side (Available Columns) of the shuttle box.

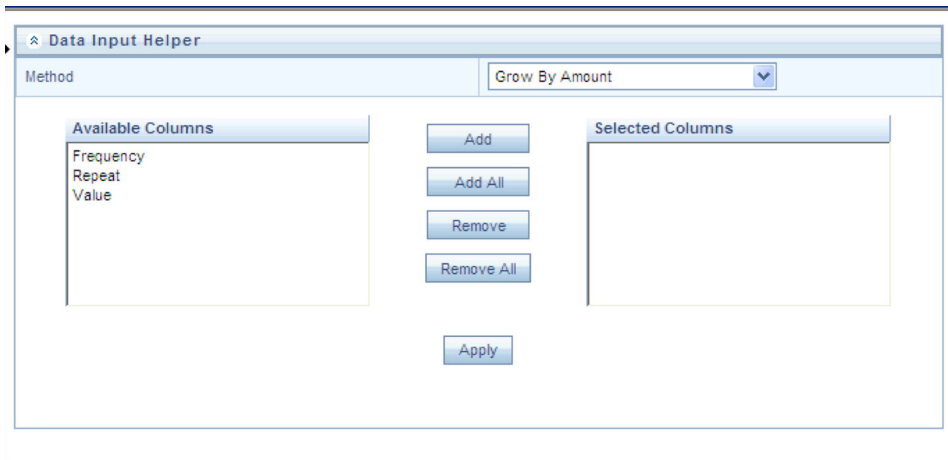

5. Select **APPLY** to copy assumptions to the selected rows.
4. Click **Apply**.

The payment pattern is saved and the Payment Pattern home page is displayed.

---



---

**Note:** Any empty rows are ignored and not saved with the payment pattern.

---



---

## Excel Import/Export

Excel import/export functionality is used for adding/editing relative payment pattern information. For more details, see [Excel Import/Export](#) section.

## Guidelines

It is not necessary to set up relative payment patterns for the complete term of an instrument. The payment pattern automatically repeats until maturity date. Suppose a payment pattern is created to make monthly payments for the first year and quarterly payments for the next three years. If you apply this pattern to an instrument record with an original term of five years, the payment pattern wraps around and the fifth year is scheduled for monthly payments.

An easy way to set up payment patterns for instruments with varying original terms is to use the repeat value of 999 in the last row of the payment pattern. For example, a payment pattern that pays monthly for the first year and quarterly thereafter, can be set up with two rows. The first row shows 12 payments at one month. The second row shows 999 payments at three months. When this payment pattern is processed it repeats the three-month payment frequency until the maturity date is reached.

The following table describes the relationship between payment phase attributes and payment types.

**Table 12–5 Relationship between Payment Phase Attributes and Payment Types**

Payment Phase Attributes	Payment Types: Conventional	Payment Types: Level Principal	Payment Types: Non-Amortizing
Frequency	Yes	Yes	Yes
Multiplier	Yes	Yes	Yes
Repeat	Yes	Yes	Yes
Payment Method	Yes	Yes	
Value	Yes	Yes	

## Defining Split Payment Patterns

You use a Split payment pattern for financial instruments that make principal payments along two concurrent amortization schedules. Split patterns may be a combination of Absolute and Relative Payment Patterns for example, and contain multiple sets of payment phases under a single amortization code. These patterns could further use a combination of Conventional, Level Principal, and Non-Amortizing Payment Types.

### Prerequisites

Select Split as the pattern type.

### Procedure

This table describes key terms used for this procedure.

**Table 12–6**

Term	Description
Percent	The percent value represents the percentage weight of the time line being defined for the individual payment phases (each row). The sum of the percentage weights must total 100%.

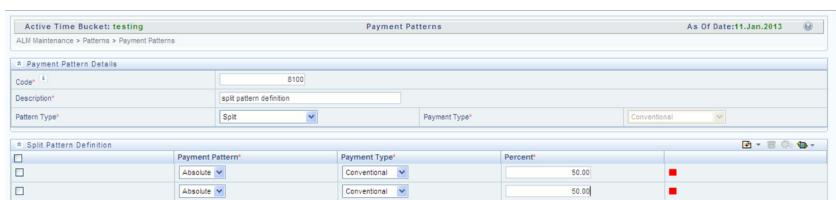

1. Select **Pattern Type Split**.  
The *Create Term Specifications* page is displayed.
2. Select the required Pattern Type for each leg.
  - Absolute
  - Relative
3. Enter the percentage value for each split.

**Note:** The sum of the percent values of all splits must add up to 100.

4. Select the Payment Type for each Payment Phase or Split.

**Note:** The payment pattern term specifications for different payment phases or splits vary depending on whether you select the Absolute or Relative Pattern Type. You can define the term specifications for the splits following the steps described previously for defining payment phases for these patterns. For more information, see the following:

- ⌵ [Defining Absolute Payment Patterns](#)
- ⌵ [Defining Relative Payment Patterns](#)

5. Select one of the legs and then select **Apply** to define pattern details for the leg.
6. You may want to utilize the Data Input Helper to copy from a row where you have already defined the Pattern definition or apply a fixed value down the page. The following optional steps describe how to use this feature
  1. Select the checkbox next to the rows that you want to work with or use the "Select ALL" option by selecting the checkbox on the header row.
  2. Select the **Data Input Helper** icon.
  3. From the Data Input Helper – popup screen, select Method – "Grow by Amount" or some other appropriate method.
  4. Select the Frequency and/or Repeat from the left side (Available Columns) of the shuttle box.

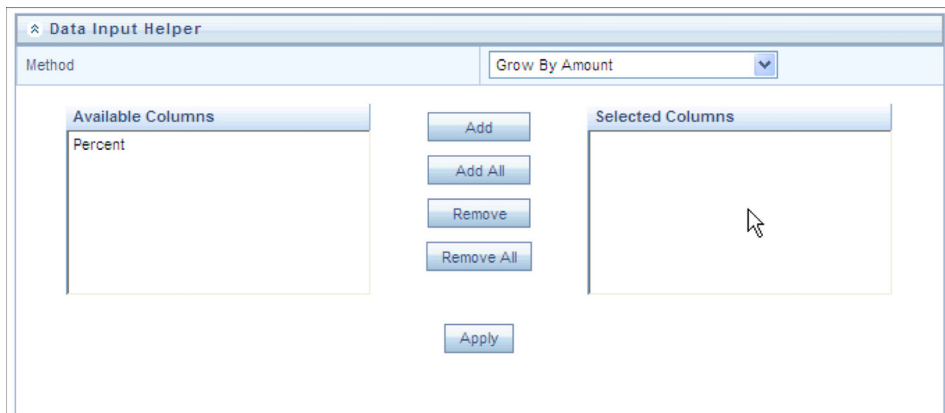

5. Select **APPLY** to copy assumptions to the selected rows.
7. Click **Save**.

The Split payment pattern is saved and the Payment Pattern summary page is displayed.

## Excel Import/Export

Excel import/export functionality is used for adding/editing split payment pattern information. For more details, refer [Excel Import/Export](#).



---

---

**Note:** The sum of the percent values of all splits must add up to 100.

---

---

## Payment Pattern Data Loader

The Payment Pattern Loader provides the ability to load bulk payment pattern definitions through a back end procedure. This Loader reads the stage table data, does data quality checks on the same, and load them into FSI\_PAYMENT\_PATTERN and FSI\_PAYMENT\_PATTERN\_EVENT tables, if the stage table data is valid. For more information on setting up the automated process, see Oracle Financial Services Analytical Applications Data Model Utilities User Guide.

To execute the Data loader process, click the Data Loader icon on the Payment Pattern Summary window.

A warning message will appear: "Upload all available Payment Pattern?" Click "Yes". A confirmation message will display.

The process will load all of the data included in the staging tables as defined in the Data Model Utilities User Guide.



---

---

## User Defined Repricing Patterns

This module discusses the procedure for working with and managing user defined repricing patterns.

This chapter covers the following topics:

- [Overview of Repricing Patterns](#)
- [Searching for Repricing Patterns](#)
- [Creating Repricing Patterns](#)

### Overview of Repricing Patterns

User defined repricing patterns provide a mechanism to capture instrument repricing patterns that are too complex to be accommodated through the use of the standard account table fields.

The procedure for working with and managing repricing patterns is, similar to that of other Oracle Asset Liability Management business rules. It includes the following steps:

- Searching for Repricing Patterns, For more information, refer to [Searching for Rules](#)
- Creating Repricing Patterns, For more information, refer to [Creating Rules](#)
- Viewing and Editing Repricing Patterns, For more information, refer to [Viewing and Editing Rules](#)
- Copying Repricing Patterns, For more information, refer to [Copying Rules](#)
- Deleting Repricing Patterns, For more information, refer to [Deleting Rules](#)

### Searching for Repricing Patterns

Search for a repricing pattern to perform any of the following tasks:

- View
- Edit
- Copy
- Delete
- Check Dependencies

## Prerequisites

Predefined repricing patterns

## Procedure

1. Navigate to the *Repricing Pattern summary* page. This page is the gateway to all repricing patterns and related functionality. You can navigate to other pages relating to repricing patterns from this point.
2. Enter the Search criteria.
  1. Enter the code or description of the pattern.
  2. Select the **Search** icon.

Only patterns that match the search criteria are displayed.

The screenshot shows the 'Repricing Patterns' interface. At the top, there is a search bar with fields for 'Code' and 'Description'. Below the search bar is a table with the following data:

Code	Description	Pattern Type	Creation Date	Created By	Last Modification Date	Last Modified By
800	repricing	Absolute	8/18/2014 07:39:16	JILNA	8/18/2014 07:39:18	JILNA
600	Repri	Absolute	8/18/2014 09:58:14	JILNA	8/18/2014 09:58:16	JILNA
3423	HM_Repricing1	Absolute	8/18/2014 13:25:39	ALMHM80USER	8/18/2014 13:25:40	ALMHM80USER
660	Repricing PAtten	Absolute	8/20/2014 05:55:15	JILNA	8/20/2014 05:55:18	JILNA

## Creating Repricing Patterns

You can calculate the Interest for multiple repricing rates for the a single period if the repricing frequency is greater than payment frequency. Net Interest, Gross Interest, and TP interest cashflows are used for multiple pricing. The multiple repricing is supported for both current and New business.

You create Repricing patterns to capture the repricing behavior of instruments whose rates change according to complex schedules.

## Procedure

1. Navigate to the *Repricing Pattern summary* page.
2. Click **Add Repricing Pattern**.  
The *Add Repricing Pattern* page is displayed.
3. Type a code value for the new Repricing Pattern.

---

**Note:** The code is a numeric internal identifier for the repricing pattern. The code value must be a number between 500 - 99999 and the code value you assign to the new pattern must be unique. In addition, the code must be mapped to the appropriate instrument records (ADJUSTABLE\_TYPE\_CD field) to connect the instrument to the appropriate pattern.

---

4. Type a brief description for the pattern.

5. Select the Repricing Pattern Type: Absolute or Relative.

The selection of the repricing pattern type determines the fields that are displayed in the **Repricing Events** table and the information you must provide to successfully define that pattern type. For more details, see the following sections:

- [Defining Absolute Repricing Patterns](#)
- [Defining Relative Repricing Patterns](#)

---

**Note:** The Add Repricing Pattern page displays the parameters associated with the Absolute repricing pattern type, which is the default repricing pattern type value. If you change this value to Relative, the system refreshes the repricing specifications corresponding to the new pattern type, and any data entered previously is lost. However, a warning message is displayed when you change the pattern type. The data is discarded only after your confirmation.

---

## Defining Absolute Repricing Patterns

The Absolute repricing pattern is used for instruments that are date dependent. Each specific date is a separate event. You need to enter the month and day for each event, except for the initial event.

The screenshot shows the 'Repricing Patterns' configuration interface. At the top, it indicates 'Active Time Bucket: IUT1\_1' and 'As Of Date: 08/25/2014'. The breadcrumb path is 'ALM Maintenance > Patterns > Repricing Patterns'. The 'Repricing Pattern Details' section includes:
 

- Code: 570
- Description: UOR 570
- Pattern Type: Absolute (selected from a dropdown)

 Below this is the 'Repricing Events - Absolute' table:
 

	Month*	Day*	Repricing Type*	
<input type="checkbox"/>	Initial		Indexed	<input type="checkbox"/>
<input type="checkbox"/>	January	12	Indexed	<input type="checkbox"/>
<input type="checkbox"/>	February	12	Indexed	<input type="checkbox"/>
<input type="checkbox"/>	March	12	Flat	<input type="checkbox"/>
<input type="checkbox"/>	April	12	Flat	<input type="checkbox"/>

 A 'Define' button is located at the bottom of the table.

## Prerequisites

Selecting Absolute as the pattern type.

## Procedure

This table describes key terms used for this procedure.

**Table 13–1 Selected Terminology**

Term	Description
Month	In conjunction with the Day field, this drop-down menu, allows you to specify a unique month-day combination for a repricing event.
Day	In conjunction with the Month drop-down menu, this field allows you to specify a unique month-day combination for a repricing event.
Repricing Type	A drop list, it displays the repricing type, Flat rate or Indexed rate, associated with a particular event.

**Table 13–1 Selected Terminology**

Term	Description
Add Row	Allows you to Add one or more repricing events.
Delete	Allows you to delete specific rows in the Repricing Events table.

1. Click **Add Event**.
2. Select the Repricing Type: **Flat** or **Indexed**.

The default value is **Flat**. If you select **Indexed**, the system automatically changes the fields available for entry.

---

**Note:** You can change your selection of the repricing type at any point in this process. Sometimes it may cause a loss of data.

---

### Flat Rate

A Flat rate is a specific rate—it is directly input. For more details, see [User Defined Repricing Event](#) section.

To define a Flat Rate Event, select check box for the event you are going to define and select the Define button. Notice the bottom half of the screen refreshes, displaying the required inputs. Complete the following steps on the Add Repricing Events page:

1. Select Balance Tier option:
  - None
  - Current Balance

If None is selected, then Balance Tiered pricing is not applied.

If Current Balance is selected, then users can define balance tiers and associate different rates with the corresponding balance tier level.
2. Specify the required month-day combination for the event.

---

**Note:** You cannot specify a month-day combination for the first event as this row is reserved for the initial period.

---

3. Enter the Net Rate.
4. Enter the Gross Rate.
5. Enter the Transfer Rate.

**Note:** You must enter a valid value for at least one of these rate fields.

- You may want to utilize the Data Input Helper to copy from a row where you have already defined the pattern definition or apply a fixed value down the page. The following optional steps describe how to use this feature.

Select the checkbox next to the rows that you want to work with or use the "Select ALL" option by selecting the checkbox on the header row.

Select the Data Input Helper icon.

From the Data Input Helper – popup screen, select Method – "Grow by Amount" or some other appropriate method.

Select the term points from the left side (Available Columns) of the shuttle box.

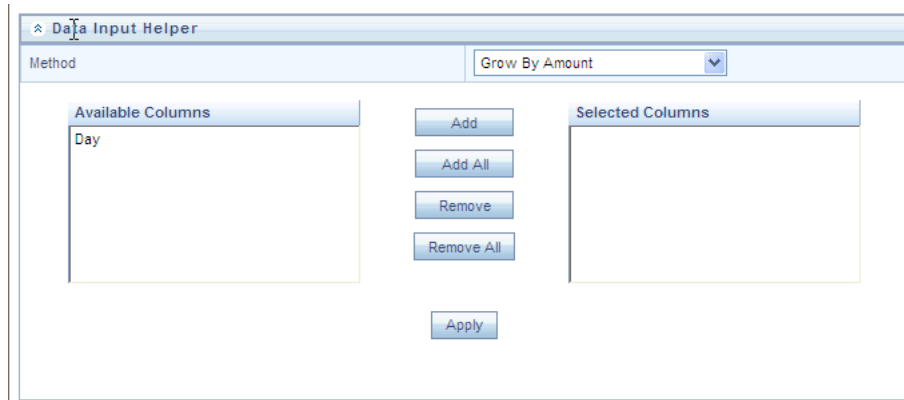

Select APPLY to copy assumptions to the selected rows.

- Click **Apply**.

The Event summary Page is displayed. Note the status indicator has changed from Red to Green indicating that details for the event have been defined.

At this point, you have the option of defining additional events or saving. To add an additional event, repeat Step 1: Click Add Event. If you want to save the repricing pattern and events, advance to the next step.

### Indexed Repricing

An Indexed rate is a set of parameters used to calculate a rate. For more information, see [User Defined Repricing Events](#) section.

To define an Indexed Repricing Event, select check box for the event you are going to define and select the Define button. Notice the bottom half of the screen refreshes, displaying the required inputs. Complete the following steps on the Add Repricing Events page:

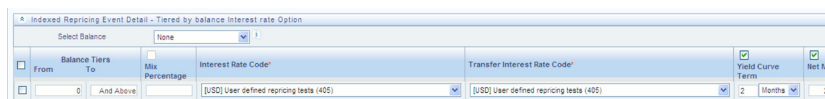

---

---

**Note:** Select the checkbox above each column that you want to include in the repricing event.

---

---

1. Select a Balance Tier option:

None

Current Balance

If None is selected, then Balance Tiered pricing is not applied.

If Current Balance is selected, then users can define balance tiers and associate different rates with the corresponding balance tier level.

2. Select the Interest Rate Code.
3. Select the Transfer Interest Rate Code.
4. Enter the Net Margin.
5. Enter the Yield Curve Term and select the appropriate Multiplier.
6. Enter the Gross Margin.
7. Enter the Transfer Rate Margin.
8. Enter the Rate Cap Life.
9. Enter the Rate Floor Life.
10. Enter the Rate Set Lag and select the appropriate Multiplier.
11. Click **Apply**.

The *Event Summary* page is displayed.

At this point, you have the option of defining additional events or saving. To add an additional event, repeat Step 1 Add Create Event. If you want to save the repricing pattern and events, advance to the next step.

3. Click **Save** at the bottom of the page.

The repricing pattern is saved and the Repricing Pattern summary page is displayed.

## Excel Import/Export

Excel import/export functionality is used for adding/editing absolute repricing pattern information. For more details, see [Excel Import/Export](#) section.

## Defining Relative Repricing Patterns

The Relative repricing pattern is used for instruments where the repricing is determined by elapsed time since origination. Defining a Relative repricing pattern involves the definition of a series of repricing events applicable to a specific repricing pattern code. You need to specify the length of each repricing period and the number of times that event should occur before calculating the next event in the pattern.



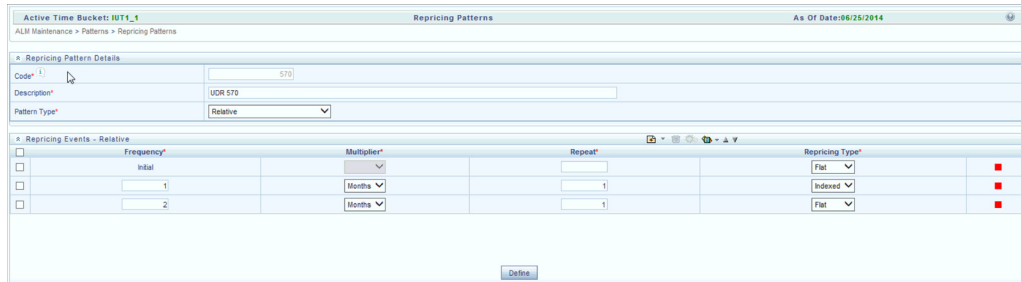

## Prerequisites

Selecting Relative as the pattern type.

## Procedure

This table describes key terms used for this procedure.

**Table 13–2 Selected Terminology**

Term	Description
Frequency	In conjunction with the Multiplier drop-down menu, this field allows you to specify how often repricing occurs.
Multiplier	The unit of time applied to the frequency. The choices are: <ul style="list-style-type: none"> <li>⌵ Days</li> <li>⌵ Months</li> <li>⌵ Years</li> </ul>
Repeat	Allows you to specify the number of times a repricing event should be repeated.
Repricing Type	A drop list, it displays the repricing type, Flat rate or Indexed rate, associated with a particular event.
Add	Allows you to Add one or more repricing events.
Move Up	Allows you to move a particular row up by one position. <b>Note:</b> This action for the first and second rows is not active.
Move Down	Allows you to move a particular row down by one position. <b>Note:</b> This action for the first and last rows is not active.
Delete	Allows you to delete specific rows in the Repricing Events table.

The steps to create Relative repricing patterns are similar to creating Absolute repricing patterns. For more information, see [Defining Absolute Repricing Patterns](#) .

The only difference is that the fields in the Repricing Events table are different. You need to specify the following parameters in the Repricing Events table for a Relative repricing pattern:

- Frequency
- Multiplier
- Repeat

You may want to utilize the Data Input Helper to copy from a row where you have already defined the pattern definition or apply a fixed value down the page. The following optional steps describe how to use this feature.

Select the checkbox next to the rows that you want to work with or use the "Select ALL" option by selecting the checkbox on the header row.

Select the Data Input Helper icon.

From the Data Input Helper – popup screen, select Method – "Grow by Amount" or some other appropriate method.

Select the term points from the left side (Available Columns) of the shuttle box.

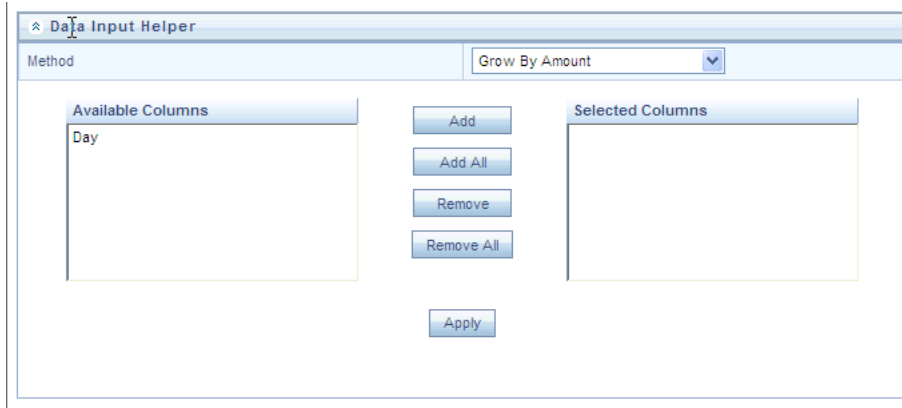

Select APPLY to copy assumptions to the selected rows.

## Excel Import/Export

Excel import/export functionality is used for adding/editing relative repricing pattern information. For more details, refer Excel Import/Export.

---

---

## Behavior Pattern Rule

This module describes the procedure for working with and managing Behavior Pattern rules.

This chapter covers the following topics:

- [Overview of Behavior Pattern Rules](#)
- [Creating Behavior Pattern Rules](#)
- [Defining Behavior Pattern Rule](#)
- [Defining a Behavior Pattern Rule: An Example](#)

### Overview of Behavior Pattern Rules

Behavior Patterns (BP) functionality works similar to amortization types. The Behavior Pattern code is assigned at the detail instrument level, and these designations are evaluated by the cash flow engine (CFE) for calculations. However Behavior Patterns are portfolio level property rather than instrument level. Generally, a bank processes aggregated data for non-maturing products. In this case Behavior Pattern is assigned effectively at portfolio level. But, if you are using ALM with any other application (for example BSP, FTP and PFT), then data is required at instrument level and BP is also assigned accordingly.

In this case you need to keep a track on changes to Behavior Pattern and assign appropriate codes to affected instruments. Due to this only one BP can be used by the CFE in the ALM processes for current business. If you want to use to model multiple types of BP under varying scenarios, then you can use Behavior Pattern Rule.

The Behavior Pattern Rule UI allows you to group Behavior Pattern codes (behavioral assumptions) together in a “set” at the Product/Currency level which then can be rotated for selecting a value on a combination. You can select which behavior assumption pattern to be used and the underlying Behavior Pattern in that set will affect the data on processing.

For more information, refer to [Creating Behavior Patterns](#)

The procedure for working with and managing Behavior Pattern Rule is similar to that of other Oracle Asset Liability Management assumption rules. It includes the following steps:

- Searching for Behavior Pattern rules. For more information, refer to [Searching for Rules](#) section.
- Creating Behavior Pattern Rules., For more information, refer to [Creating Rules](#) section.

- Viewing and Editing Behavior Pattern rules. For more information, refer to [Viewing and Editing Rules](#) section.
- Copying Behavior Pattern rules. For more information, refer to [Copying Rules](#) section.
- Deleting Behavior Pattern rules. For more information, refer to [Deleting Rules](#) section.

## Creating Behavior Pattern Rules

You create behavior pattern rule to capture the principal run-off behavior of product types that do not have contractual maturities.

### Procedure

1. Navigate to ALM Assumption Specification-> Behavior Pattern Rule page.
2. The Behavior Pattern Rule summary page is displayed. Click Add Behavior Pattern Rule.
3. Complete standard steps for this procedure.

Important: In addition to the standard steps for creating rules, the Procedure for creating a Behavior Pattern rule involves one extra step. After Standard Step 6, you need to select a product hierarchy.

You can define methodologies at any level of the hierarchical product dimension. The hierarchical relationship between the nodes allows inheritance of methodologies from parent nodes to child nodes.

## Defining Behavior Pattern Rule

The definition of a Behavior Pattern rule is part of the Create or Edit Behavior Pattern rule process. When you click Save in the Create Behavior Pattern rule process, the rule is saved and the Behavior Pattern rule summary page is displayed.

However, Behavior Pattern assumptions have not yet been defined for any of your products at this point. Typically, you would start defining your Behavior Pattern assumptions for product-currency combinations before clicking Save.

### Defining Behavior Pattern Rule Using Node Level Assumptions

Node Level Assumptions allow you to define assumptions at any level of the Product dimension Hierarchy. The Product dimension supports a hierarchical representation of your chart of accounts, so you can take advantage of the parent-child relationships defined for the various nodes of your product hierarchies while defining rules. Children of parent nodes on a hierarchy automatically inherit the assumptions defined for the parent nodes. However, assumptions directly defined for a child take precedence over those at the parent level.

### Prerequisites

Performing basic steps for creating or editing a Behavior Pattern rule

## Procedure

From the Assumption Browser screen, select the product(s) and the currency for which you want to define a Behavior Pattern(s) and select the “Add New” button to launch the Behavior Pattern Details screen.

---

**Hint:** Using the default currency to setup assumptions can save data input time. At run time, the calculation engine uses assumptions explicitly defined for a product currency combination. If assumptions are not defined for a currency, the engine uses the assumptions defined for the product and the default currency. If the assumptions are the same across some or all currencies for a specific product, you can input assumptions for the default currency. Be careful using this option on screens where an Interest Rate.

---

## The Behavior Pattern Details screen

The screenshot shows the 'Behavior Pattern Details' screen in Internet Explorer. The browser title is 'Assumption Details - New - Internet Explorer'. The page has a header with 'Active Time Bucket: Test\_TB', 'Behavior Pattern Rule', and 'As Of Date: 01/31/2012'. The main content area is divided into several sections:

- Behavior Pattern Rule Details:** Includes fields for Name, Description, Folder (set to 'ALMSEG'), Access Type (with radio buttons for Read/Write and Read Only), and a 'Read Only' checkbox.
- Select Product Hierarchy:** Includes fields for Folder (set to 'ALMSEG') and Product Hierarchy (set to 'Test\_Hierarchy').
- Select Currency:** Includes a field for Currency (set to 'Default Currency').
- Assumption Browser:** A tabbed interface with 'Assumption Browser' selected. It contains a table with columns: Product, Behavior Pattern, Conditional Behavior, and Status. The table is currently empty.

At the bottom of the form, there are 'Save' and 'Cancel' buttons.

## Defining a Behavior Pattern Rule: An Example

To create a Behavior Pattern rule, enter the following details on Behavior Pattern Rule UI:

- From the Assumption Browser, select Currency (US Dollar) and Total Loans.
  - Name
  - Description
  - Folder
  - Access Type
- From the Assumption Browser, select Currency (US Dollar) and a product from the hierarchy browser. Select the Add New icon to enter the Assumption Details page.

The screenshot shows the 'Discount Methods' configuration window. The 'Name' field is 'DiscMethSaveAs'. The 'Folder' is 'ALMSEG'. The 'Access Type' is 'Read/Write' and 'Read Only' is unselected. The 'Select Product Hierarchy' section shows 'Folder' as 'ALMSEG', 'Product Hierarchy\*' as an empty field, and 'HierTest1' as a dropdown. The 'Select Currency' section shows 'Currency\*' as 'Default Currency'. The 'Assumption Browser' section shows an 'Assumption List' table with columns 'Product', 'Discount Method', and 'Status'. Under 'Product', there are checkboxes for 'Member1' and 'Orphan Branch'. At the bottom are buttons for 'Save', 'Save As', and 'Cancel'.

3. Select a pattern from the Behavior Pattern selector. Here, the Behavior Pattern drop-down shows the list of existing Behavior patterns. For more information, refer to User Defined Behavior Pattern chapter. You can select only one Behavior Pattern at a time.
4. Click Apply.

This module describes the procedure for working with and managing Time Bucket rules.

This chapter covers the following topics:

- [Overview of Time Bucket Rules](#)
- [Creating Time Bucket Rules](#)
- [Defining Time Bucket Rules](#)

### Overview of Time Bucket Rules

Time Bucket rules allow users to create the various time bucket definitions used for computing and outputting aggregated cash flows. Time Bucket rules determine the granularity of cash flow output and can be set at any frequency through a combination of daily, monthly and yearly buckets. Time Buckets can be defined for the following type of ALM output:

- Income Simulation
- Interest Rate GAP
- Liquidity GAP

Income Simulation Buckets allow you to specify the time periods used for storing and reporting results. These bucket definitions set the modeling horizon for date-related business rule assumptions. When you change the number or frequency of the modeling buckets, existing business rules are affected.

---

---

**Note:** Be cautious when changing Time Bucket definitions when known dependencies exist.

You can specify any combination of days, months, and years when setting up the buckets. Although, all Oracle ALM cash flows are generated on a daily basis, they are aggregated into defined income simulation buckets when results are stored. Reports access information from the income simulation buckets and let you aggregate buckets. For example, you can define monthly income simulation buckets but generate a quarterly income statement. On the other hand, you cannot generate a weekly balance sheet if all income simulation buckets are monthly.

If you want to use different configurations of income simulation buckets, such as all monthly or all quarterly, you should create a separate Time Bucket rule for each and use an appropriate naming convention to identify these characteristics. All date-related assumption rules should be defined and used in the context of a single set of Income Simulation buckets or a single Time Bucket rule.

---

---

Income Simulation Bucket definitions are referenced by all bucket based forecast business rules, including Forecast Rates, Forecast Balances, Pricing Margins and Maturity Mix rules and also by ALM Deterministic Processes during ALM engine processing.

Interest Rate GAP Buckets allow you to define Interest Rate (repricing) GAP buckets. From this screen, you can also define Dynamic Start Dates (as of date is always the initial start date), which allow you to generate both static and dynamic GAP simulations.

With this Dynamic Start Date capability, users can also define forward start dates for computing dynamic market valuations. The Dynamic Start Date capability allows you to consider amortization of existing business and any new business assumptions that are applicable between the current as of date and the future dated – Dynamic Start Date. You must set up Income Simulation Buckets before defining Interest Rate GAP Buckets.

---

---

**Note:** Only Interest Rate GAP financial elements are impacted by the Interest Rate GAP bucket definitions. The Interest Rate GAP financial elements range from FE660 to FE700.

---

---

Liquidity GAP Buckets are similar to Interest Rate GAP buckets. The only difference is that Liquidity Bucket definitions impact only the Liquidity Runoff financial elements, which range from FE 1660 to 1717.

The procedure for working with and managing Time Bucket rules is similar to that of other Asset Liability Management business rules. It includes the following steps:

- Searching for Time Bucket rules. For more information, refer to [Searching for Rules](#) section.



- Creating Time Bucket Rules, For more information, refer to [Creating Rules](#) section.
- Viewing and Editing Time Bucket rules. For more information, refer to [Viewing and Editing Rules](#) section.
- Copying Time Bucket rules. For more information, refer to [Copying Rules](#) section.
- Deleting Time Bucket rules. For more information, refer to [Deleting Rules](#) section.

## Creating Time Bucket Rules

You create Time Bucket rules to specify the time periods used for storing and reporting ALM results.

### Procedure

1. Navigate to the Time Buckets summary page.

Time Buckets				
Active Time Bucket: Time_incomesimulation				
^ Search				
Name		Folder	ALMHMSEG	
^ Time Buckets				
Name	Creation Date	Created By	Last Modification Date	Last Modified By
<input type="checkbox"/> Time_test	9/11/2014 05:58:23	JILNA	9/11/2014 10:26:07	JILNA
<input type="checkbox"/> Time_incomesimulation	8/18/2014 07:27:53	JILNA	9/8/2014 09:12:24	CHANNAMMA
<input type="checkbox"/> TB_2	8/25/2014 07:02:29	CHANNAMMA	9/5/2014 07:06:46	ALMHMUSER1
<input type="checkbox"/> save as_edit	8/25/2014 07:03:11	CHANNAMMA	8/25/2014 07:04:00	CHANNAMMA
<input type="checkbox"/> save as edit	8/25/2014 07:03:57	CHANNAMMA	8/25/2014 07:03:57	CHANNAMMA
<input type="checkbox"/> TB_1	8/22/2014 11:34:01	CHANNAMMA	8/22/2014 11:34:01	CHANNAMMA

2. Complete standard steps for this procedure. For more information, see [Creating Rules](#) section.

## Defining Time Bucket Rules

The definition of a Time Bucket rule is part of the Create or Edit Time Buckets rule process. When you click Save in the Create Time Buckets rule process, the rule is saved and the Time Buckets rule summary page is displayed. However, Time Bucket assumptions may not have been defined at this point. Typically, you would start defining your Time Bucket assumptions before clicking Save.

### Prerequisites

Performing basic steps for creating or editing a Time Bucket rule.

### Procedure

From the Time Bucket details screen, you have one tab available for creating Time Bucket definitions.

- Income Simulation Buckets (required)
- Interest Rate GAP Buckets (required only if Repricing Gap is selected during processing)
- Liquidity GAP Buckets (required only if Liquidity Gap is selected during processing)

The first step is to define your Income Simulation buckets.

From the Income Simulation tab, do the following:

1. Click the Add Rows button and input the desired number of rows corresponding to the number of Income Simulation Buckets you would like to create.

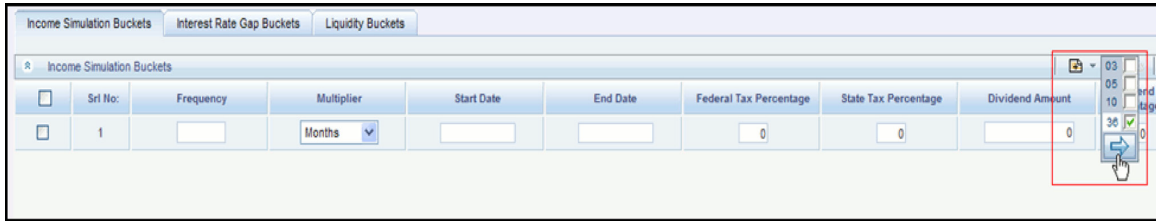

---

**Note:** You can select a pre-defined number of rows from the list, For example, 3, 5 or 10, or you can input the exact number of rows you would like to add. The maximum number of buckets you have under any tab is 240.

---

2. Under Frequency, input a numeric value, For example 1. The Frequency column displays the duration of the multiplier. The frequency in conjunction with the multiplier displays the duration of the buckets. The frequency can be any number from 1 to 999. Under Multiplier, select an appropriate value from the list. The Multiplier column includes Daily, Monthly, or Yearly choices.

---

**Note:** Limit the definition of Income Simulation buckets to the date range that is relevant to your reporting requirement. It is not necessary to create "catch-all" buckets at the end of the series. When large buckets are created, for instance, 99 Years, this can result in the following error:

INSERT Oracle Error: ORA- 01426: numeric overflow

Driver

Function: drv\_oci::Execute()

---

3. Continue adding frequencies and multipliers as needed.

**Table 15-1 Example**

Frequency	Multiplier
1	Month
1	Month
1	Month
1	Month
1	Month.....

After you fill in the frequencies and multipliers, the start and end dates are calculated automatically based on the As of Date, defined in your Application Preference settings.

The screenshot shows the 'Time Buckets' application window. At the top, there is a header 'Time Buckets' and a date field 'As Of Date: 11-Jan-2013'. Below this is a form with fields for 'Name' (gdfg), 'Description' (dgdg), 'Active' (checkbox), 'Folder' (EPM61SEG), and 'Access Type' (Read Only, Read/Write). The main area contains a table titled 'Income Simulation Buckets' with the following data:

Serial Number	Frequency	Multiplier	Start Date	End Date	Federal Tax Percentage	State Tax Percentage	Dividend Amount	Dividend Percentage
1	99	Months	12-Jan-2013	11-Apr-2021	0	0	0	0
2	999	Months	12-Apr-2021	11-Jul-2104	0	0	0	0
3	9	Months	12-Jul-2104	11-Apr-2105	0	0	0	0
4	999	Months	12-Apr-2105	11-Jul-2188	0	0	0	0
5	99	Months	12-Jul-2188	11-Oct-2196	0	0	0	0

At the bottom of the window are buttons for 'Save As', 'Save', and 'Cancel'.

**Note:** You may want to utilize the Data Input Helper to copy from a row where you have already defined the time bucket definition or apply a fixed value down the page. The following optional steps describe how to use this feature.

1. Select the checkbox next to the rows that you want to work with or use the "Select ALL" option by selecting the checkbox on the header row
2. Select the Data Input Helper icon.

This close-up screenshot shows the 'Income Simulation Buckets' table with checkboxes selected for rows 1 and 2. The 'Data Input Helper' icon is highlighted in the top right corner of the table area.

3. From the Data Input Helper – popup screen, select Method – "Keep Current Values" or some other appropriate method.

4. Select the Frequency and/or Multiplier from the left side of the shuttle box.

5. Select APPLY to copy assumptions to the selected rows.

4. After defining time bucket frequencies, move across each row to input the appropriate Federal Tax Percentages and State Tax Percentages.

Tax percentages are used in ALM when processing with the auto-balancing option selected. Type 35.00 for 35%. The tax rate entered is interpreted as the tax rate for that bucket regardless of the frequency of the bucket. That is, 35% entered for a monthly bucket is applied as a 35% monthly rate to the taxable income forecast for that month.

5. Under Dividend Amount, type a value. Dividend amounts are used in HM when processing with the auto-balancing option selected. The values you enter here will be paid out as dividends for all rate scenarios.
6. Under Dividend Percentage, type a value. Dividend percentages are used during auto-balancing calculations. The dividend percentage is defined as a percent of the net income after tax that will be paid out as dividends for the period.

Total Dividends = Dividends Amount + (Dividends Percent x Net Income after Tax)

7. Select SAVE if you are finished.

Otherwise, navigate to the Interest Rate GAP Buckets tab.

After defining Income Simulation buckets, navigate to the Interest Rate GAP Buckets tab. The Interest Rate GAP bucket detail page provides two important inputs. The first is the ability to define Interest Rate GAP buckets. The second capability allows you to define one or more Dynamic Start Dates. The following steps explain how to complete each of these setup tasks.

**Note:** By default, the last time series time bucket in all dynamic start dates will default to 99 years as a “catch all” bucket. This is used to verify the total runoff for reporting requirements.

From the Interest Rate GAP Buckets tab, do the following:

1. Click the Add Rows button corresponding to the Default Dynamic Start Date and input the desired number of rows for your Interest Rate GAP Buckets.

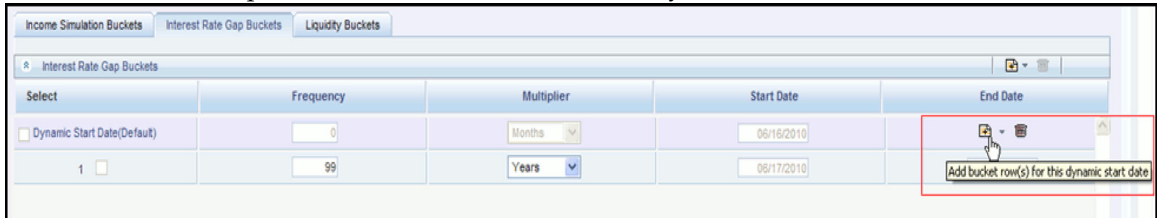

2. Follow steps 2 – 4 described above under Income Simulation buckets, to complete the setup of your Interest Rate GAP buckets for the default Dynamic Start Date.
3. If you would like to define additional – forward dated, Dynamic Start Dates, Click the “Add Dynamic Start Date” button to add one or more parent nodes to the bucket hierarchy.



4. For each additional Dynamic Start Date row, input a Frequency and Multiplier to determine future start date(s).
5. Click the Add Rows button corresponding to each new Dynamic Start Date and repeat the Interest Rate GAP Bucket definition steps described above to complete the setup.
6. For a more detailed example on creating additional Dynamic Start Dates.

After defining Interest Rate GAP buckets, navigate to the Liquidity Buckets tab. The Liquidity Buckets detail page has the same structure as the Interest Rate GAP details page. It allows you to define the Liquidity GAP Buckets for the default Dynamic Start Date and also allows you to add one or more additional Dynamic Start Dates. The use of Dynamic Start Dates will allow you to forecast your liquidity position as of some future point in time, considering all relevant assumptions, including amortization, prepayments, early withdrawals, and rollovers.

**Note:** By default, the last time series time bucket in all dynamic start dates will default to 99 years as a “catch all” bucket. This is used to verify the total runoff for reporting requirements.

From the Liquidity Buckets tab, do the following:

1. Click the Add Rows button corresponding to the Default Dynamic Start Date and input the desired number of rows for your Liquidity Buckets.
2. Follow steps 2 – 4 described above under Income Simulation buckets, to complete the setup of your Liquidity Buckets for the default Dynamic Start Date.
3. If you would like to define additional – forward dated, Dynamic Start Dates, Click the “Add Dynamic Start Date” button to add one or more parent nodes to the bucket hierarchy.
4. If needed, input a Frequency and Multiplier for the new Dynamic Start Date to determine the future start date.
5. Click the Add Rows button corresponding to the new Dynamic Start Date and repeat the Liquidity GAP Bucket definition steps described above.

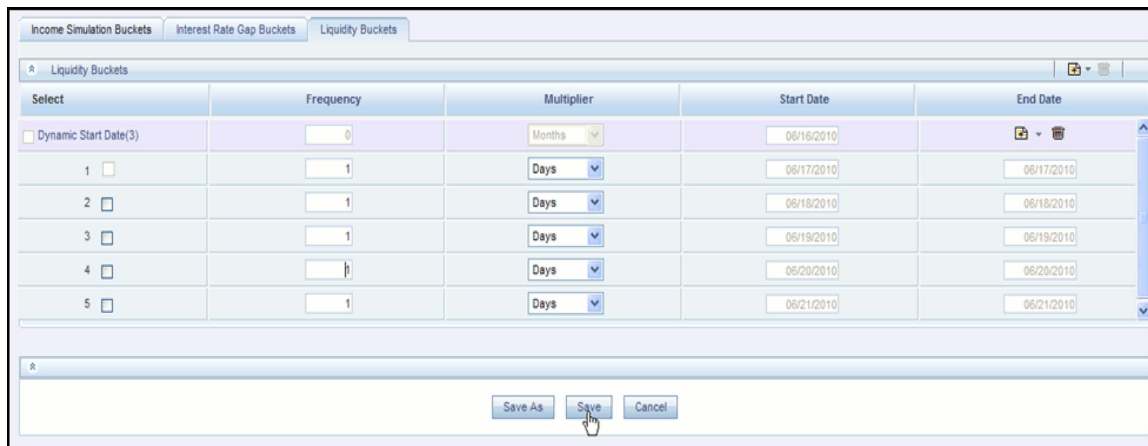

6. For a more detailed example on creating additional Dynamic Start Dates, see Example
7. Once you have completed the setup for all bucket types, click the SAVE button.

## Excel Import/Export

Excel import/export functionality is used for adding/editing time bucket information. For more details, refer to [Excel Import/Export](#)

## Additional Required Steps

All users must have an “Active” Time Bucket Rule at all times. There is a checkbox at the top of the page, above the Bucket tabs. If you wish to “Activate” a particular Time

Bucket Rule, simply check this box and Save the Rule. You will note the Active Time Bucket rule for your user appears on the Title bar in green text.

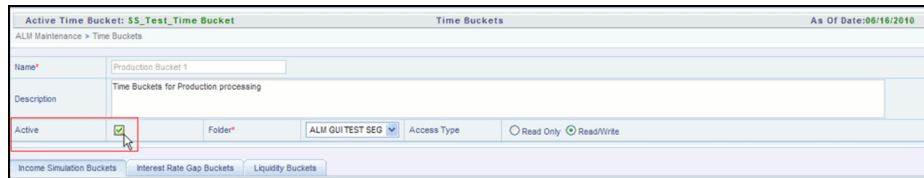

The screenshot shows a web application interface for configuring Time Buckets. At the top, the title bar displays "Active Time Bucket: SS\_Test\_Time Bucket" in green text, along with "Time Buckets" and "As Of Date: 06/18/2010". Below the title bar, the breadcrumb "ALM Maintenance > Time Buckets" is visible. The main form contains the following fields:

- Name\***: Production Bucket 1
- Description**: Time Buckets for Production processing
- Active**: A checkbox that is checked, highlighted with a red box, and has a mouse cursor over it.
- Folder\***: ALM GUI TEST SEG (dropdown menu)
- Access Type**: Radio buttons for Read Only and Read/Write (Read/Write is selected).

At the bottom of the screen, there are three tabs: "Income Simulation Buckets", "Interest Rate Gap Buckets", and "Liquidity Buckets".

---

---

**Note:** Each time you change the As of Date in your Application Preferences screen, all Time Bucket Rule Bucket Start Date and Bucket End Date gets updated automatically.

---

---





---

---

## Default Product Profiles

### Overview of Product Profiles

Product Characteristic setup can be a time consuming process as there are more than 40 attributes which can be required when defining characteristics for dimension members in the product COA hierarchy. Product Profiles allow you to pre-define and save common product definitions and reference these definitions while defining your Product Characteristic assumptions. Setup time is reduced because product profiles provide common default values for the majority of required fields. The following Product Profiles are seeded during installation:

- Bond – Adjustable Rate
- Bond – Fixed Rate
- Credit Card
- Discount Instrument
- Lease
- Loan – Adjustable Rate
- Loan – Fixed Rate
- Loan – Floating Rate
- Loan – Neg Am
- Savings
- Term Deposit

In addition to the seeded profiles, you can add custom product profiles to your setup by creating completely new profiles or by using the Save As option with one of the existing profiles.

---

---

**Note:** The seeded Product Profiles are not editable and cannot be deleted.

---

---

The procedure for working with and managing Product Profiles is similar to that of other Asset | Liability Management business rules. It includes the following steps:

- Searching for Product Profiles.
- Creating Product Profiles
- Viewing and Editing Product Profiles.

- Copying Product Profiles.
- Deleting Product Profiles.

## Viewing a seeded Product Profile

You can review any of the twelve seeded Product Profile definitions.

### Procedure

1. Navigate to the Product Profile summary page.

Product Profiles				
Active Time Bucket: Time_incomesimulation				
Search				
Name				
Product Profiles				
Name	Creation Date	Created By	Last Modification Date	Last Modified By
<input type="checkbox"/> Accrual basis check	8/22/2014 00:00:00	CHANNAMMA	9/1/2014 07:05:02	CHANNAMMA
<input type="checkbox"/> asdfs	8/18/2014 08:07:52	JILNA	8/18/2014 08:07:52	JILNA
<input type="checkbox"/> Bond Adjustable Rate	8/13/2014 07:34:54	Oracle	8/13/2014 07:34:54	
<input type="checkbox"/> Bond Fixed Rate	8/13/2014 07:34:54	Oracle	8/13/2014 07:34:54	
<input type="checkbox"/> check_Bug	8/28/2014 07:24:56	CHANNAMMA	8/28/2014 07:24:56	CHANNAMMA
<input type="checkbox"/> CM_13404431_Bond	8/28/2014 00:00:00	CHANNAMMA	8/28/2014 09:32:56	CHANNAMMA
<input type="checkbox"/> copy	8/18/2014 07:40:46	JILNA	8/18/2014 07:40:46	JILNA

2. Select the check box next to the Product Profile you want to View and select the View Icon.
3. Navigate through the All Business and New Business tabs to review the seeded values.

## Creating Product Profiles

You create Product Profiles to assign default attributes for common products and then reference these product profiles within your Product Characteristic assumption rules to reduce setup time. In addition to the seeded Product Profile templates, you can also create new Profiles.

### Procedure

1. Navigate to the Product Profile summary page.
2. Complete standard steps for this procedure.

Product Profiles				
Active Time Bucket: Time_incomesimulation				
Search				
Name				
Product Profiles				
Name	Creation Date	Created By	Last Modification Date	Last Modified By
Accrual basis check	8/22/2014 00:00:00	CHANNAMMA	9/1/2014 07:05:02	CHANNAMMA
asdfs	8/18/2014 08:07:52	JILNA	8/18/2014 08:07:52	JILNA
Bond Adjustable Rate	8/13/2014 07:34:54	Oracle	8/13/2014 07:34:54	
Bond Fixed Rate	8/13/2014 07:34:54	Oracle	8/13/2014 07:34:54	
check_Bug	8/28/2014 07:24:56	CHANNAMMA	8/28/2014 07:24:56	CHANNAMMA
CM_13404431_Bond	8/28/2014 00:00:00	CHANNAMMA	8/28/2014 09:32:56	CHANNAMMA
copy	8/18/2014 07:40:46	JILNA	8/18/2014 07:40:46	JILNA

3. Enter a Name and Description for the new Profile.
4. Define product attributes for the profile you are creating. For more information on individual attributes, see (Mandatory) Defining Product Characteristics
5. Click Save to complete the new profile definition.

## Summary of Seeded Product Profiles

The following tables summarize the attributes defined for each product profile:

### Bond Adjustment Rate

Location	Default Value	Attribute
All Business >	100	Percent Taxable
All Business >	Do Not Adjust	Pay Equivalent Compounding Convention
All Business >	Blank, that is, holiday calendar not selected	Holiday Calendar
All Business >	Unadjusted and Disabled, if holiday calendar not selected in the preceding section. Unadjusted and Enabled, if holiday calendar is selected in the preceding section.	Rolling Convention
All Business >	Shift Dates Only is selected and Disabled if Rolling Convention not selected. Shift Dates Only is selected and Enabled if Rolling Convention is selected to be other than Unadjusted.	Interest Calculation Logic
New Business > Define Core Product Attributes >	Non-Amortizing	Amortization Type
New Business > Define Core Product Attributes >	Other Adjustable	Adjustable Type
New Business > Define Core Product Attributes	Unchecked	Inflation Indexed Instrument

Location	Default Value	Attribute
New Business > Define Payment Attributes >	6 Months	Payment Frequency
New Business > Define Payment Attributes >	Interest In Arrears	Interest Type
New Business > Define Payment Attributes >	Actual / Actual	Accrual Basis
New Business > Define Payment Attributes >	Simple	Compounding Basis
New Business > Define Payment Attributes >	Floating Net Rate	Net Margin Flag
New Business > Define Adjustable Rate Attributes >	6 Months	Repricing Frequency
New Business > Define Other Mortgage Attributes >	700	Customer Credit Score
New Business > Define Other Mortgage Attributes >	80	Original Loan to value
New Business > Define Other Mortgage Attributes >	FANNIE_MAE	Issuer
New Business > Define Negative Amortization Attributes >		<Not Applicable>
New Business>Define Inflation Adjustment Attributes >	0	Index Name
New Business>Define Inflation Adjustment Attributes >	Principal and Interest payments both	Index Adjustment Type
New Business>Define Inflation Adjustment Attributes >	No Floor	No Floor Capital Protection Category

**Note:** If the user is mapped to ADCo, Product Profile will always show "Define Other Mortgages Attributes" tab.

## Bond Fixed Rate

Location	Default Value	Attribute
All Business >	100	Percent Taxable
All Business >	Do Not Adjust	Pay Equivalent Compounding Convention
All Business >	Blank, that is, holiday calendar not selected	Holiday Calendar
All Business >	Unadjusted and Disabled, if holiday calendar not selected in the preceding section. Unadjusted and Enabled, if holiday calendar is selected in the preceding section.	Rolling Convention

Location	Default Value	Attribute
All Business >	Shift Dates Only is selected and Disabled if Rolling Convention not selected. Shift Dates Only is selected and Enabled if Rolling Convention is selected to be other than Unadjusted.	Interest Calculation Logic
New Business > Define Core Product Attributes >	Non-Amortizing	Amortization Type
New Business > Define Core Product Attributes >	Fixed Rate	Adjustable Type
New Business > Define Core Product Attributes	Unchecked	Inflation Indexed Instrument
New Business > Define Payment Attributes >	6 Months	Payment Frequency
New Business > Define Payment Attributes >	Interest In Arrears	Interest Type
New Business > Define Payment Attributes >	Actual / Actual	Accrual Basis
New Business > Define Payment Attributes >	Simple	Compounding Basis
New Business > Define Payment Attributes >	Floating Net Rate	Net Margin Flag
New Business > Define Adjustable Rate Attributes >		<Not Applicable>
New Business > Define Other Mortgage Attributes >	700	Customer Credit Score
New Business > Define Other Mortgage Attributes >	80	Original Loan to value
New Business > Define Other Mortgage Attributes >	FANNIE_MAE	Issuer
New Business > Define Neg Am Attributes >		<Not Applicable>
New Business>Define Inflation Adjustment Attributes >	0	Index Name
New Business>Define Inflation Adjustment Attributes >	Principal and Interest payments both	Index Adjustment Type
New Business>Define Inflation Adjustment Attributes >	No Floor	No Floor Capital Protection Category

---

**Note:** If the user is mapped to ADCo, Product Profile will always show "Define Other Mortgages Attributes" tab.

---

## Credit Cards

Location	Default Value	Attribute
All Business >	100	Percent Taxable
All Business >	Do Not Adjust	Pay Equivalent Compounding Convention
All Business >	Blank, that is, holiday calendar not selected	Holiday Calendar
All Business >	Unadjusted and Disabled, if holiday calendar not selected in the preceding section. Unadjusted and Enabled, if holiday calendar is selected in the preceding section.	Rolling Convention
All Business >	Shift Dates Only is selected and Disabled if Rolling Convention not selected. Shift Dates Only is selected and Enabled if Rolling Convention is selected to be other than Unadjusted.	Interest Calculation Logic
New Business > Define Core Product Attributes >	Behavior Pattern	Amortization Type
New Business > Define Core Product Attributes >	Floating Rate	Adjustable Type
New Business > Define Core Product Attributes	Unchecked	Inflation Indexed Instrument
New Business > Define Payment Attributes >	1 Month	Payment Frequency
New Business > Define Payment Attributes >	Interest In Arrears	Interest Type
New Business > Define Payment Attributes >	Actual / Actual	Accrual Basis
New Business > Define Payment Attributes >	Simple	Compounding Basis
New Business > Define Payment Attributes >	Floating Net Rate	Net Margin Flag
New Business > Define Adjustable Rate Attributes >		<Not Applicable>
New Business > Define Other Mortgage Attributes >	700	Customer Credit Score
New Business > Define Other Mortgage Attributes >	80	Original Loan to value
New Business > Define Other Mortgage Attributes >	FANNIE_MAE	Issuer
New Business > Define Neg Am Attributes >		<Not Applicable>
New Business>Define Inflation Adjustment Attributes >	0	Index Name

Location	Default Value	Attribute
New Business>Define Inflation Adjustment Attributes >	Principal and Interest payments both	Index Adjustment Type
New Business>Define Inflation Adjustment Attributes >	No Floor	No Floor Capital Protection Category

**Note:** If the user is mapped to ADCo, Product Profile will always show "Define Other Mortgages Attributes" tab.

## Discount Instruments

Location	Default Value	Attribute
All Business >	100	Percent Taxable
All Business >	Do Not Adjust	Pay Equivalent Compounding Convention
All Business >	Blank, that is, holiday calendar not selected	Holiday Calendar
All Business >	Unadjusted and Disabled, if holiday calendar not selected in the preceding section. Unadjusted and Enabled, if holiday calendar is selected in the preceding section.	Rolling Convention
All Business >	Shift Dates Only is selected and Disabled if Rolling Convention not selected. Shift Dates Only is selected and Enabled if Rolling Convention is selected to be other than Unadjusted.	Interest Calculation Logic
New Business > Define Core Product Attributes >	Non-Amortizing	Amortization Type
New Business > Define Core Product Attributes >	Fixed Rate	Adjustable Type
New Business > Define Core Product Attributes >	3.0%	Original Deferred Amortization %
New Business > Define Core Product Attributes	Unchecked	Inflation Indexed Instrument
New Business > Define Payment Attributes >	90 Days	Payment Frequency
New Business > Define Payment Attributes >	Interest In Arrears	Interest Type
New Business > Define Payment Attributes >	Actual / 360	Accrual Basis
New Business > Define Payment Attributes >	Simple	Compounding Basis
New Business > Define Payment Attributes >	Floating Net Rate	Net Margin Flag

Location	Default Value	Attribute
New Business > Define Adjustable Rate Attributes >		<Not Applicable>
New Business > Define Other Mortgage Attributes >	700	Customer Credit Score
New Business > Define Other Mortgage Attributes >	80	Original Loan to value
New Business > Define Other Mortgage Attributes >	FANNIE_MAE	Issuer
New Business > Define Neg Am Attributes >		<Not Applicable>
New Business>Define Inflation Adjustment Attributes >	0	Index Name
New Business>Define Inflation Adjustment Attributes >	Principal and Interest payments both	Index Adjustment Type
New Business>Define Inflation Adjustment Attributes >	No Floor	No Floor Capital Protection Category

**Note:** If the user is mapped to ADCo, Product Profile will always show "Define Other Mortgages Attributes" tab.

## Lease

Location	Default Value	Attribute
All Business >	100	Percent Taxable
All Business >	Do Not Adjust	Pay Equivalent Compounding Convention
All Business >	Blank, that is, holiday calendar not selected	Holiday Calendar
All Business >	Unadjusted and Disabled, if holiday calendar not selected in the preceding section. Unadjusted and Enabled, if holiday calendar is selected in the preceding section.	Rolling Convention
All Business >	Shift Dates Only is selected and Disabled if Rolling Convention not selected. Shift Dates Only is selected and Enabled if Rolling Convention is selected to be other than Unadjusted.	Interest Calculation Logic
New Business > Define Core Product Attributes >	Lease	Amortization Type
New Business > Define Core Product Attributes >	Fixed Rate	Adjustable Type



Location	Default Value	Attribute
New Business > Define Core Product Attributes	Unchecked	Inflation Indexed Instrument
New Business > Define Payment Attributes >	1 Month	Payment Frequency
New Business > Define Payment Attributes >	Interest In Arrears	Interest Type
New Business > Define Payment Attributes >	Actual / 360	Accrual Basis
New Business > Define Payment Attributes >	Simple	Compounding Basis
New Business > Define Payment Attributes >	Floating Net Rate	Net Margin Flag
New Business > Define Adjustable Rate Attributes >		<Not Applicable>
New Business > Define Other Mortgage Attributes >	700	Customer Credit Score
New Business > Define Other Mortgage Attributes >	80	Original Loan to value
New Business > Define Other Mortgage Attributes >	FANNIE_MAE	Issuer
New Business > Define Neg Am Attributes >		<Not Applicable>
New Business>Define Inflation Adjustment Attributes >	0	Index Name
New Business>Define Inflation Adjustment Attributes >	Principal and Interest payments both	Index Adjustment Type
New Business>Define Inflation Adjustment Attributes >	No Floor	No Floor Capital Protection Category

**Note:** If the user is mapped to ADCo, Product Profile will always show "Define Other Mortgages Attributes" tab.

## Loan Adjustment Rate

Location	Default Value	Attribute
All Business >	100	Percent Taxable
All Business >	Do Not Adjust	Pay Equivalent Compounding Convention
All Business >	Blank, that is, holiday calendar not selected	Holiday Calendar

Location	Default Value	Attribute
All Business >	Unadjusted and Disabled, if holiday calendar not selected in the preceding section. Unadjusted and Enabled, if holiday calendar is selected in the preceding section.	Rolling Convention
All Business >	Shift Dates Only is selected and Disabled if Rolling Convention not selected. Shift Dates Only is selected and Enabled if Rolling Convention is selected to be other than Unadjusted.	Interest Calculation Logic
New Business > Define Core Product Attributes >	Conventional Adjustable	Amortization Type
New Business > Define Core Product Attributes >	Other Adjustable	Adjustable Type
New Business > Define Core Product Attributes	Unchecked	Inflation Indexed Instrument
New Business > Define Payment Attributes >	1 Month	Payment Frequency
New Business > Define Payment Attributes >	Interest In Arrears	Interest Type
New Business > Define Payment Attributes >	Actual / Actual	Accrual Basis
New Business > Define Payment Attributes >	Simple	Compounding Basis
New Business > Define Payment Attributes >	Floating Net Rate	Net Margin Flag
New Business > Define Adjustable Rate Attributes >	1 Year	Repricing Frequency
New Business > Define Other Mortgage Attributes >	700	Customer Credit Score
New Business > Define Other Mortgage Attributes >	80	Original Loan to value
New Business > Define Other Mortgage Attributes >	FANNIE_MAE	Issuer
New Business > Define Neg Am Attributes >		<Not Applicable>
New Business>Define Inflation Adjustment Attributes >	0	Index Name
New Business>Define Inflation Adjustment Attributes >	Principal and Interest payments both	Index Adjustment Type
New Business>Define Inflation Adjustment Attributes >	No Floor	No Floor Capital Protection Category

---



---

**Note:** If the user is mapped to ADCo, Product Profile will always show "Define Other Mortgages Attributes" tab.

---



---

## Loan Fixed Rate

Location	Default Value	Attribute
All Business >	100	Percent Taxable
All Business >	Do Not Adjust	Pay Equivalent Compounding Convention
All Business >	Blank, that is, holiday calendar not selected	Holiday Calendar
All Business >	Unadjusted and Disabled, if holiday calendar not selected in the preceding section. Unadjusted and Enabled, if holiday calendar is selected in the preceding section.	Rolling Convention
All Business >	Shift Dates Only is selected and Disabled if Rolling Convention not selected. Shift Dates Only is selected and Enabled if Rolling Convention is selected to be other than Unadjusted.	Interest Calculation Logic
New Business > Define Core Product Attributes >	Conventional Fixed	Amortization Type
New Business > Define Core Product Attributes >	Fixed	Adjustable Type
New Business > Define Core Product Attributes	Unchecked	Inflation Indexed Instrument
New Business > Define Payment Attributes >	1 Month	Payment Frequency
New Business > Define Payment Attributes >	Interest In Arrears	Interest Type
New Business > Define Payment Attributes >	Actual / Actual	Accrual Basis
New Business > Define Payment Attributes >	Simple	Compounding Basis
New Business > Define Payment Attributes >	Floating Net Rate	Net Margin Flag
New Business > Define Adjustable Rate Attributes >		< Not Applicable >
New Business > Define Other Mortgage Attributes >	700	Customer Credit Score
New Business > Define Other Mortgage Attributes >	80	Original Loan to value
New Business > Define Other Mortgage Attributes >	FANNIE_MAE	Issuer
New Business > Define Neg Am Attributes >		<Not Applicable>

Location	Default Value	Attribute
New Business>Define Inflation Adjustment Attributes >	0	Index Name
New Business>Define Inflation Adjustment Attributes >	Principal and Interest payments both	Index Adjustment Type
New Business>Define Inflation Adjustment Attributes >	No Floor	No Floor Capital Protection Category

**Note:** If the user is mapped to ADCo, Product Profile will always show "Define Other Mortgages Attributes" tab.

## Loan Floating Rate

Location	Default Value	Attribute
All Business >	100	Percent Taxable
All Business >	Do Not Adjust	Pay Equivalent Compounding Convention
All Business >	Blank, that is, holiday calendar not selected	Holiday Calendar
All Business >	Unadjusted and Disabled, if holiday calendar not selected in the preceding section. Unadjusted and Enabled, if holiday calendar is selected in the preceding section.	Rolling Convention
All Business >	Shift Dates Only is selected and Disabled if Rolling Convention not selected. Shift Dates Only is selected and Enabled if Rolling Convention is selected to be other than Unadjusted.	Interest Calculation Logic
New Business > Define Core Product Attributes >	Conventional Adjustable	Amortization Type
New Business > Define Core Product Attributes >	Floating Rate	Adjustable Type
New Business > Define Core Product Attributes	Unchecked	Inflation Indexed Instrument
New Business > Define Payment Attributes >	1 Month	Payment Frequency
New Business > Define Payment Attributes >	Interest In Arrears	Interest Type
New Business > Define Payment Attributes >	Actual / Actual	Accrual Basis
New Business > Define Payment Attributes >	Simple	Compounding Basis

Location	Default Value	Attribute
New Business > Define Payment Attributes >	Floating Net Rate	Net Margin Flag
New Business > Define Adjustable Rate Attributes >		< Not Applicable >
New Business > Define Other Mortgage Attributes >	700	Customer Credit Score
New Business > Define Other Mortgage Attributes >	80	Original Loan to value
New Business > Define Other Mortgage Attributes >	FANNIE_MAE	Issuer
New Business > Define Neg Am Attributes >		<Not Applicable>
New Business>Define Inflation Adjustment Attributes >	0	Index Name
New Business>Define Inflation Adjustment Attributes >	Principal and Interest payments both	Index Adjustment Type
New Business>Define Inflation Adjustment Attributes >	No Floor	No Floor Capital Protection Category

**Note:** If the user is mapped to ADCo, Product Profile will always show "Define Other Mortgages Attributes" tab.

## Loan Negative Amortization

Location	Default Value	attribute
All Business >	100	Percent Taxable
All Business >	Do Not Adjust	Pay Equivalent Compounding Convention
All Business >	Blank, that is, holiday calendar not selected	Holiday Calendar
All Business >	Unadjusted and Disabled, if holiday calendar not selected in the preceding section. Unadjusted and Enabled, if holiday calendar is selected in the preceding section.	Rolling Convention
All Business >	Shift Dates Only is selected and Disabled if Rolling Convention not selected. Shift Dates Only is selected and Enabled if Rolling Convention is selected to be other than Unadjusted.	Interest Calculation Logic
New Business > Define Core Product Attributes >	Adjustable Negative Amortization	Amortization Type

Location	Default Value	attribute
New Business > Define Core Product Attributes >	Other Adjustable	Adjustable Type
New Business > Define Core Product Attributes	Unchecked	Inflation Indexed Instrument
New Business > Define Payment Attributes >	1 Month	Payment Frequency
New Business > Define Payment Attributes >	Interest In Arrears	Interest Type
New Business > Define Payment Attributes >	Actual / Actual	Accrual Basis
New Business > Define Payment Attributes >	Simple	Compounding Basis
New Business > Define Payment Attributes >	Floating Net Rate	Net Margin Flag
New Business > Define Adjustable Rate Attributes >	1 Month	Repricing Frequency
New Business > Define Neg Am Attributes >	6 Months	Payment Change Frequency
New Business > Define Neg Am Attributes >	3 Months	Equalization Frequency
New Business > Define Other Mortgage Attributes >	700	Customer Credit Score
New Business > Define Other Mortgage Attributes >	80	Original Loan to value
New Business > Define Other Mortgage Attributes >	FANNIE_MAE	Issuer
New Business>Define Inflation Adjustment Attributes >	0	Index Name
New Business>Define Inflation Adjustment Attributes >	Principal and Interest payments both	Index Adjustment Type
New Business>Define Inflation Adjustment Attributes >	No Floor	No Floor Capital Protection Category

**Note:** If the user is mapped to ADCo, Product Profile will always show "Define Other Mortgages Attributes" tab.

## Savings

Location	Default Value	Attribute
All Business >	100	Percent Taxable
All Business >	Do Not Adjust	Pay Equivalent Compounding Convention
All Business >	Blank, that is, holiday calendar not selected	Holiday Calendar

Location	Default Value	Attribute
All Business >	Unadjusted and Disabled, if holiday calendar not selected in the preceding section. Unadjusted and Enabled, if holiday calendar is selected in the preceding section	Rolling Convention
All Business >	Shift Dates Only is selected and Disabled if Rolling Convention not selected. Shift Dates Only is selected and Enabled if Rolling Convention is selected to be other than Unadjusted.	Interest Calculation Logic
New Business > Define Core Product Attributes >	Behavior Pattern	Amortization Type
New Business > Define Core Product Attributes >	Floating Rate	Adjustable Type
New Business > Define Core Product Attributes	Unchecked	Inflation Indexed Instrument
New Business > Define Payment Attributes >	1 Month	Payment Frequency
New Business > Define Payment Attributes >	Interest In Arrears	Interest Type
New Business > Define Payment Attributes >	Actual / Actual	Accrual Basis
New Business > Define Payment Attributes >	Simple	Compounding Basis
New Business > Define Payment Attributes >	Floating Net Rate	Net Margin Flag
New Business > Define Adjustable Rate Attributes >		<Not Applicable>
New Business > Define Other Mortgage Attributes >	700	Customer Credit Score
New Business > Define Other Mortgage Attributes >	80	Original Loan to value
New Business > Define Other Mortgage Attributes >	FANNIE_MAE	Issuer
New Business > Define Neg Am Attributes >		<Not Applicable>
New Business>Define Inflation Adjustment Attributes >	0	Index Name
New Business>Define Inflation Adjustment Attributes >	Principal and Interest payments both	Index Adjustment Type
New Business>Define Inflation Adjustment Attributes >	No Floor	No Floor Capital Protection Category

**Note:** If the user is mapped to ADCo, Product Profile will always show "Define Other Mortgages Attributes" tab.

## Term Deposits

Location	Default Value	Attribute
All Business >	100	Percent Taxable
All Business >	Do Not Adjust	Pay Equivalent Compounding Convention
All Business >	Blank, that is, holiday calendar not selected	Holiday Calendar
All Business >	Unadjusted and Disabled, if holiday calendar not selected in the preceding section. Unadjusted and Enabled, if holiday calendar is selected in the preceding section.	Rolling Convention
All Business >	Shift Dates Only is selected and Disabled if Rolling Convention not selected. Shift Dates Only is selected and Enabled if Rolling Convention is selected to be other than Unadjusted.	Interest Calculation Logic
New Business > Define Core Product Attributes >	Non-Amortizing	Amortization Type
New Business > Define Core Product Attributes >	Fixed Rate	Adjustable Type
New Business > Define Core Product Attributes	Unchecked	Inflation Indexed Instrument
New Business > Define Payment Attributes >	1 Month	Payment Frequency
New Business > Define Payment Attributes >	Interest In Arrears	Interest Type
New Business > Define Payment Attributes >	Actual / Actual	Accrual Basis
New Business > Define Payment Attributes >	Simple	Compounding Basis
New Business > Define Payment Attributes >	Floating Net Rate	Net Margin Flag
New Business > Define Adjustable Rate Attributes >		<Not Applicable>
New Business > Define Other Mortgage Attributes >	700	Customer Credit Score
New Business > Define Other Mortgage Attributes >	80	Original Loan to value
New Business > Define Other Mortgage Attributes >	FANNIE_MAE	Issuer
New Business > Define Neg Am Attributes >		<Not Applicable>



---

<b>Location</b>	<b>Default Value</b>	<b>Attribute</b>
New Business>Define Inflation Adjustment Attributes >	0	Index Name
New Business>Define Inflation Adjustment Attributes >	Principal and Interest payments both	Index Adjustment Type
New Business>Define Inflation Adjustment Attributes >	No Floor	No Floor Capital Protection Category

---

---

---

**Note:** If the user is mapped to ADCo, Product Profile will always show "Define Other Mortgages Attributes" tab.

---

---



---

---

## Product Characteristics

This module describes the procedure for working with and managing Product Characteristic rules.

This chapter covers the following topics:

- [Overview of Product Characteristic Rules](#)
- [Creating Product Characteristic Rules](#)
- [Defining Product Characteristic Rules](#)
- [Copying Assumptions Across Currencies and Products](#)

### Overview of Product Characteristic Rules

Product Characteristic rules are used to define payment, pricing and repricing characteristics for new business. They are also used to specify general calculation attributes for both existing accounts and new business.

The procedure for working with and managing Product Characteristics is similar to that of other Asset | Liability Management business rules. It includes the following steps:

- Searching for Product Characteristic rules.
- Creating Product Characteristic Rules.
- Viewing and Editing Product Characteristic rules.
- Copying Product Characteristic rules.
- Deleting Product Characteristic rules.
- As part of creating and editing Product Characteristic rules, you assign product attribute assumptions to applicable products from your product hierarchy.

---

---

**Note:** Oracle Asset | Liability Management provides you with the option to copy, in total or selectively, the product assumptions contained within ALM business rules from one currency to another currency or a set of currencies or from one product to another product or a set of products.

---

---

## Creating Product Characteristic Rules

You create a Product Characteristics rule to assign attributes to your products.

### Procedure

1. Navigate to the Product Characteristics summary page.
2. Complete standard steps for this procedure.

The screenshot displays the 'Product Characteristics' configuration interface. At the top, it shows the active time bucket as 'TimeBucket1' and the current date as '6/25/2014'. The main form is divided into several sections: 'Product Characteristics Details' with fields for Name, Description, Folder, and Access Type; 'Select Product Hierarchy' with fields for Folder and Product Hierarchy; and 'Select Currency' with a Currency field. Below the form is an 'Assumption Browser' window showing a tree view of product assumptions, including 'Member1' and 'Orphan Branch'. At the bottom of the page, there are 'Save', 'Save As', and 'Cancel' buttons.

---

**Note:** In addition to the standard steps for creating rules, the procedure for creating Product Characteristics involves one extra step. After Standard Step 6, you need to select a product hierarchy. You can define methodologies at any level of the hierarchical product dimension. The hierarchical relationship between the nodes allows inheritance of methodologies from parent nodes to child nodes.

---

## Defining Product Characteristic Rules

The definition of a Product Characteristics rule is part of the Create or Edit Product Characteristics rule process. When you click Save in the Create Product Characteristics rule process, the rule is saved and the Product Characteristics rule summary page is displayed. However, Product Characteristic assumptions have not yet been defined for any of your products at this point. Typically, you would start defining your Product Characteristic assumptions for product-currency combinations before clicking Save.

### Defining Product Characteristics Using Node Level Assumptions

Node Level Assumptions allow you to define assumptions at any level of the Product dimension Hierarchy. The Product dimension supports a hierarchical representation of your chart of accounts, so you can take advantage of the parent-child relationships defined for the various nodes of your product hierarchies while defining rules.

Children of parent nodes on a hierarchy automatically inherit the assumptions defined

for the parent nodes. However, assumptions directly defined for a child take precedence over those at the parent level.

## Prerequisites

Performing basic steps for creating or editing a Product Characteristics rule

## Procedure

From the Assumption Browser screen, select the product(s) and the currency for which you want to define Product Characteristics and select the “Add New” button to launch the Product Characteristic Details screen.

To define a Product Characteristics rule, complete the following steps:

1. Choose the Currency.

---

---

**Note:** To define assumptions for all currencies with the selected product, choose the “Default Currency”.

---

---

2. From the Assumption Browser, choose the product or products that you want to define.
3. Select the Add Assumption icon.
4. Type a value for each mandatory field. Mandatory input fields are marked with a red asterisk.

---

---

**Note:** You can optionally select one of the seeded Product Profile templates or a user defined Product Profile to pre-populate the appropriate Product Characteristic fields.

---

---

5. From the File menu, select Save.

---

---

**Hint:** Using the default currency to setup assumptions can save data input time. At run time, the calculation engine uses assumptions explicitly defined for a product currency combination. If assumptions are not defined for a currency, the engine uses the assumptions defined for the product and the default currency. If the assumptions are the same across some or all currencies for a specific product, you can input assumptions for the default currency. Be careful using this option on screens where an Interest Rate Code is a required input. In most cases, you will want to use a currency specific interest rate curves for pricing instruments within each specific base currency. The Default Currency option, if used will apply a selected Interest Rate Code across all currencies.

---

---

## Assumption List Tab:

Assumption List Tab is present next to the Assumption Browser in all the screens which have assumption browser. This tab provides search capability with the help of five fields:

- Dimension Member Code
- Dimension Member Name
- Dimension Member Description
- Dimension Member Status
- Is Leaf

Dimension Member Code, Name and Description provide filter criteria for search such as: Contains, Starts With, Ends With, Exactly Matches.

Dimension Member Status is a drop-down list containing values such as: Defined, Not Defined, Inherited, Defined and Inherited, and All.

Is Leaf is a checkbox which can be toggled.

Search button initiates search on the assumption browser based on the filter criteria provided in the above mentioned fields. Reset restores default search criteria.

The search results will flatten the hierarchy and display all of the products that meet the input criteria. Use the pagination widget to display the number of products per page (up to a maximum of 99). You can proceed to edit or create new rules in the assumption list tab.

## The Product Characteristic Details screen

The details screen has three input tabs.

- All Business
- New Business
- Model Integration

---

**Note:** The Model Integration tab will be available only if Moody's structured cashflow library integration is done with ALM.

---

## The All Business tab

Assumptions made on the All Business tab apply to both current position data and new business balances.

The common Product Characteristic fields listed on the ALL Business tab are as follows:

Field	Behavior
Option Adjusted Spread	The option adjusted spread is used during stochastic processing only. It is an adjustment to the stochastic discount factor used in calculating market value and value at risk. Valid values for this spread are between -5.000% and 5.000%, but a value less than 2.00% is recommended for best results. For more information about the calculation of discount factors, see the Oracle Financial Services Cash Flow Engine Reference Guide.
Model with Gross Rates	If your institution has outsourced loan serving rights for some of your assets (most typically mortgages), the rates paid by customers on those assets (gross rates) will be greater than the rates received by your bank (net rates). For these instruments, both a net and gross rate will be calculated within the cash flow engine and both gross and net rate financial elements will be output. The gross rate is used for prepayment and amortization calculations. The net rate is used for income simulation and the calculation of retained earnings in the auto-balancing process.
Interest Credited	This option allows interest payments to be capitalized as principal on simple/non-amortizing instruments.
Percent Taxable	Percent Taxable specifies the percent of income or expense that is subject to the tax rates defined in the active Time Bucket rule. This is used with the Auto-balancing option in the ALM Process rules. Percent taxable should be setup for each product and reporting currency or product and default currency combination.
Currency Gain/Loss Basis	Currency Gain/Loss Basis determines how exchange rate fluctuations are reflected in financial element results for each product and currency combination. The choices are:  Temporal  Historical Basis  Current Rate  See the Oracle Financial Services Cash Flow Engine Reference Guide for more information on the cash flow calculations associated with currency gain/loss recognition techniques.

Field	Behavior
Pay Equivalent Compounding Convention	<p>In most cases, interest rates are not adjusted for the differences in pay-basis between the quote basis of the pricing index and the payment frequency of the account to which the index is assigned. Some instruments, notably Canadian Mortgages, follow a convention that the interest rates are adjusted. In this case, the Pay-Equivalent Compounding Convention should be set to Semi-Annual Quoting Convention. For other accounts, the convention should be set to Do Not Adjust.</p>
Holiday Calendar	<p>The default value is Blank and is Enabled. This drop-down list contains the list of all holiday calendar definitions defined in the Holiday Calendar UI.</p>
Rolling Convention	<p>The default value is Unadjusted and is Enabled, only when Holiday Calendar has been selected in the preceding field. This drop-down list contains 4 values:</p> <p>Unadjusted</p> <p>Following Business Day</p> <p>Modified following business day</p> <p>Previous business day</p> <p>Modified previous business day</p> <p>Actual/Un-adjusted</p> <p>Payment on the actual day, even if it is a non-business day.</p> <p>Following Business Day</p> <p>The payment date is rolled to the next business day.</p> <p>Modified following business day*</p> <p>The payment date is rolled to the next business day, unless doing so would cause the payment to be in the next calendar month, in which case the payment date is rolled to the previous business day.</p> <p>Previous business day</p> <p>The payment date is rolled to the previous business day.</p> <p>Modified previous business day*</p> <p>The payment date is rolled to the previous business day, unless doing so would cause the payment to be in the previous calendar month, in which case the payment date is rolled to the next business day</p> <p>*Many institutions have month-end accounting procedures that necessitate this.</p>
Interest Calculation Logic	<p>There are two options:</p> <p>Shift Dates Only</p>



Field	Behavior
	Recalculate Payment

**Note:** The holiday calendar attributes can be applied directly on the instrument records for existing business. If they are not applied on the records, the engine will use the definition from the all business tab to apply holiday calendar for existing and new business.

## The New Business tab

Assumptions made on the New Business tab impact forecast business only. These assumptions are used together with the other Forecast Assumption rules including Forecast Balances, Pricing Margins and Maturity Mix to determine the behavior of your forecast instruments. There are five sub-tabs within New Business setup including:

- Define Core Product Attributes
- Define Payment Attributes
- Define Adjustable Rate Attributes
- Define Negative Amortization Attributes
- Define Other Mortgage Attributes \*
- Define Inflation Adjustment Attributes \*\*

**Note:** Note: \* This tab will be displayed only if you are mapped to ADCo LDM functionality and currency is selected as USD.

\*\* This tab will be displayed, if Inflation Indexed Instrument option is selected in Define Core Products Attributes tab for New Business.

## Relationship Triggers

There are dependencies built into the tabular structure of this screen. Based on assumptions made in the first two tabs, the remaining two tabs may not be active.

Field	Value	Behavior
Amortization Type Code	Conv. Fixed, Conv Adjust., Adjst/Ng Amrt	Always interest in arrears, therefore disables Interest Type
Amortization Type Code	Conv. Fixed, Rule-of-78's	No repricing occurs, therefore disables Adjustable Rate Attributes and Neg Am Attributes tabs
Amortization Type Code	Adjst/Ng Amrt	Enables Negative Amortization Attributes tab
Amortization Type Code	Payment Pattern	Enables the Payment Pattern drop list
Amortization Type Code	Behavior Pattern	Enables the Behavior Pattern drop list
Amortization Type Code	Conv Fixed, Conv Adjust., Level Principal, Non Amortizing	Inflation Indexed Instrument checkbox will be enabled
Adjustable Type Code	Fixed, Floating, or Repricing pattern	Repricing Frequency is not applicable, or it is defined elsewhere, therefore disables Repricing Frequency and Multiplier
Adjustable Type Code	Other Adjustable, Floating, Repricing Pattern	Enables the Adjustable Rate Attributes tab
Adjustable Type Code	Repricing Pattern	Enables the Repricing Pattern drop list. In addition, several of the repricing attributes are defined elsewhere, therefore they are disabled in this rule. Only periodic increase and decrease, rate change min and rounding are enabled
Repricing Frequency	"0"	No repricing occurs, therefore disables Adjustable Rate Attributes
Model with Gross Rates	Off	Net Margin Flag options are only necessary when modeling with different gross rates and net rates, therefore disables Net Margin Flag
Rate Change Rounding Type	"No Rounding" or "Truncate"	Rounding does not apply, therefore disables Rate Change Rounding Percent
Currency		Allows display of Interest Rate Codes and Transfer Rate Interest Rate Codes for which the selected currency is the reference currency. In Product Characteristics, Default Currency allows all Interest Rate Codes, regardless of currency

### New Business Fields

Following is a listing of new business fields used in the Product Characteristics rule > Core Product Attributes tab.

All Business		New Business	
Define Core Products Attributes		Define Payment Attributes	Define Adjustable Rate Attributes
		Define Inflation Adjustment Attributes	
Core Products Attributes			
Amortization Type*	Conventional Adjustable	Behavior Pattern Code	
		Payment Pattern Code	
Adjustable Type*	Repricing Pattern	Repricing Pattern Code *	
Lease Residual Value	0.0%	Interest Rate Code	[AFA] excel copy paste (6576)
Amortization Method for Premiums, Discounts, Costs and Fees	Level Yield	Original Deferred Amortization Percent	0%
Inflation Indexed Instrument	<input checked="" type="checkbox"/>		

Tab	Field	Description
Core Product Attributes	Amortization Type	Method of amortizing principal and interest. The choices consist of all standard OFSAA codes and all additional user-defined codes created through the Payment Pattern and Behavior Pattern interfaces, as given below:
		Conventional Fixed
		Conventional Adjustable
		Balloon Payment
Core Product Attributes	Adjustable Type	Adjustable Negative Amortization
		Non-Amortizing
		Rule of 78's
		Level Principal
Core Product Attributes	Lease Residual Value	Payment Pattern
		Behavior Pattern
		Lease
		Determines the repricing characteristics of the new business record. The choices consist of all standard OFSAA codes plus Repricing Pattern. The standard OFSAA codes are as follows:
Core Product Attributes	Amortization Method for Premiums, Discounts and Fees	Fixed Rate
		Floating Rate
		Other Adjustable

Tab	Field	Description
		Level Yield
		Straight Line
	Behavior Pattern Code	Lists all user-defined behavior patterns created through the user interface.
	Payment Pattern Code	Lists all user-defined payment patterns defined through the user interface.
	Repricing Pattern Code	Lists all user-defined reprice patterns created through the user interface.
	Interest Rate Code	Defines the pricing index to which the instrument interest rate is contractually tied. The interest rate codes that appear as a selection option depend on the choice of currency. The interest rate code list is restricted to codes which have the selected currency as the reference currency. If the default currency is chosen, all interest rate codes are available as a selection.
	Original Deferred Amortization Percent	The initial deferred balance expressed as a percent of original par balance.
	Inflation Indexed Instrument	Check box to model instrument as Inflation Indexed.

Following is a listing of new business fields used in the Product Characteristics rule > Payment Attributes tab:

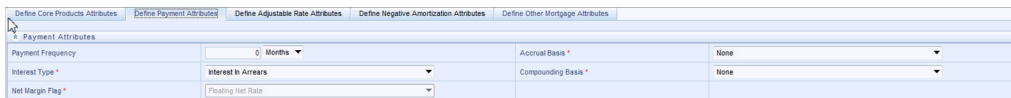

Tab	Field	Description
Payment Attributes	Payment Frequency	Frequency of payment (P & I), Interest or Principal). For bullet instruments, use zero.
	Interest Type	Determines whether interest is calculated in arrears or advance or if the rate is set in arrears. There are three interest types:  Interest in Arrears  Interest in Advance  Set in Arrears

Tab	Field	Description
		For conventional amortization products, interest in arrears is the only valid choice.
	Rolling Convention	Reserved for future use.
	Accrual Basis	The basis on which the interest accrual on an account is calculated. The choices are as follows: 30/360 Actual/360 Actual/Actual 30/365 30/Actual Actual/365 Business/252 *
	Compounding Basis	Determines the number of compounding periods per payment period. The choices are the following: Daily Monthly Quarterly Semi-Annual Yearly Continuous Simple At Maturity
	Net Margin Flag	The setting of the net margin flag affects the calculation of net rate. The two settings are: Floating Net Rate - the net rate reprices in conjunction with the gross rate, at a value net of fees. Fixed Net Rate - the net rate equals a fixed fee equal to the net margin.

---

**Note:** \* A Holiday calendar selection is required if business/252 accrual basis is selected. Business/252 accrual basis is only applicable to the recalculate option of the holiday calendar rule. If user selects the shift payment dates, the payment will still be recalculated for the non holiday/weekend date.

---

Following is a listing of new business fields used in the Product Characteristics rule > Adjustable Rate Attributes tab:

Tab	Field	Description
Adjustable Rate Attributes	Repricing Frequency	Contractual frequency of rate adjustment
	Tease Period	The tease period is used to determine the length of tease period.
	Tease Discount	The tease discount is used in conjunction with the original rate to calculate the tease rate. The tease rate is the original rate less the tease discount.
	First Reset Cap	This indicates the maximum delta between the initial rate and the first reset for mortgage instruments that have a tease period. This rate will be applicable at the tease end period, prior to the first reset. After this, the periodic and lifetime cap value will be applied. The value of this field will be automatically populated from Product Profile window if the product is mapped to Product Profile and value is defined for First Reset Cap.  For example:  Current Rate = 3.5% (from the instrument record)  Margin = 0.3 %  First Reset Cap = 0.5% (from the instrument record)  First Reset Floor = 0.1% (from the instrument record)  Scenario 1: If New Forecasted Rate = 5.1% (Forecast Rates Assumption)  Fully indexed rate (after applying minimum rate change, rounding effects) is higher than the (Current Rate + First Reset Cap). So, the new rate assigned will be 3.5% + 0.5% = 4.0%

<b>Tab</b>	<b>Field</b>	<b>Description</b>
	First Reset Floor	This is the initial minimum value for mortgage instruments that have a tease period. This floor rate will be applicable at the tease end period, prior to the first reset. After this, the periodic and lifetime floor value will be applied. The value of this field will be automatically populated from Product Profile window if the product is mapped to Product Profile and value is defined in for First Reset Floor.
	Rate Cap Life	Maximum rate for life of the instrument.
	Rate Set Lag	Period by which the rate lookup lags the repricing event date.
	Rate Change Rounding Factor	Percent to which the rate change on an adjustable instrument is rounded.
	Rate Change Rounding Type	Method used for rounding of interest rate codes. The choices are as follows: no rounding, truncate, round up, round down, round nearest.
	Rate Increase Period	Maximum interest rate increase allowed during the cycle on an adjustable rate instrument.
	Rate Decrease Period	Maximum amount rate can decrease during the repricing period of an adjustable rate instrument.
	Minimum Rate Change	The minimum required change in rate on a repricing date.
	Rate Floor Life	Minimum rate for life of the instrument.
	Rate Increase Life	Maximum interest rate increase allowed during the life of an adjustable rate instrument, used to calculate rate cap based on forecasted rate scenario. If both rate increase life and rate cap are defined, the process uses the more restrictive rate.

Tab	Field	Description
	Rate Decrease Life	Maximum amount rate can decrease during the life of an adjustable rate instrument, used to calculate the rate floor based on the forecasted rate scenario. If both rate decrease life and rate floor are defined, the process uses the more restrictive rate.

Following is a listing of new business fields used in the Product Characteristics rule > Negative Amortization Attributes tab:

Tab	Field	Description
Negative Amortization Attributes	Payment Change Frequency	The frequency at which the payment amount is recalculated for adjustable negative amortization instruments.
	Equalization Frequency	Frequency at which current payment necessary to fully amortize the instrument is re-computed.
	Payment Decrease Life	Maximum payment decrease allowed during life of a negative amortization instrument.
	Payment Decrease Period	Maximum payment decrease allowed during a payment change cycle of a negative amortization instrument.
	Equalization Limit	Maximum negative amortization allowed, as a percent of original balance. E.g., if principal balance should never exceed 125% of original balance, this column would equal 125.0
	Payment Increase Life	Maximum payment increase allowed during the life of a negative amortization instrument.
	Payment Increase Period	Maximum payment increase allowed during a payment change cycle on a negative amortization instrument.

Following is a listing of new business fields used in the Product Characteristics rule > Define Other Mortgage Attributes tab:





Tab	Field	Description
Other Mortgage Attributes	Customer Credit Score	The default value of this is 700 and it should be in the range of 300-850. The value of this field will be automatically populated from Product Profile window if the product is mapped to Product Profile and value is defined for Customer Credit Score.
	Original Loan To Value	The default value of this is 80 and it should be in the range of 1-300. The value of this field will be automatically populated from Product Profile window if the product is mapped to Product Profile and value is defined for Original Loan To Value.
	Issuer	Select the name of Issuer. The default value is FANNIE_MAE.
	Prepayment Index	This is the first index value fetched by the UI among the defined ADCo Curves.

Note: This tab will be displayed if ADCo LDM mapping is done, and if the selected currency is USD and product is of account type "Earning Assets".

### The Model Integration tab

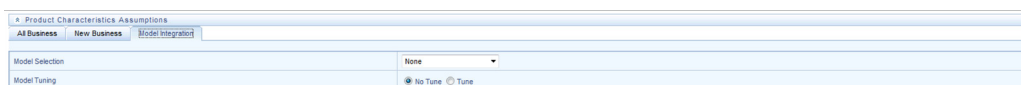

This tab allows you to made the assumptions based on Moody's structured cashflow library integration for All Business and New business balances.

This tab will be displayed only if you have installed Moody's structured cashflow library. Following are the prerequisites to view the "Model Tuning" tab:

- Moody's structured cashflow library installed on the setup
- Moody's structured cashflow library enabled for the specific user
- Product is securitized products or loans

You can tune the model using the Tune option. Select the model from Model Selection drop-down list and click Tune. Following modelling options are available in Model Selection drop-down list:

- None
- Source System Provided

- ADCo

Based on the selected model, the UI parameters will vary.

**Source System Provided**

Field	Behavior
Prepayments	This is the magnitude for prepayment rate. The default value of this is 1, and it should be greater than 0.
Default	This is the magnitude for default rate. The default value of this is 1, and it should be greater than 0.
Recovery	This is the magnitude for recovery rate. The default value of this is 1, and it should be greater than 0.
Recovery Lag	This is the recovery lag applied to each loan. The default value of this is 0, and the value range is 1 to 100.
Servicer Advancing	Select the servicer advancing as None, Interest, or Both. The default value of this is None.
Draw Rates	This is the magnitude for mortgage Draw rates. The default value of this is 1, and it should be greater than 0.

**ADCo**

Enter values in these parameters if you want to use ADCo LDM integration along with Moody's Structured Cash flow library.

Field	Behavior
SMM for Failed Loans	This is the failed loan's SMM in percentage. The default value of this is 0 and it should be in the range of 0-100.
MDR for Failed Loans	This is the failed loan's MDR in percentage. The default value of this is 0 and it should be in the range of 0-100.
Recovery for Failed Loans	This is the failed loan's recovery in percentage. The default value of this is 0 and it should be in the range of 0-100.

Field	Behavior
Subprime FICO Loans	Loan is considered subprime if FICO is less than this value ( 620 if not provided). The default value of this is 620 and it should be in the range of 300-850.
FICO to use(if not available)	FICO to use for loans which do not have this information. The default value of this is 680 and it should be in the range of 300-850.

## Define Inflation Adjustment Attributes tab

When Inflation Indexed Instrument check box is selected, the Define Inflation Adjustment Attributes tab is enabled. For more information on Inflation Indexed Instrument calculation, refer to Oracle Financial Services Cash Flow Engine Reference Guide.

**Note:** The Define Inflation Adjustment Attributes tab will be enabled if Adjustment type is selected as Conventional Adjust, Conventional Fixed, Level principal, or Non-Amortizing.

Tab	Field	Behavior
Index Adjustment Attributes	Index Name	Lists all Economic Indicator defined through user interface.
Index Adjustment Attributes	Capital Protection Category	Determines Capital protection to be provided to Inflation indexed instruments. The choices are:  No Floor  Floor of 1  Max during Life  No Floor does not provide any downside protection.

Tab	Field	Behavior
		Floor of 1 provides protection from downside movement.
		Max during life gives maximum advantage using maximum Index factor for calculation.
Index Adjustment Attributes	Index Adjustment Type	Determines type of Index adjustment. The choices are following: Principal and Interest Principal Only Interest Only

---

**Note:** For more information on cash flow calculations associated with Inflation indexed instrument, refer to Oracle Financial Services Cash Flow Engine Reference Guide.

---

## Copying Assumptions Across Currencies and Products

This functionality provides you with the option to copy, in total or selectively, the product assumptions contained within the ALM assumption rules from one currency to another currency or a set of currencies, or from one product to another product or set of products.

Copy of assumptions enhances the usability of Oracle Asset Liability Management in a multi-currency environment. For example if you have 10 currencies enabled in the application, you need to input only one set of assumptions and then copy those assumptions across all enabled currencies, instead of having to input 10 full sets, thereby saving a significant amount of input time.

This functionality also reduces the risk associated with data input errors as you need to audit inputs for just a single set of assumptions before executing the copy procedure. The copy across currencies process requires users to select a replacement yield curve for each target currency. These currency specific IRC's replace the IRC selection made for each product in the source currency selection set. It is possible to edit the target assumptions after the initial copy processes has been completed.

### Prerequisite

**Define ALM rule related product assumptions. See:**

[Overview of Product Characteristic Rules](#)

[Overview of Discount Method Rules](#)

[Overview of Prepayment Rules](#)

[Creating a Forecast Balance Rule](#)

[Overview of Maturity Mix Rules](#)

[Overview of Pricing Margin Rules](#)

[Overview of Transfer Pricing Rules](#)

## Overview of Adjustment Rules

### Procedure

Use the following procedure to copy assumptions across currencies or products:

1. Navigate to the appropriate ALM business rule assumption browser.
2. Define assumptions for the source currency / product set.
3. Save the assumptions.
4. Select the defined product assumptions using the check boxes corresponding to each product (or Node on the hierarchy) that you want to include in the copy process.
5. Click the Copy Across icon.

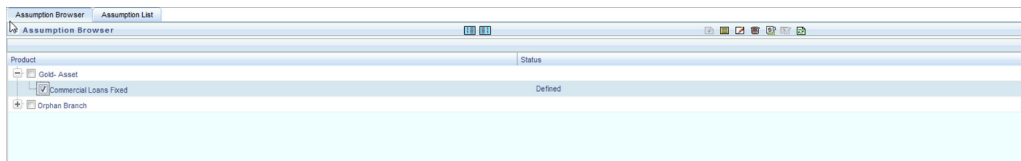

On the Copy Across details page, select the listed currencies either individually using the corresponding check boxes or in total using Select All.

6. Specify an interest rate code for each selected currency. This is necessary because each interest rate code is specific to a single currency. When copying product assumptions across currencies, you must define the interest rate code for each target currency to replace the interest rate code used for the source currency assumptions.

---

---

**Note:** While defining a rule if IRC is required, then Copy Across (currency) UI will have an option to select the IRC. For example, Product Characteristic, Discount Methods, Prepayments, Transfer Pricing Rules, Adjustment Rules UIs, the Copy Across (Currency) UI will have option for IRC selection.

While defining a rule if IRC selection is not required, then Copy Across (Currency) will have the IRC selection option disabled. For example, Forecast Balances, Maturity Mix, Pricing Margin UIs, the Copy Across (Currency) UI will not have option for IRC selection.

If a rule does not require the IRC selection and RDP selection is required (for, Forecast Balances, Maturity Mix, Pricing Margin), then Copy Across (Currency) will not have an option to select the IRC.

---

---

7. Click Apply to initiate the copy process and to return to the Assumption Browser page.

---

---

**Note:** You can review the results of the copy process from the Assumption Browser by selecting a different currency and following the usual navigation to view or edit assumptions. The application displays new assumptions for each product included in the original source selection. The copy process replaces pre-existing assumptions for any product-currency combination that is included in the target selection.

---

---

8. Click Save on the Assumption Browser page to save the assumptions to the database.





---

---

## Forecast Rate Scenarios

Forecast Rate scenario assumptions allow you to define future interest rates, future economic indicators, and future currency exchange rates. Use interest rate forecasts to project cash flows, including pricing new business, re-pricing existing business, calculating prepayments, and determining discount methods. Use Economic Indicator forecasts to include in behavioral modeling and scenario/stress analysis. Use currency exchange rate forecasts to account for the effects of currency fluctuations on income.

The Forecast Rate assumptions use interest rate, economic indicator, and currency codes defined in Rate Management, including all the active and reporting currencies and the primary, or functional, currency at your institution. See OFSAA Rate Management for information on how to define interest rates, economic indicator, and currency exchange rates.

This module describes how to create a Forecast Rates assumption rule to forecast cash flows and, if you work with multiple currencies, to model relationships between interest rates and exchange rates.

This chapter covers the following topics:

- [Creating a Forecast Rates Assumption Rule](#)
- [Currency Forecast Methods](#)
- [Economic Indicator Forecast Methods](#)
- [Interest Rate Forecast Methods](#)
- [ALM Volatility Codes](#)
- [Editing a Forecast Rate](#)
- [Behavior Pattern Rule Mapping](#)
- [Data Loader Procedure](#)

### Creating a Forecast Rates Assumption Rule

1. From the Forecast Rates bar, select the “Add” icon.

Name	Creation Date	Created By	Last Modification Date	Last Modified By	Access Type
test_FR	9/11/2014 08:48:01	JILNA	9/11/2014 08:48:06	JILNA	Read/Write
sdfs	9/8/2014 13:35:50	ALMHM80USER	9/8/2014 13:35:50	ALMHM80USER	Read/Write
chk flat	9/5/2014 11:19:30	CHANNAMMA	9/5/2014 11:19:30	CHANNAMMA	Read/Write
Bug 16100104	9/5/2014 09:50:51	CHANNAMMA	9/5/2014 11:18:59	CHANNAMMA	Read/Write
BUG_16100158_	9/5/2014 07:24:36	CHANNAMMA	9/5/2014 07:27:23	CHANNAMMA	Read/Write
Forecast Rates11	9/4/2014 12:36:51	CHANNAMMA	9/4/2014 12:39:52	CHANNAMMA	Read/Write
Forecast Rates_impliedforward	9/3/2014 09:53:27	JILNA	9/4/2014 10:42:03	JILNA	Read/Write

2. Type a descriptive name for the rule.
3. Type a description for the rule. This is an optional field.
4. Select a reporting currency.
5. Select a folder.
6. Select the Access Type option.
7. Click Save.

**Note:** Apply defined method to all IRCs is only supported for flat rates method. Other IRC methods do not support the apply to all.

### Features of Forecast Rates

The reporting currency you selected when creating the Forecast Rates assumption rule appears in the title bar. Each forecast scenario you create, up to ninety nine, will appear under Current Scenarios. Forecast scenarios use the date buckets specified in the active Time Bucket Rule. You can also set minimum rates (or floors) on any rule created for Currency, Economic, or Interest Rate. For example, if you want to run a

-200bp rate scenario, with short term rates <2%, you can set the minimum rate to floor at 0%, although negative rates are allowed if desired.

The image shows two overlapping windows from a financial software interface. The top window, titled "Forecast Rates Details", contains the following fields: "Name" (text input), "Description" (text area), "Reporting Currency" (dropdown menu showing "US Dollar"), and "Folder" (dropdown menu showing "ALNSEG"). There are also "Access Type" radio buttons for "Read Only" and "Read/Write". The bottom window, titled "Forecast Rate Scenario", has a "Current Scenario" dropdown menu. Below it are several expandable sections: "Currency Codes" (with a "1-1/1" icon), "Economic Indicators" (with a "1-1/1" icon), "Interest Rate Codes (Currency: USD : US Dollar)" (with a "1-2/2" icon), and "ALM Volatility Codes (Currency: USD : US Dollar)" (with a "1-2/2" icon). At the bottom of this window is a "Behavior Pattern Rule Mapping" section with a dropdown menu and an "Apply to all Scenarios" checkbox. "Save" and "Cancel" buttons are located at the very bottom of the interface.

The active currencies defined under Rate Management > Currencies, are listed under the Currency Codes section. The selection under Currency Codes defaults to the reporting currency when you are not forecasting exchange rates. The list of IRCs under the Interest Rate Codes section is dependent on the selected currency. The IRCs, including a reference IRC for each currency, are loaded from Rate Management. When you select a currency other than the reporting currency, the options under Currency Forecast Method provide several ways to model relationships between exchange rates and interest rates.

The Economic Indicators for all active indices are listed in the Economic Indicator section. These indices are not dependent upon the currency selected. Use these indicators to set up scenarios around changing economic conditions that will affect the forecast outcome of another variable. For example, if you forecast a higher GDP, you may have a scenario where new business volume is tied to that GDP outcome, which could be different than a lower GDP scenario. The Economic Indicators are created and maintained from Rate Management.

The IRCs for all active currencies (and reporting currencies, a subset of the active currencies) are listed under Interest Rate Codes. The options under Interest Rate Code Forecast Method provide several ways to model the effects on portfolio cash flows due to interest rate changes.

You can map your forecast scenario with Behavior Pattern Rule. For more information, refer to Behavior Pattern Mapping section.

## Currency Forecast Methods

The following currency forecast methods are available when you select a currency (other than the reporting currency) from the Currency Codes list.

Select	To
Flat	Forecast no change in the exchange rate for all dates beginning with the as-of date.
Structured Change	Forecast exchange rates as an incremental change from the previous period.
Direct Input	Type exchange rates to use in forecasting.
Parity *	Forecast the exchange rate between two currencies based on interest rate forecasts for the reference IRC associated with each of the currencies.
No Arbitrage *	Forecast the exchange rate required to maintain a no arbitrage condition between two currencies.

\* The above methods are available when the selected currency has an associated reference IRC as defined in Rate Management.

You can map your forecast scenario with Behavior Pattern Rule. For more information, refer to [Behavior Pattern Rule Mapping](#).

### Examples of Currency Forecasting

The examples below use the following data to demonstrate currency forecast methods:

- Reporting currency = U. S. dollars (USD is shown in the title bar)
- Local currency = Australian dollars – (converting from Australian dollars (AUD) to USD)
- Exchange rate loaded from Rate Manager = 1.108 AUD to 1 USD (rate in effect on the as-of date, 06/30/09)
- Modeling period = 07/01/2009 to 06/30/2010

**To Begin:** For all examples, begin by doing the following:

1. Create a new Forecast Rates assumption rule with USD as the reporting currency.
2. In the Forecast Rates window, add (or rename) a scenario:
  - Click Add (or Rename).
  - Type a name for the scenario.
  - Click Apply.

**Flat Method:** Calculate the exchange rate of Australian dollars to \$1 U. S., modeling no change in the exchange rate during the modeling period.

In the Forecast Rates window, do the following:

1. From Currency Codes, select AUD: Australian Dollar.
2. From Currency Forecast Method, click Flat.
3. Click **View**.

Under Rate Value, you will see the exchange rate: \$1.108 AUD s equal \$1 USD.  
This rate is applied uniformly to all date buckets, based on the rate in effect at the as-of date in your Application Preferences.

Bucket Number	Start Date	End Date	Rate Value
Base Rate			1.108000
1	7/1/2009	7/31/2009	1.108000
2	8/1/2009	8/31/2009	1.108000
3	9/1/2009	9/30/2009	1.108000
4	10/1/2009	10/31/2009	1.108000
5	11/1/2009	11/30/2009	1.108000
6	12/1/2009	12/31/2009	1.108000
7	1/1/2010	1/31/2010	1.108000
8	2/1/2010	2/28/2010	1.108000
9	3/1/2010	3/31/2010	1.108000
10	4/1/2010	4/30/2010	1.108000
11	5/1/2010	5/31/2010	1.108000
12	6/1/2010	6/30/2010	1.108000

4. Click **OK**.
5. At the bottom of the page, click Save.

**Structured Change:** Model a change in the exchange rate so that the rate increases by a total of 0.5% over four months, levels off for four months, and then drops a total of 0.25% over three months.

In the Forecast Rates window, do the following:

1. From Currency Codes, select AUD: Australian Dollar.
2. From Currency Forecast Method, select Structured Change.
3. Click **Define**.
4. Add rows and type bucket numbers and rate changes as follows:

Start Bucket	End Bucket	From Date	To Date	Total Rate Change
1	1	7/1/2009	7/31/2009	0.000000
2	5	8/1/2009	11/30/2009	0.500000
6	9	12/1/2009	3/31/2010	0.000000
10	12	4/1/2010	6/30/2010	-0.250000

5. You can also use the Excel import/export feature to add the rate changes.
6. Click **Apply**.
7. Click **View**.

Bucket Number	Start Date	End Date	Rate Value
Base Rate			1.108000
1	7/1/2009	7/31/2009	1.108000
2	8/1/2009	8/31/2009	1.233000
3	9/1/2009	9/30/2009	1.358000
4	10/1/2009	10/31/2009	1.483000
5	11/1/2009	11/30/2009	1.608000
6	12/1/2009	12/31/2009	1.608000
7	1/1/2010	1/31/2010	1.608000
8	2/1/2010	2/28/2010	1.608000
9	3/1/2010	3/31/2010	1.608000
10	4/1/2010	4/30/2010	1.524667
11	5/1/2010	5/31/2010	1.441333
12	6/1/2010	6/30/2010	1.358000

8. Click **OK**.
9. At the bottom of the page, click **Save**.

**Direct Input:** Model a change in the exchange rate so that rates reflect a stronger U. S. dollar during the spring of 2010.

In the Forecast Rates window, do the following:

1. From Currency Codes, select AUD: Australian Dollar.
2. From Currency Forecast Method, select Direct Input.
3. Click Define.
4. Type rate values for the following dates:

<input type="checkbox"/>	Bucket Number	Start Date	End Date	Rate Value
	Base Rate			1.108000
<input type="checkbox"/>	1	7/1/2009	7/31/2009	1.108000
<input type="checkbox"/>	2	8/1/2009	8/31/2009	1.108000
<input type="checkbox"/>	3	9/1/2009	9/30/2009	1.108000
<input type="checkbox"/>	4	10/1/2009	10/31/2009	1.108000
<input type="checkbox"/>	5	11/1/2009	11/30/2009	1.108000
<input type="checkbox"/>	6	12/1/2009	12/31/2009	1.108000
<input type="checkbox"/>	7	1/1/2010	1/31/2010	1.108000
<input type="checkbox"/>	8	2/1/2010	2/28/2010	1.108000
<input type="checkbox"/>	9	3/1/2010	3/31/2010	1.200000
<input type="checkbox"/>	10	4/1/2010	4/30/2010	1.250000
<input type="checkbox"/>	11	5/1/2010	5/31/2010	1.300000
<input type="checkbox"/>	12	6/1/2010	6/30/2010	1.108000

5. Click **Apply**.
6. Click **View** to see the output table.

Exchange Rate View Direct Input( AUD : Australian Dollar)

Bucket Number	Start Date	End Date	Rate Value
Base Rate			1.108000
1	7/1/2009	7/31/2009	1.11
2	8/1/2009	8/31/2009	1.11
3	9/1/2009	9/30/2009	1.11
4	10/1/2009	10/31/2009	1.11
5	11/1/2009	11/30/2009	1.11
6	12/1/2009	12/31/2009	1.11
7	1/1/2010	1/31/2010	1.11
8	2/1/2010	2/28/2010	1.11
9	3/1/2010	3/31/2010	1.20
10	4/1/2010	4/30/2010	1.25
11	5/1/2010	5/31/2010	1.30
12	6/1/2010	6/30/2010	1.11

Ok

7. You can also use the Excel import/export feature to add the rate values.
8. Click OK.
9. At the bottom of the page, click Save.

**Parity:** Model a period of rising interest rates for the U. S. and Australian dollars. Use the parity method to forecast the exchange rate of Australian dollars to \$1 U. S. Parity is calculated based on the forecast interest rates of the reference IRCs of the Australian dollar and the U. S. dollar.

1. In the Forecast Rates window, forecast changes in the U. S. dollar interest rate:
2. From Currency Codes, select USD: US Dollar.
3. From Interest Rate Codes, select Treasury Index.
4. From Rate Forecast Method, click Direct Input.
5. Click Define.
6. Type interest rate changes for 02/01/2010 through 04/30/2010 as follows:

Bucket Number	Start Date	End Date	1 Months	3 Months	6 Months	12 Months	24 Months	36 Months	48 Months
Base Rate			1.000000	1.000000	1.000000	1.000000	1.000000	1.000000	1.000000
<input type="checkbox"/> 1	7/1/2009	7/31/2009	1.000000	1.000000	1.000000	1.000000	1.000000	1.000000	1.00
<input type="checkbox"/> 2	8/1/2009	8/31/2009	1.000000	1.000000	1.000000	1.000000	1.000000	1.000000	1.00
<input type="checkbox"/> 3	9/1/2009	9/30/2009	1.000000	1.000000	1.000000	1.000000	1.000000	1.000000	1.00
<input type="checkbox"/> 4	10/1/2009	10/31/2009	1.000000	1.000000	1.000000	1.000000	1.000000	1.000000	1.00
<input type="checkbox"/> 5	11/1/2009	11/30/2009	1.000000	1.000000	1.000000	1.000000	1.000000	1.000000	1.00
<input type="checkbox"/> 6	12/1/2009	12/31/2009	1.000000	1.000000	1.000000	1.000000	1.000000	1.000000	1.00
<input type="checkbox"/> 7	1/1/2010	1/31/2010	1.000000	1.000000	1.000000	1.000000	1.000000	1.000000	1.00
<input type="checkbox"/> 8	2/1/2010	2/28/2010	0.500000	0.750000	1.000000	1.250000	1.500000	1.750000	2.00
<input type="checkbox"/> 9	3/1/2010	3/31/2010	1.000000	1.250000	1.500000	1.750000	1.750000	2.000000	2.25
<input type="checkbox"/> 10	4/1/2010	4/30/2010	1.500000	1.750000	2.000000	2.500000	2.500000	2.750000	2.75
<input type="checkbox"/> 11	5/1/2010	5/31/2010	1.000000	1.000000	1.000000	1.000000	1.000000	1.000000	1.00

7. Click Apply.

In the Forecast Rates window, forecast changes in the Australian dollar reference Interest rate:

1. From Currency Codes, select AUD: Australian Dollar.
2. From Interest Rate Codes, select IRC AUD.
3. From Rate Forecast Method, click Direct Input.
4. Click **Define**.
5. Type interest rate changes for 02/01/2010 through 04/30/2010 as follows:

Bucket Number	Start Date	End Date	1 Days	1 Months	3 Months	6 Months	1 Years	3 Years	5 Years
Base Rate			4.250000	4.670000	4.770000	4.870000	4.850000	4.990000	5.100000
<input type="checkbox"/> 1	7/1/2009	7/31/2009	4.250000	4.670000	4.770000	4.870000	4.850000	4.990000	5.10
<input type="checkbox"/> 2	8/1/2009	8/31/2009	4.250000	4.670000	4.770000	4.870000	4.850000	4.990000	5.10
<input type="checkbox"/> 3	9/1/2009	9/30/2009	4.250000	4.670000	4.770000	4.870000	4.850000	4.990000	5.10
<input type="checkbox"/> 4	10/1/2009	10/31/2009	4.250000	4.670000	4.770000	4.870000	4.850000	4.990000	5.10
<input type="checkbox"/> 5	11/1/2009	11/30/2009	4.250000	4.670000	4.770000	4.870000	4.850000	4.990000	5.10
<input type="checkbox"/> 6	12/1/2009	12/31/2009	4.250000	4.670000	4.770000	4.870000	4.850000	4.990000	5.10
<input type="checkbox"/> 7	1/1/2010	1/31/2010	4.250000	4.670000	4.770000	4.870000	4.850000	4.990000	5.10
<input type="checkbox"/> 8	2/1/2010	2/28/2010	4.500000	4.750000	5.000000	5.200000	5.300000	5.500000	5.60
<input type="checkbox"/> 9	3/1/2010	3/31/2010	4.750000	5.000000	5.200000	5.500000	5.700000	5.900000	6.00
<input type="checkbox"/> 10	4/1/2010	4/30/2010	5.000000	5.200000	5.400000	5.800000	5.900000	6.200000	6.20
<input type="checkbox"/> 11	5/1/2010	5/31/2010	4.250000	4.670000	4.770000	4.870000	4.850000	4.990000	5.10

6. Click Apply.

7. At the bottom of the page, click Save.



---



---

**Note:** The View button is not available for the parity feature. If you want to view results, enable the “forecast rate” option in the ALM process – Audit Block, for the relevant interest rate codes. Audit results will be written to the FSI\_INTEREST\_RATES\_AUDIT table.

---



---

**No Arbitrage:** Forecast the exchange rates required to maintain equilibrium between the U. S. and Australian dollars. The forecast is based on the historical interest rates from the reference IRC of each currency. This example assumes that the following reference IRCs have been assigned in Rate Management:

- U. S. dollar: Treasury Index
- Australian dollar: IRC AUD

In the Forecast Rates ID window, do the following:

1. From Currency Codes, select AUD: Australian Dollar.
2. From Currency Forecast Method, click No Arbitrage.
3. At the bottom of the page, click Save.

---



---

**Note:** The View button is not available for the No Arbitrage feature. If you want to view results, enable the “forecast rate” option in the ALM process – Audit Block, for the relevant interest rate codes. Audit results will be written to the FSI\_INTEREST\_RATES\_AUDIT table.

---



---

## Economic Indicator Forecast Methods

The following Economic Indicator methods are available:

Select	To
Flat	Forecast no change in the economic index for all dates beginning with the as-of date.
Structured Change	Forecast the economic index as an incremental change from the previous period.
Direct Input	Type specific economic index rates to use in forecasting.

### Examples of Economic Index Forecasting

As you follow the steps in the examples, substitute similar data at your site if this particular data is not available.

**Flat:** View an economic index forecasted for New Residential Sales.

1. From Currency Codes, select USD: US Dollar.
2. From Economic Indicators, select New Residential Sales.
3. From the Economic Indicator Forecast Method, click Flat.
4. Click **View**.

Bucket Number	Start Date	End Date	Rate Value
Base Rate			4050.000000
1	7/1/2009	7/31/2009	4050.00
2	8/1/2009	8/31/2009	4050.00
3	9/1/2009	9/30/2009	4050.00
4	10/1/2009	10/31/2009	4050.00
5	11/1/2009	11/30/2009	4050.00
6	12/1/2009	12/31/2009	4050.00
7	1/1/2010	1/31/2010	4050.00
8	2/1/2010	2/28/2010	4050.00
9	3/1/2010	3/31/2010	4050.00
10	4/1/2010	4/30/2010	4050.00
11	5/1/2010	5/31/2010	4050.00
12	6/1/2010	6/30/2010	4050.00

The Economic Indicator View window displays the rates forecasted for the New Residential Sales.

**Structured Change:** Model a gradual increase for six months in New Residential Sales.

1. From Currency Codes, select USD: US Dollar.
2. From Economic Indicators, select New Residential Sales.
3. From Rate Forecast Method, click Structured Change.
4. Click Define.
5. Type the following interest rate change:

<input type="checkbox"/>	Start Bucket	End Bucket	From Date	To Date	Total Rate Change
<input type="checkbox"/>	1	4	7/1/2009	10/31/2009	0.000000
<input type="checkbox"/>	5	10	11/1/2009	4/30/2010	150.000000

6. Click **Apply**.
7. Click **View**.

Economic Indicators View Structured Change( New Residential Sales)			
Bucket Number	Start Date	End Date	Rate Value
Base Rate			4050.000000
1	7/1/2009	7/31/2009	4050.000000
2	8/1/2009	8/31/2009	4050.000000
3	9/1/2009	9/30/2009	4050.000000
4	10/1/2009	10/31/2009	4050.000000
5	11/1/2009	11/30/2009	4075.000001
6	12/1/2009	12/31/2009	4100.000001
7	1/1/2010	1/31/2010	4125.000002
8	2/1/2010	2/28/2010	4150.000003
9	3/1/2010	3/31/2010	4175.000004
10	4/1/2010	4/30/2010	4200.000004
11	5/1/2010	5/31/2010	4200.000004
12	6/1/2010	6/30/2010	4200.000004

8. You can see the incremental increase over the six months (150 = 25 per mo \* 6 months)

**Direct Input:** To use the Direct Input method, see Structured Change: with the following modifications:

- In step 3, click Direct Input
- In step 5, type in New Residential Sales data (forecasted values for each bucket rather than forecasted values changes over a period of one or more buckets). See example below.

Economic Indicators Direct Input( New Residential Sales)				
<input type="checkbox"/>	Bucket Number	Start Date	End Date	Rate Value
	Base Rate			4050.000000
<input type="checkbox"/>	1	7/1/2009	7/31/2009	4050.000000
<input type="checkbox"/>	2	8/1/2009	8/31/2009	4050.000000
<input type="checkbox"/>	3	9/1/2009	9/30/2009	4200.000000
<input type="checkbox"/>	4	10/1/2009	10/31/2009	4300.000000
<input type="checkbox"/>	5	11/1/2009	11/30/2009	4500.000000
<input type="checkbox"/>	6	12/1/2009	12/31/2009	5000.000000

After you have defined forecast method for an Economic Indicator, you can undo the definition by selecting relevant Economic Indicator (green color check-box) and clicking "Un-Define" button. This will bring the Economic Indicator to its original un-defined state indicated by red color check box. This step is necessary if you want to delete an Economic Indicator from "Common Object Maintenance > Rate Management > Economic Indicators" user interface after defining forecast method for it.

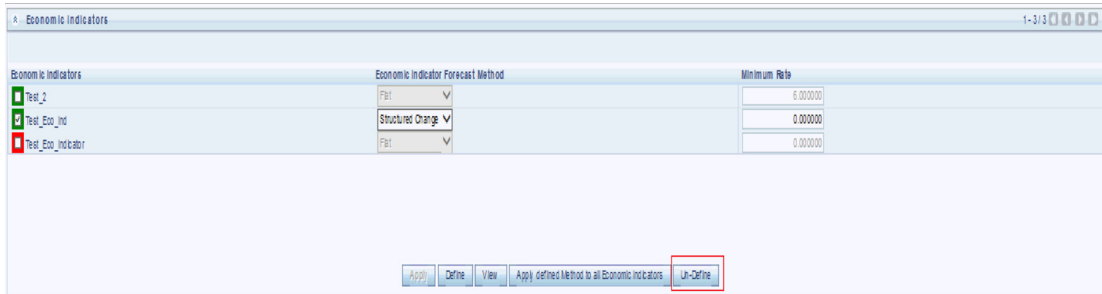

## Interest Rate Forecast Methods

The following Interest Rate Forecast methods are available:

Select	To
Flat	Forecast no change in the interest rate for all dates beginning with the as-of date.
Structured Change	Forecast rate changes in terms of absolute or percent change, for any modeling period or interest rate term, such as: +100 basis points on Day 1 -200 basis points over the first 6 months Yield curve rotation (short point decreasing, long point increasing)
Direct Input	Type interest rates directly, for any modeling period or interest rate term.
Implied Forward	Forecast interest rates based on the yield-curve interest rates in effect at the as-of date and consistent with the modeling bucket definitions.
Change from Base	Make incremental changes to an existing forecast scenario.
Yield Curve Twist	Flatten or steepen the yield curve around a specific point on the curve.

The following Interpolation Methods are available:

Select	To
Linear Interpolation	Linear interpolation uses linear yield curve smoothing. Linear yield curves are continuous but not smooth; at each knot point there is a kink in the yield curve. You may not want to use a linear yield curve with a model that assumes the existence of a continuous forward rate curve, due to the nonlinear and discontinuous knot points of a linear yield curve.
Cubic Spline of Yields	A cubic spline is a series of third degree polynomials that have the form: $y = a + bx + cx^2 + dx^3$

Select	To
Quartic Spline	<p>These polynomials are used to connect the dots formed by observable data. The polynomials are constrained so they fit together smoothly at each knot point (the observable data point.) This means that the slope and the rate of change in the slope with respect to time to maturity have to be equal for each polynomial at the knot point where they join. If this is not true, there is a kink in the yield curve and they are continuous but not differentiable.</p> <p>Two more constraints make the cubic spline curve unique. The first restricts the zero-maturity yield to equal the 1-day interest rate. The second restricts the yield curve at the longest maturity to be either straight (<math>y''=0</math>) or flat (<math>y'=0</math>).</p> <p>Quartic interpolation requires a minimum of 4 knot points. The quartic interpolation equation can be represented as</p> $Y = a + b X1 + CX2 + d X3 + e X4$ <p>The end knot points satisfy equations for one curve and all intermediate points satisfy two curves. Hence in a scenario with minimum number of knot points, there will be 6 equations. For n number of knot points, the number of equations is <math>2n-2</math>. If n is the number of points to be interpolated, the order of the matrix to be formed is <math>5^{*(n-1)} \times 5^{*(n-1)}</math>. The matrix is formed according to the following logic:</p> <p>The second derivative at the end points and the first derivative of the last point is Zero. At the points other than the end points the value of the first derivatives, second derivatives and the third derivatives of the function are equal.</p>

---

**Note:** In looking up Forecast Rates, the cash flow engine will (where necessary) perform an interpolation between yield curve term points. For example, in determining a three month rate from a yield curve that contains only a one month rate and a six month rate, the cash flow engine will perform an interpolation to determine the implied three month rate. The interpolation method used is defined by the selected interpolation method for the interest rate curve.

---

## Examples of Interest Rate Forecasting

As you follow the steps in the examples, substitute similar data at your site if this particular data is not available.

---

---

**Note:** You can generate the forecast rates for 360 calendar months, Moody's structured cashflow library's structured cashflow library integration is done with ALM. The first month corresponds to the first calendar month of As of Date. The subsequent months are full calendar months. For example, if As of Date is 30 APR 2013, then the first month is April 2013. The second month will be May 2013 and so on. ADCo model requires two IRCs for an ARM instrument (First is 2 Yr, 10 Yr IRC and second is the Prepayment Index IRC). For a fixed rate instrument, 2 Yr, 10 Yr IRC will only be passed.

You can forecast an IRC which has various term points including 2 Year and 10 Year term points. The term points 2 Year (or 24 Months) and 10 Year (or 120 Months) are available. Engine will identify 24 Months term point as 2 Years and 120 Months as 10 Years. If the term point(s) are not available, then engine will not be able to send the forecast rates for the IRC

Engine will match the last day of the calendar month with the ISB (income simulation bucket) dates and fetch the rate corresponding to the term point to pass to ADCo model while converting from ISB to 360 months. While converting from ISB to 360 months, if the total ISB size is less than 360 months, then the last available rate needs to be extended till 360th month. For example, if the ISB covers only 240 months, then 240th month rate will be applied from 241st to 360th months.

---

---

When "Show 360 months Buckets" check box is enabled, 2 year (24 months) and 10 year (240 months) term points will be highlighted in red color.

The "Show 360 months Buckets" check box is displayed only if the Curve Identifier is defined for base IRC.

**Flat:** View U. S. dollar interest rates forecasted for the Treasury Index.

1. From Currency Codes, select USD: US Dollar.
2. From Interest Rate Codes, select US Treasury Curve.
3. From Rate Forecast Method, click Flat.
4. Select the Interpolation Method.
5. Click View.

After clicking View, the Interest Rate View window displays the rates forecasted for the Treasury Index in ISB view. Here, Show Rates for 360 Months Buckets check box is disabled by default. On checking this box, the results will be displayed for the 360 months view. You cannot enter the values against buckets for Flat method in 360 months or ISB view. The Show 360 Months Buckets box is available by default if the ADCo LDM, or Moody's structured cashflow library, or both functions are mapped to the user.

**Structured Change:** Model a gradual increase for six months in U. S. dollar interest rates.

1. From Currency Codes, select USD: US Dollar.
2. From Interest Rate Codes, select US Treasury Curve.
3. From Rate Forecast Method, click Structured Change.
4. Select the Interpolation Method.
5. Click Define and enter a shock amount to apply to the IRC in absolute or percentage change. You can designate either absolute rate change or percent rate change and click apply.
6. Type the following interest rate changes:

Interest Rate Code Structured Change( 6522 : Treasury Curve)								
Shock Type				<input checked="" type="radio"/> Rate <input type="radio"/> Percent				
<input type="checkbox"/>	Start Bucket	End Bucket	From Date	To Date	3 Months	6 Months	1 Years	2 Years
<input type="checkbox"/>	1	1	7/1/2009	7/31/2009	0.000000	0.000000	0.000000	0.000000
<input type="checkbox"/>	2	7	8/1/2009	1/31/2010	1.000000	1.250000	1.500000	1.750000
<input type="checkbox"/>	8	12	2/1/2010	6/30/2010	0.000000	0.000000	0.000000	0.000000

You can also use the Excel import/export feature to add the interest rate changes.

7. Click **Apply**.
8. Click **View**.

After clicking View, the Interest Rate View window displays the results in ISB view. Here, Show Rates for 360 Months Buckets check box is disabled by default. On checking this box, the results will be displayed for the 360 months view. You

cannot enter the values against buckets for this method in 360 months or ISB view. The Show 360 Months Buckets box is available by default if the ADCo LDM, or Moody's structured cashflow library, or both functions are mapped to the user.

- The rate increases you typed in step 5 are apportioned equally over six months in this case August to January. Therefore, in monthly buckets 2-7, you will expect to see the following increments added to the Treasury Index interest rates:

3 month	6 month	1 year	2 year
1/6 of 1.00 = 0.1667	1/6 of 1.25 = 0.2083	1/6 of 1.50 = 0.25	1/6 of 1.75 = 0.2917

- The interest rates in buckets 2-7 reflect the increases.

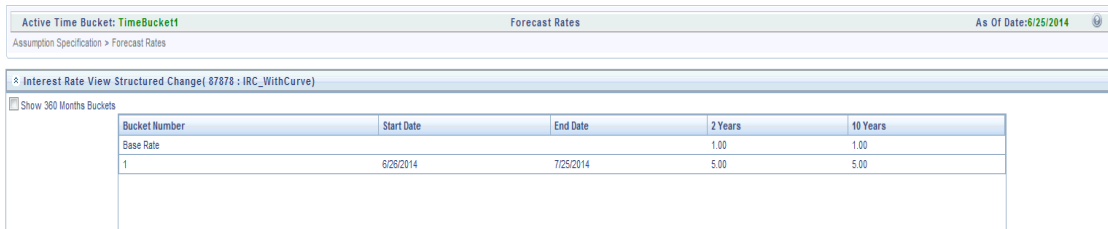

**Direct Input:** To use the Direct Input method, see Structured Change: with the following modifications:

- In step 5, type interest rates (forecasted rates for each bucket rather than forecasted rate changes over a period of one or more buckets).
- In step 3, click Direct Input
- During defining the Direct Input, "Show 360 Months Buckets" box is checked by default if the ADCo LDM, or Moody's structured cashflow library, or both functions are mapped to the user. If you enter the forecast rates against 360 months, the UI converts the same to across income simulation buckets.

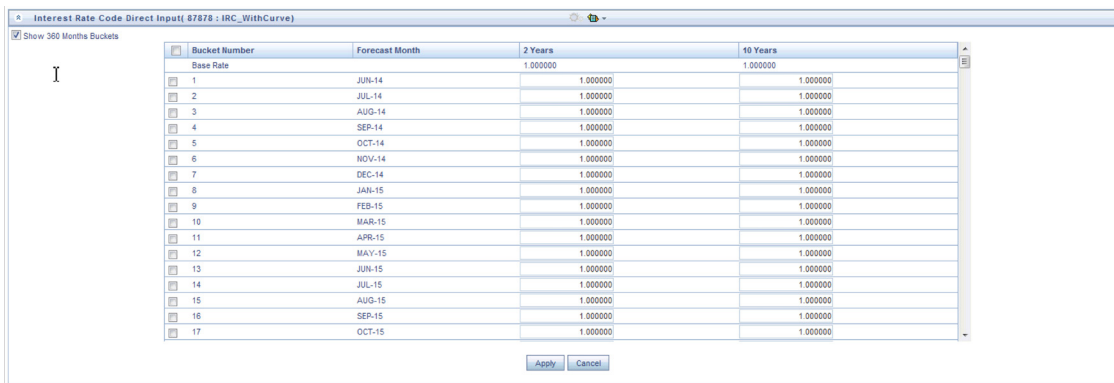

- Similarly, user can enter the data for income simulation buckets after unchecking the "Show 360 Months Buckets". Now, UI will convert the rates from ISB to 360 months view.

When you switch from ISB to 360 months view or vice versa, you will get a message "Switching the view will erase the existing definition. Do you want to



continue?" If you select YES, then the definition is erased. Else, it is retained. In effect, you will be restricted to do the following:

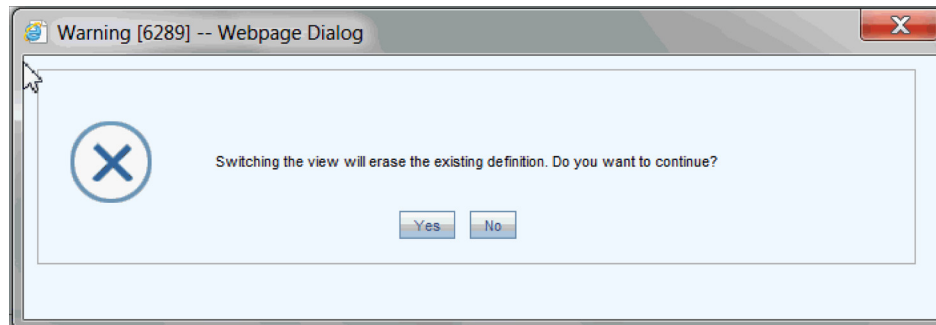

- Enter the data across ISB, check the "Show 360 Months Buckets" box and override that data for a few of the 360 months buckets.
- Enter the data across 360 months buckets, uncheck the "Show 360 Months Buckets" box and override that data for a few of the ISB.

After defining the rates in 360 Months buckets and clicking View, the Interest Rate View window displays the result in "360 Months" view. Here, "Show Rates for 360 Months Buckets" check box is enabled by default.

If you have defined the rates in ISB and click View, the Interest Rate View window displays the result in ISB view. Here, "Show Rates for 360 Months Buckets" check box is disabled by default. On checking this box, the results will be displayed for the 360 months view. You cannot enter the values against buckets for this method in 360 months or ISB view.

Bucket Number	Start Date	End Date	3 Months	5 Months	1 Years	2 Years	3 Years	5 Years	7 Years	10 Years
Base Rate			0.35	0.45	0.55	1.05	1.24	1.49	1.75	2.20
	6/06/2014	7/25/2014	0.35	0.45	0.55	1.05	1.24	1.49	1.75	2.20

You can also use the Excel import/export feature to add the interest rates. For more details, refer [Excel Import/Export](#).

**Implied Forward:** View U. S. dollar interest rates forecasted from the Treasury Index rates and terms in effect at the as-of date and consistent with the modeling buckets.

1. From Currency Codes, select USD: US Dollar.
2. From Interest Rate Codes, select US Treasury Curve.
3. From Rate Forecast Method, click **Implied Forward**.
4. Click Define and enter a shock amount to apply to the IRC in absolute or percentage change. You can designate either absolute rate change or percent rate change. If no changes desired to base curve, leave at 0.0 and click apply.
5. You can also use the Excel import/export feature to add the absolute or percent rate changes.
6. Click view to view the implied forward rates.

After clicking View, the Interest Rate View window displays the results in ISB view. Here, Show Rates for 360 Months Buckets check box is disabled by default. On checking this box, the results will be displayed for the 360 months view. You cannot enter the values against buckets for this method in 360 months view. The Show 360 Months Buckets box is available by default if the ADCo LDM, or Moody's structured cashflow library, or both functions are mapped to the user.

Bucket Number	Start Date	End Date	3 Months	5 Months	1 Years	2 Years	3 Years	5 Years	7 Years	10 Years
Base Rate			0.35	0.45	0.55	1.05	1.24	1.49	1.75	2.20
1	6/26/2014	7/25/2014	0.36	0.46	0.55	1.05	1.24	1.49	1.75	2.20

**Change from Base:** Select a forecast rates scenario that you have already defined and saved and change it by typing incremental changes to rates. For example, you might want to forecast for a scenario 1 based on incremental changes to the rates in scenario 2.

3 Months	6 Months	1 Years	2 Years	3 Years	5 Years	7 Years	10 Years	20 Years	30 Years
0.350000	0.450000	0.550000	1.050000	1.240000	1.490000	1.750000	2.200000	2.750000	3.450000

After clicking View, the Interest Rate View window displays the results in ISB view. Here, Show Rates for 360 Months Buckets check box is disabled by default. On checking this box, the results will be displayed for the 360 months view. You cannot enter the values against buckets for this method in 360 months view. The Show 360 Months Buckets box is available by default if the ADCo LDM, or Moody's structured cashflow library, or both functions are mapped to the user.

**Yield Curve Twist:** Set up a scenario to steepen or flatten a given yield curve.

1. From Currency Codes, select USD: US Dollar.
2. From Interest Rate Codes, select US Treasury Curve.
3. From Rate Forecast Method, click **Yield Curve Twist**.
4. Click **Define**.
5. Type the following interest rate changes (flattening the curve around the 3 month term point):

## 6. Click Apply.

After clicking View, the Interest Rate View window displays the results in ISB view. Here, Show Rates for 360 Months Buckets check box is disabled by default. On checking this box, the results will be displayed for the 360 months view. You cannot enter the values against buckets for this method in 360 months view. The Show 360 Months Buckets box is available by default if the ADCo LDM, or Moody's structured cashflow library, or both functions are mapped to the user.

Bucket Number	Start Date	End Date	3 Months	5 Months	1 Years	2 Years	3 Years	5 Years	7 Years	10 Years
1	6/26/2014	7/25/2014	0.35	0.45	0.55	1.05	1.24	1.49	1.75	2.20

After you have defined forecast method for an Interest Rate Code, you can undo the definition by selecting relevant Interest Rate Code (green color check-box) and clicking “Un-Define” button. This will bring the Interest Rate Code to its original un-defined state indicated by red color check box. This step is necessary if you want to delete an Interest Rate Code from “Common Object Maintenance > Rate Management > Interest Rates” user interface after defining forecast method for it.

## ALM Volatility Codes

This feature allows users to set a static shock percentage (positive or negative) to be applied to ALM Volatilities in a forecast rates screen.

For more information, refer to Cash Flow Reference Guide on OTN.

This section will display the list of Interest Rate Codes those are defined as ALM Volatility Surface. For an ALM Volatility to be viewable and editable in this screen, you should have following prerequisites:

- Be defined in Rate Management: Interest Rate as an ALM Volatility Surface
- Have a matching currency to the Forecast Rates Reporting Currency

For more information, refer to [Interest Rates Detail Screen](#)

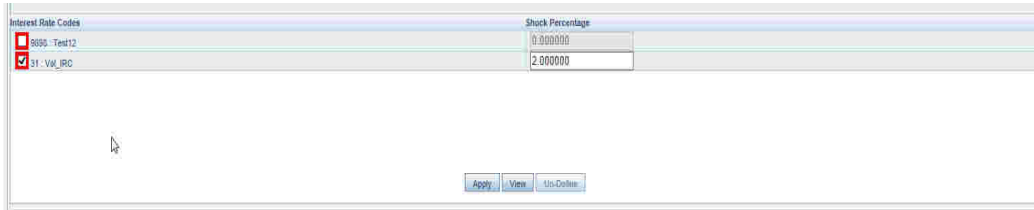

Below is an example to define the Shock Percentage for ALM Volatility Surface: These steps can be repeated for each new scenario.

1. From Currency Codes, select a currency, for example USD: US Dollar. Only ALM Volatility Surfaces of the same currency will be available.
2. In the ALM Volatility block, select a Vol Surface.

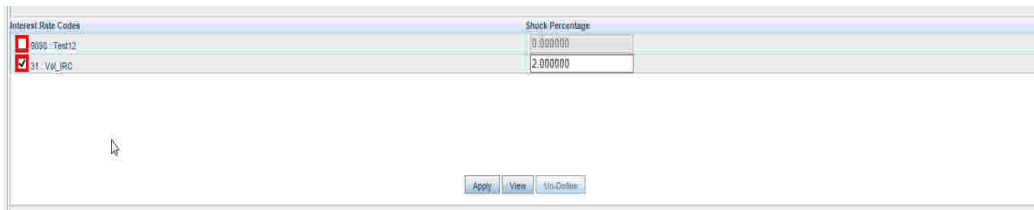

3. Enter shock percentage for respective ALM Volatility. You can enter positive or negative values here (between -99.9999 and 1,000).
4. Click **Apply**.

A confirmation box is displayed.

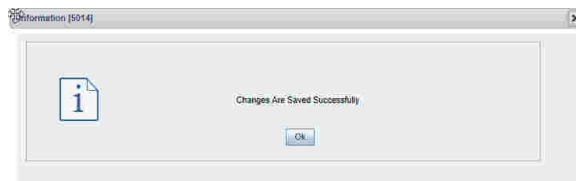

5. To view the results of the shock, select an ALM Volatility then click **View**.

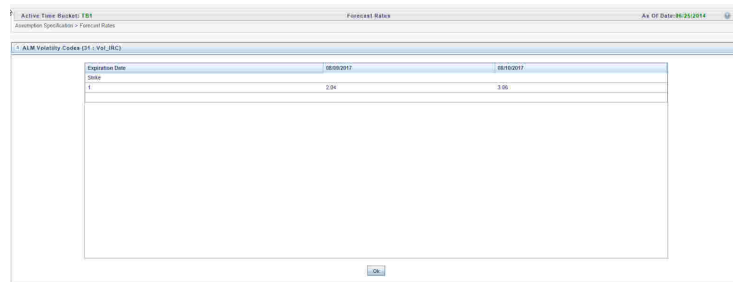

6. To remove the shock percentage, click Un-Define.

## Editing a Forecast Rate

To edit a Forecast rate, follow the steps given below:

1. From Currency Codes, select the Currency Code (for example IND: INDS).

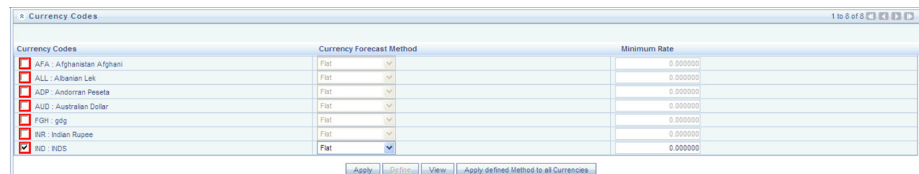

2. Here, initially the IRC is in Red color and after selection (that is, Editing of Currency Code) and clicking on Apply button, it turns to Green color.

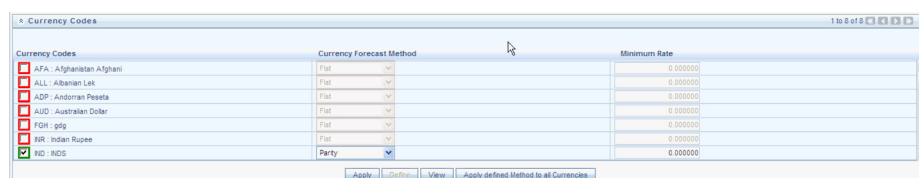

---

**Note:** Selecting a different IRC means the addition of an IRC and not the deletion/Unselection of the rest of the IRCs. When you reopen the Forecast Rate, lowest IRC code will be checked by default.

---

## Behavior Pattern Rule Mapping

The Behavior Pattern Rule Mapping drop-down shows the list of existing Behavior Pattern Rule. you can select any behavior pattern to map with current forecast scenario. If you want to map a behavior pattern to all the forecast scenarios, the use "Apply to all scenarios" check-box. For more information on Behavior Pattern Rule, refer to chapter [Behavior Pattern Rule](#).

## Data Loader Procedure

Stage Forecast Rate Loader procedure loads forecast rates definitions into OFSAA ALM Forecast rates tables from staging tables. Forecast rate parameters for Direct Input and Structured Change methods within a scenario for exchange rates, interest rates and economic indicators are loaded from staging to the Financial Services Data Model. After loading the forecast rates, user can view the information in Forecast Rate Assumptions UI.

For information on how to set up the procedure, see Oracle Financial Services Analytical Applications Data Model Utilities User Guide, Stage Forecast Rates Loader.

### Executing the Data Loader

To execute the Data Loader Procedure:

1. Navigate to the Forecast Rates Main page.
2. Click the Data Loader Execution button on the action bar – This will execute all the available Forecast Rates set up in the data loader for Direct Input and Structured Change methods.

A warning message will appear: “Update all available Forecast Rates?”

3. Click “Yes”

Name	Creation Date	Created By	Last Modification Date	Last Modified By	Access Type
test_FR	9/11/2014 08:48:01	JILNA	9/11/2014 08:48:06	JILNA	Read/Write
sdfs	9/8/2014 13:35:50	ALMHM80USER	9/8/2014 13:35:50	ALMHM80USER	Read/Write
chk flat	9/5/2014 11:19:30	CHANNAMMA	9/5/2014 11:19:30	CHANNAMMA	Read/Write
<input checked="" type="checkbox"/> Bug 16100104	9/5/2014 09:50:51	CHANNAMMA	9/5/2014 11:18:59	CHANNAMMA	Read/Write
BUG_16100158_	9/5/2014 07:24:36	CHANNAMMA	9/5/2014 07:27:23	CHANNAMMA	Read/Write
Forecast Rates11	9/4/2014 12:36:51	CHANNAMMA	9/4/2014 12:39:52	CHANNAMMA	Read/Write
Forecast RAtes_impliedforward	9/3/2014 09:53:27	JILNA	9/4/2014 10:42:03	JILNA	Read/Write

---

---

## Prepayment Rules

This module describes the procedure for working with and managing Prepayment rules.

This chapter covers the following topics:

- [Overview of Prepayment Rules](#)
- [Creating Prepayment Rules](#)
- [Defining Prepayment Methodologies](#)
- [Defining Early Redemption Assumptions](#)
- [Associating Conditional Assumptions with Prepayment Rules](#)

### Overview of Prepayment Rules

Prepayment rules allow you to specify methodologies to model the loan prepayment and deposit early redemption behavior of products in your portfolio and quantify the associated prepayment risk in monetary terms. For more information, see [Defining Prepayment Methodologies](#) section.

The methodologies contained in the Prepayment rule are referenced by Transfer Pricing and ALM Processes.

The procedure for working with and managing the Prepayment rule is similar to that of other Oracle Asset Liability Management business rules. It includes the following steps:

- Searching for Prepayment rules.
- Creating Prepayment Rules
- Viewing and Editing Prepayment rules.
- Copying Prepayment rules.
- Deleting Prepayment rules.

As part of creating and updating Prepayment rules, you can also define prepayment methodologies for all relevant product / currency combinations. For more information, see the following sections:

- [Defining Prepayment Methodologies](#)
- [Defining the Constant Prepayment Method](#)
- [Defining the Prepayment Model Method](#)
- [Defining the PSA Prepayment Method](#)

- [Defining the Arctangent Calculation Method](#)
- [Associating Conditional Assumptions with Prepayment Rules](#)

Oracle Asset Liability Management provides you with the option to copy, in total or selectively, the product assumptions contained within the Prepayment rules from one currency to another currency or a set of currencies or from one product to another product or a set of products. For more information, see [Associating Conditional Assumptions with Prepayment Rules](#) section.

## Creating Prepayment Rules

You create a Prepayment rule to define prepayment assumptions for new products.

### Procedure

1. Navigate to the Prepayment rule summary page.
2. Complete standard steps for this procedure.

---

**Note:** In addition to the standard steps for creating rules, the procedure for creating a Prepayment rule involves one extra step. After Standard Step 6, you can select a product hierarchy. You can define methodologies at any level of the hierarchical product dimension. The hierarchical relationship between the nodes allows inheritance of methodologies from parent nodes to child nodes.

---

## Defining Prepayment Methodologies

The assignment of prepayment assumptions is part of the Create or Edit Prepayment rule process where assumptions about loan prepayments or deposit early redemptions are made for product-currency combinations. When you click Save in the Create Prepayment rules process, the rule is saved and the Prepayment rule Summary page is displayed. However, prepayment assumptions have not yet been defined for any of your products at this point. Typically, you would start defining your prepayment assumptions for product-currency combinations before clicking Save.



The Prepayment rule supports definition of prepayment assumptions for combinations of two dimensions: Product and Currency.

Once you have created a Prepayment rule, you can assign prepayment methodologies to product-currency combinations in either of the following two ways:

- By creating a conditional assumption using conditional logic. For more information, see [Associating Conditional Assumptions with Prepayment Rules](#) section.
- Directly on the Prepayment methodology page, as described here.

## Defining Prepayments Using Node Level Assumptions

Node Level Assumptions allow you to define assumptions at any level of the Product dimension Hierarchy. The Product dimension supports a hierarchical representation of your chart of accounts, so you can take advantage of the parent-child relationships defined for the various nodes of your product hierarchies while defining rules. Children of parent nodes on a hierarchy automatically inherit the assumptions defined for the parent nodes. However, assumptions directly defined for a child take precedence over those at the parent level.

### Prerequisites

Performing basic steps for creating or editing a Prepayment rule.

### Procedure

This table describes key terms used for this procedure.

**Table 19–1 Selected Terminology**

Term	Description
Calculation Method	The method used to model prepayment behavior of instruments. Oracle Asset Liability Management provides four prepayment calculation methods: Constant, Prepayment Model, PSA, and Arctangent.
Cash Flow Treatment	Allows you to specify one of the following two ways in which prepayments are made. <ul style="list-style-type: none"> <li>• <b>Refinance:</b> This is the most commonly used option. Select refinance to keep payment amounts after prepayment consistent with a portfolio-based assumption. This reduces the scheduled payment amount on each loan and maintains the same maturity term.</li> <li>• <b>Curtailed:</b> Select curtailment to change the periodic payment amounts due. The prepayments are treated as accelerated payments, with a payoff earlier than the originally scheduled term.</li> </ul>
Market Rate	The market rate is defined as the sum of the Index (the yield curve rate as described by the Interest Rate Code) and the Spread (the difference between the customer rate and market rate).

**Table 19–1 Selected Terminology**

Term	Description
Associated Term	<p>Allows you to define the term for the point on the yield curve selected in the Market Rate definition that will be used in obtaining the market rate.</p> <ul style="list-style-type: none"> <li>• <b>Remaining Term:</b> The number of months remaining until the instrument matures.</li> <li>• <b>Reprice Frequency:</b> The frequency with which the instrument reprices. This defaults to the original term for a fixed rate instrument.</li> <li>• <b>Original Term:</b> The number of months that was the originally scheduled life of the instrument.</li> </ul>
Prepayment Rate Definition	<p>This table allows you to specify constant annual prepayment rate, or the associated factors, that you want to apply to the instruments having origination dates in a particular date range.</p>
Seasonality	<p>This table allows you to specify seasonality adjustments. Seasonality refers to changes in prepayments that occur predictably at given times of the year.</p> <p>Seasonality adjustments are based on financial histories and experiences, and should be modeled when you expect the amount of prepayments made for certain types of instruments to increase or decrease in certain months.</p> <p>The default value for seasonality factors is 1, which indicates that no seasonality adjustment is made for a month. Changing the seasonality factors is optional. You can change the seasonality factors for none, one, or multiple months.</p> <p>To make seasonality adjustments, you need to enter a value between 0.00 and 99.9999 for the seasonality factors associated with each month. Seasonality factors less than 1 mean that prepayments are decreased for a particular month. Seasonality factors greater than 1 indicate that prepayments are increased for a particular month.</p>

1. Navigate to the Prepayment assumption details page by selecting a currency and one or more products from the hierarchy.
2. Select a Calculation Method, Constant, Prepayment Model, PSA , or Arctangent.

**Note:** The default value for the Calculation Method drop down list is Constant. If you select "Do not calculate" as the calculation method, no prepayment assumptions will be assigned to the particular product-currency combination. This is a particularly useful option when using node level assumptions because it allows you to exclude a particular child from inheriting a parent assumption.

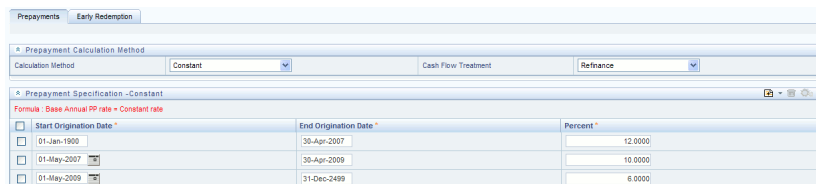

3. Select a Cash Flow Treatment type, Refinance or Curtailment.

---

---

**Note:** Refinance is the most commonly used method.

---

---

4. Define the parameters and annual prepayment rates for the selected calculation method: Constant, Prepayment Model, PSA or Arctangent.

---

---

**Note:** The parameters displayed on the Prepayment methodology page vary depending on the calculation method (Constant, Prepayment Model, PSA or Arctangent) that you have selected. For more information, see:

- [Defining the Constant Prepayment Method](#)
  - [Defining the Prepayment Model Method](#)
  - [Defining the PSA Prepayment Method](#)
  - [Defining the Arctangent Calculation Method](#)
- 
- 

5. Click **Apply**.

The *Assumption Browser Definition* page is displayed.

At this point you can:

- Continue defining additional methodologies for other product-currency combinations by repeating the above procedure.
- Complete the process by clicking **Save**.

---

---

**Note:** When you click Save, the prepayment assumptions are saved and the Prepayment rule summary page is displayed.

---

---

---

---

**Note:** Oracle Asset Liability Management provides you with the option to copy, in total or selectively, the product assumptions contained within the Prepayment rules from one currency to another currency or a set of currencies or from one product to another product or set of products. For more information, see [Associating Conditional Assumptions with Prepayment Rules](#).

---

---

## Defining the Constant Prepayment Method

Use this procedure to define prepayment assumptions using the Constant Prepayment method.

### Prerequisites

Performing basic steps for creating or updating a Prepayment rule.

## Procedure

Users also have two options for determining the timing of the Constant Prepayment assumption. The options include:

- Use Payment Dates: This is the default option. If this option is selected, then Constant Prepayment runoff will occur on scheduled payment dates only.
- User Defined Prepayment Tenors: If this option is selected, users can specify any runoff timing. For example, users might choose to define the prepayment to runoff on the first day of the forecast.

**Note:** Above options will be available only for Asset Instrument types.

To define constant prepayment within the Prepayment Rule, follow the steps given below:

### Use Payment Dates:

1. Select the "Use Payment Dates" option.

Month	Value	Month	Value
January	1.0000	July	1.0000
February	1.0000	August	1.0000
March	1.0000	September	1.0000
April	1.0000	October	1.0000
May	1.0000	November	1.0000
June	1.0000	December	1.0000

2. Select the Start Origination Date using the date picker. Alternatively, you can enter the Start Origination Date in the space provided.

---

---

**Note:** The first cell in the Start Origination Date column and all of the cells in the End Origination Date column are read only. This ensures that all possible origination dates have supporting reference values when Prepayment assumption lookups occur.

Each row in the End Origination Date column is filled in by the system when you click Add Row or save the rule.

The first Start Origination Date (in row 1) has a default value of January 1, 1900. When you enter a Start Origination Date in the next row, the system inserts a date that is a day prior to the previous End Origination Date field.

---

---

3. Enter the annual prepayment rate percent that you want to apply to the instruments having origination dates in a particular Start Origination-End Origination Date range.

---

---

**Note:** The Percent column represents the actual annualized prepayment percentage that the system uses to generate the principal runoff during the cash flow calculations.

---

---

4. Click Add Row to add additional rows and click the corresponding Delete icon to delete a row.  
You can add as many rows in this table as you require. However you need to enter relevant parameters for each new row.
5. You can also use the Excel import/export feature to add the Prepayment rate information.
6. You can use Data Input Helper feature. For more information, refer to Data Input Helper.
7. Define Seasonality assumptions as required to model date specific adjustments to the annual prepayment rate. Inputs act as multiplier, For Example, an input of 2 will double the prepayment rate in the indicated month.

User Defined Prepayment Tenors:

1. Select the User Defined Redemption Tenors option. This option allows you to specify the term and multiplier to prepayment date for the particular row. E.g. if "1

Day" is defined, then the prepayment of specified balance (redemption %) will be performed on the As of Date + 1 Day.

The screenshot shows the 'Prepayments' configuration window. The 'Prepayment Specification - Constant' section is active, displaying the formula:  $\text{Formula: Base Annual PP rate} = \text{Constant rate}$ . Below this, the 'Prepayments' table has one row with the following values:

Select	Tenor (1)	Start Maturity Date *	End Maturity Date *	Tenor *	Multiplier *	Percent *
<input type="checkbox"/>	(1)	01/01/1900	12/31/2499	1	Months	0.0000

2. Enter the Start Origination Date and End Origination Date ranges, add additional ranges as required using the Add Row button.
3. Enter the term to runoff tenor and multiplier for each of the date ranges.
4. Enter the annual prepayment rate percent for each of the date ranges.
5. Click Add Row to add additional runoff % rows and click the corresponding Delete icon to delete a row.

This screenshot shows the 'Prepayments' table with two rows. The 'Add Row' and 'Delete' icons are highlighted with a red box. The table data is as follows:

Select	Tenor (1)	Start Maturity Date *	End Maturity Date *	Tenor *	Multiplier *	Percent *
<input type="checkbox"/>	(1)	01/01/1900	12/31/2499	12	Months	40.0000
<input type="checkbox"/>	(2)			24	Months	60.0000

6. Define Seasonality assumptions as required to model date specific adjustments to the annual prepayment rate. Inputs act as multiplier, for example, an input of 2 will double the prepayment rate in the indicated month.

## Defining the Prepayment Model Method

Use this procedure to define prepayment assumptions using the Prepayment Model Calculation method.

### Prerequisites

- Performing basic steps for creating or updating a Prepayment rule
- Creating Prepayment Model rule

Prepayment Calculation Method	
Calculation Method	Prepayment Model
Cash Flow Treatment	Refinance

Prepayment Specification -Prepayment Model			
Prepayment Model Type selection		<input checked="" type="checkbox"/> Custom <input type="checkbox"/> Standard	
Formula : Base Annual PP rate + PP table factor * PP table LOOKUP( dimension x, dimension y, dimension z)			
Start Origination Date *	End Origination Date *	Coefficient *	Prepayment Model *
<input type="checkbox"/> 01-Jan-1900	30-Apr-2007	1.0000	ORG TERM/COUPON
<input type="checkbox"/> 01-May-2007	30-Apr-2009	1.0000	REM TERM/SPREAD
<input type="checkbox"/> 01-May-2009	31-Dec-2499	1.2500	REM TERM/SPREAD

Market Rate Definition	
Index	US Treasury Curve
Spread	00.0000
Associated Term	Original Term

## Procedure

1. Define the source for the Market Rate by Selecting an Index (Interest Rate Code) from the list of values.
2. Enter the Spread. The spread is added to the rate from the underlying interest rate curve to determine the market rate.
3. Select an Associated Term: Remaining Term, Reprice Frequency, or Original Term.
4. Specify the Prepayment Model parameters.

- Select the Start Origination Date using the date picker. Alternatively, you can enter the Start Origination Date in the space provided.
- Enter the Coefficient (if needed) by which the Prepayment Rate should be multiplied.

This multiple is applied to the instruments for which the origination date lies in the range defined in the Start Origination Date-End Origination Date fields.

- Select a predefined prepayment model from the Prepayment model Rule list of values. Click the View Details icon to preview the selected Prepayment Model.
- The system uses the prepayment model assumptions to calculate the prepayment amounts for each period. You need to associate a prepayment model for every Start Origination-End Origination Date range.
- Click Add Another Row to add additional rows and click the corresponding Delete to delete a row.

You can add as many rows in this model as you require. However you need to enter relevant parameters for each new row.

You can also use the Excel import/export feature to add the Prepayment rate information.

5. Define Seasonality assumptions as required to model date specific adjustments to the annual prepayment rate. Inputs act as multiplier, for example, an input of 2 will double the prepayment rate in the indicated month.

## Defining the PSA Prepayment Method

Use this procedure to define prepayment assumptions using the PSA Prepayment method.

## Prerequisites

Performing basic steps for creating or updating a Prepayment rule.

Start Origination Date	End Origination Date	PSA Speed	Prepayment Model
01-Jan-1900	30-Apr-2007	100	PSA MODEL
01-May-2007	30-Apr-2008	200	PSA MODEL
01-May-2008	31-Dec-2499	500	PSA MODEL

## Procedure

1. Select the Start Origination Date using the date picker. Alternatively, you can enter the Start Origination Date in the space provided.

---

**Note:** The first cell in the Start Origination Date column and all of the cells in the End Origination Date column are read only. This ensures that all possible origination dates have supporting reference values when Prepayment assumption lookups occur. Each row in the End Origination Date column is filled in by the system when you click Add Row or save the rule.

---

The first Start Origination Date (in row 1) has a default value of January 1, 1900. When you enter a Start Origination Date in the next row, the system inserts a date that is a day prior to the previous End Origination Date field.

2. Enter the PSA speed that you want to apply to the instruments having origination dates in a particular Start Origination-End Origination Date range. The PSA method is based on a standard PSA curve. You can view the seeded model by selecting the **View Details** icon.

---

**Note:** The default value is 100 PSA and inputs can range from 0 to 1667.

---

3. Click **Add Row** to add additional rows and click the corresponding Delete icon to delete a row. You can add as many rows in this table as you require. However you need to enter relevant parameters for each new row.
4. You can also use the Excel import/export feature to add the Prepayment rate information.
5. Define Seasonality assumptions as required to model date specific adjustments to the annual prepayment rate. Inputs act as a multiplier, For example, an input of 2 will double the prepayment rate in the indicated month.

## Defining the Arctangent Calculation Method

Use this procedure to define prepayment assumptions using the Arctangent Calculation method.



## Prerequisites

Performing basic steps for creating or updating a Prepayment rule.

The screenshot shows the 'Early Redemption' configuration interface. It includes sections for 'Prepayment Calculation Method', 'Prepayment Specification - ArcTangent Method', and 'Market Rate Definition'.

**Prepayment Calculation Method:**  
 Calculation Method: Arctangent  
 Cash Flow Treatment: Refinance

**Prepayment Specification - ArcTangent Method:**  
 Formula:  $\text{Base Annual PP rate} = K1 + (K2 * \text{ATAN}(K3 * (1 - \text{CPI} + K4)))$

Start Origination Date	End Origination Date	Constant Coe.K1	Constant Coe.K2	Constant Coe.K3	Constant Coe.K4
<input type="checkbox"/> 01-Jan-1900	30-Apr-2007	0.3000	0.2000	10.0000	1.2000
<input type="checkbox"/> 01-May-2007	30-Apr-2009	0.5000	0.4000	20.0000	1.0000
<input type="checkbox"/> 01-May-2009	31-Dec-2499	0.0000	0.0000	0.0000	0.0000

**Market Rate Definition:**  
 Index: US Treasury Curve  
 Spread: 00.0000  
 Associated Term: Original Term

## Procedure

1. Define the source for the Market Rate by Selecting an Index (Interest Rate Code) from the list of values.
2. Enter the Spread.  
 The spread is added to the rate from the underlying interest rate curve to determine the market rate.
3. Select an Associated Term: Original Term, Reprice Frequency, or Remaining Term.
4. Specify the Arctangent Argument table parameters.
5. Select the Start Origination Date using the date picker. Alternatively, you can enter the Start Origination Date in the space provided.
6. Enter the values for the Arctangent parameters (columns K1 through K4) for each Start Origination Date in the table. The valid range for each parameter is -99.9999 to 99.9999.
7. Click **Add Another Row** to add additional rows and click the corresponding **Delete** to delete a row.  
 You can add as many rows in this table as you require. However you need to enter relevant parameters for each new row.
8. You can also use the Excel import/export feature to add the Prepayment rate information.
9. Define the Seasonality assumptions as required to model date specific adjustments to the annual prepayment rate. Inputs act as multiplier, For example, an input of 2 will double the prepayment rate in the indicated month.

## Defining Early Redemption Assumptions

If you are working with deposit products, it is possible to define Early Redemption assumptions within the Prepayment Rule. While defining assumptions, the Prepayment rule will consider whether or not the product is an asset or liability (based on the account type attribute defined in dimension member management). If the product is an asset, then the Prepayments tab will be active in the prepayment assumption detail page. If the product is a liability, then the Early Redemption tab will be active.

## Prerequisites

- Performing basic steps for creating or updating a Prepayment rule.
- To define Early Redemption assumptions, the account type for the selected product must be a Liability.

Start Maturity Date *	End Maturity Date *	Percent *
01/01/1900	04/30/2008	0.0000
05/01/2008	04/30/2012	0.0000
05/01/2012	12/31/2499	0.0000

## Procedure

The procedure for defining Early Redemptions is the same as noted above for prepayments, with two exceptions:

- The list of Calculation Methods is limited to Constant and Prepayment Models
- The range definitions are based on Maturity Date ranges of the instruments rather than Origination Date ranges

Users also have two options for determining the timing of the early redemption assumption. Options include:

- **Use Payment Dates:** This is the default option. If selected early redemption runoff will occur on scheduled payment dates only.
- **User Defined Redemption Tenors:** If selected, users can specify any runoff timing. For example, users might choose to define the early redemption to runoff on the first day of the forecast.

To define Early Redemptions within the Prepayment Rule, follow the steps given below:

### Use Payment Dates

1. Select the "Use Payment Dates" option.

Start Maturity Date *	End Maturity Date *	Percent *
01/01/1900	12/31/2499	0.0000

2. Enter the Start Maturity and End Maturity Dates.

**Note:** The first cell in the Start Maturity Date column and all of the cells in the End Maturity Date column are read only. This ensures that all possible origination dates have supporting reference values when Prepayment assumption lookups occur. Each row in the End Origination Date column is filled in by the system when you click Add Row or save the rule. The first Start Origination Date (in row 1) has a default value of January 1, 1900. When you enter a Start Maturity Date in the next row, the system inserts a date that is a day prior to the previous End Maturity Date field.

3. Enter the annual prepayment rate percent that you want to apply to the instruments having origination dates in a particular Start Maturity-End Maturity Date range.

**Note:** The Percent column represents the actual annualized prepayment percentage that the system uses to generate the principal runoff during the cash flow calculations.

4. Click Add Row to add additional rows and click the corresponding Delete icon to delete a row.
5. You can add as many rows in this table as you require. However you need to enter relevant parameters for each new row.
6. You can use Data Input Helper feature. For more information, see [Data Input Helper](#) section.
7. You can also use the Excel import/export feature to add the Prepayment rate information. For more details, see [Excel Import/Export](#) section.

## User Defined Redemption Tenors

1. Select the User Defined Redemption Tenors option. This option allows you to specify the term to runoff for the particular row. E.g. if "1 Day" is defined, then the specified balance (redemption %), will runoff (mature) on the As of Date + 1 Day.

Select	Start Maturity Date *	End Maturity Date *	Tenor *	Multiplier *	Percent *
<input type="checkbox"/> Tenor(1)	01/01/1900	12/31/2499		1	0.0000
<input type="checkbox"/> Tenor(2)	12/31/2499	12/31/2499		1	0.0000

2. Enter the Start Maturity and End Maturity date ranges, add additional ranges as required using the Add Row button.

3. Enter the term to runoff tenor and multiplier for each of the date ranges.
4. Enter the early redemption runoff percentage for each of the date ranges.
5. Click **Add Row** to add additional runoff % rows and click the corresponding **Delete** icon to delete a row.

6. Define Seasonality assumptions as required to model date specific adjustments to the annual prepayment rate or early redemption rate. Inputs act as multiplier, for example an input of 2 will double the runoff rate in the indicated month.

## Associating Conditional Assumptions with Prepayment Rules

Oracle Asset Liability Management extends setup and maintenance of assumptions by allowing users to integrate conditional logic (optional) into the setup of, prepayment methods. You can define prepayment methodologies using IF-THEN-ELSE logic based on the underlying characteristics of your financial instruments, such as dates, rates, balances, and code values. The Conditional Assumption UI is accessed from the Assumption Browser by selecting the Conditional Assumption icon.

The conditional logic is defined through use of Data Filters and/or Maps. These existing objects provide the building blocks for defining Conditional logic. For example, each Data Filter can provide the logic for a specific condition. In the example below, the where clause is "Adjustable Type Code = 'Adjustable Rate'". This type of Data Filter can be selected within the Conditional Assumption UI.

Similarly, a Mapper object provides the necessary reference to one or more hierarchies, when dimension / hierarchy data is needed to define conditional logic. In the example below, this map refers to a hierarchy created on the Organization Unit dimension.

**Note:** Maps are accessed from the Infrastructure (HOME) page. You can find them at the following path:

*Common Object Maintenance > Unified Analytical Metadata > Map Maintenance*

To create a map, use the following steps:

1. Navigate to Map Maintenance.

2. Select icon to create new Map.
3. On the left hand side, select one or more hierarchies that were enabled in the initial step.
4. Fill in required information, e.g. Name, Effective Dates, and Entity Name.
5. Click **Save** button.
6. From the Map Maintenance Summary page, select the Map and the icon for "Mapper Maintenance".

Here, you will see the hierarchy and all parent/child relationships.

The range of product attributes supported for conditional assumptions and available for use within Data Filters is determined by columns which are part of the "Portfolio" definition. The "Portfolio" table class is seeded with the installation, and can be extended to include user defined columns.

For more information on adding user defined columns to the Portfolio table class, see Data Model Utilities Guide, Chapter 2 – Object Management.

When using mappers, Conditional Assumptions can be attached to any level of the hierarchy, allowing assumptions to be inherited from parent nodes by child nodes.

For example, you can use the Org Unit column to drive the assignment of Transfer Pricing Methods for all members of a particular Organization. You can create one Conditional Assumption to convey the entire Transfer Pricing Methodology logic and attach it to the top-level node of the Org Unit hierarchy. All nodes below the top-level node will inherit the same Transfer Pricing assumption.

The logic included in a Conditional Assumption determines the specific Transfer Pricing method, Prepayment assumption or Adjustment Rule that the system will assign to each individual instrument record at run time.

The Conditional Assumption screen allows users to select explicit conditions (from Data Filters and/or Maps) and apply methods and rule selections to each condition directly. The Filter Conditions are processed by the engine in the order that they appear on the screen. As soon as a condition is satisfied, the related assumption is applied. The following screenshot displays a representative Conditional Assumption using a Data

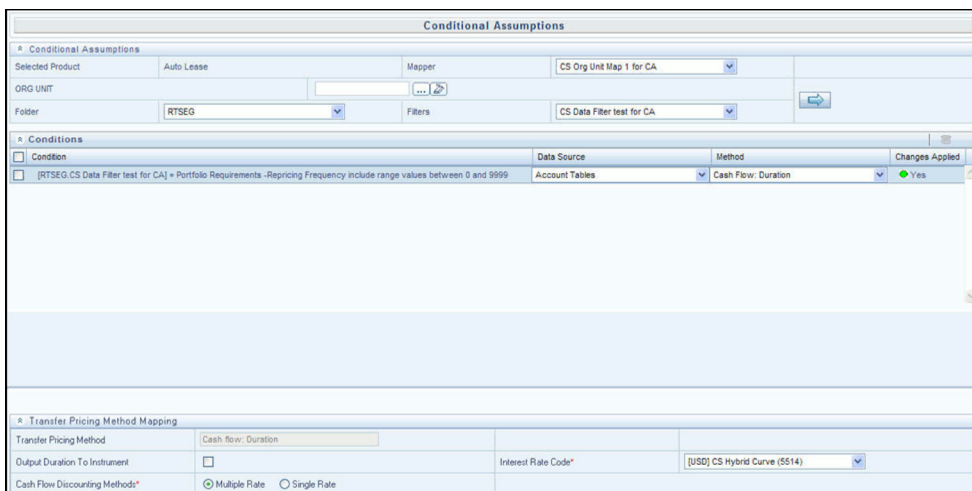

---

---

**Note:** If an instrument record does not meet any of the conditions, then the rule logic reverts to the standard assumption that is directly assigned to the Product / Currency combination. In the example below, you can see that Fed Funds has both a direct assignment and a conditional assumption. If the condition is not met, the "Fixed Rate" assumption (ELSE condition) will be applied. In the case of Reverse Repo's, there is only a Conditional Assumption. In the absence of an ELSE assumption, the engine will use the conditional assumption in all cases for the Product/Currency pair. To avoid this, users should define the Standard/Else assumption with an appropriate input.

---

---

Conditional Assumptions can be applied only to detailed account records (data stored in the Instrument Tables).





---

---

## Prepayment Models

This module describes the procedure to build prepayment models using Prepayment Model Rules.

This chapter covers the following topics:

- [Overview of Prepayment Models](#)
- [Creating Prepayment Models](#)
- [Editing Prepayment Models](#)
- [Editing Prepayment Rates in a Prepayment Model](#)
- [Prepayment Rate Data Loader](#)

### Overview of Prepayment Models

The Prepayment Model rule allows you to build custom prepayment models. These prepayment models can be referenced by a Prepayment Rule to model prepayment behavior of instruments based on a range of instrument level attributes.

The procedure for working with and managing Prepayment Models is similar to that of other Oracle Asset Liability Management business rules. It includes the following steps:

- Searching for Prepayment Models. For more information, refer to [Searching for Rules](#) section.
- Creating Prepayment Models, For more information, refer to [Creating Rules](#) section.
- Viewing and Editing Prepayment Models, For more information, refer to [Viewing and Editing Rules](#) section.
- Copying Prepayment Models. For more information, refer [Copying Rules](#) section.
- Deleting Prepayment Models. For more information, refer to [Deleting Rules](#) section.
- Loading Prepayment Models through a staging table. For more information, refer to [Prepayment Rate Data Loader](#) section.

### Creating Prepayment Models

Creating a Prepayment Model comprises the following sub procedures:

- Creating Prepayment Models

- Defining the structure of the prepayment model
- Assigning Node Values

## Procedure to create a Prepayment Model

This table describes key terms used for this procedure.

**Table 20–1 Selected Terminology**

Term	Description
Dimension	Influences the prepayment behavior of an instrument. You can build a prepayment model using up to three prepayment dimensions. Each dimension maps to an attribute of the underlying transaction (For example, age/term or rate and so on) so the cash flow engine can apply a different prepayment rate based on the specific characteristics of the record.
Lookup method	<p>Used to calculate prepayment rates for the prepayment dimension values that do not fall exactly on the defined prepayment dimension nodes. Oracle Asset Liability Management offers the following lookup methods:</p> <ul style="list-style-type: none"> <li>⌘ <b>Interpolation:</b> Under this method, the prepayment rates are determined by calculating an exact value on an axis. This method assumes that prepayment speeds change on a straight-line basis between the two nodes and calculates accordingly</li> <li>⌘ <b>Range:</b> Under this method, the prepayment rates are determined by calculating a range of values on an axis. This method assumes that the prepayment speed will remain the same for the entire range.</li> </ul> <p>The following example explains the differences between these two lookup methods. The following lists show the age and corresponding prepayment rates of instruments.</p> <p><b>Age</b></p> <ul style="list-style-type: none"> <li>⌘ 12</li> <li>⌘ 24</li> <li>⌘ 36</li> <li>⌘ 60</li> </ul> <p><b>Prepayment Rates</b></p> <ul style="list-style-type: none"> <li>⌘ 5</li> <li>⌘ 10</li> <li>⌘ 15</li> <li>⌘ 20</li> </ul> <p>Under the Interpolation method, the prepayment speeds increase gradually. In this example, the Interpolated prepayment rate of an instrument aged 30 months is 12.5%.</p> <p>This is exactly halfway between the 10% and 15% rate. However, under the Range method, the Prepayment speeds increase in steps. Using the Range method, the prepayment rate is 10%, as this rate percentage would apply to the range from 24 months to 35.9999 months.</p>
Nodes	Exact points for each dimension where attribute information has been defined.

1. Navigate to the *Prepayment Model* summary page.
2. Complete standard steps for this procedure. For more information, refer to [Creating Rules](#) section.

## Procedure to Define the Structure of the Prepayment Model

The Prepayment Model consists of the Prepayment Dimensions and the Bucket Values for these Dimensions which you select on this page. To define the prepayment model structure, you can select a maximum of three prepayment dimensions. Once the dimensions and the number of buckets (tiers) are defined, you need to assign values to the buckets.

---

**Note:** You can use the analogy of a three dimensional table to understand how to deal with the prepayment dimensions. The first dimension you select would resemble the row (X-axis). The second dimension would act as the column (Y-axis). The final third dimension will be the page (Z-axis).

---

1. Select the first Dimension.
2. Select a lookup method for that Dimension.
3. Enter the number of Buckets for the Dimension.  
This number may vary from dimension to dimension.
4. If required, repeat the previous three steps for up to two additional Dimensions.

---

**Note:** There are certain restrictions while defining Dimensions:

- ⌘ You must select the Dimension type for a row and define the values for that dimension.
  - ⌘ You cannot define the second (row) dimension until you have defined the first (row) dimension. Similarly, the third dimension cannot be defined until you have defined the first two dimensions.
- 

5. Click **Apply**.

The *Define Dimensions* page is refreshed. You can now assign the bucket values for each dimension. At this point, you can also modify the structure of the table, if required.

### Modifying the Table Structure

- To add more buckets to a particular Dimension, update the number of buckets for the Dimension and click **Apply**.
- To delete buckets from a particular Dimension, reduce the number of buckets to the desired value and click **Apply**.

---

**Note:** To change the lookup method of a particular Dimension, select the required method from the corresponding list of methods from the Dimensions tab.

---

6. Assign values for each of the buckets.

<input type="checkbox"/>	Rate Difference (in percent)	Expired Term (in months)	Coupon Rate (in percent)
<input type="checkbox"/>	0.000000	12	4.000000
<input type="checkbox"/>	0.500000	24	6.000000
<input type="checkbox"/>	1.250000	60	8.000000
<input type="checkbox"/>	2.500000	84	

7. Click **Apply**.

The Prepayment Model, Prepayment Dimensions, and Buckets are saved.

8. Enter the Prepayment Rates in the Prepayment Model.

Bucket values for the row and column dimensions are displayed as a table, while the bucket values for the page dimensions (if selected) are shown in the drop-down list.

<input type="checkbox"/>	Original Term (in Months)	Repricing Term (in Months)
<input type="checkbox"/>	7	3.0000
<input type="checkbox"/>	6	2.0000
<input type="checkbox"/>	5	6.0000

9. Repeat the process for all bucket values of the page driver. To change the bucket value along the page driver, select the required value from the drop-down list.

---

**Note:** Bucket values will be displayed in the drop-down list only if you selected three drivers.

---

10. Click **Apply**. The Prepayment Rates are saved and the Prepayment Model Rule summary page is displayed.

## Editing Prepayment Models

As part of editing Prepayment models, you can modify Prepayment rates and the structure of the Prepayment Model. You can also modify the lookup methods (Range or Interpolation), the number of Buckets, and the actual values of the Buckets. However, if you update the dimensions your previously entered prepayment rate data may be lost.

### Prerequisites

Predefined Prepayment Models.

### Procedure

1. Search for the Prepayment Model, which you want to edit. For more information, refer to [Searching for Rules](#) section.
2. Select the check box next to the Prepayment Model and select the **Edit** icon.  
The Prepayment Model opens in Edit mode.

### Procedure to Update Rates

Modify the Prepayment Rates in the table as required. For more information, refer to [Editing Prepayment Rates in a Prepayment Model](#) Editing.

### Procedure to Update Dimensions Values

1. Click **Update Dimensions Values**.  
The *Update Dimensions* page is displayed.
2. Update the structure as required.
  - To add more Nodes to a particular Dimension, update the number of Nodes for the Dimension and click **Go**.
  - To delete Nodes from a particular Dimension, click the delete icon corresponding to the Node.

---



---

**Note:** Nodes cannot be deleted by reducing their numbers. Also, all Nodes cannot be deleted and at least one Node must exist in each Dimension.

---



---

- To change the method of a particular Dimension, select the required method from the corresponding list.
  - To change the value of a Node, update the value in the corresponding field.
3. Click **Apply**.  
The *Prepayment Model summary* page is displayed.

## Editing Prepayment Rates in a Prepayment Model

Once the basic structure of the prepayment model has been created, prepayment rates can be added to, or modified for, each of the bucket values along the chosen dimensions. Use this procedure to add or edit annual prepayment rates in the prepayment model.

## Procedure

1. Search for the Prepayment Model, for which you want to define prepayment rates. For more information, refer to [Searching for Rules](#) section.
2. Select the check box next to the Prepayment Model and select the **Edit** icon.  
The Prepayment rate input page is displayed.
3. Enter the Prepayment Rates in the Prepayment Model for the required dimensions.  
Node values for the row and column dimension are displayed as a table on the Prepayment rate input, while the node values for page dimension (if selected) are shown in the drop down list.
4. Repeat the process for all node values of the page dimension. To change the node value along the page dimension, select the required node value from the drop-down list.

---

---

**Note:** Node values will be displayed in the drop-down list only if you selected three dimensions. If prepayment rates are left blank for any of the dimensions, prepayment rates are assumed to be zero.

---

---

5. Click **Apply**.  
The table with updated prepayment rates is saved.
6. Click **Save**.  
All updates to the Prepayment Model are saved and the Prepayment Model summary page is displayed.

## Excel Import/Export

Excel import/export functionality is used for adding/editing prepayment rate information. For more details, refer Excel Import/Export.

## Prepayment Rate Data Loader

The Prepayment Rate Loader procedure populates prepayment model rates in OFSAA metadata tables from staging tables. This loader program can be used to update the prepayment model rates on a periodic basis. For more information on setting up the automated process, refer to *Oracle Financial Services Analytical Applications Data Model Utilities User Guide*.

To execute the Data loader process, click the Data Loader icon on the Prepayment Models rule bar. The process will load all of the data included in the staging tables as defined in the Data Model Utilities User Guide.

Prepayment Models						
Active Time Bucket: Time_incomesimulation						
Search <span style="float: right;">[Icons]</span>						
Name		Folder		ALMHMSEG ▾		
Prepayment Models <span style="float: right;">1 - 3 / 3 [Navigation Icons] Jump to page</span>						
<input type="checkbox"/>	Name	Creation Date	Created By	Last Modification Date ▾	Last Modified By	Access Type
<input type="checkbox"/>	11adsasf	9/9/2014 10:50:50	JILNA	9/9/2014 10:50:57	JILNA	Read/Write
<input checked="" type="checkbox"/>	test_prepay2	9/9/2014 10:50:02	JILNA	9/9/2014 10:50:10	JILNA	Read/Write
<input type="checkbox"/>	prepyamodel	9/9/2014 05:49:21	JILNA	9/9/2014 05:50:25	JILNA	Read/Write





---

---

## Discount Methods

This module describes the procedure for working with and managing Discount Method rules.

This chapter covers the following topics:

- [Overview of Discount Method Rules](#)
- [Creating Discount Method Rules](#)
- [Defining Discount Method Rules](#)

### Overview of Discount Method Rules

Discount Method rules allow users to define the method for discounting projected cash flows for market value and duration calculation purposes. For each combination of product and currency, you can choose one of the following discount methods:

- [Spot Input](#)
- [Spot Interest Rate Code](#)
- [Forecast Remaining Term](#)
- [Forecast Original Term](#)

The methodologies contained in the Discount Method rules are referenced by the Static Deterministic and Dynamic Deterministic ALM Processes. See [Defining Discount Method Rules](#)

The procedure for working with and managing Discount Method rules is similar to that of other Asset Liability Management business rules. It includes the following steps:

- Searching for Discount Method rules. For more information, refer to [Searching for Rules](#) section.
- Creating Discount Method Rules., For more information, refer to [Creating Rules](#) section.
- Viewing and Editing Discount Method rules. For more information, refer to [Viewing and Editing Rules](#) section.
- Copying Discount Method rules. For more information, refer to [Copying Rules](#) section.
- Deleting Discount Method rules. For more information, refer to [Deleting Rules](#) section.

As part of creating and editing Discount Method rules, you assign Discounting methodologies to applicable products.

---

**Note:** Oracle Asset Liability Management provides you with the option to copy, in total or selectively, the product assumptions contained within ALM business rules from one currency to another currency or a set of currencies or from one product to another product or a set of products.

---

## Creating Discount Method Rules

You create a Discount Methods rule to assign Discounting Methods to your products.

1. Navigate to the Discount Methods rule summary page.
2. Complete standard steps for this procedure.

Tip: In addition to the standard steps for creating rules, the procedure for creating a Discount Methods rule involves one extra step. After Standard Step 6, you need to select a product hierarchy. You can define methodologies at any level of the hierarchical product dimension. The hierarchical relationship between the nodes allows inheritance of methodologies from parent nodes to child nodes.

## Defining Discount Method Rules

The definition of a Discount Methods rule is part of the Create or Edit Discount Methods rule process. When you click Save in the Create Discount Methods rule process, the rule is saved and the Discount Methods rule summary page is displayed. However, Discount Method assumptions have not yet been defined for any of your products at this point. Typically, you would start defining your Discount Method assumptions for product-currency combinations before clicking Save.

### Defining Discount Methods Using Node Level Assumptions

Node Level Assumptions allow you to define assumptions at any level of the Product dimension Hierarchy. The Product dimension supports a hierarchical representation

of your chart of accounts, so you can take advantage of the parent-child relationships defined for the various nodes of your product hierarchies while defining rules. Children of parent nodes on a hierarchy automatically inherit the assumptions defined for the parent nodes. However, assumptions directly defined for a child take precedence over those at the parent level.

## Prerequisites

Performing basic steps for creating or editing a Discount Methods rule

## Procedure

From the Assumption Browser screen, select the product(s) and the currency for which you want to define a discount method(s) and select the “Add New” button to launch the Discount Method Details screen.

---



---

**Hint:** Using the default currency to setup assumptions can save data input time. At run time, the calculation engine uses assumptions explicitly defined for a product currency combination. If assumptions are not defined for a currency, the engine uses the assumptions defined for the product and the default currency. If the assumptions are the same across some or all currencies for a specific product, you can input assumptions for the default currency. Be careful using this option on screens where an Interest Rate Code is a required input. In most cases, you will want to use a currency specific discount curve for discounting instruments within each specific base currency. The Default Currency option, if used will apply a selected Interest Rate Code across all currencies.

---



---

## The Discount Method Details screen

The screenshot displays the 'Discount Method Details' form. At the top, it shows the active time bucket as 'Manuel\_Bug\_1594825\_Hatton' and the date as '12/31/99'. The form is organized into several sections:

- Discount Methods Details:** Includes fields for 'Name' (set to 'New') and 'Description'.
- Product and Currency Details:** Includes 'Product' (GL-1130255) and 'Currency' (US Dollar).
- Assumption Details:** Includes 'Discount Method' (Forecast Remaining Term) and 'Cash Flow Interest Type' (Net Rate).
- Cash Flow Definition Details:** Includes radio buttons for 'Interest Only' (selected) and 'Principal and Interest', and a checkbox for 'Mature at Repricing'.
- Interest Rate Assumptions:** Includes 'Interest Rate Code' ([USD] 1. CS Break Funding Curve (2)), 'Input Rate', and 'Rate Spread' (0.000000).

At the bottom of the form, there are 'Apply' and 'Cancel' buttons.

## Discount Method

Select a method from the Discount Method list:

- Spot Input

- Spot Interest Rate Code
- Forecast (Original Term)
- Forecast (Remaining Term)

The following table describes the methods and rate choices:

Method	Single Rate	Yield Curve
Spot Input	Discounts all cash flows by the Input Rate	Not applicable
Spot Interest Rate Code	Not applicable	Discounts each cash flow period by the equivalent term rate on the base yield curve chosen (the yield curve as of the start date selected in your ALM Application Preferences). The term is defined by the remaining term of the cash flow. Refer Note
Forecast (Original Term)	Not applicable	Discounts each cash flow period by the forecasted value of the point on the yield curve corresponding to each transaction record's original term. Refer Note
Forecast (Remaining Term)	Not applicable	Discounts each cash flow period by the forecasted value of the point on the yield curve corresponding to the remaining term until each cash flow. Refer Note

**Note:** In the case of Spot Interest Rate Code, if term point is not available, engine will use linear interpolation to determine the interest rate to discount cashflows.

When Discounting method of Forecast (Original Term) and Forecast (Remaining Term) is used, if term point is not available, engine will use Interpolation method defined for Interest rate code within Forecast rate rule. If Interpolation method defined in Forecast rate rule is Linear, engine will use linear interpolation. If Interpolation method is cubic, engine will use Cubic interpolation to determine interest rate to discount cashflows.

## Cash Flow Definition Details

The Cash Flow Definition Details section is used in unique instances to specify the portion of the cash flow that is used to calculate a market value. Select from the following:

- Interest Only - ignores all principal runoff for market value purposes. Use this option for off-balance sheet items where principal is equal to notional principal, and is therefore not a true cash flow.

- Mature at Repricing - calculates a market value and YTM for a given transaction up to the repricing date. For market value and YTM purposes the transaction is assumed to mature on the repricing date. Duration is always calculated to the next reprice date, not to maturity, regardless of the mature at repricing selection.

## Cash Flow Interest Type

The Cash Flow Interest Type determines which interest component is included in the cash flow definition. The Cash Flow Interest Type can be one of three values:

- Net Rate
- Gross Rate
- Transfer Rate

For typical processing, you will use the Net Rate for the interest component of the cash flow. Special processing objectives, such as valuation of the funding center, may require you to use the other cash flow interest types.

## Interest Rate Parameters

One of the following interest rate parameters is available depending on which discount method you select:

- Input Rate - available when you select Spot Input. Type the rate you want to use for market value calculations.
- Rate Spread - available when you select Spot Interest Rate Code, Forecast (Original Term) and Forecast (Remaining Term). Type the percentage difference (+ or -) between the selected rate index and the value you want to use for the discount rate(s) within market value calculations.

## Defining a Discount Methods Rule Using Spot IRC: An Example

Define a Discount Methods rule for Total Loans using the spot IRC method.

1. From the Assumption Browser, select Currency (US Dollar) and Total Loans.
2. Select “Add New” to enter the Assumption Details page.

The screenshot displays the 'Discount Methods' configuration interface. At the top, it shows 'Active Time Bucket: TimeBucket1' and 'As Of Date: 6/25/2014'. The main form includes the following sections:

- Discount Methods:** Fields for Name (DiscountSaveAs), Description, Folder (ALMSEG), and Access Type (Read/Write, Read Only).
- Select Product Hierarchy:** Fields for Folder (ALMSEG) and Product Hierarchy (HierTest).
- Select Currency:** Field for Currency (Default Currency).
- Assumption Browser:** A tree view showing 'Product' with sub-items 'Member1' and 'Orphan Branch'.
- Assumption List:** An empty table with columns for Product, Discount Method, and Status.

At the bottom of the page, there are three buttons: 'Save', 'Save As', and 'Cancel'.

3. From the Discount Method list, select Spot IRC.
4. From Interest Rate Code list, select an appropriate Interest Rate Code.

The list of Interest Rate Codes depends on the selected currency. If the selected currency is the default currency, all Interest Rate Codes appear. For other currency selections, the list of interest rate codes includes only interest rate codes whose reference currency is the same as the selected currency.

5. Input a Rate Spread, type 1.0000.

A spread of 1% returns a discount rate of 1.00% above the reference interest rate. Type a negative number for a spread below the reference interest rate.

The screenshot shows the 'Discount Methods Details' form with the following configuration:

- Discount Methods Details:** Name: New, Description: (empty)
- Product and Currency Details:** Product: GL-1130255, Currency: US Dollar
- Assumption Details:** Discount Method: Spot IRC, Cash Flow Interest Type: Net Rate
- Cash Flow Definition Details:** Interest Only (selected), Principal and Interest (deselected), Mature at Repricing (deselected)
- Interest Rate Assumptions:** Interest Rate Code: [USD] 1. CS Break Funding Curve (2), Input Rate: (empty), Rate Spread: 0.000000

6. From Cash Flow Interest Type, select Net Rate.
7. Under Cash Flow Definition Details, use the default – Principal & Interest selection.
8. Select Apply to commit the assumption and return to the Assumption Browser page.

---

**Note:** You can select more than one product at a time from the Assumption Browser page. After applying assumptions and returning to the Assumption Browser, notice in the above screenshot, that all of the children listed below the parent member have “inherited” the Spot IRC assumption.

---

9. When Discount Method assumptions are defined for all required product / currency combinations, select SAVE from the Assumption Browser page.

## Discount Rate Method Examples

The following examples assume the interest rate has a format of zero coupon yield with annual compounding. The instrument used in each example is an annual-pay, 2-year instrument originated on the as\_of\_date. See the Oracle Financial Services Cash Flow Engine Reference Guide for details on discount factor derivation used in cash flow calculations.

## Spot Input

In the Spot Input method, the discount factor does not vary with Forecast Rate - interest rate scenarios. The discount factor calculations assume the input interest rate to reflect a format of zero coupon yield, annual compounding, and actual/actual accrual basis.

Spot Input Rate = 6.00%

The formula for the market value of the account, for any rate scenario, is:

$$\text{Market Value} = \text{Cash Flow1} / (1 + 0.06) + \text{Cash Flow 2} / ((1 + 0.06)^2)$$

Cash Flow1 is the cash flow at the end of year 1. Cash Flow2 is the cash flow at the end of year 2.

## Spot Interest Rate Code

In the Spot Interest Rate Code method, the discount factor depends on the term of the cash flow, but does not vary with interest rate scenario.

Interest Rate Code = Treasury Yield Curve

The formula for the market value of the account, for any rate scenario, is:

$$\text{Market Value} = \text{Cash Flow1} / (1 + 1 \text{ Year Treasury}) + \text{Cash Flow2} / ((1 + 2 \text{ Year Treasury})^2)$$

Cash Flow1 is the cash flow at the end of year 1. Cash Flow2 is the cash flow at the end of year 2. The values for 1 Year Treasury and 2 Year Treasury reflect the values from the historical interest rate data, beginning with the as\_of\_date.

## Forecast Remaining Term

The Forecast Remaining Term method uses forecasted interest rate data to determine the discount factor.

Interest Rate Code = Treasury Yield Curve

The formula for the market value of this account is:

$$\text{Market Value} = \text{Cash Flow1} / (1 + 1\text{Year Treasury Rate at the 1 year point in the forecast}) + \text{Cash Flow2} / ((1 + 2 \text{ Year Treasury Rate at the 2 year point in the forecast})^2)$$

Cash Flow1 is the cash flow at the end of year 1. Cash Flow2 is the cash flow at the end of year 2. The values for 1 Year Treasury and 2 Year Treasury reflect the scenario specific values from the forecast rates - interest rate data. Cash Flow1 is discounted at the 1 year Treasury rate, from the 1 year point of the forecast and Cash Flow2 is discounted at the 2 year Treasury rate, from the 2 year point of the forecast.

## Forecast Original Term

The Forecast Original Term method uses the forecasted interest rate data to determine the discount factor.

Interest Rate Code = Treasury Yield Curve

The formula for the market value of the account is:

$$\text{Market Value} = \text{Cash Flow1} / (1 + 2 \text{ Year Treasury Rate at the 1 year point in the forecast}) + \text{Cash Flow2} / ((1 + 2 \text{ Year Treasury Rate at the 2 year point in the forecast})^2)$$

Cash Flow1 is the cash flow at the end of year 1. Cash Flow2 is the cash flow at the end of year 2. Note that Cash Flow1 is discounted at the 2 year Treasury rate. The 2 Year rate is used with this method, because the Forecast Original Term method always uses the term equivalent to the original term of the instrument.



---

---

## Rate Dependency Patterns

This module describes the procedure for working with and managing Rate Dependency Patterns.

This chapter covers the following topics:

- [Overview of Rate Dependency Patterns](#)
- [Searching for Rate Dependency Patterns](#)
- [Creating Rate Dependency Patterns](#)

### Overview of Rate Dependency Patterns

Rate Dependency Patterns allow you to establish relationships between the level of interest rates, economic indicators or rate spreads and ALM forecast assumption rules. After defining Rate Dependency Patterns, you can attach these patterns to ALM forecast business rules. ALM assumption rules with Rate Dependency Patterns, work together with your Forecast Rate scenarios to determine assumptions applicable to each specific scenario within your simulation. The following rule types support Rate Dependent assumptions:

- Forecast Balances
- Forecast Maturity Mix
- Forecast Pricing Margins
- Transaction Strategies
- Formula Results

When Rate Dependency Patterns are attached to an ALM business rule, you will be able to input multiple versions of each specific assumption type within a single assumption rule. The ALM engine dynamically retrieves the assumptions which are applicable to the scenario being processed.

The procedure for working with and managing Rate Dependency Patterns is similar to that of other Asset Liability Management business rules. It includes the following steps:

- Searching for Rate Dependency Patterns. For more information, refer to [Searching for Rules](#) section.
- Creating Rate Dependency Patterns. For more information, refer to [Creating Rules](#) section.
- Viewing and Editing Rate Dependency Patterns. For more information, refer to [Viewing and Editing Rules](#) section.
- Copying Rate Dependency Patterns. For more information, refer to [Copying Rules](#) section.
- Deleting Rate Dependency Patterns. For more information, refer to [Deleting Rules](#) section.

## Searching for Rate Dependency Patterns

Search for a rate dependency pattern to perform any of the following tasks:

- View
- Edit
- Copy
- Delete
- Check Dependencies

### Prerequisites

Predefined rate dependency patterns

Name	Creation Date	Created By	Last Modification Date	Last Modified By	Access Type
copy67	8/25/2014 04:51:40	JILNA	8/25/2014 04:51:40	JILNA	Read/Write
Economicindicator7digit	8/21/2014 07:02:20	JILNA	8/21/2014 07:02:30	JILNA	Read/Write
Ratedependencyspread	8/21/2014 07:00:14	JILNA	8/21/2014 07:01:27	JILNA	Read/Write
copydd	8/21/2014 07:01:05	JILNA	8/21/2014 07:01:17	JILNA	Read/Write
Ratespreadsaving7digit	8/21/2014 07:00:47	JILNA	8/21/2014 07:00:47	JILNA	Read/Write
copy_7 digits	8/20/2014 09:27:58	JILNA	8/20/2014 09:28:08	JILNA	Read/Write

### Procedure

1. Navigate to the Rate Dependency Pattern summary page. This page is the gateway to all rate dependency patterns and related functionality. You can navigate to other pages relating to rate dependency patterns from this page.
2. Enter the Search criteria.
3. Enter the code or name of the Pattern.

4. Click the Search icon.  
Only patterns that match the search criteria are displayed.

---

**Note:** You can control the number of rows to display on screen by selecting the "Pagination Options" icon from the action bar

---

## Creating Rate Dependency Patterns

You create Rate Dependency Patterns to attach to forecast business rules.

### Procedure

1. Navigate to the Rate Dependency Pattern rule summary page.
2. Click Add New - Rate Dependency Pattern. The Rate Dependency Pattern details page is displayed.
3. Enter a Name and a brief description for the pattern.
4. Select the Rate Dependency Pattern Type: Rate-Level Dependent, Rate-Spread Dependent or Economic Indicator Dependent.

The screenshot shows a web form titled "Rate Dependency Pattern Details". It contains several input fields and a dropdown menu. The "Name" field is populated with "SMBratedep01". The "Description" field is empty. The "Folder" dropdown is set to "EPNIG1SEQ". The "Access Type" section has radio buttons for "Read Only" and "Read Write", with "Read Write" selected. Below this, there is a "Rate Dependency Selection" dropdown menu currently showing "Rate-Level Dependent". At the bottom, there is a "Rate Dependency Relationship" dropdown menu with a list of options: "Rate-Level Dependent", "Rate-Spread Dependent", and "Economic Indicator Dependent".

The selection of the Rate Dependency Pattern type made in the previous step determines the information you must provide to successfully define that pattern type. See:

- [Defining Rate-Level Dependent Rate Dependency Patterns](#)
- [Defining Rate-Spread Dependent Rate Dependency Patterns](#)
- [Defining Economic Indicator Dependent Rate Dependency Patterns](#)

## Defining Rate-Level Dependent Rate Dependency Patterns

The Rate-Level dependent relationship allows you to define assumptions for different values of a single indicator interest rate. The indicator interest rate, referred to as the Base Interest Rate, is defined by an Interest Rate Code, a term selection, and a rate lag.

The screenshot shows the 'Rate Dependency Selection' form with the 'Rate-Level Dependent' dropdown selected. Under the 'Rate Dependency Relationship' section, the 'Base Rate' tab is active. The 'Interest Rate Code' is set to '1000 New Test RC 4 (33340)', 'Term' is '1 Years', and 'Rate Lag' is '1 Months'.

## Procedure

1. Provide the following inputs.

**Interest Rate Code:** The Interest Rate Code identifies the reference yield curve or rate index whose forecasted value determines the assumptions to reference. You can select the Interest Rate Code from all available interest rate codes, as defined within Rate Management.

**Term Selection:** If the selected Interest Rate Code is a yield curve, you must also select a term. Your term choices depend on the definition of the Interest Rate Code within Rate Management. Note that the selection automatically defaults to the shortest available term.

**Rate Lag:** If you want the base interest rate calculation to perform a look back function, you can input a rate lag. The new business assumption lookup uses the forecasted interest rates as of a date within the current modeling bucket less the rate lag. If the timing of new business is End of Bucket, the lookup function uses the last day of the bucket less the rate lag. For all other cases, the mid-point of the bucket less the rate lag is used.

2. Select Apply to navigate to the Rate Tiers tab. Once you have selected a rate-level relationship and defined your base interest rate, you must define rate tiers. Rate tiers provide the lookup values for which different assumptions can be input.
3. Select the Add Rows button to add the number of Rate Tiers you would like to include in your pattern.

The screenshot shows the 'Rate Tiers' tab of the 'Rate Dependency Selection' form. It features a table with columns for 'Rate Tiers' and an 'Add Row' button. The 'Lookup Method' is set to 'Interpolation'.

Rate Tiers	Rate Tiers
<input type="checkbox"/>	.001
<input type="checkbox"/>	.5
<input type="checkbox"/>	1

Lookup Method:  Range  Interpolation

4. Input the appropriate Rate Level for each Rate Tier.
5. Select the Lookup Method. The lookup method determines which new business assumption is selected from the input values when the forecasted interest rate falls between two rate tiers. There are two methods to choose from:

**Interpolate:** If you select Interpolate, the assumption is an interpolated value, using straight line interpolation, calculated from the assumptions associated with the two nearest interest rate tiers. The interpolation uses a simple straight line interpolation formula.

Range: If you select Range, Oracle ALM selects the new business assumption as the closest assumption associated with the rate tier which is less than or equal to the forecasted interest rate.

6. Select Save to complete the definition.

## Defining Rate-Spread Dependent Rate Dependency Patterns

With the Rate-Spread dependent relationship, you can input assumptions for different spreads between two indicator interest rates. You define the first indicator interest rate, the Base Interest Rate, as described previously. The second indicator interest rate, the Alternate Interest Rate, also requires selection of an Interest Rate Code, a term selection, and a rate lag.

The rate spread equals: Alternate Interest Rate - Base Interest Rate

### Procedure

1. Define the Base Interest Rate details.

2. Select Apply.
3. Define the Alternate Interest Rate details.

4. Select Apply.
5. Define the Rate Tiers for the Spreads.

6. Select the Lookup Method. The lookup method determines which new business assumption is selected from the input values when the forecasted interest rate falls between two rate tiers. There are two methods to choose from:

Interpolate: If you select Interpolate, the assumption is an interpolated value, using straight line interpolation, calculated from the assumptions associated with

the two nearest interest rate tiers. The interpolation uses a simple straight line interpolation formula.

Range: If you select Range, Oracle ALM selects the new business assumption as the closest assumption associated with the rate tier which is less than or equal to the forecasted interest rate.

7. Select Save to complete the definition.

## Defining Economic Indicator Dependent Rate Dependency Patterns Procedure

With the Economic Indicator dependent relationship, you can input assumptions for different levels of a selected Economic Indicator. The only required selection for this method is the type of Economic Indicator. You can select the Economic Indicator from all available EI's for the selected currency, as defined within Rate Management.

1. Select the Economic Indicator.

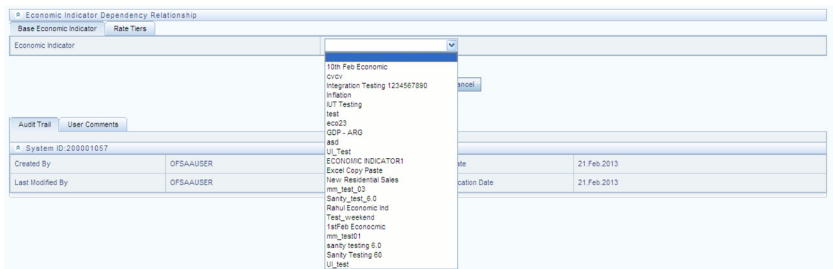

2. Select Apply.
3. Define the Rate Tiers for the Economic Indicators.

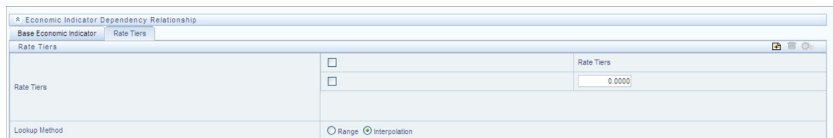

4. Select the Lookup Method. The lookup method determines which new business assumption is selected from the input values when the forecasted interest rate falls between two rate tiers. There are two methods to choose from:

Interpolate: If you select Interpolate, the assumption is an interpolated value, using straight line interpolation, calculated from the assumptions associated with the two nearest interest rate tiers. The interpolation uses a simple straight line interpolation formula.

Range: If you select Range, Oracle ALM selects the new business assumption as the closest assumption associated with the rate tier which is less than or equal to the forecasted interest rate.

5. Select Save to complete the definition.

---

---

## Forecast Balance Rules

This module discusses modeling of new business activity through the Forecast Balance rules. Included are assumption setup and processing.

Within a Forecast Balance rule, you specify the amount of new activity generated per modeling bucket on each product within each active currency. To create a new business assumption, you select from eight available forecasting methods. You can further tailor the new business assumptions to meet your expectations of future originations, including the timing of new business and the effect of interest rates on new business amounts.

This chapter covers the following topics:

- [Forecasting Methods](#)
- [Rate-Volume Modeling](#)
- [Creating a Forecast Balance Rule](#)
- [Examples of Forecast Balance Assumptions](#)

### Forecasting Methods

The new business methods within the Forecast Balance rule determine how new business assumptions are applied per product leaf within each active currency. They consist of:

For the Target Growth, Target End, and New Add methods, you select one of two timing options to indicate when new business for a new account should be originated. The two options are:

- No New Business
- Target End Balance
- Target Average Balance
- Target Growth Percent
- New Add Balance
- Rollover
- Rollover with New Add
- Rollover with Growth %

For the Target Growth, Target End, and New Add methods, you select one of two timing options to indicate when new business for a new account should be originated. The two options are:

- **Distributed Option:** Solves for the origination date of the new business account to reach an expected average balance, assuming even distribution of new business throughout the modeling bucket. For each modeling bucket, this calculation results in an average balance amount that is midway between the beginning balance and the ending balance.
- **Bucket End Method:** Generates new originations at the end of the modeling bucket. Adding new business at the end of the modeling bucket is effective in terms of processing time, but may result in irregular average balances and interest accruals over the bucket.

For the Target Average method, the system automatically determines the timing of new originations to ensure that the user-input target is achieved. For Rollover business, the system assumes that the rollover occurs at the time of runoff of existing accounts.

---

---

**Note:** For distributed originations of Target Growth and Target End balances, Transaction Strategies and future origination in the current position may impact the distributed originations calculation. Because the origination date on Transaction Strategy and current position accounts cannot be modified, the timing algorithm may not be able to find an origination date for the remaining new business which achieves the expected average balance.

---

---

The application of each new business method, including how different timing options are applied, is described below:

## No New Business

No New Business (forecasting zero changes in balances) is the default method for the Forecast Balance rule. This method allows runoff without replacement of the paid-down balances.

## Target End Balance

Use the Target End Balance method to define the total expected balance by the end of each modeling bucket. The new origination amount and the timing of originations within each modeling bucket are determined during processing, as described below:

## New Origination Amount

The new origination amount per bucket is calculated as:

Target Ending Balance - Beginning Balance - Total Runoff + Transaction Strategy Originations + Current Position Originations

## New Business Timing

For the Target End method, you can choose either the At Bucket End timing option or the Distributed timing option.

**At Bucket End:** The new origination amount is added on the final date in the bucket. Interest starts accruing on the next day, the first date of the next bucket.

**Distributed:** The new origination amount is added on the calculated date(s) which allow the average balance to equal the beginning balance plus the ending balance



divided by two, accounting for timing of runoff and other originations occurring during the modeling bucket.

## Target Average Balance

Use the Target Average Balance method to define the expected average balance per modeling bucket. The new origination amount and the timing of originations within each modeling bucket are determined during processing, as described below:

### New Origination Amount

The new origination amount per bucket is calculated as:

$$2 * (\text{Target Average Balance} - \text{Bucket Beginning Balance}) + \text{Total Runoff} - \text{Transaction Strategies Originations} - \text{Current Position Originations}$$

### New Business Timing

The new origination amount is added on the calculated date(s) which allow the average balance to equal the user-input target average. This calculation accounts for timing of runoff and other originations occurring during the modeling bucket.

---



---

**Note:** Here, Target Average formula is a general use statement that helps users to understand how Target Average Balance calculations are made and to validate output. Given the complexities of formula inputs, external detail calculation results may vary.

When you are using Target Average, it is recommend that only Target Average Balance is reported as other financial elements may fluctuate widely to achieve average targets from period to period.

---



---

## Target Growth Percent

Use the Target Growth Percent method to define the expected percentage change in the balance over each modeling bucket, expressed as a percent of the bucket's initial balance. Target Growth can be used to model flat balance sheet by assuming a growth rate of 0%. This method can be set at the node level and inherited to leaf level,\* making setup and maintenance efficient. The method does work on products that have no current business and will return 0 (zero) new business, but it is highly advised that you align the forecast balances to products that do have current business, so as not to cause unnecessary processing time. There is no restriction in the number of product/ccy combinations that OFSAA can process. However, the duration of the process will increase depending on the number of product/ccy combinations.

Note: This is the only forecast balance method that allows inheritance.

The new origination amount and the timing of origination are determined during processing, as described below:

### New Origination Amount

The new origination amount per bucket is calculated as:

(Beginning Balance \* Target Growth Percent + Total runoff – Transaction Strategy Originations - Current Position Originations) for bucket end option, and,

(Beginning Balance \* Target Growth Percent + Total Runoff - Transaction Strategy Originations - Current Position Originations) for distributed option

## **New Business Timing**

For the Target Growth method, you can choose either the At Bucket End timing option or the Distributed Originations timing option.

**At Bucket End:** The new origination amount is added on the final date in the bucket. Interest starts accruing on the next day, the first date of the next bucket.

**Distributed:** The new origination amount is added on the calculated date(s) which allow the average balance to equal the beginning balance plus the ending balance divided by two. This calculation accounts for timing of runoff and other originations occurring during the modeling bucket.

## **New Add Balance**

The New Add Balance method defines the absolute amount of new business that is added within a bucket. The new origination amount and the timing of origination are determined during processing, as described below:

### **New Origination Amount**

The new origination amount is equal to the user-input new add balance.

## **New Business Timing**

For the New Add method, you can choose either the At Bucket End timing option or the Distributed Originations timing option.

**At Bucket End:** The new origination amount is added on the final date in the bucket. Interest starts accruing on the next day, the first date of the next bucket.

**Distributed:** The new origination amount is added at the mid-point of the modeling bucket. If the modeling bucket contains an uneven number of days, the origination is apportioned evenly over the two days in the middle of the bucket.

## **Rollover**

Use the Rollover method to base the amount of new business on the rollover (reinvestment of principal on a given or like products) of existing business. You can roll any combination of prepayments, maturing balances, and principal runoff from a product into itself or into another product. For multiple currency processing, rollover processing occurs within each individual currency. Rollover cannot occur between two currencies. The new origination amount into a particular target leaf member and the timing of that origination are described below.

### **New Origination Amount**

For a single target leaf member within a single currency, the new origination amount depends on the rollover sources, which are product leaves of the same currency whose runoff drives the amount of new business generated into the target leaf member. For each rollover source, you must also define the components of principal runoff you would like to roll over. Your choices are:

**Total:** Total runoff includes runoff from all three categories of run-off: scheduled principal payments, prepayments, and maturing balances.

**Prepay:** Prepay includes runoff from prepayments, early repayment of principal balances.

**Maturity:** Maturity incorporates payment of principal on the maturity date, above that incorporated in the scheduled principal payment. Balloon payments and final principal repayment of non-amortizing instruments are included in this category.

**Payment:** Payment runoff includes scheduled principal payment on an amortizing instrument.

For each combination of source leaf and runoff type, you can input a different rollover percent. The new origination amount within a modeling bucket equals the runoff amounts multiplied by the percentage rollover for all source leaves.

## Timing of Rollover

All runoff from sources are added as new business into the target leaf with the proper currency at the average time of runoff.

The average time of runoff is calculated by taking an average of the runoff date weighted by the amount of runoff for all instruments which make principal payments during the modeling bucket.

---



---

**Note:** Rollover of runoff components, prepayment, payment, or maturity requires that those components exist in the output data set. In a Dynamic Deterministic Process rule, you must select those financial elements from the Calculation Elements block. Otherwise, no new business is generated from those runoff components.

---



---

## Rollover with New Add

Use the Rollover with New Add method to apply both rollover assumptions and new add assumptions to a single product within a single currency. It allows new business to be driven by reinvestment of existing accounts plus an expectation of new business amounts. The New Add method and the rollover method are applied independently, with the New Add applied first.

## Rollover with Growth Percent

Use the Rollover with Growth Percent method to apply both rollover assumptions and an overall Growth Percent assumption to a single product within a single currency. It allows new business to be driven by reinvestment of existing accounts plus an expectation around growth percentage. Growth Percent defined in Target Growth, determines overall growth of product, including rollovers.

Rollover assumption is applied first and is calculated independently on Runoff type selected in rule. To determine Rollover Runoff, refer to section [Rollover](#). New business via Target Growth is calculated thereafter, and is calculated as

(Beginning Balance \* Target Growth Percent + Total runoff - Transaction Strategy Originations - Current Position Originations - Rollover New Business).

For more information on Target Growth, refer to section [Target Growth Percent](#).

## Account Types and New Business

The availability of a new business method depends on the account type of the product leaf member. The account type of a product leaf comes from its associated Common COA attribute. Setup requirements for each of the account types are described below:

**Interest Bearing Accounts:** All forecasting methods are available. The following account types are classified as interest bearing:

- Earning asset
- Interest bearing liability
- Off balance sheet receivable
- Off balance sheet payable

**Income Statement Accounts:** The only method available is New Add. For these accounts, input the desired income statement value for each bucket. The following account types are classified as income statement:

- Non-interest income
- Non-interest expense
- Interest income
- Interest expense

**Balance Sheet Accounts:** The only method available is New Add. For balance sheet accounts, the input amount is interpreted as a balance. The following account types are classified as balance sheet:

- Other asset
- Other liability
- Equity

## Rate-Volume Modeling

Customer demand for new products often depends on interest rates (either the absolute level of interest rates or the spread between two rate indices) or other variables such as macro-economic drivers. You can model this behavior by selecting a rate-volume assumption. Once you have selected the rate-volume assumption, you must incorporate additional parameters through selection of a Rate Dependency Pattern, which control how interest rates or economic variables affect new business levels.

### Rate-Volume Assumptions

There are four rate-volume options to choose from:

#### No Relationship

If you want new business amounts to stay constant regardless to the interest rate environments, select this option.

#### Rate-Level Dependent

The Rate-Level dependent relationship allows you to change new business behavior for different values of a single indicator interest rate. The indicator interest rate, referred to as the Base Interest Rate, is defined by an Interest Rate Code, a term selection, and a rate lag.

**Interest Rate Code:** The Interest Rate Code identifies the reference yield curve or rate index whose forecasted value determines the new business amount. You can select the Interest Rate Code from all available interest rate codes for the selected currency, as defined within Rate Management. The list of Interest Rate Codes includes only codes with a reference currency equivalent to the currency selected in the Floating Tree Bar.

**Term Selection:** If the selected Interest Rate Code is a yield curve, you must also select a term. Your term choices depend on the definition of the Interest Rate Code within Rate Management. Note that the selection automatically defaults to the shortest available term.

**Rate Lag:** If you want the base interest rate calculation to perform a look back function, you can input a rate lag. The new business assumption lookup uses the forecasted interest rates as of a date within the current modeling bucket less the rate lag.

If the timing of new business is End of Bucket, the lookup function uses the last day of the modeling bucket less the rate lag. For all other cases, the mid-point of the bucket less the rate lag is used.

### **Rate-Spread Dependent**

With the Rate-Spread dependent relationship, you can input new business assumptions for different spreads between two indicator interest rates, or a spread between two term points on the same yield curve. You define the first indicator interest rate, the Base Interest Rate, as described previously. The second indicator interest rate, the Alternate Interest Rate, also requires definition of an Interest Rate Code, a term selection, and a rate lag.

The rate spread equals the Alternate Interest Rate minus the Base Interest Rate.

### **Economic Indicator Dependent**

With the Economic Indicator Dependent relationship, you can input new business assumptions related to defined economic indices (as defined in [OFSAA Rate Management](#)), where the change in the index will drive a different outcome of new business. For example, you can forecast a higher GDP and tie the new business assumptions to that particular forecast.

### **Rate Tiers**

The Rate Tiers tab will become available to edit when one of the following three rate volume relationships have been selected (Rate Level, Rate Spread, and Economic Indicator). Once you have selected a rate-volume relationship and defined your base and alternate interest rates, you must define rate tiers. Rate tiers provide the lookup values for which different new business assumptions can be input.

### **Lookup Method**

The lookup method determines which new business assumption is selected from the input values when the forecasted interest rate falls between two rate tiers.

There are two methods to choose from:

**Interpolate:** If you select Interpolate, the new business assumption is an interpolated value, using straight line interpolation, calculated from the assumptions associated with the two nearest interest rate tiers. The interpolation uses a simple straight line interpolation formula.

**Range:** If you select Range, Oracle ALM selects the new business assumption as the closest assumption associated with the rate tier which is less than or equal to the forecasted interest rate.

## **Creating a Forecast Balance Rule**

To create a new Forecast Balance rule, complete the following steps:

1. Click the Add New button on the Forecast Balances tool bar to add a new rule. A new screen will appear as follows:

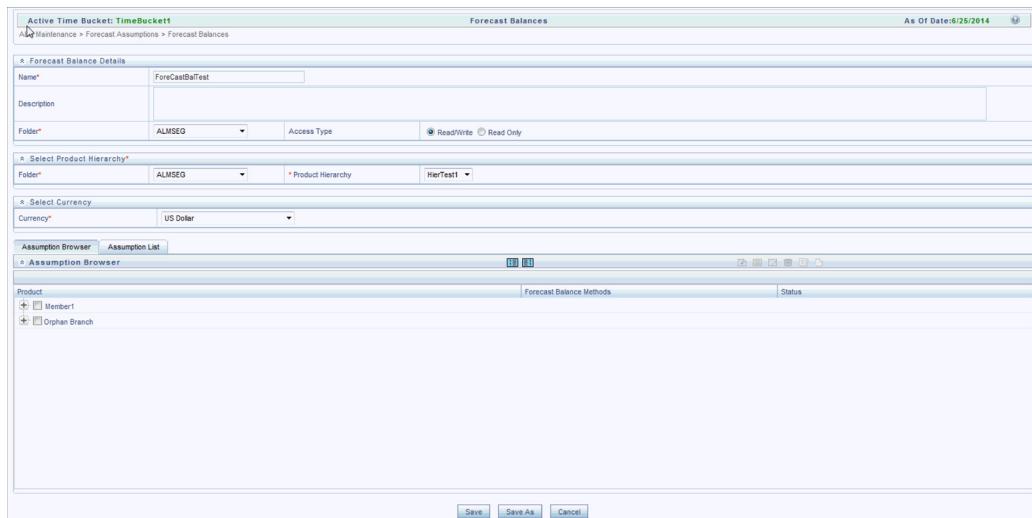

2. Type a descriptive name for the rule.
3. Type a description (optional).
4. Select a folder.
5. Select Product Hierarchy folder.
6. Select Product Hierarchy
7. Select Currency
8. Drill down to desired leaf level node(s) in the Assumption Browser
9. Click Save

When saved, go back to edit the Forecast Balance rule just created. Check the box next to the description and click the edit icon.

The Forecast Balance rule dialog opens on the Method tab. The other tabs (Rate Tiers, New Volume detail, Roll-over Set up and Detail) are dependent upon method chosen and the rate volume relationship. You must begin the assumption setup on the Method Tab and work your way through the remaining tabs, as needed. To input new assumptions for a particular product leaf and currency, follow the steps detailed under each Tab heading, described next:

### Method Tab

The Method Page is used to define the Forecast Balance method per product leaf and currency. On this page you define the New Business method, the timing option, and the type of rate-volume relationship. An example of the Method page appears as shown in the following screenshot:

Follow the steps listed below to complete this information.

1. Select a product leaf from the drop-down list under the Product and Currency Details Header (in this case, Commercial Loans fixed).
2. Select your preferred New Business Method. If you select Target End, Target Growth, New Add, or any combined rollover option, note that the Timing selection is enabled.
3. Select your preferred Timing option (with Target End, Target Growth, New Add, Rollover with Growth % and Rollover with New Add only).
4. Select the type of Rate-Volume Relationship you want to model. If the relationship is Rate Spread, Rate Level, or Economic Indicator, the Rate Tiers tab is enabled. In this case, refer to following steps listed for Rate Tiers tab.

### Rate Tiers Tab

On the Rate Tiers tab the Rate Dependency Pattern drop-down list appears. Select the desired name you defined in the Rate Dependency Patterns user interface. If you have selected No Relationship on the Method Page, this page is not accessible. An example of the Rate Tiers tab appears as shown in the following screenshot:

You can see the defaulted values for the Base Rate and the Rate Tier Bars appear as input in, when the pattern was defined.

### New Volume Detail Tab

The New Volume Detail Page is used to input new volume assumptions for the methods:

- New Add
- Target End
- Target Average
- Target Growth
- New Add component of the Rollover with New Add method
- Growth % component of the Rollover with Growth % method

On this page you select the range of modeling buckets and input balance or percentage assumptions for each modeling bucket within this bucket range. An example of the New Volume Detail page appears as shown in the following screenshot:

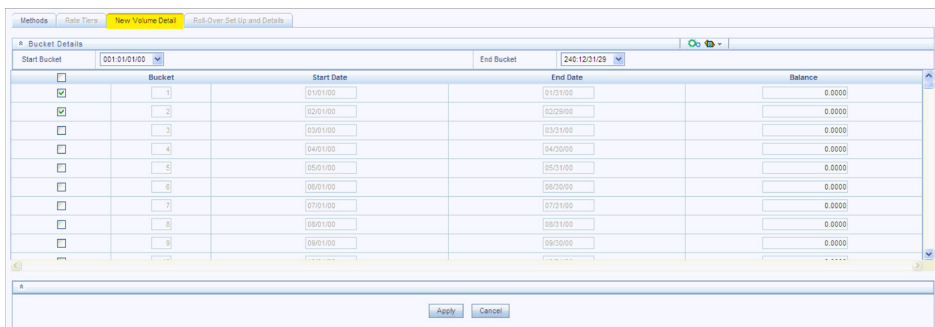

1. Select the New Volume Detail tab.
2. Select the modeling bucket start and end range. The default Bucket Range includes all modeling buckets. To forecast new business in a subset of the modeling horizon, reduce the bucket range by increasing the bucket start date or decreasing the bucket end date. As you change the bucket start and/or the bucket end, the view adjusts accordingly to display only buckets within the selected range.
3. Go to the cell corresponding to the first modeling bucket. If rate-volume relationships are used, this cell also corresponds to the first rate tier. Input the targeted value. For New Add, Target End, and Target average, input an amount. For Target Growth, input a percent. The percent should represent the percentage growth within the modeling bucket. It should not represent an annualized amount.
4. You can also use the Excel import/export feature to add the New Volume Detail information.

### Rollover Setup and Details Tab

In the Rollover Setup and Details tab, first input the setup details necessary for definition of rollover percentages (source product leaves and bucket ranges), second, input rollover percentages. The rollover percentages represent the percent of the runoff amount from the source (leaf and runoff type for the selected currency) which generates new business into the target leaf for the selected currency. An example of the Rollover Setup and Details tab appears as shown in the following screenshot:



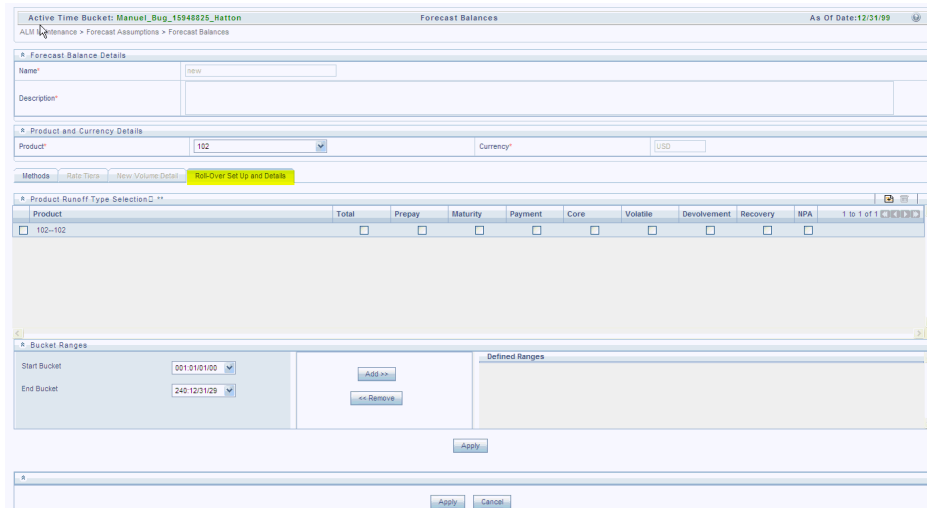

1. Click the Rollover Setup and Details tab to display the page.
2. Click the Add New button to select the Product Runoff Type Selection.
3. The Hierarchy page will appear. Select the product leaf members for the rollover and click Ok.

**Note:** If using the search icon on this screen, when results appear, you need to highlight the specific leaf member and click the focus icon. The check box will appear next to the leaf members. Check the box for inclusion.

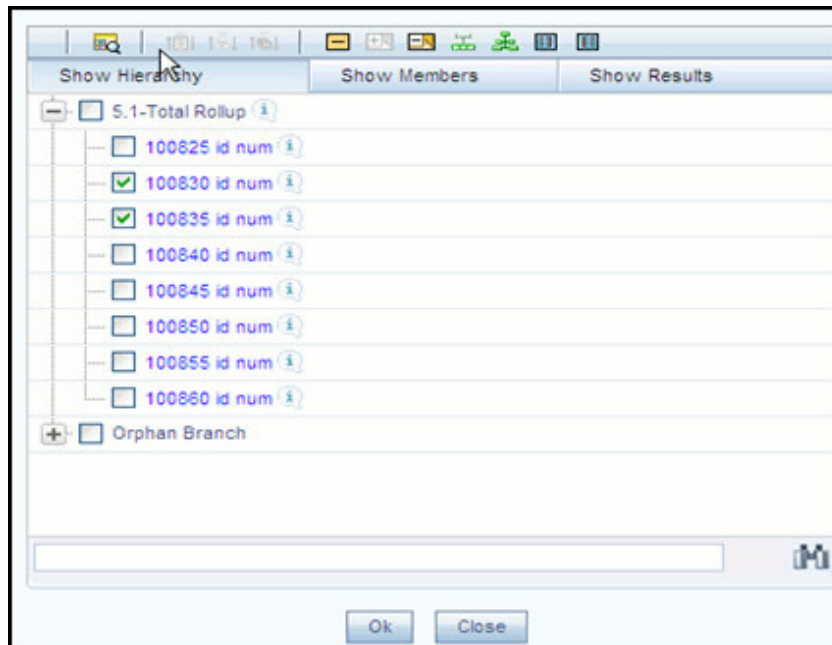

4. The selected products will appear below the Product Runoff selection bar.

5. Choose the desired runoff type (Total, Prepay, Maturity, Payment, Core, Volatile, Devolvement, Recovery, or NPA).
6. Define the input bucket ranges. You only need to define multiple bucket ranges if you want to vary rollover assumptions by modeling buckets. The bucket ranges defined here only apply to rollover occurring from the source leaf to the target leaf. You must have at least one bucket range defined. Typically, you define a bucket range from the first modeling bucket to the last modeling bucket, covering the entire modeling horizon. To define a bucket range, complete the following steps:
  - Select a start bucket date for the first date range.
  - Select an end bucket date for the first date range.
  - Select Add to add a bucket range which begins on the first date of the start bucket and ends on the last date of the end bucket.
  - Select a new start date for the next date range. You can select from any buckets that are not encompassed by a defined bucket range. Modeling buckets which are a part of an existing bucket range do not appear in this list.
  - Select an end date for the next date range. You cannot create overlapping modeling buckets. To prevent this, the list of available bucket end dates only includes modeling buckets which follow consecutively from the selected start bucket.
  - Continue adding bucket ranges until all desired ranges have been defined.
  - Once all desired products and bucket ranges have been selected and defined, click Apply.
7. The Rollover Bucket Range Details form will appear at the bottom. To define the details for the above prescribed bucket ranges, do the following:
  - Select a bucket from the drop-down list of defined bucket ranges.

---

---

**Note:** The defaulted values for runoff type are populated.

---

---

- Enter the percentage rollover for the given products.
- You can also use the Excel import/export feature to add the Rollover Bucket Range Detail information.
- Click Apply at the bottom of the screen when complete.

## Editing the Defined Forecast Balance

You can modify or edit an existing forecast balance by opening it, making the changes and then saving it as either a:

- Different Method with a new name, or
- The same forecast balance name

### Naming Convention

Generally, it is best to use a naming convention that creates different groups of forecast balances. This keeps track of which methods were created, in the context of specific modeling buckets.

### The Active Time Bucket Rules

Assumptions that you define when creating a forecast balance are based on a specific modeling horizon, which is defined in the Time Buckets section.

- If you define a forecast balance based on a Time Bucket with a monthly modeling horizon, your results are calculated in monthly time periods.
- If you redefine that same forecast balance, using a different time bucket with a weekly modeling horizon, your results are calculated in weekly time periods.

If assumptions in your Forecast Balance are based on a modeling horizon that is different from the horizon defined in the active time bucket, inaccurate data will result. You should verify that date-sensitive rules are consistent with the active Time Bucket.

### Defining Forecast Balances Using Node Level Assumptions

Node Level Assumptions allow you to define assumptions at any level of the Product dimension Hierarchy. The Product dimension supports a hierarchical representation of your chart of accounts, so you can take advantage of the parent-child relationships defined for the various nodes of your product hierarchies while defining rules. Children of parent nodes on a hierarchy automatically inherit the assumptions defined for the parent nodes. However, assumptions directly defined for a child take precedence over those at the parent level.

---

---

**Note:** The only method supported for inheritance is Target Growth.

---

---

## Examples of Forecast Balance Assumptions

Below are two examples describing how to input assumptions into the Forecast Balance for a product using the target growth method and a product using the rollover capabilities.

### Target Growth Example

The following example describes how to model the effect of interest rate changes on growth in a loan product. We will input values that cause the growth rate of loans to decrease as interest rates increase.

1. Create a new Forecast Balance rule.
2. Select US dollars in the Currency Selection.
3. Select the desired product leaf from the product list.
4. Click the Add New button to add new forecast balance rules.
5. Select Target Growth as the New Business method.
6. Select Distributed as the Timing option.
7. Select Rate-level dependent as the Rate-Volume relationship. The completed Method information should appear as shown in the following example:

8. Click the Rate Tiers Tab.
9. Select a Rate Dependency Pattern from the drop-down list.

10. Click the New Volume Detail Tab. The two lookup methods for 1% and 4% will appear in the columns, next to each bucket. Enter 8% growth for a 1% 3 year rate environment, and 2% growth for a 4% 3 year rate environment.

Bucket	Start Date	End Date	Balance
1	01/01/00	01/01/00	0.0000
2	02/01/00	02/01/00	0.0000
3	03/01/00	03/01/00	0.0000
4	04/01/00	04/01/00	0.0000
5	05/01/00	05/01/00	0.0000
6	06/01/00	06/01/00	0.0000
7	07/01/00	07/01/00	0.0000
8	08/01/00	08/01/00	0.0000
9	09/01/00	09/01/00	0.0000

**Rate Sensitive Rollover Example**

This example shows how to input rollover behavior for a product where as the yield curve steepens, holders of shorter term products increasingly choose to roll into another longer term product (for example, CD investors).

1. Create a new Forecast Balance rule.
2. Select US dollars in the Currency Selection.
3. Select the desired product leaf from the product list.
4. Click the Add New button to add new forecast balance rules.
5. Select the New Business method Rollover.
6. Define the Rate-Volume relationship as Rate-Spread Dependent.

7. Click the Rate Tiers Tab.
8. Select the desired rate dependency pattern.

**Note:** The Base Rate, Alternate Rate, and Rate Tier are populated with the definitions as defined in the Rate Dependency Pattern rule.

9. Click the Rollover Setup and details tab.
10. Click the Add New button to add desired products in Product Runoff Type Selection.  
Choose Total, Prepay, Maturity, or Prepayment runoff.
11. Define the bucket range. (In this case the entire bucket range). Click “Add” to create the range.
12. Click Apply. The rollover Bucket Details Bar will appear at the bottom of the page.

- Input the desired rollover for each rate spread scenario. In this case it is the steepening spread between 6 mo and 5 yr Libor curve points.

The screenshot shows the 'Forecast Balances' configuration window. Key elements include:

- Forecast Balance Details:** Fields for Name and Description.
- Product and Currency Details:** Product dropdown set to '102' and Currency dropdown set to 'USD'.
- Methods:** A tabbed interface with 'Roll-Over Set Up and Details' selected.
- Product Runoff Type Selection:** A table with columns: Product, Total, Prepay, Maturity, Payment, Core, Volatile, Devolvement, Recovery, NPA. A row for '102-102' is visible with checkboxes for each column.
- Bucket Ranges:** Start Bucket (001.01.0100) and End Bucket (240.12.3109) dropdowns, with 'Add' and 'Remove' buttons. A defined ranges table is empty.
- Buttons:** 'Apply' and 'Cancel' buttons at the bottom.

- Click Apply.

### Processing New Business in a Dynamic ALM Process

To process the assumptions you have input, the Forecast Balance rule must be selected in a Dynamic Deterministic or Dynamic Stochastic ALM Processing Rule. The output process selections defined within the Process rule > Output Preferences block, determine which forecast balance assumptions per currency are used. If processing output is product-only, forecast balance assumptions for the reporting currency are processed. New business assumptions for all other currencies are ignored. If the output is product and currency, forecast balance assumptions for each product and currency combination are processed. See [ALM Processing](#) for more information on processing.

---

---

## Forecast - Pricing Margins

This module describes the procedure for working with and managing Pricing Margin rules.

This chapter covers the following topics:

- [Overview of Pricing Margin Rules](#)
- [Creating Pricing Margin Rules](#)
- [Defining Pricing Margin Rules](#)
- [Defining a Pricing Margin Rule: An Example](#)

### Overview of Pricing Margin Rules

Pricing Margin rules allow users to define pricing margins (or spreads) for your products. Pricing margins are defined period by period based on your active Time Bucket definition, for each product and, potentially, each currency. Pricing margins work together with an underlying base interest rate curve to determine note rate pricing for new business volumes defined through Forecast Balance rules. New business assumptions are defined based on the combined inputs from the following four forecast related business rules:

- [Product Characteristics](#)
- [Forecast Balance Rules](#)
- [Forecast - Pricing Margins](#)
- [Forecast – Maturity Mix](#)

When you require more complex definitions of pricing margins to model unique account pricing details, user-defined repricing patterns can be used. For more information, refer to [User Defined Repricing Patterns](#)

The procedure for working with and managing Pricing Margin rules is similar to that of other Oracle Asset Liability Management business rules. It includes the following steps:

- Searching for Pricing Margin rules. For more information, refer to [Searching for Rules](#) section.
- Creating Pricing Margin Rules. For more information, refer to [Creating Rules](#) section.
- Viewing and Editing Pricing Margin rules. For more information, refer to [Viewing and Editing Rules](#) section.

- Copying Pricing Margin rules. For more information, refer to [Copying Rules](#) section.
- Deleting Pricing Margin rules. For more information, refer to [Deleting Rules](#) section.

As part of creating and editing Pricing Margin rules, you assign Pricing Margins to applicable products. Refer to [Defining Pricing Margin Rules](#)

## Creating Pricing Margin Rules

You create Pricing Margin rules to assign pricing margins (or spreads) to be used in pricing new volumes defined through Forecast Balances business rules.

1. Navigate to the Pricing Margins rule summary page.
2. Complete standard steps for this procedure.

---

**Note:** In addition to the standard steps for creating rules, the procedure for creating a Pricing Margins rule involves one extra step. After Standard Step 6, you need to select a product hierarchy. You can define methodologies at any level of the hierarchical product dimension. The hierarchical relationship between nodes allows inheritance of methodologies from parent nodes to child nodes.

Oracle Asset Liability Management provides you with the option to copy, in total or selectively, the product assumptions contained within ALM business rules from one currency to another currency or a set of currencies or from one product to another product or a set of products.

---



## Defining Pricing Margin Rules

The definition of a Pricing Margins rule is part of the Create or Edit Pricing Margins rule process. When you click Save in the Create Pricing Margins rule process, the rule is saved and the Pricing Margins rule summary page is displayed. However, Pricing Margin assumptions have not yet been defined for any of your products at this point. Typically, you would start defining your Pricing Margin assumptions for product-currency combinations before clicking Save.

### Defining Pricing Margins Using Node Level Assumptions

Node Level Assumptions allow you to define assumptions at any level of the Product dimension Hierarchy. The Product dimension supports a hierarchical representation of your chart of accounts, so you can take advantage of the parent-child relationships defined for the various nodes of your product hierarchies while defining rules. Children of parent nodes on a hierarchy automatically inherit the assumptions defined for the parent nodes. However, assumptions directly defined for a child take precedence over those at the parent level.

### Prerequisites

Performing basic steps for creating or editing a Pricing Margins rule

### Procedure

Defining Pricing Margins has two primary steps:

1. Choosing your rate dependency option
2. Inputting Pricing Margin details for the selected products

---

---

**Note:** Using the default currency to setup assumptions can save data input time. At run time, the calculation engine uses assumptions explicitly defined for a product currency combination. If assumptions are not defined for a currency, the engine uses the assumptions defined for the product and the default currency. If the assumptions are the same across some or all currencies for a specific product, you can input assumptions for the default currency. Be careful using this option on screens where an Interest Rate Code is a required input.

---

---

## Rate Dependency Selection screen

### Rate Dependency Relationships

There are four rate dependency options to choose from:

- No Relationship
- Rate Level Dependent
- Rate Spread Dependent
- Economic Indicator Dependent

### Rate Dependency Patterns

If one of the Rate Dependency options, other than No Relationship, is selected, the Rate Dependency Pattern drop list becomes active. The list of available patterns is limited to those which apply to the selected Rate Dependency Relationship type.

### The Pricing Margin Details screen

In an income simulation scenario, you may want to price new business for an account at a margin above or below a market interest rate code. For example, you can model a premium paid on CDs in relation to a market yield curve by adding a pricing margin to the interest rate code assigned to the product in the Product Characteristics rule. If you want a rate that is 25 bps above the market yield curve, you will type "0.25" as the pricing margin for the appropriate modeling period.

The Pricing Margin rule uses the modeling period defined in the "active" Time Bucket rule. You should always verify that your modeling horizon and related assumptions are consistent with the As of Date and active Time Bucket rule before processing.

The screenshot displays the 'Pricing Margins' configuration page. At the top, it shows 'Active Time Buckets: 60 M 1M each' and 'ALM Maintenance > Forecast Assumptions > Pricing Margins'. The 'Pricing Margins Details' section includes a name 'Pricing Margin 1' and a description. The 'Product and Currency Details' section shows 'Personal Loans' as the product and 'US Dollar' as the currency. The 'Rate Dependency Relationships' section is set to 'Pricing Margins'. The 'Select Rate Tiers' section has a dropdown menu. The 'Margin Type' section has radio buttons for 'Rate' and 'Percent'. The 'Date Buckets/Margins' table is the central focus, with a red box around the 'Bucket Number' column. The table has columns for 'Date Buckets/Margins', 'Bucket Number', 'Start Date', 'End Date', 'Net Margin', and 'Gross Margin'. The 'Apply Defined Buckets to all Rate Tiers' checkbox is checked. At the bottom, there are 'Apply' and 'Cancel' buttons.

Date Buckets/Margins	Bucket Number	Start Date	End Date	Net Margin	Gross Margin
<input type="checkbox"/>	1	04/01/2017	05/30/2017	0.000000	0.000000
<input type="checkbox"/>	7	10/01/2017	03/31/2018	0.000000	0.000000
<input type="checkbox"/>	15	04/01/2018	06/30/2018	0.000000	0.000000
<input type="checkbox"/>	16	07/01/2018	08/31/2018	0.000000	0.000000
<input type="checkbox"/>	18	08/01/2018	02/28/2019	0.000000	0.000000
<input type="checkbox"/>	24	03/01/2019	03/31/2022	0.000000	0.000000

## Rate Tiers

Rate Tiers reflect the Rate Dependency Pattern details from the selected Rate Dependency Pattern. You define Pricing Margin assumptions for each rate tier. The application will automatically determine which set of assumptions to apply for a given scenario based on the relationship between the Rate Tier and the related Forecast Rate assumption value.

## Margin Type

This option allows you to enter the Margin as Rate (fixed rate) or Percent (percentage of forecast Rate). By default, it is set to Rate.

- If Margin Type is selected as Rate, provided Margin is used as a fixed spread.
- If Margin Type is selected as Percent, Margin needs to be provided as Percentage of forecast rate. If margin is 10% of forecast rate, 10 needs to be provided. Margin is calculated as:

$$\text{Margin} = \text{Margin \%} * \text{Raw Rate}$$

For more information, refer to *Cash Flow Reference Guide* on [OTN](#).

Once you change from Rate to Percent, all unsaved margin data will be deleted.

An warning message is displayed: *All entered value will be lost. Do you want to proceed?*

## Bucket Number

The bucket number input allows you to select a range of buckets over which the pricing margin assumption will apply. Start Date and End Date values are updated automatically based on the Bucket Number input for each row.

## Start Date and End Date

When the Pricing Margins detail page opens, the Start Date (min value) and End Date (max value) columns are automatically populated and are read-only values. The date ranges represent the Income Simulation Date buckets as defined in the "active" Time Bucket rule. See [Time Buckets](#) for more information. Any new business originated within these dates is modeled using the pricing margins defined in the Pricing Margin rule. New business added for each date bucket will have the same net and gross

margin for its life. The margins for a particular instrument will not change as the instrument ages.

### Gross Margin

The Gross Margin you define is added to the Interest Rate Code specified in the Product Characteristics rule to define the gross rate on new business.

### Net Margin

The Net Rate is affected by setting the Net Margin Flag in the Product Characteristics rule. If Net Margin Flag is set to Floating Net Rate, then Net Rate is equal to the Interest Rate Code plus Net Margin.

If the Net Margin Flag is set to Fixed Net Rate, then Net Rate is equal to Net Margin.

---

---

**Note:** If Margin Type is selected as Percent and Net Margin Flag is set to Fixed Net Rate, provided Margin as Percent is treated as Rate.

---

---

Apply Defined Buckets to all Rate Tiers

This option allows you to copy the bucket setup from one page to all other Rate Tiers when using Rate Dependent assumptions.

## Defining a Pricing Margin Rule: An Example

Define a Pricing Margin Rule using a Rate Dependency Pattern.

1. From the Assumption Browser, select Currency (US Dollar) and a product from the hierarchy browser.

The screenshot displays the 'Pricing Margins' configuration page in the Oracle Financial Services Asset Liability Management (OFSALM) user interface. The page title is 'Active Time Bucket: TimeBucket' and 'Pricing Margins', with a date of 'As Of Date: 6/25/2014'. The 'Pricing Margins Details' section includes fields for Name (copyRMTTestCopy), Description (testing), Folder (ALMSEG), and Access Type (Read/Write, Read Only). The 'Select Product Hierarchy' section shows Folder (ALMSEG), Product Hierarchy, and HierTest. The 'Select Currency' section shows Default Currency. Below these are sections for 'Assumption Browser' and 'Assumption List'. The 'Assumption Browser' section shows a tree view with 'Product' and 'Status' columns, and a list of 'Member1' and 'Orphan Branch'.

2. Select the “Add New” icon to enter the Assumption Details page.
3. Select the Rate Level Dependent – Rate Dependency option.

4. Select the Rate Level – Rate Dependency Pattern from the drop list.
5. Select Apply to navigate to the Pricing Margin Tab where you can define assumptions for each rate tier.
6. Add bucket ranges to the page as needed. Optionally, select the “Apply Defined Buckets to All Rate Tiers” checkbox to copy the bucket structure across all rate tier pages.

Bucket Number	Start Date	End Date	Net Margin	Gross Margin
1	04/01/2017	09/30/2017	0.000000	0.000000
7	10/01/2017	03/31/2018	0.000000	0.000000
13	04/01/2018	06/30/2018	0.000000	0.000000
16	07/01/2018	08/31/2018	0.000000	0.000000
18	09/01/2018	02/28/2019	0.000000	0.000000
24	03/01/2019	03/31/2022	0.000000	0.000000

7. Input Rate Spreads for each bucket range that you define.

**Note:** You may want to utilize the Data Input Helper to copy an assumption from a row where you have already defined a value or apply a fixed amount down the page. The following optional steps describe how to use this feature.

1. Select the checkboxes next to the rows that you want to work with or use the “Select ALL” option by selecting the checkbox on the header row.
2. Select the Data Input Helper icon.
3. From the Data Input Helper – popup screen, select Method – “Keep Current Values” or some other appropriate method.
4. Select the Frequency and/or Multiplier from the left side of the shuttle box.
5. Select APPLY to copy assumptions to the selected rows.
8. You can also use the Excel import/export feature to add the Date Buckets/Margins information in the Pricing Margins tab.
9. Select Apply to commit your assumptions for each Rate Tier. Repeat the process for each rate tier. After you have defined assumptions for all Rate Tiers, you will return automatically to the Assumption Browser page.

---

---

**Note:** You can select more than one product at a time from the Assumption Browser page.

---

---

10. When Pricing Margin assumptions are defined for all required product / currency combinations, select SAVE from the Assumption Browser page.

---

---

## Forecast – Maturity Mix

This module describes the procedure for working with and managing Maturity Mix rules.

This chapter covers the following topics:

- [Overview of Maturity Mix Rules](#)
- [Creating Maturity Mix Rules](#)
- [Defining Maturity Mix Rules](#)

### Overview of Maturity Mix Rules

Maturity Mix rules allow you to define the term distribution of new business added during each forecast period. Maturity Mix assumptions are set at the product and currency levels. For new volumes generated during a simulation run, you will define the maturity and amortization terms applied to the balances originated in each period, as well as specify a maturity distribution for the volumes originated. For example, mortgage originations may be divided into 25% - 5 Year Term / 30 Year Amortization, 25% - 7 Year Term / 30 Year Amortization, and 50% - 30 Year Term / 30 Year Amortization. You attach the set of maturity assumptions to apply to all new volumes within a Dynamic ALM Process by selecting the appropriate Maturity Mix rule.

New business assumptions are defined based on the combined inputs from the following 4 forecast related business rules:

- [Product Characteristics](#)
- [Forecast Balance Rules](#)
- [Forecast - Pricing Margins](#)
- [Forecast – Maturity Mix](#)

The procedure for working with and managing Maturity Mix rules is similar to that of other Oracle Asset Liability Management business rules. It includes the following steps:

- Searching for Maturity Mix rules. For more information, refer to [Searching for Rules](#) section.

- Creating Maturity Mix Rules. For more information, refer to [Creating Rules](#) section.
- Viewing and Editing Maturity Mix rules. For more information, refer to [Viewing and Editing Rules](#) section.
- Copying Maturity Mix rules. For more information, refer to [Copying Rules](#) section.
- Deleting Maturity Mix rules. For more information, refer to [Deleting Rules](#) section.

As part of creating and editing Maturity Mix rules, you define Maturity Mix assumptions for applicable products. See: [Defining Maturity Mix Rules](#)

## Creating Maturity Mix Rules

You create Maturity Mix rules to define the maturity and amortization term for new business volumes. Maturity Mix rules use the modeling period defined in the active Time Bucket rule to establish the date range over which these assumptions can be defined.

### Procedure

1. Navigate to the Maturity Mix rule summary page.
2. Complete standard steps for this procedure.

The screenshot displays the 'Maturity Mix' configuration page in the OFSALM system. The page is titled 'Active Time Bucket: TimeBucket1' and 'Maturity Mix' with a date of 'As Of Date: 6/26/2014'. The main content area is divided into several sections:

- Maturity Mix Details:** Includes fields for 'Name' (MatMixTestCopy), 'Description', 'Folder' (ALMSEG), and 'Access Type' (Read/Write and Read Only).
- Select Product Hierarchy:** Includes fields for 'Folder' (ALMSEG), 'Product Hierarchy' (HierTest1), and 'Currency' (Default Currency).
- Assumption Browser:** A table with columns for 'Product' and 'Status'. The table contains two rows: 'Member1' and 'Orphan Branch', both with checkboxes.

At the bottom of the page, there are three buttons: 'Save', 'Save As', and 'Cancel'.



---

---

**Note:** In addition to the standard steps for creating rules, the procedure for creating a Maturity Mix rule involves one extra step. After Standard Step 6, you need to select a product hierarchy. You can define methodologies at any level of the hierarchical product dimension. The hierarchical relationship between nodes allows inheritance of methodologies from parent nodes to child nodes.

Oracle Asset Liability Management provides you with the option to copy, in total or selectively, the product assumptions contained within ALM business rules from one currency to another currency or a set of currencies or from one product to another product or a set of products.

---

---

## Defining Maturity Mix Rules

The definition of a Maturity Mix rule is part of the Create or Edit Maturity Mix rule process. When you click Save in the Create Maturity Mix rule process, the rule is saved and the Maturity Mix rule summary page is displayed. However, Maturity Mix assumptions have not yet been defined for any of your products at this point. Typically, you would start defining your Maturity Mix assumptions for product-currency combinations before clicking Save.

### Defining Maturity Mix Using Node Level Assumptions

Node Level Assumptions allow you to define assumptions at any level of the Product dimension Hierarchy. The Product dimension supports a hierarchical representation of your chart of accounts, so you can take advantage of the parent-child relationships defined for the various nodes of your product hierarchies while defining rules. Children of parent nodes on a hierarchy automatically inherit the assumptions defined for the parent nodes. However, assumptions directly defined for a child take precedence over those at the parent level.

## Prerequisites

Performing basic steps for creating or editing a Maturity Mix rule

## Procedure

Defining Maturity Mix assumptions involves three primary steps:

1. Choosing your rate dependency option
2. Defining Maturity Mix assumption bucket ranges
3. Inputting Maturity Mix assumption details

**Note:** Using the default currency to setup assumptions can save data input time. At run time, the calculation engine uses assumptions explicitly defined for a product currency combination. If assumptions are not defined for a currency, the engine uses the assumptions defined for the product and the default currency. If the assumptions are the same across some or all currencies for a specific product, you can input assumptions for the default currency. Be careful using this option on screens where an Interest Rate Code is a required input.

### Rate Dependency selection screen

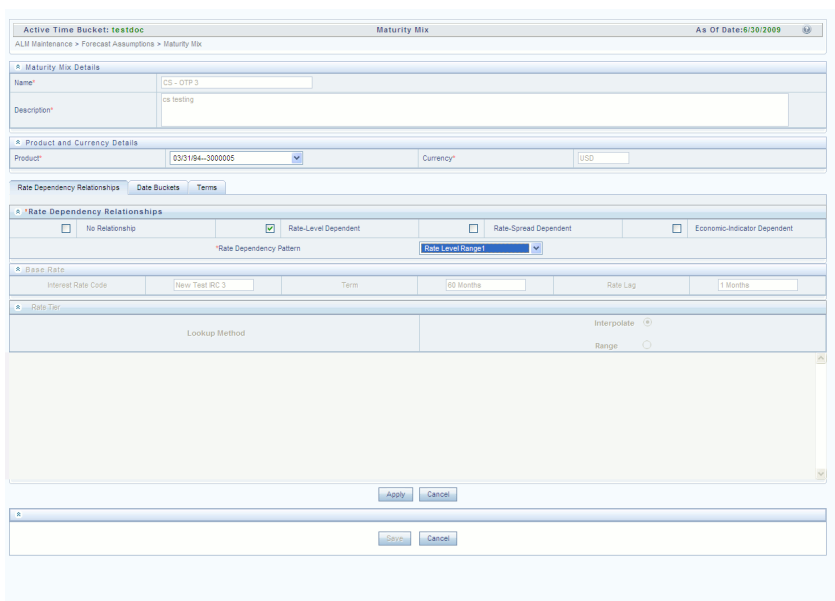

### Rate Dependency Relationships

There are four rate dependency options to choose from:

- No Relationship
- Rate Level Dependent
- Rate Spread Dependent
- Economic Indicator Dependent

### Rate Dependency Patterns

If any one of the Rate Dependency options, other than No Relationship, is selected, the Rate Dependency Pattern drop list becomes active. The list of available patterns is limited to those which apply to the selected Rate Dependency Relationship type.

### Maturity Mix Date Bucket selection screen

Click the Add Row button to select the number of maturity mix date ranges that are required during the forecast period. The Bucket Number column is used to calculate

the start and end dates. The Bucket Number column determines which income simulation bucket is used to calculate these dates.

The Maturity Mix rule uses the modeling period defined in the “active” Time Bucket rule. You should always verify that your modeling horizon and related assumptions are consistent with the As of Date and active Time Bucket rule before processing.

### Rate Tiers

Rate Tiers reflect the Rate Dependency Pattern details from the selected Rate Dependency Pattern. You define Maturity Mix assumptions for each rate tier. The application will automatically determine which set of assumptions to apply for a given scenario based on the relationship between the Rate Tier and the related Forecast Rate assumption value.

### Bucket Number

The bucket number input allows you to select a range of buckets over which the maturity mix assumptions will apply. Start Date and End Date values are updated automatically based on the Bucket Number input for each row.

### Start Date and End Date

When the Maturity Mix detail page opens, the Start Date (min value) and End Date (max value) columns are automatically populated and are read-only values. The date ranges represent the Income Simulation Date buckets as defined in the “active” Time Bucket rule. See [Time Buckets](#) for more information. Any new business originated within these dates is modeled using the Maturity Term(s) defined in the Maturity Mix rule.

**Note:** The Start Date value in the first row is always set equal to the first modeling date, i.e. the as of date plus 1 day, and the End Date value in the last row always equals the last day of the modeling horizon as defined in the “active” Time Bucket rule.

Apply Defined Buckets to all Rate Tiers

This option allows you to copy the bucket setup from one page to all other Rate Tiers when using Rate Dependent assumptions.

## Maturity Mix Details screen

The Maturity Mix details screen allows you to define the maturity mix details. You can assign one or more maturity terms within the details page, but the sum of the percentage weights must equal 100%.

Maturity	Multiplier	Amortization	Multiplier	Percent
5	Years	5	Years	25%
7	Years	7	Years	25%
30	Years	30	Years	50%

Total Percentage: 100 %

Maturity: Maturity (= term)

Multiplier: Maturity multiplier (= days, months, years)

Amortization: The amortization term will default to the maturity term. The amortization term should always be greater than or equal to the maturity term.

Multiplier: Amortization multiplier (= days, months, years)

Percent: The percentage of new business at the specified term and maturity for the associated date bucket.

For each Date Bucket defined, the maturity terms must be specified.

## Defining a Maturity Mix Rule: An Example

1. Define a Maturity Mix rule using a Rate Dependency Pattern.
2. From the Assumption Browser, select Currency (US Dollar) and a product from the hierarchy browser.

3. Select the “Add New” icon to enter the Assumption Details page.
4. Select the Rate Level Dependent – Rate Dependency option.

5. Select the Rate Level – Rate Dependency Pattern from the drop list.
6. Select Apply to navigate to the Date Buckets Tab.
7. Add bucket ranges to the page as needed. Optionally, select the “Apply Defined Buckets to All Rate Tiers” checkbox to copy the bucket structure across all rate tier pages.
8. Select the check box for the first bucket range and select “Define” to navigate to the Terms tab.
9. Add one or more rows based on the number of maturity terms needed for the selected product.

	Maturity*	Multiplier	Amortization	Multiplier	Percent*
<input type="checkbox"/>	5	Years	30	Years	25
<input type="checkbox"/>	7	Years	30	Years	25
<input type="checkbox"/>	30	Years	30	Years	50

Total Percentage : 100

Apply Cancel

10. Input Maturity Terms, Amortization Terms and Percentage Weights for each row and select Apply to save your inputs for the selected bucket range. Notice the status column on the Date Buckets tab turns from Red to Green, indicating that you have successfully defined assumptions for the bucket range.

Select Rate Tier : 4.5

	Bucket Number	Start Date	End Date	Definition Status
<input type="checkbox"/>	1	07/01/2010	03/31/2012	Green
<input checked="" type="checkbox"/>	7	04/01/2012	01/31/2018	Red
<input type="checkbox"/>	14	02/01/2015	12/31/2491	Red

11. Continue to define Maturity Mix assumptions for each Bucket Range.
12. You can also use the Excel import/export feature to add the maturity information in the Terms tab.
13. Select Apply to commit your assumptions for each Rate Tier. Repeat the process for each rate tier. After you have defined assumptions for all Rate Tiers, you will return automatically to the Assumption Browser page.

---

**Note:** You can select more than one product at a time from the Assumption Browser page.

---

14. When Maturity Mix assumptions are defined for all required product / currency combinations, select SAVE from the Assumption Browser page.

---

---

## Transfer Pricing Rules

This module describes the procedure for working with and managing Transfer Pricing rules.

This chapter covers the following topics:

- [Overview of Transfer Pricing Rules](#)
- [Creating Transfer Pricing Rules](#)
- [Defining Transfer Pricing Methodologies](#)
- [Defining the Redemption Curve Methodology](#)

### Overview of Transfer Pricing Rules

Transfer Pricing rules allow you to specify methodologies for transfer pricing your product portfolio. Within ALM, these Transfer Pricing rule assumptions apply to future balances only. If you are trying to Transfer Price instrument balances, Oracle Funds Transfer Pricing is required.

A Transfer Pricing rule may contain a transfer pricing methodology defined for a particular product, or a set of methodologies defined for all products (Dimension Members) in a particular product hierarchy. In addition, it contains certain parameters used in defining option cost methodologies. Refer to [Defining Transfer Pricing Methodologies](#)

The Transfer Pricing rule is a key component of the Transfer Pricing Process. The Transfer Pricing Process, uses the transfer pricing methodologies contained in the Transfer Pricing rules to generate transfer rates. Consequently, before processing information for a new period, you need to review and validate the assumptions contained in your Transfer Pricing rules.

---

---

**Note:** If Transfer Pricing Assumptions are managed at the Parent / Node level, new product dimension members will automatically inherit TP Method assignments.

---

---

If new members are added to the applicable product dimension, you need to update your Transfer Pricing rules by defining appropriate methodologies for the new products.

The procedure for working with and managing the Transfer Pricing rule is similar to that of other Oracle Asset Liability Management assumption rules. It includes the following steps:

- Searching for Transfer Pricing rules. For more information, refer to [Searching for Rules](#) section.
- Creating Transfer Pricing Rules. For more information, refer to [Creating Rules](#) section.
- Viewing and Editing Transfer Pricing rules. For more information, refer to [Viewing and Editing Rules](#) section.
- Copying Transfer Pricing rules. For more information, refer to [Copying Rules](#) section.
- Deleting Transfer Pricing rules. For more information, refer to [Deleting Rules](#) section.

As part of creating and editing Transfer Pricing rules, you can also define transfer pricing methodologies. See:

[Defining Transfer Pricing Methodologies](#)

[Defining the Redemption Curve Methodology](#)

Oracle Asset Liability Management provides you with the option to copy, in total or selectively, the product assumptions contained within the Transfer Pricing, Prepayment and Adjustments rules from one currency to another currency or a set of currencies or from one product to another product or a set of products.

## Creating Transfer Pricing Rules

You create a Transfer Pricing rule to map transfer pricing methodologies for your products.

### Procedure

1. Navigate to the Transfer Pricing rule summary page.
2. Complete standard steps for this procedure. .

---

---

**Note:** In addition to the standard steps for creating rules, the procedure for creating a Transfer Pricing rule involves one extra step. After Standard Step 5, you need to select a product hierarchy. You can define methodologies at any level of the hierarchical product dimension. The hierarchical relationship between the nodes allows inheritance of methodologies from parent nodes to child nodes.

---

---



## Defining Transfer Pricing Methodologies

The assignment of transfer pricing methodologies is part of the Create or Edit Transfer Pricing rules process where assumptions about transfer pricing methodologies are made for product-currency combinations. When you click Save in the Create Transfer Pricing rules process, the rule is saved and the Transfer Pricing rule Summary page is displayed. However, the transfer pricing methodology has not yet been defined for any of your products at this point. Typically, you would start defining your methodologies for product-currency combinations before clicking Save.

The Transfer Pricing rule supports definition of assumptions for combinations of two dimensions: Product and Currency.

You can define transfer pricing methodologies for your entire product portfolio one currency at a time. Suppose your portfolio is comprised of products denominated in two currencies (US Dollar and Japanese Yen) and that you want to specify different transfer pricing assumptions and /or different Transfer Pricing yield curves, for each product group. Using the currency selection drop-down list, you can first define assumptions for the products denominated in US Dollars and then proceed with defining assumptions for the Yen-based products.

Once you have created a Transfer Pricing rule, you can assign transfer pricing methodologies to product-currency combinations in either of the following two ways:

By creating a conditional assumption using conditional logic. See:

- [Associating Conditional Assumptions with Prepayment Rules](#)
- [Defining Prepayments Using Node Level Assumptions](#)

Directly on the Transfer Pricing methodology page, as described here.

### Prerequisites

Performing basic steps for creating or updating a Transfer Pricing rule

### Procedure

This table describes key terms used for this procedure.

Term	Description
Yield Curve Term	Defines the point on the yield curve that the system references to calculate transfer rates.
Historical Range	Specifies the period over which the average is to be taken for the Moving Averages method.
Lag Term	Specifies a yield curve from a date earlier than the Assignment Date for the Spread from Interest Rate Code method.
Rate Spread	The fixed positive or negative spread from an Interest Rate Code or Note Rate, used to generate transfer rates in the Spread from Interest Rate and Spread from Note Rate methods.

Term	Description
Model with Gross Rates	This option allows you to specify whether modeling should be done using the net or gross interest rate on the instrument. This option is only applicable when the Net Margin Code is also set to one, for example, Fixed. Gross rates are typically selected while modeling the effect of serviced portfolios where the underlying assets have been sold but the organization continues to earn servicing revenue based on the original portfolio.
Assignment Date	This is the effective date of the yield curve.
Percentage/Term Points	The term points that the system uses to compute the Redemption Curve method results. A percentage determines the weight assigned to each term point when generating results.

1. Navigate to the Assumption Browser page.
2. Select a Product Hierarchy
3. Select a Currency

---



---

**Note:** The list of currencies available for selection is managed within Rate Management, and reflects the list of "Active" currencies.

Expand the hierarchy and select one or more members (leaf values and/or node values) from the product hierarchy.

---



---

4. Click the Add icon to begin mapping Transfer Pricing methods to the list of selected product dimension members. The system displays a list of all the products (for which you can define assumptions) or currencies (that are active in the system).
5. In the TP Method selector page, Account Table data source is selected by default and disabled.
6. Select the Transfer Pricing method for the selected product member.

---



---

**Tip:** The Transfer Pricing methodologies available depend on the selected data source.

Depending on the transfer pricing method selected, certain required and optional parameter fields are displayed. You can update these fields as required.

---



---

7. Click Apply.

At this point you can:

- Continue defining additional methodologies for other product-currency combinations contained in your selection set, by repeating the above procedure.

- Complete the process by clicking Cancel or by answering to NO to the confirmation alert after applying assumptions for each Product / Currency combination in your select set.
8. From the Assumption Browser page, click Save.
  9. The new assumptions are saved and the Transfer Pricing rule selector page is displayed.

---

**Note:** Oracle Asset Liability Management provides you with the option to copy, in total or selectively, the product assumptions contained within the Adjustments, Transfer Pricing, and Prepayment rules from one currency to another currency or a set of currencies or from one product to another product or a set of products.

---

## Guidelines

### Availability of Transfer Pricing Methodologies

The availability of transfer pricing methodologies depends on the data source that you select: Account Table or Ledger Table. In ALM, by default, only Account Table data source is selected and is disabled. The following table describes the Transfer Pricing Methodologies available for the Account Table Data Source and displays whether that methodology requires the selection of a Transfer Pricing Interest Rate Code.

---

**Note:** The Interest Rate Code LOV is filtered by the selected Currency.

Child nodes for which no assumptions have been specified automatically inherit the methodology of their closest parent node. So if neither a child node nor its immediate parent has a method assigned, the application searches up the nodes in the hierarchy until it finds a parent node with a method assigned, and uses that method for the child node. However, if no parent node has a method assigned then the application triggers a processing error stating that no assumptions are assigned for the particular product/currency combination.

---

Transfer Pricing Methodology	Interest Rate Code		Data Source: Account Table
Cash Flow: Average Life	Yes	Yes	Yes
Cash Flow: Duration	Yes	Yes	Yes
Cash Flow: Weighted Term	Yes	Yes	Yes
Cash Flow: Zero Discount Factors	Yes	Yes	Yes
Moving Averages	Yes	Yes	Yes
Straight Term	Yes	Yes	Yes

<b>Transfer Pricing Methodology</b>	<b>Interest Rate Code</b>	<b>Data Source: Account Table</b>
Spread from Interest Rate Code	Yes	Yes
Spread from Note Rate		Yes
Redemption Curve	Yes	Yes

**Required Parameters**

You cannot define a transfer pricing methodology successfully, unless you specify the required parameters. The following table displays the parameters associated with each transfer pricing method and specifies whether they are required or optional. The optional parameter fields display default values. However, you may decide to change the values for the optional parameters.

<b>Transfer Price Method</b>	<b>Yield Curve Term</b>	<b>Historical Range</b>	<b>Lag Term</b>	<b>Rate Spread</b>	<b>Assignment Date</b>	<b>Term Points</b>
Cash Flow: Average Life						
Cash Flow: Weighted Term						
Cash Flow: Duration						
Cash Flow: Zero Discount Factors						
Moving Averages	Required	Required				
Straight Term						
Spread from IRC	Required		Required	Required	Required	
Spread from Note Rate				Required		
Redemption Curve					Required	Required

## Defining the Redemption Curve Methodology

As part of the process for defining the Redemption Curve methodology, you must select as many Term Points from your selected Transfer Pricing Yield curve as are needed and allocate the percentage weighting for each of those points.

### Prerequisites

Performing basic steps for creating or updating a Transfer Pricing rule

Procedure to Add Term Points:

The steps involved in adding Term Points are listed as follows:

1. Click Add New Term Points. The Add New Term Points page is displayed.
2. Select the Transfer Pricing Yield Curve Points as required.
3. Click OK.
4. The Term Point Selection section is displayed. Update the percentage value for each Term Point.

---

---

**Note:** The sum of all the percentages for all Term Points must add up to 100. To remove a Yield Curve Point from the Percentages/Term Points table, select the term point(s) and click the Delete icon.

---

---



---

---

## Adjustment Rules

### Overview of Adjustment Rules

Adjustment rules allow you to specify methodologies to calculate Transfer Pricing add-on rates for the relevant forecast balances in your portfolio. The methodologies contained in the Adjustments rule are referenced by the Static and Dynamic Deterministic ALM Processes.

---

---

**Note:** Adjustment Rule assumptions are used to assign TP Add-on rates to future balances only within ALM, and are assumed to be constant for the life of the record from origination. Therefore the specific rules are not referenced in a Static Deterministic process. To assign adjustment rates to your instrument table data, Oracle Funds Transfer Pricing is required.

---

---

The procedure for working with and managing Adjustment rules is similar to that of other Oracle Asset Liability Management business rules. It includes the following steps:

- Searching for Adjustment rules. For more information, refer to [Searching for Rules](#) section.
- Creating Adjustment Rules. For more information, refer to [Creating Rules](#) section.
- Viewing and Editing Adjustment rules. For more information, refer to [Viewing and Editing Rules](#) section.
- Copying Adjustment rules. For more information, refer to [Copying Rules](#) section.
- Deleting Adjustment rules. For more information, refer to [Deleting Rules](#) section.

As part of creating and editing Adjustment rules, you define adjustment methodologies for applicable products. Refer to

- [Defining Adjustment Methods](#)
- [Availability of Adjustment Methods](#)
- [Adjustment Method Parameters](#)
- [Procedure to Define the Formula Based Rate Adjustment Method](#)

Oracle Asset Liability Management provides you with the option to copy, in total or selectively, the product assumptions contained within the Adjustments, Transfer Pricing, and Prepayment rules from one currency to another currency or a set of currencies or from one product to another product or a set of products.

## Creating Adjustment Rules

You create an Adjustments rule to define adjustment methodologies for your products.

### Procedure

1. Navigate to the Adjustments rule summary page.
2. Complete standard steps for this procedure.

---

**Note:** In addition to the standard steps for creating rules, the procedure for creating an Adjustments rule involves one extra step. After Standard Step 5, you need to select a product hierarchy. You can define methodologies at any level of the hierarchical product dimension. The hierarchical relationship between the nodes allows inheritance of methodologies from parent nodes to child nodes.

---

## Defining Adjustment Methods

The definition of adjustment methods is part of the Create or Edit Adjustments rule process. When you click Save in the Create Adjustments rule process, the rule is saved and the Adjustments rule summary page is displayed. However, adjustment assumptions have not yet been defined for any of your products at this point. Typically, you would start defining your adjustment assumptions for product-currency combinations before clicking Save.



## Prerequisites

Performing basic steps for creating or editing an Adjustments rule

## Procedure

This table describes key terms used for this procedure.

Term	Definition
Reference Term	The associated term used for the add-on rate assignment. You can select one of the following types of reference terms: Original Term (the contractual term to the maturity of the account), Repricing Frequency (the frequency at which the account reprices) and Remaining Term (the number of months until the account matures).
Lookup Method	Method used to derive an add-on rate for different reference term values.  Specify Range as the lookup method if you want the application to apply the rates defined in the Adjustments rule to a range of reference term values, using the terms defined in the rule to specify the lower end of the range. Note that for values less than the lowest term point, the application uses the value associated with the lowest point.  Specify Interpolation as the lookup method if you want the application to interpolate add-on rate values for applicable reference terms falling between node points specified in the Adjustments rule, using straight line interpolation between the term points.
Term	In conjunction with the Multiplier, this field allows you to specify the value for the Reference Term, for a given lookup tier.
Multiplier	The unit of time applied to the Term. The choices are: Days, Months, Years.
Rate	The add-on rate to be applied to instruments where Reference Term is the product of the Term and Multiplier defined for the row. The rate should be in percentage form, for example, 1.25 percent should be input as 1.25.
Assignment Date	For ALM, the usage of TP Adjustment Rates is limited to assigning rates to new originations only. So, Origination Date is selected by default.
Interest Rate Code	Used for the rate lookup for the Formula Based Rate.
Formula	The mathematical formula used in the Formula Based Rate adjustment method to determine the Add-on rate: $\text{fl}(\text{Term Point Rate} * \text{Coefficient}) + \text{Rate Spread}$
Term Point	In conjunction with the Multiplier (day, month, or year), it is used in the Formula Based Rate method when looking up the rate for the designated Interest Rate Code.

Term	Definition
Coefficient	Coefficient by which the Term Point rate should be multiplied.
Rate Spread	The spread added to the interest rate read from the selected Interest Rate Code. Rate Spread is used in the Formula Based Rate adjustment method. For the Formula Based Rate method, the spread is added to the result of the Term Point Rate * Coefficient. Enter the Rate Spread in percentage form, for example, 1.25 percent should be input as 1.25.

## Availability of Adjustment Methods

The list of adjustment methods depends on the adjustment type that you select: add-on rates (including Liquidity Adjustments, Basis Risk costs, Pricing Incentives, and Other adjustments). The following table describes the adjustment methods available for each of the adjustment types.

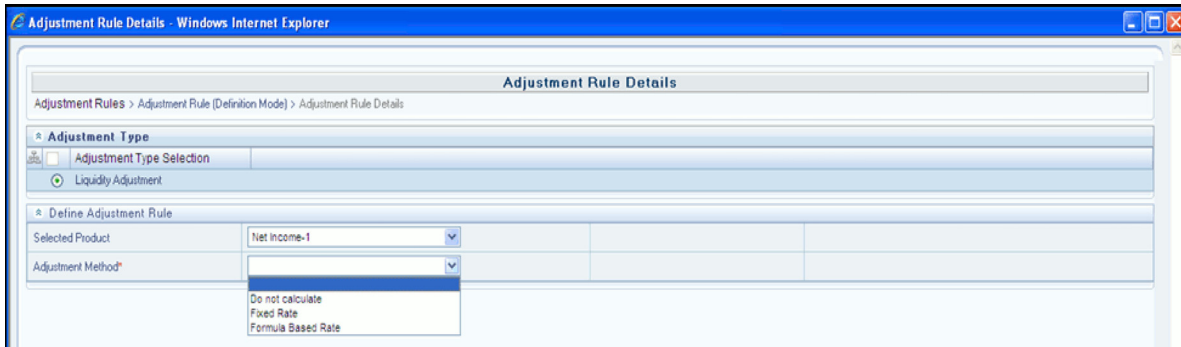

Adjustment Method	Adjustment Type: Add-On Rates (Liquidity Adjustments, Basis Risk Costs, Pricing Incentives, and Other Adjustments)
Do Not Calculate	Yes
Fixed Rate	Yes
Formula Based Rate	Yes

**Note:** If you select "Do not calculate" as the calculation method, no adjustment assumptions will be assigned to the particular product-currency combination. This is a particularly useful option when using node level assumptions because it allows you to exclude a particular child from inheriting a parent assumption.

## Adjustment Method Parameters

To define an adjustment calculation method, you must specify one or more parameters, depending on the method. The parameter fields may display a default value, which you can override.

The following tables display the parameters associated with the adjustment methods for different adjustment types.

Adjustment Method	Reference Term	Lookup Method	Term	Multiplier	Rate	Assignment Date	IRC	Formula
Do Not Calculate								
Fixed Rate	Yes	Yes	Yes	Yes	Yes			
Formula Based Rate	Yes	Yes	Yes	Yes		Yes	Yes	Yes

---

**Note:** The Add-On Rate adjustment types include Liquidity Adjustments, Basis Risk Costs, Pricing Incentives, and Other Adjustments.

---

## Prerequisites

Performing basic steps for creating or editing an Adjustments rule

## Procedure

Once you have created an Adjustments rule, you can assign adjustment methodologies to product-currency combinations in either of the following two ways:

- By creating a conditional assumption using conditional logic. See:
  - [Associating Conditional Assumptions with Prepayment Rules](#)
  - [Defining Prepayments Using Node Level Assumptions](#)
- Directly on the Adjustment methodology page, as described here.

Use the following procedure to define an adjustment method:

- Navigate to the Adjustments assumption browser page.

2. Select an appropriate adjustment type: Liquidity Adjustment, Basis Risk Cost, Pricing Incentive, or, Other Adjustment by opening the Adjustment Type selector window. You can enable one or more adjustment types within a single Adjustment Rule and apply more than one Adjustment to a single product.

**Note:** The product hierarchy refreshes when you change your Adjustment Type selection, but note that all selections made within the rule are saved. For example, when Liquidity Adjustment is selected, the hierarchy displays the status of Liquidity Adjustment mappings within the hierarchy. If you change your Adjustment Type selection to Basis Risk Cost, the hierarchy will refresh and you will see the status of all Basis Risk Cost mappings, and so on.

3. Select a Product Hierarchy.
4. Specify a currency.
5. Based on the selected hierarchy, the application displays a list of all the products (for which you can define assumptions).
6. Select the check box of one or more products for which you want to define adjustment details.

Operator	Term	Operator	Term	Multiplier	Formula
<=	0	<=	24	Months	
<=	24	<=	48	Months	
<=	48	<=	120	Months	

7. Select an adjustment method and enter the appropriate parameters.

---

**Note:** The adjustment methods available depend on the selected adjustment type. Depending on the adjustment type and method adjustment combinations selected, certain required and optional parameter fields are displayed. You can update these fields as required. See:

---

- [Adjustment Method Parameters](#)
  - [Procedure to Define the Formula Based Rate Adjustment Method](#)
8. Click Apply. If only one product was selected, the assumption browser page is displayed. If more than one product was selected on the assumption browser page, then each subsequent product in the select list will appear in the Selected Product drop list and each item should be defined appropriately. After completing the assumption details for each selected product, the assumption browser page will be displayed. At this point you can:
    - Continue defining assumptions for additional product-currency combinations for the selected Adjustment Type, by repeating the above procedure
    - Select a new Adjustment Type and continue defining assumption details for the required set of products
    - Complete the process by clicking Save. The new assumptions are saved and the Adjustments rule summary page is displayed.

---

**Note:** Oracle Asset Liability Management provides you with the option to copy, in total or selectively, the product assumptions contained within the Adjustments, Transfer Pricing, and Prepayment rules from one currency to another currency or a set of currencies or from one product to another product or a set of products.

---

## Procedure to Define the Formula Based Rate Adjustment Method

Adjustment Rule Details			
Adjustment Rules > Adjustment Rule (Definition Mode) > Adjustment Rule Details > Formula Based Rate Definition			
Interest Rate Code	Transfer Pricing Yield Curve	Term	1D, 1M, 3M, 6M, 1Y, 2Y, 3Y, 5Y, 7Y, 10Y
Assumptions			
Term Point	1	Years	Coefficient .10
Rate Spread	0.05		
		Apply	Cancel

Defining the Formula Based Rate adjustment method involves the following additional steps:

1. Select Update to define the mathematical formula. The Define Formula for Reference Term page is displayed.
2. Specify the Term Point, Coefficient, and Rate Spread parameters on the Define Formula for Reference Term page.



---

---

## Transaction Strategies

With the Transaction Strategy rules you can test the impact of various hedging strategies that are integrated with basic scenario modeling assumptions. This functionality supports you in testing alternative strategies and their incremental impact on results. The testing is facilitated by the separation of transaction strategies from basic scenario assumptions allowing you to easily view results with and without the incremental transaction(s). You can also use this rule to add specific instrument records to a processing run without changing the actual instrument data.

A transaction is either positive or negative and can be defined for any product leaf member. A Transaction Strategy rule is made up of any number of individual transactions.

This chapter covers the following topics:

- [Creating a Transaction Strategy Rule](#)
- [Defining a Transaction Strategy](#)

### Creating a Transaction Strategy Rule

To create a new Transaction Strategy Rule, complete the following steps:

1. Navigate to the Transaction Strategies summary page and click the “Add” button.
2. In the Transaction Strategy Details section:
  1. Type a descriptive name.
  2. Type a description. This is an optional field.
  3. Select a security folder and the Access Type.
3. In the Product Characteristics section:
  1. Select the Product Characteristics folder and assumption rule from the drop-down list (For additional information on setting up and defining Product Characteristic rules, See [Product Characteristics](#))

**Note:** The Product Characteristics rule that you choose determines the hierarchy and available list of products for selection within the Transaction Strategy rule. The dependent Product Characteristics rule also provides default characteristics for any selected product. Once defined, the red status box will turn green. Refer to “Setting up a Transaction Strategy” below for the list of required values and setup options.

4. Choose from one of the four rate volume relationships (For more information and definitions, refer to [Rate Dependency Patterns](#))

**Note:** If any relationship is chosen, Choose from the drop-down list the desired Rate Dependency Pattern.

5. Click Save (or continue on to define Transaction Strategy details, see “Setting up a Transaction Strategy” below).

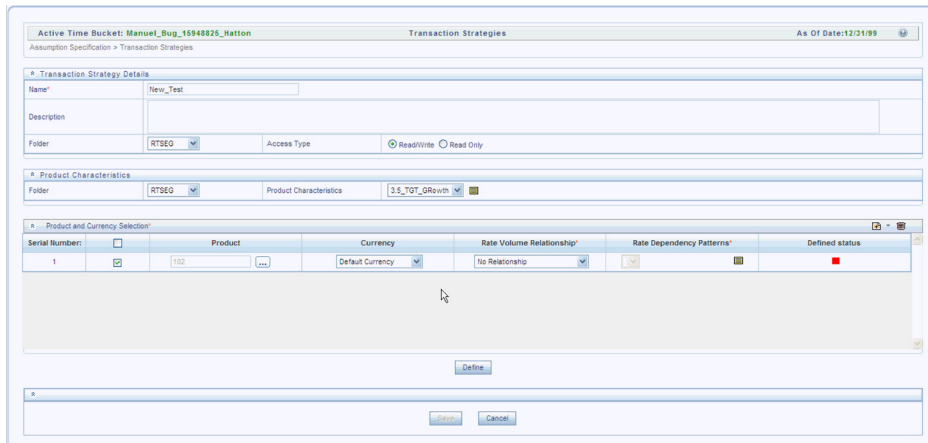

## Defining a Transaction Strategy

To add a new transaction or instrument record to the rule, click the “Add” button. A new row will appear in the Product and Currency Selection section. To delete a transaction or instrument record, check the box next to the product you want to delete; then click the Delete button.

Once you add a new Transaction row by clicking the Add button, position the cursor in the product column. Click the selector icon to bring up the hierarchy browser and select a product leaf member. The currency code defaults to the currency defined in Application Preferences.

After adding the product and selecting appropriate Product Dimension Member from the Hierarchy, the next step is to define the attributes for the Transaction.

Based on the Product Members – Account Type attribute, you will be directed to either an "On-Balance Sheet" Attribute screen or an “Off-Balance Sheet” Attribute screen.



The On-Balance Sheet Attribute screen has four tabs that require updating when defining the strategy rule for on balance sheet transactions (non-derivative). Note the last two bullets are optional based upon the product type definition in the first and second bullet.

- Define Core Product Attributes
- Define Payment Attributes
- Define Adjustable Rate Attributes
- Define Negative Amortization Attributes
- Define Other Mortgage Attributes\*
- Define Inflation Adjustment Attributes\*\*

---

---

**Note:** \* This tab will be available only if you are mapped to ADCo LDM and Currency type is selected as USD in Transaction Strategies window.

\*\* This tab will be displayed, if Inflation Indexed Instrument option is selected in Define Core Products Attributes tab for New Business.

---

---

Embedded Option Flag with and Inflation Indexed Instrument flag cannot be selected together. If both are selected, an error message is displayed “Indexed Instrument does not support Embedded Option. Do you want to continue”.

A separate definition screen will appear if you are defining an off balance sheet transaction, which includes two tabs: See “Defining an Off Balance Sheet Transaction” for more information.

- Define Core Product Attributes
- Define Leg Level Attributes: The Leg Attributes are separated into two sub-tabs:
  1. Receiving Leg/IR CAP
  2. Paying Leg/IR Floor

Define Core Products Attributes			
Amortization Type*	None	Payment Pattern	
Adjustable Type*	None	Behavior Pattern	
Balance*		Repricing Pattern	
Deferred Balance		Lease Residual Value	0.0%
Rate Pricing Option*	None	Amortization Method for Premiums, Discounts, Costs and Fees	Level Yield
Interest Rate Code	[USD] IRC1 (1)	Origination Date*	
Gross Rate	%	Original Term*	Months
Net Rate	%	Amortization Term*	Months
Transfer Rate	%	Embedded Option Flag	<input type="checkbox"/>
Margin Type	<input checked="" type="radio"/> Rate <input type="radio"/> Percent		
Net Margin	%		
Gross Margin	%		
Inflation Indexed Instrument	<input type="checkbox"/>		

All fields with the red \* are mandatory fields and must be populated. Gray boxes cannot be edited.

The values are populated with the default settings from the corresponding leaf member in the selected Product Characteristics rule. You can modify any of the settings.

You can add as many transactions for any leaf member as you wish.

New Business in Bonds with embedded Options is supported through Transaction strategy. In the 'Define Core products Attributes' screen of Transaction strategy definition, selecting the Embedded Option Flag (as shown in the following screenshot) enables the user in defining the Embedded option new business.

Define Core Products Attributes			
Amortization Type*	None	Payment Pattern	
Adjustable Type*	None	Behavior Pattern	
Balance*		Repricing Pattern	
Deferred Balance		Lease Residual Value	0.0%
Rate Pricing Option*	None	Amortization Method for Premiums, Discounts, Costs and Fees	Level Yield
Interest Rate Code	[USD] IRC1 (1)	Origination Date*	
Gross Rate	%	Original Term*	Months
Net Rate	%	Amortization Term*	Months
Transfer Rate	%	Embedded Option Flag	<input checked="" type="checkbox"/>
Margin Type	<input checked="" type="radio"/> Rate <input type="radio"/> Percent		
Net Margin	%		
Gross Margin	%		
Inflation Indexed Instrument	<input type="checkbox"/>		

### Transaction Strategy Fields

The following fields are used in the Transaction Strategy Rule for On and Off Balance Sheet Products.

Field	Description
ACCRUAL BASIS	The basis on which the interest accrual on an account is calculated. The choices are as follows:

Field	Description
	<p>30/360</p> <p>Actual/360</p> <p>Actual/Actual</p> <p>30/365</p> <p>30/Actual</p> <p>Actual/365</p> <p>Business/252</p>
	<p>Note: A Holiday calendar selection is required if business/252 accrual basis is selected. Business/252 accrual basis is only applicable to the recalculate option of the holiday calendar rule. If user selects the shift payment dates, the payment will still be recalculated for the non holiday/weekend date.</p>
<p>ADJUSTABLE TYPE</p>	<p>Determines the repricing characteristics of the new business record. The choices consist of all standard OFSAA codes and all additional user-defined repricing patterns created through the Repricing Pattern interface. The standard OFSAA codes are as follows:</p> <p>Fixed Rate</p> <p>Repricing Pattern</p> <p>Floating Rate</p> <p>Other Adjustable</p>
<p>AMORTIZATION METHOD FOR PREM, DISC, COSTS AND FEES</p>	<p>Choose from Level yield or Straight Line</p>
<p>AMORTIZATION TYPE</p>	<p>Method of amortizing principal and interest. The choices consist of all standard OFSAA codes and all additional user-defined codes created through the Payment Pattern and Behavior Pattern interfaces, as given below:</p> <p>Conventional Fixed</p> <p>Conventional Adjustable</p> <p>Balloon Payment</p> <p>Adjustable Negative Amortization</p> <p>Non-Amortizing</p> <p>Rule of 78's</p> <p>Level Principal</p> <p>Payment Pattern</p> <p>Behavior Pattern</p> <p>Lease</p>

Field	Description
AMORTIZATION TERM	<p>This field is not editable, if the Derivative Type is selected as FX Contract and sub type is selected as Spot or Forward.</p> <p>Term upon which amortization is based in units (days, months, years).</p> <p>This field is not editable, if the Derivative Type is selected as FX Contract and sub type is selected as Spot or Forward.</p>
BALANCE	<p>Represents either the originating balance for transaction strategy records originating in the future, or the current balance for transaction strategy records representing already originated accounts. If the origination date is in the past, the current balances are from the as-of date.</p>
BEHAVIOR PATTERN	<p>User defined pattern (See Behavior Pattern), necessary when "Behavior Pattern" is chosen from the Amortization Type options.</p>
BINARY RATE	<p>Off B/S field only. This Rate is used in Binary Interest Rate Cap, Floor, Collar, for interest cash flow, when Cap, Floor or Collar is IN THE MONEY. For example, if you have an Interest rate cap with a Binary Rate of 3%, and a Rate Cap of 6%, the Binary rate will be used for interest cash flow calculation, when underlying rate is above the reference strike or rate cap of 6%. This field is not editable (blank), if the Derivative Type is selected as FX Contract and sub type is selected as Spot or Forward.</p>
COMPOUNDING BASIS	<p>Determines the number of compounding periods per payment period. The choices are the following:</p> <ul style="list-style-type: none"> <li>Daily</li> <li>Monthly</li> <li>Quarterly</li> <li>Semi-Annual</li> <li>Yearly</li> <li>Continuous</li> <li>Simple</li> <li>At Maturity</li> </ul>
CURRENCY	<p>Currency of the instrument.</p>
CUSTOMER CREDIT SCORE	<p>The default value of this is 700 and it should be in the range of 300-850.</p>

<b>Field</b>	<b>Description</b>
DEFERRED BALANCE	Current Unamortized Deferred Balance associated with Instrument (i.e. Premium, Discount, Fees, etc.)
EMBEDDED OPTION FLAG	If embedded option flag is checked, Amortization Type must be non-amortizing. Warning message that says "Embedded Options only supported for non-amortizing instruments" is displayed. This flag when checked enables the Define Embedded Options Tab.
EQUALIZATION FREQUENCY	Frequency at which current payment necessary to fully amortize the instrument is re-computed in units (days, months, or years).
EQUALIZATION LIMIT	Maximum negative amortization allowed, as a percent of original balance. E.g., if principal balance should never exceed 125% of original balance, this column would equal 125.0
EXCHANGE OF PRINCIPAL	Off B/S field only. Used for Asset Swap and Spot/Forward Fx Contract types. Yes or No option determined if Principal is exchanged. By default, this option will be set as "Yes" for Derivative subtype Spot or Forward (non-editable).
EXERCISE TYPE	This is a drop-down list with values – European, Bermudan and American.  If American is selected, Option Start Date is enabled, otherwise it is disabled.  If Bermudan is selected, Ability provided to enter a list of dates and values.
GROSS MARGIN	Contractual spread over interest rate code used in calculation of gross rate.
FIRST RESET CAP	This is the initial maximum value for mortgage instruments that have a tease period. This cap rate will be applicable at the tease end period, prior to the first reset. After this, the periodic and lifetime cap value will be applied.
FIRST RESET FLOOR	This is the initial minimum value for mortgage instruments that have a tease period. This floor rate will be applicable at the tease end period, prior to the first reset. After this, the periodic and lifetime floor value will be applied.
GROSS RATE	Gross rate on the instrument (i.e. paid by the customer).

Field	Description
HOLIDAY CALENDAR	<p>The default value is Blank and is Enabled. This drop-down list contains the list of all holiday calendar definitions defined in the Holiday Calendar UI.</p>
INTEREST CALCULATION LOGIC	<p>There are two options:</p> <p>Shift Dates Only</p> <p>Recalculate Payment</p> <p>Shift Dates Only</p> <p>If a future payment date (as computed by the cash flow engine (CFE)) falls on a designated holiday (including weekends), the CFE will shift the payment date from the holiday as per the rolling convention. No changes will be made to the payment amount, or accrual amount; this is simply shifting the date on which the cash flow will post. The subsequent payment dates resume according to the original schedule.</p> <p>Recalculate Payment</p> <p>This option includes the same holiday calendar definition as in the Shift Dates Only option, but it also takes one additional step to recalculate the interest payment amount (and interest accruals) based on the actual number of days in the (adjusted) payment period. The instrument records use the payment frequency (term and multiplier) and the re-price frequency (term and multiplier) in association with the next/last payment date and next/last re-pricing date to determine when the cash flow will post. The CFE logic is enhanced to acknowledge holiday dates and re-compute the payment/interest amount given the change in days. In addition, the engine gets back on the scheduled track of payment events after a holiday event occurs in one (or many sequential) events.</p>
INTEREST RATE CODE	<p>Defines the pricing index to which interest rate is contractually tied. The interest rate codes that appear as a selection option depend on the choice of currency.</p>
INTEREST TYPE	<p>Determines whether interest is calculated in arrears or advance or if the rate is set in arrears. There are three interest types:</p> <p>Interest in Arrears</p> <p>Interest in Advance</p> <p>Set in Arrears</p>

Field	Description
	For conventional amortization products, interest in arrears is the only valid choice. This field is not editable, if Derivative type is FX Contracts and subtype is selected as Spot or Forward .
ISSUER	Select the name of Issuer. The default value is FANNIE_MAE.
LEASE RESIDUAL VALUE	The residual value of a lease in percentage of original balance.
MARGIN TYPE	<p>The Margin Type can be selected as Rate or Percentage.</p> <ul style="list-style-type: none"> <li>• <b>Rate-</b> By default, Rate is selected. This is fixed spread.</li> <li>• <b>Percent-</b> Margin is calculated using provided margin (as percent) and forecast rate. For example, if the forecast rate is 5% and the margin is 10%, then the margin calculated will be 10% of forecasted rate.</li> </ul> <p>For more information, refer to <i>Cash Flow Reference Guide</i> on <a href="#">OHC</a>.</p>
MINIMUM BALANCE AMORTIZING SWAP	Off B/S field only. The balance at which an amortizing swap can amortize down to. This field is not applicable if the Derivative type is FX Contracts and subtype is selected Spot or Forward. By default, it will be set as blank for Spot or Forward Derivative subtype.
MINIMUM RATE CHANGE	The minimum required change in rate on a repricing date. This field is not applicable if the Derivative type is FX Contracts and subtype is selected Spot or Forward.
NET MARGIN	The contractual margin over the interest rate code used in computing net rate. Gross margin minus any fees.
NET MARGIN FLAG	<p>The setting of the net margin flag affects the calculation of net rate. The two settings are:</p> <p>Floating Net Rate - the net rate reprices in conjunction with the gross rate, at a value net of fees.</p> <p>Fixed Net Rate - the net rate equals a fixed fee equal to the net margin.</p> <p>This field is not applicable if the Derivative type is FX Contracts and subtype is selected Spot or Forward.</p>

<b>Field</b>	<b>Description</b>
NET RATE	Nominal interest rate on instrument owed to, or paid by, the financial institution.
NOTIONAL PRINCIPAL	Off B/S field only. The Principal balance of a swap or option. This field is not applicable if the Derivative type is FX Contracts and subtype is selected Spot or Forward.
NUMBER OF ACCOUNTS	This field accepts value from 1 to 999999. The default value of this is 1.
OPTION START DATE and OPTION EXPIRY DATE	These are calendar selections. Option Expiry Date should be greater than Option Start Date.
OPTION TYPE	This is a drop-down list with values – None, Call and Put.
ORIGINAL TERM	Contractual term at origination date in units (days, months, or years).
ORIGINATION DATE	The date of the origination for the transaction account. This day may be in the future or the past.
ORIGINAL LOAN TO VALUE	The default value of this is 80 and it should be in the range of 1-300.
PAY CURRENCY	Off B/S field only. The currency on the pay leg of a cross currency swap. This is a mandatory field if the derivative subtype is selected as Spot/Forward Forex. The Receive Currency of Receive Leg/R Cap tab will not be equal to Pay Currency of Paying Leg/R Floor tab.
PAYMENT CHANGE FREQUENCY	The frequency at which the payment amount is recalculated for adjustable negative amortization instruments in units (days, months or years).
PAYMENT DECREASE LIFE	Maximum payment decrease allowed during life of a negative amortization instrument.
PAYMENT DECREASE PERIOD	Maximum payment decrease allowed during a payment change cycle of a negative amortization instrument.
PAYMENT FREQUENCY	Frequency of payment (P & I, Interest or Principal) in units (days, months or years). For bullet instruments, use zero. This field is not applicable if the Derivative type is FX Contracts and subtype is selected Spot or Forward.
PAYMENT INCREASE LIFE	Maximum payment increase allowed during the life of a negative amortization instrument.
PAYMENT INCREASE PERIOD	Maximum payment increase allowed during a payment change cycle on a negative amortization instrument.



<b>Field</b>	<b>Description</b>
PAYMENT PATTERN	User defined pattern (See Payment Pattern), necessary when "Payment Pattern" is chosen from the Amortization Type options. This field is not editable if the Derivative type is FX Contracts and subtype is selected Spot or Forward.
PREMIUM DEFERRED BALANCE	Off B/S field only. The deferred premium balance of the derivative. This field is not editable if the Derivative type is FX Contracts and subtype is selected Spot or Forward.
PREPAYMENT INDEX	First index fetched by the UI among the defined ADCo Curves
PREMIUM PERCENTAGE	Off B/S field only. Premium (in percent) to execute derivative transaction. This field is not editable if the Derivative type is FX Contracts and subtype is selected Spot or Forward.
PURCHASE SALE INDICATOR	Off B/S field only. Defines whether the derivative transaction is a short or long (sell or buy). The Purchase Sale Indicator attribute of Receive Leg/R Cap will not be equal to Purchase Sale Indicator attribute of Paying Leg/R Floor.
RATE CAP LIFE	Maximum rate allowed during life of the instrument. This field is not editable (blank) if the Derivative type is FX Contracts and subtype is selected Spot or Forward If the Derivative type is Interest Rate Cap or Collar, then this field stores the Cap or Strike rate.
RATE CHANGE ROUNDING FACTOR	Percent to which the rate change on an adjustable instrument is rounded. This field is not editable(blank) if the Derivative type is FX Contracts and subtype is selected Spot or Forward.
RATE CHANGE ROUNDING TYPE	Method used for rounding of interest rate codes. The choices are as follows: no rounding, truncate, round up, round down, round nearest. This field is not editable(blank) if the Derivative type is FX Contracts and subtype is selected Spot or Forward.
RATE DECREASE LIFE	Maximum amount rate can decrease during the life of an adjustable rate instrument. Will be used to calculate the rate floor based on the forecasted rate scenario. If both rate decrease life and rate floor are defined, the process uses the more restrictive rate. This field is not editable(blank) if the Derivative type is FX Contracts and subtype is selected Spot or Forward.

<b>Field</b>	<b>Description</b>
RATE DECREASE PERIOD	Maximum amount rate can decrease during the repricing period of an adjustable rate instrument. This field is not editable(blank) if the Derivative type is FX Contracts and subtype is selected Spot or Forward.
RATE FLOOR LIFE	Minimum rate for life of the instrument. This field is not editable(blank) if the Derivative type is FX Contracts and subtype is selected Spot or Forward. If the Derivative type is Interest Rate Floor or Collar, then this field stores the Floor or Strike rate.
RATE INCREASE LIFE	Maximum interest rate increase allowed during the life of an adjustable rate instrument. Will be used to calculate rate cap based on forecasted rates scenario. If both rate increase life and rate cap are defined, the process uses the more restrictive rate. This field is not editable(blank) if the Derivative type is FX Contracts and subtype is selected Spot or Forward.
RATE INCREASE PERIOD	Maximum interest rate increase allowed during the cycle on an adjustable rate instrument. This field is not editable(blank) if the Derivative type is FX Contracts and subtype is selected Spot or Forward.
RATE PRICING OPTION	<p>There are two Rate Pricing options: Direct Input and Assign During Processing.</p> <p>Direct Input - This option allows you to input rates for new business in the Transaction Strategy.</p> <p>Assign During Processing: This option uses the Origination Date and Interest Rate Code (IRC) specified in the Transaction Strategy and pulls the corresponding rate from the Forecast Rates Assumption; that is, it is priced dynamically during the simulation.</p>
RATE SET LAG	Period by which the payment recalculation lags the date of the interest rate used for calculation in units (days, months, or years). This field is not editable(blank) if the Derivative type is FX Contracts and subtype is selected Spot or Forward.
RECEIVE CURRENCY	Off B/S field only. The currency on the receive leg of a cross currency swap. The Receive Currency of Receive Leg/R Cap tab will not be equal to Pay Currency of Paying Leg/R Floor tab. This is a mandatory field, if the derivative type is FX Contracts and subtype is selected as Spot or Forward.

<b>Field</b>	<b>Description</b>
RECEIVE PRINCIPAL	Off B/S field only. The principal balance of the receive swap leg. This field is not editable(blank) if the Derivative type is FX Contracts and subtype is selected Spot or Forward.
REPRICING FREQUENCY AND MULTIPLIER	Contractual frequency of rate adjustment in units (days, months, or years).
REPRICING PATTERN	User defined pattern (See Repricing Pattern), necessary when "Repricing Pattern" is chosen from the Adjustable Type options.
ROLLING CONVENTION	<p>The default value is Unadjusted and is Enabled, only when Holiday Calendar has been selected in the preceding field. This drop-down list contains 4 values:</p> <p>Unadjusted</p> <p>Following Business Day</p> <p>Modified following business day</p> <p>Previous business day</p> <p>Modified previous business day</p> <p>Actual/Un-adjusted</p> <p>Payment on the actual day, even if it is a non-business day.</p> <p>Following Business Day</p> <p>The payment date is rolled to the next business day.</p> <p>Modified following business day*</p> <p>The payment date is rolled to the next business day, unless doing so would cause the payment to be in the next calendar month, in which case the payment date is rolled to the previous business day.</p> <p>Previous business day</p> <p>The payment date is rolled to the previous business day.</p> <p>Modified previous business day*</p> <p>The payment date is rolled to the previous business day, unless doing so would cause the payment to be in the previous calendar month, in which case the payment date is rolled to the next business day</p> <p>Many institutions have month-end accounting procedures that necessitate this.</p>
STRIKE INTEREST RATE CODE	This is the same as the Interest Rate Code provided in Define Core Product Attributes tab.

Field	Description
STRIKE TYPE	This is a drop-down with values – Price and Rate.  If Rate is selected, Strike Interest Rate Code and Rate look up Type are enabled.  If Price is selected, Strike Interest Rate Code and Rate look up Type are disabled.
STRIKE VALUE	This is a text field containing numeric Input. Strike values in case of Strike Type are to a face value of 100. And, while processing , it is matched against the market value of the instrument.
TEASE DISCOUNT	The tease discount is used in conjunction with the original rate to calculate the tease rate.
TEASE PERIOD	The tease period frequency is used to determine the length of tease period in units (days, months, or years).
TERM	First term point of the index
TRANSFER RATE	The associated transfer rate for the account.

## Defining an On Balance Sheet Transaction

Once an on balance sheet product has been chosen in the product and currency selection bar, you need to define the characteristics of the transaction. Follow the steps below to define the attributes of the transaction.

1. Check the box next to the product and click the define button.

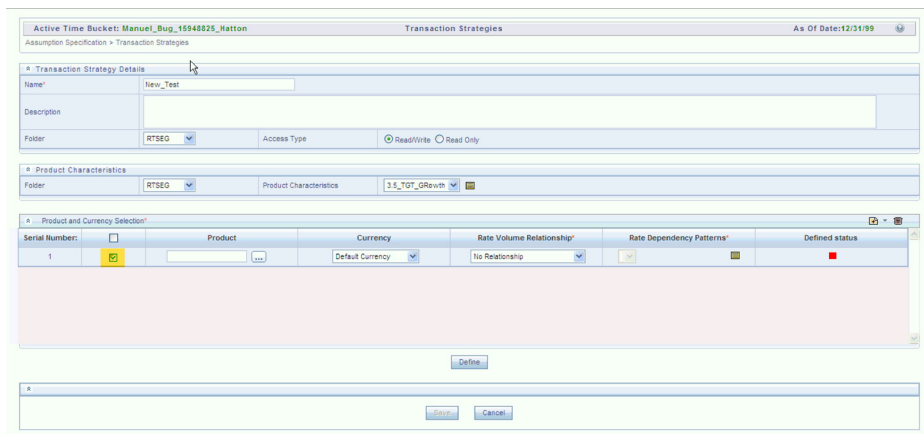

2. Define Core Products Attributes tab

1. The default information from the product definition will appear in the core attributes tab, and the relationship triggers (see above) will define what input fields are necessary.
2. Input any additional or overriding information necessary (i.e. the balance of the transaction) and click Save.

**Note:** Refer *Product Characteristics*, on page 397 for more information on product setup.

Screen shot of European and Bermudan Style exercise type follow:

For European and American exercise type, the user would be able to provide one option expiry date and Strike value.

For Bermudan exercise type, the user would be able to provide multiple exercise dates and strike values.

### 3. Define Payment Attributes tab

1. The default information from the product definition will appear in the payment attributes tab, and the relationship triggers (see above) will define what input fields are necessary.
2. Input any additional or overriding information necessary and click “apply” to save the tab.

Define Core Products Attributes	Define Payment Attributes	Define Adjustable Rate Attributes	Define Other Mortgage Attributes
Payment Frequency*	20 Months	Accrual Basis*	Actual/Actual
Interest Type*	Interest In Arrears	Compounding Basis*	Semiannual
Holiday Calendar		Net Margin Flag*	Floating Net Rate
Rolling Convention	Unadjusted	Interest Calculation Logic	<input checked="" type="checkbox"/> Shift Dates Only <input type="checkbox"/> Recalculate Payment

4. Define Adjustable Rate Attributes tab

1. This tab is utilized only when there is an adjustable or floating rate product characteristic that needs additional definition. The default values predefined by the product will appear, and the irrelevant fields will be grayed out based on the product type.
2. Input additional or overriding information necessary and click “apply” to save the tab.

Define Core Products Attributes	Define Payment Attributes	Define Adjustable Rate Attributes	Define Other Mortgage Attributes
Repricing Frequency and Multiplier	Months	Rate Increase Period	%
Tease Period	Months	Rate Decrease Period	%
Tease Discount*	%	Minimum Rate Change	%
First Reset Cap		First Reset Floor	
Rate Cap Life	20%	Rate Floor Life	670%
Rate Set Lag*	Months	Rate Increase Life	%
Rate Change Rounding Factor	20.0%	Rate Decrease Life	%
Rate Change Rounding Type*	Round to the Nearest Higher Multiple		

5. Define Negative Amortization Attributes tab

1. This tab is utilized only when there is a product with negative amortization characteristics that needs additional definition. The default values predefined by the product will appear, and the irrelevant fields will be grayed out based on the product type. If the amortization type is not Adjustable Negative Amount, all fields will be grayed out.
2. Input additional or overriding information necessary and click “apply” to save the tab.

Define Core Products Attributes	Define Payment Attributes	Define Adjustable Rate Attributes	Define Negative Amortization Attributes
Payment Change Frequency*	0 Months	Equalization Limit	0.00000 %
Equalization Frequency	0 Months	Payment Increase Life	0.0000 %
Payment Decrease Life	0.0000 %	Payment Increase Period	0.0000 %
Payment Decrease Period	0.0000 %		

6. Define Other Mortgage Attribute tab

This tab will be available only if you are mapped to ADCo LDM function.

Define Core Products Attributes	Define Payment Attributes	Define Adjustable Rate Attributes	Define Other Mortgage Attributes
Customer Credit Score	300	Original Loan To Value	1.0%
Issuer	FNMA_GAMA	Prepayment Index	11_Test_IRTest_IRC
Number of Accounts	1	Term	12 Months

7. Define Inflation Adjustment Attributes tab

This tab will be available when Inflation Indexed Instrument checkbox in Define Core Products Attributes is selected. Data in this tab will treat data as Inflation Indexed.

For more information on the cash flow calculations associated with Inflation indexed instrument, refer to Oracle Financial Services Cash Flow Engine Reference Guide .

8. When all the necessary tabs are saved, click the "Save" button, and if the definition is successful the defined status will turn green.
9. The process will then ask if you want to define another product currency combination, click "yes" to continue, or "no" to take you back to the transaction strategies summary screen.

## Defining an Off Balance Sheet Transaction

Once an off balance sheet product has been chosen in the product and currency selection block, you need to define the characteristics of the transaction. Follow the steps below to define the attributes of the transaction.

1. Check the box next to the product and click the define button.



2. In the Derivatives section, define the Derivative Type, and the Derivative Sub Type

Derivative Type: Choose "Swap", "Option", or "FX Contracts" from the drop-down list.

Derivative Sub Type:

If the derivative type is a swap, choose from one of the seven swap types: Vanilla, Basis, Set in Arrears, Forward, Asset, Amortizing, or Cross Currency.

If the derivative type is an option, choose one of the three types: Interest Rate Cap, Interest Rate Floor, and Interest Rate Collar.

If the derivative type is FX Contracts, choose subtype Spot or Forward

Depending on the combination listed above, you will need to define the two tabs listed in step 3 and 4.

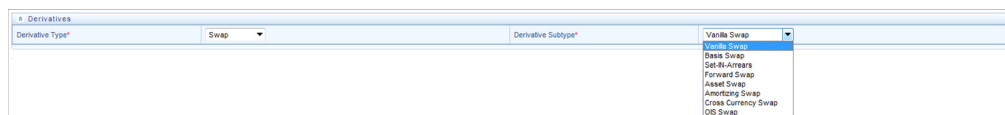

- OR -

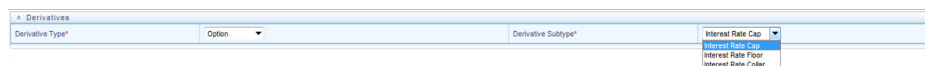

- OR -

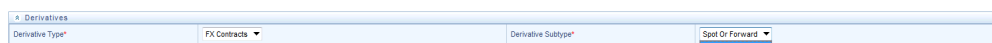

3. Define Core Products Attributes tab

- Depending on the relationship triggers on the type and sub type products, relevant fields will be editable. For example, enter the notional principal of the transaction, whether it is a short or long, and the origination date and term.
- Input additional or overriding information necessary and click “Save” to save the tab.

4. Define Leg Attributes tab.

- Receiving Leg / IR Cap tab: Use this tab to define the Receiving leg or the Cap Characteristics.

**Note:** The editable fields will be based on the relationship triggers of derivative type and sub type listed above.

For FX Contracts derivative type, Receive Principal, pay Principal, Receive Currency, and Pay Currency are mandatory fields.

- Paying Leg / IR Floor tab: Use this screen to define the pay side, or the interest rate floor. The editable fields will be based on the relationship triggers of derivative type and sub type listed above.



4 Derivatives

Derivative Type\* **FX Contracts** Derivative Subtype\* **Spot Or Forward**

Define Core Products Attributes Define Leg Level Attributes

Receiving Leg/R Cap Paying Leg/R Floor

Receive Principal		Receive Currency	Default Currency
Purchase or Sale Indicator		Rate Set Lag and Multiplier	Months
Rate Pricing Option	None	Rate Change Rounding Type	No Rounding
Interest Rate Code	(USD) Test_IRC (1)	Rate Change Rounding Factor	%
Adjustable Type	Fixed Rate	Minimum Rate Change	%
Replicating Frequency and Multiplier	10 Months	Rate Cap Life	%
Net Rate	0.001000%	Rate Floor Life	%
Gross Rate	0.001000%	Rate Decrease Life	%
Net Margin	0.001000%	Rate Increase Life	%
Gross Margin	0.001000%	Rate Increase Period	%
Binary Rate	%	Rate Decrease Period	%

Save Cancel

4 Derivatives

Derivative Type\* **FX Contracts** Derivative Subtype\* **Spot Or Forward**

Define Core Products Attributes Define Leg Level Attributes

Receiving Leg/R Cap Paying Leg/R Floor

Pay Principal

Pay Principal		Pay Currency	Default Currency
Purchase or Sale Indicator		Rate Set Lag and Multiplier	Months
Rate Pricing Option	None	Rate Change Rounding Type	No Rounding
Interest Rate Code		Rate Change Rounding Factor	%
Adjustable Type	Fixed Rate	Minimum Rate Change	%
Replicating Frequency and Multiplier	0 Months	Rate Cap Life	%
Net Rate	0.000000%	Rate Floor Life	%
Gross Rate	0.000000%	Rate Decrease Life	%
Net Margin	0.000000%	Rate Increase Life	%
Gross Margin	0.000000%	Rate Increase Period	%
Binary Rate	%	Rate Decrease Period	%

Save Cancel

5. When all the necessary tabs are applied, click the "Save" button, and if the definition is successful the defined status will turn green.
6. The process will then ask if you want to define another product currency combination, click "yes" to continue, or "no" to take you back to the transaction strategies menu screen.



---

---

## Formula Results

This module describes the procedure for working with and managing Formula Results rules.

This chapter covers the following topics:

- [Overview of Formula Results Rule](#)
- [Creating Formula Results Rules](#)
- [Defining Formula Results Rules](#)
- [Formula Results Functions](#)

### Overview of Formula Results Rule

The Formula Results rule enables you to model a product/currency leaf using the results of the cash flow, Liquidity Gap, Repricing Gap, and Market Value processes to recalculate and change the system-generated data. This allows you to model a product/currency leaf beyond results produced by the cash flow engine, using the formulas to create financial element values. The new FEs will be displayed to you, based on the Financial Type selection.

The types of Formula Results are following:

- Cash Flow
- Repricing Gap
- Liquidity Gap
- Market Value

---

---

**Note:** The Formula Result assumptions are applicable only for Deterministic Process. Only leaf level assumptions will be supported. Default currency and Preview options are not available in UI.

---

---

Here, engine picks up the assumptions and writes the results into the Result Detail and Result Master tables (including all the forecast rates scenarios). Process Cash Flows table is not populated. Consolidated Detail and Consolidated Master tables are

populated with Formula Results for Result Type Code=2 (indicating Formula Results Data) if the Consolidation flag is selected.

The Formula Results rule works only for the first dynamic start date for IRR Gap and liquidity buckets, and for As of Date (Start Date Index=0) and all the dynamic start dates for Market Value.

---

---

**Note:** Auto balancing has result type code 3, so the Auto balancing will be applicable post Formula Results are applied.

---

---

The procedure for working with and managing Formula Results rules is similar to that of other Oracle Asset Liability Management business rules. It includes the following steps:

- Searching for Formula Results rules. For more information, refer to [Searching for Rules](#) section.
- Creating Formula Results Rules. For more information, refer to [Creating Rules](#) section.
- Viewing and Editing Formula Results rules. For more information, refer to [Viewing and Editing Rules](#) section.
- Copying Formula Results rules. For more information, refer to [Copying Rules](#) section.
- Deleting Formula Results rules. For more information, refer to [Deleting Rules](#) section.
- As part of creating and editing Formula Results rules, you can assign Formula Results to applicable products.

### Process Flow of Formula Results

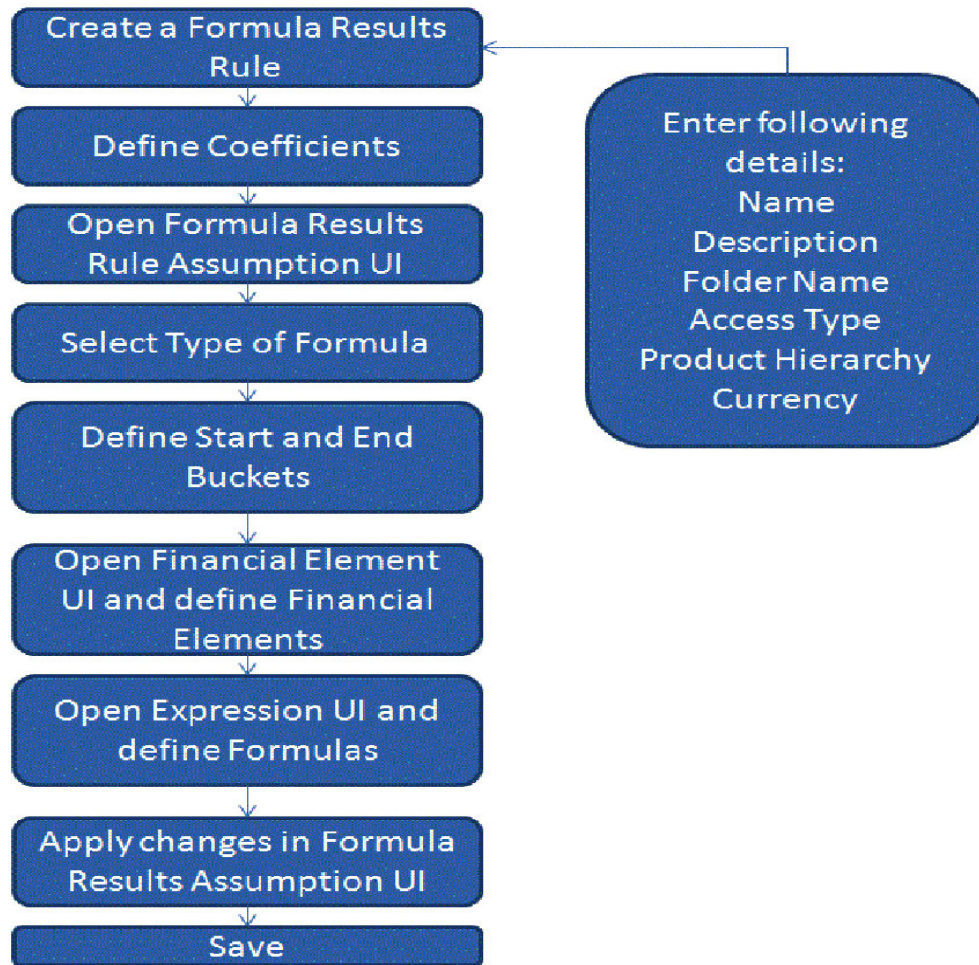

## Creating Formula Results Rules

You can create a Formula Results rule to use the results of the Cash Flow, Gap, and Market Value processes to recalculate and change system-generated data and to use the Formulas to create the financial element values. To create a new Formula Results Rule, follow these steps:

1. Navigate to the Formula Results summary page and click the "Add" button.
2. Complete standard steps for this procedure.

---

**Note:** In addition to the standard steps for creating rules, the procedure for creating a Formula Results rule involves one extra step. After Standard Step 6, you need to select a product hierarchy.

---

Name	Creation Date	Created By	Last Modification Date	Last Modified By	Access Type
Formulatetest1	9/11/2014 09:33:07	JILNA	9/11/2014 09:33:07	JILNA	Read/Write
dd	9/10/2014 06:55:08	JILNA	9/10/2014 06:55:08	JILNA	Read/Write
test2	9/10/2014 06:33:52	JILNA	9/10/2014 06:33:52	JILNA	Read/Write
gg	9/10/2014 06:15:53	JILNA	9/10/2014 06:15:53	JILNA	Read/Write
test_gl	9/10/2014 05:33:47	JILNA	9/10/2014 06:15:35	JILNA	Read/Write
copy_check depende	9/10/2014 05:25:06	JILNA	9/10/2014 05:25:06	JILNA	Read/Write
test35345d	9/9/2014 12:37:48	JILNA	9/10/2014 05:16:27	JILNA	Read/Write
test3	9/9/2014 12:13:59	JILNA	9/9/2014 12:33:26	JILNA	Read/Write

## Defining Formula Results Rules

The definition of a Formula Results rule is part of the Create or Edit Formula Results rule process. When you click Save in the Create Formula Results rule process, the rule is saved and the Formula Results rule summary page is displayed. However, Formula Results assumptions have not yet been defined for any of your products at this point. Typically, you would start defining your Formula Result assumptions for product-currency combinations before clicking Save.

You can define the Formula Results rule only at leaf level of the Product dimension hierarchy.

### Prerequisites

Performing basic steps for creating or editing a Formula Results rule

### Procedure

From the Assumption Browser screen, select the product(s) and the currency for which you want to define a Formula Result. Define the coefficients. Select the "Add New" button from Assumption browser to launch the Formula Results Details screen.

Defining Formula Results rule has four primary steps:

1. Choosing type of Formula Result
2. Defining Formula Result assumption bucket range
3. Selecting the Financial Element
4. Defining the new Formula

### Defining Coefficients

This UI allows you to define the coefficients for buckets.

1. Select Define Coefficients button from Formula Results screen.

Active Time Bucket: bb time bucket      Formula Results      As Of Date:2015.Jul.31

Assumption Specification - Formula Results

Formula Results Rule Details

Name \*

Description

Folder  Access Type  Read/Write  Read Only

Select Product Hierarchy

Folder\*  Product Hierarchy\*

Select Currency

Currency\*

Coefficients

Define Coefficients [...]

Assumption Browser      Assumption List

Assumption Browser

Product  All Products - 3      Status

Orphan Branch

Save Cancel

2. Select the type of Formula Result. It can be:

- Cash Flow
- Repricing Gap
- Liquidity Gap
- Market Value

Active Time Bucket: bb time bucket      Formula Results      As Of Date:2015.Jul.31

Cash Flow      Repricing Gap      Liquidity Gap      Market Value

Please select Bucket Range

Start Bucket  End Bucket

Coefficients

<input type="checkbox"/>	Code	Description	Bucket 1
<input type="checkbox"/>	<input type="text"/>	<input type="text"/>	<input type="text"/>

Apply Cancel

3. Enter details in Start Bucket and End Bucket fields. The bucket number input allows you to select a range of buckets over which the Formula Results assumption will apply. The Bucket numbers are automatically updated in Coefficients field based on the Bucket Number input.

Active Time Bucket: bb time bucket      Formula Results      As Of Date:2015.Jul.31

Cash Flow      Repricing Gap      Liquidity Gap      Market Value

Please select Bucket Range

Start Bucket  End Bucket

Coefficients

<input type="checkbox"/>	Code	Description	Bucket 2	Bucket 3
<input type="checkbox"/>	<input type="text"/>	<input type="text"/>	<input type="text"/>	<input type="text"/>

Apply Cancel

4. Enter the Code, Description, and Bucket details. You can add a new row using the Add Row.

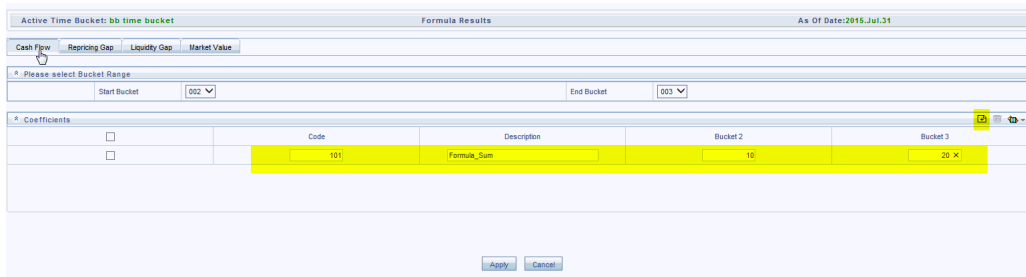

## The Formula Result Details screen

Below screenshot shows the Formula Result Details UI.

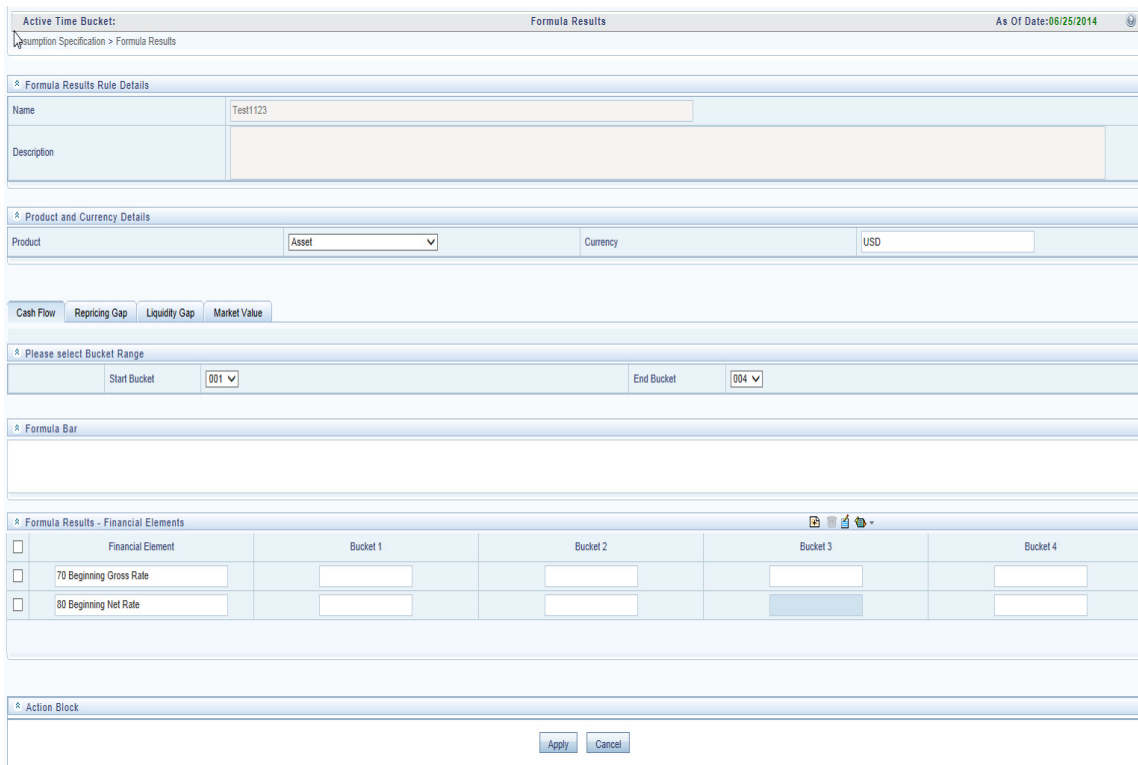

Following four Formula types are available

- Cash Flow
- Repricing Gap
- Liquidity Gap
- Market Value

The list of Financial Elements are grouped in above mentioned types.



### Start Bucket and End Bucket

The bucket number input allows you to select a range of buckets over which the Formula Results assumption will apply. The Bucket numbers are updated automatically based on the Bucket Number input.

### Formula Bar

The Formula Bar allows you to enter a new formula for a selected bucket. You can also edit the formula here which is defined using the Formula Bar or Formula Input Lanucher. Here, you can view the complete formula if it is not readable in bucket field.

### Financial Elements selection

The Financial Elements selection section allows you to select the Financial Element for defined buckets. The number of buckets can be defined using the Start Bucket and End Bucket. You can add multiple Financial Elements. Each row represents to a Financial Element. All the Financial Elements will be logically grouped in Financial Type.

To add a Financial Element, follow the steps given below:

1. Click Add.
2. Select the Financial Type from Financial Element window.
3. Select Financial Element and click Apply.

### Formula Expression block

This window allows you to define a Formula. This section has the list of all Financial Elements/Interest Rate Codes, Functions, and Operators, which you can use to define a Formula.

You can also use the custom functions in Formula Expression window. To use a custom function, type the name of function in Formula Expression window.

A custom function is defined using the PL/SQL that returns a number not exceeding the precision of NUMBER(15,2). Compile this function directly within the database schema. You can use any parameter as required and that will be captured as part of the Formula expression itself.

The following "Utility" functions/procedures within the package ALM\_FORMULA\_RESULT\_HELPER can be accessed in the custom functions. Then, these can be used as per the requirements/objectives.

Type	Name	Usage	Output Parameter(s)	Comments
Function	getBucketColumnName	getBucketColumnName (Lag NUMBER)	Column-Name – VARCHAR2	Returns the column-name in RES_DTL_XXXXX corresponding to the Lag specified;  The lag is offset against the current bucket against which the expression has been defined.  Exception(s) thrown:

Type	Name	Usage	Output Parameter(s)	Comments
				INVALID_NEGATIVE_LAG if Current Bucket + Lag <= 0
				INVALID_POSITIVE_LAG if Current Bucket + Lag > 240
Procedure	LOGMESSAGE	LOGMESSAGE (Message VARCHAR2)	-N.A.-	Logs a message into the FSI_PROCESS_ERRORS table  Note: Procedure does an autonomous_transaction based commit.
Function	getCoefficient	getCoefficient ( COEFF NUMBER, LAG NUMBER, FR_TYPE NUMBER)	Coefficient value - NUMBER	Returns the coefficient corresponding to the coefficient code, Lag and Formula-type.  Available Formula-types are FR_CASH_FLOW_TYPE = 1 FR_REPRICING_Gap_TYPE = 2 FR_LIQUIDITY_Gap_TYPE = 3 FR_MARKET_VALUE_TYPE = 4 Exception(s) thrown: INVALID_NEGATIVE_LAG if Current Bucket + Lag <= 0 INVALID_POSITIVE_LAG if Current Bucket + Lag > 240 NO_DATA_FOUND exception if no data found for the given inputs
Procedure	AssertCashFlowFE	AssertCashFlowFE(fe_num number)	-N.A.-	Asserts if the FE-Number is a cash-flow-FE.  Exception(s) thrown NOT_A_CASH_FLOW_FE if FE_NUM is not a valid FE
Procedure	AssertStaticFE	AssertStaticFE(fe_num number)	-N.A.-	Asserts if the FE-Number is a Static-FE.  Exception(s) thrown

Type	Name	Usage	Output Parameter(s)	Comments
Function	getStaticColumnName	getStaticColumnName(fe_num number)	Column-Name – VARCHAR2	<p>NOT_A_STATIC_FE if FE_NUM is not a valid FE</p> <p>Returns the column-name in FSI_O_RESULT_MASTER / FSI_O_CONSOLIDATED_MASTER corresponding to the FE-Number specified</p> <p>Exception(s) thrown</p> <p>NOT_A_STATIC_FE if FE_NUM is not a valid FE</p>
Function	getFilter	getFilter()	WHERE_CLAUSE VARCHAR2	<p>Returns the WHERE-CLAUSE that can be applied on RES_DTL/CONS_DTL and/or FSI_O_RESULT_MASTER/FSI_O_CONSOLIDATED_MASTER.</p> <p>NOT_A_STATIC_FE if FE_NUM is not a valid FE</p> <p>This clause contains filters applied on each of the relevant columns upon which the expression has been defined in Formula results.</p>
Procedure	Evaluate	evaluate(pBatchRunId varchar2, pAsOfDate varchar2, pProcessSysID number)	-N.A.-	<p>Evaluate Formula Results assumption for given process-id.</p> <p>Useful if the CFE Processing has already been completed and the need is to only evaluate the Formula Results assumption.</p> <p>Note: Do not invoke this procedure within a custom function that is embedded within an FR Expression.</p> <p>pBatchRunId is a key used to uniquely identify an execution of a batch / job</p> <p>pAsOfDate should be passed in the format YYYYMMDD</p>

The following "Utility" variables within the package ALM\_FORMULA\_RESULT\_HELPER can be accessed in the custom functions. Then, these can be used as per the requirements/objectives.

Variable Name	Data Type	Purpose
RESULT_TABLE	VARCHAR2	Holds the Result-detail table-name i.e. RES_DTL_XXXX
MASTER_TABLE	VARCHAR2	Holds the result-Master table-name i.e. FSI_O_RESULT_MASTER
CURRENT_ALM_PROCESS_SYS_ID	NUMBER	Holds the Process-Sys-Id of the current execution
CURRENT_AS_OF_DATE	DATE	AS-OF-DATE for which the Formula Result is being evaluated
ALM_PROC_EXEC_DATE_YYYYMMDD	VARCHAR2	AS-OF-DATE for which the Formula Result is being evaluated in the format YYYYMMDD
CURRENT_SCENARIO	NUMBER	The current forecast-rate scenario number for which the expression is being evaluated.
CURRENT_TIME_BUCKET	NUMBER	The Time Bucket SYS-ID for which the expression is being evaluated.
CURRENT_START_DATE_INDEX	NUMBER	The current Start-date-index number for which the expression is being evaluated.
CURRENT_BUCKET	NUMBER	The bucket-number for which the expression is being evaluated
CURRENT_PRODUCT	NUMBER	The Product-Id for which the expression is being evaluated
CURRENT_LEG_TYPE	NUMBER	The leg-type for which the expression is being evaluated
CURRENT_ORG_UNIT	NUMBER	The Org-Unit-Id for which the expression is being evaluated
CURRENT_LEGAL_ENTITY	NUMBER	The Legal-Entity Id for which the expression is being evaluated
CURRENT_CURRENCY	VARCHAR2	The Currency for which the expression is being evaluated
ALM_PROCESS_REPORTING_CURRENCY	VARCHAR2	The reporting currency currently set for the process-sys-id
ALM_PROCESS_EXECUTED_BY	VARCHAR2	The AAI user-id who last executed the process for the given as-of-date
ALM_BATCH_RUN_ID	VARCHAR2	The Batch Run-ID i.e. unique execution identifier for the current execution

Variable Name	Data Type	Purpose
PRODUCT_DIMENSION_COLUMN_NAME	VARCHAR2	The active product dimension in use for the current execution
ORG_UNIT_DIMENSION_COLUMN_NAME	VARCHAR2	The active Org-Unit dimension in use for the current execution

## Defining a Formula Results Rule: An Example

1. From the Assumption Browser, select Currency (US Dollar) and a product from the hierarchy browser

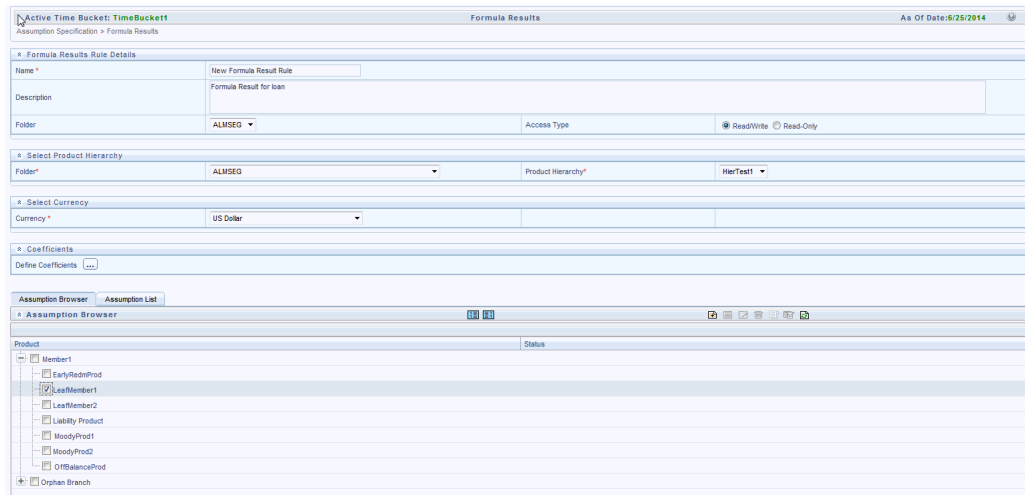

2. Select the Add New icon to enter the Assumption Details page.
3. Select the type of Formula as Cash Flow, Repricing Gap, Liquidity Gap, or Market Value option.
4. Define the Formula Result Bucket range using the Start Bucket and End Bucket options.

5. Click Add Financial Elements icon on Formula Results Details window to select the Financial Elements. The Financial Elements window is displayed. Here, all the Financial Elements are grouped in Financial Types.

6. Select the Financial Type. Based on the selected Financial Type, the list of Financial Elements will be displayed. Select the Financial Element and click Apply. You can select multiple Financial Elements at a time. The selected Financial Elements will be displayed on Formula Results Details screen.

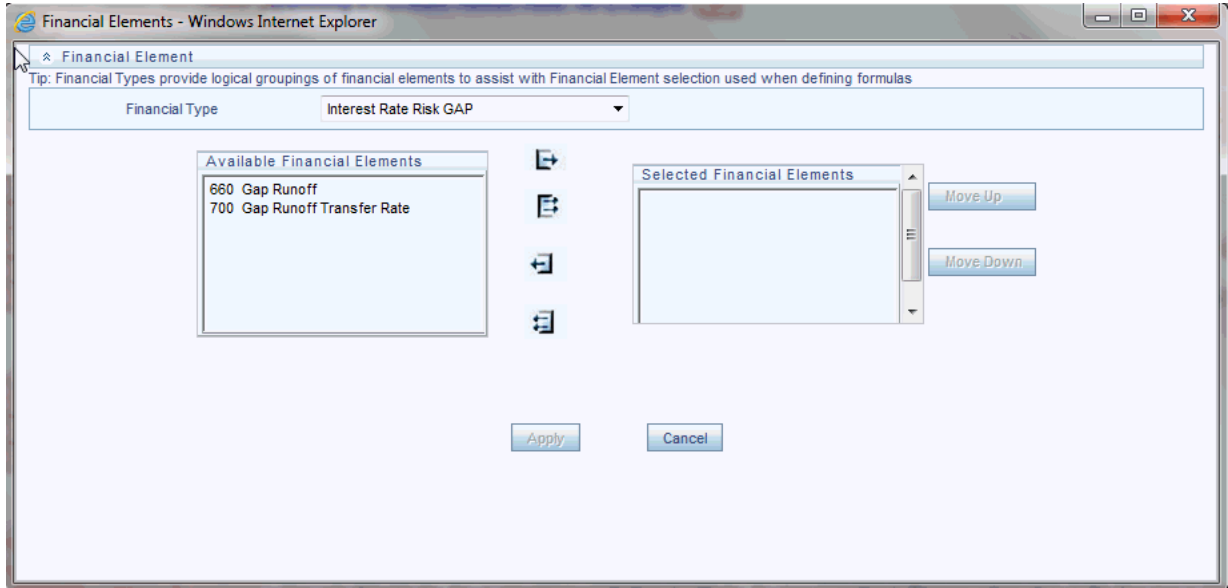

7. Select the Bucket for which you want to define a new Formula. For each Bucket, you can define a different formula that will be applicable only for corresponding bucket. Here, you can define the formula in each bucket(s) for Financial Element using the Formula Bar or Formula Input Lanucher.

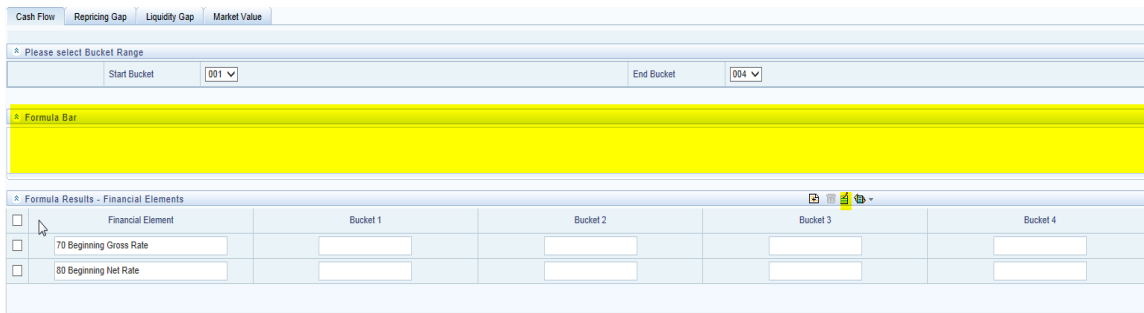

8. You can enter a formula directly in Formula Bar as displayed below:

9. Click Formula Input Launcher icon to enter the details of Formula.

10. In the Expression window, select the Financial Element/Interest Code, Functions, and Operators to define the Formula.

For more information on Functions, refer to Formula Results Functions section.



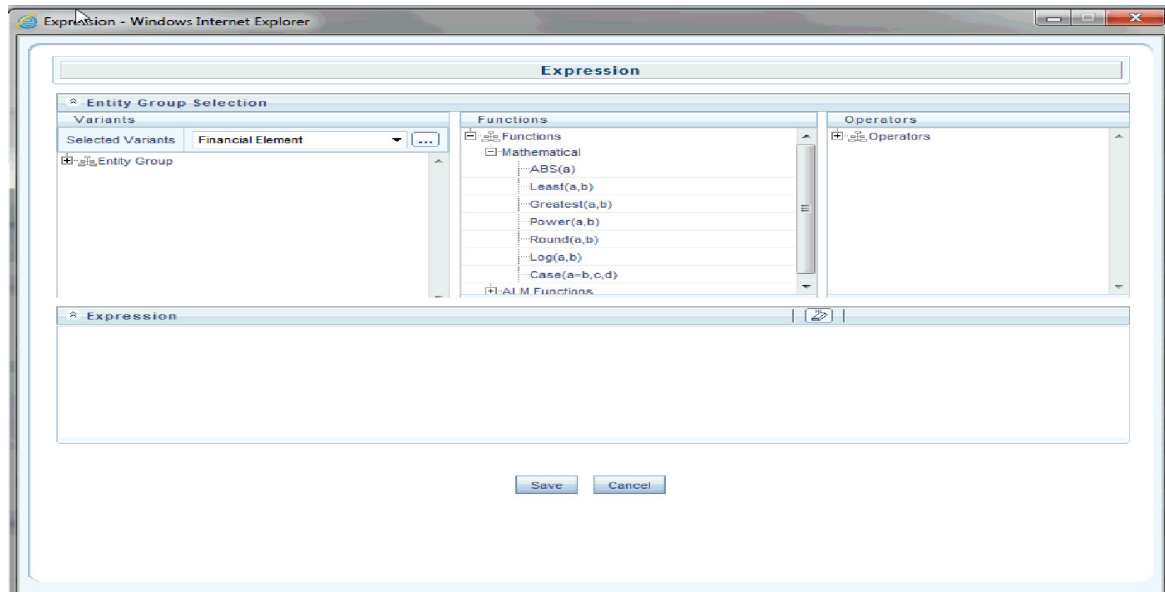

11. After saving the Formula, you will be directed back to Formula Result Details page.
12. Select Apply to commit the assumption and return to the Assumption Browser page.

---

**Note:** You can select more than one product at a time from the Assumption Browser page.

---

You can also use the Excel import/export feature to import the Buckets/Financial Element information in the Formula Results - Financial Elements tab.

When Formula Result assumptions are defined for all required product / currency combinations, select SAVE from the Assumption Browser page.

## Formula Results Functions

Formula Results Rule has its own unique functions which allows the user to access the various financial elements.

### Quick Reference

The following table can be used as a quick reference guide for the Formula Results functions.

Function (FE=Financial Element)	Formula	Use in Cash Flow	Use in Gap	Use in MV
Cash Flow FE	FE(Leaf, FE, Lag)	Yes	Yes	No
Current Leaf FE	CLFE (FE, Lag)	Yes	Yes	No
Static FE	SFE(Leaf,FE)	No	No	Yes

Function (FE=Financial Element)	Formula	Use in Cash Flow	Use in Gap	Use in MV
Static Current Leaf FE.	SCLFE(FE)	No	No	Yes
Cash Flow Coefficient	K(Coeff, Lag)	Yes	No	No
IRR Gap Coefficient	IGK(Coeff, Lag)	No	Yes	No
Liq Gap Coefficient	LGK(Coeff, Lag)	No	Yes	No
Static Coefficient	SK(Coeff)	Yes	Yes	Yes
Rate	RT(IRC, Lag, Term, Mult)	Yes	No	No
Days in Bucket	DAYS(Bucket)	Yes	No	No
Month of the Bucket	MONTH()	Yes	No	No

## Detailed Descriptions

### FE (Leaf,FE,Lag)

Used in cash flow and Gap Formulas only

The FE function returns the value of the Financial Element for the Leaf specified as stored in the Cash Flow results table.

Syntax:

Where:	FE	Function Name
	LEAF	Dimension number of applicable hierarchy. If the leaf value is greater than nine digits, it must be input with a decimal point or the answer will return zero. (Example: Leaf value 123456789012345 returns a 0 value. Leaf 123456789012345.00 returns an accurately calculated value.)
	FE	Financial Element Code number (see table above)
	Lag	Relative to Formula Results Rule buckets. May be positive or negative. 0 = Current bucket -1 = Previous Bucket 1 = Next bucket fletc.

If the leaf value is the same as the formula leaf you are modeling, it will read what was in the Cash Flow results table before processing the formula leaf you are processing. To access the values as they change during the calculation, use CLFE

---



---

**Note:** To access the results from multiple leaves, you must add together multiple FE functions (e.g. FE(995,100,0) + FE(996,100,0) +...)

---



---

**CLFE (FE,Lag)**

Used in Cash Flow and Gap Formulas only

The CLFE Function returns the value of the financial element of the current leaf in memory. This function allows you to use the result of a prior calculation within the Formula Results Rule which does not reside in the Cash Flow Results table. CLFE differs from FE (same leaf) because it accesses the computed value of the financial element, not what was in the results table when processing began

Syntax:

Where:	FE	Function Name
	Lag	Relative to Formula Results Rule buckets. May be positive or negative. 0 = Current bucket -1 = Previous Bucket 1 = Next bucket etc.

**K (Coeff,Lag)**

Used in Cash Flow Formulas only

The K Function allows the use of a user defined coefficient to be used in the formulas. Coefficients may be defined for each individual modeling bucket. This feature provides for ease of use and flexibility in building of Formula Results Rule formulas.

Syntax:

Where:	K	Function Name
	Coeff	User defined Coefficient Code number
	Lag	Relative to Coefficient defined buckets 0 = Current bucket -1 = Previous Bucket 1 = Next bucket etc.

**SFE (Leaf,FE)**

Used in Market Value Formulas only

The SFE function Returns the value of the Financial Element of the Leaf specified as stored in the Results\_Master table.

If the leaf value is the same as the formula leaf you are modeling, it will read what was in the Cash Flow Results table before processing the formula leaf you are processing. To access the values as they change during the calculation, use SCLFE.

Syntax:

Where:	SFE	Function Name
	LEAF	Dimension number of applicable hierarchy. If the leaf value is greater than nine digits, it must be input with a decimal point or the answer will return zero. (Example: Leaf value 123456789012345 returns a 0 value. Leaf 123456789012345.00 returns an accurately calculated value.)

---

**Note:** To access the results from multiple leaves, you must add together multiple SFE functions (e.g. SFE(995,2001) + SFE(996,2001) +...)

---

### SCLFE (FE)

Used in Market Value Formulas Only

The SCLFE Function returns the value of the financial element of the current leaf in memory. This function allows you to use the results of a prior calculation within the Formula Results Rule which may not reside in the results table. It differs from SFE (same leaf) because it accesses the computed value of the financial element, not what was in the results table when processing began.

Syntax

Where:	SCLFE	Function Name
fl	FE	Financial Element Code number (see table above)

### IGK(Coeff, Lag)

Used in Gap Formulas only

IRR Gap Coefficient function allows the use of a user defined coefficient to be used in the formulas. Coefficients may be defined for each individual Gap bucket. This feature provides for ease of use and flexibility in building of Formula Results Rule Formula.

Syntax:

Where:	IGK	Function Name
	Coeff	User defined Coefficient Code number
	Lag	Relative to Coefficient defined buckets 0 = Current bucket

Where:	IGK	Function Name
		-1 = Previous Bucket
		1 = Next bucket
		etc.

**LGK(Coeff, Lag)**

Used in Gap Formulas only.

Liquidity Gap Coefficient function allows the use of a user defined coefficient to be used in the formulas. Coefficients may be defined for each individual Gap bucket. This feature provides for ease of use and flexibility in building of Formula Results Rule Formula.

Syntax:

Where:	LGK	Function Name
	Coeff	User defined Coefficient Code number
	Lag	Relative to Coefficient defined buckets
		0 = Current bucket
		-1 = Previous Bucket
		1 = Next bucket
		etc.

**SK (Coeff)**

Used in Market Value Formulas

The SK Function allows the use of a user defined coefficient to be used in the formulas. This features provides for ease of use and flexibility in building of Formula Results Rule formulas.

Syntax:

Where:	SK	Function Name
	Coeff	User defined Coefficient Code number

**RT (IRC, Lag, Term, Mult)**

Used in Cash Flow Formulas only

The RT function returns the value of the Forecasted Interest Rate Code from the Forecast Rate ID utilized in the Processing ID.

Syntax:

Where:	RT	Function Name
	IRC	Interest Rate Code used in Historical and Forecast Rate ID.
	Lag	Relative to Formula Results Rule buckets. May be positive or negative. 0 = Current bucket -1 = Previous bucket 1 = Next bucket etc.
	Term	Point on the yield curve.
	Mult	Numeric code for multipliers 1 = Days 2 = Months 3 = Years

**Note:** The Term/Mult combination must be exact, even for interest rate codes with a single point. If the interest rate code has a 1 Y point, you cannot refer to it as the 12 M point. You must use 1 Y. Refer to the chapters Historical Rates ID or Forecast Rates ID elsewhere in this Guide for exact Term/Multiplier definition.

Example: The 1 Year point on the Treasury Yield Curve (110) with no lags = RT(110,0,1,3)

**DAYS (Lag)**

Used in Cash Flow Formulas Only

The DAYS function returns the number of days in the current modeling bucket or a range of modeling buckets. For example, if you defined 60 monthly modeling buckets in the Config. ID. The DAYS function will return the number of days in its respective bucket, i.e. January; 31 days, February; 28 days. Conversely, if you had defined each modeling bucket to be a period of just 2 weeks, the DAYS function would return 14.

Syntax:

Where:	DAYS	Function Name
	Lag	Relative to Formula Results Rule buckets. May be positive or negative.
Bucket 1- January	Bucket 2 - February	Bucket 3 - March
31 days	28 days	31 days
DAYS (0) Result: 31	DAYS(-1) Result: 59	DAYS(-2) Result: 90

The Lag feature in the DAYS function works differently than the other functions. Where lag normally identifies from which bucket relative to the current bucket to extract data, in the DAYS function it works as a parameter for accumulation. For example, a lag of -1 will take the number of days in the previous bucket and add it to the number of days in the current bucket, i.e. Results: 59

### MONTH()

Used in Cash Flow Formulas Only

The MONTH function returns the numeric value of the month of the 1st day of the current modeling bucket. Example: Current modeling bucket is January; MONTH() will return 1. If the modeling bucket is Jan-1 through Mar-31, MONTH( ) will also return 1.

Syntax:

Where:	MONTH	Function Name
	()	open/close parentheses

## Additional Functions

As well as system defined Functions, the Formula Results Rule also utilizes the standard mathematical, logical and relational operands and functions.

## Mathematical Functions

Abs	Returns the positive value of the expression. Example: Abs(-3.5) = 3.5.
Greatest:	Allows you to return the maximum value of the expression. Syntax: Greatest(Expr, Expr).
Least:	Allows you to return the minimum value of the expression. Syntax: Least(Expr, Expr).
Power:	Allows you to raise one value to the power of a second. Syntax: Power(x, y) -- returns x raised to the power of y.
Round:	Allows you to round a value to a number of decimal places. Syntax: Round(x, n) -- returns x rounded to n decimal places.
Log:	Allows you to calculate the log of the expression Syntax: Log(x, n) -- returns the n log of x.
Case:	Allows you to define if conditionals. Syntax: case when 21>12 then 21 else 12 end

## Relational Operators

Operator	Description
=	Equal to
<>	Not Equal to
>	Greater than
<	Less than
>=	Greater than or Equal to
<=	Less than or Equal to

## Numeric Operators

Operator	Description
+	Addition
-	Subtraction
*	Multiplication
/	Division

## Logical Operators

Operand	Description
AND	Both conditions must be true
OR	Either condition can be true

## Other Operators

Operand	Description
(	Open paren
)	Close paren
,	Comma

## Examples

### Cash Flow: Simple Account Type

The screenshot shows the 'Formula Results - Financial Elements' section of the OFSALM interface. It displays a table with columns for 'Financial Element', 'Bucket 1', 'Bucket 2', and 'Bucket 3'. The data is as follows:

Financial Element	Bucket 1	Bucket 2	Bucket 3
60 Beginning Balance	2*FE(105, 60.0)	2*FE(105, 60.0)	2*FE(105, 60.0)
80 Beginning Net Rate	2*FE(105, 60.0)	2*FE(105, 60.0)	2*FE(105, 60.0)
100 Ending Balance	2*FE(105, 100.0)	2*FE(105, 100.0)	2*FE(105, 100.0)

Gap: Leaf B = 2 \* Leaf A



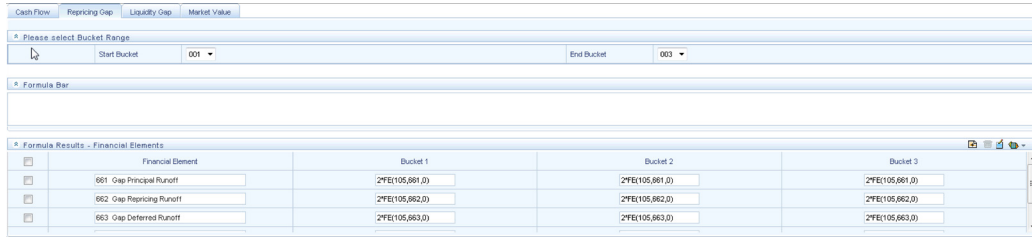

In this example, we are defining Cash Flow formula leaf with results that are twice the level of leaf value 105. We have inserted a row for every interest related cash flow financial element. Each of the formulas uses the FE( ) function to access the same financial element from leaf 105 with no lags.

### Market Value

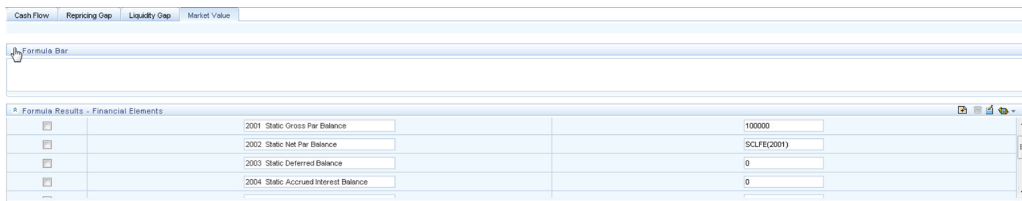

In this example, we are using the Market Value formula leaf section to input current position information and start dates for the formula leaf. By using the SFE( ) formula in either the Gap or Cash Flow sections, we can access these current position values.

### Financial Types Matrix

For a list of financial elements, see the Oracle Financial Services Technical Reference Manual.



---

---

## Stochastic Rate Indexing

This module describes the steps you need to take to work with and manage Stochastic Rate Indexing Rules.

This chapter covers the following topics:

- [Overview of Stochastic Rate Indexing Rules](#)
- [Defining Stochastic Rate Indexes](#)

### Overview of Stochastic Rate Indexing Rules

The purpose of the Stochastic Rate Index Rule is to establish a relationship between your risk-free interest rate codes (IRCs) and each of the other interest rate codes or indices. With this relationship established, you can forecast rates on any instrument tied to an IRC and as the risk-free rates change, the change in non risk-free interest rates will follow accordingly.

Examples of non risk-free interest rate codes are:

- Prime
- Libor
- Administered rates
- 11th District COFI

The Stochastic Rate Index Rule is used only in stochastic processing. see [Defining Stochastic Rate Indexes](#)

The procedure for working with and managing the Stochastic Rate Index rule is similar to that of other Oracle Asset Liability Management business rules. It includes the following steps:

- Searching for Stochastic Rate Index rules. For more information, refer to [Searching for Rules](#) section.
- Creating Stochastic Rate Index rules. For more information, refer to [Creating Rules](#) section.
- Viewing and Editing Stochastic Rate Index rules. For more information, refer to [Viewing and Editing Rules](#) section.

- Copying Stochastic Rate Index rules. For more information, refer to [Copying Rules](#) section.
- Deleting Stochastic Rate Index rules. For more information, refer to [Deleting Rules](#) section.

## Defining Stochastic Rate Indexes

A formula must be defined for each interest rate index tied to an instrument. That formula takes the following form:

$$\text{Index Rate}_{\text{term } m} = K_1 \text{ Risk Free Rate}_1^{x1} + K_2 \text{ Risk Free Rate}_2^{x2} + \dots + K_8 \text{ Risk Free Rate}_8^{x8} + \text{Spread}$$

To create your formula, you can select up to eight terms (elements) from the Risk Free curve, each multiplied by a user-defined coefficient and raised to the power of a user-defined exponent. Additionally, you can add a constant spread to the formula. It is not necessary to define any assumptions for the risk free curve. Any definition for this curve is ignored and does not affect processing.

Each of the elements you define consist of:

- A coefficient: A multiplier to weight each term selection.
- An exponent: An exponent to allow for polynomial curve-fitting.
- A term selection: A selection of rates associated with a term from the risk-free curve.

These elements define a different rate forecast generated for each instrument, with a given IRC. The definition of rate indexes is part of the create Stochastic Rate Index rule process in which rate indexes are defined for currency-valuation curve combinations. When you click Save in the create Stochastic Rate Index rule process, the rule is saved and the Stochastic Rate Index rule summary page is displayed. However, the rate indexes have not yet been defined for any of the currency-valuation curve combinations. Typically, you would start defining the rate indexes for currency-valuation curve combinations before clicking Save.

### Prerequisites

- Deciding on historical rate information and managing by creating Interest Rate Codes
- Performing basic steps for creating or editing a Stochastic Rate Index rule

### Procedure

This table describes key terms used for this procedure.

Term	Description
Valuation Curve	The Valuation curve is used to calculate the future rates of Indexes (IRCs) defined in a Stochastic Rate Index rule. Oracle Asset Liability Management allows you to assign a Valuation curve for each currency during the create process of the Stochastic Rate Index rule. Typically, the Valuation curve and the indexed rate curves derived from it have the same Referenced Currency. For example, you will use the US Treasury Yield Curve as the Valuation curve to calculate the forward rates of any US dollar-based Interest Rate Code.
Coefficient	A multiplier to weight each term selection.
Exponent	An exponent to allow for polynomial curve-fitting.
Index Term	An Interest Rate Code is made up of one or many term points that denote a particular interest rate yield curve structure. Oracle Asset Liability Management generates future rates for term points in the Interest Rate Code based on an arithmetic formula that has the following components: A combination of term point rates from the valuation curve (with a maximum selection of eight terms or elements), which need not be the standard term points as defined in IRC definition of the valuation curve. A coefficient and an exponent for each of the valuation curve term points. A single spread per index term point. A formula must be defined for each index tied to an instrument. That formula takes the following form:

$$\text{Index Rate}_t = \sum_{n=1}^8 [\text{Coefficient}_n \times (\text{RFR}_T)^{\text{Exponent}_n}] + \text{Spread}_n$$

Where:

t is the term point of the index

T is the term point of the valuation curve

n is the number of term points of the valuation curve referenced

RFR is the rate of the specific term point on the valuation curve

To create your formula, you can select up to eight term points (elements) from the risk free curve, each multiplied by a user-defined coefficient and raised to the power of a user-defined exponent.

Additionally, you can add a constant spread for each of the term points used in the formula.

⌵ Rate Index Details

Name*	Stoch Rate Index Rule
Description	Use this rule to establish relationships between the Valuation Curve and related curves used for pricing / re-pricing
Folder	ALL <span style="font-size: small;">▼</span> Access Type <span style="margin-left: 20px;"> <input checked="" type="radio"/> Read/Write <input type="radio"/> Read Only             </span>

Rate Index Assumptions

Valuation Curves	Index Definition for Currency	Index Term Definition
------------------	-------------------------------	-----------------------

⌵ Valuation Curves

Hint: Define valuation curve and index for each Currency

<input type="checkbox"/>	AUD	Australian Dollar	
<input type="checkbox"/>	GBP	British Pound	
<input type="checkbox"/>	EUR	Euro (European EMU)	
<input type="checkbox"/>	JPY	Japanese Yen	
<input type="checkbox"/>	NGN	Nigerian Naira	
<input checked="" type="checkbox"/>	USD	US Dollar	US Treasury Curve

Apply	Cancel
-------	--------

⌵

Save	Cancel
------	--------

1. Navigate to the Stochastic Rate Index Valuation Curve assignment page.
2. Select the currency you want to work with.
3. Select a Valuation Curve for the currency you selected in the previous step.

---

**Note:** Only a single Valuation Curve can be associated with a particular currency. For example, if the Valuation Curve for US Dollars is US Treasury Curve, all US Dollar indexes will be associated with the US Treasury curve.

Ideally, you need to select a risk free interest rate structure. Not all the Interest Rate Codes in the application will have the characteristics of a risk free rate curve, but the application will not prevent you from selecting any curve as the Valuation Curve.

---

4. Select Apply. The Index Definition for Currency page is displayed

### Procedure to Add the Index

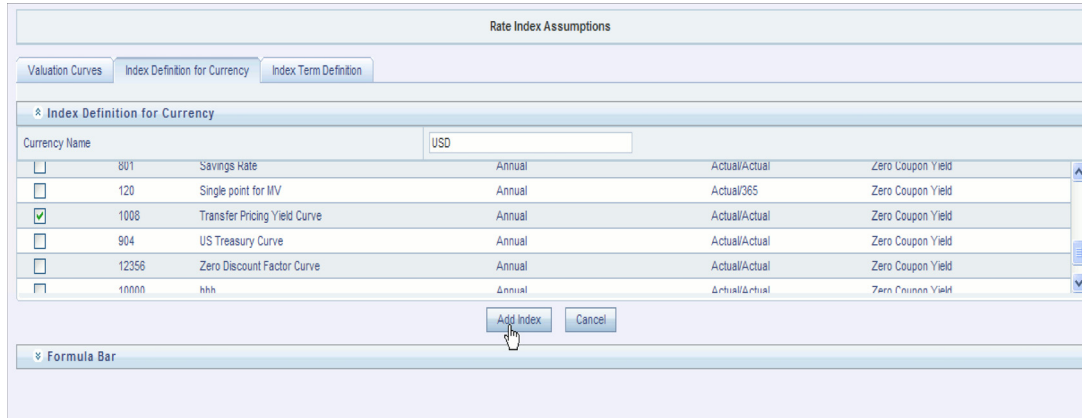

5. Select the Index you want to define.
6. Click Add Index. The Add Index Term Definition page is displayed. The general attributes of both the valuation curve and the selected IRC, are displayed. This information can be used as a reference when you define the terms.

**Procedure to Add Index Term Definitions**

Each Index Term Point can be calculated from up to eight elements of the valuation curve. The valuation curve elements specified can be any term point on the yield curve; it is not restricted to the points displayed for the valuation curve.



7. Select the Index Term you want to define. Not all IRCs have Term Points defined. To successfully define an Index, you must define at least one of its terms. Optionally, you could define one, many or all of the Index Terms. The selection of Index Term is limited to the standard Term Points as defined in the IRC definition.
8. Enter a Spread for the Index Terms, if required. A Spread is a constant percentage added to the rate produced as a result of the Monte Carlo calculations, multiplication with the defined coefficient and raising to the power of the mentioned exponent.
9. Enter the Valuation Curve Term Point and select the multiplier.

10. Enter a coefficient for the element.
11. Enter an exponent for the element.
12. Repeat the last four steps for a maximum of seven more elements for each term.
13. Click Apply (from the bottom of the page) when indexing has been completed for all required term points.

The Stochastic Rate Index Valuation Curve page is displayed. You can navigate to the Index Definition tab and continue defining rate index relationships for the existing currency selection or you can switch currencies, define the valuation curve for the new currency and proceed with Rate Index definitions.

---

---

**Note:** During rule creation, on the Index Definition for Currency tab, all undefined IRC's are displayed in the top half of the screen and all defined IRC's are displayed on the bottom half of the screen. Upon saving the rule and re-entering in Edit mode, you see the status reflected for all defined (green) and undefined (red) IRC's in the top half of the screen. If you want to Edit any of the Rate Index relationships, while in rule EDIT mode, select the appropriate IRC and again select Add Index and proceed with any changes.

---

---

14. Click Save to save the changes.

The Stochastic Rate Index rule summary page is displayed.



---

---

## ALM Processing

When all the required assumptions are defined, ALM Processing performs calculation processes and generates a result set. There are four types of ALM processing rules, each to be described in detail later in this module.

- Static Deterministic
- Static Stochastic
- Dynamic Deterministic
- Dynamic Stochastic

Depending on what type of process you choose, the corresponding Process Rule guides you through the required inputs on the process flow screen.

This chapter covers the following topics:

- [Overview of ALM Processes](#)
- [Creating an ALM Process Rule](#)
- [Executing an ALM Process](#)

### Overview of ALM Processes

ALM Processes allow you to perform the following tasks:

- Determine the data that you want to process (Product Hierarchy block).
- Submit to the ALM processing engine the financial element results you want to calculate: (Calculation Elements).
- Specify to the ALM processing engine the product characteristics, prepayments, discount methods and forecast assumptions to be used in the process (Rule Selection blocks).
- Specify the Forecast Rate Scenarios (for Deterministic processes) or Rate Index (for Stochastic processes) you want to include.
- Specify a process with only runoff (Static), or with new business included (Dynamic).

- Define the output dimension and what additional attributes you want updated at the instrument level (Output Preferences block).
- Enable the output of detailed cash flows or forecast interest rates for audit purposes (Audit Options block).
- Define the processing parameters for a reprocess on an existing run or an entire new process (Processing Parameters block).
- Formulate and execute the ALM processing request and generate results (ALM Process Summary Page).

Following buttons are available on Process Summary grid:

### **Add**

Clicking on the Add control allows you to create a new ALM Process rule. The Add control is disabled if any rows in the grid have been selected.

### **View**

Selecting a single row out of the grid enables the View control. Clicking on the View control allows you to view the contents of a Process on a read-only basis. The View control is only enabled when a single Process rule has been selected.

### **Edit**

Selecting a single row out of the grid enables the Edit control. Clicking on the Edit control allows you to modify a previously saved Process rule. The Edit control is only enabled when a single Process rule has been selected.

### **Copy**

Selecting a single row out of the grid enables the Copy control. Clicking on the Copy control allows you to create a copy of an Process rule. The Copy control is only enabled when a single Process has been selected.

### **Check Dependencies**

To generate a report on the OFSAA rules that utilize a selected process, select a single process and click on the Check Dependencies control. The Check Dependencies control is only enabled when a single process has been selected.

### **Delete**

Selecting one or more rows out of the grid enables the Delete control. Clicking on the Delete control deletes the process rule(s) you have selected.

### **Execute**

Clicking on Execute button allows you to execute an existing process. After execution, the status of process will either change to Success or Fail.

### **Refresh**

Clicking on refresh button refreshes the Process Rule summary page.

## BI Transformation

Transformation ALM results button allows you to push the ALM Results from the ALM Processing area to the ALM BI Mart. It moves the ALM result data from ALM Processing Tables to ALM BI FACT Tables for Reporting. It transforms both Deterministic and Stochastic ALM results as well as other related information such as forecast rates and detailed cash flows, based on the type of process and processing options selected. Note, this option will be enabled only if user is mapped to ALM BI application.

## Creating an ALM Process Rule

To define an ALM Process Rule, complete the following steps:

1. Determine the required process type: Static or Dynamic, Deterministic or Stochastic and choose the desired process from the menu bar.

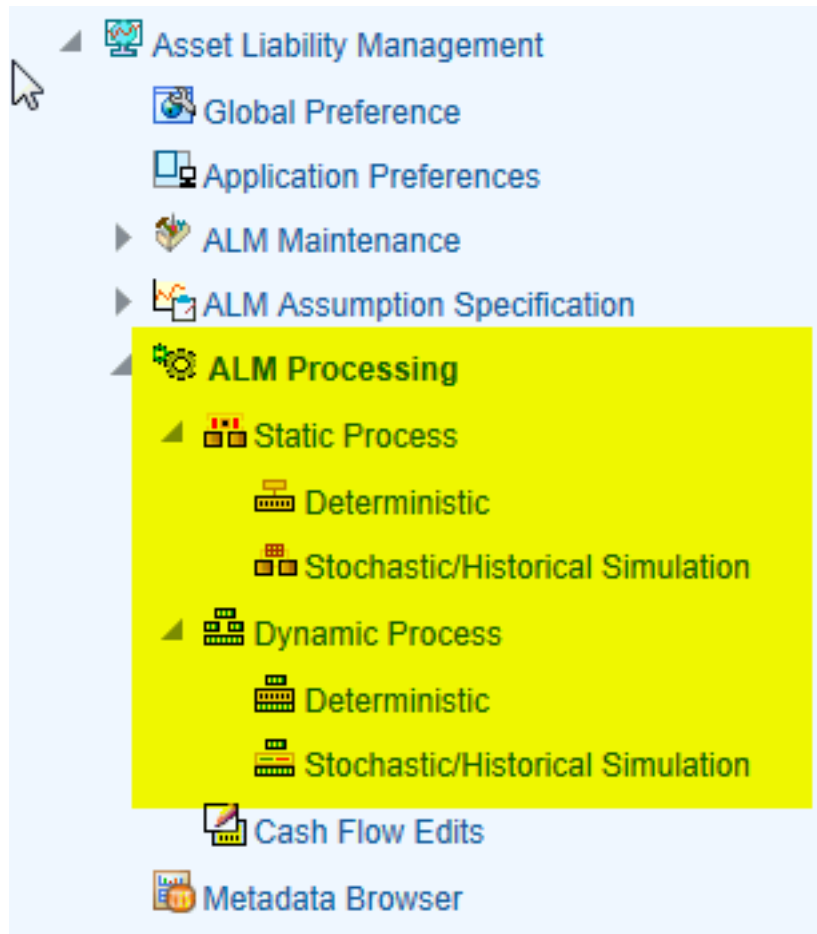

2. From the Summary Page, click the “Add New” icon.
3. The process will take you through a series of required steps to define the flow depending upon what type of process you selected. For each of the blue highlighted boxes in the process flow area, you are required to make a selection.

**Note:** The gray boxes are optional but will have an effect on the result set if defined

## Creating a Static Deterministic ALM Process Rule

Deterministic processing generates output based on a set of user-defined forecast rate scenarios. The static process indicates that new business assumptions are not included in this flow.

1. Fill in the necessary details in the **Process Details** block:
  - Name
  - Folder and Reporting Currency from respective drop-down menus
  - Click “Apply”. The process will take you to the Product Hierarchy selection options.

The screenshot displays the 'Static Deterministic Process Flow' configuration window. The top part is a flowchart showing the sequence of steps: Process Details, Product Hierarchy, Calculation Elements, Discount Methods, Product Characteristics, Forecast Rate Scenarios, Formula Results, Prepayments/Early Redemptions, Output Preferences, Audit, Processing Parameters, and Freeze Process. The bottom part is the 'Process Details' form, which includes the following fields and values:

Name*	ALM UG		
Description			
Folder*	IUTSEG	Reporting Currency*	US Dollar
Access Type*	<input type="radio"/> Read Only <input checked="" type="radio"/> Read/Write		

At the bottom of the form, there are two buttons: 'Apply' and 'Return To Summary Page'.

2. In the product Hierarchy Block,
  - a. Select a Product Hierarchy and select nodes from the hierarchy corresponding to data you want to include in the process, OR
  - b. Alternatively, select the Source Selection button, and select the instrument tables corresponding to the data you want to include in the process.
  - c. Select a Filter (optional), to further constrain the data to be included in the process. Filters work as a secondary constraint, applied after the data set is determined based on Product Hierarchy member selection or Source Selection.

---



---

**Note:** Do not use Default Product Member (value of -1) within a Product Hierarchy, for Processing. For example, if the process is running on Product Hierarchy of Common Chart of Account, do not use default chart of account member of -1.

---



---

There are four types of filters:

Data Element Filter

Hierarchy Filter

Group Filter

Attribute Filter

---



---

**Note:** Before using the product hierarchy approach for selecting data to include in your process, there is a procedure that must be run ("PRODUCT TO INSTRUMENT MAPPING"). This procedure can be executed from the Batch Scheduler – Run - interface.

The purpose of the Product to Instrument mapping procedure is to scan all instrument tables (FSI\_D\_XXX) and populate the mapping table ("FSI\_M\_PROD\_INST\_TABLE\_MAP") with a listing of the product dimension members that exist within each instrument table. When you select Products (parents or children) within an ALM or FTP process definition, the process refers to this mapping table to identify the instrument tables to include in the process.

It is recommended that you establish an internal process whereby this procedure is executed after every data load to ensure that mappings are up to date.

---



---

Related Topics: For more information on Product to Instrument mapping procedure, see *Oracle Financial Services Analytical Applications Data Model Utilities User Guide*.

- d. Select apply.
3. Rule Selection Blocks – The boxes in blue with the yellow highlight are required for the definition of the process.
    - a. In the Calculations Elements block, select either the Generated aggregated cash flow results or Stop at the Process cash flows option. By default, the Generated aggregated cash flow option is selected and required for most ALM results processing. The Stop at the Process cash flows option is only used when you do not require the aggregated results and wish to only compute detail cash flows in the FSI\_O\_PROCESS\_CASH\_FLOWS table. This is used by users who integrate with Liquidity Risk Management and need to create cash detailed flow output for a large number of instrument records. In this case, the aggregate output is not needed. The Stop at process cash flows option does not write aggregated results to the Result or Consolidated Master or Result or Consolidated Detail output tables.

- b. Choose the calculation elements to include in the process run: "Market Value, YTM, Duration, DV01/PV01", "Repricing Gap", "Liquidity Gap", "Average Life", "Transfer Pricing" – if defined then select the Folder and Transfer Pricing Rule, TP Adjustments – if defined\* then select the Folder and TP Adjustment Rule, Effective Interest Rate, Repricing Balances and Rates, Runoff components, Prepayment Runoff – if defined, Tease, Cap, Floor and Negative Amortization Details, Standard Financial Elements.

---

**Note:** The Adjustment folder and method are un-editable, since the adjustment rates are constant for the life of the record and will be read from the instrument record. You only need to check the TP adjustment box to persist the adjustment rates thru to the forecast.

---

- c. Select the Market Value, YTM, Duration, DV01/PV01 option if you want to measure the price sensitivity for small changes in the underlying interest rate curves (DV01/PV01). For this calculation, Market Value is also required.
- d. Choose Embedded Option Decisioning. This is an optional selection. This is a drop-down list with the following values:
  - Cashflow to Maturity– This selection ignores the option on the instrument and treats it as a regular bond. This is the default behavior.
  - Cashflow to the first Expiry Date– This selection forces the option on the instrument to be exercised on the first applicable date. American options exercise the option on start date if option start date > as of date. Else, if as\_of\_date > option start date, the option is called in the 1st time bucket.
  - Rate Path Dependent – This selection, checks the exercisability of the option on the bond, as per the scenario defined.
- e. The Calculate Option Market Value option is used to calculate the Market Valuation (MV) for certain embedded and stand-alone (bare) options. Supported embedded options are Calls, Puts, Caps (caplets) and Floors (floorlets). This option will be enabled only if Market Value, YTM, Duration, DV01/PV01 option is also selected.

For example,

When Calculate Option Market Value check-box is selected and RATE\_CAP\_LIFE has data filled (that is, holds a non-null value greater than 0), then Embedded CAP Option MV will be calculated.

When Calculate Option Market Value check box is selected and RATE\_FLOOR\_LIFE has data filled (that is, it is non-null value greater than 0 or it is less than RATE\_CAP\_LIFE and RATE\_CAP\_LIFE is greater than 0), then Embedded FLOOR Option MV will be calculated.

- f. Click “Apply”.
  - g. If Market Value is chosen from step 1 above, the Discount Methods box will become highlighted blue and need to be defined (see [Discount Methods](#), for rule set up). If no market value chosen, continue to step 5 below.
  - h. Select from the discount methods box the desired method (see [Discount Methods](#), for set up) and click “Apply”.
  - i. From the Product Characteristics bar, select the desired definition and click "Apply" (see [Product Characteristics](#), for rule definition).
  - j. Select the Forecast Rates rule you want applied to the process, and click “Apply”. (see [Forecast Rate Scenarios](#) , to set up rate scenarios). The flow will now take you to output preferences. Or, if you want to add a prepayment rule to the process, continue to step 7 below.
  - k. Click the Prepayments/Early Redemptions box and choose the defined prepayment rule (see [Prepayment Rules](#) ). This is an optional step.
4. Output Preferences options
- a. Select the output dimension from the drop-down list (Options include: Product, Product/Currency, Organization/Product, Organization/Product/Currency).
  - b. Depending on the dimension chosen, you can Consolidate to Reporting Currency by checking the box if the dimension Product /Currency or Organization/Product/Currency was chosen.
  - c. If you have the ALMBI reporting product, you can select to export the results to the ALM BI Mart by clicking the box. You also have the option to update the Instrument Data Tables with financial measures by checking the box of the desired calculated item (Market Value, Macaulay Duration, Modified Duration, Convexity, Yield to Maturity, Average Life, DV01/PV01, Option Market Value, Structured Cashflow Attributes\*). The DV01/PV01 and Option Market Value options will be enabled only if Market Value, YTM, Duration, DV01/PV01 option is selected in Calculation block.
  - d. Click “Apply” after the page is defined. The process will take you to the Processing Parameters section. Or you can click the audit box for the following options: If no audit options are required, skip to #6, Processing Parameters.

Output Preferences	
Output Dimension*	Product
<input type="checkbox"/> Consolidate to Reporting Currency	<input type="checkbox"/> Move Results to ALM BI Mart
<b>Update Instrument Data with :</b>	
<input type="checkbox"/> Market Value	<input type="checkbox"/> Effective Interest Rate
<input type="checkbox"/> Macaulay Duration	<input type="checkbox"/> Convexity
<input type="checkbox"/> Modified Duration	<input type="checkbox"/> Yield to Maturity
<input type="checkbox"/> DV01/PV01	<input type="checkbox"/> Average Life
<input type="checkbox"/> Fair Value Output	<input type="checkbox"/> Option Market Value
<input type="checkbox"/> Structured Cashflow Attributes	
<input type="button" value="Apply"/> <input type="button" value="Return To Summary Page"/>	

**Note:** \* The Structured Cashflow Attributes option will be enabled only if you are mapped to Moody's structured cashflow functionality.

5. Audit Preferences (optional)

- **Detailed Cash Flow:**

Check the box to record the cash flows and repricing events occurring for the desired number of records processed. For each record, daily results are written to the FSI\_O\_PROCESS\_CASH\_FLOWS table. The data in this table uses the RESULT\_SYS\_ID, which identifies the Process used. Select from the options below:

Input the desired number of Records in the dialog box

Select all records to be output.

In the financial elements tab below, you have the option to select the FE's you want to output in the detail cash flows table. Highlight the items in the available section and move selection over to the selected section.

Click apply, or go to step 2 for Forecast rates output.

- **Forecast Rates**

Select Forecast Rates to write forecast exchange, interest rates or economic indicator results to the following tables: FSI\_EXCHANGE\_RATES\_AUDIT, FSI\_INTEREST\_RATES\_AUDIT, and/or FSI\_ECONOMIC\_INDICATORS\_AUDIT. For more information on the table structures, see the Oracle Financial Services Analytical Applications Data Model Data Dictionary.

Highlight items from the available code section for the desired forecast type (Interest Rate, Exchange Rate, or Economic Indicator) and move selection (or all) to the selected items box.

**Note:** For consolidation of Formula Results output, ensure to select respective currencies in Audit section.

Click "Apply" and the screen will take you to Processing Parameters.

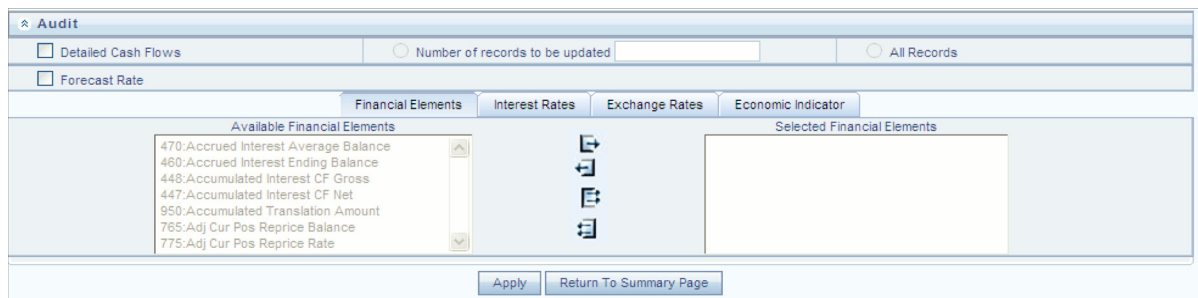

6. Processing Parameters:

- a. The processing parameters allow you to run an entire process or re-process a portion of an existing run. From the drop-down list, select Entire Process or Selective Reprocess.



- b. If Selective Reprocess is selected, you can click the box “Current Position Data” to reprocess that particular data set. With selective reprocessing you can run a subset of the process to replace invalid products and to add new products. With Selective Reprocess, the Reprocessing components are enabled to selected components for reprocessing. When the Process Rule is executed, the data in the result tables are not immediately deleted. The data for the selected subset is replaced, but the rest of the results remain intact.
- c. Select Auto balancing accounts: If you selected Auto Balancing in the Output Preferences (section 4.4.) the Auto Balancing Accounts option is available for re-processing. Click the box to apply.
- d. Select the desired product Hierarchy Filter from the drop-down list to indicate which products should be re-processed.
- e. Click “Apply” and the screen will take you to Freeze Process section.

7. Freeze Process
  - a. Select Freeze to complete the process.
  - b. Select Reset to erase all selections made previously within the process definition flow.
  - c. Select **Confirm**.
8. "Stop holiday calendar" checkbox is provided with a calendar date picker. If checked, a calendar is enabled on which a date can be selected. Cash flows generated post this date will not apply the holiday calendar. On selecting the checkbox a warning message will pop up stating "If Enabled, the outputs could have a combination of adjusted and unadjusted cashflows".

---

**Note:** Holiday calendar is used to adjust the outputs on holiday events, which may increase processing time. If Users do not want to have adjusted output after a certain time point, say, when buckets become wider, then this field stops adjusting cashflows from that time point, reducing processing time. If user wants to have cash flow adjusted for entire processing period, then this field does not require any input.

---

## Creating a Static Stochastic / Historical Simulation Process Rule

Stochastic Processing differs from Deterministic Processing in that it generates Market Value and Value at Risk through Monte Carlo simulations. Rate scenarios are generated based on Random 1 month rates and a Term Structure model, which describe how the interest rate curve changes over time. Before instrument records are processed, balance and payment fields are first translated to the reporting currency, and then reported in the reporting currency.

**Note:** Stochastic simulation is a single factor modeling of interest rates of Reporting Currency. Although the engine does convert Balances into Reporting Currency, there is no correlation of Risk factors of particular Currency's Interest rates with Reporting Currency. Stochastic processing is not intended for Multi-currency processes.

For best results, run Stochastic calculation for a Single currency where Functional Currency = Reporting Currency.

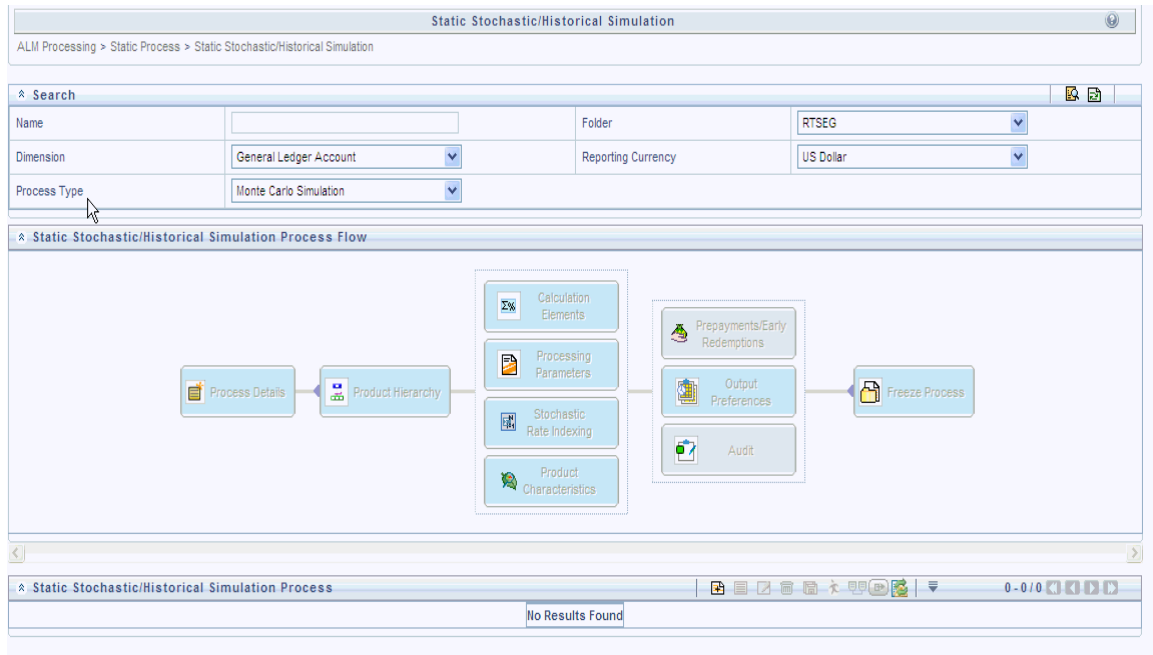

1. Follow steps 1 and 2 from the Static Deterministic process defined above.
2. Calculation Elements
  - a. Select the calculation elements. There are two choices: VaR and Market Value

**Value at Risk:** Value at Risk measures the probability of changes in value of the current position data, occurring over specified time horizons, displayed in the interface as the At Risk period. The At-Risk period defines the time period over which changes in market value are calculated.

When the user selects the Value at Risk calculation option and subsequently runs the process, the software will in addition to calculating the current market value, calculate the change in market value for each rate path and rank these changes in market value for each product leaf and for the entire balance sheet. These results are stored in two tables: FSI\_O\_STOCH\_VAR and FSI\_O\_STOCH\_TOT\_VAR.

Note: When Value at Risk is selected, market value is also written to the FSI\_O\_STOCH\_MKT\_VAL table.

**Market Value:** Market Value is calculated per rate scenario for each Product Leaf member. The result Market Value is the total Market Value over the

number of rate paths per Product Leaf. The results are stored in FSI\_O\_STOCH\_MKT\_VAL.

- b. "Stop holiday calendar" checkbox is provided with a calendar date picker. If checked, a calendar is enabled on which a date can be selected. Cash flows generated post this date will not apply the holiday calendar. On selecting the checkbox a warning message will pop up stating "If Enabled, the outputs could have a combination of adjusted and unadjusted cashflows".

---

**Note:** Holiday calendar is used to adjust the outputs on holiday events, which may increase processing time. If Users do not want to have adjusted output after a certain time point, say, when buckets become wider, then this field stops adjusting cashflows from that time point, reducing processing time. If user wants to have cash flow adjusted for entire processing period, then this field does not require any input.

---

- c. Click "Apply" and the screen will take you to Processing Parameters.

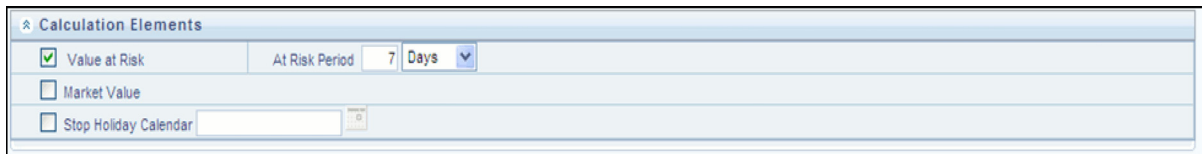

- 3. **Processing Parameters:** Here you set the parameters for the stochastic process by selecting the term structure model, smoothing method, number of rate paths, Random number generation method, and seed value. Each is described in the following sections

There is a toggle that enables the user to choose between Monte Carlo Simulation and Historical Simulation, with the default selection being Monte Carlo Simulation.

If Historical Simulation is selected, only Smoothing Method and Number of Rate Paths is enabled for selection. If Monte Carlo Simulation is selected, then all the five parameters are enabled for selection.

- a. **Term Structure Method:** four models to choose from: For more information on term structure models, see the Oracle Financial Services Analytical Applications Cash Flow Engine Reference Guide.

Merton—real interest rate model

Ho and Lee—no arbitrage model

Vasicek—real interest rate model

Extended Vasicek— no arbitrage model

- b. **Smoothing method:** Smoothing is the drawing of a smooth, continuous line through observable market data points. Because there are an infinite number of these lines passing through a given set of points, additional criteria must be added to the smoothing process to achieve the desired term structure. The following methods are available:

Linear Interpolation – Linear interpolation uses linear yield curve smoothing. Linear yield curves are continuous but not smooth; at each knot point there is a kink in the yield curve. You may not want to use a linear yield curve with a

model that assumes the existence of a continuous forward rate curve, due to the nonlinear and discontinuous knot points of a linear yield curve.

**Cubic Spline of Yields** – A cubic spline is a series of third degree polynomials that have the form

$$y = a + bx + cx^2 + dx^3$$

These polynomials are used to connect the dots formed by observable data. The polynomials are constrained so they fit together smoothly at each knot point (the observable data point.) This means that the slope and the rate of change in the slope with respect to time to maturity have to be equal for each polynomial at the knot point where they join. If this is not true, there is a kink in the yield curve and they are continuous but not differentiable.

Two more constraints make the cubic spline curve unique. The first restricts the zero-maturity yield to equal the 1-day interest rate. The second restricts the yield curve at the longest maturity to be either straight ( $y'=0$ ) or flat ( $y''=0$ ).

**Quartic Spline:** Quartic interpolation requires a minimum of 4 knot points. The quartic interpolation equation can be represented as

$$Y = a + b X^1 + c X^2 + d X^3 + e X^4$$

The end knot points satisfy equations for one curve and all intermediate points satisfy two curves. Hence in a scenario with minimum number of knot points, there will be 6 equations. For n number of knot points, the number of equations is  $2n-2$ . If n is the number of points to be interpolated, the order of the matrix to be formed is  $5*(n-1) \times 5*(n-1)$ . The matrix is formed according to the following logic:

The second derivative at the end points and the first derivative of the last point is Zero.

At the points other than the end points the value of the first derivatives, second derivatives and the third derivatives of the function are equal.

- c. **Number of paths** – Specifies the number of simulations to execute. The valid range is from 1 to 2100. If the number of rate paths is not within the range of 1 to 2100, then an error message is displayed to the user.

However, this value is subject to the Maximum number of Rate Paths for Monte Carlo Processing entered in the Application Preference. You can enter a value that is less than or equal to value that entered in the Maximum number of Rate Paths for Monte Carlo Processing field in the Application Preference.

- d. **Random Number Generation Method:** To run Monte Carlo simulations, you must specify the random number generator algorithm for the rate path generation.

**Low Discrepancy Sequences:** Also known as quasi-random sequences, are designed to prevent clustering of generated numbers; this results in achieving better accuracy than pseudo-random sequences when applied to numerical problems; integration in high dimensions, and so on

- e. **Pseudo Random Sequences:** The traditional random numbers generated by most compilers. They are designed to do well on some statistical tests: low autocorrelation, high period before the sequence repeats itself.
- f. **Seed Value:** Fixed or Variable. If fixed, maximum value of 999. Fixed seed selection results in the same set of random numbers being generated with each run. If you keep the fixed seed a constant value, you will be able to re-produce results from one run to another. The variable seed option allows the system to

determine the seed value randomly with each run. This option will result in a different set of random numbers for each run and hence different results from each run. Note: Seed value selections apply to the Pseudo Random Sequences option only.

Once defined, click “Apply” and you will be taken to the Rate Index screen.

Processing Parameters	
	<input checked="" type="radio"/> Monte Carlo Simulation <input type="radio"/> Historical Simulation
Term Structure Model*	Merton
Smoothing Method *	Linear Interpolation
Number of Rate Paths *	10
Random Number Generation Method*	Low Discrepancy Sequences
Seed Value*	Fixed Seed 0

4. Rate Index: Select the rate index as it was defined in the Stochastic Rate Indexing rule, (For additional information on the setup rules for rate indexing, see [Stochastic Rate Indexing](#))

Click “Apply”. The screen will take you to Product Characteristics.

Product Characteristics: Select the desired product characteristics rule. (For more information on creating a product characteristic rule, see [Product Characteristics](#))

Click “Apply” and the screen will take you to Output Preferences.

If you want to include a prepayment or early redemption rule in the process run, Click the Prepayments/Early Redemptions box and choose the defined prepayment rule (see [Prepayment Rules](#)). This is an optional step.

5. Output Preferences options
  - a. Select the output dimension from the drop-down list.

---

**Note:** Only Product output dimension is supported for Stochastic/Historical Simulation processing.

---

- b. If you have the ALMBI reporting product, you can select to export the results to the ALM BI Mart by clicking the box.
  - c. Click “Apply”. The screen will take you to the Freeze Process Or you can click the audit box for the following options: If no audit rule is selected, skip to #8, Freeze Process

Output Preferences	
Output Dimension*	Product
<input checked="" type="checkbox"/> Consolidate to Reporting Currency	<input type="checkbox"/> Move Results to ALM BI Mart
<input type="button" value="Apply"/> <input type="button" value="Return To Summary Page"/>	

6. Audit Preferences (optional)
  - a. Detailed Cash Flow: Check the box to record the cash flows and repricing events occurring for the desired number of records processed. For each record, daily results are written to the FSI\_O\_PROCESS\_CASH\_FLOWS table. The

data in this table uses the RESULT\_SYS\_ID, which identifies the Process used. Select from the option below:

Input the desired number of Records in the dialog box

- b. When Monte Carlo Simulation is selected in the Processing Parameters, the One Month Rates is enabled for definition. One Month Rates defines rates to be written during the Monte Carlo simulation for auditing purposes.

Select this option to view the rate paths generated during the stochastic processing run. When selected, 360 monthly rates are output to the FSI\_INTEREST\_RATES\_AUDIT table, for each rate path. Note: This process can be extremely time consuming and database space intensive when processing large numbers of rate paths

The screenshot shows a dialog box titled "Audit". It contains two checkboxes: "Detailed Cash Flows" and "One Month Rates". To the right of the "Detailed Cash Flows" checkbox is a text input field labeled "Number of records to be updated". At the bottom of the dialog, there are two buttons: "Apply" and "Return To Summary Page".

- c. When Historical Simulation is selected in the Processing Parameters, the All Term Point Rates for 5 Rate Paths is enabled for definition. All Term Point Rates for 5 Rate Paths defines rates to be written during the Historical Simulation for auditing purposes.

Once clicked, a warning message is displayed as follows: "Selecting All Term Point Rates will result in large amount of data being written to the Forecast Rates Audit table. Are you sure you want to proceed?"

The screenshot shows a dialog box titled "Audit". It contains two checkboxes: "Detailed Cash Flows" and "All Term Point Rates for 5 Rate Paths". To the right of the "Detailed Cash Flows" checkbox is a text input field labeled "Number of records to be output".

7. Freeze Process
  - a. Select Freeze to complete the process.
  - b. Select Reset to erase all selections made previously within the process definition flow.
  - c. Select Confirm.

## Creating a Dynamic Deterministic Process Rule

Dynamic Deterministic processing generates output based on a set of user-defined forecast rate scenarios and includes new business assumption rules in the process flow.

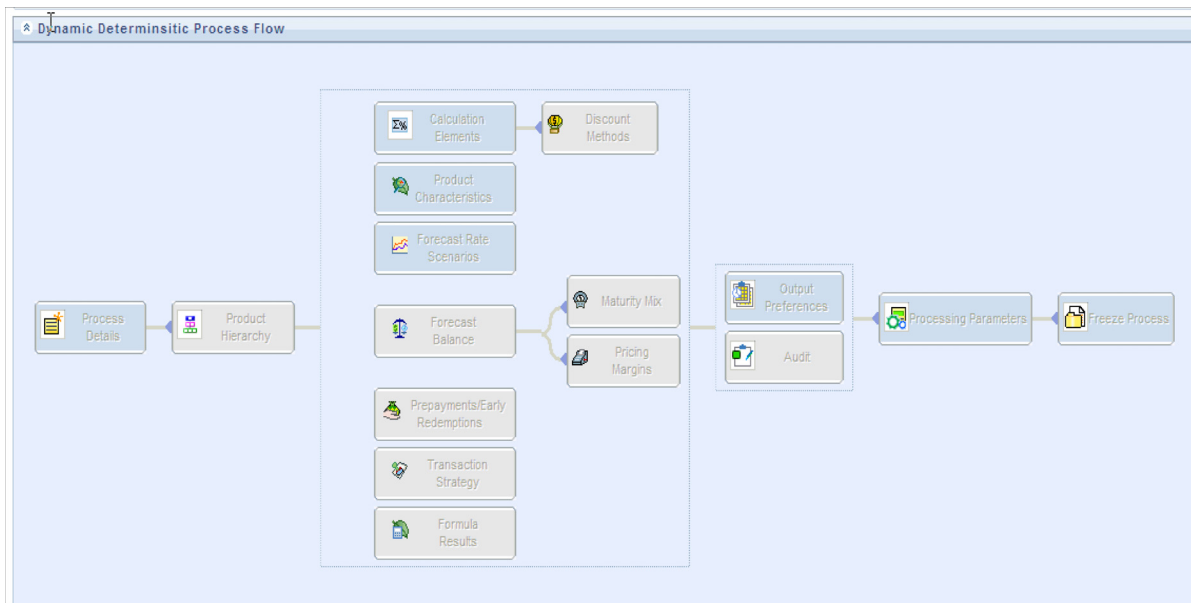

1. Follow steps 1 and 2 from the Static Deterministic process defined above.
2. Rule Selection Blocks

Calculation Elements	
<input type="checkbox"/> Market Value, YTM, Duration, DV01/PV01	<input type="checkbox"/> Effective Interest Rate
<input type="text" value="Stop Holiday Calendar"/>	<input checked="" type="checkbox"/> Repricing Balances and Rates
<input type="checkbox"/> Repricing Gap	<input checked="" type="checkbox"/> Runoff Components
<input type="checkbox"/> Liquidity Gap	<input type="checkbox"/> Prepayment Runoff
<input type="checkbox"/> Average Life	<input checked="" type="checkbox"/> Tease, Cap, Floor and Negative Amortization Details
<input type="text" value="Embedded Option Decisioning: None"/>	<input type="checkbox"/> New Origination Balances and Rates
<input type="text" value="Transfer Pricing: RTSEG"/>	<input checked="" type="checkbox"/> Standard Financial Elements
<input type="text" value="TP Adjustments: RTSEG"/>	

- a. Choose the calculation elements to include in the process run: "Market Value, YTM, Duration, DV01/PV01", "Repricing Gap", "Liquidity Gap", "Average Life", "Transfer Pricing" – if defined then select the Folder and Transfer Pricing Rule, TP Adjustments – if defined then select the Folder and TP Adjustment Rule, Effective Interest Rate, Repricing Balances and Rates, Runoff components, Prepayment Runoff – if defined, Tease, Cap, Floor and Negative Amortization Details, Standard Financial Elements.

Market Value can be calculated for the as-of-date and other dates in the future. These forward dates are defined in the Time Bucket Rule, and are shared with repricing and liquidity gap calculations. For more information on setting up dynamic start dates, see [Time Buckets](#)

Select the Market Value, YTM, Duration, DV01/PV01 option if you want to measure the price sensitivity for small changes in the underlying interest rate curves (DV01/PV01). For this calculation, Market Value is also required.

Gaps: Select Liquidity or Repricing Gap to generate dynamic gap results. To use this option, you must first define the related GAP buckets in your active Time Bucket rule. Gap profiles contain bucket-based runoff and reprice information. The information represents the balance sheet as of the dynamic

gap date. A special set of financial elements is produced for both repricing gap and liquidity gap results.

**Transfer Pricing:** During processing, the model tracks transfer rates and transfer pricing charges/credits on individual transactions. This information is aggregated, per leaf member, as financial elements and written to the results tables. Examples of transfer pricing financial elements include:

Beginning transfer rate

Ending transfer rate

Average transfer rates

Transfer pricing charge/credit

- b. "Stop holiday calendar" checkbox is provided with a calendar date picker. If checked, a calendar is enabled on which a date can be selected. Cash flows generated post this date will not apply the holiday calendar. On selecting the checkbox a warning message will pop up stating "If Enabled, the outputs could have a combination of adjusted and unadjusted cashflows".

Note: Holiday calendar is used to adjust the outputs on holiday events, which may increase processing time. If Users do not want to have adjusted output after a certain time point, say, when buckets become wider, then this field stops adjusting cashflows from that time point, reducing processing time. If user wants to have cash flow adjusted for entire processing period, then this field does not require any input.

- c. Click "Apply".
- d. If Market Value is chosen from step 1 above, the Discount Methods box will become highlighted blue and need to be defined (see [Discount Methods](#), for rule set up). If no market value chosen, continue to step 5 below.
- e. Select from the discount methods box the desired method (see [Discount Methods](#), for set up) and click "Apply". The screen will take you to Product characteristics rules box.
- f. From the Product Characteristics bar, select the desired definition and click "Apply" (see [Product Characteristics](#), for rule definition). The screen will take you to the Forecast Rates rules box.
- g. Select the Forecast Rates rule you want applied to the process, and click "Apply". (see [Forecast Rate Scenarios](#), to set up rate scenarios). The flow will now take you to output preferences. Or, if you want to add a Forecast Balance, Prepayment, or Transaction strategy rule to the process, continue to step 7 below.
- h. Forecast Balances: Click the Forecast Balance box and select from the defined forecast balance rules (For more information on setting up rules see [Forecast Balance Rules](#)). Click "Apply".

The Maturity Mix and Pricing Margin rules will then become necessary to complete the forecast assumption selection process.

**Maturity Mix:** Select the desired Maturity Mix rule and click "apply". For more information on how to set up the Maturity Mix.

**Pricing Margins:** Select the desired Pricing Margin rule from the defined list and click "Apply". The screen will take you to output preferences, or continue to step 8 below to include prepayment, or transaction rules.



- i. Click the Prepayments/Early Redemptions box and choose the defined prepayment rule and click “Apply” (see [Prepayment Rules](#) . This is an optional step.
  - j. Click the Transaction strategy box and select the defined transaction strategies for inclusion in the process. Click “Apply” ([Transaction Strategies](#) for information on defining rules).
3. Output Preferences options
- a. Select the output dimension from the drop-down list (Options include: Product, Product/Currency, Organization/Product, Organization/Product/Currency).

---

**Note:** The Organization Unit options are not available when Forecast assumptions are selected.

---

- b. Depending on the dimension chosen, you can Consolidate to Reporting Currency by checking the box if the dimension Product /Currency or Organization/Product/Currency was chosen.
- c. If you have the ALMBI reporting product, you can select to export the results to the ALM BI Mart by clicking the box.
- d. If Product was chosen from the Dimension in step 1 above, you can select the Autobalancing feature by clicking on the box.

Use autobalancing to maintain a balanced balance sheet, and generate retained earnings, dividends and taxes. Product leaf members used during the autobalancing process must be defined within your Application Preferences, including:

Assets

Liabilities

Retained Earnings

Dividends

Federal Tax

State Tax

Accumulated Translation Balance

If you do not completely define the required autobalancing leaves in Application Preferences, an error message is generated during processing. For more information, see [Application Preferences](#).

You also have the option to Update the Instrument Data Table with financial elements by checking the box of the desired elements. (Market Value, Macaulay Duration, Modified Duration, Convexity, Yield to Maturity, Average Life, DV01/PV01, Structured Cashflow Attributes \*). The DV01/PV01 option will be enabled only if Market Value, YTM, Duration, DV01/PV01 option is selected in Calculation block.

- e. Click “Apply” after the page is defined. The process will take you to the Processing Parameters section. Or you can click the audit box for the following options: If no audit rule is selected, skip to #4, Processing Parameters.

Output Preferences	
Output Dimension*	Organization/Product
<input type="checkbox"/> Consolidate to Reporting Currency	<input type="checkbox"/> Move Results to ALM BI Mart
<input type="checkbox"/> Autobalancing	
Update Instrument Data with :	
<input checked="" type="checkbox"/> Market Value	<input type="checkbox"/> Effective Interest Rate
<input type="checkbox"/> Macaulay Duration	<input type="checkbox"/> Convexity
<input type="checkbox"/> Modified Duration	<input type="checkbox"/> Yield to Maturity
<input checked="" type="checkbox"/> DV01/PV01	<input type="checkbox"/> Average Life
<input type="checkbox"/> Fair Value Output	
<input type="checkbox"/> Structured Cashflow Attributes	

---

**Note:** \* The Structured Cashflow Attributes option will be enabled only if you are mapped to Moody's structured cashflow library.

---

- f. Click “Apply” after the page is defined. The process will take you to the Processing Parameters section.

Or

You can click the Audit box for the following options: If no audit rule is selected, skip to #4, Processing Parameters.

- 4. Audit Preferences (optional):

- **Detailed Cash Flow:**

For Dynamic process, both static and dynamic new business record are populated in FSI\_O\_PROCESS\_CASH\_FLOWS table.

Check the box to record the cash flows and repricing events occurring for the desired number of records from static instrument record and dynamic new business. If user want get output for a particular set of static record, set the record number high considering new business records created and output.

The number of new business records created depends on new business definition, and can range from few to many for a single product currency combination. For example, forecast balance method of Rollover with multiple Maturity Mix Terms, defined for many modeling time bucket, can create many number of new business records, whereas for forecast balance method of New Add with single Maturity Mix Term, defined for few modeling time bucket, will create few business records.

---

**Note:** The functionality of audit of cash flows in Dynamic process is to validate and proof out small sets of record, and not intended to output entire set of record like static process.

---

The Financial Elements tab given in the Static Deterministic Process is not applicable to Dynamic Deterministic Process.

- **Forecast Rates:**

Refer to step #5 [Forecast Rates](#) in Creating a Static Deterministic Process Rule.

- 5. Processing Parameters:

- a. The processing parameters allow you to run an entire process or re-process a portion of an existing run. From the drop-down list, select Entire Process or Selective Reprocess.
- b. If Selective Reprocess is selected, you can click the box “Current Position Data” to reprocess that particular data set. With Selective Reprocess, the Reprocessing components are enabled to selected components for reprocessing. When the Process Rule is executed, the data in the result tables are not immediately deleted. The data for the selected subset is replaced, but the rest of the results remain intact.
- c. New Business/Transaction Strategies: Select to reprocess the new business and/or transaction strategies defined in the process flow.
- d. Auto balancing accounts: If you selected Auto Balancing in the Output Preferences (section 3.4.) the Auto Balancing Accounts option is available for re-processing. Click the box to apply.
- e. Click “Apply” and the screen will take you to Freeze Process section.

The screenshot shows a software interface for configuring process parameters. At the top, there's a section titled 'Processing Parameters' with a dropdown menu currently set to 'Selective Reprocess'. Below this is a sub-section 'Reprocessing Parameters' which contains four unchecked checkboxes: 'Current Position Data', 'New Business/Transaction Strategies', 'AutoBalancing Accounts', and 'Formula Results'. At the bottom of this section is a 'Product Hierarchy Filter' dropdown menu set to '-1'. Below the entire configuration area are two buttons: 'Apply' and 'Return To Summary Page'.

6. Freeze Process
  - a. Select Freeze to complete the process.
  - b. Select Reset to erase all selections made previously within the process definition flow.
  - c. Select Confirm.

## Creating a Dynamic Stochastic / Historical Simulation Process Rule

Stochastic Processing differs from Deterministic Processing in that it generates Earnings, Market Value and Value at Risk by Monte Carlo simulations. Rates scenarios are generated based on a Term Structure model, which describes how the interest rate curve changes over time. Before instrument records are processed, balance and payment fields are first translated to the reporting currency, and then reported in the reporting currency.

**Note:** Stochastic simulation is a single factor modeling of interest rates of Reporting Currency. Although the engine does convert Balances into Reporting Currency, there is no correlation of Risk factors of particular Currency's Interest rates with Reporting Currency. Stochastic processing is not intended for Multi-currency processes.

For best results, run Stochastic calculation for a Single currency where Functional Currency = Reporting Currency.

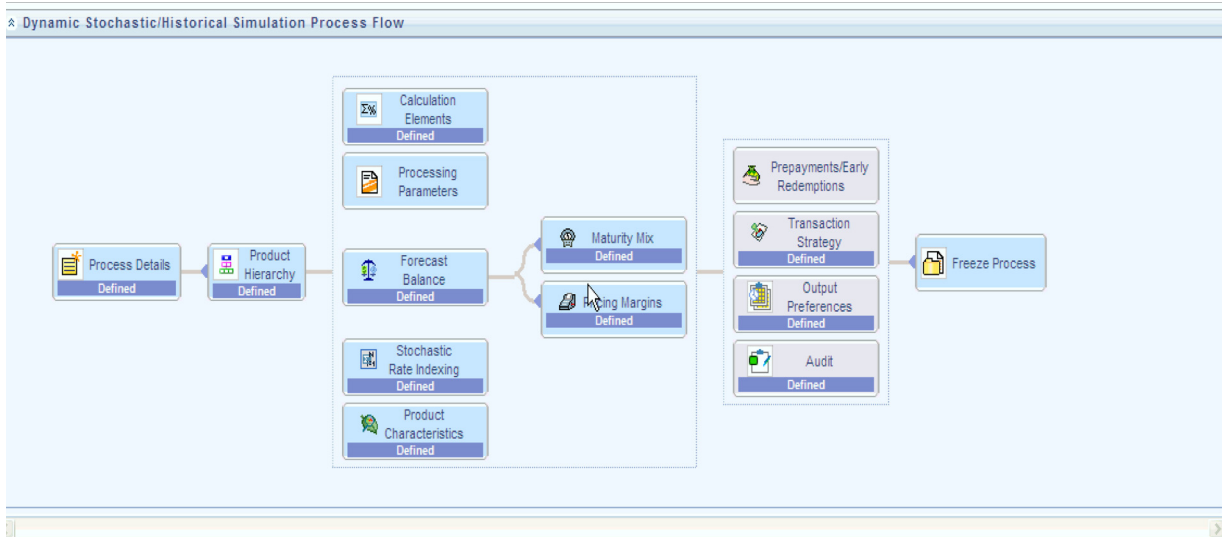

1. Follow steps 1 and 2 from the Static Deterministic process defined above.
2. Calculation Elements
  - a. Select the calculation elements. There are three choices: EaR, VaR and Market Value

**Earnings at Risk:** Earnings at Risk uses the Monte Carlo rate generator to generate a series of rate paths which is applied to instrument records to produce earning forecasts. This option writes out two standard result sets: average leaf earnings and average total portfolio earnings. Average leaf earnings is written out to EAR\_LEAF\_AVG\_xxx whereas average total portfolio earnings is written out to EAR\_TOTAL\_AVG\_xxx with xxx denoting the system id number of the process.

**Value at Risk:** Value at Risk measures the probability of changes in value of the current position data, occurring over specified time horizons, displayed in the interface as the At Risk period. The At-Risk period defines the time period over which changes in market value are calculated.

When the user selects the Value at Risk calculation option in a process ID and subsequently runs that ID, the software will in addition to calculating the current market value, calculate the change in market value for each rate path and rank these changes in market value for each product leaf and for the entire balance sheet. These results are stored in two tables: FSI\_O\_STOCH\_VAR and FSI\_O\_STOCH\_TOT\_VAR. Note: When Value at Risk is selected, market value is also written to the FSI\_O\_STOCH\_MKT\_VAL table.

Market Value: Market Value is calculated per rate scenario for each Product Leaf member. The result Market Value is the total Market Value over the number of rate paths per Product Leaf. The results are stored in FSI\_O\_STOCH\_MKT\_VAL.

- b. "Stop holiday calendar" checkbox is provided with a calendar date picker. If checked, a calendar is enabled on which a date can be selected. Cash flows generated post this date will not apply the holiday calendar. On selecting the checkbox a warning message will pop up stating "If Enabled, the outputs could have a combination of adjusted and unadjusted cashflows".

---

**Note:** Holiday calendar is used to adjust the outputs on holiday events, which may increase processing time. If Users do not want to have adjusted output after a certain time point, say, when buckets become wider, then this field stops adjusting cashflows from that time point, reducing processing time. If user wants to have cash flow adjusted for entire processing period, then this field does not require any input.

---

- c. Click "Apply" and the screen will take you to Processing Parameters.

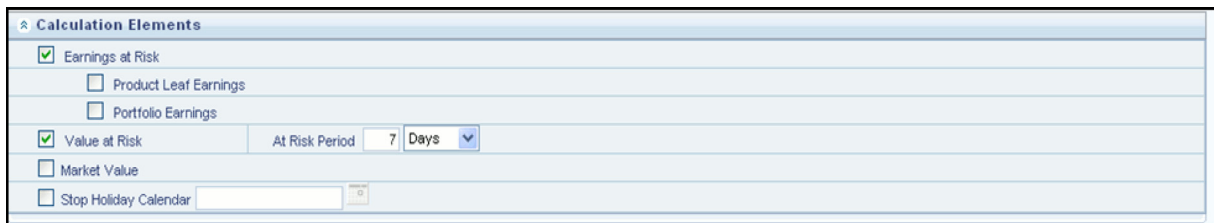

- 3. Processing Parameters: Here you set the parameters for the stochastic process by selecting the term structure model, smoothing method, number of rate paths, Random number generation method, and seed value. Each is described in the following sections:

There is a toggle that enables the user to choose between Monte Carlo Simulation and Historical Simulation, with the default selection being Monte Carlo Simulation.

If Historical Simulation is selected, only Smoothing Method and Number of Rate Paths is enabled for selection. If Monte Carlo Simulation is selected, then all the five parameters are enabled for selection.

- a. Term Structure Method: four models to choose from: For more information on term structure models, see the Oracle Financial Services Analytical Applications Cash Flow Engine Reference Guide.

Merton—real interest rate model

Ho and Lee—no arbitrage model

Vasicek—real interest rate model

Extended Vasicek— no arbitrage model

- b. Smoothing method: Smoothing is the drawing of a smooth, continuous line through observable market data points. Because there are an infinite number of these lines passing through a given set of points, additional criteria must be

added to the smoothing process to achieve the desired term structure. The following methods are available:

**Linear Interpolation** – Linear interpolation uses linear yield curve smoothing. Linear yield curves are continuous but not smooth; at each knot point there is a kink in the yield curve. You may not want to use a linear yield curve with a model that assumes the existence of a continuous forward rate curve, due to the nonlinear and discontinuous knot points of a linear yield curve

**Cubic Spline of Yields** – A cubic spline is a series of third degree polynomials that have the form

$$y = a + bx + cx^2 + dx^3$$

These polynomials are used to connect the dots formed by observable data. The polynomials are constrained so they fit together smoothly at each knot point (the observable data point.) This means that the slope and the rate of change in the slope with respect to time to maturity have to be equal for each polynomial at the knot point where they join. If this is not true, there is a kink in the yield curve and they are continuous but not differentiable.

Two more constraints make the cubic spline curve unique. The first restricts the zero-maturity yield to equal the 1-day interest rate. The second restricts the yield curve at the longest maturity to be either straight ( $y'=0$ ) or flat ( $y''=0$ ).

**Quartic Spline:** Quartic interpolation requires a minimum of 4 knot points. The quartic interpolation equation can be represented as

$$Y = a + b X^1 + c X^2 + d X^3 + e X^4$$

The end knot points satisfy equations for one curve and all intermediate points satisfy two curves. Hence in a scenario with minimum number of knot points, there will be 6 equations. For n number of knot points, the number of equations is  $2n-2$ . If n is the number of points to be interpolated, the order of the matrix to be formed is  $5*(n-1) \times 5*(n-1)$ . The matrix is formed according to the following logic:

The second derivative at the end points and the first derivative of the last point is Zero.

At the points other than the end points the value of the first derivatives, second derivatives and the third derivatives of the function are equal.

- c. **Number of paths** – Specifies the number of simulations to execute. The valid range is from 1 to 2100. The default is 200. If the number of rate paths is not within the range of 1 to 2100, then an error message is displayed to the user.
- d. **Random Number Generation Method:** To run Monte Carlo simulations, you must specify the random number generator algorithm for the rate path generation.

**Low Discrepancy Sequences:** Also known as quasi-random sequences, are designed to prevent clustering of generated numbers; this results in achieving better accuracy than pseudo-random sequences when applied to numerical problems; integration in high dimensions, and so on.

**Pseudo Random Sequences:** The traditional random numbers generated by most compilers. They are designed to do well on some statistical tests: low autocorrelation, high period before the sequence repeats itself.

- e. **Seed Value:** Fixed or Variable. If fixed, maximum value of 999. Fixed seed selection results in the same set of random numbers being generated with each run. If you keep the fixed seed a constant value, you will be able to re-produce

results from one run to another. The variable seed option allows the system to determine the seed value randomly with each run. This option will result in a different set of random numbers for each run and hence different results from each run.

---

**Note:** Seed value selections apply to the Pseudo Random Sequences option only.

---

- f. Once defined, click “Apply” and you will be taken to the Forecast Balance screen.

Processing Parameters	
<input checked="" type="radio"/> Monte Carlo Simulation <input type="radio"/> Historical Simulation	
Term Structure Model*	Merton
Smoothing Method *	Linear Interpolation
Number of Rate Paths *	10
Random Number Generation Method*	Low Discrepancy Sequences
Seed Value*	Fixed Seed   0

4. Forecast Balances: Click the Forecast Balance box and select from the defined forecast balance rules. Click “Apply”.
  - Maturity Mix: Select the desired Maturity Mix rule and click “apply”. For more information on how to set up the Maturity Mix, see [Forecast – Maturity Mix](#).
  - Pricing Margins: Select the desired Pricing Margin rule from the defined list and click “Apply”. The screen will take you to Rate Index (For more information on setup details, see [Forecast - Pricing Margins](#)).
5. Rate Index: Select the rate index as it was defined in the Stochastic Rate Indexing rule, (For additional information on the setup rules for rate indexing, see [Stochastic Rate Indexing](#) )

Click “Apply”. The screen will take you to Product Characteristics.

6. Product Characteristics: Select the desired product characteristics rule. (For more information on creating a product characteristic rule,)
  - a. Click “Apply” and the screen will take you to Freeze Process.
  - b. If you want to include a prepayment/early redemption, transaction strategy, output preference, or audit rule in the process, click the desired rule and define accordingly. The four are noted briefly below.

Prepayments/Early Redemptions: click the box and choose the defined prepayment rule, Click “Apply” (See [Prepayment Rules](#))

Transaction Strategy: Click the box and select the defined transaction strategies for inclusion in the process. Click “Apply” (See [Transaction Strategies](#))

Output Preferences options Refer to step #6 in Static Stochastic Process Rule.

Audit: Refer to Step #7 in Static Stochastic Process Rule.

7. Freeze Process
  - a. Select Freeze to complete the process.

- b. Select Reset to erase all selections made previously within the process definition flow.
- c. Select Confirm.

## Executing an ALM Process

To run a Process ID, complete the following steps:

1. Choose Process/Run from the list under the process bar.
2. Click the run icon to execute the process.
3. A popup window will appear including the execution ID. Click OK.
4. When a process is running the status bar will show one of the following three values: success, failure and processing.

---

---

**Note:** The process must be defined completely.

---

---

5. When the Status "View Log" appears, the run is complete.

---

---

**Hint:** Click the refresh grid button to see the change in status.

---

---

6. Click the "View Log" status to ensure run was complete.
7. To view the error log, click the "Task id" number in the view log page.



---

---

## Andrew Davidson and Company (ADCo) Prepayment Method

### Overview of ADCo Prepayment Method

The Andrew Davidson & Co (ADCo) prepayment method calculates the prepayment amount for a combination of currency equal to US Dollar and Product Account equal to Type Earning Asset. ADCo related UI inputs and the CFE execution are available only for a user who is an ADCo Licensee and where the specific user has the ADCo function mapped to them.

### Deployment of ADCo Libraries on OFSAAI

#### Objectives

- Deploy ADCo libraries on OFSAAI
- Enable ADCo prepayment-model functionality in ALM

#### Prerequisite

- ALM 8.0
- ADCo v1.9 libraries for Loan-Dynamic-Model, for your operating system / version

---

---

**Note:** ADCo is not available on IBM AIX operating systems.

---

---

#### Steps

- **Preparation:**
  1. Login to the UNIX Profile where OFSAAI database-tier is installed.
  2. Create a folder called "adco"; create 3 sub-folders under "adco": "io", "data", "lib"
  3. Edit the .profile script and set the following environment variables:  
ADCO\_IO\_DIR: set it to the absolute path of the "io" sub-folder created earlier.

DATAFILEDIR: set it to the absolute path of the “data” sub-folder created earlier.

LD\_LIBRARY\_PATH: update this environment variable to include the absolute-path of the “lib” sub-folder created earlier.

4. Stop all OFSAAI services.
  5. Log-out of the UNIX Session and log back in to UNIX. Verify that the 3 environment variables created above are set properly.
  6. Start all OFSAAI Services.
- **Deployment:**
    1. Download the v1.9 ADCo libraries and place the file “libadppmdl.so” into the “adco/lib” sub-folder.
    2. Place the monthly license-key and historical-rate files into the “adco/data” sub-folder.
    3. If you have been provided the following 2 files by ADCo, place both of these files in the “adco/io” sub-folder.
      - ADCO\_DefaultValues\_INACTIVE.txt
      - ADCO\_XMLSettings\_INACTIVE.txt
  - Enable ADCo functionality in ALM:
    1. Login to OFSAAI.
    2. Under the OFSAAI Home Page, go to Administration -> Security Management
    3. Expand System Administrator and click “Function – Role Map”.
    4. Associate the SMS-Function “ADCO Prepayments for ALM” with the required roles.

## Procedure For Setting Up ADCo Process

The steps to set up an ADCo process are as follows:

1. Mapping of the ADCo function to ALM Admin user
2. Set up the 7 Indices to use with ARMs.
3. Set up the 2 year, 10 year rate IRCs.
4. Set up the National HPI.
5. Load the STG\_LOAN\_CONTRACTS table.
6. Run the T2T batch to populate the FSI\_D\_MORTGAGES table.
7. Select the NHPI from Application Preferences.
8. Forecast the 2 year, 10 year rate IRCs.
9. Forecast the 7 indices (only required where indices are mapped to ARMs).
10. Forecast the National HPI (optional).
11. Setup the Prepayment rule mapping ADCO method to the required Mortgage – USD combinations.
12. Setup the Static Deterministic Process including the rules defined above (Forecast Rates and Prepayments).

13. Select the SMM Rates Output flag (optional).
14. Execute the Process.

The detailed procedure for using ADCo prepayment method comprises utilizing the above mentioned specific settings in various ALM modules as documented in the following sections.

## Mapping of the ADCo function

After acquiring the ADCo license, the user must manually map the ADCo function to the ALM Admin user in the Role Function Mapping screen of Security Management (Home>Administration>Security Management). Only after this mapping, will the user be available to view the ADCo related changes made in the Forecast Rates and Prepayments screens. This is not applicable to the common screens of Rate Management and Application Preferences. For more details on security management, see Oracle Financial Services Analytical Applications Infrastructure User Guide.

## Rate Management

### Interest Rates:

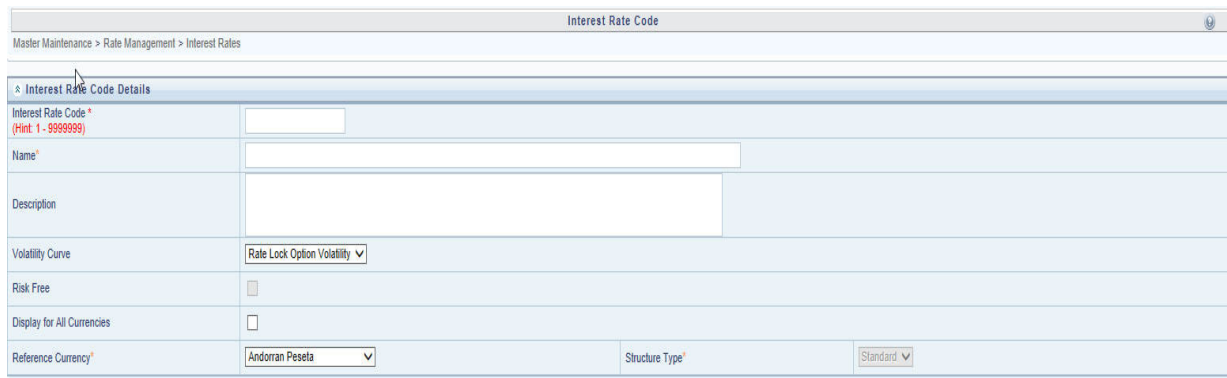

The screenshot shows the 'Interest Rate Code' form with the following fields and values:

- Interest Rate Code: [Empty]
- Name: [Empty]
- Description: [Empty]
- Volatility Curve: Rate Lock Option /Volatility
- Risk Free:
- Display for All Currencies:
- Reference Currency: Andorran Peseta
- Structure Type: Standard

In Rate Management Interest Rates detail screen, is a drop-down list called the Curve Identifier. This is a drop-down list that contains the list of 4 curve identifier types , that is, par treasury, zero coupon treasury, par libor/ swap, and zero coupon libor swap. These curve identifiers can be mapped to the seven indices to be used with the Adjustable Rate Mortgages(ARMs) meant for ADCo purpose, whose reference currency is always US Dollar. The seven indices are :

Element Name	Element Description
PAR_TSY_1YR	1-Year Par Treasury Monthly Yield (%)
PAR_LIBOR_6M	6-Month Par LIBOR Monthly Yield (%)
PAR_LIBOR_1YR	1 Year Par LIBOR Monthly Yield (%)
MTA_12	12 Month MTA Monthly Yield (%)
PAR_TSY_3YR	3-Year Par Treasury Monthly Yield (%)
PAR_TSY_5YR	5-Year Par Treasury Monthly Yield (%)

Element Name	Element Description
COFI_11D	11th District COFI Monthly Yield (%)

User has to define the 7 indices for use with the ARMs, with the same name as expected by ADCo. Also, the IRC to supply 2 year and 10 year rates also must be defined in this UI. User need not enter the Term structure parameters if the IRC is to be used only for ADCo purposes.

**Economic Indicators:**

In the Economic Indicators detail screen, the historical data for the National Housing Price Index (NHPI) is entered. Setting up the NHPI is an optional step.

**Loading the STG\_LOAN\_CONTRACTS table:**

For the purpose of ADCo, this step of loading the STG\_LOAN\_CONTRACTS table should be performed. The following are the columns that have been included in this table for ADCo Purpose:

COLUMN_NAME	DISPLAY NAME
d_last_delinquent_date	Last Delinquent Date
f_payment_option_flag	Payment Option Flag
f_relo_loan_flag	Relocation Loan Flag
f_sub_prime_flag	Sub Prime Flag
n_first_reset_cap	First Reset Cap
n_first_reset_floor	First Reset Floor
n_joining_score	Original Credit Score
n_loan_charge	Loan Charge
n_mrtgg_insrn_amount	Mortgage Insurance Amount
n_mrtgg_insrn_cutoff	Mortgage Insurance Cutoff
n_mrtgg_insrn_premium	Mortgage Insurance Premium
n_no_of_interest_only_mths	Number of Interest Only Months
n_no_of_prop_units	Number of Property Units
n_orig_cust_ltv	Original Customer LTV
n_prepmt_index_term	Prepayment Index Term
v_loan_doc_status	Loan Documentation Status
v_prepmt_index_cd	Prepayment Index Code
v_prepmt_index_term_unit	Prepayment Index Term Unit
v_prop_loc_state_cd	Property Location State Code
v_prop_purpose_cd	Property Purpose Code
v_prop_sub_type_cd	Property Sub-Type Code

**Running the T2T Batch to populate FSI\_D\_MORTGAGES table:**

In order to run the T2T Batch to populate FSI\_D\_MORTGAGES table, perform the following steps:

1. Navigate to Common Object Maintenance > Operations.
2. Set up a batch in the Batch Maintenance UI.
3. Select the above batch set up in step 2 and for a particular information date, execute the batch. This populates the FSI\_D\_MORTGAGES table.

### **Application Preferences**

In the ADCO Parameter grid, there is a input parameter called National Housing Pricing Index(NHPI).

National Housing Pricing Index (NHPI) - This is an input parameter for ADCo definition purpose, that the user has to select from the drop-down containing the list of all economic indicators defined from Rate Management. The user is required to set up a NHPI economic index as if they desire to override the base Adco NHPI forecast. This is an optional step.

Application Preferences

⌵ Select Preferences For

Show Preferences For: ALMUSER ▼

Active for Master Maintenance:

⌵ Parameters - General

Property Name	Property Value	Is Editable
Security Map	None	▼
As of Date	06/25/2014	<input checked="" type="checkbox"/>
Show Execution Parameters	<input checked="" type="checkbox"/>	<input checked="" type="checkbox"/>
Runtime Parameters	Leaf Description	
Legal Entity	<input type="text"/>	<input type="checkbox"/> Disable Legal Entity

⌵ Processing - General

Property Name	Property Value	Is Editable
Default Total Error Message Limit <small>(i)</small>	250	<input checked="" type="checkbox"/>
Default Error Message Limit Per Item <small>(i)</small>	25	<input checked="" type="checkbox"/>
Debugging Output Level	Do not output SQL to log file	<input checked="" type="checkbox"/>

⌵ Processing - Application Specific

Property Name	Property Value	Is Editable
Maximum Number of Instrument records to include in detail cash flow output	10	<input checked="" type="checkbox"/>
Maximum Number of Rate Paths for Monte Carlo Processing	10	<input checked="" type="checkbox"/>
Random Number Generation Seed Method	Fixed Seed	<input checked="" type="checkbox"/>
Initial Seed Value <small>(i)</small>	0	
Enable Holiday Calendar Adjustments	<input type="checkbox"/>	<input checked="" type="checkbox"/>

⌵ Assumption Management Defaults

Property Name	Property Value	Is Editable
Folder Name	ALMSEC	<input checked="" type="checkbox"/>
Access Type	<input type="radio"/> Read Only <input checked="" type="radio"/> Read/Write	<input checked="" type="checkbox"/>
Initial Currency Selection ["Business Rule Currency"]	US Dollar	<input checked="" type="checkbox"/>

⌵ Dimensions and Hierarchies

Property Name	Property Value	Is Editable
Product Dimension	Common Chart of Accounts	<input checked="" type="checkbox"/>
Default Product Hierarchy	AUTOD_CCA_01	<input checked="" type="checkbox"/>
Organizational Unit Dimension	Organizational Unit	<input checked="" type="checkbox"/>
Hierarchy Members Navigation Size	100	<input checked="" type="checkbox"/>

⌵ Autobalancing Leaves

Property Name	Property Value	Is Editable
Product Hierarchy	<input type="text"/>	<input checked="" type="checkbox"/>
Type of Leaf	Leaf Description	
Assets	<input type="text"/>	<input type="checkbox"/>
Liabilities	<input type="text"/>	<input type="checkbox"/>
Retained Earnings	<input type="text"/>	<input type="checkbox"/>
Dividends	<input type="text"/>	<input type="checkbox"/>
Federal Taxes	<input type="text"/>	<input type="checkbox"/>
State Taxes	<input type="text"/>	<input type="checkbox"/>
Accumulated Translation Balance	<input type="text"/>	<input type="checkbox"/>

⌵ ADCO Parameters

Property Name	Property Value	Is Editable
National Housing Pricing Index	<input type="text"/>	<input checked="" type="checkbox"/>

### Product Characteristics

Define Other Mortgage Attributes: This tab is available only if the user has an ADCo License.

For more information, refer to [Product Characteristics](#).

## Forecast Rates

### Interest Rate Forecast Methods:

In the case of an ADCo IRC forecast, while defining using Direct Input, the 'Show 360 months Buckets' checkbox is shown ONLY if the ALM\_ADCO function is mapped to the user.

- By default the checkbox is unchecked (or checkbox is not shown), and the UI continues to display its existing behavior.
- If the user checks the box, then the UI shows 360 month rows and the date display follows the MMM-YYYY format.

Forecasting the 7 indices is similar to forecasting the 2 year and 10 year rate IRCs having term points as 2 years and 10 years.

### Economic Indicator (EI) Forecast Methods:

The UI has a similar behavior for EI forecasting method selection of "Direct Input". But UI checks for the National HPI Selection in Application Preferences. In the ALM Process screen, UI shows the audit options for ADCo, ONLY if ALM\_ADCO function is mapped to the user. Forecasting the NHPI is an optional step.

## Prepayments

### Defining Prepayment Methodologies:

Oracle Asset Liability Management provides five prepayment calculation methods: Constant, Prepayment Model, PSA, Arctangent, and ADCo (Andrew Davidson and Co.) Prepayment method.

### Defining the ADCo Prepayment Method:

Use this procedure to define prepayment assumptions using the ADCo Prepayment method.

### Prerequisites:

Performing basic steps for creating or updating a Prepayment rule.

### Procedure:

1. Select the currency to be US Dollar and Product Account Type as an Earning Asset.
2. Select ADCo Prepayment method from the Prepayment method drop-down list. The UI shows "ADCO Prepayment" method as an available method in the drop-down list, ONLY if ALM\_ADCO function is mapped to the user.
3. Select Refinance or Curtailment from the Calculation drop-down list.
4. The ADCo Prepayment container is displayed containing the index drop-down list which contain IRCs defined in Rate Management including the seven indices to be used with the Adjustable Rate Mortgages (ARMs) meant for ADCo purpose, whose reference currency is always US Dollar. Select the required IRC.

5. Click Apply.

## Transaction Strategies

Define Other Mortgage Attributes: This tab is available only if the user has an ADCo License.

For more information, refer to *Transaction Strategies*, on page 527.

## ALM Processing

### Creating a Static Deterministic Process rule:

In the Audit block, there is a checkbox called Output ADCo Prepayment SMM rates. Selecting this checkbox is an optional step.

Output ADCo Prepayment SMM rates: This checkbox is enabled only if the user has an ADCo Licensee. Check this box to capture the SMM rates for each scenario, As of Date, instrument, Product Leaf, Remaining Term and the Process ID. On every rerun of the same process ID, new set of SMM rates at scenario level is written to the audit table fsi\_o\_smm\_rates\_audit after deleting the existing records for the process ID. On selective reprocessing of the same process ID, the audit table is truncated and the new set of rates is written to the table.



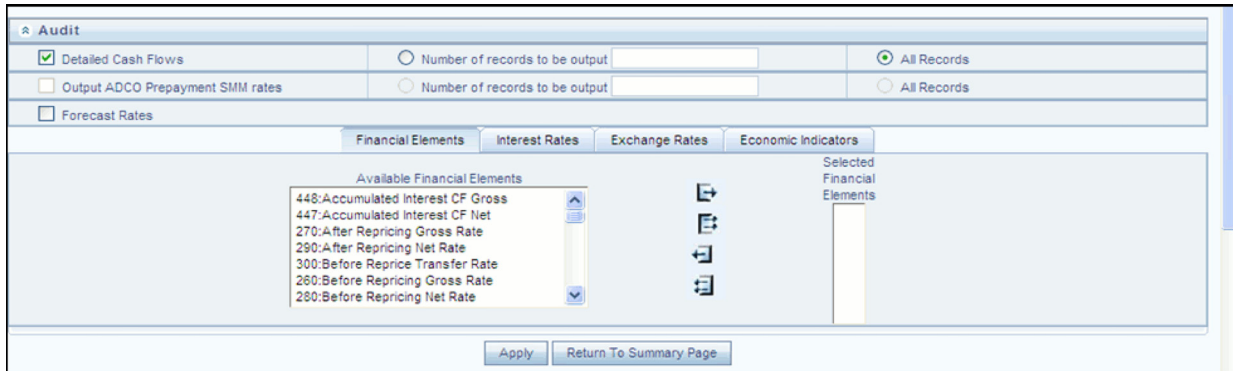

### Error Scenarios

1. ALM Engine logs error messages into FSI\_PROCESS\_ERRORS if ADCo method is assigned to a non Mortgage and process the next record. This validation check is based on the instrument type.
2. ALM Engine logs warning messages into FSI\_PROCESS\_ERRORS if the input parameters required are missing from the Mortgages table
3. ALM engine logs error messages into FSI\_PROCESS\_ERRORS if forecast rates scenario definitions are inconsistent or the definition is missing. Say, if the rule has 10 scenarios and the ADCo curves are forecast for only 9 scenarios, then a warning message is logged. No warning messages are written if National HPI is not forecast.

### CD/MLS Tables Included for ADCo

The following are the CD/MLS tables included for the purpose of ADCo:

S.No.	TABLE_NAME	DISPLAY_NAME	DESCRIPTION
1	FSI_DELIQUENCY_STATUS_CD	Delinquency Status Cd	Holds Data For Delinquency Status Cd
2	FSI_DELIQUEN_STATUS_MLS	Delinquency Status Mls	Holds Data For Delinquency Status Mls
3	FSI_DOCUMENTATION_CD	Documentation Cd	Holds Data For Documentation Cd
4	FSI_DOCUMENTATION_MLS	Documentation Mls	Holds Data For Documentation Mls
5	FSI_GEOGRAPHIC_LOC_STATE_CD	Geographic State Cd	Holds Data For Geographic State Cd
6	FSI_GEOGRAPHIC_LOC_STATE_MLS	Geographic State Mls	Holds Data For Geographic State Mls
7	FSI_ISSUER_CD	Issuer	Holds Data for Issuer Cd

S.No.	TABLE_NAME	DISPLAY_NAME	DESCRIPTION
8	FSI_PPMT_MODEL_INDICES_CD	Ppmt Model Indices Cd	Holds Data For Prepayment Model Indices Cd
9	FSI_LOAN_TYPE_CD	Loan Type Cd	Holds Data For Loan Type Cd
10	FSI_LOAN_TYPE_MLS	Loan Type Mls	Holds Data For Loan Type Mls
11	FSI_O_SMM_RATES_AUDIT	Single Monthly Mortality Rate Audit Table	Single Monthly Mortality rate audit
12	FSI_PPMT_MODEL_INDICES_MLS	Ppmt Model Indices Mls	Holds Data For Prepayment Model Indices Mls
13	FSI_PREV_DELQ_STATUS_CD	Prev Delq Status Cd	Holds Data For Previous Delinquency Status Cd
14	FSI_PREV_DELQ_STATUS_MLS	Prev Delq Status Mls	Holds Data For Previous Delinquency Status Mls
15	FSI_PROPERTY_PURPOSE_CD	Property Purpose Cd	Holds Data For Property Purpose Cd
16	FSI_PROPERTY_PURPOSE_MLS	Property Purpose Mls	Holds Data For Property Purpose Mls
17	FSI_PROPERTY_SUB_TYPE_CD	Property Sub Type Cd	Holds Data For Property Sub Type Cd
18	FSI_PROPERTY_SUB_TYPE_MLS	Property Sub Type Mls	Holds Data For Property Sub Type Mls
19	FSI_PURPOSE_CD	Purpose Cd	Holds Data For Purpose Cd
20	FSI_PURPOSE_MLS	Purpose Mls	Holds Data for Purpose Mls

## ADCo Mapping

S No	Column Mapped/Used	Input (Adco)
1	CUR_MIN_PMT	CurMinimumPayment
2	LOAN_DOC_STATUS	Documentation
3	FIRST_RESET_AGE	FirstResetAge
4	FIRST_RESET_CAP	FirstResetCap
5	FIRST_RESET_FLOOR	FirstResetFloor
6	PMT_OPTION_FLG	HasOptionalPayment
7	NO_INT_ONLY_MTHS	IOMonths
8	RELO_LOAN_FLG	IsRelo
9	SUB_PRIME_FLG	IsSubprime
10	LIEN_POSITION	LienPosition
11	MORT_INS_CUTOFF	MI_Cutoff
12	MORT_INS_PREMIUM	MI_Premium
13	MORT_INS_AMT	MIAmount
14	NO_LAST_DELQ_MTHS	MonthsSinceLastDelinquency
15	NO_PROPERTY_UNITS	NumUnits
16	ORG_CUST_LTV	OrigCombinedLTV
17	RATE_INCR_CYCLE	PeriodicCap
18	RATE_DECR_CYCLE	PeriodicFloor
19	NO_PREPAY_PENALTY_MTHS	PPMonths
20	PREV_DELQ_STATUS_CD	PreviousDelinquency
21	GEOGRAPHIC_LOC_STATE_CD	State
22	CUR_LOAN_TO_VALUE	Cur_LTV
23	PREPAY_INDEX	Index
24	JOINING_SCORE	Credit_Score
25	CUR_PAR_BAL	Cur_Face
26	FICO_SCORE	CurFICO
27	MARGIN_GROSS	GrossMargin
28	RATE_CAP_LIFE	LifeCap
29	RATE_FLOOR_LIFE	LifeFloor
30	PURPOSE_CD	Loan_Purpose
31	NEG_AMRT_LIMIT	MaxNegAm
32	REPRICE_FREQ	MonthsBetweenReset
33	PROP_PURPOSE_CD	Occupancy
34	ORG_NET_PAR_BAL_C	Orig_Face
35	ORG_LOAN_TO_VALUE	Original_LTV

S No	Column Mapped/Used	Input (Adco)
36	ORG_TERM	OriginalTerm
37	PMT_INCR_CYCLE	PayCap
38	PROP_SUB_TYPE_CD	Property_Type
39	MATURITY_DATE, AS_OF_DATE	RemainingTerm
40	CUR_GROSS_RATE	StartingWac
41	adjustable_type_cd	WacIsFixed
42	PROPERTY_ZIP_CODE	ZipCode
43	NO_BALLOON_MTHS	BalloonMonths
44	FIRST_FORECAST_MTH	FirstForecastMonth
45	FIRST_FORECAST_YR	FirstForecastYear
46	AGE_ON_BOOK	Age
47	RATE_SET_LAG	LookBackMonths
48	ORG_RATE	WAC

## Limitations

Support for Adco when using FTP forecasting methods is not currently supported and will be available when the FTP application supports Adco.

---

---

## Moody's WSA Integration with OFSAA ALM

### Overview of Moody's WSA Integration

Moody's Analytics has a model - WSA libraries, which generate structured security cash flows. This functionality is required to support the modeling of structured products (ABS/MBS CMO's, and CDO's). In OFSAA ALM, this integration is necessary for modeling structured product cash flows of a given tranche of a security. These cash flows cannot be modeled in the OFSAA CFE because of the nature of the rules in the waterfall of cash flows.

For example, a structured security is backed by a pool of loans, and these loans pay principle and interest but the certainty of cash flows is not known because of prepayment and loss activity within specified loan pool. These monthly cash flows are run through the waterfall rule within the securitization and only then are the individual tranche cash flows derived. The moody's cash flow model will output these specific tranche cash flows under given input assumptions, and OFSAA will uptake these cash flows into the ALM processing. The input assumption information is passed to the Moody's model, so their model will produce cash flows for a given tranche of a security (such as, interest and principal), and the model results will be imported into our deterministic cash flow results (Detail cash flows, Result Detail, Result Master Cons Detail and Cons Master).

Prior to using the Moody's cashflow libraries in OFSAA ALM, Users must procure a license to the WSA libraries from Moody's Analytics.

### Deployment of Moody Libraries on OFSAAI

#### Prerequisite

- ALM 8.0
- A license for the WSA libraries is required from Moody's

#### Steps

- Preparation
  1. Login to the UNIX Profile where OFSAAI database-tier is installed.

2. Create a folder called “moody”; create 2 sub-folders under “moody” : “data”, “lib64”
3. Edit the .profile script and set the following environment variables  
MOODYS\_DATA\_PATH: set it to the absolute path of the “data” sub-folder created above  
LD\_LIBRARY\_PATH: update this environment variable to include the absolute-path of the “lib64” sub-folder created above  
ADCO\_DATA\_PATH: set it to absolute path where AD-Co historical-rate files present.

---

---

**Note:** This is only required if you are using the Moody's libraries along with ADCo prepayment model. For more information on Adco LDM prepayment model, refer to chapter Andrew Davidson and Company (ADCo) Prepayment Method.

---

---

4. Stop all OFSAAI services
  5. Log-out of the UNIX Session and log back in to UNIX. Verify that the 2 environment variables created above are set properly
  6. Start all OFSAAI Services
- **Deployment:**
    1. Download the Moody libraries and place the files into the “moody/lib64” sub-folder
    2. Place the deal files in “Moody's Data” folder
  - **Enable Moody functionality in ALM**
    1. Login to OFSAAI as the SYSADMN
    2. Under the OFSAAI Home Page, go to Administration -> Security Management
    3. Expand System Administrator and click “Function – Role Map”
    4. Associate the SMS-Function “Moody Integration for ALM” with the required roles to the required user-name.

## Moody's Integration – Considerations

### WSA Engine and Processing of the Records

- Moody's WSA Engine requires CUSIP or Deal-Id/Tranche (Bond) Id for processing the instruments. Depending on the Forecast Scenario's and the behavior assumptions, the WSA engine will process the records and output the respective cash flows for various scenarios.
- Moody's provides the cash flows only at the tranche balance, Users should populate the balance of their position in the appropriate column, and the cash flows from Moody's would be scaled to the balance provided. This happens within the OFSAA ALM engine.

- If the user has Moody's installed, only securitized products (supported by Moody's) should be populated in the FSI\_D\_ASSET\_BACK\_SEC (or the table classification code for securitized products). Other records if populated in this table would not be processing. For example: If the user populates loans and securitized products in the FSI\_D\_ASSET\_BACK\_SEC table, the loan records would not be processed in the table.
- OFSAA ALM also writes back instrument attributes such as agency\_type, Asset\_type, Original balance of the tranche, current balance of the tranche, coupon, stated maturity, periodicity etc for upstream system to use, if needed.

## WSA Engine and OFSAA Rate Management

Interest Rate Curves required for Moody's should be setup through the Curve Identifier drop-down list in the Rate Management IRC UI. Moody's requires the following curves to be defined:

- LIBOR (Zero-Coupon LIBOR/Swap)
- TREASURY CURVE (Zero-Coupon Treasury)
- COFI (Cost of Funds Index)
- PRIME (Prime Lending Rate)

It's the user's responsibility to setup the proper curves while using Moody's libraries. User can define only one treasury curve / one libor curve / one COFI curve and one prime curve per currency.

---

**Note:** A majority of the deals would be based of LIBOR/Treasury Curves.

---

## WSA Engine and OFSAA Product Characteristic Definition

A New tab “Model Integration” is introduced for the Moody's WSA Integration. This tab is enabled only for the account types “Structured Products - Assets” “Structured Products - Liabilities”.

Model Selection		Source System provided	
Model Tuning		No Tune / Tune	
Tuning Parameters			
Prepayments	1.00	Default	1.00
Recovery	1.00	Recovery Lag	0
Servicer Advancing	SERVICER_ADVANCES_NOTHING	Draw Rates	1.00

Model Selection, Tuning and tuning parameters for the selected model can be passed through the Model Integration in Product Characteristic UI.

Users should logically branch the deals (RMBS, CMBS, SLABS, Credit Cards) in their hierarchy for modeling the behavior in the following two ways. Details follow:

- Passing the assumptions from a table:** User can choose to pass the following assumptions (listed in the table below) through the table “FSI\_D\_BEHAVIOR\_ASSUMPTIONS”. These would be read from the table and applied to the deal with the matching “INSTRUMENT\_NUM” in the instrument table. In the model selection UI, user has to select “Source system provided” against the particular node for modeling with the user provided assumptions.

Assumption Types/Subtype Details:

ASSUMPTION TYPE	ASSUMPTION SUBTYPE	DESCRIPTION
PREPAYMENT	PREPAY_CURVE_PSA	Standard prepayment curve measuring for prepayments in the residential mortgage market.
PREPAYMENT	PREPAY_CURVE_SMM	Monthly prepayment or default rate.
PREPAYMENT	PREPAY_CURVE_CPR	Constant Prepayment Rate (CPR): Prepayment percentage expressed as an annual compounded rate.
PREPAYMENT	PREPAY_CURVE_HEP	Home Equity Prepayment: A measure of prepayments for closed-end, fixed rate HEL loans. This curve accounts for the faster seasoning ramp for home equity loans.
PREPAYMENT	PREPAY_CURVE_ABS	Asset-Backed Securities (ABS): It is used in ABS markets, where prepayments differ significantly from standard mortgages. This model defines an increasing sequence of monthly prepayment rates, which correspond to a constant absolute level of loan prepayments in all future periods.
DEFAULT	DEFAULT_CURVE_CDR	Constant Default Rate (CDR): Default percentage expressed as an annual compounded rate
DEFAULT	DEFAULT_CURVE_SDA	Standard default curve: Measuring for defaults in the residential mortgage market
DEFAULT	DEFAULT_CURVE_MDR	Monthly Default Rate
DEFAULT	DEFAULT_CURVE_SEASONED_CDR	fl



ASSUMPTION TYPE	ASSUMPTION SUBTYPE	DESCRIPTION
DEFAULT	DEFAULT_CURVE_ SEASONED_MDR	fl
DELINQUENCY	dq30Val	A pointer to data for from 30 to 59 day's delinquency
DELINQUENCY	dq60Val	A pointer to data for from 60 to 89 day's delinquency
DELINQUENCY	dq90Val	A pointer to data for 90 plus day's delinquency
RECOVERIES	RECOVERY	flVector of recoveries
DRAW	HELOC_DRAW_RATES	Vector of annualized draw rates for HELOC
FORBEARANCE	FORBEARANCE	Sets the constant or vectored forbearance rate for SLABS deals
DEFERMENT	STUDENT_LOAN_REPAY_ TYPE_FULL_DEFER	Capitalize Interest
DEFERMENT	STUDENT_LOAN_REPAY_ TYPE_PRIN_DEFER	Pay Interest, Balance Flat
CREDIT_CARDS	CREDIT_CARD_ASSUMP_ YIELD	Portfolio/ Annual Yield
CREDIT_CARDS	CREDIT_CARD_ASSUMP_ REPAYMENT	Repayment Rate
CREDIT_CARDS	CREDIT_CARD_ASSUMP_ RECOVERY	Loss Rate
CREDIT_CARDS	CREDIT_CARD_ASSUMP_ PURCHASE	Purchase Rate
CREDIT_CARDS	CREDIT_CARD_ASSUMP_ DEFAULT	flDefault Rate

- When a user is passing assumptions, for example the Prepayment vector, the subtype values can be in; – PSA, SMM, CPR, HEP and ABS. Users has to make sure they are passing the correct and acceptable subtype with respective to Moody's. Only one subtype can be applied for prepayment and default per each CUSIP.
- When passing the delinquency assumptions, the dq30val, dq60Val and dq90Val mentioned for are not subtypes; rather they are various levels of delinquencies possible. Typically a deal would have all three vectors available.
- ADCo prepayment and default modeling: User can also choose to model through the ADCo model by selecting “ADCo” in the model selection drop-down list. ADCo can only be used against RMBS deals, as ADCo can only model Mortgage Backed Securities.

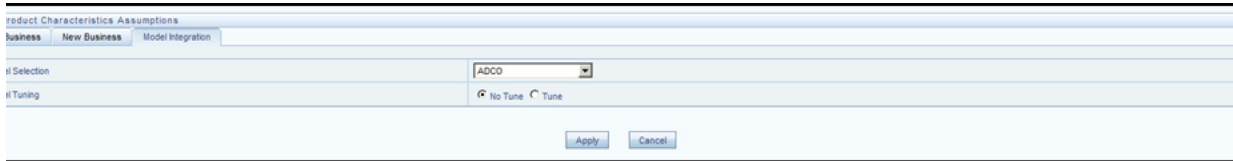

**Tuning Parameters:**

Tuning is available to allow the user to customize the assumptions being provided to the Moody's WSA engine.

- For Source System Provided:

Tuning Parameter	Description	Default Value
Prepayment	Magnitude for prepay rate	1
Default	Magnitude for default rate	1
Recovery	Magnitude for recovery rate	1
Recovery Lag	Recovery lag applied to each loan	0
Draw Rates	Magnitude for mortgage draw rates	1
Servicer Advancing	NONE/INTEREST/BOTH	None

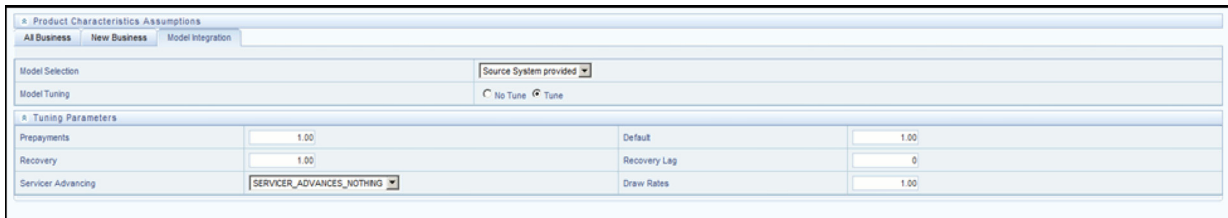

- For ADCO:

Additionally Parameters available are:

Tuning Parameters	Description	Default
ficoToUseIfNotAvailable	Fico to use for loans which do not have this INFO	680
ficoSubprimeThreshold	Loan is considered subprime if FICO is less than this value (620 if not provided)	620
SMM for Failed Loans	SMM for Failed Loans	NA
Recovery for Failed Loans	Recovery for Failed Loans	NA
MDR for Failed Loans	MDR for Failed Loans	NA

## Setting-up a Moody's Process

The steps to set up a Moody process are as follows:

1. Mapping of the Moody's function to the ALM user
2. Set up the curves needed for the Moody's WSA libraries, with the respective curve identifier.
3. Load the STG\_INVESTMENTS and STG\_INSTRUMENT\_CONTRACT\_MASTER tables.
4. Run the T2T batch to populate the FSI\_D\_ASSET\_BACK\_SEC table
5. Define the Model Integration rule in the Product Characteristic UI for the leaf nodes in the member hierarchy
6. Define the Forecast Rate rules and the discount methods - only required for valuation. (For more details on ADCo 360 Bucket forecasting, refer to chapter Forecast Rate Scenarios.)
7. Setup the Static/dynamic deterministic Process including the rules defined above (Prod Char, Forecast Rates and Discount methods). (Note: New Business is not supported for Securitized products)
8. Select the structured product output flag (optional) to update the instrument records
9. Execute the Process.

## Limitations

- New business not supported for Dynamic Deterministic processing.
- WSA libraries are only available on Linux Operating Systems (5 &6)



---

---

## Data Aggregation and Stratification

This chapter covers the following topics:

- [Overview of Data Stratification](#)
- [Setting up Stratification Definitions](#)
- [Executing a Stratification Rule](#)
- [Creating New Aggregate Table](#)

---

---

**Note:** This is applicable from ALM v8.0.5.0.1.

---

---

### Overview of Data Stratification

Data Aggregation and Stratification enables you to summarize large volumes of financial instruments to a manageable scale for processing purposes. The engine that does the aggregation and stratification processing is the Data Stratification Rule. This application enables you to perform mathematically intensive calculations on a relatively small number of instrument pools that are proxies for a much larger number of individual instrument records. Using this feature is a multi-step process, which includes:

- Understanding what you want and how you want to aggregate and stratify data
- Optionally defining balance or rate tiers to be used for grouping data
- Configuring the Data Map metadata for the source and target data maps that are to be used on the Stratification Definition page
- Setting up stratification definitions and rules in the Stratification Rule pages
- Testing the rules that you create

This section covers following topics:

- Aggregation Action
- Stratification Action
- Stratification tips

## Stratification Action Operations

When creating pools of instruments, you need to identify the operation for each of the attributes. You have the following choices in terms of how to populate each attribute in the instrument pool from the instrument data:

- **Discrete:** Directs the Aggregation and Stratification engine to populate the instrument pool with discrete values.

This option populates the pool with discrete values for an attribute if there is no logical or mathematical way to group instruments with different values, and the attribute is significant for processing purposes. Choosing the discrete action for an attribute ensures that only instruments with matching values are grouped together in a pool. The discrete action may be the correct choice for important code fields. Be careful when using the discrete action on amount, date, or rate fields. These types of fields tend to have many discrete values. A typical value for a discrete group by is a dimension ID field or a yes/no flag.

- **Group by:** Use for dimensions or other attributes that you want to use to group the detailed data.

This option allows you to select columns that you want to use to group the instrument data. This will typically be used for dimension columns like Product, Org Unit or Currency or any other dimensions that are needed for grouping the data.

- **Tier:** If you want to group the data by ranges of values, you can define the ranges using Stratification Tiers.

Tiers are typically used for balance and rate fields to assist in grouping similar data into tranches or pools. Tiers should be defined on columns that impact the way assumptions are made, such as prepayments, interest rate margins or other meaningful assumptions.

## Aggregation Action Operations

These are the default operations:

- **Average:** Calculates the average value of an attribute for all instruments in the pool
- **Weighted Average:** Calculates the average weighted value for an attribute by the current balance

Examples of attributes for which you may want to calculate the weighted average are interest rate fields: interest rates, cap rates, floor rates and interest rate margins for floating rates. Other possibilities include remaining term, original term, loan to value and so forth.

- **Min, Max (minimum, maximum):** Select one of these operators to populate the pool with the minimum or maximum value of a given attribute for all the instruments that are part of the pool.
- **Median:** Applies the Median Date value for all date values in the pool
- **Sum** (The sum action calculates the total sum value for a numeric attribute

The most common attributes that you want to calculate the sum for are the balance and payment amount fields. By calculating the total of the balance and payment amounts, the total of all pool balances should reconcile to and represent the totals of all instruments that are in the portfolio.

- **Default:** Applies a specified default value

## Stratification Tips

Here are some criteria to keep in mind when evaluating how you want to stratify data:

- When identifying attributes that you want to include as part of the instrument pools, keep in mind the primary use of the stratified data you are creating.

For example, the ALM engine uses only the current balance amount fields for its calculations. As far as the ALM engine is concerned, designing a stratification rule that populates other balance or amount fields is optional.

- You need to identify the stratification criteria for the attributes

This step is simplified by the fact that any attributes that you identify as needing to maintain discrete values for, or that are going to be dropped or defaulted by definition, cannot be used as grouping criteria for pools.

- Maximize efficient processing by designing rules to summarize the instruments into as few pools as possible, while at the same time only grouping instruments that generate the same or similar cash flows.

In other words, all of the instruments that are grouped together into a pool should share common and pertinent financial characteristics.

## Setting up Stratification Definitions

This section discusses how to setup stratification definitions

Page used to setup Stratification Configurations:

Page Name	Navigation	Usage
Stratification	Common Object Maintenance> Data Stratification> Stratification Definition	Define the aggregation process at any level of complexity

## Stratification Configuration Page

Use the Stratification Configuration page to define the aggregation process at any level of detail of complexity.

**Navigation:** Common Object Maintenance > Data Stratification> Stratification Definition > New or Edit.

This example illustrates the fields and controls on the Stratification Definition page. You can find definitions for the fields and controls later on this section.

The screenshot shows the 'Stratification Rules Definition' page. The main form is titled 'Definition' and contains the following fields and controls:

- Name \***: Agg Test1
- Description**: Agg Test1
- Source Table \***: Borrowings
- Target Table \***: Borrowings Aggregate
- Catch All Bucket**:
- Output Rules Table Name**: Agg\_Test1\_200262

Buttons for 'Apply', 'Save', and 'Cancel' are visible at the bottom of the form.

To configure Stratification, follow below steps:

1. Establish how you want the Stratification engine to process amounts, rates, dates and integers by assigning a stratification action to each.  
Default input apply a default value into the action settings on the Definition page.
2. Select a source and target instrument table, Default Values, Aggregation Actions and Stratification Actions to complete the definition for each instrument table that you want to aggregate.

## Setting up Stratification Tier Structures

An alternative to incremental grouping is to group according to tiers. You can use tiers on numbers, amounts and rate fields. The main difference between using tiers versus other aggregation actions is that you can define the specific tiers that you want to stratify the data into to match business logic, reporting requirements or both. Tiers also give you more control in terms of limiting the number of strata created for any given attribute to only ranges that are pertinent for processing or reporting purpose. For example, you could define a tier rule that groups the initial balance amounts in increments of 10,000. However, this could result in hundreds of strata if the balance amounts range anywhere from 1 to 100,000,000. A more efficient and logical way to group balance amounts may be to setup tiers so that the first tier contains records with amounts between 1 and 50,000; the second tier contains records with amounts between 50,000 and 1,000,000; and the third tier contains records with amounts between 1,000,000 and 100,000,000. Tiers are ideal for handling balance amounts.



### 34.0.0.1 Page Used to Set Up Tier Structure

Page Name	Navigation	Usage
Tier Structures	Common Object Maintenance> Data Stratification> Stratification Tier	Stratify source data into a finite number of pools that are used by the Stratification Definition under Stratification Action

### 34.0.0.2 Tier Definition Page

Use the Tier Definition page to define stratification criteria for creating a finite number of pools that are used by the **Stratification Definition – Group by** page.

#### Tier Definition Page

This example illustrates the fields and controls on the Tier Structures page. You can find definitions for the fields and controls later on this page.

The screenshot displays the 'Stratification Tier Definition' page. It features a form with the following elements:

- Name:** NewRule
- Description:** Description...
- Tier Type:** TIER
- Data Type:** RATE
- Defined Tiers:** A section titled 'Defined Ranges' containing a table with three rows of values:
 

Lower Bound	Upper Bound
0	10
10.1	100
100.1	1000
- Action Block:** Includes 'Add', 'Update', and 'Remove' buttons for the defined ranges.
- Page Navigation:** Shows 'Page 1 of 1 (1-3 of 3 items)'.
- Buttons:** 'Save' and 'Cancel' buttons are located at the bottom of the form.

Input the lower and upper boundary amounts for each tier and then add to the definition. The lower bound range must be greater than the prior upper bound amount. These values cannot be equal and do not overlap. The initial lower bound and last upper bound should small enough and large enough to capture all possible values.

Note that under Tier Type, “Discrete” is also available to select. This option populates the pool with discrete values for an attribute if there is no logical or mathematical way to group instruments with different values, and the attribute is significant for processing purposes. Choosing the discrete action for an attribute ensures that only instruments with matching values are grouped together in a pool. The discrete action may be the correct choice for important code fields. Be careful when using the discrete action on amount, date, or rate fields. These types of fields tend to have many discrete values. A typical value for a discrete group by is a dimension ID field, code field or a yes/no flag.

## Setting up Stratification Definitions

This section discusses how to setup stratification definitions.

### 34.0.0.3 Pages Used to Setup Stratification Rules

Page Name	Navigation	Usage
Stratification Rules Definition – Definition	Common Object Maintenance > Data Stratification > Stratification Definition> Definitions	Specify rule name, description, source data and target data tables
Stratification Rules Definition – Defaults	Common Object Maintenance > Data Stratification > Stratification Definition> Defaults	Specify default values for each column type
Stratification Rules Definition – Aggregation	Common Object Maintenance > Data Stratification > Stratification Definition> Aggregation	Define aggregation actions (or use the default values) for each column in the data map
Stratification Rules Definition – Stratification	Common Object Maintenance > Data Stratification > Stratification Definition> Stratification	Define how to group or pool the data

## Defining Stratification Rules

Use the Stratification Rules > Tabs to define the Stratification Definition

**Navigation:** Common Object Maintenance > Data Stratification > Stratification Definition

### Stratification Rules – Definitions Page

This example illustrates the fields and controls on the **Stratification Rules – Definition** Page.

The screenshot shows the 'Stratification Rules Definition' page. The 'Definition' tab is active. The form contains the following fields and values:

- Name \*: Agg Test1
- Description: Agg Test1
- Source Table \*: Borrowings
- Target Table \*: Borrowings Aggregate
- Output Rules Table Name: Agg Test1\_200262
- Catch All Bucket:

Buttons: Apply, Save, Cancel

To define Stratification Definition, follow below steps:

1. Provide a unique name and description for the Stratification Definition rule.
2. Select a **source instrument table**. The list of values will include all seeded and properly registered instrument tables which contain account level data records.
3. Select a **target aggregate instrument table**. This is the table that will be populated with the results of the Stratification.

4. Specify whether or not to include a catch all bucket in the process. This will ensure that all records from the source table are accounted for in the target table.
5. Select **Apply** to save your inputs and navigate to the next tab.

### Stratification Rules – Defaults Page

This example illustrates the fields and controls on the Stratification Rules – Defaults Page.

To define Stratification Defaults, follow below steps:

1. Select the **Amount default**. Possible selections are MAX, MIN, SUM, AVG. Recommended selection is SUM.
2. Select the **Date default**. Possible selections are MAX, MIN, MEDIAN. Recommended selection is MEDIAN.
3. Select the **AlphaNumeric default**. Possible selections are MAX, MIN. Recommended selection is MAX.
4. Select the **Rate default**. Possible selections are MAX, MIN, SUM, AVG and Weighted Average. Recommended selection is Weighted Average. If Weighted Average is selected, then additionally select the balance column to use for weighting.
5. Select the **Integer default**. Possible selections are MAX, MIN. Recommended selection is MAX.
6. Select **Apply** to save you inputs and navigate to the next tab.

### Stratification Rules – Aggregation Page

This example illustrates the fields and controls on the Stratification Rules – Aggregation Page.

Stratification Rules Definition

Stratification Rules > Definition

Stratification Rules Definition

Definitions Defaults Aggregation Stratification

Aggregation

Target Column \*  Source Column \*

Aggregation Action  Weighted Avg Column

Default Value

Please Click on a row from the table to edit

Aggregation Mappings for Columns

Type to filter Target Columns  Status Filter

Target Column	Source Column	Aggregation Action	Default Value	Weighted Avg Column ...	Status	Reason
Account Number	Account Number	MIN			Mapped	
Accrual Basis Code	Accrual Basis Code	MIN			Mapped	
Accrued Interest	Accrued Interest	AVG	0.0		Mapped	
Accrued Gross Amount	Accrued Gross Amount	AVG	0.0		Mapped	
Accrued Transfer Amount	Accrued Transfer Amount	AVG	0.0		Mapped	
Actual Account Or Contract Number	Actual Account Or Contract Number	MIN			Mapped	
Adjustable Type Code	Adjustable Type Code	MIN			Mapped	

Page 1 of 29 (1-7 of 202 items)

To define Stratification Aggregation details, follow below steps:

1. Select the specific row you want to define from the bottom half of the page.
2. You have the option to use the default values previously input on the Defaults tab or you can input a different Aggregation Action at the top of the page.
3. Use the pagination selections at the bottom of the page to address / review all columns or alternatively type the column name or a portion of the column name to navigate directly to a specific column.
4. Select **Apply** to save your inputs and navigate to the next page.

### Stratification Rules – Stratification Page

This example illustrates the fields and controls on the Stratification Rules – Stratification Page.

Stratification Rules Definition

Stratification Rules > Definition

Stratification Rules Definition

Definitions Defaults Aggregation Stratification

Stratification

Source Column \*  Stratification Action \*

Tiers

Please Click on a row from the table to edit

Stratification Rules

Source Column	Stratification Action	Tiers
Current Gross Book Balance	TIER	CS Cur Book Bal Tiers

Page 1 of 1 (1 of 1 items)

To define Stratification/Group by details, follow below steps:

1. Select the Column(s) and Stratification Action that you want to use for grouping the detailed records into aggregate/pooled records. Typical columns used for grouping will be dimension columns, balance or rate columns or any other meaningful columns that you want to be unique for each pool record.
2. For each Stratification column, select the Stratification Action. Options are Tier, Discrete and Group by. Both the Tier and Discrete options require an additional Stratification Tier definition to be selected.
3. Select **Apply** to save your inputs and remain in the rule or select Save to save your inputs and close the rule.

## Defining Stratification Tiers

Use the Stratification Tiers page to define the Stratification Tier Definition

**Navigation:** Common Object Maintenance > Data Stratification > Stratification Tier

### Stratification Tiers Page

This example illustrates the fields and controls on the Stratification Tiers Page.

The screenshot shows the 'Stratification Tier' page. At the top, there is a breadcrumb trail: 'Stratification Tier > Definition'. Below this, there is a section for 'Stratification Tier' with the following fields:

- Name \***: CS Cur Book Bal Tiers
- Description**: Tier definition for Current Book Balance
- Tier Type \***: TIER (dropdown menu)
- Data Type \***: BALANCE (dropdown menu)

Below the form is a section for 'Defined Tiers'. It includes a table with the following data:

Defined Ranges	Lower Bound	Upper Bound
	0.01	100000
	100000.01	1000000
	1000000.01	100000000

At the bottom of the page, there are buttons for 'Save', 'Save As', and 'Cancel'. The page number is 'Page 1 of 1 (1-3 of 3 items)'.

To define Stratification Tiers, follow below steps:

1. Provide a unique name and description for the Stratification Tier.
2. Select the Tier Type, that is Tier or Discrete
3. Select the column Data Type that this definition will apply to. This selection will limit the columns where this Tier rule will be available for selection in the Stratification Definition rule.
4. Define each individual tier with lower and upper bounds and Add as a defined range. Additionally use the Update or Remove buttons to manage the individual tier definitions.
5. Once all tiers ranges have been defined, select the Save button save the assumptions and exit the Tier screen.

**Note:** The tier definitions created in this step are mapped to the individual columns in the Stratification Definition rule on the Stratification tab.

## Executing a Stratification Rule

Stratification Rules can be executed from the Stratification Rule Summary Page:

The screenshot shows the Oracle Financial Services Funds Transfer Pricing interface. At the top, there is a navigation bar with the Oracle logo and the text 'Financial Services Funds Transfer Pricing'. On the right, there are language and user settings: 'US-English' and 'ALMUSER'. Below this, the 'Stratification Rules' section is visible, with an 'As of Date' of '06/25/2014'. A search bar is present. The main area contains a table of stratification rules. The table has columns: Name, Created Date, Created By, Last Modified, Modified By, Executed By, Executed On, and Execution Status. The table contains five rows. The row for 'CS Agg 1' is selected. In the action column of the table, there is a set of icons including a plus sign, a refresh icon, a delete icon, and a 'Run' icon (a square with a play symbol), which is highlighted by a red arrow.

Name	Created Date	Created By	Last Modified	Modified By	Executed By	Executed On	Execution Status
11	10/31/2018 11:34:25	ALMUSER	10/31/2018 11:34:30	ALMUSER			
34534	10/15/2018 17:20:36	ALMUSER	11/23/2018 14:45:51	ALMUSER			
3456456	10/15/2018 17:15:37	ALMUSER	10/15/2018 17:20:39	ALMUSER			
CS Agg 1	01/28/2019 22:00:45	ALMUSER	01/28/2019 22:39:51	ALMUSER			
test15	10/15/2018 17:13:20	ALMUSER	01/28/2019 21:56:46	ALMUSER	ALMUSER	10/15/2018 17:16:29	Success

To execute a Stratification Rule, follow below steps:

1. Navigate to the Stratification Rule Summary Page.
2. Select the Stratification Rule you want to process.
3. Select the **Run** icon.
4. Select the as of date for the instrument data you want to aggregate.
5. Select **OK** to begin the process.

You can also execute stratification rule either from **SQL\*Plus** OR from **within a PL/SQL block** OR from **ICC Batch** UI within OFSAAI framework.

## Using SQL\*Plus

To run the procedure from SQL\*Plus, login to SQL\*Plus as the Schema Owner. The function requires four parameters. Following is the syntax for calling the procedure:

```

declare
result number;
begin
---- Call the function
result := fn_insert_into_data_strat_tab(batch_id => :batch_id,
mis_date => :mis_date,
stratification_id => :stratification_id,

```

```

    user_name => :user_name);
end;

```

- **batch\_id** : any string to identify the executed batch
- **mis\_date**: in the format YYYYMMDD
- **stratification\_id**: numeric system id of stratification rule
- **user\_name**: OFSAA user id of the user executing the function

Example

```

declare
result number;
begin
    ---- Call the function
    result := fn_insert_into_data_strat_tab(batch_id => 'abc',
        mis_date => '20180601',
        stratification_id => 123,
        user_name => AUTOUSER);
end;

```

## Using ICC Batch Framework

To execute the procedure from OFSAAI ICC framework, create a new Batch with task as TRANSFORM DATA and specify the following parameters for the task:

- **Datastore Type**: Select appropriate datastore from list
- **Datastore Name**: Select appropriate name from the list
- **IP address**: Select the IP address from the list
- **Rule Name**: Data\_Stratification
- **Parameter List**: stratification\_id, user\_name

Task Definition

Task ID:  Description:

Components:

Dynamic Parameters List

Property	Value
Datastore Type	<input type="text" value="EDW"/>
Datastore Name	<input type="text" value="PM80INFO"/>
Primary IP For Runtime Processes	<input type="text" value="10.184.154.4"/>
Rule Name	<input type="text" value="Data_Stratification"/>
Parameter List	<input type="text" value="123, 'AUTOUSER'"/>

After the Stratification rule execution is complete, you can compare balances from the source table and target table to ensure all data has been accounted for, i.e. the sum of current balance from source table should equal sum of current balance in the target table.

Once data has been populated and verified in the aggregation tables, it is ready for processing by the ALM and/or FTP applications. You can select either regular instrument tables or aggregate instrument tables in the ALM and TP Processes under Source Selection. You should select one or the other. Selecting both in the same process will lead to double counting of the balances.

## Creating New Aggregate Table

The following aggregate tables are seeded with application data model:

#	Logical name	Physical table name
1	Annuity Contracts Aggregate	FSI_D_ANNUIITY_CONTRACTS_AGGR
2	Borrowings Aggregate	FSI_D_BORROWINGS_AGGR
3	Checking And Savings Accounts Aggregate	FSI_D_CASA_AGGR
4	Credit Cards Aggregate	FSI_D_CREDIT_CARDS_AGGR
5	Credit Lines Aggregate	FSI_D_CREDIT_LINES_AGGR
6	Guarantees Aggregate	FSI_D_GUARANTEES_AGGR
7	Investments Aggregate	FSI_D_INVESTMENTS_AGGR
8	Leases Aggregate	FSI_D_LEASES_AGGR
9	Loan Contracts Aggregate	FSI_D_LOAN_CONTRACTS_AGGR
10	Money Market Contracts Aggregate	FSI_D_MM_CONTRACTS_AGGR
11	Mortgages Aggregate	FSI_D_MORTGAGES_AGGR
12	Retirement Accounts Aggregate	FSI_D_RETIREMENT_ACCOUNTS_AGGR
13	Term Deposits Aggregate	FSI_D_TERM_DEPOSITS_AGGR



If you want to create a new aggregate table then, apart from basic instrument and leaf columns, the following mappings must be done in data model:

- Super-type
  - ⌘ INSTRUMENT\_AGGREGATE
  - ⌘ INSTRUMENT\_AGGREGATE\_BASIC
- Table classification
  - ⌘ EPM Aggregation (701)

This may be required when you create a custom instrument table and want to use stratification for it.



---



---

## Viewing ALM Objects in Metadata Browser

### Metadata Browser (Object and Application View)

Metadata Browser (Object and Application View)

Metadata Browser (Object and Application View) provides common repository of metadata Objects created in OFSAAI and applications hosted in OFSAAI. Using this view, you can identify the usage of base Objects in higher level Objects and the mapping of Objects to Application. It enables to perform traceability and impact analysis. It also allows you to view the data flow and the work flow of the application and understand the usage of Objects within the application.

Metadata Browser (MDB) supports Application view and Object view: In Application view, you can browse through the metadata created using the applications hosted in OFSAAI. In Object view, you can view the metadata created in OFSAAI.

To access the Metadata Browser (Object and Application View), your role Business Analyst (SYSBAU) must be mapped to the SCR\_MDB function. For more information on mapping functions to a role, see Function - Role Map.

The Application view provides the top-down approach to view the defined metadata. The Application view shows the list of Applications at the parent level, and the Child elements are Runs for the application. This list will grow dynamically based on the Run definitions mapped to Application, through this tab user can view Run execution details in Metadata Browser.

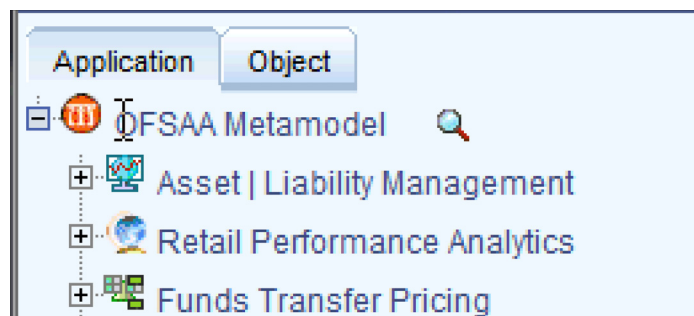

For more information on Metadata Browser, refer to Metadata Browser section of *Oracle Financial Services Analytical Application Infrastructure (OFSAAI) User Guide 8.0.0.0.0*.

#### A.0.1 Configuring Metadata Browser

You can configure the Metadata Browser for ALM using the following steps:

1. Map the MDB batch to User - Group using the Common Object Maintenance > Operations> Batch Execution Rights as mentioned below:

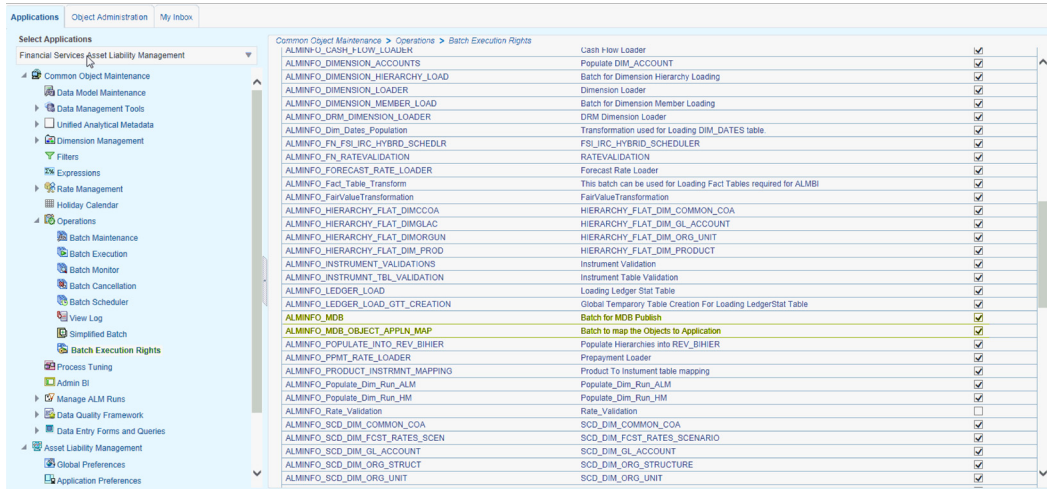

2. For more information, refer to Command Line Utility to Publish Metadata in Metadata Browser section in OFSAAI User Guide.
3. Execute the Batch for MDB publish.

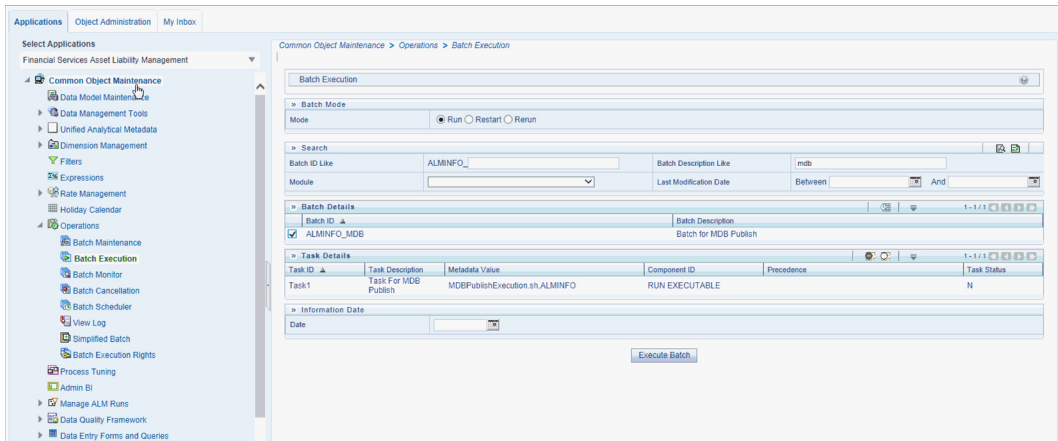

For more information, refer to ICC Batch Execution section of Oracle Financial Services Analytical Application Infrastructure (OFSAAI) User Guide 8.0.0.0.0.

4. Navigate to Metadata Browser (Object and Application) window of respective Application.

## Viewing ALM Objects in Metadata Browser

Asset Liability Management under Oracle Financial Services Analytical Applications has the Metadata Browser (MDB).

To view ALM applications and objects in MDB, perform the following steps:

1. After successful execution of the Batch for MDB Publish, in the Applications tab of the Oracle Financial Services Analytical Applications window, in the Left-Hand

Side (LHS) menu under Asset Liability Management, choose Metadata Browser. You can also access Metadata Browser in the Object Administration tab.

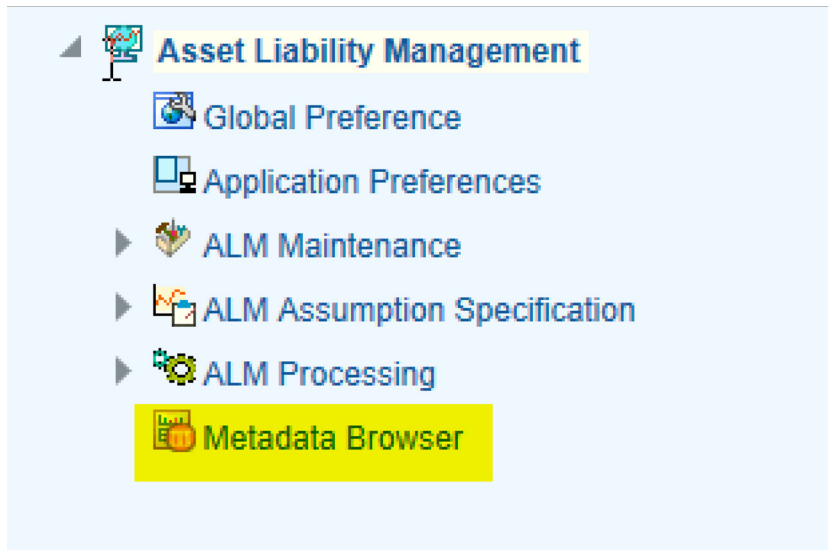

2. Click the Application tab under Metadata Browser window to view the ALM applications.

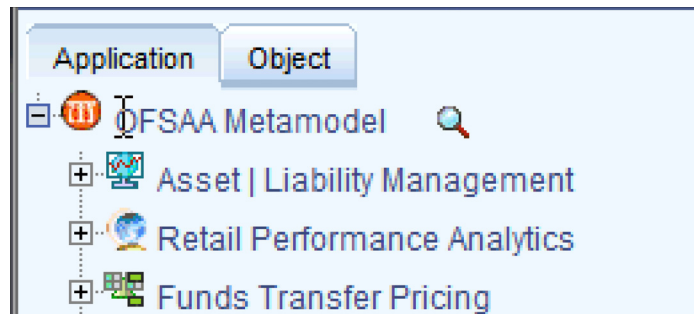

3. Click the Object tab under Metadata Browser window to view ALM objects:

4. Under Process Metadata > Rules, all the rules defined under ALM window are displayed.

---

---

## Performance Tuning

The Asset Liability Management implementation may involve many ALM processes in order to meet business requirements. Primarily a process execution window is closely related to the volume of data it operates on, underlying metadata definitions, in-memory calculations, processing individual calculation elements/attributes (for example, Account Level Cashflows, selective Financial Elements), and so on.

Below are basic guidelines, which should be considered to achieve better performance:

- Process Tuning
  - Invalid key processing data
  - Process Tuning
  - Process Cash Flow Cleanup
  - Validate Node Map
  - Data Slicing
  - Configuring Payment Schedule

For more information, see [Process Tuning](#) section.

- Operating System Level Tuning
  - Semaphores
  - Shared Memory

For more information, see [Operating System Level Tuning](#) section.

- Database Level Tuning
  - Simple View vs Materialized View
  - Cursor Sharing
  - Index Optimization

For more information, see [Database Level Tuning](#) section.

### Process Tuning

This module provides information on configuring the Oracle Financial Services Analytical Application (OFSA) server-centric software for multiprocessing through the Process Tuning UI.

---

---

**Caution:** The Process Tuning UI is available for definition ONLY for a User who has a role mapping that of 'Administrator' or 'Auditor'. The 'Auditor' role mapped user has 'READ-ONLY' access to Process Tuning UI.

---

---

This appendix covers the following topics:

- [Multiprocessing Model](#)
- [Multiprocessing Options](#)
- [Specifying Multiprocessing Parameters](#)
- [Tuning Multiprocessing](#)

For more information on OFSAA Process Tuning Options, see the Doc ID [1307766.1](#)

To improve the process tuning in ALM application, perform the following steps:

- Rule Step
- Rule Name
- Partition Type
- Number of Processes
- Commit Frequency
- Data Slice Type

## Multiprocessing Model

By default, multiprocessing is disabled for all applications. Multiprocessing is enabled by setting application specific parameters located under the Common Object Maintenance > Process Tuning. The following applications and features have multiprocessing settings:

- Asset Liability Management – Deterministic and Stochastic Processing
- Funds Transfer Pricing – Standard and Stochastic Processing

OFSAA multiprocessing is based on the concept of a unit-of-work. A unit-of-work is a set of rows from the database. A single OFSAA process becomes multiple processes by dividing the single process according to distinct sets of rows. Units of work are distributed to worker processes until all processes have been completed. To achieve multiple parallel processes, the following options must be configured:

- Creating a list or lists of units of work
- Defining the number of worker processes to service the units-of-work lists
- Defining how the worker processes service the unit-of-work lists

The specifics of each option are discussed. The following diagram illustrates the basic multiprocessing principles:



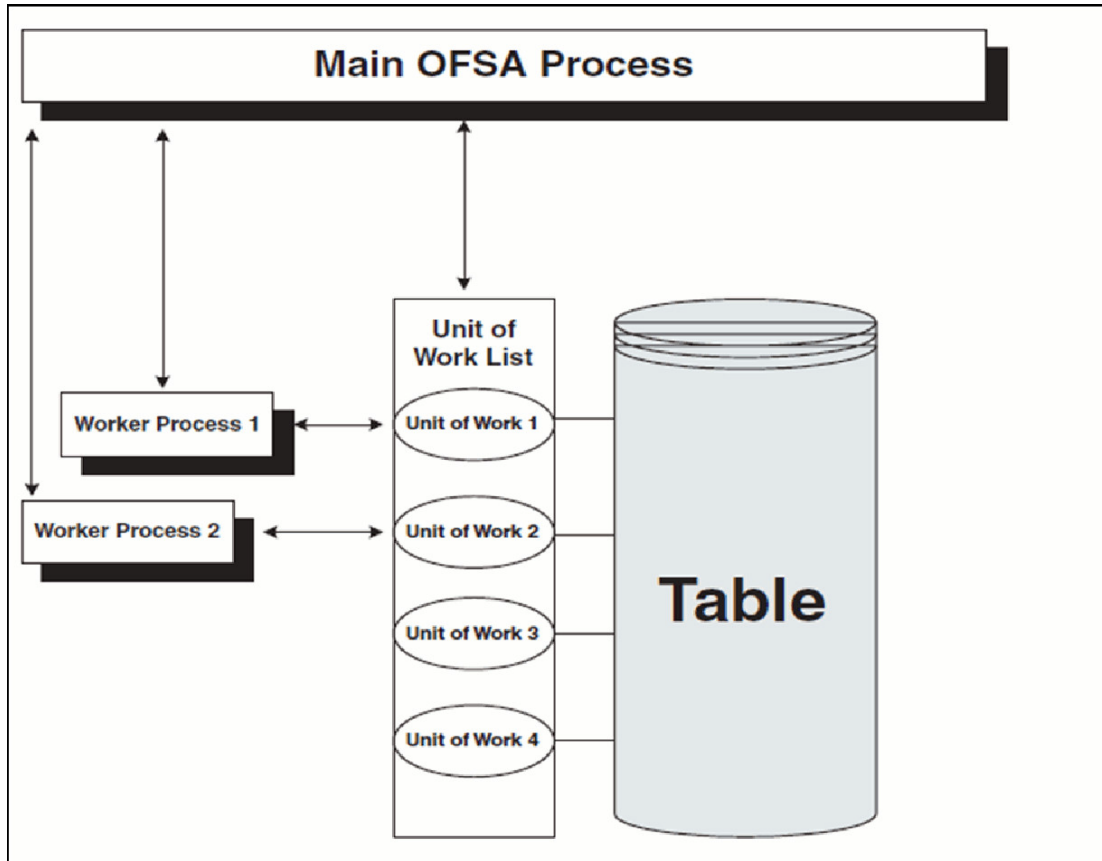

1. The main process makes a list of all units of work that must be processed.
2. The main process spawns worker processes. Each worker process is assigned a unit of work by the main process.
3. When all units of work have been completed, the worker process exits and the main process finishes any clean-up aspects of processing.
4. During processing the following is true:
  - Each worker process must form its own database connection.
  - A unit of work is processed only by a single worker process.
  - Different units of work are processed at the same time by different worker processes.

---

**Note:** If data is not distributed well across physical devices, I/O contention may offset the advantage of parallelism within OFSAA for I/O bound processing. It is recommended that users choose dimension or combination of dimensions that produce a relatively equal distribution of data records.

---

## Multiprocessing Options

The Multiprocessing Options are the settings and parameters that control how individual ALM or FTP Processes are processed by the Cash Flow engine. The seeded

data model includes default settings for all of the multiprocessing options, but you can also customize the settings for your own use. This section describes the different Multiprocessing options as well as how to customize each. These options are:

- Units of Work
- Unit-of-Work Servicing
- Worker Processes

## Units of Work

The OFSAA processing engines determine units of work for any job based upon the Process Data Slicing Code assignment. The Data Slicing Code comprises one or more columns by which data in the (processing) table is segmented. The individual segments are the defined Units of Work.

The Process Tuning user interface enables you to specify different unit-of-work definitions for your processes. You could specify one unit-of-work definition for one set of processes and then specify a different unit-of-work definition for another set of processes.

The OFSAA Processing Engines determine the units of work for a job by executing the following statement (with filtering criteria applied) on every table the process is run against:

```
select distinct<data slice columns>from<table>where<filter condition>;
```

where <data slice columns> is the comma-separated list of columns used for data slicing, <table>is the name of the instrument table being processed, and <filter condition> is the additional filter (if any) for the process. All portfolio tables with numeric columns will be used of Data slicing,.

### Default Unit-of-Work Definitions

OFSAA provides three default unit-of-work definitions:

PROCESS_DATA_SLICES_CD	PROCESS_DATA_SLICES_SEQ	COLUMN_NAME
1	1	ORG_UNIT_ID
1	2	COMMON_COA_ID
2	1	ORG_UNIT_ID
3	1	COMMON_COA_ID

Any single Process Data Slice Code can comprise multiple columns. As an example of this, the PROCESS\_DATA\_SLICES\_CD = 1 comprises both ORG\_UNIT\_ID and COMMON\_COA\_ID. The PROCESS\_DATA\_SLICES\_SEQ identifies the precedence for the columns within the Process Data Slices CD.

## Unit-of-Work Servicing

Unit-of-work servicing identifies how the OFSAA processing engines interact with Oracle Database Table Partitioning.

### What is Partitioning

Partitioning addresses the key problem of supporting very large tables and indexes by enabling you to decompose them into smaller and more manageable pieces called partitions. Once partitions are defined, SQL statements can access and manipulate the

partitions rather than entire tables or indexes. Partitions are especially useful in data warehouse applications, which commonly store and analyze large amounts of historical data.

### What Is Unit-of-Work Servicing?

Unit-of-work servicing specifies how individual units of work are processed for a table that is partitioned.

For a partitioned table, an application Rule Type/ Rule Step can create multiple units-of-work lists by executing the following statement (with filtering criteria applied) on every table partition the process is run against:

```
select distinct<data slice columns>from<table_partition_n>
```

For example,

```
SELECT DISTINCT REV.COLUMN_NAME, MLS.DISPLAY_NAME from REV_TAB_
COLUMNS REV, REV_TAB_COLUMNS_MLS MLS
```

```
WHERE REV.TABLE_NAME=MLS.TABLE_NAME AND REV.COLUMN_
NAME=MLS.COLUMN_NAME
```

```
AND REV.TABLE_NAME='PORTFOLIO' AND REV.DATA_TYPE='NUMBER' AND
MLS.MLS_CD='US'
```

```
UNION SELECT 'DATA_SLICE_ID' COLUMN_NAME,'Data Slice' DISPLAY_NAME
from DUAL
```

```
UNION SELECT 'FINANCIAL_ELEM_ID' COLUMN_NAME,'Financial Element'
DISPLAY_NAME from DUAL ORDER BY DISPLAY_NAME;
```

where <data slice columns> is the comma-separated list of columns used for data slicing. Any column in a table can be used for data slicing. <table\_partition\_n> are the unique table partitions of a table where n is assumed to be greater than 1.

The different Servicing methodologies are stored in the FSI\_PROCESS\_PARTITION\_CD and FSI\_PROCESS\_PARTITION\_MLS tables. You cannot add any customized Servicing methodologies. The Servicing methodologies provided in OFSAA are as follows:

PROCESS_PARTITION_CD	PROCESS_PARTITION
0	Do not use partitions (single servicing)
1	Use shared partitions (Cooperative Servicing)
2	Use non-shared partitions (Dedicated Servicing)

These methodologies are defined as follows:

- Single Servicing
- Cooperative Servicing
- Dedicated Servicing

### Single Servicing

Single Servicing indicates that the OFSAA processing engine fulfills unit-of-work requests regardless of any table partitioning. As each individual process completes, it requests the next unit-of-work segment, whether or not that segment belongs in the same Table partition.

Use Single Servicing when you do not have Oracle Table Partitioning in your database.

**Cooperative Servicing**

Cooperative Servicing indicates that the OFSAA processing engine fulfills unit-of-work requests so that each process works against a specific partition unless it is idle. Idle processes then work against the next available unit-of-work segment, whether or not that segment belongs in the same Table partition.

**Dedicated Servicing**

Dedicated Servicing indicates that the OFSAA processing engine fulfills unit-of-work requests so that each process works against a specific partition.

**Examples of How Worker Processes Service Units of Work**

FSI\_PROCESS\_ID\_STEP\_RUN\_OPT.PROCESS\_PARTITION\_CD defines how Worker Processes service the units-of-work list or lists. As explained in the define units-of-work list or lists step, an FSI\_PROCESS\_ID\_STEP\_RUN\_OPT.PROCESS\_PARTITION\_CD equal to 0 results in a single units-of-work list. With a single units-of-work list, all available worker processes service the list until all units of work are complete. When FSI\_PROCESS\_ID\_STEP\_RUN\_OPT.PROCESS\_PARTITION\_CD equals 1 or 2 and the table to be processed is partitioned, multiple units of work lists are created. The following scenarios explain how the worker processes service multiple units-of-work lists:

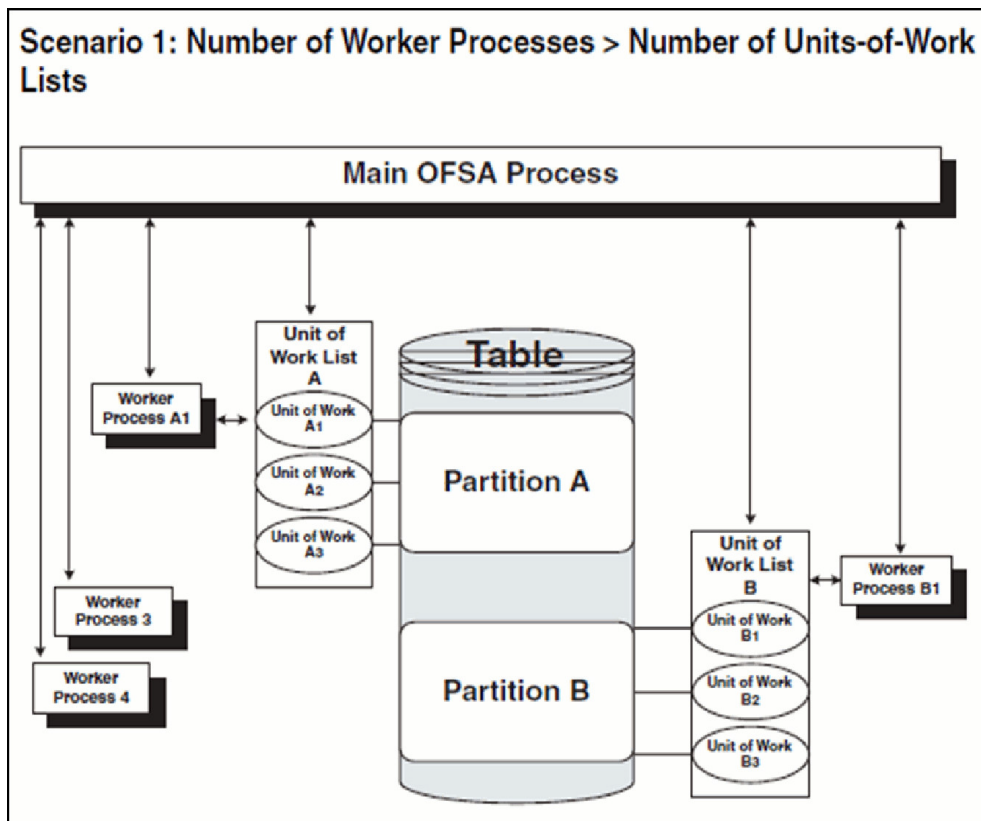

- The main process makes two lists of all units of work that need to be processed, unit-of-work list A and unit-of-work list B, respectively. (The setup is that the Table has two partitions.)

- The main process spawns four worker processes. A dedicated worker process is assigned to service each unit-of-work list, Worker Process A1 and Worker Process B1 respectively. (The setup is (FSI\_PROCESS\_ID\_STEP\_RUN\_OPT.NUM\_OF\_PROCESSES = 4))

If FSI\_PROCESS\_ID\_STEP\_RUN\_OPT.PROCESS\_PARTITION\_CD equals 1, Worker Process 3 and Worker Process 4 assist Worker Process A1. When a unit-of-work list is complete, the available worker processes assist dedicated worker process on their unit-of-work List.

If FSI\_PROCESS\_ID\_STEP\_RUN\_OPT.PROCESS\_PARTITION\_CD equals 2, Worker Process 3 and Worker Process 4 do not assist the dedicated worker processes

- When all units of work have been completed, the worker process exits and the main process finishes any clean-up aspects of processing.

- During processing the following is true:

Each worker process must form its own database connection.

A unit of work is processed only by a single worker process

Different units of work are processed at the same time by different worker processes.

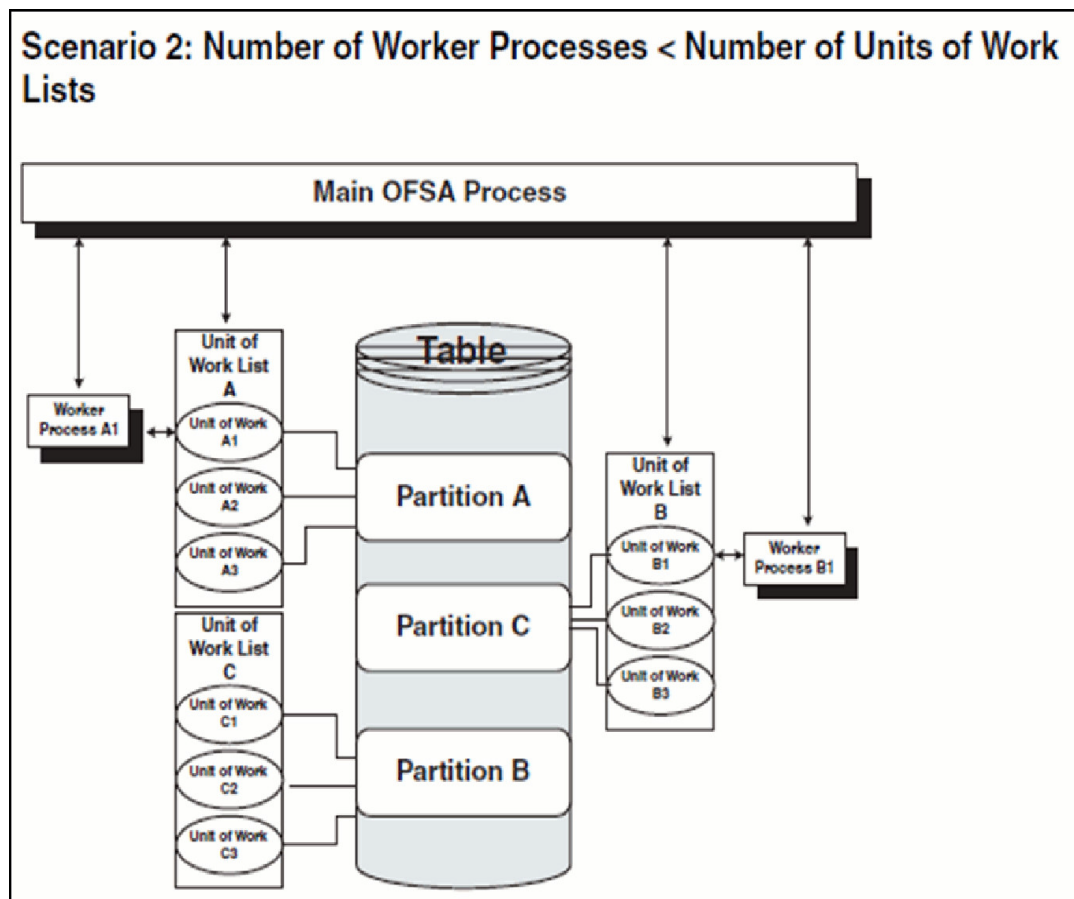

- The main process makes three lists of all units of work that need to be processed: unit-of-work list A, unit-of-work list B, and unit-of-work list C, respectively. (The setup is that the Table has three partitions.)

- The main process spawns two worker processes. A dedicated worker process is assigned to service a units-of-work list, Worker Process A1 and Worker Process B1 respectively. (The setup is (FSI\_PROCESS\_ID\_STEP\_RUN\_OPT.NUM\_OF\_PROCESSES = 2).

If FSI\_PROCESS\_ID\_STEP\_RUN\_OPT.PROCESS\_PARTITION\_CD equals 1, Worker Process A1 and Worker Process B1 work until all units of work are complete from all three unit-of-work lists.

If FSI\_PROCESS\_ID\_STEP\_RUN\_OPT.PROCESS\_PARTITION\_CD equals 2, the first worker process to complete their unit-of-work List services unit-of-work list C. When the other worker process completes their list, the worker process exits.

- When all units of work have been completed, the worker process exits and the main process finishes any clean-up aspects of processing.
- During processing the following is true:
  - Each worker process must form its own database connection.
  - A unit of work is processed only by a single worker process.
  - Different units of work are processed at the same time by different worker processes.

## Worker Processes

Worker Processes refer to the number of individual processes working simultaneously to complete the job. The Main OFSAA Process launches the individual worker processes. OFSAA enables you to specify the number of worker processes for your jobs.

## Specifying Multiprocessing Parameters

Users can access the multi-processing / tuning UI under the Common Object Maintenance on the LHS menu:

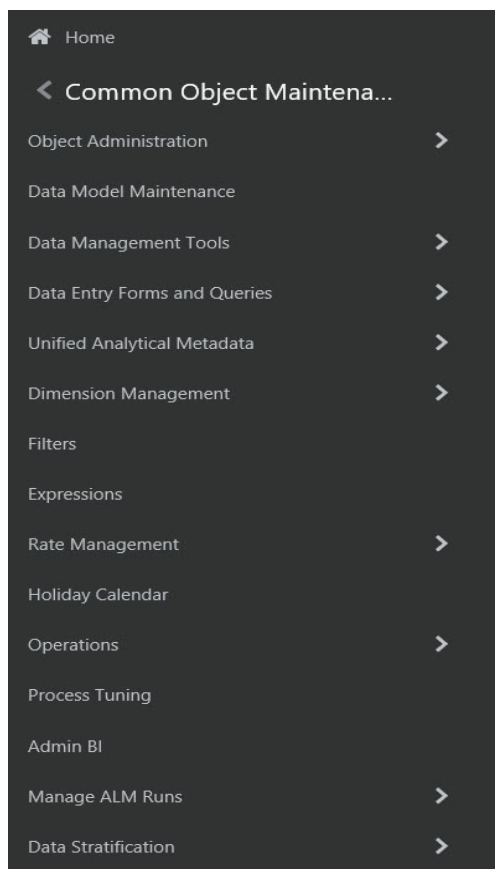

The application installation process seeds default multiprocessing parameters. By default, multiprocessing is turned off for all processes. To turn on multiprocessing, Application Administrators can define Process tuning assumptions at the application level or for individual processes.

This section discusses the following topics:

- Multiprocessing Assignment Levels
- Defining Multiprocessing
- Engine Overrides

## Multiprocessing Assignment Levels

Multiprocessing parameters can be specified at different levels. A Multiprocessing Assignment Level is the category of ALM or FTP execution that is processed with a designated set of multiprocessing parameters.

OFSAA provides multiprocessing assignments at the following levels:

- Rule Type
- Rule Step
- Rule Name

### Rule Type

When specifying multiprocessing parameters at the Rule Type level, all Rule Names for that Rule Type are processed with the designated parameters.

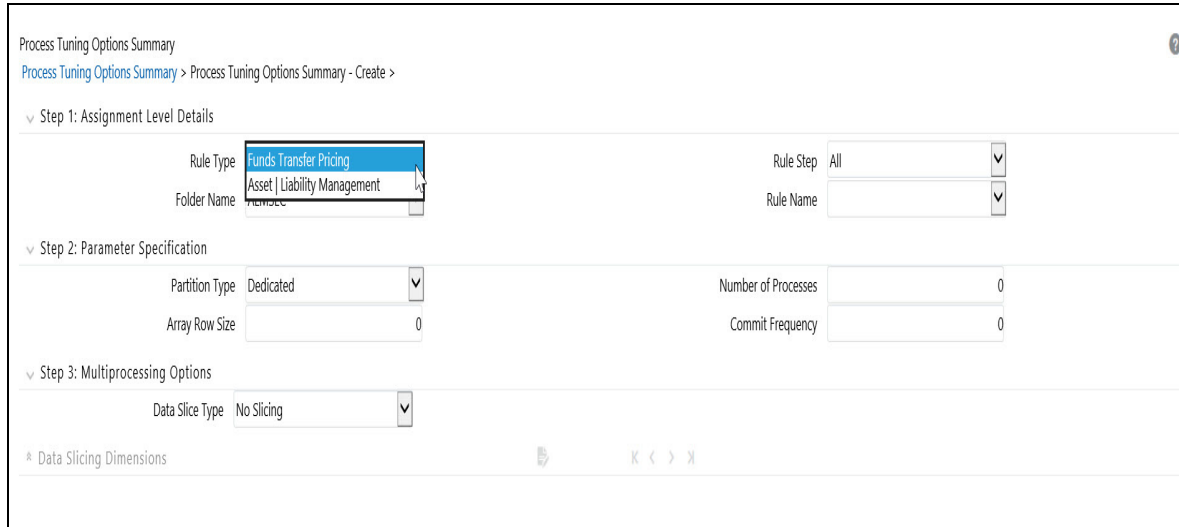

The valid Rule Type values present in the 'Rule Type' drop-down list are:

FSI_PROCESS_ENGINE_CD		
PROCESS_ENGINE_CD	DESCRIPTION	RULE TYPE
2	Asset   Liability Management Process	Asset   Liability Management Process
3	Funds Transfer Pricing Process	Funds Transfer Pricing Process

The OFSAA multiprocessing UI allows you to designate a set of multiprocessing parameters used for a specific Rule step within a given Rule Type.

**Rule Step**

The Rule Step identifies a particular phase of an OFSAA process. Rule Steps are reserved names specific to each Rule Type.

Each Rule Step Name applies to a specific Rule Type.

The mapping of the list of valid Rule Steps and the Rule Type for which they apply is as follows:

PROCESS_ENGINE_CD	RULE STEP NAME
0	ALL
2	Client Data by Prod
2	Client Data by Prod, Org
2	Client Data by Prod, Currency
2	Monte Carlo client data
3	ALL



### Rule Name

Users can optionally specify multiprocessing parameters at the Rule Name level to override any parameters assigned at the Rule Type level. This enables you to individualize your multiprocessing options to handle situations unique to specific Processes. In most cases, defining multi-process assumptions at the Application / Rule Step level is sufficient.

The list of valid Rule Names is populated from the FSI\_M\_OBJECT\_DEFINITION\_B and FSI\_M\_OBJECT\_DEFINITION\_TL tables.

Only Rule Names of the following Process types are available for multi-processing:

- Asset | Liability Management Process
- Funds Transfer Pricing Process

## Defining Multiprocessing

The process of defining Multiprocessing involves associating multiprocessing parameters to OFSAA Rule Types and/or Rule Names. Included in this section are the following topics:

- Parameter Tables
- How to Specify Parameters

### Parameter Tables

While defining multiprocessing, the user interface inserts data into the following objects:

FSI\_PROCESS\_ID\_RUN\_OPTIONS

FSI\_PROCESS\_ID\_STEP\_RUN\_OPT

FSI\_PROCESS\_ID\_RUN\_OPTIONS\_V (Read Only View)

TABLE_NAME	DISPLAY_NAME	DESCRIPTION
FSI_PROCESS_ID_RUN_OPTIONS	Process ID Run Options	This table specifies the Rule Name (ALM Process / FTP Process) for a single Process Type.

TABLE_NAME	DISPLAY_NAME	DESCRIPTION
FSI_PROCESS_ID_STEP_RUN_OPT	Process ID Step Run Options	This table stores the Process Tuning Definition and contains the Rule Name (ALM Process / FTP Process) and process tuning option selections.
FSI_PROCESS_ID_RUN_OPTIONS_V	Process ID Run Options View	This table provides a read-only view based on FSI_PROCESS_ID_RUN_OPTIONS and FSI_PROCESS_ID_STEP_RUN_OPT tables.

Each table is described as follows:

FSI\_PROCESS\_ID\_RUN\_OPTIONS

COLUMN_NAME	DESCRIPTION	Display Name
PROCESS_RUN_OPTION_SYS_ID	Rule Name (ALM Process / FTP Process) System ID Number	System ID Number
PROCESS_ENGINE_CD	Process Engine Code that run this Rule Name (ALM Process / FTP Process)	Process Engine Code

FSI\_PROCESS\_ID\_STEP\_RUN\_OPT

COLUMN_NAME	DESCRIPTION	Display Name
PROCESS_STEP_RUN_SYS_ID	This stores the Rule Name's (ALM Process / FTP Process) System ID Number.	System ID Number
PROCESS_ENGINE_STEP_CD	Rule Step of the Rule Name getting the Process Data Slices Code and Process Partition Code	Step Name
NUM_OF_PROCESSES	Number of Processes	Number of Processes
COMMIT_FREQ	The number of rows after which the process commits changes.	Commit Frequency
ARRAY_SIZE_ROWS	The number of rows updated in a single call to the database.	Array Size Rows
PROCESS_PARTITION_CD	Process Partition code used by this Rule Name (ALM Process / FTP Process) in this step	Process Partition Code
PROCESS_DATA_SLICES_CD	Process Data Slices Code used by this Rule Name (ALM Process / FTP Process) in this step	Process Data Slices Code
PROCESS_ENGINE_CD	Process Engine Code that run this Rule Name (ALM Process / FTP Process)	Process Engine Code

## FSI\_PROCESS\_ID\_RUN\_OPTIONS\_V

COLUMN_NAME	DESCRIPTION	Display Name
SYS_ID_NUM	Rule Name (ALM Process / FTP Process) System ID Number	System ID Number
STEP_NAME	Rule Step of the Rule Name getting the Process Data Slices Code and Process Partition Code	Step Name
PROCESS_ENGINE_CD	Process Engine Code that run this Rule Name (ALM Process / FTP Process)	Process Engine Code
NUM_OF_PROCESSES	Number of Processes	Number of Processes
PROCESS_DATA_SLICES_CD	Process Data Slices Code used by this Rule Name (ALM Process / FTP Process) in this step	Process Data Slices Code
PROCESS_PARTITION_CD	Process Partition code used by this Rule Name (ALM Process / FTP Process) in this step	Process Partition Code
COMMIT_FREQ	The number of rows after which the process commits changes.	Commit Frequency
ARRAY_SIZE_ROWS	The number of rows updated in a single call to the database.	Array Size Rows

### How to Specify Parameters

The setup of multiprocessing is broken down into the following steps:

- Assignment Level Details
- Parameter Specification
- Multi-Processing Options
- Assign Unit-of-Work Servicing Methodology

For each step, the relevant multiprocessing parameters are described. Some applications override the multiprocessing configuration in order to handle special processing conditions. The Engine Overrides section explains these special processing conditions.

### Assignment Level Details

The 'Rule Type', 'Rule Step' and 'Rule Name' columns identify the Assignment Level for multiprocessing.

#### Procedure:

1. Log on to Financial Services Applications with the User ID/password that has 'Administrator' Privileges.
2. Navigate to Common Object Maintenance > Process Tuning Options Summary Page. This page is the gateway to Process Tuning Options related functionality.
3. Click Add to create a new Process Tuning assumption. Note, you can create only one process tuning assumption per combination of Rule Type and Rule Name.

4. The Process Tuning Options Summary – Create page is displayed.
5. Step - 1: Assignment Level Details Block is the first block.



Step 1: Assignment Level Details

Rule Type: Asset | Liability Management

Folder Name: ALMSEC

Rule Step: Client Data by Prod

Rule Name: Test

6. This block contains 4 fields - Rule Type, Rule Step, Folder Name and Rule Name.
7. Select the required Rule Type.
8. Folder Name is a drop-down to assist rule-name selection, filtered by selected folder.
9. Select the required Rule Step. Rule Step is a drop-down that is filtered based on its mapping to the Rule Type selected.
10. Select the required Rule Name. Rule Name is a drop-down that displays rules of the selected type, within the specified folder.

The system supports four assignment levels. Because an application allows configurations that mix these levels, it is important to understand the order in which the application resolves the multiprocessing parameters when the configuration mixes assignment levels. The order is:

1. Specific Step of a specific Process for an engine
2. All Steps of a specific Process for an engine
3. Specific Step of all Processes for an engine

The next step after defining Assignment Level details is to define the Multiprocessing Parameters. Multiprocessing parameters include inputs for the following:



Step 2: Parameter Specification

Partition Type: Dedicated

Array Row Size: 0

Number of Processes: 0

Commit Frequency: 0

- Partition Type
- Array Row Size
- Number of Processes
- Commit Frequency

The following describes inputs for each parameter:

**Partition Type**

Partition Type selection is required when table partitioning is being used within your instrument tables. If no partitioning is being done, then the default selection of “No Partitioning” should be selected. If partitioning is being done, then users should select either Dedicated or Cooperative. For more information on these selections, refer to the section on Multiprocessing Options > Unit of Work servicing.

**Number of Processes**

The number of processes selection indicates the number of concurrent processes to be launched by the engine. Typically, the number of processes should be less than or

equal to the number of CPUs available on the server. Users should experiment with the number of processes setting to find the optimal value.

### Array Row Size and Commit Frequency

You must do some trials to set these at optimum level. Commit frequency can be set as 999 and array size rows as 500. Setting the array update size to be greater than the commit frequency has no effect because the array update size is limited by commit frequency.

To use Commit\_Freq = 0 Or > 0, below are recommendations:

- If only "Process Cash Flow" writing applicable as part of process definition then use COMMIT\_FREQ optimally greater than 0.
- If "Process Cash Flow" not applicable but o/p to RES\_DTL, CONS\_DTL etc as part of process definition then the entry should be set to 0 incase commit required at UOW End.
- If both "Process Cash Flow" and o/p to RES\_DTL, CONS\_DTL then one should set Commit\_Freq > 0 in order to take benefit of Process Cash Flow Bulk Processing. If user seeks commit at the end of UOW then this setting should be set to 0.

Step 3 in the multiprocessing setup includes the following selections:

The screenshot shows a software interface for configuring multiprocessing options. At the top, it says 'Step 3: Multiprocessing Options'. Below this, there is a 'Data Slice Type' dropdown menu currently set to 'Distinct Values'. Underneath, there is a section for 'Data Slicing Columns' with a small icon and the text '0 - 0 / 0 K < > X'. At the bottom, there is a section for 'Selected Products' which is currently empty.

### Data slice type

Data Slice Type is a static drop-down with 2 values [Distinct Values, No Slicing]. Users should choose distinct values to enable multiprocessing. After choosing distinct values, users are required to further select their Data Slicing dimensions.

### Data slicing dimensions

Choose the edit option to launch a pop-up window to select the slicing columns

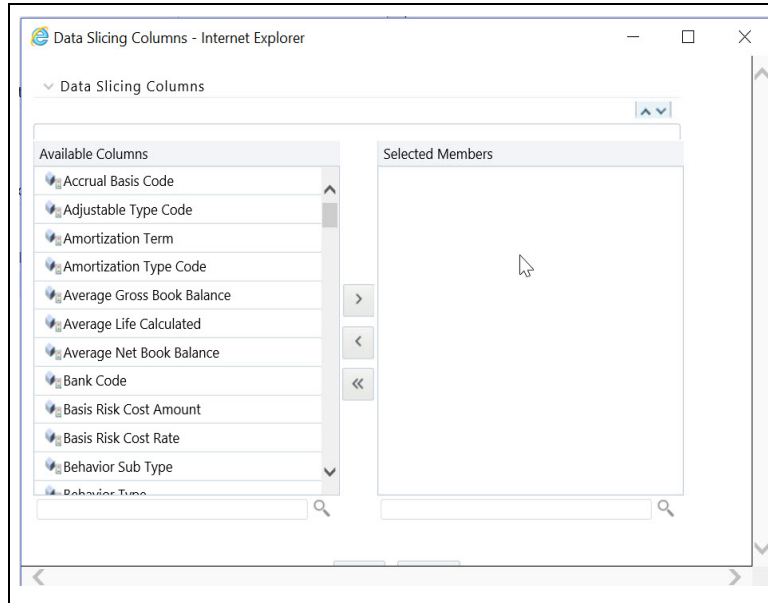

---

**Note:** All portfolio tables with numeric columns will be used of Data slicing. The columns with null values cannot be used for data slicing.

---

## Engine Overrides

For some conditions, the OFSAA Processing Engines override the multiprocessing definition for an assignment level. The overrides are as follows:

### Asset Liability Management

Asset Liability Management configures the data slicing columns automatically using the Product Leaf Column defined in the active Application Preferences as the default slicing column for all runs. The Asset Liability Management engine adds more slicing columns based upon the parameters specified in the Asset Liability Management Process, as follows:

- If Product/Organizational Unit functional dimensions are selected, the engine adds ORG\_UNIT\_ID as an additional slicing column.
- If Product/Currency functional dimensions are selected, the engine adds ISO\_CURRENCY\_CD as an additional slicing column.
- If Product/Organizational/Currency functional dimensions are selected, the engine adds ORG\_UNIT\_ID and ISO\_CURRENCY\_CD as additional slicing columns.

## Tuning Multiprocessing

Tuning for optimal multiprocessing settings is an exercise similar to tuning a database. It involves experimentation with different settings under different load conditions.

## Database Bound versus Engine Bound Jobs

OFSAA jobs fall into the following two categories:

- Database bound—Those jobs that spend more time within database manipulations.
- Engine bound—Those jobs whose calculations are complex, with the time spent with database Operations being small compared to the amount of time doing calculations.

The following table lists OFSAA jobs by Application and identifies whether the job is usually database bound or Engine bound.

Application	Job Type	Generic Job Type	OFSAA / DB Bound	MP Enabled	Comments
Asset   Liability Management	Detail Processing (Current position, Gap, Market Value)	Row by Row	OFSAA	Yes	All processing except Formula Results and Auto Balancing
Asset   Liability Management	Formula Results	Row by Row	OFSAA	No	Formula Results is not currently functional, and will be available in a later release
Asset   Liability Management	Auto Balancing	Row by Row	OFSAA	No	

The scalability of database-bound jobs is largely determined by size of the database server. The scalability of Engine bound jobs is determined by the size of the application server.

## Tuning the OFSAA Database from the Application Layer

Despite the many multiprocessing options, tuning the OFSAA database from the application layer is achieved by following a simple process. The process is as follows:

1. Identify the OFSAA job types that are used by your organization.
2. For each job type, time the runs for a series of Number of Processes settings, defined in Step 2: Parameter Details.
3. Based on the results, determine the appropriate setting per application.

### Special Considerations

Because of the nature of parallel processing performed by OFSAA, different processes tend to need to access the same tables at the same time. Unless care is taken in designing the layout of the database tables, this can lead to I/O contention, which in turn, can reduce scalability.

## Invalid key Processing Data

For key processing dimensions considered for ALM processing, user can not use default values like Missing (0) or Others (-1) in corresponding instrument tables; otherwise Engine would exhibit undefined behavior or result in hung state during process execution.

For example, assume one has General Ledger Account selected as “Product Dimension” and Organizational Unit as “Organizational Unit Dimension”. In such case, instrument table should contain valid values (i.e. Non 0 or -1) for process to execute successfully; failing which would cause Engine to hang during Source fetching & processing.

Dimensions and Hierarchies		
Property Name	Property Value	Is Editable
Product Dimension	General Ledger Account <input type="text"/>	<input checked="" type="checkbox"/>
Default Product Hierarchy	dim gl account <input type="text"/>	<input checked="" type="checkbox"/>
Organizational Unit Dimension	Organizational Unit <input type="text"/>	<input checked="" type="checkbox"/>
Hierarchy Members Navigation Size	100 <input type="text"/>	<input checked="" type="checkbox"/>

## Process Cash Flow Cleanup

If you observe huge data present in FSI\_O\_PROCESS\_CASH\_FLOWS for current process ID, then you can decide to delete cash flows from this table for that particular process id before rerunning the process again.

## Validate Node Map

An ALM process is assumptions driven execution. Based on process configuration, it reads Prepayment, Discount Rates, Product Characteristic, Pricing Margin, etc. In general these assumptions can be defined at either node or leaf level.

Based on configuration, the assumption defined at node level can be inherited to its children as well which means same definition to be to all its active child leafs. This is achieved by executing ALM Validate Node Map (VALIDATE\_NODE\_MAP\_ALM) package.

By default, ALM Engine executes this package whenever a process is re/executed. However, there may be instance especially performance hit as the package might take long time to execute incase assumptions definition is voluminous. On the other hand, there might not be any requirement to rerun it again as there is no change in underlying assumptions/ dimension/ hierarchy definitions.

In such cases, the Validate Node Map package execution can be skipped by making use of Simple Dimension "Process Identifier Code" which helps improving ALM process execution performance by skipping VALIDATE\_NODE\_MAP\_ALM package execution incase there is no change in underlying metadata while running ALM Process every time.

## Data Slicing

Data Slicing is a methodology to further granularize unit of works (UOWs) hence improving ALM process execution balancing the load among all active workers.

Current Engine allows any portfolio based column to be considered for Data Slicing.

For more information, see the Data Model Utilities Guide on [OHC](#).

## Configuring Payment Schedule

As per current design, ALM engine validates each instrument record individually in case Payment Schedule attached to it. If yes, then it queries FSI\_D\_PAYMENT\_



SCHEDULE table to fetch payment schedule metadata based on Instrument Type Code, ID Number and Identity Code for participating record. If there is considerable load in FSI\_D\_PAYMENT\_SCHEDULE table, then Engine spends significant time querying this table (hitting database each time) to fetch and prepare payment schedule; which degrades it's performance.

In order to address this issue, we have enhanced Engine to cache payment schedule at once, instead of querying them from FSI\_D\_PAYMENT\_SCHEDULE table whenever instrument record of payment schedule type is read. It supports current design too so that there is no impact on existing customer. As per new design, we have introduced a new table named as FSI\_ALM\_PROCESS\_COMMON\_CONFIGS which contains process level configurable parameters and should be maintained from backend. Based on values set for a process, Engine follows new or old code path to process payment schedules optimally.

The specification and usage of table as mentioned below.

Column Name	Column Description	Expected Values
TM_PROCESS_SYS_ID	ALM Process ID	This column should contain ALM Process ID for which Engine need to maintain payment schedules using new approach of bulk loading.  For a process which doesn't contain payment schedule Or needs to follow current approach (i.e. Row By Row payment schedule loading) should not have any entry in this table and set PMT_SCH_FLG value as 1.
PMT_SCH_FLG	Flag identifier indicating if payment schedule loading process to follow current approach of new code path.	0 - Default. If process doesn't contain payment schedule records Or needs to follow current approach of maintaining payment schedule in RBR manner.  1 - If process need to follow new approach of maintaining payment schedules in bulk.

## Operating System Level Tuning

The operating system level performance tuning is related to Semaphores and shared memory settings.

### Semaphores

Linux Semaphore settings should be set to optimal under SEMMSL configuration value.

### Shared Memory

ALM Engine consumes shared memory during any ALM process execution hence its crucial to check availability of current shared memory and tune it accordingly. Shared memory kernel parameters should be set to optimal. The configuration file (ofsrn.ini)

Sometimes users may observe “out of shared memory” error reported in ALM Engine log files during process execution. In such cases one need to verify and update shared memory size by updating SharedMemory parameter that can be found in ofsrn.ini file which is located in \$FIC\_DB\_HOME/conf. The default value of this parameter is 16500 (KB).

## Database Level Tuning

Database Level performance tuning describes a group of activities used to optimize and standardize the performance of a database. This can be improved using following options:

- Simple View vs Materialized View
- Cursor Sharing
- Indexes Optimization

### Simple View vs Materialized View

Incase ALM processes huge volume of source records; one may observe significant number of hits to the views created on REV registration tables (e.g. REV\_TAB\_COLUMNS\_V) which result generating lot of I/O and cluster waits, in turn spending most of process execution time spent querying these views only. In such case user can change the view to materialized view. However, for any future upgrade/install customer needs to take care of maintaining the changes post installation.

### Cursor Sharing

Cursor handling within ALM Engine can be implemented using CursorSharingMode entry in ofsrn.ini file as mentioned below.

1. Update CursorSharingMode entry in ofsrn.ini file (File Location: \$FIC\_DB\_HOME/conf) with cursor sharing parameter as suitable to process run (EXACT, FORCE, SIMILAR).
2. Engine reads the value against Key CursorSharingMode and set CURSOR\_SHARE at DB Session level accordingly.
3. The cursor level setting is applicable only for that process/session hence Engine executes the below statement if value set against CursorSharingMode Key.  

```
ALTER SESSION SET CURSOR_SHARING = <Input Value> in upper case  
<Input Values>: EXACT, FORCE, SIMILAR
```
4. If no value supplied, then Engine would not apply cursor sharing for that session or process.

### Process Cashflows Indexes Optimization

While persisting cash flows, existing unique index on FSI\_O\_PROCESS\_CASH\_FLOWS can be dropped and an index on RESULT\_SYS\_ID should be created prior to running an ALM process.

## Recommendations for Performance Improvement

While configuring an ALM process user can chose to output detailed cash flows (either all or part). This data is stored in table FSI\_O\_PROCESS\_CASH\_FLOWS. When

a process is re-run either for same as of date or for different date existing data of that process is deleted from this table before calculations initiate. When volume of data is high this can take time thereby impacting overall performance. Below recommendations will help improve this.

1. Create non-unique index on column RESULT\_SYS\_ID of table FSI\_O\_PROCESS\_CASH\_FLOWS. The index is expected to make DELETE of existing data faster when a process is re-run.
2. FSI\_O\_PROCESS\_CASH\_FLOWS can be partitioned by RESULT\_SYS\_ID. Automatic List Partitioning can be used so that partitions get added automatically when a new process is defined and executed.
3. Before executing ALM process, existing data for that process can be removed from FSI\_O\_PROCESS\_CASH\_FLOWS by using DELETE or TRUNCATE PARTITION function. This will ensure that engine does not spend time doing that activity.

Some other server and database level settings that can improve performance are:

1. REDO Log size of database can be increased. This will reduce log switch waits and improve overall time for analytical operations.
2. CURSOR\_SHARING parameter of database can be set to FORCE. By doing this database will try to convert SQL queries generated by cash flow engine to use bind variables which will reduce hard parses and can improve performance.

Above are just for guidance and you must take help of database administrators and other system personnel to implement the above taking your specific infrastructure and other requirements in consideration.



---

---

## Manage ALM Run

### Overview of Manage ALM Run

The Run feature in ALM helps you to combine various components and/or processes together and execute them with different underlying approaches. Further, run conditions and/or job conditions can be specified while defining a run.

Two types of runs can be defined namely Base Run and Simulation Run.

Base Run allows you to combine different rules and processes together as jobs and apply run conditions and job conditions.

Simulation Run allows you to compare the resultant performance/ calculations with respect to the baseline runs by replacing an existing job with a simulation job (a job can be a rule or a process). This comparison will provide useful insights on the effect of anticipated changes to the business.

The Roles mapped for Run module are: Run Access, Run Advanced, Run Authorize, Run Read Only, Run Write and Run Phantom. Based on the roles mapped to your user group, you can access various screens in Run module. *For more information, refer to OFS AAI User Guide.*

### Run Management

Run Management screen of the ALM application allows you to define, approve and execute Runs. All Runs except stress Runs are defined in the Run Management window of LRM application. The Run, once saved and approved, is registered in the Framework > Run in Oracle Financial Services Analytical Applications Infrastructure.

### Creating Run

You can create run definitions using the existing metadata objects. The various components that can be used to form run definitions are mentioned in Process Hierarchy Members.

The following filter conditions can also be applied to a run definition:

Condition Type	Description
Run Condition	When multiple components are selected, there is likelihood that the components may contain Rules / T2Ts whose target entities are across multiple datasets. When the selected components contain Rules, the target entities (hierarchies) which are common across the datasets are made available for defining Run Conditions. When the selected components contain T2Ts, the hierarchies that are based on the underlying destination tables which are common across the datasets are made available for defining the Run Condition. A Run Condition is defined as a filter on the available hierarchies. You can select up to 9 run conditions.
Job Condition	A further level of filter can be applied at the component level. This is achieved through a mapping process by which you can apply a job condition to the required jobs.  You can select only one job condition and the hierarchy which you have already selected as a run condition cannot be selected as job condition again.

To open the Run Management window, in Common Object Maintenance window choose, Manage ALM Runs > Run Management on the Left-Hand Side (LHS) menu.

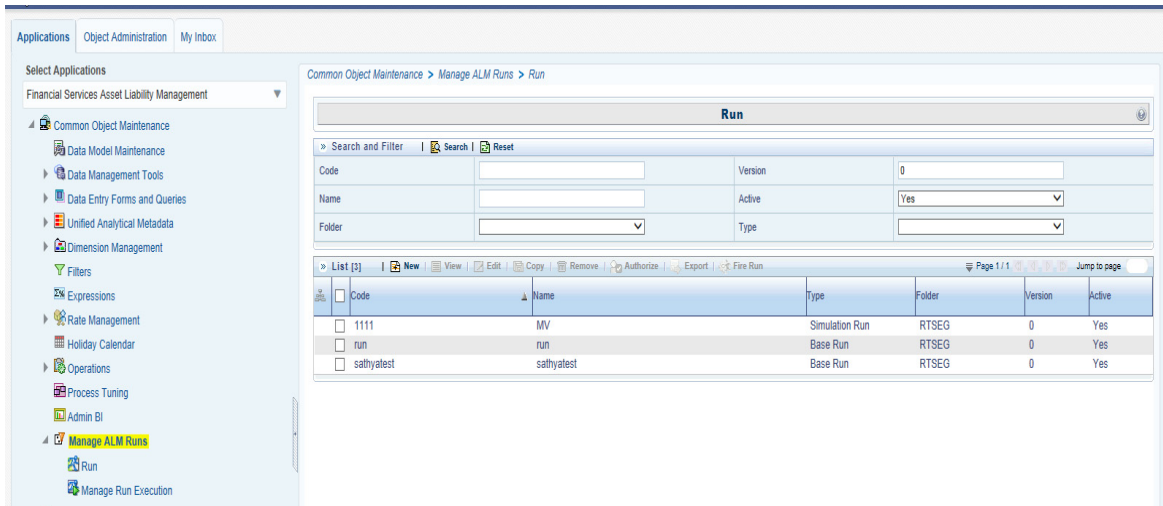

The Run management summary window of the ALM application allows you to define, approve and execute Run/s.

To define a Run, perform the following steps:

1. Click New on the Run Management window. The Run Definition window is displayed where you can define a Run. The Run Management window allows you to define a new Run or create a new Run definition.

2. In Linked To section,

- Select the Folder from the drop-down list, which is specific to the Run definition. The Run definitions are linked to a segment.
- Select the Access Type. It is either Read/Write or Read Only option

3. Enter the details of the Master information grid as tabulated below:

Field Name	Description
ID	Refers to system generated ID for a newly created run. When you create a rule, it is displayed as << New >>.
Code	Enter a valid code for the run. Ensure that the code value specified is of maximum 30 characters in length and does not contain any special characters except “_”. The code is unique and case sensitive. It is used to identify a run definition during execution. Note: You cannot use the same code of a rule which has been deleted from the UI.
Name	Enter a valid name for the run. Ensure that Run Name is alphanumeric and does not contain any of the following special characters: #, %, &, +, ", and ~. Note that the name needs not be unique.
Version	By default the version field is displayed as << NA >> for the new run being created. Once the run definition is saved, an appropriate version is assigned as either -1 or 0 depending on the authorization permissions. For more information, refer Run Definition Versioning.
Active	By default, the Active field is displayed as << NA >> for the new run being created. Once the run definition is saved, the status becomes Yes if you are an authorizer or No if the created Run needs to be authorized by an authorizer.
Type	Select the type of the run from the drop-down list. The available types are Base Run and Simulation Run.

4. Click button in the Master information grid. The Properties window is displayed.

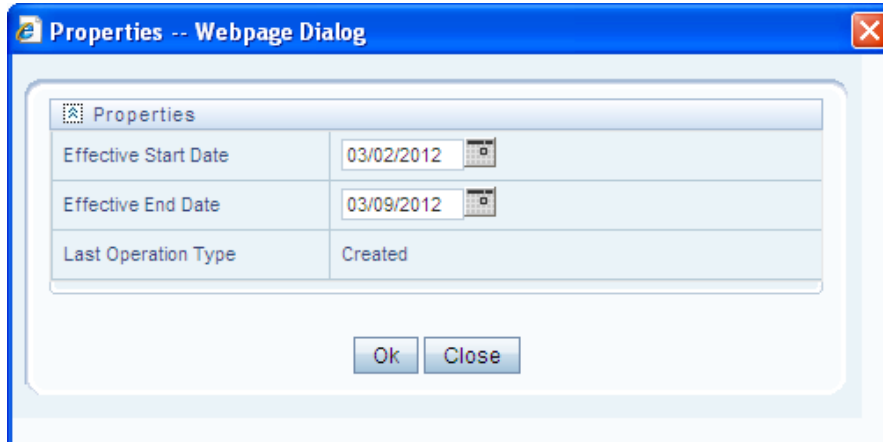

5. You can edit the below tabulated details in the Properties window:

Field Name	Description
Effective Start Date	Select the effective start date by clicking (Calendar) button.
Effective End Date	Select the effective end date by clicking (Calendar) button.
Last operation Type	By default, this field displays the last change done to the run definition. While creating a run, the field displays the operation type as Created.

6. Click OK. The properties are saved for the current Run definition.

## Select Run Condition for Run

You can select conditions to preset the initialization mechanism of a run definition.

To select a condition for a run in the Run Definition (New Mode) window:

1. Click Selector button from the List grid and select Run Condition ( ). The Hierarchy Selector window is displayed. The LHS panel of the Hierarchy Selector window displays all the available hierarchies defined in the selected infodom.
2. Select the checkbox(s) adjacent to the members you want to select and click . In the Hierarchy Selector window you can:
  - Search for a member by specifying the nearest keyword and clicking button.
  - The Pagination option helps you to manage the view of existing Hierarchies within the system.
  - Select a hierarchy and click button to view its metadata information.
  - Click Ascending or Descending button to sort the selected list of hierarchies in the alphabetical ascending or descending order.
  - Click Up or Down button to move up or move down the selected members.

---

**Note:** The re-ordering of hierarchies does not affect the resulting SQL query.

---

- Click Delete button to remove selected members from the Selected Hierarchies pane.



3. Click OK. The selected Hierarchies are listed in the Run Definition (New Mode) window
4. If the selected Run condition is a Parent Child hierarchy, the Use Descendants checkbox is displayed. If the checkbox is selected for a hierarchy, the descendants will be automatically applied and need not be selected in node selection from hierarchy browser window.

## Select ALM Jobs for Run

You can select the required jobs for the run definition being created.

To select jobs for a run:

1. Click Add button from the List grid and select Job ( ). The Job Selector window is displayed. On the List panel, you can click Add button to expand the members and view the job components
2. Select a job component and click Select to move the component to the Tasks pane.

---

---

**Note:** Note: You cannot select jobs with the same unique code in a run definition. Wherever jobs have same unique code, the jobs should be added to a process and the process should be added to the run definition.

---

---

In Job Selector window you can also:

- Search for a component by specifying the nearest keyword and clicking search button. It may not display search results if the branch of that component has not been expanded.
  - Click Ascending or Descending button to sort the selected components in ascending or descending alphabetical order.
  - Click Up or Down button to re-order the selected components.
  - Click Add button to add parameters for the selected components.
  - Click Deselect button to remove the selected components from the Tasks pane.
3. Click OK. The components are listed under the List pane in the Run Definition window.

## Select Job Condition for Run

You can select only a single job condition for the execution of predefined jobs in a run. A hierarchy which is already selected as a run condition cannot be selected as a job condition.

To select the job condition for a run:

1. Click Add button from the List grid and select Job Condition ( ). The Hierarchy Selector window is displayed
2. Select the checkbox adjacent to the hierarchy that you want to select as job condition and click Select .
3. To know about the operations you can do in this window, refer to Hierarchy Selector window. Note: Ensure that you have selected only one Job Condition and the same hierarchy is not selected as both Run & Job conditions.
4. Click OK.

From the List grid in the Run Definition (New Mode) window, you can also:

- Click Move button to change a selected run condition to job condition and conversely.
- Click Show Details button to view the metadata information of the selected member.
- If the selected Job condition is a Parent Child hierarchy, the Use Descendants checkbox is displayed. If the checkbox is selected for a hierarchy, the descendants will be automatically applied and need not be selected in node selection from hierarchy browser window.

Once all the necessary information in the first window of the Run Definition (New Mode) is populated, click the Next button to navigate to the concurrent procedures of defining a Rule.

The second window of Run Definition (New Mode) window displays all the information you have provided in the Linked to and Master information grids. You can view the selected filters in the Run Condition grid and selected jobs along with the job condition in the Detail Information grid Expand a job which is a process, then the Object, Parent Object, Precedence and Type columns are populated.

## View Run Definition

You can view individual run definition details at any given point. To view the existing Run definition details in the Run window:

1. Select the checkbox adjacent to the Run Code whose details are to be viewed.
2. Click View button in the List tool bar.

The Run Definition (View Mode) window is displayed with all the details of the selected Run. Click Next and Back buttons to navigate back and forth in the Run Definition (View Mode) window.

## Edit Run Definition

You can modify all the details except ID, Code, Version, Active status, and Type of a run definition. To modify an existing run definition in the Run window:

1. Select the checkbox adjacent to the Run Code whose details are to be updated.
2. Click Edit button in the List tool bar. Edit button is disabled if you have selected multiple Runs. The Run Definition (Edit Mode) window is displayed.
3. Edit the Run details as required. For more information, refer Create Run.
4. Click Save to save the changes.

## Run Definition Versioning

**For an authorizer:**

When you create a new run, its version will be 0. When you edit an existing run and try to save, you are prompted whether to save it as a new version or not. If you click Yes, a new run is created with version as 0 and the run having version as 0 will be saved with version as maximum version +1. If you click No, the existing run is overwritten and the version will be as it is.

**For a non-authorizer:**

When you create a new run, its version will be -1. Once the run is approved by an authorizer, the version becomes 0. When you edit an existing run and try to save, you are prompted whether to save it as a new version or not. If you click Yes, a new run is created with version as -1. Once the run is approved, its version becomes 0 and the run having version as 0 will be saved with version as maximum version +1. If you click No, the existing run is overwritten, and the Active flag of the run becomes N (which you can view from the Summary window). The version remains the same. Once the run gets approved, its Active flag changes to Y.

Note the following:

The run with version 0 is the latest one and it can have many versions say 1 to n, where 1 is the oldest run and n is the next to latest.

A run with version -1 will always be in Inactive state.

You can view all the versions of a particular rule by providing the run's name or code and clicking Search in the Search and Filter grid. (Ensure the Version field is cleared since it is auto populated with 0).

## Copy Run Definition

This option facilitates you to quickly create a new run definition based on an existing run by updating the values of the required fields.

To copy an existing Run Definition in the Run window:

1. Select the checkbox adjacent to the Run Code whose details are to be duplicated.
2. Click Copy button in the List toolbar to copy a selected Run definition. The Run Definition (Copy Mode) window is displayed. Copy button is disabled if you have selected multiple Runs.

In the Run Definition (Copy Mode) window you can:

- Create new Run definition with existing variables. Specify a new Run Code and Folder. Click Save.
- Create new Run definition by updating the required variables. Specify a new Run Code, Folder, and update other required details. For more information, refer Create Run. Click Save.

The new Run definition details are displayed in the Run window. By default, version 0 is set if you have authorization rights, else the version is set to -1.

## Authorize Run Definition

All the actions in a run definition should be approved by an authorizer. An authorizer can approve a pre-defined run definition for further execution or reject an inappropriate run definition listed within the Run window. To approve/ reject run definitions in the Process window, you need to have the Authorize role mapped to your user group. If you are an authorizer, the run definition is auto approved as you save it and the Active status is set to Yes. Otherwise, the Active status is set to No and an authorizer needs to approve it to change the Active status to Yes.

To approve/reject runs:

- Select the checkbox(s) adjacent to the required Run Codes.
- Do one of the following:

To approve the selected run definitions, click Approve button.

To reject the selected run definitions, click Reject button.

A run is made available for use only after the approval. For a rejected definition a comment with the rejection details will be added.

## Export Run to PDF

This option allows you to export multiple run definitions to a PDF file. You have the option to export only the rules or processes in the run definition to PDF by selecting the required Trace Options.

To export the run definitions in the Run window:

1. Select the checkbox(s) adjacent to the required Run Codes.
2. Click Export button in the List toolbar and click the PDF button in the popup. The Export dialog is displayed.

The Export dialog displays the Export Format, Definition Type, the names of the Selected Definitions, and the Trace Options.

- Select the checkbox adjacent to Rule or Process if you want to export only the rule details or Process details respectively. If you do not select any checkbox, all details of the selected run definitions will be exported.
  - Click Select button. The selected options are displayed in the Selected Trace Options pane. You can also select a trace option and click Select button to deselect it from the Selected Trace Options pane.
3. Click Export. The process is initiated and is displayed in a pop-up specific to the current download. Once the PDF is generated, you can open / save the file from the File Download dialog.

You can either save the file on the local machine or view the file contents in a PDF viewer. The downloaded PDF displays all the details such as Linked to, Properties, Master info, Audit Trail, List, and Comments of all the Run definitions selected.

## Fire Run

This feature facilitates you to execute a previously created Run. You can execute the run definition as a batch from the Operations module.

To execute a run definition:

1. Select the checkbox adjacent to the Run Code which you want to execute and click button in the List toolbar. The Fire Run window is displayed.
2. Enter the field details as tabulated below:

Field Name	Description
Name	This field displays the name of the selected run.
Request Type	Select the request type either as Single or as Multiple from the drop-down list.  Single Request - You need to provide the MIS Date during Batch execution from the Operations module.  Multiple Request - You can run the batch with the same MIS date multiple times from the Operations module.

Field Name	Description
Batch	Select the Batch either as Create or as Create & Execute from the drop-down list  Create- The batch will be created and needs to be executed from the Operations module.  Create & Execute- The batch will be created and executed. You can monitor it from the Operations module.
MIS Date	Click Calendar button and the Calendar is displayed. Select the MIS Date from the calendar. This field is displayed only if you have selected Request Type as Multiple with any of the Batch mode or Request Type as Single with Batch mode as Create & Execute.
Wait	Select Yes and provide the Duration in seconds after which the run definition should be executed.  Select No to execute it immediately.
Parameters	Enter the required parameters in the field provided. The parameter provided in this field is considered for Run execution.
Filters	Enter the filter details in the field provided. The filters provided in this field are considered for Run execution.

3. Click OK. The details are saved and the run definition is executed as per the Fire Run details.

## Delete Run Definition

You can remove Run definition(s) which are no longer required in the system by deleting from Run window. However, it is a soft deletion only. An authorizer has to approve the deletion.

1. Select the checkbox(s) adjacent to the Run Codes whose details are to be removed.
2. Click Delete button from the List tool bar.
3. Click OK in the information dialog to confirm deletion.

An information dialog is displayed confirming the deletion of the Run definitions and asking the authorization of the same.

## Manage Run Execution

Manage Run execution enables you to have a work flow for Run execution. The pre defined Run definitions can be executed in a unique batch depending on the Type of the Manage Run Execution defined. These batches can then be executed from the Operations module.

You can access Manage Run Execution window by expanding Rule Run Framework within the LHS menu and selecting Manage Run Execution.

The Manage Run Execution window displays the Run Execution requests created in the current Information Domain with the metadata details such as Run name, Run Execution Description, Run Execution ID, Type, MIS Date, and Request Status.

You can also make use of Search and Filter option to search for specific Runs based on Run Name, Run Execution Description, MIS Date, Run Execution ID, Type, or Request Status. The Pagination option helps you to manage the view of existing Rules within the system.

## Creating Manage Run Definition

You can create the Manage Run Definitions from the Manage Run Execution window. The Write role should be mapped to your user group, from the UserGroup Role Map window.

To create a Manage Run Definition:

1. Click Add button from the List toolbar. The Manage Run Definition (New Mode) window is displayed.
2. Click Expand button in the Run field. The Run Selector window is displayed
3. In the Run Selector window click View button to view the details of the selected Run. The Pagination option helps you to manage the view of existing Runs within the system.
4. Click OK. The selected Run is displayed in the Run field, along with the Run ID.
5. Click View button displayed adjacent to the Expand button to view the details of the selected Run.
6. Enter the details in the Master Info and Execution Details grids as tabulated:

Field Name	Description
Master Information grid	
Run Execution ID	The default ID of a newly created Run Execution is << New >>
Run Execution Code	Enter a valid Run Execution Code. Ensure that the Run Execution Code specified is of maximum 30 characters in length and does not contain any special characters except “_”.
Run Execution Name	Enter the Name of the Run Execution. Ensure that Run Execution Name is alphanumeric and does not contain any of the following special characters: #, %, &, +, ", ~, and '.
Type	Select the type of the Run Execution either as Single Request or as Multiple Request. § Single Request - You need to provide the MIS Date during Batch execution from the Operations module. § Multiple Request - You can run the batch with the same MIS date multiple times from the Operations module.
Execution Details grid	
Execution ID	The default Execution ID of a newly created Run Execution is << NA >>
Request Status	Select the request status either as Open or as Closed. § Status Open creates a Manage Run definition. § Status Closed creates a Manage Run definition along with a Batch.

Field Name	Description
MISDate	MIS Date refers to the date with which the data for the execution would be filtered. Click button and the Calendar is displayed. You can select the MIS Date from the calendar. This field is displayed only if you have selected Type as Multiple Request.
Execution Status	The default Execution status of a newly created Run Execution is << NA >>

7. Click Save. The Run Execution is saved and a confirmation dialog is appeared.
8. The Audit Trail section at the bottom of Manage Run Definition (New Mode) window displays metadata information about the Manage Run definition created. The User Comments section facilitates you to add or update additional information as comments.

## Viewing Manage Run Definition

You can view individual Manage Run definition details at any given point. To view the existing Manage Run definition details in the Manage Run Execution window:

1. Select the checkbox adjacent to the Run Name whose details are to be viewed.
2. Click View button in the List tool bar.

The Manage Run Execution Definition (View Mode) window is displayed with all the details of the selected Manage Run Definition.

## Editing Manage Run Definition

You can modify the Run Execution Description and Request Status details of a Manage Run definition. To modify an existing Manage Run definition in the Manage Run Execution window:

1. Select the checkbox adjacent to the Manage Run Definition name whose details are to be updated.
2. Click Edit button in the List tool bar. Edit button is disabled if you have selected multiple Manage Run Definitions. The Manage Run Definition (Edit Mode) window is displayed.
3. Edit the Manage Run definition details as required.

You can select the Request Status as Open, Closed, To be Deleted, or Final depending on the current status of the definition:

- Status Open creates/updates a Manage Run definition.
- Status Closed creates a Manage Run definition along with a Batch.
- Status To be Deleted indicates the Manage Run definition is marked for deletion.
- Status Final indicates the Manage Run definition is successfully executed with expected results.

The Execution Status field displays the current execution status of a triggered Run as Success, Failure, or Ongoing and << NA >> for a non-executed Run

4. Click Save to save the changes.





---

---

# Multi Language Support

## Overview

With the introduction of Multi Locale Support, the user interfaces can be viewed in various languages.



In addition to the base language (American English, for example, en\_US), the following languages are currently supported for ALM, by installing the associated Language Pack.

**Table D-1**

Language Name	Java Locale
Arabic	AR_EG

**Table D-1**

Language Name	Java Locale
Portuguese	PT_BR
French	FR_FR
German	DE_DE
Indonesian	IN_ID
Italian	IT_IT
Japanese	JA_JP
Korean	KO_KR
Russian	RU_RU
Simplified Chinese	ZH_CN
Spanish	ES_ES
Thai	TH_TH
Traditional Chinese	ZH_TW
Vietnamese	VI_VN
Turkish	TR_TR
Hebrew	iw_IL
French Canada	fr_CA

Depending on the type of the rule, the Name/Description specified during create/edit is either attached to the login-locale or is stored independent of the login-locale. The selection of the login-locale therefore governs which assumption/rules are visible, and which are not visible. The following illustrates the visibility of assumptions and rules, across languages in the 8.0.0.0.0 release. This applies to all Summary screens, embedded selections in subsequent screens and so on.

**Note:** Starting from AAI 7.3.3.0.0, all Dimension Management Objects as well as Filters and Expressions would be visible in all languages (and therefore available for embedding), regardless of the language in which they were created.

**Table D-2**

Assumption / Rules	Visible across all languages	Visible only in the creation-language*
Common Object Maintenance		
Process Tuning		☑
Simplified Batch	☑	☑
Holiday Calendar		
**	☑	
SQL Rules	Refer to the OFSAAI User Guide to verify the behavior.	

**Table D-2**

<b>Assumption / Rules</b>	<b>Visible across all languages</b>	<b>Visible only in the creation-language*</b>
Data Entry Forms and Queries		
Dimension Management (Attributes, Members, and Hierarchies)		
Filters		
Expressions		
<b>Common Object Maintenance &gt; Rate Management</b>		
Interest Rate Codes **	<input checked="" type="checkbox"/>	
Currencies **	<input checked="" type="checkbox"/>	
Economic Indicators **	<input checked="" type="checkbox"/>	
ALM Maintenance		
Behavior Patterns	<input checked="" type="checkbox"/>	
Payment Patterns **	<input checked="" type="checkbox"/>	
Repricing Patterns **	<input checked="" type="checkbox"/>	
Product Profiles**	<input checked="" type="checkbox"/>	
Time Buckets **	<input checked="" type="checkbox"/>	
<b>ALM Assumption Specification</b>		
Product Characteristics		<input checked="" type="checkbox"/>
Discount Methods		<input checked="" type="checkbox"/>
Prepayments		<input checked="" type="checkbox"/>
Prepayment Models		<input checked="" type="checkbox"/>
Rate Dependency Patterns		<input checked="" type="checkbox"/>
Forecast Rate Scenarios		<input checked="" type="checkbox"/>
Forecast Balances		<input checked="" type="checkbox"/>

**Table D-2**

<b>Assumption / Rules</b>	<b>Visible across all languages</b>	<b>Visible only in the creation-language*</b>
Transaction Strategies		<input checked="" type="checkbox"/>
Maturity Mix		<input checked="" type="checkbox"/>
Pricing Margin		<input checked="" type="checkbox"/>
Transfer Pricing Rules		<input checked="" type="checkbox"/>
TP Adjustments		<input checked="" type="checkbox"/>
Stochastic Rate Indexing		<input checked="" type="checkbox"/>
<b>ALM Processing</b>		
Static Deterministic Process		<input checked="" type="checkbox"/>
Static Stochastic Process		<input checked="" type="checkbox"/>
Dynamic Deterministic Process		<input checked="" type="checkbox"/>
Dynamic Stochastic Process		<input checked="" type="checkbox"/>
Cash Flow Edits	<input checked="" type="checkbox"/>	

\* A future release (TBD) will expand visibility for many of these application object types, to provide visibility regardless of logged-in locale.

\*\* These object-types are visible across all languages because the Name and Descriptions are not stored in translation-compatible structures, which is different from the storage format for AAI objects like Dimension Management, Filters and Expressions.

---



---

## Archive-Restore

This chapter covers the following topics:

- [Command Line Migration](#)
- [Command Line Migration Utility](#)

### Command Line Migration

Using the command line utility, you can migrate (export/ import) ALM metadata objects across different OFSAA environments. You can specify one or more objects within an object type or within multiple object types.

For the list of objects that can be migrated, see the table below.

### Command Line Migration Utility

ALM uses the same utility that is used by the OFSAA infrastructures. For more details, refer to the section *Command Line Utility to Migrate Objects* in the *AAI User Guide*.

### Supported Objects

The following table describes each of the Asset Liability Management Preference items.

Object Name	Object Type ID	Support for wild card Select all option	Support for implicit Dependency	Object Code	Remarks
Application Preferences	201	No	No	CONFIG	Entire data set is exported and replaced in the target. No validation and its dependency objects are not handled
Holiday Calendar	815	Yes	Yes	User Defined unique code	
Interest Rates	801	Yes	Yes	User Defined unique code	Historical rates from FSL_IRCRATE_HIST table are not migrated

Object Name	Object Type ID	Support for wild card Select all option	Support for implicit Dependency	Object Code	Remarks
Currency rates	803	No	No		Currency rates are not supported.
Currencies	802	Yes	No	User defined Currency code	
Economic Indicator	804	Yes	Yes	System generated code	FSI_ECONOMIC_COST_HIST are not migrated.
Filter	1	No	Yes	System generated code	
Expression	14	No	Yes	System generated code	
Time Bucket	805				
Payment patterns	809	Yes	Yes	User defined unique code	
Repricing Patterns	808	Yes	Yes	User defined unique code	
Behavior Patterns	807	Yes	Yes	User defined unique code	
Behavior Pattern Rule	314	Yes	Yes	System generated code	
Product Profiles	806	Yes	Yes		
Transfer Pricing Rules	200	Yes	Yes (Except MAP objects)	System generated code	If Conditional Assumption uses MAP objects, then they should be explicitly migrated using Archive restore.
Adjustment Rules	401	Yes	Yes (Except MAP objects)	System generated code	If Conditional Assumption uses MAP objects, then they should be explicitly migrated using Archive restore
Prepayment Rules	300	Yes	Yes	System generated code	
Prepayment Models	312	Yes	Yes	System generated code	

Object Name	Object Type ID	Support for wild card Select all option	Support for implicit Dependency	Object Code	Remarks
Stochastic Rate Index Rules	315	Yes	Yes	System generated code	
Product Characteristics	309	Yes	Yes	System generated code	
Discount Method	301	Yes	Yes	System generated code	
Forecast Rate Scenarios	305	Yes	Yes	System generated code	
Rate Dependency Patterns	612	Yes	yes	System generated code	
Forecast Balance Rules	307	Yes	yes	System generated code	
Maturity Mix Rules	302	Yes	Yes	System generated code	
Pricing Margin Rules	303	Yes	Yes	System generated code	
Transaction Strategies	306	Yes	Yes	System generated code	
Formula Result Rules	313	Yes	Yes	System generated code	
ALM Static Deterministic Process	205	Yes	Yes	System generated code	
ALM Static Stochastic Process	206	Yes	Yes	System generated code	
ALM Dynamic Deterministic Process	207	Yes	Yes	System generated code	
AL Dynamic Stochastic Process	208	Yes	Yes	System generated code	

---

**Note:** Below are De-Supported Objects in Archiv-Restore:

Hierarchy Attribute

The Object needs to be explicitly exported before migrating any rule which uses Currencies.

---

## Input Values for OBJECTMIGRATION.xml

Object Name	Object Type Id	Input value in OBJECTMIGRATION.XML for wild card	Input value in OBJECT_MIGRATION.xml for Object Code
Application Preferences	201	<OBJECT Code="CONFIG" Type="201"/>	<OBJECT Code="CONFIG" Type="201"/>
Interest Rates	801	<OBJECT Code="" Type="801"/>	<OBJECT Code="User defined unique code" Type="801"/>
Currency rates	803	<OBJECT Code="" Type="803"/>	<OBJECT Code="System generated code" Type="803"/>
Currencies	802	<OBJECT Code="" Type="802"/>	<OBJECT Code="User defined unique code" Type="802"/>
Economic Indicator	804	<OBJECT Code="" Type="804"/>	<OBJECT Code="System generated code" Type="804"/>
Filter	1	<OBJECT Code="" Type="1"/>	<OBJECT Code="System generated code" Type="1"/>
Expression	14	<OBJECT Code="" Type="14"/>	<OBJECT Code="System generated code" Type="14"/>
Time Bucket	805	<OBJECT Code="" Type="805"/>	<OBJECT Code="System generated code" Type="805"/>
Payment Patterns	809	<OBJECT Code="" Type="809"/>	<OBJECT Code="User defined unique code" Type="809"/>
Repricing Patterns	808	<OBJECT Code="" Type="808"/>	<OBJECT Code="User defined unique code" Type="808"/>
Behavior Patterns	807	<OBJECT Code="" Type="807"/>	<OBJECT Code="User defined unique code" Type="807"/>
Product Profiles	806	<OBJECT Code="" Type="806"/>	<OBJECT Code="System generated code" Type="806"/>
Transfer Price Rules	200	<OBJECT Code="" Type="200"/>	<OBJECT Code="System generated code" Type="200"/>
Adjustment Rules	401	<OBJECT Code="" Type="401"/>	<OBJECT Code="System generated code" Type="401"/>
Prepayment Rules	300	<OBJECT Code="" Type="300"/>	<OBJECT Code="System generated code" Type="300"/>
Prepayment Models	312	<OBJECT Code="" Type="312"/>	<OBJECT Code="System generated code" Type="312"/>
Stochastic Rate Index Rules	315	<OBJECT Code="" Type="315"/>	<OBJECT Code="System generated code" Type="315"/>
Product Characteristics	309	<OBJECT Code="" Type="309"/>	<OBJECT Code="System generated code" Type="309"/>
Discount Method	301	<OBJECT Code="" Type="301"/>	<OBJECT Code="System generated code" Type="301"/>
Forecast Rate Scenarios	305	<OBJECT Code="" Type="305"/>	<OBJECT Code="System generated code" Type="305"/>
Rate Dependency Patterns	612	<OBJECT Code="" Type="612"/>	<OBJECT Code="System generated code" Type="612"/>



Object Name	Object Type Id	Input value in	
		OBJECTMIGRATION.XML for wild card	OBJECT_MIGRATION.xml for Object Code
Forecast Balance Rules	307	<OBJECT Code="" Type="307"/>	<OBJECT Code="System generated code" Type="307"/>
Maturity Mix Rules	302	<OBJECT Code="" Type="302"/>	<OBJECT Code="System generated code" Type="302"/>
Pricing Margin Rules	303	<OBJECT Code="" Type="303"/>	<OBJECT Code="System generated code" Type="303"/>
Transaction Strategies	306	<OBJECT Code="" Type="306"/>	<OBJECT Code="System generated code" Type="306"/>
Formula Result Rules	313	<OBJECT Code="" Type="313"/>	<OBJECT Code="System generated code" Type="313"/>
ALM Static Deterministic Process	205	<OBJECT Code="" Type="205"/>	<OBJECT Code="System generated code" Type="205"/>
ALM Static Stochastic Process	206	<OBJECT Code="" Type="206"/>	<OBJECT Code="System generated code" Type="206"/>
ALM Dynamic Deterministic Process	207	<OBJECT Code="" Type="207"/>	<OBJECT Code="System generated code" Type="207"/>
ALM Dynamic Stochastic Process	208	<OBJECT Code="" Type="208"/>	<OBJECT Code="System generated code" Type="208"/>

## Logging

1. \$FIC\_HOME /utility/Migration/logs/offline\_migration.log
2. <War\_deployed\_location>/logs /FUSIONSUBSYSTEMSService.log



---

---

## Interest Rate Risk in the Banking Book (IRRBB)

This appendix gives you information on functionalities added to ALM with respect to Interest Rate Risk in the Banking Book (IRRBB<sup>1</sup>) regulation.

### Overview of Interest Rate Risk in the Banking Book (IRRBB)

IRRBB refers to the current or prospective risk to the bank's capital and earnings arising from adverse movements in interest rates that affect the bank's banking book positions. When interest rates change, the present value and timing of future cash flows change. This in turn changes the underlying value of a bank's assets, liabilities and off balance sheet items and hence its economic value. Changes in interest rates also affect a bank's earnings by altering interest rate sensitive income and expenses, affecting its net interest income (NII). Excessive IRRBB can pose a significant threat to a bank's current capital base and/or future earnings if not managed appropriately.

Basel Committee on Banking Supervision (BCBS) has prescribed 12 updated principles to banks to manage IRRBB.

Following three main sub-types of IRRBB are defined for the purposes of these Principles:

1. Gap risk arises from the term structure of banking book instruments, and describes the risk arising from the timing of instruments' rate changes. The extent of gap risk depends on whether changes to the term structure of interest rates occur consistently across the yield curve (parallel risk) or differentially by period (non-parallel risk).
2. Basis risk describes the impact of relative changes in interest rates for financial instruments that have similar tenors but are priced using different interest rate indices.
3. Option risk arises from option derivative positions or from optional elements embedded in a bank's assets, liabilities and/or off-balance sheet items, where the bank or its customer can alter the level and timing of their cash flows. Option risk can be further characterised into automatic option risk and behavioral option risk.

---

<sup>1</sup> For more information on Basel Committee on Banking Supervision (BCBS), see the [www.bis.org/bcbs/publ/d368.pdf](http://www.bis.org/bcbs/publ/d368.pdf)

Above all three sub-types of IRRBB potentially change the price/value or earnings/costs of interest rate-sensitive assets, liabilities and/or off-balance sheet items in a way, or at a time, that can adversely affect a bank's financial condition.

BCBS has proposed a standardised approach which supervisors could mandate their banks to follow or a bank could choose to adopt it. Following functionalities have been added to ALM to meet the standardised approach requirements and also enable banks to adopt advanced approach.

## Approach

### Amenability Category

As per standardized approach interest rate-sensitive banking book positions are allocated to one of below three categories. These categories are used to determine slotting of cash flows.

- Amenable to standardization
- Less amenable to standardization
- Not amenable to standardization

The following changes have been done to meet above requirement:

- Simple seeded dimension called "Product Amenability Category" has been introduced
- Attribute of product dimension 'Amenability Category' has been introduced. This attribute is populated in processing (FSI\_D) tables for each account so that it can be used in data filter and conditional assumption.

### Retail/Wholesale and Transactional Non Maturing Deposits

As per standardized approach non-maturing deposits (NMDs) must be segmented into retail and wholesale categories.

- Wholesale

Deposits from legal entities, sole proprietorships or partnerships are captured in wholesale deposit categories.

- Retail

Retail deposits are defined as deposits placed with a bank by an individual person.

Deposits made by small business customers and managed as retail exposures are considered as having similar interest rate risk characteristics to retail accounts. So, these are treated as retail deposits (provided the total aggregated liabilities raised from one small business customer is less than 1 million).

Retail Non-maturing deposits can be further classified into following categories:

- Transactional

Retail deposits are considered as held in a transactional account when regular transactions are carried out in that account (such as, when salaries are regularly credited) or when the deposit is non-interest bearing.

- Non-transactional

Other retail deposits are considered as held in a non-transactional account.

The following changes have been done to meet above requirement:

- Simple dimension “Customer Type” has been introduced and added as attribute to Customer Dimension in ALM
- Following two new attributes have been introduced for checking and savings account (CASA) and ALM account summary:
  - Retail-Wholesale Flag - This has two values:  
R = Retail  
W = Wholesale
  - Transactional Account Flag - This has two values:  
Y = Transactional  
N = Non transactional

These attributes can be used in conditional assumption and data filter.

## Option Valuation

This is used to calculate the Market Valuation (MV) for certain embedded and stand-alone (bare) options. Supported embedded options are Calls, Puts, Caps (caplets) and Floors (floorlets). This option will be enabled only if Market Value, YTM, Duration, DV01/PV01 option is also selected.



---

---

## Common Utilities and Scripts

This chapter covers the following topics:

- [RMIPC.SH Script](#)

### RMIPC.SH Script

rmipc.sh script is a utility script that cleans up shared memory segments and semaphores for a given Unix User ID. This file will be present as part of every OFSAA application build and is available in the `$FIC_HOME/ficdb/bin` folder. Passing the User ID as a command line is optional. When it is not passed as a command line argument, the shell script will default the ID to that of the currently logged in Unix user. The script will first check for any running OFSAA processes (for example: ALM, FTP, PFT) before attempting to remove any shared memory segments or semaphores. If there are any running OFSAA processes, the script will not run.

---

---

**Note:** The script will always consider only the first 8 characters of the User ID, while determining the list of open semaphores/shared-memory arrays.

---

---

---

---

**Caution:** If you are using AIX platforms, then this script will also kill your AM process since the AM process also creates semaphores in AIX. Any process under the OFSAA Unix ID provided which creates semaphores or shared memory segments may be killed. Also, be careful if OFSAA has been installed using the same Unix user as installed Oracle database as this script will clean up all semaphores / shared memory arrays used by the Oracle database. The script is not meant to be used in a batch process.

---

---





---



---

## Standard Navigation Paths

This appendix gives you information to navigate through the pages referred to in this guide.

### Standard Navigation Paths

Typical Oracle Financial Services Asset Liability Management navigation paths are shown in this table. Access all of these pages through the ALM Administrator or ALM Analyst responsibility.

Page	Navigation Path
Application Preferences	ALM > Application Preferences
Time Buckets Home	ALM Maintenance > Time Buckets
Time Buckets – Income Simulation Buckets	ALM Maintenance > Time Buckets > Income Simulation Buckets
Time Buckets – Repricing Gap Buckets	ALM Maintenance > Time Buckets > Repricing Gap Buckets
Time Buckets – Liquidity Gap Buckets	ALM Maintenance > Time Buckets > Liquidity Gap Buckets
Product Profiles Home	ALM Maintenance > Product Profiles
Behavior Pattern Home	ALM Maintenance > Patterns > Behavior Patterns
Payment Pattern Home	ALM Maintenance > Patterns > Payment Patterns
Repricing Pattern Home	ALM Maintenance > Patterns > Repricing Patterns
Interest Rate Code Home	Common Object Maintenance > Rate Management > Interest Rates
Currency Rates Home	Common Object Maintenance > Rate Management > Currency Rates
Currencies Home	Common Object Maintenance > Rate Management > Currencies
Economic Indicators Home	Common Object Maintenance > Rate Management > Economic Indicators
Product Characteristics Home	Assumption Specification > Product Characteristics
Product Characteristics Details	Assumption Specification > Product Characteristics > Add New

<b>Page</b>	<b>Navigation Path</b>
Discount Methods Home	Assumption Specification > Discount Methods
Discount Methods Details	Assumption Specification > Discount Methods > Add New
Prepayment Rule Home	Assumption Specification > Prepayments
Prepayment Methodology	Assumption Specification > Prepayments > Add New > Prepayment Method Selector > Add
Prepayment Models Home	Assumption Specification > Prepayment Models
Prepayment Models Details	Assumption Specification > Prepayment Models > New
Transfer Pricing Rules	Assumption Specification > Forecast Assumptions > Transfer Pricing Rules
TP Adjustments	Assumption Specification > Forecast Assumptions > TP Adjustments
Forecast Rates	Assumption Specification > Forecast Rates
Forecast Rates Details	Assumption Specification > Forecast Rates > New
Rate Dependency Patterns Home	Assumption Specification > Forecast Assumptions > Rate Dependency Patterns
Rate Dependency Patterns Details	Assumption Specification > Forecast Assumptions > Rate Dependency Patterns > New
Forecast Balances Home	Assumption Specification > Forecast Assumptions > Forecast Balances
Forecast Balances Details	Assumption Specification > Forecast Assumptions > Forecast Balances > Add New > Assumption Browser > Add
Maturity Mix Home	Assumption Specification > Forecast Assumptions > Maturity Mix
Maturity Mix Details	Assumption Specification > Forecast Assumptions > Maturity Mix > Add New > Assumption Browser > Add
Pricing Margins Home	Assumption Specification > Forecast Assumptions > Pricing Margins
Pricing Margins Details	Assumption Specification > Forecast Assumptions > Pricing Margins > Add New > Assumption Browser > Add
Transaction Strategies Home	Assumption Specification > Transaction Strategies
Transaction Strategies Details	Assumption Specification > Transaction Strategies > Add New > Add
Formula Results Home	Assumption Specification > Formula Results
Formula Results Details	Assumption Specification > Formula Results > Add New > New
Stochastic Rate Indexing Home	Assumption Specification > Stochastic Rate Indexing

---

<b>Page</b>	<b>Navigation Path</b>
Stochastic Rate Indexing Details	Assumption Specification > Stochastic Rate Indexing > Add New
Static Deterministic Process Home	ALM Processing > Static Process > Deterministic
Static Stochastic Process Home	ALM Processing > Static Process > Stochastic/Historical Simulation
Dynamic Deterministic Process Home	ALM Processing > Dynamic Process > Deterministic
Dynamic Stochastic Process Home	ALM Processing > Dynamic Process > Stochastic/Historical Simulation
Cash Flow Edits Process	ALM Processing > Cash Flow Edits
Metadata Browser	ALM > Metadata Browser

---



---

---

# Oracle ALM Error Messages

## Oracle ALM Error Messages

Error Message	Error Condition	Error Code	Effect of Error on Processing
<Assumption rule type> in Oracle ALM Process Rule <Assumption rule name> not found in database	Assumption Rule cannot be found in the database.	105	If rule is critical for processing, processing is stopped.
No Match for IRC	Interest Rate Code cannot be found in the active Historical Rates database.	110	When the instrument reprices, it will receive a zero rate.
No Data for IRC	Interest Rate Code exists in the active Historical Rates database, but there are no corresponding rate values.	115	When the instrument reprices, it will receive a zero rate.
Dimension Types mismatch: COL vs. Application Preference for dimension: <dimension number>	Definition for dimension chosen as product dimension in Application Preferences has changed or no longer exists in the database. Also can relate to Organizational Unit dimension if two-dimension output processing is defined.	120	Processing is stopped.

<b>Error Message</b>	<b>Error Condition</b>	<b>Error Code</b>	<b>Effect of Error on Processing</b>
No of Buckets mismatch Time Bucket in <Assumption Rule>	Assumption Rule was created when the active Time Bucket Rule held more/less buckets than it has currently; therefore, the Assumption Rule contains more/less bucket information than necessary.	325	If Assumption Rule holds more buckets than what currently exists, only the buckets within the current modeling term will be used. If Assumption Rule holds less buckets than what currently exists, the assumption for the last bucket will be carried forward for the remainder of the modeling term.
Distributed Option in Forecast Balance Assumptions not applicable for buckets with a term of 1 Day. Defaulted to Bucket End.	New Business timing is "Distributed" and bucket end date is same as bucket start date.	326	New Business timing is defaulted to Bucket end.
Inconsist. Run: MattStrat FcstBal PrMrgn must be def together	New business assumption rules (Pricing Margin, Maturity Strategy, Forecast Balance) are incomplete, some but not all have been defined.	330	Processing is stopped.
Inconsist. Run: Missing stochastic process assump.	Missing stochastic process assumptions.	330	Processing is stopped.
Inconsist. Run: Stochastic Rate Index Rule is not defined	The Stochastic Rate Rule is not defined in the Process Rule.	330	Processing is stopped.
Inconsist. Run: No Options Selected for Sel. Reproc.	No Options Selected for Selective Reprocessing in the Process Rule.	330	Processing is stopped.
Inconsist. Run: No Instrument Tables selected	There are no Instrument Tables selected in the Process Rule.	330	Processing is stopped.
Inconsist. Run: Inconsistent Sel. Reproc. buckets	Number of modeling buckets in results is not consistent with the number of modeling buckets in the active Time Bucket Rule during a selective reprocessing run.	330	Processing is stopped.
Inconsist. Run: Duplicate AutoBal leaves	Duplicate Auto Balance leaves defined in Application Preferences.	330	Processing is stopped.

Error Message	Error Condition	Error Code	Effect of Error on Processing
Inconsist. Run: Not all AutoBal leaves defined	Not all Auto Balancing leaves are defined.	330	Processing is stopped.
Can't hit target for Leaf member:<leaf number> bucket: <bucket number>	It is impossible to calculate a new add balance that will satisfy the conditions required for new business balances.	335	No new business will be added for this bucket.
No Product Char. for leaf member: <leaf number>	Payment and repricing data have not been set up in the current Product Characteristics Rule for leaf member being processed.	340	Default characteristics will be used:  amortization type = 700  payment frequency = original term  percent taxable = 100%  accrual basis = 30/360  repricing frequency = 0
Invalid record: Invalid Amortization Code leaf member: <leaf number>	Amortization code is not equal to 100, 200, 400, 500, 600, 700, 710, 820, 830, 840, 850	345	Oracle ALM will assume an amortization code of 700
Invalid record: Maturity Date in the past leaf member: <leaf number>	Maturity Date is less than the as of date	345	Record is not processed.
Invalid record: Remaining number of payments <= 0 leaf member: <leaf number>	Remaining number of payments is less than or equal to zero.	345	Record is not processed.
Invalid record: Pmt Freq = 0 leaf member: <leaf number>	Payment frequency is equal to zero on an amortizing instrument.	345	Record is not processed.
Invalid record: AmrtTerm < OrgTerm on amortizing instrument leaf member: <leaf number>	Amortization term is less than original term for amortizing instrument.	345	Re-amortization of payment will be affected.
Invalid record: Next payment date in the past leaf member: <leaf number>	Next payment date is less than the as of date.	345	If next payment date is much less than the as of date, it may cause the system to run out of memory.

<b>Error Message</b>	<b>Error Condition</b>	<b>Error Code</b>	<b>Effect of Error on Processing</b>
Invalid record: Invalid net margin code leaf member: <leaf number>	Net margin code <> 0 or 1	345	Oracle ALM will default the net margin code to 0: Floating Net Rate
Invalid record: Current payment = 0 on amortizing instrument leaf member: <leaf number>	Current payment equal to zero and amortization code is other than simple / non amortizing.	345	For amortization codes of 100, 500, and 600, interest will be capitalized as principal. For amortization code of 820, no principal payments will be made.
Invalid record: Valid rate cap < current rate leaf member: <leaf number>	Rate Cap is not equal to zero and it is less than the current rate.	345	Rate cap will be imposed on first repricing date.
Invalid record: Valid rate floor > current rate leaf member: <leaf number>	Rate Floor is not equal to zero and it is greater than the current rate.	345	Rate floor will be imposed on first repricing date.
Invalid record: Next repricing date in the past on repricing instrument leaf member: <leaf number>	Repricing frequency is not equal to zero and next repricing date is less than the as of date.	345	If the next repricing date is very far in the past, it may cause the system to run out of memory.
Invalid record: Invalid int rate code on repr instr leaf member: <leaf number>	Reprice frequency is greater than zero and Interest Rate Code is not found in the active Historical Rates database.	345	Instrument will not reprice.
Invalid record: Original term = 0 leaf member: <leaf number>	Original term is equal to zero.	345	This will produce erratic results if instrument is Rule of 78's; amortization term is also zero; or payment frequency is also zero on a non amortizing instrument.
Invalid record: Current net rate <= 0 on amortizing instrument leaf member: <leaf number>	Amortization code is 100, 500, 600, 820 and current net rate <= 0.	345	Negative income will be generated for positive balances.
Invalid record: Inconsistency of reprice freq and amortization leaf member: <leaf number>	Amortization code is 500 or 600 and reprice frequency is zero or amortization code is 100 and reprice frequency is non zero.	345	Reprice frequency will overwrite characteristics defined by amortization type code.
Invalid record: No of Events>16000	Number of events is greater that 16,000.	345	



Error Message	Error Condition	Error Code	Effect of Error on Processing
Invalid record: OrgTerm and PmtFreq = 0	Both original term and payment frequency are equal to zero.	345	Record is ignored.
Invalid record: Invalid Account Type	Invalid Account Type	345	Logs an error, continues execution.
Invalid record: Deferred calculations do not converge	Deferred calculations do not converge.	345	Logs an error and recognizes all deferred income at maturity.
Invalid record: YTM Calculations do not converge. leaf: <leaf number>	YTM calculation do not converge.	345	Logs an error and the YTM for the record is assumed to be zero.
Invalid record: EIR Calculations do not converge. leaf: <leaf number>	EIR calculation do not converge.	345	Logs an error and the EIR for the record is assumed to be zero.
Invalid record: Behavior Type definition is inconsistent between the Behavior Pattern and BEHAVIOR_TYPE_CD. Defaulted to the Behavior Type specified in the Behavior Pattern. leaf: <leaf number>	Behavior type code in the instrument record is not consistent with the behavior type specified in the behavior pattern definition.	345	Logs an error and the Behavior Type specified in the Behavior Pattern is used.
Invalid record: BEHAVIOR_SUB_TYPE_CD is invalid. Unable to process. leaf: <leaf number>	NPA or D and R behavior pattern is used but the behavior subtype code in the instrument record is invalid.	345	Logs an error and the Record is not processed.
Invalid record: Behavior pattern definition does not exist. Unable to process. leaf: <leaf number>	Behavior pattern definition doesn't exist.	345	Logs an error and the Record is not processed.
Invalid record: Accrued Interest <> 0 and (Last_payment_date < As_of_date) for Behavior pattern record. Accrued interest may be overstated. leaf: <leaf number>	Instrument record is using non-maturity behavior pattern and last payment date is less than as of date and Accrued interest is not 0.	345	Logs an error and the calculated accrued interest may be overstated.

Error Message	Error Condition	Error Code	Effect of Error on Processing
Invalid record: Invalid Effective Interest Rate on instrument record; Market value, Yield to Maturity, Duration, Modified Duration, Convexity values have been calculated using 0 Effective Interest Rate. leaf: <leaf number>	Effective Interest Rate in the instrument record is less than 0 or greater than 99 and the discount method is EIR and in the calculation block Market value is selected and EIR is not selected.	345	Logs an error and the Market value, Yield to Maturity, Duration, Modified Duration, Convexity values will be calculated using 0 Effective Interest Rate.
Invalid record: Invalid Average Life. leaf: <leaf number>	Calculated Average life value for the record is 0.	345	Logs an error
Accrued Interest = 0 and (Last_payment_date < As_of_date) for Multiple Reprice Instrument record. Net interest on first payment event may be understated. Leaf <leaf number>	Last Payment Date/Last Reprice Date < As of Date and Accrued Interest is not supplied in the instrument	345	Logs an error, continues execution.
Interest in Advance is not supported for multiple reprice instruments. Hence defaulted to Interest in Arrears. Leaf <leaf number>	Multiple Reprice events with interest payment in advance.	345	Logs an error, continues execution.
For Multiple Reprice Instruments with repricing patterns, the compounding is defaulted to None. Leaf <leaf number>	If it is a multiple reprice instrument with repricing patterns	345	Logs an error, continues execution.
For Floating rate Multiple Reprice instruments, the compounding is defaulted to None. Leaf <leaf number>	For floating rate instruments with multiple reprice.	345	Logs an error, continues execution.
For Multiple reprice instruments where compounding frequency <> repricing frequency. The compounding is defaulted to None. Leaf <leaf number>	Compounding frequency <> Repricing frequency	345	Logs an error, continues execution.

Error Message	Error Condition	Error Code	Effect of Error on Processing
Accrued Interest Gross = 0 and (Last_payment_date < As_of_date) for Multiple Reprice Instrument record. Gross interest on first payment event may be understated. Leaf <leaf number>	Last Payment Date/Last Reprice Date < As of Date and Accrued Interest Gross is not supplied in the instrument	345	Logs an error, continues execution.
Accrued Interest TRate = 0 and (Last_payment_date < As_of_date) for Multiple Reprice Instrument record. T rate interest on first payment event may be understated. Leaf <leaf number>	Last Payment Date/Last Reprice Date < As of Date and Accrued Interest Trate is not supplied in the instrument	345	Logs an error, continues execution.
Index Adjustment Type is Not Applicable and Capital Protection Category is filled in. Instrument processed without Inflation adjustment.	When Index Adjustment Type is Not Applicable and Capital Protection Category is filled in. Instrument processed without Inflation adjustment.	345	Logs an error, continues execution.
Index Adjustment Type is <> Not Applicable, and Base Index Value is not provided. Instrument processed without Inflation adjustment.	When Index Adjustment Type is <> Not Applicable, and Base Index Value is null. Instrument processed without Inflation adjustment.	345	Logs an error, continues execution.
No data available in Account Index History table.Hence Instrument processed without Inflation adjustment.	When Index Name filed is null and no data available in Account Index History table. Instrument is processed without Inflation adjustment.	345	Logs an error, continues execution.
Index Adjustment Type is <> Not Applicable, and Amortization code is other than 100, 500, 700, 800, 801, 802, 820. Instrument processed without Inflation adjustment.	When Index Adjustment Type is <> Not Applicable, and Amortization code <> 100, 500, 700, 800, 801, 802, 820. Instrument processed without Inflation adjustment.	345	Logs an error, continues execution.

<b>Error Message</b>	<b>Error Condition</b>	<b>Error Code</b>	<b>Effect of Error on Processing</b>
Index value has data type other than 'Numeric' in Rate Management Economic Indicator. Instrument processed without Inflation adjustment.	When a record has Index Name filed in and Index value has data type other than 'Numeric' in Rate Management Economic Indicator. Instrument processed without Inflation adjustment.	345	Logs an error, continues execution.
Capital Protection Category is Max during life, and Maximum Index value not provided. Maximum Index value to be calculated from AS_OF_DATE.	Capital Protection Category is Max during life, and Maximum Index value is not provided. Maximum Index value to be calculated from AS_OF_DATE.	345	Logs an error, continues execution.
Payment date does not have Index value in Account Index History table. Index Factor of 1 will be considered on those payment dates.	When Index Name field is null and Payment date does not have Index value in Account Index History table. Index Factor of 1 will be considered on those payment dates.	345	Logs an error, continues execution.
Bucket Number Mismatch	Assumption Rule was created when the active Time Bucket Rule held more/less buckets than it has currently; therefore, the Assumption Rule contains more/less bucket information than necessary.	350	If Assumption Rule holds more buckets than what currently exists, only the buckets within the current modeling term will be used. If Assumption Rule holds less buckets than what currently exists, the assumption for the last bucket will be carried forward for the remainder of the modeling term.
No Target for Roll/Auto leaf member: <leaf number> bucket: <bucket number>	Forecast Balance methods of Target Average or Target End cannot be used for a Leaf member value used as a roll-into leaf or as an autobalancing leaf member.	360	Targeting methods cannot be used for leaves specified as roll-into or autobalancing. The targeted balances will be ignored.
Res_det: Security violation	Current user does not have rights to create an Oracle ALM results table.	365	Processing is stopped.
Res_det: Truncate fail	Results table for current processing rule could not be cleared of old data.	365	Processing is stopped.

Error Message	Error Condition	Error Code	Effect of Error on Processing
Res_det: Creation fail	Results table for new processing Rule could not be created.	365	Processing is stopped.
Res_det the structure of the result_detail table was invalid for selective reprocessing	The structure of the current Result Detail table does not match the IDT Result Detail Table Template.	365	Processing is stopped.
Account Type not defined for leaf member (leaf number)	In Dimension Member Set-Up, an account type attribute has not been specified for the current leaf member.	370	Account type will default to Earning Assets.
No. of scen in results > expected leaf member: <leaf number>	Number of scenarios in results set is greater than number of scenarios expected from querying the current Forecast Rates Assumption Rule while processing Autobalancing.	380	Autobalancing will only be processed for the scenarios included in the current Forecast Rates Assumption Rule.
Invalid interest type - defaulted to interest in arrears	Interest type code is not equal to 0 or 1.	385	Instrument is defaulted to "interest in arrears".
Invalid Pmt pattern: pmt pattern code. <Payment Pattern Code>for new business - abs val	Payment Pattern assigned to new business has a constant payment amount.	390	Error is logged.
No Amrt Type in Product characteristics for leaf member:<leaf number>	No amortization type code has been assigned in Product Characteristics for the current leaf member.	395	An error message is logged and instrument is defaulted to simple interest.
No Amrt Type in Trans. Str. for leaf member:<leaf number>	No amortization type code has been assigned in Transaction Strategy for the current leaf member.	396	An error message is logged and instrument is defaulted to simple interest.
Formula Results Error: Mismatch in buckets number	The number of modeling buckets in result set does not match the number of modeling buckets defined in Formula Results.	397	Error is logged.
Invalid Currency Gain/Loss Basis. Defaulted to "Temporal"	fl	406	

<b>Error Message</b>	<b>Error Condition</b>	<b>Error Code</b>	<b>Effect of Error on Processing</b>
Pay-Equivalent Compounding Convention. Defaulted to "Do Not Adjust"	fl	407	fl
Negative FullIndexGrs Rate for leaf member: <leaf number>	A negative fully indexed gross rate was calculated on a repricing event.	505	The negative rate will be assigned to the instrument.
Negative FullIndexNet Rate for leaf member: <leaf number>	A negative fully indexed net rate was calculated on a repricing event.	505	The negative rate will be assigned to the instrument.
Negative CurGrsRate Rate for leaf member: <leaf number>	A negative current gross rate was calculated on a repricing event.	505	The negative rate will be assigned to the instrument.
Negative CurNetRate Rate for leaf member: <leaf number>	A negative current net rate was calculated on a repricing event.	505	The negative rate will be assigned to the instrument.
Negative CurTrRate Rate for leaf member: <leaf number>	A negative current transfer rate was calculated on a repricing event.	505	The negative rate will be assigned to the instrument.
Spread rate not found in Pricing Margins Rule	There is no pricing margin defined for the current leaf member.	515	Zero will be defaulted as the pricing margin.
Rate Not Found	Forecasted rates do not exist for interest rate code on current instrument.	520	When the instrument reprices, it will receive a zero rate.
1st point used	Reprice date occurs before forecasting period; forecasted rates do not exist.	525	This may occur if the data holds a reprice date which is less than the As of Date. Instrument will reprice to the rate as of the As of Date.
Last point used	Reprice date occurs beyond forecasting period; forecasted rates do not exist.	530	This may occur when calculating market values beyond the modeling term or calculating the last reprice/payment event for accruals in the last bucket. Instrument will reprice to the rate as of the last forecasted date.
Code found only	Interest rate code exists in Forecast Rates Assumption Rule, but no rates have been forecast.	535	When the instrument reprices, it will receive a zero rate.

Error Message	Error Condition	Error Code	Effect of Error on Processing
Prepayment tier not selected, zero prepayment rate used.	Market Rate and Quote Basis have been defined in the Prepayment Rule, but no tiers or prepayment percents have been created.	540	No prepayments will occur on this Leaf member.
Last payment date is before origination date.	The last payment date from instrument record is prior to the origination date on the instrument record.	545	Logs error and continues. For Transaction Strategy, last reprice date is set to origination date.
No reprice frequency for adjustable record.	Instrument is coded as adjustable, but the reprice frequency is equal to zero.	550	Instrument will be treated as fixed rate.
No schedule found for record.	No match can be found in the payment schedule table for the current record.	555	Logs error and defaults to simple interest record if payment frequency does not = 0.
Pattern data can not be found for AMRT_TYPE:<payment pattern code>	No payment pattern information has been defined for the documented amortization type code.	560	Log error and default to simple interest.
No pattern information found for record.	Documented amortization type code exists in database, but no supporting details are available.	565	Currently is used to notify users about invalid adjustable type code. Record defaults to fixed.
Maturity date from record does not match schedule data.	The maturity date on instrument record does not exist in the payment schedule table for the current record.	570	Logs error. Uses maturity date for schedule.
Conv amrt with interest in advance, defaulted to arrears.	Conventionally amortizing instrument is classified as interest in advance. This combination is not supported.	575	The instrument will be defaulted to interest in arrears.
Invalid Amrt. Type detected. Defaulted to Simple Int.	An unknown Amortization Type Code was used.	585	Instrument will be defaulted to simple interest.
No Repricing Pattern found for record.	An unknown Adjustable Type Code was used.	600	Instrument will be defaulted to Other Adjustable.
Invalid Event_Det_Seq (Adj_Type_CD:<Adjustable type code>); Evt_dtl_seq should start from 0.	For an Event Sequence, Event Detail Sequence has started from a non-zero value.	635	Repricing pattern is ignored and will produce erratic results if this repricing pattern is used.

Error Message	Error Condition	Error Code	Effect of Error on Processing
1st point used.	Reprice date occurs before forecasting period; forecasted rates do not exist.	725	This may occur if the data holds a reprice date which is less than the As of Date. Instrument will reprice to the rate as of the As of Date.
Last point used.	Reprice date occurs beyond forecasting period; forecasted rates do not exist.	730	This may occur when calculating market values beyond the modeling term or calculating the last reprice/payment event for accruals in the last bucket. Instrument will reprice to the rate as of the last forecasted date.
Negative Transfer Rate.		740	
Invalid duration generated for this row.		795	
Divide by zero		810	
Invalid record:Engine calculated Market Value (MARKET_VALUE_C) is more than its allowed size (9999.999999) hence resetting it as Market Value Clean (MARKET_VALUE_CLEAN_C). Leaf member:<<PLACEHOLDER>>.	If value of column MARKET_VALUE_C is beyond specified precision, then MARKET_VALUE_CLEAN_C value is considered for calculation (less than 9999.999999). If value of MARKET_VALUE_CLEAN_C is also beyond specified precision, then Engine will default this value to 100.	345	
Invalid record:Engine calculated Market Value Clean (MARKET_VALUE_CLEAN_C) is more than its allowed size (9999.999999) hence resetting it as Market Value (MARKET_VALUE_C). Leaf member:<<PLACEHOLDER>>.	If value of column MARKET_VALUE_CLEAN_C is beyond specified precision, then MARKET_VALUE_C value is considered for calculation (less than 9999.999999). If value of MARKET_VALUE_C is also beyond specified precision, then Engine will default this value to 100.	345	



---

<b>Error Message</b>	<b>Error Condition</b>	<b>Error Code</b>	<b>Effect of Error on Processing</b>
Invalid record:Both Engine calculated Market Value Clean (MARKET_VALUE_CLEAN_C) & Market Value (MARKET_VALUE_C) are more than its allowed size (9999.999999) hence updating value as 100. Leaf member:<<PLACEHOLDER>>.	If value of columns MARKET_VALUE_C and MARKET_VALUE_CLEAN_C are beyond specified precision, Engine will default these values to 100.	345	

---



**Aggregation**

To summarize detailed instruments to a table in the database which can be used for faster processing in ALM.

**Answers**

Answers is the OBIEE (Oracle Business Intelligence Enterprise Edition), ad-hoc reporting tool.

**As of Date**

Date at which the data is current

**Asset/Liability Management Committee**

The Asset/Liability Management Committee (or ALCO) is an organization within a financial institution whose charter is to manage interest rate and liquidity risk.

**At-Risk Period**

The time horizon for Value-at-Risk, such as the difference between the time in the future when we evaluate a portfolio loss and the As of Date.

**Base Rates**

Section in Oracle Asset Liability Management that stores the interest rates associated with the data As-of-Date.

**Basis Points**

1/100th of a percent (abbreviated as "bps")

**Cash Flow Instrument Table**

An instrument table that contains all of the OFSAA cash flow columns required by the cash flow engine.

**Cash Flow Column**

Column in an instrument table used by the OFSAA cash flow engine to perform cash flow analysis on a record.

**CPR**

Constant Prepayment Rate (CPR) is a measure of an annualized prepayment rate.

**Credit Risk**

The risk that a loan holder will be unable to repay any portion of the loan.

**Current Rate Risk Profit**

Component of funding center rate risk results attributed to current mismatches of assets and liabilities.

**Data Filter Rule**

Data Filters are used to define which data should go into a processing run.

**Data Input Helper**

A pop-up dialogue that facilitates the definition of a series of input values (dates or numbers) by allowing several methods for defining structured patterns in the data.

**DDA**

Demand Deposit Account. An example of a DDA is a checking account.

**De-annualize**

To compute the monthly equivalent rate of an annual rate.

**Duration**

Duration is the rate of market value change with respect to discount rate changes. It is a measure of market value sensitivity: the lower the value, the less sensitive the market value to changes in interest rates.

**Embedded Rate Risk Profit**

Portion of funding center rate risk result attributed to prior rate bets.

**Funding Center**

Area in a financial institution that receives the transfer pricing charge and credit for funds.

**Funds Transfer Pricing**

A method for valuing all sources and uses of funds for a balance sheet.

**General Ledger**

The main data source that defines an institution's financial reality. The General Ledger reflects all accounting entries.

**Grid**

A logical grouping of cells often surrounded by scroll bars.

**Hierarchy**

Hierarchical structure for dimension members in OFS applications (Examples: organizational and product type)

**Historical Rates Table**

OFSAA repository for all historical actual interest rates.

**Instrument**

Synonymous with an account record or an individual contract.

**Instrument Table**

A type of table contained in the OFSAA database used to store account level information

**Instrument Records**

Rows in the OFSAA database that carry transaction account level information (Example: deposit account by deposit account)

**Interest Rate Code**

User defined code to reference a yield curve or single rate index for historical analysis, transfer pricing, and interest rate forecasting purposes.

**Last Repricing Date**

Date the rate last changed for an adjustable rate instrument and the origination date for a fixed rate instrument.

**Leaf Fields**

OFSAA database fields used to define hierarchical segmentations of data. They also draw a relationship between the instrument data and the General Ledger data in Ledger/Stat. Also known as key dimensions

**Leaf Values**

Specific numeric values that make up the Leaf Fields. These are dimension members that can never be used as parent nodes on a hierarchy. The fact data should always be populated with dimension member - leaf values only.

**Ledger Stat**

Table in the OFSAA database that stores all General Ledger as well as statistical information for current and historical periods.

**Liquidity Premiums**

A charge levied on a long-term instrument to compensate for illiquidity of the funds.

**Log in**

To access the programs and database of any OFSAA application by providing a valid user name and password.

**Long Run Rate**

One of the user-input parameters of the Vasicek (discrete-time) term structure model; represents the equilibrium value of the one-month annually compounded rate.

**Market Price of Risk**

In financial economics theory the market price of risk is a measure of inter-temporal risk-aversion of the aggregate investor; for example, a high market price of risk during some future period means that investors will be more risk-averse, and that rates for that term should be higher to compensate for this risk; in practical terms, the market price of risk is the "plug" that makes the risk-neutral rates price risk-free bonds correctly.

**Market Value**

In Monte Carlo, average of the (scenario specific) present values. In deterministic processing, it is the present value of the cash flows of the specific scenario.

**Matched Rate Transfer Pricing**

Method of Transfer Pricing where all accounts have transfer rates that reflect their specific maturity and repricing characteristics.

**Matched Spread**

The interest profit margin for any account, measured as the Note Rate minus the Transfer Rate for asset accounts and the Transfer Rate minus the Note Rate for Liability and Equity accounts.

**Monthly Rate**

Yield on a loan contracted at the beginning of a month for a period of one month assuming a continuous compounding basis; the monthly rate is a function of time and scenario; the Rate Generator also computes rates for a different term than a month.

**Next Repricing Term**

Repricing frequency for an adjustable rate instrument and the original term to maturity for a fixed rate instrument.

**Oracle Asset Liability Management**

ALM is an Asset/Liability management simulation tool that generates daily cash flows for each individual transaction record and allows users to model their balance sheet using both deterministic and stochastic methods.

**Oracle Business Intelligence Enterprise Edition**

OBIEE is Oracle's market leading business intelligence product. OFSAA applications are fully integrated with OBIEE through the OFSAA BI applications, including Oracle Financial Services Asset Liability Management Analytics and Oracle Financial Services Profitability Analytics.

**Oracle Financial Services Balance Sheet Planning**

Balance Sheet Planning performs distributed budgeting of all balance sheet and income statement accounts.

**Oracle Financial Services Funds Transfer Pricing**

Funds Transfer Pricing performs Matched Rate Transfer Pricing for an entire balance sheet.

**Oracle Financial Services Pricing Management – Transfer Pricing Component**

Pricing Management allows users to call the Transfer Pricing engine in real time, providing the line bankers with on-demand information to support deal pricing.

**Oracle Financial Services Profitability Management**

Profitability Management assists customers in developing multiple levels of profitability (Example: organizational, product, customer, account profitability).

**Oracle Financial Services Analytical Applications Infrastructure**

OFSAAI is a set of powerful administrative tools that provide management of the OFSAA environment and access to the database by OFS application users. The Infrastructure is a required component for all OFSAA applications with the exception of Balance Sheet Planning.

**Oracle Financial Services Advanced Analytical Applications Infrastructure**

The advanced infrastructure provides the modeling framework and stress testing framework as additional complimentary components to supplement to core analytic applications.

**Operating Cost**

Non-interest related cost of running a business.

**Option Costs**

Costs assigned to measure the value of any customer option on an instrument.(Example: prepayments on mortgage loans). These costs are typically added to the base transfer rate to compute an all-in funding rate.

**Portfolio Fields**

Fields in the OFSAA database that are common to multiple instrument tables. The OFSAA Administrator determines the portfolio fields.

**Prepayment**

A reduction in the principal balance of a transaction record prior to the contracted schedule date.

**Present Value**

In Monte Carlo, sum of cash flows paid by a security along a particular rate scenario, discounted by the stochastic discount factor. In deterministic processing, the sum of the cash flows discounted by the deterministic discount factor.

**PSA**

---

A prepayment specification method established by the Public Securities Association, which relates the CPR to the age of that instrument.

**Reconciliation**

The process of comparing information from one data source to another.

**Record**

Usually a single account or transaction, or aggregation of accounts, stored in the database (also called a row).

**Reporting Currency**

An active currency to which balances in other currencies are consolidated, often used for reporting.

**Single Rate**

An interest rate code with only one point defined (Examples: prime rate and 11th District Cost of Funds Index).

**Speed of Mean Reversion**

One of the user-input parameters of the Vasicek and Extended Vasicek (discrete time) term structure models; represents the long-run drift factor.

**SQL**

Structured Query Language. A direct method of accessing the raw OFSAA database.

**Stochastic Discount Factor**

Present value (along a rate scenario) of one dollar received at some future time; it is a function of future time, OAS, and scenario.

**Transfer Pricing Rule**

An OFSAA Rule used to specify the method for transfer pricing each balance sheet account.

**Volatility**

One of the user-input term parameters of all (discrete-time) term structure models; represents a standard deviation of the one-month annually compounded rate.

**Yield Curve**

Term structure of annually compounded zero-coupon bond yield, as recorded in Rate Management > Historical Rates.

