

Oracle® Communications
Diameter Signaling Router
Rack Mount Installation Guide
Release 8.2
E88962-01

April 2018

ORACLE

Oracle Communications DSR Rack Mount Server Installation Guide, Release 8.2

Copyright © 2017, 2018 Oracle and/or its affiliates. All rights reserved.

This software and related documentation are provided under a license agreement containing restrictions on use and disclosure and are protected by intellectual property laws. Except as expressly permitted in your license agreement or allowed by law, you may not use, copy, reproduce, translate, broadcast, modify, license, transmit, distribute, exhibit, perform, publish, or display any part, in any form, or by any means. Reverse engineering, disassembly, or decompilation of this software, unless required by law for interoperability, is prohibited.

The information contained herein is subject to change without notice and is not warranted to be error-free. If you find any errors, please report them to us in writing.

If this is software or related documentation that is delivered to the U.S. Government or anyone licensing it on behalf of the U.S. Government, then the following notice is applicable:

U.S. GOVERNMENT END USERS: Oracle programs, including any operating system, integrated software, any programs installed on the hardware, and/or documentation, delivered to U.S. Government end users are "commercial computer software" pursuant to the applicable Federal Acquisition Regulation and agency-specific supplemental regulations. As such, use, duplication, disclosure, modification, and adaptation of the programs, including any operating system, integrated software, any programs installed on the hardware, and/or documentation, shall be subject to license terms and license restrictions applicable to the programs. No other rights are granted to the U.S. Government.

This software or hardware is developed for general use in a variety of information management applications. It is not developed or intended for use in any inherently dangerous applications, including applications that may create a risk of personal injury. If you use this software or hardware in dangerous applications, then you shall be responsible to take all appropriate fail-safe, backup, redundancy, and other measures to ensure its safe use. Oracle Corporation and its affiliates disclaim any liability for any damages caused by use of this software or hardware in dangerous applications.

Oracle and Java are registered trademarks of Oracle and/or its affiliates. Other names may be trademarks of their respective owners.

Intel and Intel Xeon are trademarks or registered trademarks of Intel Corporation. All SPARC trademarks are used under license and are trademarks or registered trademarks of SPARC International, Inc. AMD, Opteron, the AMD logo, and the AMD Opteron logo are trademarks or registered trademarks of Advanced Micro Devices. UNIX is a registered trademark of The Open Group.

This software or hardware and documentation may provide access to or information about content, products, and services from third parties. Oracle Corporation and its affiliates are not responsible for and expressly disclaim all warranties of any kind with respect to third-party content, products, and services unless otherwise set forth in an applicable agreement between you and Oracle. Oracle Corporation and its affiliates is not responsible for any loss, costs, or damages incurred due to your access to or use of third-party content, products, or services, except as set forth in an applicable agreement between you and Oracle.



CAUTION: Use only the Upgrade procedure included in the Upgrade Kit.

Before upgrading any system, please access My Oracle Support (MOS) (<https://support.oracle.com>) and review any Technical Service Bulletins (TSBs) that relate to this upgrade.

My Oracle Support (MOS) (<https://support.oracle.com>) is your initial point of contact for all product support and training needs. A representative at Customer Access Support (CAS) can assist you with MOS registration.

Call the CAS main number at 1-800-223-1711 (toll-free in the US), or call the Oracle Support hotline for your local country from the list at <http://www.oracle.com/us/support/contact/index.html>.

See more information My Oracle Support (MOS).

Table of Contents

1. Introduction	11
1.1 References	11
1.2 Acronyms.....	12
1.3 Terminology.....	13
1.4 How to Use this Document.....	14
1.5 Optional Features	15
2. General Description	16
2.1 Acquiring Firmware.....	16
2.1.1 HP DL380.....	16
2.1.2 Oracle X5-2/Netra X5-2/X6-2/X7-2	17
2.2 Hardware Requirements	17
2.2.1 Required Materials.....	17
2.2.2 Rack Mount Server Network Interface Reference	18
3. Software Installation Procedure	18
3.1 Prepare Servers for IPM.....	18
3.1.1 Configure BIOS Settings.....	19
3.1.2 Upgrade Rack Mount Server Firmware	21
3.2 Install and Configure TVOE on First RMS (PMAC Host)	22
3.3 Install PMAC.....	39
3.4 Initialize the PMAC Application	44
3.5 Configure Cisco 4948E-F Aggregation Switches (HP DL380 Gen 8 Servers Only)	46
3.5.1 Configure netConfig Repository (HP DL380 Gen 8 Servers Only).....	46
3.5.2 Configure Cisco 4948E-F Aggregation Switches (HP DL380 Gen 8 Servers Only).....	55
3.6 Configure PMAC Server (NetBackup Only)	62
3.7 Add a Rack Mount Server to PMAC.....	66
3.8 Install TVOE on Additional Rack Mount Servers.....	70
3.9 Configure TVOE on Additional Rack Mount Servers	75
3.10 Determine VM Placement and Socket Pinning	87
3.11 Deploy Redundant PMAC (Optional)	88
3.12 Virtual Machine/Network Fast Deployment	95
3.13 CPU Pinning	103
3.14 DSR Application Configuration	107
3.14.1 NOAM Configuration.....	107
3.14.2 NetBackup Client Installation (Optional)	122
3.14.3 Disaster Recovery NOAM (Optional).....	123

3.14.4	SOAM Configuration	131
3.14.5	Activate PCA	144
3.14.6	Activate DCA	144
3.14.7	MP Configuration	145
3.14.8	Signaling Network Configuration	181
3.14.9	DSCP Configuration (Optional)	186
3.14.10	SNMP Configuration	190
3.14.11	IPFE Configuration (Optional)	198
3.15	SDS Application Configuration	203
3.15.1	NOAM Configuration	203
3.15.2	NetBackup Client Installation (Optional)	217
3.15.3	Disaster Recovery NOAM (Optional)	218
3.15.4	Query Server Configuration	226
3.15.5	SOAM Configuration	234
3.15.6	DP Configuration	245
3.15.7	DSCP Configuration (Optional)	252
3.15.8	SNMP Configuration (Optional)	255
3.16	IDIH Installation and Configuration (Optional)	257
3.16.1	IDIH Installation	257
3.16.2	IDIH Configuration	262
3.17	Post Installation Procedures	280
3.17.1	Optimization (DSR and Oracle X5-2/Netra X5-2/X6-2/X7-2/HP DL380 Gen 9 (10Gbps) Only)	280
3.17.2	Configure ComAgent Connections (DSR and SDS Only)	281
3.17.3	Activate Optional Features	286
3.17.4	Shared Secret Encryption Key Revocation (RADIUS Only)	286
3.17.5	Enable/Disable DTLS (SCTP Diameter Connections Only)	287
3.17.6	Back Up TVOE Configuration	287
3.17.7	Back Up PMAC Application	289
3.17.8	Back Up NOAM Database	291
3.17.9	Back Up SOAM Database	294
Appendix A. Pre-IPM Procedures		297
Appendix A.1	Set the Server's CMOS Clock	297
Appendix A.2	Configure the RMS Server BIOS Settings	297
Appendix A.2.1	Configure HP Gen 8 Servers	297
Appendix A.2.2	Configure HP Gen 9 Servers	299
Appendix A.2.3	Configure Oracle X5-2/Netra X5-2/X6-2/X7-2 Server	302

Appendix B. Upgrade Server Firmware	306
Appendix B.1 HP DL380 Server	306
Appendix B.2 Oracle X5-2/Netra X5-2/X6-2/X7-2	312
Appendix C. Change the SNMP Configuration Settings	312
Appendix D. TVOE iLO/iLOM GUI Access	314
Appendix D.1 Access the iLO GUI (HP DL380)	314
Appendix D.2 Access the iLOM GUI (Oracle X5-2/Netra X5-2/X6-2/X7-2).....	315
Appendix E. Change the TVOE iLO/iLOM Address	318
Appendix E.1 HP DL380 Servers (iLO4)	318
Appendix E.2 Oracle X5-2/Netra X5-2/X6-2 Servers (Change iLOM IP Address using Keyboard/Monitor)	321
Appendix E.3 Oracle X5-2/Netra X5-2/X6-2/X7-2 Servers (Change iLOM IP Address using Serial Console)	325
Appendix F. Attach an ISO Image to a Server using the iLO or iLOM	327
Appendix F.1 HP DL380 Servers (iLO4)	327
Appendix F.2 Oracle X5-2/Netra X5-2/X6-2/X7-2 Servers (iLOM).....	329
Appendix G. Configure TVOE iLO Access	333
Appendix H. SNMP Configuration	335
Appendix I. Install NetBackup Client	338
Appendix I.1 Install NetBackup Client Using platcfg	338
Appendix I.2 Install NetBackup Client Using NBAutoInstall	345
Appendix I.3 Create NetBackup Client Configuration File.....	346
Appendix I.4 Configure PMAC Application NetBackup Virtual Disk.....	347
Appendix J. List of Frequently Used Time Zones	351
Appendix K. Upgrade Cisco 4948 PROM.....	353
Appendix L. Sample Network Element	356
Appendix M. Configure IDIH Fast Deployment	357
Appendix N. Create a Bootable USB Drive on Linux.....	367
Appendix O. Remove IDIH External Drive	368
Appendix P. Growth/De-Growth/Re-Shuffle (Oracle X5-2/Netra X5-2/X6-2/X7-2/HP DL380 Gen 9 (10Gbps) Only).....	371
Appendix P.1 Growth (Oracle X5-2/Netra X5-2/X6-2/X7-2/HP DL380 Gen 9 (10Gbps) Only)	371
Appendix P.2 De-Growth (Oracle X5-2/Netra X5-2/X6-2/X7-2/HP DL380 Gen 9 (10Gbps) Only)	389
Appendix P.3 Re-Shuffle (Oracle X5-2/Netra X5-2/X6-2/X7-2/HP DL380 Gen 9 (10Gbps) Only)	409
Appendix Q. Non-HA Lab Node Instructions (Oracle X5-2/Netra X5-2/X6-2/X7-2/HP DL380 Gen 9 (10Gbps) Non-HA Lab Node Only).....	436
Appendix Q.1 Non-HA Lab Node Pre-IPM Procedures.....	436
Appendix Q.2 Non-HA Lab Node PMAC Deployment.....	453

Appendix Q.3 Non-HA Lab Node VM Automation Profile Values	457
Appendix Q.4 Non-HA Lab Node IDIH Procedure Deviation	458
Appendix R. VM Automation Profile Values.....	462
Appendix S. VM Placement in HP DL380 Gen 8/Gen 9 (Onboard 1Gbps NICs) and CPU Pinning in HP DL380 Gen 9 (Onboard 1Gbps NICs)	463
Appendix T. Restore SNMP Configuration to SNMPv3 (Optional).....	466
Appendix U. My Oracle Support (MOS)	467

List of Tables

Table 1. Acronyms	12
Table 2. Terminology	13
Table 3. Optional Features.....	15
Table 4. RMS Network Interfaces	18
Table 5. List of Selected Time Zone Values	351
Table 6. VM Automation Profile Values	462
Table 7. HP DL380 Gen 9 (1Gbps) CPU Pinning without SS7MPs	465
Table 8. HP DL380 Gen 9 (1Gbps) CPU Pinning with SS7MPs	465

List of Figures

Figure 1. Example Procedure Steps Used in This Document	15
Figure 2. Initial Application Installation Path-Example Shown.....	16
Figure 3. Example Network Element XML File	356
Figure 4. HP DL380 Gen 8/Gen 9 (1Gbps) VM Placement Non-HA LAB Deployment.....	463
Figure 5. HP DL380 Gen 8/Gen 9 (1Gbps) VM Placement Small Production DSR with IDIH	463
Figure 6. HP DL380 Gen 8/Gen 9 (1Gbps) VM Placement Scaled DSR	464
Figure 7. HP DL380 Gen 9 (1Gbps) VM Placement Scaled DSR with SS7 MPs and IDIH	464

List of Procedures

Procedure 1. Configure BIOS Settings	19
Procedure 2. Upgrade Rack Mount Server Firmware.....	21
Procedure 3. Install and Configure TVOE on First RMS (PMAC Host)	22
Procedure 4. Configure First Rack Mount Server	26
Procedure 5. PMAC Deployment.....	39
Procedure 6. Initialize PMAC	44
Procedure 7. Configure netConfig Repository (HP DL380 Gen 8 Servers Only)	48

Procedure 8. Configure Cisco 4948E-F Aggregation Switches-netConfig (HP DL380 Servers Only) 56

Procedure 9. Configure the PMAC Server (NetBackup Only) 62

Procedure 10. Add RMS to the PMAC System Inventory 66

Procedure 11. Restore an Archive That Does Not Contain a Current User 70

Procedure 12. Configure TVOE on Additional Rack Mount Servers 75

Procedure 13. Install a Redundant PMAC 88

Procedure 14. Load DSR, SDS, and TPD ISOs onto the PMAC Server 95

Procedure 15. Execute VM/Network Fast Deployment 98

Procedure 16. Load DSR, SDS, and TPD ISOs onto the PMAC Server 103

Procedure 17. Configure First DSR NOAM NE and Server 107

Procedure 18. Configure the DSR NOAM Server Group 113

Procedure 19. Configure Second DSR NOAM Server 117

Procedure 20. Complete DSR NOAM Server Group Configuration 120

Procedure 21. Install NetBackup Client (Optional) 122

Procedure 22. Configure DSR NOAM for DR Site (Optional) 123

Procedure 23. Pairing for DSR DR NOAM Site (Optional) 127

Procedure 24. Configure DSR SOAM NE 131

Procedure 25. Configure DSR SOAM Server 133

Procedure 26. Configure the DSR SOAM Server Group 138

Procedure 27. Configure RMS-Specific B-Level Resources (HP DL380 Gen 8 Servers Only) 143

Procedure 28. Activate PCA 144

Procedure 29. Activate DCA 144

Procedure 30. Configure MP Servers 145

Procedure 31. Configure Places and Assign MP Servers to Places (PCA and DCA Only) 156

Procedure 32. Configure DAMP Server Groups and Profiles 159

Procedure 33. Configure IPFE Server Groups 164

Procedure 34. Configure SS7-MP Server Groups and Profiles 167

Procedure 35. Configure Session SBR Server Groups 173

Procedure 36. Configure Binding SBR Server Groups 177

Procedure 37. Configure Signaling Network Routes 181

Procedure 38. Configure DSCP Values for Outgoing Traffic (Optional) 186

Procedure 39. Configure SNMP Trap Receivers 190

Procedure 40. Configure IPFE (Optional) 198

Procedure 41. Configure First SDS NOAM NE and Server 203

Procedure 42. Configure the SDS NOAM Server Group 208

Procedure 43. Configure Second SDS NOAM Server 211

Procedure 44. Complete SDS NOAM Server Group Configuration 214

Procedure 45. Install NetBackup Client (Optional)	217
Procedure 46. Configure SDS NOAM for DR Site (Optional)	218
Procedure 47. Pairing for SDS DR NOAM Site (Optional)	223
Procedure 48. Configure SDS Query Server	226
Procedure 49. Pair SDS Query Server with SDS NOAMs.....	231
Procedure 50. Configure SDS DP SOAM NE	234
Procedure 51. Configure SDS DP SOAM Server	236
Procedure 52. Configure the SDS DP SOAM Server Group	241
Procedure 53. Configure SDS DP Server	245
Procedure 54. Configure the SDS DP Server Group	250
Procedure 55. Configure DSCP Values for Outgoing Traffic (Optional)	252
Procedure 56. Configure SNMP Trap Receivers (Optional)	255
Procedure 57. IDIH Installation	258
Procedure 58. Configure DSR Reference Data Synchronization for IDIH.....	262
Procedure 59. Configure the SSO Domain	266
Procedure 60. Configure in DSR	272
Procedure 61. Configure Mail Server (Optional).....	275
Procedure 62. Change SNMP Management Server (Optional).....	276
Procedure 63. Change Network Interface (Optional).....	277
Procedure 64. Back Up the Upgrade and Disaster Recovery FDC File (Optional)	278
Procedure 65. Optimization Procedure	280
Procedure 66. Configure ComAgent Connections.....	281
Procedure 67. Activate Optional Features	286
Procedure 68. Shared Secret Encryption Key Revocation (RADIUS Only)	286
Procedure 69. Enable/Disable DTLS (SCTP Diameter Connections Only).....	287
Procedure 70. Back Up TVOE Configuration.....	287
Procedure 71. Back Up PMAC Application.....	289
Procedure 72. Back Up NOAM Database.....	291
Procedure 73. Back Up SOAM Database	294
Procedure 74. Configure HP Gen 8 Server BIOS Settings.....	297
Procedure 75. Configure HP Gen 8 Server BIOS Settings.....	299
Procedure 76. Configure Oracle X5-2/Netra X5-2/X6-2/X7-2 Server BIOS Settings	302
Procedure 77. Enable Oracle Netra X5-2 CPU Power Limit for NEBS (Optional).....	305
Procedure 78. Disable Oracle Netra X5-2/X6-2/X7-2 CPU Power Limit for NEBS (Optional)	305
Procedure 79. Upgrade HP DL380 Server Firmware	307
Procedure 80. Change SNMP Configuration Settings for HP DL380.....	312
Procedure 81. Access the TVOE iLO4 GUI	314

Procedure 82. Access the iLOM GUI	315
Procedure 83. Change the TVOE iLO Address	318
Procedure 84. Change the TVOE Oracle X5-2/Netra X5-2/X6-2iLOM Address.....	321
Procedure 85. Change the TVOE Oracle X5-2/Netra X5-2/X6-2iLOM Address.....	325
Procedure 86. Mount HP DL380 Servers with ISO Image using iLO4	327
Procedure 87. Mount Oracle X5-2/Netra X5-2/X6-2/X7-2 Servers with ISO Image using iLOM.....	329
Procedure 88. Connect to the TVOE iLO.....	333
Procedure 89. Configure SNMP	335
Procedure 90. Install NetBackup Client Using platcfg	338
Procedure 91. Install NetBackup Client Using NBAutoInstall	345
Procedure 92. Create NetBackup Client Configuration File	346
Procedure 93. Configure PMAC Application NetBackup Virtual Disk.....	347
Procedure 94. Configure PMAC Application NetBackup Virtual Disk.....	353
Procedure 95. Configure PMAC Application NetBackup Virtual Disk.....	367
Procedure 96. Remove the IDIH External Drive	368
Procedure 97. Perform Backups.....	372
Procedure 98. Perform Health Check	372
Procedure 99. Add a New TVOE Server/VMs	374
Procedure 100. Growth: DR NOAM.....	375
Procedure 101. Growth: SOAM Spare (DSR/PCA Only).....	376
Procedure 102. Growth: MP/DP	377
Procedure 103. Growth: MP (For 7.x to 8.x Upgraded System)	378
Procedure 104. Growth: Query Server (SDS Only)	387
Procedure 105. Post Growth Health Check	387
Procedure 106. Post Growth Backups.....	389
Procedure 107. Perform Backups.....	389
Procedure 108. Perform Health Check	390
Procedure 109. Remove Server from Server Group	393
Procedure 110. Delete Server/Server Group.....	402
Procedure 111. Delete Server VM	405
Procedure 112. Post De-Growth Health Check	407
Procedure 113. Post De-Growth Backups	409
Procedure 114. Perform Backups.....	410
Procedure 115. Perform Health Check	410
Procedure 116. Add a New TVOE Server	412
Procedure 117. Place Server in OOS	413
Procedure 118. Delete Server VM	415

Procedure 119. Move/Re-Shuffle: Create/Configure VMs	417
Procedure 120. Move/Re-Shuffle: NOAM/DR NOAM.....	418
Procedure 121. Move/Re-Shuffle: SOAM	420
Procedure 122. Move/Re-Shuffle: MP/DP	422
Procedure 123. Move/Re-Shuffle: Query Server (SDS Only)	426
Procedure 124. Move/Re-Shuffle: iDIH.....	428
Procedure 125. Move/Re-Shuffle: PMAC	430
Procedure 126. Move/Re-Shuffle: Redundant PMAC	433
Procedure 127. Post Moving/Re-Shuffling Health Check	434
Procedure 128. Post Move/Re-Shuffle Backups	436
Procedure 129. RAID10 Logical Volume Creation Spanning Multiple HDDs (Oracle X5-2/Netra X5-2)..	436
Procedure 130. RAID10 Logical Volume Creation Spanning Multiple HDDs (Oracle X6-2)	441
Procedure 131. RAID10 Logical Volume Creation Spanning Multiple HDDs (HP DL380)	446
Procedure 132. PMAC Deployment: Deviation.....	453
Procedure 133. iDIH Installation: Deviation	458
Procedure 134. Restore SNMP Configuration to SNMP v3.....	466

1. Introduction

This document is a guide to describe procedures used to configure HP DL380 Gen 8/9 or Oracle Rack Mount Servers (RMS) to use with Oracle Communication Diameter Signaling Router. It is assumed that the hardware installation and network cabling were already executed. The audience for this document includes Oracle customers and these groups: Software system, product verification, documentation, and customer service including software operations and first office application. Throughout the remainder of this document, the term RMS refers to either HP DL380 Gen 8/9 or Oracle rack mount servers.

Oracle X5-2/Netra X5-2/X6-2/X7-2/HP DL380 Gen 9 (10Gbps) only: In scenarios where the DSR installation has already been executed, and system **growth, de-growth, or re-shuffle** is necessary, refer to Appendix P Growth/De-Growth/Re-Shuffle (Oracle X5-2/Netra X5-2/X6-2/X7-2/HP DL380 Gen 9 (10Gbps) Only).

FIPS integrity verification test failed: Throughout this procedure, an error message of **FIPS integrity verification test failed** displays while performing various procedures on the command line (SSH, feature activations, etc.). This error message is harmless and should be ignored.

1.1 References

Software-centric customers do not receive firmware upgrades through Oracle. Instead, refer to the HP Solutions Firmware Upgrade Pack, Software Centric Release Notes on <https://docs.oracle.com> under Platform documentation. The latest version is recommended if an upgrade is performed; otherwise, version 2.2.9 is the minimum.

- [1] HP Solutions Firmware Upgrade Pack, Software Centric Release Notes (Min 2.2.12)
- [2] HP Solutions Firmware Upgrade Pack, version 2.x.x (Min 2.2.12)
- [3] Oracle Firmware Upgrade Pack Release Notes (Min 3.1.8)
- [4] Oracle Firmware Upgrade Pack Upgrade Guide
- [5] Communication Agent User's Guide
- [6] DSR Communication Agent Configuration Guide
- [7] DSR RBAR Feature Activation Procedure
- [8] DSR MAP-Diameter Feature Activation Procedure
- [9] DSR Mediation Feature Activation Procedure
- [10] DSR FABR Feature Activation Procedure
- [11] Gateway Location Application (GLA) Feature Activation
- [12] DSR PCA Activation Guide
- [13] IPv6 Migration Guide
- [14] DSR Hardware and Software Installation Procedure 1/2
- [15] DSR DTLS Feature Activation Procedure
- [16] DSR VM Placement and CPU Socket Pinning Tool
- [17] DSR RADIUS Shared Secret Encryption Key Revocation
- [18] TPD Initial Product Manufacture Software Installation Procedure
- [19] DSR Security Guide
- [20] DCA Framework and Application Activation and Deactivation Guide
- [21] Oracle TPD Initial Product Manufacture Software Installation Procedure

1.2 Acronyms

An alphabetized list of acronyms used in the document.

Table 1. Acronyms

Acronym	Definition
BIOS	Basic Input Output System
DCA	Diameter Custom Applications
DSR	Diameter Signaling Router
DVD	Digital Versatile Disc
EBIPA	Enclosure Bay IP Addressing
FABR	Full Address Based Resolution
FRU	Field Replaceable Unit
GLA	Gateway Location Application
HIDS	Host Intrusion Detection System
IDIH	Integrated Diameter Intelligence Hub
iLO	Integrated Lights Out manager
IPFE	IP Front End
IPM	Initial Product Manufacture – the process of installing TPD on a hardware platform
MAP-IWF	Map-Diameter Interworking
MSA	Modular Smart Array
NB	NetBackup
OA	HP Onboard Administrator
OS	Operating System (for example, TPD)
PCA	Policy and Charging Application
PMAC	Platform Management & Configuration
RBAR	Range Based Address Resolution
RMS	Rack Mounted Server
SAN	Storage Area Network
SBR	Session Binding Repository
SDS	Subscriber Database Server
SFTP	Secure File Transfer Protocol
SNMP	Simple Network Management Protocol
TPD	Tekelec Platform Distribution
TVOE	Tekelec Virtual Operating Environment
VM	Virtual Machine
VSP	Virtual Serial Port

1.3 Terminology

An alphabetized list of terms used in the document.

Table 2. Terminology

Term	Definition
Enablement	The business practice of providing support services (hardware, software, documentation, etc.) that enable a 3rd party entity to install, configuration, and maintain Oracle products for Oracle customers.
Management Server	HP ProLiant DL380 or Oracle X5-2/ Netra X5-2/X6-2/X7-2 deployed to run TVOE and host a virtualized PMAC application.
Place Association	<p>Applicable for various applications, a Place Association is a configured object that allows places to be grouped together. A place can be a member of more than one place association.</p> <p>The Policy and Charging DRA application defines two place association types: policy binding region and Policy and Charging mated sites.</p>
PMAC Application	PMAC is an application that provides platform-level management functionality, such as the capability to manage and provision platform components of the system so it can host applications, for HP DL380 and the Oracle X5-2/Netra X5-2/X6-2/X7-2 system.
Server Group Primary Site	<p>A server group primary site is a term used to represent the principle location within a SOAM or SBR server group. SOAM and SBR server groups are intended to span several sites (places). For the Policy and Charging DRA application, these sites (places) are all configured within a single Policy and Charging Mated Sites place association.</p> <p>For the Diameter custom application, these sites (places) are configured in Applications Region place association.</p> <p>The primary site may be in a different site (place) for each configured SOAM or SBR server group.</p> <p>A primary site is described as the location in which the active and standby servers to reside; however, there cannot be any preferred spare servers within this location. All SOAM and SBR server groups have a primary site.</p>
Server Group Secondary Site	<p>A server group secondary site is a term used to represent location in addition to the Primary Site within a SOAM or SBR Server Group. SOAM and SBR server groups are intended to span several sites (places). For the Policy and Charging DRA application, these sites (places) are all configured within a single Policy and Charging Mated Sites place association.</p> <p>For the Diameter custom application, these sites (places) are configured in Applications Region place association.</p> <p>The secondary site may be in a different sites (places) for each configured SOAM or SBR server group.</p> <p>A secondary site is described as the location in which only preferred spare servers reside. The active and standby servers cannot reside within this location. If two site redundancy is wanted, a secondary site is required for all SOAM and SBR server groups.</p>
Session Binding Repository (SBR) Server Group Redundancy	The DCA and Policy and Charging applications may use SBR server groups to store application session data. The SBR server groups support both two and three site redundancy. The server group function name is Session and Binding Repository .

Term	Definition
Site	<p>Applicable for various applications, a site is type of place. A place is configured object that allows servers to be associated with a physical location.</p> <p>A site place allows servers to be associated with a physical site. For example, sites may be configured for Atlanta, Charlotte, and Chicago. Every server is associated with exactly one site when the server is configured.</p> <p>For the Policy and Charging DRA application, when configuring a site, only put DA-MPs and SBR MP servers in the site. Do not add NOAM, SOAM, or IPFE MPs to a site.</p>
Software Centric	<p>The business practice of delivering an Oracle software product while relying upon the customer to procure the requisite hardware components. Oracle provides the hardware specifications, but does not provide the hardware, and is not responsible for hardware installation, configuration, or maintenance.</p>
Two Site Redundancy	<p>Two site redundancy is a data durability configuration in which Policy and Charging data is unaffected by the loss of one site in a Policy and Charging Mated Sites Place Association containing two sites.</p> <p>Two site redundancy is a feature provided by server group configuration. This feature provides geographic redundancy. Some server groups can be configured with servers located in two geographically separate sites (locations). This feature ensures there is always a functioning active server in a server group even if all the servers in a single site fail.</p>

1.4 How to Use this Document

When executing the procedures in this document, there are a few key points to ensure you understand procedure convention. These points are:

1. Before beginning a procedure, completely read the instructional text (it displays immediately after the **Section heading for each procedure**) and **all associated procedural WARNINGS or NOTES**.
2. **Before execution of a STEP within a procedure, completely read the left and right columns including any STEP specific WARNINGS or NOTES.**
3. **If a procedural STEP fails to execute successfully or fails to receive the desired output, STOP the procedure.** It is recommended to contact My Oracle Support (MOS) for assistance, as described in Appendix U before attempting to continue.

Figure 1 shows an example of a procedural step used in this document.

- Each step has a checkbox that the user should check-off to keep track of the progress of the procedure.
- Any sub-steps within a step are referred to as step X.Y. The example in Figure 1 shows steps 1 and step 2 and substep 2.1.
- The title box describes the operations to be performed during that step.
- GUI menu items, action links, and buttons to be clicked on are in bold Arial font.
- GUI fields and values to take note of during a step are in bold Arial font.
- Each command that the user enters, as well as any response output, is formatted in 10-point Courier font.

	Title/Instructions	Directive/Result Steps
1. <input type="checkbox"/>	Change directory	Change to the backout directory. <pre>\$ cd /var/TKLC/backout</pre>
2. <input type="checkbox"/>	Verify network element data	<ol style="list-style-type: none"> 1. View the Network Elements configuration data; verify the data; save and print report. 2. Select Configuration > Network Elements to view Network Elements Configuration screen.

Figure 1. Example Procedure Steps Used in This Document

1.5 Optional Features

Further configuration and/or installation steps are needed for optional features that may be present in this deployment. Please refer to these documents for disaster recovery steps needed for their components.

Table 3. Optional Features

Feature	Document
Diameter Custom Applications (DCA)	DCA Framework and Application Activation and Deactivation Guide
Diameter Mediation	DSR Mediation Feature Activation Procedure
Full Address Based Resolution (FABR)	DSR FABR Feature Activation Procedure
Gateway Location Application (GLA)	DSR GLA Feature Activation Procedure
Host Intrusion Detection System (HIDS)	DSR Security Guide (Section 3.2)
Map-Diameter Interworking (MAP-IWF)	DSR MAP-Diameter IWF Feature Activation Procedure
Policy and Charging Application (PCA)	DSR PCA Activation Guide
Range Based Address Resolution (RBAR)	DSR RBAR Feature Activation Procedure

2. General Description

This document defines the steps to execute the initial installation of the Diameter Signaling Router application.

DSR installation paths are shown in the figures below. The general timeline for all processes to perform a software installation/configuration and upgrade is also included below.

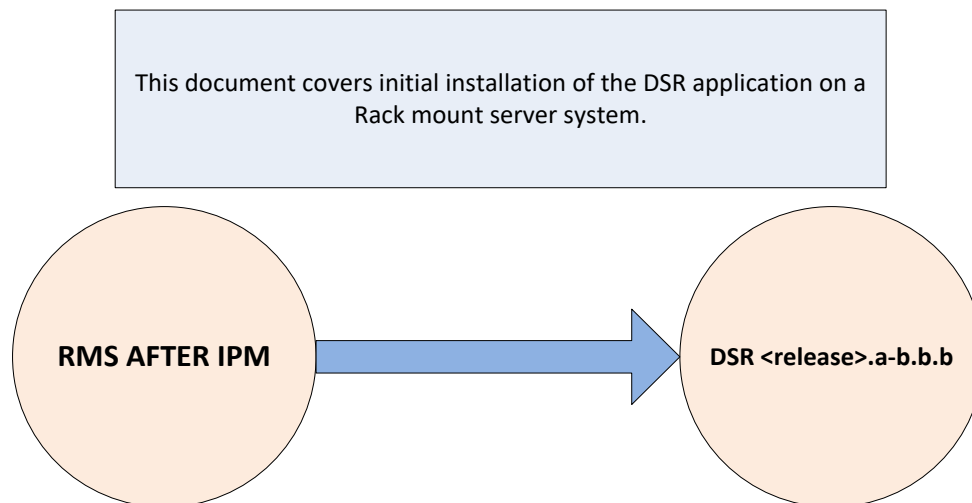

Figure 2. Initial Application Installation Path-Example Shown

2.1 Acquiring Firmware

Several procedures in this document pertain to the upgrading of firmware on various servers and hardware devices.

DSR rack mount servers and devices requiring possible firmware updates are:

- HP Rack Mount Servers (DL380)
- Oracle Rack Mount Server
- Cisco 4948/4948E/4948E-F Rack Mount Network Switches

2.1.1 HP DL380

Software-centric customers do not receive firmware upgrades through Oracle. Instead, refer to the HP Solutions Firmware Upgrade Pack, Software Centric Release Notes on <https://docs.oracle.com> under Platform documentation. The latest release is recommended if an upgrade is performed; otherwise, release 2.2.9 is the minimum.

The required firmware and documentation for upgrading the firmware on HP hardware systems and related components are distributed as the HP Solutions Firmware Upgrade Pack 2.x.x. The minimum firmware release required is HP Solutions Firmware Upgrade Pack 2.2.12; however, if a firmware upgrade is needed, use the current GA release of the HP Solutions Firmware Upgrade Pack 2.x.x.

Each version of the HP Solutions Firmware Upgrade Pack contains multiple items including media and documentation. This document provides its own upgrade procedures for firmware.

The two pieces of required firmware media provided in the HP Solutions Firmware Upgrade Pack 2.x.x releases are:

- HP Service Pack for ProLiant (SPP) firmware ISO image
- HP Solutions Firmware Upgrade Pack Release Notes [1] of the HP Firmware Upgrade Pack (FUP) release to determine specific firmware versions provided

Contact My Oracle Support (MOS) for more information on obtaining the HP firmware upgrade pack.

2.1.2 Oracle X5-2/Netra X5-2/X6-2/X7-2

The Oracle Firmware Upgrade Pack (FUP) consists of documentation to upgrade the Oracle rack mount servers. The pack consists of an upgrade guide and release notes. The current minimum supported release is 3.1.8; however, if a firmware update is required, use the latest available release. Firmware components can be downloaded from My Oracle Support (MOS) at <https://support.oracle.com>. Refer to the appropriate FUP release notes for directions on how to acquire the firmware.

2.2 Hardware Requirements

This section provides the required materials needed to install DSR on a rack mount system and provides the Ethernet interfaces depending on hardware type.

2.2.1 Required Materials

3. One (1) target release DSR Media ISO
4. One (1) target release SDS Media ISO (If equipped)
5. One (1) target release PMAC Media ISO
6. Three (3) target release IDIH Media ISOs
7. One (1) ISO of TPD release, or later shipping baseline as per Oracle ECO
8. One (1) ISO of TVOE release, or later shipping baseline as per Oracle ECO
9. One (1) TVOE release bootable USB, or later shipping baseline as per Oracle ECO
10. To obtain the default passwords refer to document [cgbu_eng_24_2229](#).
11. HP Solutions Firmware Upgrade Pack Release Notes[2]
12. Oracle Firmware Upgrade Pack Release Notes[3]
13. At least (1) Console cable and required software to connect to X7-2 blade

Other installation requirements to consider when installing DSR include:

- The total number of sites
- The number of servers at each site and their role(s)
- Does DSR's networking interface terminate on a Layer 2 or Layer 3 boundary?
- Number of enclosures at each site -- if any at all.
- Will NOAMs use rack-mount servers or server blades?
- (Per Site) Will MP's be in N+ 0 configurations or in active/standby?
- What time zone should be used across the entire collection of DSR sites?
- Will SNMP traps be viewed at the NOAM, or an external NMS be used? (Or both?)

2.2.2 Rack Mount Server Network Interface Reference

Throughout the installation procedure, configuration steps reference Ethernet interfaces. Depending on the hardware type, these Ethernet interfaces can vary. Table 4 describes the Ethernet interface to <Ethernet_interface_x> variables:

Note: For HP DL380 Gen 9 servers with 10Gbps, one 2pt 10 Gigabit FlexibleLOM cards is required. One 2 pt 10 Gigabit PCIe card is required while running the segregated signaling network topology.

Table 4. RMS Network Interfaces

Network Interface	HP DL380 (with 4pt Gigabit in PCI Slot 1) (Gen 8/Gen 9 Onboard)	HP DL380 (with FlexibleLOM and 2pt 10 Gigabit in PCI slot 3) (Gen 9 10Gbps)	Oracle X5-2/Netra X5-2/X6-2 (without 10GigE card)	Oracle X7-2
<ethernet_interface_1>	eth01	eth05	eth01	eth02
<ethernet_interface_2>	eth02	eth06	eth03	eth03
<ethernet_interface_3>	eth11	eth31	eth02	
<ethernet_interface_4>	eth12	eth32	eth04	

3. Software Installation Procedure

As mentioned earlier, the hardware installation and network cabling should be done before executing the procedures in this document.

SUDO

As a non-root user (**admusr**), many commands (when run as admusr) now require the use of **sudo**.

IPv6

Standard IPv6 formats for IPv6 and prefix can be used in all IP configuration screens, which enable DSR to be run in an IPv6 only environment. When using IPv6 for XMI and management, place the IPv6 address in brackets (highlighted in red below) as shown.

```
https://[<IPv6 address>]
```

If a dual-stack (IPv4 and IPv6) network is required, configure the topology with IPv4 and then migrate to IPv6. Refer to [13] for instructions on how to accomplish this IPv6 migration.

3.1 Prepare Servers for IPM

This section explains the steps needed to configure the BIOS settings and update the firmware (if needed) for the HP and Oracle rack mount servers.

3.1.1 Configure BIOS Settings

Procedure 1. Configure BIOS Settings

S T E P #	<p>This procedure Configures HP DL380, Oracle/Netra servers, and Oracle server BIOS settings. Check off (✓) each step as it is completed. Boxes have been provided for this purpose under each step number.</p> <p>If this procedure fails, contact My Oracle Support (MOS) and ask for assistance.</p>	
1. <input type="checkbox"/>	<p>RMS Server: Configure the BIOS settings</p>	<p>Follow the appropriate appendix procedure for the corresponding hardware type:</p> <ul style="list-style-type: none"> • HP DL380 Gen 8 RMS: Appendix A.2.1 Configure HP Gen 8 Servers • HP DL380 Gen 9 RMS: Appendix A.2.2 Configure HP Gen 9 Servers • Oracle X5-2/Netra X5-2/X6-2/X7-2: Appendix A.2.3 Configure Oracle X5-2/Netra X5-2/X6-2/X7-2 Server
2. <input type="checkbox"/>	<p>Oracle X5-2/Netra X5-2/X6-2 Server: Login HP DL380 skip this step</p>	<p>Log into the Oracle X5-2/Netra X5-2/X6-2/X7-2 iLOM.</p> <p>Please Log In</p> <div style="border: 1px solid #ccc; padding: 10px; margin: 10px 0;"> <p>SP Hostname: DSR10307Loc37TVOE</p> <p>User Name: <input type="text"/></p> <p>Password: <input type="password"/></p> <p style="text-align: center;"><input type="button" value="Log In"/></p> </div> <div style="text-align: right; margin-top: 20px;">  </div> <p style="font-size: small; margin-top: 20px;">Copyright © 2015, Oracle and/or its affiliates. All rights reserved. Oracle and Java are registered trademarks of Oracle and/or its affiliates. Other names may be trademarks of their respective owners.</p>

Procedure 1. Configure BIOS Settings

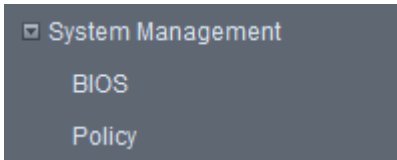
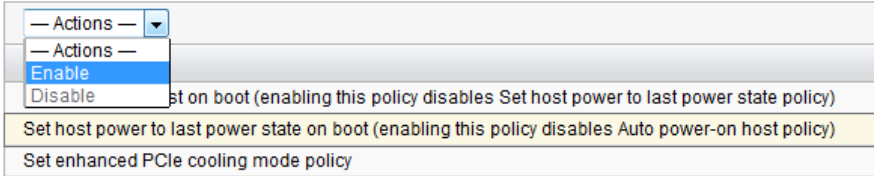
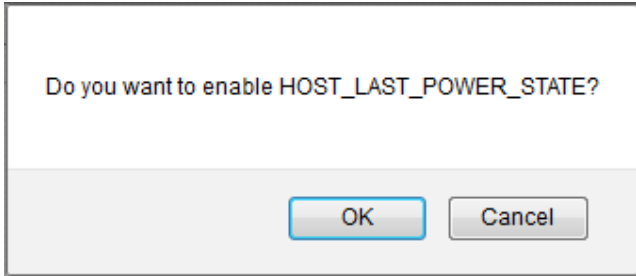
<p>3. <input type="checkbox"/> Oracle X5-2/Netra X5-2/X6-2 Server: Update power settings HP DL380 skip this step</p>	<p>1. Navigate to System Management > Policy.</p>  <p>2. Select Set host power to last power state on boot.</p> <hr/> <p>Service Processor Policies</p>  <p>3. Select the Enable from the Actions option.</p> <p>4. Click OK to confirm.</p> 
---	---

3.1.2 Upgrade Rack Mount Server Firmware

Procedure 2. Upgrade Rack Mount Server Firmware

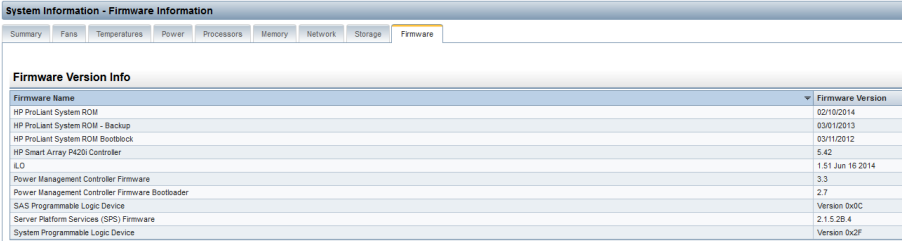
S T E P #	<p>This procedure updates firmware, if needed.</p> <p>Check off (✓) each step as it is completed. Boxes have been provided for this purpose under each step number.</p> <p>If this procedure fails, it is recommended to contact My Oracle Support (MOS) and ask for assistance.</p>																																													
1. <input type="checkbox"/>	<p>RMS Server: Verify firmware of the rack mount server</p>	<p>For Oracle X5-2/Netra X5-2/X6-2/X7-2 From the iLOM, login and verify firmware version under System Information > Summary.</p> <p>General Information</p> <table border="1"> <tr><td>System Type</td><td>Rack Mount</td></tr> <tr><td>Model</td><td>SUN SERVER X4-2</td></tr> <tr><td>QPart ID</td><td>Q10540</td></tr> <tr><td>Part Number</td><td>33300320+2+1</td></tr> <tr><td>Serial Number</td><td>1507NML0TC</td></tr> <tr><td>System Identifier</td><td>-</td></tr> <tr><td>System Firmware Version</td><td>3.2.4.46</td></tr> <tr><td>Primary Operating System</td><td>Oracle Linux Server release 6.6</td></tr> <tr><td>Host Primary MAC Address</td><td>00:10:e0:70:43:54</td></tr> <tr><td>iLOM Address</td><td>10.250.50.193</td></tr> <tr><td>iLOM MAC Address</td><td>00:10:E0:70:43:58</td></tr> </table> <p>For HP DL380 From the iLO, login and verify firmware version under Information > System Information [Firmware Tab].</p>  <p>System Information - Firmware Information</p> <p>Summary Fans Temperatures Power Processors Memory Network Storage Firmware</p> <p>Firmware Version Info</p> <table border="1"> <thead> <tr> <th>Firmware Name</th> <th>Firmware Version</th> </tr> </thead> <tbody> <tr><td>HP ProLiant System ROM</td><td>02/10/2014</td></tr> <tr><td>HP ProLiant System ROM - Backup</td><td>03/01/2013</td></tr> <tr><td>HP ProLiant System ROM Bootblock</td><td>03/11/2012</td></tr> <tr><td>HP Smart Array P420i Controller</td><td>5.42</td></tr> <tr><td>iLO</td><td>1.51 Jun 16 2014</td></tr> <tr><td>Power Management Controller Firmware</td><td>3.3</td></tr> <tr><td>Power Management Controller Firmware Bootloader</td><td>2.7</td></tr> <tr><td>SAS Programmable Logic Device</td><td>Version 0x0C</td></tr> <tr><td>Server Platform Services (SPS) Firmware</td><td>2.1.5.2B.4</td></tr> <tr><td>System Programmable Logic Device</td><td>Version 0x2F</td></tr> </tbody> </table>	System Type	Rack Mount	Model	SUN SERVER X4-2	QPart ID	Q10540	Part Number	33300320+2+1	Serial Number	1507NML0TC	System Identifier	-	System Firmware Version	3.2.4.46	Primary Operating System	Oracle Linux Server release 6.6	Host Primary MAC Address	00:10:e0:70:43:54	iLOM Address	10.250.50.193	iLOM MAC Address	00:10:E0:70:43:58	Firmware Name	Firmware Version	HP ProLiant System ROM	02/10/2014	HP ProLiant System ROM - Backup	03/01/2013	HP ProLiant System ROM Bootblock	03/11/2012	HP Smart Array P420i Controller	5.42	iLO	1.51 Jun 16 2014	Power Management Controller Firmware	3.3	Power Management Controller Firmware Bootloader	2.7	SAS Programmable Logic Device	Version 0x0C	Server Platform Services (SPS) Firmware	2.1.5.2B.4	System Programmable Logic Device	Version 0x2F
System Type	Rack Mount																																													
Model	SUN SERVER X4-2																																													
QPart ID	Q10540																																													
Part Number	33300320+2+1																																													
Serial Number	1507NML0TC																																													
System Identifier	-																																													
System Firmware Version	3.2.4.46																																													
Primary Operating System	Oracle Linux Server release 6.6																																													
Host Primary MAC Address	00:10:e0:70:43:54																																													
iLOM Address	10.250.50.193																																													
iLOM MAC Address	00:10:E0:70:43:58																																													
Firmware Name	Firmware Version																																													
HP ProLiant System ROM	02/10/2014																																													
HP ProLiant System ROM - Backup	03/01/2013																																													
HP ProLiant System ROM Bootblock	03/11/2012																																													
HP Smart Array P420i Controller	5.42																																													
iLO	1.51 Jun 16 2014																																													
Power Management Controller Firmware	3.3																																													
Power Management Controller Firmware Bootloader	2.7																																													
SAS Programmable Logic Device	Version 0x0C																																													
Server Platform Services (SPS) Firmware	2.1.5.2B.4																																													
System Programmable Logic Device	Version 0x2F																																													
2. <input type="checkbox"/>	<p>RMS Server: Upgrade firmware</p>	<p>Follow the appropriate appendix procedure for the corresponding hardware type:</p> <ul style="list-style-type: none"> • HP DL380 Gen 8/9 RMS: Appendix B.1 HP DL380 Server • Oracle Rack Mount Servers: Appendix B.2 Oracle X5-2/Netra X5-2/X6-2/X7-2 																																												

3.2 Install and Configure TVOE on First RMS (PMAC Host)

Throughout this section, the first RMS server refers to the server hosting the PMAC VM.

Note: Non-HA Lab Node Installations Only-Oracle X5-2/Netra X5-2/X6-2/X7-2/HP DL380 GEN 9:
Before starting Procedure 3, execute Appendix Q.1 Non-HA Lab Node Pre-IPM Procedures to create vgguests logical volume with RAID10 spanning across multiple HDDs:

Procedure 3. Install and Configure TVOE on First RMS (PMAC Host)

S T E P #	<p>This procedure installs TVOE on the first rack mount server.</p> <p>Check off (✓) each step as it is completed. Boxes have been provided for this purpose under each step number.</p> <p>If this procedure fails, it is recommended to contact My Oracle Support (MOS) and ask for assistance.</p>	
1. <input type="checkbox"/>	<p>Connect to the 1st RMS server</p>	<p>Connect to the server using a VGA display and USB keyboard, or using the iLO interface on a browser.</p> <p>Note: Appendix D TVOE iLO/iLOM GUI Access and Appendix E Change the TVOE iLO/iLOM Address explain how to access the rack mount server iLO and change the address, if necessary.</p>
2. <input type="checkbox"/>	<p>RMS Server: Insert TVOE media into server</p>	<p>Insert the OS IPM media (CD/DVD or USB) into the CD/DVD tray/USB slot of the rack mount server. Refer to Appendix N Create a Bootable USB Drive on Linux for creating a bootable USB</p> <p>Alternatively, ISO can be mounted using virtual media. Refer to Appendix F Attach an ISO Image to a Server using the iLO or iLOM.</p> <p>Note: If using Appendix F, skip to step 5. in this procedure.</p>
3. <input type="checkbox"/>	<p>Power cycle server</p>	<p>For HP rack mount servers, hold the power button in until the button turns amber, then release. Wait 5 seconds, then press the power button and release it again to power on the system.</p> <p>For Oracle rack mount servers, hold the power button in until the OK LED turns off, and starts a slow blink. Wait 5 seconds, press the power button, and release it again to power on the system. In a second or 2 the OK LED starts to blink faster as the system powers up.</p>
4. <input type="checkbox"/>	<p>Select boot method</p>	<p>For some servers, you must select a boot method so the server does not boot directly from the hard drive.</p> <p>For HP rack mount servers, press F11 when asked to bring up the boot menu and select the appropriate boot method.</p> <p>For Oracle rack mount servers, press F8 when asked to bring up the boot menu and select the appropriate boot method.</p>

Procedure 3. Install and Configure TVOE on First RMS (PMAC Host)

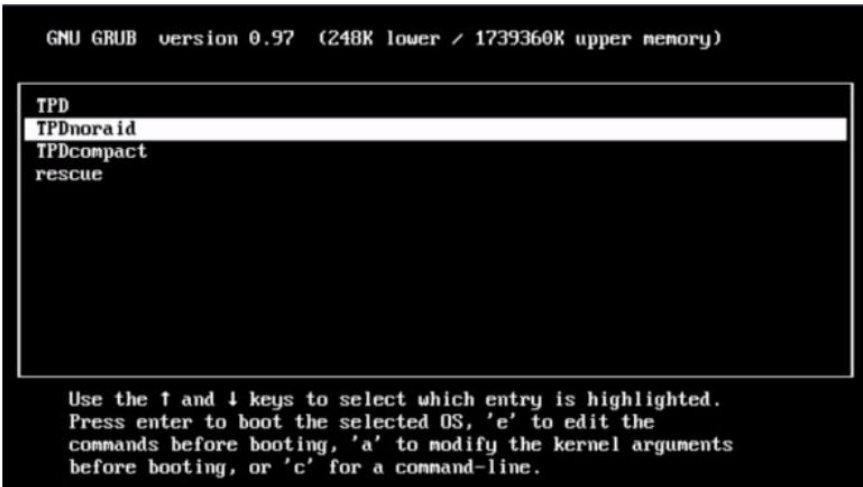
<p>5. <input type="checkbox"/> RMS Server: Begin IPM process For X7-2 hardware, skip to step 6.</p>	<pre> Copyright (C) 2003, 2014, Oracle and/or its affiliates. All rights reserved. Welcome to Tekelec Platform Distribution! Release: 7.0.0.0_06.11.0 Arch: x86_64 For a detailed description of all the supported commands and their options, please refer to the Initial Platform Manufacture document for this release. In addition to linux & rescue TPD provides the following kickstart profiles: [TPD ; TPDnoraidd ; TPDblade ; TPDcompact ; HDD] Commonly used options are: [console=<console_option>[,<console_option>]] [primaryConsole=<console_option>] [rdate=<server_ip>] [scrub] [reserved=<size1>[,<sizeN>]] [diskconfig=HWRAID[,force]] [drives=<device>[,<device>]] [guestArchive] To install using a monitor and a local keyboard, add console=tty0 boot: _ </pre> <p>IPM the server.</p> <pre> TPDnoraidd diskconfig=HWRAID,force console=tty0 </pre> <p>HP DL380 Gen 9 only (equipped with 10GB FlexLOM).</p> <pre> TPDnoraidd diskconfig=HWRAID,force console=tty0 control_if=eth05,eth06 </pre> <p>For non-HA lab node (Oracle X5-2/Netra X5-2/X6-2).</p> <pre> TPDnoraidd drives=<Volume ID recorded in procedure Q.1.1-Q.1.3> console=tty0 </pre> <p>For non-HA lab node (HP DL380 Gen 9 equipped with 10GB FlexLOM).</p> <pre> TPDnoraidd drives=<Volume ID recorded in procedure S.1/S.2> console=tty0 control_if=eth05,eth06 </pre>
<p>6. <input type="checkbox"/> RMS Server(X7-2): Begin IPM process</p>	<p>For UEFI BIOS servers (Unified Extensible Firmware Interface-compatible BIOS) such as X7-2:</p> <p>Below is a sample of the output screen indicating initial boot from the installation media was successful. The information in this screen is representative of the X7-2 support start in TPD 7.5.0.0.0.</p> <ol style="list-style-type: none"> Use the up and down arrow keys to select TPDnoraidd.  <pre> GNU GRUB version 0.97 (248K lower / 1739360K upper memory) TPD TPDnoraidd TPDcompact rescue Use the ↑ and ↓ keys to select which entry is highlighted. Press enter to boot the selected OS, 'e' to edit the commands before booting, 'a' to modify the kernel arguments before booting, or 'c' for a command-line. </pre>

Procedure 3. Install and Configure TVOE on First RMS (PMAC Host)

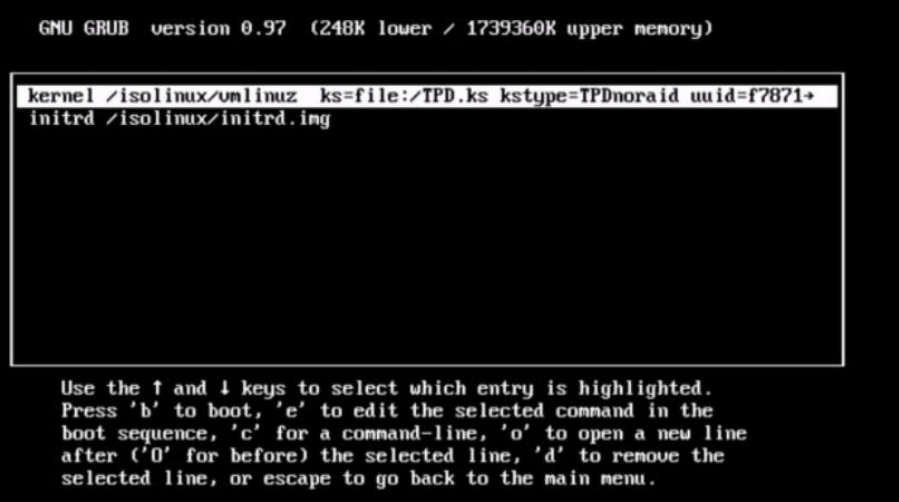
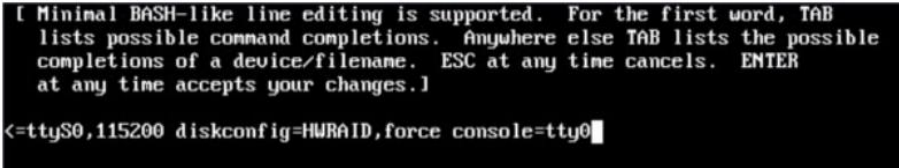
		<p>2. Type e to edit.</p>  <p>Use the ↑ and ↓ keys to select which entry is highlighted. Press 'b' to boot, 'e' to edit the selected command in the boot sequence, 'c' for a command-line, 'o' to open a new line after ('O' for before) the selected line, 'd' to remove the selected line, or escape to go back to the main menu.</p> <p>3. Append additional inputs to the TPDnoraaid command as shown (example additional arguments).</p>  <p>[Minimal BASH-like line editing is supported. For the first word, TAB lists possible command completions. Anywhere else TAB lists the possible completions of a device/filename. ESC at any time cancels. ENTER at any time accepts your changes.]</p> <p><=ttyS0,115200 diskconfig=HWRRAID,force console=tty0</p> <p>4. Press Enter to continue IPM and monitor progress.</p> <p>5. Wait 30-60 seconds for the the terminal to respond and echo to the terminal. For any additional commands or custom IPM options, refer to [21] . Some topics of interest may be OS IPM Install, IPM Command Options, Time Estimates for IPM in Minutes, and Possible Errors During IPM Installation Processing, and other useful information.</p> <p>6. Monitor the IPM installation.</p> <p>The IPM process takes about 30 minutes. Several messages and screens display in the process.</p>
--	--	---

Procedure 3. Install and Configure TVOE on First RMS (PMAC Host)

<p>7. <input type="checkbox"/></p>	<p>RMS Server: Reboot</p>	<p>1. Once the IPM is complete, remove the disk from the drive or unmount the TPD image from the iLO and press Enter to reboot the server.</p> <div data-bbox="500 321 1398 640" style="border: 1px solid black; padding: 10px; background-color: #f0f0f0;"> <p style="text-align: center; color: red; font-weight: bold;">Complete</p> <p style="text-align: center;">Congratulations, your Oracle Linux Server installation is complete.</p> <p style="text-align: center;">Please reboot to use the installed system. Note that updates may be available to ensure the proper functioning of your system and installation of these updates is recommended after the reboot.</p> <div style="text-align: center; margin-top: 20px;"> <div style="border: 2px solid red; padding: 5px; display: inline-block; background-color: white;">Reboot</div> </div> </div> <p>After a few minutes and multiple reboots, the server boot sequence starts and eventually displays that it is booting the new IPM load.</p> <div data-bbox="500 720 1421 1192" style="background-color: black; color: white; padding: 10px; font-family: monospace;"> <pre> Attempting Boot From CD-ROM Attempting Boot From Hard Drive (C:) Press any key to enter the menu Booting TPD (2.6.32-431.20.3.el6prere17.0.0.0_86.8.0.x86_64) Press any key to continue. Press any key to continue. Press any key to continue. Press any key to continue. Press any key to continue. Press any key to continue. Press any key to continue. </pre> </div> <p>Note: A successful IPM platform installation process results in a user login prompt.</p>
<p>8. <input type="checkbox"/></p>	<p>For NEBS and non NEBS deployment (Oracle Netra X5-2/X6-2 server only)</p>	<p>For NEBS and non NEBS deployment, execute these steps (Oracle Netra X5-2/X6-2 server only):</p> <ul style="list-style-type: none"> • NEBS deployment configuration, execute Procedure 77. • Non-NEBS deployment configuration, execute Procedure 78.

Procedure 4. Configure First Rack Mount Server

S T E P #	<p>This procedure configures the first TVOE/Management server.</p> <p>Check off (✓) each step as it is completed. Boxes have been provided for this purpose under each step number.</p> <p>If this procedure fails, it is recommended to contact My Oracle Support (MOS) and ask for assistance.</p>																												
1. <input type="checkbox"/>	<p>Determine bridge names and interfaces</p>	<p>Determine the bridge interfaces to use on the TVOE server and fill in the appropriate values this table. If NetBackup is used, determine the bridge interface to use for the NetBackup network and fill in the <TVOE_NetBackup_Bridge_Interface> value.</p> <table border="1" style="width: 100%; border-collapse: collapse;"> <thead> <tr> <th style="text-align: left;">Guest Interface Alias</th> <th style="text-align: left;">TVOE Bridge Name</th> <th style="text-align: left;">TVOE Bridge Interface</th> </tr> </thead> <tbody> <tr> <td style="text-align: center;">control</td> <td style="text-align: center;">control</td> <td> Fill in the appropriate value (bond0): _____ <TVOE_Control_Bridge_Interface> Note: bond0 should be used, and the craftperson must configure the control VLAN as the native VLAN on ports connecting to the OAM NICs of each server. </td> </tr> <tr> <td style="text-align: center;">management</td> <td style="text-align: center;">management</td> <td>Fill in the appropriate value: _____ <TVOE_Management_Bridge_Interface></td> </tr> <tr> <td style="text-align: center;">xmi</td> <td style="text-align: center;">xmi</td> <td>Fill in the appropriate value: _____ <TVOE_XMI_Bridge_Interface></td> </tr> <tr> <td style="text-align: center;">imi</td> <td style="text-align: center;">Imi</td> <td>Fill in the appropriate value: _____ <TVOE_IMI_Bridge_Interface></td> </tr> <tr> <td style="text-align: center;">Int (iDIH only)</td> <td style="text-align: center;">Int</td> <td>Fill in the appropriate value: _____ <TVOE_INT_Bridge_Interface></td> </tr> <tr> <td style="text-align: center;">xsi1-16</td> <td style="text-align: center;">xsi1-16</td> <td> Fill in the appropriate values: xsi1:____ xsi2:____ xsi3:____ xsi4:____ xsi5:____ xsi6:____ xsi7:____ xsi8:____ xsi9:____ xsi10:____ xsi11:____ xsi12:____ xsi13:____ xsi14:____ xsi15:____ xsi16:____ <TVOE_XSI1-16_Bridge_Interface> </td> </tr> <tr> <td style="text-align: center;">replication</td> <td style="text-align: center;">replication</td> <td>Fill in the appropriate value: _____ <TVOE_REPLICATION_Bridge_Interface></td> </tr> <tr> <td style="text-align: center;">NetBackup (if applicable)</td> <td style="text-align: center;">NetBackup</td> <td>Fill in the appropriate value: _____ <TVOE_NetBackup_Bridge_Interface></td> </tr> </tbody> </table>	Guest Interface Alias	TVOE Bridge Name	TVOE Bridge Interface	control	control	Fill in the appropriate value (bond0): _____ <TVOE_Control_Bridge_Interface> Note: bond0 should be used, and the craftperson must configure the control VLAN as the native VLAN on ports connecting to the OAM NICs of each server.	management	management	Fill in the appropriate value: _____ <TVOE_Management_Bridge_Interface>	xmi	xmi	Fill in the appropriate value: _____ <TVOE_XMI_Bridge_Interface>	imi	Imi	Fill in the appropriate value: _____ <TVOE_IMI_Bridge_Interface>	Int (iDIH only)	Int	Fill in the appropriate value: _____ <TVOE_INT_Bridge_Interface>	xsi1-16	xsi1-16	Fill in the appropriate values: xsi1:____ xsi2:____ xsi3:____ xsi4:____ xsi5:____ xsi6:____ xsi7:____ xsi8:____ xsi9:____ xsi10:____ xsi11:____ xsi12:____ xsi13:____ xsi14:____ xsi15:____ xsi16:____ <TVOE_XSI1-16_Bridge_Interface>	replication	replication	Fill in the appropriate value: _____ <TVOE_REPLICATION_Bridge_Interface>	NetBackup (if applicable)	NetBackup	Fill in the appropriate value: _____ <TVOE_NetBackup_Bridge_Interface>
Guest Interface Alias	TVOE Bridge Name	TVOE Bridge Interface																											
control	control	Fill in the appropriate value (bond0): _____ <TVOE_Control_Bridge_Interface> Note: bond0 should be used, and the craftperson must configure the control VLAN as the native VLAN on ports connecting to the OAM NICs of each server.																											
management	management	Fill in the appropriate value: _____ <TVOE_Management_Bridge_Interface>																											
xmi	xmi	Fill in the appropriate value: _____ <TVOE_XMI_Bridge_Interface>																											
imi	Imi	Fill in the appropriate value: _____ <TVOE_IMI_Bridge_Interface>																											
Int (iDIH only)	Int	Fill in the appropriate value: _____ <TVOE_INT_Bridge_Interface>																											
xsi1-16	xsi1-16	Fill in the appropriate values: xsi1:____ xsi2:____ xsi3:____ xsi4:____ xsi5:____ xsi6:____ xsi7:____ xsi8:____ xsi9:____ xsi10:____ xsi11:____ xsi12:____ xsi13:____ xsi14:____ xsi15:____ xsi16:____ <TVOE_XSI1-16_Bridge_Interface>																											
replication	replication	Fill in the appropriate value: _____ <TVOE_REPLICATION_Bridge_Interface>																											
NetBackup (if applicable)	NetBackup	Fill in the appropriate value: _____ <TVOE_NetBackup_Bridge_Interface>																											
2. <input type="checkbox"/>	<p>1st RMS iLO/iLOM: Login and start the integrated remote console</p>	<p>1. Log into iLO/iLOM and follow Appendix D TVOE iLO/iLOM GUI Access to access the iLO/iLOM GUI.</p> <div style="border: 1px solid black; padding: 5px; margin: 5px 0;"> <p style="text-align: center;">https://<management_server_iLO_ip></p> </div> <p>2. Login as admusr.</p>																											

Procedure 4. Configure First Rack Mount Server

<p>3. <input type="checkbox"/></p>	<p>1st RMS iLO/iLOM: Create the management network</p>	<p>Note: This output is for illustrative purposes only. The site information for this system determines the network interfaces (network devices, bonds, and bond enslaved devices) to configure.</p> <pre>\$ sudo /usr/TKLC/plat/bin/netAdm add --device=<TVOE_Management_Bridge_Interface> -- onboot=yes Interface bond0.2 added</pre> <pre>\$sudo /usr/TKLC/plat/bin/netAdm add --type=Bridge --name=management --bootProto=none --onboot=yes --address=<Management_Server_TVOE_IP> --netmask=<Management_Server_TVOE_Netmask/prefix> --bridgeInterfaces=<TVOE_Management_Bridge_Interface> Bridge management added!</pre>
<p>4. <input type="checkbox"/></p>	<p>1st RMS iLO/iLOM: Configure default route</p>	<pre>\$ sudo /usr/TKLC/plat/bin/netAdm add --route=default --device=management --gateway=<Management_Gateway_IP_Address> Route to management added</pre>

Procedure 4. Configure First Rack Mount Server

5. **1st RMS**
 iLO/iLOM: TVOE bond1 configuration (segregated signaling)

If the rack mount server solution is designed where the signaling traffic is segregated from the rest of the DSR OAM related networks and located on separate NICs, execute this step.
 If the OAM related networks share the same physical NICs (non-segregated), skip this step.

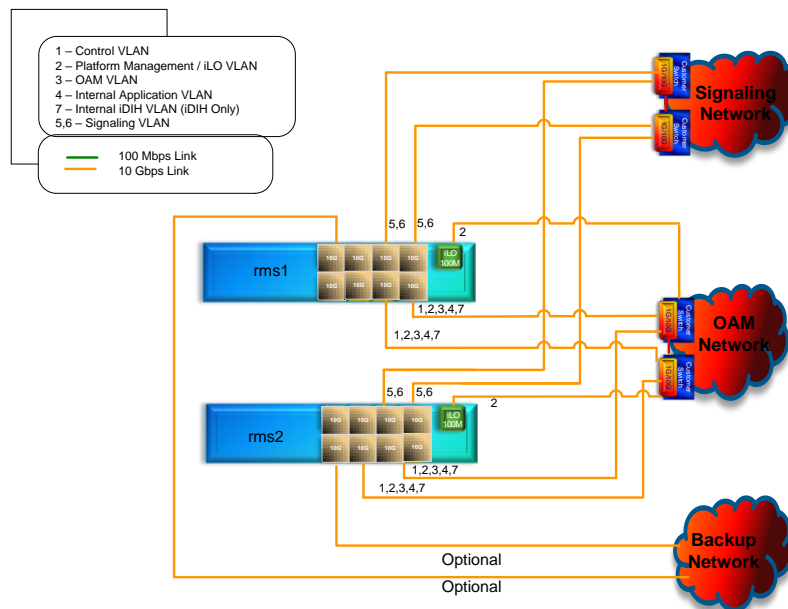

Create Bond1 interface:

Note: Refer to section 2.2.2 for network interface server reference table.

```
$ sudo /usr/TKLC/plat/bin/netAdm add --device=bond1 --onboot=yes
$ sudo /usr/TKLC/plat/bin/netAdm set --device=<ethernet_interface_3> --type=Ethernet --master=bond1 --slave=yes --onboot=yes
```

Expected output:

```
/sys/class/net/bond1/bonding/primary has 0 lines, nothing to do.
```

```
Interface <ethernet_interface_3> updated
```

```
$ sudo /usr/TKLC/plat/bin/netAdm set --device=<ethernet_interface_4> --type=Ethernet --master=bond1 --slave=yes --onboot=yes
```

Expected output:

```
/sys/class/net/bond1/bonding/primary has 0 lines, nothing to do.
```

```
Interface <ethernet_interface_4> updated
```

Procedure 4. Configure First Rack Mount Server

6.	1st RMS iLO/iLOM: Set Ethernet interface ring buffer sizes	<p>Note: Refer to section 2.2.2 for network interface server reference table.</p> <pre>\$ sudo netAdm set --device=<ethernet_interface_1> --ringBufferRx=4096 --ringBufferTx=4096 \$ sudo netAdm set --device=<ethernet_interface_2> --ringBufferRx=4096 --ringBufferTx=4096</pre> <p>If step 5. was executed, execute these commands:</p> <pre>\$ sudo netAdm set --device=<ethernet_interface_3> --ringBufferRx=4096 --ringBufferTx=4096 \$ sudo netAdm set --device=<ethernet_interface_4> --ringBufferRx=4096 --ringBufferTx=4096</pre> <p>Ring Buffer Sizes For X7-2</p> <pre>\$ sudo netAdm set --device=<ethernet_interface_1> --ringBufferRx=2047 --ringBufferTx=2047 \$ sudo netAdm set --device=<ethernet_interface_2> --ringBufferRx=2047 --ringBufferTx=2047</pre> <p>If step 5. was executed, execute these commands:</p> <pre>\$ sudo netAdm set --device=<ethernet_interface_3> --ringBufferRx=2047 --ringBufferTx=2047 \$ sudo netAdm set --device=<ethernet_interface_4> --ringBufferRx=2047 --ringBufferTx=2047</pre>
----	---	---

Procedure 4. Configure First Rack Mount Server

<p>7. <input type="checkbox"/></p>	<p>1st RMS iLO/iLOM: Add the NetBackup network — Option 1 (optional) If NetBackup is used, execute this step; otherwise, skip to step 12.</p>	<p>Before selecting the configuration option, first read the description in each step to determine which configuration is applicable to your installation and network.</p> <p>Select only this option or one of the options listed in steps 8. or 9.</p> <p>NetBackup is a tool that allows the customer to take remote backups of the system.</p> <p>Notes:</p> <ul style="list-style-type: none"> • This output is for illustrative purposes only and shows the control bridge configured. • This example shows a TVOE management server configuration with the NetBackup feature enabled and the NetBackup network configured with a non-default MTU size. • The MTU size must be consistent between a network bridge, device, or bond and associated VLANs. <p>Create NetBackup bridge using a bond containing an untagged interface.</p> <pre>\$ sudo /usr/TKLC/plat/bin/netAdm add --device=<TVOE_NetBackup_Bridge_Interface> --onboot=yes --type=Bonding --mode=active-backup -- miimon=100 --MTU=<NetBackup_MTU_size> Interface <TVOE_NetBackup_Bridge_Interface> added \$ sudo /usr/TKLC/plat/bin/netAdm set --device=<ethernet_interface_4> --type=Ethernet --master=<TVOE_NetBackup_Bridge_Interface> --slave=yes --onboot=yes Interface <ethernet_interface_4> updated \$ sudo /usr/TKLC/plat/bin/netAdm add --type=Bridge --name=<TVOE_NetBackup_Bridge> --onboot=yes -- bootProto=none --MTU=<NetBackup_MTU_size> --bridgeInterfaces=<TVOE_NetBackup_Bridge_Interface> --address=<TVOE_NetBackup_IP> --netmask=<TVOE_NetBackup_Netmask/Prefix></pre>
<p>8. <input type="checkbox"/></p>	<p>1st RMS iLO/iLOM: Add the NetBackup network — Option 2 (optional)</p>	<p>If NetBackup is used, select only this option or one of the options listed in steps 7. or 9.</p> <p>Create NetBackup bridge using an untagged native interface.</p> <pre>\$ sudo /usr/TKLC/plat/bin/netAdm add --type=Bridge --name=<TVOE_NetBackup_Bridge> --onboot=yes -- bootProto=none --MTU=<NetBackup_MTU_size> --bridgeInterfaces=<Ethernet_Interface_4> --address=<TVOE_NetBackup_IP> --netmask=<TVOE_NetBackup_Netmask/Prefix></pre>

Procedure 4. Configure First Rack Mount Server

<p>9. <input type="checkbox"/></p>	<p>1st RMS iLO/iLOM: Add the NetBackup network — Option 3 (optional)</p>	<p>If NetBackup is used, select only this option or one of the options listed in steps 7. or 8. Create NetBackup bridge using a tagged device.</p> <pre style="border: 1px solid black; padding: 5px;">\$ sudo /usr/TKLC/plat/bin/netAdm add --device=<TVOE_NetBackup_Bridge_Interface> --onboot=yes Interface <TVOE_NetBackup_Bridge_Interface> added \$sudo /usr/TKLC/plat/bin/netAdm add --type=Bridge --name=<TVOE_NetBackup_Bridge> --onboot=yes --MTU=<NetBackup_MTU_size> --bridgeInterfaces=<TVOE_NetBackup_Bridge_Interface> --address=<TVOE_NetBackup_IP> --netmask=<TVOE_NetBackup_Netmask/Prefix></pre>
<p>10. <input type="checkbox"/></p>	<p>1st RMS iLO/iLOM: Configure networking for NetBackup interface (optional)</p>	<pre>\$ sudo /usr/TKLC/plat/bin/netAdm add --route=net --device=NetBackup -- address=<TVOE_NetBackup_Network_ID> --netmask=<TVOE_NetBackup_NetMask/Prefix> --gateway=<TVOE_NetBackup_Gateway_IP_Address></pre>
<p>11. <input type="checkbox"/></p>	<p>1st RMS iLO/iLOM: Restart network interfaces</p>	<pre>\$ sudo service network restart</pre>
<p>12. <input type="checkbox"/></p>	<p>1st RMS iLO/iLOM: Set the server hostname</p>	<ol style="list-style-type: none"> Enter the platcfg menu. <pre style="border: 1px solid black; padding: 5px;">\$ sudo su - platcfg</pre> Navigate to Server Configuration > Hostname > Edit. <pre style="border: 1px solid black; padding: 5px;">lu Server Configuration Menu tk x x x Hostname x x Configure Storage x x Designation/Function a x x Set Clock a x x Time Zone a x x Exit x x x mqqqqqqqqqqqqqqqqqqqqqqqqqqqq]</pre> Set the TVOE management server hostname. Click OK. Navigate out of hostname.

Procedure 4. Configure First Rack Mount Server

<p>13. <input type="checkbox"/></p>	<p>1st RMS iLO/iLOM: Set the time zone and/or hardware clock</p>	<ol style="list-style-type: none"> 1. Navigate to Server Configuration > Time Zone. <pre data-bbox="500 294 998 613"> lu Server Configuration Menu tk x x x Hostname x x Configure Storage a x x Designation/Function a x x Set Clock x x Time Zone a x x Exit x x x mqqqqqqqqqqqqqqqqqqqqqqqqqqqqqqqq] </pre> <ol style="list-style-type: none"> 2. Click Edit. 3. Set the time zone and/or hardware clock to GMT (or appropriate time zone value). 4. Click OK. 5. Navigate out of server configuration.
-------------------------------------	---	---

Procedure 4. Configure First Rack Mount Server

<p>15. <input type="checkbox"/></p>	<p>1st RMS iLO/iLOM: Set SNMP</p>	<ol style="list-style-type: none"> Enter the platcfg menu. <pre style="border: 1px solid black; padding: 5px; margin: 5px 0;">\$ sudo su - platcfg</pre> <p>Note: Refer to Appendix H SNMP Configuration to understand the preferred SNMP configuration.</p> Navigate to Network Configuration > SNMP Configuration > NMS Configuration. <pre style="border: 1px solid black; padding: 5px; margin: 5px 0;">lu SNMP Configuration Menu tk x x x NMS Configuration x x SNMP Community Strings x x Exit x x x mqqqqqqqqqqqqqqqqqqqqqqqqqj</pre> Click Edit and select Add a New NMS Server. <pre style="border: 1px solid black; padding: 5px; margin: 5px 0;">lqqqqq NMS Server Action Menu tqqqqk x x x Add A New NMS Server x x Edit An Existing NMS Server x x Delete an Existing NMS Server a x x Exit x x x mqqqqqqqqqqqqqqqqqqqqqqqqqj</pre> Complete the form by entering the NMS server IP, Port (default port is 162), and community string provided by the customer about the SNMP trap destination. Click OK to finalize the configuration. Click Exit. Click Yes. <pre style="border: 1px solid black; padding: 5px; margin: 5px 0;">lqqqqqqqu Modified an NMS entry in snmp.cfg file: tqqqqqqqqk x x x Do you want to restart the Alarm Routing Service? x x x x x x x x x x x x x x x x x mqqqqqqqqqqqqqqqqqqqqqqqqqj</pre> Wait a few seconds while the Alarm Routing Service restarts. Exit platcfg.
<p>16. <input type="checkbox"/></p>	<p>1st RMS iLO/iLOM: Restart the server</p>	<pre style="border: 1px solid black; padding: 5px; margin: 5px 0;">\$ sudo init 6</pre>

Procedure 4. Configure First Rack Mount Server

17. <input type="checkbox"/>	1st RMS iLO/iLOM: Verify ring buffer settings	<p>Verify the ring buffer sizes have been configured correctly (from step 6.) by executing this command for each Ethernet interface configured.</p> <pre style="border: 1px solid black; padding: 5px;">\$ ethtool -g <eth interfaces configured above></pre> <p>Example output:</p> <pre style="background-color: black; color: white; padding: 5px;">[admusr@FJ-TVOE-2 ~]\$ ethtool -g eth01 Ring parameters for eth01: Pre-set maximums: RX: 4096 RX Mini: 0 RX Jumbo: 0 TX: 4096 Current hardware settings: RX: 4096 RX Mini: 0 RX Jumbo: 0 TX: 4096</pre> <p>For X7-2 Hardware: Example output:</p> <pre style="border: 1px solid blue; padding: 5px;">[admusr@X7201TVOE1 ~]\$ sudo ethtool -g eth03 Ring parameters for eth03: Pre-set maximums: RX: 2047 RX Mini: 0 RX Jumbo: 8191 TX: 2047 Current hardware settings: RX: 2047 RX Mini: 0 RX Jumbo: 8188 TX: 2047 [admusr@X7201TVOE1 ~]\$</pre>
---------------------------------	--	---

Procedure 4. Configure First Rack Mount Server

<p>18. <input type="checkbox"/></p>	<p>1st RMS iLO/iLOM: Configure NetBackup client on PMAC TVOE host — Part 1 (optional)</p>	<p>Execute this step if the NetBackup feature is enabled for this system; otherwise, skip this step.</p> <ol style="list-style-type: none"> 1. Open firewall ports for NetBackup. <pre style="border: 1px solid black; padding: 5px;">\$ sudo ln -s /usr/TKLC/plat/share/NetBackup/60NetBackup.ipt /usr/TKLC/plat/etc/iptables/ \$ sudo /usr/TKLC/plat/bin/iptablesAdm reconfig</pre> 2. Enable platcfg to show the NetBackup menu. <pre style="border: 1px solid black; padding: 5px;">\$ sudo platcfgadm --show NBConfig; \$ sudo platcfgadm --show NBInit; \$ sudo platcfgadm --show NBDeInit; \$ sudo platcfgadm --show NBInstall; \$ sudo platcfgadm --show NBVerifyEnv; \$ sudo platcfgadm --show NBVerify;</pre> 3. Create LV and file system for NetBackup client software on the vgguests volume group: <pre style="border: 1px solid black; padding: 5px;">\$ sudo /usr/TKLC/plat/sbin/storageMgr /tmp/nb.lvm</pre> <p>This creates the LV, formats it with a filesystem, and mounts it under /usr/openv/.</p> <p>Example output:</p> <pre>Called with options: /tmp/nb.lvm VG vgguests already exists. Creating lv NetBackup_lv. Volume NetBackup_lv will be created. Success: Volume NetBackup_lv was created. Creating filesystem, this may take a while. Updating fstab for lv NetBackup_lv. Configuring existing lv NetBackup_lv. The LV for NetBackup has been created!</pre>
<p>19. <input type="checkbox"/></p>	<p>1st RMS iLO/iLOM: Install/Configure NetBackup client software — Part 2 (optional)</p>	<p>Refer to Appendix I Install NetBackup Client for instructions how to install the NetBackup client.</p> <p>Note: Skip any steps relating to copying NetBackup notify scripts to the /usr/openv/NetBackup/bin. The TVOE NetBackup notify scripts are created in the next step.</p> <p>Create soft links for TVOE specific NetBackup notify scripts.</p> <pre style="border: 1px solid black; padding: 5px;">\$sudo ln -s /usr/TKLC/plat/sbin/bpstart_notify /usr/openv/NetBackup/bin/bpstart_notify \$sudo ln -s /usr/TKLC/plat/sbin/bpend_notify /usr/openv/NetBackup/bin/bpend_notify</pre> <p>Note: Once the NetBackup client is installed on TVOE, the NetBackup master should be configured to back up the /var/TKLC/bkp/*.iso file from the TVOE host.</p>

Procedure 4. Configure First Rack Mount Server

20. <input type="checkbox"/>	1st RMS iLO/iLOM: Set up syscheck	<p>syscheck must be configured to monitor bonded interfaces. Replace bondedInterfaces with bond0, or bond0,bond1, if segregated networks are used:</p> <pre>\$ sudo /usr/TKLC/plat/bin/syscheckAdm net ipbond --set --var=DEVICES --val=<bondedInterfaces> \$ sudo /usr/TKLC/plat/bin/syscheckAdm net ipbond --enable</pre>
21. <input type="checkbox"/>	1st RMS iLO/iLOM: Verify syscheck	<p>Verify syscheck:</p> <pre>\$ sudo /usr/TKLC/plat/bin/syscheck net ipbond -v</pre> <p>Expected output should look similar to below:</p> <pre>Running modules in class net... ipbond: Bonded interface bond0 is OK OK LOG LOCATION: /var/TKLC/log/syscheck/fail_log</pre>
22. <input type="checkbox"/>	1st RMS iLO/iLOM: Verify server health	<pre>\$ alarmMgr -alarmStatus</pre> <p>This command should return no output on a healthy system. If any alarms are reported, contact My Oracle Support (MOS).</p>

Procedure 4. Configure First Rack Mount Server

<p>23. <input type="checkbox"/></p>	<p>1st RMS iLO/iLOM: Back up TVOE using TPD platcfg utility</p>	<ol style="list-style-type: none"> Enter the platcfg menu from the TVOE server. <div style="border: 1px solid black; padding: 5px; margin: 5px 0;"> <pre>\$ sudo su - platcfg</pre> </div> Navigate to Maintenance > Backup and Restore >Backup Platform (CD/DVD). <p>Note: If no cdrom device is found by TPD, a No disk device available. This is normal on systems without a cdrom device error displays. Press Enter.</p> Navigate to Build ISO file only and press Enter. <div style="border: 1px solid black; padding: 5px; margin: 5px 0;"> <pre>lqqqqq Backup TekServer Menu tqqqqqk x x x Select Backup Type (plat-app) x x View Index Table of Contents a x x Select Backup Device () a x x Select Backup Media (CD-R) a x x Build ISO file only x x Test Backup a x x Backup a x x Exit x x x mqqqqqqqqqqqqqqqqqqqqqqqqqqqqqqq</pre> </div> <p>Note: Creating the ISO image may happen so quickly that this screen may only display for an instant.</p> Exit platcfg by selecting Exit. <p>After the ISO is created, platcfg returns to the Backup TekServer menu. The ISO has been created and is located in the /var/TKLC/bkp/ directory. An example filename of a backup file that was created is RMS503u14-plat-app-201210301505.iso.</p> Move the TVOE backup to a customer provided backup server for safe keeping.
-------------------------------------	---	--

3.3 Install PMAC

Note: Non-HA Lab Node Installations Only-Oracle X5-2/Netra X5-2/X6-2/HP DL380 GEN 9 (10Gbps) Only: Follow Appendix Q.2 Non-HA Lab Node PMAC Deployment instead of this Procedure 5 for PMAC Deployment.

Procedure 5. PMAC Deployment

S T E P #	<p>This procedure deploys PMAC on the TVO host.</p> <p>Prerequisite: Complete RMS network configuration (PMAC) host) first.</p> <p>Needed Material: PMAC media on USB drive or ISO</p> <p>Check off (✓) each step as it is completed. Boxes have been provided for this purpose under each step number.</p> <p>If this procedure fails, it is recommended to contact My Oracle Support (MOS) and ask for assistance.</p>	
1. <input type="checkbox"/>	<p>PMAC TVOE iLO/iLOM: Login and start the integrated remote console</p>	<p>Log into iLO/iLOM and follow Appendix D TVOE iLO/iLOM GUI Access to access the iLO/iLOM GUI.</p> <div style="border: 1px solid black; padding: 5px; margin-top: 10px;"> <p><code>https://<management_server_iLO_ip></code></p> </div>

Procedure 5. PMAC Deployment

2.	<input type="checkbox"/> TVOE iLO/iLOM: Mount the PMAC media to the TVOE server	<p>Use one of the following two options to mount the PMAC media:</p> <p>Option 1:</p> <ol style="list-style-type: none"> 1. If using a USB media, insert the PMAC USB into a USB port and execute this command to mount the ISO. <pre style="border: 1px solid black; padding: 5px;">\$ ls /media/*/*.iso /media/sddl/872-2586-101-5.7.0_57.3.0-PM&C-x86_64.iso</pre> <ol style="list-style-type: none"> 2. Use the output of the previous command to populate the next command. <pre style="border: 1px solid black; padding: 5px;">\$ sudo mount -o loop /media/sddl/872-2586-101-5.7.0_57.3.0-PM&C-x86_64.iso /mnt/upgrade</pre> <p>Option 2:</p> <ol style="list-style-type: none"> 1. If using an ISO image, run this to mount it. <pre style="border: 1px solid black; padding: 5px;">\$ sudo mount -o loop ISO_FILENAME.iso /mnt/upgrade</pre> <ol style="list-style-type: none"> 2. Validate the PMAC media. <pre style="border: 1px solid black; padding: 5px;">\$ cd /mnt/upgrade/upgrade \$.validate/validate_cd Validating cdrom... UMVT Validate Utility v2.2.2, (c)Tekelec, June 2012 Validating <device or ISO> Date&Time: 2012-10-25 10:07:01 Volume ID: tklc_872-2441-106_Rev_A_50.11.0 Part Number: 872-2441-106_Rev_A Version: 50.11.0 Disc Label: PM&C Disc description: PM&C The media validation is complete, the result is: PASS CDROM is Valid</pre> <p>Note: If the media validation fails, the media is not valid and should not be used.</p>
----	---	---

Procedure 5. PMAC Deployment

<p>3. <input type="checkbox"/></p>	<p>TVOE iLO/iLOM: Deploy PMAC</p>	<p>1. Using the PMAC-deploy script, deploy the PMAC instance using the configuration captured during the site survey.</p> <pre style="border: 1px solid black; padding: 5px;">\$ cd /mnt/upgrade/upgrade</pre> <p>2. If deploying PMAC without the NetBackup feature, run this command:</p> <pre style="border: 1px solid black; padding: 5px;">\$ sudo ./pmac-deploy --guest=<PMAC_Name> --hostname=<PMAC_Name> --controlBridge=control --controlIP=<PMAC_Control_ip_address> --controlNM=<PMAC_Control_netmask> --managementBridge=management --managementIP=<PMAC_Management_ip_address> --managementNM=<PMAC_Management_netmask/prefix> --routeGW=<PMAC_Management_gateway_address> --ntpserver=<TVOE_Management_server_ip_address> --imageSizeGB=20 --isoimagesVolSize=20</pre> <p>If deploying PMAC with NetBackup feature, run the following command:</p> <pre style="border: 1px solid black; padding: 5px;">\$ sudo ./pmac-deploy --guest=<PMAC_Name> --hostname=<PMAC_Name> -- controlBridge=<TVOE_Control_Bridge> --controlIP=<PMAC_Control_ip_address> --controlNM=<PMAC_Control_netmask> --managementBridge=<PMAC_Management_Bridge> --managementIP=<PMAC_Management_ip_address> --managementNM=<PMAC_Management_netmask/prefix> --routeGW=<PMAC_Management_gateway_address> --ntpserver=<TVOE_Management_server_ip_address> --NetBackupVol --bridge=<TVOE_NetBackup_Bridge> --nic=NetBackup --isoimagesVolSizeGB=20</pre> <p>The PMAC deploys and boots. The management and control network displays based on the settings provided to the PMAC-deploy script.</p> <p>Note: This step takes between 5 and 10 minutes.</p>
<p>4. <input type="checkbox"/></p>	<p>TVOE iLO/iLOM: Unmount the media</p>	<p>1. The media should auto-unmount, if it does not, unmount the media.</p> <pre style="border: 1px solid black; padding: 5px;">\$ cd / \$ sudo /bin/umount /mnt/upgrade</pre> <p>2. Remove the media from the drive.</p>

Procedure 5. PMAC Deployment

<p>5. <input type="checkbox"/></p>	<p>TVOE iLO/iLOM: SSH into the management server</p>	<ol style="list-style-type: none"> Using an SSH client such as putty, ssh to the TVOE host as admusr. Login using virsh and wait until you see the login prompt. <pre>\$ sudo /usr/bin/virsh list Id Name State ----- 2 PM&C running</pre> <pre>\$ sudo /usr/bin/virsh console <PM&C></pre> <p>[Output Removed]</p> <pre>Starting ntdMgr: [OK] Starting atd: [OK] 'TPD Up' notification(s) already sent: [OK] upstart: Starting tpdProvd... upstart: tpdProvd started. CentOS release 6.2 (Final) Kernel 2.6.32-220.17.1.el6prere16.0.0_80.14.0.x86_64 on an x86_64 PM&Cdev7 login:</pre>
<p>6. <input type="checkbox"/></p>	<p>Virtual PMAC: Verify the PMAC is configured correctly on first boot</p>	<ol style="list-style-type: none"> Establish an SSH session to the PMAC and login as admusr. Run this command (there should be no output). <pre>\$ sudo /bin/ls /usr/TKLC/plat/etc/deployment.d/</pre>
<p>7. <input type="checkbox"/></p>	<p>TVOE iLO/iLOM: Error doing verification, if error is outputted</p>	<p>If an error displays, delete the PMAC guest and re-deploy the guest again:</p> <pre>\$ sudo guestMgr --remove <PMAC_Name></pre>
<p>8. <input type="checkbox"/></p>	<p>Virtual PMAC: Set the PMAC time zone</p>	<p>Note: Valid time zones can be found in Appendix J List of Frequently Used Time Zones.</p> <ol style="list-style-type: none"> Run: <pre>\$ sudo set_pmac_tz.pl <time zone></pre> <p>Example:</p> <pre>\$ sudo set_pmac_tz.pl America/New_York</pre> Verify the time zone has been updated. <pre>\$ sudo date</pre>

Procedure 5. PMAC Deployment

<p>9. <input type="checkbox"/></p>	<p>Virtual PMAC: Set SNMP</p>	<ol style="list-style-type: none"> 1. Enter the platcfg menu. <pre>\$ sudo su - platcfg</pre> 2. Navigate to Network Configuration > SNMP Configuration > NMS Configuration.  <ol style="list-style-type: none"> 3. Select Edit > Add a New NMS Server. 4. Enter all the information to complete the form about the SNMP trap destination. Refer to Appendix H SNMP Configuration for more information. 5. Click OK to finalize the configuration. 6. Click Exit. 7. Click Yes and wait until the Alarm Routing Service restarts. 8. Exit platcfg.
<p>10. <input type="checkbox"/></p>	<p>Virtual PMAC: Reboot the server</p>	<pre>\$ sudo init 6</pre>

3.4 Initialize the PMAC Application

Procedure 6. Initialize PMAC

S T E P #	<p>This procedure gathers and prepares configuration files required to proceed with the DSR installation.</p> <p>Needed Material: DSR USB or ISO</p> <p>Check off (✓) each step as it is completed. Boxes have been provided for this purpose under each step number.</p> <p>If this procedure fails, it is recommended to contact My Oracle Support (MOS) and ask for assistance.</p>	
1. <input type="checkbox"/>	<p>PMAC's TVOE iLO/iLOM: SSH into the management server</p>	<ol style="list-style-type: none"> Using an SSH client such as putty, ssh to the TVOE host as admusr. Login using virsh and wait until you see the login prompt: <div style="border: 1px solid black; padding: 5px; margin: 5px 0;"> <pre>\$ sudo /usr/bin/virsh list Id Name State ----- 1 PM&C running</pre> </div> <div style="border: 1px solid black; padding: 5px; margin: 5px 0;"> <pre>\$ sudo /usr/bin/virsh console <PM&C></pre> <p>[Output Removed]</p> <pre>Starting ntdMgr: [OK] Starting atd: [OK] 'TPD Up' notification(s) already sent: [OK] upstart: Starting tpdProvd... upstart: tpdProvd started. CentOS release 6.2 (Final) Kernel 2.6.32-220.17.1.el6prere16.0.0_80.14.0.x86_64 on an x86_64 PM&Cdev7 login:</pre> </div>
2. <input type="checkbox"/>	<p>Virtual PMAC: Initialize the PMAC application</p>	<p>Initialize the PMAC application and run these commands.</p> <div style="border: 1px solid black; padding: 5px; margin: 5px 0;"> <pre>\$ sudo /usr/TKLC/smac/bin/pmacadm applyProfile -- fileName=TVOE Profile successfully applied.</pre> </div> <div style="border: 1px solid black; padding: 5px; margin: 5px 0;"> <pre>\$ sudo /usr/TKLC/smac/bin/pmacadm getPmacFeatureState PMAC Feature State = InProgress</pre> </div> <div style="border: 1px solid black; padding: 5px; margin: 5px 0;"> <pre>\$ sudo /usr/TKLC/smac/bin/pmacadm finishProfileConfig Initialization has been started as a background task</pre> </div>

Procedure 6. Initialize PMAC

<p>3. <input type="checkbox"/></p>	<p>Virtual PMAC: Initialize the PMAC application Note: Initialization typically takes about 1 minute.</p>	<p>1. Wait for the background task to successfully complete. The command displays IN_PROGRESS for a short time.</p> <p>2. Run this command until a COMPLETE or FAILED response displays.</p> <pre style="border: 1px solid black; padding: 5px;">\$ sudo /usr/TKLC/smac/bin/pmaccli getBgTasks 1: Initialize PMAC COMPLETE - PMAC initialized Step 2: of 2 Started: 2012-07-13 08:23:55 running: 29 sinceUpdate: 47 taskRecordNum: 2 Server Identity: Physical Blade Location: Blade Enclosure: Blade Enclosure Bay: Guest VM Location: Host IP: Guest Name: TPD IP: Rack Mount Server: IP: Name:</pre>
<p>4. <input type="checkbox"/></p>	<p>Virtual PMAC: Initialize the PMAC application</p>	<p>Perform a system health check on the PMAC.</p> <pre style="border: 1px solid black; padding: 5px;">\$ sudo /usr/TKLC/plat/bin/alarmMgr --alarmStatus</pre> <p>Note: Some expected networking alarms may be present. This command should return no output on a healthy system.</p> <p>Note: An NTP alarm is detected if the system switches are not configured.</p> <pre style="border: 1px solid black; padding: 5px;">\$ sudo /usr/TKLC/smac/bin/sentry status</pre> <p>All processes should be running, displaying output similar to this:</p> <pre>PM&C Sentry Status ----- sentryd started: Mon Jul 23 17:50:49 2012 Current activity mode: ACTIVE Process PID Status StartTS NumR ----- smacTalk 9039 running Tue Jul 24 12:50:29 2012 2 smacMon 9094 running Tue Jul 24 12:50:29 2012 2 hpiPortAudit 9137 running Tue Jul 24 12:50:29 2012 2 snmpEventHandler 9176 running Tue Jul 24 12:50:29 2012 2 Fri Aug 3 13:16:35 2012 Command Complete.</pre>

Procedure 6. Initialize PMAC

5. <input type="checkbox"/>	Virtual PMAC: Verify the PMAC application product release	<p>Note: If the PMAC application product release is not as expected, STOP and contact My Oracle Support (MOS).</p> <pre>\$ sudo /usr/TKLC/plat/bin/appRev Install Time: Fri Sep 28 15:54:04 2012 Product Name: PM&C Product Release: 5.0.0_50.10.0 Part Number ISO: 872-2441-905 Part Number USB: 872-2441-105 Base Distro Product: TPD Base Distro Release: 6.0.0_80.22.0 Base Distro ISO: TPD.install-</pre>
6. <input type="checkbox"/>	Virtual PMAC: Log out of the PMAC	Log out of the virsh console. Press Ctrl J to log out of the PMAC.
7. <input type="checkbox"/>	Note	If configuring a system with aggregation switches (HP DL380 Gen 8 only), continue to Procedure 7. If configuring a system without aggregation switches (Oracle X5-2/Netra X5-2/X6-2/HP DL380 Gen 9), skip to Procedure 9.

3.5 Configure Cisco 4948E-F Aggregation Switches (HP DL380 Gen 8 Servers Only)**3.5.1 Configure netConfig Repository (HP DL380 Gen 8 Servers Only)**

This procedure configures the netConfig repository for all required services and for each switch that needs to be configured. At any time, you can view the contents of the netConfig repository by using one of the following commands:

For switches, use this command:

```
$ sudo /usr/TKLC/plat/bin/netConfig --repo listDevices
```

For services, use this command:

```
$ sudo /usr/TKLC/plat/bin/netConfig --repo listServices
```

Users returning to this procedure after initial installation should run these commands and note any devices and/or services that have already been configured. Duplicate entries cannot be added. If changes to a device repository entry are required, use the editDevice command. If changes to a services repository entry are necessary, delete the original entry first and then add the service again.

IPv4 and IPv6

Configuration supports using IPv4 or IPv6 addresses through netConfig. Wherever IP addresses are required for networking procedures in section 3, IPv4 or IPv6 may be used. Commands such as ping or ssh may also be used in these procedures where for IPv6 cases may need to be **ping6** or **ssh -6**, as needed.

Terminology

The term **netConfig server** refers to the entity where netConfig is executed. This may be a virtualized or physical environment. **Management server** may also accurately describe this location, but it has been historically used to describe the physical environment while **Virtual PMAC** was used to describe the

virtualized netConfig server. Use of the term **netConfig server** to describe dual scenarios of physical and virtualized environments allows for future simplification of network configuration procedures.

Procedure Reference Tables

Steps within this procedure and subsequent procedures that require this procedure may refer to variable data indicated by text within <. Fill in these worksheets based on NAPD and refer back to these tables for the proper value to insert depending on your system type.

Variable	Value
<management_server_iLO_ip>	
<management_server_mgmt_ip_address>	
<netConfig_server_mgmt_ip_address>	
<switch_backup_user>	admusr
<switch_backup_user_password>	
<serial console type>	u=USB, c=PCIe

For the first aggregation switch (4948, 4948E, or 4948E-F): Fill in the appropriate value for this site.

Variable	Value
<switch_hostname>	
<device_model>	
<console_name>	
<switch_console_password>	
<switch_platform_username>	
<switch_platform_password>	
<switch_enable_password>	
<switch_mgmt_ip_address>	
<switch_mgmt_netmask>	
<mgmt_vlanID>	
<control_vlanID>	
<IOS_filename>	
<ip_version>	

For the second aggregation switch (4948, 4948E, or 4948E-F): Fill in the appropriate value for this site.

Variable	Value
<switch_hostname>	
<device_model>	
<console_name>	
<switch_console_password>	
<switch_platform_username>	
<switch_platform_password>	

Variable	Value
<switch_enable_password>	
<switch_mgmt_ip_address>	
<switch_mgmt_netmask>	
<mgmt_vlanID>	
<control_vlanID>	
<IOS_filename>	
<ip_version>	

Procedure 7. Configure netConfig Repository (HP DL380 Gen 8 Servers Only)

S T E P #	<p>This procedure configures 4948E-4948E-F switches with an appropriate IOS and configuration specified by platform engineering and application requirements.</p> <p>Prerequisite: This procedure assumes a recently IPMed TVOE server with a VM hosting PMAC.</p> <p>Needed Materials:</p> <ul style="list-style-type: none"> • HP Misc. Firmware USB • [1] HP Solutions Firmware Upgrade Pack, Software Centric Release Notes (Min 2.2.12) • DSR USB or ISO <p>Notes:</p> <ul style="list-style-type: none"> • Disconnect uplinks from the customer network before executing this procedure. One of the steps in this procedure instructs when to reconnect these uplink cables. • The generic XML configuration file referenced in this procedure needs to be updated to match the customer's network. 	
	<p>Check off (✓) each step as it is completed. Boxes have been provided for this purpose under each step number.</p> <p>If this procedure fails, it is recommended to contact My Oracle Support (MOS) and ask for assistance.</p>	
1. <input type="checkbox"/>	<p>1st RMS iLO/iLOM: Login and start the integrated remote console</p>	<p>1. Log into iLO/iLOM and follow Appendix D TVOE iLO/iLOM GUI Access to access the iLO/iLOM GUI.</p> <div style="border: 1px solid black; padding: 5px; margin: 5px 0;"> <p><code>https://<management_server_iLO_ip></code></p> </div> <p>2. Login as admusr.</p>

Procedure 7. Configure netConfig Repository (HP DL380 Gen 8 Servers Only)

<p>2. <input type="checkbox"/></p>	<p>1st RMS iLO/iLOM: Mount firmware image</p>	<ol style="list-style-type: none"> 1. Insert the Misc. Firmware USB media into the USB drive. 2. Copy each ISO image as determined by the release notes. Determine the correct IOS version in the HP Solutions Firmware Upgrade Pack, Software Centric Release Notes (Min 2.2.12) [1]. 3. SSH to the TVOE host server as admusr using the vsp/host console on the TVOE management server iLO/iLOM. Make the upgrade media available to the server. 4. Mount the media on the TVOE Host using one of these commands: <ul style="list-style-type: none"> • If using a USB drive, mount it. <pre data-bbox="597 611 1422 659">\$ sudo /bin/ls /media/*/*.iso</pre> <p>Use the output of the previous command to populate the next command.</p> <pre data-bbox="597 737 1422 814">\$ sudo /bin/mount -o loop /media/sdb1/<MISC file name> /mnt/upgrade</pre> • If the DSR is on an ISO, mount it. <pre data-bbox="597 863 1422 940">\$ sudo /bin/mount -o loop <path to DSR ISO> /mnt/upgrade</pre>
<p>3. <input type="checkbox"/></p>	<p>TVOE iLO/iLO: SSH into the management server</p>	<ol style="list-style-type: none"> 1. Using an SSH client such as putty, ssh to the TVOE host as admusr. 2. Login using virsh, and wait until you see the login prompt : <pre data-bbox="550 1045 1411 1241">\$ sudo /usr/bin/virsh list Id Name State ----- 1 PM&C running</pre> <pre data-bbox="550 1289 1411 1782">\$ sudo /usr/bin/virsh console <PM&C> [Output Removed] Starting ntdMgr: [OK] Starting atd: [OK] 'TPD Up' notification(s) already sent: [OK] upstart: Starting tpdProvd... upstart: tpdProvd started. CentOS release 6.2 (Final) Kernel 2.6.32-220.17.1.el6prere16.0.0 80.14.0.x86_64 on an x86_64 PM&Cdev7 login:</pre>

Procedure 7. Configure netConfig Repository (HP DL380 Gen 8 Servers Only)

<p>4. <input type="checkbox"/></p>	<p>Virtual PMAC: Copy ISO images into place (this copies both the 4948E IOS images into place)</p>	<pre>\$ sudo /usr/bin/scp -r admusr@<TVOE_management_ip_address:/mnt/upgrade/<4948E_ ISO_image_filename> /var/TKLC/smac/image/</pre> <ol style="list-style-type: none"> 1. Log out of PMAC. 2. Login again to TVOE Host and unmount the ISO. 3. Press Ctrl J to logout of the PMAC. <pre>\$ sudo umount /mnt/upgrade</pre> <ol style="list-style-type: none"> 4. Remove the Misc. Firmware media from the drive.
<p>5. <input type="checkbox"/></p>	<p>Virtual PMAC: Setup netConfig repository</p>	<ol style="list-style-type: none"> 1. Use netConfig to create a repository entry that uses the ssh service. This command displays several prompts for the user. The prompts with <variables> as the answers are site specific so the user MUST modify them. Other prompts that do not have a <variable> as an answer must be entered EXACTLY as they are shown here. <pre>\$ sudo /usr/TKLC/plat/bin/netConfig --repo addService name=ssh_service Service type? (tftp, ssh, conserver, oa) ssh Service host? <netConfig_server_mgmt_ip_address> Enter an option name <q to cancel>: user Enter the value for user: <switch_backup_user> Enter an option name <q to cancel>: password Enter the value for password: <switch_backup_user_password> Verify Password: <switch_backup_user_password> Enter an option name <q to cancel>: q Add service for ssh_service successful</pre> 2. Make sure you entered the information correctly using this command and inspect the output. <pre>\$ sudo /usr/TKLC/plat/bin/netConfig --repo showService name=ssh_service Service Name: ssh_service Type: ssh Host: 10.250.8.4 Options: password: C20F7D639AE7E7 user: admusr</pre>

Procedure 7. Configure netConfig Repository (HP DL380 Gen 8 Servers Only)

6. <input type="checkbox"/>	Virtual PMAC: Configure TFTP service	<p>Use netConfig to create a repository entry that uses the TFTP service. This command displays several prompts for the user. The prompts with <variables> as the answers are site specific so the user MUST modify them. Other prompts that do not have a <variable> as an answer must be entered EXACTLY as they are shown here.</p> <pre data-bbox="506 420 1422 749">\$ sudo /usr/TKLC/plat/bin/netConfig --repo addService name=tftp_service Service type? (tftp, ssh, conserver, oa) tftp Service host? <netConfig_server_mgmt_ip_address> Enter an option name (q to cancel): dir Enter a value for user dir: /var/TKLC/smac/image/ Enter an option name(q to cancel): q Add service for tftp_service successful</pre>
--------------------------------	--	--

Procedure 7. Configure netConfig Repository (HP DL380 Gen 8 Servers Only)

<p>7. <input type="checkbox"/></p>	<p>Virtual PMAC: Run the conserverSetup command</p>	<pre>\$ sudo /usr/TKLC/plat/bin/conserverSetup -<serial console type> -s <management_server_mgmt_ip_address></pre> <p>You are asked for the platcfg credentials.</p> <p>An example:</p> <pre>[admusr@vm-pmac1A]\$ sudo /usr/TKLC/plat/bin/conserverSetup -u -s <management_server_mgmt_ip_address></pre> <p>Enter your platcfg username, followed by [ENTER]:platcfg Enter your platcfg password, followed by [ENTER]:<platcfg_password></p> <p>Checking Platform Revision for local TPD installation... The local machine is running: Product Name: PMAC Base Distro Release: 7.0.0.0.0_86.1.0 Checking Platform Revision for remote TPD installation... The remote machine is running: Product Name: TVOE Base Distro Release: 7.0.0.0.0_86.2.0 Configuring switch 'switch1A_console' console server...Configured. Configuring switch 'switchBA_console' console server...Configured. Configuring iptables for port(s) 782...Configured. Configuring iptables for port(s) 1024:65535...Configured. Configuring console repository service... Repo entry for "console_service" already exists; deleting entry for: Service Name: console_service Type: conserver Host: <management_server_mgmt_ip_address> ...Configured. Slave interfaces for bond0: bond0 interface: eth01 bond0 interface: eth02</p>
<p>8. <input type="checkbox"/></p>	<p>Virtual PMAC: Copy the Cisco firmware to the TFTP directory</p>	<p>Copy the FW identified by <FW_image> in the aggregation switch variable table.</p> <pre>\$ sudo /bin/cp /mnt/upgrade/files/<FW_image> /var/TKLC/smac/image \$ sudo /bin/chmod 644 /var/TKLC/smac/image/<FW_image></pre>
<p>9. <input type="checkbox"/></p>	<p>Virtual PMAC: Set up the netConfig repository with aggregation switch Information</p>	<p>Use netConfig to create a repository entry for each switch.</p> <p>The initial command displays several prompts for the user. The prompts with <variables> as the answers are site specific so the user MUST modify them. Other prompts that do not have a <variable> as an answer must be entered EXACTLY as they are shown here.</p>

Procedure 7. Configure netConfig Repository (HP DL380 Gen 8 Servers Only)

	<p>Note: The <device_model> can be 4948, 4948E, or 4948E-F depending on the model of the device. If you do not know, stop now and contact My Oracle Support (MOS).</p> <pre> sudo /usr/TKLC/plat/bin/netConfig --repo addDevice name=<switch_hostname> --reuseCredentials Device Vendor? Cisco Device Model? <device_model> What is the IPv4 (CIDR notation) or IPv6 (address/prefix notation) address for management?: <switch_mgmt_ip_address><mask> Is the management interface a port or a vlan? [vlan]: [Enter] What is the VLAN ID of the management VLAN? [2]: [mgmt_vlanID] What is the name of the management VLAN? [management]: [Enter] What switchport connects to the management server? [GE40]: [Enter] What is the switchport mode (access trunk) for the management server port? [trunk]: [Enter] What are the allowed vlans for the management server port? [1,2]: <control_vlanID>, <mgmt_vlanID> Enter the name of the firmware file [cat4500e- entservicesk9-mz.122-54.XO.bin]: <IOS_filename> Firmware file to be used in upgrade: <IOS_filename> Enter the name of the upgrade file transfer service: tftp_service File transfer service to be used in upgrade: tftp_service Should the init oob adapter be added (y/n)? y Adding consoleInit protocol for <switch_hostname> using oob... What is the name of the service used for OOB access? console_service What is the name of the console for OOB access? <console name> What is the platform access username? <switch_platform_username> What is the device console password? <switch_console_password> UG006482 Revision B, April 2015 70 Software Installation Procedures </pre>
--	--

Procedure 7. Configure netConfig Repository (HP DL380 Gen 8 Servers Only)

		<pre>Verify password: <switch_console_password> What is the platform user password? <switch_platform_password> Verify password: <switch_platform_password> What is the device privileged mode password? <switch_enable_password> Verify password: <switch_enable_password> Should the live network adapter be added (y/n)? y Adding cli protocol for <switch_hostname> using network... Network device access already set: <switch_mgmt_ip_address> Should the live oob adapter be added (y/n)? y Adding cli protocol for <switch_hostname> using oob... OOB device access already set: console_service Device named <switch_hostname> successfully added.</pre>
10.	Virtual PMAC: Verification <input type="checkbox"/>	<p>Make sure you entered the information correctly.</p> <pre>\$ sudo /usr/TKLC/plat/bin/netConfig --repo showDevice name=<switch_hostname></pre> <p>Example output:</p> <pre>\$ sudo /usr/TKLC/plat/bin/netConfig --repo showDevice name=<switch_hostname> Device: <switch_hostname> Vendor: Cisco Model: <device_model> FW Ver: 0 FW Filename: <IOS_image> FW Service: tftp_service Initialization Management Options mgmtIP: <switch_mgmt_ip_address> mgmtInt: vlan mgmtVlan: <mgmt_vlanID> mgmtVlanName: management interface: GE40 mode: trunk allowedVlans: <control_vlanID>, <mgmt_vlanID> Access: Network: <switch_mgmt_ip_address> Access: OOB: Service: console_service Console: <console_name> Init Protocol Configured Live Protocol Configured</pre>

Procedure 7. Configure netConfig Repository (HP DL380 Gen 8 Servers Only)

11.	Virtual PMAC: Repeat for second 4948.	Repeat steps 9. through 10. for the second Cisco 4948.
-----	---	--

3.5.2 Configure Cisco 4948E-F Aggregation Switches (HP DL380 Gen 8 Servers Only)

This procedure configures the 4948E-F switches with the appropriate IOS and configuration from a single management server and virtual PMAC.

Procedure Reference Tables

Steps within this procedure may refer to variable data indicated by text within <>. Refer to this table for the proper value to insert depending on your system type.

Variable	Value
<switch_platform_username>	
<switch_platform_password>	
<switch_console_password>	
<switch_enable_password>	
<management_server_mgmt_ip_address>	
<pmac_mgmt_ip_address>	
<switch_mgmtVLAN_id>	
<switch1A_mgmtVLAN_ip_address>	
<switch_mgmt_netmask>	
<mgmt_Vlan_subnet_id>	
<netmask>	
<switch1B_mgmtVLAN_ip_address>	
<switch_Internal_VLANS_list>	
<management_server_mgmtInterface>	
<management_server_iLO_ip>	
<customer_supplied_ntp_server_address>	
<platcfg_password>	Initial password as provided by Oracle
<management_server_mgmtInterface>	Value gathered from NAPD
<switch_backup_user>	admusr
<switch_backup_user_password>	

Procedure 8. Configure Cisco 4948E-F Aggregation Switches-netConfig (HP DL380 Servers Only)

S T E P #	<p>This procedure configures the 4948E-F switches with the appropriate IOS and configuration from a single management server and virtual PMAC.</p> <p>Needed Materials:</p> <ul style="list-style-type: none"> • HP Misc. Firmware USB • [1] HP Solutions Firmware Upgrade Pack, Software Centric Release Notes (Min 2.2.12) • Template XML files from the DSR media <p>Check off (✓) each step as it is completed. Boxes have been provided for this purpose under each step number.</p> <p>If this procedure fails, it is recommended to contact My Oracle Support (MOS) and ask for assistance.</p>
1. <input type="checkbox"/>	<p>Virtual PMAC: Verify IOS image is on the system</p> <pre style="border: 1px solid black; padding: 5px;">\$ /bin/ls -i /var/TKLC/smac/image/<IOS_image_file></pre> <p>If the appropriate image does not exist, copy the image to the PMAC.</p>
2. <input type="checkbox"/>	<p>Virtual PMAC: Modify PMAC feature to allow TFTP</p> <pre style="border: 1px solid black; padding: 5px;">\$ sudo /usr/TKLC/smac/bin/pmacadm editFeature --featureName=DEVICE.NETWORK.NETBOOT --enable=1 \$ sudo /usr/TKLC/smac/bin/pmacadm resetFeatures</pre> <p>Notes:</p> <ul style="list-style-type: none"> • Ignore the restart instructions. • This may take up to 60 seconds to complete.
3. <input type="checkbox"/>	<p>Virtual PMAC TVOE Host: Manipulate host server physical interfaces</p> <pre style="border: 1px solid black; padding: 5px;">\$ sudo /sbin/ifup <ethernet_interface_1> \$ sudo /sbin/ifdown <ethernet_interface_2> \$ sudo /sbin/ip addr show <management_server_mgmtInterface> grep inet</pre> <p>Note: The command output should contain the IP address of variable <management_server_Mgmt_IP_address></p>

Procedure 8. Configure Cisco 4948E-F Aggregation Switches-netConfig (HP DL380 Servers Only)

<p>4. <input type="checkbox"/></p>	<p>Virtual PMAC: Determine if switch1A PROM upgrade is required</p>	<p>Note: ROM and PROM are intended to have the same meaning for this procedure.</p> <ol style="list-style-type: none"> 1. Connect serially to switch1A. <pre style="border: 1px solid black; padding: 5px;">\$ sudo /usr/bin/console -M <management_server_mgmt_ip_address> -l platcfg switch1A_console Enter platcfg@pmac5000101's password: <platcfg_password> [Enter '^Ec?' for help] Press Enter Switch> show version include ROM ROM: 12.2(31r)SGA1 System returned to ROM by reload</pre> <p>Note: If the console command fails, contact My Oracle Support (MOS).</p> <ol style="list-style-type: none"> 2. Note the IOS image and ROM version for comparison in a following step. 3. Exit from the console by pressing <Ctrl-e><c><. > to the server prompt. 4. Check the version from the previous command against the version from the release notes. If the versions are different, execute Appendix K to Upgrade Cisco 4948 PROM for switch1A.
<p>5. <input type="checkbox"/></p>	<p>Virtual PMAC: Modify the xml file with information to initialize the switch</p>	<ol style="list-style-type: none"> 1. Extract the configuration files from the zip file copied in Procedure 6. <pre style="border: 1px solid black; padding: 5px;">\$ cd /usr/TKLC/smac/etc \$ sudo unzip DSR_NetConfig_Templates.zip</pre> <p>This creates a directory called DSR_NetConfig_Templates that contains all the configuration files.</p> <ol style="list-style-type: none"> 2. Copy the files. <pre style="border: 1px solid black; padding: 5px;">\$ sudo chmod 644 DSR_NetConfig_Templates/ \$ sudo cp -a DSR_NetConfig_Templates/init/Aggregation/*.xml /usr/TKLC/smac/etc \$ sudo cp -a DSR_NetConfig_Templates /config/DSR_RMS_Productization/4948E- F_L3_configure.xml /usr/TKLC/smac/etc</pre> <ol style="list-style-type: none"> 3. Update the 4948E init and configure xml files to match your network parameters. <p>Values to modify are notated in this step by a preceding dollar sign. So if a value with <some_variable_name> needs to be modified, then remove the dollar sign and the less than, greater than signs. For example:</p> <pre style="border: 1px solid black; padding: 5px;">\$ sudo vi /usr/TKLC/smac/etc/switch1A_4948_E_E- F_cClass_template_init.xml \$ sudo vi /usr/TKLC/smac/etc/switch1B_4948_E_E- F_cClass_template_init.xml \$ sudo vi /usr/TKLC/smac/etc/4948E-F_L3_configure.xml</pre>

Procedure 8. Configure Cisco 4948E-F Aggregation Switches-netConfig (HP DL380 Servers Only)

<p>6.</p> <input type="checkbox"/>	<p>Virtual PMAC: Initialize switch1A</p>	<pre>\$ sudo /usr/TKLC/plat/bin/netConfig -- file=/usr/TKLC/smac/etc/switch1A_4948_4948E_init.xml Processing file: /usr/TKLC/smac/etc/switch1A_4948_4948E_init.xml</pre> <p>Note: This step takes 5-10 minutes.</p> <ol style="list-style-type: none"> 1. Check the output of this command for any errors. If this fails for any reason, stop this procedure and contact My Oracle Support (MOS). A successful completion of netConfig returns you to the prompt. 2. Use netConfig to get the hostname of the switch, to verify the switch was initialized properly, and to verify netConfig can connect to the switch. <pre>\$ sudo /usr/TKLC/plat/bin/netConfig --device=switch1A getHostname Hostname: switch1A</pre> <p>Note: If this command fails, stop this procedure and contact My Oracle Support (MOS).</p> <ol style="list-style-type: none"> 3. Exit PMAC by pressing Ctrl-].
<p>7.</p> <input type="checkbox"/>	<p>Virtual PMAC TVOE Host: Manipulate host server physical interfaces</p>	<p>Ensure the interface of the server connected to switch1B is the only interface up and obtain the IP address of the management server management interface.</p> <pre>\$ sudo /sbin/ifup <ethernet_interface_2> \$ sudo /sbin/ifdown <ethernet_interface_1></pre>

Procedure 8. Configure Cisco 4948E-F Aggregation Switches-netConfig (HP DL380 Servers Only)

<p>8. <input type="checkbox"/></p>	<p>TVOE iLO/iLO: SSH into the management server</p>	<ol style="list-style-type: none"> Using an SSH client such as putty, ssh to the TVOE host as admusr. Login using virsh and wait until you see the login prompt: <div data-bbox="548 338 1414 575" style="border: 1px solid black; padding: 5px;"> <pre>\$ sudo /usr/bin/virsh list Id Name State ----- 1 myTPD running 2 PM&C running</pre> </div> <div data-bbox="548 625 1414 1119" style="border: 1px solid black; padding: 5px;"> <pre>\$ sudo /usr/bin/virsh console <PM&C> [Output Removed] Starting ntdMgr: [OK] Starting atd: [OK] 'TPD Up' notification(s) already sent: [OK] upstart: Starting tpdProvd... upstart: tpdProvd started. CentOS release 6.2 (Final) Kernel 2.6.32-220.17.1.el6prere16.0.0_80.14.0.x86_64 on an x86_64 PM&Cdev7 login:</pre> </div>
<p>9. <input type="checkbox"/></p>	<p>Virtual PMAC: Initialize switch1B</p>	<pre>\$ sudo /usr/TKLC/plat/bin/netConfig -- file=/usr/TKLC/smac/etc/switch1B_4948_4948E_init.xml Processing file: /usr/TKLC/smac/etc/switch1B_4948_4948E_init.xml</pre> <p>Note: This step takes 5-10 minutes.</p> <ol style="list-style-type: none"> Check the output of this command for any errors. If this fails for any reason, stop this procedure and contact My Oracle Support (MOS). A successful completion of netConfig returns you to the prompt. Use netConfig to get the hostname of the switch, to verify the switch was initialized properly, and to verify netConfig can connect to the switch. <div data-bbox="500 1591 1422 1745" style="border: 1px solid black; padding: 5px;"> <pre>\$ sudo /usr/TKLC/plat/bin/netConfig --device=switch1B getHostname Hostname: switch1B</pre> </div> <p>Note: If this command fails, stop this procedure and contact My Oracle Support (MOS).</p>

Procedure 8. Configure Cisco 4948E-F Aggregation Switches-netConfig (HP DL380 Servers Only)

10. <input type="checkbox"/>	Virtual PMAC: Modify PMAC feature to disable TFTP	<p>Disable the DEVICE.NETWORK.NETBOOT feature.</p> <pre>\$ sudo /usr/TKLC/smac/bin/PM&Cadm editFeature --featureName=DEVICE.NETWORK.NETBOOT --enable=0 \$ sudo /usr/TKLC/smac/bin/PM&Cadm resetFeatures</pre> <p>Notes:</p> <ul style="list-style-type: none"> • Ignore the restart instructions. • This may take up to 60 seconds to complete.
11. <input type="checkbox"/>	Virtual PMAC: Configure both switches	<pre>\$ sudo /usr/TKLC/plat/bin/netConfig -- file=/usr/TKLC/smac/etc/4948_4948E_configure.xml Processing file: /usr/TKLC/smac/etc/4948_4948E_configure.xml</pre> <p>Note: This step takes about 2-3 minutes to complete.</p> <p>Check the output of this command for any errors. If this fails for any reason, stop this procedure and contact My Oracle Support (MOS).</p>
12. <input type="checkbox"/>	TVOE Management Server: Enable interfaces on TVOE host	<ol style="list-style-type: none"> 1. Exit from the virtual PMAC console, by pressing Ctrl-J to return to the server prompt. 2. Ensure the interfaces of the server connected to switch1A and switch1B are up. <pre>\$ sudo /sbin/ifup <ethernet_interface_1> \$ sudo /sbin/ifup <ethernet_interface_2></pre>

Procedure 8. Configure Cisco 4948E-F Aggregation Switches-netConfig (HP DL380 Servers Only)

13. <input type="checkbox"/>	TVOE iLO/iLO: SSH into the management server	<ol style="list-style-type: none"> Using an SSH client such as putty, ssh to the TVOE host as admusr. Login using virsh and wait until you see the login prompt: <div data-bbox="548 338 1414 575" style="border: 1px solid black; padding: 5px; margin: 5px 0;"> <pre>\$ sudo /usr/bin/virsh list Id Name State ----- 1 myTPD running 2 PM&C running</pre> </div> <div data-bbox="548 625 1414 1119" style="border: 1px solid black; padding: 5px; margin: 5px 0;"> <pre>\$ sudo /usr/bin/virsh console <PM&C> [Output Removed] Starting ntdMgr: [OK] Starting atd: [OK] 'TPD Up' notification(s) already sent: [OK] upstart: Starting tpdProvd... upstart: tpdProvd started. CentOS release 6.2 (Final) Kernel 2.6.32-220.17.1.el6prere16.0.0_80.14.0.x86_64 on an x86_64 PM&Cdev7 login:</pre> </div>
14. <input type="checkbox"/>	Virtual PMAC: Verify switch configuration	<p>Ping each interface to verify switch configuration.</p> <div data-bbox="505 1171 1422 1255" style="border: 1px solid black; padding: 5px;"> <pre>\$ /bin/ping <switch1A_mgmtVLANIP> \$ /bin/ping <switch1B_mgmtVLANIP></pre> </div>
15. <input type="checkbox"/>	Cabinet: Connect uplinks of switch1A	<p>Attach switch1A customer uplink cables. Refer to the NAPD for which ports are uplink ports.</p> <p>Note: If you are using standard 802.1D spanning-tree, the links may take up to 50 seconds to become active.</p>
16. <input type="checkbox"/>	Virtual PMAC: Verify access to customer network	<p>Verify connectivity to the customer network.</p> <div data-bbox="505 1472 1422 1528" style="border: 1px solid black; padding: 5px;"> <pre>\$ /bin/ping <customer_supplied_ntp_server_address></pre> </div>
17. <input type="checkbox"/>	Cabinet: Connect uplinks of switch1B	<p>Attach switch1B customer uplink cables and detach switch1A customer uplink cables. Refer to the NAPD for which ports are uplink ports.</p> <p>Note: If you are using standard 802.1D spanning-tree, the links may take up to 50 seconds to become active.</p>
18. <input type="checkbox"/>	Virtual PMAC: Verify access to customer network	<p>Verify connectivity to the customer network.</p> <div data-bbox="505 1745 1373 1793" style="border: 1px solid black; padding: 5px;"> <pre>\$ /bin/ping <customer_supplied_ntp_server_address></pre> </div>

Procedure 8. Configure Cisco 4948E-F Aggregation Switches-netConfig (HP DL380 Servers Only)

19. <input type="checkbox"/>	Virtual PMAC: Re-attach uplinks of switch1A	Re-attach switch1A customer uplink cables. Refer to the NAPD for which ports are uplink ports. Note: If you are using standard 802.1D spanning-tree, the links may take up to 50 seconds to become active.
20. <input type="checkbox"/>	TVOE Management Server: Restore the TVOE host to its original state	<ol style="list-style-type: none"> Exit from the virtual PMAC console, by pressing Ctrl-J to return to the server prompt. Restore the server networking to its original state. <pre style="border: 1px solid black; padding: 5px;">\$ sudo /sbin/service network restart</pre>

3.6 Configure PMAC Server (NetBackup Only)

Procedure 9. Configure the PMAC Server (NetBackup Only)

S T E P #	<p>This procedure provides PMAC configuration for NetBackup using the web interface.</p> <p>Note: The installer must be knowledgeable of the network. If you make a mistake, click Cancel and try again. The last step may take a while because it reconfigures the network and attempts to connect may fail.</p> <p>Check off (✓) each step as it is completed. Boxes have been provided for this purpose under each step number.</p> <p>If this procedure fails, it is recommended to contact My Oracle Support (MOS) and ask for assistance.</p>	
1. <input type="checkbox"/>	PMAC GUI: Login	<ol style="list-style-type: none"> Open the web browser and navigate to the PMAC GUI: <div style="border: 1px solid gray; padding: 2px; width: fit-content; margin: 5px 0;">http://<PMAC_network_IP></div> Login as the guiadmin user: <div style="text-align: center; margin: 20px 0;">  </div> <div style="text-align: center; margin: 10px 0;"> Oracle System Login Tue Jun 7 13:49:06 2016 EDT </div> <div style="border: 1px solid gray; padding: 10px; margin: 10px auto; width: 80%;"> <p style="text-align: center;">Log In</p> <p style="text-align: center;">Enter your username and password to log in</p> <p style="text-align: center;">Username: <input style="width: 100%;" type="text"/></p> <p style="text-align: center;">Password: <input style="width: 100%;" type="password"/></p> <p style="text-align: center;"><input type="checkbox"/> Change password</p> <p style="text-align: center;"><input type="button" value="Log In"/></p> </div> <p style="font-size: small; text-align: center; margin-top: 10px;">Unauthorized access is prohibited. This Oracle system requires the use of Microsoft Internet Explorer 9.0, 10.0, or 11.0 with support for JavaScript and cookies.</p> <p style="font-size: x-small; text-align: center; margin-top: 10px;">Oracle and Java are registered trademarks of Oracle Corporation and/or its affiliates. Other names may be trademarks of their respective owners.</p>

Procedure 9. Configure the PMAC Server (NetBackup Only)

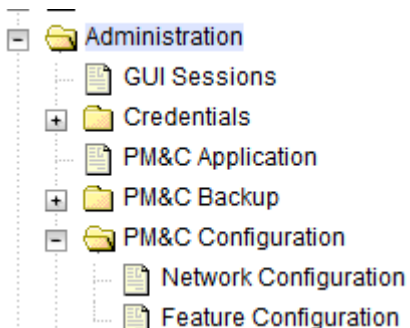
<p>2.</p> <p><input type="checkbox"/></p>	<p>PMAC GUI: Configure optional features</p>	<ol style="list-style-type: none"> 1. Navigate to Administration > PM&C Configuration > Feature Configuration. <div style="margin-left: 20px;">  </div> 2. If NetBackup is used, mark the checkbox to enable the NetBackup feature; otherwise, use the selected features as is. 3. Make sure the roles for all the features are set to management. 4. Also mark the checkbox to enable the following: <ul style="list-style-type: none"> • DEVICE.NETWORK.NETBOOT • DEVICE.NTP • PM&C.REMOTE.BACKUP • PM&C.NETBACK (only if NetBackup is used) <p>Example output:</p> <table border="1" style="width: 100%; border-collapse: collapse; margin-bottom: 10px;"> <thead> <tr> <th style="text-align: left;">Feature</th> <th style="text-align: left;">Description</th> <th style="text-align: left;">Role</th> <th style="text-align: left;">Enabled</th> </tr> </thead> <tbody> <tr> <td>DEVICE.NETWORK.NETBOOT</td> <td>Network device PXE initialization</td> <td>management</td> <td><input checked="" type="checkbox"/></td> </tr> <tr> <td>DEVICE.NTP</td> <td>PM&C as a time server</td> <td>management</td> <td><input checked="" type="checkbox"/></td> </tr> <tr> <td>PMAC.MANAGED</td> <td>Remote management of PM&C server</td> <td>management</td> <td><input type="checkbox"/></td> </tr> <tr> <td>PMAC.REMOTE.BACKUP</td> <td>Remote server for backup</td> <td>management</td> <td><input checked="" type="checkbox"/></td> </tr> <tr> <td>PMAC.NETBACKUP</td> <td>NetBackup client</td> <td>management</td> <td><input type="checkbox"/></td> </tr> <tr> <td>PMAC.IPV6.NOAUTOCONFIG</td> <td>PMAC IPv6 interface disable autoconfiguration</td> <td>NULL</td> <td><input type="checkbox"/></td> </tr> </tbody> </table> <p style="text-align: center; margin: 0;"><input type="button" value="Add Role"/></p> 5. Click Apply. 6. This foreground task takes a few moments. Refresh the view with an Info or Error notice to verify the action. To discard changes, just navigate away from the view. 7. Navigate to Administration > PM&C Configuration.	Feature	Description	Role	Enabled	DEVICE.NETWORK.NETBOOT	Network device PXE initialization	management	<input checked="" type="checkbox"/>	DEVICE.NTP	PM&C as a time server	management	<input checked="" type="checkbox"/>	PMAC.MANAGED	Remote management of PM&C server	management	<input type="checkbox"/>	PMAC.REMOTE.BACKUP	Remote server for backup	management	<input checked="" type="checkbox"/>	PMAC.NETBACKUP	NetBackup client	management	<input type="checkbox"/>	PMAC.IPV6.NOAUTOCONFIG	PMAC IPv6 interface disable autoconfiguration	NULL	<input type="checkbox"/>
Feature	Description	Role	Enabled																											
DEVICE.NETWORK.NETBOOT	Network device PXE initialization	management	<input checked="" type="checkbox"/>																											
DEVICE.NTP	PM&C as a time server	management	<input checked="" type="checkbox"/>																											
PMAC.MANAGED	Remote management of PM&C server	management	<input type="checkbox"/>																											
PMAC.REMOTE.BACKUP	Remote server for backup	management	<input checked="" type="checkbox"/>																											
PMAC.NETBACKUP	NetBackup client	management	<input type="checkbox"/>																											
PMAC.IPV6.NOAUTOCONFIG	PMAC IPv6 interface disable autoconfiguration	NULL	<input type="checkbox"/>																											

Procedure 9. Configure the PMAC Server (NetBackup Only)

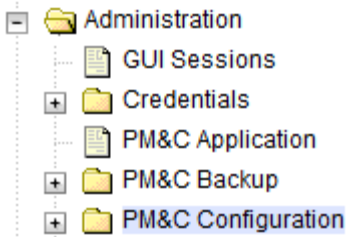
		 <p>8. Make sure the summary is what you want.</p> <p>Example output with IPv4:</p> <p>Main Menu: Administration -> PM&C Configuration -> PM&C Network Configuration</p> <p>Network Description</p> <table border="1"> <thead> <tr> <th>Network Address</th> <th>Network Mask/Prefix</th> </tr> </thead> <tbody> <tr> <td>192.168.1.0</td> <td>255.255.255.0</td> </tr> <tr> <td>10.240.214.0</td> <td>255.255.255.0</td> </tr> </tbody> </table> <p>Network and Roles Description</p> <table border="1"> <thead> <tr> <th>Network Address</th> <th>Network Mask/Prefix</th> <th>Role</th> </tr> </thead> <tbody> <tr> <td>192.168.1.0</td> <td>255.255.255.0</td> <td>control</td> </tr> <tr> <td>10.240.214.0</td> <td>255.255.255.0</td> <td>management</td> </tr> </tbody> </table> <p>Network Interface Description</p> <table border="1"> <thead> <tr> <th>Device</th> <th>IP Address</th> <th>Description</th> </tr> </thead> <tbody> <tr> <td>control</td> <td>192.168.1.1</td> <td>Control network for managed servers</td> </tr> <tr> <td>management</td> <td>10.240.214.3</td> <td>Management of system devices</td> </tr> </tbody> </table> <p>Route Configuration</p> <table border="1"> <thead> <tr> <th>Device</th> <th>Destination Address</th> <th>Network Mask/Prefix</th> <th>Gateway Address</th> </tr> </thead> <tbody> <tr> <td colspan="4">There are no provisioned routes found.</td> </tr> </tbody> </table> <p>IPv4 DHCP Configuration</p> <table border="1"> <thead> <tr> <th>Start DHCP</th> <th>End DHCP</th> </tr> </thead> <tbody> <tr> <td>192.168.1.1</td> <td>192.168.1.254</td> </tr> </tbody> </table>	Network Address	Network Mask/Prefix	192.168.1.0	255.255.255.0	10.240.214.0	255.255.255.0	Network Address	Network Mask/Prefix	Role	192.168.1.0	255.255.255.0	control	10.240.214.0	255.255.255.0	management	Device	IP Address	Description	control	192.168.1.1	Control network for managed servers	management	10.240.214.3	Management of system devices	Device	Destination Address	Network Mask/Prefix	Gateway Address	There are no provisioned routes found.				Start DHCP	End DHCP	192.168.1.1	192.168.1.254
Network Address	Network Mask/Prefix																																					
192.168.1.0	255.255.255.0																																					
10.240.214.0	255.255.255.0																																					
Network Address	Network Mask/Prefix	Role																																				
192.168.1.0	255.255.255.0	control																																				
10.240.214.0	255.255.255.0	management																																				
Device	IP Address	Description																																				
control	192.168.1.1	Control network for managed servers																																				
management	10.240.214.3	Management of system devices																																				
Device	Destination Address	Network Mask/Prefix	Gateway Address																																			
There are no provisioned routes found.																																						
Start DHCP	End DHCP																																					
192.168.1.1	192.168.1.254																																					
<p>3. <input type="checkbox"/></p>	<p>PMAC Command Line: Perform a system healthcheck</p>	<pre>\$ alarmMgr --alarmStatus</pre> <p>This command should return no output on a healthy system.</p> <pre>\$ sudo sentry status</pre> <p>All processes should be running.</p> <p>Example output:</p> <pre>[admusr@5010441PMAC ~]\$ sudo sentry status sending status command... PM&C Sentry Status ----- sentryd started: Thu Sep 15 15:02:57 2016 Current activity mode: ACTIVE Process PID Status StartTS NumR ----- smacTalk 10695 running Thu Sep 15 15:02:57 2016 1 smacMon 10705 running Thu Sep 15 15:02:57 2016 1 hpiPortAudit 10730 running Thu Sep 15 15:02:57 2016 1 snmpEventHandler 10757 running Thu Sep 15 15:02:57 2016 1 Wed Jan 4 12:21:35 2017 Command Complete.</pre>																																				

Procedure 9. Configure the PMAC Server (NetBackup Only)



4. <input type="checkbox"/>	PMAC Command Line: Install NetBackup (optional)	<p>1. If the NetBackup client installation relies on the TPD nbAutoInstall process to configure the PMAC NetBackup client, execute these commands; otherwise, refer to [14], PMAC NetBackup Client Installation and Configuration procedure, for how to install the NetBackup client on the TVOE management server.</p> <pre style="border: 1px solid black; padding: 5px;">\$ sudo mkdir -p /usr/opencv/NetBackup/bin/ \$ sudo ln -s /usr/TKLC/smac/sbin/bpstart_notify /usr/opencv/NetBackup/bin/ \$ sudo ln -s /usr/TKLC/smac/sbin/bpend_notify /usr/opencv/NetBackup/bin/</pre> <p>2. Use the TPD placfg utility to add the NetBackup server's alias and IP to the /etc/hosts file.</p>
5. <input type="checkbox"/>	PMAC Command Line: Perform a PMAC application backup	<pre style="border: 1px solid black; padding: 5px;">\$ sudo pmacadm backup PM&C backup been successfully initiated as task ID 7 [usradm@pmacDev3 ~]\$</pre> <p>Note: The pmacadm backup command uses a naming convention that includes a date/time stamp in the file name (for example, backupPmac_20111025_100251.pef). In the example provided, the backup file name indicates it was created on October 25, 2011, at 10:02:51 a.m. server time.</p> <p>1. Verify the backup was successful.</p> <pre style="border: 1px solid black; padding: 5px;">\$ sudo pmaccli getBgTasks 2: Backup PMAC COMPLETE - PMAC Backup successful Step 2: of 2 Started: 2012-07-05 16:53:10 running: 4 sinceUpdate: 2 taskRecordNum:</pre> <p>2. Copy the backup file to a remote location.</p> <p>The backup file is located under /var/TKLC/smac/backup.</p>

3.7 Add a Rack Mount Server to PMAC

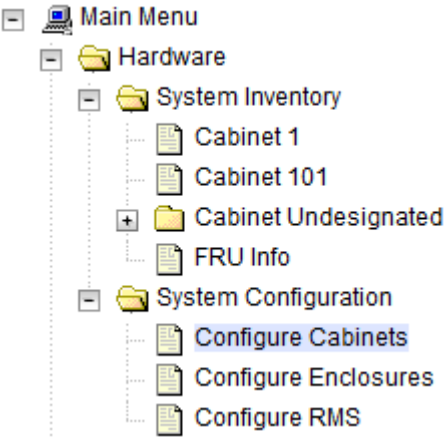
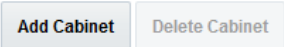

Procedure 10. Add RMS to the PMAC System Inventory

S T E P #	<p>This procedure adds rack mount servers to the PMAC system inventory.</p> <p>Check off (✓) each step as it is completed. Boxes have been provided for this purpose under each step number.</p> <p>If this procedure fails, it is recommended to contact My Oracle Support (MOS) and ask for assistance.</p>	
1. <input type="checkbox"/>	<p>PMAC GUI: Login</p>	<p>1. Open the web browser and navigate to the PMAC GUI:</p> <div style="border: 1px solid black; padding: 5px; margin: 5px 0;"> <p>http://<PMAC_network_IP></p> </div> <p>2. Login as the guiadmin user:</p> <div style="text-align: center; margin: 10px 0;">  </div> <div style="text-align: center; margin: 10px 0;"> <p>Oracle System Login</p> <hr style="width: 50%; margin: 0 auto;"/> <p style="text-align: right; font-size: small;">Tue Jun 7 13:49:06 2016 EDT</p> </div> <div style="text-align: center; margin: 20px 0;"> <div style="border: 1px solid gray; padding: 10px; width: fit-content; margin: 0 auto;"> <p>Log In</p> <p>Enter your username and password to log in</p> <p>Username: <input style="width: 100%;" type="text"/></p> <p>Password: <input style="width: 100%;" type="password"/></p> <p style="text-align: center;"><input type="checkbox"/> Change password</p> <p style="text-align: center;"><input type="button" value="Log In"/></p> </div> </div> <p style="font-size: x-small; text-align: center;">Unauthorized access is prohibited. This Oracle system requires the use of Microsoft Internet Explorer 9.0, 10.0, or 11.0 with support for JavaScript and cookies.</p> <hr style="width: 50%; margin: 0 auto;"/> <p style="font-size: x-small; text-align: center;">Oracle and Java are registered trademarks of Oracle Corporation and/or its affiliates. Other names may be trademarks of their respective owners.</p> <p style="font-size: x-small; text-align: center;">Copyright © 2010, 2016, Oracle and/or its affiliates. All rights reserved.</p>

Procedure 10. Add RMS to the PMAC System Inventory

<p>2.</p> <p><input type="checkbox"/></p>	<p>PMAC GUI: Configure cabinets</p>	<p>1. Navigate to Hardware > System Configuration > Configure Cabinets.</p>  <p>2. Click Add Cabinet.</p>  <p>3. Type the Cabinet ID and click Add Cabinet.</p> <p>Cabinet ID (required): <input type="text" value="1"/> <i>Cabinet ID must be from 1 to 654.</i></p> <hr/> 
---	--	---

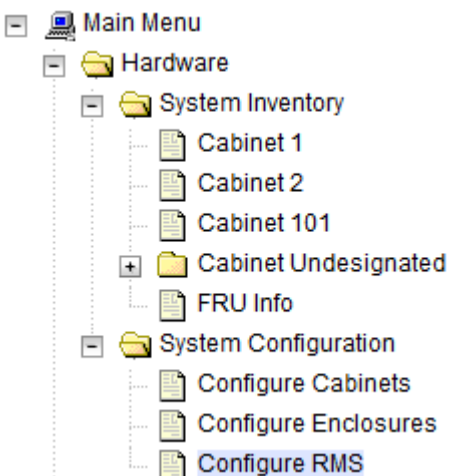
Procedure 10. Add RMS to the PMAC System Inventory

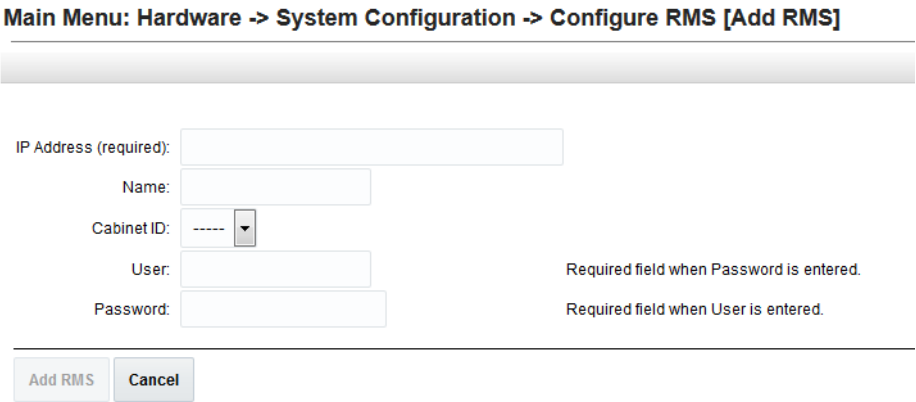
<p>3. <input type="checkbox"/></p>	<p>PMAC GUI: Add RMS</p>	<p>1. Navigate to Hardware > System Configuration > Configure RMS.</p>  <p>2. Click Add RMS.</p>  <p>3. Enter the IP Address of the rack mount server management port (iLO/iLOM) and username/password of the iLO/iLOM. All the other fields are optional.</p> <p>4. Click Add RMS.</p>  <p>Note: The PMAC contains default credentials for the rack mount server management port (not to be confused with OS or application credentials); however, if you know the default credentials do not work, then enter the valid credentials for the rack mount server management port.</p> <p>5. Repeat this step for additional rack mount servers.</p>
------------------------------------	---------------------------------	--

Procedure 10. Add RMS to the PMAC System Inventory

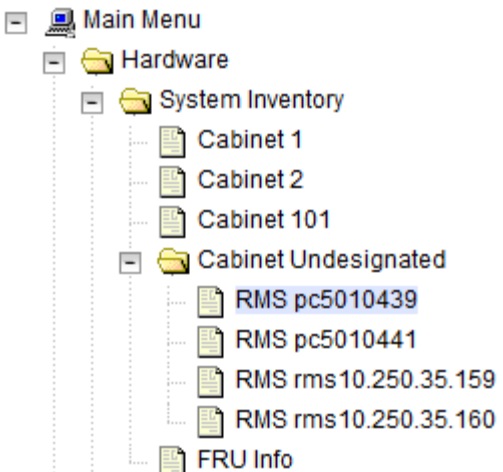
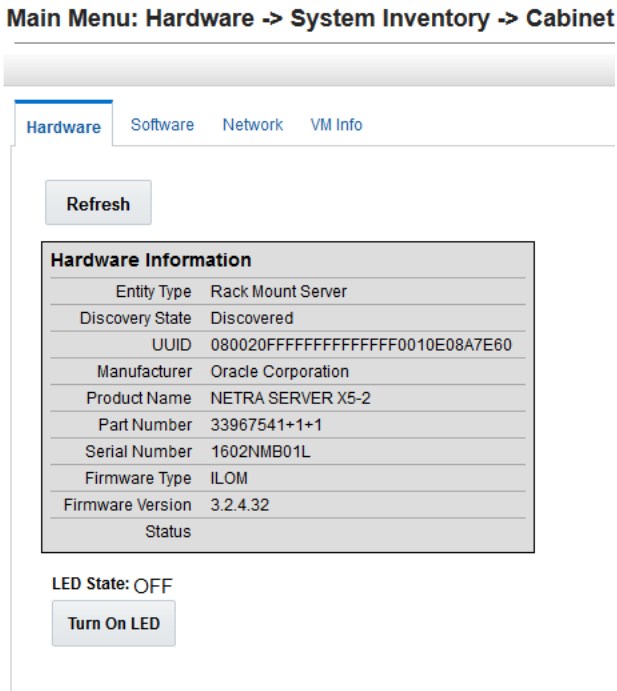
<p>4. <input type="checkbox"/> PMAC GUI: Verify RMS discovered</p>	<p>1. Navigate to Hardware > System Inventory > Cabinet xxx > RMS yyy. Where xxx is the cabinet ID selected when adding RMS (or Undesignated) and yyy is the name of the RMS.</p>  <p>2. Periodically refresh the hardware information using the double arrow to the right of the Hardware Information title until the Discovery State changes from Undiscovered to Discovered.</p> <p>Main Menu: Hardware -> System Inventory -> Cabinet</p>  <p>Note: If Status displays an error, contact My Oracle Support (MOS).</p>
---	--

3.8 Install TVOE on Additional Rack Mount Servers

Procedure 11. Restore an Archive That Does Not Contain a Current User

S T E P #	<p>This procedure installs the TVOE operating system on additional mounted servers.</p> <p>Prerequisite: PMAC (virtualized) has been installed on the first RMS.</p> <p>Check off (✓) each step as it is completed. Boxes have been provided for this purpose under each step number.</p> <p>If this procedure fails, it is recommended to contact My Oracle Support (MOS) and ask for assistance.</p>	
1. <input type="checkbox"/>	<p>PMAC GUI: Login</p>	<p>1. Open the web browser and navigate to the PMAC GUI:</p> <div style="border: 1px solid black; padding: 5px; width: fit-content; margin: 5px 0;"> <p>http://<PMAC_network_IP></p> </div> <p>2. Login as the guiadmin user:</p> <div style="text-align: center; margin: 20px 0;">  <p>The screenshot shows the Oracle System Login page. At the top is the Oracle logo in red. Below it is the text 'Oracle System Login' and the date 'Tue Jun 7 13:49:06 2016 EDT'. In the center is a 'Log In' box with the text 'Enter your username and password to log in'. Inside this box are two input fields: 'Username:' and 'Password:'. Below the password field is a checkbox labeled 'Change password' and a 'Log In' button. At the bottom of the page, there is a disclaimer: 'Unauthorized access is prohibited. This Oracle system requires the use of Microsoft Internet Explorer 9.0, 10.0, or 11.0 with support for JavaScript and cookies.' and a copyright notice: 'Copyright © 2010, 2016, Oracle and/or its affiliates. All rights reserved.'</p> </div>

Procedure 11. Restore an Archive That Does Not Contain a Current User

<p>2. <input type="checkbox"/></p>	<p>PMAC's TVOE: Load TVOE ISO</p>	<p>Use one of the following two options to add the TVOE ISO image to the PMAC:</p> <p>Option 1 — Attach the USB device containing the ISO image to a USB port.</p> <ol style="list-style-type: none"> From the PMAC GUI, navigate to VM Management > PMAC guest > View VM Guest > Media tab. Locate the ISO image in the Available Media list and click its Attach button. <p>After a pause, the image displays in the Attached Media list.</p> <hr/> <p>View guest 5010441PMAC</p> <p>VM Info Software Network Media</p> <p>Attached Media Available Media</p> <div style="border: 1px solid gray; padding: 5px;"> <p>Attached Media</p> <table border="1"> <thead> <tr> <th>Attached</th> <th>Image Path</th> </tr> </thead> <tbody> <tr> <td style="text-align: center;">Detach</td> <td>/var/TKLC/tvoe/mapping-isos/5010441PMAC.iso</td> </tr> </tbody> </table> </div> <p>Edit Delete Clone Guest Regenerate Device Mapping ISO Install OS Upgrade Accept Upgrade Reject Upgrade</p> <p>Option 2 — Use a TVOE 64 bit ISO file.</p> <ol style="list-style-type: none"> Use sftp to transfer the ISO image to the PMAC server in the /var/TKLC/smac/image/isoimages/home/smacftpusr/ directory as pmacftpusr user: cd to the directory where your ISO image is located on the TVOE host (not on the PMAC server). Using sftp, connect to the PMAC management server. <pre style="border: 1px solid gray; padding: 5px;"> > sftp pmacftpusr@<PM&C_management_network_ip> > put <image>.iso </pre> <ol style="list-style-type: none"> After the image transfer is 100% complete, close the connection. <pre style="border: 1px solid gray; padding: 5px;"> > quit </pre>	Attached	Image Path	Detach	/var/TKLC/tvoe/mapping-isos/5010441PMAC.iso
Attached	Image Path					
Detach	/var/TKLC/tvoe/mapping-isos/5010441PMAC.iso					

Procedure 11. Restore an Archive That Does Not Contain a Current User

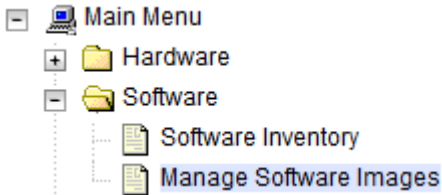
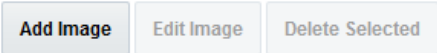
<p>3. <input type="checkbox"/></p>	<p>PMAC GUI: Add TVOE image</p>	<ol style="list-style-type: none"> Navigate to Software > Manage Software Images.  Click Add Image. Select the image from the options.  <p>If the image was supplied on a CD or a USB drive, it displays as a virtual device (device://...). These devices are assigned in numerical order as CD and USB images become available on the TVOE management server. The first virtual device is reserved for internal use by TVOE and PMAC; therefore, the ISO image of interest is normally on the second device, device://dev/sr1. If one or more CD or USB-based images was already on the TVOE management server before you started this procedure, select a correspondingly higher device number.</p> <p>If the image was transferred to PMAC using sftp, it displays in the list as a local file /var/TKLC/...</p> <p>Main Menu: Software -> Manage Software Images [Add Image]</p> <hr/> <p>Images may be added from any of these sources:</p> <ul style="list-style-type: none"> • Oracle-provided media in the PM&C host's CD/DVD drive (Refer to Note) • USB media attached to the PM&C's host (Refer to Note) • External mounts. Prefix the directory with "extfile://". • These local search paths: <ul style="list-style-type: none"> ◦ <code>/var/TKLC/upgrade/*.iso</code> ◦ <code>/var/TKLC/smac/image/isoimages/home/smacftpusr/*.iso</code> <p>Note: CD and USB images mounted on PM&C's VM host must first be made accessible to the PM&C VM guest.</p> <p>Path: <input type="text"/></p> <p>Description: <input type="text"/></p> <hr/> <p><input type="button" value="Add New Image"/> <input type="button" value="Cancel"/></p> Select the appropriate path and click Add New Image. Check the progress by clicking the Task Monitoring link. Observe the green bar indicating success. Once complete, remove the TVOE media from the optical drive of the TVOE management server.
------------------------------------	--	--

Procedure 11. Restore an Archive That Does Not Contain a Current User

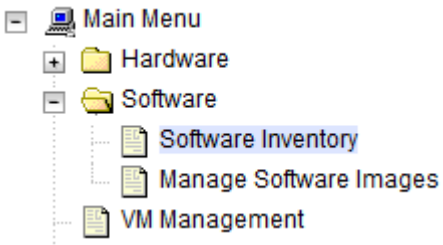
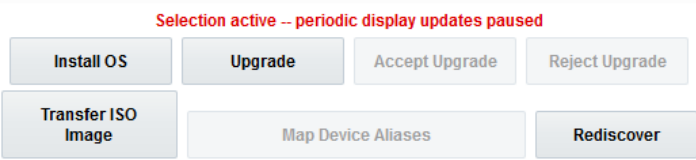
<p>4. PMAC GUI: <input type="checkbox"/> Select RMS servers for TVOE OS install</p>	<p>1. Navigate to Software > Software Inventory.</p>  <p>2. Select the RMS servers you want to IPM.</p> <p>If you want to install the same OS image to more than one server, select multiple servers by clicking on each row. Selected rows are highlighted in green.</p> <p>Main Menu: Software -> Software Inventory</p> <table border="1" data-bbox="511 724 1421 819"> <thead> <tr> <th>Identity</th> <th>IP Address</th> <th>Hostname</th> <th>Platform Name</th> <th>Platform Version</th> <th>Application Name</th> <th>Application Version</th> <th>Designation</th> <th>Function</th> </tr> </thead> <tbody> <tr style="background-color: #e0f0ff;"> <td>RMS: pc5010438</td> <td>192.168.1.32</td> <td>hostname7237c8296d11</td> <td>TPD (x86_64)</td> <td>7.2.0.0.0-88.18.0</td> <td>TVOE</td> <td>3.2.0.0.0_88.18.0</td> <td></td> <td></td> </tr> </tbody> </table> <p>3. Click Install OS.</p> 	Identity	IP Address	Hostname	Platform Name	Platform Version	Application Name	Application Version	Designation	Function	RMS: pc5010438	192.168.1.32	hostname7237c8296d11	TPD (x86_64)	7.2.0.0.0-88.18.0	TVOE	3.2.0.0.0_88.18.0		
Identity	IP Address	Hostname	Platform Name	Platform Version	Application Name	Application Version	Designation	Function											
RMS: pc5010438	192.168.1.32	hostname7237c8296d11	TPD (x86_64)	7.2.0.0.0-88.18.0	TVOE	3.2.0.0.0_88.18.0													

Procedure 11. Restore an Archive That Does Not Contain a Current User

5. **PMAC GUI:**
Initiate OS install on RMS server(s)

1. The left side of this screen shows the servers to be affected by this OS installation. From the list of available bootable images on the right side of the screen, select one OS image to install to all of the selected servers.

Software Install - Select Image

Tasks* ▾

Targets

Entity	Status
RMS: pc5010439	

Select Image

Image Name	Type	Architecture	Description
TPD.install-7.0.3.0.0_86.43.0-OracleLinux6.7-x86_64	Bootable	x86_64	
TPD.install-7.2.0.0.0_88.18.0-OracleLinux6.7-x86_64	Bootable	x86_64	
TVOE-3.0.3.0.0_86.43.0-x86_64	Bootable	x86_64	
TVOE-3.2.0.0.0_88.18.0-x86_64	Bootable	x86_64	

2. HP DL380 Gen9 with 10GB FlexLOM, enter **control_if=eth05,eth06** for the Supply Software Install Arguments (Optional).

Supply Software Install Arguments (Optional)

`control_if=eth05,eth06`

3. Click **Start Software Install**.

4. Select **OK**.

You have selected to install a bootable OS iso on the selected targets.

The following targets already have an Application:
RMS: pc5010439 ==> TVOE

Are you sure you want to install TVOE-3.2.0.0.0_88.18.0-x86_64 on all entities in the Targets list?

Procedure 11. Restore an Archive That Does Not Contain a Current User

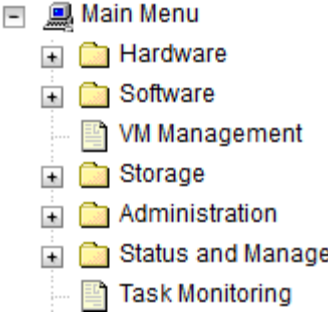
<p>6.</p> <p><input type="checkbox"/></p>	<p>PMAC GUI: Monitor OS install</p>	<p>Navigate to Task Monitoring to monitor the progress of the TVOE Installation background task.</p> <p>A separate task displays for each server.</p>  <p>Main Menu: Task Monitoring</p> <table border="1"> <thead> <tr> <th>ID</th> <th>Task</th> <th>Target</th> <th>Status</th> <th>State</th> <th>Task Output</th> <th>Running Time</th> <th>Start Time</th> <th>Progress</th> </tr> </thead> <tbody> <tr> <td>622</td> <td>Install OS</td> <td>RMS: pc5010439</td> <td>Installing packages from ISO</td> <td>IN_PROGRESS</td> <td>N/A</td> <td>0:04:19</td> <td>2016-06-07 14:10:05</td> <td>71%</td> </tr> </tbody> </table> <p>When the installation is complete, the task changes to green and the progress bar indicates 100%.</p> <p>Main Menu: Task Monitoring</p> <table border="1"> <thead> <tr> <th>ID</th> <th>Task</th> <th>Target</th> <th>Status</th> <th>State</th> <th>Task Output</th> <th>Running Time</th> <th>Start Time</th> <th>Progress</th> </tr> </thead> <tbody> <tr> <td>622</td> <td>Install OS</td> <td>RMS: pc5010439</td> <td>Done: TVOE-3.2.0.0.0_88.18.0-x86_64</td> <td>COMPLETE</td> <td>N/A</td> <td>0:28:42</td> <td>2016-06-07 14:10:05</td> <td>100%</td> </tr> </tbody> </table>	ID	Task	Target	Status	State	Task Output	Running Time	Start Time	Progress	622	Install OS	RMS: pc5010439	Installing packages from ISO	IN_PROGRESS	N/A	0:04:19	2016-06-07 14:10:05	71%	ID	Task	Target	Status	State	Task Output	Running Time	Start Time	Progress	622	Install OS	RMS: pc5010439	Done: TVOE-3.2.0.0.0_88.18.0-x86_64	COMPLETE	N/A	0:28:42	2016-06-07 14:10:05	100%
ID	Task	Target	Status	State	Task Output	Running Time	Start Time	Progress																														
622	Install OS	RMS: pc5010439	Installing packages from ISO	IN_PROGRESS	N/A	0:04:19	2016-06-07 14:10:05	71%																														
ID	Task	Target	Status	State	Task Output	Running Time	Start Time	Progress																														
622	Install OS	RMS: pc5010439	Done: TVOE-3.2.0.0.0_88.18.0-x86_64	COMPLETE	N/A	0:28:42	2016-06-07 14:10:05	100%																														

3.9 Configure TVOE on Additional Rack Mount Servers

Procedure 12. Configure TVOE on Additional Rack Mount Servers

<p>S</p> <p>T</p> <p>E</p> <p>P</p> <p>#</p>	<p>This procedure configures TVOE on all remaining rack mount servers.</p> <p>Prerequisite: RMS has been IPMed with TVOE operating system.</p> <p>Check off (✓) each step as it is completed. Boxes have been provided for this purpose under each step number.</p> <p>If this procedure fails, it is recommended to contact My Oracle Support (MOS) and ask for assistance.</p>	
<p>1.</p> <p><input type="checkbox"/></p>	<p>Determine bridge names and interfaces</p>	<p>Use the network bridge names determined in Procedure 4, step 1.</p>
<p>2.</p> <p><input type="checkbox"/></p>	<p>RMS iLO/iLOM: Login and start the integrated remote console</p>	<p>1. Log into iLO/iLOM and follow Appendix D TVOE iLO/iLOM GUI Access to access the iLO/iLOM GUI.</p> <div style="border: 1px solid black; padding: 5px; margin: 5px 0;"> <p><code>https://<management_server_iLO_ip></code></p> </div> <p>2. Login as admusr.</p>

Procedure 12. Configure TVOE on Additional Rack Mount Servers

<p>3. <input type="checkbox"/></p>	<p>RMS iLO/iLOM: Create the management network</p>	<p>Note: This output is for illustrative purposes only. The site information for this system determines the network interfaces (network devices, bonds, and bond enslaved devices) to configure.</p> <pre>\$ sudo /usr/TKLC/plat/bin/netAdm add --device=<TVOE_Management_Bridge_Interface> -- onboot=yes Interface bond0.2 added</pre> <pre>\$sudo /usr/TKLC/plat/bin/netAdm add --type=Bridge --name=management --bootProto=none --onboot=yes --address=<Management_Server_TVOE_IP> --netmask=<Management_Server_TVOE_Netmask/prefix> --bridgeInterfaces=<TVOE_Management_Bridge_Interface> Bridge management added!</pre>
<p>4. <input type="checkbox"/></p>	<p>RMS iLO/iLOM: Configure default route</p>	<pre>\$ sudo /usr/TKLC/plat/bin/netAdm add --route=default --device=management --gateway=<Management_Gateway_IP_Address> Route to management added</pre>

Procedure 12. Configure TVOE on Additional Rack Mount Servers

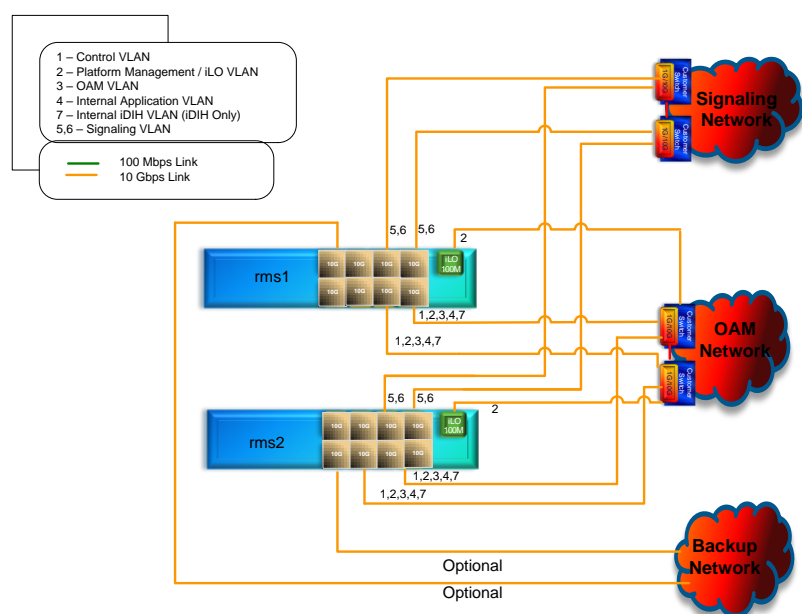
<p>5. <input type="checkbox"/></p>	<p>RMS iLO/iLOM: TVOE bond1 configuration (segregated signaling)</p>	<p>If the rack mount server solution is designed where the signaling traffic is segregated from the rest of the DSR OAM related networks and located on separate NICs, execute this step. If the OAM related networks share the same physical NICs (non-segregated), skip this step.</p>  <p>Legend: 1 – Control VLAN 2 – Platform Management / iLO VLAN 3 – OAM VLAN 4 – Internal Application VLAN 7 – Internal iDIH VLAN (iDIH Only) 5,6 – Signaling VLAN — 100 Mbps Link — 10 Gbps Link</p> <p>Diagram Description: The diagram shows two rack mount servers, rms1 and rms2. Each server has a network interface card (NIC) with multiple ports. The ports are labeled with VLAN IDs: 1, 2, 3, 4, 7, 5, 6, and iLO/iLOM. The connections are as follows: - rms1 and rms2 are connected to the Signaling Network via 10 Gbps links (orange lines) using ports 5, 6 and iLO/iLOM. - rms1 and rms2 are connected to the OAM Network via 10 Gbps links (orange lines) using ports 1, 2, 3, 4, 7. - rms1 and rms2 are connected to the Backup Network via 100 Mbps links (green lines) using ports 1, 2, 3, 4, 7. These connections are labeled as 'Optional'. - The Signaling Network, OAM Network, and Backup Network are represented by cloud icons with server racks inside.</p> <p>Create Bond1 interface: Note: Refer to section 2.2.2 for network interface server reference table.</p> <pre>\$ sudo /usr/TKLC/plat/bin/netAdm add --device=bond1 --onboot=yes \$ sudo /usr/TKLC/plat/bin/netAdm set --device=<ethernet_interface_3> --type=Ethernet --master=bond1 --slave=yes --onboot=yes \$ sudo /usr/TKLC/plat/bin/netAdm set --device=<ethernet_interface_4> --type=Ethernet --master=bond1 --slave=yes --onboot=yes</pre>
------------------------------------	---	---

Procedure 12. Configure TVOE on Additional Rack Mount Servers

6.	RMS iLO/iLOM: <input type="checkbox"/> Set Ethernet interface ring buffer sizes	<p>Note: Refer to section 2.2.2 for network interface server reference table.</p> <pre>\$ sudo netAdm set --device=<ethernet_interface_1> --ringBufferRx=4096 --ringBufferTx=4096 \$ sudo netAdm set --device=<ethernet_interface_2> --ringBufferRx=4096 --ringBufferTx=4096</pre> <p>If step 5. was executed, execute these commands:</p> <pre>\$ sudo netAdm set --device=<ethernet_interface_3> --ringBufferRx=4096 --ringBufferTx=4096 \$ sudo netAdm set --device=<ethernet_interface_4> --ringBufferRx=4096 --ringBufferTx=4096</pre> <p>Ring Buffer Sizes For X7-2</p> <pre>\$ sudo netAdm set --device=<ethernet_interface_1> --ringBufferRx=2047 --ringBufferTx=2047 \$ sudo netAdm set --device=<ethernet_interface_2> --ringBufferRx=2047 --ringBufferTx=2047</pre> <p>If step 5. was executed, execute these commands:</p> <pre>\$ sudo netAdm set --device=<ethernet_interface_3> --ringBufferRx=2047 --ringBufferTx=2047 \$ sudo netAdm set --device=<ethernet_interface_4> --ringBufferRx=2047 --ringBufferTx=2047</pre>
----	---	---

Procedure 12. Configure TVOE on Additional Rack Mount Servers

<p>7. <input type="checkbox"/></p>	<p>RMS iLO/iLOM: Add the NetBackup network — Option 1 (optional) If NetBackup is used, execute this step; otherwise, skip to step 12.</p>	<p>Before selecting the configuration option, first read the description in each step to determine which configuration is applicable to your installation and network.</p> <p>Select only this option or one of the options listed in steps 8. or 9.</p> <p>NetBackup is a tool that allows the customer to take remote backups of the system.</p> <p>Notes:</p> <ul style="list-style-type: none"> • This output is for illustrative purposes only and shows the control bridge configured. • This example shows a TVOE management server configuration with the NetBackup feature enabled and the NetBackup network configured with a non-default MTU size. • The MTU size must be consistent between a network bridge, device, or bond and associated VLANs. <p>Create NetBackup bridge using a bond containing an untagged interface.</p> <pre> \$ sudo /usr/TKLC/plat/bin/netAdm add --device=<TVOE_NetBackup_Bridge_Interface> --onboot=yes --type=Bonding --mode=active-backup -- miimon=100 --MTU=<NetBackup_MTU_size> Interface <TVOE_NetBackup_Bridge_Interface> added \$ sudo /usr/TKLC/plat/bin/netAdm set --device=<ethernet_interface_4> --type=Ethernet --master=<TVOE_NetBackup_Bridge_Interface> --slave=yes --onboot=yes Interface <ethernet_interface_4> updated \$ sudo /usr/TKLC/plat/bin/netAdm add --type=Bridge --name=<TVOE_NetBackup_Bridge> --onboot=yes -- bootProto=none --MTU=<NetBackup_MTU_size> --bridgeInterfaces=<TVOE_NetBackup_Bridge_Interface> --address=<TVOE_NetBackup_IP> --netmask=<TVOE_NetBackup_Netmask> </pre>
<p>8. <input type="checkbox"/></p>	<p>RMS iLO/iLOM: Add the NetBackup network — Option 2 (optional)</p>	<p>If NetBackup is used, select only this option or one of the options listed in steps 7. or 9.</p> <p>Create NetBackup bridge using an untagged native interface.</p> <pre> \$ sudo /usr/TKLC/plat/bin/netAdm add --type=Bridge --name=<TVOE_NetBackup_Bridge> --onboot=yes -- bootProto=none --MTU=<NetBackup_MTU_size> --bridgeInterfaces=<Ethernet_Interface_4> --address=<TVOE_NetBackup_IP> --netmask=<TVOE_NetBackup_Netmask> </pre>

Procedure 12. Configure TVOE on Additional Rack Mount Servers

<p>9. <input type="checkbox"/></p>	<p>RMS iLO/iLOM: Add the NetBackup network — Option 3 (optional)</p>	<p>If NetBackup is used, select only this option or one of the options listed in steps 7. or 8. Create NetBackup bridge using a tagged device.</p> <pre style="background-color: #f0f0f0; padding: 5px;">\$ sudo /usr/TKLC/plat/bin/netAdm add --device=<TVOE_NetBackup_Bridge_Interface> --onboot=yes Interface <TVOE_NetBackup_Bridge_Interface> added \$sudo /usr/TKLC/plat/bin/netAdm add --type=Bridge --name=<TVOE_NetBackup_Bridge> --onboot=yes --MTU=<NetBackup_MTU_size> --bridgeInterfaces=<TVOE_NetBackup_Bridge_Interface> --address=<TVOE_NetBackup_IP> --netmask=<TVOE_NetBackup_Netmask></pre>
<p>10. <input type="checkbox"/></p>	<p>RMS iLO/iLOM: Restart network interfaces</p>	<pre style="background-color: #f0f0f0; padding: 5px;">\$ sudo service network restart</pre>
<p>11. <input type="checkbox"/></p>	<p>RMS iLO/iLOM: Set the server hostname</p>	<ol style="list-style-type: none"> Enter the platcfg menu. <pre style="background-color: #f0f0f0; padding: 5px;">\$ sudo su - platcfg</pre> Navigate to Server Configuration > Hostname >Edit. <pre style="background-color: #f0f0f0; padding: 5px;">lu Server Configuration Menu tk x x x Hostname x x Configure Storage x x Designation/Function a x x Set Clock a x x Time Zone a x x Exit x x x [mqqqqqqqqqqqqqqqqqqqqqqqqqq]</pre> Set the TVOE management server hostname. Click OK. Navigate out of hostname.

Procedure 12. Configure TVOE on Additional Rack Mount Servers

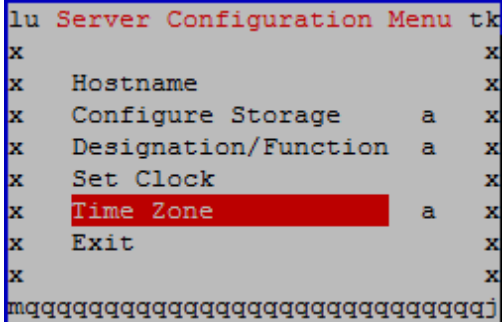
<p>12.</p>	<p>RMS iLO/iLOM: Set the time zone and/or hardware clock</p>	<ol style="list-style-type: none"> 1. Navigate to Server Configuration > Time Zone.  <pre> lu Server Configuration Menu tk x x x Hostname x x Configure Storage a x x Designation/Function a x x Set Clock x x Time Zone a x x Exit x x x mqqqqqqqqqqqqqqqqqqqqqqqqqqqqqqqq] </pre> <ol style="list-style-type: none"> 2. Click Edit. 3. Set the time zone and/or hardware clock to UTC (or appropriate time zone value). 4. Click OK. 5. Navigate out of server configuration.
------------	---	---

Procedure 12. Configure TVOE on Additional Rack Mount Servers

13. <input type="checkbox"/>	RMS iLO/iLOM: Delete PMAC VM as NTP source on RMS	<p>1. Navigate to Network Configuration > NTP.</p> <pre> lu Network Configuration Menu tk x x Network Interfaces x x SNMP Configuration a x x Network Bridges a x x Configure Network a x x Routing a x x NTP x x Iptables a x x IPSEC Configuration a x x Resolv a x x Stunnel a x x Modify Hosts File a x x Exit x x mqgqqqqqqqqqqqqqqqqqqqqqqqqqqqqqqqqqq] </pre> <p>2. Select Delete an existing NTP Server.</p> <pre> lqqqqq Edit Time Servers Menu tqqqqk x x Add a New NTP Server x x Edit an existing NTP Server x x Delete an existing NTP Server a x x Exit x x mqgqqqqqqqqqqqqqqqqqqqqqqqqqqqqqqqq] </pre> <p>3. Select the PMAC VM control IP and click OK.</p> <pre> lu NTP server to delete Menu tk x x ntpserver1 x x ntpserver2 a x x ntpserver3 x x 192.168.1.1 a x x Exit x x mqgqqqqqqqqqqqqqqqqqqqqqqqqqqqqqqqq] </pre>
------------------------------	---	---

Procedure 12. Configure TVOE on Additional Rack Mount Servers

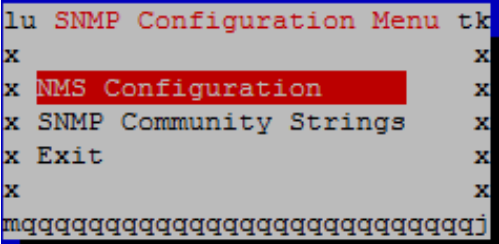
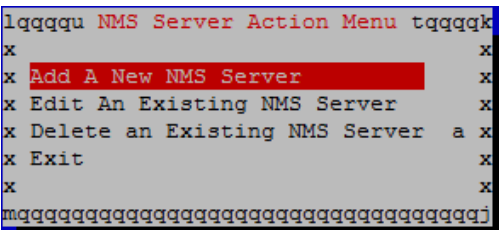
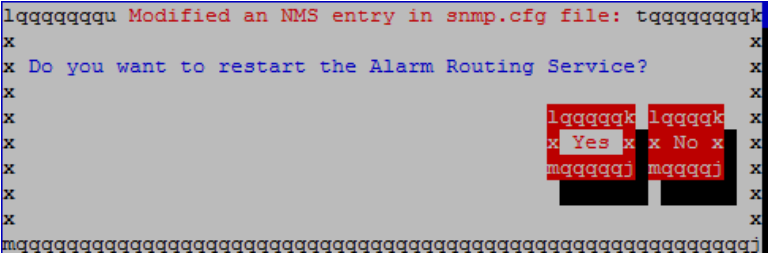
<p>14. <input type="checkbox"/></p>	<p>RMS iLO/iLOM: Set SNMP</p>	<p>Note: Refer to Appendix H SNMP Configuration to understand the preferred SNMP configuration.</p> <ol style="list-style-type: none"> Navigate to Network Configuration > SNMP Configuration > NMS Configuration.  <ol style="list-style-type: none"> Click Edit and select Add a New NMS Server.  <ol style="list-style-type: none"> Complete the form by entering the NMS server IP, port (default port is 162), and community string provided by the customer about the SNMP trap destination. Click OK to finalize the configuration. Click Exit. Click Yes.  <ol style="list-style-type: none"> Wait a few seconds while the Alarm Routing Service restarts. Exit platcfg.
<p>15. <input type="checkbox"/></p>	<p>RMS iLO/iLOM: Restart the server</p>	<pre>\$ sudo init 6</pre>

Procedure 12. Configure TVOE on Additional Rack Mount Servers

16.	RMS iLO/iLOM: <input type="checkbox"/> Verify ring buffer settings	<p>Verify the ring buffer sizes have been configured correctly (from step 6.) by executing this command for each Ethernet interface configured.</p> <pre style="border: 1px solid black; padding: 5px;">\$ ethtool -g <eth interfaces configured above></pre> <p>Example output:</p> <pre style="background-color: black; color: white; padding: 5px;">[admusr@FJ-TVOE-2 ~]\$ ethtool -g eth01 Ring parameters for eth01: Pre-set maximums: RX: 4096 RX Mini: 0 RX Jumbo: 0 TX: 4096 Current hardware settings: RX: 4096 RX Mini: 0 RX Jumbo: 0 TX: 4096</pre> <p>For X7-2 Hardware: Example output:</p> <pre style="border: 1px solid black; padding: 5px;">[admusr@X7201TVOE1 ~]\$ sudo ethtool -g eth03 Ring parameters for eth03: Pre-set maximums: RX: 2047 RX Mini: 0 RX Jumbo: 8191 TX: 2047 Current hardware settings: RX: 2047 RX Mini: 0 RX Jumbo: 8188 TX: 2047 [admusr@X7201TVOE1 ~]\$</pre>
-----	--	--

Procedure 12. Configure TVOE on Additional Rack Mount Servers

<p>17. <input type="checkbox"/></p>	<p>RMS iLO/iLOM: Configure NetBackup client on PMAC TVOE host — Part 1 (optional)</p>	<p>Execute this step if the NetBackup feature is enabled for this system; otherwise, skip this step.</p> <ol style="list-style-type: none"> 1. Open firewall ports for NetBackup. <pre style="border: 1px solid black; padding: 5px;">\$ sudo ln -s /usr/TKLC/plat/share/NetBackup/60NetBackup.ipt /usr/TKLC/plat/etc/iptables/ \$ sudo /usr/TKLC/plat/bin/iptablesAdm reconfig</pre> 2. Enable platcfg to show the NetBackup menu. <pre style="border: 1px solid black; padding: 5px;">\$ sudo platcfgadm --show NBConfig; \$ sudo platcfgadm --show NBInit; \$ sudo platcfgadm --show NBDeInit; \$ sudo platcfgadm --show NBInstall; \$ sudo platcfgadm --show NBVerifyEnv; \$ sudo platcfgadm --show NBVerify;</pre> 3. Create LV and file system for NetBackup client software on the vgguests volume group: <pre style="border: 1px solid black; padding: 5px;">\$ sudo /usr/TKLC/plat/sbin/storageMgr /tmp/nb.lvm</pre> <p>This creates the LV, formats it with a filesystem, and mounts it under /usr/openv/.</p> <p>Example output:</p> <pre>Called with options: /tmp/nb.lvm VG vgguests already exists. Creating lv NetBackup_lv. Volume NetBackup_lv will be created. Success: Volume NetBackup_lv was created. Creating filesystem, this may take a while. Updating fstab for lv NetBackup_lv. Configuring existing lv NetBackup_lv. The LV for NetBackup has been created!</pre>
<p>18. <input type="checkbox"/></p>	<p>RMS iLO/iLOM: Install/Configure NetBackup client software — Part 2 (optional)</p>	<p>Refer to Appendix I Install NetBackup Client for instructions how to install the NetBackup client.</p> <p>Note: Skip any steps relating to copying NetBackup notify scripts to the /usr/openv/NetBackup/bin. The TVOE NetBackup notify scripts are created in the next step.</p> <p>Create soft links for TVOE specific NetBackup notify scripts.</p> <pre style="border: 1px solid black; padding: 5px;">\$sudo ln -s /usr/TKLC/plat/sbin/bpstart_notify /usr/openv/NetBackup/bin/bpstart_notify \$sudo ln -s /usr/TKLC/plat/sbin/bpend_notify /usr/openv/NetBackup/bin/bpend_notify</pre> <p>Note: Once the NetBackup client is installed on TVOE, the NetBackup master should be configured to back up the /var/TKLC/bkp/*.iso file from the TVOE host.</p>

Procedure 12. Configure TVOE on Additional Rack Mount Servers

19. <input type="checkbox"/>	RMS iLO/iLOM: Set up syscheck	<p>syscheck must be configured to monitor bonded interfaces. Replace bondedInterfaces with bond0, or bond0,bond1, if segregated networks are used:</p> <pre>\$ sudo /usr/TKLC/plat/bin/syscheckAdm net ipbond --set --var=DEVICES --val=<bondedInterfaces> \$ sudo /usr/TKLC/plat/bin/syscheckAdm net ipbond -- enable</pre>
20. <input type="checkbox"/>	RMS iLO/iLOM: Verify syscheck	<p>Verify syscheck:</p> <pre>\$ sudo /usr/TKLC/plat/bin/syscheck net ipbond -v Expected output should look similar to below: Running modules in class net... ipbond: Bonded interface bond0 is OK OK LOG LOCATION: /var/TKLC/log/syscheck/fail_log</pre>
21. <input type="checkbox"/>	RMS iLO/iLOM: Verify server health	<pre>\$ alarmMgr -alarmStatus</pre> <p>This command should return no output on a healthy system. If any alarms are reported, contact My Oracle Support (MOS).</p>

Procedure 12. Configure TVOE on Additional Rack Mount Servers

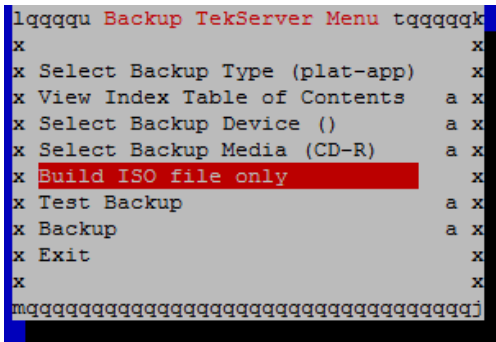
<p>22. <input type="checkbox"/></p>	<p>RMS iLO/iLOM: Back up TVOE using TPD platcfg utility</p>	<ol style="list-style-type: none"> 1. Enter the platcfg menu from the TVOE server. <pre style="border: 1px solid black; padding: 5px; width: fit-content;">\$ sudo su - platcfg</pre> 2. Navigate to Maintenance > Backup and Restore > Backup Platform (CD/DVD). Note: If no cdrom device is found by TPD, a No disk device available. This is normal on systems without a cdrom device error displays. Press Enter. 3. Navigate to Build ISO file only and press Enter.  Note: Creating the ISO image may happen so quickly that this screen may only display for an instant. 4. Exit platcfg by selecting Exit. After the ISO is created, platcfg returns to the Backup TekServer menu. The ISO has been created and is located in the /var/TKLC/bkp/ directory. An example filename of a backup file that was created is RMS503u14-plat-app-201210301505.iso. 5. Move the TVOE backup to a customer provided backup server for safe keeping.
<p>23. <input type="checkbox"/></p>	<p>Repeat</p>	<p>Repeat this procedure for additional rack mount servers.</p>

3.10 Determine VM Placement and Socket Pinning

Note: Skip this section if deploying a non-HA lab node of DL380 Gen system.

To maximize performance efficiency, customers who are deploying DSR on **Oracle X5-2/Netra X5-2/X6-2/X7-2/HP DL380 Gen 9 (10Gbps)** servers may obtain the DSR VM placement and CPU pinning information document. This recommended document can be obtained from an Oracle representative for implementation. If the DSR VM placement and CPU pinning information is NOT available, the customer may use [16] DSR VM Placement and CPU Socket Pinning Tool.

Notes:

- Determine the need for VM placement and CPU pinning for all components of the DSR installation (PMAC, IDIH, DSR, and SDS).
- HP DL380 Gen 9 equipped with onboard 1Gbps NICs should follow Appendix S VM Placement in HP DL380 Gen 8/Gen 9 (Onboard 1Gbps NICs) and CPU Pinning in HP DL380 Gen 9 (Onboard 1Gbps NICs).

3.11 Deploy Redundant PMAC (Optional)

Note: Non-HA Lab Node Installations Only (Oracle X5-2/Netra X5-2/X6-2/HP DL380 Gen 9): Skip this section.

Procedure 13. Install a Redundant PMAC

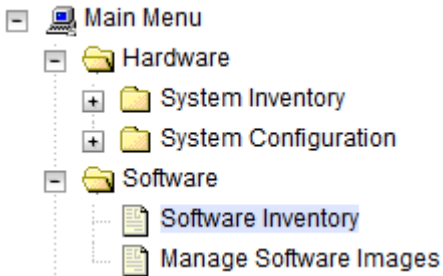
S T E P #	<p>This procedure is optional and required only if the redundant PMAC server feature is to be deployed. This procedure deploys a redundant PMAC and creates the first backup from the primary PMAC. Check off (✓) each step as it is completed. Boxes have been provided for this purpose under each step number. If this procedure fails, it is recommended to contact My Oracle Support (MOS) and ask for assistance.</p>												
1. <input type="checkbox"/>	<p>Primary PMAC: Login</p> <p>Establish an SSH session to the primary PMAC and login as admusr.</p>												
2. <input type="checkbox"/>	<p>PMAC: Exchange SSH keys between primary PMAC and redundant PMAC's TVOE host</p> <p>Use the PMAC GUI to determine the control network IP address of the redundant PMAC's TVOE host server.</p> <ol style="list-style-type: none"> From the PMAC GUI, navigate to Software > Software Inventory.  <ol style="list-style-type: none"> Note the IP address for the PMAC's TVOE host server. <p>Main Menu: Software -> Software Inventory</p> <table border="1" data-bbox="506 1192 1421 1304"> <thead> <tr> <th>Identity</th> <th>IP Address</th> <th>Hostname</th> <th>Platform Name</th> <th>Platform Version</th> <th>Application N</th> </tr> </thead> <tbody> <tr> <td>RMS: pc5010439</td> <td>192.168.1.32</td> <td>hostnameaffe0ca0cd0f</td> <td>TPD (x86_64)</td> <td>7.2.0.0-88.18.0</td> <td>TVOE</td> </tr> </tbody> </table> <ol style="list-style-type: none"> Obtain a terminal session to PMAC and login as admusr. Exchange SSH keys for admusr between the primary PMAC and the PMAC's TVOE host server using the keyexchange utility and the control network IP address for the MP blade server. <pre style="border: 1px solid gray; padding: 5px;">\$ keyexchange admusr@<MP_Control_Blade_IP Address></pre> <ol style="list-style-type: none"> When asked for the password, type the password for the admusr of the PMAC's TVOE host server. 	Identity	IP Address	Hostname	Platform Name	Platform Version	Application N	RMS: pc5010439	192.168.1.32	hostnameaffe0ca0cd0f	TPD (x86_64)	7.2.0.0-88.18.0	TVOE
Identity	IP Address	Hostname	Platform Name	Platform Version	Application N								
RMS: pc5010439	192.168.1.32	hostnameaffe0ca0cd0f	TPD (x86_64)	7.2.0.0-88.18.0	TVOE								
3. <input type="checkbox"/>	<p>Primary PMAC: Export the PMAC ISO image to the redundant PMAC's TVOE host</p> <pre style="border: 1px solid gray; padding: 5px;">\$ sudo /usr/sbin/exportfs <redundant PMAC TVOE Host Control IP>:/usr/TKLC/smac/html/TPD/<PMAC_Image_Name></pre>												

Procedure 13. Install a Redundant PMAC

4. <input type="checkbox"/>	Primary PMAC: SSH to the redundant PMAC's TVOE host	Establish an SSH session to the redundant PMAC's TVOE host server and login as admusr . <pre>\$ sudo ssh admusr@<redundant PMAC's TVOE Host server control IP></pre>
5. <input type="checkbox"/>	Redundant PMAC's TVOE Host: Mount the PMAC upgrade media from the primary PMAC server	<pre>\$ sudo /bin/mount <primary_pmac_control_IP>:/usr/TKLC/smac/html/TPD/<PMAC_Image_Name> /mnt/upgrade</pre>
6. <input type="checkbox"/>	Redundant PMAC's TVOE Host: Deploy PMAC	Using the pmac-deploy script, deploy the PMAC instance using the configuration detailed by the completed NAPD. All configuration options (NetBackup or isoimagesVolSizeGB) should match the configuration of the primary PMAC. Reference Procedure 5, step 3. For this example, deploy a PMAC without the NetBackup feature. <pre>\$ cd /mnt/upgrade/upgrade \$ sudo ./pmac-deploy -guest=<Redundant_PMAC_Name> --hostname=<Redundant_PMAC_Name> --controlBridge=<TVOE_Control_Bridge> --controlIP=<Redundant_PMAC_Control_ip_address> --controlNM=<PMAC_Control_netmask> --managementBridge=<PMAC_Management_Bridge> --managementIP=<Redundant_PMAC_Management_ip_address> --managementNM=<PMAC_Management_netmask_or_prefix> --routeGW=<PMAC_Management_gateway_address> --ntpserver=<Redundant_TVOE_Management_server_ip_address></pre> The PMAC deploys and boots. The management and control network displays based on the settings provided to the pmac-deploy script.
7. <input type="checkbox"/>	Redundant PMAC's TVOE Host: Unmount media	<pre>\$ cd / \$ sudo /bin/umount /mnt/upgrade</pre>

Procedure 13. Install a Redundant PMAC

<p>8. <input type="checkbox"/></p>	<p>Redundant PMAC's TVOE Host: SSH into the redundant PMAC server</p>	<p>Using an SSH client such as putty, ssh to the TVOE host as admusr. Login using virsh, and wait until you see the login prompt :</p> <pre>\$ sudo /usr/bin/virsh list</pre> <table border="1"> <thead> <tr> <th>Id</th> <th>Name</th> <th>State</th> </tr> </thead> <tbody> <tr> <td>1</td> <td>myTPD</td> <td>running</td> </tr> <tr> <td>2</td> <td>PM&C</td> <td>running</td> </tr> <tr> <td>3</td> <td>Redundant PM&C</td> <td>running</td> </tr> </tbody> </table> <pre>\$ sudo /usr/bin/virsh console <Redundant PM&C></pre> <p>[Output Removed]</p> <pre>Starting ntdMgr: [OK] Starting atd: [OK] 'TPD Up' notification(s) already sent: [OK] upstart: Starting tpdProvd... upstart: tpdProvd started. CentOS release 6.2 (Final) Kernel 2.6.32-220.17.1.el6prere16.0.0_80.14.0.x86_64 on an x86_64 PM&Cdev7 login:</pre>	Id	Name	State	1	myTPD	running	2	PM&C	running	3	Redundant PM&C	running
Id	Name	State												
1	myTPD	running												
2	PM&C	running												
3	Redundant PM&C	running												
<p>9. <input type="checkbox"/></p>	<p>Redundant PMAC: Verify the redundant PMAC is configured correctly on first boot</p>	<ol style="list-style-type: none"> 1. Establish an SSH session to the redundant PMAC and login as admusr. 2. Run this command (there should be no output): <pre>\$ sudo /bin/ls /usr/TKLC/plat/etc/deployment.d/</pre>												
<p>10. <input type="checkbox"/></p>	<p>Redundant PMAC's TVOE Host: Error doing verification, if error displays</p>	<p>If an error displays, use this command to delete the redundant PMAC guest and re-deploy the guest again.</p> <pre>\$ sudo guestMgr -remove < Redundant PMAC_Name></pre>												
<p>11. <input type="checkbox"/></p>	<p>Redundant PMAC: Set the PMAC time zone</p>	<p>Note: Valid time zones can be found in Appendix J List of Frequently Used Time Zones.</p> <ol style="list-style-type: none"> 1. Run: <pre>\$ sudo set_pmac_tz.pl <time zone></pre> <p>Example:</p> <pre>\$ sudo set_pmac_tz.pl America/New_York</pre> <ol style="list-style-type: none"> 2. Verify the time zone has been updated. <pre>\$ sudo date</pre>												

Procedure 13. Install a Redundant PMAC

<p>12. <input type="checkbox"/></p>	<p>Redundant PMAC: Set SNMP</p>	<ol style="list-style-type: none"> 1. Enter the platcfg menu. <div style="border: 1px solid black; padding: 2px; margin: 5px 0;"> <pre>\$ sudo su - platcfg</pre> </div> 2. Navigate to Network Configuration > SNMP Configuration > NMS Configuration.  <ol style="list-style-type: none"> 3. Select Edit > Add a New NMS Server. 4. Enter all the information to complete the form about the SNMP trap destination. Refer to Appendix H SNMP Configuration for more information. 5. Click OK to finalize the configuration. 6. Click Exit. 7. Click Yes and wait until the Alarm Routing Service restarts. 8. Exit platcfg.
<p>13. <input type="checkbox"/></p>	<p>Redundant PMAC: Reboot the server</p>	<div style="border: 1px solid black; padding: 2px; margin: 5px 0;"> <pre>\$ sudo init 6</pre> </div>

Procedure 13. Install a Redundant PMAC

<p>14. <input type="checkbox"/></p>	<p>PMAC GUI: Login</p>	<p>1. Open the web browser and navigate to the PMAC GUI:</p> <div data-bbox="552 294 1388 346" style="border: 1px solid black; padding: 2px;"><code>http://<PMAC_network_IP></code></div> <p>2. Login as the guidadmin user:</p> <div data-bbox="511 409 1421 1134"></div>
-------------------------------------	-------------------------------	--

Procedure 13. Install a Redundant PMAC

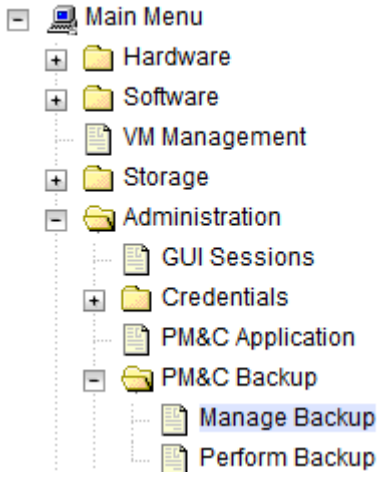
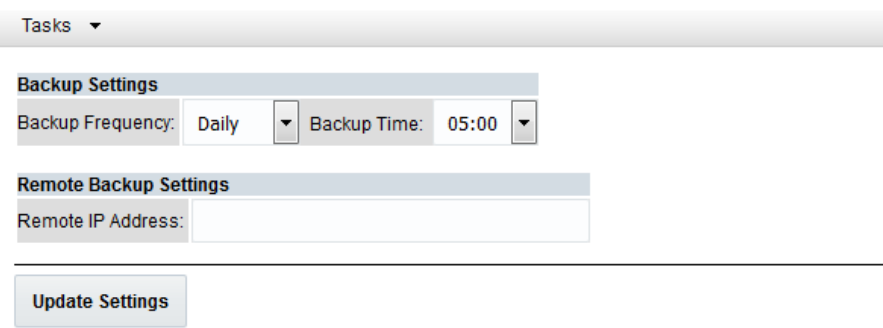
<p>15.</p> <p><input type="checkbox"/></p>	<p>PMAC GUI: Configure backups</p>	<p>1. Navigate to Administration > PM&C Backup > Manage Backup.</p>  <p>2. Configure the primary PMAC to send backups to the redundant PMAC by entering the management IP of the redundant PMAC server for the Remote IP Address.</p> <p>Main Menu: Administration -> PM&C Backup -> Manage Backup</p> 
--	---	--

Procedure 13. Install a Redundant PMAC

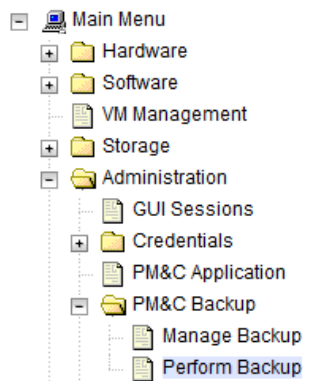
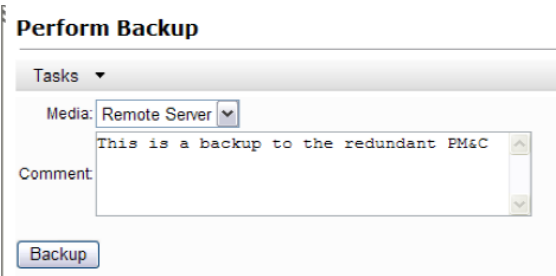
<p>16. <input type="checkbox"/></p>	<p>PMAC GUI: Perform initial backup</p>	<ol style="list-style-type: none"> Navigate to Administration > PM&C Backup > Perform Backup.  <ol style="list-style-type: none"> Select the Remote Server from the Media options Enter any desired comments Click Backup.  <ol style="list-style-type: none"> Verify the backup was successful by clicking the Task Monitoring link to monitor the backup PMAC status. <p>Note: This backup function copies existing PMAC backup files and all of the images added to the PMAC image repository from the primary PMAC server to the redundant PMAC Server.</p>
<p>17. <input type="checkbox"/></p>	<p>Primary PMAC: Un-Export the PMAC ISO image to the redundant PMAC's TVOE host server</p>	<pre>\$ sudo /usr/sbin/exportfs -u <redundant PMAC TVOE Host Control IP>:/usr/TKLC/smac/html/TPD/<PMAC_Image_Name></pre>

3.12 Virtual Machine/Network Fast Deployment

Procedure 14. Load DSR, SDS, and TPD ISOs onto the PMAC Server

S T E P #	<p>This procedure loads the DSR, SDS, and TPD ISOs onto the PMAC server.</p> <p>Note: If deploying IDIH, the IDIH ISOs can also be loaded.</p> <p>Needed Material: Application media</p> <p>Check off (✓) each step as it is completed. Boxes have been provided for this purpose under each step number.</p> <p>If this procedure fails, it is recommended to contact My Oracle Support (MOS) and ask for assistance.</p>	
1. <input type="checkbox"/>	<p>PMAC's TVOE: Load application ISO</p>	<p>Use one of the following options to add the TPD ISO image to the PMAC:</p> <p>Option 1 — Insert the CD containing the TPD image into the removable media drive.</p> <p>Option 2 — Attach the USB device containing the ISO image to a USB port.</p> <p>Option 3 — Copy the Application ISO file to the PMAC server into the /var/TKLC/smac/image/isoimages/home/smacftpusr/ directory as pmacftpusr user:</p> <p style="padding-left: 20px;">cd to the directory where your ISO image is located on the TVOE host (not on the PMAC server).</p> <p style="padding-left: 20px;">Using sftp, connect to the PMAC server.</p> <pre style="border: 1px solid black; padding: 5px;">\$ sftp pmacftpusr@<pmac_management_network_ip> \$ put <image>.iso</pre> <p style="padding-left: 20px;">After the image transfer is 100% complete, close the connection.</p> <pre style="border: 1px solid black; padding: 5px;">\$ quit</pre>

Procedure 14. Load DSR, SDS, and TPD ISOs onto the PMAC Server

<p>2. <input type="checkbox"/></p>	<p>PMAC GUI: Login</p>	<p>1. Open the web browser and navigate to the PMAC GUI:</p> <div style="border: 1px solid black; padding: 5px; width: fit-content; margin: 5px 0;"> <p>http://<PMAC_network_IP></p> </div> <p>2. Login as the guiadmin user:</p> <div style="text-align: center; margin: 20px 0;">  </div> <div style="border: 1px solid black; padding: 10px; margin: 10px auto; width: 80%;"> <p>Oracle System Login Tue Jun 7 13:49:06 2016 EDT</p> <hr/> <div style="text-align: center; border: 1px solid gray; padding: 10px; margin: 10px auto; width: 80%;"> <p>Log In Enter your username and password to log in</p> <p>Username: <input style="width: 150px;" type="text"/></p> <p>Password: <input style="width: 150px;" type="password"/></p> <p><input type="checkbox"/> Change password</p> <p><input type="button" value="Log In"/></p> </div> <p style="font-size: small; margin-top: 10px;">Unauthorized access is prohibited. This Oracle system requires the use of Microsoft Internet Explorer 9.0, 10.0, or 11.0 with support for JavaScript and cookies.</p> <hr/> <p style="font-size: x-small; text-align: center;">Oracle and Java are registered trademarks of Oracle Corporation and/or its affiliates. Other names may be trademarks of their respective owners.</p> <p style="font-size: x-small; text-align: center;">Copyright © 2010, 2016, Oracle and/or its affiliates. All rights reserved.</p> </div>						
<p>3. <input type="checkbox"/></p>	<p>PMAC GUI: Attach the software Image to the PMAC guest</p>	<p>If the ISO image was transferred directly to the PMAC guest using sftp, skip this step and continue with the next step.</p> <p>1. From the PMAC GUI, navigate to VM Management > PMAC guest > View VM Guest > Media tab.</p> <p>2. Locate the ISO image in the Available Media list and click its Attach button.</p> <div style="border: 1px solid gray; padding: 10px; margin: 10px auto; width: 90%;"> <p>Main Menu: VM Management</p> <hr/> <p>Tasks ▾</p> <div style="display: flex; justify-content: space-between;"> <div style="width: 30%;"> <p>VM Entities</p> <p>Refresh ↻</p> <ul style="list-style-type: none"> RMS: pc5010439 RMS: pc5010441 5010441PMAC Zombie_DSRD Zombie_DSRD Zombie_DSRIP Zombie_DSRN Zombie_DSRSI Zombie_DSRSI </div> <div style="width: 65%;"> <p>View guest 5010441PMAC</p> <p>VM Info Software Network Media</p> <p>Attached Media Available Media</p> <div style="border: 1px solid gray; padding: 5px; margin-top: 5px;"> <p>Available Media</p> <table border="1" style="width: 100%; border-collapse: collapse; font-size: x-small;"> <thead> <tr> <th style="width: 10%;">Attach</th> <th style="width: 40%;">Label</th> <th style="width: 50%;">Image Path</th> </tr> </thead> <tbody> <tr> <td style="text-align: center;"><input type="button" value="Attach"/></td> <td style="text-align: center;">3.2.0.0_88.18.0</td> <td style="text-align: center;">Nvar/TKLC/upgrade/TVOE-3.2.0.0_88.18.0-x86_64.iso</td> </tr> </tbody> </table> </div> </div> </div> </div>	Attach	Label	Image Path	<input type="button" value="Attach"/>	3.2.0.0_88.18.0	Nvar/TKLC/upgrade/TVOE-3.2.0.0_88.18.0-x86_64.iso
Attach	Label	Image Path						
<input type="button" value="Attach"/>	3.2.0.0_88.18.0	Nvar/TKLC/upgrade/TVOE-3.2.0.0_88.18.0-x86_64.iso						

Procedure 14. Load DSR, SDS, and TPD ISOs onto the PMAC Server

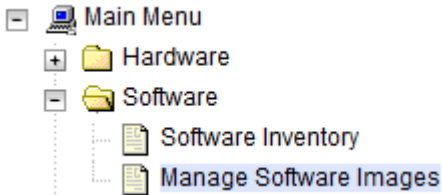
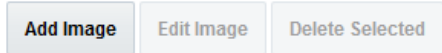
<p>4. PMAC GUI: Add TPD image</p>	<ol style="list-style-type: none"> 1. Navigate to Software > Manage Software Images. <div style="border: 1px solid #ccc; padding: 5px; margin: 5px 0;">  </div> 2. Click Add Image. 3. Select the image from the options. <div style="border: 1px solid #ccc; padding: 5px; margin: 5px 0;">  <p>If the image was supplied on a CD or a USB drive, it displays as a virtual device (device://...). These devices are assigned in numerical order as CD and USB images become available on the TVOE management server. The first virtual device is reserved for internal use by TVOE and PMAC; therefore, the ISO image of interest is normally on the second device, device://dev/sr1. If one or more CD or USB-based images was already on the management server before you started this procedure, select a correspondingly higher device number.</p> <p>If the image was transferred to PMAC using sftp, it displays in the list as a local file /var/TKLC/...</p> <div style="border: 1px solid #ccc; padding: 5px; margin: 5px 0;"> <p>Main Menu: Software -> Manage Software Images [Add Image]</p> <hr/> <p>Images may be added from any of these sources:</p> <ul style="list-style-type: none"> Oracle-provided media in the PM&C host's CD/DVD drive (Refer to Note) USB media attached to the PM&C's host (Refer to Note) External mounts. Prefix the directory with "extfile://". These local search paths: <ul style="list-style-type: none"> /var/TKLC/upgrade/* .iso /var/TKLC/smac/image/isoimages/home/smacftpusr/* .iso <p>Note: CD and USB images mounted on PM&C's VM host must first be made accessible to the PM&C VM</p> <p>Path: <input type="text" value="/var/TKLC/upgrade/DSR-8.0.0.0.0_80.4.0-x86_64.iso"/></p> <p>Description: <input type="text"/></p> <hr/> <p>Add New Image Cancel</p> </div> </div> 4. Select the appropriate path and click Add New Image. 5. Check the progress clicking the Task Monitoring link. Observe the green bar indicating success. 6. Once complete, remove the TPD Media from the optical drive of the management server.
--	--

Procedure 14. Load DSR, SDS, and TPD ISOs onto the PMAC Server

5. <input type="checkbox"/>	PMAC GUI: Load DSR ISO	If the DSR ISO has not been loaded onto the PMAC already, repeat steps 1. through 4. to load it using the DSR media or ISO.
6. <input type="checkbox"/>	PMAC GUI: Load SDS ISO	If the SDS ISO has not been loaded onto the PMAC already, repeat steps 1. through 4. to load it using the SDS media or ISO.

Procedure 15. Execute VM/Network Fast Deployment

S T E P #	<p>This procedure creates network bond interfaces and bridges, sets TVOE host NTP servers, and creates virtual machines.</p> <p>Note: Refer to section 3.10 for VM placement.</p> <p>Prerequisites:</p> <ul style="list-style-type: none"> TVOE has been installed and configured on the target RMS DSR ISO has been loaded onto PMAC <p>Check off (✓) each step as it is completed. Boxes have been provided for this purpose under each step number.</p> <p>If this procedure fails, it is recommended to contact My Oracle Support (MOS) and ask for assistance.</p>	
1. <input type="checkbox"/>	PMAC: Login	Establish an SSH session to the PMAC server and login as admusr .
2. <input type="checkbox"/>	PMAC: Transfer script and supporting files	<p>1. Copy script and supporting files from the DSR iso.</p> <pre style="border: 1px solid black; padding: 5px;">\$ sudo rsync -avz --exclude cpuset.py --exclude irqtune.sh --exclude tuned_tvov.tar /usr/TKLC/smac/html/TPD/<DSR ISO loaded previous procedure>/upgrade/overlay/RMS/ /usr/TKLC/smac/etc/RMS/</pre> <p>2. Change permissions.</p> <pre style="border: 1px solid black; padding: 5px;">\$ sudo chmod 777 /usr/TKLC/smac/etc/RMS/*</pre>
3. <input type="checkbox"/>	PMAC: Edit/Update configuration file	<p>1. Change directory.</p> <pre style="border: 1px solid black; padding: 5px;">\$ cd /usr/TKLC/smac/etc/RMS/</pre> <p>2. Edit/Update the configuration file (rms.cfg). Read all notes shown here before editing the file.</p> <p>Notes:</p> <ul style="list-style-type: none"> Comment out configuration items that are not needed. Create a separate configuration file for each rack mount server being deployed. The cabinet ID in the configuration file needs to match the cabinet added in Procedure 10. <p>The following items are mandatory:</p> <ul style="list-style-type: none"> siteName

Procedure 15. Execute VM/Network Fast Deployment

		<ul style="list-style-type: none"> • <code>tpdlso</code> • <code>dsrlso</code> (if DSR VMs are being configured) • <code>sds Iso</code> (if SDS VMs are being configured) • <code>NETWORK_xmi</code> (if DSR/SDS NOAM/DRNOAMs are being configured) • <code>XMIGATEWAY</code> (if DSR/SDS NOAM/DRNOAMs are being configured) • <code>XMISUBNETMASK</code> (if DSR/SDS NOAM/DRNOAMs are being configured) • <code>DSRNOAM1XMIIPADDRESS</code> (if DSRNOAM1 is being configured) • <code>DSRNOAM2XMIIPADDRESS</code> (if DSRNOAM2 is being configured) • <code>DSRDRNOAM1XMIIPADDRESS</code> (if DSRDRNOAM1 is being configured) • <code>DSRDRNOAM2XMIIPADDRESS</code> (if DSRDRNOAM2 is being configured) • <code>SDSNOAM1XMIIPADDRESS</code> (if SDSNOAM1 is being configured) • <code>SDSNOAM2XMIIPADDRESS</code> (if SDSNOAM2 is being configured) • <code>SDSDRNOAM1XMIIPADDRESS</code> (if SDSDRNOAM1 is being configured) • <code>SDSDRNOAM2XMIIPADDRESS</code> (if SDSDRNOAM2 is being configured) <p>Notes:</p> <ul style="list-style-type: none"> • Refer to Appendix R VM Automation Profile Values for DSR and SDS profile values with the configuration file. • Comment out SDS and DSR profile items if coresponding products are not used. • Non-HA Lab Node Installations Only-Oracle X5-2/Netra X5-2/X6-2/HP DL380 Gen 9: Refer to Appendix Q.3 Non-HA Lab Node VM Automation Profile Values for DSR and SDS profile values with the configuration file. • The VM names should not be modified in the <code>.cfg</code> file. The names are fixed and are prefixed in the <code>siteName</code>. • The VM locations should not be changed from their RMSx format. Each RMS should correspond with a separate rack mount server. • Do not change the network bond interfaces from their bondx.x format. If <code>bond1</code> was previously created for segregated signaling, update the bond interface to reflect the base bond interface (for example, <code>bond0.x</code> or <code>bond1.x</code>). <p>3. To receive the iso names for tpdlso, dsrlso, and sds Iso, execute this command:</p> <pre style="border: 1px solid black; padding: 5px; width: fit-content; margin: 10px auto;">\$ ls /var/TKLC/smac/image/repository</pre> <p>Note: DO NOT append <code>.iso</code> to the image name.</p>
4.	<input type="checkbox"/> PMAC: Rename/Transfer configuration file	Rename/Copy each of the above created configuration files to <hostname>.cfg and transferred to an external server for disaster recovery purposes.

Procedure 15. Execute VM/Network Fast Deployment

<p>5. <input type="checkbox"/></p>	<p>PMAC: Execute the config.sh script with the config file</p>	<p>Note: If this command is executed on multiple cfg files, it overwrites the existing xml file. Rename the xml file before running this command again.</p> <pre>\$ sudo ./config.sh <config file></pre> <p>Sample output:</p> <pre>[admusr@5010441PMAC RMS]\$ sudo ./config.sh rms.cfg Validating cfg file... Successful validation of cfg file. Added Cabinet 101 to Fast Deployment File. Added Zombie_TVOE1 to Fast Deployment File. Added Zombie_TVOE2 to Fast Deployment File. Added xmi(bond0.4) to Fast Deployment File. Added imi(bond0.3) to Fast Deployment File. Added rep(bond1.10) to Fast Deployment File. Added xsi1(bond1.6) to Fast Deployment File. Added xsi2(bond1.7) to Fast Deployment File. Added xsi3(bond1.8) to Fast Deployment File. Added xsi4(bond1.9) to Fast Deployment File. Added xsi5(bond1.11) to Fast Deployment File. Added xsi6(bond1.12) to Fast Deployment File. Added xsi7(bond1.13) to Fast Deployment File. Added xsi8(bond1.14) to Fast Deployment File. Added xsi9(bond1.15) to Fast Deployment File. Added xsi10(bond1.16) to Fast Deployment File. Added xsi11(bond1.17) to Fast Deployment File. Added xsi12(bond1.18) to Fast Deployment File. Added xsi13(bond1.19) to Fast Deployment File. Added xsi14(bond1.20) to Fast Deployment File. Added xsi15(bond1.21) to Fast Deployment File. Added xsi16(bond1.22) to Fast Deployment File. Added Zombie_DSRNOAM1 to Fast Deployment File. Added Zombie_DSRNOAM2 to Fast Deployment File. Added Zombie_DSRDRNOAM1 to Fast Deployment File. Added Zombie_DSRDRNOAM2 to Fast Deployment File. Added Zombie_SDSNOAM1 to Fast Deployment File. Added Zombie_SDSNOAM2 to Fast Deployment File. Added Zombie_SSDRNOAM1 to Fast Deployment File. Added Zombie_SSDRNOAM2 to Fast Deployment File. Added Zombie_DSRSOAM1 to Fast Deployment File. Added Zombie_DSRSOAM2 to Fast Deployment File. Added Zombie_SDSSOAM1 to Fast Deployment File. Added Zombie_SDSSOAM2 to Fast Deployment File. Added Zombie_DSRDAMP1 to Fast Deployment File. Added Zombie_DSRDAMP2 to Fast Deployment File. Added Zombie_DSRIPFE1 to Fast Deployment File. Added Zombie_DSRIPFE2 to Fast Deployment File. Added Zombie_SSDPSV1 to Fast Deployment File. Added Zombie_SSDPSV2 to Fast Deployment File. Validating Fast Deployment File..... Validate configuration file: "Zombie_DSR_Fast_Deployment_06-15-16.xml" Configuration file validation successful. Validation complete Successful Validation of Zombie_DSR_Fast_Deployment_06-15-16.xml SUCCESS: OPERATION SUCCESS!! [admusr@5010441PMAC RMS]\$</pre>
------------------------------------	---	--

Procedure 15. Execute VM/Network Fast Deployment

6. <input type="checkbox"/>	PMAC: Run fast deployment	<p>With the file generated from the config.sh script, execute this command to start fast deployment.</p> <pre>\$ screen \$ sudo fdconfig config --file=<fd_config.xml></pre> <p>Example:</p> <pre>\$ sudo fdconfig config --file=tvoc-ferbrms4_01-22-15.xml</pre> <p>Note: This is a long duration command (45-90 minutes). If the screen command was run before executing fdconfig, perform a screen -dr to resume the screen session in the event of a terminal timeout, etc</p>
--------------------------------	----------------------------------	---

Procedure 15. Execute VM/Network Fast Deployment

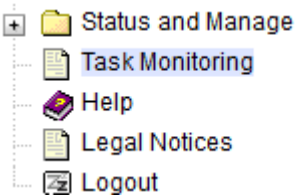
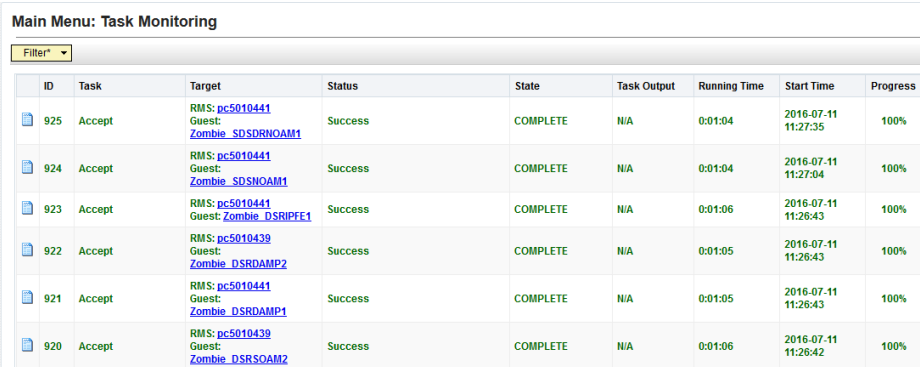
7.	<p>PMAC GUI: Monitor the configuration</p>	<ol style="list-style-type: none"> 1. If not already done so, establish a GUI session on the PMAC server. 2. Navigate to Task Monitoring. <div style="margin-left: 20px;">  </div> 3. Monitor the configuration to completion. <div style="margin-left: 20px;">  </div> <p>Note: If a failure occurs with fdconfig, logs can be accessed in /var/TKLC/log/fdconfig/fdconfig.log.</p> <pre>[admusr@melbourne-pmac-1 fdconfig]\$ sudo fdconfig dumpsteps -- file=deploy_melbourne_20170329T202458_701b.fdcdb Dump Steps in file: "deploy_melbourne_20170329T202458_701b.fdcdb" Here are the steps that were generated ----- begin ----- Dump of DB steps: NUM PHS DLY INFRA ID SVRTYPE CMD ELEMENT PRE STATE TO BGTS COMMAND TEXT ----- 1 1 0 pmac Fast_Deployment 0 21 0 Complete 300 0 Check PM&C is available 2 1 0 pmac Fast_Deployment 0 1 1 1 Skipped 300 0 Add Cabinet 3 1 0 pmac Fast_Deployment 0 3 melbourne_RMS3 1 Skipped 900 0 Add Rms 4 2 0 pmac Fast_Deployment 1</pre> <ol style="list-style-type: none"> 4. Run Below command to restart the fdconfig after a failure has occurred and has been resolved: <div style="margin-left: 20px; border: 1px solid black; padding: 5px; width: fit-content;"> <pre>\$ sudo fdconfig restart -- file=deploy_melbourne_20170329T202458_701b.fdcdb</pre> </div>
----	---	--

Procedure 15. Execute VM/Network Fast Deployment

<p>8. <input type="checkbox"/></p>	<p>PMAC: Repeat for each rack mount server configuration file</p>	<p>Repeat steps 4. through 7. for each rack mount server/configuration file created from step 3.</p>
<p>9. <input type="checkbox"/></p>	<p>PMAC: Back up FDC file</p>	<p>Create the fdc directory so the fdc file is backed up by PMAC.</p> <ol style="list-style-type: none"> 1. Create the fdc backup directory. <pre>\$ sudo /bin/mkdir -p /usr/TKLC/smac/etc/fdc</pre> 2. Change permissions. <pre>\$ sudo chmod 777 /usr/TKLC/smac/etc/fdc</pre> 3. Copy the fdc file to the fdc backup directory. <pre>\$ sudo cp /usr/TKLC/smac/etc/RMS/<fdc_file> /usr/TKLC/smac/etc/fdc/</pre> <p>Note: The fdc file referred to here is the rms.cfg file.</p> 4. Rename it to <hostname>.cfg to identify the correct fdc file during disaster recovery procedure. <pre>\$ sudo mv /usr/TKLC/smac/etc/fdc/<fdc_file> /usr/TKLC/smac/etc/fdc/<hostname.cfg></pre>

3.13 CPU Pinning

Notes:

- Skip this section if deploying a non-HA lab node of DL380 Gen system
- **HP DL380 Gen 8:** Skip this procedure

Procedure 16. Load DSR, SDS, and TPD ISOs onto the PMAC Server

<p>S T E P #</p>	<p>This procedure configures VM CPU socket pinning on each TVOE host to optimize performance. Prerequisite: Have already created VM guests Check off (✓) each step as it is completed. Boxes have been provided for this purpose under each step number. If this procedure fails, it is recommended to contact My Oracle Support (MOS) and ask for assistance.</p>	
<p>1. <input type="checkbox"/></p>	<p>Obtain CPU socket pinning information</p>	<p>Obtain CPU socket pinning information by referring to the data gathered in section 3.10. Note: For HP DL380 Gen 9 equipped with 1Gbps NICs, obtain the CPU socket pinning information from Appendix S VM Placement in HP DL380 Gen 8/Gen 9 (Onboard 1Gbps NICs) and CPU Pinning in HP DL380 Gen 9 (Onboard 1Gbps NICs).</p>
<p>2. <input type="checkbox"/></p>	<p>TVOE Host: Login</p>	<p>Establish an SSH session to the TVOE host and login as admusr.</p>
<p>3. <input type="checkbox"/></p>	<p>TVOE Host: Execute the CPU</p>	<ol style="list-style-type: none"> 1. Allocate CPU sets for each (including the PMACs) configured VM. <pre>\$ cd /var/TKLC/upgrade</pre>

Procedure 16. Load DSR, SDS, and TPD ISOs onto the PMAC Server

pinning script	<p>2. Print the current CPU pinning allocations.</p> <pre style="border: 1px solid black; padding: 5px;">\$ sudo ./cpuset.py --show</pre> <p>Expected output:</p> <pre>[admusr@Discovery-TVOE-4 ~]\$ sudo ./cpuset.py --show VM Domain Name vcpus cpuset numa state ----- Discovery-IPFEA2 4 None None running Discovery-DAMP9 12 None None running Discovery-DAMP8 12 None None running Discovery-DAMP12 12 None None running Discovery-DAMP11 12 None None running NUMA node 0 Free CPUs: count = 32 [2, 3, 4, 5, 6, 7, 8, 9, 10, 11, 12, 13, 14, 15, 16, 17, 38, 39, 40, 41, 42, 43, 44, 45, 46, 47, 48, 49, 50, 51, 52, 53] NUMA node 1 Free CPUs: count = 36 [18, 19, 20, 21, 22, 23, 24, 25, 26, 27, 28, 29, 30, 31, 32, 33, 34, 35, 54, 55, 56, 57, 58, 59, 60, 61, 62, 63, 64, 65, 66, 67, 68, 69, 70, 71]</pre> <p>Notes:</p> <p>There is known issue with PMAC in this release. PMAC uses all CPUs in the NUMA 0. PMAC will fix this issue in next release.</p> <p>If this is the case, the command output displays NUMA Node 0 free CPUs count as 0.</p> <pre>NUMA node 0 Free CPUs: count = 0 []</pre> <ul style="list-style-type: none"> • Clear the NUMA 0 and pin the CPU again. <pre style="border: 1px solid black; padding: 5px;">\$ sudo ./cpuset.py --clear=<PMAC Name></pre> <p>For example:</p> <pre style="border: 1px solid black; padding: 5px;">\$ sudo ./cpuset.py --clear=Sterling-PMAC</pre> <ul style="list-style-type: none"> • Set the CPU again for PMAC instance. <pre style="border: 1px solid black; padding: 5px;">\$ sudo ./cpuset.py --set=<PMAC Name> --numa=0</pre> <p>For example:</p> <pre style="border: 1px solid black; padding: 5px;">\$ sudo ./cpuset.py --set= Sterling-PMAC --numa=0 Successful. Domain Sterling-PMAC must be restarted for changes to take affect.</pre> <p>3. Allocate CPU pinning on each VM.</p> <pre style="border: 1px solid black; padding: 5px;">\$ sudo ./cpuset.py --set=<VM Name> --numa=<0/1></pre> <p>Example:</p> <pre>[admusr@Discovery-TVOE-4 ~]\$ sudo ./cpuset.py - set=Discovery-IPFEA2 -numa=0 Successful. Domain Discovery-IPFEA2 must be restarted for changes to take affect [admusr@Discovery-TVOE-4 ~]\$ sudo ./cpuset.py --show</pre>
----------------	--

Procedure 16. Load DSR, SDS, and TPD ISOs onto the PMAC Server

		<pre> VM Domain Name vcpus cpuset numa state ----- Discovery-IPFEA2 4 2-3,38-39 0 running Discovery-DAMP9 12 None None running Discovery-DAMP8 12 None None running Discovery-DAMP12 12 None None running Discovery-DAMP11 12 None None running NUMA node 0 Free CPUs: count = 28 [4, 5, 6, 7, 8, 9, 10, 11, 12, 13, 14, 15, 16, 17, 40, 41, 42, 43, 44, 45, 46, 47, 48, 49, 50, 51, 52, 53] NUMA node 1 Free CPUs: count = 36 [18, 19, 20, 21, 22, 23, 24, 25, 26, 27, 28, 29, 30, 31, 32, 33, 34, 35, 54, 55, 56, 57, 58, 59, 60, 61, 62, 63, 64, 65, 66, 67, 68, 69, 70, 71] </pre> <p>Notes:</p> <ul style="list-style-type: none"> • If deploying IDIH, note the CPU pinning allocations since CPU pinning will be done as part of IDIH configuration (section 3.16). • To clear pinning, execute this command on each VM, as necessary. <pre>\$ sudo ./cpuset.py --clear=<VM NAME></pre> <p>Example:</p> <pre>[admusr@Sterling-TVOE-4 admusr]# sudo ./cpuset.py - clear=Sterling2So-DA-MP4</pre>
<p>4. <input type="checkbox"/></p>	<p>Restart the TVOE host</p>	<pre>\$ sudo init 6</pre>

Procedure 16. Load DSR, SDS, and TPD ISOs onto the PMAC Server

<p>5. <input type="checkbox"/></p>	<p>TVOE Host: Verify CPU pinning</p>	<p>1. Once the TVOE host is restarted, establish an SSH session to the TVOE host and login as admusr.</p> <p>2. Verify the CPU pinning is allocated by executing the following commands.</p> <pre style="border: 1px solid black; padding: 2px;">\$ cd /var/TKLC/upgrade</pre> <p>3. Print the current CPU pinning allocations.</p> <pre style="border: 1px solid black; padding: 2px;">\$ sudo ./cpuset.py --show</pre> <p>Expected output:</p> <pre>[admusr@Discovery-TVOE-4 ~]\$ sudo ./cpuset.py - set=Discovery-DAMP8 -cpuset=4-9,40-45 Successful. Domain Discovery-DAMP8 must be restarted for changes to take affect [admusr@Discovery-TVOE-4 ~]\$ sudo ./cpuset.py --show VM Domain Name vcpus cpuset numa state ----- Discovery-IPFEA2 4 2-3,38-39 0 running Discovery-DAMP9 12 18-23,54-59 1 running Discovery-DAMP8 12 4-9,40-45 0 running Discovery-DAMP12 12 None None running Discovery-DAMP11 12 None None running NUMA node 0 Free CPUs: count = 16 [10, 11, 12, 13, 14, 15, 16, 17, 46, 47, 48, 49, 50, 51, 52, 53] NUMA node 1 Free CPUs: count = 24 [24, 25, 26, 27, 28, 29, 30, 31, 32, 33, 34, 35, 60, 61, 62, 63, 64, 65, 66, 67, 68, 69, 70, 71]</pre>
<p>6. <input type="checkbox"/></p>	<p>Repeat for each TVOE host</p>	<p>Repeat this procedure for each TVOE host.</p>

3.14 DSR Application Configuration

3.14.1 NOAM Configuration

Procedure 17. Configure First DSR NOAM NE and Server

S T E P #	<p>This procedure configures the first DSR NOAM network element and server.</p> <p>Check off (✓) each step as it is completed. Boxes have been provided for this purpose under each step number.</p> <p>If this procedure fails, it is recommended to contact My Oracle Support (MOS) and ask for assistance.</p>	
1. <input type="checkbox"/>	<p>Save the NOAM network data to an XML file</p>	<ol style="list-style-type: none"> 1. Use a text editor to create a NOAM network element file that describes the networking of the target install environment of your first NOAM server. 2. Select an appropriate file name and save the file to a known location on your computer. <p>A suggested filename format is Appname_NName_NetworkElement.XML. For example, a DSR2 NOAM network element XML file would have a DSR2_NOAM_NetworkElement.xml filename.</p> <p>Alternatively, you can update the sample DSR network element file. It can be found on the management server at:</p> <div style="border: 1px solid black; padding: 5px; margin: 10px 0;"> <pre>/usr/TKLC/smac/html/TPD/<DSR Release>/upgrade/overlay/SAMPLE-NetworkElement.xml</pre> </div> <p>A sample XML file can also be found in Appendix L Sample Network Element.</p> <p>Note: These limitations apply when specifying a network element name:</p> <ul style="list-style-type: none"> • A 1-32-character string. • Valid characters are alphanumeric and underscore. • Must contain at least one alpha and must not start with a digit.

Procedure 17. Configure First DSR NOAM NE and Server

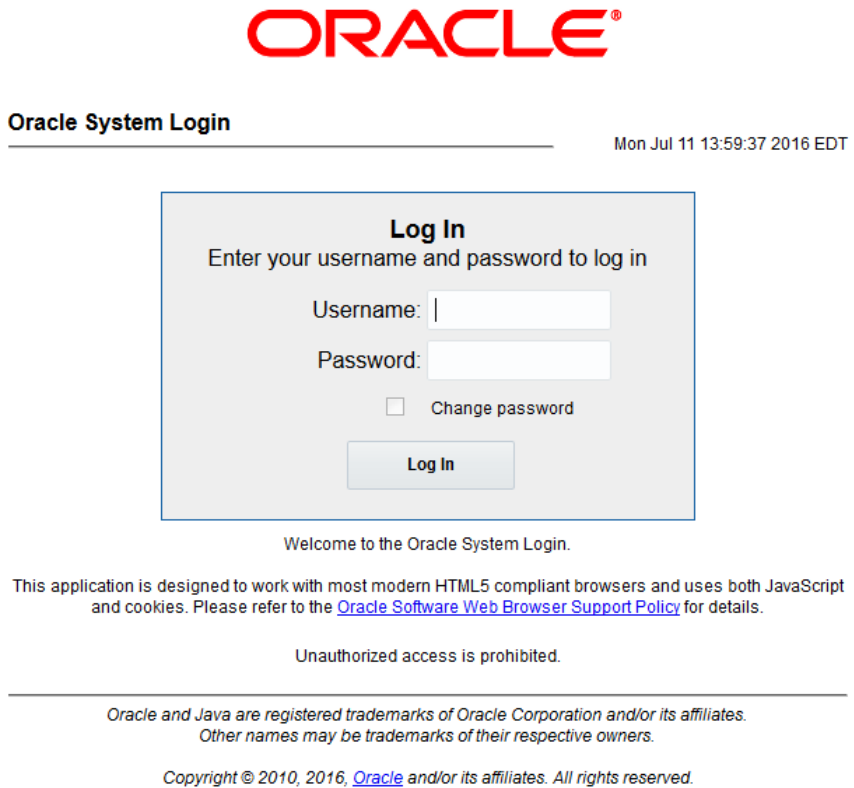
<p>2. <input type="checkbox"/></p>	<p>NOAM VIP GUI: Login</p>	<p>1. Establish a GUI session on the NOAM server by using the VIP IP address of the NOAM server (defined and configured in the DSR fast deployment rms.cfg file). Open the web browser and enter a URL of:</p> <div data-bbox="548 352 1393 401" style="border: 1px solid black; padding: 5px; margin: 10px 0;"> <p>https://<Primary_NOAM_VIP_IP_Address></p> </div> <p>2. Login as the guiadmin user.</p> <div data-bbox="532 478 1380 1260" style="text-align: center;">  </div>
------------------------------------	---------------------------------------	--

Procedure 17. Configure First DSR NOAM NE and Server

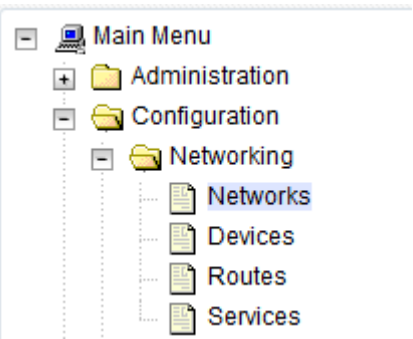
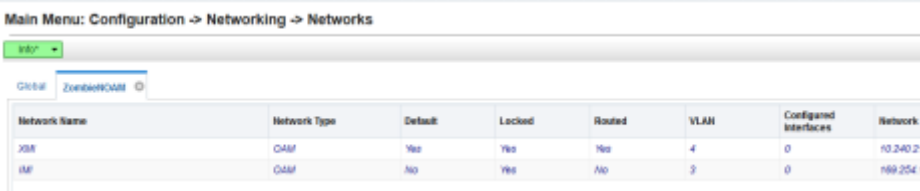
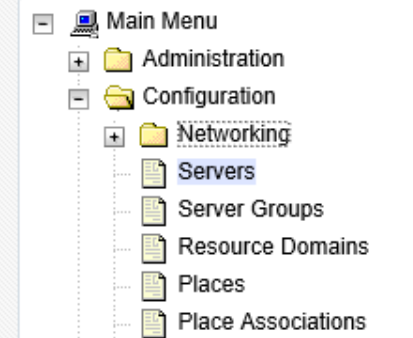
<p>3. <input type="checkbox"/></p>	<p>Create the NOAM network element using the XML file</p>	<p>1. Navigate to Configuration > Networking > Networks.</p>  <p>2. Click Browse and type the pathname to the NOAM network XML file.</p> <p>To create a new Network Element, upload a valid configuration file:</p> <p><input type="button" value="Browse..."/> zombie.xml <input type="button" value="Upload File"/></p> <p>Copyright © 2010, 2016, Oracle and/or its affiliates. All rights reserved.</p> <p>3. Click Upload File to upload the XML file and configure the NOAM network element.</p> <p>4. Once the data has been uploaded, a tab displays with the name of your network element. Click this tab to display a screen with the individual networks that are now configured.</p> 												
<p>4. <input type="checkbox"/></p>	<p>Map services to networks</p>	<p>1. Navigate to Configuration > Services.</p>  <p>2. Click Edit and set the services as shown in the table.</p> <table border="1" data-bbox="505 1707 1403 1894"> <thead> <tr> <th>Name</th> <th>Intra-NE Network</th> <th>Inter-NE Network</th> </tr> </thead> <tbody> <tr> <td>OAM</td> <td><IMI Network></td> <td><XMI Network></td> </tr> <tr> <td>Replication</td> <td><IMI Network></td> <td><XMI Network></td> </tr> <tr> <td>Signaling</td> <td>Unspecified</td> <td>Unspecified</td> </tr> </tbody> </table>	Name	Intra-NE Network	Inter-NE Network	OAM	<IMI Network>	<XMI Network>	Replication	<IMI Network>	<XMI Network>	Signaling	Unspecified	Unspecified
Name	Intra-NE Network	Inter-NE Network												
OAM	<IMI Network>	<XMI Network>												
Replication	<IMI Network>	<XMI Network>												
Signaling	Unspecified	Unspecified												

Procedure 17. Configure First DSR NOAM NE and Server

HA_Secondary	Unspecified	Unspecified
HA_MP_Secondary	Unspecified	Unspecified
Replication_MP	<IMI Network>	Unspecified
ComAgent	<IMI Network>	Unspecified

For example, if your IMI network is named **IMI** and your XMI network is named **XMI**, then your services config should look like the following:



Name	Intra-NE Network	Inter-NE Network
OAM	INTERNALIMI	INTERNALXMI
Replication	INTERNALIMI	INTERNALXMI
Signaling	Unspecified	Unspecified
HA_Secondary	Unspecified	Unspecified
HA_MP_Secondary	Unspecified	Unspecified
Replication_MP	INTERNALIMI	Unspecified
ComAgent	INTERNALIMI	Unspecified

3. Click **OK** to apply the Service-to-Network selections.
4. Click **OK** when asked to restart all servers.

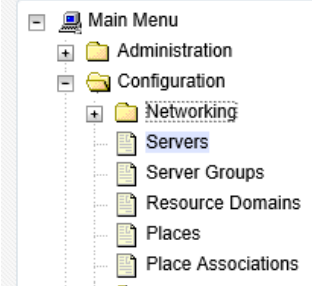
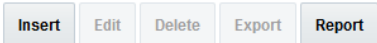
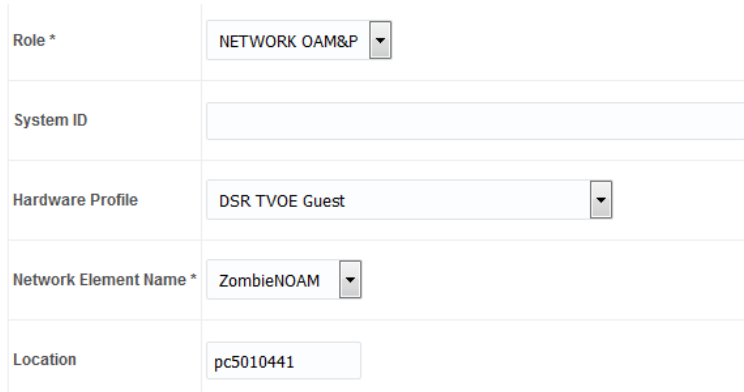

The page at https://localhost says:

You must restart all Servers to apply any services changes, ComAgent

Procedure 17. Configure First DSR NOAM NE and Server

<p>5. <input type="checkbox"/> Insert the 1st NOAM server</p>	<p>1. Navigate to Configuration > Servers.</p>  <p>2. Click Insert to insert the new NOAM server into servers table.</p>  <p>3. Enter these values:</p> <p>Hostname: <Hostname> Role: Network OAM System ID: <Site System ID> Hardware Profile: DSR TVOE Guest Network Element Name: [Select NE] Location: <Enter an optional location description></p>  <p>4. For the XMI network, type the server XMI IP address. Select the xmi interface. Leave the VLAN checkbox unmarked.</p> <p>5. For the IMI network, type the server IMI IP address. Select the xmi interface. Leave the VLAN checkbox unmarked.</p>  <p>6. Add this NTP server:</p> <table border="1" style="width: 100%; border-collapse: collapse; margin-top: 10px;"> <thead> <tr style="background-color: #e1eef6;"> <th style="text-align: left;">NTP Server</th> <th style="text-align: left;">Preferred?</th> </tr> </thead> <tbody> <tr> <td>First-NOAM-TVOE-IP-Address></td> <td>Yes</td> </tr> </tbody> </table> <p>7. Click OK.</p>	NTP Server	Preferred?	First-NOAM-TVOE-IP-Address>	Yes
NTP Server	Preferred?				
First-NOAM-TVOE-IP-Address>	Yes				

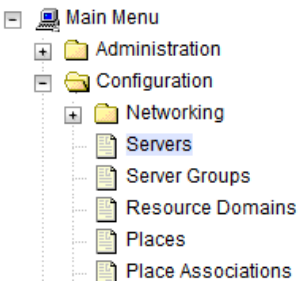
Procedure 17. Configure First DSR NOAM NE and Server

<p>6. <input type="checkbox"/></p>	<p>Export the initial configuration</p>	<p>1. Navigate to Configuration > Servers.</p>  <p>2. From the GUI screen, select the NOAM server and click Export to generate the initial configuration data for that server.</p> 
<p>7. <input type="checkbox"/></p>	<p>NOAM: Copy configuration file to 1st NOAM server</p>	<p>1. Using the xmi IP address defined and configured in the DSR fast deployment configuration file (rms.cfg), establish an SSH session to the 1st NOAM server and login as admusr.</p> <p>2. Copy the configuration file created in the previous step from the /var/TKLC/db/filemgmt directory on the 1st NOAM to the /var/tmp directory.</p> <p>The configuration file has a filename like TKLCConfigData.<hostname>.sh. The following is an example:</p> <pre style="border: 1px solid black; padding: 5px;">\$ sudo cp /var/TKLC/db/filemgmt/TKLCConfigData.blade01.sh /var/tmp/TKLCConfigData.sh</pre> <p>Note: The file in /var/tmp/ directory MUST be TKLCConfigData.sh.</p> <p>The automatic configuration daemon looks for the TKLCConfigData.sh file in the /var/tmp directory, implements the configuration in the file, and asks the user to reboot the server.</p>
<p>8. <input type="checkbox"/></p>	<p>NOAM: Wait for configuration to complete</p>	<p>Wait to be prompted to reboot the server, but DO NOT reboot the server, it is rebooted later in this procedure.</p> <p>Note: Ignore the warning about removing the USB key, since no USB key is present.</p>
<p>9. <input type="checkbox"/></p>	<p>SDS NOAM iLO: Set the time zone and reboot the server</p>	<p>Note: Valid time zones can be found in Appendix J List of Frequently Used Time Zones.</p> <p>1. Run:</p> <pre style="border: 1px solid black; padding: 5px;">\$ sudo set_pmac_tz.pl <time zone></pre> <p>Example:</p> <pre>\$ sudo set_pmac_tz.pl America/New_York</pre> <p>2. Reboot the server.</p> <pre style="border: 1px solid black; padding: 5px;">\$ sudo init 6</pre>

Procedure 17. Configure First DSR NOAM NE and Server

10. <input type="checkbox"/>	MP Server: Verify server health	<p>Login as admusr to the first SDS NOAM server and make sure no errors are returned.</p> <pre style="border: 1px solid black; padding: 5px;">\$ sudo syscheck Running modules in class hardware...OK Running modules in class disk...OK Running modules in class net...OK Running modules in class system...OK Running modules in class proc...OK LOG LOCATION: /var/TKLC/log/syscheck/fail_log</pre>
---------------------------------	--	---

Procedure 18. Configure the DSR NOAM Server Group

S T E P #	<p>This procedure configures the DSR NOAM server group.</p> <p>Check off (✓) each step as it is completed. Boxes have been provided for this purpose under each step number.</p> <p>If this procedure fails, it is recommended to contact My Oracle Support (MOS) and ask for assistance.</p>	
1. <input type="checkbox"/>	NOAM VIP GUI: Login	<ol style="list-style-type: none"> Establish a GUI session on the NOAM server by using the VIP IP address of the NOAM server. Open the web browser and enter a URL of: <div style="border: 1px solid black; padding: 2px; margin: 5px 0;"> <pre>https://<Primary_NOAM_XMI_VIP_IP_Address></pre> </div> Login as the guiadmin user. <div style="text-align: center; margin: 10px 0;">  </div> <div style="text-align: center;"> <p>Oracle System Login</p> <hr style="width: 60%; margin: 0 auto;"/> <p style="text-align: right; font-size: small;">Mon Jul 11 13:59:37 2016 EDT</p> </div> <div style="text-align: center; margin: 10px 0;"> <div style="border: 1px solid gray; padding: 10px; width: fit-content; margin: 0 auto;"> <p style="margin: 0;">Log In</p> <p style="margin: 0;">Enter your username and password to log in</p> <p style="margin: 5px 0;">Username: <input style="width: 100%;" type="text"/></p> <p style="margin: 5px 0;">Password: <input style="width: 100%;" type="password"/></p> <p style="margin: 5px 0;"><input type="checkbox"/> Change password</p> <p style="text-align: center; margin: 10px 0;"><input type="button" value="Log In"/></p> </div> <p style="margin: 5px 0; font-size: small;">Welcome to the Oracle System Login.</p> <p style="margin: 5px 0; font-size: x-small;">This application is designed to work with most modern HTML5 compliant browsers and uses both JavaScript and cookies. Please refer to the Oracle Software Web Browser Support Policy for details.</p> <p style="margin: 5px 0; font-size: x-small;">Unauthorized access is prohibited.</p> <hr style="width: 60%; margin: 10px auto;"/> <p style="margin: 5px 0; font-size: x-small;">Oracle and Java are registered trademarks of Oracle Corporation and/or its affiliates. Other names may be trademarks of their respective owners.</p> <p style="margin: 5px 0; font-size: x-small;">Copyright © 2010, 2016, Oracle and/or its affiliates. All rights reserved.</p> </div>

Procedure 18. Configure the DSR NOAM Server Group

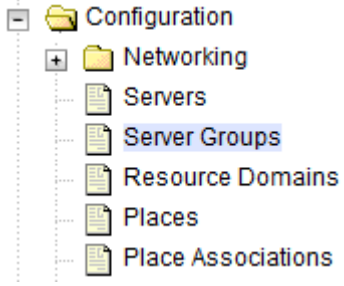
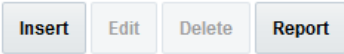
<p>2. <input type="checkbox"/></p>	<p>NOAM GUI: Enter the NOAM server group data</p>	<p>1. Navigate to Configuration > Server Groups.</p>  <p>2. Click Insert.</p>  <p>3. Enter these values:</p> <p>Server Group Name: <Server Group Name> Level: A Parent: None Function: DSR (Active/Standby Pair) WAN Replication Connection Count: Use Default Value</p> <p>Adding new server group</p> <table border="1" style="width: 100%; border-collapse: collapse;"> <thead> <tr> <th style="width: 30%;">Field</th> <th style="width: 40%;">Value</th> <th style="width: 30%;">Desc</th> </tr> </thead> <tbody> <tr> <td>Server Group Name *</td> <td>ZombieNOAM</td> <td>Uniqu requir</td> </tr> <tr> <td>Level *</td> <td>A</td> <td>Selec</td> </tr> <tr> <td>Parent *</td> <td>NONE</td> <td>Selec</td> </tr> <tr> <td>Function *</td> <td>DSR (active/standby pair)</td> <td>Selec</td> </tr> <tr> <td>WAN Replication Connection Count</td> <td>1</td> <td>Speci</td> </tr> </tbody> </table> <p>Ok Apply Cancel</p> <p>4. Click OK.</p>	Field	Value	Desc	Server Group Name *	ZombieNOAM	Uniqu requir	Level *	A	Selec	Parent *	NONE	Selec	Function *	DSR (active/standby pair)	Selec	WAN Replication Connection Count	1	Speci
Field	Value	Desc																		
Server Group Name *	ZombieNOAM	Uniqu requir																		
Level *	A	Selec																		
Parent *	NONE	Selec																		
Function *	DSR (active/standby pair)	Selec																		
WAN Replication Connection Count	1	Speci																		

Procedure 18. Configure the DSR NOAM Server Group

<p>3. <input type="checkbox"/> NOAM GUI: Edit the NOAM server group</p>	<p>1. Navigate to Configuration > Server Groups.</p>  <p>2. Select the new server group and click Edit.</p>  <p>3. Select the network element that represents the NOAM.</p> <p>4. Mark the Include in SG checkbox for the NOAM server.</p> <p>5. Leave other checkboxes blank.</p> <table border="1" data-bbox="509 835 1419 953"> <thead> <tr> <th>Server</th> <th>SG Inclusion</th> <th>Preferred HA Role</th> </tr> </thead> <tbody> <tr> <td>ZombieNOAM1</td> <td><input checked="" type="checkbox"/> Include in SG</td> <td><input type="checkbox"/> Prefer server as spare</td> </tr> </tbody> </table> <p>6. Click OK.</p>	Server	SG Inclusion	Preferred HA Role	ZombieNOAM1	<input checked="" type="checkbox"/> Include in SG	<input type="checkbox"/> Prefer server as spare
Server	SG Inclusion	Preferred HA Role					
ZombieNOAM1	<input checked="" type="checkbox"/> Include in SG	<input type="checkbox"/> Prefer server as spare					
<p>4. <input type="checkbox"/> NOAM: Verify NOAM blade server role</p>	<p>1. From terminal session on the first NOAM server, execute this command:</p> <pre>\$ ha.mystate</pre> <p>2. Verify the DbReplication and VIP items under the resourceId column have a value of Active under the role column.</p> <p>You may have to wait a few minutes for it to become in that state.</p> <p>Example:</p> <pre>[admusr@ZombieNOAM1 ~]\$ ha.mystate resourceId role node DC subResources lastUpdate ----- DbReplication Act/Act A0630.238 * 0 0713:105006.861 VIP Act/Act A0630.238 * 0 0713:105006.862 CacdProcessRes Act/OOS A0630.238 * 0 0713:105006.861 CAPM_HELP_Proc Act/OOS A0630.238 * 0 0713:105006.816 DSROAM_Proc Act/OOS A0630.238 * 0 0713:105011.916 CAPM_PSFS_Proc Act/Act A0630.238 * 0 0713:105012.017</pre>						

Procedure 18. Configure the DSR NOAM Server Group

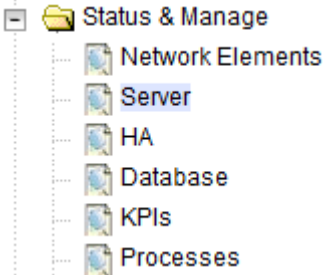
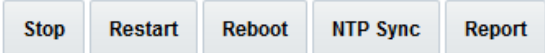
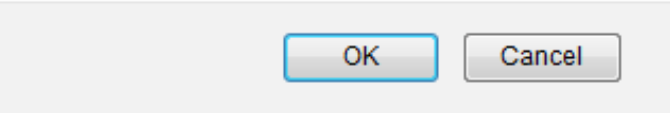
<p>5. <input type="checkbox"/></p>	<p>NOAM VIP GUI: Restart the 1st NOAM servers</p>	<p>1. From the NOAM GUI, navigate to Status & Manage > Server.</p>  <p>2. Select the first NOAM server and click Restart.</p>  <p>3. Click OK to confirm.</p> <p>Are you sure you wish to restart application software on the following server(s)? ZombieSDSNOAM1</p> 
------------------------------------	---	--

Procedure 19. Configure Second DSR NOAM Server

<p>S T E P #</p>	<p>This procedure configures the second DSR NOAM server. Check off (✓) each step as it is completed. Boxes have been provided for this purpose under each step number. If this procedure fails, it is recommended to contact My Oracle Support (MOS) and ask for assistance.</p>	
<p>1. <input type="checkbox"/></p>	<p>NOAM VIP GUI: Login</p>	<p>1. Establish a GUI session on the NOAM server by using the VIP IP address of the NOAM server. Open the web browser and enter a URL of:</p> <div style="border: 1px solid black; padding: 5px; width: fit-content; margin: 10px auto;"> <p>https://<Primary_NOAM_XMI_VIP_IP_Address></p> </div> <p>2. Login as the guiadmin user.</p> 
<p>2. <input type="checkbox"/></p>	<p>NOAM VIP GUI: Insert the 2nd NOAM server</p>	<p>1. Navigate to Configuration > Servers.</p>  <p>2. Click Insert to insert the second NOAM server into the servers table.</p> <div style="display: flex; justify-content: center; gap: 10px; margin-top: 10px;"> Insert Edit Delete Export Report </div>

Procedure 19. Configure Second DSR NOAM Server

3. Enter these values:

Hostname: <Hostname>
Role: Network OAM
System ID: <Site System ID>
Hardware Profile: DSR TVOE Guest
Network Element Name: [Select NE]
Location: <Enter an optional location description>

Hostname *	ZombieNOAM2
Role *	NETWORK OAM&P ▼
System ID	
Hardware Profile	DSR TVOE Guest ▼
Network Element Name *	ZombieNOAM ▼
Location	pc5010439

4. For the **XMI** network, type the server XMI IP address. Select the **xmi** interface. Leave the **VLAN** checkbox unmarked.

5. For the **IMI** network, type the server IMI IP address. Select the **xmi** interface. Leave the **VLAN** checkbox unmarked.

XMI (10.240.213.0/24)	10.240.213.3	xmi ▼	<input type="checkbox"/> VLAN (4)
IMI (169.254.1.0/24)	169.254.1.3	imi ▼	<input type="checkbox"/> VLAN (3)

6. Add this NTP server.

NTP Server	Preferred?
<Second-NOAM-TVOE-IP-Address>	Yes

7. Click **OK**.

Procedure 19. Configure Second DSR NOAM Server

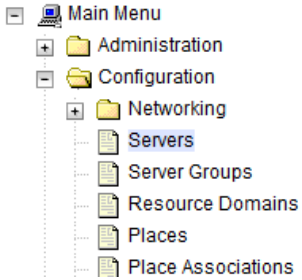
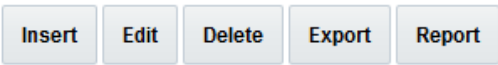
<p>3. <input type="checkbox"/></p>	<p>NOAM GUI: Export the initial configuration</p>	<p>1. Navigate to Configuration > Servers.</p>  <p>2. From the GUI screen, select the second NOAM server and click Export to generate the initial configuration data for that server.</p> 
<p>4. <input type="checkbox"/></p>	<p>1st NOAM VIP GUI: Copy the configuration file to the 2nd NOAM server</p>	<p>1. Obtain a terminal session to the first NOAM server console and login as admusr.</p> <p>2. Configure the second NOAM server.</p> <pre data-bbox="553 888 1414 1052">\$ sudo scp -r /var/TKLC/db/filemgmt/TKLCConfigData.<NOAM2_Hostname> .sh admusr@<NOAM2_xmi_IP_address>:/var/tmp/TKLCConfigData .sh</pre> <p>The automatic configuration daemon looks for the TKLCConfigData.sh file in the /var/tmp directory, implements the configuration in the file, and asks the user to reboot the server.</p>
<p>5. <input type="checkbox"/></p>	<p>2nd DR NOAM Server: Verify server configuration was called and reboot the configured server</p>	<p>1. Verify server configuration was called by checking the log file.</p> <pre data-bbox="553 1220 1414 1262">\$ sudo cat /var/TKLC/appw/logs/Process/install.log</pre> <p>Verify this message displays: [SUCCESS] script completed successfully!</p> <p>Note: The script may return success even when errors are reported in the log file. Go through the entire install.log file to verify no errors are present.</p> <p>2. Reboot the server.</p> <pre data-bbox="553 1514 1414 1556">\$ sudo init 6</pre> <p>3. Proceed to the next step once the server finishes rebooting. The server is done rebooting once the login prompt displays.</p>

Procedure 19. Configure Second DSR NOAM Server

6.	<input type="checkbox"/> 2nd NOAM Server: Verify server health	Login as admusr to the second NOAM server and make sure no errors are returned. <div style="border: 1px solid black; padding: 5px; margin-top: 10px;"> <pre> \$ sudo syscheck Running modules in class hardware...OK Running modules in class disk...OK Running modules in class net...OK Running modules in class system...OK Running modules in class proc...OK LOG LOCATION: /var/TKLC/log/syscheck/fail_log </pre> </div>
----	---	--

Procedure 20. Complete DSR NOAM Server Group Configuration

S T E P #	This procedure finishes configuration for the DSR NOAM server group. Check off (✓) each step as it is completed. Boxes have been provided for this purpose under each step number. If this procedure fails, it is recommended to contact My Oracle Support (MOS) and ask for assistance.	
1.	<input type="checkbox"/> NOAM VIP GUI: Login	<ol style="list-style-type: none"> Establish a GUI session on the NOAM server by using the VIP IP address of the NOAM server. Open the web browser and enter a URL of: <div style="border: 1px solid black; padding: 2px; margin: 5px 0;"> https://<Primary_NOAM_XMI_VIP_IP_Address> </div> Login as the guiadmin user. <div style="text-align: center; margin: 20px 0;">  </div>

Procedure 20. Complete DSR NOAM Server Group Configuration

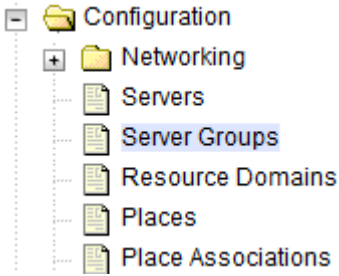
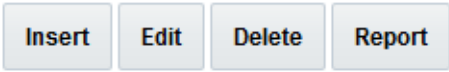
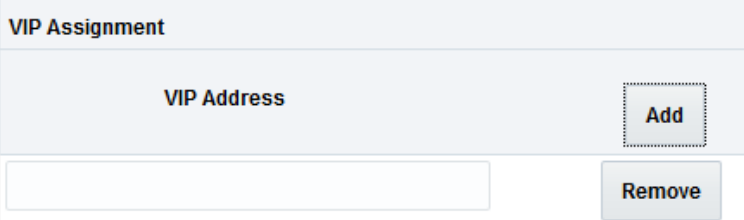
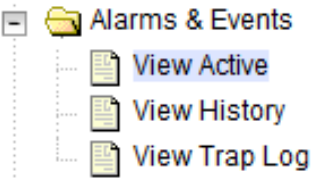
<p>2. <input type="checkbox"/></p>	<p>NOAM GUI: Edit the NOAM server group and VIP</p>	<p>1. Navigate to Configuration > Server Groups.</p>  <p>2. Select the server group you just created and click Edit.</p>  <p>3. Add the second SDS NOAM server to the server group by marking the Include in SG checkbox for the second SDS NOAM server. Do not mark any of the Preferred Spare checkboxes.</p> <table border="1" data-bbox="509 831 1419 1079"> <thead> <tr> <th>Server</th> <th>SG Inclusion</th> <th>Preferred HA Role</th> </tr> </thead> <tbody> <tr> <td>ZombieNOAM1</td> <td><input checked="" type="checkbox"/> Include in SG</td> <td><input type="checkbox"/> Prefer server as spare</td> </tr> <tr> <td>ZombieNOAM2</td> <td><input checked="" type="checkbox"/> Include in SG</td> <td><input type="checkbox"/> Prefer server as spare</td> </tr> </tbody> </table> <p>4. Click Apply.</p> <p>5. Click Add.</p> <p>6. Type the VIP Address and click OK.</p> 	Server	SG Inclusion	Preferred HA Role	ZombieNOAM1	<input checked="" type="checkbox"/> Include in SG	<input type="checkbox"/> Prefer server as spare	ZombieNOAM2	<input checked="" type="checkbox"/> Include in SG	<input type="checkbox"/> Prefer server as spare
Server	SG Inclusion	Preferred HA Role									
ZombieNOAM1	<input checked="" type="checkbox"/> Include in SG	<input type="checkbox"/> Prefer server as spare									
ZombieNOAM2	<input checked="" type="checkbox"/> Include in SG	<input type="checkbox"/> Prefer server as spare									
<p>3. <input type="checkbox"/></p>	<p>NOAM VIP GUI: Wait for remote database alarm to clear</p>	<p>Wait for the Remote Database re-initialization in progress alarm to clear before proceeding. Monitor progress by navigating to Alarms & Events > View Active.</p> 									

Procedure 20. Complete DSR NOAM Server Group Configuration

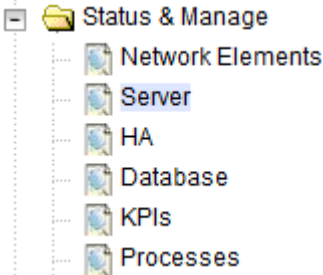
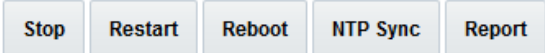
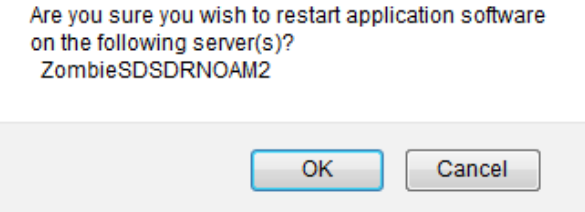
4.	<p>SDS NOAM VIP GUI: Restart the 2nd NOAM server</p>	<p>1. From the NOAM GUI, navigate to Status & Manage > Server.</p>  <p>2. Select the second NOAM server and click Restart.</p>  <p>3. Click OK to confirm.</p> 
----	--	--

3.14.2 NetBackup Client Installation (Optional)

Procedure 21. Install NetBackup Client (Optional)

S T E P #	<p>This procedure downloads and installs the NetBackup client software on the server. Location of the bpstart_notify and bpend_notify scripts is required for the execution of this procedure. For Appworks-based applications, the scripts are located as follows:</p> <ul style="list-style-type: none"> • /usr/TKLC/appworks/sbin/bpstart_notify • /usr/TKLC/appworks/sbin/bpend_notify <p>Check off (✓) each step as it is completed. Boxes have been provided for this purpose under each step number.</p> <p>If this procedure fails, it is recommended to contact My Oracle Support (MOS) and ask for assistance.</p>	
1. <input type="checkbox"/>	<p>Install NetBackup Client Software</p>	<p>If a customer has a way of transferring and installing the NetBackup client without using TPD tools (push configuration), then use Appendix I.2 Install NetBackup Client Using NBAutoInstall.</p> <p>Note: This is not common. If the answer to the previous question is not known, then use Appendix I.1 Install NetBackup Client Using platcfg.</p>
2. <input type="checkbox"/>	<p>Install NetBackup Client Software</p>	<p>Choose the same method used in step 1. to install NetBackup on the 2nd NOAM.</p>

3.14.3 Disaster Recovery NOAM (Optional)

Procedure 22. Configure DSR NOAM for DR Site (Optional)

S T E P #	<p>This procedure configures the first DR NOAM server.</p> <p>Prerequisites:</p> <ul style="list-style-type: none"> • TVOE is configured (section 3.2) • Site OMAC is installed and deployed (sections 3.3, 3.4, and 3.6) • Additional rack mount servers are installed and configured (sections 3.7, 3.8, and 3.9) • VM have been placed and deployed; and network has been configured (sections 3.10, 3.12, and 3.13) <p>Check off (✓) each step as it is completed. Boxes have been provided for this purpose under each step number.</p> <p>If this procedure fails, it is recommended to contact My Oracle Support (MOS) and ask for assistance.</p>	
<p>1. <input type="checkbox"/></p>	<p>NOAM VIP GUI: Login</p>	<p>1. Establish a GUI session on the NOAM server by using the VIP IP address of the NOAM server. Open the web browser and enter a URL of:</p> <div style="border: 1px solid black; padding: 5px; width: fit-content; margin: 5px auto;"> <p><code>https://<Primary_NOAM_XMI_VIP_IP_Address></code></p> </div> <p>2. Login as the guiadmin user.</p> <div style="text-align: center;">  </div>

Procedure 22. Configure DSR NOAM for DR Site (Optional)

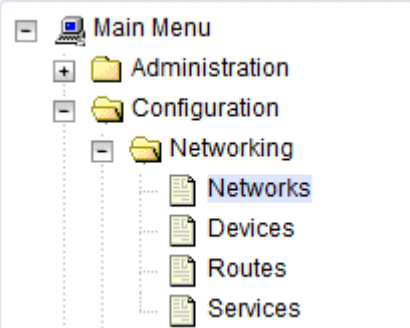
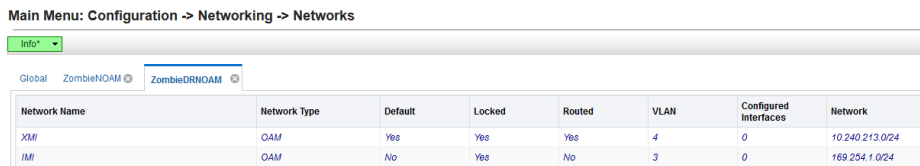
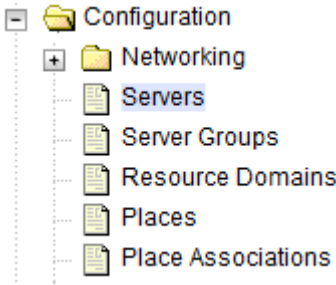
<p>2.</p> <p><input type="checkbox"/></p>	<p>Primary NOAM VIP GUI: Create the DR NOAM network element using an XML file</p>	<p>Note: The NOAM network element file that describes the networking of the target install environment of the NOAM server should already be created. Refer Procedure 17, step 1. to create the xml file, if necessary.</p> <ol style="list-style-type: none"> 1. Navigate to Configuration > Networking > Networks.  <ol style="list-style-type: none"> 2. Click Browse and enter the Pathname of the SOAM network XML file. 3. Click Upload File. <p style="text-align: center;">To create a new Network Element, upload a valid configuration file:</p> <div style="text-align: center;"> <input type="button" value="Browse..."/> zombieDR.xml <input type="button" value="Upload File"/> </div> <p style="text-align: center;">Copyright © 2010, 2016, Oracle and/or its affiliates. All rights reserved.</p> <ol style="list-style-type: none"> 4. Click on the tab to display the configured network. 
<p>3.</p> <p><input type="checkbox"/></p>	<p>Primary NOAM VIP GUI: Insert the 1st DR NOAM server</p>	<ol style="list-style-type: none"> 1. Navigate to Configuration > Servers.  <ol style="list-style-type: none"> 2. Click Insert to insert the new SDS NOAM server into the servers table. <div style="text-align: center;"> <input type="button" value="Insert"/> <input type="button" value="Edit"/> <input type="button" value="Delete"/> <input type="button" value="Export"/> <input type="button" value="Report"/> </div> <ol style="list-style-type: none"> 3. Enter these values: <p>Hostname: <Hostname></p> <p>Role: Network OAM</p>

Procedure 22. Configure DSR NOAM for DR Site (Optional)

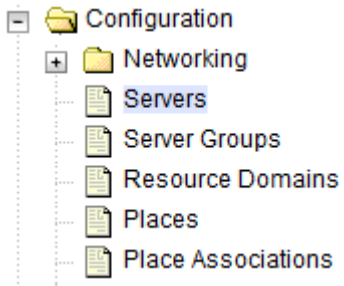
		<p>System ID: <Site System ID> Hardware Profile: DSR TVOE Guest Network Element Name: [Select NE] Location: <Enter an optional location description></p> <p>Adding a new server</p> <table border="1" style="width: 100%; border-collapse: collapse;"> <thead> <tr> <th style="width: 30%;">Attribute</th> <th style="width: 70%;">Value</th> </tr> </thead> <tbody> <tr> <td>Hostname *</td> <td>ZombieDRNOAM1</td> </tr> <tr> <td>Role *</td> <td>NETWORK OAM&P</td> </tr> <tr> <td>System ID</td> <td></td> </tr> <tr> <td>Hardware Profile</td> <td>DSR TVOE Guest</td> </tr> <tr> <td>Network Element Name *</td> <td>ZombieDRNOAM</td> </tr> <tr> <td>Location</td> <td>pc5010441</td> </tr> </tbody> </table> <p>4. For the XMI network, type the server XMI IP address. Select the xmi interface. Leave the VLAN checkbox unmarked.</p> <p>5. For the IMI network, type the server IMI IP address. Select the xmi interface. Leave the VLAN checkbox unmarked.</p> <table border="1" style="width: 100%; border-collapse: collapse;"> <tbody> <tr> <td style="width: 30%;">XMI (10.240.213.0/24)</td> <td style="width: 30%;">10.240.213.5</td> <td style="width: 10%;">xmi</td> <td style="width: 30%;"><input type="checkbox"/> VLAN (4)</td> </tr> <tr> <td>IMI (169.254.1.0/24)</td> <td>169.254.1.5</td> <td>imi</td> <td><input type="checkbox"/> VLAN (3)</td> </tr> </tbody> </table> <p>6. Add this NTP server.</p> <table border="1" style="width: 100%; border-collapse: collapse;"> <thead> <tr> <th style="width: 70%;">NTP Server</th> <th style="width: 30%;">Preferred?</th> </tr> </thead> <tbody> <tr> <td><First-DR-NOAM-TVOE-IP-Address></td> <td>Yes</td> </tr> </tbody> </table> <p>7. Click OK.</p>	Attribute	Value	Hostname *	ZombieDRNOAM1	Role *	NETWORK OAM&P	System ID		Hardware Profile	DSR TVOE Guest	Network Element Name *	ZombieDRNOAM	Location	pc5010441	XMI (10.240.213.0/24)	10.240.213.5	xmi	<input type="checkbox"/> VLAN (4)	IMI (169.254.1.0/24)	169.254.1.5	imi	<input type="checkbox"/> VLAN (3)	NTP Server	Preferred?	<First-DR-NOAM-TVOE-IP-Address>	Yes
Attribute	Value																											
Hostname *	ZombieDRNOAM1																											
Role *	NETWORK OAM&P																											
System ID																												
Hardware Profile	DSR TVOE Guest																											
Network Element Name *	ZombieDRNOAM																											
Location	pc5010441																											
XMI (10.240.213.0/24)	10.240.213.5	xmi	<input type="checkbox"/> VLAN (4)																									
IMI (169.254.1.0/24)	169.254.1.5	imi	<input type="checkbox"/> VLAN (3)																									
NTP Server	Preferred?																											
<First-DR-NOAM-TVOE-IP-Address>	Yes																											
<p>4. <input type="checkbox"/> Primary NOAM VIP GUI: Export the initial configuration</p>	<p>1. Navigate to Configuration > Servers.</p>  <p>2. From the GUI screen, select the DR NOAM server and click Export to generate the initial configuration data for that server.</p> <table border="1" style="width: 100%; border-collapse: collapse;"> <tbody> <tr> <td style="text-align: center;">Insert</td> <td style="text-align: center;">Edit</td> <td style="text-align: center;">Delete</td> <td style="text-align: center;">Export</td> <td style="text-align: center;">Report</td> </tr> </tbody> </table>	Insert	Edit	Delete	Export	Report																						
Insert	Edit	Delete	Export	Report																								

Procedure 22. Configure DSR NOAM for DR Site (Optional)

<p>5. <input type="checkbox"/></p>	<p>1st NOAM Server: Copy configuration file to DR NOAM NOAM server</p>	<p>1. Obtain a terminal session to the primary NOAM server console and login as admusr.</p> <p>2. Execute the following command to configure the DR NOAM server.</p> <pre style="border: 1px solid black; padding: 5px;">\$ sudo scp -r /var/TKLC/db/filemgmt/TKLCConfigData.<DR-NOAM_Hostname>.sh admusr@<DR-NOAM_xmi_IP_address>:/var/tmp/TKLCConfigData.sh</pre> <p>The automatic configuration daemon looks for the TKLCConfigData.sh file in the /var/tmp directory, implements the configuration in the file, and asks the user to reboot the server.</p>				
<p>6. <input type="checkbox"/></p>	<p>1st DR NOAM Server: Verify server configuration was called and reboot the configured server</p>	<p>1. Verify server configuration was called by checking the log file.</p> <pre style="border: 1px solid black; padding: 5px;">\$ sudo cat /var/TKLC/appw/logs/Process/install.log</pre> <p>Verify this message displays: [SUCCESS] script completed successfully!</p> <p>Note: The script may return success even when errors are reported in the log file. Go through the entire install.log file to verify no errors are present.</p> <p>2. Reboot the server.</p> <pre style="border: 1px solid black; padding: 5px;">\$ sudo init 6</pre> <p>3. Proceed to the next step once the server finishes rebooting. The server is done rebooting once the login prompt displays.</p>				
<p>7. <input type="checkbox"/></p>	<p>1st DR NOAM Server: Verify server health</p>	<p>Login as admusr to the first DR NOAM server and make sure that no errors are returned.</p> <pre style="border: 1px solid black; padding: 5px;">\$ sudo syscheck Running modules in class hardware...OK Running modules in class disk...OK Running modules in class net...OK Running modules in class system...OK Running modules in class proc...OK LOG LOCATION: /var/TKLC/log/syscheck/fail_log</pre>				
<p>8. <input type="checkbox"/></p>	<p>Repeat for 2nd DR NOAM server</p>	<p>Repeat steps 2. through 7. to configure second DR NOAM server. When inserting the second DR NOAM server, change the NTP server address to the following:</p> <table border="1" data-bbox="521 1528 1398 1623"> <thead> <tr> <th style="background-color: #d9e1f2;">NTP Server</th> <th style="background-color: #d9e1f2;">Preferred?</th> </tr> </thead> <tbody> <tr> <td><2nd DR NOAM-RMS-TVOE-IP-Address></td> <td>Yes</td> </tr> </tbody> </table>	NTP Server	Preferred?	<2nd DR NOAM-RMS-TVOE-IP-Address>	Yes
NTP Server	Preferred?					
<2nd DR NOAM-RMS-TVOE-IP-Address>	Yes					

Procedure 23. Pairing for DSR DR NOAM Site (Optional)

S T E P #	<p>This procedure pairs the DSR DR NOAM site.</p> <p>Prerequisite: The DSR DR NOAM site has been installed.</p> <p>Check off (✓) each step as it is completed. Boxes have been provided for this purpose under each step number.</p> <p>If this procedure fails, it is recommended to contact My Oracle Support (MOS) and ask for assistance.</p>	
<p>1.</p> <p><input type="checkbox"/></p>	<p>NOAM VIP GUI: Login</p>	<p>1. Establish a GUI session on the NOAM server by using the VIP IP address of the NOAM server. Open the web browser and enter a URL of:</p> <div style="border: 1px solid black; padding: 5px; margin: 10px 0;"> <p>https://<Primary_NOAM_XMI_VIP_IP_Address></p> </div> <p>2. Login as the guiadmin user.</p> <div style="text-align: center; margin: 20px 0;">  <p>The screenshot shows the Oracle System Login interface. At the top is the Oracle logo in red. Below it is the text 'Oracle System Login' and the date 'Mon Jul 11 13:59:37 2016 EDT'. A central box contains a 'Log In' form with fields for 'Username:' and 'Password:', a 'Change password' checkbox, and a 'Log In' button. Below the form, it says 'Welcome to the Oracle System Login.' and 'This application is designed to work with most modern HTML5 compliant browsers and uses both JavaScript and cookies. Please refer to the Oracle Software Web Browser Support Policy for details.' At the bottom, it states 'Unauthorized access is prohibited.' and includes copyright information: 'Oracle and Java are registered trademarks of Oracle Corporation and/or its affiliates. Other names may be trademarks of their respective owners. Copyright © 2010, 2016, Oracle and/or its affiliates. All rights reserved.'</p> </div>

Procedure 23. Pairing for DSR DR NOAM Site (Optional)

<p>2.</p> <p><input type="checkbox"/></p>	<p>NOAM GUI: Enter DR NOAM server group data</p>	<p>1. Navigate to Configuration > Server Groups.</p> <div style="margin-left: 20px;"> <ul style="list-style-type: none"> Configuration <ul style="list-style-type: none"> Networking <ul style="list-style-type: none"> Servers Server Groups Resource Domains Places Place Associations </div> <p>2. Click Insert.</p> <div style="margin-left: 20px;"> <div style="border: 1px solid #ccc; padding: 5px; display: flex; gap: 10px;"> Insert Edit Delete Report </div> </div> <p>3. Enter these values:</p> <p>Server Group Name: <Server Group Name> Level: A Parent: None Function: DSR (Active/Standby Pair) WAN Replication Connection Count: Use Default Value</p> <p>Adding new server group</p> <table border="1" style="width: 100%; border-collapse: collapse; margin-left: 20px;"> <thead> <tr> <th style="width: 30%;">Field</th> <th style="width: 40%;">Value</th> <th style="width: 30%;">Desc</th> </tr> </thead> <tbody> <tr> <td>Server Group Name *</td> <td><input style="width: 80%;" type="text" value="ZombieNOAM"/></td> <td>Uniqu requir</td> </tr> <tr> <td>Level *</td> <td><input style="width: 80%;" type="text" value="A"/> ▼</td> <td>Selec</td> </tr> <tr> <td>Parent *</td> <td><input style="width: 80%;" type="text" value="NONE"/> ▼</td> <td>Selec</td> </tr> <tr> <td>Function *</td> <td><input style="width: 80%;" type="text" value="DSR (active/standby pair)"/> ▼</td> <td>Selec</td> </tr> <tr> <td>WAN Replication Connection Count</td> <td><input style="width: 80%;" type="text" value="1"/></td> <td>Speci</td> </tr> </tbody> </table> <div style="margin-left: 20px; margin-top: 10px;"> <div style="border: 1px solid #ccc; padding: 5px; display: flex; gap: 10px;"> Ok Apply Cancel </div> </div> <p>4. Click OK.</p>	Field	Value	Desc	Server Group Name *	<input style="width: 80%;" type="text" value="ZombieNOAM"/>	Uniqu requir	Level *	<input style="width: 80%;" type="text" value="A"/> ▼	Selec	Parent *	<input style="width: 80%;" type="text" value="NONE"/> ▼	Selec	Function *	<input style="width: 80%;" type="text" value="DSR (active/standby pair)"/> ▼	Selec	WAN Replication Connection Count	<input style="width: 80%;" type="text" value="1"/>	Speci
Field	Value	Desc																		
Server Group Name *	<input style="width: 80%;" type="text" value="ZombieNOAM"/>	Uniqu requir																		
Level *	<input style="width: 80%;" type="text" value="A"/> ▼	Selec																		
Parent *	<input style="width: 80%;" type="text" value="NONE"/> ▼	Selec																		
Function *	<input style="width: 80%;" type="text" value="DSR (active/standby pair)"/> ▼	Selec																		
WAN Replication Connection Count	<input style="width: 80%;" type="text" value="1"/>	Speci																		

Procedure 23. Pairing for DSR DR NOAM Site (Optional)

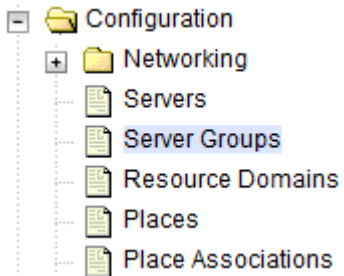
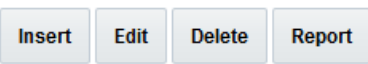
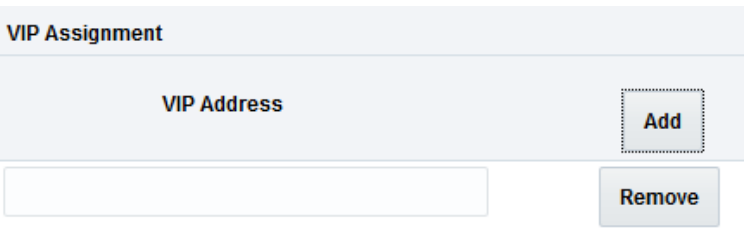
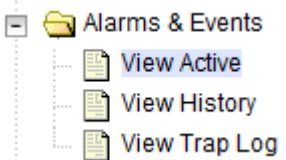
<p>3. <input type="checkbox"/></p>	<p>Primary NOAM GUI: Edit the NOAM server group and VIP</p>	<p>1. Navigate to Configuration > Server Groups.</p>  <p>2. Select the server group you just created and click Edit.</p>  <p>3. Add the second SDS NOAM server to the server group by marking the Include in SG checkbox for the second SDS NOAM server. Do not mark any of the Preferred Spare checkboxes.</p> <table border="1" data-bbox="511 808 1396 1039"> <thead> <tr> <th>Server</th> <th>SG Inclusion</th> <th>Preferred HA Role</th> </tr> </thead> <tbody> <tr> <td>ZombieDRNOAM1</td> <td><input checked="" type="checkbox"/> Include in SG</td> <td><input type="checkbox"/> Prefer server as spare</td> </tr> <tr> <td>ZombieDRNOAM2</td> <td><input checked="" type="checkbox"/> Include in SG</td> <td><input type="checkbox"/> Prefer server as spare</td> </tr> </tbody> </table> <p>4. Click Apply.</p> <p>5. Click Add.</p> <p>6. Type the VIP Address and click OK.</p> 	Server	SG Inclusion	Preferred HA Role	ZombieDRNOAM1	<input checked="" type="checkbox"/> Include in SG	<input type="checkbox"/> Prefer server as spare	ZombieDRNOAM2	<input checked="" type="checkbox"/> Include in SG	<input type="checkbox"/> Prefer server as spare
Server	SG Inclusion	Preferred HA Role									
ZombieDRNOAM1	<input checked="" type="checkbox"/> Include in SG	<input type="checkbox"/> Prefer server as spare									
ZombieDRNOAM2	<input checked="" type="checkbox"/> Include in SG	<input type="checkbox"/> Prefer server as spare									
<p>4. <input type="checkbox"/></p>	<p>Primary NOAM VIP GUI: Wait for remote database alarm to clear</p>	<p>Wait for the Remote Database re-initialization in progress alarm to clear before proceeding. Monitor progress by navigating to Alarms & Events > View Active.</p> 									

Procedure 23. Pairing for DSR DR NOAM Site (Optional)

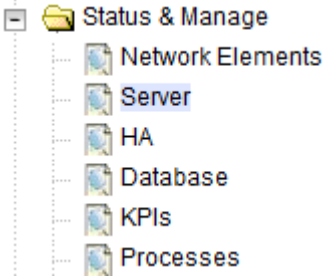
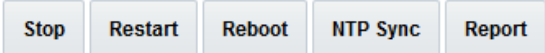
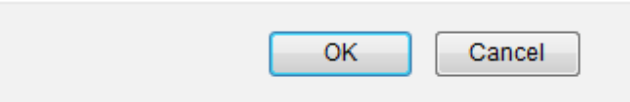
<p>5. <input type="checkbox"/></p>	<p>Primary NOAM VIP GUI: Restart the DR NOAM servers</p>	<p>1. From the NOAM GUI, navigate to Status & Manage > Server.</p>  <p>2. Select the first DR NOAM server and click Restart.</p>  <p>3. Click OK to confirm.</p> <p>Are you sure you wish to restart application software on the following server(s)? ZombieSDSDRNOAM2</p>  <p>4. Repeat this step selecting the second DR NOAM server.</p>
<p>6. <input type="checkbox"/></p>	<p>Primary NOAM: Modify DSR OAM process</p>	<p>1. Establish an SSH session to the primary NOAM, login as admusr.</p> <p>2. Retrieve the cluster ID of the DR NOAM.</p> <pre data-bbox="505 1178 1422 1329"> \$ sudo iqt -fClusterID TopologyMapping where "NodeID='<DR_NOAM_Host_Name>' " Server_ID NodeID ClusterID 1 Oahu-DSR-DR-NOAM-2 A1055 </pre> <p>3. Start the DSR OAM process on the DR NOAM.</p> <pre data-bbox="505 1381 1422 1451"> \$ echo "<clusterID> DSROAM_Proc Yes" iload -ha -xun - fcluster -fresource -foptional HaClusterResourceCfg </pre>

3.14.4 SOAM Configuration

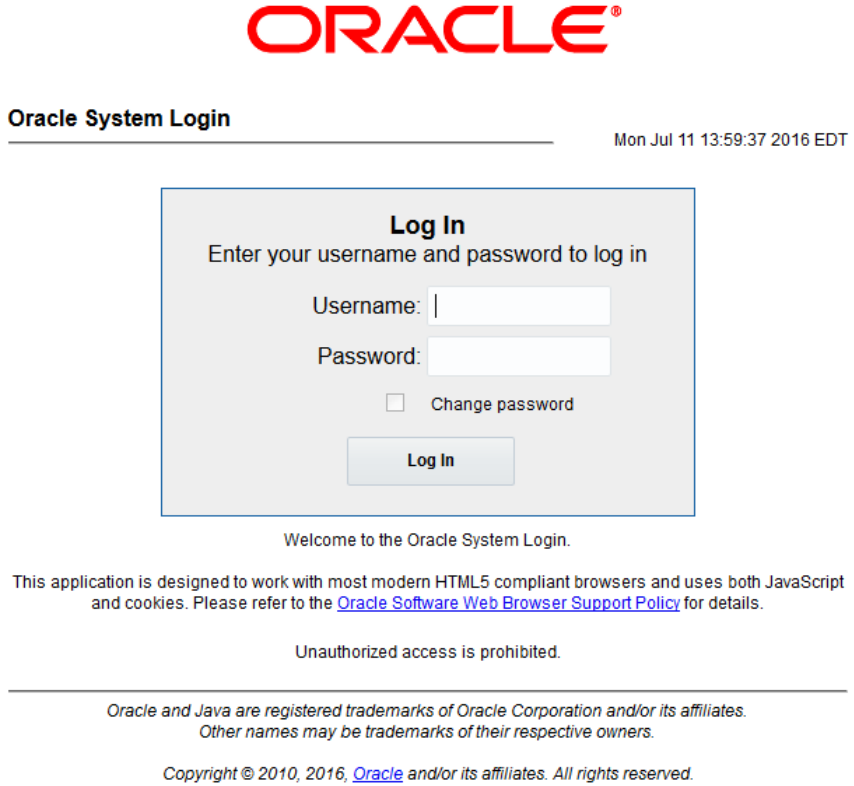

Procedure 24. Configure DSR SOAM NE

S T E P #	<p>This procedure configures the first DSR SOAM network element.</p> <p>Check off (✓) each step as it is completed. Boxes have been provided for this purpose under each step number.</p> <p>If this procedure fails, it is recommended to contact My Oracle Support (MOS) and ask for assistance.</p>	
1. <input type="checkbox"/>	<p>Primary NOAM VIP GUI: Login</p>	<p>1. Establish a GUI session on the NOAM server by using the XMI VIP IP address. Open the web browser and enter a URL of:</p> <div style="border: 1px solid black; padding: 5px; margin: 10px 0;"> <p>https://<NOAM_XMI_VIP_IP_Address></p> </div> <p>2. Login as the guidadmin user.</p> <div style="text-align: center; margin: 20px 0;">  </div>

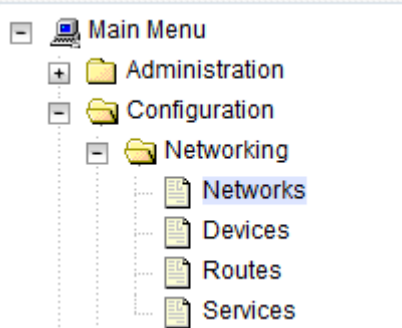
Procedure 24. Configure DSR SOAM NE

<p>2. <input type="checkbox"/></p>	<p>NOAM SDS VIP GUI: Create the SOAM network element using an XML file</p>	<p>Note: The SOAM network element file that describes the networking of the target install environment of the SOAM server should already be created. Refer Procedure 17, step 1. to create the xml file, if necessary.</p> <p>1. Navigate to Configuration > Networking > Networks.</p> <div style="border: 1px solid #ccc; padding: 5px; margin: 5px 0;">  </div> <p>2. Click Browse and enter the Pathname of the SOAM network XML file.</p> <p>3. Click Upload File.</p> <div style="text-align: center; margin: 5px 0;"> <p>To create a new Network Element, upload a valid configuration file:</p> <div style="display: flex; justify-content: center; align-items: center; gap: 20px;"> <div style="border: 1px solid #ccc; padding: 2px 10px; border-radius: 3px;">Browse...</div> zombieSOAM.xml <div style="border: 1px solid #ccc; padding: 2px 10px; border-radius: 3px;">Upload File</div> </div> </div> <p><small>Copyright © 2010, 2016, Oracle and/or its affiliates. All rights reserved.</small></p> <p>4. Click on the tab to display the configured network.</p> <div style="border: 1px solid #ccc; padding: 5px; margin-top: 10px;"> <div style="display: flex; justify-content: space-between; border-bottom: 1px solid #ccc; margin-bottom: 5px;"> Global ZombieNOAM ✕ ZombieDRNOAM ✕ ZombieSOAM ✕ </div> <table border="1" style="width: 100%; border-collapse: collapse; text-align: center;"> <thead> <tr> <th style="text-align: left;">Network Name</th> <th>Network Type</th> <th>Default</th> <th>Locked</th> <th>Routed</th> <th>VLAN</th> <th>Configured Interfaces</th> <th>Net</th> </tr> </thead> <tbody> <tr> <td style="text-align: left;"><i>XMI</i></td> <td><i>OAM</i></td> <td><i>Yes</i></td> <td><i>Yes</i></td> <td><i>Yes</i></td> <td><i>4</i></td> <td><i>0</i></td> <td><i>10.</i></td> </tr> <tr> <td style="text-align: left;"><i>IMI</i></td> <td><i>OAM</i></td> <td><i>No</i></td> <td><i>Yes</i></td> <td><i>No</i></td> <td><i>3</i></td> <td><i>0</i></td> <td><i>169</i></td> </tr> </tbody> </table> </div>	Network Name	Network Type	Default	Locked	Routed	VLAN	Configured Interfaces	Net	<i>XMI</i>	<i>OAM</i>	<i>Yes</i>	<i>Yes</i>	<i>Yes</i>	<i>4</i>	<i>0</i>	<i>10.</i>	<i>IMI</i>	<i>OAM</i>	<i>No</i>	<i>Yes</i>	<i>No</i>	<i>3</i>	<i>0</i>	<i>169</i>
Network Name	Network Type	Default	Locked	Routed	VLAN	Configured Interfaces	Net																			
<i>XMI</i>	<i>OAM</i>	<i>Yes</i>	<i>Yes</i>	<i>Yes</i>	<i>4</i>	<i>0</i>	<i>10.</i>																			
<i>IMI</i>	<i>OAM</i>	<i>No</i>	<i>Yes</i>	<i>No</i>	<i>3</i>	<i>0</i>	<i>169</i>																			

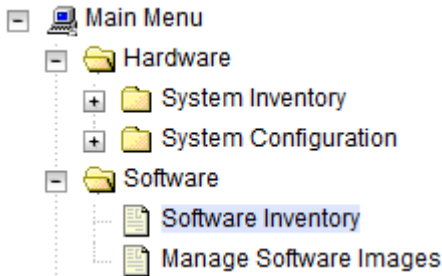
Procedure 25. Configure DSR SOAM Server

<p>S T E P #</p>	<p>This procedure configures the DSR SOAM server. Check off (✓) each step as it is completed. Boxes have been provided for this purpose under each step number. If this procedure fails, it is recommended to contact My Oracle Support (MOS) and ask for assistance.</p>	
<p>1. <input type="checkbox"/></p>	<p>PMAC: Exchange SSH keys between the SOAM site's local PMAC and the SOAM server</p>	<p>Use the PMAC GUI to determine the control network IP address of the blade server that is to be the SOAM server.</p> <ol style="list-style-type: none"> From the PMAC GUI, navigate to Software > Software Inventory.  <ol style="list-style-type: none"> Note the IP address for the SOAM server.  <ol style="list-style-type: none"> Obtain a terminal session to PMAC and login as admusr. Exchange SSH keys for admusr between the PMAC and the SOAM server using the keyexchange utility and the control network IP address for the SOAM server. <pre style="border: 1px solid black; padding: 5px; width: fit-content;">\$ keyexchange admusr@<SO1_Control_IP Address></pre> <ol style="list-style-type: none"> Enter the password for the admusr user of the NOAM server.
<p>2. <input type="checkbox"/></p>	<p>Exchange SSH keys between NOAM and PMAC at the SOAM site, if necessary</p>	<p>Note: If this SOAM shares the same PMAC as the NOAM, then skip this step.</p> <ol style="list-style-type: none"> Obtain a terminal session to the NOAM VIP and login as admusr. Exchange SSH keys for admusr between the PMAC and NOAM for this SOAM site using the keyexchange utility. <pre style="border: 1px solid black; padding: 5px; width: fit-content;">\$ keyexchange admusr@<SO1_Site_PMAC_Mgmt_IP_Address></pre> <ol style="list-style-type: none"> Enter the password for the admusr user of the PMAC server. Repeat this step for the standby SOAM server.

Procedure 25. Configure DSR SOAM Server

<p>3. <input type="checkbox"/></p>	<p>Primary NOAM VIP GUI: Login</p>	<p>1. Establish a GUI session on the NOAM server by using the XMI VIP IP address. Open the web browser and enter a URL of:</p> <div data-bbox="548 323 1393 369" style="border: 1px solid black; padding: 5px; margin: 10px 0;"> <p><code>https://<NOAM_XMI_VIP_IP_Address></code></p> </div> <p>2. Login as the guiadmin user.</p> <div data-bbox="532 451 1380 1228" style="text-align: center; padding: 20px;">  <p>The screenshot shows the Oracle System Login interface. At the top is the Oracle logo in red. Below it is the text 'Oracle System Login' and the date 'Mon Jul 11 13:59:37 2016 EDT'. A central box contains a 'Log In' form with fields for 'Username:' and 'Password:', a 'Change password' checkbox, and a 'Log In' button. Below the form, it says 'Welcome to the Oracle System Login.' and provides information about browser compatibility and unauthorized access. At the bottom, there is a copyright notice: 'Copyright © 2010, 2016, Oracle and/or its affiliates. All rights reserved.'</p> </div>
------------------------------------	---	---

Procedure 25. Configure DSR SOAM Server

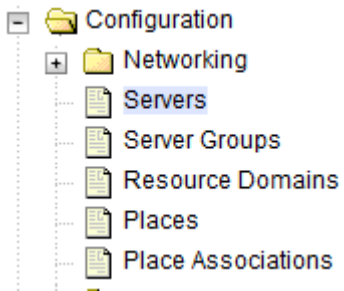
<p>4. <input type="checkbox"/> SOAM VIP GUI: Insert the 1st SOAM server</p>	<p>1. Navigate to Configuration > Servers.</p>  <p>2. Click Insert to insert the first first SOAM server into the servers table.</p> <div style="border: 1px solid #ccc; padding: 5px; margin: 5px 0;"> <p style="text-align: center;"> <input type="button" value="Insert"/> <input type="button" value="Edit"/> <input type="button" value="Delete"/> <input type="button" value="Export"/> <input type="button" value="Report"/> </p> </div> <p>3. Enter these values:</p> <p>Hostname: <Hostname> Role: System OAM System ID: <Site System ID> Hardware Profile: DSR TVOE Guest Network Element Name: [Select NE] Location: <Enter an optional location description></p> <p>Adding a new server</p> <div style="border: 1px solid #ccc; padding: 5px; margin: 5px 0;"> <p>Hostname * <input type="text" value="ZombiesSOAM1"/></p> <p>Role * <input type="text" value="SYSTEM OAM"/> ▼</p> <p>System ID <input type="text"/></p> <p>Hardware Profile <input type="text" value="DSR TVOE Guest"/> ▼</p> <p>Network Element Name * <input type="text" value="ZombieSOAM"/> ▼</p> </div> <p>4. For the XMI network, type the server's XMI IP address. Select the xmi interface. Leave the VLAN checkbox unmarked.</p> <p>5. For the IMI network, type the server's IMI IP address. Select the xmi interface. Leave the VLAN checkbox unmarked.</p> <div style="border: 1px solid #ccc; padding: 5px; margin: 5px 0;"> <p>XMI (10.240.213.0/24) <input type="text" value="10.240.213.9"/> <input type="text" value="xmi"/> ▼ <input type="checkbox"/> VLAN (4)</p> <p>IMI (169.254.1.0/24) <input type="text" value="169.254.1.9"/> <input type="text" value="imi"/> ▼ <input type="checkbox"/> VLAN (3)</p> </div> <p>6. Add this NTP server.</p> <table border="1" style="width: 100%; border-collapse: collapse; margin: 5px 0;"> <thead> <tr style="background-color: #e0e0e0;"> <th style="text-align: left;">NTP Server</th> <th style="text-align: left;">Preferred?</th> </tr> </thead> <tbody> <tr> <td><First-SOAM-TVOE-IP-Address></td> <td>Yes</td> </tr> </tbody> </table> <p>7. Click OK.</p>	NTP Server	Preferred?	<First-SOAM-TVOE-IP-Address>	Yes
NTP Server	Preferred?				
<First-SOAM-TVOE-IP-Address>	Yes				

Procedure 25. Configure DSR SOAM Server

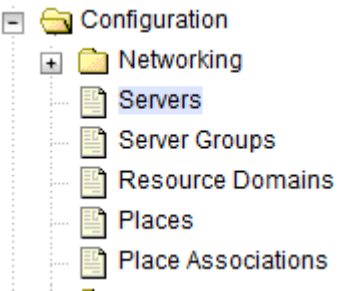
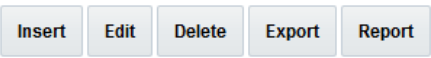
<p>5. <input type="checkbox"/></p>	<p>NOAM VIP GUI: Export the initial configuration</p>	<p>1. Navigate to Configuration > Servers.</p>  <p>2. From the GUI screen, select the SOAM server and click Export to generate the initial configuration data for that server.</p> 
<p>6. <input type="checkbox"/></p>	<p>NOAM VIP GUI: Copy configuration file to 1st SDS DP SOAM server</p>	<p>1. Obtain a terminal session to the NOAM VIP as the admusr user.</p> <p>2. Use the awpushcfg utility to copy the configuration file, created in the previous step from the /var/TKLC/db/filemgmt directory on NOAM to the first SOAM server, using the control network IP address for the first SOAM server.</p> <p>The configuration file has a filename like TKLCConfigData.<hostname>.sh.</p> <pre data-bbox="553 1003 1430 1045">\$ sudo awpushcfg</pre> <p>The awpushcfg utility is interactive, so the user is asked for the following:</p> <ul style="list-style-type: none"> • IP address of the local PMAC server: Use the local control network address from the PMAC. • Username: Use admusr • Control network IP address for the target server: In this case, enter the control IP for the first SOAM server. • Hostname of the target server: Enter the server name configured in step 4.

Procedure 25. Configure DSR SOAM Server

<p>7. <input type="checkbox"/></p>	<p>1st SOAM Server: Verify awpushcfg was called and reboot the configured server</p>	<p>1. Obtain a terminal session to the first SOAM server console by establishing an ssh session from the site PMAC terminal console.</p> <pre style="border: 1px solid black; padding: 5px;">\$ ssh admusr@<SO1_Control_IP></pre> <p>2. Login as admusr.</p> <p>The automatic configuration daemon looks for the TKLCConfigData.sh file in the /var/tmp directory, implements the configuration in the file, and asks the user to reboot the server.</p> <p>3. Verify awpushcfg was called by checking the log file.</p> <pre style="border: 1px solid black; padding: 5px;">\$ sudo cat /var/TKLC/appw/logs/Process/install.log</pre> <p>Verify this message displays: [SUCCESS] script completed successfully!</p> <p>Note: The script may return success even when errors are reported in the log file. Go through the entire install.log file to verify no errors are present.</p> <p>4. Reboot the server.</p> <pre style="border: 1px solid black; padding: 5px;">\$ sudo init 6</pre> <p>5. Proceed to the next step once the server finishes rebooting. The server is done rebooting once the login prompt displays.</p>				
<p>8. <input type="checkbox"/></p>	<p>1st SOAM Server: Login</p>	<p>Obtain a terminal session to the first SOAM server console by establishing an ssh session from the site PMAC terminal console.</p> <pre style="border: 1px solid black; padding: 5px;">\$ ssh admusr@<SO1_Control_IP></pre>				
<p>9. <input type="checkbox"/></p>	<p>1st SOAM Server: Verify server health</p>	<p>Login as admusr to the first SOAM server and make sure no errors are returned.</p> <pre style="border: 1px solid black; padding: 5px;">\$ sudo syscheck Running modules in class hardware...OK Running modules in class disk...OK Running modules in class net...OK Running modules in class system...OK Running modules in class proc...OK LOG LOCATION: /var/TKLC/log/syscheck/fail_log</pre>				
<p>10. <input type="checkbox"/></p>	<p>Insert and configure the 2nd SOAM server</p>	<p>Repeat this procedure to insert and configure the second SOAM server with the exception of the NTP server, which should be configured as:</p> <table border="1" data-bbox="524 1558 1398 1650"> <thead> <tr> <th style="background-color: #d9e1f2;">NTP Server</th> <th style="background-color: #d9e1f2;">Preferred?</th> </tr> </thead> <tbody> <tr> <td><Guest-TVOE-Host-IP-Address></td> <td>Yes</td> </tr> </tbody> </table> <p>Instead of data for the first SOAM server, insert the network data for the second SOAM server, transfer the TKLCConfigData file to the second SOAM server and reboot the second SOAM server when prompted at a terminal window.</p>	NTP Server	Preferred?	<Guest-TVOE-Host-IP-Address>	Yes
NTP Server	Preferred?					
<Guest-TVOE-Host-IP-Address>	Yes					

Procedure 25. Configure DSR SOAM Server

<p>11. <input type="checkbox"/></p>	<p>Insert and configure the spare SOAM server</p>	<p>Repeat this procedure to insert and configure the spare SOAM server with the exception of the NTP server, which should be configured as:</p> <table border="1" data-bbox="524 312 1398 405"> <thead> <tr> <th data-bbox="524 312 976 359">NTP Server</th> <th data-bbox="976 312 1398 359">Preferred?</th> </tr> </thead> <tbody> <tr> <td data-bbox="524 359 976 405"><Guest-TVOE-Host-IP-Address></td> <td data-bbox="976 359 1398 405">Yes</td> </tr> </tbody> </table> <p>Note: If the spare SOAM is located on a separate network, repeat Procedure 24 to add the spare SOAM site NE.</p> <p>Instead of data for the first SOAM server, insert the network data for the spare SOAM server, transfer the TKLCConfigData file to the spare SOAM server and reboot the spare SOAM server when prompted at a terminal window.</p>	NTP Server	Preferred?	<Guest-TVOE-Host-IP-Address>	Yes
NTP Server	Preferred?					
<Guest-TVOE-Host-IP-Address>	Yes					
<p>12. <input type="checkbox"/></p>	<p>Install NetBackup client software on SOAMs (optional)</p>	<p>If you are using NetBackup at this site, then execute Appendix I Install NetBackup Client again to install the NetBackup client on all SOAM servers.</p>				

Procedure 26. Configure the DSR SOAM Server Group

<p>S T E P #</p>	<p>This procedure configures the DSR SOAM server group. Check off (✓) each step as it is completed. Boxes have been provided for this purpose under each step number. If this procedure fails, it is recommended to contact My Oracle Support (MOS) and ask for assistance.</p>	
<p>1. <input type="checkbox"/></p>	<p>Primary NOAM VIP GUI: Login</p>	<ol style="list-style-type: none"> Establish a GUI session on the NOAM server by using the XMI VIP IP address. Open the web browser and enter a URL of: <div data-bbox="548 1073 1393 1121" style="border: 1px solid black; padding: 2px; margin: 5px 0;"> https://<NOAM_XMI_VIP_IP_Address> </div> Login as the guiadmin user. <div data-bbox="771 1199 1149 1255" style="text-align: center; font-weight: bold; color: red; font-size: 24px;"> ORACLE® </div> <div data-bbox="532 1302 763 1331" style="margin-top: 20px;"> Oracle System Login </div> <div data-bbox="1128 1325 1375 1348" style="text-align: right; font-size: 10px;"> Mon Jul 11 13:59:37 2016 EDT </div> <div data-bbox="686 1383 1218 1711" style="border: 1px solid gray; padding: 10px; margin: 20px auto; width: 80%;"> <p style="text-align: center; font-weight: bold; margin: 0;">Log In</p> <p style="text-align: center; margin: 0;">Enter your username and password to log in</p> <p style="margin: 5px 0;">Username: <input style="width: 100%;" type="text"/></p> <p style="margin: 5px 0;">Password: <input style="width: 100%;" type="password"/></p> <p style="text-align: center; margin: 5px 0;"> <input type="checkbox"/> Change password </p> <p style="text-align: center; margin: 10px 0;"> <input type="button" value="Log In"/> </p> </div> <p style="text-align: center; font-size: 10px; margin-top: 10px;"> Welcome to the Oracle System Login. This application is designed to work with most modern HTML5 compliant browsers and uses both JavaScript and cookies. Please refer to the Oracle Software Web Browser Support Policy for details. Unauthorized access is prohibited. </p>

Procedure 26. Configure the DSR SOAM Server Group

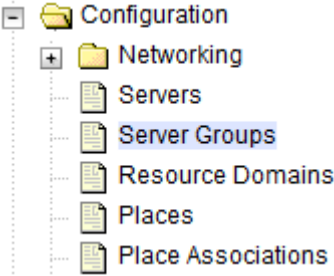
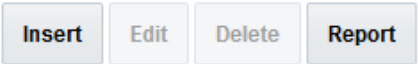
<p>2. <input type="checkbox"/></p>	<p>NOAM VIP GUI: Enter SDS DP SOAM server group data</p>	<ol style="list-style-type: none"> Navigate to Configuration > Server Groups.  Click Insert.  Enter these values: Server Group Name: <Server Group Name> Level: B Parent: Select the NOAM Server Group Function: DSR (Active/Standby Pair) WAN Replication Connection Count: Use default value Click OK. For DSR mated sites, repeat this step for additional SOAM server groups where the preferred SOAM spares may be entered before the active/standby SOAMs.
------------------------------------	---	--

Procedure 26. Configure the DSR SOAM Server Group

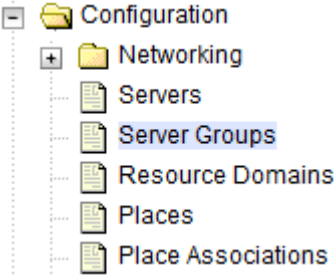
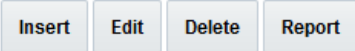
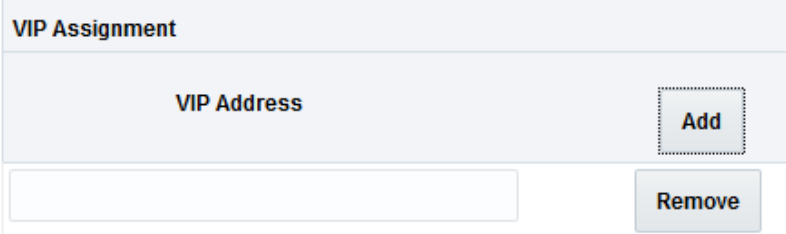
<p>3. <input type="checkbox"/> NOAM VIP GUI: Edit the SDS DP SOAM server groups and VIP</p>	<p>1. Navigate to Configuration > Server Groups.</p>  <p>2. Select the server group you just created and click Edit.</p>  <p>3. Add both SOAM servers to the server group primary site by marking the Include in SG checkbox for each SDS DP server. Do not mark any of the Preferred Spare checkboxes.</p> <table border="1" style="width: 100%; border-collapse: collapse; margin-bottom: 10px;"> <thead> <tr> <th style="text-align: left;">Server</th> <th style="text-align: left;">SG Inclusion</th> <th style="text-align: left;">Preferred HA Role</th> </tr> </thead> <tbody> <tr> <td>ZombieSOAM1</td> <td><input checked="" type="checkbox"/> Include in SG</td> <td><input type="checkbox"/> Prefer server as spare</td> </tr> <tr> <td>ZombieSOAM2</td> <td><input checked="" type="checkbox"/> Include in SG</td> <td><input type="checkbox"/> Prefer server as spare</td> </tr> </tbody> </table> <p>4. Click Apply.</p> <p>5. Click Add.</p> <p>6. Type the VIP Address and click OK.</p> 	Server	SG Inclusion	Preferred HA Role	ZombieSOAM1	<input checked="" type="checkbox"/> Include in SG	<input type="checkbox"/> Prefer server as spare	ZombieSOAM2	<input checked="" type="checkbox"/> Include in SG	<input type="checkbox"/> Prefer server as spare
Server	SG Inclusion	Preferred HA Role								
ZombieSOAM1	<input checked="" type="checkbox"/> Include in SG	<input type="checkbox"/> Prefer server as spare								
ZombieSOAM2	<input checked="" type="checkbox"/> Include in SG	<input type="checkbox"/> Prefer server as spare								

Procedure 26. Configure the DSR SOAM Server Group

<p>4. <input type="checkbox"/></p>	<p>NOAM VIP GUI: Edit the SOAM server group and add preferred spares for site redundancy (optional)</p>	<p>If the Two Site Redundancy feature for the SOAM server group is wanted, add a SOAM server that is located in its server group secondary site by marking the Include in SG checkbox. Also, mark the Preferred Spare checkbox.</p> <table border="1" data-bbox="509 344 1386 659"> <thead> <tr> <th>Server</th> <th>SG Inclusion</th> <th>Preferred HA Role</th> </tr> </thead> <tbody> <tr> <td>ZombieSOAM1</td> <td><input checked="" type="checkbox"/> Include in SG</td> <td><input type="checkbox"/> Prefer server as spare</td> </tr> <tr> <td>ZombieSOAM2</td> <td><input checked="" type="checkbox"/> Include in SG</td> <td><input type="checkbox"/> Prefer server as spare</td> </tr> <tr> <td>ZombieSOAMsp</td> <td><input checked="" type="checkbox"/> Include in SG</td> <td><input checked="" type="checkbox"/> Prefer server as spare</td> </tr> </tbody> </table> <p>If the Three Site Redundancy feature for the SOAM server group is wanted, add an additional SOAM server that is located in its server group tertiary site by marking the Include in SG checkbox. Also, mark the Preferred Spare checkbox.</p> <p>Note: The preferred spare servers must be server group secondary and tertiary sites. There should be servers from three separate sites (locations).</p> <p>For more information about server group secondary site, tertiary site, or site redundancy, see section 1.3 Terminology.</p>	Server	SG Inclusion	Preferred HA Role	ZombieSOAM1	<input checked="" type="checkbox"/> Include in SG	<input type="checkbox"/> Prefer server as spare	ZombieSOAM2	<input checked="" type="checkbox"/> Include in SG	<input type="checkbox"/> Prefer server as spare	ZombieSOAMsp	<input checked="" type="checkbox"/> Include in SG	<input checked="" type="checkbox"/> Prefer server as spare
Server	SG Inclusion	Preferred HA Role												
ZombieSOAM1	<input checked="" type="checkbox"/> Include in SG	<input type="checkbox"/> Prefer server as spare												
ZombieSOAM2	<input checked="" type="checkbox"/> Include in SG	<input type="checkbox"/> Prefer server as spare												
ZombieSOAMsp	<input checked="" type="checkbox"/> Include in SG	<input checked="" type="checkbox"/> Prefer server as spare												
<p>5. <input type="checkbox"/></p>	<p>NOAM VIP GUI: Edit the SOAM server group and add additional SOAM VIPs (optional)</p>	<p>1. To add additional SOAM VIPs, click Add.</p> <p>2. Type the VIP Address.</p> <p>3. Click OK.</p> <p>Note: Additional SOAM VIPs only apply to SOAM server groups with preferred spare SOAMs.</p> <div data-bbox="505 1262 1284 1493"> <p>VIP Assignment</p> <p>VIP Address <input type="text"/></p> <p><input type="button" value="Add"/></p> <p><input type="button" value="Remove"/></p> </div>												
<p>6. <input type="checkbox"/></p>	<p>NOAM VIP GUI: Wait for remote database alarm to clear</p>	<p>Wait for the Remote Database re-initialization in progress alarm to clear before proceeding.</p> <p>Monitor progress by navigating to Alarms & Events > View Active.</p> <div data-bbox="545 1650 821 1806"> <ul style="list-style-type: none"> - Alarms & Events <ul style="list-style-type: none"> View Active View History View Trap Log </div>												

Procedure 26. Configure the DSR SOAM Server Group

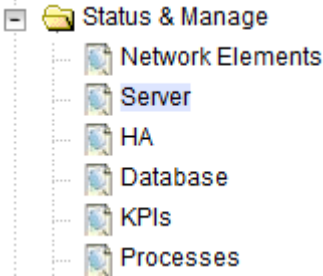
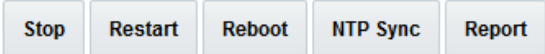
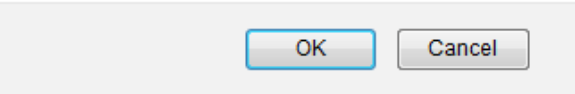
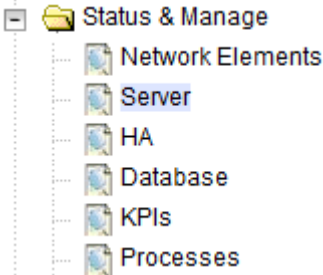
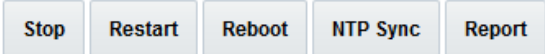
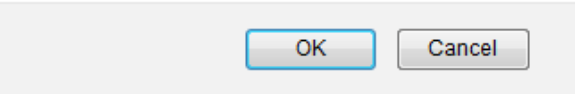
<p>7. <input type="checkbox"/></p>	<p>NOAM VIP GUI: Restart the 1st SOAM server</p>	<p>1. From the NOAM GUI, navigate to Status & Manage > Server.</p>  <p>2. Select the first SOAM server and click Restart.</p>  <p>3. Click OK to confirm.</p> <p>Are you sure you wish to restart application software on the following server(s)? ZombieSDSDRNOAM2</p> 
<p>8. <input type="checkbox"/></p>	<p>NOAM VIP GUI: Restart the 2nd NOAM server</p>	<p>1. From the NOAM GUI, navigate to Status & Manage > Server.</p>  <p>2. Select the second SOAM server and click Restart.</p>  <p>3. Click OK to confirm.</p> <p>Are you sure you wish to restart application software on the following server(s)? ZombieSDSDRNOAM2</p> 

Procedure 26. Configure the DSR SOAM Server Group

9.	<input type="checkbox"/> NOAM VIP GUI: Restart all preferred spare SOAM servers	<p>If additional preferred spare servers are not configured for Secondary or Tertiary Sites, skip this step.</p> <ol style="list-style-type: none"> If additional preferred spare servers are configured for Secondary and/or Tertiary Sites, navigate to Status & Manage > Server.  <ol style="list-style-type: none"> Select all Preferred Spare SOAM servers. Click Restart. <div style="display: flex; justify-content: center; gap: 10px; margin: 10px 0;"> Stop Restart Reboot NTP Sync Report </div> <ol style="list-style-type: none"> Click OK to confirm.
----	---	--

Procedure 27. Configure RMS-Specific B-Level Resources (HP DL380 Gen 8 Servers Only)

S T E P #	<p>This procedure configures RMS-specific B-level resources.</p> <p>Note: Oracle X5-2/NETRA X5-2/X6-2/HP DL380 GEN 9: Skip this procedure.</p> <p>Check off (✓) each step as it is completed. Boxes have been provided for this purpose under each step number.</p> <p>If this procedure fails, it is recommended to contact My Oracle Support (MOS) and ask for assistance.</p>	
1.	<input type="checkbox"/> Active SOAM: Login	Obtain a terminal session to the active SOAM server and login as admusr .
2.	<input type="checkbox"/> Active SOAM: Execute B-level resource script	<div style="border: 1px solid black; padding: 5px; margin-bottom: 5px;"> <pre>\$ sudo /usr/TKLC/dsr/bin/rmsResourceConfig.sh</pre> </div> <ol style="list-style-type: none"> Wait until the script completes and you are returned to the command line. Verify no errors display. If any errors displayed, stop this procedure and contact My Oracle Support (MOS).

3.14.5 Activate PCA

Procedure 28. Activate PCA

S T E P #	<p>This procedure activates PCA.</p> <p>Check off (✓) each step as it is completed. Boxes have been provided for this purpose under each step number.</p> <p>If this procedure fails, it is recommended to contact My Oracle Support (MOS) and ask for assistance.</p>	
1. <input type="checkbox"/>	<p>Activate PCA feature (PCA only)</p>	<p>If you are installing PCA, execute applicable procedures (Added SOAM site activation or complete system activation) in [12] DSR PCA Activation Guide to activate PCA.</p> <p>Notes:</p> <ul style="list-style-type: none"> • If not all SOAM sites are ready at this point, then you should repeat activation for each new SOAM site that comes online. • Ignore steps to restart DA-MPs and SBRs that have yet to be configured.

3.14.6 Activate DCA

Procedure 29. Activate DCA

S T E P #	<p>This procedure activates DCA.</p> <p>Check off (✓) each step as it is completed. Boxes have been provided for this purpose under each step number.</p> <p>If this procedure fails, it is recommended to contact My Oracle Support (MOS) and ask for assistance.</p>	
1. <input type="checkbox"/>	<p>Activate DCA feature (DCA only)</p>	<p>If you are installing DCA, execute procedures in [20] DCA Framework and Application Activation and Deactivation Guide to activate the DCA framework and feature.</p> <p>Notes:</p> <ul style="list-style-type: none"> • If not all SOAM sites are ready at this point, then you should repeat activation for each new SOAM site that comes online. • Ignore steps to restart DA-MPs and SBRs that have yet to be configured.

3.14.7 MP Configuration

Note: If you are adding MPs to expand an existing DSR, which was upgraded from 7.x to 8.x, skip this procedure and execute Procedure 103 Growth: MP (For 7.x to 8.x Upgraded System).

Procedure 30. Configure MP Servers

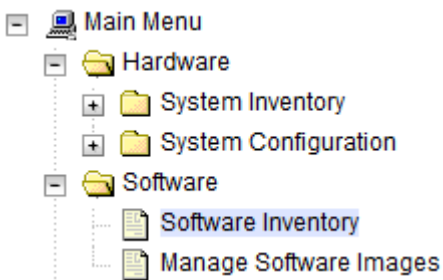
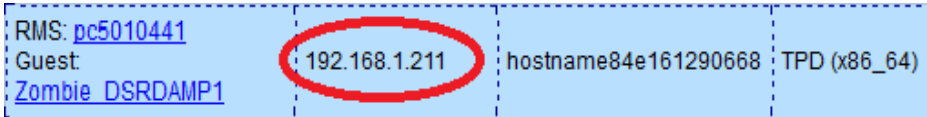
S T E P #	<p>This procedure configures MP servers (IPFE, SBR, SS7-MP, and DA-MP). Check off (✓) each step as it is completed. Boxes have been provided for this purpose under each step number. If this procedure fails, it is recommended to contact My Oracle Support (MOS) and ask for assistance.</p>	
1. <input type="checkbox"/>	<p>PMAC: Exchange SSH keys between MP site's local PMAC and the MP server</p>	<p>Use the MP site's PMAC GUI to determine the control network IP address of the server that is to be an MP server.</p> <ol style="list-style-type: none"> From the MP site's PMAC GUI, navigate to Software > Software Inventory.  <ol style="list-style-type: none"> Note the IP address for an MP server.  <ol style="list-style-type: none"> Obtain a terminal session to the MP site's PMAC and login as admusr. Exchange SSH keys for admusr between the PMAC and the MP blade server using the keyexchange utility and the control network IP address for the MP blade server. <pre style="border: 1px solid black; padding: 5px; width: fit-content;">\$ keyexchange admusr@<MP_Control_Blade_IP Address></pre> <ol style="list-style-type: none"> When asked for the password, type the password for the admusr of the MP server.

Procedure 30. Configure MP Servers

<p>2. <input type="checkbox"/></p>	<p>Primary NOAM VIP GUI: Login</p>	<p>1. Establish a GUI session on the NOAM server by using the XMI VIP IP address. Open the web browser and enter a URL of:</p> <div style="border: 1px solid black; padding: 5px; width: fit-content; margin: 10px 0;"> <p>https://<NOAM_XMI_VIP_IP_Address></p> </div> <p>2. Login as the guiadmin user.</p> <div style="text-align: center; margin: 20px 0;">  <p>Oracle System Login</p> <p style="font-size: small;">Mon Jul 11 13:59:37 2016 EDT</p> </div> <div style="border: 1px solid gray; padding: 10px; width: fit-content; margin: 20px auto;"> <p style="text-align: center;">Log In</p> <p style="text-align: center;">Enter your username and password to log in</p> <p style="text-align: center;">Username: <input style="width: 100%;" type="text"/></p> <p style="text-align: center;">Password: <input style="width: 100%;" type="password"/></p> <p style="text-align: center;"><input type="checkbox"/> Change password</p> <p style="text-align: center;"><input type="button" value="Log In"/></p> </div> <p style="text-align: center; font-size: small;">Welcome to the Oracle System Login.</p> <p style="text-align: center; font-size: x-small;">This application is designed to work with most modern HTML5 compliant browsers and uses both JavaScript and cookies. Please refer to the Oracle Software Web Browser Support Policy for details.</p> <p style="text-align: center; font-size: x-small;">Unauthorized access is prohibited.</p>									
<p>3. <input type="checkbox"/></p>	<p>NOAM VIP GUI: Navigate to signaling network configuration screen</p>	<p>1. Navigate to Configuration > Networking > Networks.</p> <div style="margin: 10px 0;"> <ul style="list-style-type: none"> [-] Configuration <ul style="list-style-type: none"> [-] Networking <ul style="list-style-type: none"> Networks Devices Routes Services </div> <p>2. Select the associated SOAM tab for the MP server.</p> <div style="margin: 10px 0;"> <p>Global ZombieNOAM ✕ ZombieDRNOAM ✕ ZombieSOAM ✕</p> <table border="1" style="width: 100%; border-collapse: collapse;"> <thead> <tr> <th style="text-align: left;">Network Name</th> <th style="text-align: left;">Network Type</th> <th style="text-align: left;">Default</th> </tr> </thead> <tbody> <tr> <td>XMI</td> <td>OAM</td> <td>Yes</td> </tr> <tr> <td>IMI</td> <td>OAM</td> <td>No</td> </tr> </tbody> </table> </div> <p>3. Click Insert.</p> <div style="margin-top: 10px;"> <div style="display: flex; justify-content: space-between; align-items: center;"> <div style="display: flex; gap: 10px;"> <input type="button" value="Insert"/> <input type="button" value="Edit"/> <input type="button" value="Lock/Unlock"/> <input type="button" value="Delete"/> <input type="button" value="Report"/> </div> <div style="display: flex; gap: 10px;"> <input type="button" value="Insert Network Element"/> <input type="button" value="Export"/> </div> </div> </div>	Network Name	Network Type	Default	XMI	OAM	Yes	IMI	OAM	No
Network Name	Network Type	Default									
XMI	OAM	Yes									
IMI	OAM	No									

Procedure 30. Configure MP Servers

4.	<p><input type="checkbox"/> NOAMP VIP: Add signaling networks</p>	<p>1. Enter the Network Name, VLAN ID, Network Address, Netmask, and Router IP that matches the signaling network.</p> <p>Insert Network</p> <table border="1" style="width: 100%; border-collapse: collapse; margin-bottom: 10px;"> <thead> <tr> <th style="text-align: left;">Field</th> <th style="text-align: left;">Value</th> <th style="text-align: left;">Description</th> </tr> </thead> <tbody> <tr> <td>Network Name *</td> <td><input type="text" value="xsi1"/></td> <td>The name of this network. [Default]</td> </tr> <tr> <td>Network Type</td> <td>Signaling <input type="button" value="v"/></td> <td>The type of this network.</td> </tr> <tr> <td>VLAN ID *</td> <td><input type="text" value="6"/></td> <td>The VLAN ID to use for this network.</td> </tr> <tr> <td>Network Address *</td> <td><input type="text" value="10.196.227.0"/></td> <td>The network address of this network.</td> </tr> <tr> <td>Netmask *</td> <td><input type="text" value="255.255.255.0"/></td> <td>Subnetting to apply to servers with this network.</td> </tr> <tr> <td>Router IP</td> <td><input type="text" value="10.196.227.1"/></td> <td>The IP address of a router on this network. (one monitored).</td> </tr> <tr> <td>Default Network</td> <td> <input type="radio"/> Yes <input checked="" type="radio"/> No </td> <td>A selection indicating whether this network is the default.</td> </tr> <tr> <td>Routed</td> <td> <input checked="" type="radio"/> Yes <input type="radio"/> No </td> <td>Whether or not this network is routed.</td> </tr> </tbody> </table> <p> <input type="button" value="Ok"/> <input type="button" value="Apply"/> <input type="button" value="Cancel"/> </p> <p>Note: Even if the network does not use VLAN tagging, you should enter the correct VLAN ID here as indicated by the NAPD.</p> <p>2. Select Signaling for Network Type.</p> <p>3. Select No for Default Network.</p> <p>4. Select Yes for Routed.</p> <p>5. Click OK, if you are finished adding signaling networks.</p> <p>-OR-</p> <p>Click Apply to save this signaling network and repeat this step to enter additional signaling networks.</p>	Field	Value	Description	Network Name *	<input type="text" value="xsi1"/>	The name of this network. [Default]	Network Type	Signaling <input type="button" value="v"/>	The type of this network.	VLAN ID *	<input type="text" value="6"/>	The VLAN ID to use for this network.	Network Address *	<input type="text" value="10.196.227.0"/>	The network address of this network.	Netmask *	<input type="text" value="255.255.255.0"/>	Subnetting to apply to servers with this network.	Router IP	<input type="text" value="10.196.227.1"/>	The IP address of a router on this network. (one monitored).	Default Network	<input type="radio"/> Yes <input checked="" type="radio"/> No	A selection indicating whether this network is the default.	Routed	<input checked="" type="radio"/> Yes <input type="radio"/> No	Whether or not this network is routed.
Field	Value	Description																											
Network Name *	<input type="text" value="xsi1"/>	The name of this network. [Default]																											
Network Type	Signaling <input type="button" value="v"/>	The type of this network.																											
VLAN ID *	<input type="text" value="6"/>	The VLAN ID to use for this network.																											
Network Address *	<input type="text" value="10.196.227.0"/>	The network address of this network.																											
Netmask *	<input type="text" value="255.255.255.0"/>	Subnetting to apply to servers with this network.																											
Router IP	<input type="text" value="10.196.227.1"/>	The IP address of a router on this network. (one monitored).																											
Default Network	<input type="radio"/> Yes <input checked="" type="radio"/> No	A selection indicating whether this network is the default.																											
Routed	<input checked="" type="radio"/> Yes <input type="radio"/> No	Whether or not this network is routed.																											

Procedure 30. Configure MP Servers

<p>5. <input type="checkbox"/></p>	<p>NOAM VIP GUI: Define SBR DB replication network (PCA/DCA Only)</p>	<p>Note: Execute this step only if you are defining a separate, dedicated network for SBR replication.</p> <p>1. Enter the Network Name, VLAN ID, Network Address, Netmask, and Router IP that matches the SBR DB replication network.</p> <p>Insert Network</p> <table border="1"> <thead> <tr> <th>Field</th> <th>Value</th> <th>Description</th> </tr> </thead> <tbody> <tr> <td>Network Name *</td> <td>replication</td> <td>The name of this</td> </tr> <tr> <td>Network Type</td> <td>Signaling</td> <td>The type of this n</td> </tr> <tr> <td>VLAN ID *</td> <td>9</td> <td>The VLAN ID to u</td> </tr> <tr> <td>Network Address *</td> <td>10.240.77.0</td> <td>The network add</td> </tr> <tr> <td>Netmask *</td> <td>255.255.255.0</td> <td>Subnetting to ap</td> </tr> <tr> <td>Router IP</td> <td>10.240.77.1</td> <td>The IP address c one monitored.</td> </tr> <tr> <td>Default Network</td> <td><input type="radio"/> Yes <input checked="" type="radio"/> No</td> <td>A selection indic:</td> </tr> <tr> <td>Routed</td> <td><input checked="" type="radio"/> Yes <input type="radio"/> No</td> <td>Whether or not th</td> </tr> </tbody> </table> <p>Ok Apply Cancel</p> <p>Note: Even if the network does not use VLAN tagging, enter the correct VLAN ID here as indicated by the NAPD.</p> <p>2. Select Signaling for Network Type.</p> <p>3. Select No for Default Network.</p> <p>4. Select Yes for Routable.</p> <p>5. Click OK, if you are finished adding signaling networks.</p> <p>-OR-</p> <p>Click Apply to save this signaling network and repeat this step to enter additional signaling networks.</p>	Field	Value	Description	Network Name *	replication	The name of this	Network Type	Signaling	The type of this n	VLAN ID *	9	The VLAN ID to u	Network Address *	10.240.77.0	The network add	Netmask *	255.255.255.0	Subnetting to ap	Router IP	10.240.77.1	The IP address c one monitored.	Default Network	<input type="radio"/> Yes <input checked="" type="radio"/> No	A selection indic:	Routed	<input checked="" type="radio"/> Yes <input type="radio"/> No	Whether or not th
Field	Value	Description																											
Network Name *	replication	The name of this																											
Network Type	Signaling	The type of this n																											
VLAN ID *	9	The VLAN ID to u																											
Network Address *	10.240.77.0	The network add																											
Netmask *	255.255.255.0	Subnetting to ap																											
Router IP	10.240.77.1	The IP address c one monitored.																											
Default Network	<input type="radio"/> Yes <input checked="" type="radio"/> No	A selection indic:																											
Routed	<input checked="" type="radio"/> Yes <input type="radio"/> No	Whether or not th																											
<p>6. <input type="checkbox"/></p>	<p>NOAM VIP GUI: Perform additional service to networks mapping (PCA/DCA Only)</p>	<p>Note: Execute this step only if you are defining a separate, dedicated network for SBR replication.</p> <p>1. Navigate to Configuration > Services.</p>																											

Procedure 30. Configure MP Servers

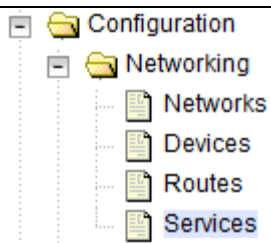

2. Click **Edit**.

Edit Report

3. Set the services according to one of these scenarios:

- If the dual path HA configuration is required:

Set up the inter-NE network to the XMI network.
Set up the intra-NE network to the IMI network for HA_MP secondary.
This configuration uses the XMI network as a secondary path to preserve the HA status of SBRs grouped between multiple sites. If the primary HA path **SBR DB Replication Network** becomes lost or impaired, the XMI network preserves the HA state and prevents the servers from entering into a scenario known as **HA Split-Brain**. Preventing HA Split-Brain keeps the existing database in sync, but the DSR mate site is isolated from the active SBR and results in traffic loss until SBR DB replication network is restored.

Name	Intra-NE Network	Inter-NE Network
HA_MP_Secondary	<IMI Network>	<XMI Network>
Replication_MP	<IMI Network>	<SBR DB Replication Network>
ComAgent	<IMI Network>	<SBR DB Replication Network>

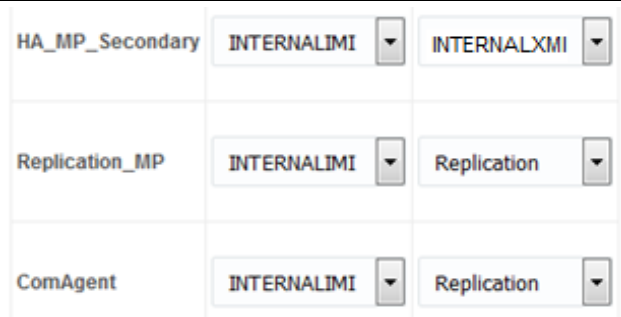

- If the dual path HA configuration is NOT required:

Set up the inter-NE network to SBR DB replication (configured in step 4.).
Set up the intra-NE network to the IMI network for HA_MP secondary.
This condition allows an **HA Split-Brain** condition between the SBRs if the SBR DB replication network becomes lost or impaired. During an HA Split-Brain condition, an active SBR server exists at each site, but the database is not in sync between the SBRs.

Page | 149

E88962-01

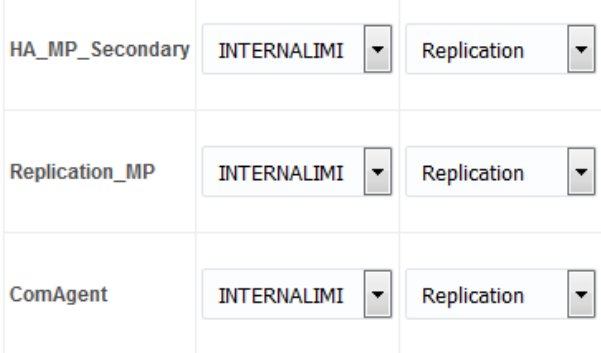
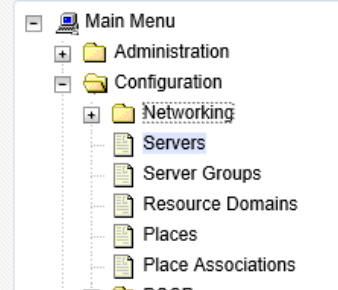
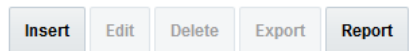
Procedure 30. Configure MP Servers

		<table border="1"> <thead> <tr> <th>Name</th> <th>Intra-NE Network</th> <th>Inter-NE Network</th> </tr> </thead> <tbody> <tr> <td>HA_MP_Secondary</td> <td><IMI Network></td> <td><SBR DB Replication Network></td> </tr> <tr> <td>Replication_MP</td> <td><IMI Network></td> <td><SBR DB Replication Network></td> </tr> <tr> <td>ComAgent</td> <td><IMI Network></td> <td><SBR DB Replication Network></td> </tr> </tbody> </table>  <p>4. Click OK to apply the Service-to-Network selections.</p>	Name	Intra-NE Network	Inter-NE Network	HA_MP_Secondary	<IMI Network>	<SBR DB Replication Network>	Replication_MP	<IMI Network>	<SBR DB Replication Network>	ComAgent	<IMI Network>	<SBR DB Replication Network>
Name	Intra-NE Network	Inter-NE Network												
HA_MP_Secondary	<IMI Network>	<SBR DB Replication Network>												
Replication_MP	<IMI Network>	<SBR DB Replication Network>												
ComAgent	<IMI Network>	<SBR DB Replication Network>												
<p>7. <input type="checkbox"/></p>	<p>NOAM VIP GUI: Insert the MP server</p>	<p>1. Navigate to Configuration > Servers.</p>  <p>2. Click Insert to insert the new MP server into servers table.</p>  <p>3. Enter these values:</p> <p>Hostname: <Hostname> Role: MP Network Element: [Choose Network Element] Hardware Profile: DSR TVOE Guest Location: <Enter an optional location description></p> <p>4. For the XMI network, type the MP's XMI IP address and select the xmi interface.</p> <p>5. For the IMI network, type the MP's IMI IP address and select the imi interface.</p> <p>6. For the XS11 network, type the MP's XS11 IP address and select the ksi1 interface.</p> <p>7. For the XS12 network, type the MP's XS12 IP address and select the ksi2 interface.</p>												

Procedure 30. Configure MP Servers

		<p>8. For the Replication network (If step 5. was executed), type the MP's replication IP address and select the replication interface.</p> <div data-bbox="511 310 1414 716"> <p>OAM Interfaces [At least one interface is required.]:</p> <table border="1"> <thead> <tr> <th>Network</th> <th>IP Address</th> <th>Interface</th> </tr> </thead> <tbody> <tr> <td>XMI (10.240.213.0/24)</td> <td><input type="text" value="10.240.213.55"/></td> <td>xmi <input type="checkbox"/> VLAN (4)</td> </tr> <tr> <td>IMI (169.254.1.0/24)</td> <td><input type="text" value="169.254.1.55"/></td> <td>imi <input type="checkbox"/> VLAN (3)</td> </tr> <tr> <td>xsi1 (10.196.227.0/24)</td> <td><input type="text" value="10.196.227.2"/></td> <td>xsi1 <input type="checkbox"/> VLAN (6)</td> </tr> <tr> <td>xsi2 (10.196.226.0/24)</td> <td><input type="text" value="10.196.226.2"/></td> <td>xsi2 <input type="checkbox"/> VLAN (7)</td> </tr> </tbody> </table> <p>Notes:</p> <ul style="list-style-type: none"> • If networks have been configured previously, but are not required on the server, remove the populated network IP from the IP address field and this device will not be created on the server. • If XSI3-16 was configured, follow the same method of entry as XSI1 and XSI2. </div> <p>9. Add the NTP server.</p> <div data-bbox="521 999 1430 1089"> <table border="1"> <thead> <tr> <th>NTP Server</th> <th>Preferred?</th> </tr> </thead> <tbody> <tr> <td><MP_RMS_TVOE_IP_Address></td> <td>Yes</td> </tr> </tbody> </table> </div> <p>10. Click OK when all fields are entered to finish MP server insertion.</p>	Network	IP Address	Interface	XMI (10.240.213.0/24)	<input type="text" value="10.240.213.55"/>	xmi <input type="checkbox"/> VLAN (4)	IMI (169.254.1.0/24)	<input type="text" value="169.254.1.55"/>	imi <input type="checkbox"/> VLAN (3)	xsi1 (10.196.227.0/24)	<input type="text" value="10.196.227.2"/>	xsi1 <input type="checkbox"/> VLAN (6)	xsi2 (10.196.226.0/24)	<input type="text" value="10.196.226.2"/>	xsi2 <input type="checkbox"/> VLAN (7)	NTP Server	Preferred?	<MP_RMS_TVOE_IP_Address>	Yes
Network	IP Address	Interface																			
XMI (10.240.213.0/24)	<input type="text" value="10.240.213.55"/>	xmi <input type="checkbox"/> VLAN (4)																			
IMI (169.254.1.0/24)	<input type="text" value="169.254.1.55"/>	imi <input type="checkbox"/> VLAN (3)																			
xsi1 (10.196.227.0/24)	<input type="text" value="10.196.227.2"/>	xsi1 <input type="checkbox"/> VLAN (6)																			
xsi2 (10.196.226.0/24)	<input type="text" value="10.196.226.2"/>	xsi2 <input type="checkbox"/> VLAN (7)																			
NTP Server	Preferred?																				
<MP_RMS_TVOE_IP_Address>	Yes																				
<p>8. <input type="checkbox"/> NOAM VIP GUI: Export the configuration</p>		<p>1. Navigate to Configuration > Servers.</p> <div data-bbox="532 1203 867 1478"> <pre> Configuration ├── Networking │ ├── Servers │ ├── Server Groups │ ├── Resource Domains │ ├── Places │ └── Place Associations </pre> </div> <p>2. From the GUI screen, select the MP server and click Export to generate the initial configuration data for that server.</p> <div data-bbox="511 1581 1024 1640"> <table border="1"> <tr> <td>Insert</td> <td>Edit</td> <td>Delete</td> <td>Export</td> <td>Report</td> </tr> </table> </div>	Insert	Edit	Delete	Export	Report														
Insert	Edit	Delete	Export	Report																	

Procedure 30. Configure MP Servers

<p>9. <input type="checkbox"/></p>	<p>NOAM VIP: Copy the configuration file to MP server</p>	<ol style="list-style-type: none"> Obtain a terminal session to the NOAM VIP as the admusr user. Use the awpushcfg utility to copy the configuration file, created in the previous step, from the /var/TKLC/db/filemgmt directory on the NOAM to the MP server, using the control network IP address for the MP server. <p>The configuration file has a filename like TKLCConfigData.<hostname>.sh.</p> <pre>\$ sudo awpushcfg</pre> <p>The awpushcfg utility is interactive, so the user is asked for the following:</p> <ul style="list-style-type: none"> IP address of the local PMAC server: Use the management network address from the PMAC. Username: Use admusr Control network IP address for the target server: In this case, enter the control IP for the MP server). Hostname of the target server: Enter the server name configured in step 1.
<p>10. <input type="checkbox"/></p>	<p>MP Server: Verify awpushcfg was called and reboot the configured server</p>	<ol style="list-style-type: none"> Obtain a terminal session to the MP server console by establishing an ssh session from the NOAM VIP terminal console. <pre>\$ ssh admusr@<MP_Control_IP></pre> <ol style="list-style-type: none"> Login as admusr. Verify awpushcfg was called by checking the log file. <pre>\$ sudo cat /var/TKLC/appw/logs/Process/install.log</pre> <p>Verify this message displays:</p> <pre>[SUCCESS] script completed successfully!</pre> <p>Note: The script may return success even when errors are reported in the log file. Go through the entire install.log file to verify no errors are present.</p> <ol style="list-style-type: none"> Reboot the server. <pre>\$ sudo init 6</pre> <ol style="list-style-type: none"> Proceed to the next step once the server finishes rebooting. The server is done rebooting once the login prompt is displayed.
<p>11. <input type="checkbox"/></p>	<p>MP Server: Verify server health</p>	<p>Login as admusr to the MP server and make sure no errors are returned.</p> <pre>\$ sudo syscheck Running modules in class hardware...OK Running modules in class disk...OK Running modules in class net...OK Running modules in class system...OK Running modules in class proc...OK LOG LOCATION: /var/TKLC/log/syscheck/fail_log</pre>

Procedure 30. Configure MP Servers

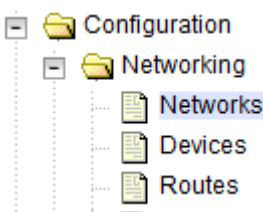
<p>12. <input type="checkbox"/></p>	<p>MP Server: Delete auto-configured default route on MP and replace it with a network route via the XMI network — Part 1 (optional)</p>	<p>Note: This step is optional and should only be executed if you plan to configure a default route on your MP that uses a signaling (XSI) network instead of the XMI network.</p> <p>Not executing this step means a default route is not configurable on this MP and you have to create separate network routes for each signaling network destination.</p> <ol style="list-style-type: none"> 1. Log into the site's PMAC and SSH to the MP's control address. Alternatively, log into the TVOE host and access the MP using the virsh console <MP VM>. 2. Determine <XMI_Gateway_IP> from your SO site network element information. 3. Gather this information: <ul style="list-style-type: none"> • <NO_XMI_Network_Address> • <NO_XMI_Network_Netmask> • <DR_NO_XMI_Network_Addres> • <DR_NO_XMI_Network_Netmask> • <TVOE_Mgmt_XMI_Network_Address> • <TVOE_Mgmt_XMI_Network_Netmask> <p>Note: You can either consult the XML files you imported earlier, or go to the NO GUI and view these values from the Configuration > Networking > Networks screen.</p> 
-------------------------------------	---	--

Procedure 30. Configure MP Servers

<p>13. <input type="checkbox"/></p>	<p>MP Server: Delete auto-configured default route on MP and replace it with a network route via the XMI network — Part 2 (optional)</p>	<ol style="list-style-type: none"> 1. Establish a connection to the MP server and login as admusr. 2. Create network routes to the NO's XMI (OAM) network. <ul style="list-style-type: none"> Note: If your NOAM XMI network is exactly the same as your MP XMI network, then you should skip this command and only configure the DR NO route. <pre style="border: 1px solid black; padding: 5px;">\$ sudo /usr/TKLC/plat/bin/netAdm add -route=net --address=<NO_Site_Network_ID> -- netmask=<NO_Site_Network_Netmask> --gateway=<MP_XMI_Gateway_IP_Address> -- device=<MP_XMI_Interface></pre> 3. Create network routes to the DR NO's XMI (OAM) network. <pre style="border: 1px solid black; padding: 5px;">\$ sudo /usr/TKLC/plat/bin/netAdm add -route=net --address=<DR-NO_Site_Network_ID> --netmask=<<DR-NO_Site_Network_Netmask> --gateway=<MP_XMI_Gateway_IP_Address> -- device=<MP_XMI_Interface></pre> 4. Create network routes to the management server TVOE XMI (OAM) network for NTP. <pre style="border: 1px solid black; padding: 5px;">\$ sudo /usr/TKLC/plat/bin/netAdm add -route=net --address=<TVOE_Mgmt_Network_Address> --netmask=<TVOE_Mgmt_Network_Netmask> --gateway=<MP_XMI_Gateway_IP_Address> -- device=<MP_XMI_Interface></pre> 5. (Optional) If sending SNMP traps from individual servers, create host routes to customer SNMP trap destinations on the XMI network. <pre style="border: 1px solid black; padding: 5px;">\$ sudo /usr/TKLC/plat/bin/netAdm add -route=host --address=<Customer_NMS_IP> -- gateway=<MP_XMI_Gateway_IP_Address> --device=<MP_XMI_Interface></pre> 6. Repeat for any existing customer NMS stations. 7. Delete the existing default route: <ol style="list-style-type: none"> a. Log into primary NOAM VIP GUI. b. Navigate to Configuration > Networking > Networks. c. Select the respective SOAM tab. d. Select the XMI network and click Unlock. Click OK to confirm. e. Navigate to Configuration > Networking > Routes. f. Select the XMI route and click Delete. g. Click OK to confirm. h. Repeat steps 1 through 7 for all required MPs to delete the XMI routes. i. Navigate to Configuration > Networking > Networks. j. Select the respective SOAM tab. k. Select the XMI network and click Lock. l. Click OK to confirm.
-------------------------------------	---	---

Procedure 30. Configure MP Servers

<p>14. <input type="checkbox"/></p>	<p>MP Server: Verify connectivity</p>	<ol style="list-style-type: none"> 1. Establish a connection to the MP server and login as admusr. 2. Ping active NO XMI IP address to verify connectivity. <pre style="border: 1px solid black; padding: 5px;">\$ ping <ACTIVE_NO_XMI_IP_Address> PING 10.240.108.6 (10.240.108.6) 56(84) bytes of data. 64 bytes from 10.240.108.6: icmp_seq=1 ttl=64 time=0.342 ms 64 bytes from 10.240.108.6: icmp_seq=2 ttl=64 time=0.247 ms</pre> <ol style="list-style-type: none"> 3. (Optional) Ping Customer NMS Station(s). <pre style="border: 1px solid black; padding: 5px;">\$ ping <Customer_NMS_IP> PING 172.4.116.8 (172.4.118.8) 56(84) bytes of data. 64 bytes from 172.4.116.8: icmp_seq=1 ttl=64 time=0.342 ms 64 bytes from 172.4.116.8: icmp_seq=2 ttl=64 time=0.247 ms</pre> <ol style="list-style-type: none"> 4. If you do not get a response, then verify your network configuration. If you continue to get failures, then stop the installation and contact Oracle customer support.
<p>15. <input type="checkbox"/></p>	<p>Repeat for remaining MPs at all sites</p>	<p>Repeat this entire procedure for all remaining MPs (SS7-MP, DA-MP, SBR, and IPFE).</p>

Procedure 31. Configure Places and Assign MP Servers to Places (PCA and DCA Only)

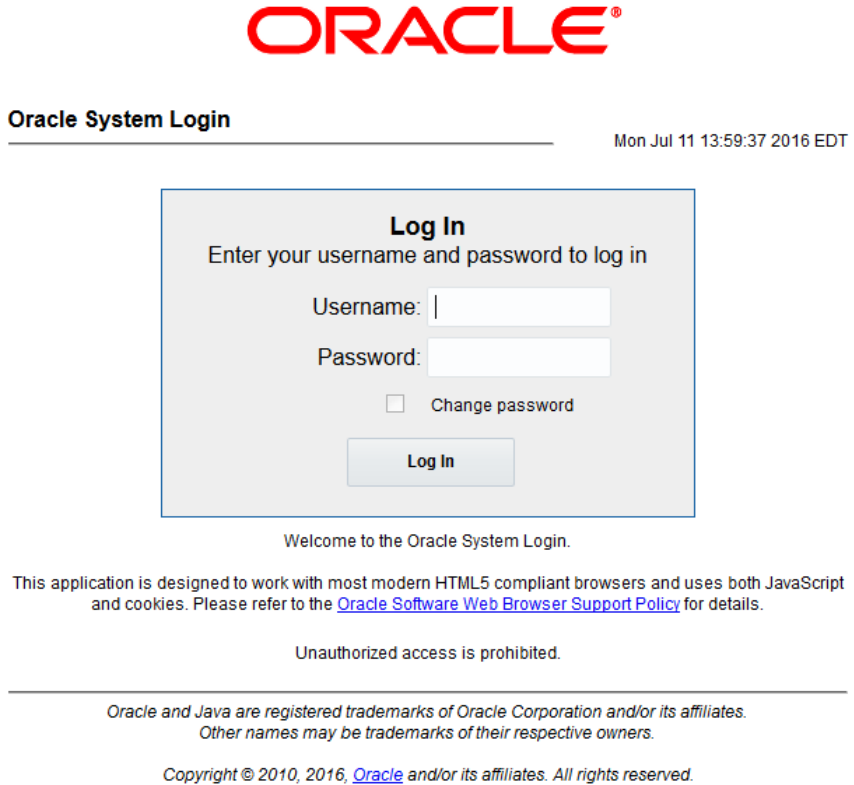
S T E P #	<p>This procedure adds places in the PCA/DCA network.</p> <p>Check off (✓) each step as it is completed. Boxes have been provided for this purpose under each step number.</p> <p>If this procedure fails, it is recommended to contact My Oracle Support (MOS) and ask for assistance.</p>	
<p>1. <input type="checkbox"/></p>	<p>Primary NOAM VIP GUI: Login</p>	<p>1. Establish a GUI session on the NOAM server by using the XMI VIP IP address. Open the web browser and enter a URL of:</p> <div style="border: 1px solid black; padding: 5px; margin: 10px 0;"> <p>https://<NOAM_XMI_VIP_IP_Address></p> </div> <p>2. Login as the guiadmin user.</p> <div style="text-align: center; margin: 20px 0;">  </div>

Procedure 31. Configure Places and Assign MP Servers to Places (PCA and DCA Only)

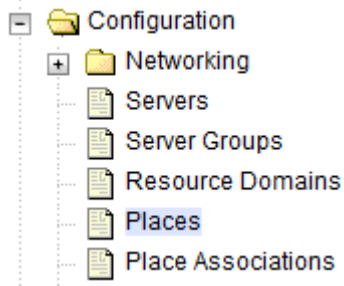
<p>2. <input type="checkbox"/> NOAM VIP GUI: Configure Places</p>	<p>1. Navigate to Configuration > Places.</p>  <p>2. Click Insert.</p> <div style="border: 1px solid #ccc; padding: 5px; margin: 5px 0;"> <p style="text-align: center; margin: 0;"> <input type="button" value="Insert"/> <input type="button" value="Edit"/> <input type="button" value="Delete"/> <input type="button" value="Report"/> </p> </div> <p style="margin: 5px 0;">Inserting a new Place</p> <table border="1" style="width: 100%; border-collapse: collapse; margin: 5px 0;"> <thead> <tr style="background-color: #f2f2f2;"> <th colspan="3">Place</th> </tr> <tr style="background-color: #f2f2f2;"> <th style="width: 25%;">Field</th> <th style="width: 30%;">Value</th> <th style="width: 45%;">Description</th> </tr> </thead> <tbody> <tr> <td>Place Name *</td> <td><input type="text" value="ZombiePlace"/></td> <td>Unique identifier used to label a Place. [Default and space.] [A value is required.]</td> </tr> <tr> <td>Parent *</td> <td>NONE <input type="button" value="v"/></td> <td>The Parent of this Place [A value is required.]</td> </tr> <tr> <td>Place Type *</td> <td>Site <input type="button" value="v"/></td> <td>The Type of this Place [A value is required.]</td> </tr> </tbody> </table> <p>3. Enter the fields as follows:</p> <p>Place Name: <Site Name> Parent: NONE Place Type: Site</p> <p>4. Repeat this step for each of the PCA places (sites) in the network. See section 1.3 Terminology for more information on sites and places.</p>	Place			Field	Value	Description	Place Name *	<input type="text" value="ZombiePlace"/>	Unique identifier used to label a Place. [Default and space.] [A value is required.]	Parent *	NONE <input type="button" value="v"/>	The Parent of this Place [A value is required.]	Place Type *	Site <input type="button" value="v"/>	The Type of this Place [A value is required.]
Place																
Field	Value	Description														
Place Name *	<input type="text" value="ZombiePlace"/>	Unique identifier used to label a Place. [Default and space.] [A value is required.]														
Parent *	NONE <input type="button" value="v"/>	The Parent of this Place [A value is required.]														
Place Type *	Site <input type="button" value="v"/>	The Type of this Place [A value is required.]														

Procedure 31. Configure Places and Assign MP Servers to Places (PCA and DCA Only)

<p>3.</p> <p><input type="checkbox"/></p>	<p>NOAM VIP GUI: Assign MP servers to places</p>	<p>1. Select the place just configured and click Edit.</p> <div style="border: 1px solid #ccc; padding: 5px; margin-bottom: 10px;"> Insert Edit Delete Report </div> <p>2. For each place you have defined, select the set of MP servers that are assigned to those places.</p> <p style="text-align: center;">Editing Place ZombiePlace</p> <div style="border: 1px solid #ccc; padding: 10px; margin-bottom: 10px;"> <table style="width: 100%; border-collapse: collapse;"> <tr> <td style="width: 30%;">Place Type *</td> <td style="width: 40%;"><input type="text" value="Site"/></td> <td style="width: 30%;">The Ty</td> </tr> <tr> <td colspan="3" style="background-color: #f2f2f2; padding: 5px;">Servers</td> </tr> <tr> <td rowspan="2" style="vertical-align: top;">ZombieNOAM</td> <td><input type="checkbox"/> ZombieNOAM1</td> <td rowspan="2" style="vertical-align: top;">Availal</td> </tr> <tr> <td><input type="checkbox"/> ZombieNOAM2</td> </tr> <tr> <td rowspan="2" style="vertical-align: top;">ZombieDRNOAM</td> <td><input type="checkbox"/> ZombieDRNOAM1</td> <td rowspan="2" style="vertical-align: top;">Availal</td> </tr> <tr> <td><input type="checkbox"/> ZombieDRNOAM2</td> </tr> <tr> <td rowspan="4" style="vertical-align: top;">Zombie SOAM</td> <td><input type="checkbox"/> ZombieSOAM1</td> <td rowspan="4" style="vertical-align: top;">Availal</td> </tr> <tr> <td><input type="checkbox"/> ZombieSOAM2</td> </tr> <tr> <td><input checked="" type="checkbox"/> ZombieDAMP1</td> </tr> <tr> <td><input checked="" type="checkbox"/> ZombieDAMP2</td> </tr> </table> <div style="margin-top: 10px;"> Ok Apply Cancel </div> </div> <p>3. Mark the PCA DA-MP and SBR server checkboxess assigned to this place.</p> <p>4. Repeat this step for all other DA-MP or SBR servers you want to assign to places.</p> <p>Note: All PCA DA-MPs, SS7MPs, and SBR MPs must be added to the site place that corresponds to the physical location of the server.</p> <p>See section 1.3 Terminology for more information on sites.</p>	Place Type *	<input type="text" value="Site"/>	The Ty	Servers			ZombieNOAM	<input type="checkbox"/> ZombieNOAM1	Availal	<input type="checkbox"/> ZombieNOAM2	ZombieDRNOAM	<input type="checkbox"/> ZombieDRNOAM1	Availal	<input type="checkbox"/> ZombieDRNOAM2	Zombie SOAM	<input type="checkbox"/> ZombieSOAM1	Availal	<input type="checkbox"/> ZombieSOAM2	<input checked="" type="checkbox"/> ZombieDAMP1	<input checked="" type="checkbox"/> ZombieDAMP2
Place Type *	<input type="text" value="Site"/>	The Ty																				
Servers																						
ZombieNOAM	<input type="checkbox"/> ZombieNOAM1	Availal																				
	<input type="checkbox"/> ZombieNOAM2																					
ZombieDRNOAM	<input type="checkbox"/> ZombieDRNOAM1	Availal																				
	<input type="checkbox"/> ZombieDRNOAM2																					
Zombie SOAM	<input type="checkbox"/> ZombieSOAM1	Availal																				
	<input type="checkbox"/> ZombieSOAM2																					
	<input checked="" type="checkbox"/> ZombieDAMP1																					
	<input checked="" type="checkbox"/> ZombieDAMP2																					

Procedure 32. Configure DAMP Server Groups and Profiles

<p>S T E P #</p>	<p>This procedure configures MP server groups as DAMPs. Check off (✓) each step as it is completed. Boxes have been provided for this purpose under each step number. If this procedure fails, it is recommended to contact My Oracle Support (MOS) and ask for assistance.</p>	
<p>1. <input type="checkbox"/></p>	<p>Primary NOAM VIP GUI: Login</p>	<p>1. Establish a GUI session on the NOAM server by using the XMI VIP IP address. Open the web browser and enter a URL of:</p> <div data-bbox="553 510 1393 558" style="border: 1px solid black; padding: 2px;"> <p>https://<NOAM_XMI_VIP_IP_Address></p> </div> <p>2. Login as the guiadmin user.</p>  <p>The screenshot shows the Oracle System Login interface. At the top is the Oracle logo. Below it, the text 'Oracle System Login' is on the left and 'Mon Jul 11 13:59:37 2016 EDT' is on the right. A central box titled 'Log In' contains the instruction 'Enter your username and password to log in'. There are two input fields: 'Username:' and 'Password:'. Below the password field is a checkbox labeled 'Change password' and a 'Log In' button.</p>
<p>2. <input type="checkbox"/></p>	<p>NOAM VIP GUI: Enter MP server group data</p>	<p>1. Navigate to Configuration > Server Groups.</p>  <p>The screenshot shows a tree view of the configuration menu. 'Configuration' is expanded to show 'Networking', 'Servers', 'Server Groups', 'Resource Domains', 'Places', and 'Place Associations'. 'Server Groups' is highlighted.</p> <p>2. Click Insert.</p> <div data-bbox="509 1575 854 1625" style="border: 1px solid gray; padding: 2px;"> <p>Insert Edit Delete Report</p> </div> <p>3. Enter these values:</p> <p>Server Group Name: <Server Group Name> Level: C Parent: SOAM server group that is parent to this MP Function: DSR (multi-active cluster)</p> <p>4. Click OK.</p>

Procedure 32. Configure DAMP Server Groups and Profiles

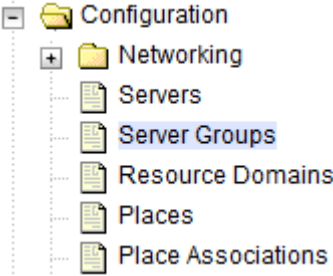
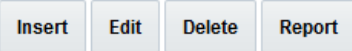
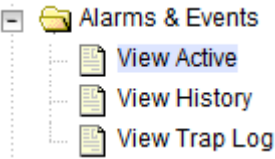
<p>3. <input type="checkbox"/></p>	<p>NOAM VIP GUI: Edit the MP server groups to include MPs</p>	<p>1. Navigate to Configuration > Server Groups.</p>  <p>2. Select the server group you just created and click Edit.</p>  <p>3. Select the network element that represents the MP server group.</p> <p>4. Mark the Include in SG checkbox for the MP server.</p> <p>5. Leave other checkboxes blank.</p> <table border="1" data-bbox="513 852 1419 1073"> <thead> <tr> <th>Server</th> <th>SG Inclusion</th> <th>Preferred HA Role</th> </tr> </thead> <tbody> <tr> <td>ZombieDAMP1</td> <td><input checked="" type="checkbox"/> Include in SG</td> <td><input type="checkbox"/> Prefer server as spare</td> </tr> <tr> <td>ZombieDAMP2</td> <td><input checked="" type="checkbox"/> Include in SG</td> <td><input type="checkbox"/> Prefer server as spare</td> </tr> </tbody> </table> <p>Each MP server should be included in the server group one at a time. Do not include multiple MPs at a time in the server group.</p> <p>6. Click OK.</p>	Server	SG Inclusion	Preferred HA Role	ZombieDAMP1	<input checked="" type="checkbox"/> Include in SG	<input type="checkbox"/> Prefer server as spare	ZombieDAMP2	<input checked="" type="checkbox"/> Include in SG	<input type="checkbox"/> Prefer server as spare
Server	SG Inclusion	Preferred HA Role									
ZombieDAMP1	<input checked="" type="checkbox"/> Include in SG	<input type="checkbox"/> Prefer server as spare									
ZombieDAMP2	<input checked="" type="checkbox"/> Include in SG	<input type="checkbox"/> Prefer server as spare									
<p>4. <input type="checkbox"/></p>	<p>NOAM VIP GUI: Wait for remote database alarm to clear</p>	<p>Wait for the Remote Database re-initialization in progress alarm to clear before proceeding.</p> <p>Monitor progress by navigating to Alarms & Events > View Active.</p> 									

Procedure 32. Configure DAMP Server Groups and Profiles

<p>5. <input type="checkbox"/></p>	<p>SOAM VIP GUI: Login</p>	<p>1. Establish a GUI session on the SOAM server by using the VIP IP address of the SOAM server. Open the web browser and enter a URL of:</p> <div data-bbox="548 323 1393 369" style="border: 1px solid black; padding: 2px;"> <p>https://<Primary_SOAM_VIP_IP_Address></p> </div> <p>2. Login as the guidadmin user.</p> <div data-bbox="532 449 1377 1230" style="text-align: center;"> </div>
------------------------------------	---------------------------------------	--

Procedure 32. Configure DAMP Server Groups and Profiles

6. **SOAM VIP GUI:**
Assign profiles to DA-MPs from SOAM GUI

1. Navigate to **Diameter Common > MPs > Profiles Assignments.**

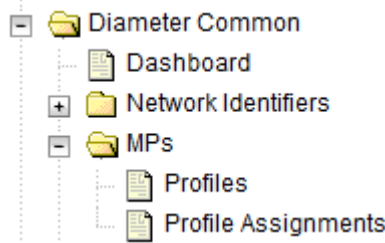

If the site has both DSR and MAP-IWF server groups, both DA-MP and SS7-MP sections display.

Main Menu: Diameter Common -> MPs -> Profile Assignments

DA-MP	MP Profile	current value
ZombieDAMP1	VM:10K_MPS	The current MP Profile for ZombieDAMP1 is VM:10K_MPS . <i>Virtualized DA-MP rated at 10K MPS for all configurations [A value is required.]</i>
ZombieDAMP2	VM:10K_MPS	The current MP Profile for ZombieDAMP2 is VM:10K_MPS . <i>Virtualized DA-MP rated at 10K MPS for all configurations [A value is required.]</i>
<hr/>		
SS7-MP	MP Profile	current value
ZombieSS7MP1	VM:MD-IWF	The current MP Profile for ZombieSS7MP1 is VM:MD-IWF . <i>Virtualized SS7-MP running MD-IWF application [A value is required.]</i>
ZombieSS7MP2	VM:MD-IWF	The current MP Profile for ZombieSS7MP2 is VM:MD-IWF . <i>Virtualized SS7-MP running MD-IWF application [A value is required.]</i>

Assign Cancel

2. For each MP, select the proper profile assignment based on the function of each MP.



Profile Name	Description
VM:10K_MPS	Virtualized DA-MP rated at 10K MPS for all configurations
VM:Relay	Virtualized DA-MP Guest running the relay application
VM:Database	Virtualized DA-MP Guest running relay and database applications

DA-MP	MP Profile	current value
MultiApp3-DA-MP1	VM:10K_MPS	The current MP Profile for MultiApp3-DA-MP1 is VM:10K_MPS . <i>Virtualized DA-MP rated at 10K MPS for all configurations [A value is r</i>

Note: If the DA-MPs at this site are configured for **Active/Standby**, then there is a single selection box that assigns profiles for all MPs.

3. Click **Assign**.

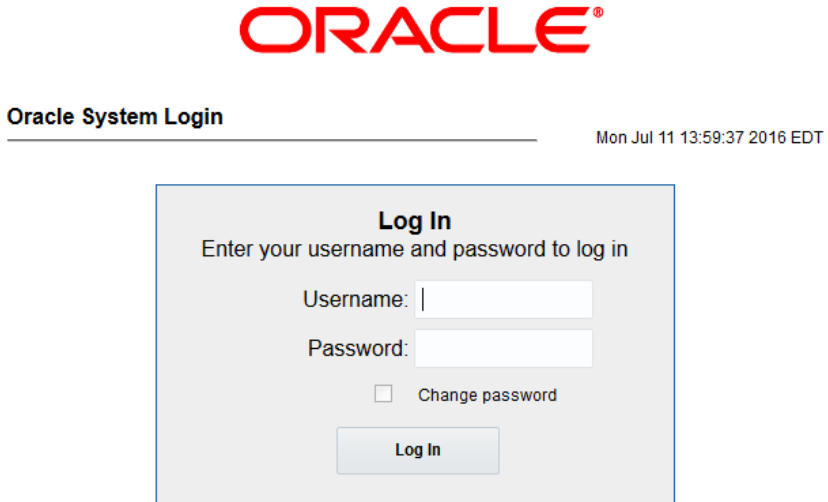
Procedure 32. Configure DAMP Server Groups and Profiles

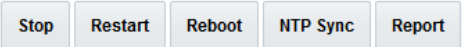
<p>7. <input type="checkbox"/></p>	<p>NOAM VIP GUI: Login</p>	<p>1. Establish a GUI session on the NOAM server by using the VIP IP address of the NOAM server. Open the web browser and enter a URL of:</p> <div style="border: 1px solid black; padding: 5px; margin: 10px 0;"> <pre>https://<Primary_NOAM_VIP_IP_Address></pre> </div> <p>2. Login as the guiadmin user.</p> <div style="text-align: center; margin: 20px 0;">  <p>The screenshot shows the Oracle System Login page. At the top is the Oracle logo. Below it is the text 'Oracle System Login' and the date 'Mon Jul 11 13:59:37 2016 EDT'. In the center is a 'Log In' box with the instruction 'Enter your username and password to log in'. It contains fields for 'Username:' and 'Password:', a 'Change password' checkbox, and a 'Log In' button.</p> </div>
<p>8. <input type="checkbox"/></p>	<p>NOAM VIP GUI: Restart all MP servers</p>	<p>1. Navigate to Status & Manage > Server.</p> <div style="margin: 10px 0;">  <p>The screenshot shows a tree view under 'Status & Manage' with sub-items: 'Network Elements', 'Server', and 'HA'.</p> </div> <p>2. For each MP server, select the MP server and click Restart.</p> <div style="margin: 10px 0;">  <p>The screenshot shows a row of buttons: 'Stop', 'Restart', 'Reboot', 'NTP Sync', and 'Report'.</p> </div> <p>3. Click OK to confirm. Wait for the restart successful message.</p> <p>Note: Policy and Charging DRA Installations/DCA Installations: You may see alarms related to ComAgent until the PCA/DCA installation is complete.</p>
<p>9. <input type="checkbox"/></p>	<p>NOAM VIP: Clear DA_MP_Leader Alarm Active/Standby DA-MP Configurations Only</p>	<p>1. If the DSR (active/standby pair) server group function was configured for the DA-MPs, execute this step.</p> <div style="border: 1px solid black; padding: 5px; margin: 10px 0;"> <pre>\$ sudo iqt -fClusterID TopologyMapping where "NodeID='<DA-MP Server Hostname>'" Server_ID NodeID ClusterID 7 ZombieDAMP2 C2479</pre> </div> <p>2. Using the ClusterID above, enter this.</p> <div style="border: 1px solid black; padding: 5px; margin: 10px 0;"> <pre>\$ echo "<Cluster_ID> DA_MP_Leader Yes" iload -ha - xun -fcluster -fresource -foptional HaClusterResourceCfg</pre> </div>

Procedure 33. Configure IPFE Server Groups

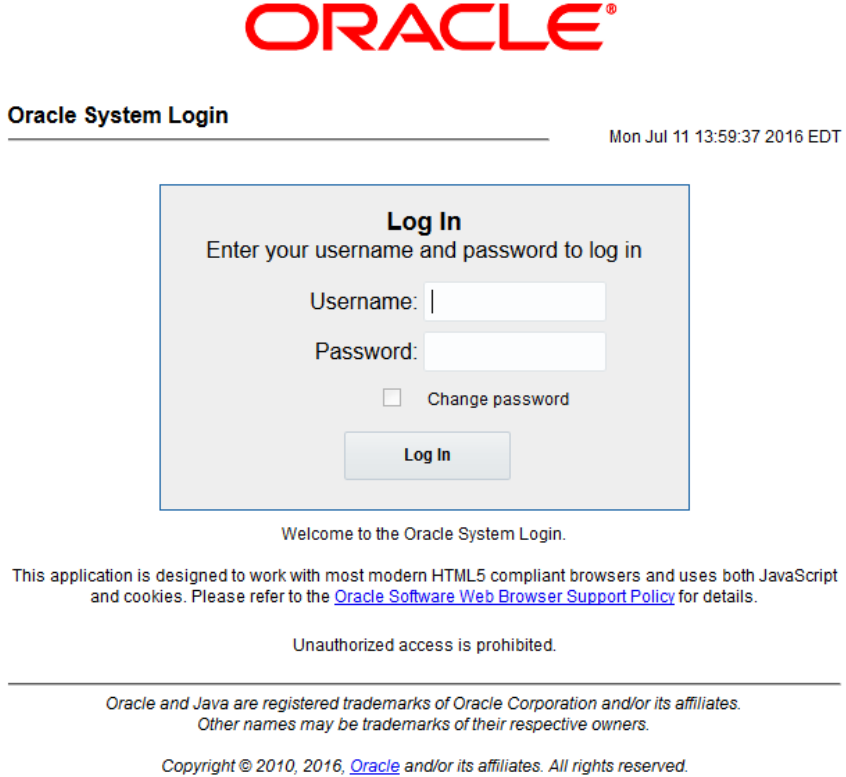
S T E P #	<p>This procedure configures MP server groups as IPFEs.</p> <p>Check off (✓) each step as it is completed. Boxes have been provided for this purpose under each step number.</p> <p>If this procedure fails, it is recommended to contact My Oracle Support (MOS) and ask for assistance.</p>	
<p>1. <input type="checkbox"/></p>	<p>NOAM VIP GUI: Login</p>	<p>1. Establish a GUI session on the NOAM server by using the VIP IP address of the NOAM server. Open the web browser and enter a URL of:</p> <div style="border: 1px solid black; padding: 5px; margin: 10px 0;"> <p>https://<Primary_NOAM_VIP_IP_Address></p> </div> <p>2. Login as the guiadmin user.</p> <div style="text-align: center; margin: 20px 0;">  </div>

Procedure 33. Configure IPFE Server Groups

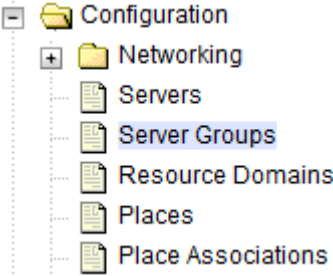
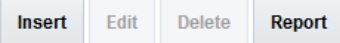
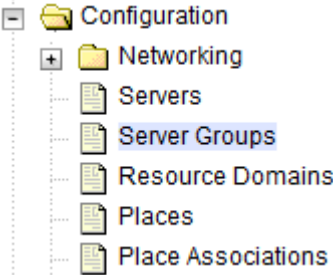
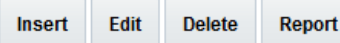
<p>2. <input type="checkbox"/></p>	<p>NOAM VIP GUI: Enter MP server group data</p>	<p>1. Navigate to Configuration > Server Groups.</p>  <p>2. Click Insert.</p>  <p>3. Enter these values:</p> <p>Server Group Name: <Server Group Name> Level: C Parent: SOAM server group that is parent to this MP Function: IP Front End</p> <p>4. Click OK.</p>									
<p>3. <input type="checkbox"/></p>	<p>NOAM VIP GUI: Edit the MP server groups to include MPs</p>	<p>1. Navigate to Configuration > Server Groups.</p>  <p>2. Select the server group you just created and click Edit.</p>  <p>3. Select the network element that represents the MP server group.</p> <p>4. Mark the Include in SG checkbox for the IPFE MP server.</p> <p>5. Leave other checkboxes blank.</p> <table border="1" data-bbox="513 1570 1419 1793"> <thead> <tr> <th>Server</th> <th>SG Inclusion</th> <th>Preferred HA Role</th> </tr> </thead> <tbody> <tr> <td>ZombieDAMP1</td> <td><input checked="" type="checkbox"/> Include in SG</td> <td><input type="checkbox"/> Prefer server as spare</td> </tr> <tr> <td>ZombieDAMP2</td> <td><input checked="" type="checkbox"/> Include in SG</td> <td><input type="checkbox"/> Prefer server as spare</td> </tr> </tbody> </table> <p>IPFE MP server should have an individual server group of type IPFE.</p> <p>6. Click OK.</p>	Server	SG Inclusion	Preferred HA Role	ZombieDAMP1	<input checked="" type="checkbox"/> Include in SG	<input type="checkbox"/> Prefer server as spare	ZombieDAMP2	<input checked="" type="checkbox"/> Include in SG	<input type="checkbox"/> Prefer server as spare
Server	SG Inclusion	Preferred HA Role									
ZombieDAMP1	<input checked="" type="checkbox"/> Include in SG	<input type="checkbox"/> Prefer server as spare									
ZombieDAMP2	<input checked="" type="checkbox"/> Include in SG	<input type="checkbox"/> Prefer server as spare									

Procedure 33. Configure IPFE Server Groups

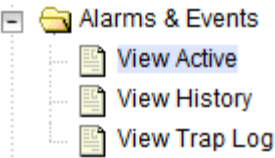
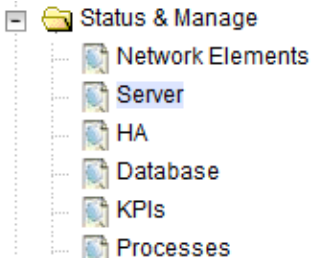
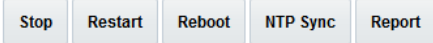
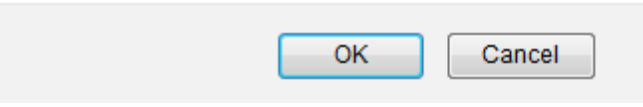
<p>4.</p> <p><input type="checkbox"/></p>	<p>NOAM VIP GUI: Wait for remote database alarm to clear</p>	<p>Wait for the Remote Database re-initialization in progress alarm to clear before proceeding. Monitor progress by navigating to Alarms & Events > View Active.</p> 
<p>5.</p> <p><input type="checkbox"/></p>	<p>NOAM GUI: Restart MP server</p>	<p>1. Navigate to Status & Manage > Server.</p>  <p>2. Select the MP server and click Restart.</p>  <p>3. Click OK to confirm.</p> <p>Are you sure you wish to restart application software on the following server(s)? ZombieSOAM1</p> 

Procedure 34. Configure SS7-MP Server Groups and Profiles

S T E P #	<p>This procedure configures MP server groups as SS7-MPs.</p> <p>Check off (✓) each step as it is completed. Boxes have been provided for this purpose under each step number.</p> <p>If this procedure fails, it is recommended to contact My Oracle Support (MOS) and ask for assistance.</p>	
<p>1.</p> <p><input type="checkbox"/></p>	<p>NOAM VIP GUI: Login</p>	<p>1. Establish a GUI session on the NOAM server by using the VIP IP address of the NOAM server. Open the web browser and enter a URL of:</p> <div style="border: 1px solid black; padding: 5px; margin: 10px 0;"> <p>https://<Primary_NOAM_VIP_IP_Address></p> </div> <p>2. Login as the guiadmin user.</p> 

Procedure 34. Configure SS7-MP Server Groups and Profiles

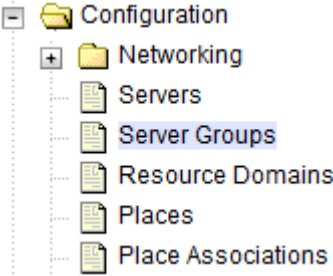
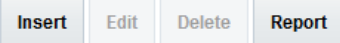
<p>2.</p> <p><input type="checkbox"/></p>	<p>NOAM VIP GUI: Enter MP server group data</p>	<p>1. Navigate to Configuration > Server Groups.</p>  <p>2. Click Insert.</p>  <p>3. Enter these values:</p> <p>Server Group Name: <Server Group Name> Level: C Parent: SOAM server group that is parent to this MP Function: SS7-IWF</p> <p>4. Click OK.</p>
---	--	--

Procedure 34. Configure SS7-MP Server Groups and Profiles

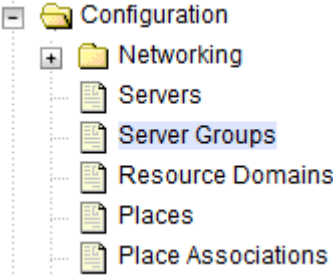
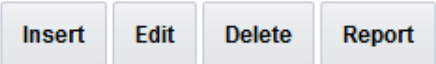
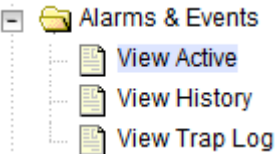
<p>3. <input type="checkbox"/></p>	<p>NOAM VIP GUI: Edit the MP server groups to include MPs</p>	<p>1. Navigate to Configuration > Server Groups.</p>  <p>2. Select the server group you just created and click Edit.</p>  <p>3. Select the network element that represents the MP server group.</p> <p>4. Mark the Include in SG checkbox for the SS7-IWF MP server.</p> <p>5. Leave other checkboxes blank.</p> <table border="1" data-bbox="513 867 1419 1094"> <thead> <tr> <th>Server</th> <th>SG Inclusion</th> <th>Preferred HA Role</th> </tr> </thead> <tbody> <tr> <td>ZombieDAMP1</td> <td><input checked="" type="checkbox"/> Include in SG</td> <td><input type="checkbox"/> Prefer server as spare</td> </tr> <tr> <td>ZombieDAMP2</td> <td><input checked="" type="checkbox"/> Include in SG</td> <td><input type="checkbox"/> Prefer server as spare</td> </tr> </tbody> </table> <p>Each MP server should be included in the server group one at a time. Do not include multiple MPs at a time in the server group.</p> <p>6. Click OK.</p>	Server	SG Inclusion	Preferred HA Role	ZombieDAMP1	<input checked="" type="checkbox"/> Include in SG	<input type="checkbox"/> Prefer server as spare	ZombieDAMP2	<input checked="" type="checkbox"/> Include in SG	<input type="checkbox"/> Prefer server as spare
Server	SG Inclusion	Preferred HA Role									
ZombieDAMP1	<input checked="" type="checkbox"/> Include in SG	<input type="checkbox"/> Prefer server as spare									
ZombieDAMP2	<input checked="" type="checkbox"/> Include in SG	<input type="checkbox"/> Prefer server as spare									
<p>4. <input type="checkbox"/></p>	<p>NOAM VIP GUI: Wait for remote database alarm to clear</p>	<p>Wait for the Remote Database re-initialization in progress alarm to clear before proceeding.</p> <p>Monitor progress by navigating to Alarms & Events > View Active.</p> 									

Procedure 34. Configure SS7-MP Server Groups and Profiles

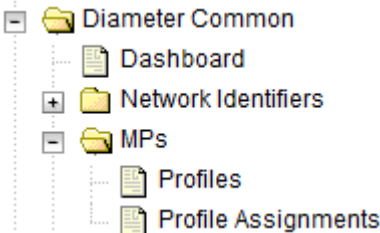
<p>5. <input type="checkbox"/></p>	<p>SOAM VIP GUI: Login</p>	<p>1. Establish a GUI session on the SOAM server by using the VIP IP address of the SOAM server. Open the web browser and enter a URL of:</p> <div style="border: 1px solid black; padding: 5px; margin: 10px 0;"> <p>https://<Primary_SOAM_VIP_IP_Address></p> </div> <p>2. Login as the guidadmin user.</p>  <p style="text-align: center;"><i>Oracle and Java are registered trademarks of Oracle Corporation and/or its affiliates. Other names may be trademarks of their respective owners.</i></p> <p style="text-align: center;"><i>Copyright © 2010, 2016, Oracle and/or its affiliates. All rights reserved.</i></p>
<p>6. <input type="checkbox"/></p>	<p>SOAM VIP GUI: Assign profiles to DA-MPs from SOAM GUI</p>	<p>1. Navigate to Diameter Common > MPs > Profiles Assignments.</p>  <p>If the site has both DSR and MAP-IWF server groups, both DA-MP and SS7-MP sections display.</p>

Procedure 34. Configure SS7-MP Server Groups and Profiles

Main Menu: Diameter Common -> MPs -> Profile Assignments

DA-MP	MP Profile	current value
ZombieDAMP1	VM:10K_MPS	The current MP Profile for ZombieDAMP1 is VM:10K_MPS . <i>Virtualized DA-MP rated at 10K MPS for all configurations [A value is required.]</i>
ZombieDAMP2	VM:10K_MPS	The current MP Profile for ZombieDAMP2 is VM:10K_MPS . <i>Virtualized DA-MP rated at 10K MPS for all configurations [A value is required.]</i>

SS7-MP	MP Profile	current value
ZombieSS7MP1	VM:MD-IWF	The current MP Profile for ZombieSS7MP1 is VM:MD-IWF . <i>Virtualized SS7-MP running MD-IWF application [A value is required.]</i>
ZombieSS7MP2	VM:MD-IWF	The current MP Profile for ZombieSS7MP2 is VM:MD-IWF . <i>Virtualized SS7-MP running MD-IWF application [A value is required.]</i>



2. For each SS7-MP, select the proper profile assignment based on the function of each MP.

Profile Name	Description
VM:MD-IWF	Virtualized SS7-MP running MD-IWF application

SS7-MP	MP Profile	current value
MultiApp3-SS7-MP1	VM:MD-IWF	The current MP Profile for MultiApp3-SS7-MP1 is VM:MD-IWF . <i>Virtualized SS7-MP running MD-IWF application [A value is req</i>
MultiApp3-SS7-MP2	VM:MD-IWF	The current MP Profile for MultiApp3-SS7-MP2 is VM:MD-IWF . <i>Virtualized SS7-MP running MD-IWF application [A value is req</i>
MultiApp3-SS7-MP3	VM:MD-IWF	The current MP Profile for MultiApp3-SS7-MP3 is VM:MD-IWF . <i>Virtualized SS7-MP running MD-IWF application [A value is req</i>
MultiApp3-SS7-MP4	VM:MD-IWF	The current MP Profile for MultiApp3-SS7-MP4 is VM:MD-IWF . <i>Virtualized SS7-MP running MD-IWF application [A value is req</i>

3. Click **Assign**.

Procedure 34. Configure SS7-MP Server Groups and Profiles

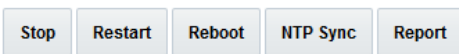
<p>7. <input type="checkbox"/></p>	<p>NOAM VIP GUI: Login</p>	<p>1. Establish a GUI session on the NOAM server by using the VIP IP address of the NOAM server. Open the web browser and enter a URL of:</p> <div style="border: 1px solid black; padding: 5px; width: fit-content; margin: 10px 0;"> <p>https://<Primary_NOAM_VIP_IP_Address></p> </div> <p>2. Login as the guidadmin user.</p> <div style="text-align: center; margin: 20px 0;">  </div> <div style="text-align: center;"> <p>Oracle System Login</p> <hr/> <p>Mon Jul 11 13:59:37 2016 EDT</p> </div> <div style="text-align: center; margin: 20px 0;"> <div style="border: 1px solid gray; padding: 10px; width: 300px; margin: 0 auto;"> <p>Log In</p> <p>Enter your username and password to log in</p> <p>Username: <input style="width: 100%;" type="text"/></p> <p>Password: <input style="width: 100%;" type="password"/></p> <p><input type="checkbox"/> Change password</p> <p style="text-align: center;"><input type="button" value="Log In"/></p> </div> <p>Welcome to the Oracle System Login.</p> <p>This application is designed to work with most modern HTML5 compliant browsers and uses both JavaScript and cookies. Please refer to the Oracle Software Web Browser Support Policy for details.</p> <p>Unauthorized access is prohibited.</p> <hr/> <p><small>Oracle and Java are registered trademarks of Oracle Corporation and/or its affiliates. Other names may be trademarks of their respective owners.</small></p> <p><small>Copyright © 2010, 2016, Oracle and/or its affiliates. All rights reserved.</small></p> </div>
<p>8. <input type="checkbox"/></p>	<p>NOAM VIP GUI: Restart all MP servers</p>	<p>1. Navigate to Status & Manage > Server.</p> <div style="margin: 10px 0;">  </div> <p>2. For each MP server, select the MP server and click Restart.</p> <div style="margin: 10px 0;">  </div> <p>3. Click OK to confirm.</p> <p>Wait for the restart successful message.</p>

Procedure 35. Configure Session SBR Server Groups

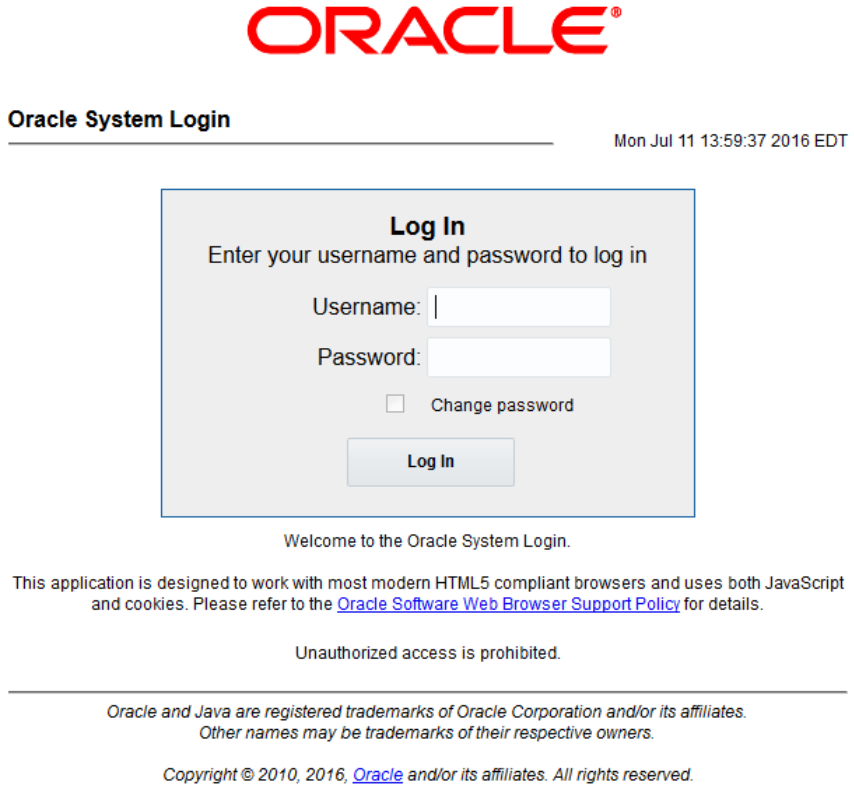
S T E P #	<p>This procedure configures MP server groups as session SBRs.</p> <p>Check off (✓) each step as it is completed. Boxes have been provided for this purpose under each step number.</p> <p>If this procedure fails, it is recommended to contact My Oracle Support (MOS) and ask for assistance.</p>	
<p>1.</p> <p><input type="checkbox"/></p>	<p>NOAM VIP GUI: Login</p>	<p>1. Establish a GUI session on the NOAM server by using the VIP IP address of the NOAM server. Open the web browser and enter a URL of:</p> <div style="border: 1px solid black; padding: 5px; margin: 10px 0;"> <p>https://<Primary_NOAM_VIP_IP_Address></p> </div> <p>2. Login as the guiadmin user.</p> <div style="text-align: center; margin: 20px 0;">  </div>

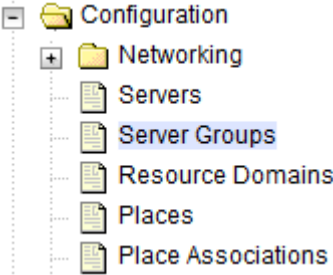
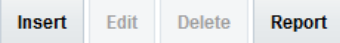

Procedure 35. Configure Session SBR Server Groups

<p>2.</p> <p><input type="checkbox"/></p>	<p>NOAM VIP GUI: Enter MP server group data</p>	<p>1. Navigate to Configuration > Server Groups.</p>  <p>2. Click Insert.</p>  <p>3. Enter these values:</p> <p>Server Group Name: <Server Group Name> Level: C Parent: SOAM server group that is parent to this MP Function: SBR WAN Replication Connection Count: 8</p> <p>4. Click OK.</p>
---	--	--

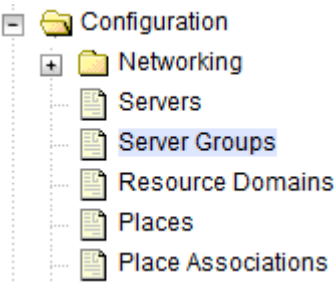
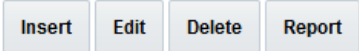
Procedure 35. Configure Session SBR Server Groups

<p>3. <input type="checkbox"/></p>	<p>NOAM VIP GUI: Edit the MP server groups to include MPs</p>	<p>1. Navigate to Configuration > Server Groups.</p>  <p>2. Select the server group you just created and click Edit.</p>  <p>3. Select the network element that represents the MP server group.</p> <p>4. Mark the Include in SG checkbox for the Session SBR MP server.</p> <p>5. Leave other checkboxes blank.</p> <table border="1" data-bbox="509 848 1419 1066"> <thead> <tr> <th>Server</th> <th>SG Inclusion</th> <th>Preferred HA Role</th> </tr> </thead> <tbody> <tr> <td>ZombieDAMP1</td> <td><input checked="" type="checkbox"/> Include in SG</td> <td><input type="checkbox"/> Prefer server as spare</td> </tr> <tr> <td>ZombieDAMP2</td> <td><input checked="" type="checkbox"/> Include in SG</td> <td><input type="checkbox"/> Prefer server as spare</td> </tr> </tbody> </table> <p>Each MP server should be included in the server group one at a time. Do not include multiple MPs at a time in the server group.</p> <p>6. Click OK.</p>	Server	SG Inclusion	Preferred HA Role	ZombieDAMP1	<input checked="" type="checkbox"/> Include in SG	<input type="checkbox"/> Prefer server as spare	ZombieDAMP2	<input checked="" type="checkbox"/> Include in SG	<input type="checkbox"/> Prefer server as spare
Server	SG Inclusion	Preferred HA Role									
ZombieDAMP1	<input checked="" type="checkbox"/> Include in SG	<input type="checkbox"/> Prefer server as spare									
ZombieDAMP2	<input checked="" type="checkbox"/> Include in SG	<input type="checkbox"/> Prefer server as spare									
<p>4. <input type="checkbox"/></p>	<p>NOAM VIP GUI: Edit the MP server group and add preferred spares for site redundancy (optional) PCA/DCA Only</p>	<p>If Two Site Redundancy feature for the Policy and Charging SBR server group OR Session Binding Repository is wanted, add an MP server that is physically located in a separate site (location) to the server group by marking the Include in SG checkbox. Also, mark the Preferred Spare checkbox.</p> <table border="1" data-bbox="509 1339 1419 1465"> <thead> <tr> <th>Server</th> <th>SG Inclusion</th> <th>Preferred HA Role</th> </tr> </thead> <tbody> <tr> <td>ZombieSBRsp</td> <td><input checked="" type="checkbox"/> Include in SG</td> <td><input checked="" type="checkbox"/> Prefer server as spare</td> </tr> </tbody> </table> <p>If Three Site Redundancy feature for the SBR MP server group is wanted, add two SBR MP servers that are both physically located in separate sites (location) to the server group by marking the Include in SG checkbox. Also, mark the Preferred Spare checkbox for both servers.</p> <p>Note: The preferred spare servers should be different sites from the original server and should not be in the same site. There should be servers from three separate sites (locations).</p> <p>For more information about site redundancy for Policy and Charging SBR server groups/session binding repository server groups, see section 1.3 Terminology.</p> <p>Click OK to save.</p>	Server	SG Inclusion	Preferred HA Role	ZombieSBRsp	<input checked="" type="checkbox"/> Include in SG	<input checked="" type="checkbox"/> Prefer server as spare			
Server	SG Inclusion	Preferred HA Role									
ZombieSBRsp	<input checked="" type="checkbox"/> Include in SG	<input checked="" type="checkbox"/> Prefer server as spare									

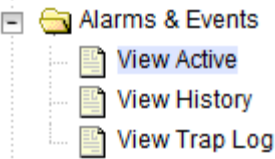
Procedure 35. Configure Session SBR Server Groups

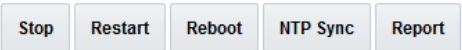
<p>5. <input type="checkbox"/></p>	<p>NOAM VIP GUI: Wait for remote database alarm to clear</p>	<p>Wait for the Remote Database re-initialization in progress alarm to clear before proceeding. Monitor progress by navigating to Alarms & Events > View Active.</p> 
<p>6. <input type="checkbox"/></p>	<p>NOAM VIP GUI: Restart all MP servers</p>	<p>1. Navigate to Status & Manage > Server.</p>  <p>2. For each MP server, select the MP server and click Restart.</p>  <p>3. Click OK to confirm. Wait for the restart successful message.</p>

Procedure 36. Configure Binding SBR Server Groups

S T E P #	<p>This procedure configures MP server groups as binding SBRs.</p> <p>Check off (✓) each step as it is completed. Boxes have been provided for this purpose under each step number.</p> <p>If this procedure fails, it is recommended to contact My Oracle Support (MOS) and ask for assistance.</p>	
<p>1.</p> <p><input type="checkbox"/></p>	<p>NOAM VIP GUI: Login</p>	<p>1. Establish a GUI session on the NOAM server by using the VIP IP address of the NOAM server. Open the web browser and enter a URL of:</p> <div style="border: 1px solid black; padding: 5px; margin: 10px 0;"> <p>https://<Primary_NOAM_VIP_IP_Address></p> </div> <p>2. Login as the guiadmin user.</p> <div style="text-align: center; margin: 20px 0;">  </div>

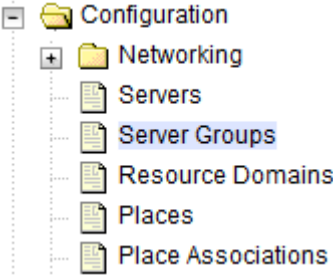
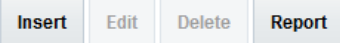

Procedure 36. Configure Binding SBR Server Groups

<p>2. <input type="checkbox"/></p>	<p>NOAM VIP GUI: Enter MP server group data</p>	<p>1. Navigate to Configuration > Server Groups.</p>  <p>2. Click Insert.</p>  <p>3. Enter these values:</p> <p>Server Group Name: <Server Group Name> Level: C Parent: SOAM server group that is parent to this MP Function: SBR WAN Replication Connection Count: 8</p> <p>4. Click OK.</p>
------------------------------------	--	--

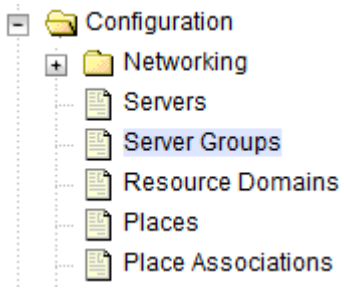
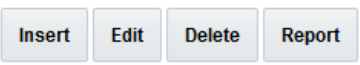
Procedure 36. Configure Binding SBR Server Groups

<p>3. NOAM VIP GUI: <input type="checkbox"/> Edit the MP server groups to include MPs</p>	<p>1. Navigate to Configuration > Server Groups.</p>  <p>2. Select the server group you just created and click Edit.</p>  <p>3. Select the network element that represents the MP server group.</p> <p>4. Mark the Include in SG checkbox for the MP server.</p> <p>5. Leave other checkboxes blank.</p> <table border="1" data-bbox="503 850 1421 1144"> <thead> <tr> <th colspan="3">NO_HPC02</th> </tr> <tr> <th>Server</th> <th>SG Inclusion</th> <th>Preferred HA Role</th> </tr> </thead> <tbody> <tr> <td>HPC2-bPSBR1</td> <td><input checked="" type="checkbox"/> Include in SG</td> <td><input type="checkbox"/> Prefer server as spare</td> </tr> <tr> <td>HPC2-bPSBR2</td> <td><input checked="" type="checkbox"/> Include in SG</td> <td><input type="checkbox"/> Prefer server as spare</td> </tr> </tbody> </table> <p>Each MP server should be included in the server group one at a time. Do not include multiple MPs at a time in the server group.</p> <p>6. Click OK.</p>	NO_HPC02			Server	SG Inclusion	Preferred HA Role	HPC2-bPSBR1	<input checked="" type="checkbox"/> Include in SG	<input type="checkbox"/> Prefer server as spare	HPC2-bPSBR2	<input checked="" type="checkbox"/> Include in SG	<input type="checkbox"/> Prefer server as spare
NO_HPC02													
Server	SG Inclusion	Preferred HA Role											
HPC2-bPSBR1	<input checked="" type="checkbox"/> Include in SG	<input type="checkbox"/> Prefer server as spare											
HPC2-bPSBR2	<input checked="" type="checkbox"/> Include in SG	<input type="checkbox"/> Prefer server as spare											

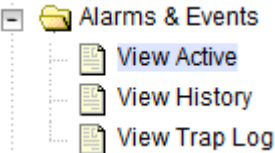
Procedure 36. Configure Binding SBR Server Groups

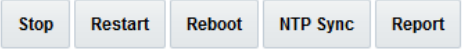
<p>4. <input type="checkbox"/></p>	<p>NOAM VIP GUI: Edit the MP server group and add preferred spares for site redundancy (optional) PCA/DCA Only</p>	<p>If Two Site Redundancy feature for the Policy and Charging SBR server group OR Session Binding Repository is wanted, add an MP server that is physically located in a separate site (location) to the server group by marking the Include in SG checkbox. Also, mark the Preferred Spare checkbox.</p> <table border="1" data-bbox="505 373 1414 499"> <thead> <tr> <th>Server</th> <th>SG Inclusion</th> <th>Preferred HA Role</th> </tr> </thead> <tbody> <tr> <td>ZombieSBRsp</td> <td><input checked="" type="checkbox"/> Include in SG</td> <td><input checked="" type="checkbox"/> Prefer server as spare</td> </tr> </tbody> </table> <p>If Three Site Redundancy feature for the SBR MP server group is wanted, add two SBR MP servers that are both physically located in separate sites (location) to the server group by marking the Include in SG checkbox. Also, mark the Preferred Spare checkbox for both servers.</p> <p>Note: The preferred spare servers should be different sites from the original server and should not be in the same site. There should be servers from three separate sites (locations).</p> <p>For more information about site redundancy for Policy and Charging SBR server groups/session binding repository server groups, see section 1.3 Terminology.</p> <p>Click OK to save.</p>	Server	SG Inclusion	Preferred HA Role	ZombieSBRsp	<input checked="" type="checkbox"/> Include in SG	<input checked="" type="checkbox"/> Prefer server as spare
Server	SG Inclusion	Preferred HA Role						
ZombieSBRsp	<input checked="" type="checkbox"/> Include in SG	<input checked="" type="checkbox"/> Prefer server as spare						
<p>5. <input type="checkbox"/></p>	<p>NOAM VIP GUI: Wait for remote database alarm to clear</p>	<p>Wait for the Remote Database re-initialization in progress alarm to clear before proceeding.</p> <p>Monitor progress by navigating to Alarms & Events > View Active.</p> 						
<p>6. <input type="checkbox"/></p>	<p>NOAM VIP GUI: Restart all MP servers</p>	<p>1. Navigate to Status & Manage > Server.</p>  <p>2. For each MP server, select the MP server and click Restart.</p>  <p>3. Click OK to confirm.</p> <p>Wait for the restart successful message.</p>						

3.14.8 Signaling Network Configuration

Procedure 37. Configure Signaling Network Routes

S T E P #	<p>This procedure configures signaling network routes on MP servers (IPFE, SBR, SS7-MP, and DA-MP).</p> <p>Check off (✓) each step as it is completed. Boxes have been provided for this purpose under each step number.</p> <p>If this procedure fails, it is recommended to contact My Oracle Support (MOS) and ask for assistance.</p>
<p>1. <input type="checkbox"/></p>	<p>Primary NOAM VIP GUI: Login</p> <ol style="list-style-type: none"> Establish a GUI session on the NOAM server by using the XMI VIP IP address. Open the web browser and enter a URL of: <div style="border: 1px solid black; padding: 5px; margin: 10px 0;"> <code>https://<NOAM_XMI_VIP_IP_Address></code> </div> Login as the guiadmin user. <div style="text-align: center;">  </div>

Procedure 37. Configure Signaling Network Routes

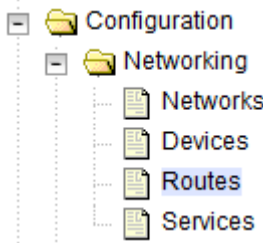
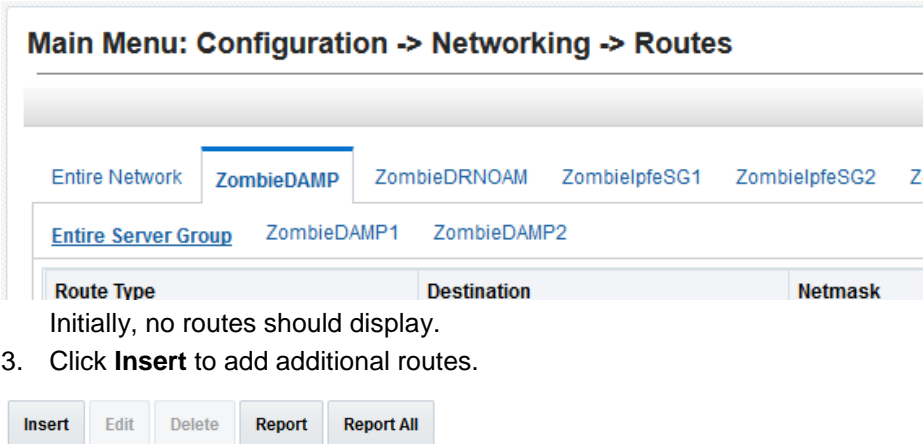
<p>2. NOAM VIP GUI: Add route</p>	<p>1. Navigate to Configuration > Networking > Routes.</p>  <p>2. Select the MP server group tab and verify the Entire Server Group link is selected, if not, select the link.</p>  <p>3. Click Insert to add additional routes.</p> <p>For SBRs that span multiple sites, add routes individually.</p>
--	--

Procedure 37. Configure Signaling Network Routes

<p>3. <input type="checkbox"/></p>	<p>NOAM VIP GUI: Add a default route for MPs going through signaling network gateway (optional)</p>	<p>Execute this step only if you performed Procedure 30, step 14. , which removed the XMI gateway default route on MPs. If your MP servers no longer have a default route, then insert a default route to use one of the signaling network gateways.</p> <p>Main Menu: Configuration -> Networking -></p> <p>Info* ▼</p> <p>Insert Route on ZombieDAMP</p> <table border="1"> <thead> <tr> <th>Field</th> <th>Value</th> <th>Description</th> </tr> </thead> <tbody> <tr> <td>Route Type *</td> <td> <input type="radio"/> Net <input checked="" type="radio"/> Default <input type="radio"/> Host </td> <td>Select a route type. </td> </tr> <tr> <td>Device *</td> <td> <input type="text" value="xsi1"/> ▼ </td> <td>Select the network c</td> </tr> <tr> <td>Destination</td> <td><input type="text"/></td> <td>The destination net</td> </tr> <tr> <td>Netmask</td> <td><input type="text"/></td> <td>A valid netmask for t</td> </tr> <tr> <td>Gateway IP *</td> <td><input type="text"/></td> <td>The IP address of th</td> </tr> </tbody> </table> <p>Ok Apply Cancel</p> <p>1. Enter the fields as follows: Route Type: Default Device: Select the signaling device that is directly attached to the network where the XSI default gateway resides Gateway IP: The XSI gateway you wish to use for default signaling network access.</p> <p>2. Click OK.</p> <p>Ok Apply Cancel</p>	Field	Value	Description	Route Type *	<input type="radio"/> Net <input checked="" type="radio"/> Default <input type="radio"/> Host	Select a route type.	Device *	<input type="text" value="xsi1"/> ▼	Select the network c	Destination	<input type="text"/>	The destination net	Netmask	<input type="text"/>	A valid netmask for t	Gateway IP *	<input type="text"/>	The IP address of th
Field	Value	Description																		
Route Type *	<input type="radio"/> Net <input checked="" type="radio"/> Default <input type="radio"/> Host	Select a route type.																		
Device *	<input type="text" value="xsi1"/> ▼	Select the network c																		
Destination	<input type="text"/>	The destination net																		
Netmask	<input type="text"/>	A valid netmask for t																		
Gateway IP *	<input type="text"/>	The IP address of th																		
<p>4. <input type="checkbox"/></p>	<p>NOAM VIP GUI: Add network routes for diameter peers</p>	<p>This step adds the IP and/or IPv6 routes to diameter peer destination networks. This ensures diameter traffic uses the gateway(s) on the signaling networks.</p>																		

Procedure 37. Configure Signaling Network Routes

Insert Route on ZombieDAMP		
Field	Value	Description
Route Type *	<input checked="" type="radio"/> Net <input type="radio"/> Default <input type="radio"/> Host	Select a route type. [Default = N/A. Options = Net, Default, Host. You
Device *	xsi1	Select the network device name through which traffic is being route
Destination	10.240.55.0	The destination network address. [Default = N/A. Range = Valid Net
Netmask	255.255.255.0	A valid netmask for the network route destination IP address. [Defa
Gateway IP *	10.196.227.1	The IP address of the gateway for this route. [Default = N/A. Range :

- Enter the fields as follows:
 - Route Type:** Net
 - Device:** Select the appropriate signaling interface that will be used to connect to that network
 - Destination:** Enter the network ID of network to which the peer node is connected to
 - Netmask:** Enter the corresponding Netmask (if configuring Net routes)
 - Gateway IP:** Enter the Int-XSI switch VIP of the chosen network for L3 deployments (either of int-XSI-1 or of int-XSI2). Or the IP of the customer gateway for L2 deployments.
- Click **Apply** and repeat to enter more routes, if necessary.
- Click **OK** to save the latest route and leave this screen.

Layer 3 Configurations Aggregation Switch Configurations Only:
 Configure routes on the aggregation switches so that destination networks configured in this step are reachable. This can be done by running the following **netconfig** commands from the site's local PMAC. For example:

Add routes (IPv4 and IPv6):

```
$ sudo netConfig --device=switch1A addRoute
network=10.10.10.0/24 nexthop=10.50.76.81
$ sudo netConfig --device=switch1A addRoute
network6=2001::/64 nexthop=fd0f::1
```

Delete routes (IPv4 and IPv6):

```
$ sudo netConfig --device=switch1A deleteRoute
network=10.10.10.0/24 nexthop=10.50.76.81
$ sudo netConfig -device=switch1A deleteRoute
network6=2001::/64 nexthop=fd0f::1
```

Procedure 37. Configure Signaling Network Routes

5. <input type="checkbox"/>	Local PMAC: Perform a netConfig backup	<p>After the routes are added to the aggregation switches using netconfig, take a netconfig backup so the new routes are retained in the backup.</p> <p>1. Execute the following command:</p> <pre>\$ netConfig backupConfiguration --device=<Switch Hostname> service=<ssh_Service> filename=<Backup Filename></pre> <p>2. Copy the files to the backup directory:</p> <pre>\$ sudo /bin/mv -i ~<switch_backup_user>/<switch_name>- backup* /usr/TKLC/smac/etc/switch/backup</pre>
6. <input type="checkbox"/>	NOAM VIP GUI: Repeat for all other MP server groups	<p>If you have additional MP server groups, repeat this procedure, but this time select an MP from the next MP server group.</p> <p>Continue until you have covered all MP server groups. This includes DAMP, IPFE, and SS7MP servers.</p> <p>Note: IPFE and DAMP servers must have the same routes configured.</p>

3.14.9 DSCP Configuration (Optional)

Procedure 38. Configure DSCP Values for Outgoing Traffic (Optional)

S T E P #	<p>This procedure configures the DSCP values for outgoing packets on servers. DSCP values can be applied to an outbound interface as a whole, or to all outbound traffic using a specific TCP or SCTP source port. This step is optional and should only be executed if your network uses packet DSCP markings for quality-of-service.</p> <p>Check off (✓) each step as it is completed. Boxes have been provided for this purpose under each step number.</p> <p>If this procedure fails, it is recommended to contact My Oracle Support (MOS) and ask for assistance.</p>
1. <input type="checkbox"/>	<p>Primary NOAM VIP GUI: Login</p> <ol style="list-style-type: none"> Establish a GUI session on the NOAM server by using the XMI VIP IP address. Open the web browser and enter a URL of: <div style="border: 1px solid black; padding: 5px; margin: 10px 0;"> <code>https://<NOAM_XMI_VIP_IP_Address></code> </div> Login as the guiadmin user. <div style="text-align: center;">  </div>
2. <input type="checkbox"/>	<p>NOAM VIP GUI: Option 1 — Configure interface DSCP</p> <p>Note: The values displayed in the screenshots are for demonstration purposes only. The exact DSCP values for your site vary.</p> <ol style="list-style-type: none"> Navigate to Configuration > DSCP > Interface DSCP.

Procedure 38. Configure DSCP Values for Outgoing Traffic (Optional)

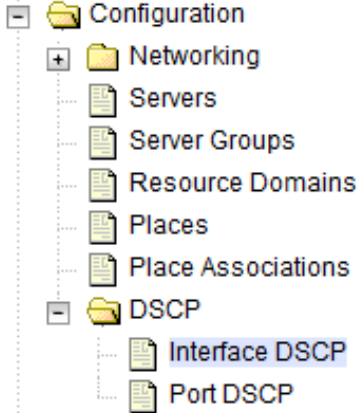
		 <p>3. Select the server you want to configure from the list of servers on the second line. You can view all servers with Entire Network selected; or limit yourself to a specific server group by clicking on that server group name's tab.</p> <p>4. Click Insert.</p> <div style="border: 1px solid #ccc; padding: 5px; margin: 5px 0;"> Insert Delete Report </div> <p>Main Menu: Configuration -> DSCP -> Interface DSCP</p> <div style="border: 1px solid #ccc; padding: 5px; margin: 5px 0;"> <p>Tasks ▾</p> <table style="width: 100%; border-collapse: collapse;"> <tr> <td style="border: 1px solid #ccc; padding: 2px;">Entire Network</td> <td style="border: 1px solid #ccc; padding: 2px;">NOAMMEMORYTEST</td> </tr> <tr> <td style="border: 1px solid #ccc; padding: 2px;">FZTEST-NO1</td> <td style="border: 1px solid #ccc; padding: 2px;">FZTEST-MP1</td> </tr> </table> <table style="width: 100%; border-collapse: collapse;"> <tr> <td style="border: 1px solid #ccc; padding: 2px;">Interface</td> <td style="border: 1px solid #ccc; padding: 2px;">DSCP</td> </tr> </table> </div> <p>5. Select the network Interface, type the DSCP value to apply to packets leaving this interface, and select the transport Protocol.</p>	Entire Network	NOAMMEMORYTEST	FZTEST-NO1	FZTEST-MP1	Interface	DSCP
Entire Network	NOAMMEMORYTEST							
FZTEST-NO1	FZTEST-MP1							
Interface	DSCP							

Procedure 38. Configure DSCP Values for Outgoing Traffic (Optional)

		<p>Main Menu: Configuration -> DSC</p> <p>Info* ▼</p> <p>Insert DSCP by Interface on Zombiel</p> <table border="1"> <tr> <td>Interface *</td> <td>xsi1 ▼</td> <td>The server Note: To c</td> </tr> <tr> <td>DSCP *</td> <td>34</td> <td>A valid DS</td> </tr> <tr> <td>Protocol *</td> <td>TCP ▼</td> <td>TCP or SC</td> </tr> </table> <p>Ok Apply Cancel</p> <p>6. Click OK if there are no more interfaces on this server to configure, or click Apply to finish this interface and continue with more interfaces by selecting them from the drop down and entering their DSCP values.</p>	Interface *	xsi1 ▼	The server Note: To c	DSCP *	34	A valid DS	Protocol *	TCP ▼	TCP or SC
Interface *	xsi1 ▼	The server Note: To c									
DSCP *	34	A valid DS									
Protocol *	TCP ▼	TCP or SC									
<p>3. <input type="checkbox"/></p>	<p>NOAM VIP GUI: Option 2 — Configure port DSCP</p>	<p>Note: The exact DSCP values for your site vary.</p> <p>1. Navigate to Configuration > DSCP > Port DSCP.</p> <ul style="list-style-type: none"> - Configuration <ul style="list-style-type: none"> + Networking <ul style="list-style-type: none"> Servers Server Groups Resource Domains Places Place Associations - DSCP <ul style="list-style-type: none"> Interface DSCP Port DSCP <p>2. Select the server you want to configure from the list of servers on the second line. You can view all servers with Entire Network selected; or limit yourself to a specific server group by clicking on that server group name's tab.</p>									

Procedure 38. Configure DSCP Values for Outgoing Traffic (Optional)

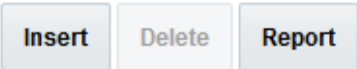
		<p>Main Menu: Configuration -> DSCP -> Port DSCP</p>  <p>3. Click Insert.</p>  <p>4. Enter the source Port, DSCP value, and select the transport Protocol.</p> <p>Main Menu: Configuration -> DSCP -> Port DSCP</p>  <p>5. Click OK if there are no more port DSCPs on this server to configure, or Apply to finish this port entry and continue entering more port DSCP mappings.</p>
<p>4. <input type="checkbox"/></p>	<p>NOAM VIP GUI: Repeat for additional servers</p>	<p>Repeat this procedure for all remaining servers.</p>

3.14.10 SNMP Configuration

Procedure 39. Configure SNMP Trap Receivers

S T E P #	<p>This procedure configures forwarding of SNMP traps from each individual server.</p> <p>Note: If SNMP configuration is not required, skip to step 4.</p> <p>Check off (√) each step as it is completed. Boxes have been provided for this purpose under each step number.</p> <p>If this procedure fails, it is recommended to contact My Oracle Support (MOS) and ask for assistance.</p>
1. <input type="checkbox"/>	<p>Primary NOAM VIP GUI: Login</p> <p>1. Establish a GUI session on the NOAM server by using the XMI VIP IP address. Open the web browser and enter a URL of:</p> <div style="border: 1px solid black; padding: 5px; margin: 10px 0;"> <p>https://<NOAM_XMI_VIP_IP_Address></p> </div> <p>2. Login as the guiadmin user.</p> <div style="text-align: center;">  </div>
2. <input type="checkbox"/>	<p>NOAM VIP GUI: Configure system-wide SNMP trap receiver(s)</p> <p>1. Navigate to Administration > Remote Servers > SNMP Trapping.</p>

Procedure 39. Configure SNMP Trap Receivers

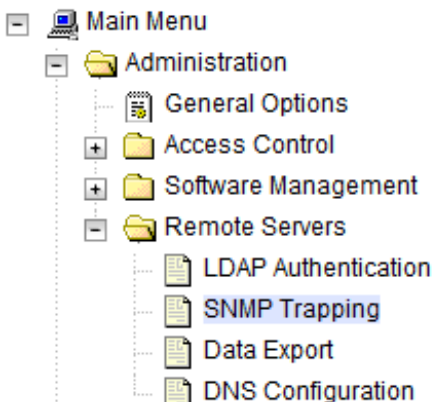

2. Select the Server Group tab for SNMP trap configuration.

Main Menu: Administration -> Remote Servers

Info* ▼

ZombieDRNOAM **ZombieNOAM** ZombieSOAM

Name

3. Type the **IP address** or **Hostname** of the Network Management Station (NMS) to forward traps to. This IP should be reachable from the NOAMP's XMI network.

4. Add additional secondary, tertiary, etc., **Manager IPs** in the corresponding slots, if desired.

SNMP Trap Configuration Insert for ZombieNOAM

Configuration Mode *	<input checked="" type="radio"/> Global <input type="radio"/> Per-site
Manager 1	<input type="text"/>
Manager 2	<input type="text"/>

5. Mark the **Traps Enabled** checkboxes for the manager servers being configured:

Traps Enabled	<input type="checkbox"/> Manager 1 <input type="checkbox"/> Manager 2 <input type="checkbox"/> Manager 3 <input type="checkbox"/> Manager 4 <input type="checkbox"/> Manager 5
----------------------	--

Procedure 39. Configure SNMP Trap Receivers

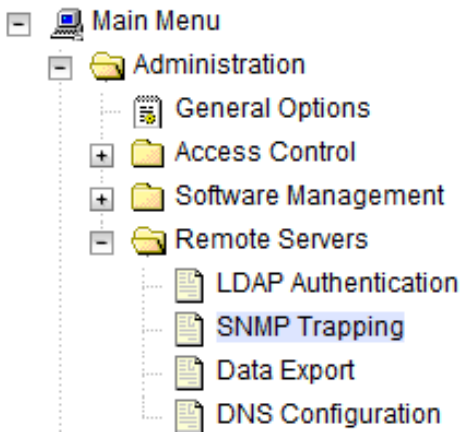
		<p>6. Type the SNMP Community Name.</p> <p>SNMPv2c Read-Only Community Name <input type="text"/></p> <hr/> <p>SNMPv2c Read-Write Community Name <input type="text"/></p> <p>7. Leave all other fields at their default values.</p> <p>8. Click OK.</p>
<p>3.</p> <p><input type="checkbox"/></p>	<p>NOAMP VIP: Enable traps from individual servers (optional)</p>	<p>Note: By default, SNMP traps from DPs are aggregated and displayed at the active NOAMP. If instead, you want every server to send its own traps directly to the NMS, then execute this procedure.</p> <p>This procedure requires all servers, including DPs, have an XMI interface on which the customer SNMP target server (NMS) is reachable.</p> <p>1. Navigate to Administration > Remote Servers > SNMP Trapping.</p>  <p>2. Make sure the checkbox next to Enabled is checked, if not, check it.</p> <p>Traps from Individual Servers <input checked="" type="checkbox"/> Enabled</p> <p>3. Click Apply and verify the data is committed.</p>

Procedure 39. Configure SNMP Trap Receivers

4. <input type="checkbox"/>	PMAC GUI: Update the TVOE host SNMP community string	<ol style="list-style-type: none">1. Establish an SSH session to the PMAC and Login as admusr.2. Update the community string. <pre>\$ sudo pmaccli setCommStr --accessType=rw --commStr=<site specific value></pre>Note: When this operation is initiated, all supporting TVOE hosting servers and the PMAC guest on the PMAC control network are updated. All servers that match the existing site specific community string are not updated again until the string name is changed.3. Restart the server. <pre>\$ sudo sentry restart</pre>
--------------------------------	--	--

Procedure 39. Configure SNMP Trap Receivers

<p>5. <input type="checkbox"/></p>	<p>NOAM VIP GUI: Login</p>	<p>Note: This workaround step should be performed only in these cases:</p> <ul style="list-style-type: none"> • If SNMP is not configured. • If SNMP is already configured and SNMPv3 is selected as enabled version. <p>Note: This is a workaround step to configure SNMP with 'SNMPv2c and SNMPv3' as the enabled versions for SNMP Traps configuration, since PMAC does not support SNMPv3.</p> <ol style="list-style-type: none"> 1. Establish a GUI session on the NOAM server using the VIP IP address of the NOAM server. 2. Open the web browser and enter a URL of: <div style="border: 1px solid black; padding: 2px; width: fit-content; margin: 5px auto;"> <code>https://<Primary_NOAM_VIP_IP_Address></code> </div> 3. Log into the NOAM GUI as the guiadmin user: <div style="text-align: center; margin: 20px 0;">  </div> <div style="text-align: center;"> <p>Oracle System Login Tue Jun 7 13:49:06 2016 EDT</p> <hr/> <div style="border: 1px solid gray; padding: 10px; width: 80%; margin: 0 auto; background-color: #f0f0f0;"> <p style="text-align: center;">Log In</p> <p style="text-align: center;">Enter your username and password to log in</p> <p style="text-align: center;">Username: <input style="width: 100%;" type="text"/></p> <p style="text-align: center;">Password: <input style="width: 100%;" type="password"/></p> <p style="text-align: center;"><input type="checkbox"/> Change password</p> <p style="text-align: center;"><input type="button" value="Log In"/></p> </div> <p style="font-size: small; text-align: center;">Unauthorized access is prohibited. This Oracle system requires the use of Microsoft Internet Explorer 9.0, 10.0, or 11.0 with support for JavaScript and cookies.</p> <hr/> <p style="font-size: x-small; text-align: center;"><i>Oracle and Java are registered trademarks of Oracle Corporation and/or its affiliates. Other names may be trademarks of their respective owners.</i></p> <p style="font-size: x-small; text-align: center;">Copyright © 2010, 2016, Oracle and/or its affiliates. All rights reserved.</p> </div>
<p>6. <input type="checkbox"/></p>	<p>NOAM VIP GUI: Configure system-wide SNMP trap receiver(s)</p>	<ol style="list-style-type: none"> 1. Navigate to Administration > Remote Servers > SNMP Trapping.

Procedure 39. Configure SNMP Trap Receivers

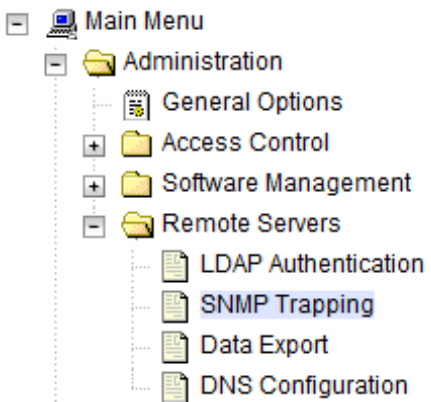

2. Select the Server Group tab for SNMP trap configuration.

Main Menu: Administration -> Remote Servers

Info* ▼

ZombieDRNOAM **ZombieNOAM** ZombieSOAM

Name

3. Type the **IP address** or **Hostname** of the Network Management Station (NMS) where you want to forward traps. This IP should be reachable from the NOAMP's XML network. If already configured SNMP with **SNMPv3** as enabled version, another server needs to be configured here.

4. Add additional secondary, tertiary, etc., **Manager IPs** in the corresponding slots, if desired.

SNMP Trap Configuration Insert for ZombieNOAM

Configuration Mode *	<input checked="" type="radio"/> Global <input type="radio"/> Per-site
Manager 1	<input style="width: 100%;" type="text"/>
Manager 2	<input style="width: 100%;" type="text"/>

5. Set the Enabled Versions as **SNMPv2c and SNMPv3**.

Enabled Versions SNMPv2c and SNMPv3 ▼

6. Mark the **Traps Enabled** checkboxes for the manager servers being configured.

Procedure 39. Configure SNMP Trap Receivers

		<div style="border: 1px solid #ccc; padding: 5px;"> <p><input type="checkbox"/> Manager 1</p> <p><input type="checkbox"/> Manager 2</p> <p><input type="checkbox"/> Manager 3</p> <p><input type="checkbox"/> Manager 4</p> <p><input type="checkbox"/> Manager 5</p> </div> <p>Traps Enabled</p> <p>7. Type the SNMP Community Name.</p> <p>SNMPv2c Read-Only Community Name <input style="width: 150px;" type="text"/></p> <hr/> <p>SNMPv2c Read-Write Community Name <input style="width: 150px;" type="text"/></p> <p>8. Leave all other fields at their default values.</p> <p>9. Click OK.</p>
<p>7.</p> <p><input type="checkbox"/></p>	<p>NOAMP VIP: Enable traps from individual servers (optional)</p>	<p>Note: By default, SNMP traps from DPs are aggregated and displayed at the active NOAMP. If instead, you want every server to send its own traps directly to the NMS, then execute this procedure.</p> <p>This procedure requires all servers, including DPs, have an XMI interface on which the customer SNMP target server (NMS) is reachable.</p> <p>1. Navigate to Administration > Remote Servers > SNMP Trapping.</p> <div style="border: 1px solid #ccc; padding: 5px;"> <ul style="list-style-type: none"> <input type="checkbox"/> Main Menu <input type="checkbox"/> Administration <ul style="list-style-type: none"> <input type="checkbox"/> General Options <input type="checkbox"/> Access Control <input type="checkbox"/> Software Management <input type="checkbox"/> Remote Servers <ul style="list-style-type: none"> <input type="checkbox"/> LDAP Authentication <input checked="" type="checkbox"/> SNMP Trapping <input type="checkbox"/> Data Export <input type="checkbox"/> DNS Configuration </div> <p>2. Make sure the checkbox next to Enabled is checked, if not, check it.</p> <p>Traps from Individual Servers <input checked="" type="checkbox"/> Enabled</p> <p>3. Click Apply and verify the data is committed.</p>

Procedure 39. Configure SNMP Trap Receivers

8. <input type="checkbox"/>	PMAC GUI: Update the TVOE host SNMP community string	<ol style="list-style-type: none"> 1. Establish an SSH session to the PMAC and Login as admusr. 2. Update the community string. <div data-bbox="548 338 1430 420" style="border: 1px solid black; padding: 5px; margin: 5px 0;"> <pre>\$ sudo pmaccli setCommStr --accessType=rw --commStr=<site specific value></pre> </div> <p>Note: When this operation is initiated, all supporting TVOE hosting servers and the PMAC guest on the PMAC control network are updated. All servers that match the existing site specific community string are not updated again until the string name is changed.</p> 3. Restart the server. <div data-bbox="548 619 1430 667" style="border: 1px solid black; padding: 5px; margin: 5px 0;"> <pre>\$ sudo sentry restart</pre> </div>
9. <input type="checkbox"/>	SNMPv3 (optional)	Refer to Appendix T Restore SNMP Configuration to SNMPv3 (Optional) to restore SNMPv3 after installation, if required.

3.14.11 IPFE Configuration (Optional)

Procedure 40. Configure IPFE (Optional)

S T E P #	<p>This procedure configures IP front end (IPFE) and optimizes performance.</p> <p>Check off (✓) each step as it is completed. Boxes have been provided for this purpose under each step number.</p> <p>If this procedure fails, it is recommended to contact My Oracle Support (MOS) and ask for assistance.</p>	
<p>1.</p> <p><input type="checkbox"/></p>	<p>SOAM VIP GUI: Login</p>	<p>1. Establish a GUI session on the SOAM server by using the VIP IP address of the SOAM server. Open the web browser and enter a URL of:</p> <div style="border: 1px solid black; padding: 5px; margin: 10px 0;"> <p>https://<Primary_SOAM_VIP_IP_Address></p> </div> <p>2. Login as the guidadmin user.</p> <div style="text-align: center; margin: 20px 0;">  </div>

Procedure 40. Configure IPFE (Optional)

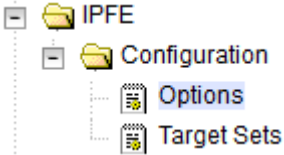
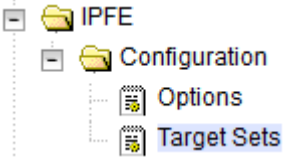
<p>2. <input type="checkbox"/></p>	<p>SOAM VIP GUI: Configure replication IPFE association data</p>	<p>1. Navigate to IPFE > Configuration > Options.</p>  <p>2. Type the IP address of the first IPFE as the IPFE-A1 IP Address and the IP address of the second IPFE as the IPFE-A2 IP Address.</p> <p>3. If applicable, type the addresses of the third and fourth IPFE servers as the IPFE-B1 IP Address and IPFE-B2 IP Address.</p> <p>Configuration Options</p> <table border="1" data-bbox="513 655 1422 936"> <thead> <tr> <th>Variable</th> <th>Value</th> <th>Descript</th> </tr> </thead> <tbody> <tr> <td colspan="3">Inter-IPFE Synchronization</td> </tr> <tr> <td>IPFE-A1 IP Address</td> <td>169.254.1.11 - ZombieIPFE1</td> <td>IPv4 or I This sel</td> </tr> <tr> <td>IPFE-A2 IP Address</td> <td>169.254.1.12 - ZombieIPFE2</td> <td>IPv4 or I This sel</td> </tr> </tbody> </table> <p>Notes:</p> <ul style="list-style-type: none"> • The address should reside on the IMI (Internal Management Interface) network. • IPFE-A1 and IPFE-A2 must have connectivity between each other through these addresses. The same applies with IPFE-B1 and IPFE-B2. • Accept default configuration for remaining entries. 	Variable	Value	Descript	Inter-IPFE Synchronization			IPFE-A1 IP Address	169.254.1.11 - ZombieIPFE1	IPv4 or I This sel	IPFE-A2 IP Address	169.254.1.12 - ZombieIPFE2	IPv4 or I This sel
Variable	Value	Descript												
Inter-IPFE Synchronization														
IPFE-A1 IP Address	169.254.1.11 - ZombieIPFE1	IPv4 or I This sel												
IPFE-A2 IP Address	169.254.1.12 - ZombieIPFE2	IPv4 or I This sel												
<p>3. <input type="checkbox"/></p>	<p>SOAM VIP GUI: Configure/Insert IPFE target sets</p>	<p>1. Navigate to IPFE > Configuration > Target Sets.</p>  <p>2. Click either Insert IPv4 or Insert IPv6, depending on the IP version of the target set you plan to use.</p> <p><input type="button" value="Insert IPv4"/> <input type="button" value="Insert IPv6"/> <input type="button" value="Edit"/> <input type="button" value="Delete"/></p> <p>Protocols: Protocols the target set supports.</p> <table border="1" data-bbox="509 1617 1422 1751"> <tr> <td>Protocols</td> <td> <input type="radio"/> TCP only <input type="radio"/> SCTP only <input checked="" type="radio"/> Both TCP and SCTP </td> </tr> </table> <p>Delete Age: Specifies when the IPFE should remove its association data for a connection. Any packets presenting a source IP address/port combination that had been previously stored as association state but have been idle longer than the</p>	Protocols	<input type="radio"/> TCP only <input type="radio"/> SCTP only <input checked="" type="radio"/> Both TCP and SCTP										
Protocols	<input type="radio"/> TCP only <input type="radio"/> SCTP only <input checked="" type="radio"/> Both TCP and SCTP													

Procedure 40. Configure IPFE (Optional)

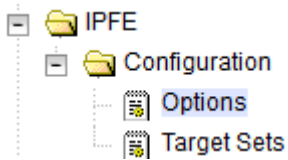
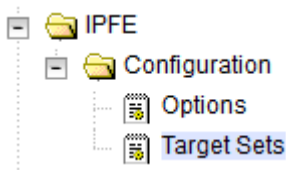
		<p>Delete Age configuration are treated as a new connection and do not automatically go to the same application server.</p> <p>Delete Age * <input type="text" value="600"/></p> <p>Load Balance Algorithm: Hash or Least Load options.</p> <p>Load Balance Algorithm <input type="radio"/> Hash <input checked="" type="radio"/> Least Load</p> <p>Note: For the IPFE to provide Least Load distribution, navigate to IPFE > Configuration > Options. Monitoring protocol must be set to Heartbeat so the application servers can provide the load information the IPFE uses to select the least-loaded server for connections.</p>  <p>Monitoring Protocol * <input type="text" value="Heartbeat"/></p> <p>Note: The Least Load option is default and recommended with exception of unique backward compatibility scenarios.</p> <p>3. Execute the following command if Hash Load Balance Algorithm was selected above (advise cut and paste to prevent errors):</p> <p>4. Establish an SSH session to the SOAM VIP and login as admusr.</p> <pre style="border: 1px solid black; padding: 5px;">\$ sudo iset -fvalue="50" DpiOption where "name='MpEngIngressMpsPercentile'" === changed 1 records ===</pre> <p>5. Navigate to IPFE > Configuration > Target Sets.</p>  <p>6. (Optional) If you have selected the Least Load, you may configure the following fields to adjust the algorithm's behavior.</p> <p>MPS Factor: Messages Per Second (MPS) is one component of the least load algorithm. This field allows you to set it from 0 (not used in load calculations) to 100 (the only component used for load calculations). It is recommended that IPFE connections have Reserved Ingress MPS set to something other than the default, which is 0.</p>
--	--	--

Procedure 40. Configure IPFE (Optional)

		<div data-bbox="521 262 1117 317"> <p>MPS Factor * <input type="text" value="50"/></p> </div> <hr/> <div data-bbox="521 478 1117 533"> <p>Connection Count Factor * <input type="text" value="50"/></p> </div> <p data-bbox="813 562 1425 743">To configure Reserved Ingress MPS, navigate to Diameter > Configuration > Configuration Sets > Capacity Configuration Sets. If you choose not to use Reserved Ingress MPS, set MPS Factor to 0 and Connection Count Factor, described below, to 100.</p> <p data-bbox="548 751 1425 932">Connection Count Factor: This is the other component of the least load algorithm. This field allows you to set it from 0 (not used in load calculations) to 100 (the only component used for load calculations). Increase this setting if connection storms (the arrival of many connections at a very rapid rate) are a concern.</p> <p data-bbox="548 940 1425 1100">Allowed Deviation: Percentage within which two application server's load calculation results are considered to be equal. If very short, intense connection bursts are expected to occur, increase the value to smooth out the distribution.</p> <div data-bbox="508 1121 984 1176"> <p>Allowed Deviation * <input type="text" value="5"/></p> </div> <p data-bbox="548 1213 1317 1247">Primary Public IP Address: IP address for the target set.</p> <div data-bbox="508 1255 1419 1310" style="background-color: #e0e0e0; padding: 2px;"> <p>Public IP Address</p> </div> <div data-bbox="508 1318 1419 1457"> <p>Address * <input type="text"/></p> </div> <hr/> <div data-bbox="508 1478 1419 1646"> <p>Active IPFE</p> <p><input checked="" type="radio"/> IPFE A1 ----- IPFE A2 <input type="radio"/></p> <p><input type="radio"/> IPFE B1 ----- IPFE B2 <input type="radio"/></p> </div> <p data-bbox="548 1667 1425 1814">Note: This address must reside on the XSI (External Signaling Interface) network because it is used by the application clients to reach the application servers. This address MUST NOT be a real interface address (that is, must not be associated with a network interface card).</p> <p data-bbox="548 1835 1419 1864">Active IPFE: IPFE to handle the traffic for the target set address.</p>
--	--	---

Procedure 40. Configure IPFE (Optional)

Secondary Public IP Address: If this target set supports either multi-homed SCTP or Both TCP and SCTP, provide a Secondary IP Address.

Alternate Public IP Address†

Alternate Address

Active IPFE for alternate address

IPFE A1 ----- IPFE A2
 IPFE B1 ----- IPFE B2

Notes:

- A secondary address is required to support SCTP multi-homing. A secondary address can support TCP, but the TCP connections will not be multi-homed.
- If SCTP multi-homing is to be supported, select the mate IPFE of the Active IPFE for the Active IPFE for secondary address to ensure that SCTP failover functions as designed.

Target Set IP List: Select an IP address; a secondary IP address, if supporting SCTP multi-homing; a description; and a weight for the application server.

Target Set IP List

IP Address	Alternate IP Address	Description	Weighting *
01 - Select -	- Select -		100 X

Add Weighting range is 0 - 65535.

Notes:

- The IP address must be on the XSI network since they must be on the same network as the target set address. This address must also match the IP version of the target set address (IPv4 or IPv6). If the Secondary Public IP Address is configured, it must reside on the same application server as the first IP address.
- If all application servers have an equal weight (for example, 100, which is the default), they have an equal chance of being selected. Application servers with larger weights have a greater chance of being selected.

7. Click **Add** to add more application servers (up to 16).

8. Click **Apply**.

Ok Apply Cancel

Procedure 40. Configure IPFE (Optional)

4.	SOAM VIP GUI: Repeat for additional configuration of IPFE target sets	Repeat steps 3. for each target set (up to 16). At least one target set must be configured.
----	---	--

3.15 SDS Application Configuration

3.15.1 NOAM Configuration

Procedure 41. Configure First SDS NOAM NE and Server

S T E P #	<p>This procedure configures the first SDS NOAM network element and server.</p> <p>Note: SDS NOAM configuration only applicable on Oracle X5-2/Netra X5-2/X6-2/HP DL380 Gen 9.</p> <p>Check off (√) each step as it is completed. Boxes have been provided for this purpose under each step number.</p> <p>If this procedure fails, it is recommended to contact My Oracle Support (MOS) and ask for assistance.</p>	
1.	<p>Save the NOAM network data to an XML file</p>	<ol style="list-style-type: none"> 1. Use a text editor to create a SDS NOAM network element file that describes the networking of the target install environment of your first SDS NOAM server. 2. Select an appropriate file name and save the file to a known location on your computer. <p>A suggested filename format is Appname_NName_NetworkElement.XML. For example, a SDS NOAM network element XML file would have a SDS_NOAM_NetworkElement.xml filename.</p> <p>Alternatively, you can update the sample SDS network element file. It can be found on the management server at:</p> <div style="border: 1px solid black; padding: 5px; margin: 5px 0;"> <pre>/usr/TKLC/smac/html/TPD/<DSR Release>/upgrade/overlay/SAMPLE-NetworkElement.xml</pre> </div> <p>A sample XML file can also be found in Appendix L Sample Network Element.</p> <p>Note: These limitations apply when specifying a network element name:</p> <ul style="list-style-type: none"> • A 1-32-character string. • Valid characters are alphanumeric and underscore. • Must contain at least one alpha and must not start with a digit.

Procedure 41. Configure First SDS NOAM NE and Server

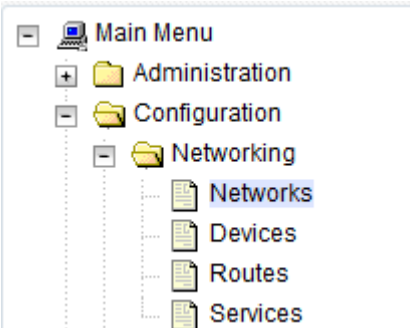
<p>2. <input type="checkbox"/></p>	<p>SDS NOAM VIP GUI: Login</p>	<p>1. Establish a GUI session on the SDS NOAM server by using the VIP IP address of the NOAM server (defined and configured in the DSR fast deployment rms.cfg file). Open the web browser and enter a URL of:</p> <div style="border: 1px solid black; padding: 5px; width: fit-content; margin: 10px auto;"> <p>https://<Primary_SDS_NOAM_VIP_IP_Address></p> </div> <p>2. Login as the guiadmin user.</p> <div style="text-align: center; margin: 20px 0;">  </div> <div style="text-align: center; margin: 10px 0;"> <p>Oracle System Login</p> <hr style="width: 50%; margin: 0 auto;"/> Mon Jul 11 13:59:37 2016 EDT </div> <div style="border: 1px solid gray; padding: 10px; width: fit-content; margin: 10px auto;"> <p style="text-align: center;">Log In</p> <p style="text-align: center;">Enter your username and password to log in</p> <p style="text-align: center;">Username: <input style="width: 100%;" type="text"/></p> <p style="text-align: center;">Password: <input style="width: 100%;" type="password"/></p> <p style="text-align: center;"><input type="checkbox"/> Change password</p> <p style="text-align: center; margin-top: 10px;"><input type="button" value="Log In"/></p> </div>																								
<p>3. <input type="checkbox"/></p>	<p>Primary SDS NOAM VIP GUI: Create the SDS NOAM network element using an XML file</p>	<p>1. Navigate to Configuration > Networking > Networks.</p> <div style="border: 1px solid gray; padding: 5px; margin: 10px 0;">  </div> <p>2. Click Browse and enter the Pathname of the NOAM network XML file.</p> <p>3. Click Upload File.</p> <p style="text-align: center;">To create a new Network Element, upload a valid configuration file:</p> <div style="text-align: center; margin: 10px 0;"> <input style="border: 1px solid blue; padding: 2px 10px;" type="button" value="Browse..."/> SDSzombie.xml <input style="margin-left: 100px; padding: 2px 10px;" type="button" value="Upload File"/> </div> <p>4. Click on the tab to display the configured network.</p> <div style="border: 1px solid gray; padding: 5px; margin: 10px 0;"> <p>Main Menu: Configuration -> Networking -> Networks</p> <p style="margin: 0;">Info* ▾</p> <p style="margin: 0;">Global ZombieNOAM</p> <table border="1" style="width: 100%; border-collapse: collapse; font-size: small;"> <thead> <tr> <th>Network Name</th> <th>Network Type</th> <th>Default</th> <th>Locked</th> <th>Routed</th> <th>VLAN</th> <th>Configured Interfaces</th> <th>Netwo</th> </tr> </thead> <tbody> <tr> <td>XMI</td> <td>OAM</td> <td>Yes</td> <td>Yes</td> <td>Yes</td> <td>4</td> <td>0</td> <td>10.24</td> </tr> <tr> <td>IMI</td> <td>OAM</td> <td>No</td> <td>Yes</td> <td>No</td> <td>3</td> <td>0</td> <td>169.2</td> </tr> </tbody> </table> </div>	Network Name	Network Type	Default	Locked	Routed	VLAN	Configured Interfaces	Netwo	XMI	OAM	Yes	Yes	Yes	4	0	10.24	IMI	OAM	No	Yes	No	3	0	169.2
Network Name	Network Type	Default	Locked	Routed	VLAN	Configured Interfaces	Netwo																			
XMI	OAM	Yes	Yes	Yes	4	0	10.24																			
IMI	OAM	No	Yes	No	3	0	169.2																			

Procedure 41. Configure First SDS NOAM NE and Server

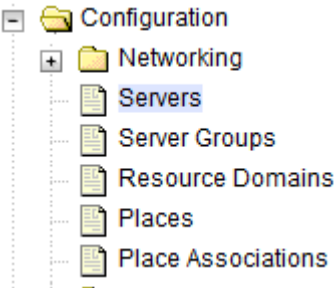
<p>4. <input type="checkbox"/></p>	<p>Map services to networks</p>	<p>1. Navigate to Configuration > Services.</p> <p>2. Click Edit and set the services as shown in this table.</p> <table border="1" data-bbox="505 338 1406 716"> <thead> <tr> <th>Name</th> <th>Intra-NE Network</th> <th>Inter-NE Network</th> </tr> </thead> <tbody> <tr> <td>OAM</td> <td><IMI Network></td> <td><XMI Network></td> </tr> <tr> <td>Replication</td> <td><IMI Network></td> <td><XMI Network></td> </tr> <tr> <td>Signaling</td> <td>Unspecified</td> <td>Unspecified</td> </tr> <tr> <td>HA_Secondary</td> <td><IMI Network></td> <td><XMI Network></td> </tr> <tr> <td>HA_MP_Secondary</td> <td><IMI Network></td> <td><XMI Network></td> </tr> <tr> <td>Replication_MP</td> <td><IMI Network></td> <td><XMI Network></td> </tr> <tr> <td>ComAgent</td> <td><IMI Network></td> <td><XMI Network></td> </tr> </tbody> </table> <p>For example, if your IMI network is named IMI and your XMI network is named XMI, then your services should configure to look like this:</p> <table border="1" data-bbox="509 793 1422 993"> <caption>Services</caption> <thead> <tr> <th>Name</th> <th>Intra-NE Network</th> <th>Inter-NE Network</th> </tr> </thead> <tbody> <tr> <td>OAM</td> <td>INTERNALIMI</td> <td>INTERNALXMI</td> </tr> <tr> <td>Replication</td> <td>INTERNALIMI</td> <td>INTERNALXMI</td> </tr> <tr> <td>Signaling</td> <td>Unspecified</td> <td>Unspecified</td> </tr> <tr> <td>HA_Secondary</td> <td>INTERNALIMI</td> <td>INTERNALXMI</td> </tr> <tr> <td>HA_MP_Secondary</td> <td>INTERNALIMI</td> <td>INTERNALXMI</td> </tr> <tr> <td>Replication_MP</td> <td>INTERNALIMI</td> <td>INTERNALXMI</td> </tr> <tr> <td>ComAgent</td> <td>INTERNALIMI</td> <td>INTERNALXMI</td> </tr> </tbody> </table> <p style="text-align: right;"><input type="button" value="Ok"/> <input type="button" value="Apply"/> <input type="button" value="Cancel"/></p> <p>3. Click OK to apply the service-to-network selections.</p>	Name	Intra-NE Network	Inter-NE Network	OAM	<IMI Network>	<XMI Network>	Replication	<IMI Network>	<XMI Network>	Signaling	Unspecified	Unspecified	HA_Secondary	<IMI Network>	<XMI Network>	HA_MP_Secondary	<IMI Network>	<XMI Network>	Replication_MP	<IMI Network>	<XMI Network>	ComAgent	<IMI Network>	<XMI Network>	Name	Intra-NE Network	Inter-NE Network	OAM	INTERNALIMI	INTERNALXMI	Replication	INTERNALIMI	INTERNALXMI	Signaling	Unspecified	Unspecified	HA_Secondary	INTERNALIMI	INTERNALXMI	HA_MP_Secondary	INTERNALIMI	INTERNALXMI	Replication_MP	INTERNALIMI	INTERNALXMI	ComAgent	INTERNALIMI	INTERNALXMI
Name	Intra-NE Network	Inter-NE Network																																																
OAM	<IMI Network>	<XMI Network>																																																
Replication	<IMI Network>	<XMI Network>																																																
Signaling	Unspecified	Unspecified																																																
HA_Secondary	<IMI Network>	<XMI Network>																																																
HA_MP_Secondary	<IMI Network>	<XMI Network>																																																
Replication_MP	<IMI Network>	<XMI Network>																																																
ComAgent	<IMI Network>	<XMI Network>																																																
Name	Intra-NE Network	Inter-NE Network																																																
OAM	INTERNALIMI	INTERNALXMI																																																
Replication	INTERNALIMI	INTERNALXMI																																																
Signaling	Unspecified	Unspecified																																																
HA_Secondary	INTERNALIMI	INTERNALXMI																																																
HA_MP_Secondary	INTERNALIMI	INTERNALXMI																																																
Replication_MP	INTERNALIMI	INTERNALXMI																																																
ComAgent	INTERNALIMI	INTERNALXMI																																																
<p>5. <input type="checkbox"/></p>	<p>Primary SDS NOAM VIP GUI: Insert the 1st SDS NOAM server</p>	<p>1. Navigate to Configuration > Servers.</p>  <p>2. Click Insert to insert the new SDS NOAM server into the servers table.</p> <table border="1" data-bbox="513 1476 951 1528"> <tr> <td><input type="button" value="Insert"/></td> <td><input type="button" value="Edit"/></td> <td><input type="button" value="Delete"/></td> <td><input type="button" value="Export"/></td> <td><input type="button" value="Report"/></td> </tr> </table> <p>3. Enter these values:</p> <p>Hostname: <Hostname> Role: Network OAM System ID: <Site System ID> Hardware Profile: SDS TVOE Guest Network Element Name: [Select NE] Location: <Enter an optional location description></p>	<input type="button" value="Insert"/>	<input type="button" value="Edit"/>	<input type="button" value="Delete"/>	<input type="button" value="Export"/>	<input type="button" value="Report"/>																																											
<input type="button" value="Insert"/>	<input type="button" value="Edit"/>	<input type="button" value="Delete"/>	<input type="button" value="Export"/>	<input type="button" value="Report"/>																																														

Procedure 41. Configure First SDS NOAM NE and Server

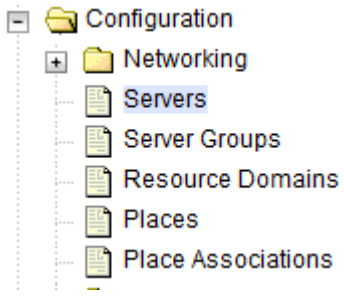
		<table border="1"> <thead> <tr> <th>Attribute</th> <th>Value</th> </tr> </thead> <tbody> <tr> <td>Hostname *</td> <td>ZombieSDSNOAM1</td> </tr> <tr> <td>Role *</td> <td>NETWORK OAM&P</td> </tr> <tr> <td>System ID</td> <td></td> </tr> <tr> <td>Hardware Profile</td> <td>SDS TVOE Guest</td> </tr> <tr> <td>Network Element Name *</td> <td>ZombieSDSNOAM</td> </tr> <tr> <td>Location</td> <td>pc5010441</td> </tr> </tbody> </table> <p>4. For the XMI network, type the server XMI IP address. Select the xmi interface. Leave the VLAN checkbox unmarked.</p> <p>5. For the IMI network, type the server IMI IP address. Select the xmi interface. Leave the VLAN checkbox unmarked.</p> <table border="1"> <tr> <td>XMI (10.240.213.0/24)</td> <td>10.240.213.20</td> <td>xmi</td> <td><input type="checkbox"/> VLAN (4)</td> </tr> <tr> <td>IMI (169.254.1.0/24)</td> <td>169.254.1.20</td> <td>imi</td> <td><input type="checkbox"/> VLAN (3)</td> </tr> </table> <p>6. Add this NTP server.</p> <table border="1"> <thead> <tr> <th>NTP Server</th> <th>Preferred?</th> </tr> </thead> <tbody> <tr> <td><First-SDS-NOAM-TVOE-IP-Address></td> <td>Yes</td> </tr> </tbody> </table> <p>7. Click OK.</p>	Attribute	Value	Hostname *	ZombieSDSNOAM1	Role *	NETWORK OAM&P	System ID		Hardware Profile	SDS TVOE Guest	Network Element Name *	ZombieSDSNOAM	Location	pc5010441	XMI (10.240.213.0/24)	10.240.213.20	xmi	<input type="checkbox"/> VLAN (4)	IMI (169.254.1.0/24)	169.254.1.20	imi	<input type="checkbox"/> VLAN (3)	NTP Server	Preferred?	<First-SDS-NOAM-TVOE-IP-Address>	Yes
Attribute	Value																											
Hostname *	ZombieSDSNOAM1																											
Role *	NETWORK OAM&P																											
System ID																												
Hardware Profile	SDS TVOE Guest																											
Network Element Name *	ZombieSDSNOAM																											
Location	pc5010441																											
XMI (10.240.213.0/24)	10.240.213.20	xmi	<input type="checkbox"/> VLAN (4)																									
IMI (169.254.1.0/24)	169.254.1.20	imi	<input type="checkbox"/> VLAN (3)																									
NTP Server	Preferred?																											
<First-SDS-NOAM-TVOE-IP-Address>	Yes																											
<p>6. <input type="checkbox"/></p>	<p>SDS NOAM VIP GUI: Export the initial configuration</p>	<p>1. Navigate to Configuration > Servers.</p>  <p>2. From the GUI screen, select the SDS NOAM server and click Export to generate the initial configuration data for that server.</p> <table border="1"> <tr> <td>Insert</td> <td>Edit</td> <td>Delete</td> <td>Export</td> <td>Report</td> </tr> </table>	Insert	Edit	Delete	Export	Report																					
Insert	Edit	Delete	Export	Report																								

Procedure 41. Configure First SDS NOAM NE and Server

7. <input type="checkbox"/>	SDS NOAM VIP GUI: Copy the configuration file to the 2 nd NOAM server	<ol style="list-style-type: none"> Obtain a terminal session to the first NOAM server console and login as admusr. Copy the configuration file, created in the previous step, from the /var/TKLC/db/filemgmt directory on the first SDS NOAM to the /var/tmp directory. <p>The configuration file has a filename like TKLCConfigData.<hostname>.sh.</p> <pre>\$ sudo cp /var/TKLC/db/filemgmt/TKLCConfigData.RMS01.sh /var/tmp/TKLCConfigData.sh</pre> <p>The automatic configuration daemon looks for the TKLCConfigData.sh file in the /var/tmp directory, implements the configuration in the file, and asks the user to reboot the server.</p>
8. <input type="checkbox"/>	SDS NOAM iLO: Wait for configuration to complete	<p>Wait to be prompted to reboot the server, but DO NOT reboot the server, it is rebooted later in this procedure.</p> <p>Note: Ignore the warning about removing the USB key, since no USB key is present.</p>
9. <input type="checkbox"/>	SDS NOAM iLO: Set the time zone and reboot the server	<p>Note: Valid time zones can be found in Appendix J List of Frequently Used Time Zones.</p> <ol style="list-style-type: none"> Run: <pre>\$ sudo set_pmac_tz.pl <time zone></pre> <p>Example: \$ sudo set_pmac_tz.pl America/New_York</p> Reboot the server. <pre>\$ sudo init 6</pre>
10. <input type="checkbox"/>	MP Server: Verify server health	<p>Login as admusr to the first SDS NOAM server and make sure no errors are returned.</p> <pre>\$ sudo syscheck Running modules in class hardware...OK Running modules in class disk...OK Running modules in class net...OK Running modules in class system...OK Running modules in class proc...OK LOG LOCATION: /var/TKLC/log/syscheck/fail_log</pre>

Procedure 42. Configure the SDS NOAM Server Group

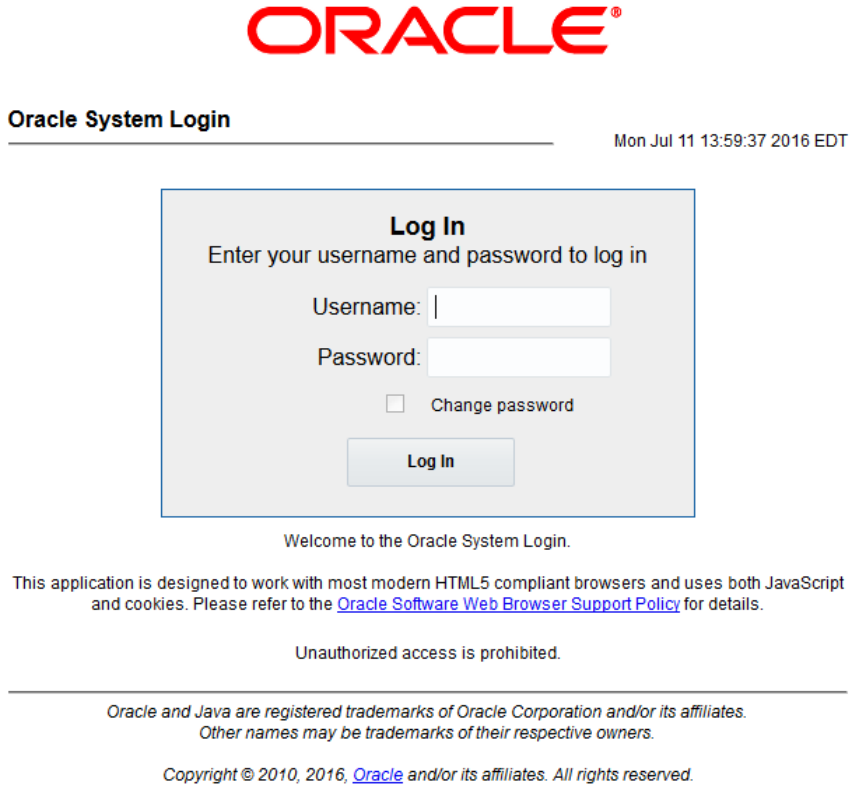
S T E P #	<p>This procedure configures the SDS NOAM server group.</p> <p>Check off (✓) each step as it is completed. Boxes have been provided for this purpose under each step number.</p> <p>If this procedure fails, it is recommended to contact My Oracle Support (MOS) and ask for assistance.</p>	
<p>1.</p> <p><input type="checkbox"/></p>	<p>SDS NOAM VIP GUI: Login</p>	<p>1. Establish a GUI session on the first SDS NOAM server by using the VIP IP address of the NOAM server. Open the web browser and enter a URL of:</p> <div style="border: 1px solid black; padding: 5px; width: fit-content; margin: 10px auto;"> <p><code>https://<Primary_SDS_NOAM_VIP_IP_Address></code></p> </div> <p>2. Login as the guiadmin user.</p> <div style="text-align: center; margin: 20px 0;">  </div>

Procedure 42. Configure the SDS NOAM Server Group

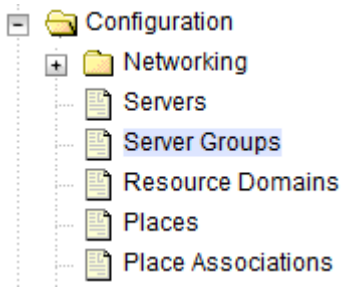
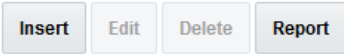
<p>2. <input type="checkbox"/></p>	<p>SDS NOAM GUI: Enter the NOAM server group data</p>	<p>1. Navigate to Configuration > Server Groups.</p>  <p>2. Click Insert.</p>  <p>3. Enter these values:</p> <p>Server Group Name: <Server Group Name> Level: A Parent: None Function: SDS WAN Replication Connection Count: Use Default Value</p> <p>Adding new server group</p> <table border="1" style="width: 100%; border-collapse: collapse; margin-top: 10px;"> <thead> <tr> <th style="width: 35%;">Field</th> <th style="width: 35%;">Value</th> <th style="width: 30%;">Description</th> </tr> </thead> <tbody> <tr> <td>Server Group Name *</td> <td><input type="text" value="SDSNOAM"/></td> <td>Unique iden required.]</td> </tr> <tr> <td>Level *</td> <td><input type="text" value="A"/> ▼</td> <td>Select one o</td> </tr> <tr> <td>Parent *</td> <td><input type="text" value="NONE"/> ▼</td> <td>Select an ex</td> </tr> <tr> <td>Function *</td> <td><input type="text" value="SDS"/> ▼</td> <td>Select one o</td> </tr> <tr> <td>WAN Replication Connection Count</td> <td><input type="text" value="1"/></td> <td>Specify the r</td> </tr> </tbody> </table> <p>4. Click OK.</p>	Field	Value	Description	Server Group Name *	<input type="text" value="SDSNOAM"/>	Unique iden required.]	Level *	<input type="text" value="A"/> ▼	Select one o	Parent *	<input type="text" value="NONE"/> ▼	Select an ex	Function *	<input type="text" value="SDS"/> ▼	Select one o	WAN Replication Connection Count	<input type="text" value="1"/>	Specify the r
Field	Value	Description																		
Server Group Name *	<input type="text" value="SDSNOAM"/>	Unique iden required.]																		
Level *	<input type="text" value="A"/> ▼	Select one o																		
Parent *	<input type="text" value="NONE"/> ▼	Select an ex																		
Function *	<input type="text" value="SDS"/> ▼	Select one o																		
WAN Replication Connection Count	<input type="text" value="1"/>	Specify the r																		

Procedure 42. Configure the SDS NOAM Server Group

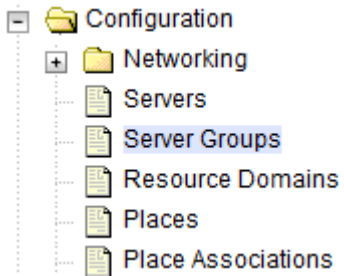
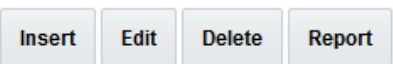
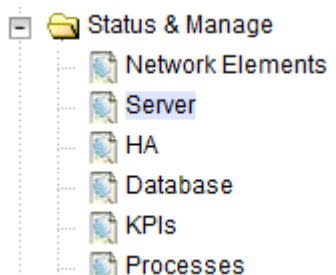
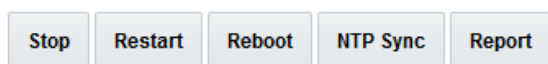
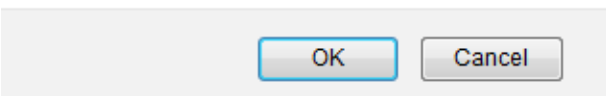
<p>3. <input type="checkbox"/></p>	<p>SDS NOAM GUI: Edit the SDS NOAM server group</p>	<p>1. Navigate to Configuration > Server Groups.</p>  <p>2. Select the new server group and click Edit.</p>  <p>3. Select the network element that represents the SDS NOAM.</p> <p>4. Mark the Include in SG checkbox for the SDS NOAM server.</p> <p>5. Leave other checkboxes blank.</p> <table border="1" data-bbox="511 829 1421 976"> <thead> <tr> <th>Server</th> <th>SG Inclusion</th> <th>Preferred HA Role</th> </tr> </thead> <tbody> <tr> <td>ZombieSDSNOAM1</td> <td><input checked="" type="checkbox"/> Include in SG</td> <td><input type="checkbox"/> Prefer server as spare</td> </tr> </tbody> </table> <p>6. Click OK.</p>	Server	SG Inclusion	Preferred HA Role	ZombieSDSNOAM1	<input checked="" type="checkbox"/> Include in SG	<input type="checkbox"/> Prefer server as spare
Server	SG Inclusion	Preferred HA Role						
ZombieSDSNOAM1	<input checked="" type="checkbox"/> Include in SG	<input type="checkbox"/> Prefer server as spare						
<p>4. <input type="checkbox"/></p>	<p>Primary SDS NOAM VIP GUI: Restart the 1st SDS NOAM servers</p>	<p>1. From the SDS NOAM GUI, navigate to Status & Manage > Server.</p>  <p>2. Select the first SDS NOAM server and click Restart.</p>  <p>3. Click OK to confirm.</p> <p>Are you sure you wish to restart application software on the following server(s)? ZombieSDSNOAM1</p> 						

Procedure 43. Configure Second SDS NOAM Server

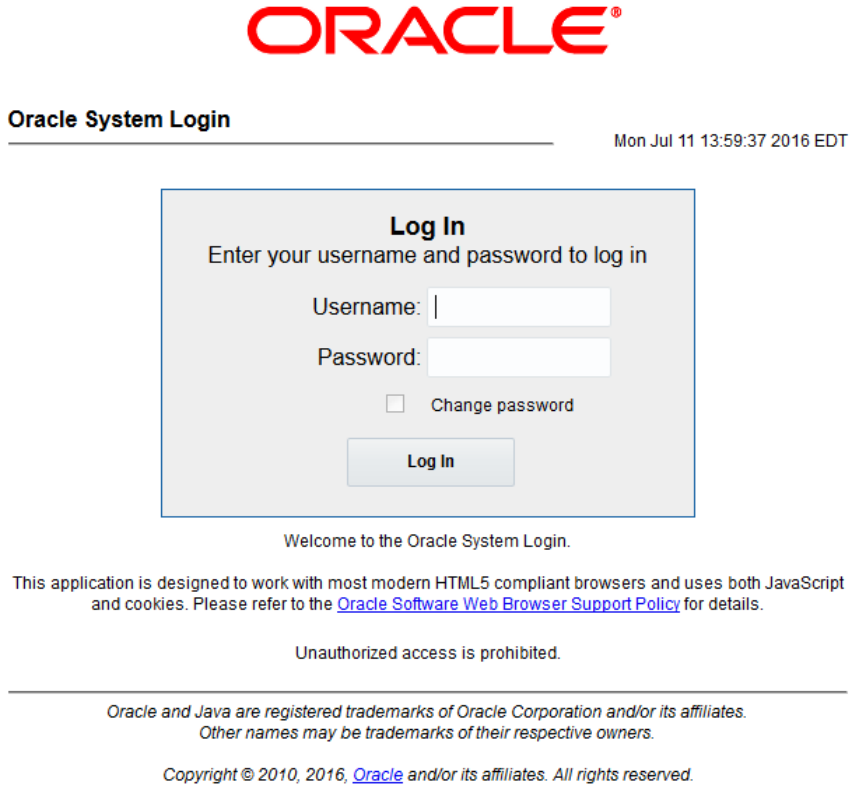
S T E P #	<p>This procedure configures the second SDS NOAM server.</p> <p>Check off (✓) each step as it is completed. Boxes have been provided for this purpose under each step number.</p> <p>If this procedure fails, it is recommended to contact My Oracle Support (MOS) and ask for assistance.</p>	
<p>1.</p> <p><input type="checkbox"/></p>	<p>SDS NOAM VIP GUI: Login</p>	<p>1. Establish a GUI session on the first SDS NOAM server by using the VIP IP address of the NOAM server. Open the web browser and enter a URL of:</p> <div style="border: 1px solid black; padding: 5px; width: fit-content; margin: 10px auto;"> <p><code>https://<Primary_SDS_NOAM_VIP_IP_Address></code></p> </div> <p>2. Login as the guiadmin user.</p> <div style="text-align: center; margin: 20px 0;">  </div>

Procedure 43. Configure Second SDS NOAM Server

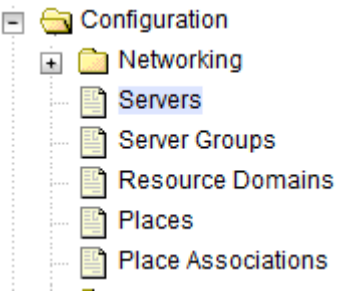
<p>2. <input type="checkbox"/> SDS NOAM VIP GUI: Insert the 2nd SDS NOAM server</p>	<p>1. Navigate to Configuration > Servers.</p>  <p>2. Click Insert to insert the second SDS NOAM server into the servers table.</p> <div style="border: 1px solid #ccc; padding: 5px; margin: 5px 0;"> Insert Edit Delete Export Report </div> <p>3. Enter these values:</p> <p>Hostname: <Hostname> Role: Network OAM System ID: <Site System ID> Hardware Profile: SDS TVOE Guest Network Element Name: [Select NE] Location: <Enter an optional location description></p> <table border="1" style="width: 100%; border-collapse: collapse; margin: 5px 0;"> <thead> <tr> <th style="width: 30%;">Attribute</th> <th>Value</th> </tr> </thead> <tbody> <tr> <td>Hostname *</td> <td><input type="text" value="ZombieSDSNOAM2"/></td> </tr> <tr> <td>Role *</td> <td><input type="text" value="NETWORK OAM&P"/></td> </tr> <tr> <td>System ID</td> <td><input type="text"/></td> </tr> <tr> <td>Hardware Profile</td> <td><input type="text" value="SDS TVOE Guest"/></td> </tr> </tbody> </table> <p>4. For the XMI network, type the server XMI IP address. Select the xmi interface. Leave the VLAN checkbox unmarked.</p> <p>5. For the IMI network, type the server IMI IP address. Select the xmi interface. Leave the VLAN checkbox unmarked.</p> <table style="width: 100%; margin: 5px 0;"> <tr> <td style="width: 30%;">XMI (10.240.213.0/24)</td> <td style="width: 30%;"><input type="text" value="10.240.213.21"/></td> <td style="width: 10%;"><input type="text" value="xmi"/></td> <td style="width: 10%;"><input type="checkbox"/> VLAN (4)</td> </tr> <tr> <td>IMI (169.254.1.0/24)</td> <td><input type="text" value="169.254.1.21"/></td> <td><input type="text" value="imi"/></td> <td><input type="checkbox"/> VLAN (3)</td> </tr> </table> <p>6. Add this NTP server.</p> <table border="1" style="width: 100%; border-collapse: collapse; margin: 5px 0;"> <thead> <tr> <th style="width: 70%;">NTP Server</th> <th>Preferred?</th> </tr> </thead> <tbody> <tr> <td><Second-SDS NOAM-TVOE-IP-Address></td> <td>Yes</td> </tr> </tbody> </table> <p>7. Click OK.</p>	Attribute	Value	Hostname *	<input type="text" value="ZombieSDSNOAM2"/>	Role *	<input type="text" value="NETWORK OAM&P"/>	System ID	<input type="text"/>	Hardware Profile	<input type="text" value="SDS TVOE Guest"/>	XMI (10.240.213.0/24)	<input type="text" value="10.240.213.21"/>	<input type="text" value="xmi"/>	<input type="checkbox"/> VLAN (4)	IMI (169.254.1.0/24)	<input type="text" value="169.254.1.21"/>	<input type="text" value="imi"/>	<input type="checkbox"/> VLAN (3)	NTP Server	Preferred?	<Second-SDS NOAM-TVOE-IP-Address>	Yes
Attribute	Value																						
Hostname *	<input type="text" value="ZombieSDSNOAM2"/>																						
Role *	<input type="text" value="NETWORK OAM&P"/>																						
System ID	<input type="text"/>																						
Hardware Profile	<input type="text" value="SDS TVOE Guest"/>																						
XMI (10.240.213.0/24)	<input type="text" value="10.240.213.21"/>	<input type="text" value="xmi"/>	<input type="checkbox"/> VLAN (4)																				
IMI (169.254.1.0/24)	<input type="text" value="169.254.1.21"/>	<input type="text" value="imi"/>	<input type="checkbox"/> VLAN (3)																				
NTP Server	Preferred?																						
<Second-SDS NOAM-TVOE-IP-Address>	Yes																						

Procedure 43. Configure Second SDS NOAM Server

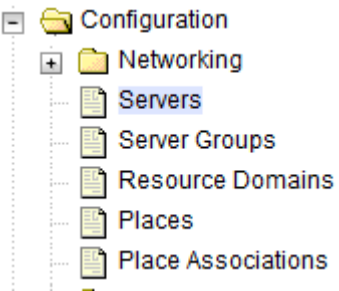
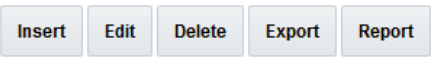
3.	SDS NOAM VIP GUI: Export the initial configuration	<ol style="list-style-type: none"> Navigate to Configuration > Servers.  From the GUI screen, select the SDS NOAM server and click Export to generate the initial configuration data for that server. 
4.	1st SDS NOAM VIP GUI: Copy the configuration file to the 2 nd NOAM server	<ol style="list-style-type: none"> Obtain a terminal session to the first NOAM server console and login as admusr. Configure the second NOAM server. <pre data-bbox="553 871 1430 1039">\$ sudo scp -r /var/TKLC/db/filemgmt/TKLCConfigData.<NOAM2_Hostname> .sh admusr@<NOAM2_xmi_IP_address>:/var/tmp/TKLCConfigData .sh</pre> <p>The automatic configuration daemon looks for the TKLCConfigData.sh file in the /var/tmp directory, implements the configuration in the file, and asks the user to reboot the server.</p>
5.	2nd SDS DR NOAM Server: Verify server configuration was called and reboot the configured server	<ol style="list-style-type: none"> Verify server configuration was called by checking the log file. <pre data-bbox="553 1203 1430 1249">\$ sudo cat /var/TKLC/appw/logs/Process/install.log</pre> <p>Verify this message displays: [SUCCESS] script completed successfully!</p> <p>Note: The script may return success even when errors are reported in the log file. Go through the entire install.log file to verify no errors are present.</p> Reboot the server. <pre data-bbox="553 1497 1430 1543">\$ sudo init 6</pre> Proceed to the next step once the server finishes rebooting. The server is done rebooting once the login prompt displays.

Procedure 43. Configure Second SDS NOAM Server

6. <input type="checkbox"/>	2nd SDS NOAM Server: Verify server health	<p>Login as admusr to the second SDS NOAM server and make sure no errors are returned.</p> <pre style="border: 1px solid black; padding: 5px;">\$ sudo syscheck Running modules in class hardware...OK Running modules in class disk...OK Running modules in class net...OK Running modules in class system...OK Running modules in class proc...OK LOG LOCATION: /var/TKLC/log/syscheck/fail_log</pre>
--------------------------------	---	--



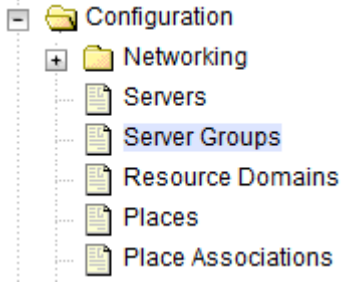
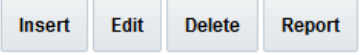
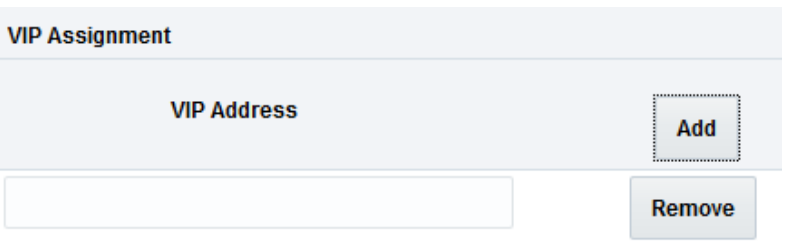

Procedure 44. Complete SDS NOAM Server Group Configuration

S T E P #	<p>This procedure finishes configuration for the SDS NOAM server group.</p> <p>Check off (✓) each step as it is completed. Boxes have been provided for this purpose under each step number.</p> <p>If this procedure fails, it is recommended to contact My Oracle Support (MOS) and ask for assistance.</p>	
1. <input type="checkbox"/>	<p>SDS NOAM VIP GUI: Login</p>	<ol style="list-style-type: none"> Establish a GUI session on the first SDS NOAM server by using the VIP IP address of the NOAM server. Open the web browser and enter a URL of: <div style="border: 1px solid black; padding: 2px; margin: 5px 0;"> <pre>https://<Primary_SDS_NOAM_VIP_IP_Address></pre> </div> Login as the guidadmin user. <div style="text-align: center; margin: 10px 0;">  <p>The screenshot shows the Oracle System Login interface. At the top is the Oracle logo. Below it, the text 'Oracle System Login' is displayed on the left and 'Mon Jul 11 13:59:37 2016 EDT' on the right. A central box contains a 'Log In' form with fields for 'Username:' and 'Password:', a 'Change password' checkbox, and a 'Log In' button. Below the form, it says 'Welcome to the Oracle System Login.' and 'This application is designed to work with most modern HTML5 compliant browsers and uses both JavaScript and cookies. Please refer to the Oracle Software Web Browser Support Policy for details.' At the bottom, it states 'Unauthorized access is prohibited.' and includes copyright information: 'Oracle and Java are registered trademarks of Oracle Corporation and/or its affiliates. Other names may be trademarks of their respective owners. Copyright © 2010, 2016, Oracle and/or its affiliates. All rights reserved.'</p> </div>

Procedure 44. Complete SDS NOAM Server Group Configuration

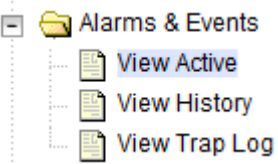
<p>2. <input type="checkbox"/> SDS NOAM VIP GUI: Edit server group and VIP</p>	<p>1. Navigate to Configuration > Server Groups.</p>  <p>2. Select the server group you just created and click Edit.</p>  <p>3. Add the second SDS NOAM server to the server group by marking the Include in SG checkbox for the second SDS NOAM server. Do not mark any of the Preferred Spare checkboxes.</p> <table border="1" style="width: 100%; border-collapse: collapse;"> <tr> <td style="padding: 5px;">ZombieSDSSOAM1</td> <td style="padding: 5px;"><input checked="" type="checkbox"/> Include in SG</td> <td style="padding: 5px;"><input type="checkbox"/> Prefer server as spare</td> </tr> <tr> <td style="padding: 5px;">ZombieSDSSOAM2</td> <td style="padding: 5px;"><input checked="" type="checkbox"/> Include in SG</td> <td style="padding: 5px;"><input type="checkbox"/> Prefer server as spare</td> </tr> </table> <p>4. Click Apply.</p> <p>5. Click Add.</p> <p>6. Type the VIP Address and click OK.</p> 	ZombieSDSSOAM1	<input checked="" type="checkbox"/> Include in SG	<input type="checkbox"/> Prefer server as spare	ZombieSDSSOAM2	<input checked="" type="checkbox"/> Include in SG	<input type="checkbox"/> Prefer server as spare
ZombieSDSSOAM1	<input checked="" type="checkbox"/> Include in SG	<input type="checkbox"/> Prefer server as spare					
ZombieSDSSOAM2	<input checked="" type="checkbox"/> Include in SG	<input type="checkbox"/> Prefer server as spare					

Procedure 44. Complete SDS NOAM Server Group Configuration

<p>3. <input type="checkbox"/></p>	<p>SDS NOAM VIP GUI: Login</p>	<p>1. Establish a GUI session on the first SDS NOAM server by using the VIP IP address of the NOAM server. Open the web browser and enter a URL of:</p> <div style="border: 1px solid black; padding: 5px; width: fit-content; margin: 10px auto;"> <p><code>https://<Primary_SDS_NOAM_VIP_IP_Address></code></p> </div> <p>2. Login as the guiadmin user.</p> <div style="text-align: center; margin: 20px 0;">  </div> <div style="text-align: center;"> <p>Oracle System Login Mon Jul 11 13:59:37 2016 EDT</p> <hr/> <div style="border: 1px solid gray; padding: 10px; width: 80%; margin: 10px auto;"> <p style="text-align: center;">Log In</p> <p style="text-align: center;">Enter your username and password to log in</p> <p style="text-align: center;">Username: <input style="width: 100%;" type="text"/></p> <p style="text-align: center;">Password: <input style="width: 100%;" type="password"/></p> <p style="text-align: center;"><input type="checkbox"/> Change password</p> <p style="text-align: center;"><input type="button" value="Log In"/></p> </div> <p style="text-align: center; margin-top: 10px;">Welcome to the Oracle System Login.</p> <p style="text-align: center; font-size: small;">This application is designed to work with most modern HTML5 compliant browsers and uses both JavaScript and cookies. Please refer to the Oracle Software Web Browser Support Policy for details.</p> <p style="text-align: center; font-size: x-small;">Unauthorized access is prohibited.</p> <hr style="width: 50%; margin: 10px auto;"/> <p style="text-align: center; font-size: x-small;">Oracle and Java are registered trademarks of Oracle Corporation and/or its affiliates. Other names may be trademarks of their respective owners.</p> <p style="text-align: center; font-size: x-small;">Copyright © 2010, 2016, Oracle and/or its affiliates. All rights reserved.</p> </div>
<p>4. <input type="checkbox"/></p>	<p>SDS NOAM VIP GUI: Wait for remote database alarm to clear</p>	<p>Wait for the Remote Database re-initialization in progress alarm to clear before proceeding.</p> <p>Monitor progress by navigating to Alarms & Events > View Active.</p> <div style="margin-top: 10px;">  <ul style="list-style-type: none">  Alarms & Events <ul style="list-style-type: none">  View Active  View History  View Trap Log </div>

Procedure 44. Complete SDS NOAM Server Group Configuration

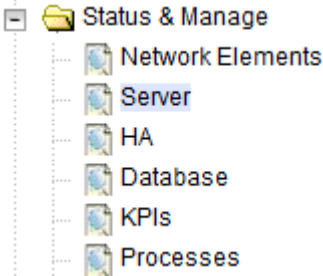
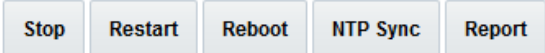
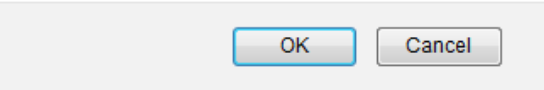
5.	<p>SDS NOAM VIP GUI: Restart the 2nd SDS NOAM server</p>	<p>1. From the SDS NOAM GUI, navigate to Status & Manage > Server.</p>  <p>2. Select the second SDS NOAM server and click Restart.</p>  <p>3. Click OK to confirm.</p> <p>Are you sure you wish to restart application software on the following server(s)? ZombieSDSDRNOAM2</p> 
----	--	--

3.15.2 NetBackup Client Installation (Optional)

Procedure 45. Install NetBackup Client (Optional)

S T E P #		<p>This procedure downloads and installs the NetBackup client software on the server. Location of the bpstart_notify and bpend_notify scripts is required for the execution of this procedure. For Appworks-based applications, the scripts are located as follows:</p> <ul style="list-style-type: none"> • /usr/TKLC/appworks/sbin/bpstart_notify • /usr/TKLC/appworks/sbin/bpend_notify <p>Check off (✓) each step as it is completed. Boxes have been provided for this purpose under each step number.</p> <p>If this procedure fails, it is recommended to contact My Oracle Support (MOS) and ask for assistance.</p>
1.	<p>Install NetBackup Client Software</p>	<p>If a customer has a way of transferring and installing the NetBackup client without using TPD tools (push configuration), then use Appendix I.2 Install NetBackup Client Using NBAutoInstall.</p> <p>Note: This is not common. If the answer to the previous question is not known, then use Appendix I.1 Install NetBackup Client Using platcfg.</p>
2.	<p>Install NetBackup Client Software</p>	<p>Choose the same method used in step 1. to install NetBackup on the 2nd NOAM.</p>

3.15.3 Disaster Recovery NOAM (Optional)

Procedure 46. Configure SDS NOAM for DR Site (Optional)

S T E P #	<p>This procedure configures the first DR NOAM server.</p> <p>Check off (✓) each step as it is completed. Boxes have been provided for this purpose under each step number.</p> <p>If this procedure fails, it is recommended to contact My Oracle Support (MOS) and ask for assistance.</p>	
1. <input type="checkbox"/>	<p>Primary SDS NOAM VIP GUI: Login</p>	<ol style="list-style-type: none"> Establish a GUI session on the first SDS NOAM server by using the VIP IP address of the NOAM server. Open the web browser and enter a URL of: <div style="border: 1px solid black; padding: 5px; margin: 10px 0;"> <code>https://<Primary_SDS_NOAM_VIP_IP_Address></code> </div> Login as the guiadmin user. 

Procedure 46. Configure SDS NOAM for DR Site (Optional)

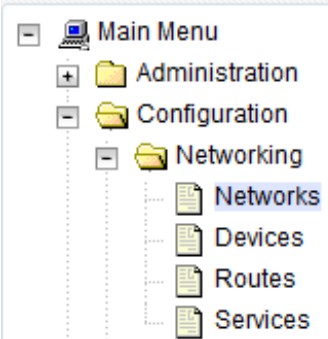
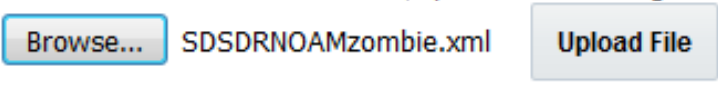
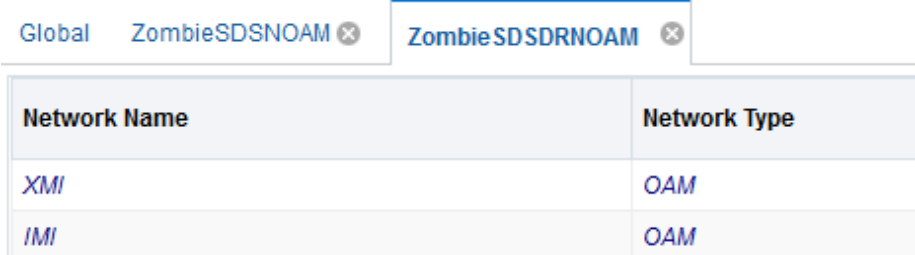
<p>2. Primary SDS NOAM VIP GUI: Create the SDS DR NOAM network element using an XML file</p>	<p>1. Navigate to Configuration > Networking > Networks.</p>  <p>2. Click Browse and enter the Pathname of the DR NOAM network XML file.</p> <p>3. Click Upload File.</p> <p>To create a new Network Element, upload a valid configuration file:</p>  <p>4. Click on the tab to display the configured network.</p>  <table border="1" style="width: 100%; border-collapse: collapse;"> <thead> <tr> <th style="text-align: left;">Network Name</th> <th style="text-align: left;">Network Type</th> </tr> </thead> <tbody> <tr> <td><i>XMI</i></td> <td><i>OAM</i></td> </tr> <tr> <td><i>IMI</i></td> <td><i>OAM</i></td> </tr> </tbody> </table>	Network Name	Network Type	<i>XMI</i>	<i>OAM</i>	<i>IMI</i>	<i>OAM</i>
Network Name	Network Type						
<i>XMI</i>	<i>OAM</i>						
<i>IMI</i>	<i>OAM</i>						

Procedure 46. Configure SDS NOAM for DR Site (Optional)

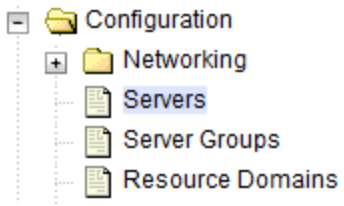
<p>3. <input type="checkbox"/></p> <p>Primary SDS NOAM VIP GUI: Insert the 1st SDS DR NOAM server</p>	<p>1. Navigate to Configuration > Servers.</p>  <p>2. Click Insert to insert the first SDS DR NOAM server into the servers table.</p> <div style="border: 1px solid #ccc; padding: 5px; margin: 5px 0;"> Insert Edit Delete Export Report </div> <p>3. Enter these values:</p> <p>Hostname: <Hostname> Role: Network OAM System ID: <Site System ID> Hardware Profile: SDS TVOE Guest Network Element Name: [Select NE] Location: <Enter an optional location description></p> <table border="1" style="width: 100%; border-collapse: collapse; margin: 5px 0;"> <thead> <tr> <th style="width: 30%;">Attribute</th> <th>Value</th> </tr> </thead> <tbody> <tr> <td>Hostname *</td> <td><input type="text" value="ZombieSDSNOAM1"/></td> </tr> <tr> <td>Role *</td> <td><input type="text" value="NETWORK OAM&P"/> ▼</td> </tr> <tr> <td>System ID</td> <td><input type="text"/></td> </tr> <tr> <td>Hardware Profile</td> <td><input type="text" value="SDS TVOE Guest"/> ▼</td> </tr> <tr> <td>Network Element Name *</td> <td><input type="text" value="ZombieSDSNOAM"/> ▼</td> </tr> <tr> <td>Location</td> <td><input type="text" value="pc5010441"/></td> </tr> </tbody> </table> <p>4. For the XMI network, type the server XMI IP address. Select the xmi interface. Leave the VLAN checkbox unmarked.</p> <p>5. For the IMI network, type the server IMI IP address. Select the xmi interface. Leave the VLAN checkbox unmarked.</p> <table border="1" style="width: 100%; border-collapse: collapse; margin: 5px 0;"> <tbody> <tr> <td style="width: 30%;">XMI (10.240.213.0/24)</td> <td style="width: 30%;"><input type="text" value="10.240.213.23"/></td> <td style="width: 10%;"><input type="text" value="xmi"/> ▼</td> <td style="width: 10%;"><input type="checkbox"/> VLAN (4)</td> </tr> <tr> <td>IMI (169.254.1.0/24)</td> <td><input type="text" value="169.254.1.23"/></td> <td><input type="text" value="imi"/> ▼</td> <td><input type="checkbox"/> VLAN (3)</td> </tr> </tbody> </table> <p>6. Add this NTP server.</p> <table border="1" style="width: 100%; border-collapse: collapse; margin: 5px 0;"> <thead> <tr> <th style="width: 70%;">NTP Server</th> <th>Preferred?</th> </tr> </thead> <tbody> <tr> <td><First-SDS-DR NOAM-RMS-TVOE-IP-Address></td> <td>Yes</td> </tr> </tbody> </table> <p>7. Click OK.</p>	Attribute	Value	Hostname *	<input type="text" value="ZombieSDSNOAM1"/>	Role *	<input type="text" value="NETWORK OAM&P"/> ▼	System ID	<input type="text"/>	Hardware Profile	<input type="text" value="SDS TVOE Guest"/> ▼	Network Element Name *	<input type="text" value="ZombieSDSNOAM"/> ▼	Location	<input type="text" value="pc5010441"/>	XMI (10.240.213.0/24)	<input type="text" value="10.240.213.23"/>	<input type="text" value="xmi"/> ▼	<input type="checkbox"/> VLAN (4)	IMI (169.254.1.0/24)	<input type="text" value="169.254.1.23"/>	<input type="text" value="imi"/> ▼	<input type="checkbox"/> VLAN (3)	NTP Server	Preferred?	<First-SDS-DR NOAM-RMS-TVOE-IP-Address>	Yes
Attribute	Value																										
Hostname *	<input type="text" value="ZombieSDSNOAM1"/>																										
Role *	<input type="text" value="NETWORK OAM&P"/> ▼																										
System ID	<input type="text"/>																										
Hardware Profile	<input type="text" value="SDS TVOE Guest"/> ▼																										
Network Element Name *	<input type="text" value="ZombieSDSNOAM"/> ▼																										
Location	<input type="text" value="pc5010441"/>																										
XMI (10.240.213.0/24)	<input type="text" value="10.240.213.23"/>	<input type="text" value="xmi"/> ▼	<input type="checkbox"/> VLAN (4)																								
IMI (169.254.1.0/24)	<input type="text" value="169.254.1.23"/>	<input type="text" value="imi"/> ▼	<input type="checkbox"/> VLAN (3)																								
NTP Server	Preferred?																										
<First-SDS-DR NOAM-RMS-TVOE-IP-Address>	Yes																										

Procedure 46. Configure SDS NOAM for DR Site (Optional)

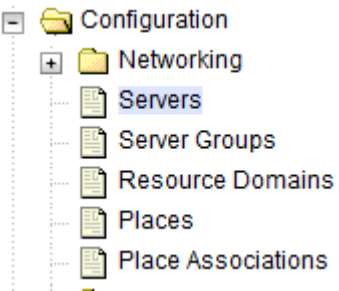
4. <input type="checkbox"/>	Primary SDS NOAM VIP GUI: Export the initial configuration	<p>1. Navigate to Configuration > Servers.</p>  <p>2. From the GUI screen, select the SDS DR NOAM server and click Export to generate the initial configuration data for that server.</p> <p><input type="button" value="Insert"/> <input type="button" value="Edit"/> <input type="button" value="Delete"/> <input type="button" value="Export"/> <input type="button" value="Report"/></p>
5. <input type="checkbox"/>	Primary SDS NOAM VIP GUI: Copy the configuration file to the DR NOAM server	<p>1. Obtain a terminal session to the primary NOAM server console and login as admusr.</p> <p>2. Configure the first DR NOAM server.</p> <pre data-bbox="553 871 1430 1039">\$ sudo scp -r /var/TKLC/db/filemgmt/TKLCConfigData.<DRNOAM1_Hostname>.sh admusr@<DRNOAM1_xmi_IP_address>:/var/tmp/TKLCConfigData.sh</pre> <p>The automatic configuration daemon looks for the TKLCConfigData.sh file in the /var/tmp directory, implements the configuration in the file, and asks the user to reboot the server.</p>
6. <input type="checkbox"/>	1st SDS DR NOAM Server: Verify server configuration was called and reboot the configured server	<p>1. Verify server configuration was called by checking the log file.</p> <pre data-bbox="553 1203 1430 1249">\$ sudo cat /var/TKLC/appw/logs/Process/install.log</pre> <p>Verify this message displays: [SUCCESS] script completed successfully!</p> <p>Note: The script may return success even when errors are reported in the log file. Go through the entire install.log file to verify no errors are present.</p> <p>2. Reboot the server.</p> <pre data-bbox="553 1497 1430 1543">\$ sudo init 6</pre> <p>3. Proceed to the next step once the server finishes rebooting. The server is done rebooting once the login prompt displays.</p>

Procedure 46. Configure SDS NOAM for DR Site (Optional)

<p>7. <input type="checkbox"/></p>	<p>1st SDS DR NOAM Server: Verify server health</p>	<p>Login as admusr to the first SDS DR NOAM server and make sure no errors are returned.</p> <pre style="background-color: #f0f0f0; padding: 5px;">\$ sudo syscheck Running modules in class hardware...OK Running modules in class disk...OK Running modules in class net...OK Running modules in class system...OK Running modules in class proc...OK LOG LOCATION: /var/TKLC/log/syscheck/fail_log</pre>				
<p>8. <input type="checkbox"/></p>	<p>Repeat for 2nd SDS DR NOAM server</p>	<p>Repeat steps 3. through 7. to configure second SDS DR NOAM server. When inserting the second SDS DR NOAM server, change the NTP server address to this:</p> <table border="1" data-bbox="524 701 1398 806"> <thead> <tr style="background-color: #d9e1f2;"> <th data-bbox="524 701 1144 743">NTP Server</th> <th data-bbox="1144 701 1398 743">Preferred?</th> </tr> </thead> <tbody> <tr> <td data-bbox="524 743 1144 806"><2nd SDS DR NOAM-RMS-TVOE-IP-Address></td> <td data-bbox="1144 743 1398 806">Yes</td> </tr> </tbody> </table>	NTP Server	Preferred?	<2 nd SDS DR NOAM-RMS-TVOE-IP-Address>	Yes
NTP Server	Preferred?					
<2 nd SDS DR NOAM-RMS-TVOE-IP-Address>	Yes					

Procedure 47. Pairing for SDS DR NOAM Site (Optional)

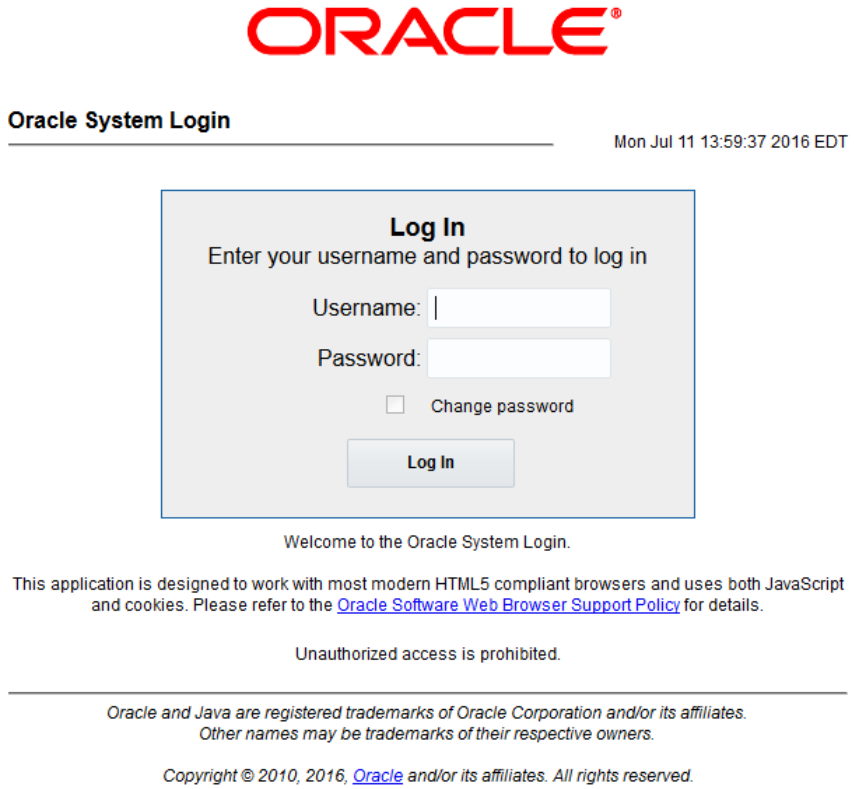
S T E P #	<p>This procedure pairs the SDS DR NOAM site.</p> <p>Prerequisite: The SDS DR NOAM site has been installed.</p> <p>Check off (✓) each step as it is completed. Boxes have been provided for this purpose under each step number.</p> <p>If this procedure fails, it is recommended to contact My Oracle Support (MOS) and ask for assistance.</p>	
<p>1.</p> <input type="checkbox"/>	<p>SDS NOAM VIP GUI: Login</p>	<p>1. Establish a GUI session on the first SDS NOAM server by using the VIP IP address of the NOAM server. Open the web browser and enter a URL of:</p> <div style="border: 1px solid black; padding: 5px; margin: 10px 0;"> <p><code>https://<Primary_SDS_NOAM_VIP_IP_Address></code></p> </div> <p>2. Login as the guiadmin user.</p> <div style="text-align: center; margin: 20px 0;">  </div>

Procedure 47. Pairing for SDS DR NOAM Site (Optional)

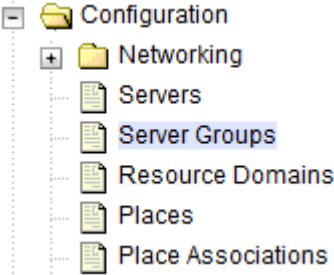
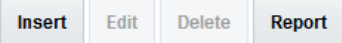
<p>2.</p> <p><input type="checkbox"/></p>	<p>Primary SDS NOAM VIP GUI: Enter SDS DR NOAM server group data</p>	<p>1. Navigate to Configuration > Server Groups.</p>  <p>2. Click Insert.</p>  <p>3. Enter these values:</p> <p>Server Group Name: <Server Group Name> Level: A Parent: None Function: SDS WAN Replication Connection Count: Use Default Value</p> <p>4. Click OK.</p>
---	---	---

Procedure 47. Pairing for SDS DR NOAM Site (Optional)

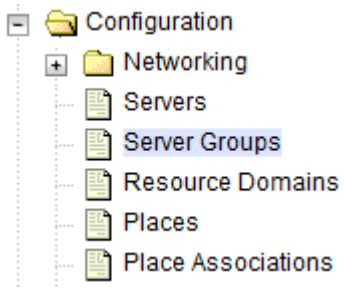
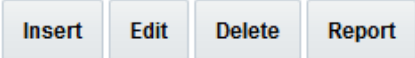
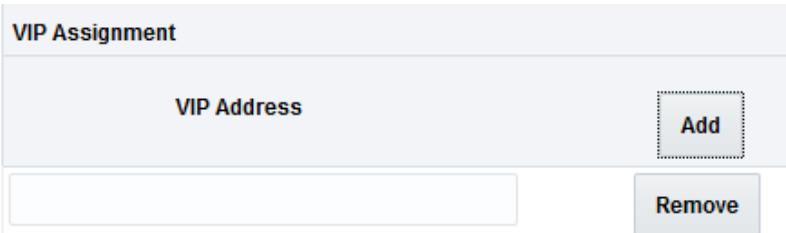
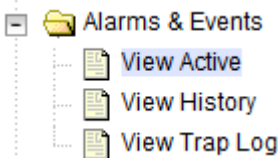
<p>3. <input type="checkbox"/></p>	<p>Primary SDS NOAM VIP GUI: Edit server group and VIP</p>	<p>1. Navigate to Configuration > Server Groups.</p>  <p>2. Select the server group you just created and click Edit.</p>  <p>3. Add both SDS DR NOAM servers to the server group primary site by marking the Include in SG checkbox for each SDS DR server. Do not mark any of the Preferred Spare checkboxes.</p> <table border="1" data-bbox="506 835 1430 1039"> <tr> <td>ZombieSDSSOAM1</td> <td><input checked="" type="checkbox"/> Include in SG</td> <td><input type="checkbox"/> Prefer server as spare</td> </tr> <tr> <td>ZombieSDSSOAM2</td> <td><input checked="" type="checkbox"/> Include in SG</td> <td><input type="checkbox"/> Prefer server as spare</td> </tr> </table> <p>4. Click Apply.</p> <p>5. Click Add.</p> <p>6. Type the VIP Address and click OK.</p> 	ZombieSDSSOAM1	<input checked="" type="checkbox"/> Include in SG	<input type="checkbox"/> Prefer server as spare	ZombieSDSSOAM2	<input checked="" type="checkbox"/> Include in SG	<input type="checkbox"/> Prefer server as spare
ZombieSDSSOAM1	<input checked="" type="checkbox"/> Include in SG	<input type="checkbox"/> Prefer server as spare						
ZombieSDSSOAM2	<input checked="" type="checkbox"/> Include in SG	<input type="checkbox"/> Prefer server as spare						
<p>4. <input type="checkbox"/></p>	<p>Primary SDS NOAM VIP GUI: Wait for remote database alarm to clear</p>	<p>Wait for the Remote Database re-initialization in progress alarm to clear before proceeding. Monitor progress by navigating to Alarms & Events > View Active.</p> 						

Procedure 47. Pairing for SDS DR NOAM Site (Optional)

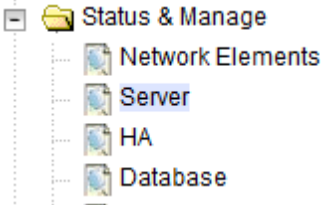
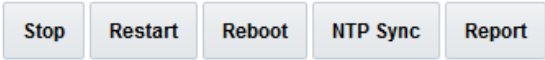
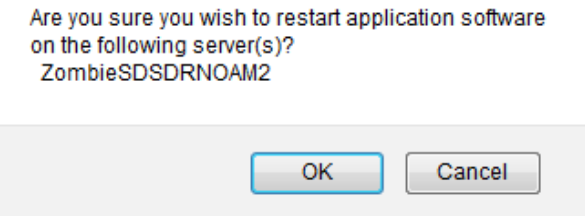
<p>5. <input type="checkbox"/> Primary SDS NOAM VIP GUI: Restart the SDS DR NOAM servers</p>	<p>1. From the SDS NOAM GUI, navigate to Status & Manage > Server.</p>  <p>2. Select the first SDS DR NOAM server and click Restart.</p>  <p>3. Click OK to confirm.</p>  <p>4. Repeat this step selecting the second SDS DR NOAM server.</p>
---	--

3.15.4 Query Server Configuration

Various errors may display at different stages of this procedure. Ignore errors related to values other than the errors referenced in a specific step.

Procedure 48. Configure SDS Query Server

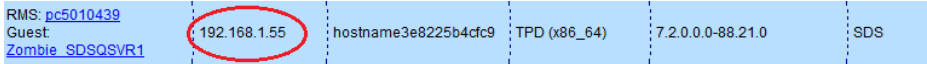
<p>S T E P #</p>	<p>This procedure configures SDS query server.</p> <p>Check off (✓) each step as it is completed. Boxes have been provided for this purpose under each step number.</p> <p>If this procedure fails, it is recommended to contact My Oracle Support (MOS) and ask for assistance.</p>
<p>1. <input type="checkbox"/> PMAC: Exchange SSH keys between SOAM site's local PMAC and the query server</p>	<p>1. Use the PMAC GUI to determine the control network IP address of the server that is to be the query server. From the PMAC GUI, navigate to Software > Software Inventory.</p>  <p>2. Note the IP address for the query server.</p> <p>3. Obtain a terminal session to PMAC and login as admusr.</p> <p>4. Exchange SSH keys for admusr between the PMAC and the query server using the keyexchange utility and control network IP address for the query server.</p> <pre style="border: 1px solid black; padding: 5px;">\$ keyexchange admusr@<Query_Server_Control_IP Address></pre> <p>5. Enter the password for the admusr user of the SOAM server.</p>

Procedure 48. Configure SDS Query Server

<p>2. <input type="checkbox"/></p>	<p>SDS NOAM VIP GUI: Login</p>	<p>1. Establish a GUI session on the first SDS NOAM server by using the VIP IP address of the NOAM server. Open the web browser and enter a URL of:</p> <div style="border: 1px solid black; padding: 5px; width: fit-content; margin: 10px auto;"> <p><code>https://<Primary_SDS_NOAM_VIP_IP_Address></code></p> </div> <p>2. Login as the guiadmin user.</p> <div style="text-align: center; margin: 20px 0;">  </div> <div style="text-align: center;"> <p>Oracle System Login</p> <hr style="width: 60%; margin: 0 auto;"/> <p style="font-size: small;">Mon Jul 11 13:59:37 2016 EDT</p> </div> <div style="text-align: center; margin: 20px 0;"> <div style="border: 1px solid gray; padding: 10px; width: 80%; margin: 0 auto;"> <p style="text-align: center;">Log In</p> <p style="text-align: center;">Enter your username and password to log in</p> <p style="text-align: center;">Username: <input style="width: 100%;" type="text"/></p> <p style="text-align: center;">Password: <input style="width: 100%;" type="password"/></p> <p style="text-align: center;"><input type="checkbox"/> Change password</p> <p style="text-align: center;"><input type="button" value="Log In"/></p> </div> <p style="font-size: x-small; margin-top: 10px;">Welcome to the Oracle System Login.</p> <p style="font-size: x-small; margin-top: 10px;">This application is designed to work with most modern HTML5 compliant browsers and uses both JavaScript and cookies. Please refer to the Oracle Software Web Browser Support Policy for details.</p> <p style="font-size: x-small; margin-top: 10px;">Unauthorized access is prohibited.</p> <hr style="width: 80%; margin: 0 auto;"/> <p style="font-size: x-small; margin-top: 10px;">Oracle and Java are registered trademarks of Oracle Corporation and/or its affiliates. Other names may be trademarks of their respective owners.</p> <p style="font-size: x-small; margin-top: 10px;">Copyright © 2010, 2016, Oracle and/or its affiliates. All rights reserved.</p> </div>
------------------------------------	---------------------------------------	--

Procedure 48. Configure SDS Query Server

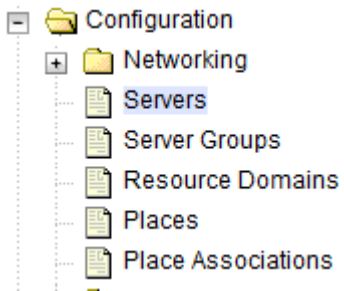
<p>3. <input type="checkbox"/></p>	<p>SDS SOAM VIP GUI: Insert the SDS DP SOAM server</p>	<p>1. Navigate to Configuration > Servers.</p>  <p>2. Click Insert to insert the new SDS query server into the servers table.</p> <div style="border: 1px solid #ccc; padding: 5px; display: flex; justify-content: space-around; margin: 5px 0;"> Insert Edit Delete Export Report </div> <p>3. Enter these values:</p> <p>Hostname: <Hostname> Role: Query server System ID: <Site System ID> Hardware Profile: SDS TVOE Guest Network Element Name: [Select NE]</p> <p>4. For the XMI network, type the server XMI IP address. Select the xmi interface. Leave the VLAN checkbox unmarked.</p> <p>5. For the IMI network, type the server IMI IP address. Select the xmi interface. Leave the VLAN checkbox unmarked.</p> <div style="margin: 5px 0;"> <table style="width: 100%; border-collapse: collapse;"> <tr> <td style="width: 30%; border-bottom: 1px solid #ccc;">XMI (10.240.213.0/24)</td> <td style="width: 40%; border-bottom: 1px solid #ccc;"><input style="width: 95%;" type="text" value="10.240.213.29"/></td> <td style="width: 30%; border-bottom: 1px solid #ccc;"> <div style="display: flex; justify-content: space-between; align-items: center;"> xmi <input type="checkbox"/> VLAN (4) </div> </td> </tr> <tr> <td style="border-bottom: 1px solid #ccc;">IMI (169.254.1.0/24)</td> <td style="border-bottom: 1px solid #ccc;"><input style="width: 95%;" type="text" value="169.254.1.29"/></td> <td style="border-bottom: 1px solid #ccc;"> <div style="display: flex; justify-content: space-between; align-items: center;"> imi <input type="checkbox"/> VLAN (3) </div> </td> </tr> </table> </div> <p>6. Add this NTP server.</p> <table border="1" style="width: 100%; border-collapse: collapse; margin: 5px 0;"> <thead> <tr style="background-color: #e6f2ff;"> <th style="text-align: left; padding: 5px;">NTP Server</th> <th style="text-align: left; padding: 5px;">Preferred?</th> </tr> </thead> <tbody> <tr> <td style="padding: 5px;"><Query-Server-TVOE-IP-Address></td> <td style="padding: 5px;">Yes</td> </tr> </tbody> </table> <p>7. Click OK.</p>	XMI (10.240.213.0/24)	<input style="width: 95%;" type="text" value="10.240.213.29"/>	<div style="display: flex; justify-content: space-between; align-items: center;"> xmi <input type="checkbox"/> VLAN (4) </div>	IMI (169.254.1.0/24)	<input style="width: 95%;" type="text" value="169.254.1.29"/>	<div style="display: flex; justify-content: space-between; align-items: center;"> imi <input type="checkbox"/> VLAN (3) </div>	NTP Server	Preferred?	<Query-Server-TVOE-IP-Address>	Yes
XMI (10.240.213.0/24)	<input style="width: 95%;" type="text" value="10.240.213.29"/>	<div style="display: flex; justify-content: space-between; align-items: center;"> xmi <input type="checkbox"/> VLAN (4) </div>										
IMI (169.254.1.0/24)	<input style="width: 95%;" type="text" value="169.254.1.29"/>	<div style="display: flex; justify-content: space-between; align-items: center;"> imi <input type="checkbox"/> VLAN (3) </div>										
NTP Server	Preferred?											
<Query-Server-TVOE-IP-Address>	Yes											

Procedure 48. Configure SDS Query Server

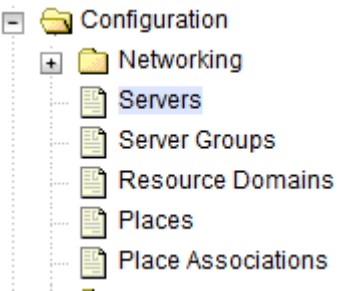
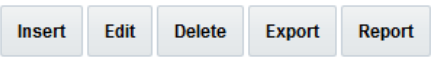
<p>4. <input type="checkbox"/></p>	<p>SDS NOAM VIP GUI: Export the initial configuration</p>	<p>1. Navigate to Configuration > Servers.</p>  <p>2. From the GUI screen, select the query server and click Export to generate the initial configuration data for that server.</p> 
<p>5. <input type="checkbox"/></p>	<p>SDS NOAM VIP GUI: Copy configuration file to 1st query server</p>	<p>1. Obtain a terminal session to the SDS NOAM VIP as the admusr user.</p> <p>2. Use the awpushcfg utility to copy the configuration file, created in the previous step from the /var/TKLC/db/filemgmt directory on the SDS NOAM to the query server, using the control network IP address for the query server.</p> <p>The configuration file has a filename like TKLCConfigData.<hostname>.sh.</p> <pre style="border: 1px solid black; padding: 5px;">\$ sudo awpushcfg</pre> <p>The awpushcfg utility is interactive, so the user is asked for the following:</p> <ul style="list-style-type: none"> • IP address of the local PMAC server: Use the local control network address from the PMAC. • Username: Use admusr • Control network IP address for the target server: In this case, enter the control IP for the query server. • Hostname of the target server: Enter the server name configured in step 3.

Procedure 48. Configure SDS Query Server

<p>6. <input type="checkbox"/></p>	<p>Query Server: Verify awpushcfg was called and reboot the configured server</p>	<ol style="list-style-type: none"> Obtain a terminal session to the query server console by establishing an ssh session from the SDS NOAM VIP terminal console. <pre>\$ ssh admusr@<Query_Server_Control_IP></pre> Login as admusr. The automatic configuration daemon looks for the TKLCConfigData.sh file in the /var/tmp directory, implements the configuration in the file, and asks the user to reboot the server. Verify awpushcfg was called by checking the log file. <pre>\$ sudo cat /var/TKLC/appw/logs/Process/install.log</pre> <p>Verify this message displays: [SUCCESS] script completed successfully!</p> <p>Note: The script may return success even when errors are reported in the log file. Go through the entire install.log file to verify no errors are present.</p> Reboot the server. <pre>\$ sudo init 6</pre> Proceed to the next step once the server finishes rebooting. The server is done rebooting once the login prompt is displayed.
<p>7. <input type="checkbox"/></p>	<p>Query Server: Verify server health</p>	<p>Login as admusr to the query server and make sure no errors are returned.</p> <pre>\$ sudo syscheck Running modules in class hardware...OK Running modules in class disk...OK Running modules in class net...OK Running modules in class system...OK Running modules in class proc...OK LOG LOCATION: /var/TKLC/log/syscheck/fail_log</pre>

Procedure 49. Pair SDS Query Server with SDS NOAMs

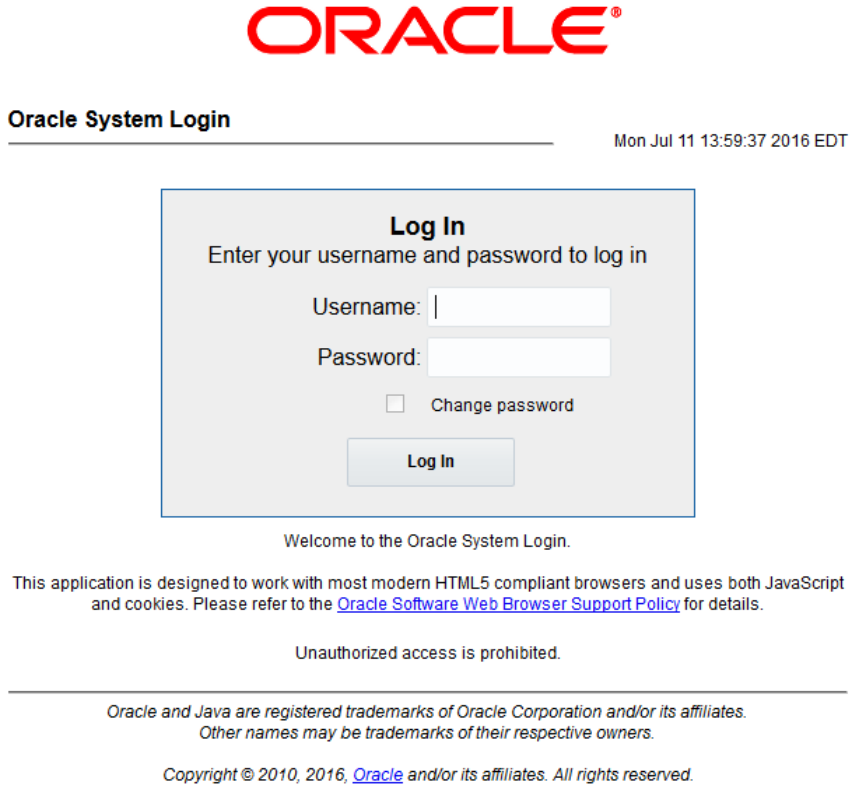
S T E P #	<p>This procedure pairs SDS query servers with SDS NOAMs.</p> <p>Check off (✓) each step as it is completed. Boxes have been provided for this purpose under each step number.</p> <p>If this procedure fails, it is recommended to contact My Oracle Support (MOS) and ask for assistance.</p>	
<p>1.</p> <input type="checkbox"/>	<p>SDS NOAM VIP GUI: Login</p>	<p>1. Establish a GUI session on the first SDS NOAM server by using the VIP IP address of the NOAM server. Open the web browser and enter a URL of:</p> <div style="border: 1px solid black; padding: 5px; width: fit-content; margin: 10px auto;"> <p>https://<Primary_SDS_NOAM_VIP_IP_Address></p> </div> <p>2. Login as the guiadmin user.</p> <div style="text-align: center; margin: 20px 0;">  </div>

Procedure 49. Pair SDS Query Server with SDS NOAMs

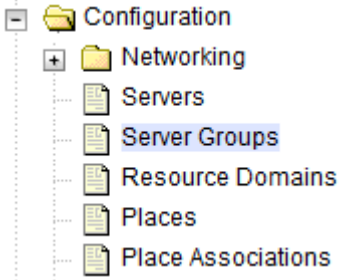
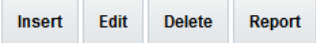
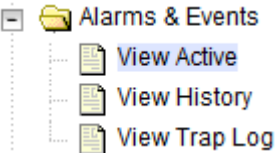
<p>2.</p> <p><input type="checkbox"/></p>	<p>SDS NOAM VIP GUI: Edit the SDS NOAM server group data</p>	<p>1. Navigate to Configuration > Server Groups.</p>  <p>2. Select the SDS NOAM server group and click Edit.</p>  <p>3. Mark the Include in SG checkbox for the query server to add it to the server group.</p> <table border="1" data-bbox="508 779 1419 1125"> <thead> <tr> <th>Server</th> <th>SG Inclusion</th> <th>Preferred HA Role</th> </tr> </thead> <tbody> <tr> <td>ZombieSDSNOAM1</td> <td><input checked="" type="checkbox"/> Include in SG</td> <td><input type="checkbox"/> Prefer server as spare</td> </tr> <tr> <td>ZombieSDSNOAM2</td> <td><input checked="" type="checkbox"/> Include in SG</td> <td><input type="checkbox"/> Prefer server as spare</td> </tr> <tr> <td>ZombieQS1</td> <td><input checked="" type="checkbox"/> Include in SG</td> <td><input type="checkbox"/> Prefer server as spare</td> </tr> </tbody> </table> <p>4. Click OK.</p>	Server	SG Inclusion	Preferred HA Role	ZombieSDSNOAM1	<input checked="" type="checkbox"/> Include in SG	<input type="checkbox"/> Prefer server as spare	ZombieSDSNOAM2	<input checked="" type="checkbox"/> Include in SG	<input type="checkbox"/> Prefer server as spare	ZombieQS1	<input checked="" type="checkbox"/> Include in SG	<input type="checkbox"/> Prefer server as spare
Server	SG Inclusion	Preferred HA Role												
ZombieSDSNOAM1	<input checked="" type="checkbox"/> Include in SG	<input type="checkbox"/> Prefer server as spare												
ZombieSDSNOAM2	<input checked="" type="checkbox"/> Include in SG	<input type="checkbox"/> Prefer server as spare												
ZombieQS1	<input checked="" type="checkbox"/> Include in SG	<input type="checkbox"/> Prefer server as spare												
<p>3.</p> <p><input type="checkbox"/></p>	<p>SDS NOAM VIP GUI: Wait for remote database alarm to clear</p>	<p>Wait for the Remote Database re-initialization in progress alarm to clear before proceeding. Monitor progress by navigating to Alarms & Events > View Active.</p> 												

Procedure 49. Pair SDS Query Server with SDS NOAMs

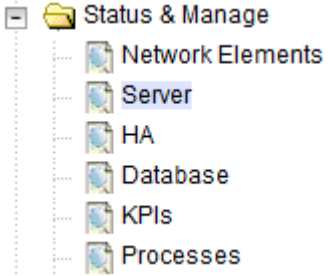
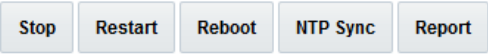
<p>4. <input type="checkbox"/></p>	<p>SDS NOAM VIP GUI: Restart query server</p>	<p>1. Navigate to Status & Manage > Server.</p>  <p>2. Select the query server and click Restart.</p>  <p>3. Click OK to confirm. Wait for the restart successful message.</p>
<p>5. <input type="checkbox"/></p>	<p>Repeat for SDS DR NOAM</p>	<p>If SDS DR NOAMs have been configured, repeat this procedure at the site of the SDS DR NOAMs.</p>

3.15.5 SOAM Configuration

Procedure 50. Configure SDS DP SOAM NE

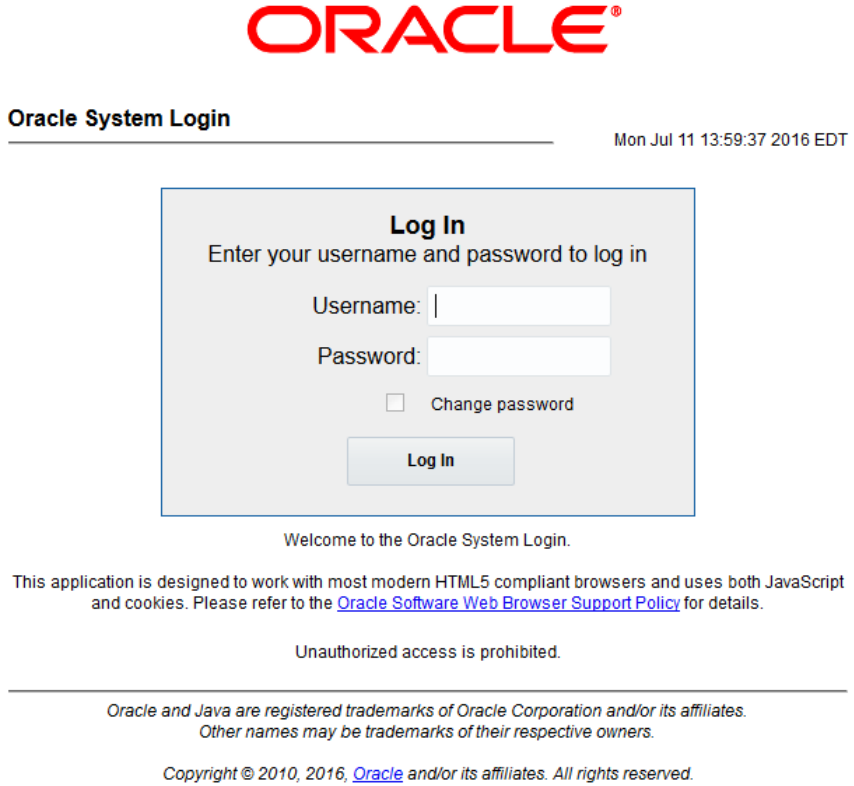
S T E P #	<p>This procedure configures the first SDS DP SOAM network element.</p> <p>Check off (✓) each step as it is completed. Boxes have been provided for this purpose under each step number.</p> <p>If this procedure fails, it is recommended to contact My Oracle Support (MOS) and ask for assistance.</p>	
1. <input type="checkbox"/>	<p>SDS NOAM VIP GUI: Login</p>	<ol style="list-style-type: none"> Establish a GUI session on the first SDS NOAM server by using the VIP IP address of the NOAM server. Open the web browser and enter a URL of: <div style="border: 1px solid black; padding: 5px; margin: 10px 0;"> <code>https://<Primary_SDS_NOAM_VIP_IP_Address></code> </div> Login as the guiadmin user. <div style="text-align: center;">  </div>

Procedure 50. Configure SDS DP SOAM NE

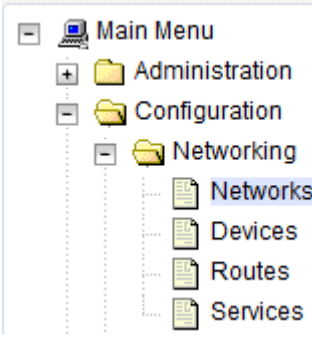
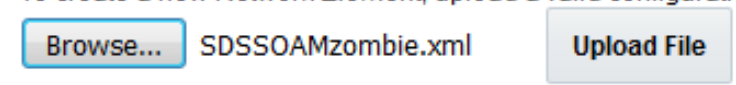
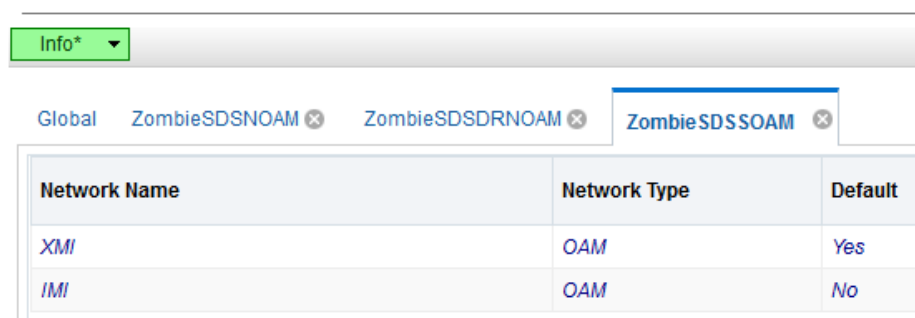
<p>2. NOAM SDS VIP GUI: Create the SOAM network element using an XML file</p>	<p>1. Navigate to Configuration > Networking > Networks.</p>  <p>2. Click Browse and enter the Pathname of the SOAM network XML file.</p> <p>3. Click Upload File.</p> <p>To create a new Network Element, upload a valid configuration file:</p>  <p>4. Click on the tab to display the configured network.</p> <p>Main Menu: Configuration -> Networking -> Networks</p>  <table border="1" style="margin-top: 10px;"> <thead> <tr> <th>Network Name</th> <th>Network Type</th> <th>Default</th> </tr> </thead> <tbody> <tr> <td><i>XMI</i></td> <td><i>OAM</i></td> <td><i>Yes</i></td> </tr> <tr> <td><i>IMI</i></td> <td><i>OAM</i></td> <td><i>No</i></td> </tr> </tbody> </table>	Network Name	Network Type	Default	<i>XMI</i>	<i>OAM</i>	<i>Yes</i>	<i>IMI</i>	<i>OAM</i>	<i>No</i>
Network Name	Network Type	Default								
<i>XMI</i>	<i>OAM</i>	<i>Yes</i>								
<i>IMI</i>	<i>OAM</i>	<i>No</i>								

Procedure 51. Configure SDS DP SOAM Server

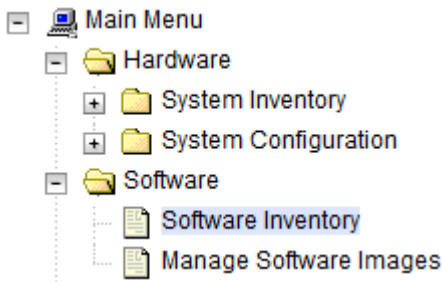
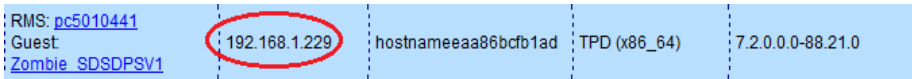
<p>S T E P #</p>	<p>This procedure configures the SDS DP SOAM server. Check off (✓) each step as it is completed. Boxes have been provided for this purpose under each step number. If this procedure fails, it is recommended to contact My Oracle Support (MOS) and ask for assistance.</p>	
<p>1. <input type="checkbox"/></p>	<p>PMAC: Exchange SSH keys between SDS DP SOAM site's local PMAC and the SOAM server</p>	<ol style="list-style-type: none"> Use the PMAC GUI to determine the control network IP address of the server that is to be a SDS DP SOAM server. From the PMAC GUI, navigate to Software > Software Inventory.  Note the IP address for a SDS DP SOAM server.  Obtain a terminal session to PMAC and login as admusr. Exchange SSH keys for admusr between the PMAC and SDS DP SOAM server using the keyexchange utility and control network IP address for the SDS DP server. <pre>\$ keyexchange admusr@<SO1_Control_IP Address></pre> Enter the password for the admusr user of the SDS DP SOAM server.
<p>2. <input type="checkbox"/></p>	<p>Exchange SSH keys between SDS NOAM and PMAC at the SDS DP SOAM site, if necessary</p>	<p>Note: If this SDS DP SOAM shares the same PMAC as the SDS NOAM, then skip this step.</p> <ol style="list-style-type: none"> Obtain a terminal session to the SDS NOAM VIP and login as admusr. Exchange SSH keys for admusr between the PMAC and the SDS NOAM for this SDS DP SOAM site using the keyexchange utility. <pre>\$ keyexchange admusr@<SO1_Site_PMAC_Mgmt_IP_Address></pre> Enter the password for the admusr user of the PMAC server. Repeat this step for the standby SDS DP SOAM server.



Procedure 51. Configure SDS DP SOAM Server

<p>3. <input type="checkbox"/></p>	<p>SDS NOAM VIP GUI: Login</p>	<p>1. Establish a GUI session on the first SDS NOAM server by using the VIP IP address of the NOAM server. Open the web browser and enter a URL of:</p> <div style="border: 1px solid black; padding: 5px; margin: 10px 0;"> <p><code>https://<Primary_SDS_NOAM_VIP_IP_Address></code></p> </div> <p>2. Login as the guiadmin user.</p> <div style="text-align: center; margin: 20px 0;">  </div> <div style="text-align: center;"> <p>Oracle System Login</p> <hr style="width: 60%; margin: 0 auto;"/> <p style="font-size: small;">Mon Jul 11 13:59:37 2016 EDT</p> </div> <div style="text-align: center; margin: 20px 0;"> <div style="border: 1px solid gray; padding: 10px; width: fit-content; margin: 0 auto;"> <p>Log In</p> <p>Enter your username and password to log in</p> <p>Username: <input style="width: 100%;" type="text"/></p> <p>Password: <input style="width: 100%;" type="password"/></p> <p><input type="checkbox"/> Change password</p> <p><input type="button" value="Log In"/></p> </div> </div> <p style="text-align: center; font-size: small;">Welcome to the Oracle System Login.</p> <p style="text-align: center; font-size: x-small;">This application is designed to work with most modern HTML5 compliant browsers and uses both JavaScript and cookies. Please refer to the Oracle Software Web Browser Support Policy for details.</p> <p style="text-align: center; font-size: x-small;">Unauthorized access is prohibited.</p> <hr style="width: 60%; margin: 0 auto;"/> <p style="text-align: center; font-size: x-small;">Oracle and Java are registered trademarks of Oracle Corporation and/or its affiliates. Other names may be trademarks of their respective owners.</p> <p style="text-align: center; font-size: x-small;">Copyright © 2010, 2016, Oracle and/or its affiliates. All rights reserved.</p>
------------------------------------	---------------------------------------	---

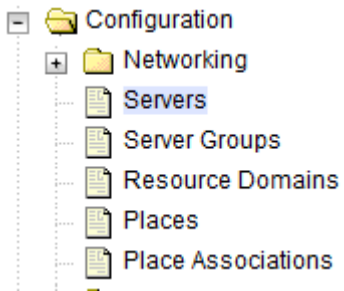
Procedure 51. Configure SDS DP SOAM Server

<p>4. SDS SOAM VIP GUI: Insert the SDS DP SOAM server</p>	<p>1. Navigate to Configuration > Servers.</p>  <p>2. Click Insert to insert the first SDS DP SOAM server into the servers table.</p> <div style="border: 1px solid #ccc; padding: 5px; margin: 5px 0;"> Insert Edit Delete Export Report </div> <p>3. Enter these values:</p> <p>Hostname: <Hostname> Role: System OAM System ID: <Site System ID> Hardware Profile: SDS TVOE Guest Network Element Name: [Select NE] Location: <Enter an optional location description></p> <table border="1" style="width: 100%; border-collapse: collapse; margin: 5px 0;"> <thead> <tr> <th style="width: 30%;">Attribute</th> <th>Value</th> </tr> </thead> <tbody> <tr> <td>Hostname *</td> <td>ZombieSDSSOAM1</td> </tr> <tr> <td>Role *</td> <td>SYSTEM OAM</td> </tr> <tr> <td>System ID</td> <td></td> </tr> <tr> <td>Hardware Profile</td> <td>SDS TVOE Guest</td> </tr> <tr> <td>Network Element Name *</td> <td>ZombieSDSSOAM</td> </tr> </tbody> </table> <p>4. For the XMI network, type the SDS DP SOAM's XMI IP address. Select the xmi interface. Leave the VLAN checkbox unmarked.</p> <p>5. For the IMI network, type the SDS DP SOAM's IMI IP address. Select the xmi interface. Leave the VLAN checkbox unmarked.</p> <table style="width: 100%; margin: 5px 0;"> <tr> <td style="width: 30%;">XMI (10.240.213.0/24)</td> <td style="width: 40%;">10.240.213.30</td> <td style="width: 10%;">xmi</td> <td style="width: 10%;"><input type="checkbox"/> VLAN (4)</td> </tr> <tr> <td>IMI (169.254.1.0/24)</td> <td>169.254.1.30</td> <td>imi</td> <td><input type="checkbox"/> VLAN (3)</td> </tr> </table> <p>6. Add this NTP server.</p> <table border="1" style="width: 100%; border-collapse: collapse; margin: 5px 0;"> <thead> <tr> <th style="width: 70%;">NTP Server</th> <th>Preferred?</th> </tr> </thead> <tbody> <tr> <td><First-SDS-SOAM-RMS-TVOE-IP-Address></td> <td>Yes</td> </tr> </tbody> </table> <p>7. Click OK.</p>	Attribute	Value	Hostname *	ZombieSDSSOAM1	Role *	SYSTEM OAM	System ID		Hardware Profile	SDS TVOE Guest	Network Element Name *	ZombieSDSSOAM	XMI (10.240.213.0/24)	10.240.213.30	xmi	<input type="checkbox"/> VLAN (4)	IMI (169.254.1.0/24)	169.254.1.30	imi	<input type="checkbox"/> VLAN (3)	NTP Server	Preferred?	<First-SDS-SOAM-RMS-TVOE-IP-Address>	Yes
Attribute	Value																								
Hostname *	ZombieSDSSOAM1																								
Role *	SYSTEM OAM																								
System ID																									
Hardware Profile	SDS TVOE Guest																								
Network Element Name *	ZombieSDSSOAM																								
XMI (10.240.213.0/24)	10.240.213.30	xmi	<input type="checkbox"/> VLAN (4)																						
IMI (169.254.1.0/24)	169.254.1.30	imi	<input type="checkbox"/> VLAN (3)																						
NTP Server	Preferred?																								
<First-SDS-SOAM-RMS-TVOE-IP-Address>	Yes																								

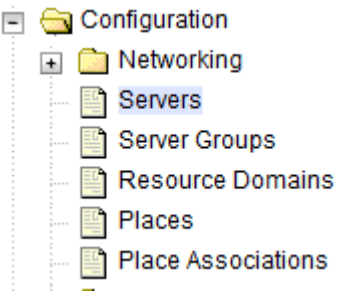
Procedure 51. Configure SDS DP SOAM Server

<p>5.</p> <p><input type="checkbox"/></p>	<p>SDS NOAM VIP GUI: Export the initial configuration</p>	<p>1. Navigate to Configuration > Servers.</p>  <p>2. From the GUI screen, select the SDS DP SOAM server and click Export to generate the initial configuration data for that server.</p> 
<p>6.</p> <p><input type="checkbox"/></p>	<p>SDS NOAM VIP GUI: Copy configuration file to 1st SDS DP SOAM server</p>	<p>1. Obtain a terminal session to the SDS NOAM VIP as the admusr user.</p> <p>2. Use the awpushcfg utility to copy the configuration file, created in the previous step, from the /var/TKLC/db/filemgmt directory on the SDS SOAM to the first SDS DP NOAM server, using the control network IP address for the first SDS DP SOAM server.</p> <p>The configuration file has a filename like TKLCConfigData.<hostname>.sh.</p> <pre>\$ sudo awpushcfg</pre> <p>The awpushcfg utility is interactive, so the user is asked for the following:</p> <ul style="list-style-type: none"> • IP address of the local PMAC server: Use the local control network address from the PMAC. • Username: Use admusr • Control network IP address for the target server: In this case, enter the control IP for the first SDS DP SOAM server. • Hostname of the target server: Enter the server name configured in step 4.

Procedure 51. Configure SDS DP SOAM Server

<p>7. <input type="checkbox"/></p>	<p>SDS DP Server: Verify awpushcfg was called and reboot the configured server</p>	<ol style="list-style-type: none"> Obtain a terminal session to the first SDS DP SOAM server console by establishing an ssh session from the site PMAC terminal console. <pre>\$ ssh admusr@<SDS_SO1_Control_IP></pre> Login as admusr. The automatic configuration daemon looks for the TKLCConfigData.sh file in the /var/tmp directory, implements the configuration in the file, and asks the user to reboot the server. Verify awpushcfg was called by checking the log file. <pre>\$ sudo cat /var/TKLC/appw/logs/Process/install.log</pre> <p>Verify this message displays: [SUCCESS] script completed successfully!</p> <p>Note: The script may return success even when errors are reported in the log file. Go through the entire install.log file to verify no errors are present.</p> Reboot the server. <pre>\$ sudo init 6</pre> Proceed to the next step once the server finishes rebooting. The server is done rebooting once the login prompt displays. 				
<p>8. <input type="checkbox"/></p>	<p>SDS DP Server: Verify server health</p>	<p>Login as admusr to the first SDS DP SOAM server and make sure no errors are returned.</p> <pre>\$ sudo syscheck Running modules in class hardware...OK Running modules in class disk...OK Running modules in class net...OK Running modules in class system...OK Running modules in class proc...OK LOG LOCATION: /var/TKLC/log/syscheck/fail_log</pre>				
<p>9. <input type="checkbox"/></p>	<p>Insert and configure the 2nd SDS DP SOAM server</p>	<p>Repeat this procedure to insert and configure the second SDS DP SOAM server with the exception of the NTP server, which should be configured as:</p> <table border="1" data-bbox="524 1432 1398 1522"> <thead> <tr> <th data-bbox="524 1432 1159 1478">NTP Server</th> <th data-bbox="1159 1432 1398 1478">Preferred?</th> </tr> </thead> <tbody> <tr> <td data-bbox="524 1478 1159 1522"><Second SDS DP SOAM-RMS-TVOE-IP-Address></td> <td data-bbox="1159 1478 1398 1522">Yes</td> </tr> </tbody> </table> <p>Instead of data for the first SDS DP SOAM server, insert the network data for the second SDS DP SOAM server, transfer the TKLCConfigData file to the second SDS DP SOAM server and reboot the second SDS DP SOAM server when prompted at a terminal window.</p>	NTP Server	Preferred?	<Second SDS DP SOAM-RMS-TVOE-IP-Address>	Yes
NTP Server	Preferred?					
<Second SDS DP SOAM-RMS-TVOE-IP-Address>	Yes					

Procedure 52. Configure the SDS DP SOAM Server Group

S T E P #	<p>This procedure configures the SDS DP SOAM server group.</p> <p>Check off (✓) each step as it is completed. Boxes have been provided for this purpose under each step number.</p> <p>If this procedure fails, it is recommended to contact My Oracle Support (MOS) and ask for assistance.</p>	
<p>1.</p> <p><input type="checkbox"/></p>	<p>SDS NOAM VIP GUI: Login</p>	<p>1. Establish a GUI session on the first SDS NOAM server by using the VIP IP address of the NOAM server. Open the web browser and enter a URL of:</p> <div style="border: 1px solid black; padding: 5px; width: fit-content; margin: 10px auto;"> <p>https://<Primary_SDS_NOAM_VIP_IP_Address></p> </div> <p>2. Login as the guiadmin user.</p> <div style="text-align: center; margin: 20px 0;">  </div> <div style="text-align: center;"> <p>Oracle System Login</p> <hr style="width: 60%; margin: 0 auto;"/> <p style="font-size: small; margin: 0;">Mon Jul 11 13:59:37 2016 EDT</p> </div> <div style="text-align: center; margin: 20px 0;"> <div style="border: 1px solid gray; padding: 10px; width: 80%; margin: 0 auto;"> <p style="text-align: center;">Log In</p> <p style="text-align: center;">Enter your username and password to log in</p> <p style="text-align: center;">Username: <input style="width: 100%;" type="text"/></p> <p style="text-align: center;">Password: <input style="width: 100%;" type="password"/></p> <p style="text-align: center;"><input type="checkbox"/> Change password</p> <p style="text-align: center;"><input type="button" value="Log In"/></p> </div> <p style="font-size: x-small; margin-top: 10px;">Welcome to the Oracle System Login.</p> <p style="font-size: x-small; margin-top: 10px;">This application is designed to work with most modern HTML5 compliant browsers and uses both JavaScript and cookies. Please refer to the Oracle Software Web Browser Support Policy for details.</p> <p style="font-size: x-small; margin-top: 10px;">Unauthorized access is prohibited.</p> <hr style="width: 60%; margin: 0 auto;"/> <p style="font-size: x-small; margin-top: 10px;">Oracle and Java are registered trademarks of Oracle Corporation and/or its affiliates. Other names may be trademarks of their respective owners.</p> <p style="font-size: x-small; margin-top: 10px;">Copyright © 2010, 2016, Oracle and/or its affiliates. All rights reserved.</p> </div>

Procedure 52. Configure the SDS DP SOAM Server Group

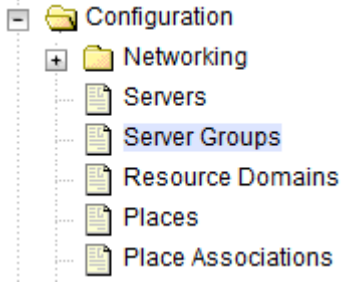
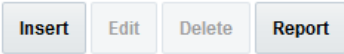
<p>2.</p> <p><input type="checkbox"/></p>	<p>SDS NOAM VIP GUI: Enter SDS DP SOAM server group data</p>	<p>1. Navigate to Configuration > Server Groups.</p>  <p>2. Click Insert.</p>  <p>3. Enter these values:</p> <p>Server Group Name: <Server Group Name> Level: B Parent: Select the NOAM Server Group Function: SDS (Active/Standby Pair) WAN Replication Connection Count: Use default value</p> <p>4. Click OK.</p>
---	---	---

Procedure 52. Configure the SDS DP SOAM Server Group

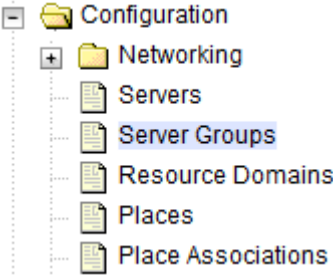
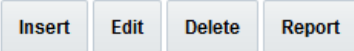
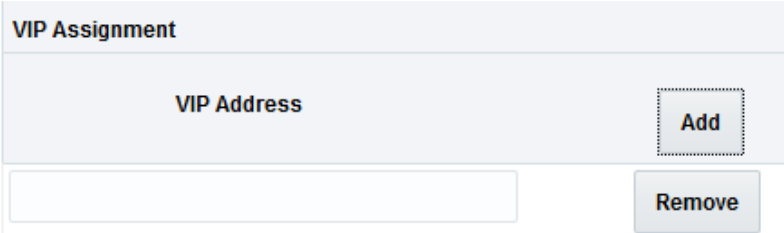
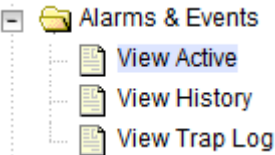
<p>3. <input type="checkbox"/></p>	<p>SDS NOAM VIP GUI: Edit the SDS DP SOAM server groups and VIP</p>	<p>1. Navigate to Configuration > Server Groups.</p>  <p>2. Select the server group you just created and click Edit.</p>  <p>3. Add both SDS DP SOAM servers to the server group primary site by marking the Include in SG checkbox for each SDS DP server. Do not mark any of the Preferred Spare checkboxes.</p> <table border="1" data-bbox="506 831 1430 1024"> <tr> <td>ZombieSDSSOAM1</td> <td><input checked="" type="checkbox"/> Include in SG</td> <td><input type="checkbox"/> Prefer server as spare</td> </tr> <tr> <td>ZombieSDSSOAM2</td> <td><input checked="" type="checkbox"/> Include in SG</td> <td><input type="checkbox"/> Prefer server as spare</td> </tr> </table> <p>4. Click Apply.</p> <p>5. Click Add.</p> <p>6. Type the VIP Address and click OK.</p> 	ZombieSDSSOAM1	<input checked="" type="checkbox"/> Include in SG	<input type="checkbox"/> Prefer server as spare	ZombieSDSSOAM2	<input checked="" type="checkbox"/> Include in SG	<input type="checkbox"/> Prefer server as spare
ZombieSDSSOAM1	<input checked="" type="checkbox"/> Include in SG	<input type="checkbox"/> Prefer server as spare						
ZombieSDSSOAM2	<input checked="" type="checkbox"/> Include in SG	<input type="checkbox"/> Prefer server as spare						
<p>4. <input type="checkbox"/></p>	<p>SDS NOAM VIP GUI: Wait for remote database alarm to clear</p>	<p>Wait for the Remote Database re-initialization in progress alarm to clear before proceeding. Monitor progress by navigating to Alarms & Events > View Active.</p> 						

Procedure 52. Configure the SDS DP SOAM Server Group

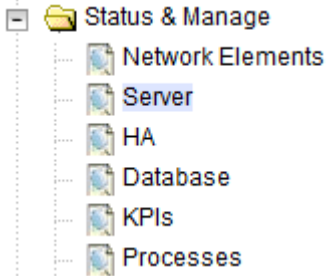
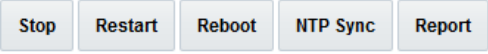
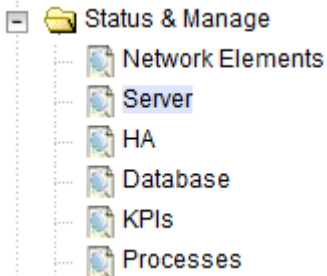
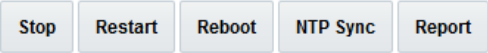
<p>5. <input type="checkbox"/></p>	<p>SDS NOAM VIP GUI: Restart 1st SDS DP servers</p>	<p>1. Navigate to Status & Manage > Server.</p>  <p>2. Select the first SDS DP server and click Restart.</p>  <p>3. Click OK to confirm. Wait for the restart successful message.</p>
<p>6. <input type="checkbox"/></p>	<p>SDS NOAM VIP GUI: Restart 2nd SDS DP servers</p>	<p>1. Navigate to Status & Manage > Server.</p>  <p>2. Select the second SDS DP server and click Restart.</p>  <p>3. Click OK to confirm. Wait for the restart successful message.</p>

3.15.6 DP Configuration

Procedure 53. Configure SDS DP Server

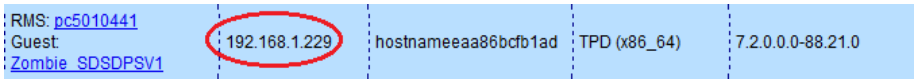
S T E P #	<p>This procedure configures SDS DP server.</p> <p>Check off (✓) each step as it is completed. Boxes have been provided for this purpose under each step number.</p> <p>If this procedure fails, it is recommended to contact My Oracle Support (MOS) and ask for assistance.</p>	
<p>1. <input type="checkbox"/></p>	<p>PMAC: Exchange SSH keys between SDS DP site's local PMAC and the DP server</p>	<ol style="list-style-type: none"> Use the DP site's PMAC GUI to determine the control network IP address of the server that is to be a SDS DP server. From the MP site's PMAC GUI, navigate to Software > Software Inventory.  <ol style="list-style-type: none"> Note the IP address for a SDS DP server. Obtain a terminal session to the SDS DP site's PMAC and login as admusr. Exchange SSH keys for admusr between the PMAC and the SDS DP server using the keyexchange utility and control network IP address for the SDS DP server. <div style="border: 1px solid black; padding: 5px; margin: 10px 0;"> <pre>\$ keyexchange admusr@<MP_Control_IP Address></pre> </div> <ol style="list-style-type: none"> Enter the password for the admusr user of the SDS DP server.



Procedure 53. Configure SDS DP Server

<p>2. <input type="checkbox"/> SDS NOAM VIP GUI: Login</p>	<p>1. Establish a GUI session on the first SDS NOAM server by using the VIP IP address of the NOAM server. Open the web browser and enter a URL of:</p> <div style="border: 1px solid black; padding: 5px; margin: 5px 0;"> <p><code>https://<Primary_SDS_NOAM_VIP_IP_Address></code></p> </div> <p>2. Login as the guiadmin user.</p> <div style="text-align: center; margin: 20px 0;">  </div>
---	--

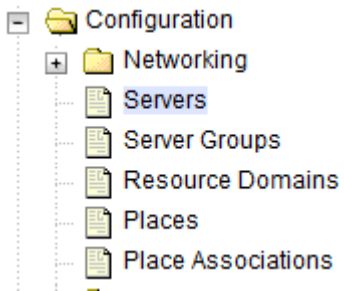
Procedure 53. Configure SDS DP Server

<p>3. <input type="checkbox"/></p>	<p>SDS NOAM VIP GUI: Insert the SDS DP server</p>	<p>1. Navigate to Configuration > Servers.</p>  <p>2. Click Insert to insert the new SDS DP server into the servers table.</p> <div style="border: 1px solid #ccc; padding: 5px; margin: 5px 0;"> Insert Edit Delete Export Report </div> <p>3. Enter these values:</p> <p>Hostname: <Hostname> Role: MP Network Element: [Choose Network Element] Hardware Profile: SDS TVOE Guest Location: <Enter an optional location description></p> <p>4. For the XMI network, type the SDS DP's XMI IP address. Select the xmi interface. Leave the VLAN checkbox unmarked.</p> <p>5. For the IMI network, enter the SDS DP's IMI IP address. Select the xmi interface. Leave the VLAN checkbox unmarked.</p> <div style="margin-top: 10px;"> <table style="width: 100%; border-collapse: collapse;"> <tr> <td style="width: 30%; border: none;">XMI (10.240.213.0/24)</td> <td style="width: 40%; border: none;"><input style="width: 95%;" type="text" value="10.240.213.30"/></td> <td style="width: 30%; border: none;">xmi <input type="checkbox"/> VLAN (4)</td> </tr> <tr> <td style="border: none;">IMI (169.254.1.0/24)</td> <td style="border: none;"><input style="width: 95%;" type="text" value="169.254.1.30"/></td> <td style="border: none;">imi <input type="checkbox"/> VLAN (3)</td> </tr> </table> </div> <p>6. Add this NTP server.</p> <table border="1" style="width: 100%; border-collapse: collapse; margin-top: 10px;"> <thead> <tr style="background-color: #e6f2ff;"> <th style="text-align: left;">NTP Server</th> <th style="text-align: left;">Preferred?</th> </tr> </thead> <tbody> <tr> <td style="padding: 2px;"><SDS-DP-RMS-TVOE-IP-Address></td> <td style="padding: 2px;">Yes</td> </tr> </tbody> </table> <p>7. Click OK.</p>	XMI (10.240.213.0/24)	<input style="width: 95%;" type="text" value="10.240.213.30"/>	xmi <input type="checkbox"/> VLAN (4)	IMI (169.254.1.0/24)	<input style="width: 95%;" type="text" value="169.254.1.30"/>	imi <input type="checkbox"/> VLAN (3)	NTP Server	Preferred?	<SDS-DP-RMS-TVOE-IP-Address>	Yes
XMI (10.240.213.0/24)	<input style="width: 95%;" type="text" value="10.240.213.30"/>	xmi <input type="checkbox"/> VLAN (4)										
IMI (169.254.1.0/24)	<input style="width: 95%;" type="text" value="169.254.1.30"/>	imi <input type="checkbox"/> VLAN (3)										
NTP Server	Preferred?											
<SDS-DP-RMS-TVOE-IP-Address>	Yes											

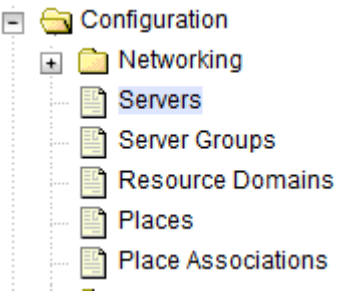
Procedure 53. Configure SDS DP Server

<p>4. <input type="checkbox"/></p>	<p>SDS NOAM VIP GUI: Export the configuration</p>	<p>1. Navigate to Configuration > Servers.</p>  <p>2. From the GUI screen, select the SDS DP server and click Export to generate the initial configuration data for that server.</p> 
<p>5. <input type="checkbox"/></p>	<p>SDS NOAM VIP GUI: Copy configuration file to SDS DP server</p>	<p>1. Obtain a terminal session to the SDS NOAM VIP as the admusr user.</p> <p>2. Use the awpushcfg utility to copy the configuration file, created in the previous step from the /var/TKLC/db/filemgmt directory on the SDS NOAM to the SDS DP server, using the control network IP address for the MP server.</p> <p>The configuration file has a filename like TKLCConfigData.<hostname>.sh.</p> <pre>\$ sudo awpushcfg</pre> <p>The awpushcfg utility is interactive, so the user is asked for the following:</p> <ul style="list-style-type: none"> • IP address of the local PMAC server: Use the management network address from the PMAC. • Username: Use admusr • Control network IP address for the target server: In this case, enter the control IP for the SDS DP server. • Hostname of the target server: Enter the server name configured in step 3.

Procedure 53. Configure SDS DP Server

6. <input type="checkbox"/>	SDS DP Server: Verify awpushcfg was called and reboot the configured server	<ol style="list-style-type: none"> Obtain a terminal session to the SDS DP server console by establishing an ssh session from the SDS NOAM VIP terminal console. <pre>\$ ssh admusr@<DP_Control_IP></pre> Login as admusr. Verify awpushcfg was called by checking the log file. <pre>\$ sudo cat /var/TKLC/appw/logs/Process/install.log</pre> <p>Verify this message displays: [SUCCESS] script completed successfully!</p> <p>Note: The script may return success even when errors are reported in the log file. Go through the entire install.log file to verify no errors are present.</p> Reboot the server. <pre>\$ sudo init 6</pre> Proceed to the next step once the server finishes rebooting. The server is done rebooting once the login prompt displays.
7. <input type="checkbox"/>	SDS DP Server: Verify server health	Login as admusr to the server and make sure no errors are returned. <pre>\$ sudo syscheck Running modules in class hardware...OK Running modules in class disk...OK Running modules in class net...OK Running modules in class system...OK Running modules in class proc...OK LOG LOCATION: /var/TKLC/log/syscheck/fail_log</pre>
8. <input type="checkbox"/>	Repeat for remaining SDS DPs	Repeat this procedure for all remaining SDS DP servers.

Procedure 54. Configure the SDS DP Server Group

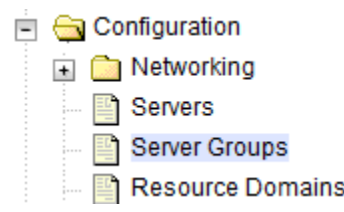
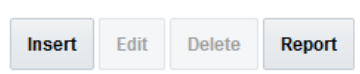
<p>S T E P #</p>	<p>This procedure configures the SDS DP server group. Check off (✓) each step as it is completed. Boxes have been provided for this purpose under each step number. If this procedure fails, it is recommended to contact My Oracle Support (MOS) and ask for assistance.</p>	
<p>1. <input type="checkbox"/></p>	<p>SDS NOAM VIP GUI: Login</p>	<p>1. Establish a GUI session on the first SDS NOAM server by using the VIP IP address of the NOAM server. Open the web browser and enter a URL of:</p> <div style="border: 1px solid black; padding: 5px; width: fit-content; margin: 10px auto;"> <p>https://<Primary_SDS_NOAM_VIP_IP_Address></p> </div> <p>2. Login as the guiadmin user.</p> 
<p>2. <input type="checkbox"/></p>	<p>SDS NOAM VIP GUI: Enter SDS DP server group data</p>	<p>1. Navigate to Configuration > Server Groups.</p>  <p>2. Click Insert.</p>  <p>3. Enter these values:</p> <p>Server Group Name: <Server Group Name> Level: C Parent: SDS DP SOAM server group that is parent to this SDS DP Function: SDS</p> <p>4. Click OK.</p> <p>5. Repeat this step for any remaining SDS DP server groups.</p>

Procedure 54. Configure the SDS DP Server Group

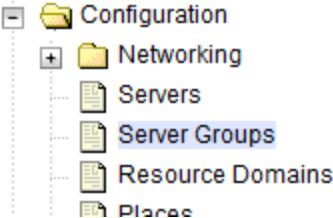
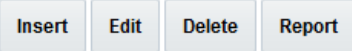
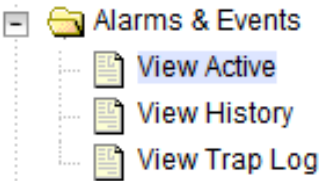
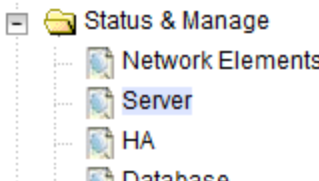
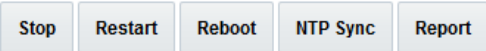
<p>3. <input type="checkbox"/></p>	<p>SDS NOAM VIP GUI: Edit the SDS DP server groups to include SDS DPs</p>	<p>1. Navigate to Configuration > Server Groups.</p>  <p>2. Select the server group you just created and click Edit.</p>  <p>3. Select the network element that represents the SDS DP server group.</p> <p>4. Mark the Include in SG checkbox for the SDS DP server.</p> <p>5. Leave other checkboxes blank.</p> <table border="1" data-bbox="505 789 1360 932"> <thead> <tr> <th>Server</th> <th>SG Inclusion</th> <th>Preferred HA Role</th> </tr> </thead> <tbody> <tr> <td>ZombieSDSDP1</td> <td><input checked="" type="checkbox"/> Include in SG</td> <td><input type="checkbox"/> Prefer server as spare</td> </tr> </tbody> </table> <p>Each SDS DP server should be in its own server group.</p> <p>6. Click OK.</p> <p>7. Repeat this step for any remaining SDS DP server groups you need to edit.</p>	Server	SG Inclusion	Preferred HA Role	ZombieSDSDP1	<input checked="" type="checkbox"/> Include in SG	<input type="checkbox"/> Prefer server as spare
Server	SG Inclusion	Preferred HA Role						
ZombieSDSDP1	<input checked="" type="checkbox"/> Include in SG	<input type="checkbox"/> Prefer server as spare						
<p>4. <input type="checkbox"/></p>	<p>SDS NOAM VIP GUI: Wait for remote database alarm to clear</p>	<p>Wait for the Remote Database re-initialization in progress alarm to clear before proceeding.</p> <p>Monitor progress by navigating to Alarms & Events > View Active.</p> 						
<p>5. <input type="checkbox"/></p>	<p>SDS NOAM VIP GUI: Restart SDS DP servers</p>	<p>1. Navigate to Status & Manage > Server.</p>  <p>2. For each SDS DP server, select the SDS DP server and click Restart.</p>  <p>3. Click OK to confirm.</p> <p>Wait for the restart successful message.</p>						

3.15.7 DSCP Configuration (Optional)

Procedure 55. Configure DSCP Values for Outgoing Traffic (Optional)

S T E P #	<p>This procedure configures the DSCP values for outgoing packets on servers. DSCP values can be applied to an outbound interface as a whole, or to all outbound traffic using a specific TCP or SCTP source port. This step is optional and should only be executed if your network uses packet DSCP markings for quality-of-service.</p> <p>Check off (✓) each step as it is completed. Boxes have been provided for this purpose under each step number.</p> <p>If this procedure fails, it is recommended to contact My Oracle Support (MOS) and ask for assistance.</p>
1. <input type="checkbox"/>	<p>SDS NOAM VIP GUI: Login</p> <ol style="list-style-type: none"> Establish a GUI session on the first SDS NOAM server by using the VIP IP address of the NOAM server. Open the web browser and enter a URL of: <div style="border: 1px solid black; padding: 5px; margin: 10px 0;"> <code>https://<Primary_SDS_NOAM_VIP_IP_Address></code> </div> Login as the guiadmin user. <div style="text-align: center;">  </div> <p style="text-align: center; font-size: small;">Welcome to the Oracle System Login.</p> <p style="text-align: center; font-size: x-small;">This application is designed to work with most modern HTML5 compliant browsers and uses both JavaScript and cookies. Please refer to the Oracle Software Web Browser Support Policy for details.</p> <p style="text-align: center; font-size: x-small;">Unauthorized access is prohibited.</p> <hr style="width: 50%; margin: 10px auto;"/> <p style="text-align: center; font-size: x-small;">Oracle and Java are registered trademarks of Oracle Corporation and/or its affiliates. Other names may be trademarks of their respective owners.</p> <p style="text-align: center; font-size: x-small;">Copyright © 2010, 2016, Oracle and/or its affiliates. All rights reserved.</p>

Procedure 55. Configure DSCP Values for Outgoing Traffic (Optional)

<p>2. <input type="checkbox"/> NOAM VIP GUI: Option 1 — Configure Interface DSCP</p>	<p>Note: The values displayed in the screenshots are for demonstration purposes only. The exact DSCP values for your site will vary.</p> <p>1. Navigate to Configuration > DSCP > Interface DSCP.</p> <div style="border: 1px solid #ccc; padding: 5px; margin-bottom: 10px;"> <ul style="list-style-type: none"> [-] Configuration <ul style="list-style-type: none"> [+] Networking <ul style="list-style-type: none"> Servers Server Groups Resource Domains Places Place Associations [-] DSCP <ul style="list-style-type: none"> Interface DSCP Port DSCP </div> <p>2. Select the server to configure on the 2nd line. You can view all servers with Entire Network selected or limit it to a specific server group by clicking on that server group name's tab.</p> <div style="border: 1px solid #ccc; padding: 5px; margin-bottom: 10px;"> <table style="width: 100%; border-collapse: collapse;"> <tr> <td style="border: 1px solid #ccc; padding: 2px;">Entire Network</td> <td style="border: 1px solid #ccc; padding: 2px;">SDSDP</td> <td style="border: 1px solid #ccc; padding: 2px;">SDSDRNOAM</td> <td style="border: 1px solid #ccc; padding: 2px;">SDSNOAM</td> <td style="border: 1px solid #ccc; padding: 2px;">SDSSOAM</td> </tr> <tr> <td style="border: 1px solid #ccc; padding: 2px;">ZombieSDSNOAM1</td> <td style="border: 1px solid #ccc; padding: 2px;">ZombieSDSNOAM2</td> <td style="border: 1px solid #ccc; padding: 2px;">ZombieSDSDRNOAM1</td> <td style="border: 1px solid #ccc; padding: 2px;">ZombieSDSDRNOAM2</td> <td style="border: 1px solid #ccc; padding: 2px;">ZombieSDSSOAM1</td> </tr> </table> <table style="width: 100%; border-collapse: collapse; margin-top: 5px;"> <tr> <td style="border: 1px solid #ccc; padding: 2px;">Interface</td> <td style="border: 1px solid #ccc; padding: 2px;">DSCP</td> </tr> </table> </div> <p>3. Click Insert.</p> <div style="border: 1px solid #ccc; padding: 5px; margin-bottom: 10px;"> <table style="width: 100%; border-collapse: collapse;"> <tr> <td style="border: 1px solid #ccc; padding: 2px;">Insert</td> <td style="border: 1px solid #ccc; padding: 2px;">Delete</td> <td style="border: 1px solid #ccc; padding: 2px;">Report</td> </tr> </table> </div> <p>4. Select the network Interface option and type the DSCP value to apply to packets leaving this interface.</p> <p style="text-align: center;">Insert DSCP by Interface on ZombieSDSNOAM1</p> <div style="border: 1px solid #ccc; padding: 5px; margin-bottom: 10px;"> <table style="width: 100%; border-collapse: collapse;"> <tr> <td style="width: 20%; padding: 5px;">Interface *</td> <td style="width: 30%; padding: 5px;">xmi <input type="text"/></td> <td style="padding: 5px;">The server interface. [Default: xmi]</td> </tr> <tr> <td style="padding: 5px;">DSCP *</td> <td style="padding: 5px;">34 <input type="text"/></td> <td style="padding: 5px;">A valid DSCP value. [Default: 34]</td> </tr> <tr> <td style="padding: 5px;">Protocol *</td> <td style="padding: 5px;">TCP <input type="text"/></td> <td style="padding: 5px;">TCP or SCTP protocol</td> </tr> </table> <div style="text-align: right; margin-top: 5px;"> <input type="button" value="Ok"/> <input type="button" value="Apply"/> <input type="button" value="Cancel"/> </div> </div> <p>5. Click OK if there are no more interfaces on this server to configure, or click Apply to finish this interface and continue entering more interfaces.</p>	Entire Network	SDSDP	SDSDRNOAM	SDSNOAM	SDSSOAM	ZombieSDSNOAM1	ZombieSDSNOAM2	ZombieSDSDRNOAM1	ZombieSDSDRNOAM2	ZombieSDSSOAM1	Interface	DSCP	Insert	Delete	Report	Interface *	xmi <input type="text"/>	The server interface. [Default: xmi]	DSCP *	34 <input type="text"/>	A valid DSCP value. [Default: 34]	Protocol *	TCP <input type="text"/>	TCP or SCTP protocol
Entire Network	SDSDP	SDSDRNOAM	SDSNOAM	SDSSOAM																					
ZombieSDSNOAM1	ZombieSDSNOAM2	ZombieSDSDRNOAM1	ZombieSDSDRNOAM2	ZombieSDSSOAM1																					
Interface	DSCP																								
Insert	Delete	Report																							
Interface *	xmi <input type="text"/>	The server interface. [Default: xmi]																							
DSCP *	34 <input type="text"/>	A valid DSCP value. [Default: 34]																							
Protocol *	TCP <input type="text"/>	TCP or SCTP protocol																							

Procedure 55. Configure DSCP Values for Outgoing Traffic (Optional)

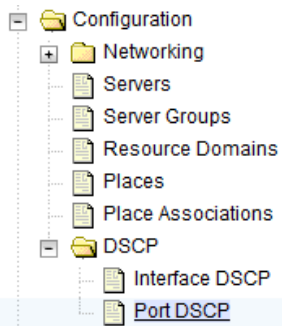
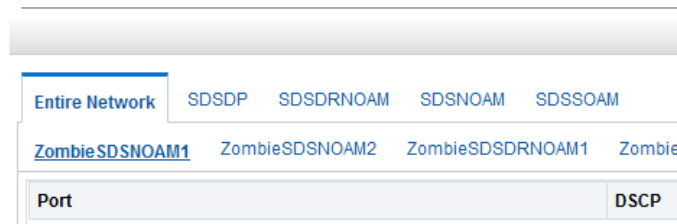
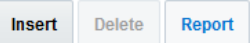
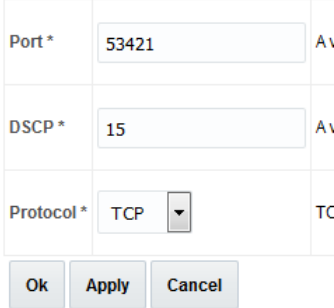

<p>3. <input type="checkbox"/></p>	<p>NOAM VIP GUI: Option 2 — Configure Port DSCP</p>	<p>Note: The values displayed in the screenshots are for demonstration purposes only. The exact DSCP values for your site will vary.</p> <p>1. Navigate to Configuration > DSCP > Port DSCP.</p>  <p>2. Select the server to configure on the 2nd line. You can view all servers with Entire Network selected or limit it to a specific server group by clicking on that server group name's tab.</p> <p>Main Menu: Configuration -> DSCP -> Port DSCP</p>  <p>3. Click Insert.</p>  <p>4. Enter the source Port, DSCP value, and select the transport Protocol.</p> <p>Insert DSCP by Port on Zombi</p>  <p>5. Click OK if there are no more port DSCPs on this server to configure, or click Apply to finish this port entry and continue entering more port DSCP mappings.</p>
<p>4. <input type="checkbox"/></p>	<p>NOAM VIP GUI: Repeat for additional servers</p>	<p>Repeat steps 2. through 3. for all remaining servers.</p>

3.15.8 SNMP Configuration (Optional)

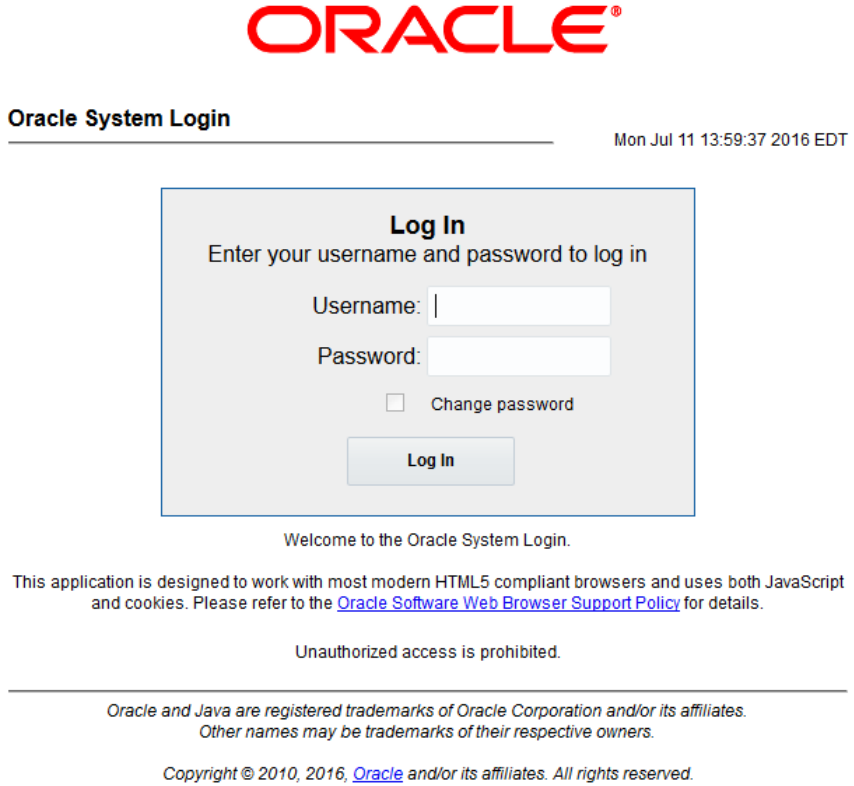
Procedure 56. Configure SNMP Trap Receivers (Optional)

S T E P #	<p>This procedure configures forwarding of SNMP traps from each individual server.</p> <p>Check off (✓) each step as it is completed. Boxes have been provided for this purpose under each step number.</p> <p>If this procedure fails, it is recommended to contact My Oracle Support (MOS) and ask for assistance.</p>	
<p>1. <input type="checkbox"/></p>	<p>SDS NOAM VIP GUI: Login</p>	<ol style="list-style-type: none"> Establish a GUI session on the first SDS NOAM server by using the VIP IP address of the NOAM server. Open the web browser and enter a URL of: <div style="border: 1px solid black; padding: 5px; margin: 10px 0;"> <code>https://<Primary_SDS_NOAM_VIP_IP_Address></code> </div> Login as the guiadmin user. <div style="text-align: center;">  </div>

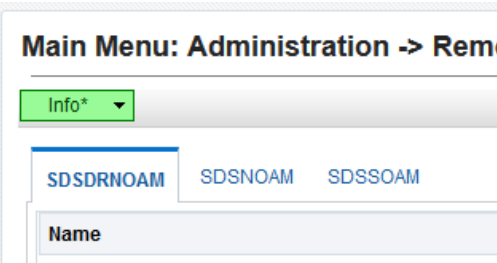
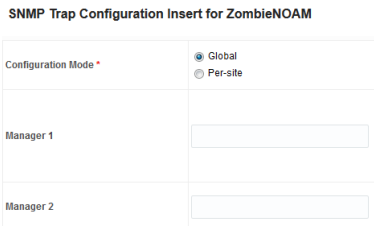
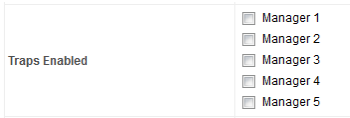
Procedure 56. Configure SNMP Trap Receivers (Optional)

<p>2. <input type="checkbox"/></p>	<p>SDS NOAM VIP GUI: Configure system-wide SNMP trap receiver(s)</p>	<ol style="list-style-type: none"> 1. Navigate to Administration > Remote Servers > SNMP Trapping. 2. Select the server group tab for SNMP trap configuration.  <ol style="list-style-type: none"> 3. Type the IP address or hostname of the network management station (NMS) to forward traps. This IP should be reachable from the NOAMP's XMI network. 4. Continue add additional secondary, tertiary, etc., manager IPs in the corresponding slots, if desired.  <ol style="list-style-type: none"> 5. Mark Traps Enabled checkboxes for the manager servers being configured.  <ol style="list-style-type: none"> 6. Type the SNMP Community Name.  <ol style="list-style-type: none"> 7. Leave all other fields at their default values. 8. Click OK.
------------------------------------	---	---

Procedure 56. Configure SNMP Trap Receivers (Optional)

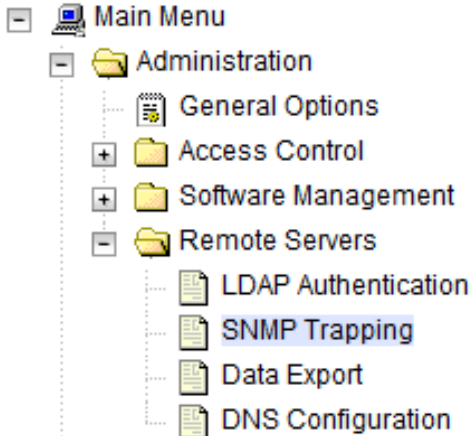
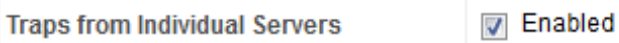
3.	SDS NOAM VIP GUI: Enable Traps from Individual Servers (optional)	<p>Note: By default SNMP traps from DPs are aggregated and display on the active NOAMP. If instead, you wish for every server to send its own traps directly to the NMS, then execute this procedure.</p> <p>This procedure requires all servers, including DPs, have an XMI interface on which the customer SNMP target server (NMS) is reachable.</p> <p>1. Navigate to Administration > Remote Servers > SNMP Trapping.</p>  <p>2. Make sure Enabled checkbox is marked.</p>  <p>3. Click Apply and verify that the data is committed.</p>
----	--	---

3.16 IDIH Installation and Configuration (Optional)

If IDIH already exists, and this is an IDIH re-installation; execute Appendix O Remove IDIH External Drive before proceeding.

Note: Refer to section 3.10 for IDIH VM placement information.

3.16.1 IDIH Installation

This procedure is part of DSR software installation. The installation procedure uses the **fast deployment** utility (fdconfig) bundled with the PMAC server to install and configure IDIH.

Note: Non-HA Lab Node Installations Only-Oracle X5-2/Netra X5-2/X6-2/HP DL380 Gen 9 (10Gbps) Only: Follow Appendix Q.4 Non-HA Lab Node IDIH Procedure Deviation instead of Procedure 57 for IDIH installation.

Procedure 57. IDIH Installation

S T E P #	<p>This procedure installs IDIH.</p> <p>Check off (✓) each step as it is completed. Boxes have been provided for this purpose under each step number.</p> <p>If this procedure fails, it is recommended to contact My Oracle Support (MOS) and ask for assistance.</p>	
1. <input type="checkbox"/>	<p>TVOE Host: Load application ISO</p>	<p>Note: If the IDIH ISO images have NOT yet been added to the PMAC, execute this steps 1. through 4.</p> <p>Use one of the following options add the application ISO images (mediation, application, and oracleGuest) to the PMAC:</p> <p>Option 1 — Insert the CD containing the IDIH media into the removable media drive.</p> <p>Option 2 — Attach the USB device containing the ISO image to a USB port.</p> <p>Option 3 — Copy the Application ISO file to the PMAC server into the /var/TKLC/smac/image/isoimages/home/smacftpusr/ directory as pmacftpusr user:</p> <p style="padding-left: 20px;">cd to the directory where your ISO image is located on the TVOE host (not on the PMAC server).</p> <p style="padding-left: 20px;">Using sftp, connect to the PMAC server.</p> <pre style="border: 1px solid black; padding: 5px;">\$ sftp pmacftpusr@<pmac_management_network_ip> \$ put <image>.iso</pre> <p>After the image transfer is 100% complete, close the connection.</p> <pre style="border: 1px solid black; padding: 5px;">\$ quit</pre>

Procedure 57. IDIH Installation

<p>2. <input type="checkbox"/></p>	<p>PMAC GUI: Login</p>	<p>1. Open the web browser and navigate to the PMAC GUI:</p> <div style="border: 1px solid black; padding: 5px; width: fit-content; margin: 5px 0;"> <p>http://<PMAC_network_IP></p> </div> <p>2. Login as the guiadmin user:</p> <div style="text-align: center; margin: 10px 0;">  </div> <div style="border: 1px solid black; padding: 10px; margin: 10px 0;"> <p>Oracle System Login Tue Jun 7 13:49:06 2016 EDT</p> <hr/> <div style="border: 1px solid gray; padding: 10px; text-align: center; margin: 10px auto; width: 80%;"> <p>Log In Enter your username and password to log in</p> <p>Username: <input style="width: 100%;" type="text"/></p> <p>Password: <input style="width: 100%;" type="password"/></p> <p><input type="checkbox"/> Change password</p> <p><input type="button" value="Log In"/></p> </div> <p style="font-size: small; text-align: center;">Unauthorized access is prohibited. This Oracle system requires the use of Microsoft Internet Explorer 9.0, 10.0, or 11.0 with support for JavaScript and cookies.</p> <hr/> <p style="font-size: x-small; text-align: center;"><i>Oracle and Java are registered trademarks of Oracle Corporation and/or its affiliates. Other names may be trademarks of their respective owners.</i></p> <p style="font-size: x-small; text-align: center;"><i>Copyright © 2010, 2016, Oracle and/or its affiliates. All rights reserved.</i></p> </div>
------------------------------------	-------------------------------	---

Procedure 57. IDIH Installation

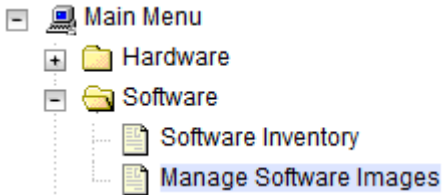
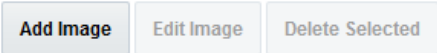
<p>4. <input type="checkbox"/></p>	<p>PMAC GUI: Add application image</p>	<ol style="list-style-type: none"> Navigate to Software > Manage Software Images.  Click Add Image. Select the image from the options.  <p>If the image was supplied on a CD or a USB drive, it displays as a virtual device (device://...). These devices are assigned in numerical order as CD and USB images become available on the management server. The first virtual device is reserved for internal use by TVOE and PMAC; therefore, the ISO image of interest is normally on the second device, device://dev/sr1. If one or more CD or USB-based images were already on the management server before you started this procedure, select a correspondingly higher device number.</p> <p>If the image was transferred to PMAC using sftp, it displays in the list as a local file /var/TKLC/...</p> <div data-bbox="529 1024 1419 1682" style="border: 1px solid #ccc; padding: 10px;"> <p>Main Menu: Software -> Manage Software Images [Add Image]</p> <hr/> <p>Images may be added from any of these sources:</p> <ul style="list-style-type: none"> • Oracle-provided media in the PM&C host's CD/DVD drive (Refer to Note) • USB media attached to the PM&C's host (Refer to Note) • External mounts. Prefix the directory with "extfile://". • These local search paths: <ul style="list-style-type: none"> ◦ /var/TKLC/upgrade/* .iso ◦ /var/TKLC/smac/image/isoimages/home/smacftpusr/* .iso <p>Note: CD and USB images mounted on PM&C's VM host must first be made accessible to the PM&C VM</p> <p>Path: <input type="text" value="/var/TKLC/upgrade/DSR-8.0.0.0.0_80.4.0-x86_64.iso"/></p> <p>Description: <input type="text"/></p> <hr/> <p><input type="button" value="Add New Image"/> <input type="button" value="Cancel"/></p> </div> Select the appropriate path and click Add New Image. Check the progress clicking the Task Monitoring link. Observe the green bar indicating success. Once complete, remove the TPD Media from the optical drive of the management server.
------------------------------------	---	---

Procedure 57. IDIH Installation

5. <input type="checkbox"/>	PMAC: Establish terminal session	Establish an SSH session to the PMAC and login as admusr .
6. <input type="checkbox"/>	PMAC: Reset create guest default timeout and other timeout parameters	<p>1. Reset the create guest default timeout by executing these commands:</p> <pre style="border: 1px solid black; padding: 5px;">\$ sudo sqlite3 /usr/TKLC/plat/etc/TKLCfd-config/db/fdcRepo.fdcdb `update params set value=3000 where name="DEFAULT_CREATE_GUEST_TIMEOUT"`; \$ sudo pmacadm setParam --paramName=defaultTpdProvdTimeout --paramValue=120 \$ sudo pmacadm setParam --paramName=guestDiskDeployTimeout --paramValue=50</pre> <p>2. Verify whether the above values are set correctly.</p> <pre style="border: 1px solid black; padding: 5px;">\$ sudo sqlite3 /usr/TKLC/plat/etc/TKLCfd-config/db/fdcRepo.fdcdb 'select name, value from params where name like "%TIMEOUT%"; \$ sudo pmacadm getParam --paramName=defaultTpdProvdTimeout \$ sudo pmacadm getParam --paramName=guestDiskDeployTimeout</pre>
7. <input type="checkbox"/>	PMAC: Copy the fdconfig.xml template XML file to the guest-dropin directory	<p>3. Copy the vedsr_idih.xml.template XML file to the pmac guest-dropin directory.</p> <pre style="border: 1px solid black; padding: 5px;">\$ sudo cp /usr/TKLC/smac/html/TPD/mediation-8.2.0.0.0_x.x.x.x/vedsr_idih.xml.template /var/TKLC/smac/guest-dropin \$ cd /var/TKLC/smac/guest-dropin/ \$ mv vedsr_idih.xml.template <idih_fdc_file_name>.xml</pre>
8. <input type="checkbox"/>	PMAC: Configure the fdconfig.xml file	<p>1. Configure the <idih_fdc_file_name>.xml file.</p> <p>See Appendix M Configure IDIH Fast Deployment for a breakdown of the parameters and a sample XML configuration file.</p> <p>2. Update the software versions, hostnames, bond interfaces, network addresses, and network VLAN information for the TVOE host and IDIH guests that you are installing.</p>
9. <input type="checkbox"/>	PMAC: Run the fdconfig	<pre style="border: 1px solid black; padding: 5px;">\$ screen \$ sudo fdconfig config --file=<idih_fdc_file_name>.xml</pre> <p>Example:</p> <pre>\$ sudo fdconfig config --file=tvoe-ferbrms4_01-22-15.xml</pre> <p>Note: This is a long duration command (45-90 minutes). If the screen command was run before executing fdconfig, perform a screen -dr to resume the screen session in the event of a terminal timeout, etc.</p>

Procedure 57. IDIH Installation

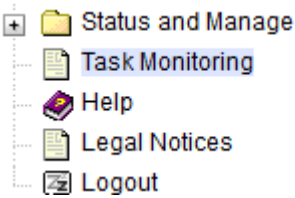
10. <input type="checkbox"/>	<p>PMAC GUI: Monitor the configuration</p>	<ol style="list-style-type: none"> 1. If not already done so, establish a GUI session on the PMAC server. 2. Navigate to Task Monitoring.  3. Monitor the IDIH configuration to completion.
---------------------------------	---	--

3.16.2 IDIH Configuration

3.16.2.1 Configure DSR Reference Data Synchronization

After an IDIH fresh installation, reference data synchronization is initially disabled. Reference data synchronization requires some initial configuration before it is enabled.

The Trace Ref Data Adapter application must retrieve data from web services hosted by the DSR SOAM web server, and this requires the DSR SOAM virtual IP address (VIP) to be configured.

The DSR SOAM VIP is unique at each customer site because it is defined based on the customer's network configuration; therefore, there is no standard default value for the DSR SOAM VIP.

Procedure 58. Configure DSR Reference Data Synchronization for IDIH

S T E P #		<p>This procedure configures DSR reference data synchronization for IDIH. Check off (✓) each step as it is completed. Boxes have been provided for this purpose under each step number. If this procedure fails, it is recommended to contact My Oracle Support (MOS) and ask for assistance.</p>
1. <input type="checkbox"/>	<p>IDIH Application Server: Login</p>	<ol style="list-style-type: none"> 1. Establish an SSH session to the IDIH application server login as admusr. 2. Login as tekelec user. <div style="border: 1px solid black; padding: 2px; margin-top: 5px;"> <pre>\$ sudo su - tekelec</pre> </div>
2. <input type="checkbox"/>	<p>IDIH Application Server: Execute configuration script</p>	<div style="border: 1px solid black; padding: 2px; margin-bottom: 5px;"> <pre>\$ apps/trda-config.sh</pre> </div> <p>Example output: <pre>corsair-app:/usr/TKLC/xIH apps/trda-config.sh dos2unix: converting file /usr/TKLC/xIH/bea/user_projects/domains/tekelec/nsp/trace- refdata-ad Please enter DSR oam server IP address: 10.240.39.175 SQL*Plus: Release 12.1.0.2.0 Production on Thu Oct 1 15:04:40 2015 Copyright (c) 1982, 2014, 2018 Oracle. All rights reserved. Last Successful login time: Thu Oct 01 2015 13:27:57 -</pre> </p>

Procedure 58. Configure DSR Reference Data Synchronization for IDIH

		<pre> 04:00 Connected to: Oracle Database 12c Enterprise Edition Release 12.1.0.2.0 - 64bit Production With the Partitioning, Automatic Storage Management, OLAP, Advanced Analytics and Real Application Testing options SQL> SQL> 2 3 4 5 1 row merged. SQL> Commit complete. SQL> Disconnected from Oracle Database 12c Enterprise Edition Release 12.1.0.2.0 - 64bit Produ With the Partitioning, Automatic Storage Management, OLAP, Advanced Analytics and Real Application Testing options Buildfile: /usr/TKLC/xIH/apps/trace-refdata- adapter/build.xml app.disable: common.weblogic.stop: [echo] [echo] [echo] ===== [echo] application: xihtra [echo] date: 2015-10-01 15:04:41 [echo] ===== [echo] === stop application EAR [echo] date: 2015-10-01 15:04:41 [java] weblogic.Deployer invoked with options: - adminurl t3://appserver:7001 - userconfigprojects/domains/tekelec/keyfile.secure -name xIH Trace Reference Data Adapter -stop [java] <Oct 1, 2015 3:05:08 PM EDT> <Info> <J2EE Deployment SPI> <BEA-260121> <Initiating [java] Task 24 initiated: [Deployer:149026]stop application xIH Trace Reference Data Adap [java] Task 24 completed: [Deployer:149026]stop application xIH Trace Reference Data Adap </pre>
--	--	--

Procedure 58. Configure DSR Reference Data Synchronization for IDIH

		<pre>[java] Target state: stop completed on Server nsp [java] BUILD SUCCESSFUL Total time: 29 seconds Buildfile: /usr/TKLC/xIH/apps/trace-refdata- adapter/build.xml app.enable: common.weblogic.start: [echo] [echo] [echo] ===== [echo] application: xihtra [echo] date: 2015-10-01 15:05:10 [echo] ===== [echo] === start application EAR [echo] date: 2015-10-01 15:05:10 [java] weblogic.Deployer invoked with options: - adminurl t3://appserver:7001 - userconfigprojects/domains/tekelec/keyfile.secure -name xIH Trace Reference Data Adapter -start [java] <Oct 1, 2015 3:05:56 PM EDT> <Info> <J2EE Deployment SPI> <BEA-260121> <Initiating [java] Task 25 initiated: [Deployer:149026]start application xIH Trace Reference Data Ada [java] Task 25 completed: [Deployer:149026]start application xIH Trace Reference Data Ada [java] Target state: start completed on Server nsp [java] BUILD SUCCESSFUL Total time: 1 minute 17 seconds 3. When asked to enter DSR OAM server IP address, type the VIP of the DSR SOAM, and press Enter. Note: If the address entered is unreachable, the script exits with an Unable to connect to <ip-address> error.</pre>
<p>3. <input type="checkbox"/></p>	<p>IDIH Application Server: Monitor completion</p>	<ol style="list-style-type: none"> 1. Monitor the log file located at /var/TKLC/xIH/log/apps/weblogic/apps/application.log. 2. Examine the log file for entries containing text Trace Reference Data Adapter.

Procedure 58. Configure DSR Reference Data Synchronization for IDIH

4. <input type="checkbox"/>	IDIH Application Server (optional): Switch iDIH from one DSR to another DSR in a different network	<p>Note: This is an optional step that is needed to switch an IDIH from one DSR to another DSR in a different network.</p> <ol style="list-style-type: none">1. Establish an SSH session to the iDIH application server and login as the tekelec user.2. Execute these commands. <pre>cd /usr/TKLC/xIH/apps/trace-refdata-adapter ant clean.data cd /usr/TKLC/xIH/apps/xihoam ant imp.init (flush comagent connection data) cd /usr/TKLC/xIH/apps/trace-refdata-adapter ant app.enable (Sync MOs from SOAM) cd /usr/TKLC/xIH/apps ./trda-config.sh <DSR SOAM VIP in different network></pre>
--------------------------------	--	---

3.16.2.2 Configure the SSO Domain



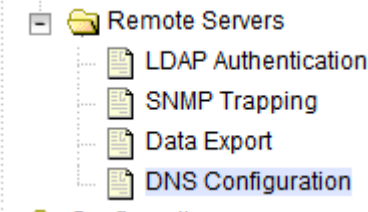
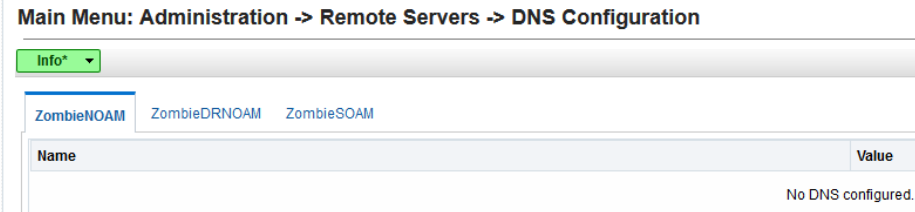
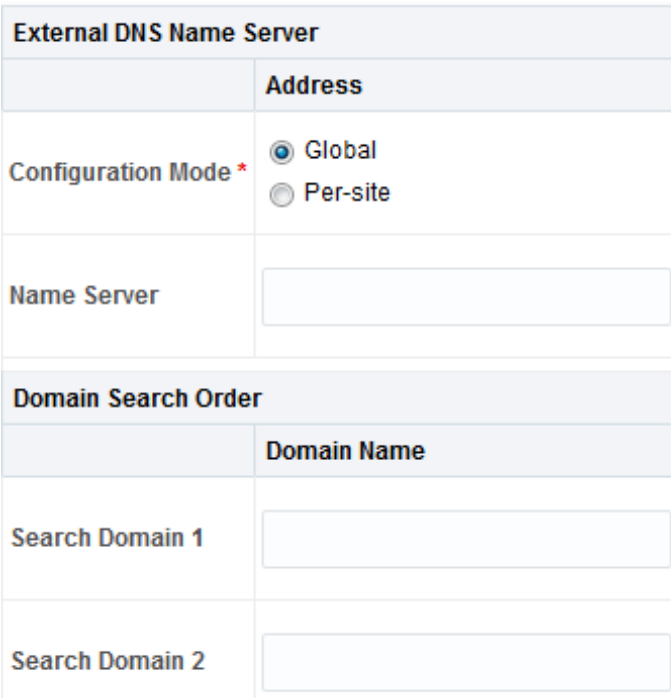
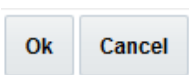

Procedure 59. Configure the SSO Domain

S T E P #	<p>This procedure configures the SSO domain for IDIH.</p> <p>Check off (✓) each step as it is completed. Boxes have been provided for this purpose under each step number.</p> <p>If this procedure fails, it is recommended to contact My Oracle Support (MOS) and ask for assistance.</p>	
<p>1.</p> <p><input type="checkbox"/></p>	<p>NOAM VIP GUI: Login</p>	<p>1. Establish a GUI session on the NOAM server by using the VIP IP address of the NOAM server. Open the web browser and enter a URL of:</p> <div style="border: 1px solid gray; padding: 5px; width: fit-content; margin: 10px auto;"> <p>https://<Primary_NOAM_VIP_IP_Address></p> </div> <p>2. Login as the guiadmin user.</p> <div style="text-align: center; margin: 20px 0;">  <p>The screenshot shows the Oracle System Login page. At the top is the Oracle logo in red. Below it is the text 'Oracle System Login' and the date 'Mon Jul 11 13:59:37 2016 EDT'. A central box contains a 'Log In' form with fields for 'Username:' and 'Password:', a 'Change password' checkbox, and a 'Log In' button. Below the form, it says 'Welcome to the Oracle System Login.' and 'This application is designed to work with most modern HTML5 compliant browsers and uses both JavaScript and cookies. Please refer to the Oracle Software Web Browser Support Policy for details.' At the bottom, it states 'Unauthorized access is prohibited.' and includes a copyright notice: 'Copyright © 2010, 2016, Oracle and/or its affiliates. All rights reserved.'</p> </div>

Procedure 59. Configure the SSO Domain

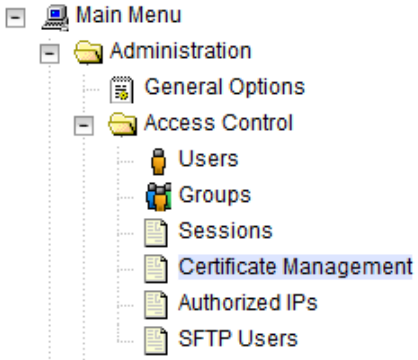
<p>2. NOAM VIP GUI: Configure DNS</p>	<p>1. Navigate to Administration > Remote Servers > DNS Configuration.</p>  <p>2. Select the NOAM tab.</p>  <p>3. Configure values for the following fields:</p> <ul style="list-style-type: none"> • Name Server • Domain Name • Search Domain 1  <p>If values have already been configured, click Cancel.</p> <p>4. Click OK.</p> 
--	---

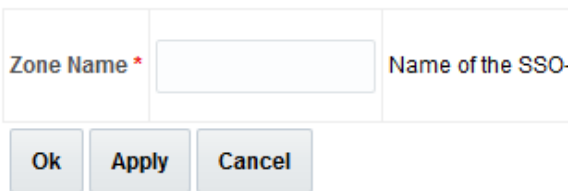
Procedure 59. Configure the SSO Domain

<p>3. NOAM VIP GUI: Establish SSO local zone</p>	<ol style="list-style-type: none"> 1. Navigate to Access Control > Certification Management.  2. Click Establish SSO Zone.  3. Type a value for Zone Name. 4. Click OK.  <p style="text-align: center; margin-top: 10px;">Information for the new Certificate type of SSO Local displays.</p> 5. Click Report.  6. Select and copy the encoded certificate text to the clipboard for future access. <div style="border: 1px solid black; padding: 5px; margin-top: 10px;"> <pre>-----BEGIN CERTIFICATE----- MIICKzCCAdWgAwIBAgIJAOVfSLNc3CeJMA0GCSqGSIb3DQEBCwUAMHExCzAJBgNV BAYTAlVTMQswCQYDVQQIDAJOQzEQMA4GA1UEBwwHUWVsZWlnaDEPMA0GA1UECgwG T3JhY2x1MQswCQYDVQQQLDAJQVjEQMA4GA1UEAwHTG1iZXJ0eTETMBEGCSqGSIb3 DQEJARYEdGVzdDAAeFw0xNTA1MDQxNDIzNTRaFw0xNjA1MDMxNDIzNTRaMHExCzAJ BgNVBAYTAlVTMQswCQYDVQQIDAJOQzEQMA4GA1UEBwwHUWVsZWlnaDEPMA0GA1UE CgwGT3JhY2x1MQswCQYDVQQQLDAJQVjEQMA4GA1UEAwHTG1iZXJ0eTETMBEGCSqG SIb3DQEJARYEdGVzdDBcMA0GCSqGSIb3DQEBAQUAA0sAMEgCQQCZ/MpkhlvMP/iJ s5xDO2MwxJm3jYim43H8gR9pfBTMNP6L9kluJYi+2T0hngJFQLpIn6SK6pXnuAGY f/vDWfqPAGMBAAGjUDBOMB0GA1UdDgQWBBS6IzIOLP1gizQ6+BERr8Fo2XyDVDAf BgNVHSMEGDAwBS6IzIOLP1gizQ6+BERr8Fo2XyDVBAMBgNVHRMBETAQH/MA0G CSqGSIb3DQEBCwUAA0EAOWIqBMEQyvfvvt38r/yfgIx3w5dN8SBwHjHC5TpJrHV6U zFlg5dfzoLz7ditjGohWJ919VRw39LQ81KFp7SMXwA== -----END CERTIFICATE-----</pre> </div>
---	--

Procedure 59. Configure the SSO Domain

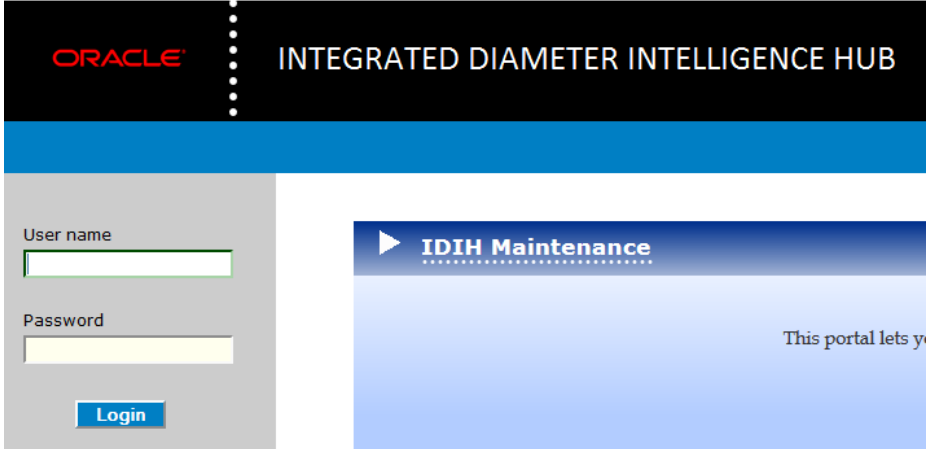
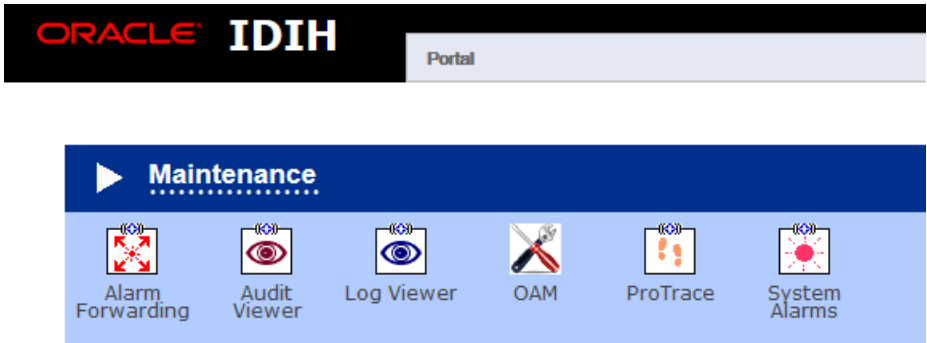
<p>4. <input type="checkbox"/></p>	<p>IDIH Application Server GUI: Login</p>	<p>1. Establish a GUI session on the IDIH app server <app server IP>. 2. Login as the idihadmin user.</p> 
<p>5. <input type="checkbox"/></p>	<p>IDIH Application Server GUI: Open the OAM portal</p>	<p>Select the OAM portal Icon to open the OAM web application.</p> 

Procedure 59. Configure the SSO Domain

6. **IDIH Application Server GUI:**
Configure the SSO domain

1. Navigate to **System > Single Sign On.**

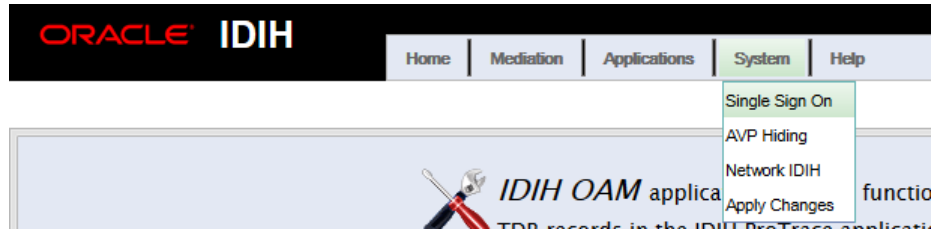

2. From the **SSO Parameters** tab, select the **Edit Value** icon

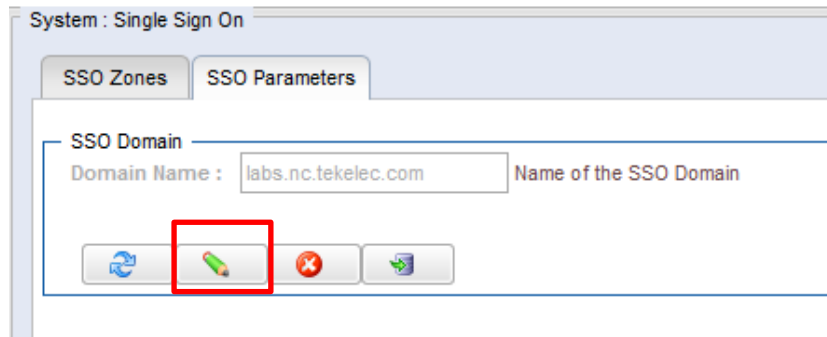

3. Type a value for the **Domain Name**.

Note: This should be the same domain name assigned in the DSR NOAM DNS Configuration (step 2.).

4. Select the **Save** icon.



5. Select the **Refresh** icon to display data saved for the remote zone.

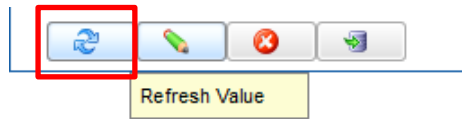

Procedure 59. Configure the SSO Domain

7. **IDIH Application Server GUI:**
Configure the SSO remote zone

1. Navigate to **System > Single Sign On.**

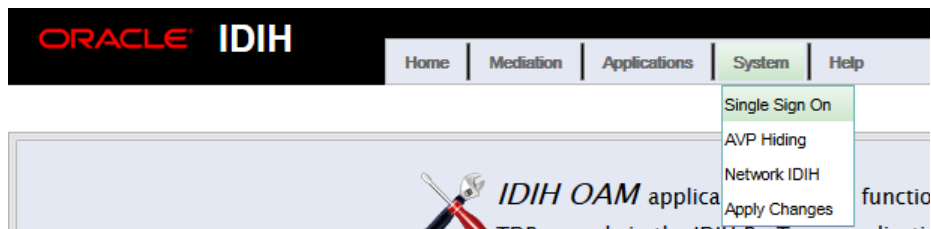

2. From the **SSO Zones** tab.

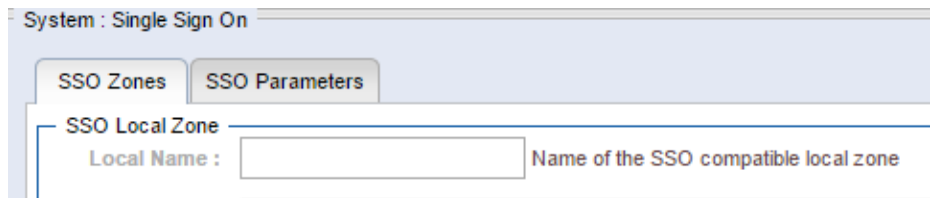

3. Select the **Add** icon and type a value for field **Remote Name**.

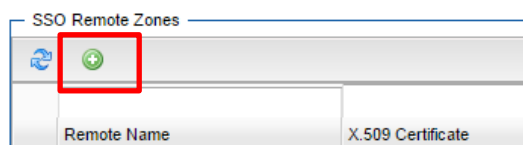

4. For field X.509 Certificate, paste the encoded certificate text from the clipboard.

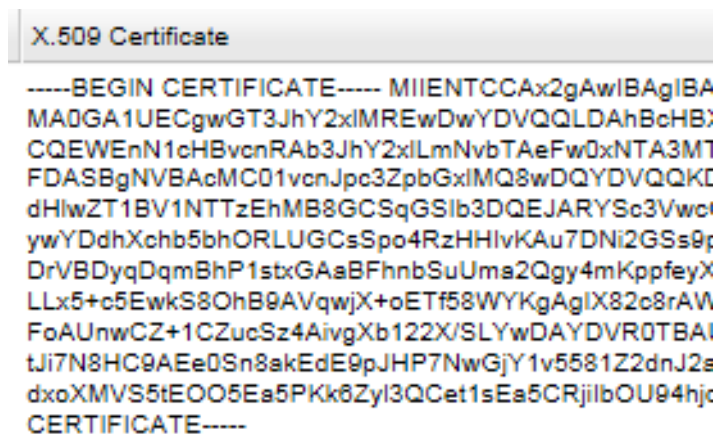

5. Select the **Save** icon.

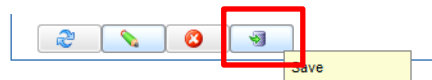

6. Select the **Refresh** icon to display the data saved for remote zone.



3.16.2.3 Configure IDIH in DSR

Procedure 60. Configure in DSR

S T E P #	<p>This procedure completes IDIH integration on DSR.</p> <p>Check off (✓) each step as it is completed. Boxes have been provided for this purpose under each step number.</p> <p>If this procedure fails, it is recommended to contact My Oracle Support (MOS) and ask for assistance.</p>	
<p>1.</p> <p><input type="checkbox"/></p>	<p>NOAM VIP GUI: Login</p>	<p>1. Establish a GUI session on the NOAM server by using the VIP IP address of the SOAM server. Open the web browser and enter a URL of:</p> <div style="border: 1px solid gray; padding: 5px; margin: 10px 0;"> <p>https://<Primary_NOAM_VIP_IP_Address></p> </div> <p>2. Login as the guiadmin user.</p> <div style="text-align: center; margin: 20px 0;">  </div>

Procedure 60. Configure in DSR

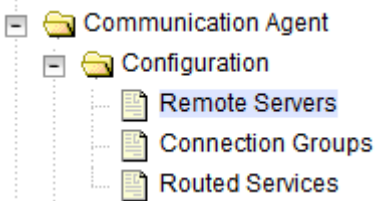
<p>2. <input type="checkbox"/> NOAM VIP GUI: Configure ComAgent connection</p>	<p>1. Navigate to Communication Agent > Configuration > Remote Servers.</p>  <p>2. Click Insert.</p> <div style="border: 1px solid #ccc; padding: 5px; width: fit-content; margin: 5px 0;"> Insert Edit Delete </div> <p>3. Add the IDIH Mediation Server.</p> <p>4. For the Remote Server IP Address, type the IMI IP address of the IDIH Mediation Server.</p> <p>5. For the IP address Preference, type the IP protocol preference (if IPv6 and IPv4 are configured).</p> <p>6. Select the Remote Server Mode to server.</p> <p style="margin-top: 10px;">Inserting Remote Servers</p> <table border="1" style="width: 100%; border-collapse: collapse; margin-top: 5px;"> <thead> <tr> <th style="width: 30%;">Field</th> <th style="width: 50%;">Value</th> <th style="width: 20%;"></th> </tr> </thead> <tbody> <tr> <td>Remote Server Name *</td> <td><input type="text"/></td> <td>U I S</td> </tr> <tr> <td>Remote Server IPv4 IP Address</td> <td><input type="text"/></td> <td>T C F</td> </tr> <tr> <td>Remote Server IPv6 IP Address</td> <td><input type="text"/></td> <td>T C F</td> </tr> <tr> <td>Remote Server Mode *</td> <td>-- Select --</td> <td>I S</td> </tr> <tr> <td>IP Address Preference</td> <td>ComAgent Network Preference</td> <td>T C F</td> </tr> </tbody> </table> <p>7. Select the DA-MP Server Group from the Available Local Server Groups column and click Add to assign.</p> <div style="margin-top: 10px;"> <table border="1" style="width: 100%; border-collapse: collapse;"> <thead> <tr> <th style="width: 70%;">Available Local Server Groups</th> <th style="width: 30%;"></th> </tr> </thead> <tbody> <tr> <td style="padding: 5px;"> Zombie S7 SG1 Zombie S7 SG2 ZombieIpf SG1 ZombieIpf SG2 </td> <td style="text-align: center; vertical-align: middle;"> <input type="button" value="Add"/> <input type="button" value="Remove"/> </td> </tr> <tr> <th style="padding: 5px;">Assigned Local Server Groups *</th> <td style="padding: 5px;"> <table border="1" style="width: 100%; border-collapse: collapse;"> <thead> <tr> <th style="width: 70%;">Assigned Local Server Groups</th> <th style="width: 30%;"></th> </tr> </thead> <tbody> <tr> <td style="padding: 5px;">ZombieDAMP</td> <td style="text-align: center; vertical-align: middle;"> <input type="button" value="Add"/> <input type="button" value="Remove"/> </td> </tr> </tbody> </table> </td> </tr> </tbody> </table> </div> <p>8. Click OK.</p>	Field	Value		Remote Server Name *	<input type="text"/>	U I S	Remote Server IPv4 IP Address	<input type="text"/>	T C F	Remote Server IPv6 IP Address	<input type="text"/>	T C F	Remote Server Mode *	-- Select --	I S	IP Address Preference	ComAgent Network Preference	T C F	Available Local Server Groups		Zombie S7 SG1 Zombie S7 SG2 ZombieIpf SG1 ZombieIpf SG2	<input type="button" value="Add"/> <input type="button" value="Remove"/>	Assigned Local Server Groups *	<table border="1" style="width: 100%; border-collapse: collapse;"> <thead> <tr> <th style="width: 70%;">Assigned Local Server Groups</th> <th style="width: 30%;"></th> </tr> </thead> <tbody> <tr> <td style="padding: 5px;">ZombieDAMP</td> <td style="text-align: center; vertical-align: middle;"> <input type="button" value="Add"/> <input type="button" value="Remove"/> </td> </tr> </tbody> </table>	Assigned Local Server Groups		ZombieDAMP	<input type="button" value="Add"/> <input type="button" value="Remove"/>
Field	Value																												
Remote Server Name *	<input type="text"/>	U I S																											
Remote Server IPv4 IP Address	<input type="text"/>	T C F																											
Remote Server IPv6 IP Address	<input type="text"/>	T C F																											
Remote Server Mode *	-- Select --	I S																											
IP Address Preference	ComAgent Network Preference	T C F																											
Available Local Server Groups																													
Zombie S7 SG1 Zombie S7 SG2 ZombieIpf SG1 ZombieIpf SG2	<input type="button" value="Add"/> <input type="button" value="Remove"/>																												
Assigned Local Server Groups *	<table border="1" style="width: 100%; border-collapse: collapse;"> <thead> <tr> <th style="width: 70%;">Assigned Local Server Groups</th> <th style="width: 30%;"></th> </tr> </thead> <tbody> <tr> <td style="padding: 5px;">ZombieDAMP</td> <td style="text-align: center; vertical-align: middle;"> <input type="button" value="Add"/> <input type="button" value="Remove"/> </td> </tr> </tbody> </table>	Assigned Local Server Groups		ZombieDAMP	<input type="button" value="Add"/> <input type="button" value="Remove"/>																								
Assigned Local Server Groups																													
ZombieDAMP	<input type="button" value="Add"/> <input type="button" value="Remove"/>																												

Procedure 60. Configure in DSR

<p>3. SOAM VIP GUI: Login</p>	<p>1. Establish a GUI session on the SOAM server by using the VIP IP address of the SOAM server. Open the web browser and enter a URL of:</p> <div style="border: 1px solid black; padding: 5px; margin: 5px 0;"> <p>https://<Primary_SOAM_VIP_IP_Address></p> </div> <p>2. Login as the guiadmin user.</p> <div style="text-align: center; margin: 20px 0;">  </div> <div style="text-align: center; margin: 10px 0;"> <p>Oracle System Login</p> <hr style="width: 50%; margin: 0 auto;"/> <p style="font-size: small;">Mon Jul 11 13:59:37 2016 EDT</p> </div> <div style="text-align: center; margin: 20px 0;"> <div style="border: 1px solid gray; padding: 10px; width: fit-content; margin: 0 auto;"> <p>Log In</p> <p>Enter your username and password to log in</p> <p>Username: <input style="width: 100%;" type="text"/></p> <p>Password: <input style="width: 100%;" type="password"/></p> <p><input type="checkbox"/> Change password</p> <p><input type="button" value="Log In"/></p> </div> <p style="font-size: x-small; margin-top: 5px;">Welcome to the Oracle System Login.</p> <p style="font-size: x-small; margin-top: 5px;">This application is designed to work with most modern HTML5 compliant browsers and uses both JavaScript and cookies. Please refer to the Oracle Software Web Browser Support Policy for details.</p> <p style="font-size: x-small; margin-top: 5px;">Unauthorized access is prohibited.</p> <hr style="width: 50%; margin: 10px auto;"/> <p style="font-size: x-small; margin-top: 5px;">Oracle and Java are registered trademarks of Oracle Corporation and/or its affiliates. Other names may be trademarks of their respective owners.</p> <p style="font-size: x-small; margin-top: 5px;">Copyright © 2010, 2016, Oracle and/or its affiliates. All rights reserved.</p> </div>
--	---

Procedure 60. Configure in DSR

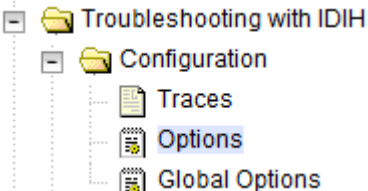
4.	<input type="checkbox"/> SOAM VIP GUI: Configure IDIH hostname	<ol style="list-style-type: none"> Navigate to Diameter > Troubleshooting with IDIH > Configuration > Options.  <ol style="list-style-type: none"> From the IDIH Host Name options, select the mediation server. Enter the fully qualified domain name (or IP address) of the App server as the IDIH Visualization Address. Click Apply. <p>IDIH Configuration</p> <table border="1" style="width: 100%; border-collapse: collapse;"> <thead> <tr> <th style="width: 50%;">Field</th> <th style="width: 50%;">Value</th> </tr> </thead> <tbody> <tr> <td>Max bandwidth *</td> <td style="text-align: center;">25</td> </tr> <tr> <td>IDIH Host Name</td> <td style="text-align: center;">- Select -</td> </tr> <tr> <td>IDIH Visualization address</td> <td style="text-align: center;"> </td> </tr> </tbody> </table> <p style="text-align: center;"> <input type="button" value="Apply"/> <input type="button" value="Cancel"/> </p>	Field	Value	Max bandwidth *	25	IDIH Host Name	- Select -	IDIH Visualization address	
Field	Value									
Max bandwidth *	25									
IDIH Host Name	- Select -									
IDIH Visualization address										

3.16.2.4 Configure the Mail Server (Optional)

This procedure is optional; however, this option is required for security (password initialization set to AUTOMATIC) and forwarding (forwarding by mail filter defined) and is available only on the application server.

Procedure 61. Configure Mail Server (Optional)

S T E P #	This procedure configures the SMTP mail server. Check off (✓) each step as it is completed. Boxes have been provided for this purpose under each step number. If this procedure fails, it is recommended to contact My Oracle Support (MOS) and ask for assistance.	
1.	<input type="checkbox"/> IDIH Application Server: Login	Establish an SSH session to the IDIH Application Server and login as admusr.

Procedure 62. Change SNMP Management Server (Optional)

2. <input type="checkbox"/>	<p>IDIH Application Server: Configure SNMP management server</p>	<ol style="list-style-type: none"> 1. Enter the platcfg menu. <div style="border: 1px solid black; padding: 2px; margin: 5px 0;">\$ sudo su - platcfg</div> 2. Navigate to Application Server Configuration > SNMP Agent Configuration. <pre style="font-family: monospace; font-size: 0.9em; margin: 5px 0;">lu Application Server Configuration Menu tk x x SNMP Agent Configuration x x SMTP Configuration x x Exit x x x maa</pre> 3. Select Edit. 4. Enter the IP address of the SNMP management server. <p>Note: The SNMP agent configuration is updated and the SNMP management server is automatically restarted.</p> 5. Select OK. 6. Exit out of platcfg by selecting Exit.
--------------------------------	---	--

3.16.2.6 Change Network Interface (Optional)

Notes:

- Initially the default network interface used to transport TTRs from DSR to DIH uses the internal imi network; however, this can be changed, if required. Changing this interface could degrade performance of the TTR transmission.
- A script is provided to manage the settings so the operator does not need to know the details required to apply the settings. There are two settings **interface.name** and **interface.enabled**.

When **interface.enabled=True**, then communications over the **interface.name=value**, where **value** is the name of the network interface as defined on the platform and is the only specified interface used for communications.

When **interface.enabled=False**, then communications over the named interface is not enforced, that is, all interfaces configured on the platform are allowed to be used for communications.

For example, if it is required to use the xmi interface for communication, instead of the default internal imi interface, then the operator would supply **xmi** when prompted for the interface name and **True** when prompted if interface filtering should be applied.

Procedure 63. Change Network Interface (Optional)

S T E P #	<p>This procedure changes the default network interface.</p> <p>Check off (✓) each step as it is completed. Boxes have been provided for this purpose under each step number.</p> <p>If this procedure fails, it is recommended to contact My Oracle Support (MOS) and ask for assistance.</p>	<ol style="list-style-type: none"> 1. Establish an SSH session to the IDIH mediation server login as admusr. 2. Login as tekelec user. <div style="border: 1px solid black; padding: 2px; margin: 5px 0;">\$ sudo su - tekelec</div>
1. <input type="checkbox"/>	<p>IDIH Mediation Server: Login</p>	<ol style="list-style-type: none"> 1. Establish an SSH session to the IDIH mediation server login as admusr. 2. Login as tekelec user.

Procedure 63. Change Network Interface (Optional)

2.	<input type="checkbox"/> IDIH Mediation Server: Execute the change interface script	<div style="border: 1px solid black; background-color: #f0f0f0; padding: 2px; margin-bottom: 5px;"> <pre>\$ chgIntf.sh</pre> </div> <p>Answer the following questions during execution of the script:</p> <p>This script is used to change the interface name (default = imi) used for mediation communications and whether to enable network interface filtering or not. Please answer the following questions or enter CTRL-C to exit out of the script.</p> <p>Current setting are: interface.name=imi interface.enabled=True</p> <p>Enter new network interface name, return to keep current [imi]: xmi</p> <p>Do you want to enable network interface filtering [True False], return to keep current [True]:</p> <p>Updating configuration properties file with 'interface.name=xmi' and 'interface.enable=True', and restarting mediation configuration bundle...</p>
----	--	---

3.16.2.7 CPU Pinning

Follow section 3.13 for CPU pinning on servers that host IDIH VMs.

3.16.2.8 Generate Disaster Recovery FDC File (Optional)

Procedure 64. Back Up the Upgrade and Disaster Recovery FDC File (Optional)

S T E P #	This procedure generates a disaster recovery FDC file. Check off (√) each step as it is completed. Boxes have been provided for this purpose under each step number. If this procedure fails, it is recommended to contact My Oracle Support (MOS) and ask for assistance.	
1.	<input type="checkbox"/> Identify backup server	Identify an external server to use as a backup server for this procedure. The server should not be co-located with any of these systems: <ul style="list-style-type: none"> • TVOE • PMAC • DSR NOAM • DSR SOAM
2.	<input type="checkbox"/> PMAC Server: Login	Establish an SSH session to the PMAC server and login as admusr.

Procedure 64. Back Up the Upgrade and Disaster Recovery FDC File (Optional)

3. <input type="checkbox"/>	PMAC: Verify upgrade fdc file exists	<p>Execute these commands to verify the upgrade FDC file for IDIH exists.</p> <pre>\$ cd /var/TKLC/smac/guest-dropin \$ ls -l *.xml</pre> <p>This output is expected:</p> <pre>-rw-r----- 1 root smac 9542 May 11 09:43 <idih_install>.xml -rw-r----- 1 root smac 5107 May 11 09:43 <idih_upgrade>.xml</pre> <p>Note: The <idih_upgrade>.xml file is the same file used for upgrade and disaster recovery procedures.</p>
4. <input type="checkbox"/>	PMAC: Transfer the FDC file to a remote server	<ol style="list-style-type: none"> 1. Log into the backup server identified in step 1. and copy the backup image to the customer server where it can be safely stored. 2. If the customer system is a Linux system, copy the backup image to the customer system. <pre>\$ sudo scp <idih_upgrade.xml> /path/to/destination/ \$ sudo scp <idih_install.xml> /path/to/destination/</pre> 3. Enter the admusr user password and press Enter. <p>If the customer system is a Windows system, refer to [14], the Using WinSCP procedure, to copy the backup image to the customer system.</p>
5. <input type="checkbox"/>	PMAC Server: Back up FDC file	<ol style="list-style-type: none"> 1. Transfer the fdc file to the fdc directory so the file can be backed up with PMAC backups. 2. Ensure the directory where the backups will be stored exists. <pre>\$ sudo /bin/ls -i -l /usr/TKLC/smac/etc/fdc</pre> <p>If you receive an error such as this:</p> <pre>-bash: ls: /usr/TKLC/smac/etc/fdc: No such file or directory</pre> <p>Create the directory by issuing this command.</p> <pre>\$ sudo /bin/mkdir -p /usr/TKLC/smac/etc/fdc</pre> 3. Copy the fdc files to the fdc backup directory. <pre>\$ sudo cp /var/TKLC/smac/guest- dropin<idih_upgrade.xml> /usr/TKLC/smac/etc/fdc/ \$ sudo cp /var/TKLC/smac/guest- dropin<idih_install.xml> /usr/TKLC/smac/etc/fdc/</pre>

3.17 Post Installation Procedures

3.17.1 Optimization (DSR and Oracle X5-2/Netra X5-2/X6-2/X7-2/HP DL380 Gen 9 (10Gbps) Only)

Procedure 65. Optimization Procedure

S T E P #	<p>This procedure runs optimization scripts for Oracle X5-2/Netra X5-2/X6-2/HP DL380 Gen 9 (10Gbps) only.</p> <p>Prerequisite: Completed all previous DSR installation procedures.</p> <p>Check off (✓) each step as it is completed. Boxes have been provided for this purpose under each step number.</p> <p>If this procedure fails, it is recommended to contact My Oracle Support (MOS) and ask for assistance.</p>	
1. <input type="checkbox"/>	DSR NOAM VIP: Login	Establish an SSH to the NOAM VIP address and login as admusr .
2. <input type="checkbox"/>	DSR NOAM VIP: Execute the performance optimization script on the active NOAM	<div style="border: 1px solid black; padding: 5px; margin-bottom: 5px;"> <pre>\$ cd /usr/TKLC/dsr/bin/ \$ sudo ./rmsNoamConfig.sh</pre> </div> <p>Configuration Successful output should display.</p>

3.17.2 Configure ComAgent Connections (DSR and SDS Only)

Procedure 66. Configure ComAgent Connections

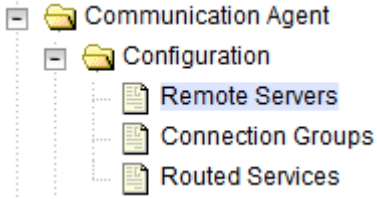
<p>S T E P #</p>	<p>This procedure configures ComAgent connections on DSR/SDS for use in the FABR application. Prerequisite: Activated FABR application. Check off (✓) each step as it is completed. Boxes have been provided for this purpose under each step number. If this procedure fails, it is recommended to contact My Oracle Support (MOS) and ask for assistance.</p>	
<p>1. <input type="checkbox"/></p>	<p>SDS NOAM VIP GUI: Login</p>	<p>1. Establish a GUI session on the SDS NOAM server by using the VIP IP address of the NOAM server. Open the web browser and enter a URL of:</p> <div style="border: 1px solid black; padding: 5px; width: fit-content; margin: 5px 0;"> <p>https://<Primary_SDS_NOAM_VIP_IP_Address></p> </div> <p>2. Login as the guidadmin user.</p> 
<p>2. <input type="checkbox"/></p>	<p>SDS NOAM VIP GUI: Configure remote server IP address</p>	<p>1. Navigate to Communication Agent > Configuration > Remote Servers.</p>  <p>2. Click Insert.</p> <div style="border: 1px solid gray; padding: 5px; width: fit-content; margin: 5px 0;"> <p><input type="button" value="Insert"/> <input type="button" value="Edit"/> <input type="button" value="Delete"/></p> </div>
<p>3. <input type="checkbox"/></p>	<p>SDS NOAM VIP GUI: Configure remote server IP address</p>	<p>1. Enter the Remote Server Name for the DSR MP server.</p> <div style="border: 1px solid gray; padding: 5px; width: fit-content; margin: 5px 0;"> <p>Remote Server Name * <input type="text" value="ZombieDAMP1"/></p> </div> <p>2. Enter the Remote Server IMI IP Address.</p>

Procedure 66. Configure ComAgent Connections

		<p>Remote Server IPv4 IP Address <input type="text" value="169.254.1.13"/></p> <p>Remote Server IPv6 IP Address <input type="text"/></p> <p>Note: This should be the IMI IP address of the DAMP server.</p> <p>3. Select Client from the Remote Server Mode options.</p> <p>Remote Server Mode * <input type="text" value="Client"/></p> <p>4. Select IP Address Preference (ComAgent Network Preference, IPv4, or IPv6).</p> <p>IP Address Preference <input type="text" value="ComAgent Network Preference"/> <ul style="list-style-type: none"> ComAgent Network Preference <li style="background-color: #0070C0; color: white;">ComAgent Network Preference IPv4 Preferred IPv6 Preferred </p> <p>5. Select the Local Server Group from the available SDS DP server groups and click Add to assign.</p> <div style="border: 1px solid #ccc; padding: 5px;"> <p style="text-align: center; margin: 0;">Available Local Server Groups</p> <div style="border: 1px solid #ccc; height: 40px; margin: 2px;"></div> <p style="text-align: center; margin: 0;"> <input type="button" value="Add"/> <input type="button" value="Remove"/> </p> <p style="text-align: center; margin: 0;">Assigned Local Server Groups</p> <div style="border: 1px solid #ccc; padding: 2px; margin: 2px;"> <p style="margin: 0;">SDS SDP</p> </div> </div> <p>6. Click Apply.</p> <p style="text-align: center;"> <input type="button" value="Ok"/> <input type="button" value="Apply"/> <input type="button" value="Cancel"/> </p>
<p>4. <input type="checkbox"/></p>	<p>SDS NOAM VIP GUI: Repeat</p>	<p>Repeat steps 2. though 3. for each remote MP in the same SOAM NE.</p>

Procedure 66. Configure ComAgent Connections

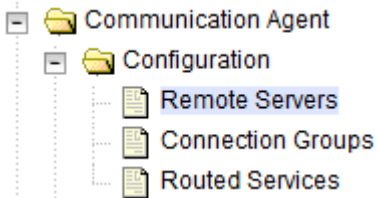
<p>5. <input type="checkbox"/></p>	<p>DSR NOAM VIP GUI: Login</p>	<p>1. Establish a GUI session on the DSR NOAM server by using the VIP IP address of the SOAM server. Open the web browser and enter a URL of:</p> <div style="border: 1px solid black; padding: 5px; width: fit-content; margin: 10px auto;"> <p>https://<Primary_DSR_NOAM_VIP_IP_Address></p> </div> <p>2. Login as the guidadmin user.</p> <div style="text-align: center; margin: 20px 0;">  </div> <div style="text-align: center;"> <p>Oracle System Login</p> <hr/> <p style="font-size: small;">Mon Jul 11 13:59:37 2016 EDT</p> </div> <div style="text-align: center; margin: 20px 0;"> <div style="border: 1px solid gray; padding: 10px; width: 80%; margin: 0 auto;"> <p style="text-align: center;">Log In</p> <p style="text-align: center;">Enter your username and password to log in</p> <p style="text-align: center;">Username: <input style="width: 100%;" type="text"/></p> <p style="text-align: center;">Password: <input style="width: 100%;" type="password"/></p> <p style="text-align: center;"><input type="checkbox"/> Change password</p> <p style="text-align: center;"><input type="button" value="Log In"/></p> </div> <p style="font-size: x-small; margin-top: 10px;">Welcome to the Oracle System Login.</p> <p style="font-size: x-small; margin-top: 10px;">This application is designed to work with most modern HTML5 compliant browsers and uses both JavaScript and cookies. Please refer to the Oracle Software Web Browser Support Policy for details.</p> <p style="font-size: x-small; margin-top: 10px;">Unauthorized access is prohibited.</p> <hr style="width: 50%; margin: 10px auto;"/> <p style="font-size: x-small; margin-top: 10px;">Oracle and Java are registered trademarks of Oracle Corporation and/or its affiliates. Other names may be trademarks of their respective owners.</p> <p style="font-size: x-small; margin-top: 10px;">Copyright © 2010, 2016, Oracle and/or its affiliates. All rights reserved.</p> </div>
<p>6. <input type="checkbox"/></p>	<p>DSR NOAM VIP GUI: Configure remote server IP address</p>	<p>1. Navigate to Communication Agent > Configuration > Remote Servers.</p> <div style="margin: 10px 0;">  </div> <p>2. Click Insert.</p> <div style="margin-top: 10px;"> <div style="display: flex; gap: 10px;"> <input type="button" value="Insert"/> <input type="button" value="Edit"/> <input type="button" value="Delete"/> </div> </div>

Procedure 66. Configure ComAgent Connections

<p>7. <input type="checkbox"/></p>	<p>DSR NOAM VIP GUI: Configure remote server IP address</p>	<p>1. Enter the Remote Server Name for the SDS DP server:</p> <p>Remote Server Name * <input type="text" value="SDSDP1"/></p> <p>2. Enter the Remote Server IMI IP Address.</p> <p>Remote Server IPv4 IP Address <input type="text" value="169.254.1.30"/></p> <p>Remote Server IPv6 IP Address <input type="text"/></p> <p>Note: This should be the IMI IP address of the DP server.</p> <p>3. Select Server from the Remote Server Mode options.</p> <p>Remote Server Mode * <input type="text" value="Server"/></p> <p>4. Select IP Address Preference (ComAgent Network Preference, IPv4, or IPv6).</p> <p>IP Address Preference <input type="text" value="ComAgent Network Preference"/></p> <p>5. Select the Local Server Group from the available SDS DP server groups and click Add to assign.</p> <p>Available Local Server Groups</p> <ul style="list-style-type: none"> ZombieSS7SG1 ZombieSS7SG2 ZombieIpfSG1 ZombieIpfSG2 <p>Assigned Local Server Groups *</p> <p>Add Remove</p> <p>Assigned Local Server Groups</p> <ul style="list-style-type: none"> ZombieDAMP <p>6. Click Apply.</p> <p><input type="button" value="Ok"/> <input type="button" value="Apply"/> <input type="button" value="Cancel"/></p>
<p>8. <input type="checkbox"/></p>	<p>DSR NOAM VIP GUI: Repeat</p>	<p>Repeat steps 6. through 7. for each remote DP in the same SOAM NE.</p>

Procedure 66. Configure ComAgent Connections

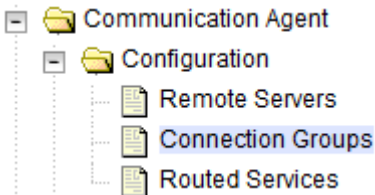
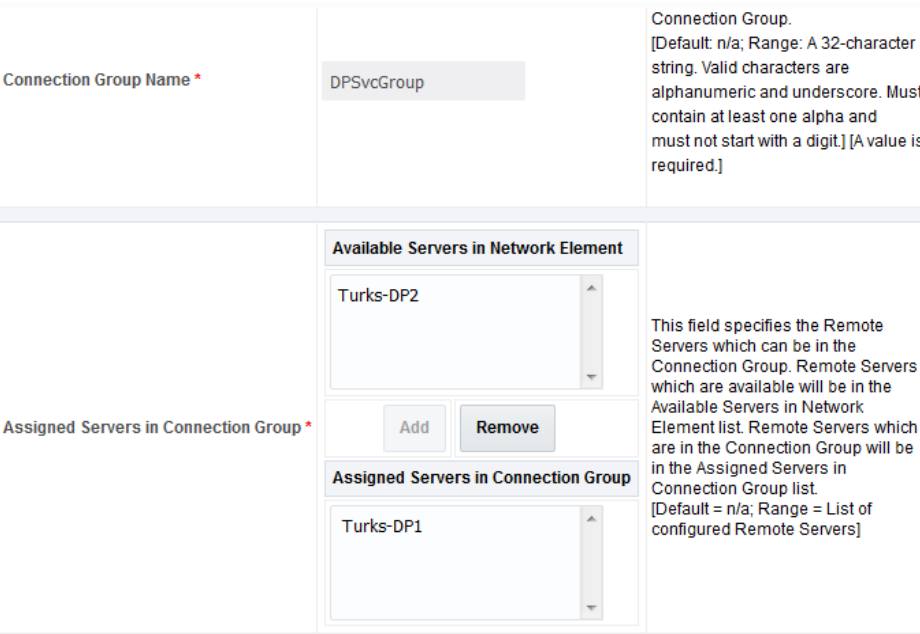
<p>9. <input type="checkbox"/></p>	<p>DSR NOAM VIP GUI: Edit connection groups</p>	<p>1. Navigate to Communication Agent > Configuration > Connection Groups.</p>  <p>2. Select the DPSvcGroup connection group.</p> <p>If DPSvcGroup Connection Group is not present please refer section 3.17.3 Activate Optional Features to activate FABR application.</p> <table border="1" data-bbox="505 646 1419 730"> <thead> <tr> <th>Connection Group</th> <th>Server</th> </tr> </thead> <tbody> <tr> <td>DPSvcGroup</td> <td>+ 0 Servers</td> </tr> </tbody> </table> <p>3. Click Edit.</p> <p>4. Select the desired DP servers from the Available Servers in Network Element.</p> <p>5. Click Add.</p>  <p>6. Click OK.</p>	Connection Group	Server	DPSvcGroup	+ 0 Servers
Connection Group	Server					
DPSvcGroup	+ 0 Servers					
<p>10. <input type="checkbox"/></p>	<p>DSR NOAM VIP GUI: Verify the correct number of servers in group</p>	<p>Verify the correct number of servers are in the connection group.</p> <table border="1" data-bbox="513 1717 1325 1829"> <thead> <tr> <th>Connection Group</th> <th>Server</th> </tr> </thead> <tbody> <tr> <td>DPSvcGroup</td> <td> <input type="checkbox"/> 1 Server SDSDP1 </td> </tr> </tbody> </table>	Connection Group	Server	DPSvcGroup	<input type="checkbox"/> 1 Server SDSDP1
Connection Group	Server					
DPSvcGroup	<input type="checkbox"/> 1 Server SDSDP1					

3.17.3 Activate Optional Features

Procedure 67. Activate Optional Features

S T E P #	<p>This procedure installs DSR optional components once regular installation is complete.</p> <p>Prerequisite: Completed all previous DSR installation procedures.</p> <p>Check off (✓) each step as it is completed. Boxes have been provided for this purpose under each step number.</p> <p>If this procedure fails, it is recommended to contact My Oracle Support (MOS) and ask for assistance.</p>	
1. <input type="checkbox"/>	Refer to Installation Guides for optional features to complete installation	Refer to section 1.5 for a list of feature install documents whose procedures are to be executed at this moment.
2. <input type="checkbox"/>	DR NOAM: Feature activation	<ol style="list-style-type: none"> 1. If the DR NOAM was configured in section 3.15.3, and MAPIWF has been activated in step 1. ; ssh to the active DR NOAM and login as admusr. 2. Execute these commands. <div style="border: 1px solid black; padding: 5px; margin: 5px 0;"> <pre>\$ cd /usr/TKLC/dsr/prod/maint/loaders/activate \$ sudo ./load.mapinterworkingActivateAsourced</pre> </div> 3. Repeat this step for the standby DR NOAM.

3.17.4 Shared Secret Encryption Key Revocation (RADIUS Only)

Procedure 68. Shared Secret Encryption Key Revocation (RADIUS Only)

S T E P #	<p>This procedure changes the shared secret encryption key on DSR RADIUS setup.</p> <p>Check off (✓) each step as it is completed. Boxes have been provided for this purpose under each step number.</p> <p>If this procedure fails, it is recommended to contact My Oracle Support (MOS) and ask for assistance.</p>	
1. <input type="checkbox"/>	Revoke RADIUS shared secret encryption key	<p>Refer to RADIUS shared secret key revocation MOP to change the encryption key on the DSR installed setup. Refer to [17] DSR RADIUS Shared Secret Encryption Key Revocation.</p> <p>Note: It is highly recommended to change the key after installation due to security reasons.</p>

3.17.5 Enable/Disable DTLS (SCTP Diameter Connections Only)

Procedure 69. Enable/Disable DTLS (SCTP Diameter Connections Only)

S T E P #	<p>This procedure prepared clients before configuring SCTP diameter connections.</p> <p>Check off (√) each step as it is completed. Boxes have been provided for this purpose under each step number.</p> <p>If this procedure fails, it is recommended to contact My Oracle Support (MOS) and ask for assistance.</p>	
1. <input type="checkbox"/>	<p>Enable/Disable DTLS (SCTP Diameter Connections Only)</p>	<p>Oracle's SCTP Datagram Transport Layer Security (DTLS) has SCTP AUTH extensions by default. SCTP AUTH extensions are required for SCTP DTLS; however, there are known impacts with SCTP AUTH extensions as covered by the CVEs referenced below. Customers should prepare clients before the DSR connections are established after installation. This ensures the DSR-to-client SCTP connection establishes with SCTP AUTH extensions enabled. See RFC 6083. If customers DO NOT prepare clients to accommodate the DTLS changes, then the SCTP connections to client devices MAY NOT establish after the DSR is installed.</p> <p style="text-align: center;"> https://access.redhat.com/security/cve/CVE-2015-1421 https://access.redhat.com/security/cve/CVE-2014-5077 </p> <p>Execute procedures in [15] to disable/enable the DTLS feature.</p>

3.17.6 Back Up TVOE Configuration

Procedure 70. Back Up TVOE Configuration

S T E P #	<p>This procedure backs up each TVOE rack mounter server after a successful installation.</p> <p>Check off (√) each step as it is completed. Boxes have been provided for this purpose under each step number.</p> <p>If this procedure fails, it is recommended to contact My Oracle Support (MOS) and ask for assistance.</p>	
1. <input type="checkbox"/>	<p>Identify backup server</p>	<p>Identify an external server to use as a backup server for this procedure. The server should not be co-located with any of these systems:</p> <ul style="list-style-type: none"> • TVOE • PMAC • DSR NOAM • DSR SOAM • SDS NOAM • SDS DP SOAM
2. <input type="checkbox"/>	<p>TVOE Server: Login</p>	<p>Establish an SSH session to the TVOE host server and login as admusr.</p>

Procedure 70. Back Up TVOE Configuration

<p>3. <input type="checkbox"/></p>	<p>TVOE Server: Back up the ISO file</p>	<ol style="list-style-type: none"> 1. Enter the platcfg menu from the TVOE server. <pre style="border: 1px solid black; padding: 5px;">\$ sudo su - platcfg</pre> 2. Navigate to Maintenance > Backup and Restore > Backup Platform (CD/DVD). Note: If no cdrom device is found by TPD, a No disk device available. This is normal on systems without a cdrom device error displays. Press Enter. 3. Navigate to Build ISO file only and press Enter. <pre style="border: 1px solid black; padding: 5px;">lqqqqqu Backup TekServer Menu tqqqqqk x x Select Backup Type (plat-app) x x View Index Table of Contents a x x Select Backup Device () a x x Select Backup Media (CD-R) a x x Build ISO file only x x Test Backup a x x Backup a x x Exit x x x mqqqqqqqqqqqqqqqqqqqqqqqqqqqqqqq</pre> Note: Creating the ISO image may happen so quickly that this screen may only display for an instant. 4. Exit out of platcfg by selecting Exit. After the ISO is created, platcfg returns to the Backup TekServer menu. The ISO has been created and is located in the /var/TKLC/bkp/ directory. An example filename of a backup file that was created is hostname1307466752-plat-app-201104171705.iso. 5. Move the TVOE backup to a customer provided backup server for safe keeping.
<p>4. <input type="checkbox"/></p>	<p>Backup Server: Transfer TVOE files to backup server</p>	<ol style="list-style-type: none"> 1. Login to the backup server identified in step 1. and copy the backup image to the customer server where it can be safely stored. 2. If the customer system is a Linux system, copy the backup image to the customer system. <pre style="border: 1px solid black; padding: 5px;">\$ sudo scp tvoexfer@<TVOE IP Address>:/var/TKLC/bkp/* /path/to/destination/</pre> 3. Move the TVOE backup to a customer-provided backup server for safe keeping. 4. Enter the tvoexfer user password and press Enter. If the customer system is a Windows system, refer to [14], the Using WinSCP procedure, to copy the backup image to the customer system.
<p>5. <input type="checkbox"/></p>	<p>Repeat for additional TVOE servers</p>	<p>Repeat steps 2. through 4. for additional TVOE servers</p>

3.17.7 Back Up PMAC Application

Procedure 71. Back Up PMAC Application

S T E P #	<p>This procedure backs up each PMAC application.</p> <p>Check off (✓) each step as it is completed. Boxes have been provided for this purpose under each step number.</p> <p>If this procedure fails, it is recommended to contact My Oracle Support (MOS) and ask for assistance.</p>	
1. <input type="checkbox"/>	Identify backup server	<p>Identify an external server to use as a backup server for this procedure. The server should not be co-located with any of these systems:</p> <ul style="list-style-type: none"> • TVOE • PMAC • DSR NOAM • DSR SOAM • SDS NOAM • SDS DP SOAM
2. <input type="checkbox"/>	PMAC Server: Login	Establish an SSH session to the PMAC server and login as admusr .
3. <input type="checkbox"/>	PMAC Server: Build backup file	<p>Execute this command from the PMAC server:</p> <div style="border: 1px solid black; padding: 5px; margin: 5px 0;"> <pre>\$ sudo /usr/TKLC/smac/bin/pmacadm backup PM&C backup been successfully initiated as task ID 7</pre> </div> <p>Note: The backup runs as a background task. To check the status of the background task use the PMAC GUI Task Monitor page or issue the command sudo pmaccli getBgTasks. The result should eventually be PMAC Backup successful and the background task should indicate COMPLETE.</p>

Procedure 71. Back Up PMAC Application

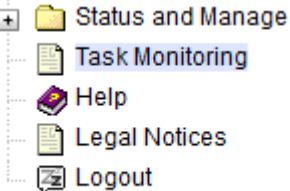
<p>4. PMAC GUI: Login</p> <p><input type="checkbox"/></p>		<p>1. Open the web browser and navigate to the PMAC GUI:</p> <pre>http://<PMAC_network_IP></pre> <p>2. Login as the guidadmin user.</p>  <p>Unauthorized access is prohibited. This Oracle system requires the use of Microsoft Internet Explorer 9.0, 10.0, or 11.0 with support for JavaScript and cookies.</p> <p><i>Oracle and Java are registered trademarks of Oracle Corporation and/or its affiliates. Other names may be trademarks of their respective owners.</i></p> <p><i>Copyright © 2010, 2016, Oracle and/or its affiliates. All rights reserved.</i></p>										
<p>5. PMAC Server GUI: Monitor/Verify backup task completion</p> <p><input type="checkbox"/></p>		<p>1. Navigate to Task Monitoring.</p>  <p>2. Monitor the Backup PMAC task.</p> <p>Main Menu: Task Monitoring</p> <p>Filter* ▾</p> <table border="1" data-bbox="516 1591 1433 1680"> <thead> <tr> <th>ID</th> <th>Task</th> <th>Target</th> <th>Status</th> <th>State</th> </tr> </thead> <tbody> <tr> <td>1458</td> <td>Backup PM&C</td> <td></td> <td>PM&C Backup successful</td> <td>COMPLETE</td> </tr> </tbody> </table> <p>Note: Alternatively, you can monitor the backup task by executing this command:</p> <pre>\$ sudo pmaccli getBgTasks</pre>	ID	Task	Target	Status	State	1458	Backup PM&C		PM&C Backup successful	COMPLETE
ID	Task	Target	Status	State								
1458	Backup PM&C		PM&C Backup successful	COMPLETE								

Procedure 71. Back Up PMAC Application

<p>6. <input type="checkbox"/></p>	<p>Backup Server: transfer PMAC file to backup server</p>	<p>1. Log into the backup server identified in step 1. and copy the backup image to the customer server where it can be safely stored.</p> <p>2. If the customer system is a Linux system, copy the backup image to the customer system.</p> <div style="border: 1px solid black; padding: 5px; margin: 10px 0;"> <pre>\$ sudo scp admusr@<PMAC_IP_Address>:/var/TKLC/smac/backup/* /path/to/destination/</pre> </div> <p>3. Enter the admusr user password and press Enter.</p> <p>If the customer system is a Windows system, refer to [14], the Using WinSCP procedure, to copy the backup image to the customer system.</p>
<p>7. <input type="checkbox"/></p>	<p>Repeat for additional PMAC servers</p>	<p>Repeat steps 2. though 6. for additional PMAC servers.</p>

3.17.8 Back Up NOAM Database

Procedure 72. Back Up NOAM Database

<p>S T E P #</p>	<p>This procedure backs up the NOAM database.</p> <p>Check off (✓) each step as it is completed. Boxes have been provided for this purpose under each step number.</p> <p>If this procedure fails, it is recommended to contact My Oracle Support (MOS) and ask for assistance.</p>	
<p>1. <input type="checkbox"/></p>	<p>Identify backup server</p>	<p>Identify an external server to use as a backup server for this procedure. The server should not be co-located with any of these systems:</p> <ul style="list-style-type: none"> • TVOE • PMAC • DSR NOAM • DSR SOAM • SDS NOAM • SDS DP SOAM

Procedure 72. Back Up NOAM Database

<p>2. NOAM VIP GUI: Login</p>	<p>1. Establish a GUI session on the NOAM server by using the VIP IP address of the SOAM server. Open the web browser and enter a URL of:</p> <div style="border: 1px solid black; padding: 5px; margin: 5px 0;"> <p>https://<Primary_NOAM_VIP_IP_Address></p> </div> <p>2. Login as the guiadmin user.</p> <div style="text-align: center; margin: 20px 0;">  </div> <div style="text-align: center;"> <p>Oracle System Login</p> <hr style="width: 60%; margin: 0 auto;"/> <p style="text-align: right; font-size: small;">Mon Jul 11 13:59:37 2016 EDT</p> </div> <div style="text-align: center; margin: 20px 0;"> <div style="border: 1px solid gray; padding: 10px; width: fit-content; margin: 0 auto;"> <p>Log In</p> <p>Enter your username and password to log in</p> <p>Username: <input style="width: 100%;" type="text"/></p> <p>Password: <input style="width: 100%;" type="password"/></p> <p><input type="checkbox"/> Change password</p> <p style="text-align: center;"><input type="button" value="Log In"/></p> </div> <p style="font-size: x-small; margin-top: 5px;">Welcome to the Oracle System Login.</p> <p style="font-size: x-small; margin-top: 5px;">This application is designed to work with most modern HTML5 compliant browsers and uses both JavaScript and cookies. Please refer to the Oracle Software Web Browser Support Policy for details.</p> <p style="font-size: x-small; margin-top: 5px;">Unauthorized access is prohibited.</p> <hr style="width: 60%; margin: 0 auto;"/> <p style="font-size: x-small; margin-top: 5px;">Oracle and Java are registered trademarks of Oracle Corporation and/or its affiliates. Other names may be trademarks of their respective owners.</p> <p style="font-size: x-small; margin-top: 5px;">Copyright © 2010, 2016, Oracle and/or its affiliates. All rights reserved.</p> </div>
--	---

Procedure 72. Back Up NOAM Database

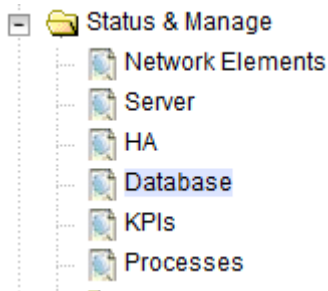
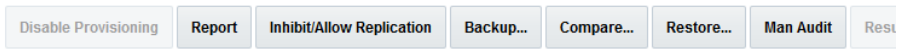
<p>3. SOAM VIP GUI: Perform database backup</p>	<p>1. Navigate to Status & Manage > Database.</p>  <p>2. Select the active NOAM.</p> <p>3. Click Backup.</p>  <p>4. Select the desired file compression method.</p> <p>5. Provide the archive file name, if needed.</p> <p>6. Click OK.</p> <p>Database Backup</p> <table border="1" style="width: 100%; border-collapse: collapse;"> <thead> <tr> <th style="text-align: left;">Field</th> <th style="text-align: left;">Value</th> <th style="text-align: left;">Description</th> </tr> </thead> <tbody> <tr> <td colspan="3">Server: ZombieNOAM2</td> </tr> <tr> <td>Select data for backup</td> <td> <input type="checkbox"/> Provisioning <input checked="" type="checkbox"/> Configuration </td> <td>Select the type of Backup to perform.</td> </tr> <tr> <td>Compression *</td> <td> <input type="radio"/> gzip <input checked="" type="radio"/> bzip2 <input type="radio"/> none </td> <td> Select the backup archive compression algorithm. The following file suffix will be applied for the selected compression method: • .tar.gz - gzip compression, • .tar.bz2 - bzip2 compression, • .tar - no compression. [A value is required.] </td> </tr> <tr> <td>Archive Name *</td> <td>Backup.dsr.ZombieNOAM2.Configuration.NETWORK_OAMP.20160810_13073</td> <td>Modify archive name if desired. Do not include th</td> </tr> <tr> <td>Comment</td> <td><input type="text"/></td> <td>May not contain the following characters: ' * \$</td> </tr> <tr> <td colspan="3" style="text-align: center;"> <input type="button" value="Ok"/> <input type="button" value="Cancel"/> </td> </tr> </tbody> </table>	Field	Value	Description	Server: ZombieNOAM2			Select data for backup	<input type="checkbox"/> Provisioning <input checked="" type="checkbox"/> Configuration	Select the type of Backup to perform.	Compression *	<input type="radio"/> gzip <input checked="" type="radio"/> bzip2 <input type="radio"/> none	Select the backup archive compression algorithm. The following file suffix will be applied for the selected compression method: • .tar.gz - gzip compression, • .tar.bz2 - bzip2 compression, • .tar - no compression. [A value is required.]	Archive Name *	Backup.dsr.ZombieNOAM2.Configuration.NETWORK_OAMP.20160810_13073	Modify archive name if desired. Do not include th	Comment	<input type="text"/>	May not contain the following characters: ' * \$	<input type="button" value="Ok"/> <input type="button" value="Cancel"/>		
Field	Value	Description																				
Server: ZombieNOAM2																						
Select data for backup	<input type="checkbox"/> Provisioning <input checked="" type="checkbox"/> Configuration	Select the type of Backup to perform.																				
Compression *	<input type="radio"/> gzip <input checked="" type="radio"/> bzip2 <input type="radio"/> none	Select the backup archive compression algorithm. The following file suffix will be applied for the selected compression method: • .tar.gz - gzip compression, • .tar.bz2 - bzip2 compression, • .tar - no compression. [A value is required.]																				
Archive Name *	Backup.dsr.ZombieNOAM2.Configuration.NETWORK_OAMP.20160810_13073	Modify archive name if desired. Do not include th																				
Comment	<input type="text"/>	May not contain the following characters: ' * \$																				
<input type="button" value="Ok"/> <input type="button" value="Cancel"/>																						

Procedure 72. Back Up NOAM Database

<p>4. <input type="checkbox"/></p>	<p>Backup Server: Transfer file to backup server</p>	<ol style="list-style-type: none"> 1. Login to the backup server identified in step 1. and copy the backup image and key file (RADIUS only) to the customer server where it can be safely stored. 2. If the customer system is a Linux system, copy the backup image to the customer system. <pre style="border: 1px solid black; padding: 5px; margin: 5px 0;">\$ sudo scp admusr@<NOAM VIP>:/var/TKLC/db/filemgmt/backup/* /path/to/destination/</pre> 3. Encrypt the key file before sending it to the filemgmt area. <pre style="border: 1px solid black; padding: 5px; margin: 5px 0;">\$./sharedKrevo -encr</pre> 4. Copy key file to customer server. <pre style="border: 1px solid black; padding: 5px; margin: 5px 0;">\$ sudo scp admusr@<NOAM VIP>:/var/TKLC/db/filemgmt/DpiKf.bin.encr /path/to/destination/</pre> 5. Enter the admusr user password and press Enter. <p>If the customer system is a Windows system, refer to [14], the Using WinSCP procedure, to copy the backup image to the customer system.</p>
<p>5. <input type="checkbox"/></p>	<p>Repeat for additional NOAM aervers</p>	<p>Repeat steps 2. though 4. for additional DSR and SDS NOAM sites.</p>

3.17.9 Back Up SOAM Database

Procedure 73. Back Up SOAM Database

<p>S T E P #</p>	<p>This procedure backs up the SOAM database. Check off (√) each step as it is completed. Boxes have been provided for this purpose under ach step number. If this procedure fails, it is recommended to contact My Oracle Support (MOS) and ask for assistance.</p>	
<p>1. <input type="checkbox"/></p>	<p>Identify backup server</p>	<p>Identify an external server to use as a backup server for this procedure. The server should not be co-located with any of these systems:</p> <ul style="list-style-type: none"> • TVOE • PMAC • DSR NOAM • DSR SOAM • SDS NOAM • SDS DP SOAM

Procedure 73. Back Up SOAM Database

<p>2. SOAM VIP GUI: Login</p>	<p>1. Establish a GUI session on the SOAM server by using the VIP IP address of the SOAM server. Open the web browser and enter a URL of:</p> <div style="border: 1px solid black; padding: 5px; margin: 5px 0;"> <p>https://<Primary_SOAM_VIP_IP_Address></p> </div> <p>2. Login as the guidadmin user.</p> <div style="text-align: center; margin: 20px 0;">  </div> <div style="text-align: center; margin: 10px 0;"> <p>Oracle System Login</p> <hr style="width: 50%; margin: 0 auto;"/> <p style="font-size: small;">Mon Jul 11 13:59:37 2016 EDT</p> </div> <div style="text-align: center; margin: 20px 0;"> <div style="border: 1px solid gray; padding: 10px; width: fit-content; margin: 0 auto;"> <p>Log In</p> <p>Enter your username and password to log in</p> <p>Username: <input style="width: 100%;" type="text"/></p> <p>Password: <input style="width: 100%;" type="password"/></p> <p><input type="checkbox"/> Change password</p> <p><input type="button" value="Log In"/></p> </div> <p style="font-size: x-small; margin-top: 5px;">Welcome to the Oracle System Login.</p> <p style="font-size: x-small; margin-top: 5px;">This application is designed to work with most modern HTML5 compliant browsers and uses both JavaScript and cookies. Please refer to the Oracle Software Web Browser Support Policy for details.</p> <p style="font-size: x-small; margin-top: 5px;">Unauthorized access is prohibited.</p> <hr style="width: 50%; margin: 10px auto;"/> <p style="font-size: x-small; margin-top: 5px;">Oracle and Java are registered trademarks of Oracle Corporation and/or its affiliates. Other names may be trademarks of their respective owners.</p> <p style="font-size: x-small; margin-top: 5px;">Copyright © 2010, 2016, Oracle and/or its affiliates. All rights reserved.</p> </div>
--	--

Procedure 73. Back Up SOAM Database

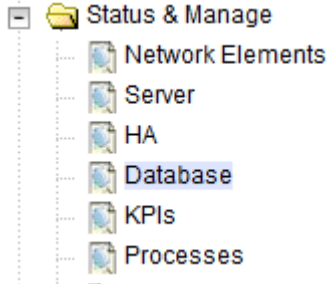
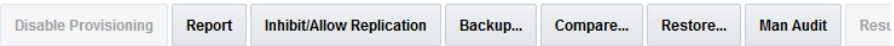
<p>3. <input type="checkbox"/> SOAM VIP GUI: Perform database backup</p>	<p>1. Navigate to Status & Manage > Database.</p>  <p>2. Select the active SOAM.</p> <p>3. Click Backup.</p>  <p>4. Select the desired file compression method.</p> <p>5. Provide the archive file name, if needed.</p> <p>6. Click OK.</p> <p>Database Backup</p> <table border="1" style="width: 100%; border-collapse: collapse;"> <thead> <tr> <th style="width: 30%;">Field</th> <th style="width: 50%;">Value</th> <th style="width: 20%;">Descrip</th> </tr> </thead> <tbody> <tr> <td colspan="3" style="background-color: #e0e0e0;">Server: ZombieSOAM1</td> </tr> <tr> <td>Select data for backup</td> <td> <input type="checkbox"/> Provisioning <input checked="" type="checkbox"/> Configuration </td> <td>Select th</td> </tr> <tr> <td>Compression *</td> <td> <input type="radio"/> gzip <input checked="" type="radio"/> bzip2 <input type="radio"/> none </td> <td> Select th The follo • .t • .t • .t [A value </td> </tr> <tr> <td>Archive Name *</td> <td>Backup.dsr.ZombieSOAM1.Configuration.SYSTEM_OAM.20160810_130916.M</td> <td>Modify ai</td> </tr> <tr> <td>Comment</td> <td><input style="width: 100%;" type="text"/></td> <td>May not i</td> </tr> </tbody> </table> <p style="text-align: center;"> <input type="button" value="Ok"/> <input type="button" value="Cancel"/> </p>	Field	Value	Descrip	Server: ZombieSOAM1			Select data for backup	<input type="checkbox"/> Provisioning <input checked="" type="checkbox"/> Configuration	Select th	Compression *	<input type="radio"/> gzip <input checked="" type="radio"/> bzip2 <input type="radio"/> none	Select th The follo • .t • .t • .t [A value	Archive Name *	Backup.dsr.ZombieSOAM1.Configuration.SYSTEM_OAM.20160810_130916.M	Modify ai	Comment	<input style="width: 100%;" type="text"/>	May not i
Field	Value	Descrip																	
Server: ZombieSOAM1																			
Select data for backup	<input type="checkbox"/> Provisioning <input checked="" type="checkbox"/> Configuration	Select th																	
Compression *	<input type="radio"/> gzip <input checked="" type="radio"/> bzip2 <input type="radio"/> none	Select th The follo • .t • .t • .t [A value																	
Archive Name *	Backup.dsr.ZombieSOAM1.Configuration.SYSTEM_OAM.20160810_130916.M	Modify ai																	
Comment	<input style="width: 100%;" type="text"/>	May not i																	

Procedure 73. Back Up SOAM Database

<p>4. <input type="checkbox"/></p>	<p>Backup Server: Transfer SOAM file to backup server</p>	<p>1. Log into the backup server identified in step 1. and copy the backup image to the customer server where it can be safely stored.</p> <p>2. If the customer system is a Linux system, copy the backup image to the customer system.</p> <div style="border: 1px solid black; padding: 5px; margin: 10px 0;"> <pre>\$ sudo scp admusr@<SOAM VIP>:/var/TKLC/db/filemgmt/backup/* /path/to/destination/</pre> </div> <p>3. Enter the admusr user password and press Enter.</p> <p>If the customer system is a Windows system, refer to [14], the Using WinSCP procedure, to copy the backup image to the customer system.</p>
<p>5. <input type="checkbox"/></p>	<p>Repeat for additional TVOE servers</p>	<p>Repeat steps 2. through 4. for additional DSR SOAM sites.</p>

Appendix A. Pre-IPM Procedures

Appendix A.1 Set the Server’s CMOS Clock

Set the date and time in the server’s CMOS clock accurately before running the IPM procedures.

Note: The IPM installation process managed by PMAC for blade servers automatically sets the server’s CMOS clock, so there is no need to set the server CMOS clock when using PMAC.

Appendix A.2 Configure the RMS Server BIOS Settings

Appendix A.2.1 Configure HP Gen 8 Servers

Procedure 74. Configure HP Gen 8 Server BIOS Settings

<p>S T E P #</p>	<p>This procedure configures HP DL380 server BIOS settings.</p> <p>Check off (✓) each step as it is completed. Boxes have been provided for this purpose under each step number.</p> <p>If this procedure fails, it is recommended to contact My Oracle Support (MOS) and ask for assistance.</p>	
<p>1. <input type="checkbox"/></p>	<p>HP DL380 Server: Connect VGA monitor and USB keyboard</p>	<p>Connect using a VGA monitor and USB keyboard.</p>

Procedure 74. Configure HP Gen 8 Server BIOS Settings

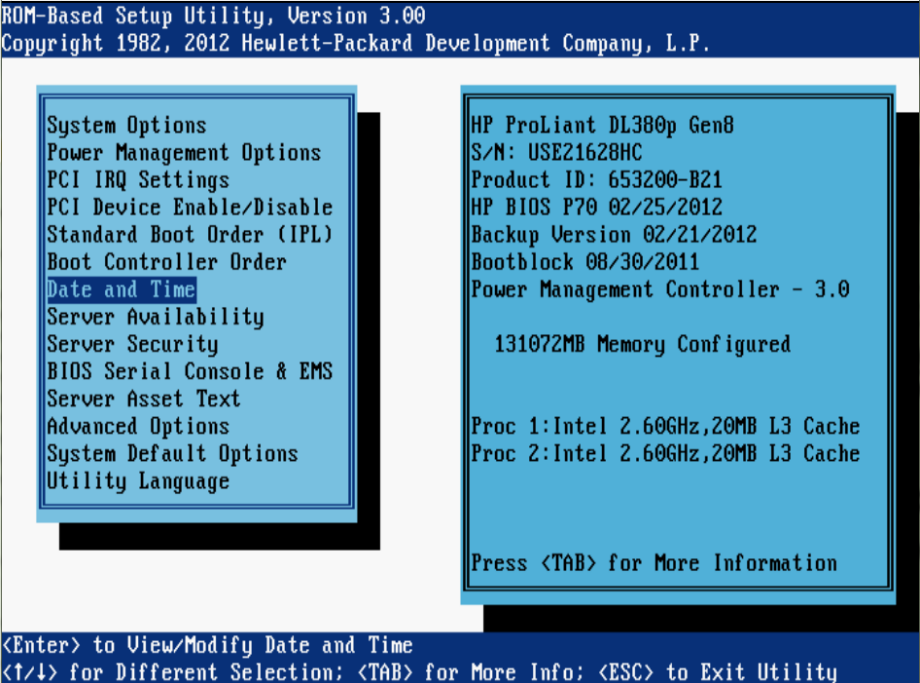
<p>2. <input type="checkbox"/></p>	<p>HP DL380 Server: Reboot</p>	<p>Reboot the server and after the server is powered on, press F9 when asked to access the ROM-Based Setup Utility.</p> 
<p>3. <input type="checkbox"/></p>	<p>HP DL380 Server: Set the date and time</p>	<ol style="list-style-type: none"> 1. Select Date and Time to set the date and time to GMT (Greenwich Mean Time). 2. Press Esc to navigate to the main menu.
<p>4. <input type="checkbox"/></p>	<p>HP DL380 Server: Set the server availability</p>	<ol style="list-style-type: none"> 1. Select Server Availability. 2. Change Automatic Power-On to Enabled. 3. Change Power-On Delay to No Delay. 4. Press Esc to navigate to the main menu.
<p>5. <input type="checkbox"/></p>	<p>HP DL380 Server: System options</p>	<ol style="list-style-type: none"> 1. Select System Options. 2. Select Power Management Options. 3. Select HP Power Regulator. 4. Select HP Status High Performance Mode. 5. Press Esc to navigate to the main menu.
<p>6. <input type="checkbox"/></p>	<p>HP DL380 Server: Power management options</p>	<ol style="list-style-type: none"> 1. Select System Options. 2. Select Processor Options. 3. Change Intel Virtualization Technology to Enabled. 4. Select Serial Port Options. 5. Press Esc to return to System Options.

Procedure 74. Configure HP Gen 8 Server BIOS Settings

7.	HP DL380 Server: Exit ROM-based utility	Press Esc to Save & Exit from the ROM-Based Setup Utility.
----	---	--

Appendix A.2.2 Configure HP Gen 9 Servers

The HP Gen 9 systems can have UEFI boot enabled. Since TPD is configured to use the legacy BIOS option, rack mount Gen 9 servers should have their BIOS settings checked before IPM. Rack mount servers should also have the iLO serial port configured at this time. Directions for both settings are provided in this procedure.

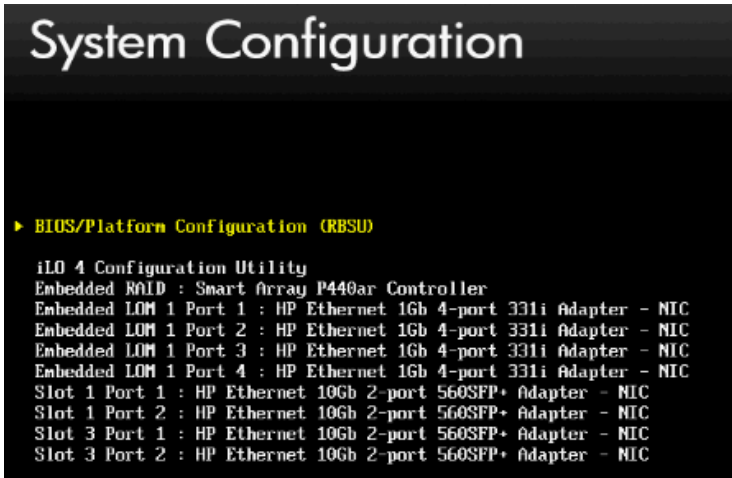

Procedure 75. Configure HP Gen 8 Server BIOS Settings

S T E P #	<p>This procedure configures HP Gen 9 server BIOS settings.</p> <p>Check off (✓) each step as it is completed. Boxes have been provided for this purpose under each step number.</p> <p>If this procedure fails, it is recommended to contact My Oracle Support (MOS) and ask for assistance.</p>	
1.	HP Gen 9 Server: Connect VGA Monitor and USB Keyboard	Connect via a VGA monitor and USB keyboard.
2.	HP Gen 9 Server: Reboot	<p>Reboot the server. After the server is powered on, press F9 when prompted to access the System Utilities menu.</p> <p>Navigate to System Configuration > BIOS/Platform Configuration (RBSU).</p> 

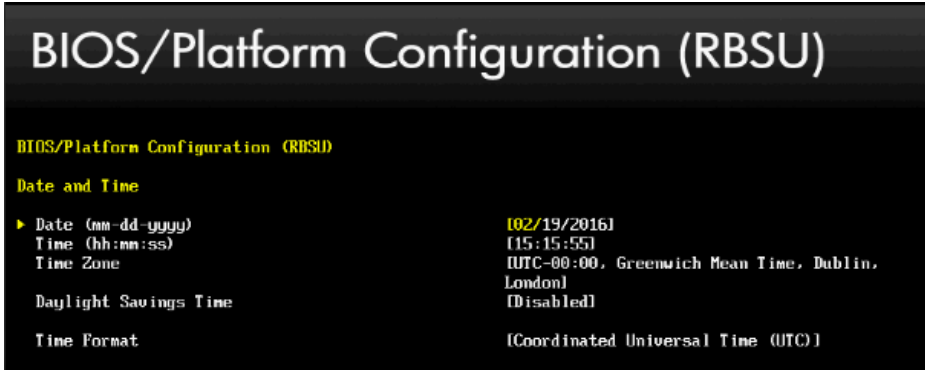
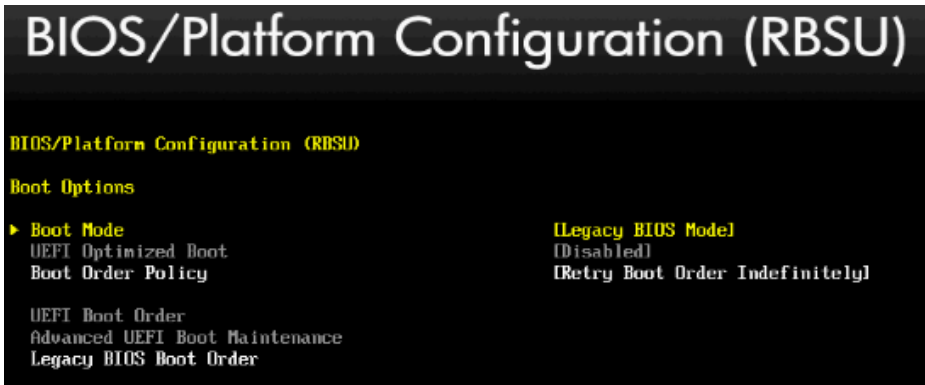
Procedure 75. Configure HP Gen 8 Server BIOS Settings

<p>3. <input type="checkbox"/></p>	<p>HP Gen 9 Server: Set the date and time</p>	<ol style="list-style-type: none"> Navigate to Date and Time. Set the data and time, and time format.  <ol style="list-style-type: none"> Press Esc to navigate to the main menu.
<p>4. <input type="checkbox"/></p>	<p>HP Gen 9 Server: System configuration</p>	<ol style="list-style-type: none"> Select the Boot Options menu. If the Boot Mode is NOT Legacy BIOS mode, press Enter to open the BIOS mode menu; otherwise, skip to the next step.  <ol style="list-style-type: none"> Select Legacy BIOS Mode. Press Esc once to back out to the BIOS/Platform Configuration (RBSU) menu.

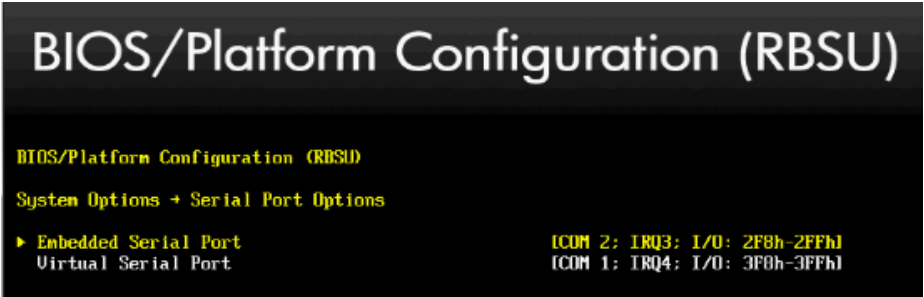
Procedure 75. Configure HP Gen 8 Server BIOS Settings

<p>5. <input type="checkbox"/></p>	<p>HP Gen 9 Server: System Configuration</p>	<ol style="list-style-type: none"> 1. Select the System Options menu 2. Select the Serial Port Options menu. 3. Change Embedded Serial Port to COM2. 4. Change Virtual Serial Port to COM1.  <ol style="list-style-type: none"> 5. Press Esc twice to back out to the BIOS/Platform Configuration (RBSU) menu.
<p>6. <input type="checkbox"/></p>	<p>HP Gen 9 Server: Server Availability</p>	<ol style="list-style-type: none"> 1. Select the Server Availability menu. 2. Set the Automatic Power-On to Restore Last Power State. 3. Set Power-On Delay to No Delay.  <ol style="list-style-type: none"> 4. Press Esc twice to back out to the BIOS/Platform Configuration (RBSU) menu.

Procedure 75. Configure HP Gen 8 Server BIOS Settings

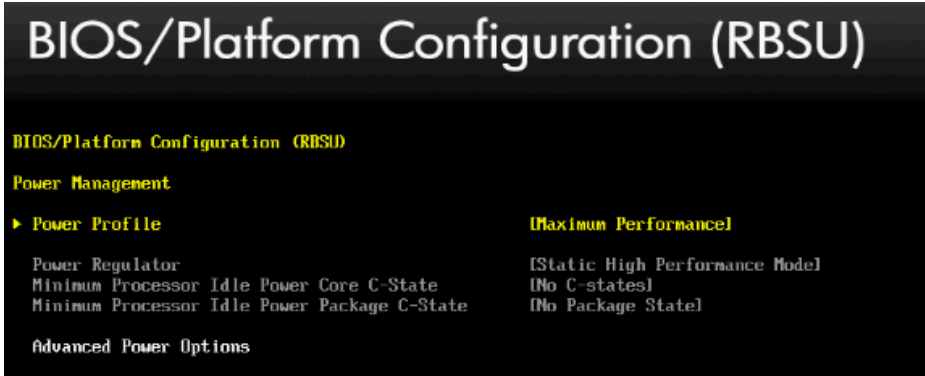
<p>7.</p> <p><input type="checkbox"/></p>	<p>HP Gen 9 Server: Power Management</p>	<ol style="list-style-type: none"> 1. Select the Power Management menu. 2. Set HP Power Profile to Maximum Performance.  <ol style="list-style-type: none"> 3. Press Esc once to back out to the BIOS/Platform Configuration (RBSU) menu.
<p>8.</p> <p><input type="checkbox"/></p>	<p>HP Gen 9 Server: Save settings and exit</p>	<ol style="list-style-type: none"> 1. Press F10 to save the updated settings, then y to confirm the settings change. 2. Press Esc twice to back out to the System Utilities menu.
<p>9.</p> <p><input type="checkbox"/></p>	<p>HP Gen 9 Server: Reboot</p>	<p>Select Reboot the System and press Enter to confirm.</p>

Appendix A.2.3 Configure Oracle X5-2/Netra X5-2/X6-2/X7-2 Server



Procedure 76. Configure Oracle X5-2/Netra X5-2/X6-2/X7-2 Server BIOS Settings

<p>S T E P #</p>	<p>This procedure configures Oracle rack mount server BIOS settings.</p> <p>Check off (✓) each step as it is completed. Boxes have been provided for this purpose under each step number.</p> <p>If this procedure fails, it is recommended to contact My Oracle Support (MOS) and ask for assistance.</p>	
<p>1.</p> <p><input type="checkbox"/></p>	<p>Oracle X5-2/Netra X5-2/X6-2/X7-2: Access iLO GUI</p>	<p>Obtain access to the Oracle X5-2/Netra X5-2/X6-2/X7-2 iLOM by following Appendix D.2 Access the iLOM GUI (Oracle X5-2/Netra X5-2/X6-2/X7-2).</p>

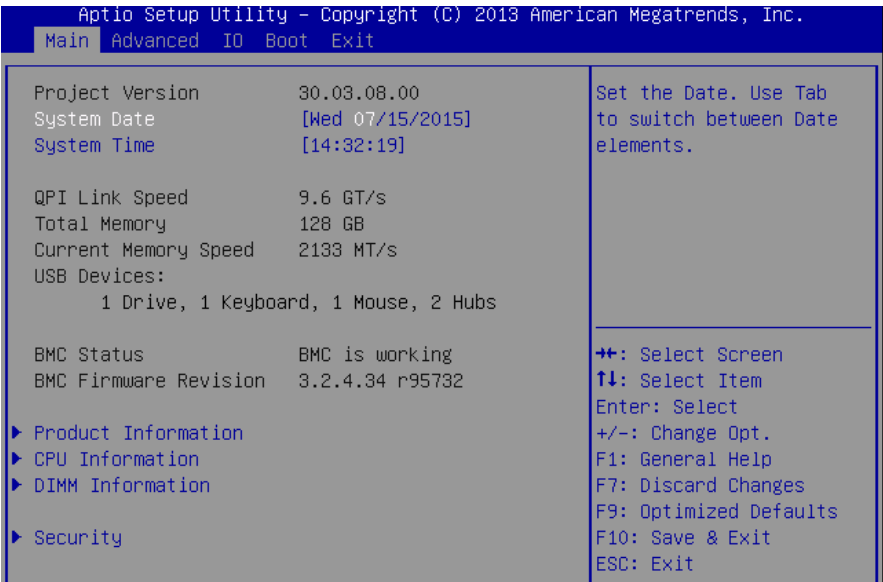
Procedure 76. Configure Oracle X5-2/Netra X5-2/X6-2/X7-2 Server BIOS Settings

<p>2. <input type="checkbox"/></p>	<p>Oracle X5-2/Netra X5-2/X6-2/X7-2: Reboot</p>	<ol style="list-style-type: none"> 1. Reboot the server. 2. After the server is powered on, press F2 when prompted to access the Setup Utility. <div style="border: 1px solid black; padding: 5px; background-color: #f0f0f0;">  <p style="text-align: center;">This action takes you to the Main Menu.</p>  </div>
<p>3. <input type="checkbox"/></p>	<p>Oracle X5-2/Netra X5-2/X6-2: Set the server date and time</p>	<p>Set the System Date and System Time.</p>

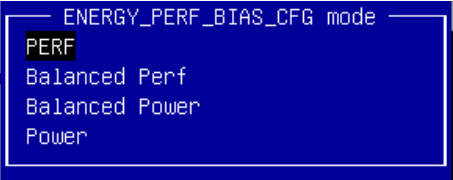
Procedure 76. Configure Oracle X5-2/Netra X5-2/X6-2/X7-2 Server BIOS Settings

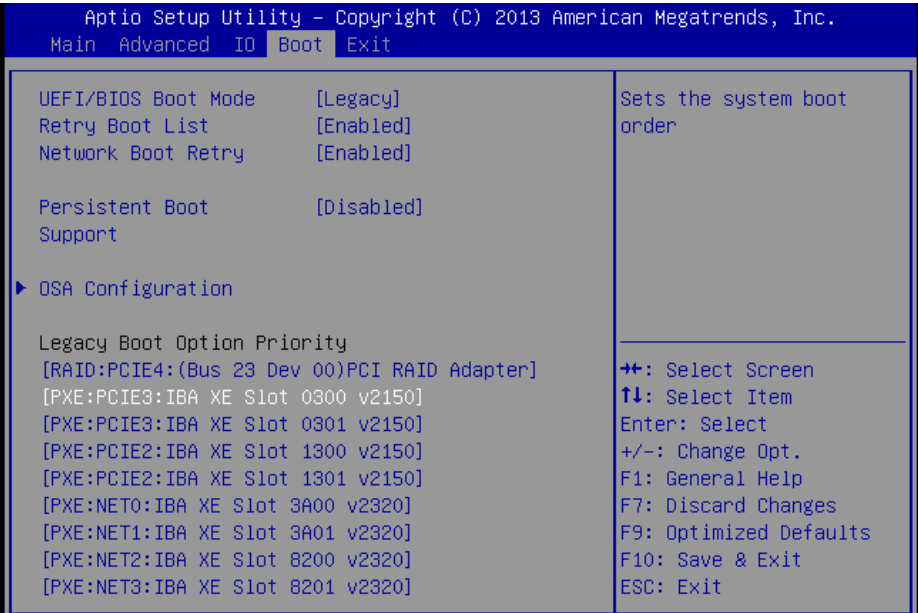
<p>4. <input type="checkbox"/></p>	<p>Oracle X5-2/Netra X5-2/X6-2: Advanced menu</p>	<ol style="list-style-type: none"> 1. Select the Advanced menu.  <ol style="list-style-type: none"> 2. Select the CPU Power Management Configuration option. 3. Make sure the ENERGY_PERF_BIAS_CFG mode is set to PERF and press Enter.  <ol style="list-style-type: none"> 4. Press Esc to return to the advanced menu. 
<p>5. <input type="checkbox"/></p>	<p>Oracle X5-2/Netra X5-2/X6-2: Advanced menu</p>	<ol style="list-style-type: none"> 1. Select the Boot menu. 2. Under Legacy Boot Option, verify the RAID Adapter is listed first. If not, highlight it and use the + key to move it to the top of the list.  <p style="text-align: right;">Version 2.16.1243. Copyright (C) 2013 American Megatrends, Inc. B4</p>

Procedure 76. Configure Oracle X5-2/Netra X5-2/X6-2/X7-2 Server BIOS Settings

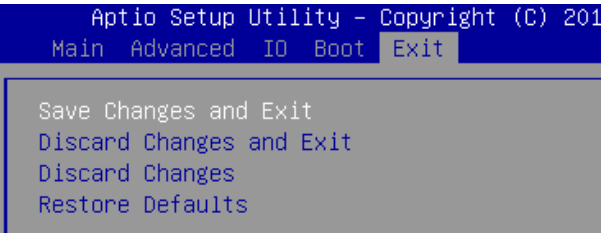
<p>6. <input type="checkbox"/></p>	<p>Oracle X5-2/Netra X5-2/X6-2: Save changes and exit</p>	<p>1. Select the Exit menu.</p>  <p>2. Select Save Changes and Exit.</p> <p>3. Click Yes to confirm.</p>
<p>7. <input type="checkbox"/></p>	<p>Oracle X7-2 server BIOS settings</p>	<p>Refer to [21] Oracle TPD Initial Product Manufacture Software Installation Procedure for BIOS configuration parameters and BIOS setup utility menu sections for details on executing the above required procedures for X7-2 BIOS settings.</p>

Procedure 77. Enable Oracle Netra X5-2 CPU Power Limit for NEBS (Optional)

<p>S T E P #</p>	<p>This procedure configures Oracle rack mount server NEBS settings Check off (✓) each step as it is completed. Boxes have been provided for this purpose under each step number. If this procedure fails, it is recommended to contact My Oracle Support (MOS) and ask for assistance.</p>	
<p>1. <input type="checkbox"/></p>	<p>Oracle Netra X5-2: Enable CPU power limit after IPM</p>	<p>Log into the TVOE as admusr.</p> <pre>\$ sudo /usr/TKLC/plat/sbin/cpuPowerLimit --enable</pre>
<p>2. <input type="checkbox"/></p>	<p>Oracle Netra X5-2: Reboot server</p>	<p>Reboot the server.</p> <pre>\$ sudo init 6</pre>
<p>3. <input type="checkbox"/></p>	<p>Oracle Netra X5-2: Check current setting</p>	<p>Check the current CPU power limit setting.</p> <pre>\$ sudo /usr/TKLC/plat/sbin/cpuPowerLimit --status</pre>

Procedure 78. Disable Oracle Netra X5-2/X6-2/X7-2 CPU Power Limit for NEBS (Optional)

<p>S T E P #</p>	<p>This procedure disables Oracle rack mount server NEBS settings Check off (✓) each step as it is completed. Boxes have been provided for this purpose under each step number. If this procedure fails, it is recommended to contact My Oracle Support (MOS) and ask for assistance.</p>	
<p>1. <input type="checkbox"/></p>	<p>Oracle Netra X5-2: Disable CPU power limit after IPM</p>	<p>Log into the TVOE as admusr.</p> <pre>\$ sudo /usr/TKLC/plat/sbin/cpuPowerLimit --disable</pre>

Procedure 78. Disable Oracle Netra X5-2/X6-2/X7-2 CPU Power Limit for NEBS (Optional)

2. <input type="checkbox"/>	Oracle Netra X5-2: Reboot server	Reboot the server. <pre>\$ sudo init 6</pre>
3. <input type="checkbox"/>	Oracle Netra X5-2: Check current setting	Check the current CPU power limit setting. <pre>\$ sudo /usr/TKLC/plat/sbin/cpuPowerLimit --status</pre>

Appendix B. Upgrade Server Firmware**Appendix B.1 HP DL380 Server**

This procedure upgrade the DL380 server firmware. All HP servers should have SNMP disabled. Refer to Appendix C Change the SNMP Configuration Settings.

The Service Pack for ProLiant (SPP) installer automatically detects the firmware components available on the target server and only upgrades those components with firmware older than what is provided by the SPP in the HP FUP version being used.

Variable	Value
<iLO_IP>	Fill in the IP address of the iLO for the server being upgraded _____
<iLO_admin_user>	Fill in the username of the iLO's administrator user _____
<iLO_admin_password>	Fill in the password for the iLO's administrator user _____
<local_HPSP image_path>	Fill in the filename for the HP support pack for ProLiant ISO _____
<admusr_password>	Fill in the password for the admusr user for the server being upgraded _____

Needed Materials:

- HP service pack for ProLiant (SPP) firmware ISO image (minimum version 2.2.9)
- HP MISC firmware ISO image (for errata updates if applicable)
- HP Solutions Firmware Upgrade Pack Release Notes [1]
- 4GB or larger USB stick is needed if upgrading firmware with USB media

Note: For the **Update Firmware Errata** step, check the HP Solutions Firmware Upgrade Pack Release notes [1] to see if there are any firmware errata items that apply to the server being upgraded. If there is, there is a directory matching the errata's ID in the **errata** directory of the HP MISC firmware ISO image. The errata directories contain the errata firmware and a README file detailing the installation steps.



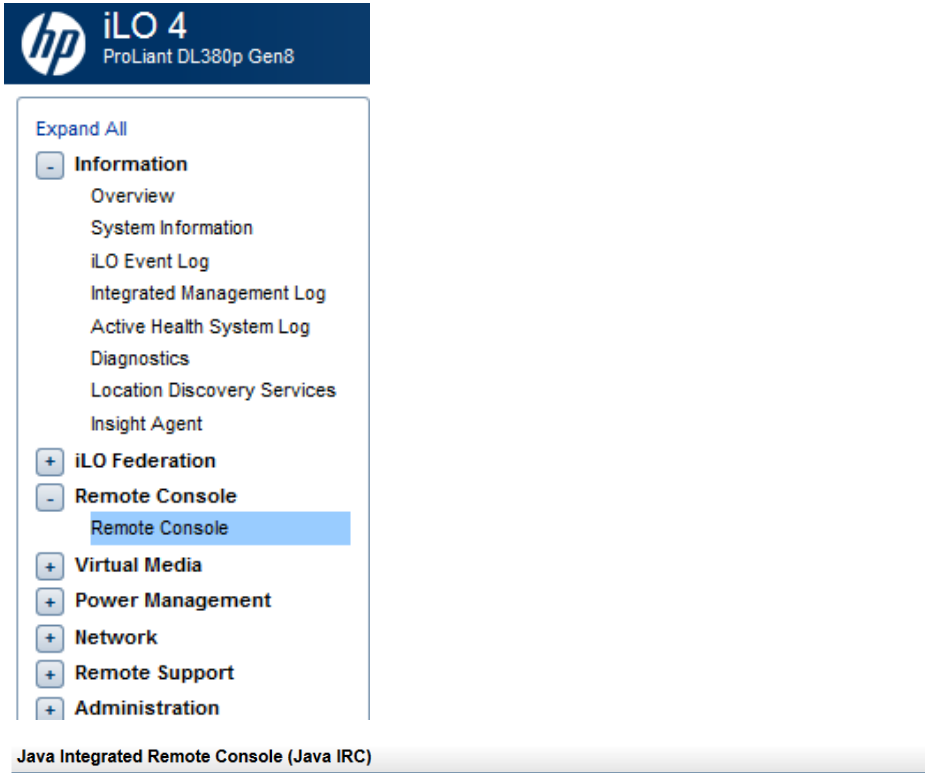
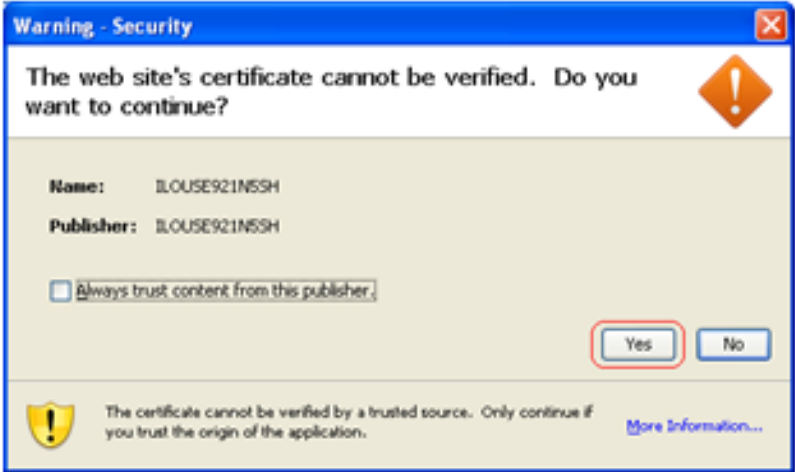

Procedure 79. Upgrade HP DL380 Server Firmware

S T E P #	<p>This procedure upgrades the DL380 server firmware.</p> <p>Check off (✓) each step as it is completed. Boxes have been provided for this purpose under each step number.</p> <p>If this procedure fails, it is recommended to contact My Oracle Support (MOS) and ask for assistance.</p>	
<p>1.</p> <p><input type="checkbox"/></p>	<p>Local Work Station: Log into the iLO web GUI</p>	<p>Access the iLO web GUI.</p> <div style="border: 1px solid black; padding: 5px; margin-bottom: 5px;"> <p>https://<iLO_IP>/</p> </div>  <p>Username: <iLO_admin_user> Password: <iLO_admin_password></p>

Procedure 79. Upgrade HP DL380 Server Firmware

<p>2. <input type="checkbox"/></p>	<p>iLO4 Web GUI: Launch remote console</p>	<ol style="list-style-type: none"> 1. Launch the Java Integrated Remote Console applet. 2. Navigate to the Remote Console page. Under Java Integrated Remote Console (Java IRC), click Launch.  <ol style="list-style-type: none"> 3. Click Yes to acknowledge the security warning, if presented. 
------------------------------------	---	--

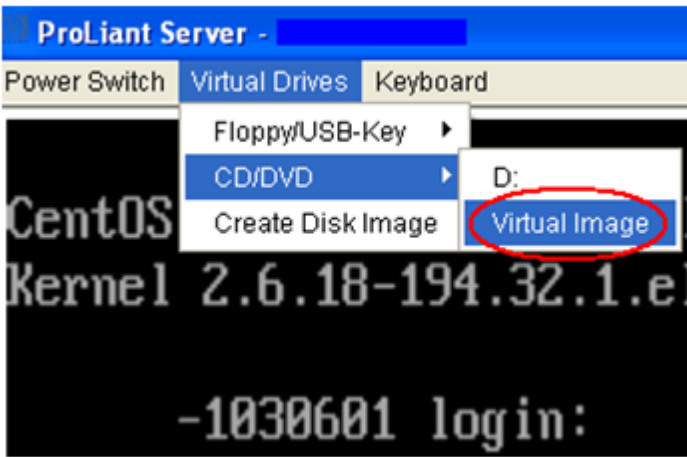
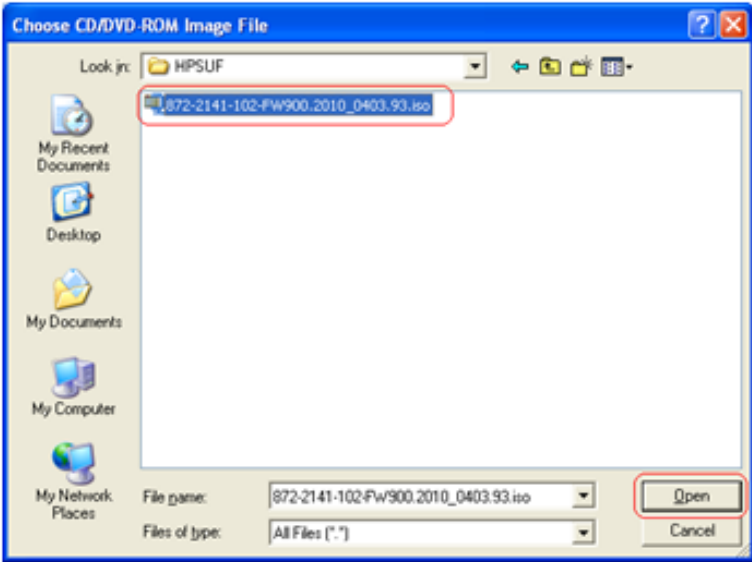
Procedure 79. Upgrade HP DL380 Server Firmware

<p>3. <input type="checkbox"/> iLO4 Remote Console: Create virtual drive connection</p>	<div style="text-align: right;">   </div> <p>1. Navigate to Virtual Drives > CD/DVD > Virtual Image.</p>  <p>2. Browse to the HP Support Pack for ProLiant ISO file copied to the workstation and click Open.</p>  <p>At the bottom of the remote console screen, the VirtualIM green highlighted drive icon displays.</p> 
<p>4. <input type="checkbox"/> iLO4 Remote Console: Login</p>	<p>Log into the server as admusr.</p>
<p>5. <input type="checkbox"/> iLO4 Remote Console: Reboot the server</p>	<pre>\$ sudo init 6</pre>

Procedure 79. Upgrade HP DL380 Server Firmware

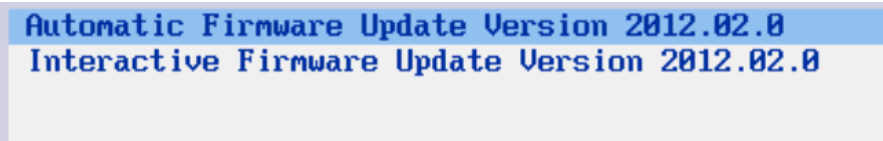
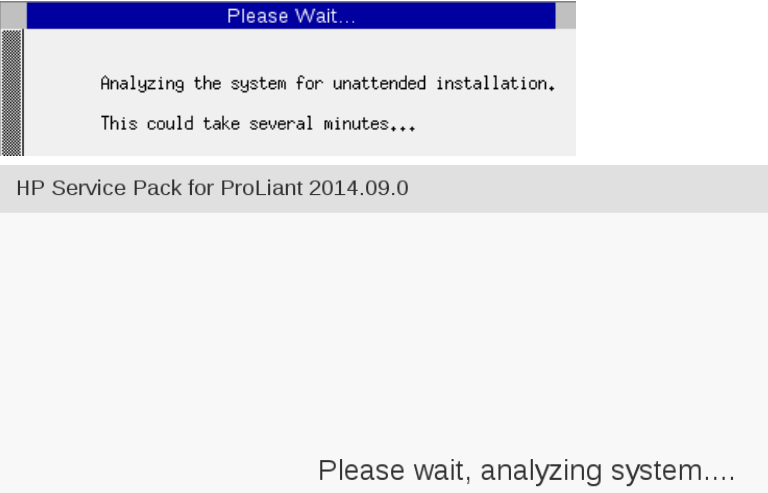
<p>6. <input type="checkbox"/></p>	<p>iLO4 Remote Console: Perform an unattended firmware upgrade</p>	<p>Press Enter to select the Automatic Firmware Update procedure.</p>  <p>Note: If no key is pressed in 30 seconds, the system automatically performs an automatic firmware update.</p>
<p>7. <input type="checkbox"/></p>	<p>iLO4 Remote Console: Monitor installation</p>	<p>Important: Do not click inside the remote console during the rest of the firmware upgrade process.</p> <p>The firmware install stays at the EULA acceptance screen for a short period. The time it takes to complete this process varies by server and network connection speed and takes several minutes.</p> <p>Depending on the hardware, these screens display.</p>  <p>Note: No progress indication displays. The installation proceeds automatically to the next step.</p>

Procedure 79. Upgrade HP DL380 Server Firmware

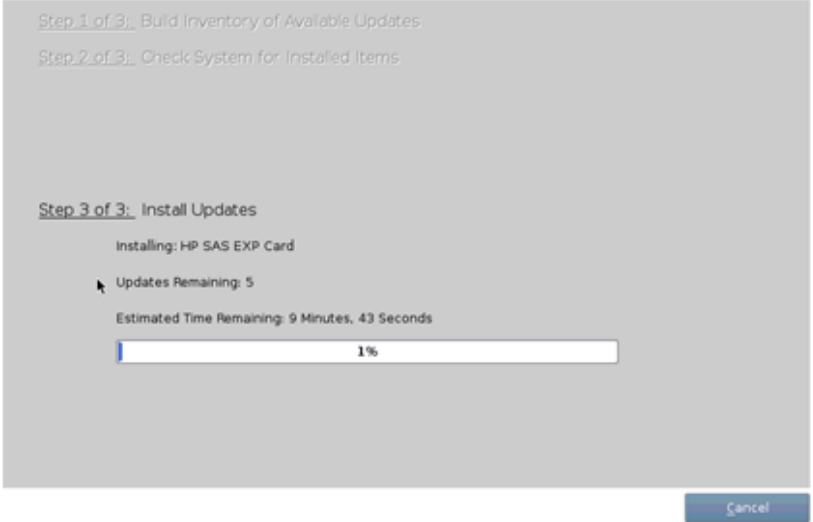
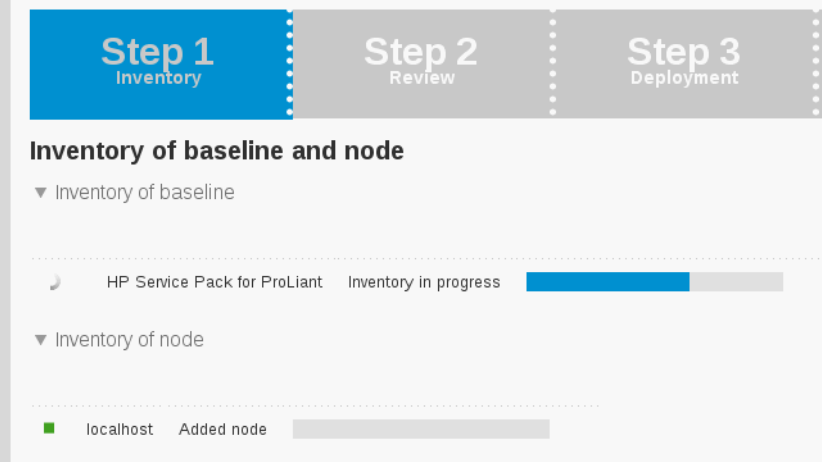
<p>8. <input type="checkbox"/></p>	<p>iLO4 Remote Console: Monitor installation</p>	<p>Once analysis is complete, the installer begins to upgrade inventory and deploy the eligible firmware components.</p> <p>A progress indicator displays. If iLO firmware is applied, the remote console disconnects, but continues upgrading.</p> <p>If the remote console closes due to the iLO upgrading, wait 3-5 minutes and log back into the iLO Web GUI and re-connect to the remote console. The server might already be done upgrading and might have rebooted.</p> <p>Depending on the hardware, these screens display.</p>   <p>Note: If the iLO firmware is to be upgraded, it is upgraded last. At this point the iLO 2 session is terminated and you lose the remote console, virtual media, and web GUI connections to the server. This is expected and does not impact the firmware upgrade process.</p>
<p>9. <input type="checkbox"/></p>	<p>Local Work Station: Clean up</p>	<p>Once the firmware updates have been completed, the server automatically reboots.</p> <p>Closing the remote console window disconnects the virtual image and you can close the iLO3/iLO4 web GUI browser session.</p> <p>If you are using SPP USB media plugged into the server, you can now remove it.</p>

Procedure 79. Upgrade HP DL380 Server Firmware

10. <input type="checkbox"/>	Local Work Station: Verify server availability	Wait 3 to 5 minutes and verify the server has rebooted and is available by gaining access to the login prompt.
11. <input type="checkbox"/>	Local Work Station: Update firmware errata	Refer to the ProLiant Server Firmware Errata section of [1] to determine if this HP Solutions Firmware Update Pack contains additional firmware errata updates that should be applied to the server.
12. <input type="checkbox"/>	Repeat for additional RMS servers	Repeat this procedure for additional HP DL380 rack mount servers.

Appendix B.2 Oracle X5-2/Netra X5-2/X6-2/X7-2

Needed Materials:

- Oracle Firmware Upgrade Pack 3.x.x
- Oracle Firmware Upgrade Pack 3.x.x Upgrade Guide

Note: The minimum supported Oracle Firmware Upgrade Pack is release 3.1.7 (X7-2: 3.1.8). However, when upgrading firmware, it is recommended that the latest release is used. Refer to the Oracle Firmware Upgrade Pack Release Notes for procedures on how to obtain the firmware, and follow the procedures in the Oracle Firmware Upgrade Pack Upgrade Guide to upgrade the firmware.

Appendix C. Change the SNMP Configuration Settings

Procedure 80. Change SNMP Configuration Settings for HP DL380

S T E P #	This procedure upgrades the HP DL380 server firmware. Check off (✓) each step as it is completed. Boxes have been provided for this purpose under each step number. If this procedure fails, it is recommended to contact My Oracle Support (MOS) and ask for assistance.	
	1. <input type="checkbox"/>	<p>Local Work Station: Log into the iLO web GUI</p> <p>Access the iLO web GUI.</p> <div style="border: 1px solid black; padding: 5px; margin-bottom: 5px;"> <p>https://<iLO_IP>/</p> </div> 

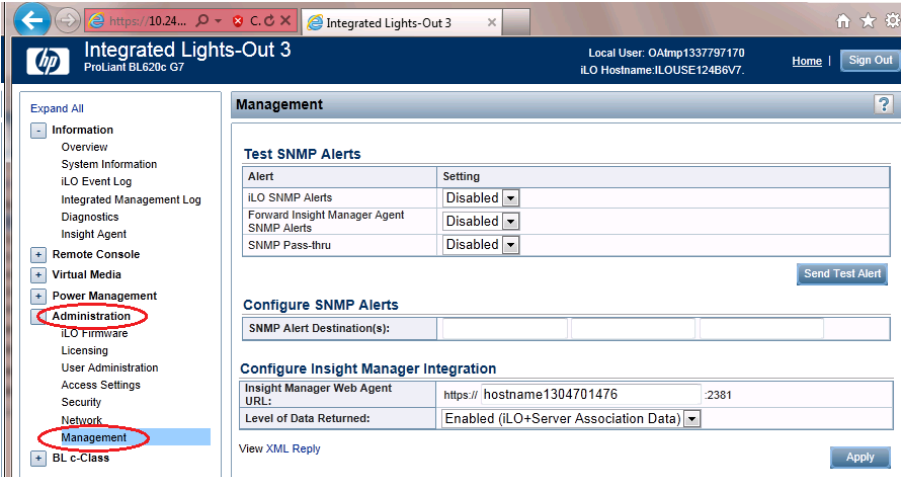
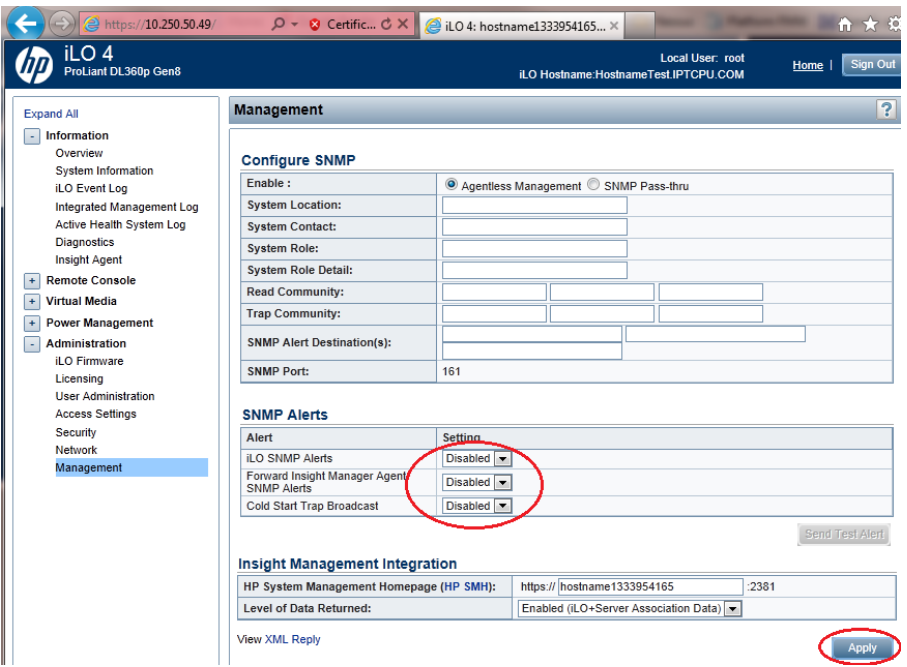

Procedure 80. Change SNMP Configuration Settings for HP DL380

<p>2. <input type="checkbox"/></p>	<p>iLO4 GUI: Navigate to the management screen</p>	<p>Navigate to Administration > Management.</p> 
<p>3. <input type="checkbox"/></p>	<p>iLO4 GUI: Disable SNMP alerts</p>	<p>1. Select Disabled for each of the 3 SNMP alerts options.</p>  <p>2. Click Apply to save the change.</p> <p>Note: To verify the setting changes, navigate away from the management configuration page and go back to the page to verify the SNMP settings.</p>
<p>4. <input type="checkbox"/></p>	<p>iLO4 GUI: Exit</p>	<p>Click Sign Out in upper right corner of page to log out of the iLO GUI.</p>
<p>5. <input type="checkbox"/></p>	<p>Repeat for additional RMS servers</p>	<p>Repeat this procedure for additional HP DL380 rack mount servers.</p>

Appendix D. TVOE iLO/iLOM GUI Access

Appendix D.1 Access the iLO GUI (HP DL380)

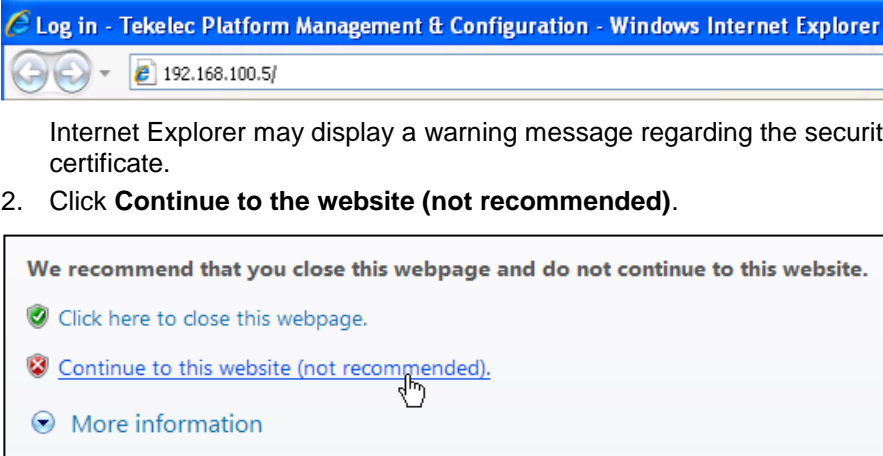
Procedure 81. Access the TVOE iLO4 GUI

<p>S T E P #</p>	<p>This procedure accesses the TVO iLO4 GUI. Check off (✓) each step as it is completed. Boxes have been provided for this purpose under each step number. If this procedure fails, it is recommended to contact My Oracle Support (MOS) and ask for assistance.</p>	
<p>1. <input type="checkbox"/></p>	<p>Launch Internet Explorer</p>	<p>1. Navigate to 192.168.100.5 (manufacturing default) or customer IP set during installation using Appendix E Change the TVOE iLO/iLOM Address.</p>  <p>Internet Explorer may display a warning message regarding the security certificate.</p> <p>2. Click Continue to the website (not recommended).</p>
<p>2. <input type="checkbox"/></p>	<p>Log into the iLO4</p>	<p>Log into the iLO4.</p>  <p>The iLO4 Home page displays.</p> 

Procedure 81. Access the TVOE iLO4 GUI

<p>3. <input type="checkbox"/></p>	<p>Launch the PMAC iLO4 CLI</p>	<p>Click Launch to start the PMAC iLO4 CLI.</p> 
------------------------------------	---------------------------------	---

Appendix D.2 Access the iLOM GUI (Oracle X5-2/Netra X5-2/X6-2/X7-2)

Procedure 82. Access the iLOM GUI

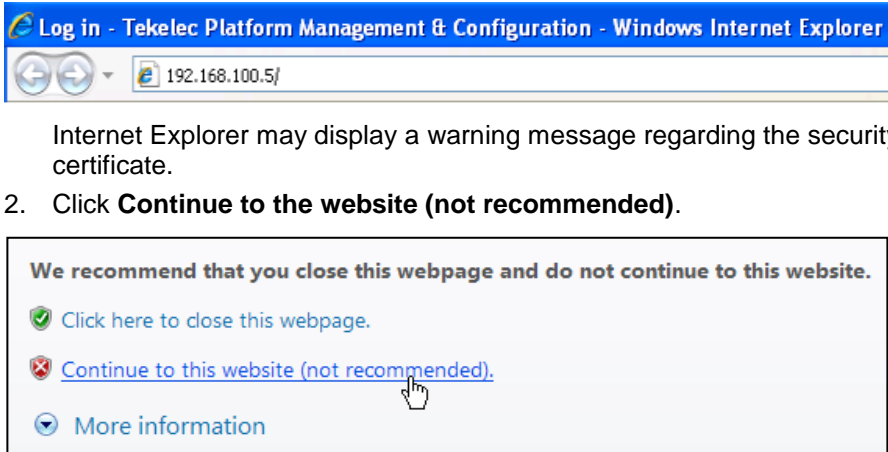
<p>S T E P #</p>	<p>This procedure sets a static IP address on the iLOM and access the TVOE iLOM GUI. Check off (✓) each step as it is completed. Boxes have been provided for this purpose under each step number. If this procedure fails, it is recommended to contact My Oracle Support (MOS) and ask for assistance.</p>	
<p>1. <input type="checkbox"/></p>	<p>Launch Internet Explorer</p>	<p>1. Navigate to 192.168.100.5 (manufacturing default) or customer IP set during installation using Appendix E Change the TVOE iLO/iLOM Address.</p>  <p>Internet Explorer may display a warning message regarding the security certificate.</p> <p>2. Click Continue to the website (not recommended).</p>

Procedure 82. Access the iLOM GUI

<p>2.</p> <p><input type="checkbox"/></p>	<p>Oracle X5-2/Netra X5-2/X6-2/X7-2: Login</p>	<p>Log into the Oracle rack mount server ILOM.</p> 
<p>3.</p> <p><input type="checkbox"/></p>	<p>Oracle X5-2/Netra X5-2/X6-2/X7-2: Access the remote console</p>	<ol style="list-style-type: none"> 1. Navigate to Remote Control > Redirection. 2. Click Launch Remote Console. 

Procedure 82. Access the iLOM GUI

4. **Oracle X5-2/Netra X5-2/X6-2/X7-2:**
Access the remote console

1. Click **OK** and open with **Java Web Start Launcher**.

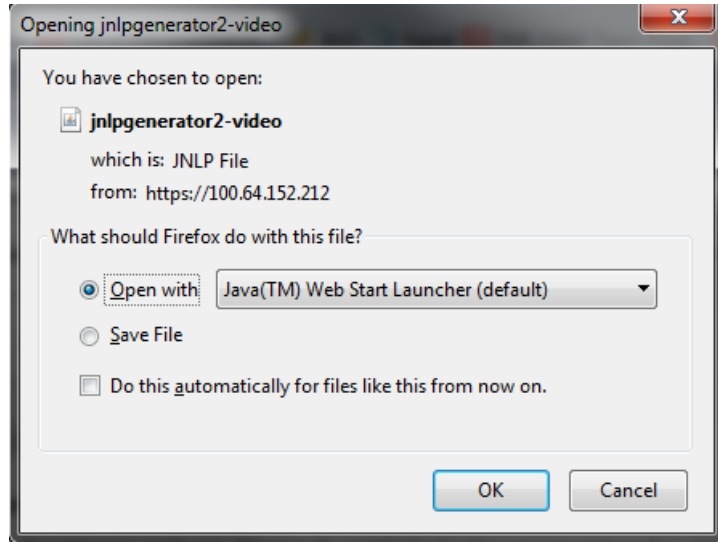

2. Select **Continue**.

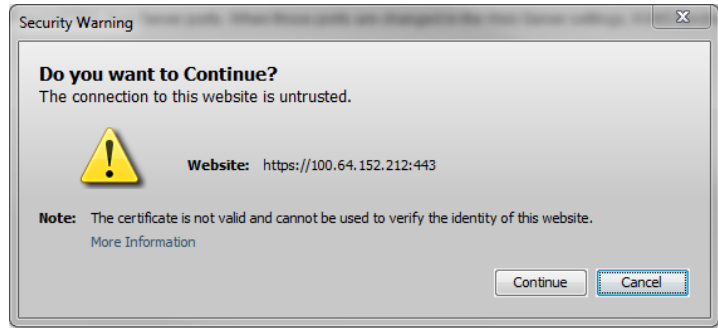

3. Click **Run** for any security warning prompts.

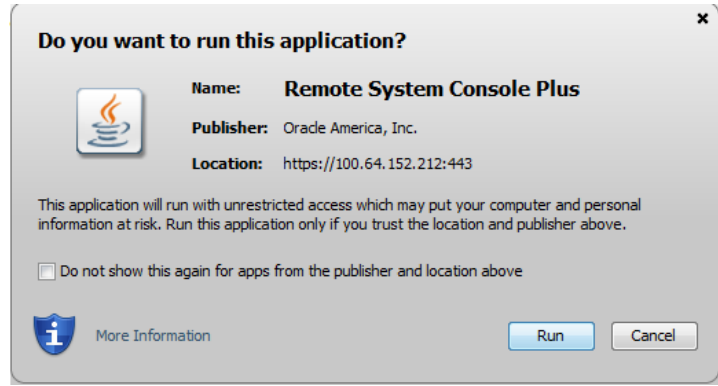

Appendix E. Change the TVOE iLO/iLOM Address

Appendix E.1 HP DL380 Servers (iLO4)

Procedure 83. Change the TVOE iLO Address

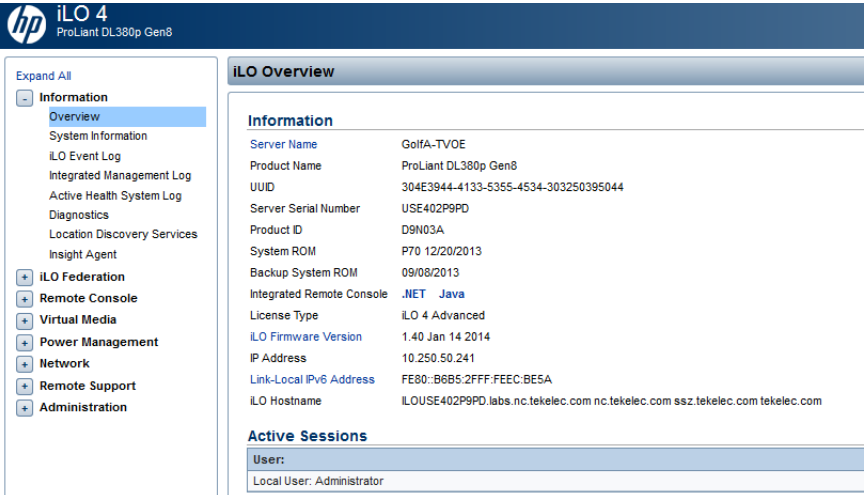
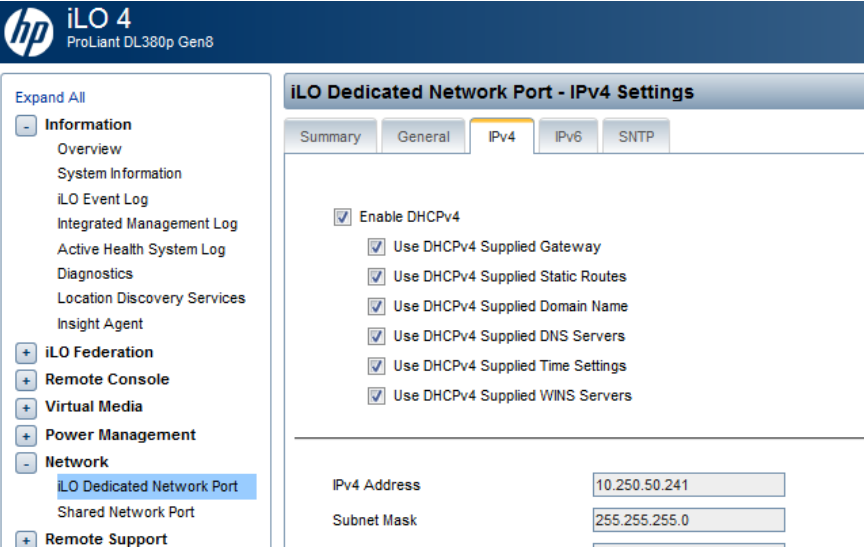
<p>S T E P #</p>	<p>This procedure sets the IP address of the TVOE iLO4 on HP DL380 servers to the customer's network so it can be accessed by Oracle support.</p> <p>Check off (✓) each step as it is completed. Boxes have been provided for this purpose under each step number.</p> <p>If this procedure fails, it is recommended to contact My Oracle Support (MOS) and ask for assistance.</p>	
<p>1. <input type="checkbox"/></p>	<p>HP DL380: Connect to the TVOE iLO GUI</p>	<p>Using the instructions in Appendix D TVOE iLO/iLOM GUI Access and connect to the iLO4 GUI.</p> 
<p>2. <input type="checkbox"/></p>	<p>iLO4 GUI: Navigate to network menu</p>	<p>1. Navigate to Network > iLO Dedicated Network Port.</p>  <p>2. Select the tab for either IPv4 or IPv6.</p>

Procedure 83. Change the TVOE iLO Address

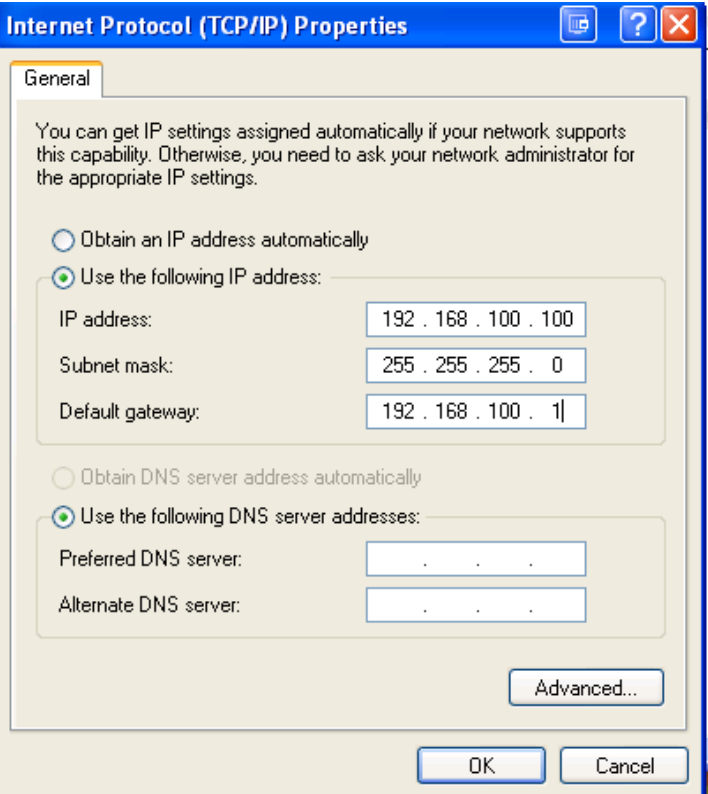

<p>3. <input type="checkbox"/></p>	<p>iLO4 GUI: Change IP information</p>	<p>1. Change the IP address, subnet Mask/prefix, and Gateway address to the values supplied in the NAPD for the TVOE iLO.</p> <p>IPv4 Address <input type="text" value="10.250.50.241"/></p> <p>Subnet Mask <input type="text" value="255.255.255.0"/></p> <p>Gateway IPv4 Address <input type="text" value="10.250.50.1"/></p> <table border="1"> <thead> <tr> <th></th> <th>Destination</th> <th>Mask</th> <th>Gateway</th> </tr> </thead> <tbody> <tr> <td>Static Route #1</td> <td><input type="text" value="0.0.0.0"/></td> <td><input type="text" value="0.0.0.0"/></td> <td><input type="text" value="0.0.0.0"/></td> </tr> <tr> <td>Static Route #2</td> <td><input type="text" value="0.0.0.0"/></td> <td><input type="text" value="0.0.0.0"/></td> <td><input type="text" value="0.0.0.0"/></td> </tr> <tr> <td>Static Route #3</td> <td><input type="text" value="0.0.0.0"/></td> <td><input type="text" value="0.0.0.0"/></td> <td><input type="text" value="0.0.0.0"/></td> </tr> </tbody> </table> <p>2. Click Submit.</p> <p><input type="button" value="Submit"/> <input type="button" value="Reset"/></p> <p>Note: Access is lost at this point and is expected.</p>		Destination	Mask	Gateway	Static Route #1	<input type="text" value="0.0.0.0"/>	<input type="text" value="0.0.0.0"/>	<input type="text" value="0.0.0.0"/>	Static Route #2	<input type="text" value="0.0.0.0"/>	<input type="text" value="0.0.0.0"/>	<input type="text" value="0.0.0.0"/>	Static Route #3	<input type="text" value="0.0.0.0"/>	<input type="text" value="0.0.0.0"/>	<input type="text" value="0.0.0.0"/>
	Destination	Mask	Gateway															
Static Route #1	<input type="text" value="0.0.0.0"/>	<input type="text" value="0.0.0.0"/>	<input type="text" value="0.0.0.0"/>															
Static Route #2	<input type="text" value="0.0.0.0"/>	<input type="text" value="0.0.0.0"/>	<input type="text" value="0.0.0.0"/>															
Static Route #3	<input type="text" value="0.0.0.0"/>	<input type="text" value="0.0.0.0"/>	<input type="text" value="0.0.0.0"/>															
<p>4. <input type="checkbox"/></p>	<p>Local Machine: Reset the computer's network connection</p>	<p>Reset the computer's network connection replacing the Subnet Mask and Gateway with those just used for the TVOE iLO. Use an appropriate IP address for this subnet.</p> 																

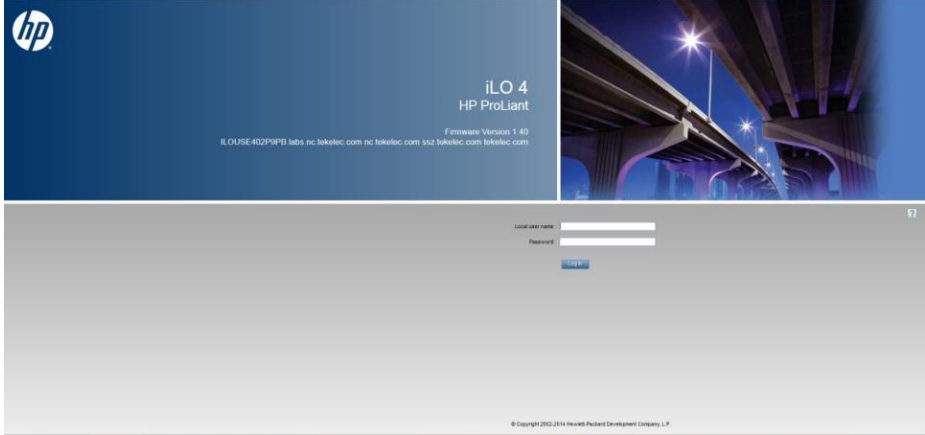
Procedure 83. Change the TVOE iLO Address



5.	Local Machine: Connect to the TVOE iLO GUI	Connect to the TVOE iLO GUI using the instructions in Appendix D TVOE iLO/iLOM GUI Access. Note: Use the IP address from step 3. 
----	--	--

Appendix E.2 Oracle X5-2/Netra X5-2/X6-2 Servers (Change iLOM IP Address using Keyboard/Monitor)

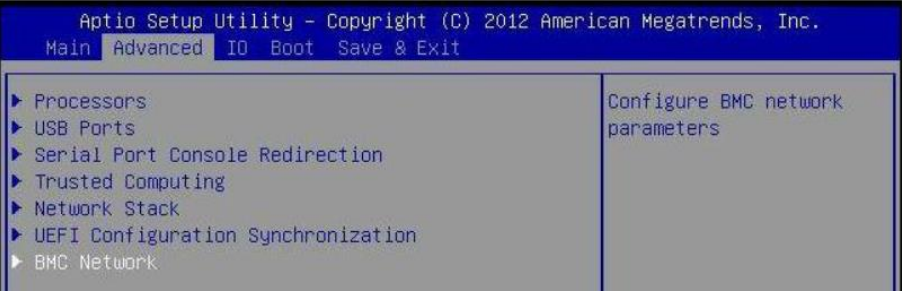
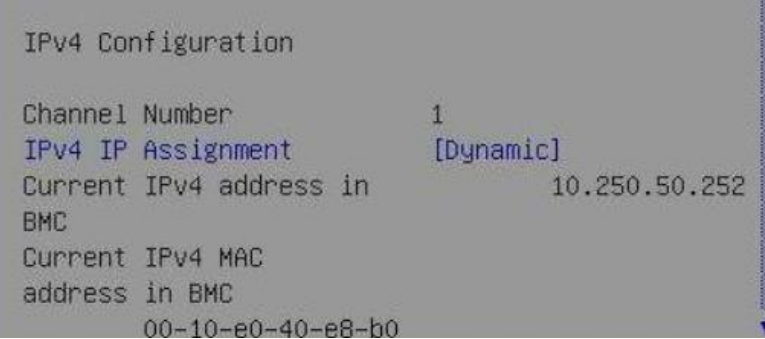
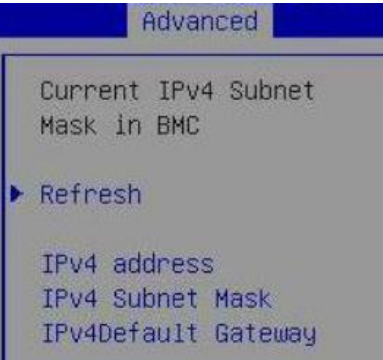

Procedure 84. Change the TVOE Oracle X5-2/Netra X5-2/X6-2iLOM Address

S T E P #	<p>This procedure sets the IP address of the TVOE iLOM on Oracle X5-2/Netra X5-2/X6-2 servers to the customer's network so it can be accessed by Oracle support.</p> <p>Note: By default the ILOM is configured to get its IP address dynamically through DHCP. This procedure describes how to statically set the IP address of the ILOM using a keyboard and monitor.</p> <p>Check off (✓) each step as it is completed. Boxes have been provided for this purpose under each step number.</p> <p>If this procedure fails, it is recommended to contact My Oracle Support (MOS) and ask for assistance.</p>
1. <input type="checkbox"/>	<p>Oracle X5-2/Netra X5-2/X6-2: Reboot and access BIOS configuration menu</p> <ol style="list-style-type: none"> 1. Reboot the server. 2. After the server is powered on, press F2 when prompted to enter the BIOS configuration menu.  <p style="text-align: center;">This action takes you to the Main Menu.</p> 

Procedure 84. Change the TVOE Oracle X5-2/Netra X5-2/X6-2iLOM Address

<p>2. <input type="checkbox"/></p>	<p>Oracle X5-2/Netra X5-2/X6-2: Access the Configuration Menu</p>	<p>1. Select the Advanced menu. 2. Select the BMC Network option.</p>  <p>Aptio Setup Utility - Copyright (C) 2012 American Megatrends, Inc. Main Advanced IO Boot Save & Exit</p> <ul style="list-style-type: none"> ▶ Processors ▶ USB Ports ▶ Serial Port Console Redirection ▶ Trusted Computing ▶ Network Stack ▶ UEFI Configuration Synchronization ▶ BMC Network <p>Configure BMC network parameters</p>
<p>3. <input type="checkbox"/></p>	<p>Oracle X5-2/Netra X5-2/X6-2: Configure the static IPv4 addresses IPv6 skip this step</p>	<p>1. Highlight IPv4 IP Assignment and press Enter.</p>  <p>IPv4 Configuration</p> <p>Channel Number 1</p> <p>IPv4 IP Assignment [Dynamic]</p> <p>Current IPv4 address in BMC 10.250.50.252</p> <p>Current IPv4 MAC address in BMC 00-10-e0-40-e8-b0</p> <p>2. Highlight Static and press Enter. 3. Highlight IPv4 address and press Enter.</p>  <p>Advanced</p> <p>Current IPv4 Subnet Mask in BMC</p> <p>▶ Refresh</p> <p>IPv4 address</p> <p>IPv4 Subnet Mask</p> <p>IPv4Default Gateway</p> <p>4. Enter the desired IPv4 address and press Enter. 5. Repeat for the IPv4 Subnet Mask and IPv4 Default Gateway. 6. Select Commit BELOW the IPv4 fields.</p>  <p>▶ Refresh</p> <p>IPv4 address</p> <p>IPv4 Subnet Mask</p> <p>IPv4Default Gateway</p> <p>▶ Commit</p>

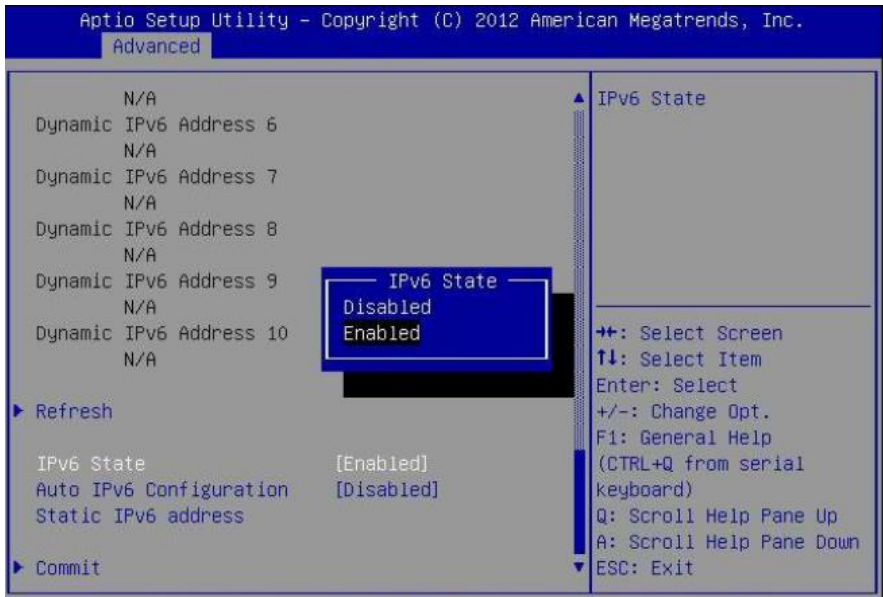
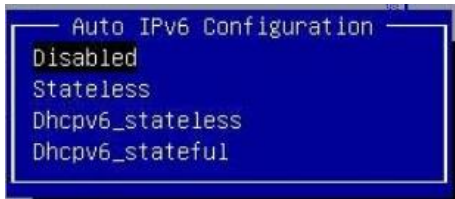
Procedure 84. Change the TVOE Oracle X5-2/Netra X5-2/X6-2iLOM Address

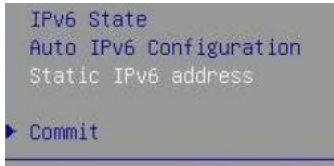
<p>4. <input type="checkbox"/> Oracle X5-2/Netra X5-2/X6-2: Configure static IPv6 addresses</p>	<ol style="list-style-type: none"> Page down to the IPv6 configuration settings, set IPv6 State to Enabled and press Enter.  Navigate to Auto IPv6 Configuration, set Auto IPv6 Configuration to Disabled and press Enter.  Highlight Static IPv6 address and press Enter. Enter the IPv6 address and press Enter.  Select Commit BELOW the IPv6 fields. 
--	--

Procedure 84. Change the TVOE Oracle X5-2/Netra X5-2/X6-2iLOM Address

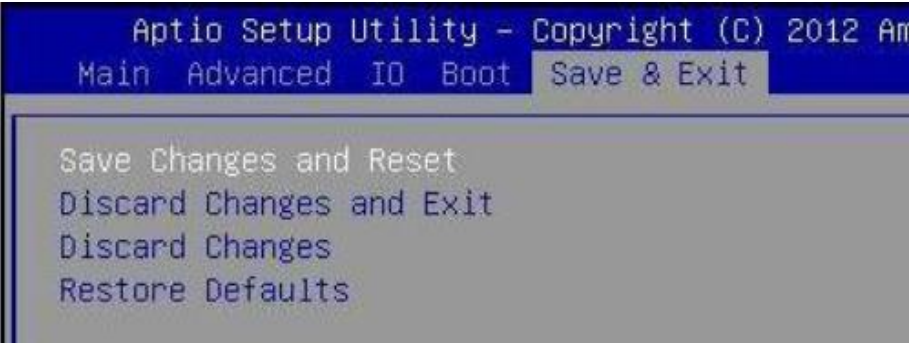
<p>5. <input type="checkbox"/></p>	<p>Oracle X5-2/Netra X5-2/X6-2: Save and exit</p>	<ol style="list-style-type: none"> 1. Press Esc to exit the BMC Network menu. 2. Select the Save & Exit menu.  <ol style="list-style-type: none"> 3. Select Save Changes and Reset. 4. Click Yes to confirm Save configuration and reset? <p>The server reboots.</p>
------------------------------------	--	--

Appendix E.3 Oracle X5-2/Netra X5-2/X6-2/X7-2 Servers (Change iLOM IP Address using Serial Console)

Procedure 85. Change the TVOE Oracle X5-2/Netra X5-2/X6-2iLOM Address

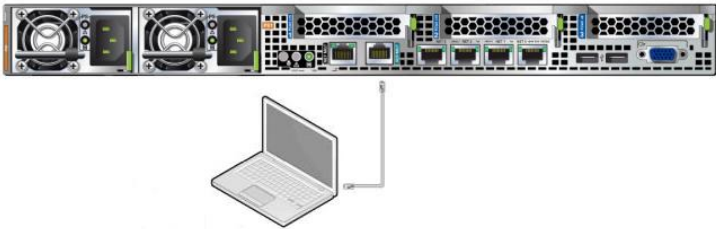
S T E P #	<p>This procedure sets the IP address of the TVOE iLOM on Oracle X5-2/Netra X5-2/X6-2/X7-2 servers to the customer's network so it can be accessed by Oracle support.</p> <p>Note: By default the ILOM is configured to get its IP address dynamically through DHCP. This procedure describes how to statically set the IP address of the ILOM using a keyboard and monitor.</p> <p>Check off (✓) each step as it is completed. Boxes have been provided for this purpose under each step number.</p> <p>If this procedure fails, it is recommended to contact My Oracle Support (MOS) and ask for assistance.</p>													
1. <input type="checkbox"/>	Oracle X5-2/Netra X5-2/X6-2/X7-2 Server	<p>1. Connect to the serial management port.</p>  <p>Serial Management Port</p> <p>The serial management connector (labeled SER MGT) is an RJ-45 connector that can be accessed from the rear panel. This port is the default connection to the server. Use this port <i>only</i> for server management.</p> <p>TABLE 19 Default Serial Connections for Serial Port</p> <table border="1"> <thead> <tr> <th>Parameter</th> <th>Setting</th> </tr> </thead> <tbody> <tr> <td>Connector</td> <td>SER MGT</td> </tr> <tr> <td>Rate</td> <td>9600 baud</td> </tr> <tr> <td>Parity</td> <td>None</td> </tr> <tr> <td>Stop bits</td> <td>1</td> </tr> <tr> <td>Data bits</td> <td>8</td> </tr> </tbody> </table> <p>2. Connect a laptop to the serial management (SER MGT) port on the server.</p> 	Parameter	Setting	Connector	SER MGT	Rate	9600 baud	Parity	None	Stop bits	1	Data bits	8
Parameter	Setting													
Connector	SER MGT													
Rate	9600 baud													
Parity	None													
Stop bits	1													
Data bits	8													

Procedure 85. Change the TVOE Oracle X5-2/Netra X5-2/X6-2iLOM Address

<p>2. <input type="checkbox"/></p>	<p>Log into the serial console</p>	<p>1. Press Enter on the terminal.</p> <p>2. Type your Oracle ILOM user name (default user: root) and press Enter.</p> <p>3. Type the password associated with your user name and press Enter.</p> <p>Oracle ILOM displays the default command prompt (->), indicating that you have successfully logged in.</p>
<p>3. <input type="checkbox"/></p>	<p>Configure NET_MGT network interface</p>	<p>1. Navigate to the /SP/network target.</p> <pre>> cd /SP/network</pre> <p>2. Ensure the SP network interface is enabled.</p> <pre>> set state=enabled</pre> <p>3. Configure a static IPv4 address for the SP.</p> <pre>> set pendingipdiscovery=static pendingipaddress=<ip_address> pendingipnetmask=<netmask> pendingipgateway=<gateway> commitpending=true</pre> <p>4. Verify settings.</p> <pre>> show</pre>
<p>4. <input type="checkbox"/></p>	<p>Connect to the NET_MGT port</p>	<p>Connect a laptop to the network management (NET MGT) port on the server:</p> 

Appendix F. Attach an ISO Image to a Server using the iLO or iLOM

As an alternative to mounting the ISO image using USB, you may also mount the ISO using the iLO or iLOM for HP and Oracle rack mount servers.

Appendix F.1 HP DL380 Servers (iLO4)

Procedure 86. Mount HP DL380 Servers with ISO Image using iLO4

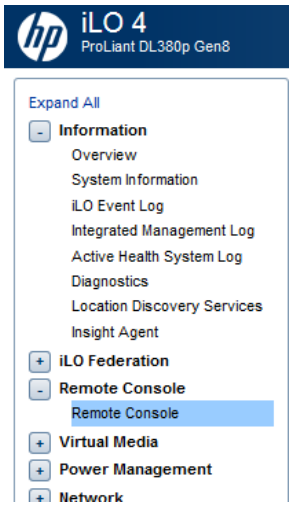
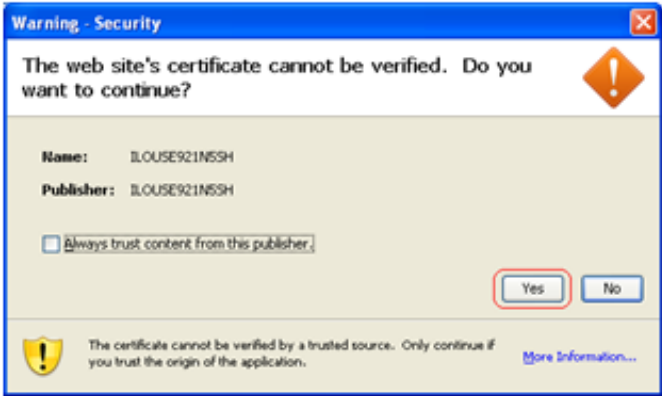
S T E P #	<p>This procedure attaches an ISO image to HP DL380 servers using the iLO4.</p> <p>Check off (✓) each step as it is completed. Boxes have been provided for this purpose under each step number.</p> <p>If this procedure fails, it is recommended to contact My Oracle Support (MOS) and ask for assistance.</p>	
<p>1. <input type="checkbox"/></p>	<p>iLO4 Web GUI: Launch remote console</p>	<ol style="list-style-type: none"> Launch the Java Integrated Remote Console applet. Navigate to the Remote Console page. Under Java Integrated Remote Console (Java IRC), click Launch.  <p>Java Integrated Remote Console (Java IRC)</p> <p><small>The Java IRC provides remote access to the system KVM and control of Virtual Power and Media from a Java applet-based console. Java IRC requires the availability of Java.</small></p> <ol style="list-style-type: none"> Click Yes to acknowledge the security warning, if presented. 

Procedure 86. Mount HP DL380 Servers with ISO Image using iLO4

2. **iLO4 Remote Console:** Create virtual drive connection

1. Navigate to **Virtual Drives > CD/DVD > Virtual Image.**

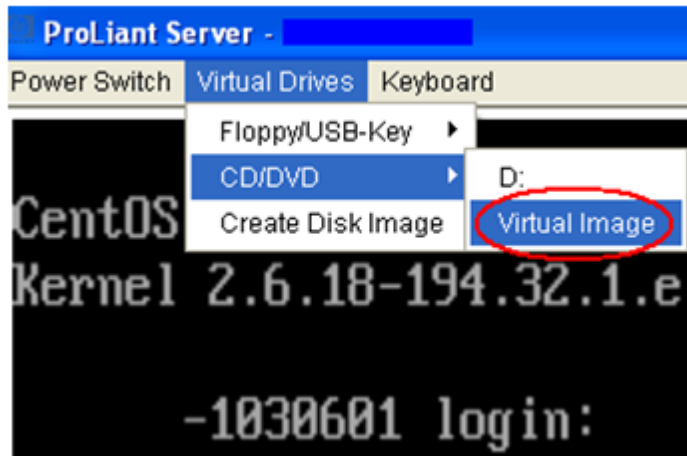

2. Browse to the **HP Support Pack for ProLiant ISO** file copied to the workstation and click **Open.**

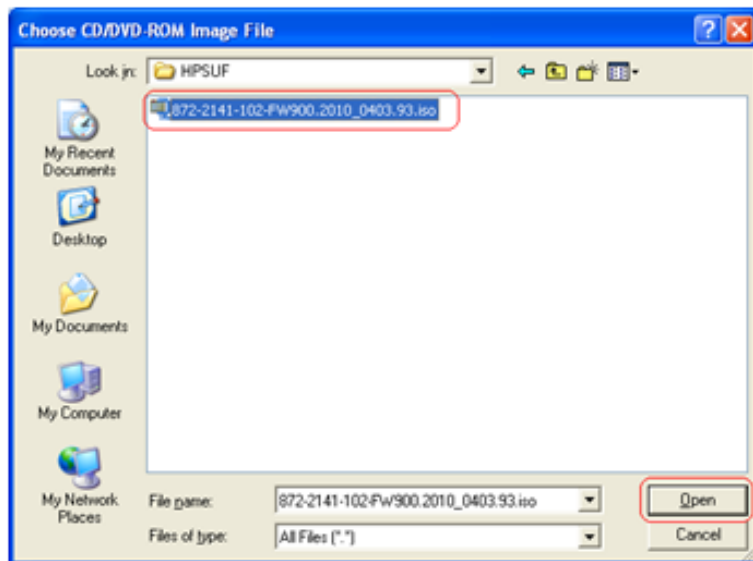

At the bottom of the remote console screen, the VirtualIM green highlighted drive icon displays.



Appendix F.2 Oracle X5-2/Netra X5-2/X6-2/X7-2 Servers (iLOM)

Procedure 87. Mount Oracle X5-2/Netra X5-2/X6-2/X7-2 Servers with ISO Image using iLOM

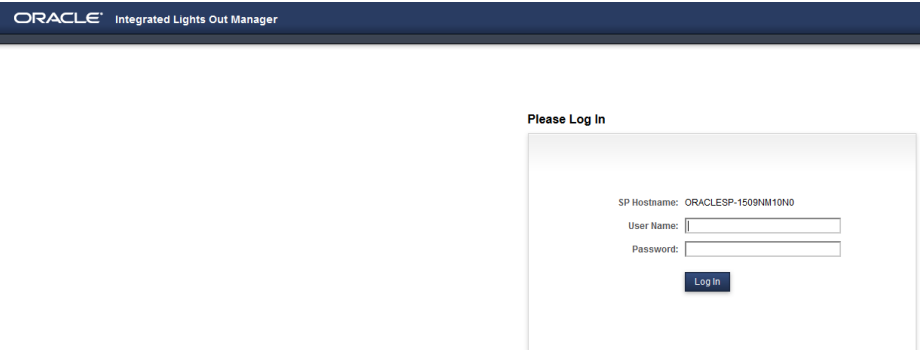
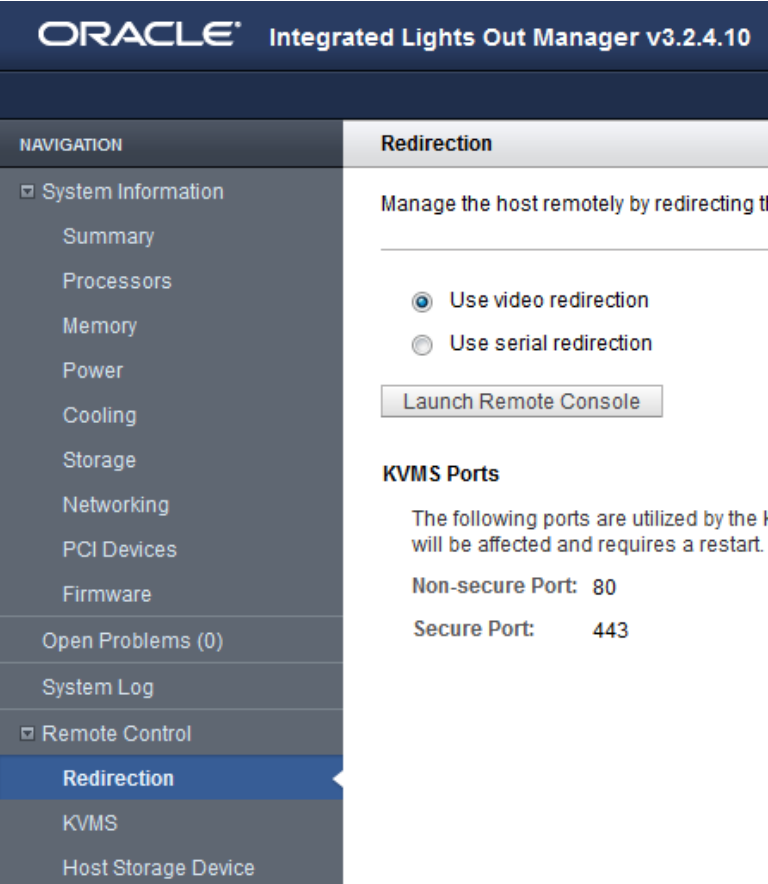
<p>S T E P #</p>	<p>This procedure attaches an ISO image to Oracle rack mount servers using the iLOM. Check off (✓) each step as it is completed. Boxes have been provided for this purpose under each step number. If this procedure fails, it is recommended to contact My Oracle Support (MOS) and ask for assistance.</p>	
<p>1. <input type="checkbox"/></p>	<p>Oracle X5-2/Netra X5-2/X6-2: Login</p>	<p>Log into the Oracle rack mount server iLOM.</p> 
<p>2. <input type="checkbox"/></p>	<p>Oracle X5-2/Netra X5-2/X6-2: Access the remote console</p>	<ol style="list-style-type: none"> 1. Navigate to Remote Control > Redirection. 2. Click Launch Remote Console. 

Procedure 87. Mount Oracle X5-2/Netra X5-2/X6-2/X7-2 Servers with ISO Image using iLOM

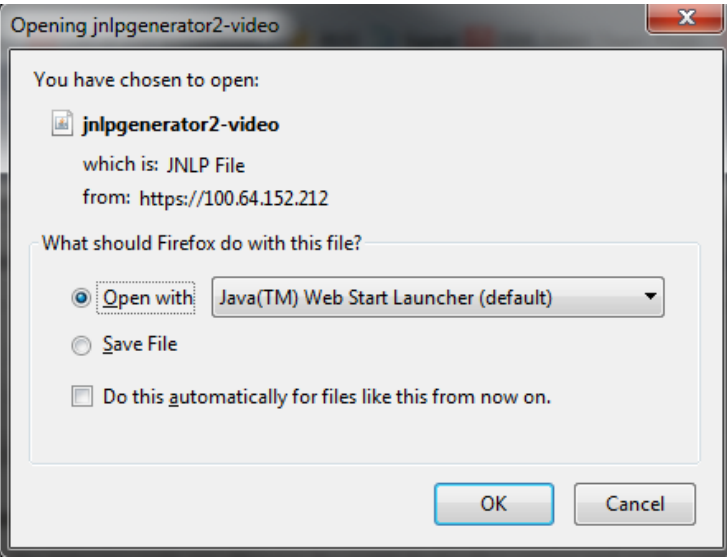
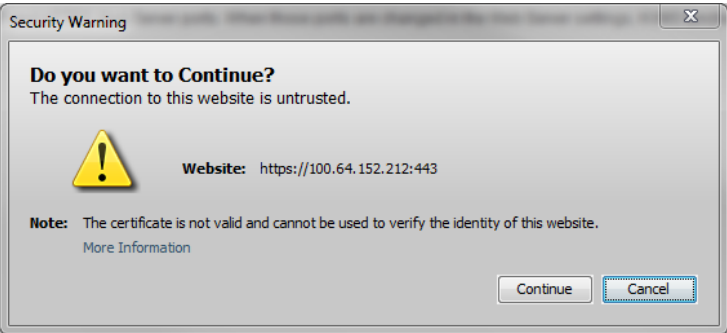
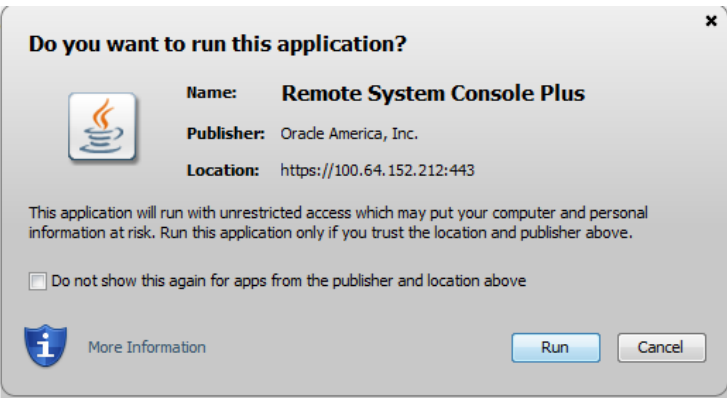
<p>3. <input type="checkbox"/></p>	<p>Oracle X5-2/Netra X5-2/X6-2/X7-2: Access the remote console</p>	<p>1. Click OK and open with Java Web Start Launcher.</p>  <p>2. Click Continue.</p>  <p>3. Click Run for any security warning prompts.</p> 
<p>4. <input type="checkbox"/></p>	<p>Oracle X5-2/Netra X5-2/X6-2/X7-2: Mount the ISO from the remote console</p>	<p>1. Navigate to KVMS > Storage.</p>

Procedure 87. Mount Oracle X5-2/Netra X5-2/X6-2/X7-2 Servers with ISO Image using iLOM

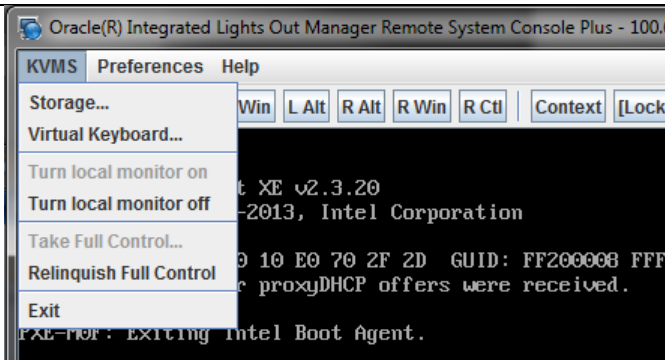

Note: If using a Windows 7 computer to configure the storage, ensure the **SSL Enabled** checkbox is NOT marked:

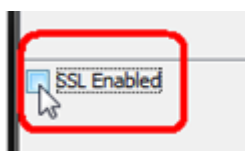

2. Click **Add** and browse to the ISO located on the local computer.

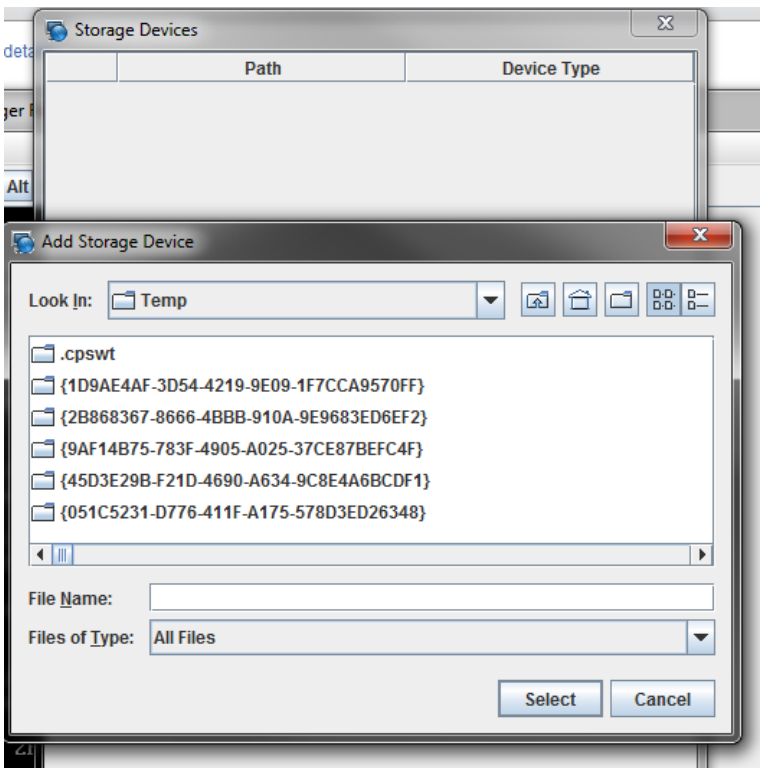

3. Click **Select**.

4. Once the ISO image is selected, click **Connect**.

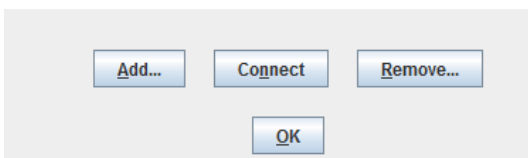

Procedure 87. Mount Oracle X5-2/Netra X5-2/X6-2/X7-2 Servers with ISO Image using iLOM

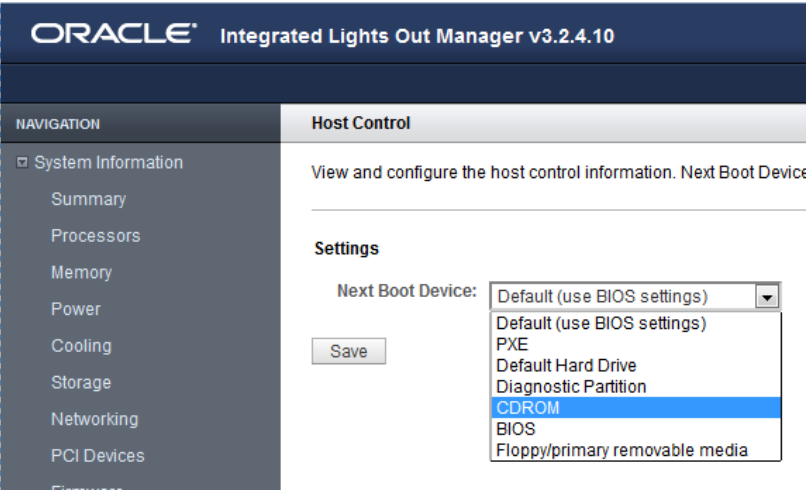
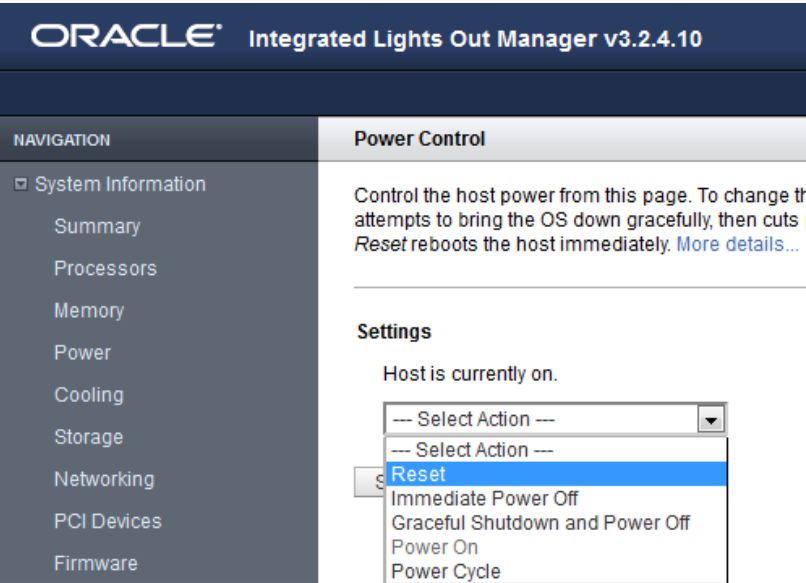
<p>5. <input type="checkbox"/></p>	<p>Oracle X5-2/Netra X5-2/X6-2/X7-2: Change the device for next boot</p>	<ol style="list-style-type: none"> Navigate to Host Management > Host Control. Select the CDROM option.  <ol style="list-style-type: none"> Click Save.
<p>6. <input type="checkbox"/></p>	<p>Oracle X5-2/Netra X5-2/X6-2/X7-2: Reboot the rack mount server to start the install</p>	<ol style="list-style-type: none"> Navigate to Host Management > Power Control. Select the Reset option.  <ol style="list-style-type: none"> Click Save. Confirm Save.

Appendix G. Configure TVOE iLO Access

Procedure 88. Connect to the TVOE iLO

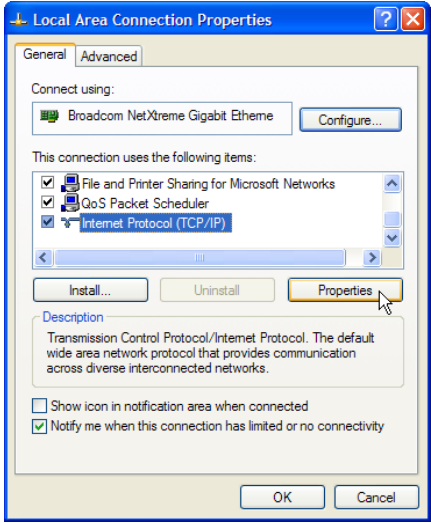
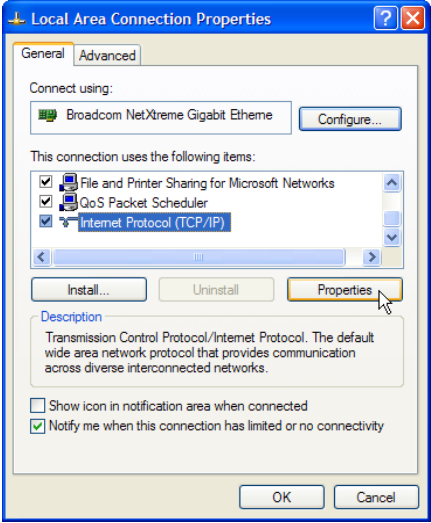
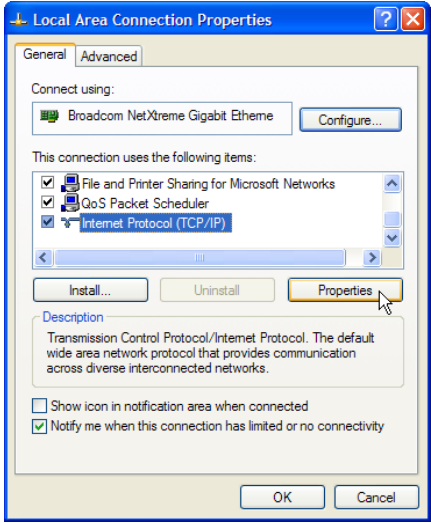
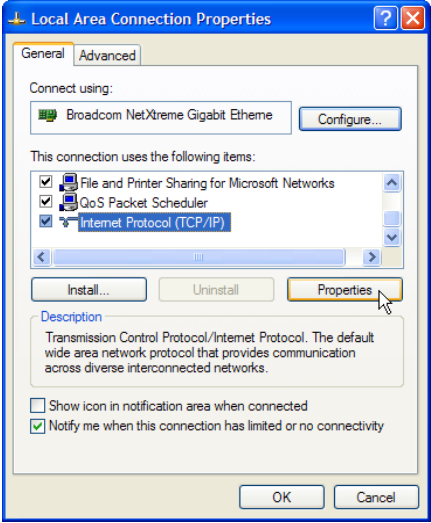
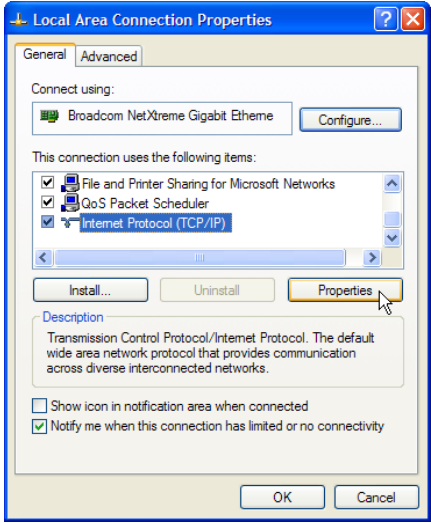
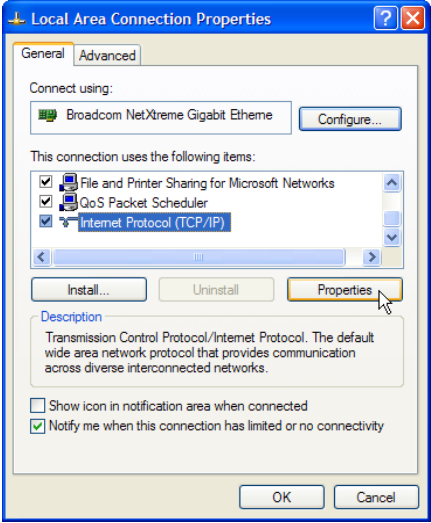
S T E P #	<p>This procedure connects a laptop to the TVOE iLO using a directly cabled ethernet connection. Check off (✓) each step as it is completed. Boxes have been provided for this purpose under each step number.</p> <p>If this procedure fails, it is recommended to contact My Oracle Support (MOS) and ask for assistance.</p>						
1. <input type="checkbox"/>	<table border="1" style="width: 100%; border-collapse: collapse;"> <thead> <tr> <th style="width: 30%;"></th> <th style="width: 35%; text-align: center;">Windows XP</th> <th style="width: 35%; text-align: center;">Windows 7</th> </tr> </thead> <tbody> <tr> <td style="vertical-align: top;"> <p>Access the laptop network interface cards TCP/IP Properties screen.</p> <p>Note: For this step, follow the procedure specific to the laptop's OS (XP or 7).</p> </td> <td style="vertical-align: top;"> <ol style="list-style-type: none"> 1. From the Control Panel, double click on Network Connections. 2. Right-click on the wired Ethernet Interface icon and click Properties. 3. Select Internet Protocol (TCP/IP). 4. Click Properties.  </td> <td style="vertical-align: top;"> <ol style="list-style-type: none"> 1. From the Control Panel, double click on Network and Sharing Center. 2. Select Change Adapter Settings (left menu). 3. Right-click on the Local Area Connection icon and select Properties. 4. Click Internet Protocol Version 4 (TCP/IPv4).  </td> </tr> </tbody> </table>		Windows XP	Windows 7	<p>Access the laptop network interface cards TCP/IP Properties screen.</p> <p>Note: For this step, follow the procedure specific to the laptop's OS (XP or 7).</p>	<ol style="list-style-type: none"> 1. From the Control Panel, double click on Network Connections. 2. Right-click on the wired Ethernet Interface icon and click Properties. 3. Select Internet Protocol (TCP/IP). 4. Click Properties. 	<ol style="list-style-type: none"> 1. From the Control Panel, double click on Network and Sharing Center. 2. Select Change Adapter Settings (left menu). 3. Right-click on the Local Area Connection icon and select Properties. 4. Click Internet Protocol Version 4 (TCP/IPv4). 
	Windows XP	Windows 7					
<p>Access the laptop network interface cards TCP/IP Properties screen.</p> <p>Note: For this step, follow the procedure specific to the laptop's OS (XP or 7).</p>	<ol style="list-style-type: none"> 1. From the Control Panel, double click on Network Connections. 2. Right-click on the wired Ethernet Interface icon and click Properties. 3. Select Internet Protocol (TCP/IP). 4. Click Properties. 	<ol style="list-style-type: none"> 1. From the Control Panel, double click on Network and Sharing Center. 2. Select Change Adapter Settings (left menu). 3. Right-click on the Local Area Connection icon and select Properties. 4. Click Internet Protocol Version 4 (TCP/IPv4). 					

Procedure 88. Connect to the TVOE iLO

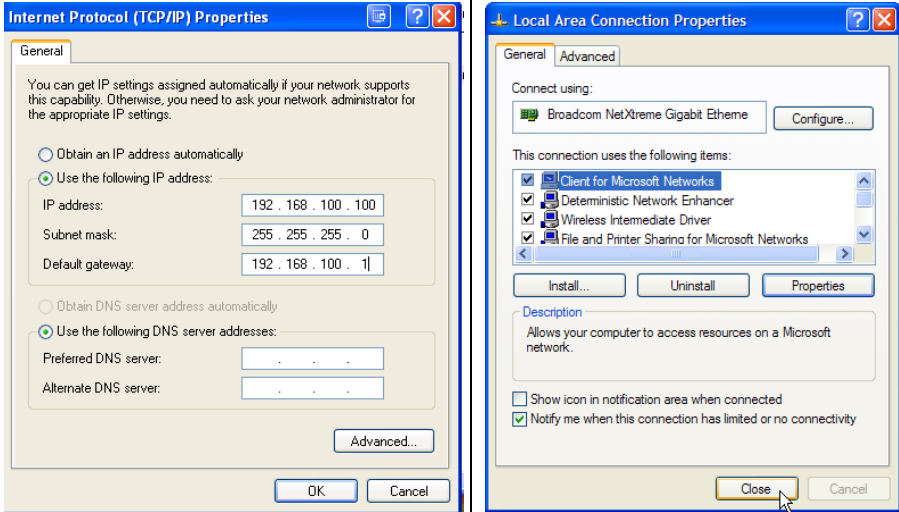
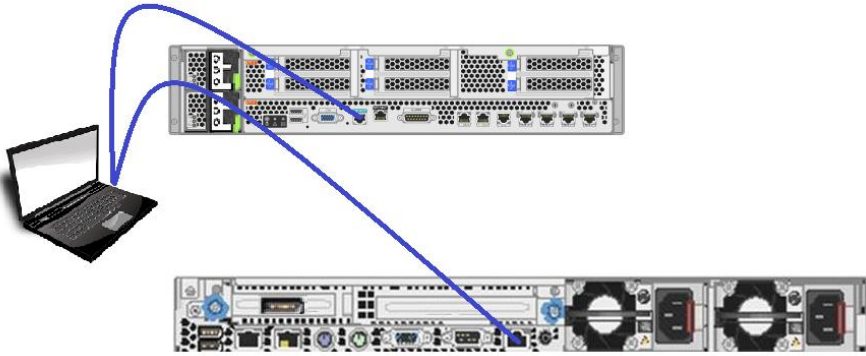
<p>2. <input type="checkbox"/></p>	<p>Set the IP properties</p>	<ol style="list-style-type: none"> 1. Click Use the following IP address. 2. Set the IP address to 192.168.100.100. 3. Set the Subnet mask to 255.255.255.0. 4. Set the Default gateway to 192.168.100.1. 5. Click OK. 6. Click Close from the network interface card's main Properties screen. 
<p>3. <input type="checkbox"/></p>	<p>Connect the laptop's Ethernet port directly to the TVOE iLO port using a standard Cat-5 cross-over cable</p>	

Appendix H. SNMP Configuration

Procedure 89. Configure SNMP

S T E P #	<p>This workaround configures SNMP with SNMPv2c and SNMPv3 as the enabled versions for SNMP traps configuration since PMAC does not support SNMPv3.</p> <p>Check off (✓) each step as it is completed. Boxes have been provided for this purpose under each step number.</p> <p>If this procedure fails, it is recommended to contact My Oracle Support (MOS) and ask for assistance.</p>	
1. <input type="checkbox"/>	<p>NOAM VIP GUI: Login</p>	<p>Note: This workaround step should be performed only in these cases:</p> <ul style="list-style-type: none"> • If SNMP is not configured. • If SNMP is already configured and SNMPv3 is selected as enabled version. <p>Note: This is a workaround step to configure SNMP with 'SNMPv2c and SNMPv3' as the enabled versions for SNMP Traps configuration, since PMAC does not support SNMPv3.</p> <ol style="list-style-type: none"> 1. Establish a GUI session on the NOAM server using the VIP IP address of the NOAM server. 2. Open the web browser and enter a URL of: <div style="border: 1px solid black; padding: 2px; width: fit-content; margin: 5px auto;">https://<Primary_NOAM_VIP_IP_Address></div> 3. Log into the NOAM GUI as the guiadmin user: <div style="text-align: center; margin: 10px 0;">  </div> <div style="text-align: center;"> <p>Oracle System Login Tue Jun 7 13:49:06 2016 EDT</p> <hr/> <div style="border: 1px solid gray; padding: 10px; width: 80%; margin: auto;"> <p style="text-align: center;">Log In Enter your username and password to log in</p> <p style="text-align: center;">Username: <input style="width: 100%;" type="text"/></p> <p style="text-align: center;">Password: <input style="width: 100%;" type="password"/></p> <p style="text-align: center;"><input type="checkbox"/> Change password</p> <p style="text-align: center;"><input type="button" value="Log In"/></p> </div> <p style="font-size: small; text-align: center;">Unauthorized access is prohibited. This Oracle system requires the use of Microsoft Internet Explorer 9.0, 10.0, or 11.0 with support for JavaScript and cookies.</p> <hr/> <p style="font-size: x-small; text-align: center;">Oracle and Java are registered trademarks of Oracle Corporation and/or its affiliates. Other names may be trademarks of their respective owners.</p> <p style="font-size: x-small; text-align: center;">Copyright © 2010, 2016, Oracle and/or its affiliates. All rights reserved.</p> </div>
2. <input type="checkbox"/>	<p>NOAM VIP GUI: Configure system-wide SNMP trap</p>	<ol style="list-style-type: none"> 1. Navigate to Administration > Remote Servers > SNMP Trapping.

Procedure 89. Configure SNMP

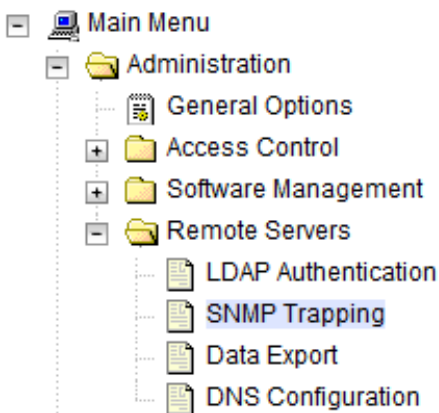
<p>receiver(s)</p>	<div style="border: 1px solid black; padding: 5px;">  <p>2. Select the Server Group tab for SNMP trap configuration.</p> <p>Main Menu: Administration -> Remote Servers</p> <p>Info* ▼</p> <p>ZombieDRNOAM ZombieNOAM ZombieSOAM</p> <p>Name</p> <p>3. Type the IP address or hostname of the Network Management Station (NMS) where you want to forward traps. This IP should be reachable from the NOAMP's XMI network. If already configured SNMP with SNMPv3 as enabled version, another server needs to be configured here.</p> <p>4. Continue to fill in additional secondary, tertiary, etc., Manager IPs in the corresponding slots if desired.</p> <p>SNMP Trap Configuration Insert for ZombieNOAM</p> <table border="1" style="width: 100%; border-collapse: collapse;"> <tr> <td style="width: 60%; padding: 5px;">Configuration Mode *</td> <td style="padding: 5px;"> <input checked="" type="radio"/> Global <input type="radio"/> Per-site </td> </tr> <tr> <td style="padding: 5px;">Manager 1</td> <td style="padding: 5px;"><input style="width: 100%;" type="text"/></td> </tr> <tr> <td style="padding: 5px;">Manager 2</td> <td style="padding: 5px;"><input style="width: 100%;" type="text"/></td> </tr> </table> <p>5. Set the Enabled Versions as SNMPv2c and SNMPv3.</p> <p>Enabled Versions <input style="border: 1px solid gray;" type="text" value="SNMPv2c and SNMPv3"/></p> </div>	Configuration Mode *	<input checked="" type="radio"/> Global <input type="radio"/> Per-site	Manager 1	<input style="width: 100%;" type="text"/>	Manager 2	<input style="width: 100%;" type="text"/>
Configuration Mode *	<input checked="" type="radio"/> Global <input type="radio"/> Per-site						
Manager 1	<input style="width: 100%;" type="text"/>						
Manager 2	<input style="width: 100%;" type="text"/>						

Procedure 89. Configure SNMP

		<p>6. Check Traps Enabled checkboxes for the Manager servers being configured.</p> <div data-bbox="509 317 1110 512"> </div> <p>7. Type the SNMP Community Name.</p> <div data-bbox="509 583 1349 827"> </div> <p>8. Leave all other fields at their default values.</p> <p>9. Click OK.</p>
<p>3. <input type="checkbox"/></p>	<p>NOAMP VIP: Enable traps from individual servers (optional)</p>	<p>Note: By default SNMP traps from MPs are aggregated and displayed at the active NOAMP. If, instead, you want every server to send its own traps directly to the NMS, then execute this procedure.</p> <p>This procedure requires all servers, including MPs, to have an XMI interface on which the customer SNMP target server (NMS) is reachable.</p> <p>1. Navigate to Administration > Remote Servers > SNMP Trapping.</p> <div data-bbox="509 1171 954 1591"> </div> <p>2. Make sure the Enabled checkbox is marked.</p> <div data-bbox="509 1654 1230 1696"> </div> <p>3. Click Apply and verify the data is committed.</p>

Procedure 89. Configure SNMP

4. <input type="checkbox"/>	<p>PMAC GUI: Update the TVOE host SNMP community string</p>	<ol style="list-style-type: none"> 1. Establish an SSH session to the PMAC. 2. Login as admusr. 3. Update the TVOE hos community string with this command. <div style="border: 1px solid black; padding: 5px; margin: 5px 0;"> <pre>\$ sudo pmaccli setCommStr --accessType=rw --commStr=<site specific value></pre> </div> <p>Note: When this operation is initiated, all supporting TVOE hosting servers and the PMAC guest on the PMAC control network are updated. All those servers that match the existing Site Specific Community String are not updated again until the string name is changed.</p>
--------------------------------	--	--

Appendix I. Install NetBackup Client

NetBackup is a utility that manages backups and recovery of remote systems. The NetBackup suite is used to support disaster recovery at the customer site. These procedures install and configure the NetBackup client software on an application server using two methods: first, using platcfg; and second, using nbAutoInstall (push Configuration). The supported versions of NetBackup are 7.6, and 7.7.

Prerequisites:

- Application server platform installation has been completed.
- Site survey has been performed to determine the network requirements for the application server, and interfaces have been configured.
- NetBackup server is available to copy, sftp, the appropriate NetBackup Client software to the application server.

Appendix I.1 Install NetBackup Client Using platcfg

Execute this procedure to switch/migrate NetBackup installation using platcfg, instead of using NBAutoInstall (push configuration).

Procedure 90. Install NetBackup Client Using platcfg

S T E P #		<p>This procedure installs NetBackup using platcfg.</p> <p>Check off (✓) each step as it is completed. Boxes have been provided for this purpose under each step number.</p> <p>If this procedure fails, it is recommended to contact My Oracle Support (MOS) and ask for assistance.</p>
1. <input type="checkbox"/>	<p>Application Server iLO: Login</p>	<ol style="list-style-type: none"> 1. Login and launch the integrated remote console. 2. SSH to the application server (PMAC or NOAM) as admusr using the management network for the PMAC or XMI network for the NOAM.

Procedure 90. Install NetBackup Client Using platcfg

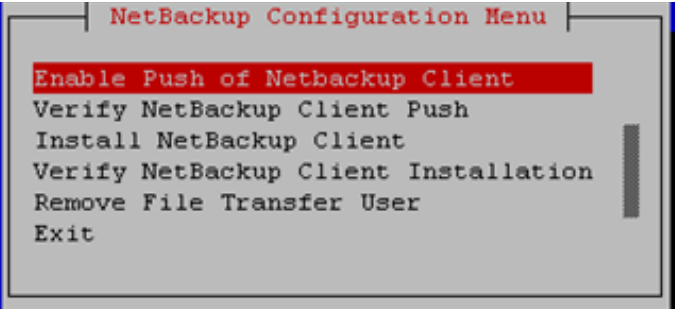
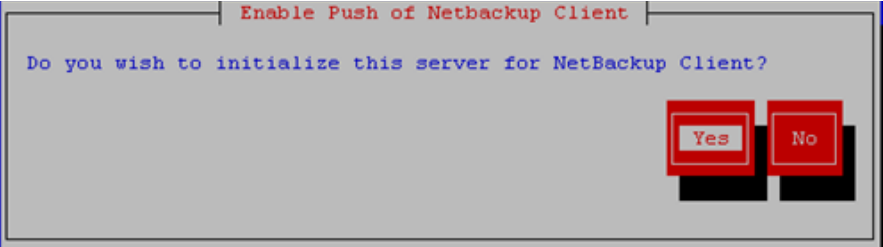
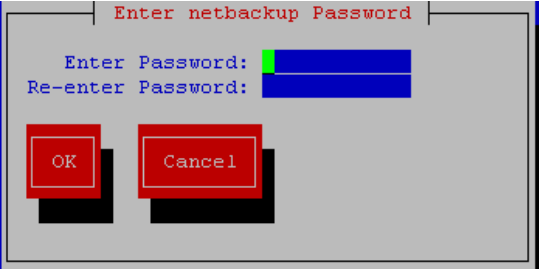
<p>2. <input type="checkbox"/></p>	<p>Application Server iLO: Navigate to NetBackup configuration</p>	<p>1. Enter the platcfg menu.</p> <pre style="border: 1px solid black; padding: 5px;">\$ sudo su - platcfg</pre> <p>2. Navigate to NetBackup > Configuration.</p> 
<p>3. <input type="checkbox"/></p>	<p>Application Server iLO: Enable push of NetBackup client</p>	<p>Navigate to NetBackup Configuration > Enable Push of NetBackup Client.</p> 
<p>4. <input type="checkbox"/></p>	<p>Application Server iLO: Enter NetBackup password</p>	<p>1. Enter the NetBackup password.</p>  <p>2. Select OK.</p> <p>3. If the version of NetBackup is 7.6.0.0 or greater, follow the instructions provided by the OSDC download for the version of NetBackup being pushed.</p>

Procedure 90. Install NetBackup Client Using platcfg

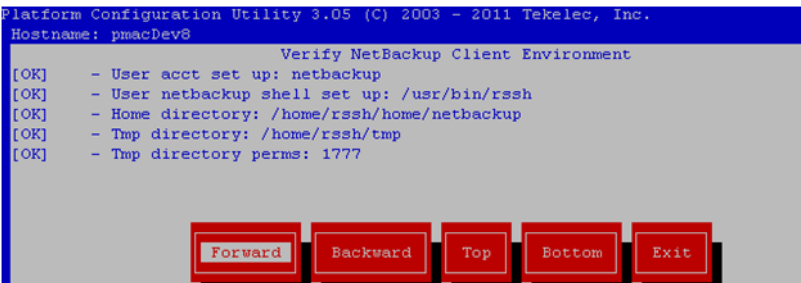
<p>5. <input type="checkbox"/></p>	<p>Application Server iLO: Verify NetBackup client software push is enabled</p>	<p>1. Navigate to NetBackup Configuration > Verify NetBackup Client Push.</p>  <p>2. Verify list entries indicate OK for NetBackup client software environment.</p> <p>3. Select Exit to return to NetBackup Configuration menu.</p>
<p>6. <input type="checkbox"/></p>	<p>NetBackup Server: Push appropriate NetBackup client software to application server</p>	<p>Notes:</p> <ul style="list-style-type: none"> The NetBackup server is not an application asset. Access to the NetBackup server and location path of the NetBackup Client software is under the control of the customer. These steps are required on the NetBackup server to push the NetBackup client software to the application server. These example steps assume the NetBackup server is executing in a Linux environment. The backup server is supported by the customer, and the backup utility software provider. If this procedural STEP, executed at the backup utility server, fails to execute successfully, STOP and contact the Customer Care Center of the backup and restore utility software provider being used at this site. <p>1. Log into the NetBackup server using password provided by customer.</p> <p>2. Navigate to the appropriate NetBackup Client software path.</p> <p>Example input:</p> <pre>\$ cd /usr/opensv/NetBackup/client/Linux/7.6</pre> <p>3. Execute the sftp_to_client NetBackup utility using the application IP address and application NetBackup user:</p>

Procedure 90. Install NetBackup Client Using platcfg

		<pre> \$./sftp_to_client <application IP> NetBackup Connecting to 192.168.176.31 NetBackup@192.168.176.31's password: Enter application server NetBackup user password; the following NetBackup software output is expected, observe the sftp completed successfully: File "/usr/opensv/NetBackup/client/Linux/6.5/.sizes" not found. Couldn't rename file "/tmp/bp.6211/sizes" to "/tmp/bp.6211/.sizes": No such file or directory File "/usr/opensv/NB-Java.tar.Z" not found. ./sftp_to_client: line 793: [: : integer expression expected ./sftp_to_client: line 793: [: : integer expression expected ./sftp_to_client: line 793: [: : integer expression expected ./sftp_to_client: line 793: [: : integer expression expected ./sftp_to_client: line 793: [: : integer expression expected ./sftp_to_client: line 793: [: : integer expression expected ./sftp_to_client: line 793: [: : integer expression expected ./sftp_to_client: line 793: [: : integer expression expected ./sftp_to_client: line 793: [: : integer expression expected ./sftp_to_client: line 793: [: : integer expression expected ./sftp_to_client: line 793: [: : integer expression expected ./sftp_to_client: line 793: [: : integer expression expected sftp completed successfully. </pre> <p>4. The user on 192.168.176.31 must execute this command.</p> <pre> \$ sh /tmp/bp.6211/client_config [-L] </pre> <p>Notes:</p> <ul style="list-style-type: none"> • Although the command executed above instructs you to execute the client_config command, DO NOT execute that command since it is executed by platcfg in the next step. • The optional argument, -L, is used to avoid modification of the client's current bp.conf file.
--	--	--

Procedure 90. Install NetBackup Client Using platcfg

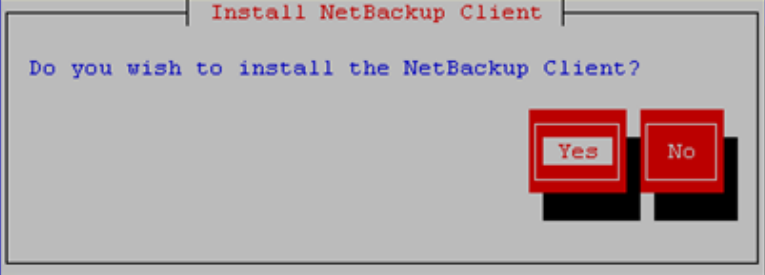
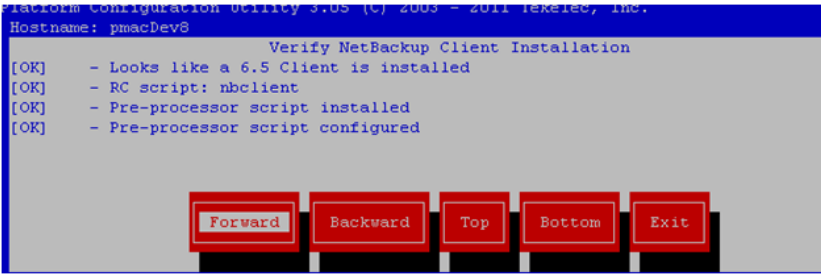
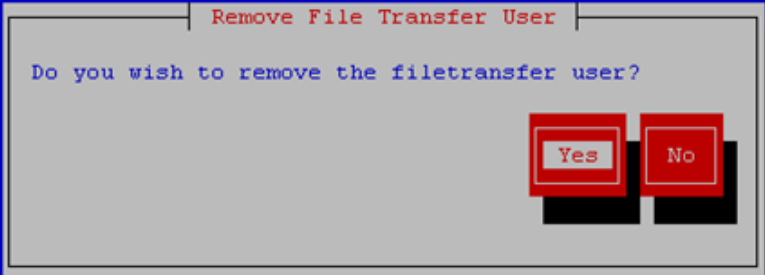
<p>7. <input type="checkbox"/></p>	<p>Application server iLO: Install NetBackup client software on application server</p>	<p>1. Execute the command.</p> <pre style="border: 1px solid black; padding: 5px;">\$ sudo chmod 555 /var/TKLC/home/rssh/tmp/client_config</pre> <p>where NETBACKUP_BIN is the temporary directory where the NetBackup client install programs were copied in step 5. The directory should look similar to /tmp/bp.XXXX/.</p> <p>2. Navigate to NetBackup Configuration > Install NetBackup Client.</p>  <p>3. Verify list entries indicate OK for NetBackup client software installation.</p> <p>4. Click Exit to return to NetBackup Configuration menu.</p>
<p>8. <input type="checkbox"/></p>	<p>Application Server iLO: Verify NetBackup client software installation on the application server</p>	<p>1. Navigate to NetBackup Configuration > Verify NetBackup Client Installation.</p>  <p>2. Verify list entries indicate OK for NetBackup Client software installation.</p> <p>3. Click Exit to return to NetBackup Configuration menu.</p>
<p>9. <input type="checkbox"/></p>	<p>Application Server iLO: Disable NetBackup client software transfer to the application server</p>	<p>1. Navigate to NetBackup Configuration > Remove File Transfer User.</p>  <p>2. Click Yes to remove the NetBackup file transfer user from the application server.</p>

Procedure 90. Install NetBackup Client Using platcfg

10. <input type="checkbox"/>	Application Server iLO: Exit platform configuration utility (platcfg)	Exit out of platcfg by selecting Exit .
11. <input type="checkbox"/>	Application Server iLO: Verify server bp.conf file	Verify the server has been added to the /usr/opensv/NetBackup/bp.conf file. <pre data-bbox="505 457 1382 569">\$ sudo cat /usr/opensv/NetBackup/bp.conf CLIENT_NAME = 10.240.34.10 SERVER = NB71server</pre>

Procedure 90. Install NetBackup Client Using platcfg

12. **Application Server iLO:** Use platform configuration utility (platcfg) to modify hosts file with NetBackup server alias

Note: After the successful transfer and installation of the NetBackup client software the NetBackup servers hostname can be found in the NetBackup `/usr/opensv/NetBackup/bp.conf` file, identified by the SERVER configuration parameter.

1. The NetBackup server hostname and IP address must be added to the application server's host's file. List the NetBackup server's hostname.

```
$ sudo cat /usr/opensv/NetBackup/bp.conf
SERVER = nb70server
CLIENT_NAME = pmacDev8
```

2. Enter the platcfg menu to update application hosts file with the NetBackup Server alias.

```
$ sudo su - platcfg
```

3. Navigate to **Network Configuration > Modify Hosts File.**
4. Click **Edit.**

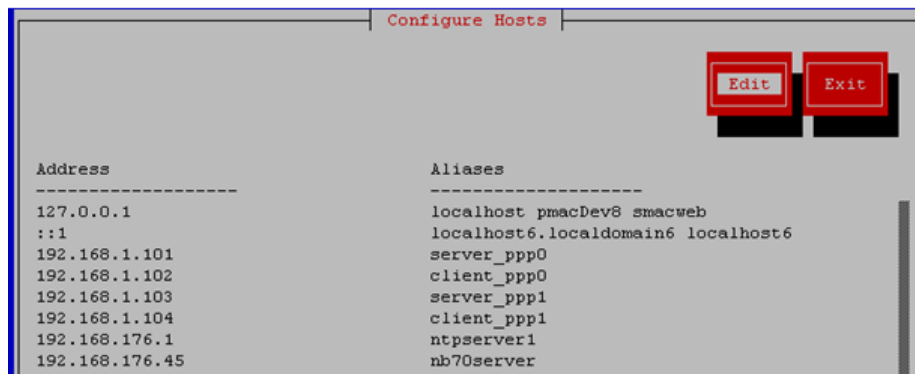

5. Click **Add Host.**

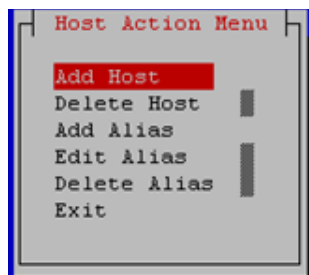

6. Enter the appropriate data and click **OK.**

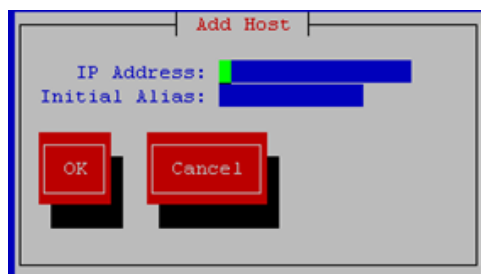

7. Confirm the host alias addition and exit the Platform Configuration Utility.

Procedure 90. Install NetBackup Client Using platcfg

13. <input type="checkbox"/>	Application Server iLO: Create links to NetBackup client notify scripts on application server where NetBackup expects to find them	Copy the notify scripts from appropriate path on application server for given application. <div style="border: 1px solid black; padding: 5px; margin: 5px 0;"> <pre>\$ sudo ln -s <path>/bpstart_notify /usr/opensv/NetBackup/bin/bpstart_notify \$ sudo ln -s <path>/bpend_notify /usr/opensv/NetBackup/bin/bpend_notify</pre> </div> An example of <path> is /usr/TKLC/appworks/sbin .
---------------------------------	--	--

Appendix I.2 Install NetBackup Client Using NBAutoInstall

Execute this procedure to switch/migrate NetBackup installation using NBAutoInstall (push configuration), instead of manual installation using platcfg.

Notes:

- Skip this procedure for DSR 8.2 VE DSR Deployment on X7-2.
- This procedure enables TPD to automatically detect when a NetBackup Client is installed and then completes TPD related tasks needed for an effective NetBackup Client operation. With this procedure, the NetBackup Client installation (pushing the client and performing the installation) is the responsibility of the customer and is not covered in this procedure

Procedure 91. Install NetBackup Client Using NBAutoInstall

S T E P #	This procedure installs NetBackup using NBAutoInstall. Check off (✓) each step as it is completed. Boxes have been provided for this purpose under each step number. If this procedure fails, it is recommended to contact My Oracle Support (MOS) and ask for assistance.	
1. <input type="checkbox"/>	Application Server iLO: Login	1. Login and launch the integrated remote console. 2. SSH to the application server (PMAC or NOAM) as admusr using the management network for the PMAC or XMI network for the NOAM.
2. <input type="checkbox"/>	Application Server iLO: Enable nbAutoInstall	<div style="border: 1px solid black; padding: 5px;"> <pre>\$ sudo /usr/TKLC/plat/bin/nbAutoInstall --enable</pre> </div>
3. <input type="checkbox"/>	Application Server iLO: Create links to NetBackup client notify scripts on the application server where NetBackup expects to find them	<div style="border: 1px solid black; padding: 5px;"> <pre>\$ sudo mkdir -p /usr/opensv/NetBackup/bin/ \$ sudo ln -s <path>/bpstart_notify /usr/opensv/NetBackup/bin/bpstart_notify \$ sudo ln -s <path>/bpend_notify /usr/opensv/NetBackup/bin/bpend_notify</pre> </div> An example of <path> is /usr/TKLC/appworks/sbin .

Procedure 91. Install NetBackup Client Using NBAutoInstall

<p>4. <input type="checkbox"/></p> <p>Application Server iLO: Verify NetBackup configuration file</p>	<p>1. Open <code>/usr/opensv/NetBackup/bp.conf</code> and make sure it points to the NetBackup server.</p> <pre style="border: 1px solid black; padding: 5px;">\$ sudo vi /usr/opensv/NetBackup/bp.conf SERVER = nb75server CLIENT_NAME = 10.240.10.185 CONNECT_OPTIONS = localhost 1 0 2</pre> <p>Note: Verify the server name matches the NetBackup server, and verify the CLIENT_NAME matches the hostname or IP of the local client machine. If they do not, update them as necessary.</p> <p>2. Edit <code>/etc/hosts</code> and add the NetBackup server.</p> <pre style="border: 1px solid black; padding: 5px;">\$ sudo vi /etc/hosts e.g.: 192.168.176.45 nb75server</pre> <p>Note: The server now periodically checks for a new version of the NetBackup client and performs necessary TPD configuration accordingly.</p> <p>3. At any time, you can push and install a new version of the NetBackup client.</p>
--	---

Appendix I.3 Create NetBackup Client Configuration File**Procedure 92. Create NetBackup Client Configuration File**

<p>S T E P #</p>	<p>This procedure copies a NetBackup Client config file into the appropriate location on the TPD based application server. This config file installs previously unsupported versions of NetBackup Client by providing necessary information to TPD.</p> <p>Note: Skip this procedure for DSR 8.2 VE deployments.</p> <p>Check off (✓) each step as it is completed. Boxes have been provided for this purpose under each step number.</p> <p>If this procedure fails, it is recommended to contact My Oracle Support (MOS) and ask for assistance.</p>
<p>1. <input type="checkbox"/></p> <p>Application Server iLO: Create NetBackup config File</p>	<p>Create the NetBackup client config file on the server using the contents that were previously determined. The config file should be placed in the <code>/usr/TKLC/plat/etc/NetBackup/profiles</code> directory and should follow this naming convention:</p> <p style="padding-left: 40px;"><code>NB\$ver.conf</code></p> <p>where \$ver is the client version number with the periods removed. For the 7.5 client, the value of \$ver would be 75 and the full path to the file would be:</p> <p style="padding-left: 40px;"><code>/usr/TKLC/plat/etc/NetBackup/profiles/NB75.conf</code></p> <p>Note: The config files must start with NB and must have a suffix of .conf.</p> <p>The server is now capable of installing the corresponding NetBackup Client.</p>

Procedure 92. Create NetBackup Client Configuration File



2. <input type="checkbox"/>	Application Server iLO: Create NetBackup config script	<p>Create the NetBackup client config script file on the server using the contents that were previously determined. The config script file should be placed in the /usr/TKLC/plat/etc/NetBackup/scripts directory. The name of the NetBackup Client config script file should be determined from the contents of the NetBackup Client config file.</p> <p>As an example for the NetBackup 7.5 client:</p> <p>NetBackup Client config: /usr/TKLC/plat/etc/NetBackup/profiles/NB75.conf</p> <p>NetBackup Client config script: /usr/TKLC/plat/etc/NetBackup/scripts/NB75</p>
--------------------------------	--	---

Appendix I.4 Configure PMAC Application NetBackup Virtual Disk

Procedure 93. Configure PMAC Application NetBackup Virtual Disk

S T E P #	<p>This procedure configures the PMAC application guest NetBackup virtual disk. Check off (✓) each step as it is completed. Boxes have been provided for this purpose under each step number. If this procedure fails, it is recommended to contact My Oracle Support (MOS) and ask for assistance.</p>	
1. <input type="checkbox"/>	PMAC GUI: Login	<p>1. Open the web browser and navigate to the PMAC GUI:</p> <div style="border: 1px solid gray; padding: 5px; margin: 5px 0;"> http://<PMAC_network_IP> </div> <p>2. Login as the guiadmin user.</p> <div style="text-align: center; margin: 20px 0;">  </div> <div style="text-align: center; margin: 10px 0;"> Oracle System Login Tue Jun 7 13:49:06 2016 EDT </div> <div style="border: 1px solid gray; padding: 10px; margin: 10px auto; width: 80%;"> <p style="text-align: center;">Log In</p> <p style="text-align: center;">Enter your username and password to log in</p> <p style="text-align: center;">Username: <input style="width: 100%;" type="text"/></p> <p style="text-align: center;">Password: <input style="width: 100%;" type="password"/></p> <p style="text-align: center;"><input type="checkbox"/> Change password</p> <p style="text-align: center;"><input type="button" value="Log In"/></p> </div> <p style="font-size: small; text-align: center; margin-top: 10px;">Unauthorized access is prohibited. This Oracle system requires the use of Microsoft Internet Explorer 9.0, 10.0, or 11.0 with support for JavaScript and cookies.</p> <p style="font-size: x-small; text-align: center; margin-top: 10px;">Oracle and Java are registered trademarks of Oracle Corporation and/or its affiliates. Other names may be trademarks of their respective owners.</p> <p style="font-size: x-small; text-align: center; margin-top: 10px;">Copyright © 2010, 2016, Oracle and/or its affiliates. All rights reserved.</p>

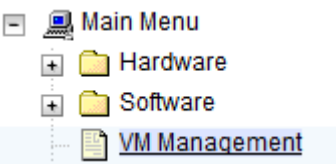
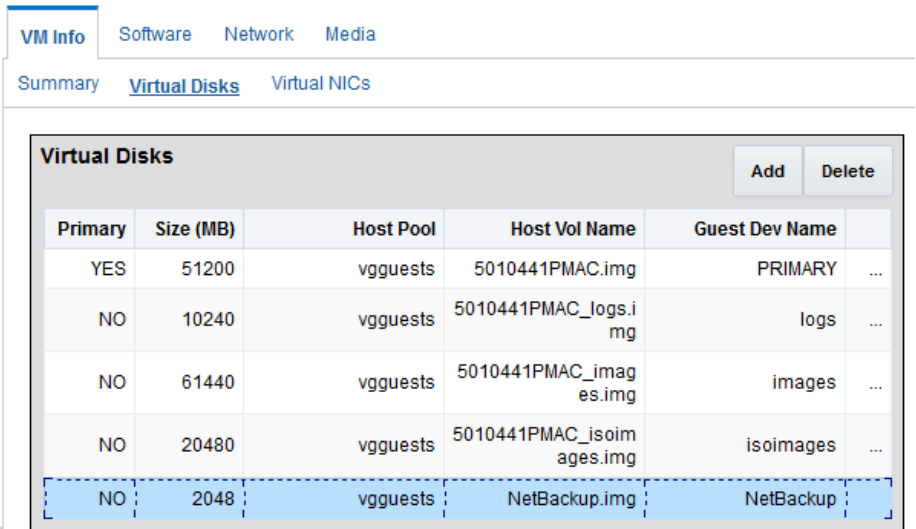
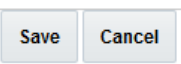
Procedure 93. Configure PMAC Application NetBackup Virtual Disk

<p>2. <input type="checkbox"/> PMAC GUI: Create NetBackup virtual disk</p>	<p>1. Navigate to VM Management.</p>  <p>2. Click Edit and enter this data for the new NetBackup virtual disk.</p> <p>Size (MB): 2048 Host Pool: vgguests Host Vol Name: <pmacGuestName>_NetBackup.img Guest Dev Name: NetBackup</p> <p>Edit guest 5010441PMAC</p>  <p>3. Click Save to continue.</p>  <p>4. Click OK to confirm.</p> <p>Changes to the PMAC guest: 5010441PMAC will not take effect until after the next power cycle. Do you wish to continue?</p> 
---	---

Procedure 93. Configure PMAC Application NetBackup Virtual Disk

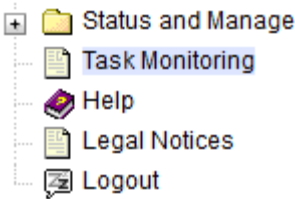
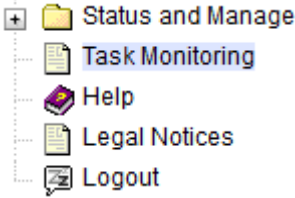
<p>3. <input type="checkbox"/></p>	<p>PMAC GUI: Verify NetBackup virtual disk</p>	<p>Confirm the Edit VM Guest task has completed successfully.</p> <ol style="list-style-type: none"> Navigate to Task Monitoring.  <ol style="list-style-type: none"> Confirm the guest edit task has completed successfully. <p>Main Menu: Task Monitoring</p> <p>Filter* ▼</p> <table border="1"> <thead> <tr> <th>ID</th> <th>Task</th> <th>Target</th> <th>Status</th> </tr> </thead> <tbody> <tr> <td>1459</td> <td>Edit Guest</td> <td>RMS: pc5010441 Guest: 5010441PMAC</td> <td>Guest editing completed (5010441PMAC)</td> </tr> </tbody> </table>	ID	Task	Target	Status	1459	Edit Guest	RMS: pc5010441 Guest: 5010441PMAC	Guest editing completed (5010441PMAC)																																																																								
ID	Task	Target	Status																																																																															
1459	Edit Guest	RMS: pc5010441 Guest: 5010441PMAC	Guest editing completed (5010441PMAC)																																																																															
<p>4. <input type="checkbox"/></p>	<p>PMAC GUI: Verify In-Progress tasks</p>	<ol style="list-style-type: none"> Navigate to Task Monitoring.  <ol style="list-style-type: none"> If any tasks show as in-progress (blue), then wait for the task to complete before going to the next step. <table border="1"> <tbody> <tr> <td>1455</td> <td>Backup PM&C</td> <td></td> <td>PM&C Backup successful</td> <td>COMPLETE</td> <td>N/A</td> <td>0:00:15</td> <td>2016-08-10 05:00:02</td> </tr> <tr> <td>1454</td> <td>Run Script</td> <td>RMS: pc5010439</td> <td>Script execution success</td> <td>COMPLETE</td> <td></td> <td>0:00:12</td> <td>2016-08-09 16:47:03</td> </tr> <tr> <td>1453</td> <td>File Transfer</td> <td>RMS: pc5010439</td> <td>File transfer success</td> <td>COMPLETE</td> <td></td> <td>0:00:03</td> <td>2016-08-09 16:46:47</td> </tr> <tr> <td>1452</td> <td>Accept</td> <td>RMS: pc5010439 Guest: Zombie_SDSQSVR1</td> <td>Success</td> <td>COMPLETE</td> <td>N/A</td> <td>0:01:04</td> <td>2016-08-09 16:45:30</td> </tr> <tr> <td>1451</td> <td>Upgrade</td> <td>RMS: pc5010439 Guest: Zombie_SDSQSVR1</td> <td>Success</td> <td>COMPLETE</td> <td></td> <td>0:07:22</td> <td>2016-08-09 16:36:53</td> </tr> <tr> <td>1450</td> <td>Accept</td> <td>RMS: pc5010441 Guest: Zombie_DSRNOAM1</td> <td>Success</td> <td>COMPLETE</td> <td>N/A</td> <td>0:01:07</td> <td>2016-08-09 16:22:28</td> </tr> <tr> <td>1449</td> <td>Accept</td> <td>RMS: pc5010441 Guest: Zombie_DSRNOAM1</td> <td>Success</td> <td>COMPLETE</td> <td>N/A</td> <td>0:01:07</td> <td>2016-08-09 16:22:28</td> </tr> <tr> <td>1448</td> <td>Accept</td> <td>RMS: pc5010441 Guest: ZombieDR_DSRDRNOAM1</td> <td>Success</td> <td>COMPLETE</td> <td>N/A</td> <td>0:01:09</td> <td>2016-08-09 16:22:27</td> </tr> <tr> <td>1447</td> <td>Accept</td> <td>RMS: pc5010441 Guest: 5010441PMAC</td> <td>Success</td> <td>COMPLETE</td> <td>N/A</td> <td>0:01:07</td> <td>2016-08-09 16:22:27</td> </tr> <tr> <td>1446</td> <td>Accept</td> <td>RMS: pc5010441</td> <td>Success</td> <td>COMPLETE</td> <td>N/A</td> <td>0:01:09</td> <td>2016-08-09 16:22:27</td> </tr> </tbody> </table> <p style="text-align: right;"> <input type="button" value="Delete Completed"/> <input type="button" value="Delete Failed"/> <input type="button" value="Delete Selected"/> </p> <p>Note: If desired, you can delete all of the Complete and Failed tasks using the Delete Completed and Delete Failed buttons. This leaves only the in-progress tasks.</p>	1455	Backup PM&C		PM&C Backup successful	COMPLETE	N/A	0:00:15	2016-08-10 05:00:02	1454	Run Script	RMS: pc5010439	Script execution success	COMPLETE		0:00:12	2016-08-09 16:47:03	1453	File Transfer	RMS: pc5010439	File transfer success	COMPLETE		0:00:03	2016-08-09 16:46:47	1452	Accept	RMS: pc5010439 Guest: Zombie_SDSQSVR1	Success	COMPLETE	N/A	0:01:04	2016-08-09 16:45:30	1451	Upgrade	RMS: pc5010439 Guest: Zombie_SDSQSVR1	Success	COMPLETE		0:07:22	2016-08-09 16:36:53	1450	Accept	RMS: pc5010441 Guest: Zombie_DSRNOAM1	Success	COMPLETE	N/A	0:01:07	2016-08-09 16:22:28	1449	Accept	RMS: pc5010441 Guest: Zombie_DSRNOAM1	Success	COMPLETE	N/A	0:01:07	2016-08-09 16:22:28	1448	Accept	RMS: pc5010441 Guest: ZombieDR_DSRDRNOAM1	Success	COMPLETE	N/A	0:01:09	2016-08-09 16:22:27	1447	Accept	RMS: pc5010441 Guest: 5010441PMAC	Success	COMPLETE	N/A	0:01:07	2016-08-09 16:22:27	1446	Accept	RMS: pc5010441	Success	COMPLETE	N/A	0:01:09	2016-08-09 16:22:27
1455	Backup PM&C		PM&C Backup successful	COMPLETE	N/A	0:00:15	2016-08-10 05:00:02																																																																											
1454	Run Script	RMS: pc5010439	Script execution success	COMPLETE		0:00:12	2016-08-09 16:47:03																																																																											
1453	File Transfer	RMS: pc5010439	File transfer success	COMPLETE		0:00:03	2016-08-09 16:46:47																																																																											
1452	Accept	RMS: pc5010439 Guest: Zombie_SDSQSVR1	Success	COMPLETE	N/A	0:01:04	2016-08-09 16:45:30																																																																											
1451	Upgrade	RMS: pc5010439 Guest: Zombie_SDSQSVR1	Success	COMPLETE		0:07:22	2016-08-09 16:36:53																																																																											
1450	Accept	RMS: pc5010441 Guest: Zombie_DSRNOAM1	Success	COMPLETE	N/A	0:01:07	2016-08-09 16:22:28																																																																											
1449	Accept	RMS: pc5010441 Guest: Zombie_DSRNOAM1	Success	COMPLETE	N/A	0:01:07	2016-08-09 16:22:28																																																																											
1448	Accept	RMS: pc5010441 Guest: ZombieDR_DSRDRNOAM1	Success	COMPLETE	N/A	0:01:09	2016-08-09 16:22:27																																																																											
1447	Accept	RMS: pc5010441 Guest: 5010441PMAC	Success	COMPLETE	N/A	0:01:07	2016-08-09 16:22:27																																																																											
1446	Accept	RMS: pc5010441	Success	COMPLETE	N/A	0:01:09	2016-08-09 16:22:27																																																																											

Procedure 93. Configure PMAC Application NetBackup Virtual Disk

<p>5. <input type="checkbox"/></p>	<p>Management Server TVOE iLO/iLOM: SSH into the management server</p>	<p>3. Using an SSH client such as putty, ssh to the TVOE host as admusr.</p> <p>4. Login using virsh and wait until you see the login prompt:</p> <pre style="border: 1px solid black; padding: 5px;">\$ sudo /usr/bin/virsh list Id Name State ----- 1 myTPD running 2 PM&C running</pre> <pre style="border: 1px solid black; padding: 5px;">\$ sudo /usr/bin/virsh console <PM&C> [Output Removed] Starting ntdMgr: [OK] Starting atd: [OK] 'TPD Up' notification(s) already sent: [OK] upstart: Starting tpdProvd... upstart: tpdProvd started. CentOS release 6.2 (Final) Kernel 2.6.32-220.17.1.el6prere16.0.0_80.14.0.x86_64 on an x86_64 PM&Cdev7 login:</pre>
<p>6. <input type="checkbox"/></p>	<p>PMAC: Shut down the PMAC guest</p>	<p>Assuming no in-progress tasks exist, it is safe to shut down the PMAC guest. Execute this command.</p> <pre style="border: 1px solid black; padding: 5px;">[admusr@pmac ~]\$ sudo /usr/bin/halt -p Broadcast message from root@pmacDev901 (/dev/ttyS0) at 11:20 ... The system is going down for power off NOW!</pre> <p>Eventually the virsh console session is closed and you are returned to the TVOE host command prompt.</p> <pre>Halting system... Power down. [admusr@tvoe ~]\$</pre>
<p>7. <input type="checkbox"/></p>	<p>Management Server TVOE iLO/iLOM: Verify PMAC guest is shut down</p>	<p>1. From the TVOE host command prompt, execute this command.</p> <pre style="border: 1px solid black; padding: 5px;">[admusr@tvoe ~]\$ sudo /usr/bin/virsh list --all Id Name State ----- - pmac shut off</pre> <p>This displays the guest state as shut off.</p> <p>2. Make sure all guests are in the shut off state.</p>

Procedure 93. Configure PMAC Application NetBackup Virtual Disk

8.	<input type="checkbox"/> Management Server TVOE iLO/iLOM: Start the PMAC guest	<pre> \$ sudo /usr/bin/virsh virsh # list --all Id Name State ----- 20 pmacU14-1 shut off virsh # start pmacU14-1 Domain pmacU14-1 started virsh # list --all Id Name State ----- 20 pmacU14-1 running </pre>	
----	---	---	--

Appendix J. List of Frequently Used Time Zones

This table lists several valid time zone strings that can be used for the time zone setting in a CSV file, or as the time zone parameter when manually setting a DSR blade time zone. For an exhaustive list of **ALL** time zones, log into the PMAC server console and view the `/usr/share/zoneinfo/zone.tab` text file.

Table 5. List of Selected Time Zone Values

Time Zone Value	Description	Universal Time Code (UTC) Offset
UTC	Universal Time Coordinated	UTC-00
America/New_York	Eastern Time	UTC-05
America/Chicago	Central Time	UTC-06
America/Denver	Mountain Time	UTC-07
America/Phoenix	Mountain Standard Time — Arizona	UTC-07
America/Los Angeles	Pacific Time	UTC-08
America/Anchorage	Alaska Time	UTC-09
Pacific/Honolulu	Hawaii	UTC-10
Africa/Johannesburg		UTC+02
America/Mexico City	Central Time — most locations	UTC-06
Africa/Monrovia		UTC+00
Asia/Tokyo		UTC+09
America/Jamaica		UTC-05
Europe/Rome		UTC+01
Asia/Hong Kong		UTC+08
Pacific/Guam		UTC+10
Europe/Athens		UTC+02

Time Zone Value	Description	Universal Time Code (UTC) Offset
Europe/London		UTC+00
Europe/Paris		UTC+01
Europe/Madrid	mainland	UTC+01
Africa/Cairo		UTC+02
Europe/Copenhagen		UTC+01
Europe/Berlin		UTC+01
Europe/Prague		UTC+01
America/Vancouver	Pacific Time — west British Columbia	UTC-08
America/Edmonton	Mountain Time — Alberta, east British Columbia & west Saskatchewan	UTC-07
America/Toronto	Eastern Time — Ontario — most locations	UTC-05
America/Montreal	Eastern Time — Quebec — most locations	UTC-05
America/Sao Paulo	South & Southeast Brazil	UTC-03
Europe/Brussels		UTC+01
Australia/Perth	Western Australia — most locations	UTC+08
Australia/Sydney	New South Wales — most locations	UTC+10
Asia/Seoul		UTC+09
Africa/Lagos		UTC+01
Europe/Warsaw		UTC+01
America/Puerto Rico		UTC-04
Europe/Moscow	Moscow+00 — west Russia	UTC+04
Asia/Manila		UTC+08
Atlantic/Reykjavik		UTC+00
Asia/Jerusalem		UTC+02

Appendix K. Upgrade Cisco 4948 PROM

Procedure 94. Configure PMAC Application NetBackup Virtual Disk

S T E P #	<p>This procedure upgrades the Cisco 4948 PROM.</p> <p>Check off (✓) each step as it is completed. Boxes have been provided for this purpose under each step number.</p> <p>If this procedure fails, it is recommended to contact My Oracle Support (MOS) and ask for assistance.</p>	
1. <input type="checkbox"/>	<p>Virtual PMAC: Verify PROM image is on the system</p>	<p>Determine if the PROM image for the 4948E-F is on the system. Execute this command.</p> <pre style="border: 1px solid black; padding: 5px;">\$ ls /var/TKLC/smac/image/<PROM_image_file></pre> <p>Note: If the file exists, continue with the next step. If the file does not exist, copy the file from the firmware media and ensure the file is specified by the [1] HP Solutions Firmware Upgrade Pack, Software Centric Release Notes (Min 2.2.12).</p>
2. <input type="checkbox"/>	<p>Virtual PMAC: Attach to switch console</p>	<p>1. Connect serially to the switch by issuing this command as admusr on the server.</p> <pre style="border: 1px solid black; padding: 5px;">\$ sudo /usr/bin/console -M <management_server_mgmt_ip_address> -l platcfg switch1A_console Enter platcfg@pmac5000101's password: <platcfg_password> [Enter `^Ec?' for help] Press Enter</pre> <p>2. If the switch is not already in enable mode (switch# prompt), then issue the enable command; otherwise, continue with the next step.</p> <pre style="border: 1px solid black; padding: 5px;">Switch> enable Switch#</pre>

Procedure 94. Configure PMAC Application NetBackup Virtual Disk

3. <input type="checkbox"/>	4948E-F: Configure ports on the switch on the 4948E-F switch	<p>1. To ensure connectivity, ping the management server's management VLAN IP <pmac_mgmt_ip_address> address from the switch.</p> <p>2. Execute these commands.</p> <pre>Switch# conf t Switch(config-if)# switchport mode trunk Switch(config-if)# spanning-tree portfast trunk Switch(config-if)# end Switch# write memory</pre> <p>3. Issue ping command.</p> <pre>Switch# ping <pmac_mgmtVLAN_ip_address> Type escape sequence to abort. Sending 5, 100-byte ICMP Echos to <pmac_mgmt_ip_address>, timeout is 2 seconds: !!!! Success rate is 100 percent (5/5), round trip min/avg/max = 1/1/4 ms</pre> <p>If ping is not successful, double check that the procedure was completed correctly by repeating all steps up to this point. If after repeating those steps, ping is still unsuccessful, contact My Oracle Support (MOS).</p>
4. <input type="checkbox"/>	4948E-F: Upgrade PROM	<pre>Switch# copy tftp: bootflash: Address or name of remote host []? <pmac_mgmt_ip_address> Source filename []? <PROM_image_file> Destination filename [<PROM_image_file>]? [Enter] Accessing tftp://<pmac_mgmt_ip_address>/<PROM_image_file>... Loading <PROM_image_file> from <pmac_mgmt_ip_address> (via Vlan2): !!!!!!! [OK- 45606 bytes] 45606 bytes copied in 3.240 secs (140759 bytes/sec) Switch#</pre>
5. <input type="checkbox"/>	4948E-F: Reload the switch	<pre>Switch# reload System configuration has been modified. Save? [yes/no]: no Proceed with reload? [confirm] [Enter] === Boot messages removed ===</pre> <p>Note: Press Ctrl+C when the Type control-C to prevent autobooting message displays.</p>

Procedure 94. Configure PMAC Application NetBackup Virtual Disk

<p>6. <input type="checkbox"/></p>	<p>4948E-F: Initiate the PROM upgrade</p>	<pre>rommon 1 > boot bootflash:<PROM_image_file> === PROM upgrade messages removed === System will reset itself and reboot within few seconds....</pre> <p>The switch reboots when the firmware upgrade completes.</p> <ol style="list-style-type: none"> 1. Allow it to boot up. 2. Wait for this line to display. <pre>Press RETURN to get started! Would you like to terminate autoinstall? [yes]: [Enter] Switch> show version include ROM ROM: 12.2(31r)SGA1 System returned to ROM by reload</pre> <ol style="list-style-type: none"> 3. Review the output and look for the ROM version. 4. Verify the version is the desired new version. <p>If the switch does not boot properly or has the wrong ROM version, contact My Oracle Support (MOS).</p>
<p>7. <input type="checkbox"/></p>	<p>4948E-F: Reset switch factory defaults</p>	<pre>Switch# write erase Switch# reload</pre> <p>Notes:</p> <ul style="list-style-type: none"> • Wait until the switch reloads, then exit from console, press <ctrl-e><c><. > to return to the server prompt. • If asked to confirm, press Enter. If asked yes or no, type no and press Enter.

Appendix L. Sample Network Element

To enter all the network information for a network element, a specially formatted XML file needs to be filled out with the required network information. The network information is needed to configure both the NOAM and any SOAM network elements.

It is expected that the maintainer/creator of this file has networking knowledge of this product and the customer site at which it is being installed. The following is an example of a network element XML file.

The SOAM network element XML file needs to have same network names for the networks as the NOAMP network element XML file has. It is easy to create different network names accidentally for the NOAMP and SOAM network elements and then the mapping of services to networks is not possible.

Note: In Figure 3. Example Network Element XML File, IP values are network ID IPs and not host IPs.

```
<?xml version="1.0"?>
<networkelement>
  <name>NE</name>
  <networks>
    <network>
      <name>INTERNALXMI</name>
      <vlanId>3</vlanId>
      <ip>10.2.0.0</ip>
      <mask>255.255.255.0</mask>
      <gateway>10.2.0.1</gateway>
      <isDefault>>true</isDefault>
    </network>
    <network>
      <name>INTERNALIMI</name>
      <vlanId>4</vlanId>
      <ip>10.3.0.0</ip>
      <mask>255.255.255.0</mask>
      <nonRoutable>>true</nonRoutable>
    </network>
  </networks>
</networkelement>
```

Figure 3. Example Network Element XML File

nonRoutable Field: By defining a network as **nonRoutable** as seen above for INTERNALIMI, this means that the network shall not be routable outside the layer 3 boundary. This allows the user to define the same IP range in each SOAM site, and no duplicate IP check is performed during server creation.

Appendix M. Configure IDIH Fast Deployment

The `fdc.cfg` file contains sections. This table lists those sections with a short description.

Section	Description
Software Images	A list of the TVOE, TPD, and iDIH application versions.
TVOE RMS	Includes Hardware Type and ILO address of the Rack Mount Server.
TVOE Configuration (Up to 3)	Contains all IP addresses, hostname, and network devices for the TVOE host.
Guest Configurations (3)	The guest sections contain network and hostname configuration for the Oracle, Mediation, and Application guests.

Software Images

Update the software images section based on software versions you intend to install. The following table outlines typical installation failures caused by incorrect software versions. Use the `fdconfig dumpsteps -file=` command to produce output of a fast deployment session.

Software Image	Element	Command Text
TVOE ISO	mgmtsrvrtvoe	IPM Server
TPD ISO	Oracle,tpd Mediation,tpd Application,tpd	IPM Server
iDIH Mediation ISO	Mgmtsrvrtvoe,configExt	Transfer File
iDIH Oracle ISO iDIH Mediation ISO iDIH Application ISO	Oracle,ora Mediation,med Application,app	Upgrade Server

Note: For installation, `oracleGuest-8.2.0.0.0_82.x.x-x86_64.iso` is to be used.

TVOE RMS

The TVOE RMS section contains the ILO IP address and hardware profile. If the ILO IP address is incorrect, the PMAC cannot discover the rack mount server. Server discovery must occur before the installation can begin.

TVOE Configuration

This section defines the hostname, network IP addresses for the TVOE bridges and it defines the network devices. You can define the devices you intend to use for bonded interfaces and the tagged bonded interfaces you intend to associate with a bridge.

Guest Configuration

These sections contain the hostname, IPv4 addresses, IPv4 netmask, IPv4 gateway, and IPv6 addresses. If you do not intend to configure IPv6 addresses, then leave those IP addresses commented out. The IPv6 netmask is included in the IPv6 address.

Note: Although the network for the iDIH `int` network can be changed to a unique value, the IP scheme must follow these rules:

- db-guest int ip = x.y.z.**n**
- Mediation-guest int ip = x.y.z.**n+1**
- Appserver-guest int ip = x.y.z.**n+2**

Note: This network is a non-routable network, so if the IP range of this network is not required; it is recommended that these values are left unchanged from the fast deployment template.

Below is FDC configuration template included on the mediation ISO:

IPv4 configuration shown:

Notes:

- IPv6 addresses should be entered into the <address> field in the FDC template. IPv6 prefix should be configured in the '<netmask>' field in the FDC template as only the number of the prefix (for example, 64).
- The template below is just an example. It may not always synchronize with the actual template. Please always refer to the actual template file in the delivered iso file.

```
<?xml version="1.0"?>

<!--
- Copyright (C) 2010, 2016,2018 Oracle and/or its affiliates. All rights
reserved.
-->

<fdc>
  <infrastructures>
    <infrastructure name="localPMAC">
      <software>
        <image id="ora">
          <name>oracleGuest-8.2.0.0.0_82.3.0-x86_64</name>
        </image>
        <image id="med">
          <name>mediation-8.2.0.0.0_82.3.0-x86_64</name>
        </image>
        <image id="app">
          <name>apps-8.2.0.0.0_82.3.0-x86_64</name>
        </image>
      </software>
      <hardware>
        <cabinet id="1">
          <cabid>1</cabid>
        </cabinet>
        <rms id="mgmtsrvr1">
          <!-- RMS #1 iLO/iLOM address -->
          <rmsOOBIP>10.250.56.201</rmsOOBIP>
          <!-- RMS #1 hostname can be changed here -->
          <rmsname>Sterling-TVOE-3</rmsname>
          <!--iLO login user/pass -->
          <rmsuser>root</rmsuser>
          <rmsppassword>changeme</rmsppassword>
        </rms>
      </hardware>
    </infrastructure>
  </infrastructures>
</fdc>
```

```

<rms id="mgmtsrvr2">
  <!-- RMS #2 iLO/iLOM address -->
  <rmsOOBIP>10.250.56.202</rmsOOBIP>
  <!-- RMS #2 hostname can be changed here -->
  <rmsname>Sterling-TVOE-4</rmsname>
  <!--iLO login user/pass -->
  <rmsuser>root</rmsuser>
  <rmsppassword>changeme</rmsppassword>
</rms>
<rms id="mgmtsrvr3">
  <!-- RMS #3 iLO/iLOM address -->
  <rmsOOBIP>10.250.56.203</rmsOOBIP>
  <!-- RMS #3 hostname can be changed here -->
  <rmsname>Sterling-TVOE-5</rmsname>
  <!--iLO login user/pass -->
  <rmsuser>root</rmsuser>
  <rmsppassword>changeme</rmsppassword>
</rms>
</hardware>
<tvoehost id="mgmtsrvrtvoel">
  <hardware>
    <!--rmshwid must match rms id above -->
    <rmshwid>mgmtsrvr1</rmshwid>
  </hardware>
</tvoehost>
<tvoehost id="mgmtsrvrtvoe2">
  <hardware>
    <!--rmshwid must match rms id above -->
    <rmshwid>mgmtsrvr2</rmshwid>
  </hardware>
</tvoehost>
<tvoehost id="mgmtsrvrtvoe3">
  <hardware>
    <!--rmshwid must match rms id above -->
    <rmshwid>mgmtsrvr3</rmshwid>
  </hardware>
</tvoehost>
</infrastructure>
</infrastructures>
<servers>
  <tvoeguest id="ORA">
    <infrastructure>localPMAC</infrastructure>
    <!--Specify which Rack Mount Server TVOE Host the Oracle server will be
placed -->
    <tvoehost>mgmtsrvrtvoel</tvoehost>

```

```

<name>ORA</name>
<cpus>4</cpus>
<memory>8192</memory>
<watchdog>ON</watchdog>
<vnics>
  <vnic>
    <hostbridge>control</hostbridge>
    <guestdevname>control</guestdevname>
  </vnic>
  <vnic>
    <hostbridge>int</hostbridge>
    <guestdevname>int</guestdevname>
  </vnic>
  <vnic>
    <hostbridge>xmi</hostbridge>
    <guestdevname>xmi</guestdevname>
  </vnic>
</vnics>
<vdisks>
  <vdisk>
    <hostvolname>ORA.img</hostvolname>
    <hostpool>vgguests</hostpool>
    <size>81920</size>
    <primary>yes</primary>
    <guestdevname>PRIMARY</guestdevname>
  </vdisk>
  <vdisk>
    <hostvolname>ORA_sdb.img</hostvolname>
    <hostpool>vgguests</hostpool>
    <size>51200</size>
    <primary>no</primary>
    <guestdevname>sdb</guestdevname>
  </vdisk>
  <vdisk>
    <hostvolname>ORA_sdc.img</hostvolname>
    <hostpool>vgguests</hostpool>
    <size>51200</size>
    <primary>no</primary>
    <guestdevname>sdc</guestdevname>
  </vdisk>
</vdisks>
<archive>
  <image>ora</image>
  <name>idih-ora</name>
</archive>

```

```

<tpdnetworking>
  <tpdinterfaces>
    <tpdinterface id="int">
      <device>int</device>
      <type>Ethernet</type>
      <onboot>yes</onboot>
      <bootproto>none</bootproto>
      <address>10.254.254.2</address>
      <netmask>255.255.255.224</netmask>
    </tpdinterface>
    <tpdinterface id="xmi">
      <device>xmi</device>
      <type>Ethernet</type>
      <onboot>yes</onboot>
      <bootproto>none</bootproto>
      <!--Specify xmi IP address -->
      <address>10.240.30.204</address>
      <!--Specify xmi subnet -->
      <netmask>255.255.255.128</netmask>
    </tpdinterface>
  </tpdinterfaces>
  <tpdroutes>
    <tpdroute id="xmi_default">
      <type>default</type>
      <device>xmi</device>
      <!--Specify default gateway of xmi network-->
      <gateway>10.240.30.129</gateway>
    </tpdroute>
  </tpdroutes>
</tpdnetworking>
<serverinfo>
  <!--Specify Oracle server hostname-->
  <hostname>Sterling-IDIH-ora</hostname>
</serverinfo>
<scripts>
  <postsrvapp>
    <scriptfile id="oraPostImageInstall">
      <filename>/usr/bin/sudo</filename>
</scriptfile>
</postsrvapp>
<postdeploy>
  <scriptfile id="oraHealthcheck">

```

```

        <filename>/usr/bin/sudo</filename>
        <arguments>/usr/TKLC/xIH/plat/bin/analyze_server.sh -i >
/tmp/analyze_server.sh</arguments>
    </scriptfile>
</postdeploy>
</scripts>
</tvoeguest>
<tvoeguest id="APP">
    <infrastructure>localPMAC</infrastructure>
    <!--Specify which Rack Mount Server TVOE Host the Application server
will be placed -->
    <tvoehost>mgmtsrvrtvoe3</tvoehost>
    <name>APP</name>
    <cpus>4</cpus>
    <memory>8192</memory>
    <watchdog>ON</watchdog>
    <vnics>
        <vnic>
            <hostbridge>control</hostbridge>
            <guestdevname>control</guestdevname>
        </vnic>
        <vnic>
            <hostbridge>int</hostbridge>
            <guestdevname>int</guestdevname>
        </vnic>
        <vnic>
            <hostbridge>xmi</hostbridge>
            <guestdevname>xmi</guestdevname>
        </vnic>
    </vnics>
    <vdisks>
        <vdisk>
            <hostvolname>APP.img</hostvolname>
            <hostpool>vgguests</hostpool>
            <size>65536</size>
            <primary>yes</primary>
            <guestdevname>PRIMARY</guestdevname>
        </vdisk>
    </vdisks>
    <archive>
        <image>app</image>
        <name>idih-app</name>
    </archive>
    <tpdnetworking>
    <tpdinterfaces>

```

```

<tpdinterface id="int">
  <device>int</device>
  <type>Ethernet</type>
  <onboot>yes</onboot>
  <bootproto>none</bootproto>
  <address>10.254.254.4</address>
  <netmask>255.255.255.224</netmask>
</tpdinterface>
<tpdinterface id="xmi">
  <device>xmi</device>
  <type>Ethernet</type>
  <onboot>yes</onboot>
  <bootproto>none</bootproto>
  <!--Specify xmi IP address -->
  <address>10.240.30.202</address>
  <!--Specify xmi subnet mask -->
  <netmask>255.255.255.128</netmask>
</tpdinterface>
</tpdinterfaces>
<tpdroutes>
  <tpdroute id="xmi_default">
    <type>default</type>
    <device>xmi</device>
    <!--Specify default gateway of xmi network-->
    <gateway>10.240.30.129</gateway>
  </tpdroute>
</tpdroutes>
</tpdnetworking>
<serverinfo>
  <!--Specify Application server hostname-->
  <hostname>Sterling-IDIH-app</hostname>
</serverinfo>
<scripts>
<postdeploy>
  <scriptfile id="appPreSleep">
    <filename>/bin/sleep</filename>
    <arguments>200</arguments>
  </scriptfile>
  <scriptfile id="appPostImageInstall">
    <filename>/usr/bin/sudo</filename>
    <arguments>/opt/xIH/apps/post_image_install.sh</arguments>
  </scriptfile>
  <scriptfile id="appSleep">
    <filename>/bin/sleep</filename>
    <arguments>60</arguments>

```

```

</scriptfile>
<scriptfile id="appHealthcheck">
  <filename>/usr/bin/sudo</filename>
  <arguments>/usr/TKLC/xIH/plat/bin/analyze_server.sh -i >
/tmp/analyze_server.log</arguments>
</scriptfile>
</postdeploy>
</scripts>
</tvoeguest>
<tvoeguest id="MED">
  <infrastructure>localPMAC</infrastructure>
  <!--Specify which Rack Mount Server TVOE Host the Mediation server will
be placed -->
  <tvoehost>mgmtsrvrtvoe2</tvoehost>
  <name>MED</name>
  <cpus>4</cpus>
  <memory>8192</memory>
  <watchdog>ON</watchdog>
  <vnics>
    <vnic>
      <hostbridge>control</hostbridge>
      <guestdevname>control</guestdevname>
    </vnic>
    <vnic>
      <hostbridge>int</hostbridge>
      <guestdevname>int</guestdevname>
    </vnic>
    <vnic>
      <hostbridge>xmi</hostbridge>
      <guestdevname>xmi</guestdevname>
    </vnic>
    <vnic>
      <hostbridge>imi</hostbridge>
      <guestdevname>imi</guestdevname>
    </vnic>
  </vnics>
  <vdisk>
    <hostvolname>MED.img</hostvolname>
    <hostpool>vgguests</hostpool>
    <size>65536</size>
    <primary>yes</primary>
    <guestdevname>PRIMARY</guestdevname>
  </vdisk>
</vdisk>

```



```

<archive>
  <image>med</image>
  <name>idih-med</name>
</archive>
<tpdnetworking>
  <tpdinterfaces>
    <tpdinterface id="imi">
      <device>imi</device>
      <type>Ethernet</type>
      <onboot>yes</onboot>
      <bootproto>none</bootproto>
      <!--Specify imi IP address -->
      <address>192.168.201.139</address>
      <!--Specify imi subnet mask -->
      <netmask>255.255.255.0</netmask>
    </tpdinterface>
    <tpdinterface id="int">
      <device>int</device>
      <type>Ethernet</type>
      <onboot>yes</onboot>
      <bootproto>none</bootproto>
      <address>10.254.254.3</address>
      <netmask>255.255.255.224</netmask>
    </tpdinterface>
    <tpdinterface id="xmi">
      <device>xmi</device>
      <type>Ethernet</type>
      <onboot>yes</onboot>
      <bootproto>none</bootproto>
      <!--Specify xmi IP address -->
      <address>10.240.30.203</address>
      <!--Specify xmi subnet mask -->
      <netmask>255.255.255.128</netmask>
    </tpdinterface>
  </tpdinterfaces>
  <tpdroutes>
    <tpdroute id="xmi_default">
      <type>default</type>
      <device>xmi</device>
      <!--Specify default gateway of xmi network-->
      <gateway>10.240.30.129</gateway>
    </tpdroute>
  </tpdroutes>
</tpdnetworking>
<serverinfo>

```

```
<!--Specify Mediation server hostname-->
  <hostname>Sterling-IDIH-med</hostname>
</serverinfo>
<scripts>
<postdeploy>
  <scriptfile id="medPreSleep">
    <filename>/bin/sleep</filename>
    <arguments>200</arguments>
  </scriptfile>
  <scriptfile id="medPostImageInstall">
    <filename>/usr/bin/sudo</filename>
    <arguments>/opt/xIH/mediation/post_image_install.sh</arguments>
  </scriptfile>
  <scriptfile id="medSleep">
    <filename>/bin/sleep</filename>
    <arguments>60</arguments>
  </scriptfile>
  <scriptfile id="medHealthcheck">
    <filename>/usr/bin/sudo</filename>
    <arguments>/usr/TKLC/xIH/plat/bin/analyze_server.sh -i >
/tmp/analyze_server.log</arguments>
  </scriptfile>
</postdeploy>
</scripts>
</tvoeguest>
</servers>
</fdc>
```

Appendix N. Create a Bootable USB Drive on Linux



Procedure 95. Configure PMAC Application NetBackup Virtual Disk

S T E P #	<p>This procedure upgrades the Cisco 4948 PROM.</p> <p>Check off (✓) each step as it is completed. Boxes have been provided for this purpose under each step number.</p> <p>If this procedure fails, it is recommended to contact My Oracle Support (MOS) and ask for assistance.</p>	
1. <input type="checkbox"/>	Insert USB Media	<ol style="list-style-type: none"> 1. Insert the USB media into the USB port. It should automatically be mounted under /media 2. Obtain the path of the USB drive by running. <pre style="border: 1px solid black; padding: 2px;">\$ ls /media</pre> The output should be similar to this: sdb1 3. Note the path without the partition number (in this case, it would be /dev/sdb).
2. <input type="checkbox"/>	Linux Machine	Obtain the TVOE .iso file and copy it onto the local Linux computer (for example, under /var/TKLC/upgrade).
3. <input type="checkbox"/>	Copy the .USB file onto the USB drive	<p>Use the dd command to copy the .usb file onto the USB drive.</p> <p>Note: Make sure you do not use the partition number when copying the file.</p> <pre style="border: 1px solid black; padding: 2px;">\$ sudo dd if=<path_to_iso> of=/dev/sdb bs=4M oflag=direct</pre>

Appendix O. Remove IDIH External Drive

Run this procedure only if you intend to do a fresh installation on an existing IDIH.

Procedure 96. Remove the IDIH External Drive

S T E P #	<p>This procedure destroys all data in the Oracle database.</p> <div style="text-align: center;">  <h2 style="color: red; margin: 10px 0;">Warning</h2> <p style="color: red; font-weight: bold;">Do not perform this procedure on an IDIH system unless your intent is to do a fresh TVO installation.</p> <p>Check off (✓) each step as it is completed. Boxes have been provided for this purpose under each step number.</p> <p>If this procedure fails, it is recommended to contact My Oracle Support (MOS) and ask for assistance.</p> </div>	
1.	<p>PMAC GUI: Login</p> <div style="border: 1px solid black; width: 20px; height: 20px; margin-left: 10px;"></div>	<ol style="list-style-type: none"> Open the web browser and navigate to the PMAC GUI: <div style="border: 1px solid black; padding: 2px; margin: 5px 0;"> <code>http://<PMAC_network_IP></code> </div> Login as the guiadmin user. <div style="text-align: center; margin: 20px 0;">  </div> <div style="border: 1px solid gray; padding: 10px; margin: 10px 0;"> <p>Oracle System Login Tue Jun 7 13:49:06 2016 EDT</p> <hr/> <div style="border: 1px solid gray; padding: 10px; text-align: center; margin: 10px auto; width: 80%;"> <p>Log In Enter your username and password to log in</p> <p>Username: <input style="width: 100%;" type="text"/></p> <p>Password: <input style="width: 100%;" type="password"/></p> <p><input type="checkbox"/> Change password</p> <p><input type="button" value="Log In"/></p> </div> <p style="font-size: small; text-align: center;">Unauthorized access is prohibited. This Oracle system requires the use of Microsoft Internet Explorer 9.0, 10.0, or 11.0 with support for JavaScript and cookies.</p> <hr/> <p style="font-size: x-small; text-align: center;">Oracle and Java are registered trademarks of Oracle Corporation and/or its affiliates. Other names may be trademarks of their respective owners.</p> <p style="font-size: x-small; text-align: center;">Copyright © 2010, 2016, Oracle and/or its affiliates. All rights reserved.</p> </div>

Procedure 96. Remove the IDIH External Drive

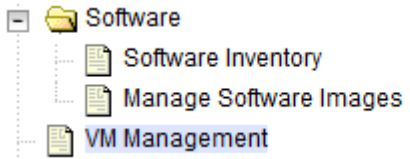
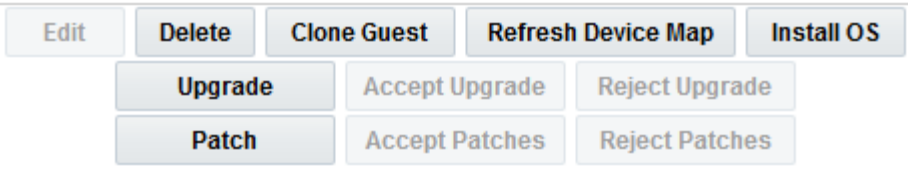
<p>2. <input type="checkbox"/></p>	<p>PMAC GUI: Delete VMs, if Needed</p>	<p>Before a re-installation can be performed, the IDIH VMs must be removed first.</p> <p>1. Navigate to VM Management.</p>  <p>2. Select each of the IDIH VMs and click Delete.</p> 
<p>3. <input type="checkbox"/></p>	<p>IDIH TVOE Host: Login</p>	<p>Establish an SSH session to the TVOE host and login as admusr.</p>
<p>4. <input type="checkbox"/></p>	<p>IDIH TVOE HOST: Verify external drive exists</p>	<p>HP DL380</p> <pre>\$ sudo hpssacli ctrl slot=2 Id all show</pre>

Procedure 96. Remove the IDIH External Drive

5.	IDIH TVOE Host: <input type="checkbox"/> Remove the external drive and volume group	HP DL380 <pre style="border: 1px solid black; padding: 5px;">\$ sudo /usr/TKLC/plat/sbin/storageClean hpdisk --slot=2</pre> Oracle X5-2/Netra X5-2/X6-2 Log into the TVOE host as root user and execute the virsh commands to delete the image files manually. Make sure the storage pool, other than vgguests, is also cleaned. <pre style="border: 1px solid black; padding: 5px;">[root@hellcat ~]# virsh vol-list vgguests Name Path ----- application.img /dev/vgguests/application.img mediation.img /dev/vgguests/mediation.img oracle.img /dev/vgguests/oracle.img pmac.img /dev/vgguests/pmac.img pmac_images.img /dev/vgguests/pmac_images.img pmac_isoimages.img /dev/vgguests/pmac_isoimages.img pmac_logs.img /dev/vgguests/pmac_logs.img [root@hellcat ~]# virsh vol-delete --vol=oracle.img --pool=vgguests Vol oracle.img deleted [root@hellcat ~]# virsh vol-delete --vol=mediation.img --pool=vgguests Vol mediation.img deleted [root@hellcat ~]# virsh vol-delete --vol=application.img --pool=vgguests Vol application.img deleted</pre> <pre style="border: 1px solid black; padding: 5px;">[root@hellcat ~]# virsh pool-list Name State Autostart ----- external1 active yes external2 active yes external3 active yes vgguests active yes [root@hellcat ~]# virsh vol-list external1 Name Path ----- [root@hellcat ~]# virsh vol-list external2 Name Path ----- [root@hellcat ~]# virsh vol-list external3 Name Path -----</pre>
----	---	---

Appendix P. Growth/De-Growth/Re-Shuffle (Oracle X5-2/Netra X5-2/X6-2/X7-2/HP DL380 Gen 9 (10Gbps) Only)

For scenarios where growth or de-growth is required, it may be necessary to delete or re-shuffle VM guests, SDS, and DSR servers. Appendix L.1 explains how to add individual VMs and add various DSR/SDS servers. Appendix L.2 explains how to delete individual VMs and move or remove various DSR/SDS servers.

Appendix P.1 Growth (Oracle X5-2/Netra X5-2/X6-2/X7-2/HP DL380 Gen 9 (10Gbps) Only)

For growth scenarios where it is necessary to add DSR servers, follow these procedures.

Step	Procedure(s)
Perform backups	Procedure 97 Perform Backups
Perform system health check	Procedure 98 Perform Health Check
Identify servers affected by growth: <ul style="list-style-type: none"> • DR NOAM • SOAM Spares • MP (IPFE, SBR, SS7-MP)/SDS DP • Query Server 	
Add new servers Create and configure the VMs on new servers (SOAM spare and DR NOAMs only)	Procedure 99 Add a New TVOE Server/VMs
Configure servers in new VM locations	<p>NOAM/DR NOAM (DSR/SDS): Procedure 100 Growth: DR NOAM</p> <p>SOAM (DSR/SDS): Procedure 101 Growth: SOAM Spare (DSR/PCA Only)</p> <p>MP/DP (DSR/SDS): Procedure 102 Growth: MP or Procedure 103 Growth: MP (For 7.x to 8.x Upgraded System)</p> <p>Query Server: Procedure 104 Growth: Query Server (SDS Only)</p>
Post growth health check	Procedure 105 Post Growth Health Check
Post growth backups	Procedure 106 Post Growth Backups

Procedure 97. Perform Backups

S T E P #	<p>This procedure backs up all necessary items before a growth scenario. Check off (✓) each step as it is completed. Boxes have been provided for this purpose under each step number. If this procedure fails, contact My Oracle Support (MOS) and ask for assistance.</p>	
1. <input type="checkbox"/>	Backup TVOE	Back up all TVOE host configurations by executing section 3.17.6 Back Up TVOE Configuration.
2. <input type="checkbox"/>	Backup PMAC	Back up the PMAC application by executing section 3.17.7 Back Up PMAC Application.
3. <input type="checkbox"/>	Backup NOAM/SOAM databases	Back up the NOAM and SOAM databases by executing sections 3.17.8 Back Up NOAM Database and 3.17.9 Back Up SOAM Database. Note: Database backup on SDS SOAMs is not required.

Procedure 98. Perform Health Check

S T E P #	<p>This procedure verifies system status and logs all alarms. Check off (✓) each step as it is completed. Boxes have been provided for this purpose under each step number. If this procedure fails, contact My Oracle Support (MOS) and ask for assistance.</p>	
1. <input type="checkbox"/>	<p>NOAM VIP GUI: Login</p>	<p>1. Establish a GUI session on the NOAM server by using the VIP IP address of the NOAM server. Open the web browser and enter a URL of:</p> <div style="border: 1px solid black; padding: 5px; width: fit-content; margin: 5px 0;"> <p>https://<Primary_NOAM_VIP_IP_Address></p> </div> <p>2. Login as the guiadmin user.</p> <div style="text-align: center; margin: 20px 0;">  </div> <p>This application is designed to work with most modern HTML5 compliant browsers and uses both JavaScript and cookies. Please refer to the Oracle Software Web Browser Support Policy for details.</p>

Procedure 98. Perform Health Check

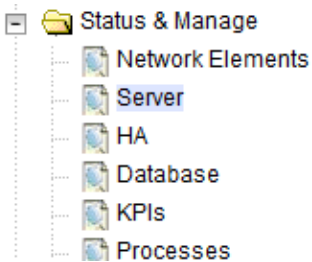
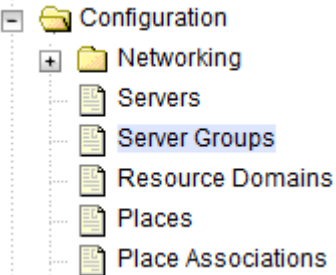
<p>2. <input type="checkbox"/></p>	<p>NOAM VIP GUI: Verify server status</p>	<p>1. Navigate to Status & Manage > Server.</p>  <p>2. Verify all Server Status is Normal (Norm) for Alarm (Alm), Database (DB), Replication Status, and Processes (Proc).</p> <table border="1" data-bbox="500 632 1406 789"> <thead> <tr> <th>Appl State</th> <th>Alm</th> <th>DB</th> <th>Reporting Status</th> <th>Proc</th> </tr> </thead> <tbody> <tr> <td>Enabled</td> <td>Norm</td> <td>Norm</td> <td>Norm</td> <td>Norm</td> </tr> <tr> <td>Enabled</td> <td>Norm</td> <td>Norm</td> <td>Norm</td> <td>Norm</td> </tr> <tr> <td>Enabled</td> <td>Norm</td> <td>Norm</td> <td>Norm</td> <td>Norm</td> </tr> <tr> <td>Enabled</td> <td>Norm</td> <td>Norm</td> <td>Norm</td> <td>Norm</td> </tr> </tbody> </table> <p>Do not proceed with Growth/De-Growth if any of the above states are not Norm. If any of these are not Norm, corrective action should be taken to restore the non-Norm status to Norm before proceeding with the feature activation.</p> <p>If the Alarm (Alm) status is not Norm but only Minor alarms are present, it is acceptable to proceed. If there are Major or Critical alarms present, these alarms should be analyzed prior to proceeding with the feature activation. The activation may be able to proceed in the presence of certain Major or Critical alarms.</p>	Appl State	Alm	DB	Reporting Status	Proc	Enabled	Norm	Norm	Norm	Norm	Enabled	Norm	Norm	Norm	Norm	Enabled	Norm	Norm	Norm	Norm	Enabled	Norm	Norm	Norm	Norm
Appl State	Alm	DB	Reporting Status	Proc																							
Enabled	Norm	Norm	Norm	Norm																							
Enabled	Norm	Norm	Norm	Norm																							
Enabled	Norm	Norm	Norm	Norm																							
Enabled	Norm	Norm	Norm	Norm																							
<p>3. <input type="checkbox"/></p>	<p>NOAM VIP GUI: Verify server configuration</p>	<p>1. Navigate to Configuration > Server Groups.</p>  <p>2. Verify the configuration data is correct for your network.</p>																									

Procedure 98. Perform Health Check

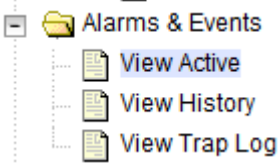
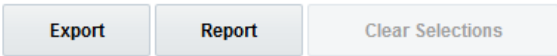
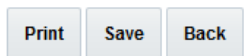
<p>4. <input type="checkbox"/></p>	<p>NOAM VIP GUI: Log current alarms</p>	<p>1. Navigate to Alarms & Events > View Active.</p>  <p>2. Click Report.</p>  <p>3. Save or Print this report, keep copies for future reference.</p> 
<p>5. <input type="checkbox"/></p>	<p>SOAM VIP GUI: Repeat for SOAM</p>	<p>Repeat this procedure for the SOAM.</p>

Procedure 99. Add a New TVOE Server/VMs

<p>S T E P #</p>	<p>This procedure adds a new rack mount server. Check off (✓) each step as it is completed. Boxes have been provided for this purpose under each step number. If this procedure fails, contact My Oracle Support (MOS) and ask for assistance.</p>	
<p>1. <input type="checkbox"/></p>	<p>Add/Configure additional servers</p>	<p>Follow these sections to install and configure TVOE on additional rack mount servers:</p> <ol style="list-style-type: none"> Section 3.7 Add a Rack Mount Server to PMAC Section 3.8 Install TVOE on Additional Rack Mount Servers Section 3.9 Configure TVOE on Additional Rack Mount Servers
<p>2. <input type="checkbox"/></p>	<p>Add/Configure new VMs</p>	<ol style="list-style-type: none"> Determine CPU placement and pinning information by referring to section 3.10 Determine VM Placement and Socket Pinning. Create new virtual machines by following section 3.12 Virtual Machine/Network Fast Deployment. Perform CPU pinning by following section 3.13 CPU Pinning.

Procedure 100. Growth: DR NOAM

S T E P #	<p>This procedure configures a DR NOAM on the new virtual machine for VM growth scenarios.</p> <p>Prerequisites:</p> <ul style="list-style-type: none"> • New virtual machine created • TPD/DSR software installed <p>Check off (✓) each step as it is completed. Boxes have been provided for this purpose under each step number.</p> <p>If this procedure fails, contact My Oracle Support (MOS) and ask for assistance.</p>	
1. <input type="checkbox"/>	<p>NOAM VIP GUI: Configure the DR NOAM</p>	<p>Configure the DR NOAM by executing the steps referenced in these procedures:</p> <p>DSR DR NOAM: Section 3.14.3 Disaster Recovery NOAM (Optional)</p> <p>SDS DR NOAM: Section 3.15.3 Disaster Recovery NOAM (Optional)</p>
2. <input type="checkbox"/>	<p>DR NOAM: Activate optional features.</p> <p>DSR only. If SDS DR NOAM, then skip this step.</p>	<p>If there are any optional features currently activated, the feature activation procedures need to be run again. Refer to section 1.5 Optional Features.</p>
3. <input type="checkbox"/>	<p>DR NOAM VIP: Login</p>	<p>Establish an SSH to the DR NOAM VIP address and login as admusr.</p>
4. <input type="checkbox"/>	<p>DR NOAM VIP: Transfer optimization script from the primary NOAM</p>	<p>Execute these commands to transfer and set permissions of the optimization script from the primary NOAM.</p> <pre style="border: 1px solid black; padding: 5px;">\$ sudo scp -r admusr@<Primary NOAM XMI VIP>:/usr/TKLC/dsr/bin/rmsNoamConfig.sh /usr/TKLC/dsr/bin \$ sudo chmod 777 /usr/TKLC/dsr/bin/rmsNoamConfig.sh</pre>
5. <input type="checkbox"/>	<p>NOAM VIP: Execute the optimization script on the active NOAM</p>	<p>Execute these commands for the performance optimization script on the active NOAM server.</p> <pre style="border: 1px solid black; padding: 5px;">\$ cd /usr/TKLC/dsr/bin/ \$ sudo ./rmsNoamConfig.sh</pre> <p>Note: Configuration successful output should display.</p>
6. <input type="checkbox"/>	<p>NOAM VIP: Execute the key revocation script on the active NOAM server (RADIUS only) to copy key file to new NOAM server created</p>	<p>If the RADIUS key has never been revoked, skip this step (If RADIUS was never configured on any site in the network, the RADIUS key would have most likely never been revoked. Check with your system administrator).</p> <pre style="border: 1px solid black; padding: 5px;">\$ cd /usr/TKLC/dsr/bin/ \$./sharedKrevo -synchronize -server <new_NOAM_hostname></pre> <p>Note: Key transfer successful output should display.</p>

Procedure 101. Growth: SOAM Spare (DSR/PCA Only)

S T E P #	<p>This procedure configures an SOAM spare on the new virtual machine for VM growth scenarios.</p> <p>Prerequisites:</p> <ul style="list-style-type: none"> • New virtual machine created • TPD/DSR software installed <p>Check off (✓) each step as it is completed. Boxes have been provided for this purpose under each step number.</p> <p>If this procedure fails, contact My Oracle Support (MOS) and ask for assistance.</p>	
1. <input type="checkbox"/>	NOAM VIP GUI: Configure the SOAM spare	<p>Configure the SOAM spare by executing these procedures:</p> <ul style="list-style-type: none"> • Procedure 24 Configure DSR SOAM NE • Procedure 25 Configure DSR SOAM Server • Procedure 26 Configure the DSR SOAM Server Group (steps 1. , 4. , 6. , and 9.)
2. <input type="checkbox"/>	NOAM GUI: Activate optional features	<p>If there are any optional features currently activated, the feature activation procedures need to be run again. Refer to section 1.5 Optional Features.</p>
3. <input type="checkbox"/>	NOAM VIP: Execute the key revocation script on the active NOAM server (RADIUS) to copy key file to new SOAM server created	<p>If the RADIUS key has never been revoked, skip this step (If RADIUS was never configured on any site in the network, the RADIUS key would have most likely never been revoked. Check with your system administrator).</p> <pre style="border: 1px solid black; padding: 5px;">\$ cd /usr/TKLC/dsr/bin/ \$./sharedKrevo -synchronize -server <new_SOAM_hostname></pre> <p>Note: Key transfer successful output should be given.</p>

Procedure 102. Growth: MP/DP

<p>S T E P #</p>	<p>This procedure configures an MP/DP on the new virtual machine for growth scenarios.</p> <p>Prerequisites:</p> <ul style="list-style-type: none"> • New virtual machine created • TPD/DSR software installed <p>Check off (✓) each step as it is completed. Boxes have been provided for this purpose under each step number.</p> <p>If this procedure fails, contact My Oracle Support (MOS) and ask for assistance.</p>	
<p>1. <input type="checkbox"/></p>	<p>NOAM VIP GUI: Configure the MP</p>	<p>Configure the MP/DP by executing the steps referenced in these procedures:</p> <p>DSR MP</p> <ul style="list-style-type: none"> • Procedure 30 Configure MP Servers (steps 1. , 2. , 7. through 12. , 13. through 14. (optional), 15. • Procedure 31 Configure DAMP Server Groups and Profiles • Procedure 32 Configure DAMP Server Groups and Profiles • Procedure 64 Back Up the Upgrade and Disaster Recovery FDC File (Optional) <p>SDS DP</p> <ul style="list-style-type: none"> • Procedure 49 Pair SDS Query Server with SDS NOAMs • Procedure 50 Configure SDS DP SOAM NE • Procedure 64 Back Up the Upgrade and Disaster Recovery FDC File (Optional)
<p>2. <input type="checkbox"/></p>	<p>NOAM VIP: Execute the key revocation script on the active NOAM server (RADIUS) to copy key file to new MP server created</p>	<p>If the RADIUS key has never been revoked, skip this step (If RADIUS was never configured on any site in the network, the RADIUS key would have most likely never been revoked. Check with your system administrator.</p> <pre style="border: 1px solid black; padding: 5px;">\$ cd /usr/TKLC/dsr/bin/ \$./sharedKrevo -synchronize -server <new_MP_hostname></pre> <p>Note: Key transfer successful output should be given.</p>

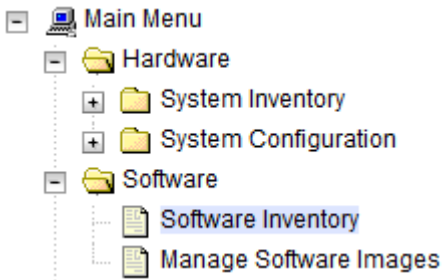

Procedure 103. Growth: MP (For 7.x to 8.x Upgraded System)

<p>S T E P #</p>	<p>This procedure should be executed ONLY to configure an MP on the new virtual machine for growth scenarios for 7.x to 8.x upgraded system.</p> <p>Prerequisites:</p> <ul style="list-style-type: none"> • New virtual machine created • TPD/DSR software installed <p>Check off (✓) each step as it is completed. Boxes have been provided for this purpose under each step number.</p> <p>If this procedure fails, contact My Oracle Support (MOS) and ask for assistance.</p>					
<p>1. <input type="checkbox"/></p>	<p>PMAC: Exchange SSH keys between MP site's local PMAC and the MP server</p>	<p>Use the MP site's PMAC GUI to determine the control network IP address of the server that is to be an MP server.</p> <ol style="list-style-type: none"> From the MP site's PMAC GUI, navigate to Software > Software Inventory.  <ol style="list-style-type: none"> Note the IP address for an MP server. <table border="1" style="width: 100%; border-collapse: collapse;"> <tr> <td style="padding: 2px;">Enc:103 Bay:1E</td> <td style="padding: 2px;">192.168.1.207</td> <td style="padding: 2px;">LG-MP2</td> <td style="padding: 2px;">TPD (x86_64)</td> </tr> </table> <ol style="list-style-type: none"> Obtain a terminal session to the MP site's PMAC and login as admusr. Exchange SSH keys for admusr between the PMAC and the MP blade server using the keyexchange utility and the control network IP address for the MP blade server. <pre style="border: 1px solid black; padding: 5px; width: fit-content;">\$ keyexchange admusr@<MP_Control_Blade_IP Address></pre> <ol style="list-style-type: none"> When asked for the password, type the password for the admusr of the MP server. 	Enc:103 Bay:1E	192.168.1.207	LG-MP2	TPD (x86_64)
Enc:103 Bay:1E	192.168.1.207	LG-MP2	TPD (x86_64)			

Procedure 103. Growth: MP (For 7.x to 8.x Upgraded System)

<p>2. <input type="checkbox"/></p>	<p>NOAM VIP GUI: Login</p>	<p>1. Establish a GUI session on the NOAM server by using the VIP IP address of the NOAM server. Open the web browser and enter a URL of:</p> <div style="border: 1px solid black; padding: 5px; margin: 10px 0;"> <p><code>https://<Primary_NOAM_XMI_VIP_IP_Address></code></p> </div> <p>2. Login as the guiadmin user.</p> <div style="text-align: center; margin: 20px 0;">  </div> <div style="text-align: center;"> <p>Oracle System Login Mon Jul 11 13:59:37 2016 EDT</p> <hr/> <div style="border: 1px solid gray; padding: 10px; width: fit-content; margin: 10px auto;"> <p style="text-align: center;">Log In</p> <p style="text-align: center;">Enter your username and password to log in</p> <p style="text-align: center;">Username: <input style="width: 100%;" type="text"/></p> <p style="text-align: center;">Password: <input style="width: 100%;" type="password"/></p> <p style="text-align: center;"><input type="checkbox"/> Change password</p> <p style="text-align: center;"><input type="button" value="Log In"/></p> </div> <p style="text-align: center; margin-top: 10px;">Welcome to the Oracle System Login.</p> <p style="text-align: center; font-size: small;">This application is designed to work with most modern HTML5 compliant browsers and uses both JavaScript and cookies. Please refer to the Oracle Software Web Browser Support Policy for details.</p> <p style="text-align: center; font-size: x-small;">Unauthorized access is prohibited.</p> <hr style="width: 50%; margin: 10px auto;"/> <p style="text-align: center; font-size: x-small;">Oracle and Java are registered trademarks of Oracle Corporation and/or its affiliates. Other names may be trademarks of their respective owners.</p> <p style="text-align: center; font-size: x-small;">Copyright © 2010, 2016, Oracle and/or its affiliates. All rights reserved.</p> </div>
------------------------------------	---------------------------------------	--

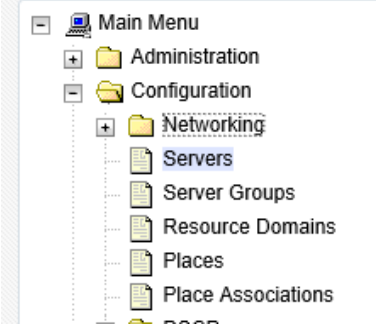
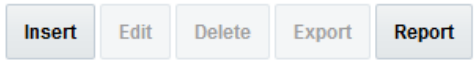
Procedure 103. Growth: MP (For 7.x to 8.x Upgraded System)

<p>3. <input type="checkbox"/> NOAM VIP GUI: Insert the MP server</p>	<ol style="list-style-type: none"> 1. Navigate to Configuration > Servers. <div style="margin-left: 20px;">  </div> 2. Click Insert to insert the new MP server into servers table. <div style="margin-left: 20px;">  </div> 3. Enter these values: <div style="margin-left: 20px;"> <p>Hostname: <Hostname></p> <p>Role: MP</p> <p>Network Element: [Choose Network Element]</p> <p>Hardware Profile: DSR TVOE Guest</p> <p>Location: <Enter an optional location description></p> </div> 4. For the XMI network, type the MP's XMI IP address and select the xmi interface. 5. For the IMI network, type the MP's IMI IP address and select the imi interface. <div style="margin-left: 20px;">  </div> 6. Add the NTP server. <div style="margin-left: 20px;"> <table border="1" style="width: 100%; border-collapse: collapse;"> <thead> <tr style="background-color: #e1eef6;"> <th style="text-align: left;">NTP Server</th> <th style="text-align: left;">Preferred?</th> </tr> </thead> <tbody> <tr> <td><MP_RMS_TVOE_IP_Address></td> <td>Yes</td> </tr> </tbody> </table> </div> 7. Click OK when all fields are entered to finish MP server insertion. 	NTP Server	Preferred?	<MP_RMS_TVOE_IP_Address>	Yes
NTP Server	Preferred?				
<MP_RMS_TVOE_IP_Address>	Yes				

Procedure 103. Growth: MP (For 7.x to 8.x Upgraded System)

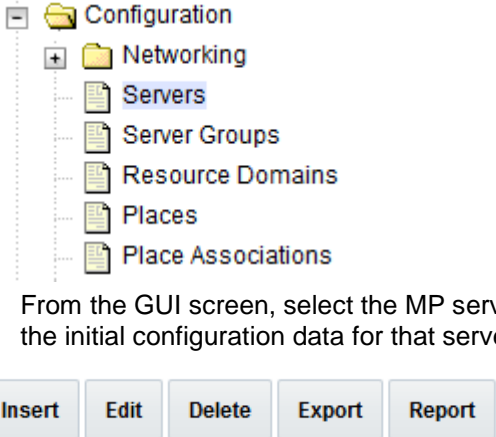
<p>4. <input type="checkbox"/></p>	<p>NOAM VIP GUI: Export the configuration</p>	<p>1. Navigate to Configuration > Servers.</p>  <p>2. From the GUI screen, select the MP server and click Export to generate the initial configuration data for that server.</p>
<p>5. <input type="checkbox"/></p>	<p>NOAM VIP: Copy the configuration file to MP server</p>	<p>1. Obtain a terminal session to the NOAM VIP as the admusr user.</p> <p>2. Use the awpushcfg utility to copy the configuration file, created in the previous step, from the /var/TKLC/db/filemgmt directory on the NOAM to the MP server, using the control network IP address for the MP server.</p> <p>The configuration file has a filename like TKLCConfigData.<hostname>.sh.</p> <pre>\$ sudo awpushcfg</pre> <p>The awpushcfg utility is interactive, so the user is asked for the following:</p> <ul style="list-style-type: none"> • IP address of the local PMAC server: Use the management network address from the PMAC. • Username: Use admusr • Control network IP address for the target server: In this case, enter the control IP for the MP server). • Hostname of the target server: Enter the server name configured in step 3.

Procedure 103. Growth: MP (For 7.x to 8.x Upgraded System)

<p>6. <input type="checkbox"/></p>	<p>MP Server: Verify awpushcfg was called and reboot the configured server</p>	<ol style="list-style-type: none"> Obtain a terminal session to the MP server console by establishing an ssh session from the NOAM VIP terminal console. <pre>\$ ssh admusr@<MP_Control_IP></pre> Login as admusr. Verify awpushcfg was called by checking the log file. <pre>\$ sudo cat /var/TKLC/appw/logs/Process/install.log</pre> <p>Verify this message displays: [SUCCESS] script completed successfully!</p> <p>Note: The script may return success even when errors are reported in the log file. Go through the entire install.log file to verify no errors are present.</p> Reboot the server. <pre>\$ sudo init 6</pre> Proceed to the next step once the server finishes rebooting. The server is done rebooting once the login prompt is displayed.
<p>7. <input type="checkbox"/></p>	<p>MP Server: Verify server health</p>	<p>Login as admusr to the MP server and make sure no errors are returned.</p> <pre>\$ sudo syscheck Running modules in class hardware...OK Running modules in class disk...OK Running modules in class net...OK Running modules in class system...OK Running modules in class proc...OK LOG LOCATION: /var/TKLC/log/syscheck/fail_log</pre>

Procedure 103. Growth: MP (For 7.x to 8.x Upgraded System)

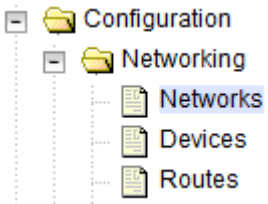
<p>8. <input type="checkbox"/></p>	<p>MP Server: Delete auto-configured default route on MP and replace it with a network route via the XMI network — Part 1 (optional)</p>	<p>Note: This step is optional and should only be executed if you plan to configure a default route on your MP that uses a signaling (XSI) network instead of the XMI network.</p> <p>Not executing this step means a default route is not configurable on this MP and you have to create separate network routes for each signaling network destination.</p> <ol style="list-style-type: none"> 1. Log into the site's PMAC and SSH to the MP's control address. Alternatively, log into the TVOE host and access the MP using the virsh console <MP VM>. 2. Determine <XMI_Gateway_IP> from your SO site network element information. 3. Gather this information: <ul style="list-style-type: none"> • <NO_XMI_Network_Address> • <NO_XMI_Network_Netmask> • <DR_NO_XMI_Network_Addres> • <DR_NO_XMI_Network_Netmask> • <TVOE_Mgmt_XMI_Network_Address> • <TVOE_Mgmt_XMI_Network_Netmask> <p>Note: You can either consult the XML files you imported earlier, or go to the NO GUI and view these values from the Configuration > Networking > Networks screen.</p> 
------------------------------------	---	--



Procedure 103. Growth: MP (For 7.x to 8.x Upgraded System)

<p>9. <input type="checkbox"/></p>	<p>MP Server: Delete auto-configured default route on MP and replace it with a network route via the XMI network — Part 2 (optional)</p>	<ol style="list-style-type: none"> 1. Establish a connection to the MP server and login as admusr. 2. Create network routes to the NO's XMI (OAM) network. <ul style="list-style-type: none"> Note: If your NOAM XMI network is exactly the same as your MP XMI network, then you should skip this command and only configure the DR NO route. <pre style="border: 1px solid black; padding: 5px;">\$ sudo /usr/TKLC/plat/bin/netAdm add -route=net --address=<NO_Site_Network_ID> -- netmask=<NO_Site_Network_Netmask> --gateway=<MP_XMI_Gateway_IP_Address> -- device=<MP_XMI_Interface></pre> 3. Create network routes to the DR NO's XMI (OAM) network. <pre style="border: 1px solid black; padding: 5px;">\$ sudo /usr/TKLC/plat/bin/netAdm add -route=net --address=<DR-NO_Site_Network_ID> --netmask=<<DR-NO_Site_Network_Netmask> --gateway=<MP_XMI_Gateway_IP_Address> -- device=<MP_XMI_Interface></pre> 4. Create network routes to the management server TVOE XMI (OAM) network for NTP. <pre style="border: 1px solid black; padding: 5px;">\$ sudo /usr/TKLC/plat/bin/netAdm add -route=net --address=<TVOE_Mgmt_Network_Address> --netmask=<TVOE_Mgmt_Network_Netmask> --gateway=<MP_XMI_Gateway_IP_Address> -- device=<MP_XMI_Interface></pre> 5. (Optional) If sending SNMP traps from individual servers, create host routes to customer SNMP trap destinations on the XMI network. <pre style="border: 1px solid black; padding: 5px;">\$ sudo /usr/TKLC/plat/bin/netAdm add -route=host --address=<Customer_NMS_IP> -- gateway=<MP_XMI_Gateway_IP_Address> --device=<MP_XMI_Interface></pre> 6. Repeat for any existing customer NMS stations. 7. Delete the existing default route: <ol style="list-style-type: none"> a. Log into primary NOAM VIP GUI. b. Navigate to Configuration > Networking > Networks. c. Select the respective SOAM tab. d. Select the XMI network and click Unlock. Click OK to confirm. e. Navigate to Configuration > Networking > Routes. f. Select the XMI route and click Delete. g. Click OK to confirm. h. Repeat steps 1 through 7 for all required MPs to delete the XMI routes. i. Navigate to Configuration > Networking > Networks. j. Select the respective SOAM tab. k. Select the XMI network and click Lock. l. Click OK to confirm.
------------------------------------	---	---

Procedure 103. Growth: MP (For 7.x to 8.x Upgraded System)

10. <input type="checkbox"/>	MP Server: Verify connectivity	<ol style="list-style-type: none"> Establish a connection to the MP server and login as admusr. Ping active NO XMI IP address to verify connectivity. <div data-bbox="505 338 1419 562" style="border: 1px solid black; padding: 5px;"> <pre>\$ ping <ACTIVE_NO_XMI_IP_Address> PING 10.240.108.6 (10.240.108.6) 56(84) bytes of data. 64 bytes from 10.240.108.6: icmp_seq=1 ttl=64 time=0.342 ms 64 bytes from 10.240.108.6: icmp_seq=2 ttl=64 time=0.247 ms</pre> </div> (Optional) Ping Customer NMS Station(s). <div data-bbox="505 617 1419 842" style="border: 1px solid black; padding: 5px;"> <pre>\$ ping <Customer_NMS_IP> PING 172.4.116.8 (172.4.118.8) 56(84) bytes of data. 64 bytes from 172.4.116.8: icmp_seq=1 ttl=64 time=0.342 ms 64 bytes from 172.4.116.8: icmp_seq=2 ttl=64 time=0.247 ms</pre> </div> If you do not get a response, then verify your network configuration. If you continue to get failures, then stop the installation and contact Oracle customer support.
11. <input type="checkbox"/>	Repeat for remaining MPs at all sites	Repeat this entire procedure for all remaining MPs (SS7-MP, DA-MP, SBR, and IPFE).
12. <input type="checkbox"/>	Configure MP	Execute these procedures: <ol style="list-style-type: none"> Procedure 31 Configure Places and Assign MP Servers to Places (PCA and DCA Only) Procedure 32 Configure DAMP Server Groups and Profiles
Steps (13. through 16.) configure the signaling interfaces for the newly added MPs.		
13. <input type="checkbox"/>	Newly Created MP Server Console: Manually configure signaling interface	<ol style="list-style-type: none"> Log into iLO/iLOM and follow Appendix D TVOE iLO/iLOM GUI Access to access the iLO/iLOM GUI. <div data-bbox="553 1367 1409 1415" style="border: 1px solid black; padding: 5px;"> <pre>https://<management_server_iLO_ip></pre> </div> Log into the newly added MP console. Execute this command to configure the signaling interfaces. <div data-bbox="553 1520 1409 1661" style="border: 1px solid black; padding: 5px;"> <pre>\$ sudo /usr/TKLC/plat/bin/netAdm add --onboot=yes --netmask=<netmask> --device=xsil --address=<IP address> Interface xsil added.</pre> </div> Repeat to configure the required number of signaling interfaces. Reboot the VM. <div data-bbox="553 1766 1409 1814" style="border: 1px solid black; padding: 5px;"> <pre>\$ sudo init 6</pre> </div> <p>It takes approximately five minutes for the VM to complete rebooting.</p>

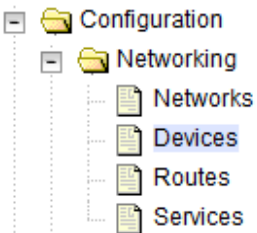
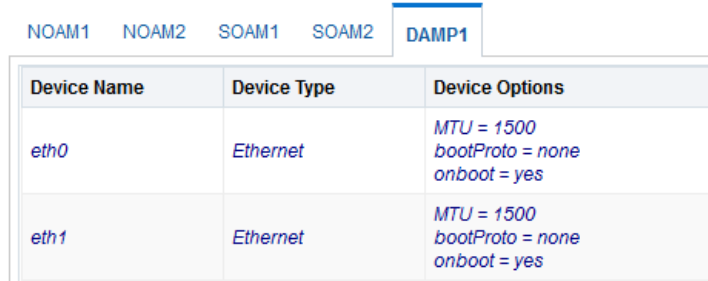
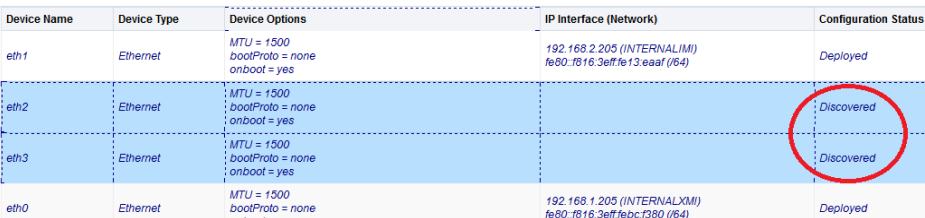
Procedure 103. Growth: MP (For 7.x to 8.x Upgraded System)

<p>14. <input type="checkbox"/></p>	<p>NOAM VIP GUI: Take ownership of the signaling interfaces and make it deployed</p>	<p>1. Navigate to Configuration > Network > Devices.</p>  <p>2. Click on the tab representing the newly added MP blade.</p> <p>Main Menu: Configuration -> Networking -> Devices</p>  <table border="1" data-bbox="516 745 1209 966"> <thead> <tr> <th>Device Name</th> <th>Device Type</th> <th>Device Options</th> </tr> </thead> <tbody> <tr> <td>eth0</td> <td>Ethernet</td> <td>MTU = 1500 bootProto = none onboot = yes</td> </tr> <tr> <td>eth1</td> <td>Ethernet</td> <td>MTU = 1500 bootProto = none onboot = yes</td> </tr> </tbody> </table> <p>3. Select all newly configured signaling ethernet devices that have Discovered as their Configuration Status.</p>  <table border="1" data-bbox="506 1060 1425 1276"> <thead> <tr> <th>Device Name</th> <th>Device Type</th> <th>Device Options</th> <th>IP Interface (Network)</th> <th>Configuration Status</th> </tr> </thead> <tbody> <tr> <td>eth1</td> <td>Ethernet</td> <td>MTU = 1500 bootProto = none onboot = yes</td> <td>192.168.2.205 (INTERNAL/IM) fe80::f816:3eff:fe13:eaaf/64</td> <td>Deployed</td> </tr> <tr> <td>eth2</td> <td>Ethernet</td> <td>MTU = 1500 bootProto = none onboot = yes</td> <td></td> <td>Discovered</td> </tr> <tr> <td>eth3</td> <td>Ethernet</td> <td>MTU = 1500 bootProto = none onboot = yes</td> <td></td> <td>Discovered</td> </tr> <tr> <td>eth0</td> <td>Ethernet</td> <td>MTU = 1500 bootProto = none onboot = yes</td> <td>192.168.1.205 (INTERNAL/XMI) fe80::f816:3eff:febc:1390/64</td> <td>Deployed</td> </tr> </tbody> </table> <p>4. Click Take Ownership.</p>  <p>Converts a discovered device to a configured one.</p> <p>The selected devices change their Configuration Status to Configured.</p>	Device Name	Device Type	Device Options	eth0	Ethernet	MTU = 1500 bootProto = none onboot = yes	eth1	Ethernet	MTU = 1500 bootProto = none onboot = yes	Device Name	Device Type	Device Options	IP Interface (Network)	Configuration Status	eth1	Ethernet	MTU = 1500 bootProto = none onboot = yes	192.168.2.205 (INTERNAL/IM) fe80::f816:3eff:fe13:eaaf/64	Deployed	eth2	Ethernet	MTU = 1500 bootProto = none onboot = yes		Discovered	eth3	Ethernet	MTU = 1500 bootProto = none onboot = yes		Discovered	eth0	Ethernet	MTU = 1500 bootProto = none onboot = yes	192.168.1.205 (INTERNAL/XMI) fe80::f816:3eff:febc:1390/64	Deployed
Device Name	Device Type	Device Options																																		
eth0	Ethernet	MTU = 1500 bootProto = none onboot = yes																																		
eth1	Ethernet	MTU = 1500 bootProto = none onboot = yes																																		
Device Name	Device Type	Device Options	IP Interface (Network)	Configuration Status																																
eth1	Ethernet	MTU = 1500 bootProto = none onboot = yes	192.168.2.205 (INTERNAL/IM) fe80::f816:3eff:fe13:eaaf/64	Deployed																																
eth2	Ethernet	MTU = 1500 bootProto = none onboot = yes		Discovered																																
eth3	Ethernet	MTU = 1500 bootProto = none onboot = yes		Discovered																																
eth0	Ethernet	MTU = 1500 bootProto = none onboot = yes	192.168.1.205 (INTERNAL/XMI) fe80::f816:3eff:febc:1390/64	Deployed																																
<p>15. <input type="checkbox"/></p>	<p>Repeat for remaining MPs and IPFEs</p>	<p>Repeat steps 13. through 14. for any newly created remaining MP servers.</p>																																		
<p>16. <input type="checkbox"/></p>	<p>Configure ComAgent connection</p>	<p>Execute section 3.17.2 Configure ComAgent Connections (DSR and SDS Only).</p>																																		



Procedure 104. Growth: Query Server (SDS Only)

S T E P #	<p>This procedure configures a query server on the new virtual machine for growth scenarios.</p> <p>Prerequisites:</p> <ul style="list-style-type: none"> • New virtual machine created • TPD/DSR software installed <p>Check off (√) each step as it is completed. Boxes have been provided for this purpose under each step number.</p> <p>If this procedure fails, contact My Oracle Support (MOS) and ask for assistance.</p>	
1. <input type="checkbox"/>	<p>SDS NOAM VIP GUI: Configure the query server</p>	<p>Configure the query server by executing section 3.15.4 Query Server Configuration.</p>

Procedure 105. Post Growth Health Check

S T E P #	<p>This procedure verifies system status and logs all alarms after growth.</p> <p>Check off (√) each step as it is completed. Boxes have been provided for this purpose under each step number.</p> <p>If this procedure fails, contact My Oracle Support (MOS) and ask for assistance.</p>	
1. <input type="checkbox"/>	<p>NOAM VIP GUI: Login</p>	<p>1. Establish a GUI session on the NOAM server by using the VIP IP address of the NOAM server. Open the web browser and enter a URL of:</p> <div style="border: 1px solid black; padding: 2px; margin: 5px 0;"> <p><code>https://<Primary_NOAM_VIP_IP_Address></code></p> </div> <p>2. Login as the guiadmin user.</p> <div style="text-align: center; margin: 20px 0;">  <p>The screenshot shows the Oracle System Login interface. At the top is the Oracle logo. Below it, the text 'Oracle System Login' is on the left and 'Mon Jul 11 13:59:37 2016 EDT' is on the right. A central box contains a 'Log In' form with fields for 'Username:' and 'Password:', a 'Change password' checkbox, and a 'Log In' button. Below the form, it says 'Welcome to the Oracle System Login.' and 'This application is designed to work with most modern HTML5 compliant browsers and uses both JavaScript and cookies. Please refer to the Oracle Software Web Browser Support Policy for details.' At the bottom, it states 'Unauthorized access is prohibited.'</p> </div>

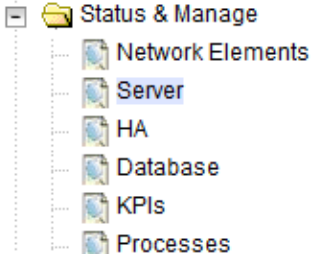
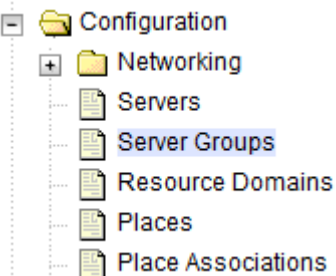
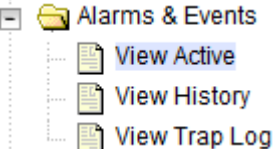
Procedure 105. Post Growth Health Check

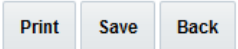
<p>2. <input type="checkbox"/></p>	<p>NOAM VIP GUI: Verify server status</p>	<p>1. Navigate to Status & Manage > Server.</p>  <p>2. Verify all server status is Normal (Norm) for Alarm (Alm), Database (DB), Replication Status, and Processes (Proc).</p> <table border="1" data-bbox="505 636 1430 785"> <thead> <tr> <th>Appl State</th> <th>Alm</th> <th>DB</th> <th>Reporting Status</th> <th>Proc</th> </tr> </thead> <tbody> <tr> <td>Enabled</td> <td>Norm</td> <td>Norm</td> <td>Norm</td> <td>Norm</td> </tr> <tr> <td>Enabled</td> <td>Norm</td> <td>Norm</td> <td>Norm</td> <td>Norm</td> </tr> <tr> <td>Enabled</td> <td>Norm</td> <td>Norm</td> <td>Norm</td> <td>Norm</td> </tr> <tr> <td>Enabled</td> <td>Norm</td> <td>Norm</td> <td>Norm</td> <td>Norm</td> </tr> </tbody> </table>	Appl State	Alm	DB	Reporting Status	Proc	Enabled	Norm	Norm	Norm	Norm	Enabled	Norm	Norm	Norm	Norm	Enabled	Norm	Norm	Norm	Norm	Enabled	Norm	Norm	Norm	Norm
Appl State	Alm	DB	Reporting Status	Proc																							
Enabled	Norm	Norm	Norm	Norm																							
Enabled	Norm	Norm	Norm	Norm																							
Enabled	Norm	Norm	Norm	Norm																							
Enabled	Norm	Norm	Norm	Norm																							
<p>3. <input type="checkbox"/></p>	<p>NOAM VIP GUI: Verify server configuration</p>	<p>1. Navigate to Configuration > Server Groups.</p>  <p>2. Verify the configuration data is correct for your network.</p>																									
<p>4. <input type="checkbox"/></p>	<p>NOAM VIP GUI: Log current alarms</p>	<p>1. Navigate to Alarms & Events > View Active.</p>  <p>2. Click Report.</p>  <p>3. Save or Print this report and keep copies for future reference.</p>  <p>4. Compare this alarm report with those gathered in Procedure 98 Perform Health Check.</p>																									
<p>5. <input type="checkbox"/></p>	<p>SOAM VIP GUI: Repeat</p>	<p>Repeat steps 1. through 3. for the SOAM.</p>																									

Procedure 106. Post Growth Backups

S T E P #	This procedure backs up all necessary items after a growth scenario.		
	Check off (√) each step as it is completed. Boxes have been provided for this purpose under each step number.		
	If this procedure fails, contact My Oracle Support (MOS) and ask for assistance.		
	1.	Backup TVOE	Back up all TVOE host configurations by executing section 3.17.6 Back Up TVOE Configuration.
<input type="checkbox"/>	2.	Backup PMAC	Back up the PMAC application by executing section 3.17.7 Back Up PMAC Application.
<input type="checkbox"/>	3.	Backup NOAM/SOAM databases	Back up the NOAM and SOAM databases by executing sections 3.17.8 Back Up NOAM Database and 3.17.9 Back Up SOAM Database. Note: Database backup on SDS SOAMs is not required.

Appendix P.2 De-Growth (Oracle X5-2/Netra X5-2/X6-2/X7-2/HP DL380 Gen 9 (10Gbps) Only)

For de-growth scenarios where it is necessary to remove/delete DSR/SDS MP (IPFE, SBR, SS7-MP) servers, follow these procedures.

Step	Procedure(s)
Perform backups	Procedure 107 Perform Backups
Perform system health check	Procedure 108 Perform Health Check
Identify servers affected by de-growth: DSR MP (IPFE, SBR, SS7-MP)/SDS DP	
Remove identified servers from server group	Procedure 109 Remove Server from Server Group and Procedure 110 Delete Server/Server Group
Shut down and remove the identified server's VM	Procedure 111 Delete Server VM
Post de-growth health check	Procedure 112 Post De-Growth Health Check
Post de-growth backups	Procedure 113 Post De-Growth Backups

Procedure 107. Perform Backups

S T E P #	This procedure backs up all necessary items before a de-growth scenario.		
	Check off (√) each step as it is completed. Boxes have been provided for this purpose under each step number.		
	If this procedure fails, contact My Oracle Support (MOS) and ask for assistance.		
	1.	Backup TVOE	Back up all TVOE host configurations by executing section 3.17.6 Back Up TVOE Configuration.
<input type="checkbox"/>	2.	Backup PMAC	Back up the PMAC application by executing section 3.17.7 Back Up PMAC Application.
<input type="checkbox"/>			

Procedure 107. Perform Backups

3. <input type="checkbox"/>	Backup NOAM/SOAM databases	Back up the NOAM and SOAM databases by executing sections 3.17.8 Back Up NOAM Database and 3.17.9 Back Up SOAM Database. Note: Database backup on SDS SOAMs is not required.
--------------------------------	----------------------------	--



Procedure 108. Perform Health Check

S T E P #	<p>This procedure verifies system status and logs all alarms.</p> <p>Check off (✓) each step as it is completed. Boxes have been provided for this purpose under each step number.</p> <p>If this procedure fails, contact My Oracle Support (MOS) and ask for assistance.</p>	
1. <input type="checkbox"/>	<p>NOAM VIP GUI: Login</p>	<p>1. Establish a GUI session on the NOAM server by using the VIP IP address of the NOAM server. Open the web browser and enter a URL of:</p> <div style="border: 1px solid black; padding: 5px; margin: 5px 0;"> <p>https://<Primary_NOAM_VIP_IP_Address></p> </div> <p>2. Login as the guiadmin user.</p> <div style="text-align: center; margin: 20px 0;">  </div> <div style="text-align: center; margin: 10px 0;"> <p>Oracle System Login</p> <hr style="width: 50%; margin: 0 auto;"/> <p style="font-size: small; margin: 0;">Mon Jul 11 13:59:37 2016 EDT</p> </div> <div style="text-align: center; margin: 20px 0;"> <div style="border: 1px solid gray; padding: 10px; width: fit-content; margin: 0 auto;"> <p>Log In</p> <p>Enter your username and password to log in</p> <p>Username: <input style="width: 100%;" type="text"/></p> <p>Password: <input style="width: 100%;" type="password"/></p> <p><input type="checkbox"/> Change password</p> <p style="text-align: center;"><input type="button" value="Log In"/></p> </div> <p style="font-size: x-small; margin-top: 10px;">Welcome to the Oracle System Login.</p> <p style="font-size: x-small; margin-top: 10px;">This application is designed to work with most modern HTML5 compliant browsers and uses both JavaScript and cookies. Please refer to the Oracle Software Web Browser Support Policy for details.</p> <p style="font-size: x-small; margin-top: 10px;">Unauthorized access is prohibited.</p> <hr style="width: 50%; margin: 10px auto;"/> <p style="font-size: x-small; margin: 0;">Oracle and Java are registered trademarks of Oracle Corporation and/or its affiliates. Other names may be trademarks of their respective owners.</p> <p style="font-size: x-small; margin: 0;">Copyright © 2010, 2016, Oracle and/or its affiliates. All rights reserved.</p> </div>

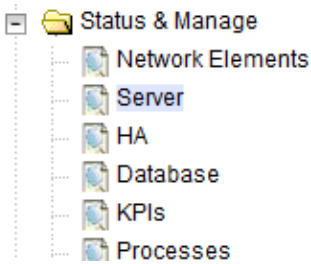
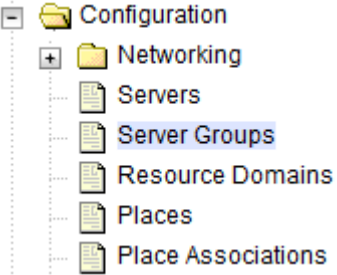
Procedure 108. Perform Health Check

<p>2. <input type="checkbox"/></p>	<p>NOAM VIP GUI: Verify server status</p>	<p>1. Navigate to Status & Manage > Server.</p>  <p>2. Verify all server status is Normal (Norm) for Alarm (Alm), Database (DB), Replication Status, and Processes (Proc).</p> <table border="1" data-bbox="506 634 1425 789"> <thead> <tr> <th>Appl State</th> <th>Alm</th> <th>DB</th> <th>Reporting Status</th> <th>Proc</th> </tr> </thead> <tbody> <tr> <td>Enabled</td> <td>Norm</td> <td>Norm</td> <td>Norm</td> <td>Norm</td> </tr> <tr> <td>Enabled</td> <td>Norm</td> <td>Norm</td> <td>Norm</td> <td>Norm</td> </tr> <tr> <td>Enabled</td> <td>Norm</td> <td>Norm</td> <td>Norm</td> <td>Norm</td> </tr> <tr> <td>Enabled</td> <td>Norm</td> <td>Norm</td> <td>Norm</td> <td>Norm</td> </tr> </tbody> </table> <p>Do not proceed to with Growth/De-Growth if any of the above states are not Norm. If any of these are not Norm, corrective action should be taken to restore the non-Norm status to Norm before proceeding with the feature activation.</p> <p>If the Alarm (Alm) status is not Norm but only Minor alarms are present, it is acceptable to proceed. If there are Major or Critical alarms present, these alarms should be analyzed prior to proceeding with the feature activation. The activation may be able to proceed in the presence of certain Major or Critical alarms</p>	Appl State	Alm	DB	Reporting Status	Proc	Enabled	Norm	Norm	Norm	Norm	Enabled	Norm	Norm	Norm	Norm	Enabled	Norm	Norm	Norm	Norm	Enabled	Norm	Norm	Norm	Norm
Appl State	Alm	DB	Reporting Status	Proc																							
Enabled	Norm	Norm	Norm	Norm																							
Enabled	Norm	Norm	Norm	Norm																							
Enabled	Norm	Norm	Norm	Norm																							
Enabled	Norm	Norm	Norm	Norm																							
<p>3. <input type="checkbox"/></p>	<p>NOAM VIP GUI: Verify server configuration</p>	<p>1. Navigate to Configuration > Server Groups.</p>  <p>2. Verify the configuration data is correct for your network.</p>																									

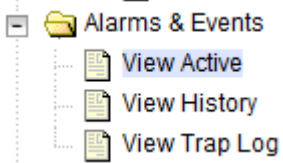
Procedure 108. Perform Health Check

<p>4. <input type="checkbox"/></p>	<p>NOAM VIP GUI: Log current alarms</p>	<p>1. Navigate to Alarms & Events > View Active.</p>  <p>2. Click Report.</p>  <p>3. Save or Print this report and keep copies for future reference.</p> 
<p>5. <input type="checkbox"/></p>	<p>SOAM VIP GUI: Repeat for SOAM</p>	<p>Repeat this procedure for the SOAM.</p>

Procedure 109. Remove Server from Server Group

S T E P #	<p>Once the server that will be deleted has been identified, the server first needs to be removed from its server group.</p> <p>This procedure removes a server from a server group.</p> <p style="text-align: center;">Warning</p> <p>It is recommended that no more than one server from each server group be removed from a server group at a time.</p> <p>Check off (✓) each step as it is completed. Boxes have been provided for this purpose under each step number.</p> <p>If this procedure fails, contact My Oracle Support (MOS) and ask for assistance.</p>
<p>1. <input type="checkbox"/></p>	<p>SOAM VIP GUI: Login</p> <p>Execute this step if removing SS7-MP, otherwise skip to step 10.</p> <ol style="list-style-type: none"> Establish a GUI session on the SOAM server by using the VIP IP address of the SOAM server. Open the web browser and enter a URL of: <div style="border: 1px solid black; padding: 5px; margin: 10px 0;"> <p>https://<Primary_SOAM_VIP_IP_Address></p> </div> Login as the guiadmin user. <div style="text-align: center;">  </div> <p style="text-align: center;"><small>Oracle and Java are registered trademarks of Oracle Corporation and/or its affiliates. Other names may be trademarks of their respective owners. Copyright © 2010, 2016, Oracle and/or its affiliates. All rights reserved.</small></p>

Procedure 109. Remove Server from Server Group

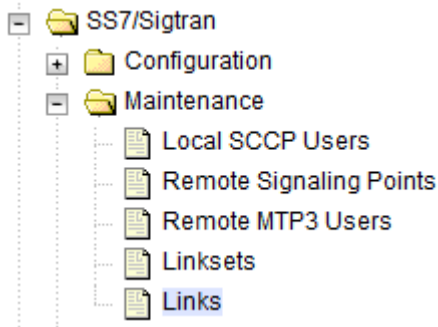
<p>2. <input type="checkbox"/></p>	<p>SOAM VIP GUI: Disable SS7-MP links</p>	<p>Execute this step if removing SS7-MP, otherwise skip to step 10.</p> <p>1. Navigate to SS7/Sigtran > Maintenance > Links.</p>  <p>2. Disable the associated links of the identified SS7-MP.</p> <table border="1" data-bbox="503 709 1458 1037"> <thead> <tr> <th rowspan="2">Signaling Network Element Name</th> <th rowspan="2">Link Name</th> <th rowspan="2">Link Set</th> <th rowspan="2">MP Server Hostname</th> <th rowspan="2">Admin State</th> <th colspan="2">Operational</th> <th rowspan="2">MP Server HA Status</th> </tr> <tr> <th>Status</th> <th>Reason</th> </tr> </thead> <tbody> <tr> <td>ZombieSOAM</td> <td>L1</td> <td>LS1</td> <td>ZombieSS7MP 1</td> <td>Disable d</td> <td>Down</td> <td>Disabled</td> <td>Active</td> </tr> <tr> <td>ZombieSOAM</td> <td>L10</td> <td>LS10</td> <td>ZombieSS7MP 2</td> <td>Disable d</td> <td>Down</td> <td>Disabled</td> <td>Active</td> </tr> <tr> <td>ZombieSOAM</td> <td>L11</td> <td>LS11</td> <td>ZombieSS7MP 1</td> <td>Disable d</td> <td>Down</td> <td>Disabled</td> <td>Active</td> </tr> <tr> <td>ZombieSOAM</td> <td>L12</td> <td>LS12</td> <td>ZombieSS7MP 2</td> <td>Disable d</td> <td>Down</td> <td>Disabled</td> <td>Active</td> </tr> <tr> <td>ZombieSOAM</td> <td>L13</td> <td>LS13</td> <td>ZombieSS7MP 1</td> <td>Disable d</td> <td>Down</td> <td>Disabled</td> <td>Active</td> </tr> </tbody> </table>	Signaling Network Element Name	Link Name	Link Set	MP Server Hostname	Admin State	Operational		MP Server HA Status	Status	Reason	ZombieSOAM	L1	LS1	ZombieSS7MP 1	Disable d	Down	Disabled	Active	ZombieSOAM	L10	LS10	ZombieSS7MP 2	Disable d	Down	Disabled	Active	ZombieSOAM	L11	LS11	ZombieSS7MP 1	Disable d	Down	Disabled	Active	ZombieSOAM	L12	LS12	ZombieSS7MP 2	Disable d	Down	Disabled	Active	ZombieSOAM	L13	LS13	ZombieSS7MP 1	Disable d	Down	Disabled	Active
Signaling Network Element Name	Link Name	Link Set						MP Server Hostname	Admin State		Operational		MP Server HA Status																																							
			Status	Reason																																																
ZombieSOAM	L1	LS1	ZombieSS7MP 1	Disable d	Down	Disabled	Active																																													
ZombieSOAM	L10	LS10	ZombieSS7MP 2	Disable d	Down	Disabled	Active																																													
ZombieSOAM	L11	LS11	ZombieSS7MP 1	Disable d	Down	Disabled	Active																																													
ZombieSOAM	L12	LS12	ZombieSS7MP 2	Disable d	Down	Disabled	Active																																													
ZombieSOAM	L13	LS13	ZombieSS7MP 1	Disable d	Down	Disabled	Active																																													
<p>3. <input type="checkbox"/></p>	<p>SOAM VIP GUI: Disable SS7-MP SCCP users</p>	<p>Execute this step if removing SS7-MP, otherwise skip to step 10.</p> <p>1. Navigate to SS7/Sigtran > Maintenance > Local SCCP Users.</p>  <p>2. Disable the associated local SCCP users of the identified SS7-MP.</p> <table border="1" data-bbox="503 1507 1458 1753"> <thead> <tr> <th rowspan="2">Signaling Network Element Name</th> <th rowspan="2">SSN</th> <th colspan="2">Local Signaling Point</th> <th rowspan="2">Application Name</th> <th rowspan="2">SSN Status</th> <th rowspan="2">Up/Down Since</th> </tr> <tr> <th>Point Code</th> <th>SS7 Domain</th> </tr> </thead> <tbody> <tr> <td>ZombieSOAM</td> <td>248</td> <td>100-100-100</td> <td>ANSI</td> <td>MAPIWF</td> <td>Disabled</td> <td>2016-08-10 13:06:31 EDT</td> </tr> <tr> <td>ZombieSOAM</td> <td>249</td> <td>111-111-111</td> <td>ANSI</td> <td>MAPIWF</td> <td>Disabled</td> <td>2016-08-10 13:06:54 EDT</td> </tr> <tr> <td>ZombieSOAM</td> <td>250</td> <td>1-100-1</td> <td>ITUI</td> <td>MAPIWF</td> <td>Disabled</td> <td>2016-08-10 13:07:09 EDT</td> </tr> <tr> <td>ZombieSOAM</td> <td>251</td> <td>1-101-1</td> <td>ITUI</td> <td>MAPIWF</td> <td>Disabled</td> <td>2016-08-10 13:07:17 EDT</td> </tr> </tbody> </table>	Signaling Network Element Name	SSN	Local Signaling Point		Application Name	SSN Status	Up/Down Since	Point Code	SS7 Domain	ZombieSOAM	248	100-100-100	ANSI	MAPIWF	Disabled	2016-08-10 13:06:31 EDT	ZombieSOAM	249	111-111-111	ANSI	MAPIWF	Disabled	2016-08-10 13:06:54 EDT	ZombieSOAM	250	1-100-1	ITUI	MAPIWF	Disabled	2016-08-10 13:07:09 EDT	ZombieSOAM	251	1-101-1	ITUI	MAPIWF	Disabled	2016-08-10 13:07:17 EDT													
Signaling Network Element Name	SSN	Local Signaling Point			Application Name	SSN Status				Up/Down Since																																										
		Point Code	SS7 Domain																																																	
ZombieSOAM	248	100-100-100	ANSI	MAPIWF	Disabled	2016-08-10 13:06:31 EDT																																														
ZombieSOAM	249	111-111-111	ANSI	MAPIWF	Disabled	2016-08-10 13:06:54 EDT																																														
ZombieSOAM	250	1-100-1	ITUI	MAPIWF	Disabled	2016-08-10 13:07:09 EDT																																														
ZombieSOAM	251	1-101-1	ITUI	MAPIWF	Disabled	2016-08-10 13:07:17 EDT																																														

Procedure 109. Remove Server from Server Group

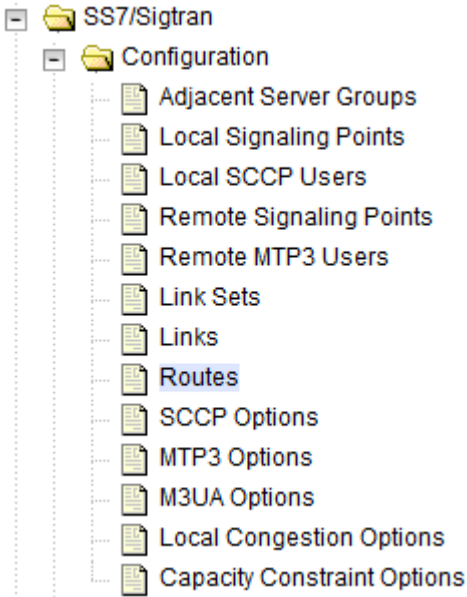
4.	<input type="checkbox"/> SOAM VIP GUI: Delete SS7-MP routes	<p>Execute this step if removing SS7-MP, otherwise skip to step 10.</p> <p>1. Navigate to SS7/Sigtran > Configuration > Routes.</p>  <p>2. Delete the associated routes of the identified SS7-MP.</p> <table border="1" data-bbox="503 982 1421 1186"> <thead> <tr> <th>Signaling Network Element Name</th> <th>SS7 Domain</th> <th>Remote Point Code</th> <th>Link Set</th> <th>Adjacent Point Code</th> <th>Relative Cost</th> <th>Route Name</th> </tr> </thead> <tbody> <tr> <td>ZombieSOAM</td> <td>ANSI</td> <td>200-200-200</td> <td>LS1</td> <td>200-200-200</td> <td>20</td> <td>R1</td> </tr> <tr> <td>ZombieSOAM</td> <td>ANSI</td> <td>200-200-200</td> <td>LS2</td> <td>200-200-200</td> <td>20</td> <td>R2</td> </tr> <tr style="background-color: #e0f0ff;"> <td>ZombieSOAM</td> <td>ANSI</td> <td>201-201-201</td> <td>LS3</td> <td>201-201-201</td> <td>20</td> <td>R3</td> </tr> <tr> <td>ZombieSOAM</td> <td>ANSI</td> <td>201-201-201</td> <td>LS4</td> <td>201-201-201</td> <td>20</td> <td>R4</td> </tr> <tr> <td>ZombieSOAM</td> <td>ANSI</td> <td>202-202-202</td> <td>LS5</td> <td>202-202-202</td> <td>20</td> <td>R5</td> </tr> <tr> <td>ZombieSOAM</td> <td>ANSI</td> <td>202-202-202</td> <td>LS6</td> <td>202-202-202</td> <td>20</td> <td>R6</td> </tr> <tr> <td>ZombieSOAM</td> <td>ANSI</td> <td>202-202-202</td> <td>LS7</td> <td>202-202-202</td> <td>20</td> <td>R7</td> </tr> </tbody> </table>	Signaling Network Element Name	SS7 Domain	Remote Point Code	Link Set	Adjacent Point Code	Relative Cost	Route Name	ZombieSOAM	ANSI	200-200-200	LS1	200-200-200	20	R1	ZombieSOAM	ANSI	200-200-200	LS2	200-200-200	20	R2	ZombieSOAM	ANSI	201-201-201	LS3	201-201-201	20	R3	ZombieSOAM	ANSI	201-201-201	LS4	201-201-201	20	R4	ZombieSOAM	ANSI	202-202-202	LS5	202-202-202	20	R5	ZombieSOAM	ANSI	202-202-202	LS6	202-202-202	20	R6	ZombieSOAM	ANSI	202-202-202	LS7	202-202-202	20	R7
Signaling Network Element Name	SS7 Domain	Remote Point Code	Link Set	Adjacent Point Code	Relative Cost	Route Name																																																				
ZombieSOAM	ANSI	200-200-200	LS1	200-200-200	20	R1																																																				
ZombieSOAM	ANSI	200-200-200	LS2	200-200-200	20	R2																																																				
ZombieSOAM	ANSI	201-201-201	LS3	201-201-201	20	R3																																																				
ZombieSOAM	ANSI	201-201-201	LS4	201-201-201	20	R4																																																				
ZombieSOAM	ANSI	202-202-202	LS5	202-202-202	20	R5																																																				
ZombieSOAM	ANSI	202-202-202	LS6	202-202-202	20	R6																																																				
ZombieSOAM	ANSI	202-202-202	LS7	202-202-202	20	R7																																																				

Procedure 109. Remove Server from Server Group

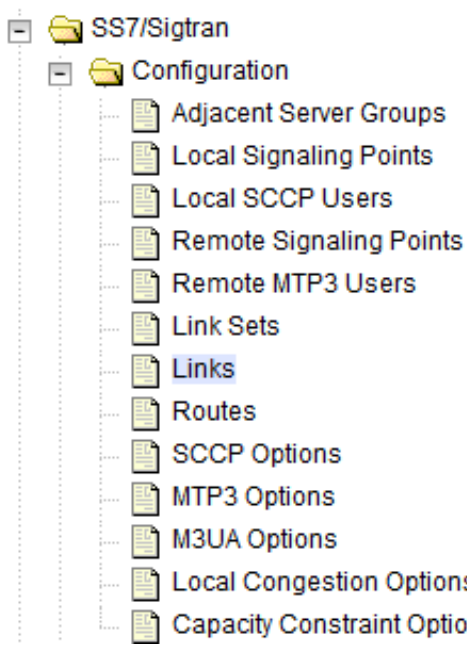
<p>5. <input type="checkbox"/></p>	<p>SOAM VIP GUI: Delete SS7-MP links</p>	<p>Execute this step if removing SS7-MP, otherwise skip to step 10.</p> <p>1. Navigate to SS7/Sigtran > Configuration > Links.</p>  <p>2. Delete the associated links of the identified SS7-MP.</p> <table border="1" data-bbox="503 1018 1421 1228"> <thead> <tr> <th>Signaling Network Element Name</th> <th>Link Name</th> <th>Link Set</th> <th>Association</th> </tr> </thead> <tbody> <tr> <td>ZombieSOAM</td> <td>L1</td> <td>LS1</td> <td>pc9111729_046</td> </tr> <tr style="background-color: #e0f0ff;"> <td>ZombieSOAM</td> <td>L2</td> <td>LS2</td> <td>pc9111729_0461</td> </tr> <tr> <td>ZombieSOAM</td> <td>L3</td> <td>LS3</td> <td>pc9111729_0462</td> </tr> <tr> <td>ZombieSOAM</td> <td>L4</td> <td>LS4</td> <td>pc9111729_0463</td> </tr> <tr> <td>ZombieSOAM</td> <td>L5</td> <td>LS5</td> <td>pc9111729_1</td> </tr> <tr> <td>ZombieSOAM</td> <td>L6</td> <td>LS6</td> <td>pc9111729_11</td> </tr> </tbody> </table>	Signaling Network Element Name	Link Name	Link Set	Association	ZombieSOAM	L1	LS1	pc9111729_046	ZombieSOAM	L2	LS2	pc9111729_0461	ZombieSOAM	L3	LS3	pc9111729_0462	ZombieSOAM	L4	LS4	pc9111729_0463	ZombieSOAM	L5	LS5	pc9111729_1	ZombieSOAM	L6	LS6	pc9111729_11
Signaling Network Element Name	Link Name	Link Set	Association																											
ZombieSOAM	L1	LS1	pc9111729_046																											
ZombieSOAM	L2	LS2	pc9111729_0461																											
ZombieSOAM	L3	LS3	pc9111729_0462																											
ZombieSOAM	L4	LS4	pc9111729_0463																											
ZombieSOAM	L5	LS5	pc9111729_1																											
ZombieSOAM	L6	LS6	pc9111729_11																											

Procedure 109. Remove Server from Server Group

6. **SOAM VIP GUI:**
 Delete SS7-MP link sets

Execute this step if removing SS7-MP, otherwise skip to step 10.

1. Navigate to **SS7/Sigtran > Configuration > Link Sets**.

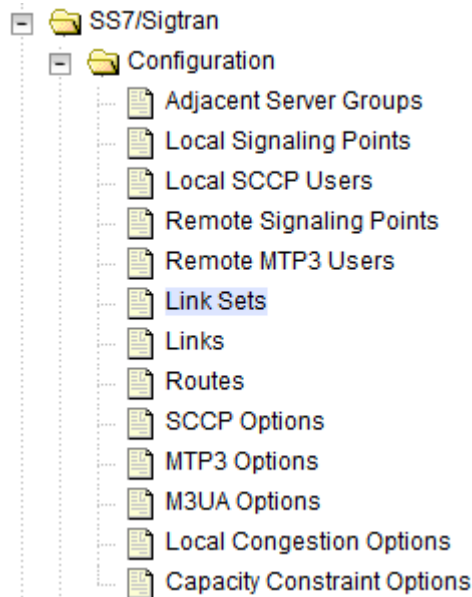

2. Delete the associated link sets of the identified SS7-MP.

Signaling Network Element Name	Link Set Name	Mode	Local Signaling Point	SS7 Domain	LSP Point Code	Adjacent Remote Point Code	Routing Context
ZombieSOAM	LS1	AS→SG	ANSI_100_100_100	ANSI	All	200-200-200	----
ZombieSOAM	LS2	AS→SG	ANSI_111_111_111	ANSI	All	200-200-200	----
ZombieSOAM	LS3	AS→SG	ANSI_100_100_100	ANSI	All	201-201-201	----
ZombieSOAM	LS4	AS→SG	ANSI_111_111_111	ANSI	All	201-201-201	----
ZombieSOAM	LS5	AS→SG	ANSI_100_100_100	ANSI	All	202-202-202	----
ZombieSOAM	LS6	AS→SG	ANSI_111_111_111	ANSI	All	202-202-202	----

Procedure 109. Remove Server from Server Group

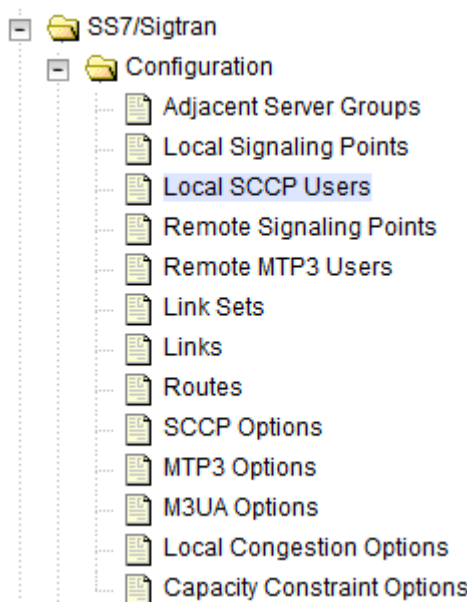
<p>7. <input type="checkbox"/></p>	<p>SOAM VIP GUI: Delete SS7-MP local SCCP users</p>	<p>Execute this step if removing SS7-MP, otherwise skip to step 10.</p> <p>1. Navigate to SS7/Sigtran > Configuration > Local SCCP Users.</p>  <p>2. Delete the associated Local SCCP Users from the identified SS7-MP.</p> <table border="1" data-bbox="503 976 1421 1281"> <thead> <tr> <th rowspan="2">Signaling Network Element Name</th> <th rowspan="2">SSN</th> <th colspan="2">Local Signaling Point</th> <th rowspan="2">Application Name</th> </tr> <tr> <th>SS7 Domain</th> <th>Point Code</th> </tr> </thead> <tbody> <tr> <td>ZombieSOAM</td> <td>248</td> <td>ANSI</td> <td>100-100-100</td> <td>MAPIWF</td> </tr> <tr style="border: 2px dashed blue;"> <td>ZombieSOAM</td> <td>249</td> <td>ANSI</td> <td>111-111-111</td> <td>MAPIWF</td> </tr> <tr> <td>ZombieSOAM</td> <td>250</td> <td>ITU</td> <td>1-100-1</td> <td>MAPIWF</td> </tr> <tr> <td>ZombieSOAM</td> <td>251</td> <td>ITU</td> <td>1-101-1</td> <td>MAPIWF</td> </tr> </tbody> </table>	Signaling Network Element Name	SSN	Local Signaling Point		Application Name	SS7 Domain	Point Code	ZombieSOAM	248	ANSI	100-100-100	MAPIWF	ZombieSOAM	249	ANSI	111-111-111	MAPIWF	ZombieSOAM	250	ITU	1-100-1	MAPIWF	ZombieSOAM	251	ITU	1-101-1	MAPIWF
Signaling Network Element Name	SSN	Local Signaling Point			Application Name																								
		SS7 Domain	Point Code																										
ZombieSOAM	248	ANSI	100-100-100	MAPIWF																									
ZombieSOAM	249	ANSI	111-111-111	MAPIWF																									
ZombieSOAM	250	ITU	1-100-1	MAPIWF																									
ZombieSOAM	251	ITU	1-101-1	MAPIWF																									

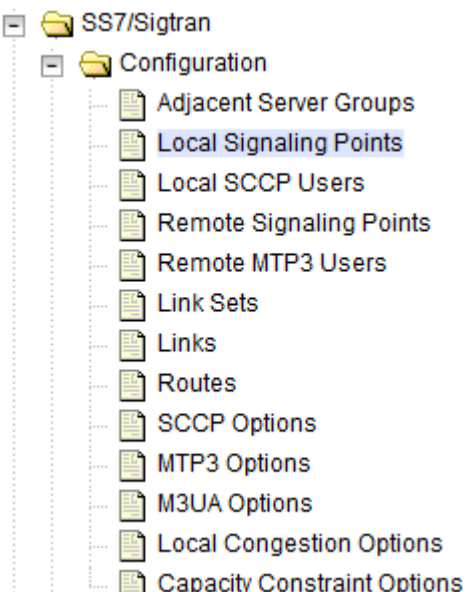
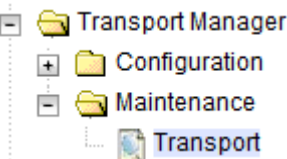

Procedure 109. Remove Server from Server Group

<p>8. <input type="checkbox"/></p>	<p>SOAM VIP GUI: Delete SS7-MP local signaling points</p>	<p>Execute this step if removing SS7-MP, otherwise skip to step 10.</p> <p>1. Navigate to SS7/Sigtran > Configuration > Local Signaling Points.</p>  <p>2. Delete the associated Local signaling points from the identified SS7-MP.</p> <table border="1" data-bbox="503 966 1421 1102"> <thead> <tr> <th>Signaling Network Element Name</th> <th>Local Signaling Point Name</th> <th>SS7 Domain</th> <th>MTP True Point Code</th> <th>MTP Capability Point Code(s)</th> <th>ServerGroup(s)</th> </tr> </thead> <tbody> <tr> <td>ZombieSOAM</td> <td>ANSI_100_100_100</td> <td>ANSI</td> <td>100-100-100</td> <td>----</td> <td>ZombieSS7SG</td> </tr> <tr> <td>ZombieSOAM</td> <td>ANSI_111_111_111</td> <td>ANSI</td> <td>111-111-111</td> <td>----</td> <td>ZombieSS7SG</td> </tr> <tr> <td>ZombieSOAM</td> <td>ITUI_1_100_1</td> <td>ITUI</td> <td>1-100-1</td> <td>----</td> <td>ZombieSS7SG</td> </tr> <tr> <td>ZombieSOAM</td> <td>ITUI_1_101_1</td> <td>ITUI</td> <td>1-101-1</td> <td>----</td> <td>ZombieSS7SG</td> </tr> </tbody> </table>	Signaling Network Element Name	Local Signaling Point Name	SS7 Domain	MTP True Point Code	MTP Capability Point Code(s)	ServerGroup(s)	ZombieSOAM	ANSI_100_100_100	ANSI	100-100-100	----	ZombieSS7SG	ZombieSOAM	ANSI_111_111_111	ANSI	111-111-111	----	ZombieSS7SG	ZombieSOAM	ITUI_1_100_1	ITUI	1-100-1	----	ZombieSS7SG	ZombieSOAM	ITUI_1_101_1	ITUI	1-101-1	----	ZombieSS7SG			
Signaling Network Element Name	Local Signaling Point Name	SS7 Domain	MTP True Point Code	MTP Capability Point Code(s)	ServerGroup(s)																														
ZombieSOAM	ANSI_100_100_100	ANSI	100-100-100	----	ZombieSS7SG																														
ZombieSOAM	ANSI_111_111_111	ANSI	111-111-111	----	ZombieSS7SG																														
ZombieSOAM	ITUI_1_100_1	ITUI	1-100-1	----	ZombieSS7SG																														
ZombieSOAM	ITUI_1_101_1	ITUI	1-101-1	----	ZombieSS7SG																														
<p>9. <input type="checkbox"/></p>	<p>SOAM VIP GUI: Disable SS7-MP transports</p>	<p>Execute this step if removing SS7-MP, otherwise skip to step 10.</p> <p>1. Navigate to Transport Manager > Maintenance > Transport.</p>  <p>2. Disable the associated transports from the identified SS7-MP.</p> <table border="1" data-bbox="503 1428 1421 1533"> <thead> <tr> <th>Signaling Network Element Name</th> <th>MP Server Hostname</th> <th>Adapter</th> <th>Transport Name</th> <th>Transport Protocol</th> <th>Transport Type</th> <th>Adjacent Node</th> <th>Admin State</th> <th>Operational Status</th> <th>Operational Reason</th> <th>Up/Down Since</th> </tr> </thead> <tbody> <tr> <td>ZombieSOAM</td> <td>ZombieSS7MP1</td> <td>M3UA</td> <td>pc9111729_046</td> <td>SCTP</td> <td>Initiator</td> <td>pc9111729_net046</td> <td>Disabled</td> <td>Down</td> <td>Disabled</td> <td>2016-08-10 09:57:25 EDT</td> </tr> <tr> <td>ZombieSOAM</td> <td>ZombieSS7MP2</td> <td>M3UA</td> <td>pc9111729_0461</td> <td>SCTP</td> <td>Initiator</td> <td>pc9111729_net0461</td> <td>Disabled</td> <td>Down</td> <td>Disabled</td> <td>2016-08-10 10:02:36 EDT</td> </tr> </tbody> </table>	Signaling Network Element Name	MP Server Hostname	Adapter	Transport Name	Transport Protocol	Transport Type	Adjacent Node	Admin State	Operational Status	Operational Reason	Up/Down Since	ZombieSOAM	ZombieSS7MP1	M3UA	pc9111729_046	SCTP	Initiator	pc9111729_net046	Disabled	Down	Disabled	2016-08-10 09:57:25 EDT	ZombieSOAM	ZombieSS7MP2	M3UA	pc9111729_0461	SCTP	Initiator	pc9111729_net0461	Disabled	Down	Disabled	2016-08-10 10:02:36 EDT
Signaling Network Element Name	MP Server Hostname	Adapter	Transport Name	Transport Protocol	Transport Type	Adjacent Node	Admin State	Operational Status	Operational Reason	Up/Down Since																									
ZombieSOAM	ZombieSS7MP1	M3UA	pc9111729_046	SCTP	Initiator	pc9111729_net046	Disabled	Down	Disabled	2016-08-10 09:57:25 EDT																									
ZombieSOAM	ZombieSS7MP2	M3UA	pc9111729_0461	SCTP	Initiator	pc9111729_net0461	Disabled	Down	Disabled	2016-08-10 10:02:36 EDT																									

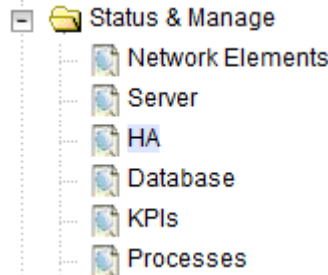
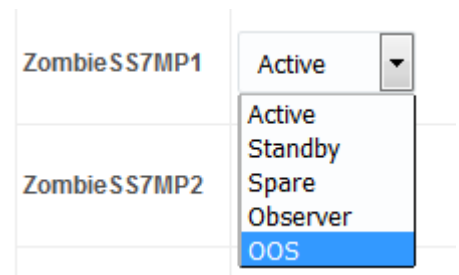
Procedure 109. Remove Server from Server Group

<p>10. <input type="checkbox"/></p>	<p>NOAM VIP GUI: Login</p>	<ol style="list-style-type: none"> Establish a GUI session on the NOAM server by using the VIP IP address of the NOAM server. Open the web browser and enter a URL of: <div style="border: 1px solid black; padding: 2px; width: fit-content; margin: 5px 0;"> <code>https://<Primary_NOAM_VIP_IP_Address></code> </div> Login as the guidadmin user. <div style="text-align: center; margin: 20px 0;">  </div> <div style="text-align: center;"> <p>Oracle System Login Mon Jul 11 13:59:37 2016 EDT</p> <hr/> <div style="border: 1px solid gray; padding: 10px; width: fit-content; margin: 10px auto;"> <p style="text-align: center;">Log In Enter your username and password to log in</p> <p>Username: <input style="width: 100%;" type="text"/></p> <p>Password: <input style="width: 100%;" type="password"/></p> <p style="text-align: center;"><input type="checkbox"/> Change password</p> <p style="text-align: center;"><input type="button" value="Log In"/></p> </div> <p style="text-align: center; margin-top: 10px;">Welcome to the Oracle System Login.</p> <p style="font-size: small; text-align: center;">This application is designed to work with most modern HTML5 compliant browsers and uses both JavaScript and cookies. Please refer to the Oracle Software Web Browser Support Policy for details.</p> </div>
<p>11. <input type="checkbox"/></p>	<p>NOAM VIP GUI: Set server to OOS</p>	<ol style="list-style-type: none"> Navigate to Status & Manage > HA. <div style="margin-left: 20px;">  </div> Click Edit. Set the server's Max Allowed HA Role to OOS. <div style="margin-left: 20px;">  </div> Click OK.

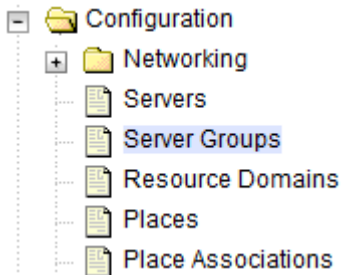
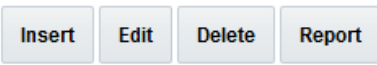
Procedure 109. Remove Server from Server Group

<p>12. <input type="checkbox"/></p>	<p>NOAM VIP GUI: Delete server from server group</p>	<p>1. Navigate to Configuration > Server Groups.</p>  <p>2. Select the server group for which the server from step 2 that was placed OOS.</p> <p>3. Click Edit.</p>  <p>4. Unmark the Include in SG checkbox next to the server from step 2.</p> <table border="1" style="width: 100%; border-collapse: collapse; margin-bottom: 10px;"> <tr> <td style="width: 30%;">Server Group Name *</td> <td style="width: 30%;">ZombieSS7SG1</td> <td style="width: 40%;">Unique identifier used to label a with a digit.] [A value is required.]</td> </tr> <tr> <td>Level *</td> <td>C</td> <td>Select one of the Levels support</td> </tr> <tr> <td>Parent *</td> <td>ZombieSOAM</td> <td>Select an existing Server Group [</td> </tr> <tr> <td>Function *</td> <td>SS7-IWF</td> <td>Select one of the Functions supp</td> </tr> <tr> <td>WAN Replication Connection Count</td> <td>1</td> <td>Specify the number of TCP conn</td> </tr> </table> <table border="1" style="width: 100%; border-collapse: collapse; margin-bottom: 10px;"> <tr> <td colspan="3">ZombieSOAM <input type="checkbox"/> Prefer Network Element as spare</td> </tr> <tr> <th style="width: 40%;">Server</th> <th style="width: 30%;">SG Inclusion</th> <th style="width: 30%;">Preferred HA Role</th> </tr> <tr> <td>ZombieSS7MP1</td> <td><input type="checkbox"/> Include in SG</td> <td><input type="checkbox"/> Prefer server as spare</td> </tr> </table> <p>VIP Assianment</p> <p>5. Click OK.</p> 	Server Group Name *	ZombieSS7SG1	Unique identifier used to label a with a digit.] [A value is required.]	Level *	C	Select one of the Levels support	Parent *	ZombieSOAM	Select an existing Server Group [Function *	SS7-IWF	Select one of the Functions supp	WAN Replication Connection Count	1	Specify the number of TCP conn	ZombieSOAM <input type="checkbox"/> Prefer Network Element as spare			Server	SG Inclusion	Preferred HA Role	ZombieSS7MP1	<input type="checkbox"/> Include in SG	<input type="checkbox"/> Prefer server as spare
Server Group Name *	ZombieSS7SG1	Unique identifier used to label a with a digit.] [A value is required.]																								
Level *	C	Select one of the Levels support																								
Parent *	ZombieSOAM	Select an existing Server Group [
Function *	SS7-IWF	Select one of the Functions supp																								
WAN Replication Connection Count	1	Specify the number of TCP conn																								
ZombieSOAM <input type="checkbox"/> Prefer Network Element as spare																										
Server	SG Inclusion	Preferred HA Role																								
ZombieSS7MP1	<input type="checkbox"/> Include in SG	<input type="checkbox"/> Prefer server as spare																								



Procedure 110. Delete Server/Server Group

<p>S T E P #</p>	<p>Once the server has been removed from the server group, it is safe to delete the server. The server group can also be deleted, if there are no more servers associated with it.</p> <p>This procedure deletes a server and a server group.</p> <p>Check off (✓) each step as it is completed. Boxes have been provided for this purpose under each step number.</p> <p>If this procedure fails, contact My Oracle Support (MOS) and ask for assistance.</p>	
<p>1. <input type="checkbox"/></p>	<p>NOAM VIP GUI: Login</p>	<p>1. Establish a GUI session on the NOAM server by using the VIP IP address of the NOAM server. Open the web browser and enter a URL of:</p> <div style="border: 1px solid black; padding: 5px; margin: 10px 0;"> <p><code>https://<Primary_NOAM_VIP_IP_Address></code></p> </div> <p>2. Login as the guiadmin user.</p> <div style="text-align: center; margin: 20px 0;">  </div> <div style="text-align: center;"> <p>Oracle System Login</p> <hr style="width: 50%; margin: 0 auto;"/> <p style="font-size: small;">Mon Jul 11 13:59:37 2016 EDT</p> </div> <div style="text-align: center; margin: 20px 0;"> <div style="border: 1px solid gray; padding: 10px; width: fit-content; margin: 0 auto;"> <p>Log In</p> <p>Enter your username and password to log in</p> <p>Username: <input style="width: 100%;" type="text"/></p> <p>Password: <input style="width: 100%;" type="password"/></p> <p><input type="checkbox"/> Change password</p> <p style="text-align: center;"><input type="button" value="Log In"/></p> </div> <p style="font-size: x-small; margin-top: 10px;">Welcome to the Oracle System Login.</p> <p style="font-size: x-small; margin-top: 10px;">This application is designed to work with most modern HTML5 compliant browsers and uses both JavaScript and cookies. Please refer to the Oracle Software Web Browser Support Policy for details.</p> <p style="font-size: x-small; margin-top: 10px;">Unauthorized access is prohibited.</p> <hr style="width: 50%; margin: 0 auto;"/> <p style="font-size: x-small; margin-top: 10px;">Oracle and Java are registered trademarks of Oracle Corporation and/or its affiliates. Other names may be trademarks of their respective owners.</p> <p style="font-size: x-small; margin-top: 10px;">Copyright © 2010, 2016, Oracle and/or its affiliates. All rights reserved.</p> </div>

Procedure 110. Delete Server/Server Group

<p>2.</p> <p><input type="checkbox"/></p>	<p>NOAM VIP GUI: Delete the server</p>	<p>1. Navigate to Configuration > Servers.</p> <div style="border: 1px solid #ccc; padding: 5px; margin-bottom: 10px;"> <ul style="list-style-type: none"> [-] Configuration <ul style="list-style-type: none"> [+] Networking <ul style="list-style-type: none"> Servers Server Groups Resource Domains Places Place Associations </div> <p>2. Select the server that has been previously removed from the server group and click Delete.</p> <table border="1" style="width: 100%; border-collapse: collapse; margin-bottom: 10px;"> <tr><td>ZombieSOAM2</td><td>System OAM</td><td></td></tr> <tr><td>ZombieDAMP1</td><td>MP</td><td></td></tr> <tr><td>ZombieDAMP2</td><td>MP</td><td></td></tr> <tr style="background-color: #e0f0ff;"><td>ZombieSS7MP1</td><td>MP</td><td></td></tr> <tr><td>ZombieSS7MP2</td><td>MP</td><td></td></tr> <tr><td>ZombieLPFE1</td><td>MP</td><td></td></tr> <tr><td>ZombieLPFE2</td><td>MP</td><td></td></tr> </table> <div style="display: flex; justify-content: space-between; margin-bottom: 10px;"> Insert Edit Delete Export Report </div> <p>3. Click OK to confirm.</p> <div style="border: 1px solid #ccc; padding: 5px; margin-bottom: 10px;"> <p>Delete Server(s) : ZombieSS7MP1?</p> </div> <div style="display: flex; justify-content: center; gap: 20px;"> OK Cancel </div>	ZombieSOAM2	System OAM		ZombieDAMP1	MP		ZombieDAMP2	MP		ZombieSS7MP1	MP		ZombieSS7MP2	MP		ZombieLPFE1	MP		ZombieLPFE2	MP	
ZombieSOAM2	System OAM																						
ZombieDAMP1	MP																						
ZombieDAMP2	MP																						
ZombieSS7MP1	MP																						
ZombieSS7MP2	MP																						
ZombieLPFE1	MP																						
ZombieLPFE2	MP																						

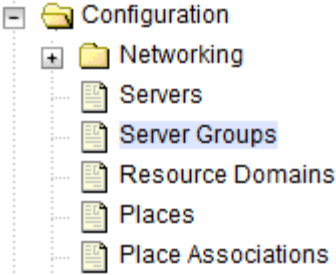
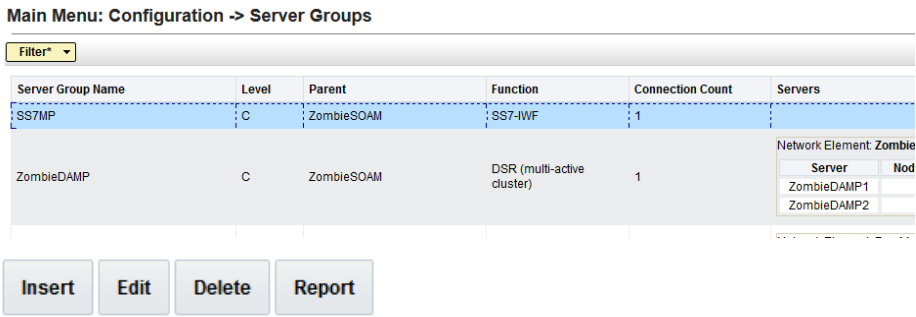
Procedure 110. Delete Server/Server Group

<p>3.</p> <p><input type="checkbox"/></p>	<p>NOAM VIP GUI: Delete server group</p>	<p>If all servers have been removed from a server group, it is now safe to delete the server group.</p> <p>1. Navigate to Configuration > Server Groups.</p>  <p>2. Select the empty server group and click Delete.</p>  <p>3. Click OK to confirm.</p> 
---	---	---

Procedure 111. Delete Server VM

<p>S T E P #</p>	<p>Once the servers being deleted have been identified, placed in OOS, and removed the from the server group, it is safe to shut down and delete the VM for the server. This procedure removes a VM from a TVOE host.</p> <p style="text-align: center;">WARNING</p> <p>Confirm the server to VM mapping before proceeding.</p> <p>Check off (✓) each step as it is completed. Boxes have been provided for this purpose under each step number.</p> <p>If this procedure fails, contact My Oracle Support (MOS) and ask for assistance.</p>
<p>1. <input type="checkbox"/></p>	<p>PMAC GUI: Login</p> <p>1. Open the web browser and navigate to the PMAC GUI:</p> <div style="border: 1px solid gray; padding: 2px; margin: 5px 0;"> <p>http://<PMAC_network_IP></p> </div> <p>2. Login as the guiadmin user.</p> <div style="text-align: center;">  <p>Oracle System Login</p> <hr/> <p style="text-align: right;">Tue Jun 7 13:49:06 2016 EDT</p> <div style="border: 1px solid gray; padding: 10px; margin: 10px auto; width: 80%;"> <p style="text-align: center;">Log In</p> <p style="text-align: center;">Enter your username and password to log in</p> <p style="text-align: center;">Username: <input style="width: 100%;" type="text"/></p> <p style="text-align: center;">Password: <input style="width: 100%;" type="password"/></p> <p style="text-align: center;"><input type="checkbox"/> Change password</p> <p style="text-align: center;"><input type="button" value="Log In"/></p> </div> <p style="text-align: center; font-size: small;">Unauthorized access is prohibited. This Oracle system requires the use of Microsoft Internet Explorer 9.0, 10.0, or 11.0 with support for JavaScript and cookies.</p> <hr/> <p style="text-align: center; font-size: x-small;">Oracle and Java are registered trademarks of Oracle Corporation and/or its affiliates. Other names may be trademarks of their respective owners.</p> <p style="text-align: center; font-size: x-small;">Copyright © 2010, 2016, Oracle and/or its affiliates. All rights reserved.</p> </div>

Procedure 111. Delete Server VM

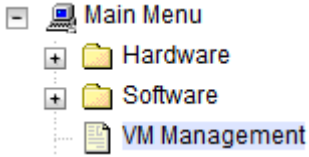
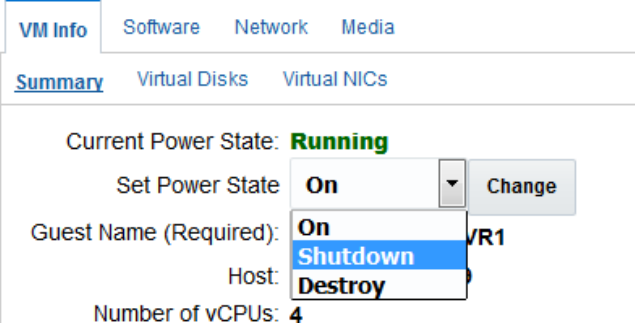
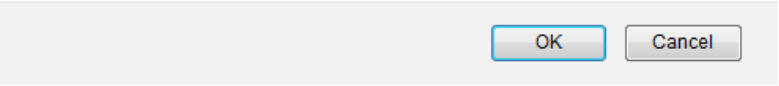
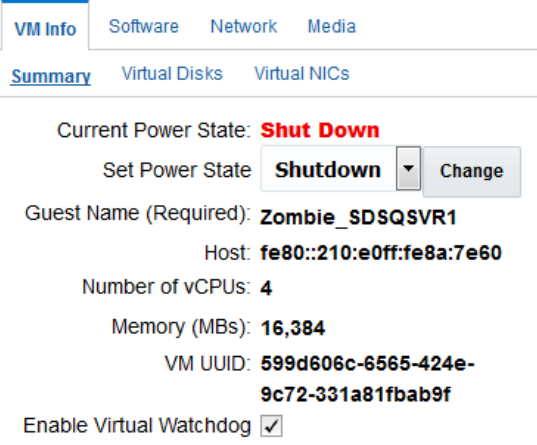
<p>2. <input type="checkbox"/> NOAM VIP GUI: Shut down the VM</p>	<ol style="list-style-type: none"> 1. Navigate to VM Management. <div style="margin-left: 20px;">  </div> 2. Expand the view of the rack mount server, if needed. 3. Shut down the VM by setting the Current Power State to Shutdown. <div style="margin-left: 20px;"> <p>View guest Zombie_SDSQSVR1</p>  </div> 4. Click Change. 5. Click OK. <div style="margin-left: 20px;"> <p>It may not always be possible to shutdown a guest or to do so in a timely manner. You may monitor the power state and opt to destroy the guest rather than shut it down. Are you sure you want to attempt to shutdown this guest?</p>  </div> <p>The Current Power State displays as Shutdown.</p> <div style="margin-left: 20px;"> <p>View guest Zombie_SDSQSVR1</p>  </div>
--	--

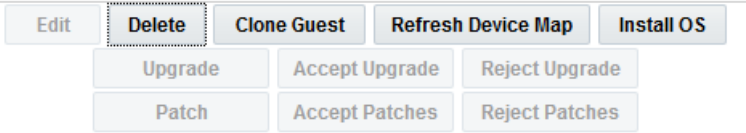

Procedure 111. Delete Server VM

3.	<p>PMAC GUI: Delete the VM</p>	<ol style="list-style-type: none"> Once the server has been shut down, select the VM. Verify the current power state is Shutdown and click Delete.  <ol style="list-style-type: none"> Click OK to confirm. 
----	---	--

Procedure 112. Post De-Growth Health Check

S T E P #		<p>This procedure verifies system status and logs all alarms after de-growth. Check off (✓) each step as it is completed. Boxes have been provided for this purpose under each step number. If this procedure fails, contact My Oracle Support (MOS) and ask for assistance.</p>
1.	<p>NOAM VIP GUI: Login</p>	<ol style="list-style-type: none"> Establish a GUI session on the NOAM server by using the VIP IP address of the NOAM server. Open the web browser and enter a URL of: <div style="border: 1px solid black; padding: 5px; margin: 5px 0;"> <code>https://<Primary_NOAM_VIP_IP_Address></code> </div> Login as the guiadmin user. 

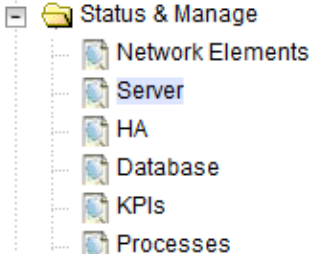
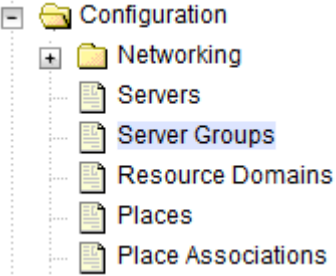
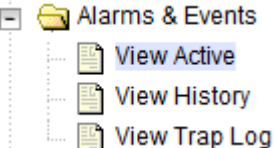
Procedure 112. Post De-Growth Health Check

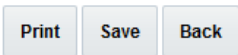
<p>2. <input type="checkbox"/></p>	<p>NOAM VIP GUI: Verify server status</p>	<p>1. Navigate to Status & Manage > Server.</p>  <p>2. Verify all server status is Normal (Norm) for Alarm (Alm), Database (DB), Replication Status, and Processes (Proc).</p> <table border="1" data-bbox="505 636 1409 787"> <thead> <tr> <th>Appl State</th> <th>Alm</th> <th>DB</th> <th>Reporting Status</th> <th>Proc</th> </tr> </thead> <tbody> <tr> <td>Enabled</td> <td>Norm</td> <td>Norm</td> <td>Norm</td> <td>Norm</td> </tr> <tr> <td>Enabled</td> <td>Norm</td> <td>Norm</td> <td>Norm</td> <td>Norm</td> </tr> <tr> <td>Enabled</td> <td>Norm</td> <td>Norm</td> <td>Norm</td> <td>Norm</td> </tr> <tr> <td>Enabled</td> <td>Norm</td> <td>Norm</td> <td>Norm</td> <td>Norm</td> </tr> </tbody> </table>	Appl State	Alm	DB	Reporting Status	Proc	Enabled	Norm	Norm	Norm	Norm	Enabled	Norm	Norm	Norm	Norm	Enabled	Norm	Norm	Norm	Norm	Enabled	Norm	Norm	Norm	Norm
Appl State	Alm	DB	Reporting Status	Proc																							
Enabled	Norm	Norm	Norm	Norm																							
Enabled	Norm	Norm	Norm	Norm																							
Enabled	Norm	Norm	Norm	Norm																							
Enabled	Norm	Norm	Norm	Norm																							
<p>3. <input type="checkbox"/></p>	<p>NOAM VIP GUI: Verify server configuration</p>	<p>1. Navigate to Configuration > Server Groups.</p>  <p>2. Verify the configuration data is correct for your network.</p>																									
<p>4. <input type="checkbox"/></p>	<p>NOAM VIP GUI: Log current alarms</p>	<p>1. Navigate to Alarms & Events > View Active.</p>  <p>2. Click Report.</p>  <p>3. Save or Print this report, keep copies for future reference.</p>  <p>4. Compare this alarm report with those gathered in Procedure 108 Perform Health Check.</p>																									
<p>5. <input type="checkbox"/></p>	<p>SOAM VIP GUI: Repeat</p>	<p>Repeat this procedure the SOAM.</p>																									

Procedure 113. Post De-Growth Backups

S T E P #	<p>This procedure backs up all necessary items after a de-growth scenario.</p> <p>Check off (✓) each step as it is completed. Boxes have been provided for this purpose under each step number.</p> <p>If this procedure fails, contact My Oracle Support (MOS) and ask for assistance.</p>	
1. <input type="checkbox"/>	Back up TVOE	Back up all TVOE host configurations by executing section 3.17.6 Back Up TVOE Configuration.
2. <input type="checkbox"/>	Back up PMAC	Back up the PMAC application by executing section 3.17.7 Back Up PMAC Application.
3. <input type="checkbox"/>	Back up NOAM/SOAM databases	<p>Back up the NOAM and SOAM databases by executing sections 3.17.8 Back Up NOAM Database and 3.17.9 Back Up SOAM Database.</p> <p>Note: Database backup on SDS SOAMs is not required.</p>

Appendix P.3 Re-Shuffle (Oracle X5-2/Netra X5-2/X6-2/X7-2/HP DL380 Gen 9 (10Gbps) Only)

For growth/de-growth scenarios where you need to move or re-shuffle DSR/SDS servers to different TVOE hosts, follow these procedures.

Step	Procedure(s)
Perform backups	Procedure 107 Perform Backups
Perform system health check	Procedure 108 Perform Health Check
Add new rack mount server, if necessary	
Identify servers affected by growth: <ul style="list-style-type: none"> • NOAM • SOAM • DSR MP (SBR, SS7MP, IPFE)/SDS DP • Query Server • PMAC 	
Remove identified servers from server group	Procedure 109 Remove Server from Server Group and Procedure 110 Delete Server/Server Group
Shut down and remove the identified server's VM	Procedure 111 Delete Server VM
Identify new rack mount server	
Create and configure VMs on new rack mount server	
Configure servers in new VM locations	
Post move/re-shuffle health check	Procedure 112 Post De-Growth Health Check
Post move/re-shuffle backups	Procedure 113 Post De-Growth Backups

Procedure 114. Perform Backups

S T E P #	<p>This procedure backs up all necessary items before a re-shuffle scenario. Check off (√) each step as it is completed. Boxes have been provided for this purpose under each step number. If this procedure fails, contact My Oracle Support (MOS) and ask for assistance.</p>	
1. <input type="checkbox"/>	Backup TVOE	Back up all TVOE host configurations by executing section 3.17.6 Back Up TVOE Configuration.
2. <input type="checkbox"/>	Backup PMAC	Back up the PMAC application by executing section 3.17.7 Back Up PMAC Application.
3. <input type="checkbox"/>	Backup NOAM/SOAM databases	Back up the NOAM and SOAM databases by executing sections 3.17.8 Back Up NOAM Database and 3.17.9 Back Up SOAM Database. Note: Database backup on SDS SOAMs is not required.

Procedure 115. Perform Health Check

S T E P #	<p>This procedure verifies system status and logs all alarms. Check off (√) each step as it is completed. Boxes have been provided for this purpose under each step number. If this procedure fails, contact My Oracle Support (MOS) and ask for assistance.</p>	
1. <input type="checkbox"/>	<p>NOAM VIP GUI: Login</p>	<p>1. Establish a GUI session on the NOAM server by using the VIP IP address of the NOAM server. Open the web browser and enter a URL of:</p> <div style="border: 1px solid black; padding: 2px; width: fit-content; margin: 5px auto;"> <p>https://<Primary_NOAM_VIP_IP_Address></p> </div> <p>2. Login as the guiadmin user.</p> <div style="text-align: center;">  </div>

Procedure 115. Perform Health Check

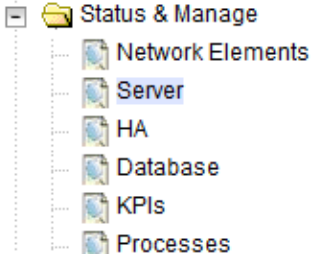
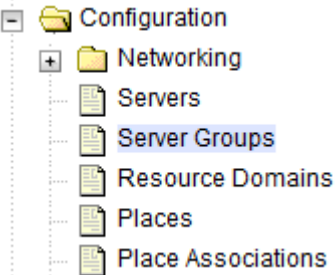
<p>2. <input type="checkbox"/></p>	<p>NOAM VIP GUI: Verify server status</p>	<p>1. Navigate to Status & Manage > Server.</p>  <p>2. Verify all Server Status is Normal (Norm) for Alarm (Alm), Database (DB), Replication Status, and Processes (Proc).</p> <table border="1" data-bbox="505 636 1406 789"> <thead> <tr> <th>Appl State</th> <th>Alm</th> <th>DB</th> <th>Reporting Status</th> <th>Proc</th> </tr> </thead> <tbody> <tr> <td>Enabled</td> <td>Norm</td> <td>Norm</td> <td>Norm</td> <td>Norm</td> </tr> <tr> <td>Enabled</td> <td>Norm</td> <td>Norm</td> <td>Norm</td> <td>Norm</td> </tr> <tr> <td>Enabled</td> <td>Norm</td> <td>Norm</td> <td>Norm</td> <td>Norm</td> </tr> <tr> <td>Enabled</td> <td>Norm</td> <td>Norm</td> <td>Norm</td> <td>Norm</td> </tr> </tbody> </table> <p>Do not proceed with Growth/De-Growth if any of the above states are not Norm. If any of these are not Norm, corrective action should be taken to restore the non-Norm status to Norm before proceeding with the feature activation.</p> <p>If the Alarm (Alm) status is not Norm but only Minor alarms are present, it is acceptable to proceed. If there are Major or Critical alarms present, these alarms should be analyzed prior to proceeding with the feature activation. The activation may be able to proceed in the presence of certain Major or Critical alarms.</p>	Appl State	Alm	DB	Reporting Status	Proc	Enabled	Norm	Norm	Norm	Norm	Enabled	Norm	Norm	Norm	Norm	Enabled	Norm	Norm	Norm	Norm	Enabled	Norm	Norm	Norm	Norm
Appl State	Alm	DB	Reporting Status	Proc																							
Enabled	Norm	Norm	Norm	Norm																							
Enabled	Norm	Norm	Norm	Norm																							
Enabled	Norm	Norm	Norm	Norm																							
Enabled	Norm	Norm	Norm	Norm																							
<p>3. <input type="checkbox"/></p>	<p>NOAM VIP GUI: Verify server configuration</p>	<p>1. Navigate to Configuration > Server Groups.</p>  <p>2. Verify the configuration data is correct for your network.</p>																									

Procedure 115. Perform Health Check

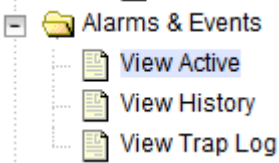
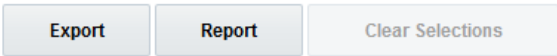
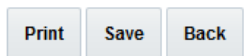
<p>4.</p> <p><input type="checkbox"/></p>	<p>NOAM VIP GUI: Log current alarms</p>	<p>1. Navigate to Alarms & Events > View Active.</p>  <p>2. Click Report.</p>  <p>3. Save or Print this report, keep copies for future reference.</p> 
<p>5.</p> <p><input type="checkbox"/></p>	<p>SOAM VIP GUI: Repeat for SOAM</p>	<p>Repeat this procedure for the SOAM.</p>

Procedure 116. Add a New TVOE Server

<p>S T E P #</p>	<p>This procedure adds a new rack mount server. Check off (✓) each step as it is completed. Boxes have been provided for this purpose under each step number. If this procedure fails, contact My Oracle Support (MOS) and ask for assistance.</p>	
<p>1.</p> <p><input type="checkbox"/></p>	<p>Add/Configure additional servers</p>	<p>Follow these sections to install and configure TVOE on additional rack mount servers:</p> <ol style="list-style-type: none"> 1. Section 3.8 Install TVOE on Additional Rack Mount Servers 2. Section 3.9 Configure TVOE on Additional Rack Mount Servers

Procedure 117. Place Server in OOS

S T E P #	<p>Once the server that will be moved has been identified, the server first needs to be placed in HA OOS. This procedure places the server in OOS HA state.</p> <p style="text-align: center;">WARNING</p> <p>No more than one server from each server should be placed in OOS at one time. For NOAM and SOAM servers, move/re-shuffle the servers one at a time.</p> <p>Check off (✓) each step as it is completed. Boxes have been provided for this purpose under each step number. If this procedure fails, contact My Oracle Support (MOS) and ask for assistance.</p>	
<p>1. <input type="checkbox"/></p>	<p>NOAM VIP GUI: Login</p>	<p>1. Establish a GUI session on the NOAM server by using the VIP IP address of the NOAM server. Open the web browser and enter a URL of:</p> <div style="border: 1px solid black; padding: 5px; margin: 5px 0;"> <p>https://<Primary_NOAM_VIP_IP_Address></p> </div> <p>2. Login as the guiadmin user.</p> <div style="text-align: center; margin: 20px 0;">  </div> <div style="text-align: center;"> <p>Oracle System Login</p> <hr style="width: 50%; margin: 0 auto;"/> <p style="text-align: right; font-size: small;">Mon Jul 11 13:59:37 2016 EDT</p> </div> <div style="text-align: center; margin: 20px 0;"> <div style="border: 1px solid gray; padding: 10px; width: fit-content; margin: 0 auto;"> <p>Log In</p> <p>Enter your username and password to log in</p> <p>Username: <input style="width: 100%;" type="text"/></p> <p>Password: <input style="width: 100%;" type="password"/></p> <p><input type="checkbox"/> Change password</p> <p style="text-align: center;"><input type="button" value="Log In"/></p> </div> <p style="font-size: small; margin-top: 10px;">Welcome to the Oracle System Login.</p> <p style="font-size: x-small; margin-top: 10px;">This application is designed to work with most modern HTML5 compliant browsers and uses both JavaScript and cookies. Please refer to the Oracle Software Web Browser Support Policy for details.</p> <p style="font-size: x-small; margin-top: 10px;">Unauthorized access is prohibited.</p> <hr style="width: 50%; margin: 0 auto;"/> <p style="font-size: x-small; margin-top: 10px;">Oracle and Java are registered trademarks of Oracle Corporation and/or its affiliates. Other names may be trademarks of their respective owners.</p> <p style="font-size: x-small; margin-top: 10px;">Copyright © 2010, 2016, Oracle and/or its affiliates. All rights reserved.</p> </div>

Procedure 117. Place Server in OOS

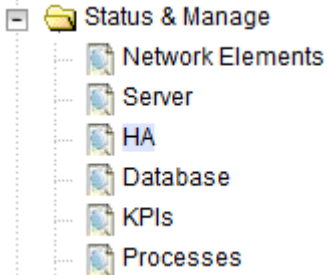
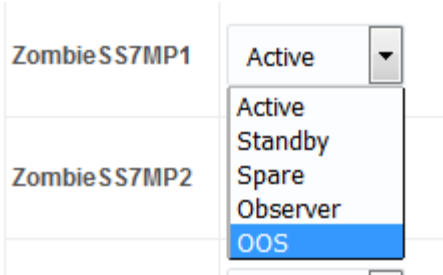
<p>2.</p> <p><input type="checkbox"/></p>	<p>NOAM VIP GUI: Set server to OOS</p>	<p>1. Navigate to Status & Manage > HA.</p>  <p>2. Click Edit.</p> <p>3. Set the server's Max Allowed HA Role to OOS.</p>  <p>4. Click OK.</p>
---	---	---

Procedure 118. Delete Server VM

<p>S T E P #</p>	<p>Once the servers being deleted have been identified, placed in OOS, and removed the from the server group, it is safe to shut down and delete the VM for the server. This procedure removes a VM from a TVOE host.</p> <p style="text-align: center;">WARNING</p> <p>Confirm the server to VM mapping before proceeding.</p> <p>Check off (✓) each step as it is completed. Boxes have been provided for this purpose under each step number.</p> <p>If this procedure fails, contact My Oracle Support (MOS) and ask for assistance.</p>
<p>1. <input type="checkbox"/></p>	<p>PMAC GUI: Login</p> <p>1. Open the web browser and navigate to the PMAC GUI:</p> <div style="border: 1px solid gray; padding: 5px; width: fit-content; margin: 5px 0;"> <p>http://<PMAC_network_IP></p> </div> <p>2. Login as the guiadmin user.</p> <div style="text-align: center; margin: 20px 0;">  </div> <div style="border: 1px solid gray; padding: 10px; margin: 20px 0;"> <p style="text-align: center;">Oracle System Login</p> <p style="text-align: right;">Tue Jun 7 13:49:06 2016 EDT</p> <div style="border: 1px solid gray; padding: 10px; margin: 10px 0;"> <p style="text-align: center;">Log In</p> <p style="text-align: center;">Enter your username and password to log in</p> <p style="text-align: center;">Username: <input style="width: 100px;" type="text"/></p> <p style="text-align: center;">Password: <input style="width: 100px;" type="password"/></p> <p style="text-align: center;"><input type="checkbox"/> Change password</p> <p style="text-align: center;"><input type="button" value="Log In"/></p> </div> <p style="text-align: center; font-size: small;">Unauthorized access is prohibited. This Oracle system requires the use of Microsoft Internet Explorer 9.0, 10.0, or 11.0 with support for JavaScript and cookies.</p> <hr/> <p style="text-align: center; font-size: x-small;">Oracle and Java are registered trademarks of Oracle Corporation and/or its affiliates. Other names may be trademarks of their respective owners.</p> <p style="text-align: center; font-size: x-small;">Copyright © 2010, 2016, Oracle and/or its affiliates. All rights reserved.</p> </div>

Procedure 118. Delete Server VM

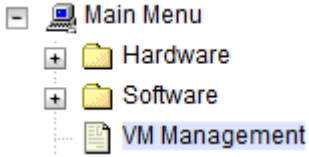
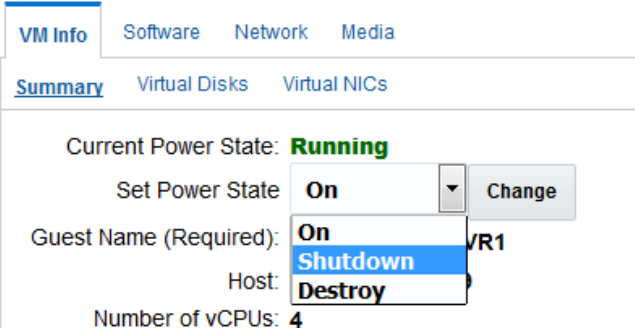
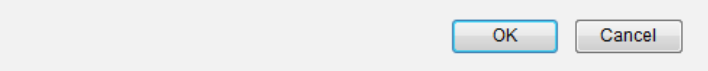
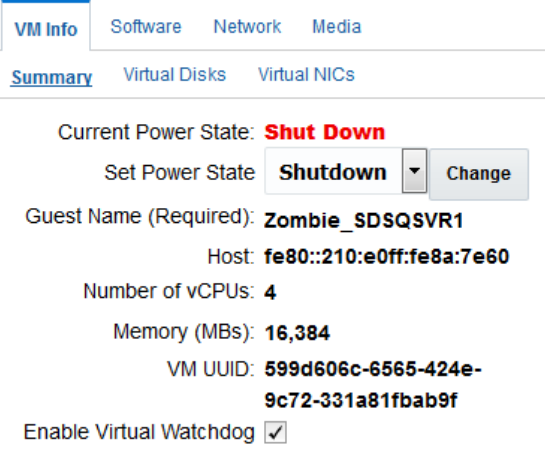
<p>2. <input type="checkbox"/> NOAM VIP GUI: Shut down the VM</p>	<p>1. Navigate to VM Management.</p>  <p>2. Expand the view of the rack mount server, if needed.</p> <p>3. Shut down the VM by setting the Current Power State to Shutdown.</p> <p>View guest Zombie_SDSQSVR1</p>  <p>4. Click Change.</p> <p>5. Click OK.</p> <p><small>It may not always be possible to shutdown a guest or to do so in a timely manner. You may monitor the power state and opt to destroy the guest rather than shut it down. Are you sure you want to attempt to shutdown this guest?</small></p>  <p>The Current Power State displays as Shutdown.</p> <p>View guest Zombie_SDSQSVR1</p> 
--	---

Procedure 118. Delete Server VM

3.	<p>PMAC GUI: Delete the VM</p>	<p>1. Once the server has been shut down, select the VM.</p> <p>2. Verify the current power state is Shutdown and click Delete.</p> <div style="text-align: center; border: 1px solid #ccc; padding: 5px; margin: 10px 0;"> Edit Delete Clone Guest Refresh Device Map Install OS Upgrade Accept Upgrade Reject Upgrade Patch Accept Patches Reject Patches </div> <p>3. Click OK to confirm.</p> <div style="text-align: center; border: 1px solid #ccc; padding: 5px; margin: 10px 0;"> <p>Are you sure you want to delete guest Zombie_SDSQSVR1?</p> OK Cancel </div>
----	---	---

Procedure 119. Move/Re-Shuffle: Create/Configure VMs

S T E P #	<p>This procedure creates the new VM, loads, the software, and configures the server.</p> <p>Prerequisites:</p> <ul style="list-style-type: none"> Server has been identifies placed in OOS, and its corresponding VM has been deleted. Proper VM mapping has been determined to maintain performance efficiency. See section 3.10 Determine VM Placement and Socket Pinning. PMAC contains TPD, DSR, and SDS ISO software. See Procedure 14 Load DSR, SDS, and TPD ISOs onto the PMAC Server. <p>Check off (√) each step as it is completed. Boxes have been provided for this purpose under each step number.</p> <p>If this procedure fails, contact My Oracle Support (MOS) and ask for assistance.</p>	
1.	<p>PMAC GUI: Create virtual machine</p>	<p>To create a virtual machine for all applicable servers, follow section 3.12 Virtual Machine/Network Fast Deployment.</p>
2.	<p>TVOE Host: Execute CPU pinning</p>	<p>Execute section 3.13 CPU Pinning to allocate CPU resources on each new VM.</p>

Procedure 120. Move/Re-Shuffle: NOAM/DR NOAM

S T E P #	<p>This procedure configures the NOAM/DR NOAM on the new VM for VM re-shuffling scenarios.</p> <p>Prerequisites:</p> <ul style="list-style-type: none"> • NOAM/DR NOAM has been Identified • Placed in OOS • Old VM deleted • New VM created • TPD/DSR software installed <p>Check off (√) each step as it is completed. Boxes have been provided for this purpose under each step number.</p> <p>If this procedure fails, contact My Oracle Support (MOS) and ask for assistance.</p>	
1. <input type="checkbox"/>	<p>NOAM VIP GUI: Configure the 2nd NOAM/DR NOAM</p>	<p>Configure the second NOAM/DR NOAM by following these sections:</p> <ul style="list-style-type: none"> • DSR NOAM: Procedure 17 Configure First DSR NOAM NE and Server, steps 1. through 2. , 4. through 7. , 8. (optional for NetBackup), and 9. • DSR DR NOAM: Procedure 22 Configure DSR NOAM for DR Site (Optional), steps • SDS NOAM: Procedure 41 Configure First SDS NOAM NE and Server, steps 1. through 2. , 4. through 5. , 6. (optional for NetBackup), and 7. • SDS DR NOAM: Procedure 46 Configure SDS NOAM for DR Site (Optional)
2. <input type="checkbox"/>	<p>NOAM VIP GUI: Login</p>	<p>1. Establish a GUI session on the NOAM server by using the VIP IP address of the NOAM server. Open the web browser and enter a URL of:</p> <div style="border: 1px solid black; padding: 5px; margin: 10px 0;"> <p>https://<Primary_NOAM_VIP_IP_Address></p> </div> <p>2. Login as the guiadmin user.</p> <div style="text-align: center; margin: 20px 0;">  </div> <div style="text-align: center; margin: 10px 0;"> <p>Oracle System Login Mon Jul 11 13:59:37 2016 EDT</p> <hr style="width: 50%; margin: 0 auto;"/> </div> <div style="border: 1px solid gray; padding: 10px; margin: 10px auto; width: 80%;"> <p style="text-align: center;">Log In</p> <p style="text-align: center;">Enter your username and password to log in</p> <p style="text-align: center;">Username: <input style="width: 100%;" type="text"/></p> <p style="text-align: center;">Password: <input style="width: 100%;" type="password"/></p> <p style="text-align: center;"><input type="checkbox"/> Change password</p> <p style="text-align: center;"><input type="button" value="Log In"/></p> </div> <p style="text-align: center; margin-top: 10px;">Welcome to the Oracle System Login.</p> <p style="font-size: small; text-align: center;">This application is designed to work with most modern HTML5 compliant browsers and uses both JavaScript and cookies. Please refer to the Oracle Software Web Browser Support Policy for details.</p>

Procedure 120. Move/Re-Shuffle: NOAM/DR NOAM

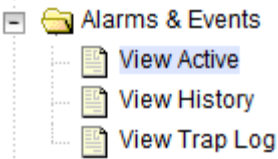
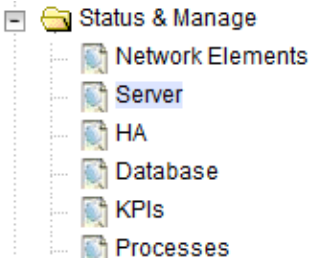
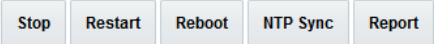
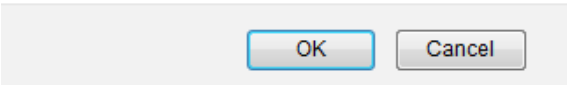
<p>3. <input type="checkbox"/></p>	<p>NOAM VIP: Wait for remote database alarm to clear</p>	<p>Wait for the Remote Database re-initialization in progress alarm to clear before proceeding. Monitor progress by navigating to Alarms & Events > View Active.</p>  <p>The screenshot shows a tree view with 'Alarms & Events' expanded. Underneath, there are three items: 'View Active' (highlighted in blue), 'View History', and 'View Trap Log'.</p>
<p>4. <input type="checkbox"/></p>	<p>NOAM GUI: Restart 2nd NOAM/DR NOAM server</p>	<p>1. Navigate to Status & Manage > Server.</p>  <p>The screenshot shows a tree view with 'Status & Manage' expanded. Underneath, there are six items: 'Network Elements', 'Server' (highlighted in blue), 'HA', 'Database', 'KPIs', and 'Processes'.</p> <p>2. Select the second NOAM/DR NOAM server and click Restart.</p>  <p>The screenshot shows a row of five buttons: 'Stop', 'Restart', 'Reboot', 'NTP Sync', and 'Report'. The 'Restart' button is highlighted.</p> <p>3. Click OK to confirm.</p> <p>Are you sure you wish to restart application software on the following server(s)? ZombieNOAM2</p>  <p>The screenshot shows a dialog box with two buttons: 'OK' (highlighted in blue) and 'Cancel'.</p>
<p>5. <input type="checkbox"/></p>	<p>NOAM GUI: Activate optional features</p>	<p>If there are any optional features currently activated, the feature activation procedures need to be run again. Refer to section 1.5 Optional Features.</p>

Procedure 121. Move/Re-Shuffle: SOAM

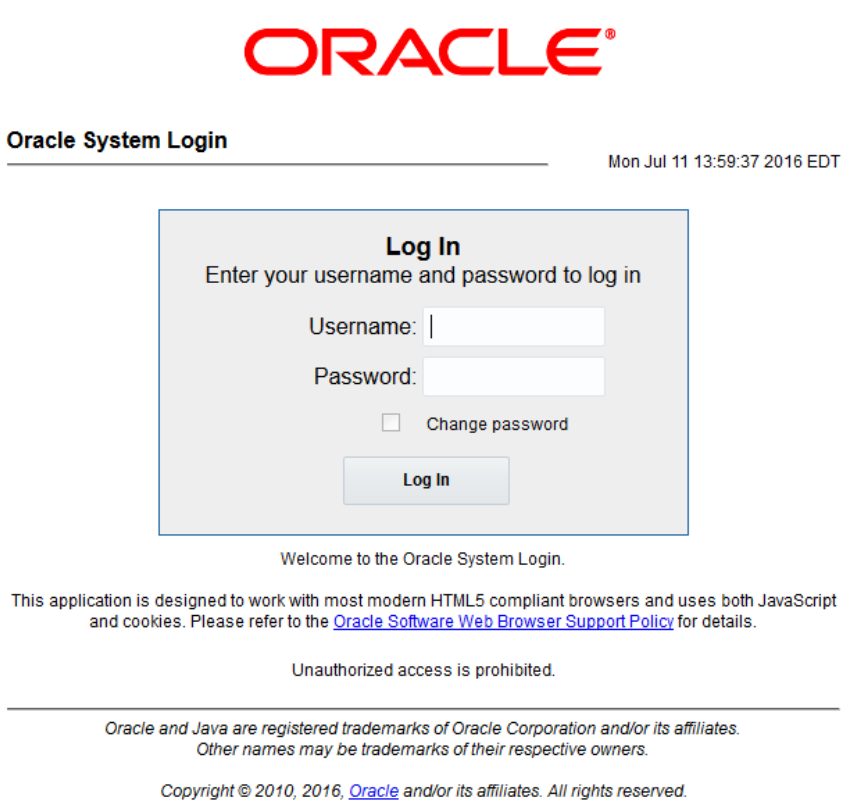
S T E P #	<p>This procedure configures the SOAM on the new VM for VM re-shuffling scenarios.</p> <p>Prerequisites:</p> <ul style="list-style-type: none"> • SOAM has been Identified • Placed in OOS • Old VM deleted • New VM created • TPD/DSR software installed <p>Check off (√) each step as it is completed. Boxes have been provided for this purpose under each step number.</p> <p>If this procedure fails, contact My Oracle Support (MOS) and ask for assistance.</p>	
1. <input type="checkbox"/>	<p>NOAM VIP GUI: Configure the SOAM</p>	<p>Configure the SOAM by following these sections:</p> <ul style="list-style-type: none"> • DSR SOAM: Procedure 25 Configure DSR SOAM Server, steps 1. through 3. , 5. through 9. , 11. (optional for NetBackup) • SDS DP SOAM: Procedure 51 Configure SDS DP SOAM Server, steps 1. through 3. , 5. through 9.
2. <input type="checkbox"/>	<p>NOAM VIP GUI: Login</p>	<p>1. Establish a GUI session on the NOAM server by using the VIP IP address of the NOAM server. Open the web browser and enter a URL of:</p> <div style="border: 1px solid black; padding: 5px; margin: 10px 0;"> <p>https://<Primary_NOAM_VIP_IP_Address></p> </div> <p>2. Login as the guiadmin user.</p> <div style="text-align: center;">  </div>

Procedure 121. Move/Re-Shuffle: SOAM

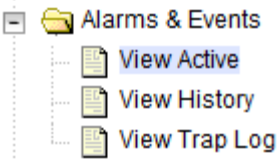
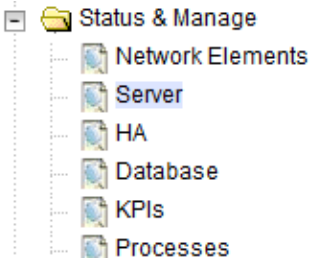
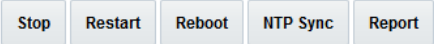
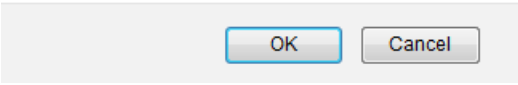
<p>3. <input type="checkbox"/></p>	<p>NOAM VIP: Wait for remote database alarm to clear</p>	<p>Wait for the Remote Database re-initialization in progress alarm to clear before proceeding. Monitor progress by navigating to Alarms & Events > View Active.</p> 
<p>4. <input type="checkbox"/></p>	<p>NOAM GUI: Restart SOAM server</p>	<p>1. Navigate to Status & Manage > Server.</p>  <p>2. Select the SOAM server and click Restart.</p>  <p>3. Click OK to confirm.</p> <p>Are you sure you wish to restart application software on the following server(s)? ZombieSOAM1</p> 
<p>5. <input type="checkbox"/></p>	<p>NOAM GUI: Activate optional features</p>	<p>If there are any optional features currently activated, the feature activation procedures need to be run again. Refer to section 1.5 Optional Features.</p>

Procedure 122. Move/Re-Shuffle: MP/DP

S T E P #	<p>This procedure configures MP/DP on the new VM for VM re-shuffling scenarios.</p> <p>Prerequisites:</p> <ul style="list-style-type: none"> • MP/DP has been Identified • Placed in OOS • Old VM deleted • New VM created • TPD/DSR software installed <p>Check off (✓) each step as it is completed. Boxes have been provided for this purpose under each step number.</p> <p>If this procedure fails, contact My Oracle Support (MOS) and ask for assistance.</p>	
1. <input type="checkbox"/>	<p>NOAM VIP GUI: Configure the MP/DP</p>	<p>Configure the MP/DP by following these sections:</p> <ul style="list-style-type: none"> • DSR MP: Procedure 30 Configure MP Servers, steps 1. through 2. , 7. , 9. , 10. through 11. , 12. through 13. (optional for NetBackup), 14. • SDS DP: Procedure 53 Configure SDS DP Server, steps 1. through 2. , 4. through 8.
2. <input type="checkbox"/>	<p>NOAM VIP GUI: Login</p>	<p>1. Establish a GUI session on the NOAM server by using the VIP IP address of the NOAM server. Open the web browser and enter a URL of:</p> <div style="border: 1px solid black; padding: 5px; width: fit-content; margin: 10px auto;"> <p>https://<Primary_NOAM_VIP_IP_Address></p> </div> <p>2. Login as the guiadmin user.</p> <div style="text-align: center; margin: 20px 0;">  </div> <div style="text-align: center;"> <p>Oracle System Login</p> <hr style="width: 60%; margin: 0 auto;"/> <p style="font-size: small;">Mon Jul 11 13:59:37 2016 EDT</p> </div> <div style="text-align: center; margin: 20px 0;"> <div style="border: 1px solid gray; padding: 10px; width: 80%; margin: 0 auto;"> <p style="text-align: center;">Log In</p> <p style="text-align: center;">Enter your username and password to log in</p> <p style="text-align: center;">Username: <input style="width: 100%;" type="text"/></p> <p style="text-align: center;">Password: <input style="width: 100%;" type="password"/></p> <p style="text-align: center;"><input type="checkbox"/> Change password</p> <p style="text-align: center;"><input type="button" value="Log In"/></p> </div> <p style="font-size: x-small; margin-top: 10px;">Welcome to the Oracle System Login.</p> <p style="font-size: x-small; margin-top: 10px;">This application is designed to work with most modern HTML5 compliant browsers and uses both JavaScript and cookies. Please refer to the Oracle Software Web Browser Support Policy for details.</p> <p style="font-size: x-small; margin-top: 10px;">Unauthorized access is prohibited.</p> <hr style="width: 60%; margin: 0 auto;"/> <p style="font-size: x-small; margin-top: 10px;">Oracle and Java are registered trademarks of Oracle Corporation and/or its affiliates. Other names may be trademarks of their respective owners.</p> <p style="font-size: x-small; margin-top: 10px;">Copyright © 2010, 2016, Oracle and/or its affiliates. All rights reserved.</p> </div>

Procedure 122. Move/Re-Shuffle: MP/DP

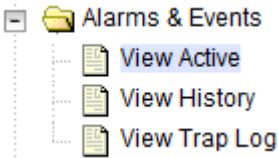
<p>3. <input type="checkbox"/></p>	<p>NOAM VIP GUI: Edit the MP server group and add preferred spares for site redundancy (optional) PCA/DCA Only</p>	<p>If Two Site Redundancy feature for the Policy and Charging SBR server group OR Session Binding Repository is wanted, add an MP server that is physically located in a separate site (location) to the server group by marking the Include in SG checkbox. Also, mark the Preferred Spare checkbox.</p> <table border="1" data-bbox="500 373 1414 499"> <thead> <tr> <th>Server</th> <th>SG Inclusion</th> <th>Preferred HA Role</th> </tr> </thead> <tbody> <tr> <td>ZombieSBRsp</td> <td><input checked="" type="checkbox"/> Include in SG</td> <td><input checked="" type="checkbox"/> Prefer server as spare</td> </tr> </tbody> </table> <p>If Three Site Redundancy feature for the SBR MP server group is wanted, add two SBR MP servers that are both physically located in separate sites (location) to the server group by marking the Include in SG checkbox. Also, mark the Preferred Spare checkbox for both servers.</p> <p>Notes:</p> <ul style="list-style-type: none"> • The preferred spare servers should be different sites from the original server and should not be in the same site. There should be servers from three separate sites (locations). • There must first be non-preferred spare available in the server group before adding the preferred spare. <p>For more information about site redundancy for Policy and Charging SBR server groups/session binding repository server groups, see section 1.3 Terminology.</p> <p>Click OK to save.</p>	Server	SG Inclusion	Preferred HA Role	ZombieSBRsp	<input checked="" type="checkbox"/> Include in SG	<input checked="" type="checkbox"/> Prefer server as spare
Server	SG Inclusion	Preferred HA Role						
ZombieSBRsp	<input checked="" type="checkbox"/> Include in SG	<input checked="" type="checkbox"/> Prefer server as spare						
<p>4. <input type="checkbox"/></p>	<p>NOAM VIP: Wait for remote database alarm to clear</p>	<p>Wait for the Remote Database re-initialization in progress alarm to clear before proceeding.</p> <p>Monitor progress by navigating to Alarms & Events > View Active.</p> 						

Procedure 122. Move/Re-Shuffle: MP/DP

<p>5. <input type="checkbox"/></p>	<p>SOAM VIP GUI: Login</p>	<p>1. Establish a GUI session on the SOAM server by using the VIP IP address of the SOAM server. Open the web browser and enter a URL of:</p> <div style="border: 1px solid black; padding: 5px; margin: 5px 0;"> <p>https://<Primary_SOAM_VIP_IP_Address></p> </div> <p>2. Login as the guidadmin user.</p> <div style="text-align: center; margin: 20px 0;">  </div> <div style="text-align: center;"> <p>Oracle System Login Mon Jul 11 13:59:37 2016 EDT</p> <hr/> <div style="border: 1px solid gray; padding: 10px; width: fit-content; margin: 10px auto;"> <p style="text-align: center;">Log In</p> <p style="text-align: center;">Enter your username and password to log in</p> <p style="text-align: center;">Username: <input style="width: 100px;" type="text"/></p> <p style="text-align: center;">Password: <input style="width: 100px;" type="password"/></p> <p style="text-align: center;"><input type="checkbox"/> Change password</p> <p style="text-align: center;"><input type="button" value="Log In"/></p> </div> <p style="text-align: center; margin-top: 10px;">Welcome to the Oracle System Login.</p> <p style="text-align: center; font-size: small;">This application is designed to work with most modern HTML5 compliant browsers and uses both JavaScript and cookies. Please refer to the Oracle Software Web Browser Support Policy for details.</p> <p style="text-align: center; font-size: small;">Unauthorized access is prohibited.</p> <hr style="width: 50%; margin: 10px auto;"/> <p style="text-align: center; font-size: x-small;">Oracle and Java are registered trademarks of Oracle Corporation and/or its affiliates. Other names may be trademarks of their respective owners.</p> <p style="text-align: center; font-size: x-small;">Copyright © 2010, 2016, Oracle and/or its affiliates. All rights reserved.</p> </div>
------------------------------------	---------------------------------------	---

Procedure 122. Move/Re-Shuffle: MP/DP

6. **SOAM VIP GUI:**
Assign profiles to DA-MPs from SOAM GUI

1. Navigate to **Diameter Common > MPs > Profiles Assignments.**

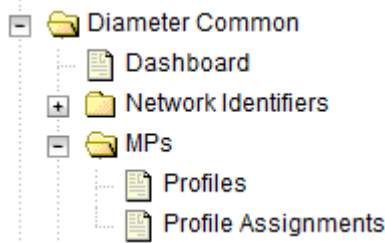

If the site has both DSR and MAP-IWF server groups, both DA-MP and SS7-MP sections display.

Main Menu: Diameter Common -> MPs -> Profile Assignments

DA-MP	MP Profile	current value
ZombieDAMP1	VM:10K_MPS	The current MP Profile for ZombieDAMP1 is VM:10K_MPS . <i>Virtualized DA-MP rated at 10K MPS for all configurations [A value is required.]</i>
ZombieDAMP2	VM:10K_MPS	The current MP Profile for ZombieDAMP2 is VM:10K_MPS . <i>Virtualized DA-MP rated at 10K MPS for all configurations [A value is required.]</i>

SS7-MP	MP Profile	current value
ZombieSS7MP1	VM:MD-IWF	The current MP Profile for ZombieSS7MP1 is VM:MD-IWF . <i>Virtualized SS7-MP running MD-IWF application [A value is required.]</i>
ZombieSS7MP2	VM:MD-IWF	The current MP Profile for ZombieSS7MP2 is VM:MD-IWF . <i>Virtualized SS7-MP running MD-IWF application [A value is required.]</i>

2. For each MP, select the proper profile assignment based on the function of each MP.

Profile Name	Description
VM:10K_MPS (Oracle X5-2/Netra X5-2/X6-2/HP DL380 Gen 9 (10Gbps) Only)	Virtualized DA-MP on TVOE guest running relay, session, and database applications
VM:MD-IWF	Virtualized SS7-MP on TVOE guest running MD-IWF applications

3. Click **Assign**.

Procedure 122. Move/Re-Shuffle: MP/DP

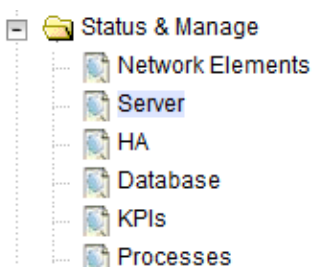
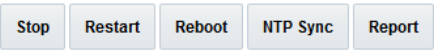
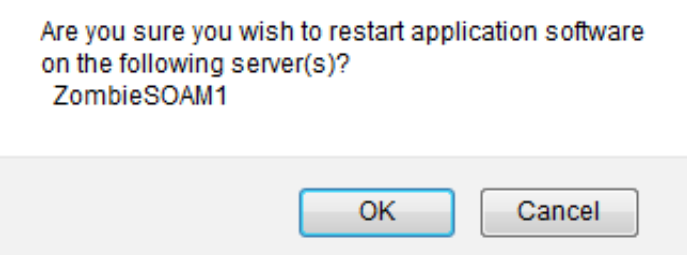
<p>7. <input type="checkbox"/></p>	<p>NOAM GUI: Restart MP/DP server</p>	<p>1. Navigate to Status & Manage > Server.</p>  <p>2. Select the MP/DP server and click Restart.</p>  <p>3. Click OK to confirm.</p> 
--	--	--

Procedure 123. Move/Re-Shuffle: Query Server (SDS Only)

<p>S T E P #</p>		<p>This procedure configures the query server on the new VM for VM re-shuffling scenarios.</p> <p>Prerequisites:</p> <ul style="list-style-type: none"> • Query server has been Identified • Placed in OOS • Old VM deleted • New VM created • TPD/DSR software installed <p>Check off (√) each step as it is completed. Boxes have been provided for this purpose under each step number.</p> <p>If this procedure fails, contact My Oracle Support (MOS) and ask for assistance.</p>
<p>1. <input type="checkbox"/></p>	<p>NOAM VIP GUI: Configure the query server</p>	<p>Configure the query server by following Procedure 48 Configure SDS Query Server.</p>

Procedure 123. Move/Re-Shuffle: Query Server (SDS Only)

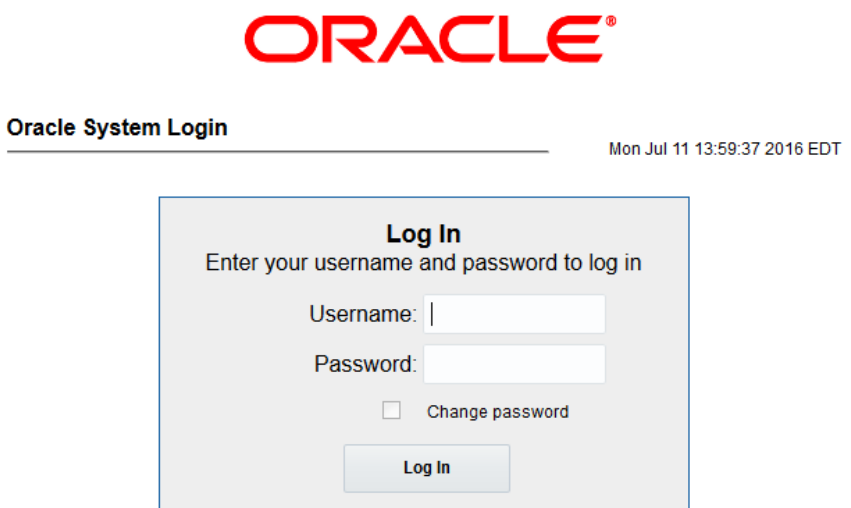
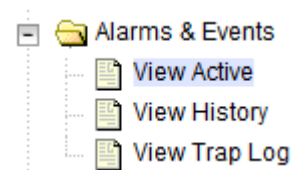
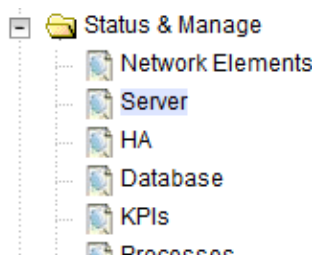
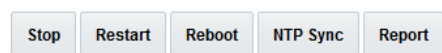
<p>2. <input type="checkbox"/></p>	<p>NOAM VIP GUI: Login</p>	<p>1. Establish a GUI session on the NOAM server by using the VIP IP address of the NOAM server. Open the web browser and enter a URL of:</p> <div style="border: 1px solid black; padding: 5px; width: fit-content; margin: 10px 0;"> <p>https://<Primary_NOAM_VIP_IP_Address></p> </div> <p>2. Login as the guiadmin user.</p> 
<p>3. <input type="checkbox"/></p>	<p>NOAM VIP: Wait for remote database alarm to clear</p>	<p>Wait for the Remote Database re-initialization in progress alarm to clear before proceeding. Monitor progress by navigating to Alarms & Events > View Active.</p> 
<p>4. <input type="checkbox"/></p>	<p>NOAM GUI: Restart SOAM server</p>	<p>1. Navigate to Status & Manage > Server.</p>  <p>2. Select the query server and click Restart.</p>  <p>3. Click OK to confirm.</p>

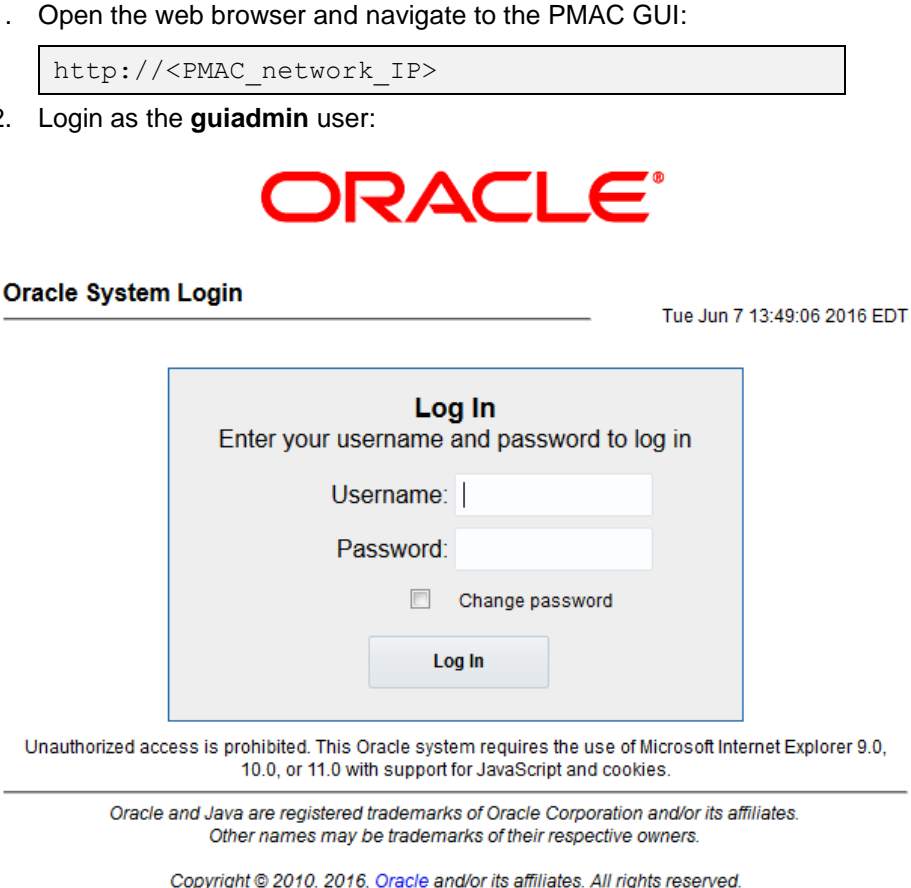

Procedure 124. Move/Re-Shuffle: iDIH

S T E P #	<p>This procedure configures the iDIH server on the new VM for VM re-shuffling scenarios.</p> <p>Note: If moving/re-shuffling the Oracle VM/server, doing so removes all historical trace data. However, moving/re-shuffling application and mediation VMs can be done without affecting historical trace data.</p> <p>Check off (√) each step as it is completed. Boxes have been provided for this purpose under each step number.</p> <p>If this procedure fails, contact My Oracle Support (MOS) and ask for assistance.</p>	
1. <input type="checkbox"/>	<p>PMAC GUI: Login</p>	<p>1. Open the web browser and navigate to the PMAC GUI:</p> <div style="border: 1px solid black; padding: 5px; margin: 5px 0;"> <p>http://<PMAC_network_IP></p> </div> <p>2. Login as the guiadmin user:</p> <div style="text-align: center; margin: 10px 0;">  </div>

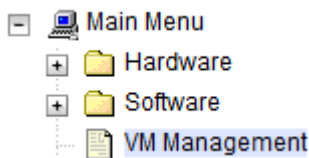
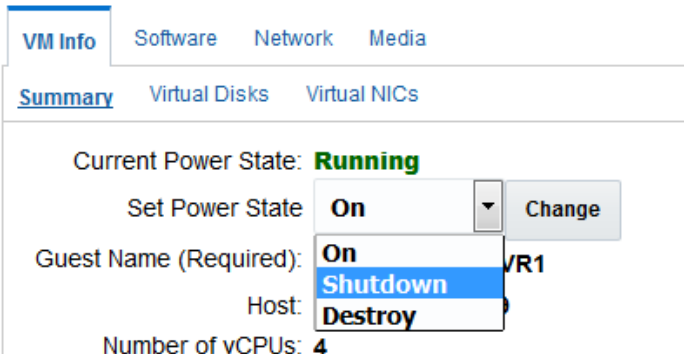
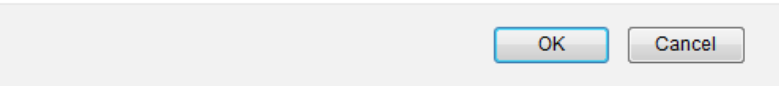
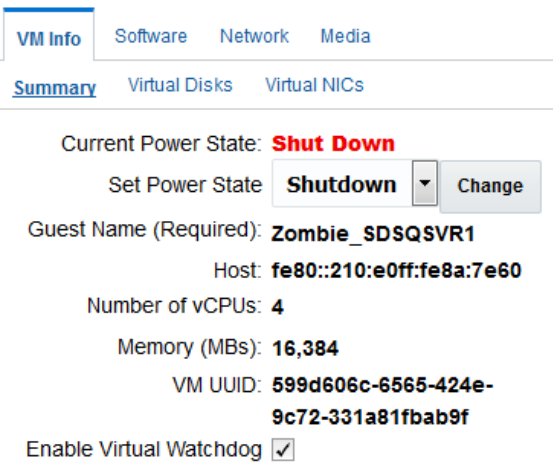
Procedure 124. Move/Re-Shuffle: iDIH

<p>2. <input type="checkbox"/></p> <p>NOAM VIP GUI: Shut down the VM</p>	<ol style="list-style-type: none"> Navigate to VM Management.  <ol style="list-style-type: none"> Expand the view of the rack mount server, if needed. Shut down the VM by setting the Current Power State to Shutdown. <p>View guest Zombie_SDSQSVR1</p>  <ol style="list-style-type: none"> Click Change. Click OK. <p>It may not always be possible to shutdown a guest or to do so in a timely manner. You may monitor the power state and opt to destroy the guest rather than shut it down. Are you sure you want to attempt to shutdown this guest?</p>  <p>The Current Power State displays as Shutdown.</p> <p>View guest Zombie_SDSQSVR1</p> 
---	--

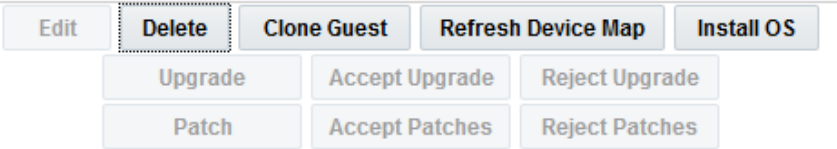
Procedure 124. Move/Re-Shuffle: iDIH

<p>3. <input type="checkbox"/></p>	<p>PMAC GUI: Delete the VM</p>	<p>1. Once the server has been shut down, select the VM.</p> <p>2. Verify the current power state is Shutdown and click Delete.</p>  <p>3. Click OK to confirm.</p> 
<p>4. <input type="checkbox"/></p>	<p>PMAC Server: Navigate to guest-dropin directory</p>	<pre>\$ cd /var/TKLC/smac/guest-dropin/</pre>
<p>5. <input type="checkbox"/></p>	<p>PMAC Server: Edit the IDIH fdc file</p>	<p>Edit the existing idih_fdc_file_name.xml (or create a new) file configured in Procedure 57 IDIH Installation, step 7.</p> <p>Changing the rack mount server to the VM being moved/re-shuffled is done by changing the <tvoehost> item for the applicable VM (<tvoeguest id>).</p> <p>Note: It may also be necessary to change the XMI, IMI, and default route IP addresses depending on the location of the rack mount server.</p>

Procedure 125. Move/Re-Shuffle: PMAC

<p>S T E P #</p>	<p>This procedure configures PMAC on the new VM for VM re-shuffling scenarios.</p> <p>Prerequisite: Database backup of PMAC server is available.</p> <p>Check off (✓) each step as it is completed. Boxes have been provided for this purpose under each step number.</p> <p>If this procedure fails, contact My Oracle Support (MOS) and ask for assistance.</p>	
<p>1. <input type="checkbox"/></p>	<p>PMAC: Back up the PMAC database</p>	<p>Back up the PMAC database by following section 3.17.7 Back Up PMAC Application.</p>
<p>2. <input type="checkbox"/></p>	<p>PMAC TVOE Host: Login</p>	<p>Establish an SSH session to the PMAC's TVOE host and login as admusr.</p>
<p>3. <input type="checkbox"/></p>	<p>PMAC TVOE Host: Verify PMAC location</p>	<p>Verify the location of the redundant PMAC VM using virsh.</p> <pre>\$ sudo /usr/bin/virsh list Id Name State ----- 2 Redundant-PM&C running</pre>

Procedure 125. Move/Re-Shuffle: PMAC

4. <input type="checkbox"/>	PMAC TVOE Host: Remove existing PMAC guest	Delete the PMAC guest. <pre>\$ sudo guestMgr -remove <PMAC_Name></pre>
5. <input type="checkbox"/>	New PMAC TVOE Host: Deploy PMAC on new TVOE host	Once the TVOE host for the new PMAC location has been identified, execute section 3.3 Install PMAC to deploy the new PMAC.
6. <input type="checkbox"/>	PMAC: Login	Establish an SSH session to the PMAC server and login as admusr .
7. <input type="checkbox"/>	Restore PMAC backup image to the TVOE host	From the remote backup location, copy the backup file to the deployed PMAC. There are too many possible backup scenarios to cover them all here. The example below is a simple scp from a redundant PMAC backup location. If using IPv6 addresses, command requires shell escapes, for example, admusr@[<ipV6addr>]:/<file> <pre>\$ sudo /usr/bin/scp -p \ admsur@<remoteserver>:/var/TKLC/smac/backup/*.pef \ /var/TKLC/smac/backup/</pre> <p>Note: Copy the correct backup file to use in the restore. The latest backup may not be the backup which contains the system data of interest. This could be the case if the automatic backup, which is scheduled in the morning, is performed on the newly installed PMAC before restoring the data.</p>
8. <input type="checkbox"/>	PMAC: Verify no alarms are present	<pre>\$ sudo /usr/TKLC/plat/bin/alarmMgr --alarmStatus</pre>
9. <input type="checkbox"/>	Restore the PMAC data from backup	<pre>\$ sudo /usr/TKLC/smac/bin/pmacadm restore PM&C Restore been successfully initiated as task ID 1</pre> <p>Note: By default, the PMAC restore used the most recent file in /var/TKLC/smac/backup folder that starts with backupPmac. If the name of the file copied to the system uses a different name or is not the most recent, then provide the name using the --fileName parameter.</p> <ol style="list-style-type: none">1. To check the status of the background task, issue this command: <pre>\$ sudo /usr/TKLC/smac/bin/pmaccli getBgTasks</pre>2. Wait for the PMAC Restore successful message.

Procedure 125. Move/Re-Shuffle: PMAC

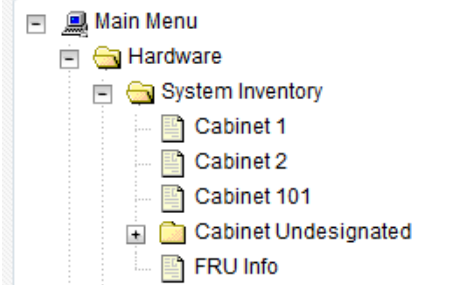
<p>10. <input type="checkbox"/></p>	<p>PMAC GUI: Login</p>	<p>1. Open the web browser and navigate to the PMAC GUI: <div style="border: 1px solid black; padding: 2px; width: fit-content; margin: 5px 0;"> http://<PMAC_network_IP> </div> </p> <p>2. Login as the guidadmin user:</p> <div style="text-align: center; margin: 10px 0;">  </div> <div style="text-align: center; margin: 10px 0;"> <p>Oracle System Login</p> <hr style="width: 50%; margin: 0 auto;"/> Tue Jun 7 13:49:06 2016 EDT </div> <div style="text-align: center; border: 1px solid gray; padding: 10px; margin: 10px auto; width: 80%;"> <p>Log In Enter your username and password to log in</p> <p>Username: <input style="width: 100%;" type="text"/></p> <p>Password: <input style="width: 100%;" type="password"/></p> <p><input type="checkbox"/> Change password</p> <p><input type="button" value="Log In"/></p> </div> <p style="font-size: small; text-align: center; margin-top: 10px;">Unauthorized access is prohibited. This Oracle system requires the use of Microsoft Internet Explorer 9.0, 10.0, or 11.0 with support for JavaScript and cookies.</p> <hr style="width: 50%; margin: 0 auto;"/> <p style="font-size: x-small; text-align: center; margin: 0 auto;">Oracle and Java are registered trademarks of Oracle Corporation and/or its affiliates. Other names may be trademarks of their respective owners.</p> <p style="font-size: x-small; text-align: center; margin: 0 auto;">Copyright © 2010, 2016, Oracle and/or its affiliates. All rights reserved.</p>
<p>11. <input type="checkbox"/></p>	<p>PMAC GUI: Verify restore task completed</p>	<p>1. Navigate to Task Monitoring.</p> <p>2. Verify the restore background task completed successfully.</p> <p>Notes:</p> <ul style="list-style-type: none"> After the restore is complete, Add Enclosure tasks start for all previously provisioning servers. Allow these to complete before continuing. After the restore is complete, some tasks delete ISO images. This is normal behavior, ISO images are added in the next step.
<p>12. <input type="checkbox"/></p>	<p>PMAC GUI: Verify system inventory</p>	<p>1. Navigate to Hardware > System Inventory.</p> <div style="border: 1px solid gray; padding: 5px; margin: 10px 0;">  </div> <p>2. Verify previously provisioned enclosures are present.</p>

Procedure 125. Move/Re-Shuffle: PMAC

<p>13. <input type="checkbox"/></p>	<p>PMAC: Verify PMAC</p>	<p>Perform a system health check on the PMAC.</p> <pre style="border: 1px solid black; padding: 5px;">\$ sudo /usr/TKLC/plat/bin/alarmMgr --alarmStatus</pre> <p>Note: Some expected networking alarms may be present. This command should return no output on a healthy system.</p> <pre style="border: 1px solid black; padding: 5px;">\$ sudo /usr/TKLC/smac/bin/sentry status</pre> <p>All processes should be running and display output similar to this:</p> <pre>PM&C Sentry Status ----- sentryd started: Mon Jul 23 17:50:49 2012 Current activity mode: ACTIVE Process PID Status StartTS NumR ----- smacTalk 9039 running Tue Jul 24 12:50:29 2012 2 smacMon 9094 running Tue Jul 24 12:50:29 2012 2 hpiPortAudit 9137 running Tue Jul 24 12:50:29 2012 2 snmpEventHandler 9176 running Tue Jul 24 12:50:29 2012 2 Fri Aug 3 13:16:35 2012 Command Complete.</pre>
<p>14. <input type="checkbox"/></p>	<p>PMAC: Add ISO images to the PMAC</p>	<p>Re-add any needed ISO images to the PMAC by executing section 3.8 Install TVOE on Additional Rack Mount Servers.</p>

Procedure 126. Move/Re-Shuffle: Redundant PMAC

<p>S T E P #</p>	<p>This procedure configures the redundant PMAC on the new VM for VM re-shuffling scenarios. Check off (√) each step as it is completed. Boxes have been provided for this purpose under each step number. If this procedure fails, contact My Oracle Support (MOS) and ask for assistance.</p>	
<p>1. <input type="checkbox"/></p>	<p>Redundant PMAC TVOE Host: Login</p>	<p>Establish an SSH session to the redundant PMAC's TVOE host and login as admusr.</p>
<p>2. <input type="checkbox"/></p>	<p>Redundant PMAC TVOE Host: Verify PMAC location</p>	<p>Verify the location of the redundant PMAC VM using virsh.</p> <pre style="border: 1px solid black; padding: 5px;">\$ sudo /usr/bin/virsh list Id Name State ----- 2 Redundant-PM&C running</pre>
<p>3. <input type="checkbox"/></p>	<p>Redundant PMAC TVOE Host: Remove existing PMAC guest</p>	<p>If an error was made, use this command to delete the PMAC guest and re-deploy the guest.</p> <pre style="border: 1px solid black; padding: 5px;">\$ sudo guestMgr -remove <PMAC_Name></pre>



Procedure 126. Move/Re-Shuffle: Redundant PMAC

4. <input type="checkbox"/>	New Redundant PMAC TVOE Host: Deploy redundant PMAC on new TVOE host	Once the TVOE host for the redundant PMAC location has been identified, execute section 3.11 Deploy Redundant PMAC (Optional) to deploy the redundant PMAC.
--------------------------------	---	---

Procedure 127. Post Moving/Re-Shuffling Health Check

S T E P #	<p>This procedure verifies system status and logs all alarms after moving/re-shuffling. Check off (✓) each step as it is completed. Boxes have been provided for this purpose under each step number. If this procedure fails, contact My Oracle Support (MOS) and ask for assistance.</p>	
1. <input type="checkbox"/>	<p>NOAM VIP GUI: Login</p>	<p>1. Establish a GUI session on the NOAM server by using the VIP IP address of the NOAM server. Open the web browser and enter a URL of:</p> <div style="border: 1px solid black; padding: 5px; margin: 10px 0;"> <p>https://<Primary_NOAM_VIP_IP_Address></p> </div> <p>2. Login as the guiadmin user.</p> <div style="text-align: center; margin: 20px 0;">  <p>The screenshot shows the Oracle System Login interface. At the top is the Oracle logo in red. Below it is the text 'Oracle System Login' and the date 'Mon Jul 11 13:59:37 2016 EDT'. A central box contains a 'Log In' form with fields for 'Username:' and 'Password:', a 'Change password' checkbox, and a 'Log In' button. Below the form, it says 'Welcome to the Oracle System Login.' and 'This application is designed to work with most modern HTML5 compliant browsers and uses both JavaScript and cookies. Please refer to the Oracle Software Web Browser Support Policy for details.' At the bottom, it states 'Unauthorized access is prohibited.' and includes copyright information: 'Oracle and Java are registered trademarks of Oracle Corporation and/or its affiliates. Other names may be trademarks of their respective owners. Copyright © 2010, 2016, Oracle and/or its affiliates. All rights reserved.'</p> </div>

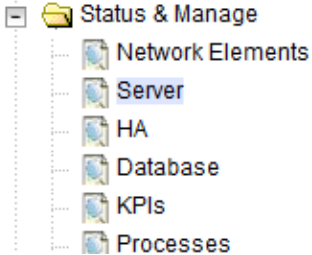
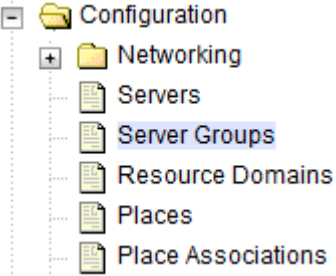
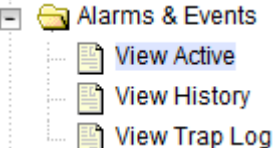
Procedure 127. Post Moving/Re-Shuffling Health Check

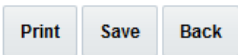
<p>2. <input type="checkbox"/></p>	<p>NOAM VIP GUI: Verify server status</p>	<p>1. Navigate to Status & Manage > Server.</p>  <p>2. Verify all server status is Normal (Norm) for Alarm (Alm), Database (DB), Replication Status, and Processes (Proc).</p> <table border="1" data-bbox="505 636 1409 787"> <thead> <tr> <th>Appl State</th> <th>Alm</th> <th>DB</th> <th>Reporting Status</th> <th>Proc</th> </tr> </thead> <tbody> <tr> <td>Enabled</td> <td>Norm</td> <td>Norm</td> <td>Norm</td> <td>Norm</td> </tr> <tr> <td>Enabled</td> <td>Norm</td> <td>Norm</td> <td>Norm</td> <td>Norm</td> </tr> <tr> <td>Enabled</td> <td>Norm</td> <td>Norm</td> <td>Norm</td> <td>Norm</td> </tr> <tr> <td>Enabled</td> <td>Norm</td> <td>Norm</td> <td>Norm</td> <td>Norm</td> </tr> </tbody> </table>	Appl State	Alm	DB	Reporting Status	Proc	Enabled	Norm	Norm	Norm	Norm	Enabled	Norm	Norm	Norm	Norm	Enabled	Norm	Norm	Norm	Norm	Enabled	Norm	Norm	Norm	Norm
Appl State	Alm	DB	Reporting Status	Proc																							
Enabled	Norm	Norm	Norm	Norm																							
Enabled	Norm	Norm	Norm	Norm																							
Enabled	Norm	Norm	Norm	Norm																							
Enabled	Norm	Norm	Norm	Norm																							
<p>3. <input type="checkbox"/></p>	<p>NOAM VIP GUI: Verify server configuration</p>	<p>1. Navigate to Configuration > Server Groups.</p>  <p>2. Verify the configuration data is correct for your network.</p>																									
<p>4. <input type="checkbox"/></p>	<p>NOAM VIP GUI: Log current alarms</p>	<p>1. Navigate to Alarms & Events > View Active.</p>  <p>2. Click Report.</p>  <p>3. Save or Print this report, keep copies for future reference.</p>  <p>4. Compare this alarm report with those gathered in Procedure 115 Perform Health Check.</p>																									
<p>5. <input type="checkbox"/></p>	<p>SOAM VIP GUI: Repeat</p>	<p>Repeat this procedure the SOAM.</p>																									

Procedure 128. Post Move/Re-Shuffle Backups

S T E P #	<p>This procedure backs up all necessary items after a move/re-shuffle scenario. Check off (√) each step as it is completed. Boxes have been provided for this purpose under each step number. If this procedure fails, contact My Oracle Support (MOS) and ask for assistance.</p>	
1. <input type="checkbox"/>	Backup TVOE	Back up all TVOE host configurations by executing section 3.17.6 Back Up TVOE Configuration.
2. <input type="checkbox"/>	Backup PMAC	Back up the PMAC application by executing section 3.17.7 Back Up PMAC Application.
3. <input type="checkbox"/>	Backup NOAM/SOAM databases	Back up the NOAM and SOAM databases by executing sections 3.17.8 Back Up NOAM Database and 3.17.9 Back Up SOAM Database. Note: Database backup on SDS SOAMs is not required.

Appendix Q. Non-HA Lab Node Instructions (Oracle X5-2/Netra X5-2/X6-2/X7-2/HP DL380 Gen 9 (10Gbps) Non-HA Lab Node Only)

Appendix Q.1 Non-HA Lab Node Pre-IPM Procedures

Procedure 129. RAID10 Logical Volume Creation Spanning Multiple HDDs (Oracle X5-2/Netra X5-2)

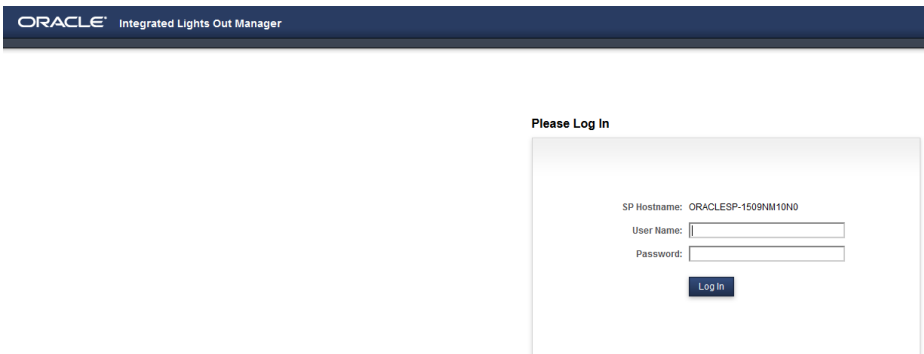
S T E P #	<p>This procedure creates an HD RAID10 volume by combining multiple HDD on Oracle X5-2/Netra X5-2. Prerequisites:</p> <ul style="list-style-type: none"> Multiple HDD must be installed and configured on the target RMS. TVOE ISO USB must be inserted into USB socket. <p>Check off (√) each step as it is completed. Boxes have been provided for this purpose under each step number. If this procedure fails, contact My Oracle Support (MOS) and ask for assistance.</p>	
1. <input type="checkbox"/>	<p>Oracle X5-2/Netra X5-2: Login</p>	<p>Log into the Oracle rack mount server ILOM.</p> 

Procedure 129. RAID10 Logical Volume Creation Spanning Multiple HDDs (Oracle X5-2/Netra X5-2)

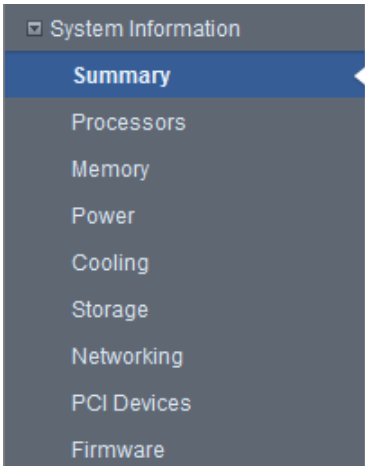
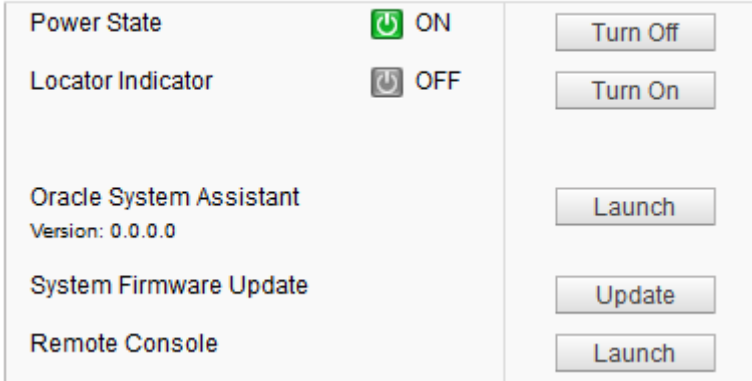
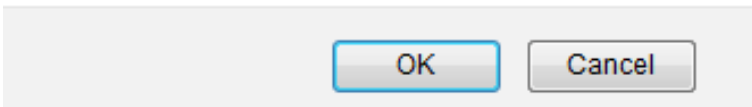
<p>2. <input type="checkbox"/></p>	<p>ILOM GUI: Turn off the power</p>	<p>1. Navigate to System Information > Summary.</p>  <p>2. From the Actions window, click Turn Off for Power State.</p>  <p>3. Click OK to confirm</p> <p>The host power will be set to off. Click OK to continue.</p> 
------------------------------------	--	---

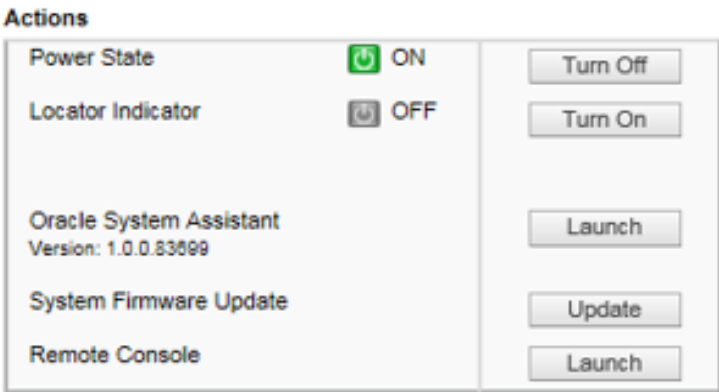
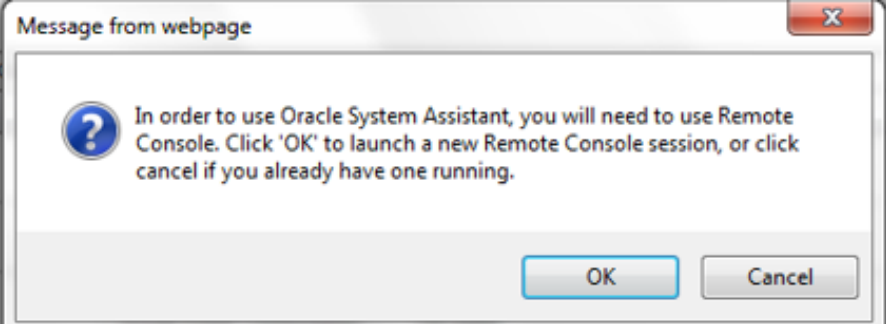
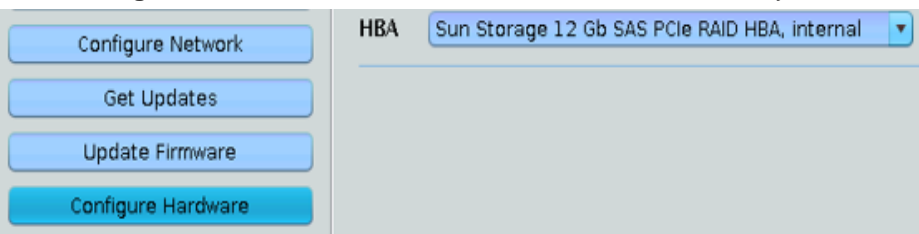

Procedure 129. RAID10 Logical Volume Creation Spanning Multiple HDDs (Oracle X5-2/Netra X5-2)

<p>3. <input type="checkbox"/></p>	<p>ILOM GUI: Launch Oracle system assistant and accept license agreement</p>	<p>1. Click Launch next to Oracle System Assistant to launch a remote console.</p>  <p>2. Click OK and wait for Oracle System Assistant to open.</p>  <p>3. Click Accept to accept the license agreement.</p>
<p>4. <input type="checkbox"/></p>	<p>ILOM GUI: Configure hardware and select HBA</p>	<p>Click Configure Hardware and select the HBA. There should only be one.</p> 

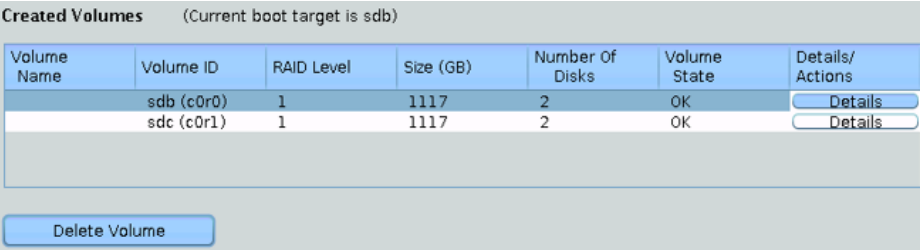
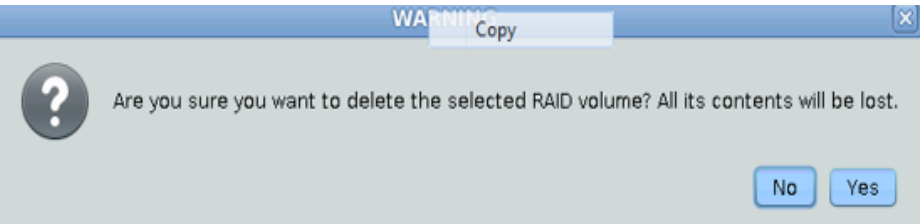
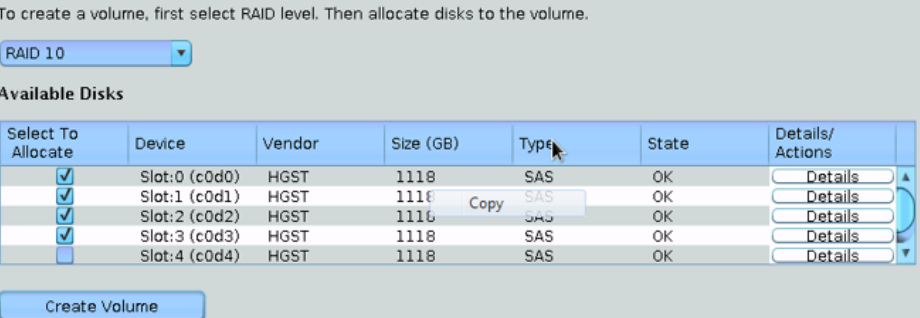
Procedure 129. RAID10 Logical Volume Creation Spanning Multiple HDDs (Oracle X5-2/Netra X5-2)

<p>5. <input type="checkbox"/></p>	<p>ILOM GUI: Delete the existing volume, if it exists</p>	<ol style="list-style-type: none"> 1. Look under Created Volumes. If there is a volume created that does not match the configuration you want, then complete this step. 2. Click Delete Volume.  <ol style="list-style-type: none"> 3. Click Yes to confirm.  <ol style="list-style-type: none"> 4. Delete all the volumes.
<p>6. <input type="checkbox"/></p>	<p>ILOM GUI: Select RAID Level and disks</p>	<ol style="list-style-type: none"> 1. Click Select RAID Level and select RAID 10. 2. Under Available Disks, select each disk to add to the logical volume you want to create. 

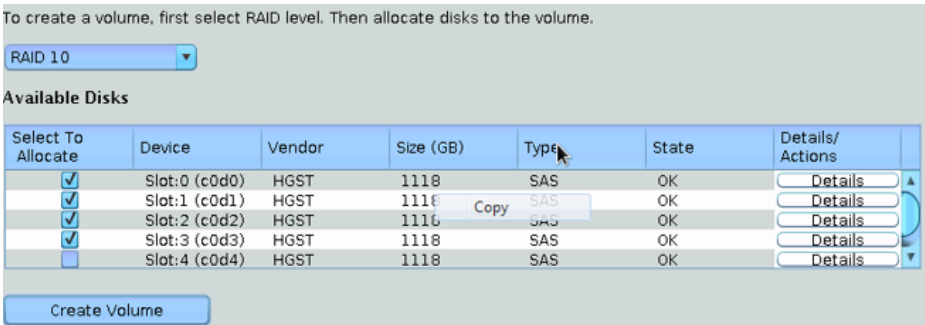
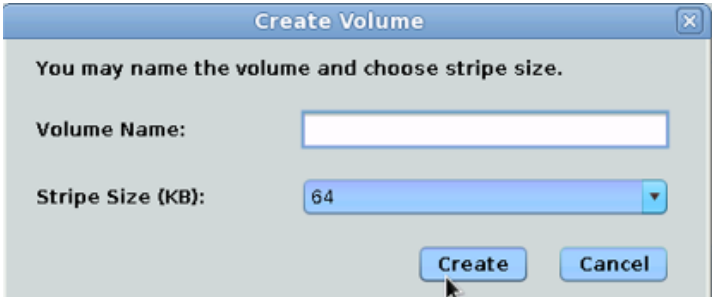
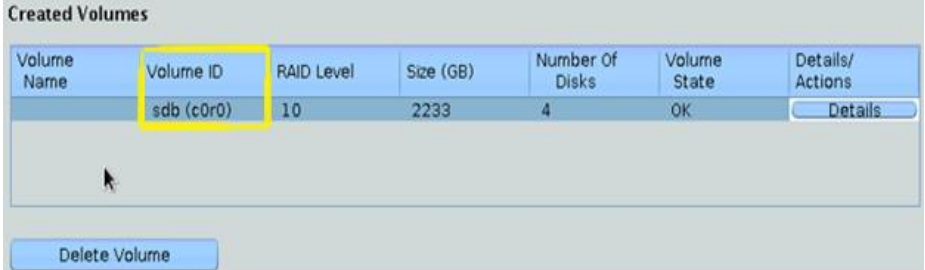
Procedure 129. RAID10 Logical Volume Creation Spanning Multiple HDDs (Oracle X5-2/Netra X5-2)

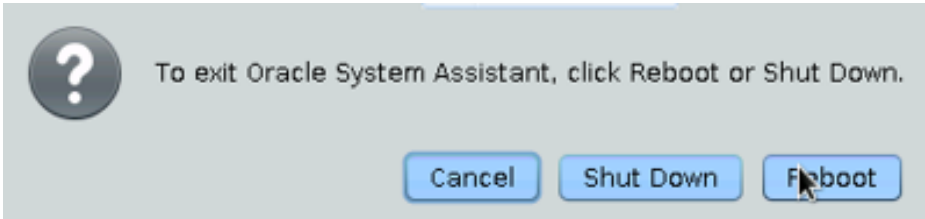
<p>7.</p> <p><input type="checkbox"/></p>	<p>ILOM GUI: Create a volume</p>	<p>1. Click Create Volume.</p>  <p>2. Click Create to confirm creation. No name is needed.</p>  <p>3. Under Created Volumes, note the Volume ID and save this information for later. For example, in this case, the Volume ID is sdb.</p> 
<p>8.</p> <p><input type="checkbox"/></p>	<p>ILOM GUI: Exit OSA screen UI and Reboot</p>	<p>1. Click Exit in the OSA GUI.</p>  <p>2. Click Reboot on the warning screen.</p>  <p>Note: Ignore the warning messages related to primary OS and storage not being available.</p>

Procedure 130. RAID10 Logical Volume Creation Spanning Multiple HDDs (Oracle X6-2)

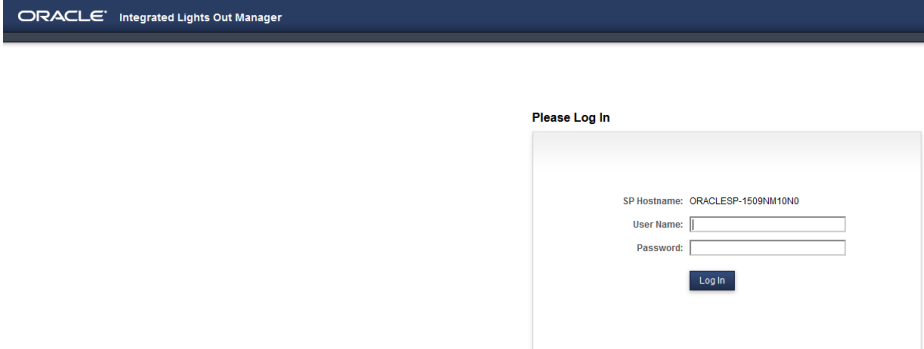
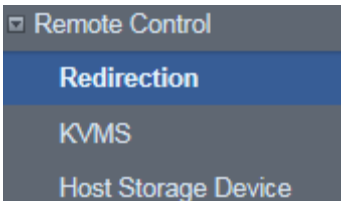
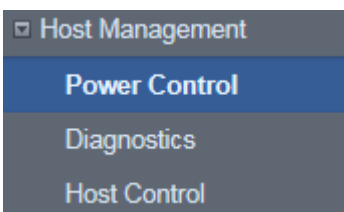
<p>S T E P #</p>	<p>This procedure creates an HD RAID10 volume by combining multiple HDD on Oracle X6-2.</p> <p>Prerequisites:</p> <ul style="list-style-type: none"> • Multiple HDD must be installed and configured on the target RMS. • TVOE ISO USB must be inserted into USB socket. <p>Check off (✓) each step as it is completed. Boxes have been provided for this purpose under each step number.</p> <p>If this procedure fails, contact My Oracle Support (MOS) and ask for assistance.</p>	
<p>1. <input type="checkbox"/></p>	<p>Oracle X6-2: Login</p>	<p>Log into the Oracle rack mount server ILOM.</p>  <p>The screenshot shows the Oracle Integrated Lights Out Manager (ILOM) login interface. At the top, it says 'ORACLE Integrated Lights Out Manager'. Below that, there is a 'Please Log In' section with a form. The form includes the SP Hostname 'ORACLESP-1509NM10ND', a 'User Name' field, a 'Password' field, and a 'Log In' button.</p>
<p>2. <input type="checkbox"/></p>	<p>ILOM GUI: Launch remote console</p>	<p>1. Navigate to Remote Control > Redirection.</p>  <p>The screenshot shows the ILOM GUI 'Remote Control' menu. The 'Redirection' option is highlighted in blue. Other options visible are 'KVMS' and 'Host Storage Device'.</p> <p>2. Click Launch Remote Console.</p>
<p>3. <input type="checkbox"/></p>	<p>ILOM GUI: Power cycle server</p>	<p>1. Navigate to Host Management > Power Control.</p>  <p>The screenshot shows the ILOM GUI 'Host Management' menu. The 'Power Control' option is highlighted in blue. Other options visible are 'Diagnostics' and 'Host Control'.</p> <p>2. Select Power Cycle and Save.</p>

Procedure 130. RAID10 Logical Volume Creation Spanning Multiple HDDs (Oracle X6-2)

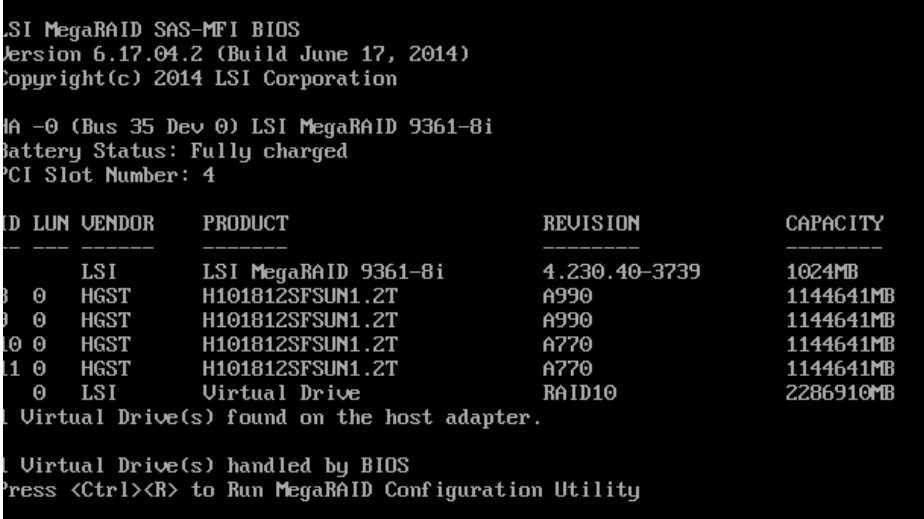
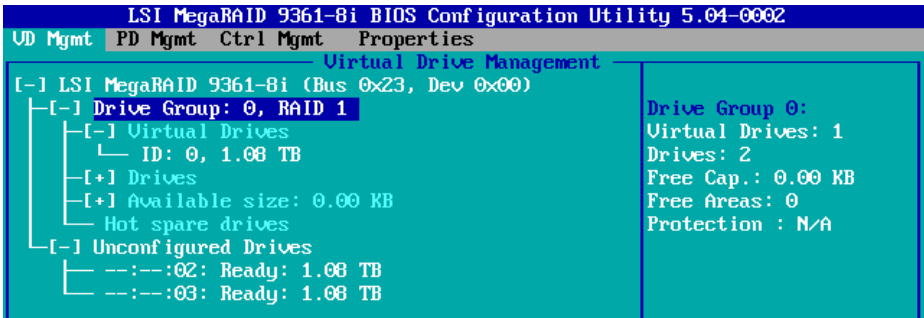
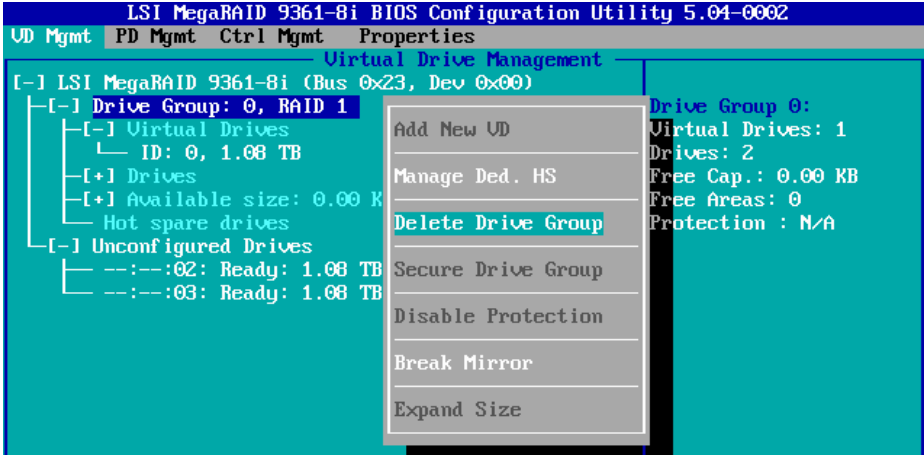
<p>4. <input type="checkbox"/></p>	<p>ILOM GUI: Launch RAID BIOS configuration utility</p>	<p>Press Ctrl+R during the boot process to launch the BIOS Configuration Utility. The LSI MegaRAID BIOS Configuration Utility displays.</p>  <p>LSI MegaRAID SAS-MFI BIOS Version 6.17.04.2 (Build June 17, 2014) Copyright(c) 2014 LSI Corporation</p> <p>RA -0 (Bus 35 Dev 0) LSI MegaRAID 9361-8i Battery Status: Fully charged PCI Slot Number: 4</p> <table border="1"> <thead> <tr> <th>ID</th> <th>LUN</th> <th>VENDOR</th> <th>PRODUCT</th> <th>REVISION</th> <th>CAPACITY</th> </tr> </thead> <tbody> <tr> <td></td> <td></td> <td>LSI</td> <td>LSI MegaRAID 9361-8i</td> <td>4.230.40-3739</td> <td>1024MB</td> </tr> <tr> <td>0</td> <td>0</td> <td>HGST</td> <td>H101812SFSUN1.2T</td> <td>A990</td> <td>1144641MB</td> </tr> <tr> <td>0</td> <td>0</td> <td>HGST</td> <td>H101812SFSUN1.2T</td> <td>A990</td> <td>1144641MB</td> </tr> <tr> <td>0</td> <td>0</td> <td>HGST</td> <td>H101812SFSUN1.2T</td> <td>A770</td> <td>1144641MB</td> </tr> <tr> <td>1</td> <td>0</td> <td>HGST</td> <td>H101812SFSUN1.2T</td> <td>A770</td> <td>1144641MB</td> </tr> <tr> <td></td> <td>0</td> <td>LSI</td> <td>Virtual Drive</td> <td>RAID10</td> <td>2286910MB</td> </tr> </tbody> </table> <p>Virtual Drive(s) found on the host adapter. Virtual Drive(s) handled by BIOS Press <Ctrl><R> to Run MegaRAID Configuration Utility</p>	ID	LUN	VENDOR	PRODUCT	REVISION	CAPACITY			LSI	LSI MegaRAID 9361-8i	4.230.40-3739	1024MB	0	0	HGST	H101812SFSUN1.2T	A990	1144641MB	0	0	HGST	H101812SFSUN1.2T	A990	1144641MB	0	0	HGST	H101812SFSUN1.2T	A770	1144641MB	1	0	HGST	H101812SFSUN1.2T	A770	1144641MB		0	LSI	Virtual Drive	RAID10	2286910MB
ID	LUN	VENDOR	PRODUCT	REVISION	CAPACITY																																							
		LSI	LSI MegaRAID 9361-8i	4.230.40-3739	1024MB																																							
0	0	HGST	H101812SFSUN1.2T	A990	1144641MB																																							
0	0	HGST	H101812SFSUN1.2T	A990	1144641MB																																							
0	0	HGST	H101812SFSUN1.2T	A770	1144641MB																																							
1	0	HGST	H101812SFSUN1.2T	A770	1144641MB																																							
	0	LSI	Virtual Drive	RAID10	2286910MB																																							
<p>5. <input type="checkbox"/></p>	<p>ILOM GUI: Delete the existing drive group, if it exists</p>	<ol style="list-style-type: none"> Look under Drive Group. If there is a volume created that does not match the configuration you want, then complete this step.  <p>LSI MegaRAID 9361-8i BIOS Configuration Utility 5.04-0002 UD Mgmt PD Mgmt Ctrl Mgmt Properties Virtual Drive Management [-] LSI MegaRAID 9361-8i (Bus 0x23, Dev 0x00) [-] Drive Group: 0, RAID 1 [-] Virtual Drives ID: 0, 1.08 TB [+] Drives Available size: 0.00 KB Hot spare drives [-] Unconfigured Drives --:--:02: Ready: 1.08 TB --:--:03: Ready: 1.08 TB</p> <p>Drive Group 0: Virtual Drives: 1 Drives: 2 Free Cap.: 0.00 KB Free Areas: 0 Protection : N/A</p> <ol style="list-style-type: none"> Press F2. Select Delete Drive Group.  <p>LSI MegaRAID 9361-8i BIOS Configuration Utility 5.04-0002 UD Mgmt PD Mgmt Ctrl Mgmt Properties Virtual Drive Management [-] LSI MegaRAID 9361-8i (Bus 0x23, Dev 0x00) [-] Drive Group: 0, RAID 1 [-] Virtual Drives ID: 0, 1.08 TB [+] Drives Available size: 0.00 KB Hot spare drives [-] Unconfigured Drives --:--:02: Ready: 1.08 TB --:--:03: Ready: 1.08 TB</p> <p>Drive Group 0: Virtual Drives: 1 Drives: 2 Free Cap.: 0.00 KB Free Areas: 0 Protection : N/A</p> <p>Context Menu: Add New UD Manage Ded. HS Delete Drive Group Secure Drive Group Disable Protection Break Mirror Expand Size</p> <ol style="list-style-type: none"> Click Yes to confirm. 																																										

Procedure 130. RAID10 Logical Volume Creation Spanning Multiple HDDs (Oracle X6-2)

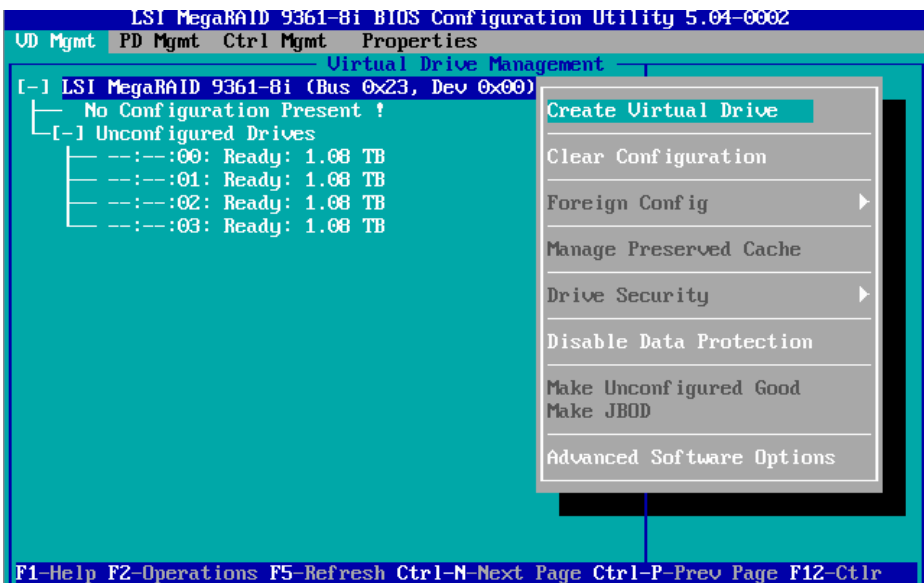
<p>6. <input type="checkbox"/> ILOM GUI: Create virtual drive</p>	<p>1. Select the MegaRAID item and press F2.</p>  <p>The screenshot shows the LSI MegaRAID BIOS Configuration Utility interface. At the top, it reads 'LSI MegaRAID 9361-Bi BIOS Configuration Utility 5.04-0002'. Below this are tabs for 'UD Mgmt', 'PD Mgmt', 'Ctrl Mgmt', and 'Properties'. The main menu is titled 'Virtual Drive Management'. Underneath, it shows '[-] LSI MegaRAID 9361-Bi (Bus 0x23, Dev 0x00)' and 'No Configuration Present !'. A sub-menu '[-] Unconfigured Drives' is expanded, listing four drives: '---:---:00: Ready: 1.08 TB', '---:---:01: Ready: 1.08 TB', '---:---:02: Ready: 1.08 TB', and '---:---:03: Ready: 1.08 TB'. A context menu is open over the 'Unconfigured Drives' section, with 'Create Virtual Drive' highlighted in blue. Other options in the menu include 'Clear Configuration', 'Foreign Config', 'Manage Preserved Cache', 'Drive Security', 'Disable Data Protection', 'Make Unconfigured Good', 'Make JBOD', and 'Advanced Software Options'. At the bottom of the screen, a status bar shows 'F1-Help F2-Operations F5-Refresh Ctrl-N-Next Page Ctrl-P-Prev Page F12-Ctrl'.</p> <p>2. Select Create Virtual Drive.</p>
--	---

Procedure 130. RAID10 Logical Volume Creation Spanning Multiple HDDs (Oracle X6-2)

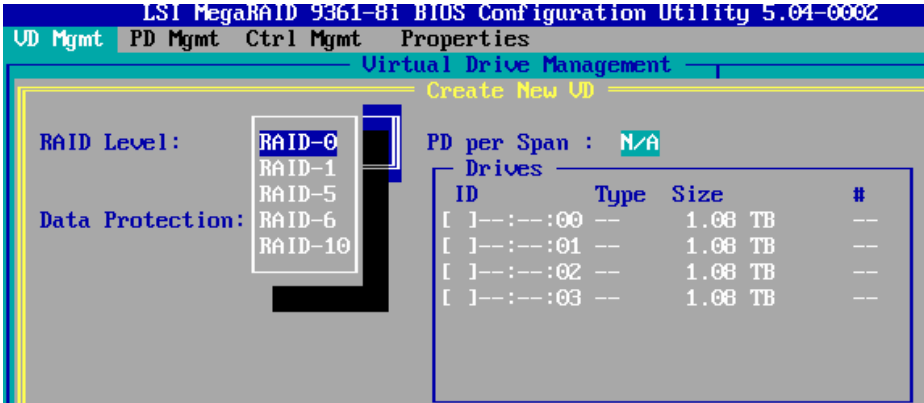
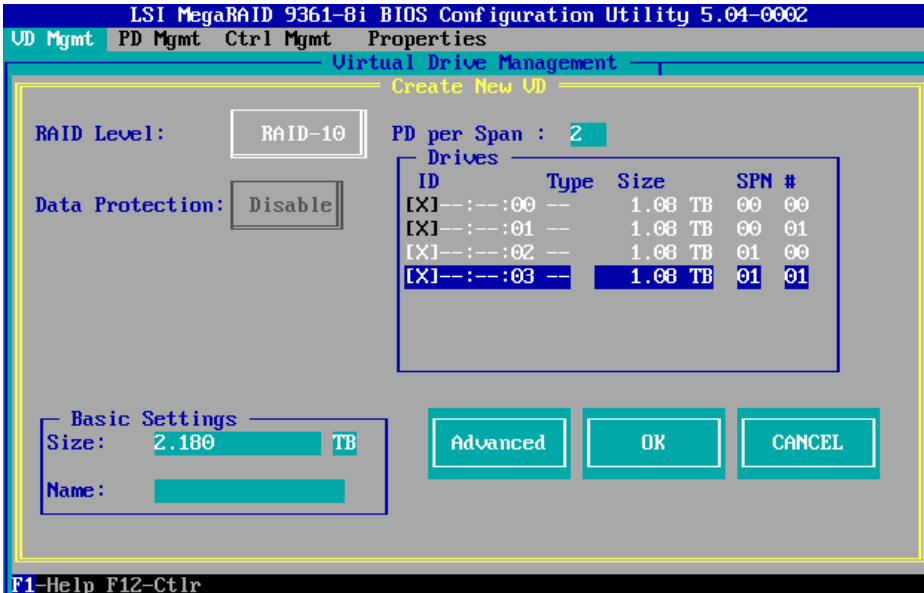
<p>7. ILOM GUI: Select RAID level and assign drives</p>	<p>1. Select RAID-10 as the Raid Level.</p>  <p>The screenshot shows the 'Virtual Drive Management' screen. The 'RAID Level:' field has a dropdown menu open with options: RAID-0, RAID-1, RAID-5, RAID-6, and RAID-10. 'RAID-10' is selected. The 'Data Protection:' field is set to 'RAID-6'. The 'PD per Span' is 'N/A'. A table of drives is shown below:</p> <table border="1"> <thead> <tr> <th>ID</th> <th>Type</th> <th>Size</th> <th>#</th> </tr> </thead> <tbody> <tr> <td>[]--:--:00</td> <td>--</td> <td>1.08 TB</td> <td>--</td> </tr> <tr> <td>[]--:--:01</td> <td>--</td> <td>1.08 TB</td> <td>--</td> </tr> <tr> <td>[]--:--:02</td> <td>--</td> <td>1.08 TB</td> <td>--</td> </tr> <tr> <td>[]--:--:03</td> <td>--</td> <td>1.08 TB</td> <td>--</td> </tr> </tbody> </table>	ID	Type	Size	#	[]--:--:00	--	1.08 TB	--	[]--:--:01	--	1.08 TB	--	[]--:--:02	--	1.08 TB	--	[]--:--:03	--	1.08 TB	--
	ID	Type	Size	#																	
[]--:--:00	--	1.08 TB	--																		
[]--:--:01	--	1.08 TB	--																		
[]--:--:02	--	1.08 TB	--																		
[]--:--:03	--	1.08 TB	--																		
<p>2. For each drive you want in the logical drive, navigate to the drive and press Enter in its ID field to display an X in the field.</p>  <p>The screenshot shows the 'Virtual Drive Management' screen with 'RAID Level:' set to 'RAID-10' and 'Data Protection:' set to 'Disable'. The 'PD per Span' is '2'. The 'Drives' table now has 'X' marks in the ID field for all four drives:</p> <table border="1"> <thead> <tr> <th>ID</th> <th>Type</th> <th>Size</th> <th>SPN #</th> </tr> </thead> <tbody> <tr> <td>[X]--:--:00</td> <td>--</td> <td>1.08 TB</td> <td>00 00</td> </tr> <tr> <td>[X]--:--:01</td> <td>--</td> <td>1.08 TB</td> <td>00 01</td> </tr> <tr> <td>[X]--:--:02</td> <td>--</td> <td>1.08 TB</td> <td>01 00</td> </tr> <tr> <td>[X]--:--:03</td> <td>--</td> <td>1.08 TB</td> <td>01 01</td> </tr> </tbody> </table> <p>At the bottom, there are 'Basic Settings' fields for 'Size' (2.180 TB) and 'Name'. There are also 'Advanced', 'OK', and 'CANCEL' buttons.</p> <p>3. Navigate to OK, press Enter, and click OK.</p>	ID	Type	Size	SPN #	[X]--:--:00	--	1.08 TB	00 00	[X]--:--:01	--	1.08 TB	00 01	[X]--:--:02	--	1.08 TB	01 00	[X]--:--:03	--	1.08 TB	01 01	
ID	Type	Size	SPN #																		
[X]--:--:00	--	1.08 TB	00 00																		
[X]--:--:01	--	1.08 TB	00 01																		
[X]--:--:02	--	1.08 TB	01 00																		
[X]--:--:03	--	1.08 TB	01 01																		

Procedure 130. RAID10 Logical Volume Creation Spanning Multiple HDDs (Oracle X6-2)

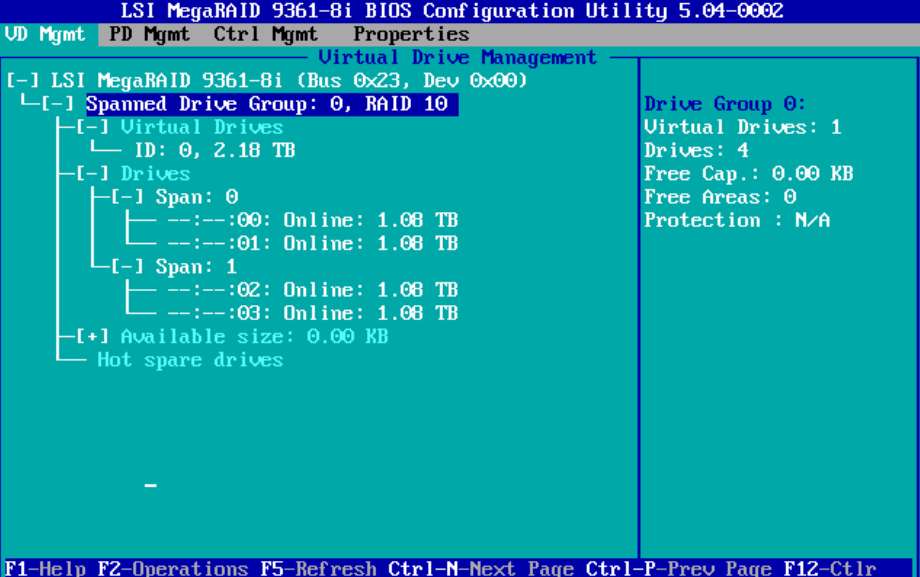
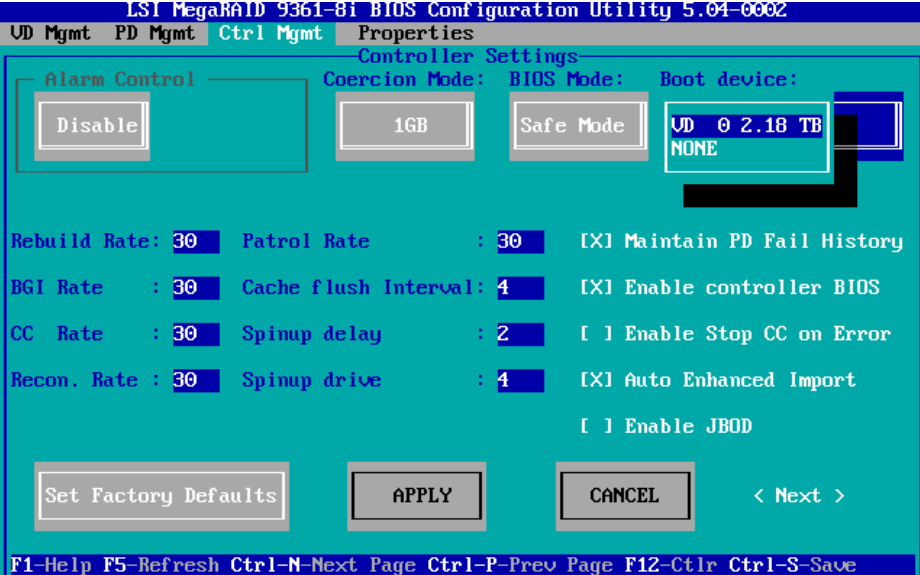
<p>8.</p> <p><input type="checkbox"/></p>	<p>ILOM GUI: Verify drive creation</p>	<p>Verify the logical drive creation by reviewing the drive groups on the main page of the BIOS Configuration Utility. Note the new drive group displayed on the page.</p> 
<p>9.</p> <p><input type="checkbox"/></p>	<p>ILOM GUI: Make drive bootable</p>	<ol style="list-style-type: none"> 1. Press Ctrl + N twice to select Ctrl Mgmt. 2. Navigate to the Boot device and press Enter. 3. Select the drive to make it bootable.  <ol style="list-style-type: none"> 4. Navigate to Apply and press Enter. 5. Press CTRL+S to save the configuration.

Procedure 130. RAID10 Logical Volume Creation Spanning Multiple HDDs (Oracle X6-2)

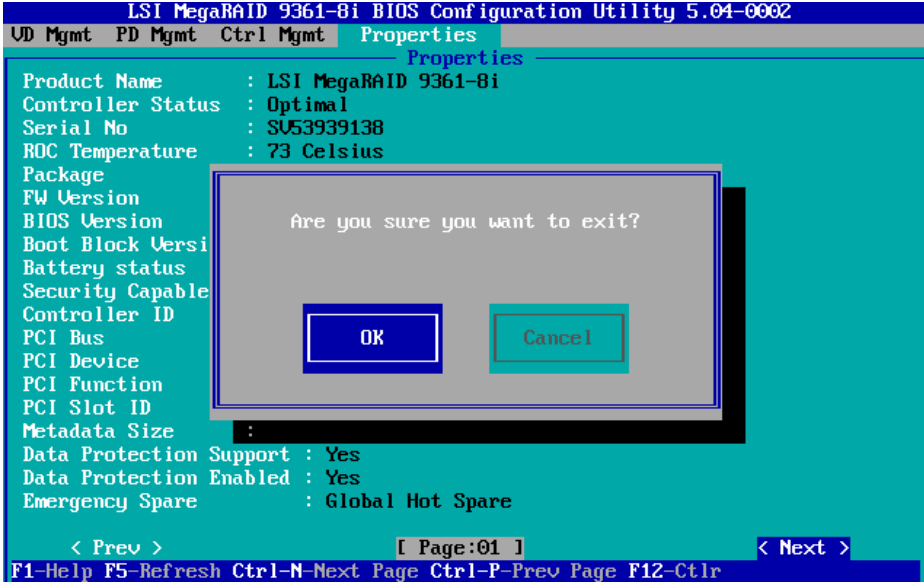
<p>10. <input type="checkbox"/></p>	<p>ILOM GUI: Exit configuration</p>	<p>Press Esc and click OK.</p> 
<p>11. <input type="checkbox"/></p>	<p>ILOM GUI: Reboot</p>	<p>Press Ctrl + Alt + Delete to reboot.</p> <p>Note: Volume ID for X6-2 is: sda. This is used when installing TVOE.</p>

Procedure 131. RAID10 Logical Volume Creation Spanning Multiple HDDs (HP DL380)

<p>S T E P #</p>	<p>This procedure creates an HD RAID10 volume by combining multiple HDD on HP DL380 Gen 9.</p> <p>Prerequisites:</p> <ul style="list-style-type: none"> Multiple HDD must be installed and configured on the target RMS. TVOE ISO USB must be inserted into USB socket. <p>Check off (√) each step as it is completed. Boxes have been provided for this purpose under each step number.</p> <p>If this procedure fails, contact My Oracle Support (MOS) and ask for assistance.</p>	
<p>1. <input type="checkbox"/></p>	<p>HP Gen 9: Log into the ILOM GUI</p>	<p>Log into the HP rack mount server ILOM.</p> 

Procedure 131. RAID10 Logical Volume Creation Spanning Multiple HDDs (HP DL380)

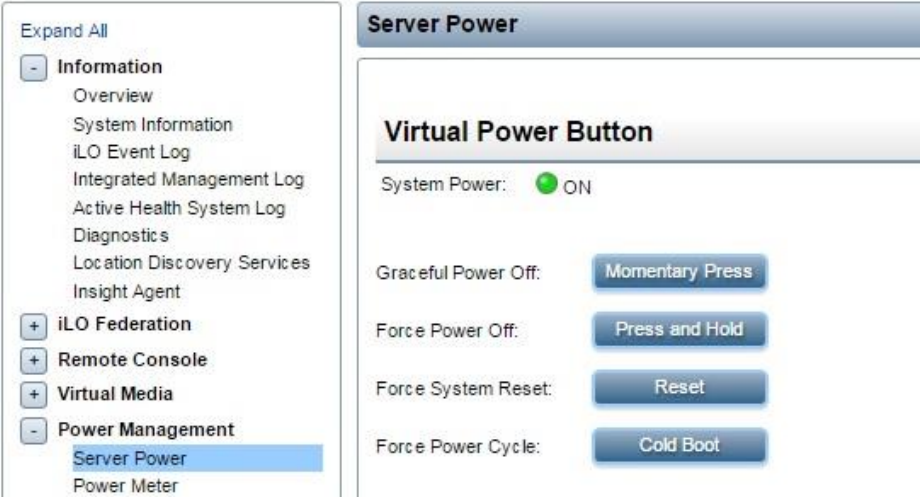
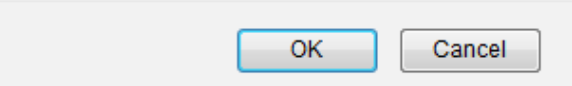
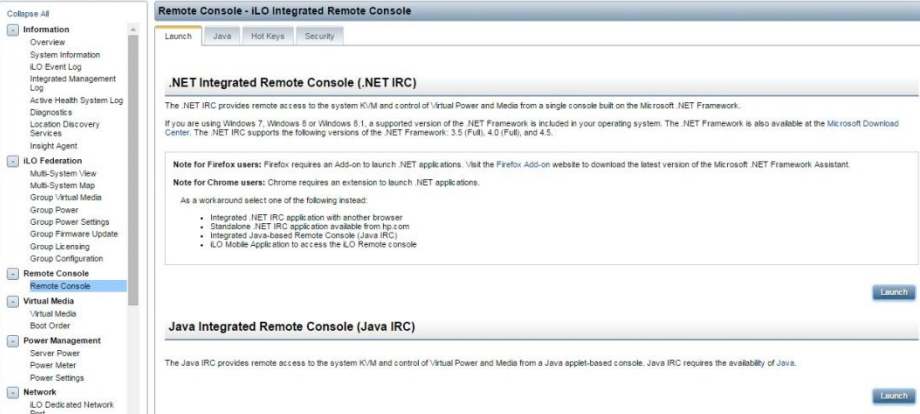
<p>2. <input type="checkbox"/></p>	<p>ILOM GUI: Turn off the power</p>	<ol style="list-style-type: none"> Navigate to Power Management > Server Power.  <ol style="list-style-type: none"> From the Virtual Power Button, click Momentary Press for graceful power off. Click OK to confirm. <p>The host power will be set to off. Click OK to continue.</p> 
<p>3. <input type="checkbox"/></p>	<p>ILOM GUI: Launch HP iLO Integrated Remote Console</p>	<ol style="list-style-type: none"> Navigate to Remote Console > Remote Console. Click Launch. 

Procedure 131. RAID10 Logical Volume Creation Spanning Multiple HDDs (HP DL380)

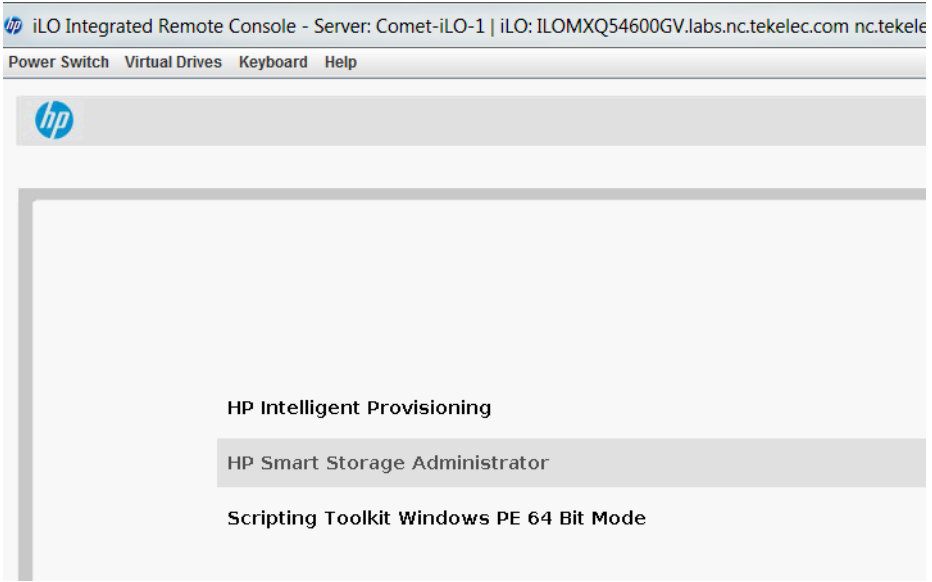
<p>4. <input type="checkbox"/></p>	<p>ILOM GUI: Access HP Intelligent Provisioning/ HP Smart Storage Administrator</p>	<p>1. Enter into the HP Intelligent Provisioning by pressing F10 during boot up.</p> <p>2. Enter HP Smart Storage Administrator.</p> 
------------------------------------	--	--

Procedure 131. RAID10 Logical Volume Creation Spanning Multiple HDDs (HP DL380)

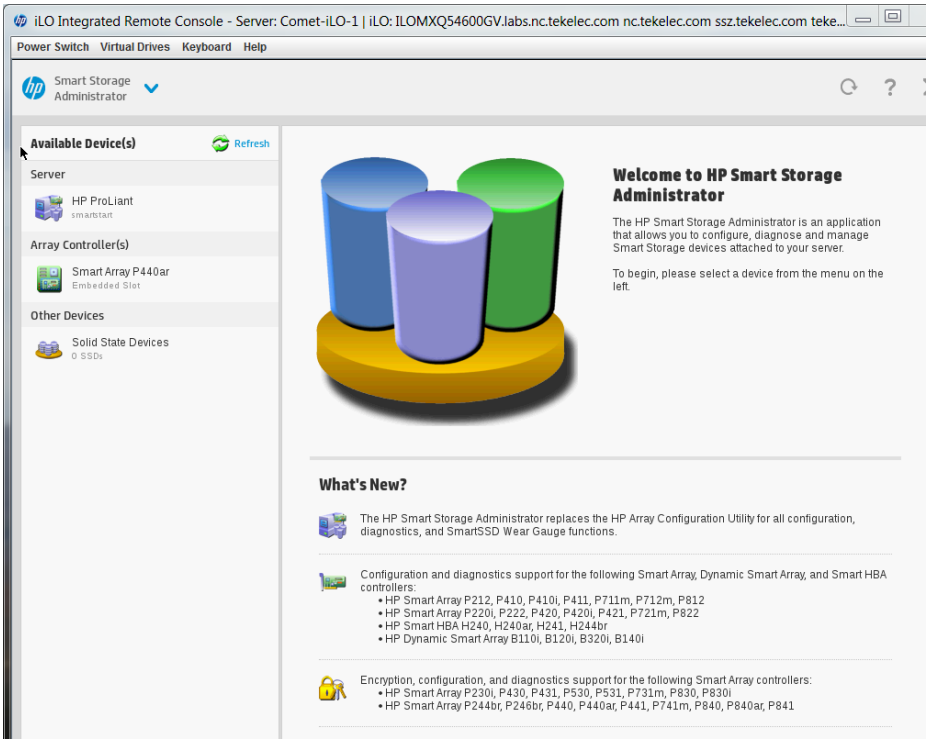
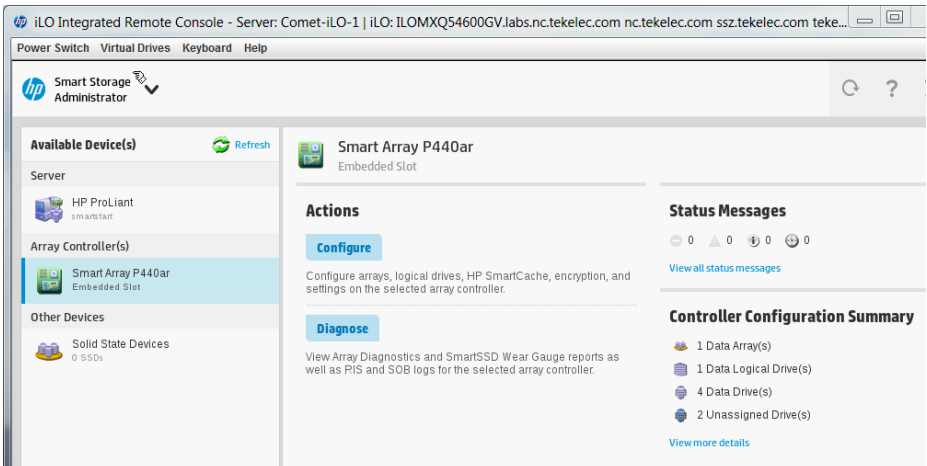
<p>5. <input type="checkbox"/></p>	<p>ILOM GUI: Configure array controllers</p>	<p>1. Click Smart Array P440ar.</p>  <p>2. Click Configure.</p> 
------------------------------------	---	---

Procedure 131. RAID10 Logical Volume Creation Spanning Multiple HDDs (HP DL380)

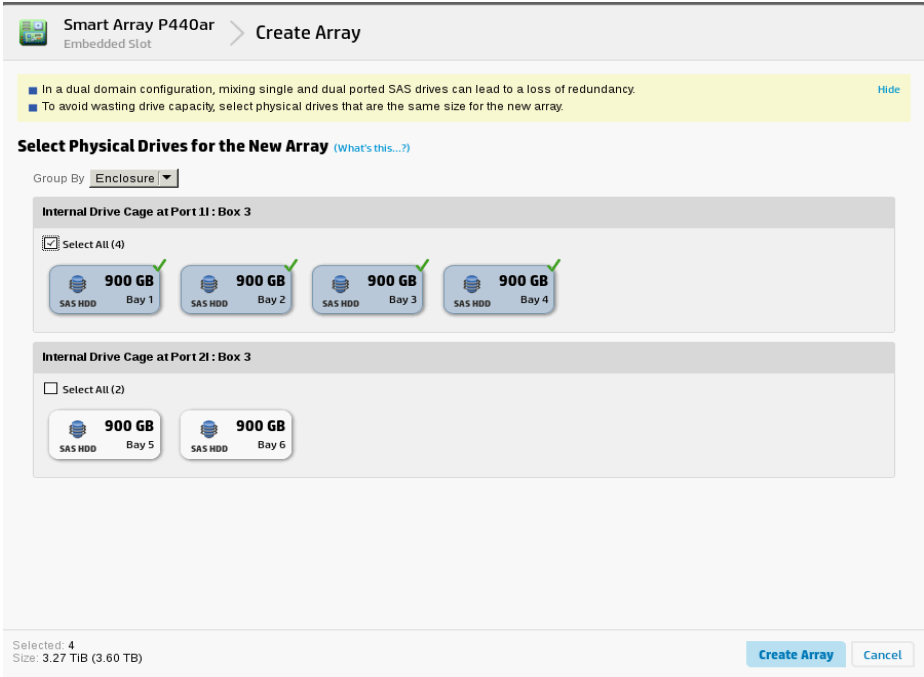
<p>6. <input type="checkbox"/></p>	<p>ILOM GUI: Create new array</p>	<p>Select 4 physical drives and click Create Array.</p>  <p>Smart Array P440ar > Create Array Embedded Slot</p> <p><input type="checkbox"/> In a dual domain configuration, mixing single and dual ported SAS drives can lead to a loss of redundancy. Hide <input type="checkbox"/> To avoid wasting drive capacity, select physical drives that are the same size for the new array.</p> <p>Select Physical Drives for the New Array (What's this...?)</p> <p>Group By Enclosure</p> <p>Internal Drive Cage at Port 11 : Box 3</p> <p><input checked="" type="checkbox"/> Select All (4)</p> <p>SAS HDD 900 GB Bay 1 SAS HDD 900 GB Bay 2 SAS HDD 900 GB Bay 3 SAS HDD 900 GB Bay 4</p> <p>Internal Drive Cage at Port 21 : Box 3</p> <p><input type="checkbox"/> Select All (2)</p> <p>SAS HDD 900 GB Bay 5 SAS HDD 900 GB Bay 6</p> <p>Selected: 4 Size: 3.27 TiB (3.60 TB)</p> <p>Create Array Cancel</p>
------------------------------------	--	---

Procedure 131. RAID10 Logical Volume Creation Spanning Multiple HDDs (HP DL380)

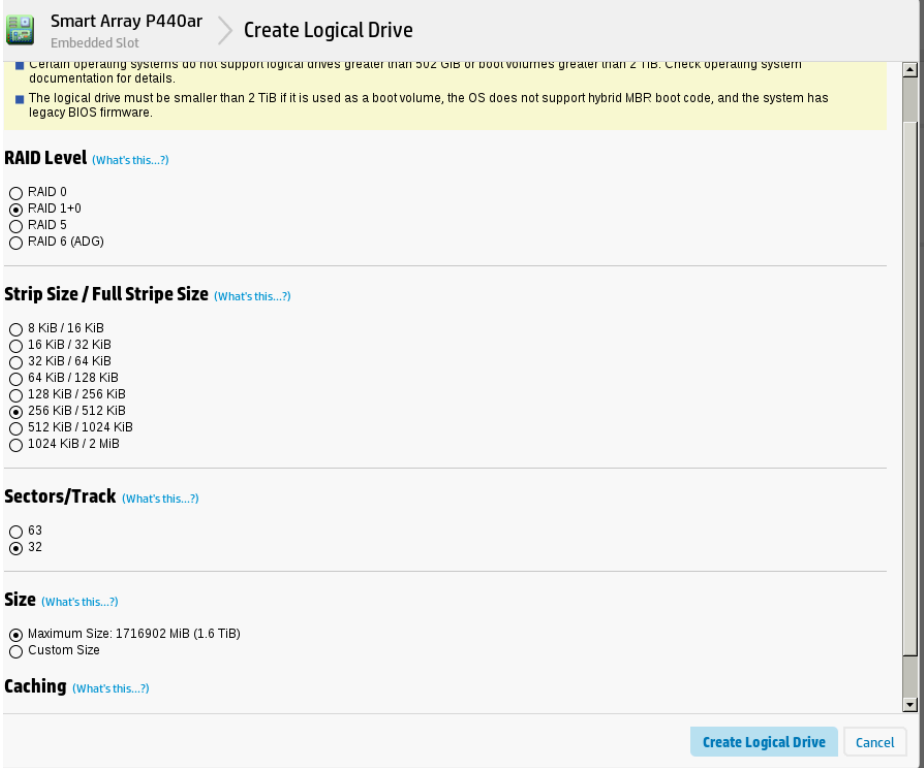
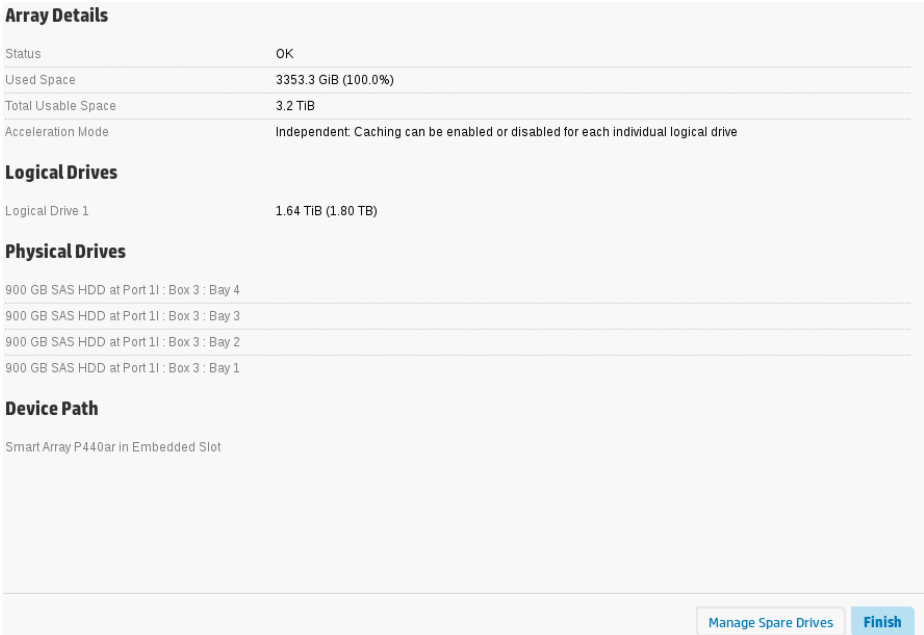
<p>7.</p> <p><input type="checkbox"/></p>	<p>ILOM GUI: RAID 10 logical volume creation</p>	<p>1. Select RAID Level as RAID1+0, leave the rest as defaults, and click Create Logical Drive.</p>  <p>2. Click Finish.</p> 
---	---	---

Procedure 131. RAID10 Logical Volume Creation Spanning Multiple HDDs (HP DL380)

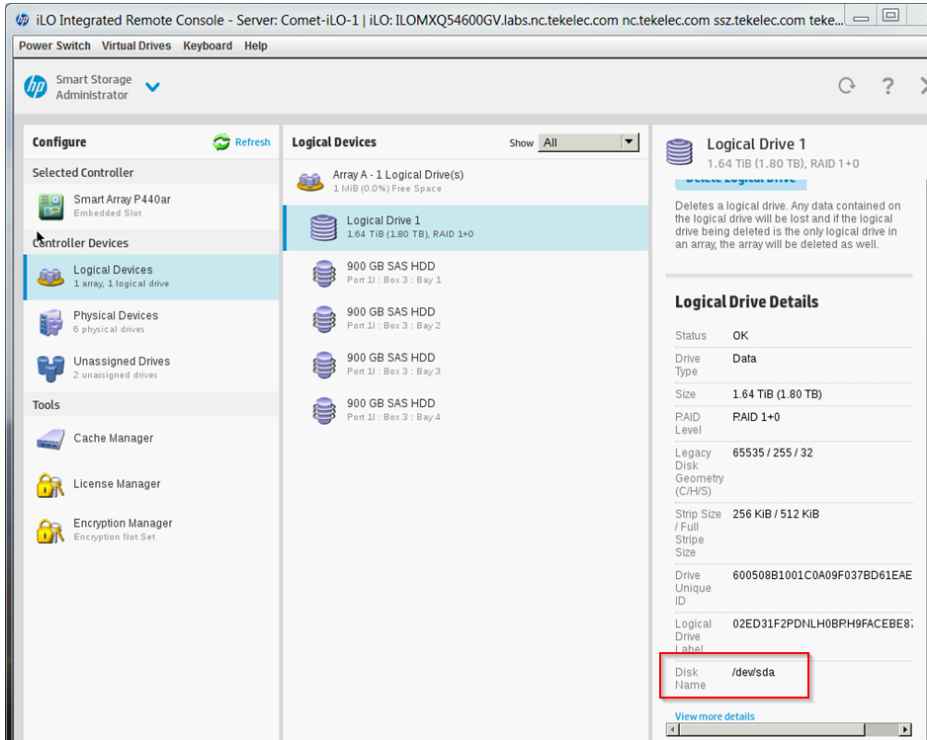
<p>8. <input type="checkbox"/></p>	<p>ILOM GUI: Restart the server</p>	<p>Restart the server by clicking the power button at the bottom right corner of the window.</p> 
<p>9. <input type="checkbox"/></p>	<p>ILOM GUI</p>	<p>Repeat step 4. to get into the Smart Storage Administrator screen.</p>
<p>10. <input type="checkbox"/></p>	<p>ILOM GUI: Select the created logical drive</p>	<ol style="list-style-type: none"> 1. Click on the Logical Devices under the Controller Devices and select Logical Drive 1. 2. Note the Disk Name. For example, /dev/sda. This is used in the next step. 

Procedure 131. RAID10 Logical Volume Creation Spanning Multiple HDDs (HP DL380)

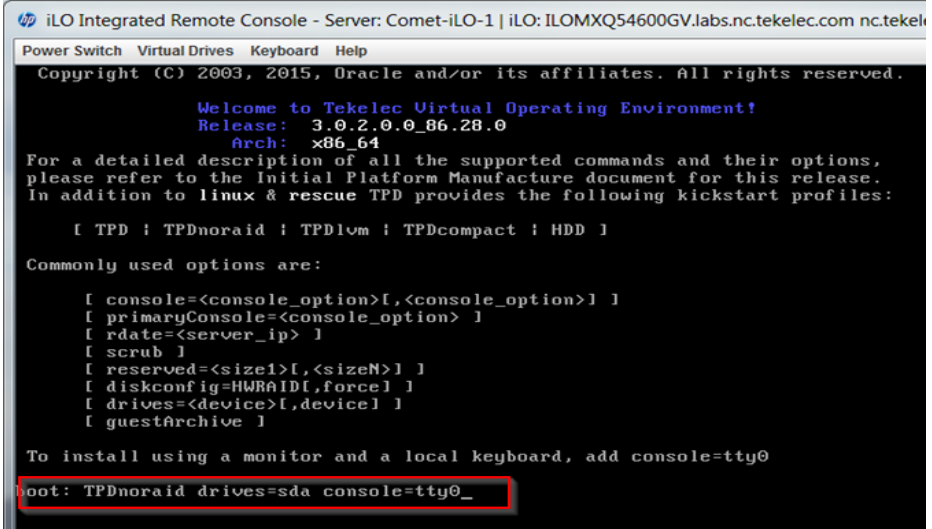
<p>11. <input type="checkbox"/></p>	<p>ILOM GUI: Reboot the server</p>	<p>1. Reboot the server by clicking the power button icon at the bottom right hand corner.</p>  <p>2. When prompted, provide correct Disk Name (noted in step 10.) and press Enter.</p> 
---	---	---

Appendix Q.2 Non-HA Lab Node PMAC Deployment

This section deploys PMAC, creates VMs, and provides CPU, RAM, and hard disk information to override the default values when importing a profile while creating a VM.

Procedure 132. PMAC Deployment: Deviation

<p>S T E P #</p>	<p>This procedure deploys PMAC on the TVOE host. Prerequisites: Completed first RMS network configuration (PMAC host). Needed Material: PMAC media on USB drive or ISO. Check off (✓) each step as it is completed. Boxes have been provided for this purpose under each step number. If this procedure fails, contact My Oracle Support (MOS) and ask for assistance.</p>	
<p>1. <input type="checkbox"/></p>	<p>PMAC TVOE iLO/iLOM: Login and start the integrated remote console</p>	<p>Log into iLO/iLOM and follow Appendix D TVOE iLO/iLOM GUI Access to access the iLO/iLOM GUI.</p> <div style="border: 1px solid gray; padding: 5px; width: fit-content;"> <p><code>https://<management_server_iLO_ip></code></p> </div>

Procedure 132. PMAC Deployment: Deviation

<p>2. <input type="checkbox"/></p>	<p>TVOE iLO/iLOM: Mount the PMAC media to the TVOE server</p>	<p>Use one of the following two options to mount the PMAC media:</p> <p>Option 1:</p> <ol style="list-style-type: none"> 1. If using a USB media, insert the PMAC USB into a USB port and execute this command to mount the ISO. <pre style="border: 1px solid black; padding: 5px;">\$ ls /media/*/*.iso /media/sddl/872-2586-101-5.7.0_57.3.0-PM&C-x86_64.iso</pre> 2. Use the output of the previous command to populate the next command. <pre style="border: 1px solid black; padding: 5px;">\$ sudo mount -o loop /media/sddl/872-2586-101-5.7.0_57.3.0-PM&C-x86_64.iso /mnt/upgrade</pre> <p>Option 2</p> <ol style="list-style-type: none"> 1. If using an ISO image, run this to mount it. <pre style="border: 1px solid black; padding: 5px;">\$ sudo mount -o loop ISO_FILENAME.iso /mnt/upgrade</pre> 2. Validate the PMAC media. <pre style="border: 1px solid black; padding: 5px;">\$ cd /mnt/upgrade/upgrade \$.validate/validate_cd Validating cdrom... UMVT Validate Utility v2.2.2, (c)Tekelec, June 2012 Validating <device or ISO> Date&Time: 2012-10-25 10:07:01 Volume ID: tklc_872-2441-106_Rev_A_50.11.0 Part Number: 872-2441-106_Rev_A Version: 50.11.0 Disc Label: PM&C Disc description: PM&C The media validation is complete, the result is: PASS CDROM is Valid</pre> <p>Note: If the media validation fails, the media is not valid and should not be used.</p>
------------------------------------	--	--

Procedure 132. PMAC Deployment: Deviation

<p>3. <input type="checkbox"/></p>	<p>TVOE iLO/iLOM: Deploy PMAC</p>	<p>1. Using the PMAC-deploy script, deploy the PMAC instance using the configuration captured during the site survey.</p> <pre style="border: 1px solid black; padding: 5px;">\$ cd /mnt/upgrade/upgrade</pre> <p>2. If deploying PMAC without the NetBackup feature, run this command:</p> <pre style="border: 1px solid black; padding: 5px;">\$ sudo ./pmac-deploy --guest=<PMAC_Name> --hostname=<PMAC_Name> --controlBridge=control --controlIP=<PMAC_Control_ip_address> --controlNM=<PMAC_Control_netmask> --managementBridge=management --managementIP=<PMAC_Management_ip_address> --managementNM=<PMAC_Management_netmask/prefix> --routeGW=<PMAC_Management_gateway_address> --ntpserver=<TVOE_Management_server_ip_address> --imageSizeGB=20 --isoimagesVolSize=20</pre> <p>If deploying PMAC with NetBackup feature, run the following command:</p> <pre style="border: 1px solid black; padding: 5px;">\$ sudo ./pmac-deploy --guest=<PMAC_Name> --hostname=<PMAC_Name> -- controlBridge=<TVOE_Control_Bridge> --controlIP=<PMAC_Control_ip_address> --controlNM=<PMAC_Control_netmask> --managementBridge=<PMAC_Management_Bridge> --managementIP=<PMAC_Management_ip_address> --managementNM=<PMAC_Management_netmask/prefix> --routeGW=<PMAC_Management_gateway_address> --ntpserver=<TVOE_Management_server_ip_address> --NetBackupVol --bridge=<TVOE_NetBackup_Bridge> --nic=NetBackup --isoimagesVolSizeGB=20</pre> <p>The PMAC deploys and boots. The management and control network displays based on the settings provided to the PMAC-deploy script.</p> <p>Note: This step takes between 5 and 10 minutes.</p>
<p>4. <input type="checkbox"/></p>	<p>TVOE iLO/iLOM: Unmount the media</p>	<p>1. The media should auto-unmount, if it does not, unmount the media.</p> <pre style="border: 1px solid black; padding: 5px;">\$ cd / \$ sudo /bin/umount /mnt/upgrade</pre> <p>2. Remove the media from the drive.</p>

Procedure 132. PMAC Deployment: Deviation

<p>5. <input type="checkbox"/></p>	<p>TVOE iLO/iLOM: SSH into the management server</p>	<ol style="list-style-type: none"> Using an SSH client such as putty, ssh to the TVOE host as admusr. Login using virsh and wait until you see the login prompt. <pre style="border: 1px solid black; padding: 5px;">\$ sudo /usr/bin/virsh list Id Name State ----- 2 PM&C running</pre> <pre style="border: 1px solid black; padding: 5px;">\$ sudo /usr/bin/virsh console <PM&C></pre> <p>[Output Removed]</p> <pre>Starting ntdMgr: [OK] Starting atd: [OK] 'TPD Up' notification(s) already sent: [OK] upstart: Starting tpdProvd... upstart: tpdProvd started. CentOS release 6.2 (Final) Kernel 2.6.32-220.17.1.el6prere16.0.0_80.14.0.x86_64 on an x86_64 PM&Cdev7 login:</pre>
<p>6. <input type="checkbox"/></p>	<p>Virtual PMAC: Verify the PMAC is configured correctly on first boot</p>	<ol style="list-style-type: none"> Establish an SSH session to the PMAC and login as admusr. Run this command (there should be no output). <pre style="border: 1px solid black; padding: 5px;">\$ sudo /bin/ls /usr/TKLC/plat/etc/deployment.d/</pre>
<p>7. <input type="checkbox"/></p>	<p>TVOE iLO/iLOM: Error doing verification, if error is outputted</p>	<p>If an error displays, delete the PMAC guest and re-deploy the guest again:</p> <pre style="border: 1px solid black; padding: 5px;">\$ sudo guestMgr --remove <PMAC_Name></pre>
<p>8. <input type="checkbox"/></p>	<p>Virtual PMAC: Set the PMAC time zone</p>	<p>Note: Valid time zones can be found in Appendix J List of Frequently Used Time Zones.</p> <ol style="list-style-type: none"> Run: <pre style="border: 1px solid black; padding: 5px;">\$ sudo set_pmac_tz.pl <time zone></pre> <p>Example:</p> <pre>\$ sudo set_pmac_tz.pl America/New_York</pre> Verify the time zone has been updated. <pre style="border: 1px solid black; padding: 5px;">\$ sudo date</pre>

Procedure 132. PMAC Deployment: Deviation

<p>9. <input type="checkbox"/></p>	<p>Virtual PMAC: Set SNMP</p>	<ol style="list-style-type: none"> 1. Enter the platcfg menu. <pre>\$ sudo su - platcfg</pre> 2. Navigate to Network Configuration > SNMP Configuration > NMS Configuration.  <ol style="list-style-type: none"> 3. Select Edit > Add a New NMS Server. 4. Enter all the information to complete the form about the SNMP trap destination. Refer to Appendix H SNMP Configuration for more information. 5. Click OK to finalize the configuration. 6. Click Exit. 7. Click Yes and wait until the Alarm Routing Service restarts. 8. Exit out of platcfg by selecting Exit.
<p>10. <input type="checkbox"/></p>	<p>Virtual PMAC: Reboot the server</p>	<pre>\$ sudo init 6</pre>

Appendix Q.3 Non-HA Lab Node VM Automation Profile Values

This table reflects the values needed for Non-HA lab node VM profile values.

CPU	MEMORY	VDISK
DSR NOAM		
DSR_VIRT_NOAM_CPU="2"	DSR_VIRT_NOAM_MEM="6144"	DSR_VIRT_NOAM_VDISK="71680"
DSR SOAM		
DSR_VIRT_SOAM_CPU="2"	DSR_VIRT_SOAM_MEM="6144"	DSR_VIRT_SOAM_VDISK="71680"
DSR DAMP		
DSR_VIRT_DAMP_CPU="6"	DSR_VIRT_DAMP_MEM="24576"	DSR_VIRT_DAMP_VDISK="71680"
DSR SS7MP		
DSR_VIRT_SS7MP_CPU="6"	DSR_VIRT_SS7MP_MEM="24576"	DSR_VIRT_SS7MP_VDISK="71680"
DSR IPFE		
DSR_VIRT_IPFE_CPU="2"	DSR_VIRT_IPFE_MEM="16384"	DSR_VIRT_IPFE_VDISK="71680"
DSR SESSION SBR		
DSR_VIRT_SBR_SESSION_CPU="6"	DSR_VIRT_SBR_SEESION_MEM="16384"	DSR_VIRT_SBR_SESSION_VDISK="71680"

CPU	MEMORY	VDISK
DSR BINDING SBR		
DSR_VIRT_SBR_BINDING_CPU="6"	DSR_VIRT_SBR_BINDING_MEM="16384"	DSR_VIRT_SBR_BINDING_VDISK="71680"
SDS NOAM		
SDS_VIRT_NOAM_CPU="4"	SDS_VIRT_NOAM_MEM="12288"	SDS_VIRT_NOAM_VDISK="102400"
SDS SOAM		
SDS_VIRT_SOAM_CPU="2"	SDS_VIRT_SOAM_MEM="10240"	SDS_VIRT_SOAM_VDISK="71680"
SDS DP		
SDS_VIRT_DP_CPU="2"	SDS_VIRT_DP_MEM="10240"	SDS_VIRT_DP_VDISK="71680"
SDS QUERY SERVER		
SDS_VIRT_QS_CPU="2"	SDS_VIRT_QS_MEM="16384"	SDS_VIRT_QS_VDISK="71680"

Appendix Q.4 Non-HA Lab Node IDIH Procedure Deviation

Procedure 133. iDIH Installation: Deviation

S T E P #	<p>This procedure installs and configures iDIH.</p> <p>Prerequisites: TVOE has been installed and configured on the target RMS.</p> <p>Check off (✓) each step as it is completed. Boxes have been provided for this purpose under each step number.</p> <p>If this procedure fails, contact My Oracle Support (MOS) and ask for assistance.</p>	
1. <input type="checkbox"/>	<p>TVOE Host: Load application ISO</p>	<p>Note: If the IDIH ISO images have NOT yet been added to the PMAC, execute steps 1. through 4.</p> <ol style="list-style-type: none"> Add the application ISO images (Mediation, Application, and OracleGuest) to the PMAC using one of these methods: <ul style="list-style-type: none"> Insert the CD containing the IDIH media into the removable media drive. Attach the USB device containing the ISO to a USB port. Copy the Application ISO file to the PMAC server into the /var/TKLC/smac/image/isoimages/home/smacftpusr/ directory as pmacftpusr user: <pre>cd to the directory where your ISO image is located on the TVOE Host (not on the PMAC server).</pre> Using sftp, connect to the PMAC server. <pre>\$ sftp pmacftpusr@<pmac_management_network_ip> \$ put <image>.iso</pre> After the image transfer is 100% complete, close the connection. <pre>\$ quit</pre>

Procedure 133. iDIH Installation: Deviation

<p>2. <input type="checkbox"/></p>	<p>PMAC GUI: Login</p>	<p>1. Open the web browser and navigate to the PMAC GUI:</p> <div style="border: 1px solid black; padding: 5px; width: fit-content; margin: 5px 0;"> <p>http://<PMAC_network_IP></p> </div> <p>2. Login as the guiadmin user:</p> <div style="text-align: center; margin: 20px 0;">  <p>The screenshot shows the Oracle System Login page. At the top is the Oracle logo. Below it is the text 'Oracle System Login' and the date 'Tue Jun 7 13:49:06 2016 EDT'. A central box titled 'Log In' contains the instruction 'Enter your username and password to log in'. There are input fields for 'Username:' and 'Password:', a 'Change password' checkbox, and a 'Log In' button. At the bottom, there is a disclaimer: 'Unauthorized access is prohibited. This Oracle system requires the use of Microsoft Internet Explorer 9.0, 10.0, or 11.0 with support for JavaScript and cookies. Oracle and Java are registered trademarks of Oracle Corporation and/or its affiliates. Other names may be trademarks of their respective owners. Copyright © 2010, 2016, Oracle and/or its affiliates. All rights reserved.'</p> </div>
------------------------------------	-------------------------------	---

Procedure 133. iDIH Installation: Deviation

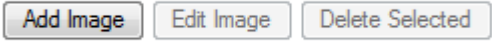
<p>4. <input type="checkbox"/></p>	<p>PMAC GUI: Add an application image</p>	<ol style="list-style-type: none"> 1. Navigate to Software > Manage Software Images. 2. Click Add Image and select the image from the list of options. <div style="text-align: center;">  </div> <p>If the image was supplied on a CD or a USB drive, it displays as a virtual device (device://...). These devices are assigned in numerical order as CD and USB images become available on the management server. The first virtual device is reserved for internal use by TVOE and PMAC; therefore, the iso image of interest is normally on the second device, device://dev/sr1. If one or more CD or USB-based images were already on the management server before you started this procedure, select a correspondingly higher device number.</p> <p>If the ISO image was transferred to PMAC using sftp (step 1.), it displays in the list as a local file in /var/TKLC/...</p> <ol style="list-style-type: none"> 3. Select the appropriate path and click Add New Image. 4. Check the progress by clicking the Task Monitoring link. 5. Observe the green bar indicating success. Once the file has transferred, remove the IDIH media from the optical drive of the management server.
<p>5. <input type="checkbox"/></p>	<p>PMAC: Establish terminal session</p>	<p>Establish an SSH session to the PMAC and login as admusr.</p>
<p>6. <input type="checkbox"/></p>	<p>PMAC: Copy the vedsr_idih.xml.template XML file to the PMAC guest-dropin directory</p>	<pre>\$ sudo cp /usr/TKLC/pmac/html/TPD/mediation-7.1.0.0.0_x.x.x.x/vedsr_idih.xml.template /var/TKLC/smac/guest-dropin \$ cd /var/TKLC/smac/guest-dropin/ \$ mv vedsr_idih.xml.template <idih_fdc_file_name>.xml</pre>

Procedure 133. iDIH Installation: Deviation

<p>7. <input type="checkbox"/></p>	<p>PMAC: Configure the fdc.cfg file</p>	<p>Configure the <idih_fdc_file_name>.xml template file. See Appendix M Configure IDIH Fast Deployment for a breakdown of the parameters and a sample XML configuration file.</p> <p>Update the software versions, hostnames, bond interfaces, network addresses, and network VLAN information for the TVOE host and IDIH guests that you are installing. Also modify CPU, RAM, and virtual disk information as shown:</p> <table border="1" data-bbox="500 447 1421 1680"> <thead> <tr> <th data-bbox="500 447 633 552">IDIH</th> <th data-bbox="633 447 933 552">Profile Parameters (No. of CPU, RAM, Virtual Disk)</th> <th data-bbox="933 447 1421 552">XML Stanzas to Modify</th> </tr> </thead> <tbody> <tr> <td data-bbox="500 552 633 863">IDIH-Mediation</td> <td data-bbox="633 552 933 863"> No. of CPUs: 2 Memory (MBs): 8192 MB Virtual Disks: 65536 MB </td> <td data-bbox="933 552 1421 863"> <pre> <cpus>2</cpus> <memory>8192</memory> <vdisk> <hostvolname>MED.img</hostvolname> <hostpool>vgguests</hostpool> <size>65536</size> <primary>yes</primary> <guestdevname>PRIMARY</guestdevname> </vdisk> </pre> </td> </tr> <tr> <td data-bbox="500 863 633 1161">IDIH-Application</td> <td data-bbox="633 863 933 1161"> No. of CPUs: 2 Memory (MBs): 8192 MB Virtual Disks: 65536 MB </td> <td data-bbox="933 863 1421 1161"> <pre> <cpus>2</cpus> <memory>8192</memory> <vdisk> <hostvolname>APP.img</hostvolname> <hostpool>vgguests</hostpool> <size>65536</size> <primary>yes</primary> <guestdevname>PRIMARY</guestdevname> </vdisk> </pre> </td> </tr> <tr> <td data-bbox="500 1161 633 1680">IDIH-Database</td> <td data-bbox="633 1161 933 1680"> No. of CPUs: 4 Memory (MBs): 8192 MB Virtual Disks: 166926 MB (102400 MB for ORA_SDB and 65536 MB for ORA) </td> <td data-bbox="933 1161 1421 1680"> <pre> <cpus>2</cpus> <memory>8192</memory> <vdisk> <hostvolname>ORA.img</hostvolname> <hostpool>vgguests</hostpool> <size>65536</size> <primary>yes</primary> <guestdevname>PRIMARY</guestdevname> </vdisk> <vdisk> <hostvolname>ORA_sdb.img</hostvolname> <hostpool>vgguests</hostpool> <size>102400</size> <primary>yes</primary> <guestdevname>PRIMARY</guestdevname> </vdisk> </pre> </td> </tr> </tbody> </table>	IDIH	Profile Parameters (No. of CPU, RAM, Virtual Disk)	XML Stanzas to Modify	IDIH-Mediation	No. of CPUs: 2 Memory (MBs): 8192 MB Virtual Disks: 65536 MB	<pre> <cpus>2</cpus> <memory>8192</memory> <vdisk> <hostvolname>MED.img</hostvolname> <hostpool>vgguests</hostpool> <size>65536</size> <primary>yes</primary> <guestdevname>PRIMARY</guestdevname> </vdisk> </pre>	IDIH-Application	No. of CPUs: 2 Memory (MBs): 8192 MB Virtual Disks: 65536 MB	<pre> <cpus>2</cpus> <memory>8192</memory> <vdisk> <hostvolname>APP.img</hostvolname> <hostpool>vgguests</hostpool> <size>65536</size> <primary>yes</primary> <guestdevname>PRIMARY</guestdevname> </vdisk> </pre>	IDIH-Database	No. of CPUs: 4 Memory (MBs): 8192 MB Virtual Disks: 166926 MB (102400 MB for ORA_SDB and 65536 MB for ORA)	<pre> <cpus>2</cpus> <memory>8192</memory> <vdisk> <hostvolname>ORA.img</hostvolname> <hostpool>vgguests</hostpool> <size>65536</size> <primary>yes</primary> <guestdevname>PRIMARY</guestdevname> </vdisk> <vdisk> <hostvolname>ORA_sdb.img</hostvolname> <hostpool>vgguests</hostpool> <size>102400</size> <primary>yes</primary> <guestdevname>PRIMARY</guestdevname> </vdisk> </pre>
IDIH	Profile Parameters (No. of CPU, RAM, Virtual Disk)	XML Stanzas to Modify												
IDIH-Mediation	No. of CPUs: 2 Memory (MBs): 8192 MB Virtual Disks: 65536 MB	<pre> <cpus>2</cpus> <memory>8192</memory> <vdisk> <hostvolname>MED.img</hostvolname> <hostpool>vgguests</hostpool> <size>65536</size> <primary>yes</primary> <guestdevname>PRIMARY</guestdevname> </vdisk> </pre>												
IDIH-Application	No. of CPUs: 2 Memory (MBs): 8192 MB Virtual Disks: 65536 MB	<pre> <cpus>2</cpus> <memory>8192</memory> <vdisk> <hostvolname>APP.img</hostvolname> <hostpool>vgguests</hostpool> <size>65536</size> <primary>yes</primary> <guestdevname>PRIMARY</guestdevname> </vdisk> </pre>												
IDIH-Database	No. of CPUs: 4 Memory (MBs): 8192 MB Virtual Disks: 166926 MB (102400 MB for ORA_SDB and 65536 MB for ORA)	<pre> <cpus>2</cpus> <memory>8192</memory> <vdisk> <hostvolname>ORA.img</hostvolname> <hostpool>vgguests</hostpool> <size>65536</size> <primary>yes</primary> <guestdevname>PRIMARY</guestdevname> </vdisk> <vdisk> <hostvolname>ORA_sdb.img</hostvolname> <hostpool>vgguests</hostpool> <size>102400</size> <primary>yes</primary> <guestdevname>PRIMARY</guestdevname> </vdisk> </pre>												

Procedure 133. iDIH Installation: Deviation

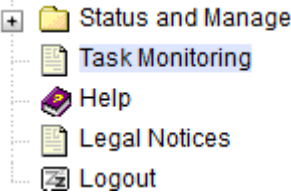
<p>8. <input type="checkbox"/></p>	<p>PMAC: Run the fdconfig</p>	<pre>\$ screen \$ sudo fdconfig config --file=<idih_fdc_file_name>.xml</pre> <p>Example:</p> <pre>\$ sudo fdconfig config --file=tvoe-ferbrms4_01-22-15.xml</pre> <p>Note: This is a long duration command (45-90 minutes). If the screen command was run before executing fdconfig, perform a screen -dr to resume the screen session in the event of a terminal timeout, etc.</p>
<p>9. <input type="checkbox"/></p>	<p>PMAC GUI: Monitor the configuration</p>	<ol style="list-style-type: none"> 1. If not already done so, establish a GUI session on the PMAC server. 2. Navigate to Task Monitoring.  3. Monitor the IDIH configuration to completion.

Appendix R. VM Automation Profile Values

Server profile values defined in VM automation .cfg file.

Note: It is recommended that there should be no deviation in the values defined in the VM automation .cfg file from the values defined in Table 6.

Table 6. VM Automation Profile Values

CPU	MEMORY	VDISK
DSR NOAM		
DSR_VIRT_NOAM_CPU="4"	DSR_VIRT_NOAM_MEM="6144"	DSR_VIRT_NOAM_VDISK="71680"
DSR SOAM		
DSR_VIRT_SOAM_CPU="4"	DSR_VIRT_SOAM_MEM="6144"	DSR_VIRT_SOAM_VDISK="71680"
DSR DAMP		
DSR_VIRT_DAMP_CPU="12"	DSR_VIRT_DAMP_MEM="24576"	DSR_VIRT_DAMP_VDISK="71680"
DSR SS7MP		
DSR_VIRT_SS7MP_CPU="12"	DSR_VIRT_SS7MP_MEM="24576"	DSR_VIRT_SS7MP_VDISK="71680"
DSR IPFE		
DSR_VIRT_IPFE_CPU="4"	DSR_VIRT_IPFE_MEM="16384"	DSR_VIRT_IPFE_VDISK="71680"
DSR SESSION SBR		
DSR_VIRT_SBR_SESSION_CPU="14"	DSR_VIRT_SBR_SEESION_MEM="32768"	DSR_VIRT_SBR_SESSION_VDISK="71680"
DSR BINDING SBR		
DSR_VIRT_SBR_BINDING_CPU="12"	DSR_VIRT_SBR_BINDING_MEM="25600"	DSR_VIRT_SBR_BINDING_VDISK="71680"

CPU	MEMORY	VDISK
SDS NOAM		
SDS_VIRT_NOAM_CPU="4"	SDS_VIRT_NOAM_MEM="16384"	SDS_VIRT_NOAM_VDISK="204800"
SDS SOAM		
SDS_VIRT_SOAM_CPU="4"	SDS_VIRT_SOAM_MEM="10240"	SDS_VIRT_SOAM_VDISK="71680"
SDS DP		
SDS_VIRT_DP_CPU="6"	SDS_VIRT_DP_MEM="10240"	SDS_VIRT_DP_VDISK="71680"
SDS QUERY SERVER		
SDS_VIRT_QS_CPU="4"	SDS_VIRT_QS_MEM="16384"	SDS_VIRT_QS_VDISK="102400"

Appendix S. VM Placement in HP DL380 Gen 8/Gen 9 (Onboard 1Gbps NICs) and CPU Pinning in HP DL380 Gen 9 (Onboard 1Gbps NICs)

HP DL380 Gen 8 and HP DL380 Gen 9 rack mount server solutions should place VMs in one of these deployment scenarios:

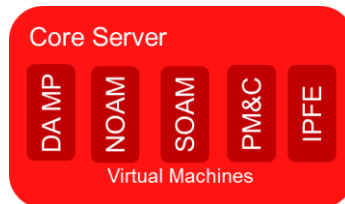

Figure 4. HP DL380 Gen 8/Gen 9 (1Gbps) VM Placement Non-HA LAB Deployment

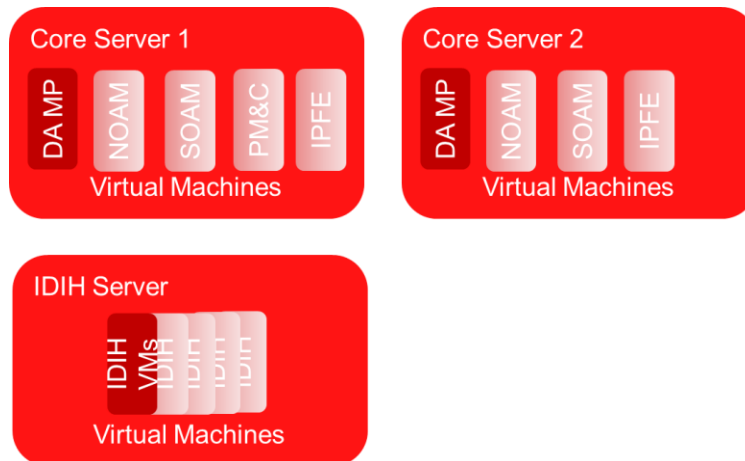

Figure 5. HP DL380 Gen 8/Gen 9 (1Gbps) VM Placement Small Production DSR with IDIH

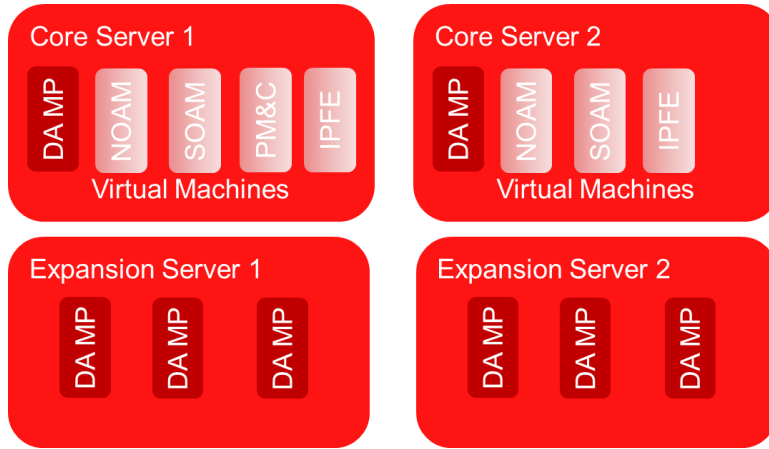

Figure 6. HP DL380 Gen 8/Gen 9 (1Gbps) VM Placement Scaled DSR

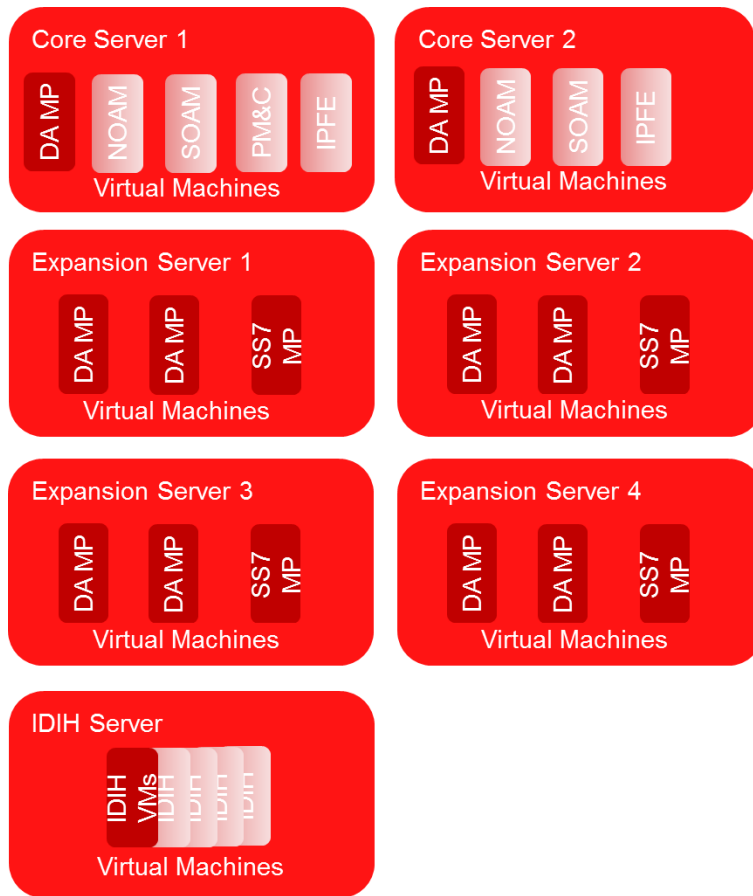

Figure 7. HP DL380 Gen 9 (1Gbps) VM Placement Scaled DSR with SS7 MPs and IDIH

Table 7. HP DL380 Gen 9 (1Gbps) CPU Pinning without SS7MPs

Core Server 1		Core Server 2		Expansion Server 1		Expansion Server 2		IDIH Server	
Numa 0	Numa 1	Numa 0	Numa 1	Numa 0	Numa 1	Numa 0	Numa 1	Numa 0	Numa 1
NOAM	DAMP	NOAM	DAMP	DAMP	DAMP	DAMP	DAMP	IDIH-A	
SOAM		SOAM			DAMP		DAMP	IDIH-M	
IPFE		IPFE						IDIH-DB	
PMAC									

Table 8. HP DL380 Gen 9 (1Gbps) CPU Pinning with SS7MPs

Core Server 1		Core Server 2		Expansion Server 1		Expansion Server 2		Expansion Server 3		Expansion Server 4		IDIH Server	
Numa 0	Numa 1	Numa 0	Numa 1	Numa 0	Numa 1	Numa 0	Numa 1	Numa 0	Numa 1	Numa 0	Numa 1	Numa 0	Numa 1
NOAM	DAMP	NOAM	DAMP	DAMP	DAMP	DAMP	DAMP	DAMP	DAMP	DAMP	DAMP	IDIH-A	
SOAM		SOAM			SS7MP		SS7MP		SS7MP		SS7MP	IDIH-M	
IPFE		IPFE										IDIH-DB	
PMAC													



Refer 3.13 CPU Pinning to perform the pinning.

Appendix T. Restore SNMP Configuration to SNMPv3 (Optional)

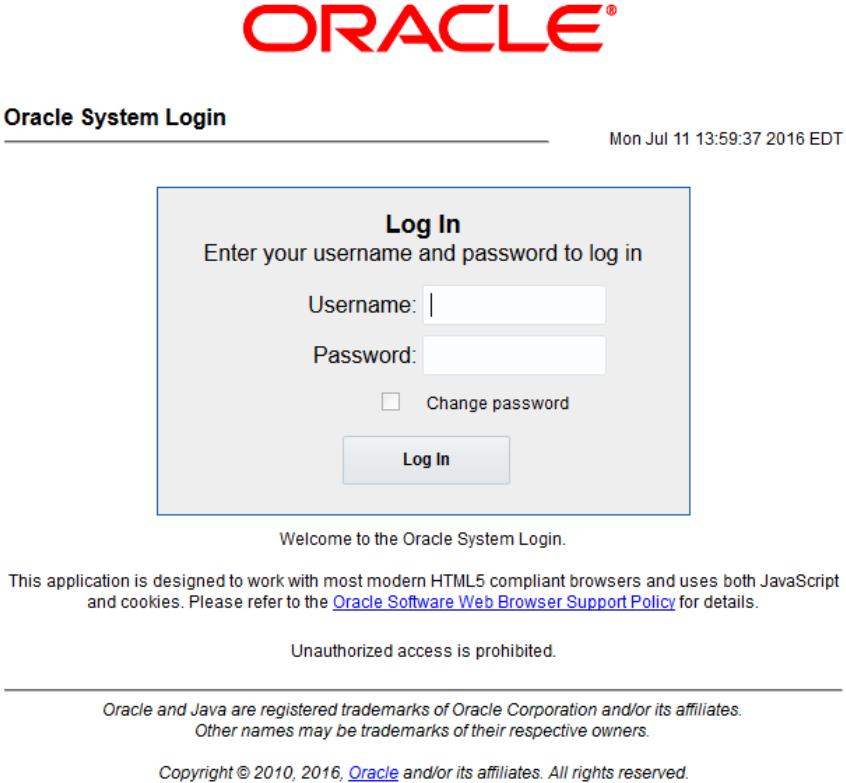
Procedure 134. Restore SNMP Configuration to SNMP v3

S T E P #	<p>This procedure restores SNMP configuration to SNMPv3 for forwarding of SNMP traps from each individual server.</p> <p>Note: If SNMP is configured with SNMPv2c and SNMPv3 as enabled versions as a workaround step (Procedure 39 Configure SNMP Trap Receivers, steps 4. through 8.) and the SNMPv3 is required to be configured.</p> <p>Check off (√) each step as it is completed. Boxes have been provided for this purpose under each step number.</p> <p>If this procedure fails, contact My Oracle Support (MOS) and ask for assistance.</p>	
<p>1. <input type="checkbox"/></p>	<p>(Workaround) Primary NOAM VIP GUI: Login</p>	<p>Note: This workaround should be performed only if SNMP is configured with SNMPv2c and SNMPv3 as enabled versions as a workaround (Procedure 39 Configure SNMP Trap Receivers, steps 4. through 8.) and the SNMPv3 is required to be configured.</p> <ol style="list-style-type: none"> Establish a GUI session on the NOAM server by using the XMI VIP IP address. Open the web browser and enter a URL of: <div style="border: 1px solid black; padding: 5px; width: fit-content; margin: 5px 0;"> <code>https://<NOAM_XMI_VIP_IP_Address></code> </div> Login as the guiadmin user. <div style="text-align: center; margin: 20px 0;">  </div> <p style="text-align: center; font-size: small;"> Oracle and Java are registered trademarks of Oracle Corporation and/or its affiliates. Other names may be trademarks of their respective owners. Copyright © 2010, 2016, Oracle and/or its affiliates. All rights reserved. </p>

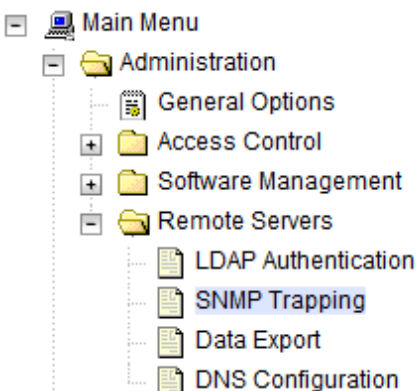
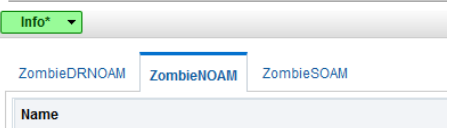
Procedure 134. Restore SNMP Configuration to SNMP v3

<p>2. <input type="checkbox"/></p>	<p>NOAM VIP GUI: Configure system-wide SNMP Trap receiver(s)</p>	<p>1. Navigate to Administration > Remote Servers > SNMP Trapping.</p>  <p>2. Select the Server Group tab for SNMP trap configuration. The server group that is configured for SNMPv2c and SNMPv3 as a workaround:</p> <p>Main Menu: Administration -> Remote Servers</p>  <p>3. Click Edit.</p>  <p>4. Update the Enabled Versions as SNMPv3:</p>  <p>5. Click OK.</p>
------------------------------------	---	--

Appendix U. My Oracle Support (MOS)**My Oracle Support**

MOS (<https://support.oracle.com>) is your initial point of contact for all product support and training needs. A representative at Customer Access Support (CAS) can assist you with MOS registration.

Call the CAS main number at **1-800-223-1711** (toll-free in the US), or call the Oracle Support hotline for your local country from the list at <http://www.oracle.com/us/support/contact/index.html>. When calling, make the selections in the sequence shown on the Support telephone menu:

1. Select **2** for **New Service Request**.
2. Select **3** for **Hardware, Networking, and Solaris Operating System Support**.
3. Select one of these options:
 - For technical issues such as creating a new Service Request (SR), select **1**.
 - For non-technical issues such as registration or assistance with MOS, select **2**.

You are connected to a live agent who can assist you with MOS registration and opening a support ticket. MOS is available 24 hours a day, 7 days a week, 365 days a year.

Emergency Response

In the event of a critical service situation, emergency response is offered by the CAS main number at 1-800-223-1711 (toll-free in the US), or by calling the Oracle Support hotline for your local country from the list at <http://www.oracle.com/us/support/contact/index.html>. The emergency response provides immediate coverage, automatic escalation, and other features to ensure that the critical situation is resolved as rapidly as possible.

A critical situation is defined as a problem with the installed equipment that severely affects service, traffic, or maintenance capabilities, and requires immediate corrective action. Critical situations affect service and/or system operation resulting in one or several of these situations:

- A total system failure that results in loss of all transaction processing capability
- Significant reduction in system capacity or traffic handling capability
- Loss of the system's ability to perform automatic system reconfiguration
- Inability to restart a processor or the system
- Corruption of system databases that requires service affecting corrective actions
- Loss of access for maintenance or recovery operations
- Loss of the system ability to provide any required critical or major trouble notification

Any other problem severely affecting service, capacity/traffic, billing, and maintenance capabilities may be defined as critical by prior discussion and agreement with Oracle.

Locate Product Documentation on the Oracle Help Center

Oracle Communications customer documentation is available on the web at the Oracle Help Center (OHC) site, <http://docs.oracle.com>. You do not have to register to access these documents. Viewing these files requires Adobe Acrobat Reader, which can be downloaded at <http://www.adobe.com>.

1. Access the Oracle Help Center site at <http://docs.oracle.com>.
2. Click **Industries**.
3. Under the **Oracle Communications** subheading, click the **Oracle Communications documentation** link. The Communications Documentation page appears. Most products covered by these documentation sets display under the headings **Network Session Delivery and Control Infrastructure** or **Platforms**.
4. Click on your Product and then the Release Number. A list of the entire documentation set for the selected product and release displays. To download a file to your location, right-click the PDF link, select **Save target as** (or similar command based on your browser), and save to a local folder.